







595.23

**Journal**  
of the  
**New York**  
**ENTOMOLOGICAL SOCIETY**

Devoted to Entomology in General

VOLUME LXXXII



Published by the Society  
New York, N. Y.

ALLEN PRESS, INC.

PRINTED  
IN  
U.S.A.

LAWRENCE, KANSAS



## INDEX OF AUTHORS

ALEXANDER, CHARLES P. New or Little-Known Crane Flies from Iran. I (Diptera: Tipulidae) .....	279
ALLEN, GEORGE E. and WILLIAM F. BUREN. Microsporidian and Fungal Diseases of <i>Solenopsis invicta</i> Buren in Brazil .....	125
BLUM, MURRAY S. Myrmecine Trail Pheromones: Specificity, Source and Significance .....	141
BROWN, F. MARTIN. Andean Larvae and Chrisalids of <i>Dione juno andicola</i> (Bates) and <i>Agraulis vanillae lucina</i> Felder and Felder .....	61
BROWN, F. MARTIN. William Couper, Taxonomist-Entomologist .....	222
BROWN, WILLIAM L., JR. A Supplement to the Revision of the Ant Genus <i>Basiceros</i> (Hymenoptera: Formicidae) .....	131
BUREN, WILLIAM F., GEORGE E. ALLEN, WILLARD H. WHITCOMB, FRANCIS E. LENNARTZ and ROGER N. WILLIAMS. Zoogeography of the Imported Fire Ants .....	113
CREIGHTON, WILLIAM S. and ROY R. SNELLING. Notes on the Behavior of Three Species of <i>Cardiocondyla</i> in the United States (Hymenoptera: Formicidae) .....	82
DELFINADO, MERCEDES D. and EDWARD W. BAKER. Terrestrial Mites of New York (Acarina: Prostigmata); I-Tarsocheylidae, Paratydeidae, and Pseudo- cheylidae .....	202
ELLIOTT, NANCY B. and FRANK E. KURCZEWSKI. Seasonal variation in <i>Tachysphex terminatus</i> (Smith) (Hymenoptera: Sphecidae, Larrinae) .....	268
EVANS, HOWARD E. Digger Wasps as Colonizers of New Habitat (Hymenoptera: Aculeata) .....	259
FORBES, JAMES. The William S. Creighton Memorial Issue .....	66
GREGG, ROBERT E. William Steel Creighton—An Appreciation .....	67
HUCKETT, H. C. The Anthomyiidae and Muscidae of the Great Smoky Mountains and Mt. Mitchell, North Carolina (Diptera) .....	150
MARAMOROSCH, KARL. Ovipositing of <i>Circulifer tenellus</i> Baker (Homoptera, Cicadellidae) .....	42
MCCLUSKEY, ELWOOD S. Generic Diversity in Phase of Rhythm in Myrmi- cine Ants .....	93
MCDONALD, F. J. D. Revision of the Genus <i>Holcostethus</i> in North America (Hemiptera: Pentatomidae) .....	245
MUYSHONDT, ALBERTO. Notes on the Life Cycle and Natural History of Butterflies of El Salvador. V. A. <i>Pyrrhogyra hypsenor</i> (Nymphalidae-Cato- nephelinae) .....	163
NEVIN, F. REESE. A New Genus and Two New Species of <i>Achipteriidae</i> from New York State (Acari: Cryptostigmata: Oribatei) .....	177
PECHUMAN, L. L. Two New Tabanidae from Southeastern United States (Diptera) .....	183

ROLSTON, L. H. A New Genus of Pentatominae from South America, Distinguished by the Position of its Spiracles (Hemiptera: Pentatomidae)	57
ROLSTON, L. H. and R. KUMAR. Two New Genera and Two New Species of Acanthosomatidae (Hemiptera) from South America, with a Key to the Genera of the Western Hemisphere	271
ROZEN, JEROME G., JR. The Biology of Two African Melittid Bees (Hymenoptera, Anthophoridae)	230
SCHMITT, JOHN B. The Distribution of Brood Ten of the Periodical Cicadas in New Jersey in 1970	189
SEIFERT, RICHARD P. The Sphingidae of Turrialba, Costa Rica	45
SLATER, JAMES A. and JANE E. HARRINGTON. <i>Tenuicoris myrmeforme</i> : A New Genus and Species of Myodochini (Hemiptera: Lygaeidae)	173
SNELLING, ROY R. Studies on California Ants. 8. A New Species of Cardiocondyla (Hymenoptera: Formicidae)	76
THOMPSON, F. CHRISTIAN. The Genus <i>Pterallastes</i> Loew (Diptera: Syrphidae)	15
VAN SICKLE, DEBRA and R. M. WESELOH. Habitat Variables That Influence the Attack by Hyperparasites of <i>Apanteles melanoscelus</i> Cocoons	2
VAURIE, PATRICIA. Synonymy in <i>Sphenophorus pertinax</i> Olivier (Coleoptera, Curculionidae, Rhynchophorinae)	14
WHEELER, GEORGE C. and JEANETTE WHEELER. Supplementary Studies on Ant Larvae: <i>Simopone</i> and <i>Turneria</i>	103
WILSON, EDWARD O. and ROBERT FAGAN. On the Estimation of Total Behavioral Repertoires in Ants	106
YOUNG, ALLEN M. Further Observations on the Natural History of <i>Philaethria dido dido</i> (Lepidoptera: Nymphalidae: Heliconiinae)	30
YOUNG, ALLEN M. Notes on the Natural History of the Rare <i>Adelpha</i> Butterfly (Lepidoptera: Nymphalidae) in Costa Rican High Country	235
<b>BOOK REVIEWS</b>	
KLOTS, ALEXANDER B. The South Asiatic Olethreutini (Lepidoptera, Tortricidae). A. Diakonoff	188
KLOTS, ALEXANDER B. The Common Insects of North America. Lester A. Swann and Charles S. Papp	213
MARAMOROSCH, KARL. Tissue Culture: Methods and Applications. Paul F. Kruse, Jr. and M. K. Patterson	201
MARAMOROSCH, KARL. The Gunong Benom Expedition, 1967: Parts 11-13. R. Traub	212
XV INTERNATIONAL CONGRESS OF ENTOMOLOGY	220
NEW YORK ENTOMOLOGICAL SOCIETY GUEST SPEAKERS, 1974/1975	219
<b>PROCEEDINGS OF THE NEW YORK ENTOMOLOGICAL SOCIETY</b>	
October 2, 1973-December 18, 1973	245

595.70673

Ent.

Vol. LXXXII

MARCH 1974

No. 1

Journal  
of the  
New York  
Entomological Society

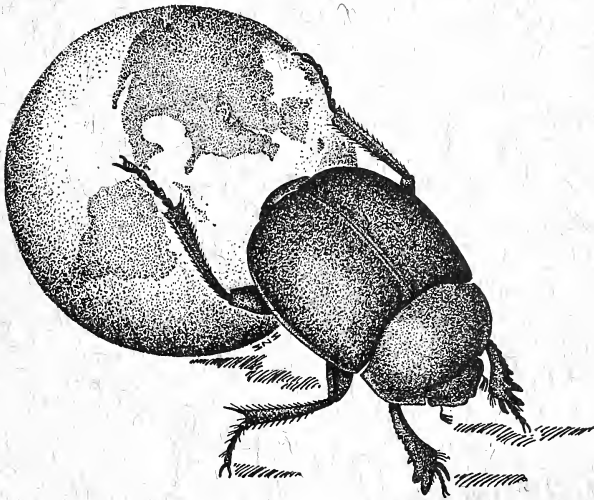

Devoted to Entomology in General

**The New York Entomological Society**  
**Incorporating The Brooklyn Entomological Society**  
**Incorporated May 21, 1968**

---

**The New York Entomological Society**  
**Organized June 29, 1892—Incorporated February 25, 1893**  
**Reincorporated February 17, 1943**

---

**The Brooklyn Entomological Society**  
**Founded in 1872—Incorporated in 1885**  
**Reincorporated February 10, 1936**

The meetings of the Society are held on the first and third Tuesday of each month (except June, July, August and September) at 8 P.M., in the AMERICAN MUSEUM OF NATURAL HISTORY, 79th St. & Central Park W., New York, N. Y. 10024.

Annual dues for Active Members, \$4.00; including subscription to the Journal, \$9.00.

Members of the Society will please remit their annual dues, payable in January, to the Treasurer.

---

**Officers for the Year 1974**

*President*, Dr. Daniel J. Sullivan, S.J.  
Fordham University, New York 10458

*Vice-President*, Dr. Peter Moller  
American Museum of Natural History, New York 10024

*Secretary*, Dr. Charles C. Porter  
Fordham University, New York 10458

*Assistant Secretary*, Dr. Louis Trombetta  
Pelham Manor, New York 10803

*Treasurer*, Dr. Winifred B. Trakimas  
State University of New York, Farmingdale, New York 11735

*Assistant Treasurer*, Ms. Joan DeWind  
American Museum of Natural History, New York 10024

---

**Trustees**

Class of 1974

Dr. Lee Herman

Mr. Edwin Way Teale

Class of 1975

Dr. Howard Topoff

Dr. Pedro Wygodzinsky

---

Mailed May 23, 1974

The Journal of the New York Entomological Society is published quarterly for the Society by Allen Press Inc., 1041 New Hampshire, Lawrence, Kansas 66044. Second class postage paid at New York, New York and at additional mailing office.

Known office of publication: Central Park West at 79th Street, New York, New York 10024.

# Journal of the New York Entomological Society

VOLUME LXXXII

MARCH, 1974

No. 1

## EDITORIAL BOARD

*Editor* DR. KARL MARAMOROSCH  
Institute of Microbiology  
Rutgers University  
New Brunswick, New Jersey 08903

*Associate Editors* DR. LAWRENCE E. LIMPEL  
HELEN MCCARTHY

Publication Committee

Mrs. Joan DeWind

Dr. Ayodha P. Gupta

Dr. Alexander B. Klots, Chairman

## CONTENTS

Habitat Variables That Influence the Attack by Hyperparasites of <i>Apanteles melanoscelus</i> Cocoons .....	Debra Van Sickle and R. M. Weseloh	2
The Biology of Two African Melittid Bees (Hymenoptera, Apoidea) .....	Jerome G. Rozen, Jr.	6
Synonymy in <i>Sphenophorus pertinax</i> Olivier (Coleoptera, Curculionidae, Rhynchophorinae) .....	Patricia Vaurie	14
The Genus <i>Pterallastes</i> Loew (Diptera: Syrphidae) .....	F. Christian Thompson	15
Further Observations on the Natural History of <i>Philaethria dido dido</i> (Lepidoptera: Nymphalidae: Heliconiinae) .....	Allen M. Young	30
Ovipositing of <i>Circulifer tenellus</i> Baker (Homoptera, Cicadellidae) .....	Karl Maramorosch	42
The Sphingidae of Turrialba, Costa Rica .....	Richard P. Seifert	45
A New Genus of Pentatominae from South America, Distinguished by the Position of Its Spiracles (Hemiptera: Pentatomidae) .....	L. H. Rolston	57
Andean Larvae and Chrysalids of <i>Dione juno andicola</i> (Bates) and <i>Agraulis vanillae lucina</i> Felder & Felder .....	F. Martin Brown	61

# Habitat Variables That Influence the Attack by Hyperparasites of *Apanteles melanoscelus* Cocoons

DEBRA VAN SICKLE AND R. M. WESELOH

DEPARTMENT OF ENTOMOLOGY, THE CONNECTICUT AGRICULTURAL EXPERIMENT STATION,  
NEW HAVEN 06504

RECEIVED FOR PUBLICATION SEPTEMBER 18, 1973

**Abstract:** Overwintering cocoons of *Apanteles melanoscelus* Ratzeburg (Hymenoptera: Braconidae), a larval parasite of the gypsy moth *Porthetria dispar* L. (Lepidoptera: Lymantriidae), were collected from the field, and laboratory-reared cocoons were exposed in the field to determine under what situations they would be most readily attacked by hyperparasites. It was found that hidden cocoons were attacked more readily than exposed ones and that percent parasitism increased as the season progressed.

## INTRODUCTION

Insect hyperparasites may be a problem in the establishment of imported insect enemies for the control of injurious insects. As Muesebeck and Dohanian (1927) point out, hyperparasites could overwhelm primary parasites before the latter become established. Even after establishment, hyperparasites may be important in suppressing primary parasites so that the latter are not effective. This is evidently the case for *Apanteles melanoscelus* Ratzeburg (Hymenoptera: Braconidae), a bivoltine oligophagous imported parasite of the gypsy moth *Porthetria dispar* (L.) (Lepidoptera: Lymantriidae). *A. melanoscelus* overwinters as a mature larva within a cocoon that is exposed to the attack of hyperparasites throughout late summer and autumn. The cocoons are attacked by over thirty native hymenopterous hyperparasites that are mainly in the superfamilies Ichneumonoidea and Chalcidoidea (Muesebeck and Dohanian, 1927). The objective of this study was to determine if habitat variation in the placement of overwintering cocoons of *A. melanoscelus* had any effect on the extent of hyperparasitism.

## MATERIALS AND METHODS

Two procedures were used to determine the incidence of parasitism on *A. melanoscelus* cocoons.

*Field Collections.* Approximately 300 overwintering cocoons of *A. melanoscelus* were collected from trees in various forested sites in southcentral Connecticut during July, 1973. Each cocoon was placed individually in a 2-in. plastic cream cup and the date of collection, height of cocoon above ground, and extent of exposure were recorded. Cocoons were considered to be in a

nonexposed situation if they were under bark flaps, in cracks, etc. Collections were made from both dead and living trees, up to 7 ft above ground. No attempt was made to record species of trees. Cocoons were kept in an incubator at 24°C and 20 hr light/day for emergence of hyperparasites. Cocoons that had no exit holes were dissected at the end of July to determine if they had been hyperparasitized. Cocoons that had exit holes at the time of collection were assumed to have formed the year before. They were classified as to whether or not a hyperparasite had emerged by characteristics of their exit holes. Data were converted to percentages and analyzed after transformation to arcsines.

*Placement of Laboratory-Reared Cocoons.* To exercise better control over cocoon placement, laboratory-reared *A. melanoscelus* cocoons were exposed in the field according to the following procedure.

First-instar gypsy moth larvae were parasitized by adult females of *A. melanoscelus* and kept in a light chamber at 24°C and 14 hr light/day (to induce diapause in the *A. melanoscelus* larvae). The caterpillars were fed an artificial diet until overwintering cocoons of the parasite formed. These cocoons were placed in the field in two sites in Guilford, Conn. At each site, two dead oak trees of about 6 in. diameter were selected. Eight cocoons were placed at each of three heights (0, 3, 6 ft) on the trunk of each tree. Four were placed in an exposed position and four were placed under a bark flap. Elmer's Milk Glue was used to hold the cocoons in place.

Cocoons were also placed in other situations as indicated below. On a living oak tree at each site, four cocoons were placed in each of four situations at the 6-ft level. The situations were: (1) exposed on the trunk, (2) nonexposed under a bark flap on the trunk, (3) exposed on a small twig, and (4) exposed on the undersurface of a leaf. Cocoons were also placed on a large 2 ft diam. rock at each site. Four cocoons were exposed on top of the rock and four were placed in a nonexposed position under the overhanging ledge of the rock.

Cocoons were left out for eleven days beginning July 16, 1973. They were then collected and dissected to determine incidence of hyperparasitism.

#### RESULTS

At least seven different species of hyperparasites in four different families emerged from the field-collected cocoons. The families were: Ichneumonidae, Encyrtidae, Eurytomidae, and Pteromalidae. None were identified by species.

For the field-collected cocoons there was no difference in hyperparasitism at the different heights. A two-way analysis of variance was performed by grouping the data by exposure and dates collected; the results are presented in Table 1. Variation due to dates and length of exposure was significant. Percent hyperparasitism increased as the summer progressed, and the highest

TABLE 1. Percent parasitism by hyperparasites of cocoons of *A. melanoscelus* collected in the field

Exposure	Collection Dates				
	July 2, 3, 5	July 6, 9, 10	July 11-13	July 16, 18, 23	1972 Season (old cocoons)
Exposed	8	32	33	53	78
Nonexposed	9	56	56	69	91

percent hyperparasitism was for those cocoons, formed during the previous year, that were exposed to the attack of hyperparasites the previous summer and autumn. Table 1 also shows that nonexposed cocoons were attacked more readily than exposed cocoons.

For the laboratory-reared cocoons, an analysis of variance on percent parasitism of cocoons placed on the four dead trees failed to show any differences in height or exposure. Analyses of variance were not run for the other situations, but it would appear that exposed cocoons were generally attacked less by hyperparasites than nonexposed cocoons (Table 2).

#### DISCUSSION

Increase in percent parasitism by hyperparasites as the season progresses has been noted by Muesebeck and Dohanian (1927), Clancy (1944), and Schlinger (1960). As the summer progresses, the hyperparasites that attack *A. melanoscelus* are evidently able to parasitize a greater and greater proportion of the host population, eventually destroying up to 90 percent of them.

TABLE 2. Percent parasitism by hyperparasites of *A. melanoscelus* cocoons reared in the laboratory and placed in the field. July 16-27, 1973

Situation	Height		
	0 ft	3 ft	6 ft
Four dead trees			
Exposed	37	19	56
Nonexposed	44	4	50
Two living trees			
Exposed on trunk .....			62
Nonexposed on trunk .....			75
Exposed on twig .....			62
Exposed under leaf .....			38
Two rocks			
Exposed	38		
Nonexposed	62		



Of perhaps more interest is the rather unexpected result that hyperparasites attack nonexposed cocoons more readily than exposed ones. Evidently these hyperparasites search for hosts primarily in concealed locations. As most cocoons of *A. melanoscelus* are found in nonexposed situations, especially under bark flaps, the hyperparasites are well adapted to exploitation of this insect.

#### Literature Cited

- CLANCY, D. W. 1944. Hyperparasitization of *Clausenia purpurea* Ishii, an important parasite of the Comstock mealybug. J. Econ. Entomol., **37**: 450-451.
- MUESEBECK, C. F. W. AND DOHANIAN, S. M. 1927. A study in hyperparasitism, with particular reference to the parasites of *Apanteles melanoscelus* (Ratzeburg). U.S.D.A. Bull. 1487, 35 pp.
- SCHLINGER, E. I. 1960. Diapause and secondary parasites nullify the effectiveness of rose aphid parasites in Riverside, California, 1957-1958. J. Econ. Entomol., **53**: 151-154.

## The Biology of Two African Melittid Bees (Hymenoptera, Apoidea)

JEROME G. ROZEN, JR.<sup>1</sup>

RECEIVED FOR PUBLICATION OCTOBER 18, 1973

### INTRODUCTION

In terms of anatomical structures of both larvae and adults, bees belonging to the Melittidae are diverse even though the family is small. We do not know if this diversity is also revealed in their life histories because their biology has been little studied. I present the following with the hope that it will augment what is already known about their biology and that it will lead eventually to a better understanding of the phylogeny of the family.

These observations were made on a trip in October, 1972, to the Western Cape Region of the Republic of South Africa. Although three of the four sub-families of melittids (Melittinae, Dasypodinae, and Ctenoplectrinae) occur in southern Africa, these notes refer only to two species in the Dasypodinae, *Capicola braunsiana* and *Haplomelitta ogilviei*. Adults of *Melitta capensis* Friese (Melittinae) were also seen but nests could not be located. This species mimics *Apis mellifera* Linnaeus to a remarkable extent as do species of a number of other genera of African bees. Ctenoplectrinae apparently do not occur in the arid regions where my observations were carried out. Mature larvae of *Capicola braunsiana* were described in a separate paper by Rozen and McGinley (in press). Adults and immatures collected in connection with this study are deposited in The American Museum of Natural History.

My studies were greatly assisted by Dr. F. Christian Thompson and Mr. Ronald J. McGinley whose companionship I enjoyed on the trip. Dr. Gerald I. Stage, University of Connecticut, Storrs, aided in the identification of adult bees. The research was supported by National Science Foundation Grant GB32193.

### *Capicola braunsiana* Friese

This species was found nesting at 67 km. east of Port Nolloth, Cape Province, Republic of South Africa, on October 17, 1972, by Dr. Thompson. He and Mr. McGinley assisted me in the excavation of the site between 2 and 5 P.M. on the same day, which was clear and sunny. The nesting area (Fig. 1) was in a sandy, treeless region with low hills and numerous widely spaced

---

<sup>1</sup>Deputy Director for Research and Curator of Hymenoptera, The American Museum of Natural History, Central Park West at 79th Street, New York, New York 10024

**Abstract:** This paper treats the nesting biology of *Capicola braunsiana* Friese and *Haplomelitta ogilviei* (Cockerell) (Melittidae, Dasypodinae) from Cape Province, Republic of South Africa.



FIG. 1. Nesting site of *Capicola brausiana*, 67 kilometers east of Port Nolloth, Cape Province, Republic of South Africa. Large-leaved vegetation is pollen plant.

FIG. 2. Nesting site of *Haplomelitta ogilviei*, 28 kilometers east of Velddrif, Cape Province, Republic of South Africa. Dr. F. Christian Thompson is peering into excavation of nest.

desert plants, most conspicuously succulents belonging to the *Mesembryanthemum*, *sensu lato*, (Aizoaceae). The gently sloping nesting site, covering an area of approximately two meters square, was mostly barren sand with a few plants including the pollen plant, a large, unidentified species of *Mesembryanthemum*; none of the plants shaded the nesting site appreciably. Dry loose sand mixed with some gravel and a few stones on the surface, the soil was more consolidated below the surface and became moist at a depth of about 12 cm. No other species of bee was seen burrowing at the site during the course of the brief observations but a nest of an halictid, probably *Dialictus*, was uncovered.

**Nesting Activity:** Although time did not permit an accurate counting, at least seven nests were definitely identified and other female bees flying around suggested that additional nests—perhaps a total of ten to fifteen—were present within the two-meter-square area. About half the nest entrances were adjacent to or under small stones on the surface of the ground, and the other entrances were in the open. Tumuli were observed around some of the entrances but in most cases excavated material apparently was quickly blown away.

The following information was obtained from excavating two nests (Figs. 3, 4). In each case the main tunnel, open at the surface, descended obliquely with considerable meandering to a depth of about 13 to 15 cm. The average rate of descent was somewhat less than 45 degrees from the horizontal. The main tunnel, 3.0 mm. in diameter, seemed to be clogged with soil at various intervals along the way but had some open spaces between and apparently was open more below than near the surface. Its wall was smooth and without a special lining. In one nest (Fig. 3), the tunnel, after reaching a depth of about 13 cm., gave rise to a linear series of four cells, each containing a mature larva. The tunnel then turned sharply and extended for 13 cm. in a unidirectional but somewhat meandering fashion, dropping only about 2 cm. over that length. It ended in an open cell containing a fully formed pollen ball. In the other nest (Fig. 4) the tunnel ended in a linear series of three cells as soon as it reached a depth of 14.5 cm. The cell closest to the tunnel was open and unprovisioned; the other two contained pollen masses and eggs. In a third nest, more hastily excavated than the other two, the main tunnel ran in meandering fashion downward to a depth of 14 cm., over a distance of about 32 cm., and ended in a linear sequence of three cells; the cell closest to the tunnel was open, the second was closed and contained a pollen ball and presumably an egg, and the third contained a pollen ball and an egg.

Hence, except for the single terminal cell in the first nest, all cells seemed to be arranged in a linear series. In the first nest cells in series were separated by a distance of 1.5 to 2.0 mm. Cells from all nests ranged in maximum length from 7.0 to 7.5 mm. (five measurements) and in maximum diameter from

4.5 to 5.0 mm. (five measurements). They were broadly rounded at the rear and more narrowed in front. Their long axis tilted from 30 degrees to 45 degrees from the horizontal and the anterior end was higher. Although cell walls appeared to be unlined, having a dull finish, a droplet of water placed upon the floor showed that it was waterproof while the upper part of the wall, similarly treated, only retarded absorption. Closures were concave on the inside with at best an indistinct spiral.

Only a single adult female was associated with each nest. However, the first nest consisted of a newly provisioned cell and four cells each with a mature larva. As the female associated with the nest was fresh, she was presumably not the parent of the larvae. Perhaps the nest had been occupied previously by another female.

Provisioning: The pollen plant grew profusely in the general area and was found on the nesting site itself (Fig. 1). The bee however apparently visits a number of species of *Mesembryanthemum* as it had been taken elsewhere, on other plants. The flowers of the pollen plant opened about 2 P.M. The female transported the pollen dry to the nest and there formed it into a perfect sphere, which was 2.5 to 2.9 mm. (three measurements) in diameter, mealy-moist throughout, pale green in color, and emitted no detectable odor.

Development: Several strongly curved eggs, translucent white with a shiny chorion, were each found on top of the pollen sphere in the longitudinal vertical plane of the cell. They were oriented with their anterior end toward the front of the cell. Their anterior and posterior ends were attached to the pollen mass while the middle looped upward. Two eggs measured 1.8 to 2.0 mm. in length and one was 0.45 mm. maximum diameter.

No feeding larvae were found but the four predefecating mature larvae from the first nest were oriented so that their posterior ends were at the rear of the cells. Each started defecating within a few hours of being brought in from the field. The feces are probably deposited, at least in part and perhaps entirely, toward the rear of the cell. All had completed defecation by October 22, 1972, at which time pupal features could be seen through the larval integument. This fact indicates either that the species has a number of generations per year or that unlike *Melitta*, *Macropis*, *Dasygoda*, and *Hesperapis* it overwinters as an adult rather than as a postdefecating larva. The larva closest to the burrow was male, the farthest female; the sex of the other two is unknown.

No parasitic bees were found in the vicinity of the nesting site.

*Haplomelitta ogilviei* (Cockerell)

This species was located first on October 15, 1972, at 28 km. east of Veldrif, Cape Province, Republic of South Africa. At that time the season was

early in that neither the bees nor their pollen flowers were numerous. Consequently the area was revisited on October 23, when the following observations were made.

The site was in an extensive sandy region, the "Sandvelt," that extends from the mountains to the Atlantic coast. There is sufficient moisture for wheat farming and the site had been rained on the day prior to my excavations. The original vegetation was probably a semiarid scrub, although now the surrounding area is wheatlands. The nesting site and also the pollen plant (Fig. 2) occurred along the sides of a paved road, where the ground surface was flat, sandy, and covered with low herbs, including a very common yellow-flowered composite and the rather rare purple-flowered *Monopsis simplex* (Linnaeus) E. Wimmer, the pollen source of *Haplomelitta ogilviei*. Only two nests were found; neither was shaded by the vegetation. The soil immediately below the surface was moist because of the rain the previous day. The bee fauna of the area was abundant, with *Capicola*, *Scapter*, halictids, and associated parasitic bees fairly common.

**Nesting Activity:** The two nest entrances were widely separated, one among the pollen plants that grew most abundantly on the south side of the road and the other 65 to 70 m. away on the north side. Neither entrance was associated with an object, such as a stone or twig, and both entered the ground obliquely where it was level. The low tumulus, 2.0 to 3.0 cm. in diameter, was to one side of the entrance, the side away from the descending tunnel.

In each nest (Figs. 5, 6) the main tunnel was open, extending at first obliquely downward and then descending nearly vertically. It was circular in cross section on one nest 5.0 mm. in diameter, and on the other varying from 4.0 to 5.0 mm. in diameter. Both tunnels ended in single cells. In the first nest excavated, the cell was open; in the other, closed. In each nest the diameter of the tunnel immediately before the open cell was 4.0 mm. in diameter, somewhat less than the remaining burrow and the terminal 3 cm. of the tunnel descended only very slightly. The cells were very shallow, being 4 and 6 cm. in depth. Both tilted from the horizontal by about 30 degrees and had their anterior ends higher. They were comparatively short (7.0 and 8.0 mm. long) in relation to width (6.0 mm.). Although without a visible lining, the cell wall was somewhat waterproof when tested with a droplet of water and the wall was slightly more rigid than the surrounding soil, an indication that the female had applied some substance that had permeated the soil. The cell closure was a partition of soil (mostly sand), evenly concave on the outside. On the inside no spiral could be detected, the closure seeming to consist of a single ring. The thickness of the closure at its middle was 1.0 to 1.5 mm.; at the periphery, approximately 3.0 mm.

This species may normally construct only a single cell to the nest because

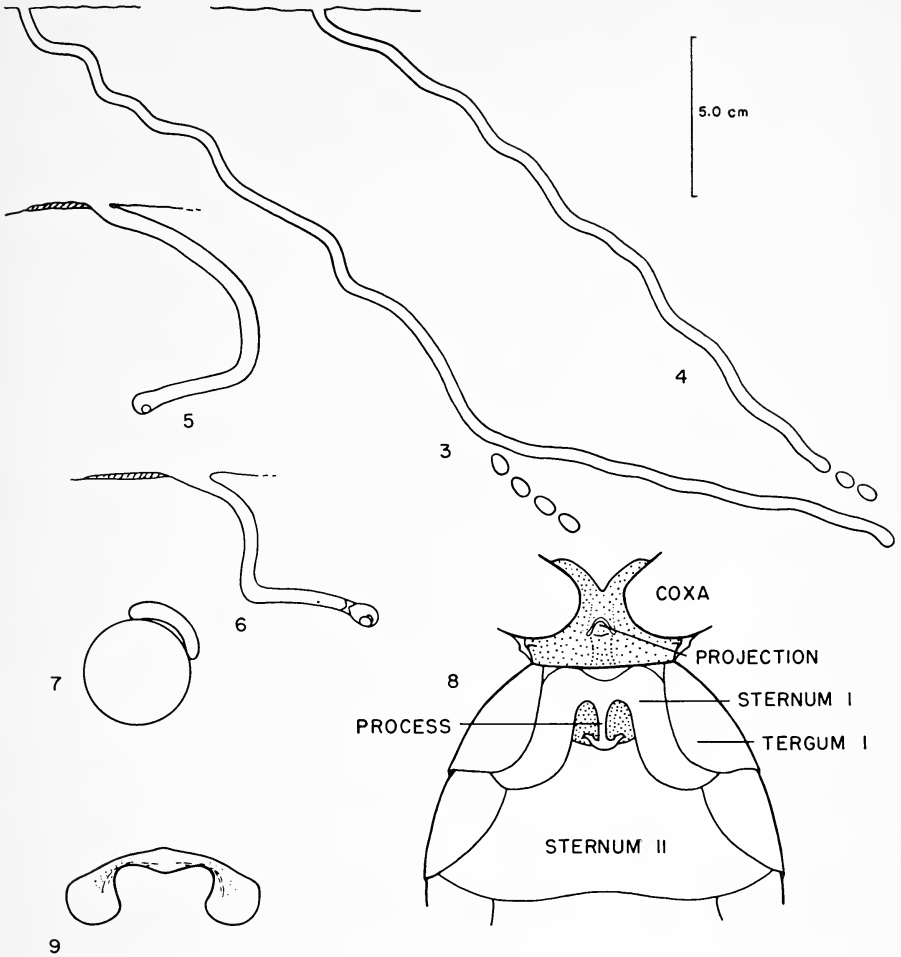

FIGS. 3, 4. Highly diagrammatic representation of two nests of *Capicola braunsiana*.

FIGS. 5, 6. Semidiagrammatic representation of the nests of *Haplomelitta ogilviei* showing contents of cells. These illustrations are more precise than Figs. 3 and 4.

FIG. 7. Pollen ball and egg of *Haplomelitta ogilviei*.

FIG. 8. Posterior edge of mesosoma and base of metasoma of female of *Haplomelitta ogilviei*, ventral view.

FIG. 9. Apex of median process of metasomal sternum I of female of *Haplomelitta ogilviei*, posterior view.

(1) the cells were very shallow; (2) each nest had only a single cell; (3) the wings of the females from the nest were frayed (suggesting they had been active for a considerable period); and (4) the female of the second nest, after closing the cell, departed without first constructing either another lateral or a cell immediately in front of the closed cell.

Provisioning: Females, when gathering pollen from the flowers of *Monopsis simplex*, flew from flower to flower until a sufficient quantity of pollen had been accumulated on their hind legs and then would depart for the nest. Both females seen entering nests did so without first searching for entrances. One female was followed for 65 to 70 m. on her return to the nest from the pollen flowers, a path that took her across the road. Although strong winds caused her to land occasionally, her general route was direct.

The open cell contained a pollen ball, 2.25 mm. in diameter, which was spherical and of the same mealy-moist consistency as the provisions in the other nest. Its small size and the fact that the cell was still open indicated that it was a preliminary deposit of food. This species and certain panurgines (including *Nomadopsis*, *Calliopsis*, and most *Perdita*) are the only bees known to me to shape preliminary provisions. The female removed the pollen from her legs, shaped the sphere, and departed from the nest during a period of from one to two minutes. The other cell contained a complete pale grayish yellow pollen ball, 3.25 mm. in diameter, spherical, and evenly mealy-moist, which was not coated with a waterproof substance. The female finished adding to and shaping the provisions, deposited an egg, and closed the cell during a period of approximately one half-hour.

Development: The egg (Fig. 7), approximately 2.4 mm. long and 0.5 mm. wide at maximum diameter, was elongate, curved, translucent white, and with a shiny chorion. Its anterior end was blunter than the posterior and it was attached to the pollen sphere by its ends, whereas the middle part did not touch the food. The anterior tip of the egg was at the top of the pollen mass (Fig. 7) and the rest of the egg was to the rear of the pollen ball. Although in general its long axis was in the vertical longitudinal plane of the cell, the egg curved slightly toward the rear as seen from above, a situation that probably was atypical.

Cycles of Activity: The nests of the species were studied on a cool day that was partly cloudy in the morning but cleared toward noon. No adults were flying at 11:00 A.M., the first males were observed around noontime, and the females became active at about 1:30 P.M. Activity decreased after 3 P.M., perhaps because the weather again turned cool and partly cloudy. Adults were quite active during the early afternoon when the site was first discovered on October 15. Although the above observations are obviously incomplete, these bees may be active primarily during the early afternoon, a diurnal activity fairly common among other South African bees.

When active the males flew close to the ground from one flower of *Monopsis simplex* to another, and often rested on the ground or sat on the flowers. While on the flowers they lay motionless across the blossom, antennae erect, and head usually, if not always, at the edge of the corolla. On the ground, they



consistently rested with their hind legs spreading somewhat from their body in a stereotyped pose that males of most bees assume. The somewhat inflated hind basitarsus of the male may be a correlation with this posture. Because females entered the center of the flower head first they could be easily distinguished from males, which merely sat across the bellshaped flower. Because of their larger size and the fact that the hind legs were not slightly spread, females resting on the ground could be easily separated from males.

Females display a median projection (Fig. 8) on the ventral conjunctiva between the mesosoma and the metasoma. This projection is apparently associated with a peculiar modification of the first metasomal sternum which is deeply emarginate posteriorly and possesses a thin median process. The process expands slightly at the apex and gives rise to two ventrally directed, short, apically flattened branches (Fig. 9). No observations were made that explained the function of these adaptations.

Parasitism: Parasitic bees were not found in definite association with either nest. Although *Pseudodichroa*, *Sphecodopsis*, and *Sphecodes* were captured in the area, they seemed to be associated with solitary bees other than *Haplo-melitta*. These parasitic bees and *H. ogilviei* have the same general body color pattern, i.e., pitch black head and mesosoma and a deep red metasoma with a black apex. The coloration seems to represent a wide-ranging mimetic color pattern especially common among South African parasitic bees as well as some nonparasitic forms.

#### Literature Cited

- ROZEN, JEROME G., JR., AND MCGINLEY, RONALD J. Phylogeny and systematics of Melitidae based on the mature larvae (Insecta, Hymenoptera, Apoidea). Amer. Mus. Novitates. [In Press.]

**Synonymy in *Sphenophorus pertinax* Olivier  
(Coleoptera, Curculionidae, Rhynchophorinae)**

PATRICIA VAURIE

AMERICAN MUSEUM OF NATURAL HISTORY, NEW YORK CITY

RECEIVED FOR PUBLICATION OCTOBER 2, 1973

*Sphenophorus pertinax peninsularis* Chittenden, 1905 (Jacksonville, Florida) is not separable from nominate *pertinax* Olivier, 1807 (New Jersey). NEW SYNONYMY.

*Sphenophorus peninsularis*, described as a species, was considered a subspecies of *pertinax* by Vaurie (1951) on the basis of six specimens from eastern Florida and Georgia and an additional specimen (Vaurie, 1967) from North Carolina. These specimens differed from nominate *pertinax* (Virginia north to northern New England and west to South Dakota) by having the three pronotal vittae more widely separated and the sides ventrally coated, not shining. However, specimens seen subsequently from the intervening area of South Carolina (1 ♂ from Little River, and 1 ♂ and 4 ♀ from Myrtle Beach) belong to nominate *pertinax* because the vittae are not separated "by at least twice their own width" (Vaurie, 1951, p. 163), and only two of the six specimens are coated ventrally. I no longer have the example from Wrightsville Beach, North Carolina, which I had considered to be *peninsularis*, but presumably its pronotal vittae were widely separated. It was collected from a plant of the same genus, *Spartina*, as nominate *pertinax*, but the species was *alterniflora* instead of *cynosuroides*. Thus the range of nominate *pertinax* extends the entire length of the Atlantic coast.

Another subspecies, *ludovicianus* Chittenden (type locality, New Orleans, Louisiana), occurs from extreme northwestern Florida and Alabama north to southern Missouri, west to eastern Texas. The vittae of this subspecies are only partially separated and the bare elytral stripes are longer than those of nominate *pertinax*.

**Literature Cited**

- VAURIE, P. 1951. Revision of the genus *Calendra* (formerly *Sphenophorus*) in the United States and Mexico (Coleoptera, Curculionidae).  
———. 1967. A new *Sphenophorus* from Arizona and distributional notes (Coleoptera: Curculionidae).

## The Genus *Pterallastes* Loew (Diptera: Syrphidae)

F. CHRISTIAN THOMPSON

DEPARTMENT OF ENTOMOLOGY, THE AMERICAN MUSEUM OF NATURAL HISTORY,  
NEW YORK, NEW YORK

RECEIVED FOR PUBLICATION OCTOBER 9, 1973

**Abstract:** The genus *Pterallastes* Loew is reviewed, its phylogeny and distribution discussed, the key to and figures of its species are given, *Pseudozetterstedtia* Shiraki is synonymized under it, and **bomboides** (China) is described as a new species of it.

### INTRODUCTION

The genus *Pterallastes* has been previously known only from the northeastern United States, where it is represented by a single species, *thoracicus* Loew. The discovery of a new *Pterallastes* species from the Szechuan Province of China has prompted a review of the whole genus, the results of which are presented below.

Loew (1863) described *Pterallastes* for two new species but Osten Sacken (1875) later indicated that the two species were not congeneric and restricted *Pterallastes* to *thoracicus* Loew, which he designated as the type species. He erected *Teuchocnemis* for the other species, *lituratus* Loew, including also *Milesia bacuntius* Walker. Van der Wulp (1888), unaware of Osten Sacken's restriction of the generic limits of *Pterallastes*, described a new species of *Pterallastes*, *nubeculosus*, from Argentina, which he stated was closely allied to *lituratus*. Thus, even if van der Wulp's statements about relationships of his species to *lituratus* were accurate, his species would be assignable to *Teuchocnemis* Osten Sacken, not *Pterallastes*. However, van der Wulp states the *nubeculosus* has pilose eyes and this character state clearly excludes his species from both *Pterallastes* and *Teuchocnemis*. Two other Nearctic species were originally described in *Pterallastes*, *perfidious* Hunter and *borealis* Cole [=

---

**Acknowledgments:** I would like to thank Drs. H. E. Evans and J. F. Lawrence of the Museum of Comparative Zoology, Cambridge, for the privilege of studying the material in their care; Drs. V. S. van der Goot of Amsterdam, Netherlands, and Prof. A. A. Stackelberg of the Zoological Institute, Leningrad, for the gift of the *Pseudozetterstedtia unicolor* Shiraki material used in this study; Dr. G. B. Fairchild of the University of Florida, Gainesville, for his information with regard to the types of species described by van der Wulp; Dr. L. V. Knutson, of the Systematic Entomology Laboratory, USDA, for permission to study the material in his care; and Dr. J. R. Vockeroth of the Entomology Research Institute, Canada Department of Agriculture, for searching for the type of "*Pterallastes*" *nubeculosus* van der Wulp and his comments on the relationships of *Pterallastes* and its related genera.

*colei* (Wirth)], but both belong to *Helophilus* (*Anasimyia*) (Curran and Fluke, 1926; Shannon, 1926; Wirth et al., 1965).

The search for the sister group of *Pterallastes* led to the discovery that Shiraki's subgenus *Mallota* (*Pseudozetterstedtia*) was based on a species of *Pterallastes*. An examination of "*Mallota*" *unicolor* Shiraki, the type species of *Pseudozetterstedtia*, revealed that *unicolor* is very similar to *thoracicus*, the type species of *Pterallastes*, and that the differences between the two species are trivial. Thus *Pseudozetterstedtia* is here transferred from *Mallota* and synonymized under *Pterallastes*.

#### Genus *Pterallastes* Loew

*Pterallastes* Loew, 1863:317 (also, 1864-201). Type-species, *thoracicus* Loew, subsequent designation by Osten Sacken, 1875:64. Subsequent references: Kertész, 1910:267 (cat. citation, 3 spp. listed); Shannon, 1921:127 and 1922:31 (transfer of genus to Xylotinae), 1926:8 (descr. notes); Hull, 1949:375 (description); Wirth, Sedman, and Weems, 1965:609 (cat. citation).

*Pseudozetterstedtia* Shiraki, 1930:199 (as a subgenus of *Mallota*). Type species, *unicolor* Shiraki by original designation. Hull, 1949:394 (descript.); Shiraki, 1968:246 (descript.).

#### NEW SYNONYM

**Head.** Higher than long; face bare, completely pollinose in male, frequently shiny medially in female, with a low but distinct medial tubercle in male, concave in female; cheeks broad, broader than long; facial grooves short, extending along lower third of eye margins and only half way to bases of antennae; facial stripes indistinct, narrow, pilose; frontal prominence low, at middle of head; frontal triangle of male short, from about two-thirds as long to almost as long as vertical triangle, bare; vertical triangle of male long, about twice as long as broad at occiput; front of female broad, only slightly longer than broad at base of frontal prominence, slightly longer than face, with convergent sides above, only one-half as broad at ocellar triangle as at base of frontal prominence, bare and shiny on lower third; ocellar triangle clearly before posterior margin of eyes; eyes bare, narrowly holoptic in males. Antennae short, about one-half as long as face; third segment orbicular; arista bare, long, about twice as long as antennae and slightly longer than maximal facial width.

**Thorax.** Distinctly longer than broad, with long pile but pile not obscuring color of pollinosity; long yellow bristles above wings, on postalar calli, and posterior edge of mesopleura; anterior mesopleura bare; sternopleura with broadly separated dorsal and ventral pile patches; posterior pteropleura bare; hypopleura including barrettes bare; metasterna underdeveloped and bare; postmetacoxal bridge incomplete; metathoracic spiracle small; metathoracic pleura bare; scutellum without distinct ventral pile fringe, with a few ventral hairs laterally and in some specimens with many marginal hairs directed ventrally, usually without apical emarginate rim; in some specimens with an indistinct and shallow apical emarginate rim; legs simple; mesocoxae with three to four bristlelike hairs on posterior surface; hind femora not swollen, with ventral spines, without basoventral setal patches. Wing: marginal cell open; apical cell petiolate, with petiole short, about as long as humeral crossvein; third vein moderately to strongly looped into apical cell; anterior crossvein distinct beyond middle of discal cell, at outer third of discal cell, slightly oblique; anal cell with a long and slightly curved apical petiole; apical and posterior crossveins continuous; apical and discal cells without spurs at their apicoposterior corners.

**Abdomen.** Oval; first abdominal spiracle embedded in metathoracic epimeron. Male geni-

talia: Cerci simple, pilose; ninth tergum simple, bare; surstyli pilose, triangular in profile, slightly asymmetric; ninth sternum with a ventrolateral membranous area on each side and with a process laterad to this membranous area; lingula absent; superior lobes fused to ninth sternum, pilose dorsobasally, produced into a long curved prong; aedeagus with large earlike lateral lobes, with apical process short and stout.

#### DISCUSSION

Earlier workers considered that *Pterallastes* undoubtedly belonged with the helophilines because of its looped third vein and open marginal cell. Shannon (1921, 1922) was first to point out the true affinities of *Pterallastes* with the milesine genera (Milesini = Xylotinae *auctororum*). While Hull (1949) recognized six tribes in the Xylotinae, he did not place *Pterallastes* in any of them nor did he place the genus in his key. I (1972) followed Hull's basic arrangement of genera within the Milesini (= his Xylotinae), but I made a few changes. In my arrangement I placed *Pterallastes* in the *Temnostoma* group. I considered that the *Temnostoma* and *Milesia* groups were closely related because both have the lateral lobes of the aedeagus well developed (synapomorphy). I separated the *Milesia* group from the *Temnostoma* group on the basis of the presence of well-developed metasterna and emarginate scutellar rims in most of the genera of the *Milesia* group. However, this separation was not totally satisfactory since the dichotomy is not clearcut; some genera have intermediate conditions of the characters used, leaving the *Temnostoma* group as a symple-siomorphic assemblage. The reevaluation of the phylogenetic relationships of *Pterallastes* has led me to discard my previous symple-siomorphic grouping of the *Temnostoma* genera and to combine these genera with those of the *Milesia* group on the basis of their common possession of well-developed lateral lobes of the aedeagus.

The sister group of *Pterallastes* is undoubtedly *Palumbia* + *Korinchia*. These three genera are distinguished from all other syrphids by the presence of an abundance of a peculiar type of long bristlelike hair above the wings, on the postalar calli and usually along the margin of the scutellum (synapomorphy). Also, *Pterallastes*, *Palumbia*, and *Korinchia* have the third vein (R4+5) looped into the apical cell, another synapomorphous condition. While other syrphid genera have the looped third vein character state, I consider this character state to be convergent in all these other genera because the following characters, among others, exclude the possibility of a close relationship with either *Pterallastes*, *Palumbia*, or *Korinchia*: All cristaline genera have pilose metasterna and patches of setulae on the hind femora; *Rhinotropidia* and *Parrhyngia*, both tropidines, have carinate faces and hind femora; *Orthroprosopa*, another tropidine, has a pilose and divided metasterna; *Syrittosyrphus*, a milesine, has a well-developed but pilose metasterna; *Dideomimia*, *Salpingogaster*, *Asiodidea*, and *Didea*, all syrphines, have bare humeri and five pregenital segments in

## PTERALLASTES

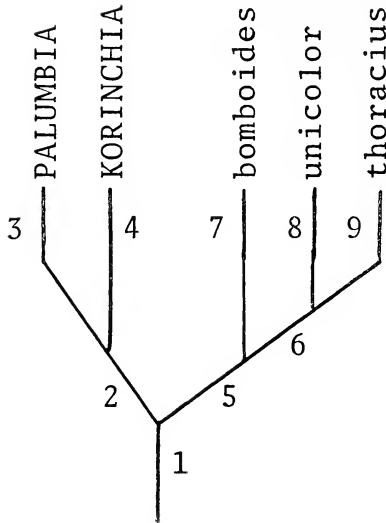
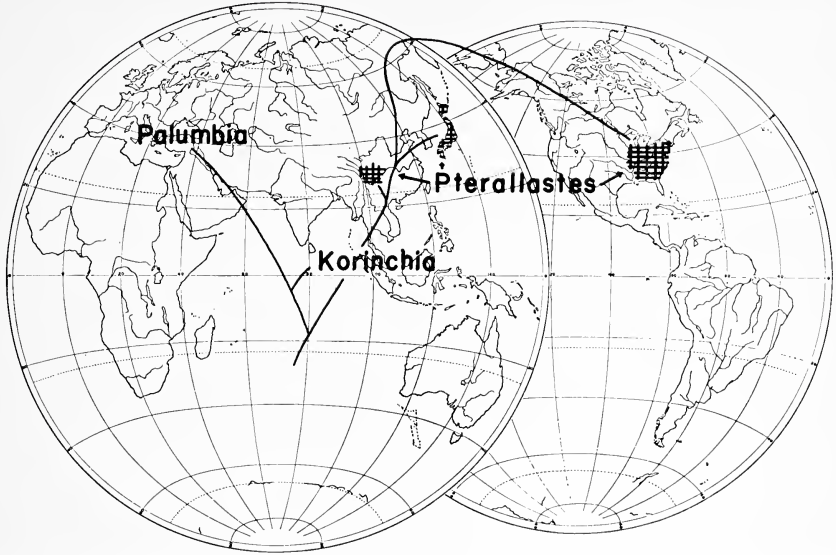

Diagram 1. Phylogenetic relationships of and within the genus *Pterallastes* Loew. The autapomorphic character states used are: 1, the presence of bristlelike pile on the mesonotum, the bare metasterna and looped third vein; 2, the closed and petiolate marginal cell; 3, the absence of a facial tubercle in both sexes; 4, the presence of a single asymmetric ventral membranous area on the ninth sternum (male genitalia); 5, the presence of ventrolateral lobes on ninth sternum (male genitalia); 6, the bifid nature of the ventrolateral lobe on the ninth sternum; 7-9, specialized character states of the species of *Pterallastes* are discussed in the text under the respective species. Genus-group taxa are in capital letters and species are in small letters.

the males. The phylogenetic relationships of *Pterallastes* are given in Diagram 1.

Both *Palumbia* and *Korinchia* have petiolate marginal cells (synapomorphy). *Palumbia* is distinguished from *Korinchia* by its lack of a facial tubercle in the male (autapomorphy) and *Korinchia* is distinguished from *Palumbia* by the presence of a single large ventral membranous area on ninth sternum of the male (autapomorphy). I know of no other external or genitalic characters by which I can distinguish these two genera. Thus I am combining *Palumbia* and *Korinchia*, but I have retained *Korinchia* as a subgenus of *Palumbia*. These changes will be discussed in more detail in another paper.

*Distribution and past dispersal.* The known distribution of the genus *Pterallastes* (map 1) is significantly enlarged with the addition of *bomboides* (China) and *unicolor* (Japan). The sister group of *Pterallastes* is Oriental (*Korinchia*) and western Palaearctic (*Palumbia*) in distribution; the most plesiomorphic species of *Pterallastes*, *bomboides*, is restricted to the Szechuan Province of



Map 1. Distribution of the genus *Pterallastes* with a diagram of its phylogenetic relationships.

China; the next most plesiomorphic species, *unicolor*, is restricted to Japan; and the most derived species, *thoracicus*, is restricted to southeastern North America. From these facts, the following history of dispersal in the genus *Pterallastes* is postulated: 1) The genus arose in southern China, probably the same area where *bomboides* is now found. 2) Some of the species dispersed northward and eastward, with one ancestral species dispersing over the Bering land bridge to North America. 3) During an ice age, probably the last one, the northern species of the genus were forced to restrict their ranges. 4) *Unicolor* in Japan and *thoracicus* in southeastern North America are the survivors of this last episode of range restriction and extinction.

KEY TO SPECIES

1. Disc of mesonotum bright yellow to orange pollinose; 3rd vein forming a shallow loop in apical cell (Fig. 4); abdomen black with fine yellowish or black pile, not obscuring ground color ..... 2
- Disc of mesonotum dark brownish-black pollinose; 3rd vein forming a strong loop in apical cell (Fig. 5); abdomen with long shaggy yellowish and reddish pile, obscuring ground color on apical segments ..... *bomboides*, n. sp.
2. Abdominal terga shiny, without pollinose markings; sterna yellow pilose, rarely with a few black hairs on last sternum; terga usually completely yellow pilose, rarely black pilose on apical half or less of 3rd and 4th terga; femora usually yellow pilose, except black spinulose on ventral portion of hind femora and rarely with black pile on dorsal edge of hind femora on apical half ..... *thoracicus* Loew

Abdominal terga with gray pollinose markings, 1st tergum all pollinose, 2nd with two large transverse pollinose spots, 3rd with two small basal transverse spots; 4th and 5th sterna (in female) black pilose; apical two-thirds of 4th and all 5th terga (in female) black pilose; anterior four femora black pilose on anterior apical third; hind femora black pilose on apical half ..... *unicolor* (Shiraki)

*Pterallastes thoracicus* Loew

*Pterallastes thoracicus* Loew, 1963:317 (also, 1864:201). Type locality: U.S.A., Pennsylvania. Types 1♂ 1♀ Museum of Comparative Zoology. Subsequent references: Banks, 1907:450 (distribution rec.—Virginia); Kertész, 1910:267 (catalog citation, 2 references); Johnson, 1910:770 (distribution recs.—New Jersey); Metcalf, 1913:94 (distribution recs.—Ohio), 1916:107 (distribution recs.—North Carolina); Banks *et al.*, 1916:188 (distribution recs.—District of Columbia); Smith, 1919:273 (distribution recs.—Indiana); Britton, 1920:188 (distribution recs.—Connecticut); Metcalf, 1921:169–214, Figs. 97, 101 (male genitalia); Wehr, 1922:157 (distribution recs.—Nebraska); Johnson, 1925:176 (distribution recs.—Connecticut); Shannon, 1926:9 (distribution notes, type depository); Leonard, 1928:800 (distribution recs.—New York); Curran, 1930:73 (distributional recs.—New York); Brimley, 1938:353 (distribution recs.—North Carolina); Wirth, Sedman and Weems, 1965:609 (catalog citation, Nearctic distribution).

*Male*. Head: black; face silvery pollinose, with a low medial tubercle, with tubercle lower than frontal prominence; cheeks shiny on anterior half, whitish pollinose and pilose on posterior half; frontal lunule orange; frontal triangle silvery pollinose; vertical triangle silvery pollinose except very sparsely pollinose on ocellar triangle, yellow pilose; occiput silvery-white pollinose and pilose below becoming yellow on upper half. Antennae orange, frequently with brownish tinge; third segment small, only about as large as metathoracic spiracle; arista orange.

*Thorax*. Dorsum yellow pollinose and pilose, with pile of medium length except long bristlelike hairs above wings and on postalar calli; scutellum yellow pollinose and pilose; pleura silvery pollinose, yellowish to white pilose; squamae and plumulae white; halteres white to orangish; legs black except as follows, yellow femora tibia joints, yellowish basal third of middle tibiae, orange middle and hind tarsi; in some specimens hind metatarsi with brownish tinge; pile yellowish except black on front tarsi and ventral portion of tibiae and hind femora and rarely on dorsal edge of hind femora on apical half. Wings: hyaline or with a slight grayish tinge apically, microtrichose except bare narrowly behind anal vein and in front of auxiliary vein; third vein with shallow loop in apical cell.

*Abdomen*. black, shiny, with slight metallic bluish luster under strong light; in some specimens appear reddish brown under strong light; usually completely whitish yellow pilose, rarely with black pile on apical portions of third and fourth terga (see below under discussion section). Male genitalia: Surstyli triangular, with ventral margin virtually straight, not produced basoventrally; ninth sternum with ventrolateral membranous area small

→

Figs. 1–8. Figs. 1–3. Head of *Pterallastes*, lateral view; 1. *thoracicus* Loew, male; 2. *bomboides*, n. sp., male; 3. *unicolor* (Shiraki). 4–5. Wings of *Pterallastes*; 4. *thoracicus* Loew; 5. *bomboides*, n. sp. Figs. 6–8. Aedeagi of *Pterallastes*, lateral view. 6. *thoracicus* Loew; 7. *unicolor* (Shiraki); 8. *bomboides*, n. sp.



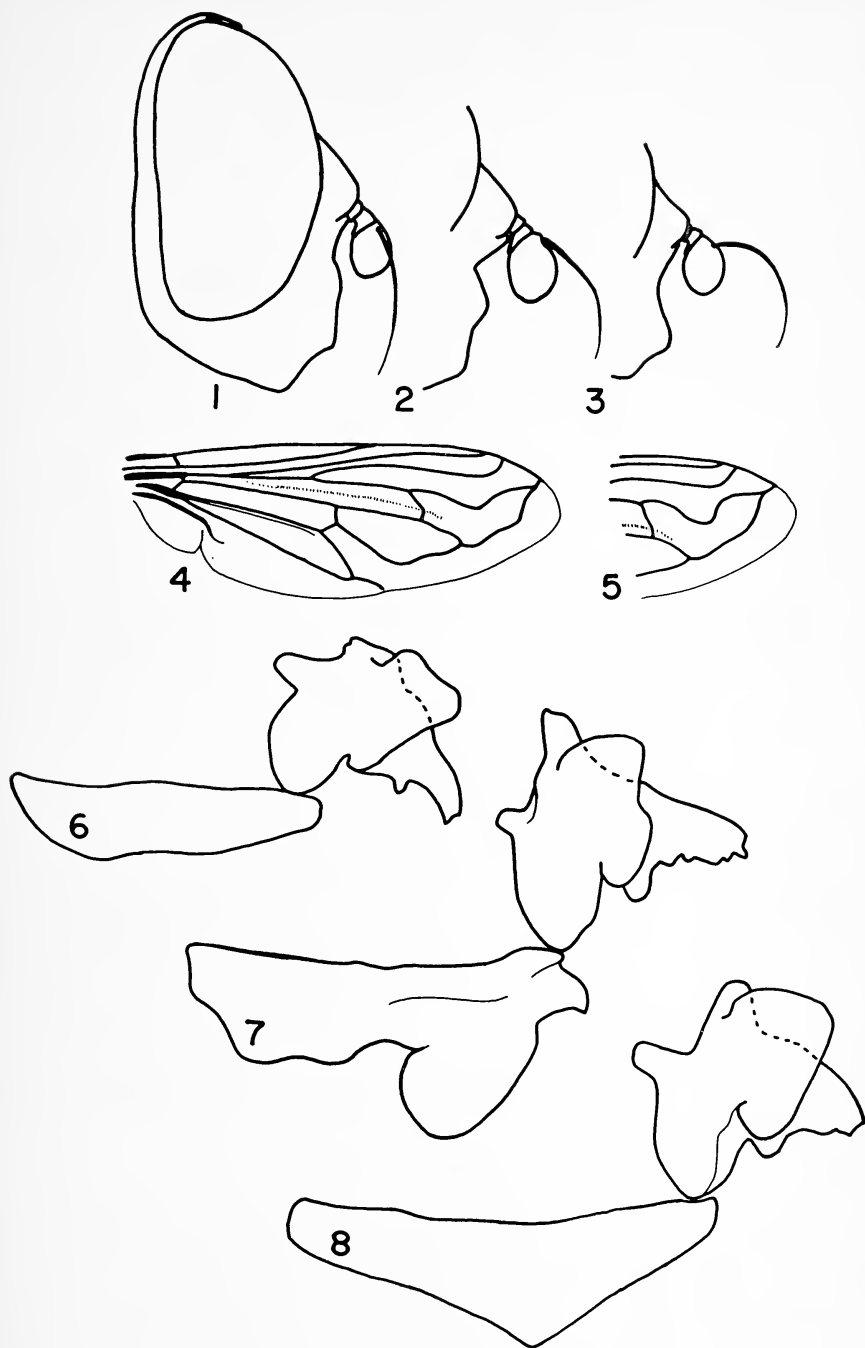

and apicomedial to lateral process, with lateral process bifid and directed apically; superior lobes only pilose dorsobasally, produced into a short broad apical prong with a single large ventral tooth, with a few short bristlelike hairs on ventral tooth; aedeagus with lateral lobes triangular, with apical process slender and longer than in both *bomboides* and *unicolor* and with a single bump on ventral margin.

*Female.* Quite similar to male except for normal sexual dimorphism; less black pile on legs; lower third of front shiny and upper two-thirds yellow pollinose and pilose; and lower medial third of face frequently shiny.

#### MATERIAL EXAMINED

The two syntypes in the Loew Collection at the Museum of Comparative Zoology and some 80 additional specimens of both sexes from the following states and counties: Kansas (Douglas); Connecticut (Fairfield); New York (Westchester, New York City); New Jersey (Bergen, Essex, Middlesex); Pennsylvania (Philadelphia, Montgomery, Delaware, Westmoreland); Maryland (Arundel, Prince George, Montgomery, Calvert); District of Columbia; Virginia (Arlington, Fairfax); North Carolina (Buncombe); and Georgia. Some of these specimens were labeled as collected in association with the following plants: *Ceanothus*, *Solidago*, *Viburnum nudum*, and *Castanea dentata*. The earliest collection recorded was 23 May (Virginia); the latest was 7 October (New York), with June and August being the months with the most numerous records. More detailed information about this material is available from the author.

#### DISCUSSION

The differences between *P. thoracicus* and *unicolor* or *bomboides* are discussed under the latter species. Among the material of *P. thoracicus* examined there was some variation in the extent of black pile on the abdomen—ranging from a few black hairs intermixed with yellow pile on apical portion of the 4th (♂) or 5th (♀) segments to large triangular areas of solid black pile on apical half or more of the third through fourth (♂) or 5th (♀) segments.

#### *Pterallastes bomboides*, n. sp.

*Male.* Head: black; face silvery pollinose, with a distinct medial tubercle, with tubercle almost as high as frontal prominence; cheeks shiny; frontal lunule yellowish orange; frontal triangle silvery pollinose; vertical triangle grayish pollinose, black pilose; occiput silvery-gray pollinose, white pilose below becoming yellow on upper half. Antennae orange, with brownish tinge in paratype; third segment large, larger than metathoracic spiracle; arista orange.

*Thorax.* Black; dorsum dark brownish-black pollinose except narrowly silvery-gray pollinose laterally and on scutellum, long shaggy yellow pilose laterally and on scutellum, yellow and black pilose medially and almost completely black pilose behind sutures; pleura

→

Figs. 9–14. Figs. 9–11. Ninth tergum and associated structure, of *Pterallastes*, lateral view; 9. *thoracicus* Loew; 10. *unicolor* (Shiraki); 11. *bomboides*, n. sp. Figs. 12–14. Left surstyli of *Pterallastes*, lateral view; 12. *thoracicus* Loew; 13. *unicolor* (Shiraki); 14. *bomboides*, n. sp.

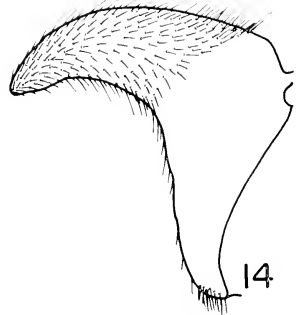
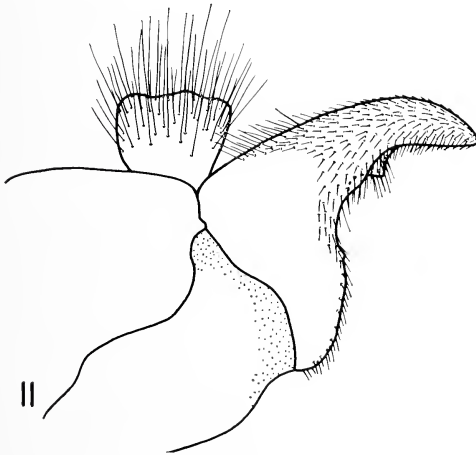
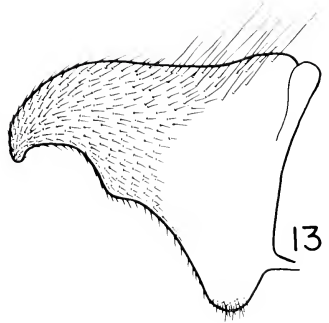
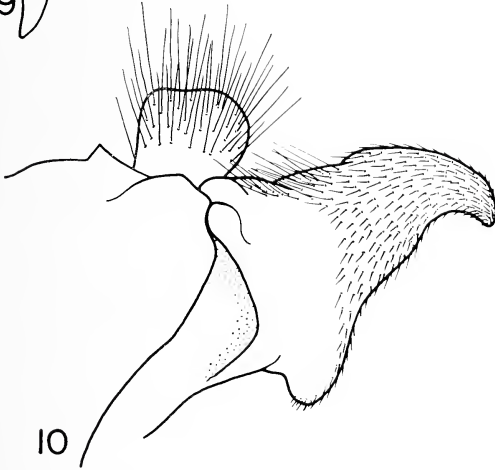
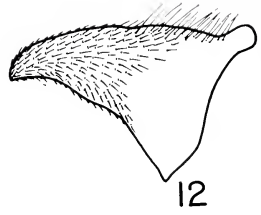
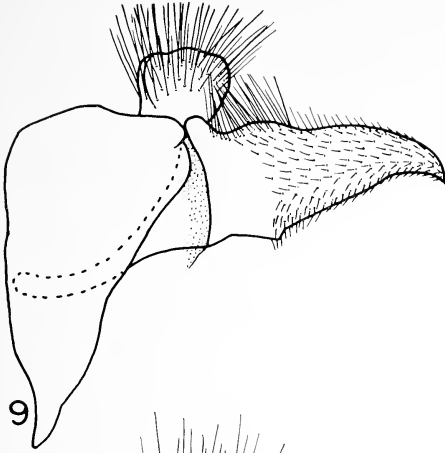

silvery-gray pollinose, long whitish to yellowish pilose; legs black except yellowish tips of femora and bases of tibiae and orangish middle and hind tarsi, yellow to white pilose except black pilose on ventral part of hind femora and apical three tarsal segments; plumulae brown; squamae white with brownish margin and fringe; halteres brown; wings hyaline microtrichose except bare narrowly behind anal vein and in front of auxiliary vein, third vein with a strong loop in apical cell.

Abdomen black, shiny except reddish apical half of fourth segment and genital segments; short black pilose on medial third of second tergum; white pilose on first tergum, sterna, lateral third of second and lateral margins of third terga, long on lateral margins and sterna; long yellowish red pile on third and fourth terga, obscuring ground color; short yellowish pile on genital segments. Male genitalia: Surstyli triangular, strongly concave on ventral margin, with a small triangular inner tooth on ventroapical margin of right surstyli; ninth sternum with ventrolateral membranous area large and posteromedial to lateral process, with lateral process simple and directed ventrally; superior lobe produced into a long slender apical prong, without teeth on ventral margin, generally pilose, with a small tuft of hairs on ventroapical angle; aedeagus with lateral lobes broadly triangular, with apical process stout and with an even ventral margin.

*Female.* Quite similar to male except for normal sexual dimorphism; lower third of front shiny and upper two-thirds brownish pollinose and black pilose; reddish ground color of abdomen is reduced.

#### MATERIAL EXAMINED

Holotype and paratype males, CHINA, Szechuan, West of Chetu Pass, near Tatsielu, 13,000 to 14,500 ft; D. C. Graham; allotype female, west of Chego Pass, July 13-18, 1923, D. C. Graham. The holotype and allotype are in the American Museum of Natural History collection; paratype is retained in the author's collection.

#### DISCUSSION

Besides the differences mentioned in the above key, *P. bomboides* differs from both *P. thoracicus* and *unicolor* in: (1) the facial tubercle is larger and more distinct, not low and obscure; (2) the vertical triangle in male and front and vertex in female is black pilose, not yellow or tawny; (3) the third antennal segment is large, larger than metathoracic spiracle, not the same size; and (4) the plumulae and halteres are brown, not white to whitish orange. The specific name *bomboides* is an adjectival form used as a substantive in the genitive case and alludes to the mimetic similarity to *Bombus*.

#### *Pterallastes unicolor* (Shiraki)

*Pseudozetterstedtia unicolor* Shiraki, 1930:200. Type locality: Japan, Hokkaido, Josankei and Sapporo; Honshu, Wakayama, Towada and Chuzenji. Types ♂ ♀ Ent. Mus., Natn. Inst. Agric. Sci., Tokyo

*Mallota unicolor*: Sack, 1932:337 [descript., figs. (head)]; Stackelberg, 1950:287 (notes); Violovitsh, 1955:350 [distr. recs. (Kuril Is.), notes]; Violovitsh, 1960:247 [distr. recs. (Kuril Is.), notes]; Shiraki, 1968:246 (descript.).

*Male.* Head: black; face yellowish white pollinose, with a very low medial tubercle, with tubercle much lower than frontal prominence; cheeks shiny black on anterior half, yellow-

ish white pollinose and pilose on posterior half; frontal lunule brownish yellow; frontal triangle yellowish white pollinose; vertical triangle yellowish white pollinose anteriorly, slightly more brownish yellow pollinose posteriorly, tawny pilose; occiput yellowish white pollinose and pilose below becoming more orange or tawny yellow on upper half. Antennae brownish orange, black pilose; third segment small, oval, only about as large as metathoracic spiracle; arista brownish orange.

*Thorax.* black; dorsum orange yellow to deep orange pollinose and pilose, with pile of medium length except long bristlelike hairs above wings and on postalar calli; scutellum the same as dorsum; pleura more or less grayish pollinose, with meso-, ptero-, and sternopleura distinctly gray pollinose, yellow pilose; squamae and plumulae orange; halteres white to orange; legs: black, except yellowish brown femoral-tibial joints and basal segments of middle tarsi; coxae and front four trochanters yellow pilose, with pile bristlelike on coxae; anterior four femora whitish yellow pilose except black on anterior apical half; anterior tibiae black pilose except for scattered yellow hairs on posterior half; anterior tarsi all black pilose; middle tibiae whitish yellow pilose except black pilose on apical ventral half; middle tarsi yellow pilose with apical segments with some black hairs intermixed; hind trochanter with black setulae; hind femora whitish yellow pilose on basal half, black pilose on apical half and with black setulae on ventral edge; hind tibiae whitish yellow pilose on basal half, black pilose on apical half; hind tarsi all black pilose. Wings: hyaline or with a slight grayish tinge apically, microtrichose except bare narrowly behind anal vein and in front of auxiliary vein; third vein with a moderately shallow loop in apical cell.

Abdomen black; venter gray pollinose, white pilose on first through third sterna, with fourth sternum black pilose; first tergum grayish pollinose and yellow pilose; second tergum with a pair of large transverse yellowish gray pollinose spots, elsewhere brownish gray pollinose, yellow pilose; third tergum with narrow basal transverse yellowish gray pollinose spots, elsewhere brownish gray pollinose except slightly shiny submedially, yellow pilose, except usually with a few black hairs on apical margins, rarely all black pilose on apical third; fourth tergum with yellow gray pollinose basal transverse spots similar to those on third but very narrow, black pilose except yellow pilose on basolateral corners, male genitalia black pilose, sparsely grayish pollinose. Male genitalia: surstyli triangular, slightly concave on ventral margin, without any teeth; ninth sternum with ventrolateral membranous area small and apicomедial to lateral process, with lateral process bifid and directed slightly dorsoapically; superior lobes only pilose dorsobasally, produced into long slender apical prong with three large ventral teeth, with two long bristles on ventroapical margin; aedeagus with lateral lobes almost rectangular in shape, with apical process more slender than in *bomboides* and with ventral margin very irregular.

*Female.* Quite similar to male except for normal sexual dimorphism; lower third of front shiny and upper two-thirds orangish-yellow pollinose and pilose; fifth abdominal segment black pilose.

#### MATERIAL EXAMINED

JAPAN, Honshu, Iwato, 840 m, 21 July 1971, 1 ♂, V. S. van der Goot and J. A. W. Lucas (FCT).

#### DISCUSSION

*P. unicolor* is very similar to *thoracicus* differing principally in the structure of the male genitalia; in the gray pollinose marking on abdominal terga; and in the pile and pollinosity that are tawny orange, not pale yellow. Also, *P.*

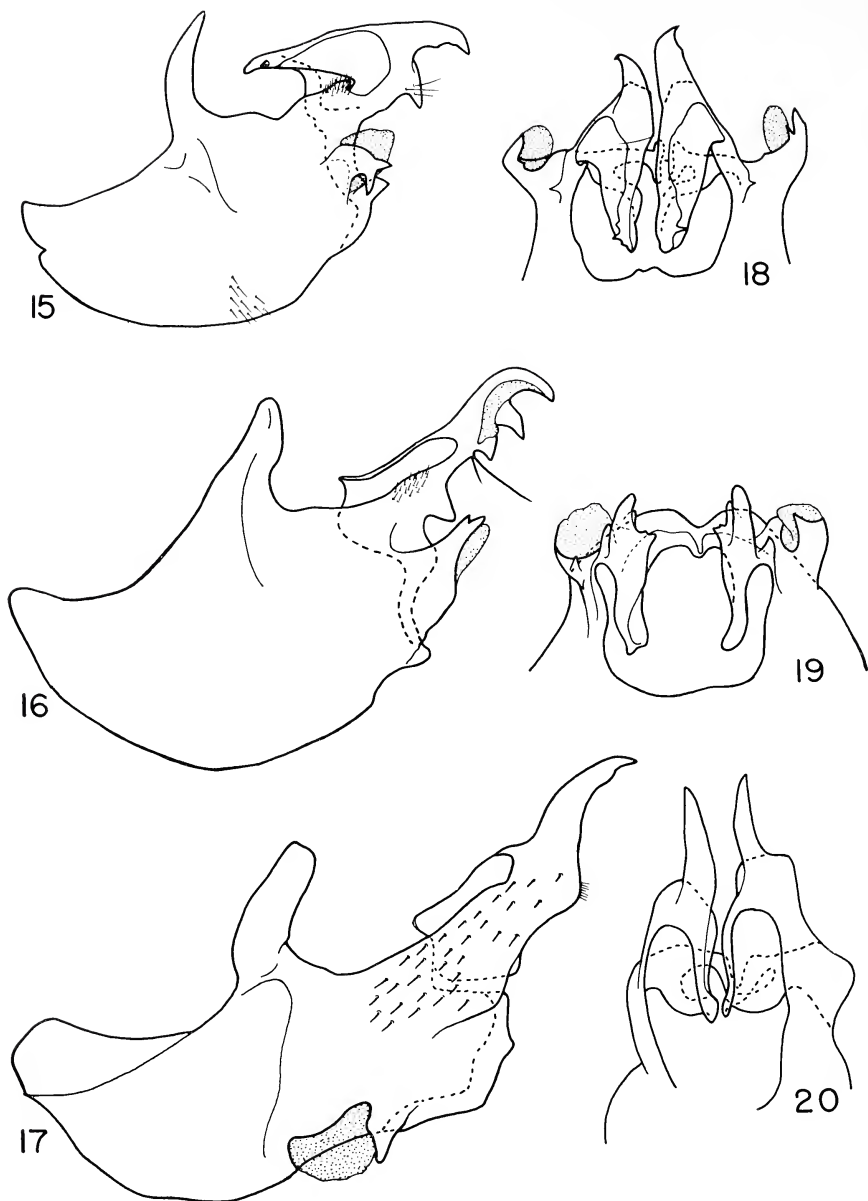

Figs. 15-20. Figs. 15-17. Ninth sternum and associated structures of *Pterallastes*, lateral view; 15. *thoracicus* Loew; 16. *unicolor* (Shiraki); 17. *bomboides*, n. sp. Figs. 18-20. Apical half of ninth sternum and associated structure of *Pterallastes*, dorsal view; 18. *thoracicus* Loew; 19. *unicolor* (Shiraki); 20. *bomboides*, n. sp.

*unicolor* has more extensive black pile on the legs and abdomen than the typical specimens of *thoracicus*.

"*Pterallastes*" *nubeculosus* van der Wulp

? *nubeculosus* van der Wulp, 1888:372 (*Pterallastes*). Type locality: Argentina, Prov. Tucuman. Type ♂ (lost, see below). Subsequent references: Kertész, 1910:267 (cat. citation, 1 reference); Brèthes, 1907:293 (cat. citation); Fluke, 1957:1555 (cat. citation).

"Brownish-black antennae and arista, femoral apices, tibiae and tarsi rufous; eyes strongly pilose; front, thorax scutellum and abdomen densely ocher-yellow pilose; wings hyaline, base and costa cinereous clouded.

"Properly fitting the generic characteristics of the genus *Pterallastes* Loew and appears closely allied to the North American species *Pt. lituratus* Loew, but nevertheless in many respects distinct from it.

"Ground color brownish-black, shiny, with scutellum brownish red. Face pale yellowish pollinose, the obvious facial tubercle and oral margin<sup>1</sup> shiny, on the sides with similar colored pile; vertical triangle very small; eyes pilose; occiput behind eyes pale yellowish pollinose, with pile similarly colored, darker above. Antennae reddish brown, arista of a lighter color. Front, thorax and scutellum with rather thick light ocher-yellow pile; similar pile on abdomen, mostly on sides and on hind edges of segment, anus curved down ventrally. Legs blackish brown, tips of femora, tibiae and tarsi of a lighter color, almost reddish yellow; hind femora thicken in the middle, hind tibiae curved. Halteres yellow. Wings hyaline, with base and front edge reddish gray clouded.

"One ♂, prov. Tucuman, Argentina."

DISCUSSION

"*Pterallestes*" *nubeculosus* van der Wulp has not been recognized since its original description, which is translated above. Van der Wulp states that his species "properly" fits the generic characteristics of *Pterallastes*, which were given by Loew as "*Pterallastes forma ac figura totius corporis, praecipue capitatis, et pictura Myoleptam simulans, alas Helophilii habet.*" The principal character states, which Loew was probably referring to in his description, are the sexually dimorphic face of *Myolepta* and the looped third vein and open submarginal cell of the helophilines. Since van der Wulp had only a male of his species it was impossible for him to know whether his species had a sexually dimorphic face as in *Myolepta* or *Pterallastes* but clearly it is safe to assume that his species had the looped third vein and open submarginal cell. The combination of these two character states, along with the pilose eyes, restricts the placement of van der Wulp's species to either *Mallota* or *Quichuana* among the known neotropical syrphids. It is always possible that van der Wulp's species could represent a new genus, but I think this possibility is highly unlikely.

<sup>1</sup> The original text for this phrase is: "*die de duidelijke gezichtshult en den mondrad vrij laat,*" which literally translates as "the obvious facial tubercle and mouthedge leaving free." I have assumed this to mean that the oral margin and facial tubercle are "free" from pollinosity.

Unfortunately it appears that the type of *nubeculosus* is lost. Dr. J. R. Vockeroth, at my request, searched for this type while examining the various collections that contain van der Wulp material, but he was unable to find any trace of it. In van der Wulp's paper there is no mention of any particular collection in which the material was deposited, only that the material came from Prof. H. Weyenbergh, Jr. According to Horn and Kahle (1937:301) all the Weyenbergh material was destroyed. Thus, if van der Wulp did return the material to Weyenbergh, it is lost. Dr. G. B. Fairchild (*in litt.*) also was unable to find the type of another species (*Pangonia lasiophthalma*) described in the same paper.

#### Literature Cited

- BANKS, N. 1907. Captures of Diptera. Ent. News, **18**: 450.
- BANKS, N., GREENE, C. T., MCATEE, W. L., and SHANNON, R. C. 1916. District of Columbia Diptera. Proc. Biol. Soc. Washington, **29**: 173-203.
- BRÈTHES, J. 1907. Catalogo de los Dipteros de las Republicas del Plata. An. Mus. nac. Buenos Aires, (3)**9**: 277-305.
- BRITTON, W. E. 1920. Checklist of the insects of Connecticut. Bull. State Geol. Nat. Hist. Survey Connecticut 31, 397 pp.
- CURRAN, C. H. 1930. Report on the Diptera collected at the Station for the study of Insects, Harriman Interstate Park, N. Y. Bull. Amer. Mus. Nat. Hist., **61**: 21-115 (1931).
- , and FLUKE, C. L. 1926. Revision of the Nearctic species of *Helophilus* and allied genera. Trans. Wisconsin Acad. Sci., Arts, Letters, **22**: 207-281, 3 pls.
- FLUKE, C. L. 1956-57. Catalogue of the family Syrphidae in the Neotropical region (Diptera). Revta. Brasil. Ent., **6**: 193-268, **7**: 1-181.
- HULL, F. M. 1949. The morphology and interrelationship of the genera of syrphid flies, recent and fossil. Trans. Zool. Soc. London, **26**: 257-408, 25 figs.
- JOHNSON, C. W. 1910. Order Diptera. Pp. 703-814, Figs. 293-340. In Smith, J. B., The insects of New Jersey. Annu. Rpt. N. J. State Mus., **1909**: 15-1888, 340 figs.
- . 1925. Fauna of New England. 15. List of the Diptera or two-winged flies. Occas. Papers Boston Soc. Nat. Hist., **7(15)**: 1-326, 1 fig.
- KERTÉSZ, K. 1910. Catalogus dipterorum hucusque descriptorum. Vol. 7, 470 pp. Lipsiae, Budapestini [= Leipzig, Budapest].
- LEONARD, M. D. 1928. List of the insects of New York with a list of the spiders and certain other allied groups. Mem. N.Y. (Cornell) Agr. Expt. Sta., **101**: 1-1121 (1926).
- LOEW, H. 1863. Diptera Americae septentrionalis indigena. Centuria quarta. Berlin. Ent. Ztschr., **7**: 275-326 (also published in Loew, 1864: 159-210).
- . 1864. Diptera Americae septentrionalis indigena. Vol. 1, 266 pp. Berolini [= Berlin], 1861.
- METCALF, C. L. 1913. The Syrphidae of Ohio. Bull. Ohio Biol. Survey, **1**: 7-122, 3 figs., 11 pls. (= Bull. 1) [= Bull. Ohio State Univ. **17**:(31).]
- . 1916. A list of Syrphidae of North Carolina. J. Elisha Mitchell Sci. Soc., **32**: 95-112.
- . 1921. The genitalia of male Syrphidae: Their morphology, with especial reference to its taxonomic significance. Ann. Ent. Soc. Amer., **14(3)**: 169-214.



- OSTEN SACKEN, C. R. 1875. A list of the North American Syrphidae. Bull. Buffalo Soc. Nat. Sci., **3**: 38-71.
- SACK, P. 1928-1932. 31. Syrphidae. In Lindner, E., ed., Die Fliegen der Palaearktischen Region. Bd. 4, pt. 6, pp. 1-48 (1928), 49-144 (1929), 145-240 (1930), 241-336 (1931), 337-451 (1932).
- SHANNON, R. C. 1926. Review of the American xylotine syrphid-flies. Proc. U.S. Natl. Mus. #2635, **69(9)**: 1-52.
- SHIRAKI, T. 1930. Die Syrphiden des Japanischen Kaiserreichs, mit Berücksichtigung benachbarter Gebiete. Mem. Fac. Sci. Agric. Taihoku Imp. Univ., **1**: 9-xx, 1-446, 100 figs.
- . 1968. Fauna Japonica. Syrphidae (Insecta: Diptera). v. III, 272 pp., 47 pls. Biogeogr. Soc. Japan, Tokyo.
- SMITH, M. R. 1919. A list of Syrphidae of Northern Indiana. Canad. Ent., **51**: 273.
- STACKELBERG, A. A. 1950. [Brief survey of the palaearctic species of the genus *Mallota* Meigen (Diptera, Syrphidae)]. Ent. Obozr., **31**: 285-296 (in Russian.)
- VIOLOVITSH, N. A. 1955. [New and little-known hover flies (Diptera, Syrphidae) from Kunashir Island]. Ent. Obozr., **34**: 350-359, 12 figs.
- . 1960. [A contribution to the knowledge of the hover flies fauna (Diptera, Syrphidae) of Sachalin and the Kuril Isles]. Trudy vses. ent. Obshch., **47**: 217-272.
- WEHR, E. 1922. A synopsis of the Syrphidae of Nebraska with descriptions of new species from Nebraska and Colorado. Univ. Stud., Lincoln, Nebraska, **22**: 119-162.
- WILLISTON, S. W. 1886. Synopsis of the North American Syrphidae. U.S. Natl. Mus. Bull., **31**: i-xxx, 1-335 (actual date, 1887).
- WIRTH, W. W., SEDMAN, Y. S. and WEEMS, H. V., JR. 1965. Family Syrphidae. In Stone, A., C. Sabrosky, W. W. Wirth, R. H. Foote, and J. Coulsen. 1965. A catalog of the Diptera of America North of Mexico. U.S. Dept. Agri. Handb. #276, 1696 pp.

**Further Observations on the Natural History of  
*Philaethria dido dido* (Lepidoptera: Nymphalidae: Heliconiinae)**

ALLEN M. YOUNG

DEPARTMENT OF BIOLOGY, LAWRENCE UNIVERSITY, APPLETON, WISCONSIN 54911

RECEIVED FOR PUBLICATION NOVEMBER 5, 1973

**Abstract:** Observations on the life cycle and natural history of *Philaethria dido dido* (Lepidoptera: Nymphalidae: Heliconiinae) as studied in northeastern Costa Rica are summarized. Emphasis is placed on: (1) additional descriptions of life stages, (2) a larval food plant record (*Passiflora vitifolia*-Passifloraceae), (3) developmental time in the laboratory (37-39 days), and (4) various behavior patterns associated with oviposition and larval development. These data and other information from the literature are discussed from the standpoint that *P. dido* is a specialized insect of tropical rain forests and that it has a widespread but strongly localized geographical distribution pattern in Central and South America.

INTRODUCTION

Owing perhaps to their apparently close evolutionary history with the Passifloraceae and their roles in mimicry complexes, neotropical butterflies of the subfamily Heliconiinae have received considerable attention from biologists interested in phylogeny, ecology, and behavior (e.g., Kaye, 1917; Beebe, 1955; Beebe, Crane, and Fleming, 1960; Crane, 1957; Emsley, 1963; 1964; 1965; Benson, 1971; Turner, 1971; Brown and Mielke, 1972). Of the seven genera in the subfamily, the genus *Philaethria* comprises a single conservative subdivision and represents a different lineage of heliconiine evolution from the other two subdivisions (Emsley, 1963). Since *Philaethria* is conservative in the sense of exhibiting many subfamily characteristics in their most generalized form and has very few specializations (Emsley, 1963), studies of member species in this genus are predicted to provide more information on the general ecological and behavioral adaptations of the subfamily as a whole. The paper of Beebe, Crane, and Fleming (1960) gives a detailed account of the early stages and food plants of *Philaethria dido dido* (Clerck) on Trinidad, and Brown and Mielke (1972) provide similar food plant data for both *P. dido dido* and *P. wernickei* (for two subspecies, *wernickei* and *pygmalion*) in extra-Amazonian and Amazonian Brazil. And while *P. dido* has a broad geographical distribution in wet tropical regions of Central and South America (Emsley, 1963;

---

**Acknowledgments:** This research is a by-product of N.S.F. Grant GB-33060, with logistic support provided by the Costa Rican Program of the Associated Colleges of the Midwest. I am grateful to Dr. J. Robert Hunter of A.C.M. for allowing me to conduct studies on his property, Finca Tirimbina. Dr. Woodruff W. Benson (Rio de Janeiro) kindly identified the larval food plant and also provided some of his own data on heliconiines exploiting this species. Keith S. Brown, Jr. (Rio) later identified the same food plant for *Heliconius hecale*.

Barcant, 1970), a good deal more needs to be learned about the biology of this interesting butterfly throughout this range. At least part of the reason why the butterfly has not been studied in Central America stems from the elusive habits of this insect: Many authors report that it is a high flier, preferring the canopy of virgin forests; it is seldom seen near the ground.

This paper summarizes some further observations on the biology of *P. dido* (Fig. 1) on the Central American mainland, with an emphasis on life cycle and natural history. The descriptions of the early stages, so well presented by Beebe, Crane, and Fleming (1960), are supplemented here with the first illustrations of the egg, third and fourth instars, and pupa. An egg-adult developmental time as measured for one species of *Passiflora* is given for the first time. These and other aspects of natural history comprise a new attempt to study the butterfly in Central America.

#### METHODS

Studies were initiated on July 1, 1973 when I made my first field record of oviposition in *P. dido* in the thinned-out old secondary forest (Fig. 2) that borders the Rio Tirimbina near La Virgen, Heredia Province, Costa Rica. Oviposition was studied on the gentle slope of forest rising from the river but not including the narrow strip of very disturbed young secondary growth where another wet-forest butterfly, *Parides arcas mylotes*, has been studied (Young, 1973). Much of this gentle slope of old secondary forest will be eliminated within two years in a land-clearing project to raise cattle, and it therefore represents one habitat or part of a larger habitat of *P. dido* that is endangered. This general region of Costa Rica on the Caribbean drainage of the Central Cordillera to the west is a basal belt transitional zone between montane and premontane tropical wet forest, and the elevation is about 225 meters.

The thinned-out condition of the forest where oviposition has been repeatedly observed is the result of farm workers beginning to clear the land with machetes, but this was postponed for two years when I spoke to the owner of this land so that various ecological studies of cicadas and butterflies could be completed. The original understory was considerably more dense than it is now (Fig. 2), but the plant species used for oviposition by *P. dido* has remained intact. Oviposition and general flying behavior of adult *P. dido* were observed in this thinned-out forest by walking slowly through 200 meters of forest, then moving about 15 meters to one side (up the slope) and repeating this; the procedure was repeated four times giving a total of five 200-meter transects, and the census was done on July 1-2, 1973; August 12-13, 1973; September 1, 1973. These censuses were conducted while sampling nested quadrats in the forest for exuviae of a large cicada (*Zammara* sp.) which was very active in the adult stage at this time.

Eggs seen to be oviposited in the field were brought into the laboratory for rearing studies. From eggs collected in this way during July and August, I reared a total of eight individuals to the adult stage, keeping records on each one for: (1) external morphology and coloration, (2) duration (days) of each life stage, including separate instars of larvae, and (3) behavior patterns of larvae. Each individual was reared separately in a small clear plastic bag containing fresh clippings of the food plant; the bag was always kept tightly tied to prevent desiccation of the food. All bags (a total of thirteen) were kept together on a shaded shelf in a second-story apartment (Apartamentos Miami) in San José and cleaned every three or four days for removal of fecal material and excess condensation. In order to observe intraspecific interactions among larvae, I occasionally would place three or four individuals together in a plastic bag containing one or two cuttings of the food plant. My interest here was to observe aggressive encounters, or lack thereof, among larvae. All life stages were photographed at the same time that notes were made on coloration and morphology. The adult specimens obtained from these rearings are preserved in my permanent collection and can be made available to interested workers upon request. Owing to the reputed high local variation in the wing color pattern of adult *P. dido* (e.g., Emsley, 1963), students of intraspecific variation in tropical insects might find such collections useful for systematic studies. Pupal shells have also been preserved from this study.

## RESULTS

### *Life Cycle*

Since there exists one excellent text account of the life stages of *P. dido* (Beebe, Crane, and Fleming, 1960), it would be redundant to describe the stages as seen in the present study. Rather, I refer the interested reader to the account of Beebe, Crane, and Fleming, and wish only to supplement those observations with figures of the egg, third instar, fourth instar, and pupa (Fig. 3)—stages described but not pictured in Beebe, Crane, and Fleming. I also present some observations on color differences in the fifth instar between Costa Rica and Trinidad and give specific developmental time data for *P. dido* (not given in Beebe et al., 1960), contrasting this developmental time to the general pattern offered by Beebe et al.

Beebe et al. (1960) report that the head of fifth instar is bright orange, but for the Costa Rican individuals studied the head is clearly beige and slightly shiny. At the base of each of the two head scoli there is an irregularly shaped black spot not given in Beebe et al., and the portions of the body described in Beebe et al. as being white are pale green throughout the fifth instar in the Costa Rican *P. dido* studied. The supralateral thoracic scoli in the Costa Rican fifth instars do not have black tips and the basal portion



FIG. 1. An adult male *Philaethria dido dido* (dorsal view). This is one of the individuals obtained from eggs collected at Finca Tirimbina, La Virgen, Heredia Province, Costa Rica, July 1973.

of each is distinctly orange while the shaft is red. This does not occur in Trinidad *P. dido*. Furthermore, the sublaterals of abdominal segments in Costa Rica are greenish-white with faint black tips, and not the white-orange-black pattern as seen on Trinidad (Beebe et al., 1960). The longest scoli on the Costa Rican fifth instars are 8–9 mm long.

Beebe et al. (1960) also state that the usual duration of the egg stage in Trinidad heliconiines (including *P. dido*) is about four days. For Costa Rican *P. dido* at about 23°C and humid confined bags, the egg stage lasts seven days. The entire larval period is about nineteen days, with the first instar lasting three days, the second three days, the third three days, the fourth about four days, and the fifth about six days.

Beebe et al. (1960) state that pupae of the "group A type," which includes (in addition to *P. dido*) *Agraulis vanillae*, *Dione juno*, *Dryadula phaetusa*, *Dryas julia*, and *Heliconius doris*, are generally brown in color. I figure the pupa of *P. dido* here (Fig. 3F) to point out its distinct mottled color pattern as seen in Costa Rica. The pupa is about 30 mm long and resembles a piece of broken-off, rough tree bark, being mottled boldly in various shades of brown and gray. It is perhaps one of the most cryptic of heliconiine pupae.



FIG. 2. The thinned-out old secondary forest habitat at the edge of transitional-zone rain forest at Finca Tirimbina where female *P. dido dido* oviposits on *Passiflora vitifolia* (Passifloraceae) vines that grow along the ground and over rocks and tree stumps.

The pupa for Costa Rican *P. dido* lasts about eleven days for the male and twelve or thirteen days in the female. Beebe et al. do not give a typical duration figure for the pupal stage.

From these considerations, the overall egg-adult developmental time for *P. dido* in laboratory culture in Costa Rica is 37 to 39 days. Some discrepancies between the present study of *P. dido* and the larval developmental time generalizations of Beebe et al. (1960) for heliconiines include: (1) the first and second instars of three days as opposed to two days, (2) the fourth instar of four days, and (3) the usual duration of the fifth instar of six days instead of the usual five days. The overall larval period noted by Beebe et al. is twelve days as opposed to the nineteen days found here for *P. dido*.

#### *Larval Food Plant*

The plant used for oviposition is *Passiflora vitifolia* and it occurs at the study site as a large, sprawling vine on the ground, logs, and tree stumps. The vine does not go into the canopy here, but it is difficult to say if this has

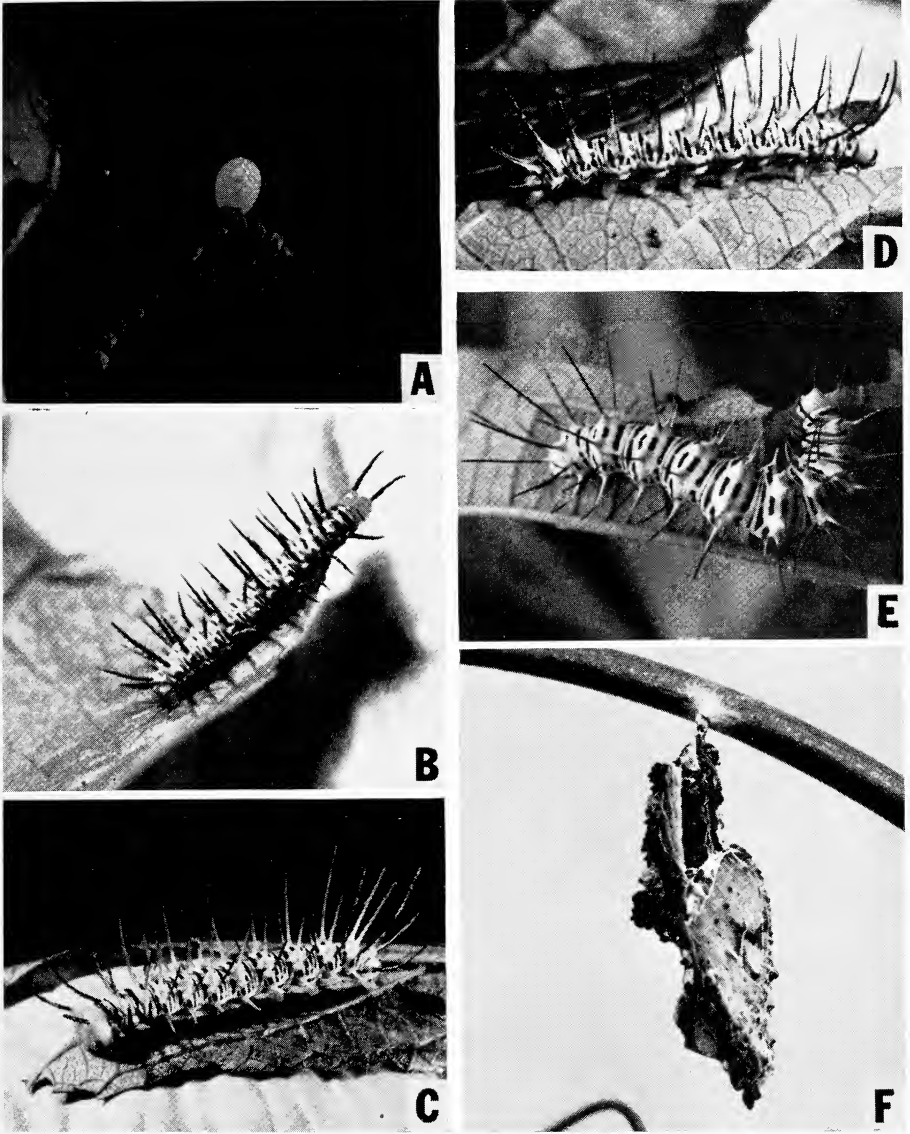

FIG. 3. Some life stages of *P. dido dido* in Costa Rica. (A) egg, (B) third instar larva, (C) fourth instar larva showing one aspect of scoli distribution and coloration, (D) fourth instar larva showing another aspect of scoli distribution and coloration, (E) fifth instar, dorsal view, and (F) the pupa, lateral view.

always been the case owing to the selective thinning out of trees by farmers. But the large size of the sprawling vine near the ground is indicative of successful thriving in this zone of the forest environment. The leaves are thick and with rough texture. I have not found other heliconiines on this species of *Passiflora* in the study site, but at Rincon de Osa, a lowland tropical wet-forest site on the southern Pacific coast of Costa Rica, Dr. Woodruff W. Benson (pers. comm.) has found *P. dido* and several other heliconiines feeding on this plant. It is a species of *Passiflora* that has clearly been exploited by heliconiines at different stages in the evolutionary development of the subfamily. It appears to be a favorite food plant for the subfamily at wetter lowland sites in Costa Rica and other regions of southern Central America.

The larvae of all instars for *P. dido* feed primarily on the older and larger leaves of *P. vitifolia* as studied in the laboratory. But this may also be true in the wild since eggs are laid on older leaves (see below).

#### *Oviposition Behavior*

Some authors (e.g., Barcant, 1970; Brown and Mielke, 1972) have commented that *P. dido* is a high flier over treetops in forests. But oviposition clearly sometimes occurs near the ground as seen in the present study. For all of the times I observed oviposition, it occurred in sunny weather, either in the morning or early afternoon. The typical flight pattern of female *P. dido* would be to appear suddenly in the lower portion of the thinned-out forest and make several attempted ovipositions before actually laying an egg. In several instances, the female would actually grasp a tendril or leaf with wings fluttering for stability, but an egg was not laid. I followed one female on July 2 and it was almost twelve minutes before an egg was laid, despite several intervening attempts at oviposition. The pattern is somewhat frustrating to the observer since it almost appears as if the *Passiflora* species in question was not acceptable to *P. dido*.

The bright yellow large egg is laid either on the ventral side of an older leaf of *P. vitifolia*, or else on a dead tendril. In a total of fourteen eggs actually observed to be oviposited, nine were on leaves and the remaining five on dead tendrils. The female flies very erratically between ovipositions or attempted ovipositions, suddenly darting up into the canopy and then coming back down to the *Passiflora*. A single female will remain in the same general area where the *Passiflora* is growing for as long as 25 minutes in my experience. Out of a total of probably five different females of *P. dido* observed ovipositing during July and August, three of these were very fresh individuals, and could not have been more than a day or two out of the chrysalis. It is especially easy to distinguish very young or fresh adults in *P. dido* since, as noted by Emsley (1963), wing color fades very rapidly in this species. Females of *P. dido* may therefore be mated almost immediately after emerging



from their pupae. It is not known, however, if males wait near female pupae for future mates, as noted for *Ornithoptera* (Papilionidae) species (Borch and Schmid, 1973).

### *Larval Behavior*

The first instar larva devours its empty eggshell, and during subsequent molts, larvae also eat their castoff exuviae. These two behavior patterns have not been previously reported for *P. dido* by Alexander (1961a). In terms of feeding on leaf tissue, the larvae exhibit the channeling behavior reported by Alexander (1961a) for *Dione*. The larvae of *P. dido* do not remove fecal material with the jaws as described in Alexander (1961a) for the larvae of several *Heliconius*. The resting behavior, not studied for *P. dido* by Alexander, is very variable in the laboratory, but usually involves the larva facing the direction of feeding; often a larva assumes a hooked or "J" position as noted by Alexander for *Heliconius isabella*, *H. melpomene*, and *H. ricini*.

Weaving is also well expressed in the construction of silken pathways along stems and ventral sides of leaves. Disturbed larvae are very mobile for several minutes, and they walk very fast. As in *Heliconius erato* (Alexander, 1961a), the larvae of *P. dido* are clearly asocial and very aggressive and there are no signs of any gregarious behavior (including social defecation) of the type so evident in *Dione juno* (Alexander, 1961a; Muysshondt, Young, and Muysshondt, 1973). Individual larvae do not share the same leaf without fighting, as seen in laboratory culture. Another aspect suggesting that *P. dido* is truly a solitary species is the complete lack of synchrony among larvae for feeding and resting. From these observations, I suspect that the larvae of *P. dido* are considerably more aggressive and asocial than originally predicted by Alexander, thus being closer to the behavior patterns of *H. erato* than to *H. melpomene* or *Dione*.

### DISCUSSION

The above observations are intended to supplement what has been already determined of the life cycle and natural history of *P. dido* as studied in Trinidad (Beebe, Crane, and Fleming, 1960; Alexander, 1961a; Emsley, 1963; Barcant, 1970) and Brazil (Brown and Mielke, 1972). This report concerns the butterfly in Central America where I am sure several researchers have reared the species in the past.

One of the interesting characteristics of the distributional biology of *P. dido* is the apparently widespread but strongly localized occurrence of the butterfly in the rain forests of Central and South America. The species is susceptible to regional restriction by land barriers: Brown and Mielke (1972) comment that in extra-Amazonian Brazil this species and several other heliconiines are restricted to tropical regions by high southeastern coastal mountains but that it and *P. wernickei* are sympatric over the lower and middle Amazon

Basin and along the eastern coast of Brazil (as far south as Rio de Janeiro). In Costa Rica, the distributional pattern is also molded by the Central Cordillera and confines the butterfly to all of the Caribbean lowlands and southwestern Pacific wet lowlands. The butterfly seldom occurs above 400-meters elevation in Costa Rica, although an occasional adult is seen at elevations as high as 900 meters. The butterfly is also rare in lowland Guanacaste Province, where there is a strong but variable dry season each year.

Various authors (Emsley, 1963; Barcant, 1970; Brown and Mielke, 1972) have emphasized that *P. dido* inhabits forest clearings and edges of rain forests. The same pattern is seen in Costa Rica, although studies are lacking from the canopy in the interior of forests. Certainly one larval food plant, *P. vitifolia*, is abundant in thinned-out forest at their edges; the distributional pattern of such plants and the spectrum of *Passiflora* species exploitation by *P. dido* are the major determinants of habitat selection for oviposition and larval development.

The literature suggests that there may exist considerable specificity for certain species of *Passiflora* in *P. dido*. Beebe, Crane, and Fleming (1960) noted that although the usual food plant in Trinidad is *P. laurifolia*, oviposition (I am equating oviposition with correct larval food plant) also occasionally occurs on *P. cyanea*. Brown and Mielke (1972) report that the preferred food plant is *P. mucronata* in extra-Amazonian Brazil and that larvae refuse *P. alata* and *P. speciosa*, even though both of these are very closely related to *P. vitifolia*, the food plant in Costa Rica (this paper and Woodruff Benson, pers. comm.), and also in Colombia and Panama (Brown and Mielke). Of other Brazilian *Passifloraceae*, *P. dido* also refuses *P. violacea*, *P. jileki*, and *Tetrastylis ovalis* (Brown and Mielke, 1972). Such food plant specialization in *P. dido* in Brazil could have resulted from an evolutionary divergence in food plant exploitation brought about by sympatry with *P. wernickei*, which has been observed (Brown and Mielke, 1972) to feed on other species of *Passiflora* not used by *P. dido*. But clearly other heliconiines might also have exerted some ecological pressure for food plant specialization. However, this is apparently not the case in Costa Rica where several heliconiines exploit *P. vitifolia* at least on the Osa Peninsula. Another important factor to consider is the relative ease with which some species of *Passiflora* can be exploited as larval food plants over others. For example, *Heliconius hecale* and *Agraulis vanillae* are at least two other heliconiines found together on *P. vitifolia* in Guanacaste, Costa Rica (Allen M. Young, pers. obs.). And it is known that *H. hecale* exploits this species over much of Central America and Colombia and as far as Ecuador, along with many other heliconiine species (Keith S. Brown, Jr., pers. comm.). The abundance of this vine and the size of individuals may provide a nonlimited food source for many heliconiines, especially if many of these butterflies have low average fecundities per female (e.g., see Labine,

1968, for *Heliconius erato* egg production). Furthermore, if the local complex of heliconiines exploiting one or a few species of Passifloraceae contains some genera with high dispersal tendencies in the adult stage (see Benson, 1971, for comments concerning generic patterns of heliconiine dispersal tendencies), then this would also lessen the local exploitation of single patches of the vines, a consideration especially important if a given local species of *Passiflora* is very dispersed itself. Although I have not found many other heliconiines on *P. vitifolia* at Tirimbina, this is because systematic searches have not yet been conducted, although I suspect that the herbivore load would be reasonably similar to that observed by Benson on the Osa Peninsula (to be reported by him in a forthcoming paper).

The traditional question of palatability that shrouds ecological and evolutionary approaches to the Heliconiinae is interesting to consider for *Philaethria* butterflies, owing to the generalized separate lineage from other members of the subfamily (Emsley, 1963). If it is assumed that the genetic and physiological adaptations for withstanding toxic compounds derived from plant tissue are a derivative or advanced evolutionary trait in butterflies (Brower and Brower, 1964), the question then arises whether a generalized genus like *Philaethria* has the ability to develop unpalatability. Certainly, the rather convincing resemblance between this butterfly and the presumably palatable mimic *Victorina (Metamorpha) stelenes* (Nymphalidae: Nymphalinae) suggests that *P. dido* is a Batesian model in this interaction (Brower and Brower, 1964), although (1) *P. dido* is absent in El Salvadore where *V. stelenes* is very abundant, and (2) local abundance of *V. stelenes* exceeds that of *P. dido* in young secondary fields in northeastern Costa Rica (Young, 1972). The ability of several of the more primitive heliconiine genera, such as *Agraulis* to feed on *P. vitifolia* suggests that *Philaethria dido* may be palatable, if primitive or generalized genera are unable to develop detoxication systems, as suggested recently by Benson (1971). But since *Philaethria* represents a separate lineage of heliconiine evolution from these other genera, a physiological divergence might have occurred with respect to detoxication systems: *Philaethria* may have evolved them while the clustered lineage of *Agraulis*, *Dione*, *Dryadula*, and *Podotricha* (Emsley, 1963) might not have achieved this, allowing toxic materials to pass out of the gut in fecal pellets. It is clear that the question of palatability, or lack thereof, is still very open in *Philaethria* and warrants further study.

Beebe, Crane, and Fleming (1960) have gone into considerable detail on the comparative analysis of life stages among many heliconiines, including *P. dido*. But I do wish to point out some variations in coloration seen in the fifth instar larva and adult from Costa Rica. It is difficult at the present to attach significance to color differences in the fifth instar between Costa Rica and Trinidad since presumably the same subspecies (*dido*) applies to both regions.

But in the adult series from Tirimbina, the marginal row of light green spots on the dorsal side of each hindwing (Fig. 1) is considerably smaller than in the adult figured in Beebe, Crane, and Fleming (1960). The difference is very stable in all reared adults, and it is also consistent with wild-caught specimens from Tirimbina and nearby Finca La Selva (8 km) that I have obtained over the past five years. Color differences in immatures are difficult to evaluate since they may reflect contemporary ecological specializations and have little or nothing to do with evolutionary history. Brown (1972) comments that the color pattern of older larvae for *Heliconius hermatheria* converges on that of *P. dido* and he interprets this as ecological specialization.

Borrowing from the recent discussion of Benson (1971), it is interesting to cast life cycle and natural historical data for *P. dido* in terms of a pattern of ecological adaptation. Single oviposition, highly aggressive larvae, and apparent food plant specialization are ethological and ecological mechanisms that reflect increased dispersal tendencies of the adult population. From selection pressures favoring a noncohesive adult population, it is also predicted that the opportunity for communal roosting to evolve in *P. dido* would also be very low. In my experience and surely in that of other researchers, *P. dido* adults occur at very low densities in tropical forests, even though a given population might be strongly localized in a region (Brown and Mielke, 1972, point out the latter). I believe that the natural historical observations discussed here and in previous papers are consistent with a non-home-ranging and non-viscous (Benson, 1971) adult population structure for *P. dido* at edges and clearings of tropical rain forests in Central and South America. Localizations of populations of *P. dido* are predicted to be determined primarily by local topographic effects and by a variety of other natural and perhaps man-made land barriers. If topographic barriers are few in a region or become modified by man, we might expect zones of overlap where two or more different forms might co-occur. This would account for the confusion in the literature concerning sympatric populations of *P. dido dido* and *P. dido wernickei* or other varieties on the Central American mainland, while other populations contain only one form, as discussed in Emsley (1963). Especially near breaks in mountains and low hills, we might expect considerable local variety in color pattern, but along the more distal coastal regions, uniformity of the sort encountered in Costa Rica at Tirimbina and La Selva would be expected.

#### Literature Cited

- ALEXANDER, A. J. 1961a. A study of the biology and behavior of the caterpillars, pupae, and emerging butterflies of the subfamily Heliconiinae in Trinidad, West Indies. Part I. Some aspects of larval behavior. *Zoologica*, **46**: 1-24.
- ALEXANDER, A. J. 1961b. Part II. Molting, and the behavior of pupae and emerging adults. *Zoologica*, **46**: 105-122.

- BARCANT, M. 1970. "Butterflies of Trinidad and Tobago." London: Collins, 314 pp.
- BEEBE, W. 1955. Polymorphism in reared broods of *Heliconius* butterflies from Surinam and Trinidad. *Zoologica*, **40**: 139-143.
- BEEBE, W., CRANE, J., AND FLEMING, H. 1960. A comparison of eggs, larvae, and pupae in fourteen species of heliconiine butterflies from Trinidad, West Indies. *Zoologica*, **45**: 111-154.
- BENSON, W. W. 1971. Evidence for the evolution of unpalatability through kin selection in the Heliconiinae (Lepidoptera: Nymphalidae). *Amer. Nat.*, **105**: 213-226.
- BORCH, H., AND SCHMID, F. 1973. On *Ornithoptera priamus caelestis* Rothschild, *demonophanes* Fruhstorfer and *boisduvali* Montrouzier (Papilionidae). *J. Lep. Soc.*, **27**: 196-205.
- BROWER, L. P., AND BROWER, J. V. Z. 1964. Birds, butterflies, and plant poisons: A study in ecological chemistry. *Zoologica*, **49**: 137-159.
- BROWN, K. S., JR., AND MIELKE, O. H. H. 1972. The Heliconians of Brazil (Lepidoptera: Nymphalidae). Part II. Introduction and general comments, with a supplementary revision of the tribe. *Zoologica*, **57**: 1-40.
- CRANE, J. 1957. Imaginal behavior in butterflies of the subfamily Heliconiinae: Changing social patterns and irrelevant actions. *Zoologica*, **42**: 135-146.
- EMSLEY, M. G. 1963. A morphological study of imagine Heliconiinae (Lep.: Nymphalidae), with a consideration of the evolutionary relationships within the group. *Zoologica*, **48**: 85-130.
- EMSLEY, M. G. 1964. The geographical distribution of the color pattern components of *Heliconius erato* and *Heliconius melpomene*, with genetical evidence for a systematical relationship between the two species. *Zoologica*, **49**: 245-286.
- EMSLEY, M. G. 1965. Speciation in *Heliconius* (Lep.: Nymphalidae): Morphology and geographic distribution. *Zoologica*, **50**: 191-254.
- KAYE, W. J. 1917. A reply to Dr. Eltringham's paper on the genus *Heliconius*. *Trans. Ent. Soc. London*, **1916**: 149-155.
- LABINE, P. A. 1968. The population biology of the butterfly *Euphydryas editha*. VIII. Oviposition and its relation to patterns of oviposition in other butterflies. *Evolution*, **22**: 799-805.
- MUYSHONDT, A., YOUNG, A. M., AND MUYSHONDT, A., JR. 1973. The biology of the butterfly *Dione juno huascama* (Nymphalidae: Heliconiinae) in El Salvador. *Jour. New York Entomol. Soc.*, **81**: 137-151.
- TURNER, J. R. G. 1971. The genetics of some polymorphic forms of the butterflies *Heliconius melpomene* (Linnaeus) and *H. erato* (Linnaeus). II. The hybridization of subspecies of *H. melpomene* from Surinam and Trinidad. *Zoologica*, **56**: 125-157.
- YOUNG, A. M. 1972. Interactions of *Philaethria dido* (Heliconiinae) and *Victorina stelenes* (Nymphalinae) at *Stachytarpheta* flowers in Costa Rica: Evidence against mimetic association. *Act. Biol. Venez.*, **8**: 1-17.
- YOUNG, A. M. 1973. Notes on the life cycle and natural history of *Parides arcas mylotus* (Papilionidae) in Costa Rican premontane wet forest. *Psyche*, **80**: 1-22.

## Ovipositing of *Circulifer tenellus* Baker (Homoptera, Cicadellidae)

KARL MARAMOROSCH

INSTITUTE OF MICROBIOLOGY, RUTGERS UNIVERSITY, NEW BRUNSWICK, N. J. 08903

RECEIVED FOR PUBLICATION NOVEMBER 15, 1973

In the course of experiments with leafhopper vectors of certain plant disease agents, such as viruses and mollicutelike organisms (Maramorosch, 1969), an observation was made concerning oviposition by *Circulifer tenellus* Baker, the beet leafhopper that transmits the agent of sugar beet curly top disease. Groups of 10 adult male and female leafhoppers were routinely confined to sugar beet plants in small cages, fastened to either the upper or the lower leaf surface by clip cages (Maramorosch, 1951) or by magnetically attached cages (Kaloostian, 1955). The latter were modified sometimes so as to provide adequate aeration through a cylinder made of Saran monofilament plastic screen (Fig. 1). Irrespective of the type of leaf cage used, only the upper or lower leaf surface was accessible to the feeding insects. This "limited access" feeding differed from the usual methods in which stock culture or disease agent-carrying insects are given free access to all aboveground parts of a test plant.

Frequently during the summer months gravid beet leafhopper females deposited eggs in leaf tissues while confined to beet plants in small cages. Surprisingly, eggs were deposited in such a manner that nymphs never hatched on the side on which the females were confined. Whenever the cages were attached to the upper surface of leaves (Fig. 1), the eggs were found protruding from the lower surface (Fig. 2). When insects were placed on the lower leaf surface, their eggs were seen on the upper surface only (Fig. 3). The number of eggs found on the lower surfaces seemed to exceed the number deposited on the upper ones, but no statistical analysis was made to ascertain whether the difference was significant.

In a few instances leaf cages containing gravid females were left attached for as long as three to five weeks without disturbing the insects. In such instances nymphs that hatched from deposited eggs began to feed on the side opposite the caged adults. Some nymphs managed to squeeze through occasional narrow gaps between the leaf surface and the bottom part of the clip cage and they would occasionally appear on other parts of a test plant. Once free to move, such first and second instar nymphs would become potential sources of greenhouse contamination.

To prevent the escape of progeny nymphs and accidental greenhouse contamination, exposed leaves were marked by punched holes. After the

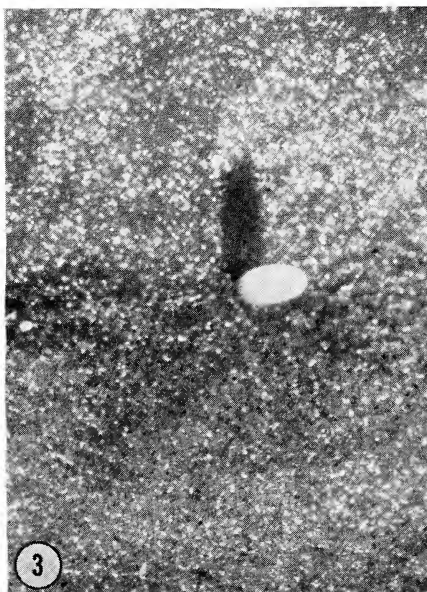
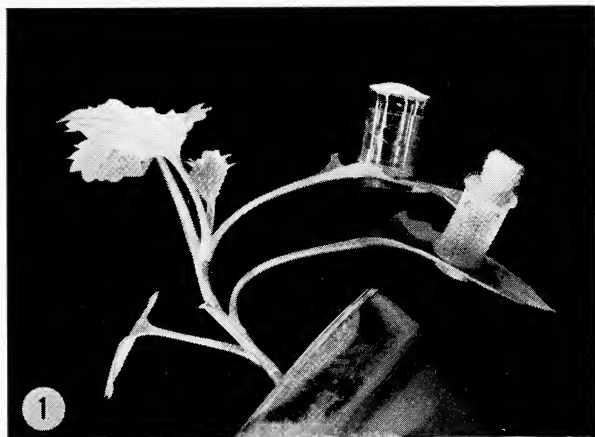

FIG. 1. Two insect cages, magnetically attached to leaves. Upper (left) cage is of cellulose nitrate tubing, with a Saran monofilament screen on top. Lower (right) cage is made entirely of Saran monofilament screen, with cotton plug on top to insert insects. The bottom of each cage, resting on the leaf surface, is covered by a 15 denier nylon screen.

FIG. 2. When caged insects were confined to the upper leaf surface, eggs were protruding from the lower surface.

FIG. 3. Single leafhopper egg, protruding from upper surface of a leaf; in this instance a gravid female was confined to the lower surface of the leaf.

removal of insect cages, usually within the first ten days of test feeding, the marked leaf portion was cut off and destroyed before first instar nymphs began to hatch. Whenever gravid females had to be confined to plants in leaf cages for periods exceeding three to four days, the cages were transferred from one area to another, or from leaf to leaf, and the exposed portion containing deposited eggs was excised and discarded. This procedure did not prevent successful inoculation of plants with viruses or mollicutelike agents (Maramorosch et al., 1962) since these disease agents were rapidly transported through phloem elements to other parts of the plant.

A probable explanation of the observed hatching of nymphs on the leaf surface opposite that of female confinement was the length of the ovipositor and the depth of penetration (Müller, 1942). It seems less likely, though not inconceivable, to assume that the females were making a deliberate attempt to place their eggs in such a manner as to ensure that their progeny would not hatch within the limited area of their own "prison confinement." The first, purely mechanistic, explanation seems the more plausible.

Forcing oviposition by means of leaf cages within a limited area of a leaf has also been advantageous for the rapid collection of leafhopper eggs, used as the source of embryonic material for insect tissue culture (Hirumi and Maramorosch, 1964).

#### Literature Cited

- HIRUMI, H. AND MARAMOROSCH, K. 1964. Insect tissue culture: use of blastokinetic stage of leafhopper embryo. *Science*, **144**: 1465-1467.
- KALOOSTIAN, G. H. 1955. A magnetically suspended insect cage. *J. Econ. Entomol.*, **48**: 756-757.
- MARAMOROSCH, K. 1951. Handy insect-vector cage. *Jour. New York Entomol. Soc.*, **59**: 49-50.
- MARAMOROSCH, K. (ed.). 1969. "Viruses, Vectors, and Vegetation." John Wiley-Interscience, New York. 666 pp.
- MARAMOROSCH, K., MARTINEZ, A. L., AND MAISEY, S. 1962. Translocation of aster yellows virus in aster plants. *Phytopathology*, **52**: 20.
- MÜLLER, H. J. 1942. Über Bau und Funktion des Legapparates der Zikaden (Homoptera Cicadina). *Z. Morphologie u. Ökologie der Tiere*, **38**: 534-629.



## The Sphingidae of Turrialba, Costa Rica

RICHARD P. SEIFERT

DEPARTMENT OF ECOLOGY AND EVOLUTION, STATE UNIVERSITY OF NEW YORK, STONY BROOK,  
NEW YORK 11790

RECEIVED FOR PUBLICATION OCTOBER 19, 1973

**Abstract:** A five-month study of the Sphingidae at Turrialba, Costa Rica, was made. A total of 565 specimens of 66 species was collected, of which *Errinyis ello* was the most common. A monthly record of these data is presented. Selected data from other Costa Rican sites are included; they bring the total number of species discussed to 80. The known distribution of ten species is extended.

Statistical data on the times of flights are given for the Turrialba species, particularly for those that are common. Differences in temporal activity of closely related species may be the result of competition.

### INTRODUCTION

In most regions of the New World Tropics, there is a paucity of knowledge about insect communities. Even in the families of Lepidoptera where the taxonomy is well known, distributional data in general are very limited and collections covering a considerable time span at a single locality are few. In this study, I focus on the seasonal abundance of the hawk moths (Sphingidae) within the vicinity of the Interamerican Institute of Agricultural Sciences near Turrialba, Costa Rica, during a five-month period from January through May of 1967. Certain species discussed here were collected only in Costa Rican localities other than Turrialba. I have included these species to provide broader knowledge of the Costa Rican fauna. However, this paper gives a complete record of sphingids from Turrialba only.

### *Field Site*

The Interamerican Institute of Agricultural Sciences (09°45' North Latitude; 83°38' West Longitude; 602 meters elevation) is located 45 km. south-

---

**Acknowledgments:** I should like to thank Robert Hunter and Leslie Holdridge for their help throughout this project, as well as Kenneth Christiansen and O. R. Taylor who read drafts of this paper and contributed valuable comments. It gives me particular pleasure to thank W. L. Staudinger, who provided encouragement and constant help, and William Sieker, who helped identify many of the difficult specimens and was never too busy to answer my myriad questions. This research was sponsored by Grinnell College and by the Associated Colleges of the Midwest. The Tropical Science Center, the Interamerican Institute of Agricultural Sciences, and the Universidad de Costa Rica allowed use of their facilities. The typing was done by Florence H. Seifert and Eileen Fischer.

east of San José. The average yearly temperature, rainfall, and relative humidity of this area are 22.4°C, 2547.5 mm., and 87.5 percent, respectively. This area is classified by the Holdridge system (Holdridge, 1964) as Tropical Premontane Wet Forest. An important feature of the study site is the large area of primary vegetation near the institute. Two rivers, the Rio Turrialba and the Rio Reventazon, join near the study area, and the land along the edges of these rivers is largely primary forest. The study area is surrounded on three sides by these forests; the fourth side faces pasture and coffee fields. The site is situated in a small valley and probably drew moths from the surrounding hills.

Fourteen fluorescent lights were situated approximately three meters off the ground along the edges of the forest. One additional fluorescent light was set up on a white reflecting wall looking into the forest at a height of ten meters. Two black lights were installed at about two meters height facing the forest. The lights were situated in a manner so that each light could be observed at least once within a one-hour period and the time of collection of most moths was recorded. The perimeter of this study site was about three kilometers and collections were generally made from 7:00 P.M. until 2:00 A.M., approximately fifteen nights each month.

#### RESULTS AND DISCUSSION

##### *Annotated List of Species*

A total of 80 species of Sphingidae was covered in this report, of which 565 specimens of 66 species were collected in Turrialba. The most abundant species in the Turrialba collection was *Erinnyis ello*, which is the most common species of Sphingidae in the New World tropics. *Ampllyterus gannascus*, *Erinnyis oenotrus*, *Agrilus cingulata*, and *Pachylia resumens* were the next most common species, in order of abundance. Tables 1 through 5 list by subfamily the Sphingidae collected in Costa Rica. Except where otherwise noted, the species were collected at Turrialba. Numbers of specimens per month are given as well as the relative abundances. The terms for abundance are those used by Fleming in his 1947 paper on the Sphingidae of Rancho Grande. They are as follows:

Abundant .....	101 or more specimens
Common .....	11 to 100 specimens
Occasional .....	5 to 10 specimens
Rare .....	2 to 4 specimens
Unique .....	Only 1 specimen

Seventeen species of the subfamily Acherontiinae were collected throughout Costa Rica during the study, of which 92 specimens of thirteen species

TABLE 1. Annotated List of Acherontiinae

Species	Relative Abundance	Number Collected				
		Jan.	Feb.	March	April	May
<i>Agrilus cingulata</i> (Fabricius)	Common	0	1	1	19	5
<i>Neococytius cluentius</i> (Cramer)	Collected only at San José					
<i>Coccytius duponchal</i> (Poey)	Common	0	0	2	3	6
<i>Coccytius anteus medor</i> (Stoll)	Unique	0	0	0	1	0
<i>Amphimoea walkeri</i> (Boisduval)	Collected only at Buenos Aires					
<i>Manduca sexta</i> (Johansson)	Occasional	5	0	0	1	1
<i>Manduca dilucida</i> (W. H. Edwards)	Collected only at Taboga					
<i>Manduca occulta</i> (Rothschild and Jordan)	Common	11	0	2	1	3
<i>Manduca hannibal</i> (Cramer)	Unique	1	0	0	0	0
<i>Manduca pellentia</i> (Herrich-Schäffer)	Unique	1	0	0	0	0
<i>Manduca ochus</i> (Klug)	Rare	3	0	0	0	2
<i>Manduca lefeburei</i> (Guer.)	Rare	2	0	0	0	1
<i>Manduca rustica</i> (Fabricius)	Rare	4	0	0	1	2
<i>Manduca lichenea</i> (Burmeister)	Unique	1	0	0	0	0
<i>Manduca florestan</i> (Stoll)	Common	15	1	4	1	4
<i>Manduca corallina</i> (Druce)	Collected only in Santa Cruz					
<i>Sphinx merops</i> (Boisduval)	Common	11	0	0	2	6

TABLE 2. Annotated List of Ambulicinae

Species	Relative Abundance	Number Collected				
		Jan.	Feb.	March	April	May
<i>Protoambulyx strigilis</i> (Linnaeus)	Common	14	0	0	2	4
<i>Ampliterus gannascus</i> (Stoll)	Common	27	0	5	4	8
<i>Ampliterus ypsilon</i> (Rothschild and Jordan)	Common	16	0	3	3	4
<i>Ampliterus donysa</i> (Druce)	Collected only at Vara Blanca					

TABLE 3. Annotated List of Sesinae

Species	Relative Abundance	Number Collected				
		Jan.	Feb.	March	April	May
<i>Pseudosphinx tetrio</i> (Linnaeus)	Unique	1	0	0	1	0
<i>Isognathus rimosa inclitus</i> (W. H. Edwards)	Unique	1	0	0	0	1
<i>Erinnyis ello</i> (Linnaeus)	Abundant	150	6	5	66	46
<i>Erinnyis alope</i> (Drury)	Occasional	6	0	0	2	2
<i>Erinnyis crameri</i> (Schaus)	Unique	1	0	0	0	1
<i>Erinnyis oenotrus</i> (Stoll)	Common	25	1	2	10	6
<i>Erinnyis obscura</i> (Fabricius)	Occasional	6	1	2	1	2
<i>Erinnyis lassauxi</i> (Boisduval)	Rare	4	0	1	2	1
<i>Pachylia ficus</i> (Linnaeus)	Common	16	1	1	4	9
<i>Pachylia syces</i> (Hubner)	Unique	1	0	0	1	0
<i>Pachylia resumens</i> (Walker)	Common	20	0	1	7	12
<i>Pachylia darceta</i> (Druce)	Unique	1	0	0	1	0
<i>Leucorhampha triptolemus</i> (Cramer)	Unique	1	0	0	1	0
<i>Madoryx phuto</i> (Cramer)	Rare	3	0	0	1	2
<i>Madoryx oiclus</i> (Cramer)	Collected only at Orotina					
<i>Hemeroplanes parce</i> (Fabricius)	Unique	1	0	1	0	0
<i>Hemeroplanes nomius</i> (Walker)	Rare	3	0	0	1	1
<i>Hemeroplanes pan denticulata</i> (Schaus)	Occasional	8	0	1	3	1
<i>Hemeroplanes inuus</i> (Rothschild and Jordan)	Rare	4	0	0	0	2
<i>Epistor lugubris</i> (Linnaeus)	Occasional	6	0	0	1	5
<i>Epistor ocypete</i> (Linnaeus)	Occasional	8	0	0	0	7
<i>Epistor gorgon</i> (Cramer)	Rare	2	0	0	2	0
<i>Stolidoptera tachasara</i> (Druce)	Collected only at Vara Blanca					
<i>Aleuron neglectum</i> (Rothschild and Jordan)	Collected only at Finca La Selva					

TABLE 3. Continued

<i>Enyo pronoe</i> (Druce)	Collected only at Finca La Selva							
<i>Pacaygonia drucei</i> (Rothschild and Jordan)	Collected only at Finca La Selva							
<i>Cautethia spuria</i> (Boisduval)	Common	12	0	3	7	1	1	1
<i>Nyceryx coffeae</i> (Walker)	Unique	1	0	0	1	0	0	0
<i>Nyceryx magna</i> (Felder)	Unique	1	0	0	1	0	0	0
<i>Nyceryx tacita</i> (Druce)	Rare	2	0	0	2	0	0	0
<i>Nyceryx eximia</i> (Rothschild and Jordan)	Occasional	5	0	1	0	4	0	0
<i>Perygonia stulta</i> (Herrich-Schafer)	Unique	1	0	0	0	1	0	0
<i>Perygonia lusca restituta</i> (Walker)	Rare	4	0	0	0	4	0	0
<i>Sesia ceculus</i> (Cramer)	Collected only at Finca La Selva							
<i>Sesia titan</i> (Cramer)	Collected only at Tilaran							

TABLE 4. Annotated List of Philampelinae

Species	Relative Abundance	Number Collected				
		Jan.	Feb.	March	April	May
<i>Eumorpha anchemolus</i> (Cramer)	Common	0	0	4	2	5
<i>Eumorpha triangulum</i> (Rothschild and Jordan)	Common	0	3	4	4	5
<i>Eumorpha satellita lichaon</i> (Cramer)	Unique	0	0	1	0	0
<i>Eumorpha obliquus</i> (Rothschild and Jordan)	Occasional	0	1	3	1	0
<i>Eumorpha fasciatus</i> (Sulzer)	Unique	0	0	0	0	1
<i>Eumorpha labruscae</i> (Linnaeus)	Rare	0	0	0	0	2
<i>Eumorpha phorbis</i> (Cramer)	Rare	0	0	1	1	0
<i>Eumorpha capronnieri</i> (Boisduval)	Unique	1	No data	label		

TABLE 5. Annotated List of Choerocampinae

Species	Relative Abundance	Number Collected	Number Collected				
			Jan.	Feb.	March	April	May
<i>Xylophanes pluto</i> (Fabricius)	Common	22	0	1	6	11	4
<i>Xylophanes pistacina</i> (Boisduval)	Unique	1	0	0	0	0	1
<i>Xylophanes porcus continentalis</i> (Rothschild and Jordan)	Common	13	1	1	5	4	2
<i>Xylophanes zurcheri</i> (Druce)	Rare	4	0	0	1	2	1
<i>Xylophanes ceratomioides</i> (Grote and Robinson)	Common	11	0	1	3	3	4
<i>Xylophanes anubus</i> (Cramer)	Rare	3	0	0	1	1	1
<i>Xylophanes beltii</i> (Druce)	Unique	1	0	0	0	1	0
<i>Xylophanes chiron nechus</i> (Cramer)	Occasional	5	0	1	2	1	1
<i>Xylophanes titana</i> (Druce)	Occasional	7	0	1	2	3	1
<i>Xylophanes tersa</i> (Linnaeus)	Occasional	7	0	0	1	5	1
<i>Xylophane libya</i> (Druce)	Rare	2	0	0	0	2	0
<i>Xylophanes locia</i> (Druce)	Rare	2	0	0	1	1	0
<i>Xylophanes neoptolemus</i> (Stoll)	Rare	2	0	0	1	1	0
<i>Xylophanes thyelia</i> (Linnaeus)	Rare	2	0	0	1	1	0
<i>Xylophanes crotonis</i> (Walker)	Rare	3	0	0	1	1	1
Collected only at Vara Blanca							
<i>Hyles lineata</i> (Fabricius)			Collected only at Liberia				

were found in Turrialba and four species, *Amphimoea walkeri*, *Neococytius cluentius*, *Manduca corallina*, and *M. dilucida* were taken at secondary sites (sites other than Turrialba). The Acherontiinae represented 16 percent of the total sample from Turrialba. *Agrius cingulata* and *Manduca florestan* were the most common species of this subfamily.

Only four species of the subfamily Ambulicinae were collected in Costa Rica, three of which were found in Turrialba. One species, *Amphypterus donysa*, was collected at a secondary site. All of the species of Ambulicinae found at Turrialba were common, totaling 57 specimens, or nearly 10 percent of the samples.

The Sesiinae is the largest subfamily of hawk moths in the New World tropics with about 100 described species. Thirty-five species were taken in Costa Rica, with twenty-eight being taken at Turrialba. At Turrialba, 294 specimens were collected, representing nearly 54 percent of the total number of specimens collected. *Erinnyis ello* was the most common hawk moth at Turrialba, representing 49 percent of the Sesiinae collected.

Only thirty-nine specimens and eight species of the subfamily Philampeliinae were collected in Costa Rica, all of which are represented in Turrialba.

Of the sixteen species of the subfamily Choerocampinae captured in Costa Rica, fourteen were represented at Turrialba, yielding 83 specimens. *Xylophanes pluto* and *Xylophanes porcus continentalis* were the only species that were common at Turrialba where they represented 41 percent of the Choerocampinae collected.

#### RANGE EXTENSIONS

This study extends the known range of ten species of Sphingidae (Draudt, 1931; Rothschild and Jordan, 1903; Mosser, 1939; and Cary, 1951). Of these species, five were known from Panama and the extension is therefore not surprising. *Manduca hannibal* was believed to exist from southern Brazil to Panama. *Manduca pellenia* was known from records of its capture in Panama, Colombia, Venezuela, and Mexico. *Pachylia darceta* was believed to be distributed from Panama to Bolivia and Peru. *Pachygonia drucei* has previously been recorded only from Panama and Honduras and *Nyceryx eximia* was recorded only from Panama. *Cautethia spuria* was evidently considered to be endemic to Mexico. *Manduca dilucida* was recorded from Mexico to Honduras. *Eumorpha phorbis*, which was found at Turrialba, was previously considered to be distributed from Venezuela to northern Brazil and *Eumorpha capronnieri*, which was also found in the collection at Turrialba, was recorded from sites in Venezuela, Surinam, Ecuador, Peru, and the Amazon Valley. *Nyceryx magna*, collected at Turrialba, had been previously recorded only in Peru and Ecuador.



*Analysis of Temporal Activity for the Turrialba Specimens*

An estimate of the period of flight activity for each species of moth was made by recording the time of capture for each individual at Turrialba. Each light was visited at least once and often twice each hour from 7:00 P.M. to 2:00 A.M. Table 6 gives a summation per half-hour of the number of specimens of twenty-two species collected throughout the study. The final column in Table 6 sums all individuals collected after 1:30 A.M. Since collecting was only occasionally continued after 2:00 A.M., further late groupings yield little information. The table includes all species that I have considered common (and that, therefore, provide a sufficient amount of data to be examined), plus four additional species that show significant nonrandom flight times. The flight-time distribution of each species was tested for randomness of temporal activity, using a Kolmogorov-Smirnov one-sample test. The level of significance of each test is given in the table using standard statistical notation (n.s. = not significant; \* = significant at 0.05 level; \*\* = significant at 0.01 level). The remaining forty-four Turrialba species showed no significant departure from randomness; for this reason and because their sample sizes are small, data from these species were not included in the table. Three of the common species in Table 6 each yielded a computed D, the Kolmogorov-Smirnov statistic, close to the appropriate critical values of D, indicating that nonrandom flight times probably occur for these species and would be shown if the sample size were larger. These species were *Cautethia spuria*, *Eumorpha triangulum*, and *Xylophanes porcus*. The computed D's for these species are, respectively, .346, .322, and .353, while the critical values are, respectively, .375, .328, and .361.

The time of activity may be a resource subdividable by the Sphingidae. Certain species are using highly discrete time periods for activity (presumably feeding) while others are acting as generalists with respect to the time resource and are flying randomly throughout 7:00 P.M. to 2:00 A.M. To elucidate this, Table 7 gives a representation of the times of activities of the eighteen species of sphingids that I consider common as well as the four additional species that show significant nonrandom temporal activity.

Using a Kolmogorov-Smirnov two sample test, six pairwise comparisons were made between common species of the same genus to determine if closely related species exhibited statistically significant differing times of flight, indicating effects of competition. These six pairs are: *Manduca occulta* and *M. florestan*; *Amplifyterus gannascus* and *A. ypsilon*; *Erinnyis ello* and *E. oenotrus*; *Pachylia ficus* and *P. resumens*; *Eumorpha anchemolus* and *E. triangulum*; and *Xylophanes porcus* and *X. ceratomioides*. The *Erinnyis*, *Eumorpha*, and *Xylophanes* pairs were nonsignificant, indicating that the random flight times of one of the species for each pair had a mean value near the mean of the nonrandom pair member. This does not, of course, invalidate

TABLE 6. Per half-hour summary of collection of twenty-two species of Spingidae collected over a five-month period at Turrialba. The data for each species were subjected to a Kolmogorov-Smirnov one-sample test; the level of significance for each test is given following the appropriate species using standard statistical notation.

	7:00-7:30	7:31-8:00	8:01-8:30	8:31-9:00	9:01-9:30	9:31-10:00	10:01-10:30	10:31-11:00	11:01-11:30	11:31-12:00	12:01-12:30	12:31-1:00	1:01-1:30	1:31-on
<i>Agrius cingulata</i> , n.s.	3	3	4	1	2	0	4	1	0	2	1	3	1	1
<i>Cocytius duponchel</i> , n.s.	0	3	0	0	1	1	0	1	0	2	2	0	0	0
<i>Manduca occulta</i> , n.s.	0	1	0	4	1	0	0	2	1	0	2	0	0	0
<i>Manduca florestan</i> **	8	1	3	1	0	1	0	0	0	0	0	0	0	0
<i>Sphinx merops</i> *	2	1	1	1	4	0	0	1	0	0	0	1	0	0
<i>Protoambulyx strigilis</i> , n.s.	0	0	4	1	0	0	3	0	1	2	1	0	0	2
<i>Ampliterus gannascus</i> **	1	0	0	0	1	2	5	3	3	7	0	2	0	3
<i>Ampliterus ypsilon</i> *	2	3	2	2	0	3	0	1	0	0	2	1	0	0
<i>Erinnyis ello</i> *	7	6	4	6	21	17	11	10	17	18	6	16	1	4
<i>Erinnyis oenotrus</i> , n.s.	1	1	3	1	2	2	2	2	0	1	5	1	0	3
<i>Pachylia ficus</i> , n.s.	1	0	0	4	4	1	0	2	0	2	0	1	0	0
<i>Pachylia resumens</i> *	6	6	0	0	1	2	0	1	2	1	0	0	0	0
<i>Madoryx pluto</i> *	2	0	1	0	0	0	0	0	0	0	0	0	0	0
<i>Hemeroplanes pan</i> **	3	1	0	1	1	2	0	0	0	0	0	0	0	0
<i>Epistor gorgon</i> *	1	1	0	0	0	0	0	0	0	0	0	0	0	0
<i>Cautethia spuria</i> , n.s.	0	0	1	4	0	3	2	1	0	0	0	0	0	1
<i>Nyceryx eximia</i> **	2	1	1	0	0	0	0	0	0	0	0	0	0	0
<i>Eumorpha anchemolus</i> , n.s.	2	0	0	1	0	0	0	1	1	2	0	0	0	1
<i>Eumorpha triangulum</i> , n.s.	2	1	3	2	3	1	1	0	2	0	0	1	0	0
<i>Xylophanes pluto</i> , n.s.	3	0	2	1	1	2	0	2	3	1	1	1	2	2
<i>Xylophanes porcus</i> , n.s.	1	0	2	4	1	2	1	1	0	1	0	0	0	0
<i>Xylophanes ceratomioides</i> *	0	2	3	2	2	0	0	0	0	1	0	0	0	1



the fact that for these species pairs, competition apparently has resulted in one generalist and one specialist with respect to the time resource.

The remaining three pairs were significant at the .01 level indicating high-resource dividing between closely related species. In the *Manduca* and *Eumorphia* pairs this apparently indicates that the mean time of flight for the random member is different from that of the nonrandom member. In the case of the *Amplifyterus* pair, both species show nonrandom temporal activity. We are then faced with the interesting conclusion that each species shows a non-random and separate activity period, thus indicating high competitive effects.

It should be pointed out that any nonrandom temporal flight activity may be associated with corresponding synchronous nonrandom flower opening by food sources. This type of flowering system occurs in the tropics and yields a system whereby long-distance pollinators, such as euglossine bees (Janzen, 1971) and sphingids (personal observation and Janzen, 1971), promote out-crossing, thus allowing individuals of plant species to reproduce even at great distances from their nearest neighbors.

#### Literature Cited

- CARY, M. M. 1951. Distribution of Sphingidae (Lepidoptera: Heterocera) in the Antillean-Caribbean region. *Trans. Am. Ent. Soc.*, **77**: 63-129.
- DRAUDT, M. 1931. Sphingidae in Sietz, A., *Macro-Lepidoptera of the world*. Kernen, Stuttgart, **6**: 839-900 and plates 90-98.
- FLEMING, H. 1947. Sphingidae (moths) of Rancho Grande, North Central Venezuela. *Zoologica*, **30**: 133-145.
- HOLDRIDGE, L. R. 1964. *Life-zone ecology*. Tropical Science Center, San Jose, 124 pp.
- JANZEN, D. 1971. Euglossine bees as long-distance pollinators of tropical plants. *Science*, **171**: 203-205.
- MOSSER, O. 1939. Enumeracion de los esfingidos Mexicanos. *Anales Escuela National de Cienc. Biologicas*, **1**: 407-495.
- ROTHSCHILD, W., and JORDAN, K. 1903. A revision of the Lepidopterous family Sphingidae. *Novit. Zool.*, **9**. 972 pp. and 67 plates.

## A New Genus of Pentatominae from South America, Distinguished by the Position of Its Spiracles (Hemiptera: Pentatomidae)

L. H. ROLSTON

DEPARTMENT OF ENTOMOLOGY, LOUISIANA STATE UNIVERSITY,  
BATON ROUGE, LOUISIANA 70803

RECEIVED FOR PUBLICATION NOVEMBER 30, 1973

**Abstract:** *Caonabo*, new genus, and *C. casicus*, new species, are described from Brazil. In this genus the spiracles are located near the lateral margins of the abdomen, while the paired trichobothria associated with each spiracle remain in a submarginal position. The spatial relationship of the spiracles and trichobothria appears unique among genera of Pentatominae.

### INTRODUCTION

This new genus is apparently unique among members of Pentatominae in having the spiracles located near the lateral margin of the abdominal sternites while the paired trichobothria are caudad and mesad of each spiracle in the submarginal position usual for the subfamily. A similar spatial relationship between the trichobothria and spiracles exists in several pentatomoid families (Acanthosomatidae, Dinidoridae, Tessaratomidae, and Urostylidae) but among pentatomids only in Phyllocephalinae according to Ruckes (1962).

#### *Caonabo*, n. g.

Juga and tylus subequal in length; antennae five-segmented, basal segment not surpassing apex of head; bucculae moderately developed, weakly toothed at anterior limit, then percurrent, terminating truncately at base of head near distal end of first rostral segment. Anterolateral margins of pronotum rounded vertically, anterior angles contiguous with eyes. Frena extending along basal half of scutellum. Costal angles of coria surpassing apex of scutellum.

Prosternum and metasternum nearly flat; median low carina on mesosternum diminishing posteriorly to obscurity. Metathoracic ostiole auriculate. Femora unarmed, tibiae weakly sulcate on superior surface, tarsi three-segmented. Spiracles located near lateral margin on second through fifth visible abdominal sternites, laterad and cephalad of paired trichobothria, these somewhat diagonally transverse with one trichobothrium entad and cephalad of other (Fig. 2). Abdomen lacking median tubercle or spine.

Male with one pair of lateroventral thecal appendages and greatly developed median penal lobes (Figs. 4 to 6).

Type species: *Caonabo casicus*, new species.

#### *Caonabo casicus*, n. sp.

Light brown to castaneous above, generally grading to black on humeri, brownish yellow beneath; occasionally entirely fuscous or black. Length of body, 7.4 to 10.7 mm.

Head usually slightly longer than wide across eyes, 1.6 to 1.9 mm wide, 1.7 to 2.1 mm long. Lateral margins weakly concave above antenniferous tubercles, strongly elevated

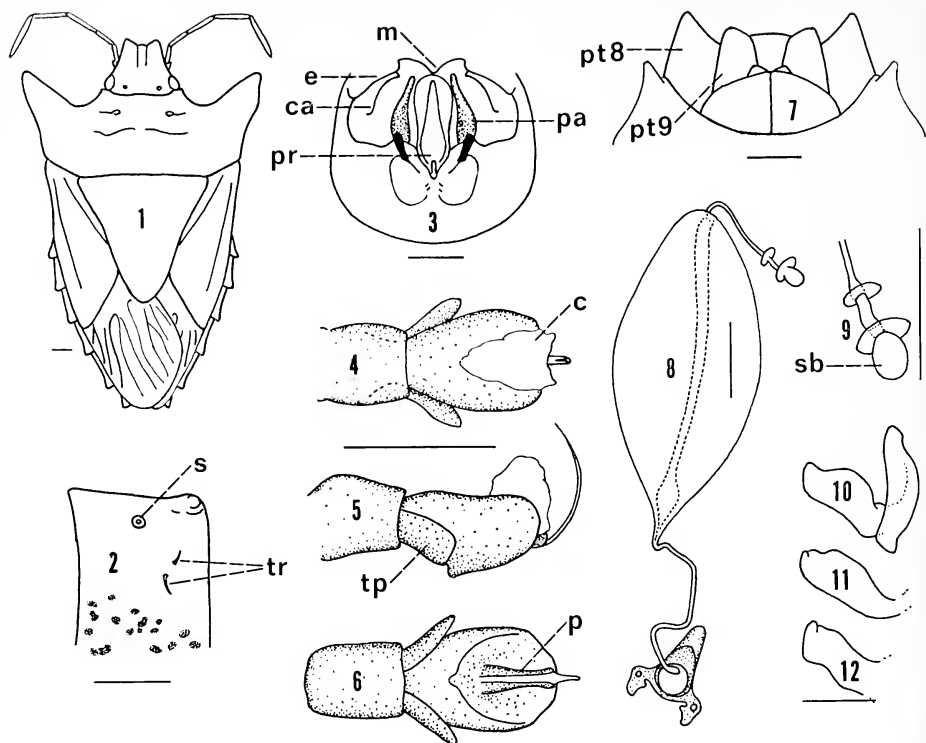

FIG. 1. Dorsal aspect, female. FIG. 2. Lateral margin of abdominal sternite; spiracle (s); trichobothrium (tr). FIG. 3. Pygophore, dorsal aspect; carina (ca); elevated margin of genital cup (e); median process (m); paramere (pa); proctiger (pr). FIG. 4. Theca and related structures, dorsal aspect; conjunctiva (c). FIG. 5. Same, lateral aspect; thecal process (tp). FIG. 6. Same, ventral aspect; penisfilum (p). FIG. 7. Genital plates; 8th paratergite (pt 8); 9th paratergite (pt 9). FIG. 8. Spermatheca. FIG. 9. Distal portion of spermatheca; spermathecal bulb (sb). FIGS. 10 to 12. Variations in right paramere.

Dimensional lines equal 0.5 mm.

toward apex. Juga usually a little shorter than tylus, each jugum and tylus separately rounded at apex. Punctuation moderately strong and rather uniformly arranged, entirely fuscous or with castaneous to concolorous punctures on and about tylus and vertex. Antennae uniformly yellowish brown to pale castaneous; basal two segments subequal in length, next two segments each about twice as long as basal segment, distal segment longest; length of segments, 0.4 to 0.6; 0.5 to 0.6; 0.8 to 1.0; 0.9 to 1.0; 1.2 to 1.4 mm. Apex of rostrum usually falling between mesocoxae and metacoxae, occasionally shorter, not surpassing mesocoxae, or longer, reaching between metacoxae

Humeri strongly produced, subacute to acute, somewhat elevated, directed obliquely forward (Fig. 1). Anterolateral pronotal margins concave from dorsal view, rough but not crenulate, usually slightly tuberculate at anterior angles; posterolateral margins convex, rough, usually pale. Disk traversed by strong ruga about midway between base and apex. Cicatrices indistinct, their posterior margin delineated by a transverse ruga swollen on each

side of meson into an irregular callous, this often accented posteriorly by a dense patch of black punctures. Punctuation stronger than on head, ranging from dark brown to black, coalescing into irregular lines on humeri. Width across humeri, 4.9 to 6.0 mm, length at meson, 1.9 to 2.5 mm.

Scutellum usually a little longer than wide at base, 2.6 to 3.3 mm wide; sides weakly concave. A small pale callous, indifferently to clearly delineated, present in basal angles. Disk often rough, sometimes with submarginal impressions converging beyond distal end of frena. Punctuation as strong as on pronotum, many punctures forming short irregular lines on basal disk.

Coria more finely and regularly punctate than scutellum; posterior margin extending posterolaterad in slight arc from scutellum; membrane frosty, venation weakly differentiated. Connexiva moderately exposed, black with border of each segment draped in brownish yellow; posterior angle of each segment markedly produced, resulting in strongly serrate connexival margin.

Punctuation beneath humeri especially dense, strong, black, continuing as submarginal band along thorax and along abdomen mesad of trichobothria (Fig. 2); punctuation in broad marginal band on abdomen concolorous, shallow, dense, with trichobothria located about midway in this band; punctuation elsewhere on head, thorax, and disk of abdomen mostly black, moderately dense, variable in size, irregular in distribution. Evaporatorium on each side rugose, extending from between coxae laterad about halfway from orifice to lateral margin of metapleuron.

A segment of anterior margin of genital cup elevated on each side of median process; entad of this segment a carina running along lateral wall; posterior margin of genital cup produced on each side as short oblique process located caudad of parameres and cephalad of large impression in broad posterior border of pygophore (Fig. 3). Proctiger longitudinally impressed, elevated at distal extremity as pale median crest, this semicircular from lateral view. Distal portion of parameres variable in form (Figs. 10 to 12). A pair of thecal appendages located ventrolaterally (Figs. 4 to 6). Median penal lobes longer and wider than theca, without a discernible division. Penisfilum lying on median plane, pigmented basally except along midline, flagellate and hyaline distally. Conjunctiva with median lobe.

Apical angles of 8th paratergite acute, narrowly rounded (Fig. 7); 9th paratergite longitudinally impressed, deeply so toward base; spermathecal bulb ovoid (Figs. 8 and 9).

*Types.* Holotype, male, labeled Museum Leiden, Nova Friburgo, Estado do Rio, 900 m. 1-1946, Wygodzinsky. Deposited in Rijksmuseum van Natuurlijke Historie, Leiden, Netherlands.

*Paratypes.* 9 males, 5 females. Same data as holotype (2 ♂♂, ♀ Rijksmuseum); Viçosa, Minas Gerais, Brazil, 25-IV-33, E. J. Hambleton (♂ U. S. Nat. Mus.); (a) Rio Vermelho, S. Cath., Brazil, Apr. 1947; (b) A. Maller Coll., Frank Johnson, Donor (♂, ♀ Am. Mus. Nat. Hist.); Cacador, S. Catarina (♂ authors coll.); 12.2.73 Paraná, Bocaiuva do Sul (♂ Univ. Fed. do Paraná); (a) Stieglmayr, Rio Gr. do Sul; (b) Brit. Mus. 1955-16 (3 ♂♂, 3 ♀♀ Brit. Mus. Nat. Hist.).

*Distribution.* Brazil, in states of Rio Grande do Sul, Santa Catarina, Paraná, Rio de Janeiro, and Minas Gerais.

#### DISCUSSION

*Caonabo* seems related to a South American species group, currently placed in the genus *Euschistus*, whose members have a pair of lateral appendages on the aedeagus. In at least some species of this group the conjunctiva is eversible

and the appendages clearly pertain to this structure rather than arising on or near the posterior margin of the theca as elsewhere in this and neighboring genera. In *Caonabo* the conjunctiva is not eversible but the appendages arise within the theca, their origin, whether on the theca or on the conjunctiva, obscure. If these conjunctival and thecal appendages are homologous, *Caonabo* may represent a transitory stage from the former to the latter condition.

**Acknowledgments:** Messr. W. R. Dolling of the British Museum (Natural History), R. C. Froeschner of the United States National Museum, A. R. Panizzi of the Universidade Federal do Paraná, P. H. van Doesburg of the Rijksmuseum van Natuurlijke Historie, and P. Wygodzinsky of the American Museum of Natural History loaned the specimens upon which these descriptions are based.

#### Literature Cited

- RUCKES, H. 1961 (1962). The diagnostic value of trichobothria in pentatomid taxonomy. Verh. XI Internat. Kongr. Entomol. (Wien), I: 35-37.



## Andean Larvae and Chrysalids of *Dione juno andicola* (Bates) and *Agraulis vanillae lucina* Felder & Felder

F. MARTIN BROWN

6715 So. MARKSHEFFEL ROAD, COLORADO SPRINGS, COLORADO 80909

RECEIVED FOR PUBLICATION NOVEMBER 19, 1973

**Abstract:** The mature larva and pupa of *Dione juno andicola* Bates are described from Baños, Ecuador, and compared with those of other subspecies of *juno*. The differences are sufficient to cast doubt upon the assignment of *andicola* to the species *juno*. The egg and five larval stages of *Agraulis vanillae lucina* Felder & Felder are described from Baños, Ecuador. Although the imago of *lucina* is quite different from those of other subspecies of *vanillae*, the larval stages support assignment of *lucina* to *vanillae*.

### INTRODUCTION

While I was going through old papers trying to make manageable the accumulations from three offices I found the following notes of observations made in 1938 in Ecuador. I sent them at that time to the late Dr. John A. Comstock and do not recall that he ever published them. At this time I have added to the original manuscript comparisons with the mature larvae and pupae of the species as observed in other areas.

#### *Dione juno andicola* Bates

Two full-grown larvae of this Andean taxon were collected October 9, 1938, on the trail from Baños, Tungurahua, Ecuador, to Runtun—a high hill just south of the town. They were making silk patches on the heavy leaves of maguey, which obviously is not their food plant. One specimen was preserved in alcohol (and dispatched to Comstock) and the other allowed to pupate and emerge for determination.

**MATURE LARVAE.** Length 3.0 cm., greatest diameter 4.5 mm. The ground color is dark olive brown, almost black. This is almost obliterated by a mosaic of dark burnt-orange spots. The anal plate and head are black. Segment T1 bears two short subdorsal scoli, T2 has two long lateral scoli and T3 two long subdorsal and two short lateral scoli. Each abdominal segment except the last bears six short scoli. These are arranged in subdorsal, lateral, and sublateral rows. The lateral pair is missing on the last segment. All of the scoli and the spines that adorn them are black.

Beebe, Crane, and Fleming (1960, text Fig. 5A) show a caterpillar of *Dione juno juno* (Cramer) from Trinidad, and Muyschondt, Young, and Muyschondt (1973, Fig. 2A) show *D. juno huascama* Reakirt caterpillars from Salvador with the scoli on the thorax not prominently different in length from those on the abdominal segments. This suggests to me that *andicola* may not be a subspecies of *juno* but a valid, albeit cryptic, species. Trinidadian *juno* (Beebe, Crane, and Fleming, 1960, p. 129) is described as "body velvety dark brown to almost black with small, paired spots, brownish-yellow to brown-orange. On middle part of body the arrangement is very regular, in three series. . . . Thus structurally and in coloring *andicola* differs from *juno juno* in the fifth instar.

Salvadorian *huascama* is colored more like *andicola*. Muysshondt et al. (1973, p. 141) states: "In the fifth instar the coloration is distinctive, being a mottled light brown." This is in accord with *andicola* so far as coloring is concerned. The scoli on *huascama* are like those on *juno juno*.

PUPA. Length 2.23 cm., greatest depth 0.89 cm., greatest width (at wing flanges) 0.67 cm. Highly cryptic, marbled black and cream with the black predominant. It hangs pendant from a tuft of silk. It is strongly keeled with a deep thoracic arch in the dorsum. All the organs of the head are studded with dull red-brown warts. The inner margins of the forewings form thick, dirty white flanges on the sides. The outer margins of the wings are decorated with fine black lines forming "Ts" at the ends of the nervules. The first three abdominal segments are decorated with subdorsal warty ridges and a wart above the black stigma. The ventrum of these segments is covered by the wing cases. Segments 4-6 bear large, subdorsal, warty prominences at their caudal margins and, centrally, at the anterior margin, have smaller, deep cream-colored warts. Segment 7 bears a subdorsal pair of small, red-brown warts. Segment 8 and the cremaster are covered with small red-brown warts. On the sides of segments 4-7 the creamy white marbling dominates the coloring. The ventrum of segments 4-6 is a creamy pink that is reminiscent of a patch of mold.

The specimen pupated during the night of October 11 and emerged at 10:30 A.M. on October 25.

Beebe et al. (1960, pl. XIV, Fig. 82) and Muysshondt et al. (1973, Fig. 2B) suggest that the shapes of the pupae of *juno*, *huascama*, and *andicola* are essentially the same. This probably is a generic feature. Both *juno juno* and *huascama* are described as brown or dark brown in color. Thus *andicola*'s strongly mottled coloring is quite different.

Until proven wrong I will consider *andicola* Bates to be a full species in the genus *Dione*.

#### *Agraulis vanillae lucina* Felder & Felder

This seems to be the most common representative of the family in Baños during October. The imagoes vary considerably, some of them being very dark on the underside, others much lighter and in that respect like *Agraulis vanillae*. For a while I wondered if this was *moneta* (Huebner). The larvae, however, are markedly different from those of *Dione*. Michener (1942) found what have been accepted to be valid generic differences between *moneta* and *vanillae*. As he pointed out, *lucina* is quite unlike *vanillae* in markings and some might hold it a different species. *Oviposition*: The only females observed ovipositing were very much battered. Oviposition took place only in bright sunshine. The eggs were laid singly on various parts of a *Passiflora* vine (species not determined). Some were on the leaves, some on the stem, others on the tendrils and buds. One female was observed on the first sunny afternoon after almost a week of rain and dull weather. During a half-hour period she laid twenty-three eggs on the upper side of a leaf near its tip. This is the only time such an occurrence was observed. Unfortunately for me and posterity, a pet parrot discovered the batch of eggs before I tried to collect them! *Egg*: Subconical, lemon-yellow in color, 0.9 mm. high and 0.4 mm. in greater diameter. The sides are sculptured with 14 ridges. Between these ridges the surfaces are pitted with elliptic depressions.

These eggs were somewhat smaller than those of *vanillae vanillae* (Linnaeus) (Beebe et al., 1960, p. 117) and with several fewer vertical ridges. The number of ridges and the coloring probably have little taxonomic value at species level since, within the Heliconiidae, species are known with highly variable eggs.

FIRST INSTAR. The larva at eclosion is 2.2 mm. long with a head capsule about 0.3 mm. across. It grew to between 4 and 5 mm. before making its first moult. The head is black

with scattered long, black spines. The body is dirty olive gray with a little white mottling. T1 bears 16 black spines of which 10 terminate in little knobs. Such knobbed spines (or setae) are highly diagnostic for *Agraulis*. T2 and T3 each bear 14 spines of which 8 are knobbed. Each of the abdominal segments bears 10 knobbed spines. The anal plate bears 4. The 6 dorsal spines of T1 are set in a black patch.

**SECOND INSTAR.** The larvae at this stage are about 7 mm. long and the head capsule is 0.6 mm. across. In general the insect appears as in the first instar with increased white mottling and each of the spines set in a small, subconical, brown papule, except the dorsal spines of T1 in the black patch.

**THIRD INSTAR.** The larvae of this stage are about 15 mm. long and the head capsule 1.1 mm. wide. The ground color is purple brown. There are broad dorsal and lateral stripes of yellow which are finely set with black hairs. Each segment bears three pairs of black scoli. The head, legs, and anal appendages are black. The head bears in addition to short black spines two rather large coronal scoli. As the time for the third moult approaches, the yellow dorsal stripe breaks up in each segment into a "T" with 5 dots, 3 over the crossbar and one on each side of the stem.

**FOURTH INSTAR.** During this stage the larvae attain 25 mm. length and the head capsule is 2.0 mm. wide. The markings and decoration are as in the third instar with one great exception: The dorsal stripe is divided into three parallel stripes broken at the septa.

**FIFTH INSTAR.** The largest specimens of this instar measured 51 mm. long but the average was about 45 mm. The head capsules were close to 3.5 mm. wide. The ground color is nearly puce. The dorsal stripe is dull orange yellow to canary yellow and patterned as in the 4th instar. The lateral stripes are creamy white to pale canary yellow. These are occasionally tinged with purple toward the close of the instar. The dorsal stripes are sometimes edged with gray-white. The coronal scoli are prominent.

**PUPA.** Length 23 mm., greatest depth 9.6 mm., greatest width 6.4 mm. The pupa is suspended from a pad of silk. The shape of the pupa is not much different from typical *vanillae* as described by Beebe et al. (1960, p. 147, Figs. 71, 72). Compared with *juno*, the pupa of *lucina* has the keel and laterally compressed thoracic process but much more prominent. The color is dull rust brown with a few streaks of darker brown on the wing cases. The entire surface is finely rugous. The abdominal processes are not as bold as those on *juno* nor are they as warty.

There appears to be very little difference between the larvae of *vanillae vanillae* from Trinidad noted by Beebe et al., and those of the "unvanillae"-looking subspecies *lucina*. The longitudinal stripes on *lucina* appear to be broader and more continuous. The knobbed hairs of the 1st-instar larvae are highly characteristic of *vanillae*. D'Almeida's (1922, p. 126) description of the larvae of the Brazilian subspecies *maculosa* (Stichel) differs only in minor points of coloration from the Andean subspecies.

#### Literature Cited

- D'ALMEIDA, R. FERREIRA. 1922. "Melanges Lepidopterologiques," R. Friedlander & Sohn, Berlin.
- BEEBE, WILLIAM, CRANE, JOCELYN AND FLEMING, HENRY. 1960. A comparison of eggs, larvae and pupae in fourteen species of Heliconiine butterflies from Trinidad, W.I. *Zoologica*, **45**: 111-154, xvi plates, 111 figures.
- MICHENER, CHARLES D. 1942a. A generic revision of the Heliconiinae (Lepidoptera, Nymphalidae). *American Museum Novitates*, No. 1197, 8 pp., 17 figs. 9 October 1942.

- . 1942*b*. A review of the subspecies of *Agraulis vanillae* (Linnaeus). Lepidoptera, Nymphalidae. American Museum Novitates, No. 1215, 5 pp., 31 December 1942.
- MUYSHONDT, ALBERTO, YOUNG, ALLEN M., AND MUYSHONDT, ALBERTO, JR. 1973. The biology of the butterfly *Dione juno huascama* (Nymphalidae: Heliconiinae) in El Salvador. Jour. New York Entomol. Soc., **81**: 137-151, September 1973.

a

## JOURNAL of the NEW YORK ENTOMOLOGICAL SOCIETY

The JOURNAL of the NEW YORK ENTOMOLOGICAL SOCIETY is devoted to the advancement and dissemination of knowledge pertaining to insects and their related forms.

SUBSCRIPTIONS are \$8.00 per year, in advance, and should be sent to the New York Entomological Society, the American Museum of Natural History, 79th Street at Central Park West, New York, N. Y. 10024. The Society will not be responsible for lost JOURNALS unless immediately notified of change of address. We do not exchange publications.

Please make all checks, money-orders, or drafts payable to the NEW YORK ENTOMOLOGICAL SOCIETY.

ORDERS and inquiries for back issues and complete sets should be sent to our agent, S-H Service Agency, Inc., 866 Third Ave. New York, N. Y. 10022. Complete files of back issues are in stock.

### INFORMATION FOR AUTHORS

Submit manuscript in duplicate (original and one carbon) to the Editor, New York Entomological Society, Boyce Thompson Institute, Yonkers, N.Y. 10701.

1. GENERAL POLICY. Manuscript submitted must be a report of unpublished research which is not being considered for publication elsewhere. A manuscript accepted and published in the JOURNAL must not be published again in any form without the consent of the New York Entomological Society.

A page charge of \$15 per printed page is assessed except that the charge may be reduced in the case of a member of the Society who cannot obtain institutional or grant funds for publication.

The page charge includes black and white illustrations and tabular material.

2. FORM OF MANUSCRIPT. Text, footnotes and legends must be typewritten, double or triple spaced, with margins of at least 1½ inches on all sides. The editorial style of the JOURNAL essentially follows the *CBE Style Manual* (3rd edition, A.I.B.S., 1972).

Genetic symbols: follow recommendations of Demerec, et al.  
(Genetics **54**: 61, 1969)

Biochemical abbreviations: follow rules of the U.I.P.A.C. -I.U.B.  
(J. Biol. Chem. **241**: 527, 1966)

Enzyme activity: should be expressed in terms of international units.  
(Enzyme Nomenclature. Elsevier Pub. Co., 1965)

Geographical names, authors names and names of plants and animals should  
be spelled in full.

The JOURNAL reserves the privilege of editing manuscript or of returning it  
to the author for revision.

3. **ABSTRACT.** Each manuscript must be accompanied by an abstract,  
typewritten on a separate sheet.

4. **TITLE.** Begin each title with a word useful in indexing and information  
retrieval (Not "Effect" or "New".)

5. **ILLUSTRATIONS.** Original drawings *should not be submitted*. Glossy  
prints are desirable—not larger than 8½ by 11 inches and preferably not  
smaller than 5 by 7 inches. When appropriate, magnification should be indi-  
cated by a suitable scale on the photograph.

6. **REPRINTS** (in multiples of 100) may be purchased from the printer  
by contributors. A table showing the cost of reprints, and an order form, will  
be sent with the proof.

7. **SUBSCRIPTION** to the JOURNAL is \$8.00 per year, in advance, and  
should be sent to the New York Entomological Society, The American Museum  
of Natural History, Central Park West at 79th Street, New York, New York,  
10024. The Society will not be responsible for lost JOURNALS unless im-  
mediately notified of change of address. We do not exchange publications.  
Please make all checks, money orders and drafts payable to the NEW YORK  
ENTOMOLOGICAL SOCIETY.

8. **ORDERS** and inquiries for back issues and complete sets should be sent  
to our agent: S-H Service Agency, Inc., 866 Third Ave., New York, N.Y. 10022.

595.70673

Vol. LXXXII

*Ent.* JUNE 1974

No. 2

**Journal**  
of the  
**New York**  
**Entomological Society**

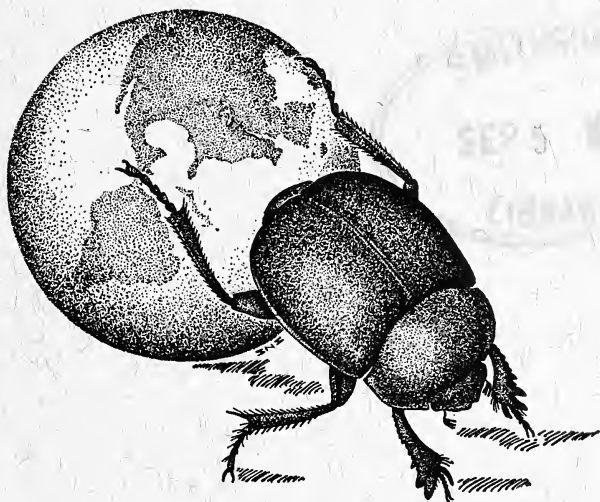

**Devoted to Entomology in General**

**The New York Entomological Society**  
**Incorporating The Brooklyn Entomological Society**  
**Incorporated May 21, 1968**

---

**The New York Entomological Society**  
**Organized June 29, 1892—Incorporated February 25, 1893**  
**Reincorporated February 17, 1943**

---

**The Brooklyn Entomological Society**  
**Founded in 1872—Incorporated in 1885**  
**Reincorporated February 10, 1936**

The meetings of the Society are held on the first and third Tuesday of each month (except June, July, August and September) at 8 P.M., in the AMERICAN MUSEUM OF NATURAL HISTORY, 79th St. & Central Park W., New York, N. Y. 10024.

Annual dues for Active Members, \$4.00; including subscription to the Journal, \$9.00.

Members of the Society will please remit their annual dues, payable in January, to the Treasurer.

---

**Officers for the Year 1974**

- President*, Dr. Daniel J. Sullivan, S.J.  
Fordham University, New York 10458
- Vice-President*, Dr. Peter Moller  
American Museum of Natural History, New York 10024
- Secretary*, Dr. Charles C. Porter  
Fordham University, New York 10458
- Assistant Secretary*, Dr. Louis Trombetta  
Pelham Manor, New York 10803
- Treasurer*, Dr. Winifred B. Trakimas  
State University of New York, Farmingdale, New York 11735
- Assistant Treasurer*, Ms. Joan DeWind  
American Museum of Natural History, New York 10024
- 

**Trustees**

- Class of 1974  
Dr. Lee Herman  
Mr. Edwin Way Teale
- Class of 1975  
Dr. Howard Topoff  
Dr. Pedro Wygodzinsky
- 

Mailed August 22, 1974

The Journal of the New York Entomological Society is published quarterly for the Society by Allen Press Inc., 1041 New Hampshire, Lawrence, Kansas 66044. Second class postage paid at New Brunswick, New Jersey and at additional mailing office.

Known office of publication: Waksman Institute of Microbiology, New Brunswick, New Jersey 08903.



# Journal of the New York Entomological Society

VOLUME LXXXII

JUNE, 1974

No. 2

## EDITORIAL BOARD

*Editor* DR. KARL MARAMOROSCH  
Waksman Institute of Microbiology  
Rutgers University  
New Brunswick, New Jersey 08903

*Associate Editors* DR. LAWRENCE E. LIMPEL  
HELEN MCCARTHY

Publication Committee

Dr. Kumar Krishna                      Dr. Ayodha P. Gupta  
Dr. James Forbes, Chairman

---

## CONTENTS

The William S. Creighton Memorial Issue .....	James Forbes	66
William Steel Creighton—An Appreciation .....	Robert E. Gregg	67
Studies on California Ants. 8. A New Species of <i>Cardiocondyla</i> (Hymenoptera: Formicidae) .....	Roy R. Snelling	76
Notes on the Behavior of Three Species of <i>Cardiocondyla</i> in the United States (Hymenoptera: Formicidae) .....	William S. Creighton and Roy R. Snelling	82
Generic Diversity in Phase of Rhythm in Myrmicine Ants .....	Elwood S. McCluskey	93
Supplementary Studies on Ant Larvae: <i>Simopone</i> and <i>Turneria</i> .....	George C. Wheeler and Jeanette Wheeler	103
On the Estimation of Total Behavioral Repertoires in Ants .....	Edward O. Wilson and Robert Fagen	106
Zoogeography of the Imported Fire Ants .....	William F. Buren, George E. Allen, Willard H. Whitcomb, Frances E. Lennartz, and Roger N. Williams	113
Microsporidan and Fungal Diseases of <i>Solenopsis invicta</i> Buren in Brazil .....	George E. Allen and William F. Buren	125
A Supplement to the Revision of the Ant Genus <i>Basiceros</i> (Hymenoptera: Formicidae) .....	William L. Brown, Jr.	131
Myrmicine Trail Phermones: Specificity, Source and Significance .....	Murray S. Blum	141

### The William S. Creighton Memorial Issue

The sequence of circumstances that led to the publication of this issue of the *Journal* demonstrates the desire of friends and associates to recognize the achievements of William Creighton and to provide for him a fitting memorial. At the end of last summer the news of Dr. Creighton's death was received by Dr. Howard Topoff, President of the New York Entomological Society. A few weeks later at an Executive Committee meeting of the Society the decision was made to solicit papers from myrmecologists for a memorial issue of the *Journal*. Preparations were just begun when a letter was received from Dr. Roy Snelling of Los Angeles, California, advising the Society that he and Dr. E. O. Wilson were collecting papers and asking if the New York Entomological Society would sponsor a memorial issue. The two projects were combined.

William Creighton joined the New York Entomological Society shortly after he came to the Biology Department of the City College of New York in 1931. In his early membership his main service to the group was as a speaker at meetings. From time to time he would spend an evening presenting some aspect of his research. During the 1950's he became an active worker in the Society. In 1957 he was elected Vice-President. Later he joined the Publication Committee, and in 1960 he undertook the Editorship of the *Journal*. He held this post for a year and a half until his early retirement from C.C.N.Y. It was a change in the retirement regulations of the New York City colleges that gave him the opportunity to retire early and to begin a period of vigorous research in the taxonomy and the biology of the ants in the southwestern region of the United States.

The New York Entomological Society is proud to have had William S. Creighton as a member and as a Society worker and is grateful for the contributions he has made to the field of myrmecology. To his memory this issue of the *Journal* is affectionately dedicated.

James Forbes

## William Steel Creighton—An Appreciation

ROBERT E. GREGG

DEPARTMENT OF BIOLOGY, UNIVERSITY OF COLORADO, BOULDER, COLO. 80302

RECEIVED FOR PUBLICATION JANUARY 7, 1974

The accompanying photograph of Dr. Creighton is an excellent likeness, and while there seem not to be many such available, this one has been graciously furnished by his wife, Martha. I am indebted to her for this and also for certain biographical information without which this account could not be written.

Dr. Creighton was born April 3, 1902, in Philadelphia, Penn., the son of John Harvey and Ethel Steel Creighton, and died July 23, 1973, at Alexandria Bay, New York. He received a bachelor's degree from Roanoke College, Virginia, in 1924, his M.S. degree from Princeton in 1926, and the D.Sc. degree from Harvard in 1930. During his attendance at Princeton he carried out research on the luminescence mechanism of fireflies, but, in 1926, while working with Dr. Frank E. Lutz of the American Museum of Natural History, he became interested in the study of ants. Dr. William Morton Wheeler, one of the leading authorities on ants, who was at the American Museum, was transferred to Harvard University, so Creighton moved to Boston in order to continue his interests and his training under Professor Wheeler. The two men cemented a lasting friendship and an academic rapport that was often reflected in Creighton's sincere and high regard for his mentor by his references to "Uncle Bill Wheeler." The combination of their efforts was to have a very significant effect on the course of myrmecology; it brought a maturity to the study of ants in North America that was salutary. Nevertheless, Creighton did not hesitate to disagree with Wheeler nor to correct his own mistakes when scientific accuracy so demanded, and this is quite evident to those who peruse the now standard volume on North American Formicidae.

In 1931, Dr. Creighton joined the faculty of the Department of Biology at the City College of New York and gave continuous and dedicated service for 31 years, retiring as professor emeritus in February 1962. His associates have prepared a mimeographed resolution of respect, and I have the permission to quote from this statement, as no more fitting tribute to his capacities as a teacher could be made.

"His chief devotion . . . was to his teaching and to his students. A grandson of a preacher, he had a touch of the pulpit in his proselytizing approach to biology. He was deeply committed to demonstrating to his students the intellectual and emotional rewards of the pursuit of the science of biology. This commitment was especially evident by his preference for teaching our freshman general biology courses. These are clearly



the most difficult courses to teach successfully, and here, he felt, was where future biologists could be made. He believed that, course content and syllabus aside, first and foremost we must instill in our students a respect and enthusiasm for the subject. The communication of information comes easily as a consequence. He was a stirring lecturer, and always managed to project a personal involvement in the subject matter—that magical feeling of wonder about life, and curiosity about how it works. It was a dull mind indeed that could not be stimulated with a sense of excitement by one of his lectures.

In his last several years prior to retirement, Professor Creighton saw major changes in his field. The advent of molecular and biochemical approaches to biology took many by surprise. Not so Bill Creighton. He revised and up-dated his teaching materials constantly, but always with the basic principle of projecting his personal enthusiasm to the students. In this way, he found that he could demand high standards of performance, and his students gave him their best willingly. His patience with students and their questions seemed inexhaustible, yet there were times when he erupted easily, especially when faced with sloth or with bureaucratic red tape. Under such conditions he spoke his mind clearly and unequivocally.

Bill's colleagues found in him a staunch friend and a frank critic. He had a delightfully earthy sense of humor, and had the remarkable facility for separating fraud from truth, and doing so with devastating clarity."

Professor Creighton's interests and research contributions were in the field of ant biology, especially the systematics of the Formicidae. In collaboration with Wheeler he began a study of the taxonomy of ants in North America that was to summarize the diverse knowledge that had already accumulated, and to provide in a single publication a guide to the identification and other aspects of the taxonomy of all our native species. Before this effort was far along, Professor Wheeler died (1937), and Creighton was left the task of completing the study. That he did so with outstanding success is now history. He enjoyed unlimited access to the Wheeler Collection, part of which was in the American Museum in New York, and part in the Museum of Comparative Zoology at Harvard in Cambridge, both of which contained a large number of type specimens, and otherwise authentically determined material identified by Wheeler himself and such renowned authorities in Europe as Emery and Forel. In addition, he availed himself of the very substantial holdings in the United States National Museum in Washington, through the cooperation of Dr. Marion R. Smith, who was then in charge of these specimens. Creighton also built a personal collection which contained numerous types presented to him by Wheeler, by other ant students, and types resulting from the descriptions of new species for which Creighton was the original author. But more than this, Bill Creighton amassed a superb collection based upon years of field work and direct acquaintance through automobile travel with virtually all sections of the country. Thus he reinforced his study of cabinet specimens by coming to know the geographical and ecological conditions in which his species existed. He always insisted that those who did no field work were under serious handicaps and could not possibly understand the full significance of the biology of the forms being studied. Although he did not travel widely over the world, Creighton did acquire experience at the Soledad field station in Cuba in the earlier years of his life and, in later years, after the publication of his book, extended his journeys to many parts of Mexico, particularly the nontropical areas. And, finally, he cultivated opportunities for augmenting his collection by exchanging specimens and making gifts to support the work of colleagues, too numerous to mention separately.

Museum work and laboratory work were indispensable tools, as they are for all taxonomists, but Bill Creighton was a first-class naturalist as well, and his knowledge of distributional ecology, vegetation, and the names of plants (as well as animals), was truly remarkable. He knew of the manifold complexities and interrelationships that exist in the natural world and that this matrix must not be ignored if one hoped to gain a satisfactory comprehension of the distribution, and the causes thereof, of the particular group of organisms in which he was interested. As far as practicable, his collecting of specimens always entailed the gathering of relevant habit and habitat notes associated with ants, and he was very cognizant of the role of altitude in

affecting the occurrence of living things. Especially for mountainous districts, elevation became a conspicuous inclusion on his labels. Meticulous attention to essential details was not foreign to him. A glimpse of the intensity and thoroughness of his field work is revealed by his willingness to lie prone in the dirt in search of minute species, his efforts literally to leave no stone unturned, his pursuit of the arboreals (a most difficult type of ant to find and bag) even when it necessitated tearing off rotten branches and injuring his hands in the bargain. He visited type localities in an effort to locate additional topotypes, although in the areas he ransacked for specimens he was not always successful. Rare species were a challenge, and he had the perseverance to track them in likely as well as unlikely places.

The work of revising the taxonomy of the entire North American ant fauna developed into an enormous undertaking. He soon realized that far-reaching changes would be necessary to modernize the nomenclature and that the job would go well beyond what he and Wheeler had originally visualized. Many species had been described utilizing subtle and confusing differences in color and inconsequential variations in size. To Creighton, these criteria (particularly color) as separatory characters were suspect, and he succeeded in many instances in proving his point by demonstrating that the supposed differences were inconstant over long series of specimens, or could be found among a series of individuals obtained from a single nest! The work entailed not only a critical re-examination of specimens representing numerous taxa but also a painstaking review of the voluminous literature on the subject, both foreign and domestic, containing original descriptions of ants, as well as a penetrating analysis of what the authors said or did not say about the insects they studied. The result of such investigations was extensive synonymy of many well-known taxa commonly accepted by previous writers. Although this was unavoidable in the light of new knowledge and although some cherished names had to be sacrificed on the altar of scientific accuracy, Creighton strove sincerely to salvage and conserve every ant name possible, and as he would put it, "refrain from upsetting too many apple carts." To serve the concept of stability in nomenclature, he exercised the privilege of the "first reviser" to sustain a name by not adhering strictly to the law of priority, where to do so would only weaken the status of the taxon in question. However, this action was rare indeed.

Of even greater magnitude was the problem of complicated quadriminomial nomenclature that had gradually built up in myrmecology over the years and that reached its culmination in Emery's treatment of the world ant fauna in the several fascicules of the *Genera Insectorum*, the last of which appeared in 1925. Subsequent to this, new ideas concerning the nature of species came into clear focus through the work of Ernst Mayr and others who showed that species should be regarded each as living and evolving populations of individuals that are for the most part biologically (reproductively)

isolated from one another. In the course of their evolution, it was thought, these populations developed through stages of divergence that could be detected and recognized as subspecies, and these subspecific populations could be designated by formal names added to the basic binomial, thus producing the widely used trinomial nomenclature. But only this one infraspecific category seemed to be objective and defensible, varieties and forms then having to be discarded. In the midst of this atmosphere Creighton carried out his revision, and he adopted the practice of employing binomials, as usual, and the trinomial wherever the facts, particularly distributional data, justified its use. For it was believed that subspecies arise as geographic or topographic isolates and that by definition they must replace each other geographically to be valid. Accordingly, wherever a species appeared to be composed of two or more structurally different and essentially allopatric populations, and especially if there could be found any evidence of intergradation among them in intermediate localities, Creighton treated them as subspecies. Forms that were unquestionably distinct, with constant nonintergrading traits, however minute, he regarded as full species. In given cases, forms that were thought of as separate species were, on review, reduced to subspecies; those that had been subspecies or even varieties, if they qualified, were necessarily raised to species rank. The varietal category itself was abandoned. Thus in one great consistent effort he effectively swept aside the troublesome varietal rank, recognized the validity of any previous taxon as a full or subspecies (if the data supported such action), described new species when their populations conformed to the refined criteria of the biological species concept, and in the end simplified and enormously improved the taxonomy of American ants. This achievement was and will remain a milestone in the history of myrmecology. Since then new forms are not given varietal status, most being described as species and some as subspecies. Interestingly, the biological validity of the latter category also has been challenged since Creighton completed his studies. His work was entitled, "The Ants of North America," and was published as Volume 104, 585 pp., 57 plates, 1950, in the *Bulletin of the Museum of Comparative Zoology*, at Harvard College.

I came to know Professor Creighton personally in 1950, just after the publication of his treatise on American ants. There had been a few previous exchanges of letters, but there was no indication he might be spending a year at the University of Colorado. The chairman of our department, Dr. Gordon Alexander, had met Creighton at Princeton, and the Creightons and Alexanders were close friends. So when a year's leave of one of our staff created a temporary vacancy, Bill Creighton was invited to fill it. His inimitable capacities as a teacher showed themselves again, judging from the testimony of students, and he seemed to fully enjoy the experience as well. My opportunities to consult with him at length, for he was always most generous with his time, were invaluable. Our myrmecological conversa-

tions were almost a daily occurrence, but I must confess the benefits flowed nearly completely in my direction. For one who was (prior to that time) necessarily accustomed to identifying ants with limited access to scattered publications, the help of irregular correspondence, and the aid of occasional exchanges of specimens, this association was a bonanza. He brought with him numerous type specimens of North American ants, and we were able to make many direct comparisons with ants collected in Colorado. All this, together with the newly published Ant Book which was worked over in minute detail, gave tremendous impetus to the study of Colorado ants. It may be safely asserted also that this book opened the way for a much clearer understanding of our native ants than ever before, as it has stimulated the publication of many significant investigations by myrmecologists in widely separated portions of the United States and Canada.

Toward the end of the academic year, Dr. Creighton was awarded a Guggenheim Fellowship, and with this recognition of his accomplishments, he was able to turn his attention to another aspect of American ant biology. He had already traveled extensively in many parts of the United States, including the Rocky Mountain States and the Pacific Coast areas. He now looked to Mexico, whose ant populations had been so little studied and so sparsely collected that it was a country with almost unlimited possibilities. He penetrated far south in Mexico but found the nontropical territories exceedingly rich as well as the tropical, and decided to confine the most concentrated efforts of field work to the former. His letters about the various localities visited were full of enthusiasm, and frequently contained descriptions of people, places, or events made vivid by a style distinctively his own. The jeep the Creightons used was ingeniously fitted out as a traveling laboratory, even to the addition of a rigid support for a binocular microscope. Martha designed a monogram for the vehicle showing the queen of a leaf-cutting ant! They camped out and traveled Mexico the hard way, and on a very rugged road high in the Sierra San Pedro Martir of Baja, California, they nearly came to grief. Today very many localities are easily accessible by fine paved highways, and the numbers of good motels are increasing steadily.

After Bill's retirement from City College, the Creightons spent summers at their modest but charming home on Tar Island in the St. Lawrence near the exit from Lake Ontario. The house was improved for comfort and a room added. By his own labor, the boat dock was rebuilt and heavy rocks were fashioned into a sea wall to avert erosion from annual changes in the level of the river. Most enjoyable of all was the development of the grounds, complete with rock garden, and a collection of dwarf evergreens from numerous localities, in which the Creightons took great and justifiable pride. For their winters they returned to the community of La Feria, Texas, in the valley of the Rio Grande. Here Bill became interested in studying the behavior of ants. Long mild seasons and newly acquired leisure time, as well



as ideal ant subjects, contributed to his success, and a series of papers flowed from his pen. During this period also a latent ability showed up for making excellent, finely shaded, pen-and-ink drawings of certain ant species. He did not lose his concern for ant systematics, however, for he continued to visit Mexico for specimens, and some months before his death had suggested that I accompany him to one of the localities near the eastern Sierra. Unfortunately, this could not be carried out. Studies on *Cardiocondyla* and on *Colobopsis* are scheduled to appear posthumously.

He was a member of a number of scientific societies, Sigma Xi, the New York Entomological Society, Georgia Entomological Society, and he was honored by election as a Research Associate to the American Museum of Natural History. He seemed to have a constitutional aversion to politics in science, preferring to make his influence felt strictly through the publication of research papers on the subject to which he was so deeply devoted.\* One could be certain always of his candor and of his absolute sincerity. His advice was trustworthy wisdom, but with it all he retained an enviable humility. Whether consciously or not, he was aware that science is greater than men.

To one who has known Bill Creighton as friend and colleague for the past twenty-three years, his passing is an irreparable loss. He has left an indelible imprint on my efforts in myrmecology, as well as on the contributions of many others. In an exchange of correspondence with him, letters in excess of 225 have been accumulated and preserved. Our collection of ants has received important and crucial additions, some of them types, thanks to his generosity and willingness to share in mutually advantageous exchange.

He married Martha Patterson, of Cranford, New Jersey, in 1930, and although there were no children, he, together with Martha's constant help and companionship, has given us a legacy of solid scientific achievement and unimpeachable integrity. In the words, again, of his associates during his long tenure at the "College" in the City of New York, he was "a unique combination of scholar, teacher, and powerful personality. His death leaves a hiatus in the hearts of his friends that will never be filled."

### Bibliography

CREIGHTON, W. S.

1927. The slave raids of *Harpagoxenus americanus*. Psyche, **34**:11-29.  
 1928. Notes on three abnormal ants. Psyche, **35**:51-55.  
 1928a. A new species of *Thaumatomyrmex* from Cuba. Psyche, **35**:162-166.  
 1929. New forms of *Odontoponera transversa*. Psyche, **36**:150-154.  
 1929a. Further notes on the habits of *Harpagoxenus americanus*. Psyche, **36**:48-50.  
 1930. A review of the genus *Myrmoteras*. Jour. New York Entomol. Soc. **38**:177-191.  
 1930a. The New World species of the genus *Solenopsis*. Proc. Amer. Acad. Arts Sci. **66**:39-151.  
 1932. A new female of *Acamatus* from Texas. Psyche. **39**:73-78.

\* See accompanying bibliography.

1933. *Cyathomyrmex*, a new name for the subgenus *Cyathocephalus* Emery. Psyche, **40**:98-100.
1934. Descriptions of three new North American ants with certain ecological observations on previously described forms. Psyche, **41**:185-200.
1935. Two new species of *Formica* from western United States. Amer. Mus. Nov., No. 773, 8 pp.
1937. Notes on the habits of *Strumigenys*. Psyche, **44**:97-109.
1938. On formicid nomenclature. Jour. New York Entomol. Soc. **46**:1-9.
1939. A generic re-allocation for *Myrmoteras kuroiwae*. Jour. New York Entomol. Soc. **47**:39-40.
- 1939a. A new subspecies of *Crematogaster minutissima* with revisionary notes concerning that species. Psyche, **46**:137-140.
1940. A revision of the North American variants of the ant *Formica rufa*. Amer. Mus. Nov., No. 1055, 10 pp.
- 1940a. A revision of the forms of *Stigmatomma pallipes*. Amer. Mus. Nov., No. 1079, 8 pp.
1945. Observations on the subgenus *Rhachiocrema* with the description of a new species from Borneo. Psyche, **52**:109-118.
1950. The ants of North America. Bull. Mus. Comp. Zool. **104**:1-585.
- 1950a. *Polyhomoa* Azuma, a synonym of *Kyidris* Brown. Psyche, **57**:93-94.
1951. Studies on Arizona ants 1. The habits of *Camponotus ulcerosus* Wheeler, and its identity with *C. bruesi* Wheeler. Psyche, **58**:47-64.
- 1951a. Studies on Arizona ants 2. New data on the ecology of *Aphaenogaster huachucana* and a description of the sexual forms. Psyche, **58**:89-99.
1952. Studies on Arizona ants 3. The habits of *Pogonomyrmex huachucanus* Wheeler, and a description of the sexual castes. Psyche, **59**:71-81.
- 1952a. Studies on Arizona ants 4. *Camponotus (Colobopsis) papago*, a new species from southern Arizona. Psyche, **59**:148-162.
- 1952b. *Pseudomyrmex apache*, a new species from the southwestern United States. Psyche, **59**:131-142.
1953. New data on the habits of the ants of the genus *Veromessor*. Amer. Mus. Nov., No. 1612, 18 pp.
- 1953a. New data on the habits of *Camponotus (Myrmaphaenus) ulcerosus* Wheeler. Psyche, **60**:82-84.
- 1953b. A new subspecies of *Xenomyrmex stollii* from northeastern Mexico. Amer. Mus. Nov., No. 1634, 5 pp.
- 1953c. The rediscovery of *Leptothorax silvestrii* (Santschi). Amer. Mus. Nov., No. 1635, 7 pp.
1954. Additional studies on *Pseudomyrmex apache*. Psyche, **61**:9-16.
1955. Observations on *Pseudomyrmex elongata* Mayr. Jour. New York Entomol. Soc., **63**:17-20.
- 1955a. Studies on the distribution of the genus *Novemessor*. Psyche, **62**:89-97.
1956. Notes on *Myrmecocystus lugubris* Wheeler and its synonym, *Myrmecocystus yuma* Wheeler. Amer. Mus. Nov., No. 1807, 4 pp.
- 1956a. Studies on the North American representatives of *Ephebomyrmex*. Psyche, **63**:54-66.
1957. A study of the genus *Xenomyrmex*. Amer. Mus. Nov., No. 1843, 14 pp.
- 1957a. A revisionary study of *Pheidole vasliti* Pergande. Jour. New York Entomol. Soc. **65**:203-212.

1963. Further studies on the habits of *Cryptocerus texanus* Santschi. *Psyche*, **70**:133-143.
- 1963a. Further observations on *Pseudomyrmex apache*. *Amer. Mus. Nov.*, No. 2156, 4 pp.
1964. The habits of *Pheidole (Ceratopheidole) clydei* Gregg. *Psyche*, **71**:169-173.
1965. Studies on southwestern ants belonging to *Camponotus*, subgenus *Myrmobrachys*. *Amer. Mus. Nov.*, No. 2239, 9 pp.
- 1965a. The habits and distribution of *Macromischa subditiva* Wheeler. *Psyche*, **72**:282-286.
1966. The habits of *Pheidole ridicula* Wheeler, with remarks on the habit patterns in the genus *Pheidole*. *Psyche*, **73**:1-7.
1967. Studies on free colonies of *Cryptocerus texanus* Santschi. *Psyche*, **74**:34-41.
- 1967a. Living doors. *Nat. Hist.*, **76**:71-73.
- 1967b. Ant, *In* *Encyclopedia Britannica*, 2:1-4.
1969. Studies on *Camponotus (Myrmaphaenus) andrei* Forel. *Amer. Mus. Nov.*, No. 2393, 6 pp.
1971. New data on the distribution and habits of *Leptothorax (Nesomyrmex) willda*. *Jour. Georg. Entomol. Soc.*, **6**:207-210.
- CREIGHTON, W. S., AND TULLOCH, G. S. 1930. Notes on *Euponera gilva* (Roger). *Psyche*, **37**: 71-79.
- , AND CRANDALL, R. H. 1954. New data on the habits *Myrmecocystus melliger* Forel. *Biol. Rev., C.C.N.Y.* **16**:2-6.
- , AND GREGG, R. E. 1954. Studies on the habits and distribution of *Cryptocerus texanus* Santschi. *Psyche*, **61**:41-57.
- , AND GREGG, R. E. 1955. New and little-known species of *Pheidole* from the southwestern United States and northern Mexico. *Univ. Colo. Stud., Ser. Biol.*, No. 3, 46 pp.
- , AND CREIGHTON, M. P. 1959. The habits of *Pheidole militicida* Wheeler. *Psyche*, **66**:1-12.
- , AND NUTTING, W. L. 1965. The habits and distribution of *Cryptocerus rohweri* Wheeler. *Psyche*, **72**:59-64.
- , AND SNELLING, R. R. 1966. The rediscovery of *Camponotus (Myrmaphaenus) yogi* Wheeler. *Psyche*, **73**:187-195.
- AND ———. 1974. Notes on the behavior of three species of *Cardiocondyla* in the United States. *Jour. New York Entomol. Soc.*, **82**:82-92.
- WHEELER, W. M., AND CREIGHTON, W. S. 1934. A study of the ant genera *Novomessor* and *Veromessor*. *Proc. Amer. Acad. Arts Sci.*, **69**:341-387.

## Studies on California Ants. 8. A New Species of *Cardiocondyla* (Hymenoptera: Formicidae)

ROY R. SNELLING

NATURAL HISTORY MUSEUM OF LOS ANGELES COUNTY, LOS ANGELES, CALIFORNIA 90007

RECEIVED FOR PUBLICATION JANUARY 7, 1974

**Abstract:** A new species of introduced ant, *C. ectopia*, is described and figured, based on material from Orange and Los Angeles counties. All three castes are included and the species is compared to the other four species known to occur in the United States.

*Cardiocondyla* is an Old World genus of approximately 30 species, about half a dozen of which are regularly transported by commerce into new areas. Four species have been introduced into the eastern United States (Smith, 1944); all seem to be firmly established in Florida. No species has previously been reported from California. This seems surprising since the three most commonly transported species are common in the Pacific region.

The first California specimens to come to my attention were collected by R. J. Hamton at his home in Long Beach, Los Angeles Co., in 1967. During the following year, specimens were collected by K. C. Stephens in Downey and Artesia, L. A. Co. Specimens from Tustin, Orange Co., were collected in 1970 by A. Mintzer, and the author found the species in his yard at Seal Beach, Orange Co., in 1972.

I have been unable to associate this species with any previously described name. In order to discuss this species in the following paper, I am describing the ant as new. Hopefully the correct name, if the species is previously described, can be determined at a later date.

*Cardiocondyla ectopia* Snelling, n. sp.

### DIAGNOSIS

*Worker* (among species in North America) with shallow but distinctly impressed meta-notal suture; antennal scape failing to attain occipital margin by about apical breadth; propodeum with a pair of short, triangular denticles; promesonotum slight shiny, irregularly roughened and with shallow, obscure punctures; petiolar node, from above, slightly longer than wide; anterior border of postpetiolar node slightly concave. *Female* and *male*: see DISCUSSION (Figs. 1-5).

**WORKER Measurements** (Figs. 1, 2). HL 0.55-0.60 (0.60); HW 0.43-0.48 (0.47); SL 0.40-0.44 (0.44); WL 0.65-0.71 (0.68); PW 0.30-0.33 (0.33) mm.

Head distinctly longer than wide, CI 76-81 (79), longer than scape, SI 90-97 (92); in frontal view, sides nearly straight, a little convergent above; occipital margin straight, corners fully rounded. Median lobe of clypeus high, weakly carinate laterally, apical margin shallowly concave. Scape short of occipital margin by about its maximum thickness, less than length of second antennomere. Eye large, with 11-14 facets in greatest

**Acknowledgments:** I wish to thank R. J. Hamton, A. Mintzer, and K. C. Stephens for the gift of material of *C. ectopia*. Important sexual material of other species was loaned by D. R. Smith, United States National Museum. The figures were prepared by Ruth A. DeNicola.

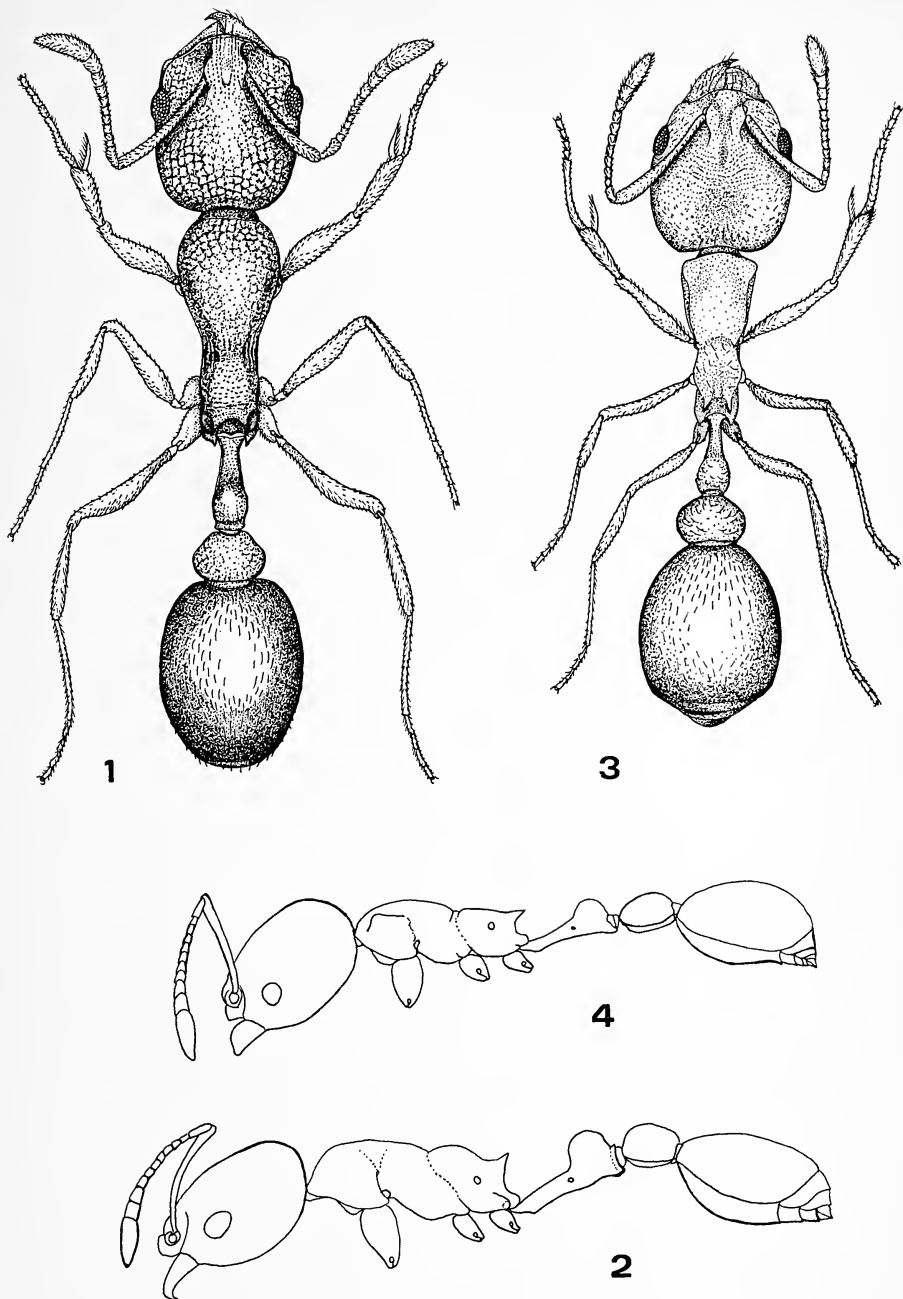

FIGS. 1-4. *Cardiocondyla ectopia*. 1. Worker, dorsal view; 2. Same, lateral view; 3. Male, dorsal view; 4. Same, lateral view. Figures by Ruth Ann DeNicola.

diameter, removed from mandibular insertion by 0.58–0.80 (0.80) times its greatest diameter. Mandible quinque-dentate.

Thorax slender, PW 0.44–0.49 (0.49)  $\times$  WL. Pronotum, from above, with rounded humeri. In profile, metanotal suture broadly, shallowly impressed. Propodeum spinose, spines stout, about as long as basal width; distance between apices of spines about three times their length.

Anterior peduncle of petiole slightly longer than height of node; node in profile distinctly longer than high; node, from above, a little longer than wide; peduncle with anteroventral tooth. Node of postpetiole about twice wider than that of petiole; from above, 1.24–1.50 times wider than long, lateral margins strongly convex; anterior margin straight or slightly concave.

*Integument.* Front of head slightly shiny, finely reticulate and with obscure fine punctures; median line obscure. Supraclypeal area polished, shiny. Median lobe of clypeus slightly shiny, with several irregular, fine longitudinal rugulae. Sides and venter of head shiny and sparsely punctate, reticulae faint.

Thoracic dorsum a little shinier than front of head, faintly reticulate and with shallow punctures. Pronotal side shiny, with sparse, fine punctures. Sides of mesopleura and propodeum moderately shiny; closely, finely striatopunctate. Petiolar node moderately shiny, finely sparsely punctate; anterior peduncle dull, closely punctate. Node of postpetiole moderately shiny, with sparse, obscure, fine punctures. First gastric tergite shiny, with sparse, fine piligerous punctures.

*Vestiture.* Pubescence everywhere fine, appressed, as usual in genus. Clypeal margin with three long, erect hairs; mandibles with a few long, decumbent hairs; apical gastric segments with a few long, decumbent hairs.

*Color.* Head brownish ferruginous, lighter anteriorly; thorax, petiole and postpetiole light ferruginous to yellowish; gaster blackish; antenna and legs light ferruginous to yellowish.

**FEMALE Measurements** (Fig. 5). HL 0.59–0.63; HW 0.47–0.50; SL 0.43–0.44; WL 0.84–0.89; PW 0.40–0.42; Wing 2.00–2.07 mm.

Head shape similar to that of worker, CI 78–82. Scape short of occiput by about its greatest thickness, less than length of second antennomere; proportionately shorter than that of worker, SI 88–91. Eye large, removed from base of mandible by 0.58–0.67 times its greatest length. Lateral ocelli about  $\frac{1}{3}$  smaller than median ocellus, separated by about five times their diameters. Clypeus and mandible as in worker.

Thorax slender, WL 0.47–0.49 times WL. Pronotal humeri weakly angulate. Basal face of propodeum about as long as posterior face; spines triangular, length slightly less than greatest width, distance between apices about three times their length.

Petiole and postpetiole as in worker.

*Integument.* Head as in worker. Pronotal humeri, mesoscutum and scutellum slightly shiny, coarsely reticulopunctate. Side of pronotum, pleurae and side of propodeum shinier than dorsum, finely longitudinally striatopunctate. Basal face of propodeum closely, finely punctate, posterior face shiny, finely transversely striate. Petiole and postpetiole as in worker. First gastric tergite similar to that of worker, but punctures relatively coarser.

→

FIG. 5. *Cardiocondyla ectopia*. Female, dorsal view. Figure by Ruth Ann DeNicola.

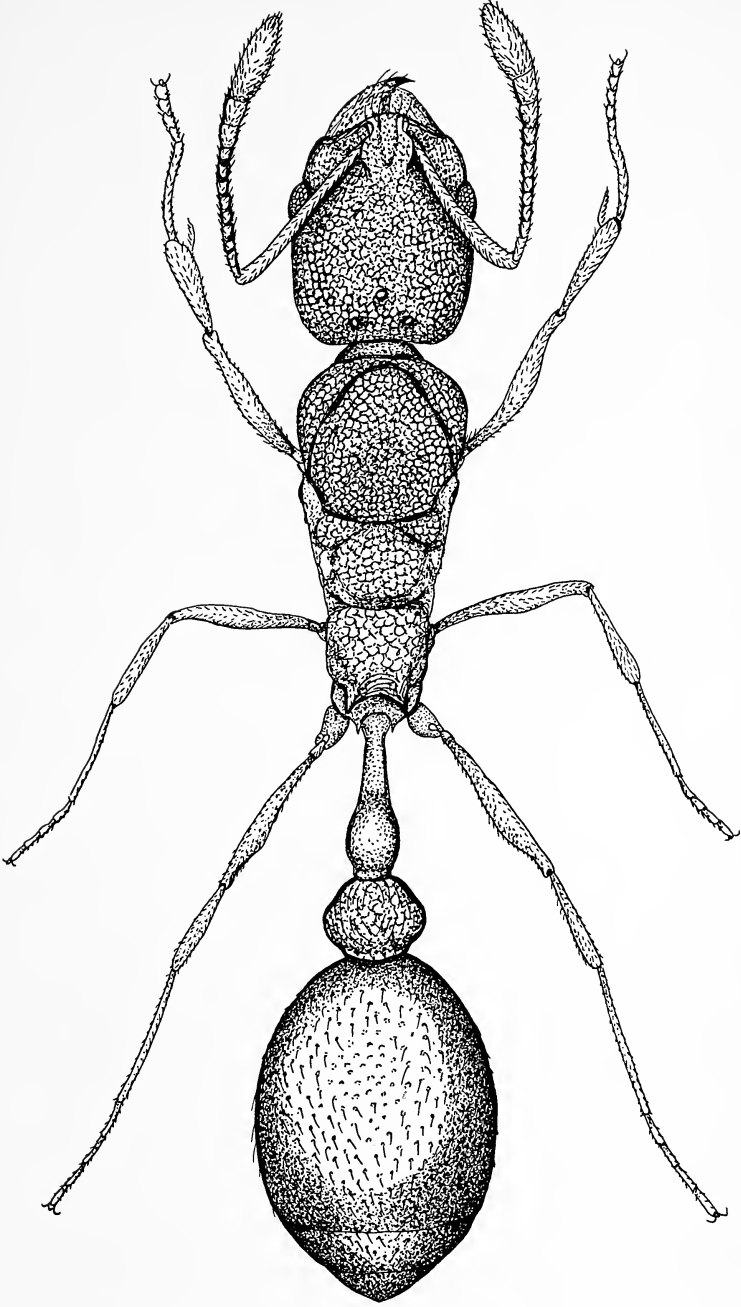

5

*Vestiture.* As in worker.

*Color.* Light brownish ferruginous, thorax, petiole, postpetiole, and appendages lighter; gaster blackish. Wings whitish, veins and stigma pale yellowish.

**MALE Measurements** (Figs. 3, 4). HL 0.51–0.54 (0.53); HW 0.48–0.50 (0.48); SL 0.38–0.39 (0.38); WL 0.61–0.63 (0.63); PW 0.30–0.31 (0.30).

Head slightly longer than broad, CI 91–93 (91), distinctly longer than scape, SI 78–79 (79); in frontal view, sides of head and occipital margin nearly straight, occipital corners broadly rounded. Median lobe of clypeus short, weakly carinate at sides, margin slightly concave. Antenna 12-segmented, apical club one-segmented; scape short of occiput by a little less (5:6) than its greatest thickness, about length of second antennomere. Eye small, separated from mandibular insertion by 0.88–1.00 (1.00) times its greatest diameter. Ocelli absent. Mandible quinquedentate, apical tooth massive, pre-apical tooth larger than basal teeth.

Thorax slender, PW 0.48–0.50 (0.48) times WL, broadest at humeri. Humeri right-angular; pronotum and mesonotum abruptly declivitous laterally. Metanotal suture impressed. Basal face of propodeum distinctly longer than posterior; spines short, triangular, about as long as greatest width, apices separated by slightly more than twice length.

Node of petiole, from above, a little broader than long; in profile, longer than high; peduncle with anteroventral tooth. Node of postpetiole about twice wider than that of petiole, 1.4–1.5 times wider than long, sides strongly convex from above.

*Integument.* Head shiny, smooth to slightly roughened between sparse, fine, shallow, piligerous punctures; clypeus moderately shiny, with obscure median carinula; sides and venter duller, integument more roughened. Promesonotum shiny, with sparse, fine punctures; side of propodeum smooth and shiny, with sparse fine punctures; pleurae similar, but weakly striatopunctate on lower half. Basal face of propodeum shiny, with sparse, fine punctures; side similar, but obscurely striatopunctate below. Nodes of petiole and postpetiole moderately shiny, with sparse, fine punctures. First tergite smooth and shiny between scattered fine, piligerous punctures.

*Vestiture.* As described for worker.

*Color.* Head, thorax, petiole, and postpetiole pale yellowish; clypeus, mandible, thoracic sutures, and pleurae more reddish; gaster light brownish; vertex with obscure pale brownish spot; appendages pale reddish yellow.

*Holotype* worker, *allotype* male; 17 female, two male and 282 worker paratypes: Seal Beach, 25', Orange Co., Calif., 17–24 July 1972 (R. R. Snelling, No. 72–9), in Natural History Museum of Los Angeles County, except one female and two worker paratypes in each of the following: American Museum of Natural History, Museum of Comparative Zoology, and United States National Museum.

The specific name is from Greek, *ektopios*, strange or out of place, alluding to the alien origin of this species.

#### DISTRIBUTION

Although certainly of Old World origin, this species is presently known only from southern California. In addition to material from the type locality, specimens from the following localities have been studied: Long Beach, Los Angeles Co., various dates (R. J. Hamton; LACM, RJH); Downey, Los Angeles Co., 6 June 1968 (K. C. Stephens;



LACM); Artesia, Los Angeles Co., 22 Aug. 1968 (K. C. Stephens; LACM); Tustin, Orange Co., 6 June 1970 (A. Mintzer; LACM).

#### DISCUSSION

The worker of *C. ectopia* cannot be run out in the key by Smith (1944) since it fails to agree fully with either alternative of the first couplet. In that of Creighton (1950) it will go to *C. emeryi* Forel. Workers differ from those of *C. emeryi* by the broader head, longer oculomandibular distance, concave anterior clypeal margin, striatopunctate pleurae, broader propodeal spines, and less compressed petiolar node. From *C. nuda* (Mayr), *C. ectopia* is readily separable by the shorter oculomalar distance, rounded humeri, striatopunctate pleurae, and impressed metanotal suture. In *C. venustula* Wheeler and Mann, the clypeus is more massive, the pleurae punctate only, the propodeal spines are reduced to minute tubercles and the antennal scape fails to reach the occipital margin by less than its greatest thickness. In *C. wroughtoni* Forel, the node of the petiole is broader, the anterior margin of the postpetiole is distinctly concave, the pronotal humeri are subangular and the propodeal spines are longer.

Males in this genus are very poorly known and the few descriptions are meaningless, especially those of the ergatoid males. These usually have been compared to the workers. Normal, winged males are produced by *C. emeryi*. This same species also has modified ergatoid males in which the antennae are 11-segmented, the mandible is unusually long and slender, without a dentate cutting margin, the anterior margin of the clypeus is deeply emarginate and with lateral angulations, and the mesonotum has a transverse gibbosity. An ergatoid male similar to that of *C. ectopia* is produced by *C. nuda* but the description of that form by Forel (1904) is too general to be useful. No males of *C. venustula* or *C. wroughtoni* have been available, nor have they been described.

The female of *C. venustula* has the propodeal spines reduced to denticles, the nodes of petiole and postpetiole are sharply reticulopunctate, and the sides of the thorax are longitudinally rugulose. Those of *C. wroughtoni* and *C. emeryi* also have rather coarsely and closely punctate petiolar and postpetiolar nodes, the anterior margin of the postpetiole is concave in dorsal view, the petiolar spines are about thrice longer than wide and the sides of the pronotum are uniformly contiguously punctate. The female of *C. ectopia* is most similar to that of *C. nuda*, but the sides of the pronotum are shinier, with irregularly spaced punctures and longitudinal rugulae, rather than uniformly closely punctate. In *C. nuda* the piligerous punctures of the first tergite are very fine, hardly exceeding the diameter of the hairs arising from them. In that species, too, the oculomandibular distance is about half the maximum eye length, a little longer in *C. ectopia*.

#### Literature Cited

- CREIGHTON, W. S. 1950. The ants of North America. *Bull. Mus. Comp. Zool.*, **104**:1-585.
- FOREL, A. 1904. *Miscellanea Myrmécologiques*. *Rev. Suisse Zool.*, **12**:1-52.
- SMITH, M. R. 1944. Ants of the genus *Cardiocondyla* Emery in the United States. *Proc. Entom. Soc. Wash.*, **46**:30-41.

## Notes on the Behavior of Three Species of *Cardiocondyla* in the United States (Hymenoptera: Formicidae)

WILLIAM S. CREIGHTON<sup>1</sup>

LA FERIA, TEXAS 78559

AND

ROY R. SNELLING

NATURAL HISTORY MUSEUM OF LOS ANGELES COUNTY, LOS ANGELES, CALIFORNIA 90007

RECEIVED FOR PUBLICATION JANUARY 7, 1974

**Abstract:** The behavior, both in the field and in observation nests, of three species of *Cardiocondyla* are described: *C. emeryi* and *C. nuda* were studied in Texas and *C. ectopia* in California. Observations include data on length of immature stages, foraging habits, foods utilized, reactions with other ant species and mating behavior. The data are summarized and compared against observations made by E. O. Wilson on *C. venustula* and *C. emeryi*.

Although the observations presented in this paper are based on a limited number of colonies, we believe that they will substantially augment the habit data now available for three of the five species of *Cardiocondyla* which occur in the United States. When M. R. Smith monographed our representatives of *Cardiocondyla* in 1944, four species were known to occur in the United States, restricted to southern Florida. At that time Dr. Smith opined that subsequent field work would turn up records in other parts of the southern United States. His view has been amply confirmed. The senior author has been able to study colonies of *C. emeryi* Forel and *C. nuda* (Mayr) at La Feria, Texas, and the junior author has studied colonies of *C. ectopia* Snelling at Seal Beach, California. Moreover, the colonies have been favorably placed for continuous observation. It is the lack of continuous observation that has limited previous accounts of the habits of these species. In the many times that *C. emeryi* has been taken in the field, few of these encounters have permitted a protracted study of the colonies. Indeed, in many instances no nest was found and observations were based on the behavior of strays or foragers at food sources. As far as we have been able to determine, no one has attempted to study these tiny ants in observation nests. This is not surprising since they are so small that they are difficult to confine. They can escape through minute apertures and frequently do so. We have been able to study all three species in observation nests. In *emeryi* the observations extended over a period of a year and a half. The observations on the free nests covered a considerably longer period.

---

<sup>1</sup> Died 23 July 1973. The sections on *C. emeryi* and *C. nuda* were in unfinished manuscript, completed by the junior author.

*Cardiocondyla emeryi* Forel

The senior author took stray workers of *emeryi* near La Feria, Texas, as early as 1964, but extensive search failed to reveal the nest. This was particularly frustrating, since it was clear that the nest must be situated in an area that was less than twenty-five feet square. Although this nest was never found, its workers continued to forage for the ensuing three years. At that time the colony either moved to another area or came to an end. Similar difficulties marked the second nest of *emeryi*. In early December of 1970, foragers of *emeryi* were found on a concrete sidewalk in front of the senior author's cottage in La Feria, Texas. The opportunity for observing these foragers could scarcely have been more favorable. They were close at hand and as long as they kept to the sidewalk there was little possibility of losing sight of them. Yet despite daily inspections it was not until nearly two months later that the nest was discovered. The entrance was a tiny, circular opening about one millimeter in diameter in the soil at the edge of the walk. Originally this entrance was completely concealed by a heavy overgrowth of grass. When the nest was excavated, three deâlated females and thirty-four workers were secured. These were placed in a small Janet nest for further observation. It later became apparent that only a part of the colony had been taken, for, after a few days, a new nest entrance was opened up and foraging began again. This provided a good opportunity for checking the actions of the captive workers against those of their free nest mates. These observations were continued over a period of eighteen months, for the captive colony proved to be hardy and comparatively easy to handle.

The transfer of the females to the observation nest did not interrupt their egg laying, and subsequent events showed that this proceeds all year long. The egg is a stubby oval, approximately 0.3 mm. long and 0.17 mm. wide. When about to lay an egg, the female turns her abdomen under the thorax until she can touch the tip of it with her mandibles. As a rule the female grasps the egg in her mandibles as it emerges but occasionally the emerging egg will be seized by one of the workers. The eggs, which appear to be unusually sticky, are collected in packets which are often shifted about by the workers.

No attempt was made to maintain the captive colony at a constant temperature, although, for the most part, the temperature ranged between 60°–70°F. The following data are, therefore, mainly useful in showing the relative length of the various stages. Twelve days after the egg is laid the larva emerges. As the larva increases in size, its anterior end becomes more and more bent until finally the mandibles are in close proximity to the swollen ventral body wall. Twenty-three days after the larva has hatched, the meconium is voided and the larva transforms to a pupa four days later. Six days after transformation, the eyes and the mandibular teeth of the pupa begin to show pigmentation, and by the end of two weeks the pigmentation is general. Transformation to the adult

occurs a day or two later. As the pigmentation is well advanced by this time, the callow period lasts only a day or two.

The data just presented may be summarized as follows:

Egg to larva	12 days
Larva to pupa	27 days
Pupa to adult	16 days
Egg to adult	55 days

Since the observations on which the above figures are based were made during a period from January 18 to March 15, it is probable that during the warmer months of the year the rate of development of *emeryi* is more rapid.

It was soon apparent that the workers in the captive colony would accept anything edible that was put in the food chamber. Moreover, there was no indication of preference for a particular kind of food. Honey-dew and nectar elicited just as vigorous feeding responses as did the tissues and body fluids of other insects. On the other hand, there were some interesting points in the mechanics of feeding. It is not to be expected that an ant as small as *emeryi* could easily cut to pieces heavily sclerotized insect body wall. But the ants seemed particularly inept at this sort of activity. They often failed to cut up the soft body wall of termites, although they would "mine" termites extensively when the body wall was torn open. They had better success with lightly sclerotized insects such as mosquitoes, crane flies, and may flies and usually managed to cut them apart although the process was a slow one. When this was done, pieces of the dissected victim were sometimes carried into the brood chamber and fed to the larvae, but most of the time the larvae were fed by regurgitation. This also seemed to be true of the free colony. During two years of observation, only a few foragers were seen to carry anything back to the nest. Two of these foragers were relieved of their burdens which, in each case, consisted of a much macerated bit of soft insect body wall.

Most of the insects placed in the food chamber of the captive colony were killed before they were given to the ants, but on three occasions living victims were offered to them. Prudence demanded that these be small insects which would not be able to disrupt the colony. The living victims used were collembola (snow fleas), the small nymphs of the woolly apple aphid, and the first instars of a pentatomid bug. The reaction of the *emeryi* workers was essentially the same for all three. The victims were immobilized either by having the head crushed or by having the appendages bitten off, whereupon their body fluids and softer tissues were cleaned out. While the ants attacked their victims energetically, there was no evidence that any of them were stung. If the captive colony was not liberally supplied with food, the workers would eat the brood. When they did so, it was usually the pupae which were eaten.

To summarize the above, it appears that *emeryi* is omnivorous. It is prob-

ably predatory on small, soft-bodied insects and almost certainly scavenges the remains of larger ones. Solid food is rarely brought back to the nest and food transfer in the colony mainly involves regurgitated liquid foods.

Although the captive colony kept the brood chamber fairly clean, it was remarkably slack about the rest of the nest. Dead members of the colony which had been cut to pieces, together with bits of insects which had served as food, would be dropped at random in any part of the nest except the brood chamber. At times so much of this refuse accumulated in the passages that the workers had difficulty in getting through them. This led to a serious mold problem; since the refuse was not concentrated in a kitchen midden, mold easily spread throughout most of the nest. This made frequent cleaning necessary. It was soon found that the best way to do this was to chill the ants to immobility. This was done many times without deleterious results, a rather remarkable response on the part of a species which is regarded as a tropicopolitan tramp.

The foraging activities of the free colony showed a number of puzzling features. About the only clear-cut controlling factor was temperature, for foraging would not occur unless the surface temperature was 70°F (21°C) or higher. Beyond this there was little to indicate what factors were involved in the foraging pattern. The foragers emerged singly from the nest entrance at widely separated intervals. Even under optimum conditions at least fifteen minutes intervened between the emergence of one worker and that of its follower. As a result, there was no concentration of foragers around the nest entrance, since the forager was well away from the nest entrance by the time the next one emerged from it. A secondary result was that no more than a dozen foragers (often less) were outside the nest at once.

On leaving the nest the forager might start off in any direction and the course which it followed was extraordinarily crooked. It was exceptional for a forager to move for more than three or four centimeters in a straight line. Moreover, they often doubled back over their previous course. This same random, tortuous course marked the return to the nest and here there was even stronger evidence of lack of orientation, for the returning forager would often overshoot the nest entrance even though it passed close by it. As already noted, few returning foragers carried solid food to the nest, and it seemed possible that the erratic return course to the nest might be an indication that no food had been found. In order to test this, grains of sugar were placed on the sidewalk fifteen centimeters from the nest entrance. The foragers carried the sugar grains back to the nest in their mandibles. But it was exceptional to find that one of these obviously food-burdened foragers returned directly to the nest. Instead they continued on their erratic courses and were equally inept at finding the nest entrance. It may be recalled that when Dr. E. O. Wilson (1959) published his observations on the foraging of *C. venustula*, he reported that the foragers proceeded from nest entrance to food source over a straight course. Moreover, they would

stick to this course even when this involved surmounting obstacles which could have been avoided by slight course deviations. Dr. Wilson believed that this behavior was due to the fact that the foragers orient themselves by sight. It is hard to see how such an explanation could apply to the tortuous courses characteristic of *emeryi*. On the other hand, it is equally hard to suggest what, if anything, controls the random foraging of *emeryi*. But it is clear enough that this sort of foraging gives no chance for recruitment by tandem running. Over many months of observation, no tandem running was ever observed in *emeryi*.

The foragers of *emeryi* often met other species of ants on the sidewalk. Most of the dozen or so species which foraged on the sidewalk posed no particular threat to the *emeryi* foragers, but two of them, *Solenopsis geminata* (Fabricius) and *Pheidole dentata* Mayr, are aggressive and carnivorous, and it seemed likely that encounters with these two species would be extremely hazardous for the *emeryi* workers. It was a surprise, therefore, to discover that in such encounters the two larger species exhibited a marked avoidance reaction to *emeryi*. When such encounters occurred, the *emeryi* forager stood still while the other ant scrambled away. This was particularly noticeable in *P. dentata* minors which seemed to go into a near panic in the presence of an *emeryi* forager. Since the size disparity rules out any possibility that the foragers of *geminata* and *dentata* were trying to avoid an attack by the *emeryi* worker, it can only be supposed that despite its small size the worker of *emeryi* possesses a highly effective repellent pheromone. This would also explain how *emeryi* is able to nest in close proximity to flourishing colonies of *S. geminata* and *P. dentata*.

#### *Cardiocondyla nuda* (Mayr)

It now seems clear that the senior author was mistaken in treating Forel's variety *minutior* as a subspecies in 1950. At that time there were few long nest series of *nuda* available for study; hence it was not certain how the single nest series which had yielded workers of the typical *nuda* and others of the variety *minutior* ought to be handled. Subsequent studies have shown that the above situation is normally encountered in any long nest series of *nuda*. It follows that *minutior* must be treated as a synonym of *nuda*, as shown by Wilson and Taylor (1967).

In April 1972, several nests of *nuda* were found in a brick sidewalk about seventy-five yards away from the nest of *emeryi* described earlier in this paper. These were built in the thin layers of soil which had pressed up between the bricks. On April 14 one of these colonies was excavated and installed in an observation nest. The colony consisted of two dealated queens and thirty-eight workers. Since *emeryi* had shown itself to be easily adaptable to life in an artificial nest, no difficulty was anticipated in the observation nest of *nuda*. Actually the *nuda* colony proved to be far more difficult to handle.

At first the *nuda* colony seemed to be doing well. Both queens laid eggs and

the workers carried out their usual nest activities. But at the end of two weeks, the rate of egg laying declined. Ultimately both queens ceased to produce eggs. By this time some had been in the nest a month, and it might have been expected that larvae would have been present. However, no egg ever hatched. About the end of May, both queens were cut to pieces by the workers and the colony expired.

It seems worth noting that during the brief duration of this *nuda* colony, the observation colony of *emeryi* was bringing much brood to maturity. Since this seems to indicate that nest conditions were satisfactory, considerable effort was made to assure that the *nuda* colony received identical treatment. The two Janet nests were kept in contact to minimize temperature differences. Their humidity was, as far as possible, kept at the same level and the same food was given each. Since the *emeryi* colony survived until the summer of 1972, at which time the last queen died, the obvious conclusion must be that *nuda* requires nest conditions different from those which satisfy *emeryi*.

Better results were secured from observation on the free colonies of *nuda*. The foragers leave the nest singly but as they emerge more frequently than do those of *emeryi* there are usually more of them outside the nest. They forage somewhat more rapidly than do the workers of *emeryi* and the courses they follow, while by no means straight, are far less tortuous than those of *emeryi*. It is rare for a forager of *nuda* to double back on its own course. The result is that their progress between nest entrance and food source is more direct. They also seem to have less difficulty finding the nest entrance on their return.

#### *Cardiocondyla ectopia* Snelling

A single polydomous colony was found in the junior author's front yard in mid-July 1972. The subcolonies from northeast to southwest were designated A, B, C. Subcolony B was situated 2.6 m. SW of A; C was about 3 m. S of B. The entrances of A and B, both between bricks set into the soil, were fully exposed and marked by piles of debris. That of C, although similarly marked by debris, was more difficult to discover because it was partially concealed by a dense mat of *Euphorbia serpens*.<sup>2</sup>

Foraging activities of this species have been observed intermittently for about one year. Other than modifications of diurnal activity, which seem directly related to temperature, activity appears to be uniform. During the cooler months, November to March, there is little surface activity. Daytime temperatures often are not sufficiently high to prompt activity, or the duration of suitable temperature levels is too short.

During July 1972 the colonies were watched whenever circumstances permitted. At five-minute intervals during observation periods, two temperature readings

---

<sup>2</sup> Determined by R. Gustafson, Natural History Museum of Los Angeles County.

were made—one of the ambient temperature at a level of six feet, the other of the surface of the asphalt driveway. At this time of the year, worker ants emerge from the nest and begin foraging when the ambient temperature is at 19°–20°C; the asphalt surface, in full sun, is at about 24°C. On one date in July, the ambient reading at 1100 hrs. was 26°C and workers were no longer moving onto the exposed surfaces. For workers from colonies A and B, access to food resource areas was across a distance of about 0.3 m. When surface temperatures reached as high as 42°C at 1100 hrs., there was no foraging activity by individuals from these colonies. Workers from C continued to forage, though at a greatly reduced density, since they had direct access to the patch of *Euphorbia*.

On another day, however, by 1100 hrs. the ambient temperature was at 23°C, the surface at 36°C. Because of cloud cover, the surface temperature had been at that level for nearly an hour. From 1000–1045 hrs., ants were active on the paved surfaces, but at about 1045 began to abandon these surfaces. On other days, when surface temperatures never exceeded 35°C, there was a noticeable lessening of activity after 1100 hrs., so it would appear that time of day is, at least partially, a controlling factor in the foraging pattern of this species. However, notes by the junior author record some surface activity as late as 1925 hrs.

Foragers traveled at least 6 m. from the nest in search of food. The small size of the ants made observation difficult once the workers reached food source areas amid the plants in the yard. Attempts to determine foraging distances were frustrated by two factors: the reluctance of the ants to accept bait of any sort and the competition of the much larger Argentine ant *Iridomyrmex humilis* (Mayr). The latter species quickly discovered and monopolized baits.

Individuals which foraged in the mats of *Euphorbia* were observed with some success. Many proceeded directly to the flowers and took nectar. Several seconds (3–21, average 7.4) were spent at each blossom. After a period of up to 35 min. the forager returned to the nest with distended gaster. Other workers wandered about, picking up bits of soil, fragments of plant fiber, and pieces of dead arthropods. Once an acceptable item was discovered, it was transported back to the nest. Fragments collected were so small that no attempt was made at specific identification.

From the onset of foraging until about 1030 hrs., the *Cardiocondyla* workers foraged throughout the area, even though *I. humilis* frequently utilized the same areas. After about 1030, however, most areas were abandoned by the smaller species. An exception was the patch of *Euphorbia* adjacent to nest C. This resource was worked until about 1300 hrs., after which time only Argentine ants were to be found on it. Since this pattern was consistent, it seems safe to assume that the foraging period of the *Cardiocondyla* regularly ends in early afternoon. Occasional encounters between the two species were uncommon. As a rule, both



species retreated from the point of encounter. Often, however, the *Cardiocondyla* would continue along its original course or was but slightly diverted. The *Iridomyrmex* behaved in a very erratic fashion, and usually left the point of encounter rapidly, and at a course highly divergent from its original course. Less often, the *Cardiocondyla* worker would stop with gaster slightly elevated, head lifted and directed forward, with spread mandibles.

Workers departing from the nests were observed often. Most proceeded singly in a very irregular but basically unidirectional mode. There were many turns and divergences for no apparent reason. Return from the foraging area did not always reverse the outward course. In fact, seldom was this so, for often the ant would head back to the nest from a point in the foraging area fully a meter from where she entered it. The return was frequently much less direct than the departure, involving more divergences from the straight line and much back-tracking. Once within 0.2 m. of the nest the ant seemed more certain of her direction and would head more or less directly toward the nest entrance. Even so, misses were frequent and some search was necessary.

From the above we may perhaps deduce that orientation is partially solar-directional and partially a matter of visual recognition within a limited area. There may also be a distance recognition factor, as suggested by a series of tests. An individual which discovered a bait placed in the driveway was marked on the gaster. After feeding, it returned to the nest, 1 m. distant. A period of almost 15 min. elapsed before the marked ant appeared, heading toward the bait. The path between the ant and the bait was washed with ethyl alcohol and the bait displaced 5 cm. to one side. The worker proceeded across the washed area with only momentary hesitation. She stopped when she reached a point about 1.5 cm. from where the bait had been and began searching for several centimeters in all directions. Ultimately the new location was discovered. This experiment was repeated, with similar results, several times with different individuals. When the bait was displaced as much as 15 cm., it usually was not relocated for the ants would not search so far from the known locus.

Although most foragers depart singly from the nest, tandem running is frequent in this species. Tandems almost invariably consist of a pair of ants, rarely three. The pattern is as described by Wilson (1959) for *venustula*. By working with marked individuals in an observation colony, it was possible to discover that the leader of the tandem pair was guiding the follower to a previously discovered food source and that the follower was recruited. The follower, in turn, would recruit another individual once she returned to the nest. When the lead ant arrived at the bait, she would immediately begin feeding. The follower, after searching for a few seconds, would discover the bait and also begin to feed.

On 23 July 1972 colony A was excavated and placed in a Janet nest. The colony consisted of eight dealate females, two alate females, about 75 workers,

and two males. Brood was not counted but estimated at 55 larvae and 15 pupae. About five hours after removal to the artificial nest, mating between one of the males and one of the alate females was observed. The female was motionless, antennae slightly extended, head vertical, mandibles slightly open. The male mounted the female, parallel with her body, and began to nip at the top of the head of the female, then rapidly jerked his head up and down along the front of the female's, apparently effecting contact with her mouthparts. The jerking movement of the male was excited and rapid, appearing almost violent, and lasted about 15 sec. After this, he backed along the dorsum of her body, curled the gastric tip under that of the female, establishing genital contact. Genitalic contact lasted about five sec., after which the male returned to the forward position, cleaned the gastric apex, followed by renewal of the entire procedure. The entire sequence of activities was repeated three times within a five-min. period. After the last repetition, the male completed his cleaning procedure, then remained motionless. At this time the female began to walk about and the male eventually fell off. At some time during the following day this female shed her wings and became indistinguishable from the others. The other female was not observed to mate; on 17 August she was not to be found among the colony residents.

Santschi (1907) stated that males of *nuda* "var. *mauritanica*" assisted in moving brood. We have no observations to indicate that the male of *ectopia* practices such remarkable behavior.

Males of this species are ergatoid, hence wingless, so mating flights do not take place. Mating, of necessity, occurs within the nest. But, does the mating take place between individuals born within the same colony, hence potentially brother and sister? If so, does the female always, or only occasionally, shed her wings and remain with her colony? Or does she shed her wings and migrate with part of the worker force to establish a new colony by budding? Does she sometimes fly after mating either to (a) found a new colony or (b) become adopted into a neighboring nest? Or does she fly forth from her parent nest still virgin, become adopted into a neighboring colony, and mate with a male there?

Unfortunately, no answer as yet can be given to the above questions. We incline to the last-mentioned alternative, however. Adoption into another colony seems to be a very simple matter. Workers and females from different nests have been introduced into the observation colony without evidence of animosity; the new ants acted as if they were a part of the colony. One alate female in colony A at the time of its capture was not observed to mate, nor did she shed her wings. On 17 August she disappeared. No remains were found in the midden. From this we assume she escaped by flight. It is assumed that she attempted to locate another colony.

In our view the pre-mating flight-adoption-mating alternative seems most logical, even though there is no firm evidence for it. A mated female represents a

considerable reproductive potential, far more than does an unmated female. Furthermore, mating with a male from a different colony is genetically more sound.

Females do not emerge en masse for flight. Rather, they emerge singly and take flight over a period of an hour or more. On 17 July 1972 females flew from colony C as follows: 0905—1 ♀; 0906—1 ♀; 0907—1 ♀; 0908—2 ♀ ♀; 0910—1 ♀; 0915—1 ♀; 1018—1 ♀; 1023—1 ♀. On 23 July 1972: 1010—1 ♀; 1012—1 ♀; 1015—1 ♀; 1018—1 ♀; 1035—1 ♀. On 7 August 1972 one female emerged from C at 0930. On 19 February 1973 a single female flew from C at 1400, air temperature about 23°C, as was true for all of these (observed range: 22.7°–24.1°C).

#### DISCUSSION

Wilson (1955) summarized the natural history of *venustula* as he observed it in Puerto Rico. He found that the colonies were polydomous and that the populations were low, probably not in excess of two hundred workers. Nest entrances were small and surrounded by debris. Foraging occurred mostly during the middle part of the day. Tandem running was observed and presumed to be a highly evolved form of recruitment. Tandem running was also noted to occur in *emeryi* in Puerto Rico.

Our observations, based on *emeryi*, *nuda*, and *ectopia*, tend to corroborate Wilson's conclusions. The siting of nests seems to be very similar for all four species, and the entrances are concealed by miscellaneous debris. Foraging of the three species which we studied takes place mostly during the midmorning to midafternoon period, at temperatures above 19°C, and ceases when the ambient temperature reaches 26°C.

Colonies of *ectopia* appear to be polydomous, as in *venustula*, with the components up to six meters apart. Multiple queens seem to be normal in all species. Males of *ectopia* are wingless and mating takes place within the nest. Alate females emerge singly and fly quickly. Mating possibly occurs before emergence or it may be that the females seek adoption in a neighboring nest and mate there.

Curiously, although Wilson reported tandem running of *emeryi*, the senior author found no examples of such behavior in this species at La Feria, Texas. The foraging pattern of this ant is highly erratic and it may be that tandem recruitment is not common in this species. This recruitment technique was not observed in *nuda*. The two species should be more thoroughly studied.

Better results were obtained for *ectopia*. Departing workers pursue an erratic pattern when searching for food; but once a large source, requiring more ants, is located, the foragers return more or less directly to the nest. Here, another worker is recruited and led back to the food source, again more or less directly. Additional ants are recruited in the same manner, if necessary.

Wilson described his experiments with tandem pairs of *venustula*. Similar experiments with *ectopia* produced similar results. From these data it seems clear that chemical trails are not laid down and orientation to a food source is probably based on solar position and distance. Since there is no chemical trail to indicate direction, it follows that the discoverer must lead its nestmates to the food source. The leader of the tandem pair evidently releases an excitant pheromone by which the follower is led. It seems possible that this chemical is so volatile it functions for only a short distance and that only a single individual can follow it. Hence tandems consist only of a single pair.

The ants are small and can carry only small arthropods or fragments of larger ones. Relatively large items, such as can be exploited only by large numbers, probably are seldom available. These are likely effectively taken over by larger ants (*Pheidole*, *Solenopsis*, *Iridomyrmex*, etc.) or by those which recruit in large numbers (*Monomorium*, *Wasmannia*, *Iridomyrmex*, etc.). While individuals of *Cardiocondyla* can apparently repel individuals of *Iridomyrmex*, it is unlikely that the colonies can effectively compete against such numerically superior species at more bountiful food sources. Further studies of these and other *Cardiocondyla* should investigate food resource utilization as compared to other ants in the same foraging area.

#### Literature Cited

- CREIGHTON, W. S. 1950. The ants of North America. Bull. Mus. Comp. Zool. Harvard, **104**: 1-585.
- SANTSCHI, F. 1907. Fourmis de Tunisie capturées en 1906. Rev. Suisse Zool., **15**: 305-334.
- SMITH, M. R. 1944. Ants of the genus *Cardiocondyla* Emery in the United States. Proc. Entom. Soc. Wash., **46**: 30-41.
- SNELLING, R. R. 1974. Studies on California ants. 8. A new species of *Cardiocondyla*. Jour. New York Entomol. Soc., **82**: 76-81.
- WILSON, E. O. 1959. Communication by tandem running in the ant genus *Cardiocondyla*. Psyche, **66**: 29-34.
- WILSON, E. O. AND TAYLOR, R. W. 1967. The ants of Polynesia. Pac. Insects Monog., **14**: 1-109.

## Generic Diversity in Phase of Rhythm in Myrmicine Ants

ELWOOD S. MCCLUSKEY

DEPARTMENTS OF PHYSIOLOGY AND OF BIOLOGY, LOMA LINDA UNIVERSITY,  
LOMA LINDA, CALIFORNIA 92354

RECEIVED FOR PUBLICATION FEBRUARY 11, 1974

**Abstract:** Few comparative studies in functional biology have been made at the genus level. In the tribe Myrmicini, the latest morning hour the workers are aboveground was compared for 58 species in 9 genera and the hour of mating flight for 40 species in 13 genera. In each case there is more difference in phase of rhythm among than within genera. When the possible influence of season, altitude, latitude, average rainfall, and average temperature is statistically removed by analysis of covariance, the generic diversity remains significant. This evidence suggests a taxonomic explanation of the diversity (as opposed to a strictly ecological or geographical explanation).

### INTRODUCTION

Relatively few comparative studies in functional biology have been made at the genus level. In the ant tribe Formicini time of day both of mating flight and of worker foraging is much more alike from species to species within a genus than among genera (McCluskey, 1973). This correlation of behavior with taxonomic grouping suggested the value of studying more groups of ants. The present paper considers the tribe Myrmicini (broad sense) in another subfamily (Myrmicinae). It is again based on literature records.

### DESCRIPTIVE COMPARISONS

#### *Mating Flight*

Figure 1 presents the midpoint flight hour for each species of each genus where records are available for at least two species. It can be seen first that the generic means range from 0700 to 1800 and second that the species flight hours tend to be similar within each genus. This generic diversity was tested by the circular distribution method of Watson and Williams (1956; cf. Batschelet

---

**Acknowledgments:** Field studies of rhythms in this group were made by Dr. Creighton, most notably his paper of 1953. He gave me personal encouragement when I visited his home in 1956 at an early stage in my research. I thank P. Yahiku for help with statistical analysis; L. Brand, B. Buttler, I. Fraser, and B. Neufeld for reading the manuscript; and R. Snelling for determining *Pheidole pilifera pacifica* and *Solenopsis xyloni*. Part of my inspiration for developing explanatory comparisons was the paper by Waterman (1961). Computer time for the project was supported in part by NIH, Division of Research Resources, Grant RR-00276. For the analysis of covariance, UCLA Health Sciences Computing Facility made its BMDX General Linear Hypothesis program available; this was run at the Loma Linda University Data Processing Facility. G. McCluskey aided with programming.

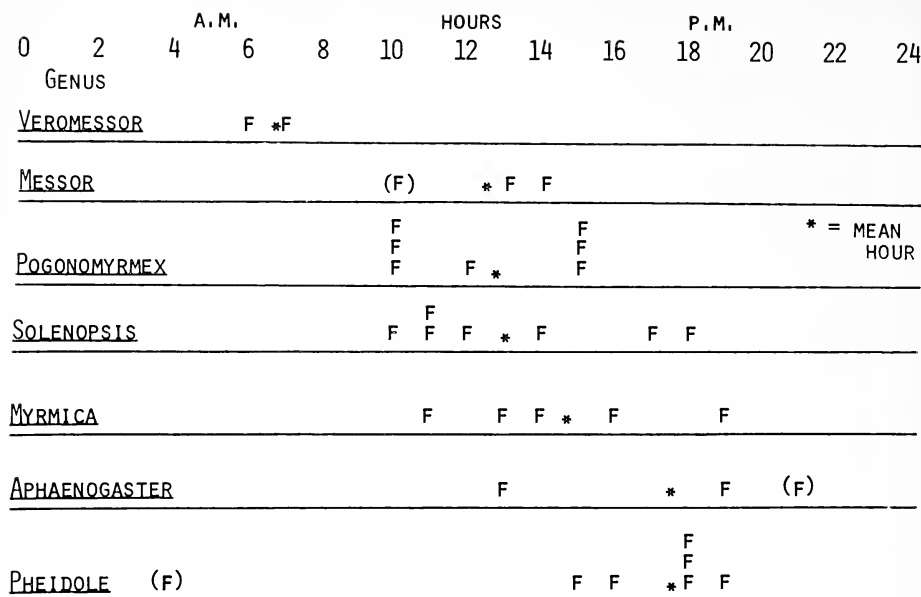

FIG. 1. Flight hours (all recognizable Daylight Time records were converted to Standard Time). Each F represents for one species the midpoint between earliest and latest literature records of flight; ( ) indicate the most fragmentary records. Each asterisk shows the mean of the species midpoints for a particular genus. Following are the species and literature sources represented, including single-species records for 6 genera not plotted on the graph. Where personal communication (person. com.) is the source, the hour precedes name. *ATOPOMYRMEX*: *mocquerysi* (Wheeler 1922). *APHAENOGASTER*: *megommatus* (Smith 1963), *pythia* (Saunders 1969), *treatae* (Talbot 1966). *CAREBARA*: *jumodi* (Wheeler 1922). *CAREBARELLA*: *bicolor* (Kempf 1969). *LEPTOTHORAX*: *mon-jauzei* (Cagniant 1968). *MESSOR*: *capitatus* and *structor* (Delage 1968, Meyer 1927), *semirufus concolor* (Mursaloglu 1957). *MYRMICA*: *laevinodis* (Donisthorpe 1927), *lobicornis fracticornis* (Kannowski 1959), *ruginodis* (Beare 1913; Brian & Brian 1955; Donisthorpe 1927), *sabuleti americana* (Kannowski & Kannowski 1957), *schenki emeryana* (Medler 1958; Talbot 1945, 1965). *PHEIDOLE*: *bicarinata* (1600, W. L. Brown pers. com.), *creightoni* (Gregg 1955), *megacephala* (Illingworth 1933, 1935; Williams 1935), *nari* and *sp. #10591* (Kusnezov 1962), *sitarches* (Wilson 1957), *pilifera pacifica* (1530, E. A. McCluskey pers. com.). *POGONOMYRMEX*: *badius* (Van Pelt 1953), *barbatus* (Wheeler 1910, 1917), *californicus* (Michener 1942), *imberbicus* (Wheeler 1917), *maricopa* (Cole 1968), *occidentalis* (Nagel & Rettenmeyer 1973), *rugosus* (1515, F. Taylor pers. com.). *SOLENOPSIS*: *angulatus* and *sp. #10576* and *sp. #10577* (Kusnezov 1962), *invicta* (Markin et al. 1971), *molesta* (Mallis 1941; Talbot 1966; Wilson & Hunt 1966), *richteri* or *saevisima*? (Kusnezov 1962; Rhoades & Davis 1967), *xyloni* (1815, McCluskey unpublished; Wheeler & Wheeler 1973). *STENAMMA*: *brevicorne* (Kannowski 1958). *TETRAMORIUM*: *caespitum* (0700, G. C. & J. Wheeler pers. com.). *VEROMESSOR*: *andrei* (McCluskey 1963), *pergandei* (0730, McCluskey unpublished). An annotated table giving the details of support for Figs. 1 and 2 is available from the author.

1965, but only for a two-sample case):  $F_{q-1, N-q} = [(N-q)(R_i - R)] / [(q-1)(N - R_i)] = 2.80$  and  $P < .02$ . ( $N = 40$  species,  $q = 13$  genera,  $R_i$  refers to the combination vector for all the species in each genus, and  $R$  refers to the combination vector of all genera.)

### *Worker Surface Activity*

Whereas mating flights usually occur at a particular season for a given species, the workers come out of the nest over several seasons. In order to compare the various species most directly, I attempted to use only summer records from clear days. Since many of the literature records are incidental or otherwise fragmentary, the single item of information most useful for comparison was the approximate lateness of the hour the workers stay out of the nest in the morning.

In Fig. 2 a nocturnal species is indicated by an X representing out until "Dawn"; a species which stays out until the sun hits the nest is placed under "Sunshine"; etc. An intermediate time is indicated by an X between two adjacent columns. Every genus was included where records are available for at least three species.

The mean generic hour is seen to range from soon after the sun hits the nest (*Aphaenogaster*) to late morning (*Monomorium*); and there is a noticeable grouping of species. Arbitrarily scoring "Dawn" as 5 AM, "Sunshine" as 7 AM, "Midmorn" as 10 AM, and "Midday" as 1 PM, Watson and Williams' test indicates significant diversity ( $P < .001$ ).

### EXPLANATORY COMPARISONS

How might this generic diversity in phase of rhythm be explained? The data are too limited to answer an ultimate question such as whether the time relations are adaptive. But it is possible to ask preliminary questions. Is there a relationship at the genus level between phase and such gross measures of environment as altitude, latitude, average temperature, average rainfall, or season? (Current examples of studies at the species and microhabitat level indicating sensitivity to the environment include Bernstein, 1971; Levins et al., 1973; and Whitford, 1973).

For each observation locality cited I estimated the altitude (range, 0-2300 m), latitude ( $3^\circ$ - $55^\circ$ ), average temperature ( $10^\circ$ - $32^\circ\text{C}$ ) and total rainfall (2-75 cm) for the appropriate season (using mainly Hammond's Comparative World Atlas, 1963, and Nystrom's World Rainfall maps).

Analysis of covariance permitted consideration of the regression of the dependent variable on a number of independent variables (covariates) simultaneously. For the workers the latest-hour-out was used as the dependent variable, and altitude and latitude, or temperature and rain, as covariates. The generic diversity again appeared highly significant, even though possible altitude,

GENUS	DAWN	SUNSHINE	MIDMORN	MIDDAY
<u>APHAENOGASTER</u>	X X	(X) (X) (X) X *	(X) (X) X	
<u>VEROMESSOR</u>		(X)	X* X	(X) X X
<u>PHEIDOLE</u>	(X)	X	X* X	X
<u>MANICA</u>			X X *	X X
<u>NOVOMESSOR</u>			X X*	X
			X X X X X X*	
<u>MESSOR</u>			X	X
				(X) X X X X
<u>POGONOMYRMEX</u>		X	X* X	X
<u>MYRMICA</u>			X X *	X X X
<u>MONOMORIUM</u>			X	X* X

\* = MEAN HOUR

FIG. 2. Worker surface activity. Each X represents one species and shows its nearest approach to midday. See text and also legend for Fig. 1. The following are represented: *APHAENOGASTER*: *ashmeadi* & *floridana* (Van Pelt 1958; Whitcomb et al. 1972), *fulva* (Park et al. 1931), *longiceps* (Brown 1955), *megommatus* (Cole 1966), *pallida* (Bernard 1968), *rudis picea* and *tennesseensis* (Park & Strohecker 1936), *splendida* (Tohmé 1969), *treatae* (Talbot 1953, 1966). *MANICA*: *bradleyi*, *hunteri*, and *mutica* (Wheeler & Wheeler 1970), *rubida* (Reichle 1943). *MESSOR*: *aegyptiacus* (Délye 1968; Sheata & Kaschef 1971), *alexandri* and *orientalis* (Tohmé 1969), *arenarius* (Délye 1968, 1971), *barbarus* (Buxton 1924; Forel 1928; Pickles 1944; Wheeler & Creighton 1934), *capitatus* (Delage 1968), *caviceps* (Délye 1964, 1968, 1969), *semirufus* (Bodenheimer & Klein 1930; Mursaloglu 1957). *MONOMORIUM*: *chobauti* (Délye 1968, *niloticoides* and *venustum* (Tohmé 1969), *salomonis* (Délye 1968; Kemp 1952). *MYRMICA*: *lobicornis* *fracticornis* (Dondale et al. 1972), *rubra* (Reichle 1943), *ruginodis* and *scabrinodis* (Brian 1955), *sabuleti americana*



TABLE 1. Analyses of Covariance. The contribution of rainfall and temperature might heavily overlap that of altitude and latitude as variables; therefore a second analysis, shown in ( ), was done, with rain and temperature replacing altitude and latitude as covariates

Source of Variation	DF	MS	F	P	
Workers (latest hour out) (58 species, 9 genera)					
Genera	8	12.7 (12.7)	5.5 (5.4)	<.001	(<.001)
Covariates	2	3.7 ( 3.7)	1.6 (1.6)	ns	(ns)
Altitude (or rain)	1	2.1 ( 5.4)	.9 (2.3)	ns	(ns)
Latitude (or temp.)	1	5.9 ( 1.4)	2.5 ( .6)	ns	(ns)
Error	47	2.3 ( 2.3)			
Flights (deviation from midday) (40 species, 13 genera) (With season as months' deviation from August 1)					
Genera	12	8.7 (8.2)	2.5 (2.3)	<.05	(<.05)
Covariates	3	5.4 (4.1)	1.6 (1.1)	ns	(ns)
Altitude (or rain)	1	.7 (2.9)	.2 ( .8)	ns	(ns)
Latitude (or temp.)	1	9.2 (2.9)	2.7 ( .8)	ns	(ns)
Season	1	.0 (8.2)	.0 (2.3)	ns	(ns)
Error	24	3.4 (3.6)			
(With season as months' deviation from June 21)					
Genera	12	8.5 (7.4)	2.6 (2.1)	<.05	(<.10)
Covariates	3	7.0 (4.2)	2.2 (1.2)	ns	(ns)
Altitude (or rain)	1	.4 (2.2)	.1 ( .6)	ns	(ns)
Latitude (or temp.)	1	11.8 (1.6)	3.7 ( .5)	ns	(ns)
Season	1	4.6 (8.5)	1.4 (2.4)	ns	(ns)
Error	24	3.2 (3.6)			

latitude, average temperature and rainfall effects had been statistically removed by the analysis of covariance (see Table 1). The same was true if the possible complicating variables of the tropics were eliminated by performing the analysis for only the temperate zone species (which were the majority).

←

(Dondale et al. 1972; Talbot 1946, 1953), *schenki emeryana* (Talbot 1965). *NOVOMESSOR*: *albisetosus* (Wheeler & Creighton 1934), *cockerelli* (Wheeler & Creighton 1934; Whitford 1973), *manni* (Kannowski 1954). *PHEIDOLE*: *megacephala* (Carnegie 1960; Greenslade 1972; Levins et al. 1973; Steyn 1954), *morrisi* (Van Pelt 1958), *ridicula* (Creighton 1966), *saxicola* (Wheeler 1922), *sculpturata* and/or *crassinoda* and *sp. A* and *sp. Q* (Kemp 1952), *xerophila* (until 0630, R. Bernstein pers. com.). *POGONOMYRMEX*: *badius* (Carlson & Gentry 1973; Golley & Gentry 1964; Van Pelt 1953, 1966), *barbatus* (Box 1960; McCook 1879), *californicus* (Cole 1932; Michener 1942; Whitford 1973), *desertorum* (Whitford 1973), *magnacanthus* (Cole 1968), *maricopa* (La Rivers 1968), *occidentalis* (Headlee & Dean 1908; McCook 1882; Stevens 1965; Wheeler & Wheeler 1963), *owyheeii* (Cole 1934b; Willard & Crowell 1965), *rugosus* (until 0745, R. Bernstein pers. com.; Whitford 1973). *VEROMESSOR*: *andrei* (Creighton 1953; McCluskey 1963), *juliana* (Creighton 1953), *lariversi* (Cole 1963, 1966), *lobognathus* (Cole 1963; Wheeler & Wheeler 1959, 1963), *pergandei* (Cole, 1934a, 1963; Creighton 1953; Tevis 1958; Went et al. 1972; Wheeler & Creighton 1934), *smithi* (Cole 1963, 1966).

A similar search was made for an explanation of the diversity in flight timing. Flights, unless near midday, are generally either morning *or* afternoon, rather than bimodal like worker activity and like the environment. To relate both morning and afternoon flight times similarly to the middle of the "environmental" day, I used the difference between the hour of midday and the hour of either morning or afternoon flight as the dependent variable for regression studies. "Midday" was arbitrarily defined as 1300, since that is closer than noon to the hottest time of day according to the thermometer. Also 1345 divides the day into two equal halves with respect to the number of species flying. Further, 1307 is the average center of the midday hours avoided by workers; I calculated this from the 12 species (4 genera) where the records cited (legend of Fig. 2) are complete enough to show the worker bimodal activity pattern.

Season was included as an additional covariate, because flight records were used (Fig. 1) no matter what the season, rather than just summer records as for the workers. Season was measured two ways: as the difference between the date of the cited observation and either August 1 (to represent the average "heat center" of the summer) or June 21 (with the longest dawn- or dusk-to-midday interval). (Southern Hemisphere records were converted by 6 mo.)

Taking distance of flight hour from midday as the dependent variable, analysis of covariance shows the generic difference in timing to remain significant after removal of the effects of the covariates (Table 1). This is the more noteworthy because the morning-vs.-afternoon difference between genera is ignored in the choice of the dependent variable as simply the time from midday.

#### CONCLUSION

The records displayed here indicate generic diversity both of worker phase and of flight phase of rhythm beyond the effects of altitude, latitude, average temperature, average rainfall, and season. This is not to suggest that no relation with such variables would be found locally (e.g., temperate latitudes only), or in a microclimatic study, or at the species level. Nevertheless, at the genus level the evidence suggests a taxonomic explanation of the diversity (as opposed to a strictly ecological or geographical explanation).

#### Literature Cited

- BATSCHULET, E. 1965. Statistical methods for the analysis of problems in animal orientation and certain biological rhythms. American Institute of Biological Sciences, Washington, D.C.
- BEARE, T. H. 1913. *Myrmica ruginodis*, a marriage flight. Entomol. Record J. Variation, **25**: 258.
- BERNARD, F. 1968. Les fourmis (Hymenoptera Formicidae) d'Europe occidentale et septentrionale. Masson et Cie, Paris.
- BERNSTEIN, R. A. 1971. The ecology of ants in the Mojave Desert: Their interspecific relationships, resource utilization and diversity. Ph.D. thesis, University of California at Los Angeles.

- BODENHEIMER, F. S. AND KLEIN, H. Z. 1930. Über die temperaturabhängigkeiten von insekten. II. Die abhängigkeit der aktivität bei der ernteamise *Messor semirufus* E. André von temperatur und anderen factoren. Zeitschr. Vergl. Physiol., **11**: 345-85.
- BOX, T. W. 1960. Notes on the harvester ant *Pogonomyrmex barbatus* var. *molefaciens*, in South Texas. Ecology, **41**: 381-382.
- BRIAN, M. V. 1955. Food collection by a Scottish ant community. J. Anim. Ecol. **24**: 336-351.
- BRIAN, M. V. AND BRIAN, A. D. 1955. On the two forms macrogyna and microgyna of the ant *Myrmica rubra* L. Evolution, **9**: 280-290.
- BROWN, W. L. 1955. A revision of the Australian ant genus *Notoncus* Emery, with notes on the other genera of Melophorini. Mus. Comp. Zool. Bull., **113**: 471-494.
- BUXTON, P. A. 1924. Physical factors controlling harvesting in an ant. Trans. Entomol. Soc. London, **71**: 538-543.
- CAGNIANT, H. 1968. Description de *Leptothorax monjauzei* n. sp. d'Algérie (Hym. Formicidae Myrmicinae): Représentation des trois castes et notes biologiques. Bull. Soc. Entomol. France, **73**: 83-90.
- CARLSON, D. M. AND GENTRY, J. B. 1973. Effects of shading on the migratory behavior of the Florida harvester ant *Pogonomyrmex badius*. Ecology, **54**: 452-453.
- CARNEGIE, A. J. M. 1960. Effects of temperature variations on the activities of the brown house ant *Pheidole megacephala* F. race *punctulata* Mayr (Hymenopt.: Formicidae). J. Entomol. Soc. Southern Africa, **23**: 304-311.
- COLE, A. C. 1932. Notes on the ant *Pogonomyrmex californicus*, Buckley (Hym.: Formicidae). Entomol. News, **43**: 113-115.
- COLE, A. C. 1934a. An ecological study of the ants of the southern desert shrub region of the United States. Ann. Entomol. Soc. Amer., **27**: 388-405.
- COLE, A. C. 1934b. A brief account of aestivation and overwintering of the occident ant, *Pogonomyrmex occidentalis* Cresson, in Idaho. Canad. Entomol., **66**: 193-198.
- COLE, A. C. 1963. A new species of *Veromessor* from the Nevada test site and notes on related species (Hymenoptera: Formicidae). Ann. Entomol. Soc. Amer., **56**: 678-682.
- COLE, A. C. 1966. Ants of the Nevada test site. Brigham Young University Sci. Bull., Biological Series **7(3)**: 1-27.
- COLE, A. C. 1968. *Pogonomyrmex* harvester ants. A study of the genus in North America. University of Tennessee, Knoxville.
- CREIGHTON, W. S. 1953. New data on the habits of the ants of the genus *Veromessor*. Amer. Mus. Novit., **1612**: 1-18.
- CREIGHTON, W. S. 1966. The habits of *Pheidole ridicula* Wheeler with remarks on habit patterns in the genus *Pheidole* (Hymenoptera: Formicidae). Psyche, **73**: 1-7.
- DELAGE, B. 1968. Recherches sur les fourmis moissonneuses du Bassin Aquitain: Ethologie. Physiologie de l'alimentation. Ann. Sci. Naturelles Zool., **10**: 197-266.
- DÉLYE, G. 1964. Sur le peuplement myrmécologique de quelques ergs du Sahara nord-occidental. Travaux Institut Recherches Sahariennes Univ. Alger, **23**: 165-169.
- DÉLYE, G. 1968. Recherches sur l'écologie, la physiologie et l'éthologie des fourmis du Sahara. Thesis, Marseilles.
- DÉLYE, G. 1969. Répartition des fourmis dans les grands massifs de dunes du Sahara nord-occidental (Hym.). Bull. Soc. Entomol. France, **74**: 224-227.
- DÉLYE, G. 1971. Observations sur de nid et le comportement constructeur de *Messor arenarius* (Hyménoptères Formicidae). Insectes Soc., **18**: 15-20.
- DONDALE, C. D., REDNER, J. H., AND SEMPLE, R. B. 1972. Diel activity periodicities in meadow arthropods. Canad. J. Zool., **50**: 1155-1163

- DONISTHORPE, H. 1927. British ants, their life-history and classification, 2nd ed. Routledge, London.
- FOREL, A. 1928. The social world of the ants. Vol. 1, p. 413. Vol. 2, p. 85. Putnam's, New York.
- GOLLEY, F. B. AND GENTRY, J. B. 1964. Bioenergetics of the southern harvester ant *Pogonomyrmex badius*. Ecology, **45**: 217-225.
- GREENSLADE, P. J. M. 1972. Comparative ecology of four tropical ant species. Insectes Soc., **19**: 195-212.
- GREGG, R. E. 1955. A new species of ant belonging to the *Pheidole pilifera* complex (Hymenoptera: Formicidae). Psyche, **62**: 19-28.
- HEADLEE, T. J. AND DEAN, G. A. 1908. The mound-building prairie ant. Kansas State Agric. Expt. Station Bull., **154**: 165-180.
- ILLINGWORTH. 1933. Hawaiian Entomol. Soc. Proc., **8**: 243-244.
- ILLINGWORTH. 1935. Hawaiian Entomol. Soc. Proc., **9**: 3.
- KANNOWSKI, P. B. 1954. Notes on the ant *Novomessor manni* Wheeler and Creighton. Mus. Zool. Univ. Michigan. Occas. Papers, **556**: 1-6.
- KANNOWSKI, P. B. AND KANNOWSKI, P. M. 1957. The mating activities of the ant *Myrmica americana* Weber. Ohio J. Sci., **57**: 371-374.
- KANNOWSKI, P. B. 1958. Swarming of the ant *Stenamamma brevicorne* (Mayr). Entomol. News, **69**: 231-233.
- KANNOWSKI, P. B. 1959. The flight activities and colony-founding behavior of bog ants in southeastern Michigan. Insectes Soc., **6**: 115-162.
- KEMP, P. B. 1952. Field observations on the activity of *Pheidole*. Bull. Entomol. Research, **42**: 201-206.
- KEMPF, W. W. 1969. Miscellaneous studies on neotropical ants (Hymenoptera, Formicidae). V. Studia Entomologica, **12**: 273-296.
- KUSNEZOV, N. 1962. El vuelo nupcial de las hormigas. Acta Zoologica Lilloana, **18**: 385-442.
- LAVIGNE, R. J. 1969. Bionomics and nest structure of *Pogonomyrmex occidentalis* (Hymenoptera: Formicidae). Ann. Entomol. Soc. Amer., **62**: 1166-1175.
- LARIVERS, I. 1968. A first listing of the ants of Nevada (Hymenoptera: Formicidae). Biological Soc. Nevada Occas. Papers, **17**: 1-12.
- LEVINS, R., PRESSICK, M. L., AND HEATWOLE, H. 1973. Coexistence patterns in insular ants. Amer. Scientist, **61**: 463-472.
- MALLIS, A. 1941. A list of the ants of California with notes on their habits and distribution. Southern California Acad. Sci. Bull., **40**: 61-100.
- MARKIN, G. P., DILLIER, J. H., HILL, S. O., BLUM, M. S., AND HERMANN, H. R. 1971. Nuptial flight and flight ranges of the imported fire ant *Solenopsis saevissima richteri* (Hymenoptera: Formicidae). J. Georgia Entomol. Soc., **6**: 145-156.
- MCCCLUSKEY, E. S. 1963. Rhythms and clocks in harvester and Argentine ants. Physiol. Zool., **36**: 273-292.
- MCCCLUSKEY, E. S. 1973. Generic diversity in phase of rhythm in formicine ants. Psyche, **80**: 295-304.
- MCCOOK, H. C. 1879. The natural history of the agricultural ant of Texas. A monograph of the habits, architecture, and structure of *Pogonomyrmex barbatus*. Academy of Natural Sciences, Philadelphia.
- MCCOOK, H. C. 1882. "The Honey Ants of the Garden of the Gods, and the Occident Ants of the American Plains." Lippincott, Philadelphia.
- MEDLER, J. T. 1958. A note on swarming and emergence of ants (Hymenoptera: Formicidae). Proc. Entomol. Soc. Wash., **60**: 258.

- MEYER, E. 1927. Die Ernährung der mutterameise und ihrer brut während der solitären koloniegründung. *Biol. Zent.*, **47**: 264-307.
- MICHENER, C. D. 1942. The history and behavior of a colony of harvester ants. *Scientific Monthly*, **55**: 248-258.
- MURSALOGLU, B. 1957. Untersuchungen über biologie von *Messor semirufus* Andr. var. *concolor* Em. aus körner sammelnden ameisen. *Faculte Sci. Univ. Ankara Communications*, **8**: 58-94.
- NAGEL, H. G. AND RETTENMEYER, C. W. 1973. *J. Kans. Entomol. Soc.*, **46**: 82-101.
- PARK, O., LOCKETT, J. A., AND MYERS, D. J. 1931. Studies in nocturnal ecology with special reference to climax forest. *Ecology*, **12**: 709-727.
- PARK, O. AND STROHECKER, H. F. 1936. Studies in nocturnal ecology. V. An experiment in conducting field classes at night. *Ohio J. Science*, **36**: 46-54.
- PICKLES, W. 1944. The territory and activities of the Algerian ant *Cataglyphus bicolor* F. s-sp. *megalocola* Först. *Entomologist's Monthly Magazine*, **80**: 61-63.
- REICHEL, F. 1943. Untersuchungen über frequenzrhythmen bei ameisen. *Z. Vergl. Physiol.*, **30**: 227-251.
- RHOADES, W. C. AND DAVIS, D. R. 1967. Effects of meteorological factors on the biology and control of the imported fire ant. *J. Econ. Entomol.*, **60**: 554-558.
- SAUNDERS, G. W. 1969. An investigation of funnel ants *Aphaenogaster* spp. as positive pests in North Queensland. D. Agr. Sc. thesis, Queensland.
- SHEATA, M. N. AND KASCHEF, A. H. 1971. Foraging activities of *Messor aegyptiacus* Emery (Hym., Formicidae). *Insectes Soc.*, **18**: 215-226.
- SMITH, M. R. 1963. A new species of *Aphaenogaster* (*Attomyrma*) from the western United States (Hymenoptera: Formicidae). *Jour. New York Entomol. Soc.*, **71**: 244-246.
- STEVENS, L. J. 1965. The food preference and foraging habits of the western harvester ant, *Pogonomyrmex occidentalis* (Cresson). M.S. thesis, University of Wyoming, Laramie (cited by Lavigne, 1969).
- STEYN, J. J. 1954. The pugnacious ant (*Anoplolepis custodiens* Smith) and its relation to the control of citrus scales at Letaba. *Memoir Entomol. Soc. S. Africa* No. 3. 96 pp.
- TALBOT, M. 1945. A comparison of flights of four species of ants. *Amer. Midland Naturalist*, **34**: 504-510.
- TALBOT, M. 1946. Daily fluctuations in aboveground activity of three species of ants. *Ecology*, **27**: 65-70.
- TALBOT, M. 1953. Ants of an old-field community on the Edwin S. George Reserve, Livingston County, Michigan. *Contributions Laboratory Vertebrate Biology University of Michigan*, **63**: 1-13.
- TALBOT, M. 1965. Populations of ants in a low field. *Insectes Soc.*, **12**: 19-48.
- TALBOT, M. 1966. Flights of the ant *Aphaenogaster treatae*. *J. Kans. Entomol. Soc.*, **39**: 67-77.
- TEVIS, L. 1958. Interrelations between the harvester ant *Veromessor pergandei* (Mayr) and some desert ephemerals. *Ecology*, **39**: 695-704.
- TOHMÉ, G. 1969. Répartition géographique des fourmis du Liban (Hymenoptera: Formicoidea). Thesis, Toulouse.
- VAN PELT, A. 1953. Notes on the above-ground activity and a mating flight of *Pogonomyrmex badius* (Latr.). *J. Tenn. Acad. Sci.*, **28**: 164-168.
- VAN PELT, A. F. 1958. The ecology of the ants of the Welaka Reserve, Florida (Hymenoptera: Formicidae). II. Annotated list. *Amer. Midland Naturalist*, **59**: 1-57.
- VAN PELT, A. F. 1966. Activity and density of old-field ants of the Savannah River Plant, South Carolina. *J. Elisha Mitchell Sci. Soc.*, **82**: 35-43.

- WATERMAN, T. H. 1961. Comparative physiology. In "The Physiology of Crustacea" (ed., Waterman, T. H.). Vol. 2. Pp. 521-593.
- WATSON, G. S. AND WILLIAMS, E. J. 1956. On the construction of significance tests on the circle and the sphere. *Biometrika*, **43**: 344-352.
- WENT, F. W., WHEELER, J., AND WHEELER, G. C. 1972. Feeding and digestion in some ants (*Veromessor* and *Manica*). *Bioscience*, **22**: 82-88.
- WHEELER, G. C. AND WHEELER, J. 1959. *Veromessor lobognathus*: Second note (Hymenoptera: Formicidae). *Ann. Entomol. Soc. Amer.*, **52**: 176-179.
- WHEELER, G. C. AND WHEELER, J. 1963. "The Ants of North Dakota." University of North Dakota, Grand Forks.
- WHEELER, G. C. AND WHEELER, J. 1970. The natural history of *Manica* (Hymenoptera: Formicidae). *J. Kans. Entomol. Soc.*, **43**: 129-162.
- WHEELER, G. C. AND WHEELER, J. 1973. "Ants of Deep Canyon, Colorado Desert, California." University of California, Riverside.
- WHEELER, W. M. 1910. "Ants: Their Structure, Development, and Behavior." Columbia University, New York.
- WHEELER, W. M. 1917. Notes on the marriage flights of some Sonoran ants. *Psyche*, **24**: 177-180.
- WHEELER, W. M. 1922. The ants collected by the American Museum Congo expedition. *Amer. Mus. Nat. Hist. Bull.*, **45**: 39-269.
- WHEELER, W. M. AND CREIGHTON, W. S. 1934. A study of the ant genera *Novomessor* and *Veromessor*. *Amer. Acad. Arts Sci. Proc.*, **69**: 341-387.
- WHITCOMB, W. H., DENMARK, H. A., BHATKAR, A. P., AND GREENE, G. L. 1972. Preliminary studies on the ants of Florida soybean fields. *Florida Entomol.*, **55**: 129-142.
- WHITFORD, W. G. 1973. Demography and bioenergetics of herbivorous ants in a desert ecosystem as functions of vegetation, soil type and weather variables. US/IBP Desert Biome Research Memorandum RM 73-29.
- WILLARD, J. R. AND CROWELL, H. H. 1965. Biological activities of the harvester ant *Pogonomyrmex owyheei*, in central Oregon. *J. Econ. Entomol.*, **58**: 484-489.
- WILLIAMS. 1935. *Hawaiian Entomol. Soc. Proc.*, **9**: 3.
- WILSON, E. O. 1957. The organization of a nuptial flight of the ant *Pheidole sitarches* Wheeler. *Psyche*, **64**: 46-50.
- WILSON, E. O. AND HUNT, G. L. 1966. Habitat selection by queens of two field-dwelling species of ants. *Ecology*, **47**: 485-487.

Supplementary Studies on Ant Larvae: *Simopone* and *Turneria*<sup>1</sup>

GEORGE C. WHEELER AND JEANETTE WHEELER

LABORATORY OF DESERT BIOLOGY, DESERT RESEARCH INSTITUTE,  
UNIVERSITY OF NEVADA SYSTEM, RENO 89507

RECEIVED FOR PUBLICATION JANUARY 7, 1974

**Abstract:** This study supplements our "Ant Larvae: Review and Synthesis" (1974). The larvae of *Simopone* n. sp. and *Turneria* sp. (near *dahli*) are described and figured and each genus is characterized. *Simopone* is definitely cerapachyine but quite distinct from the larvae of other known genera of the subfamily. *Turneria* is typically dolichoderine but readily distinguished from other genera of the subfamily by the tail and the shape and location of the dorsal bosses.

## SUBFAMILY CERAPACHYINAE

The larva of *Simopone* is definitely cerapachyine. Its profile is myrmecoid like that of the other four known genera (*Cerapachys*, *Eusphinctus*, *Lioponera*, and *Phyracaces*). The mandible is sui generis and we must establish for it a new monotypic rubric "*simoponoid*." The small size of the mouth parts is also distinctive for the genus. In our general key for ant larvae *Simopone* runs to 49b in company with *Cerapachys*, *Eusphinctus*, and *Phyracaces*; from these it can be distinguished by the shape of the mandibles. Its index of specialization (see our 1974) is 24; that of the subfamily is 22. [The most specialized ant larvae—Leptanillinae—have an index of 35, while the Ponerinae are less specialized with 17. The index for the family as a whole is 22.]

Genus *SIMOPONE* Forel

Body myrmecoid; head on anterior end; anus ventral. Body hairs sparse and minute. Head suboctagonal; antennae large; mouth parts small. Mandibles with about 8 teeth on medial border.

**Simopone** n. sp. (Fig. 2). Length (through spiracles) about 3 mm. Shape myrmecoid (i.e., elongate and rather slender; curved ventrally; without a differentiated neck; diameter decreasing only slightly from AV to anterior end); leg vestiges present as small papillae; anus ventral. Head on anterior end. Segmentation indistinct. Spiracles small; ten pairs. Entire integument spinulose, the spinules minute and in arcuate rows, rows forming a reticulate pattern on venter of T1; isolated and coarse, or minute and in short rows, elsewhere. Body hairs sparse and minute (0.013–0.025 mm. long); unbranched, smooth and slightly curved, most numerous on AX. Cranium suboctagonal; occipital border sinuate; mouth parts small. Antennae rather large, slightly raised ellipsoids with 3 sensilla, each of which bears a spinule. Head hairs few, minute (about 0.004 mm. long), unbranched, smooth, and slightly curved. Labrum bilobed, about 3 times as wide as long; each lobe with 4 minute sensilla on each ventrolateral surface; posterior surface of each lobe with about 7 sensilla near the middle in a longitudinal row. Mandibles small; subtriangular; without a blade; with the apex slightly curved medially and with about 8 minute to large teeth on distal ½ of convex medial border. Maxillae apparently adnate; palp a slightly raised

<sup>1</sup>Hymenoptera: Formicidae.

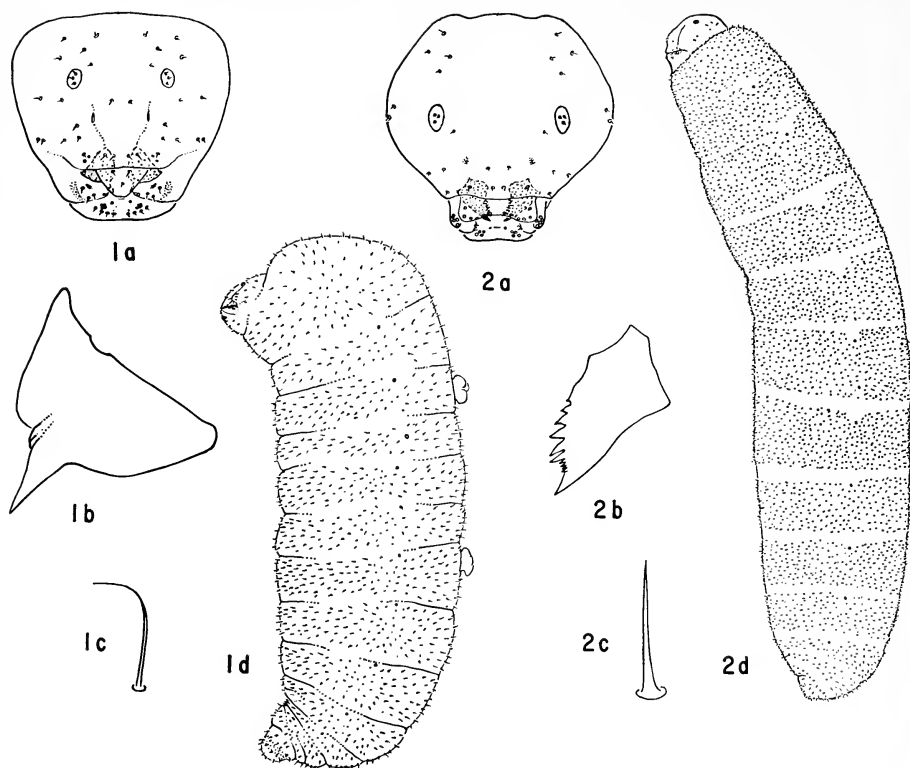

Text figure 1. *Turneria* sp. (near *dahli*). 1a. Head in anterior view,  $\times 88$ ; b. Left mandible in anterior view,  $\times 397$ ; c. Body hair,  $\times 212$ ; d. Body in side view,  $\times 28$ . Text figure 2. *Simopone* n. sp. 2a. Head in anterior view,  $\times 101$ ; b. Left mandible in anterior view,  $\times 314$ ; c. Body hair,  $\times 667$ ; d. Larva in side view,  $\times 28$ .

cluster of 5 sensilla; galea represented by 2 sensilla with a spinule each. Labium with a few short transverse rows of minute spinules on the anterior surface; palp represented by a cluster of 5 sensilla; an isolated sensillum between each palp and the opening of the sericteries; the latter a short transverse slit.

Material Studied: 4 larvae from Ghana: New Tafo (Akim), 29 XI 1970, B. Bolton; courtesy of Dr. W. L. Brown.

#### SUBFAMILY DOLICHODERINAE

The larva of *Turneria* is so typically dolichoderine that it does not disturb in the least the nearly perfect homogeneity of the subfamily. Nevertheless it is distinct from all other dolichoderine genera. In our key to all ant larvae (1974) it would run to "51a. Boss or bosses dorsal . . . *Forelius*, *Froggattella* and *Iridomyrmex*." It can be distinguished from those three genera by its tail and the shape and location of the bosses.

The index of specialization (see our 1974) for *Turneria* is 27, while that for the subfamily is 24. [For the most specialized ant larvae—the Leptanillinae—the index is 35, while the Ponerinae are less specialized with 17. The index for the family as a whole is 22.]



Genus *TURNERIA* Forel

Body dolichoderoid but with 2 middorsal doorknob-shaped tubercles (1 on T3 and 1 on AIV); AIX and AX narrowed and turned ventrally as a stout tail. Body hairs unbranched, smooth and spike-like. Labrum subtriangular, broadest dorsally. Mandibles dolichoderoid.

*Turneria* sp. (near *dahli*) (Fig. 1). Length (through spiracles) about 1.9 mm. Body dolichoderoid (i.e., short, stout, plump, and nearly straight, with both ends broadly rounded; anterior end formed by the enlarged dorsum of the prothorax; head ventral, near anterior end; no neck; segmentation indistinct); AIX and AX narrowed abruptly and bent ventrally as a small tail; on the dorsum of each T3 and AIV a middorsal doorknob-shaped boss. Anus on anterior surface of tail. Spiracles small; those on AI greatest in diameter, on AVIII vestigial. Entire integument spinulose, the spinules minute and in short transverse rows. Body hairs sparse, short (0.005–0.025 mm. long), unbranched, smooth and spike-like, longer and more numerous on the dorsal surface. Cranium subtrapezoidal with corners rounded; mouth parts small. Each antenna with 2 or 3 sensilla, each of which bears minute spinule. Head hairs few, minute (0.006–0.013 mm. long) and spike-like. Labrum subtriangular in anterior view; anterior surface with 2 minute sensilla; ventral border with 2 sensilla each on a slight elevation; posterior surface with 6 small sensilla medially and with a few arcuate rows of minute spinules laterally. Mandibles small, feebly sclerotized, dolichoderoid (i.e., basal portion inflated and narrowed abruptly to the distal portion, which is slender and sharp-pointed; no medial teeth); with a few short ridges at base of apical tooth. Maxillae small, apex rounded, appearing adnate; palp represented by a cluster of 5 (1 encapsulated and 4 with a spinule each) sensilla; galea a low knob with 2 sensilla, each with a minute spinule. Each labial palp represented by a cluster of 4 (1 encapsulated and 3 with a spinule each) sensilla; an isolated sensillum between each palp and the opening of the sericteries; the latter a short slit between the tips of the maxillae. Hypopharynx densely spinulose, spinules arranged in subtransverse rows, rows grouped in 2 subtriangles which have their bases near middle.

Material Studied: numerous larvae from Espiritu Santo, New Hebrides, E. O. Wilson, 7–13 Jan. 1954; courtesy Dr. W. L. Brown.

## Literature Cited

- WHEELER, G. C. AND WHEELER, J. 1974. Ant larvae: review and synthesis. Mem. Entom. Soc. Washington (in press).

## On the Estimation of Total Behavioral Repertories in Ants

EDWARD O. WILSON

MUSEUM OF COMPARATIVE ZOOLOGY, HARVARD UNIVERSITY, CAMBRIDGE, MASS. 02138

AND

ROBERT M. FAGEN

DIVISION OF ENGINEERING AND APPLIED PHYSICS, HARVARD UNIVERSITY, CAMBRIDGE, MASS. 02138

RECEIVED FOR PUBLICATION JANUARY 7, 1974

**Abstract:** The total behavioral catalog size of *Leptothorax curvispinosus* workers in a nest environment has been estimated by means of the Fagen-Goldman method of fitting frequency data to negative binomial and lognormal Poisson distributions. The worker repertory is characterized by a smaller number of rare behaviors in comparison with vertebrate repertories. This trait makes the preparation of an adequate ethogram much less time-consuming. The behavior of a partially bilateral worker-male gynandromorph is described and the estimation method used to show that its repertory is probably intermediate in size between those of full workers and males. The limitation of worker behaviors to the worker (as opposed to male) appendages suggests a bilateral as opposed to diffuse control of movement by the gynandromorph's brain. The advantages and difficulties of the estimation technique are then discussed.

### INTRODUCTION

The listing of behavioral repertories to produce "ethograms" is an essential first step in the comparative study of behavior. But it is also one of the most time-consuming. Studies of single bird species commonly last hundreds of hours, while a few primate projects have consumed a thousand observation hours or more over a period of years. Even at this level, there has been no systematic way of judging how nearly complete the ethogram has become, and ethologists have ordinarily relied on unaided intuition in choosing the time to stop. Recently Fagen and Goldman (1974) proposed a method for estimating the total size of behavioral categories by fitting frequency data of behavioral acts to one or both of the most general distributions likely to be appropriate, namely the lognormal Poisson and negative binomial.

The present article examines the application of this technique to two castes of the ant genus *Leptothorax* and considers its general strengths and weaknesses for insect studies. The method has also been used to evaluate the repertory of a rare gynandromorph discovered in a colony of *L. curvispinosus*.

---

**Acknowledgments:** We are grateful to Dr. Mary Talbot for supplying live colonies of *Leptothorax* and to Dr. Arnold M. Clark for advice on the study of gynandromorph behavior. The research was supported by funds from National Science Foundation grant number GB-40247.

TABLE 1. Relative frequencies of behavioral acts by workers and a gynandromorph of the ant *Leptothorax curvispinosus* and by males of *L. duloticus*. (*N*, total number of behavioral acts recorded in each column)

Behavioral Act	<i>Leptothorax curvispinosus</i> workers ( <i>N</i> = 1962)	<i>L. curvispinosus</i> gynandromorph ( <i>N</i> = 45)	<i>L. duloticus</i> males ( <i>N</i> = 65)
1. Self-grooming	0.2370	0.7333	0.6462
2. Antennal tipping	0.0122	0	0
3. Allogroom worker	0.0428	0.0667	0
4. Allogroom queen	0.0025	0	0
Brood care:			
5. Carry egg	0.0153	0	0
6. Lick egg	0.0255	0	0
7. Carry larva	0.1264	0	0
8. Licking larva	0.1804	0	0
9. Assist larval ecdysis	0.0056	0	0
10. Feed larva solid food	0.0336	0	0
11. Carry pupa	0.0122	0	0
12. Lick pupa	0.0484	0	0
13. Assist eclosion of adult	0.0082	0	0
14. Lay egg	0.0025	0	0
Regurgitate:			
15. With larva	0.0775	0.0222	0
16. With worker	0.0642	0.1778	0.3538
17. With queen	0.0138	0	0
18. Fight queen or workers	0.0092	0	0
19. Lick wall of nest	0.0138	0	0
20. Forage	0.0291	0	0
21. Feed on honey	0.0056	0	0
22. Feed on solid	0.0173	0	0
23. Carry dead insect	0.0025	0	0
24. Carry dead nestmate	0.0025	0	0
25. Carry live nestmate	0.0015	0	0
26. Handle nest material	0.0041	0	0
27. Stridulate	0.0061	0	0
TOTALS	1.0	1.0	1.0

## METHODS

Colonies of *Leptothorax* were collected by Dr. Mary Talbot at the E. S. George Reserve, near Pinckney, Michigan. Some consisted of pure *L. curvispinosus*, with *curvispinosus* queens, others of *curvispinosus* enslaved by the rare parasitic species *L. duloticus*, the latter containing *duloticus* queens. The colonies were maintained in narrow glass tubes moistened by cotton wool at one end and left open at the other. The workers were allowed to forage freely out of the tubes and onto the floor of small, steep-sided containers. The containers were small enough in turn (9 × 15 cm on the side by 6 cm deep) to be

placed on the stage of a dissecting microscope. As a consequence the entire worker populations of colonies, consisting of 20 to 100 workers, could be monitored simultaneously. Behavioral catalogs were constructed and frequencies of each behavior accumulated by scanning back and forth for as long as an hour or more in continuous sessions. By this means it was possible to record all of the discrete behavioral acts displayed by virtually every worker. Observation periods were scattered according to convenience from 8 in the morning to one or two hours past midnight. Over this span no differences in level or pattern of activities were noted. Nor were any expected, since the internal nest environment remained essentially constant.

Behavioral repertoires and their frequency distributions did not differ significantly between pure *curvispinosus* colonies and those mixed with *duloticus*. Consequently, in order to obtain as large a sample size as possible, counts were taken from two *curvispinosus* colonies that had been especially well analyzed in connection with a separate study of ant slavery (see Wilson, 1974), one pure and the other enslaved. When a worker-male gynandromorph eclosed in one of the pure colonies during the course of the study, it was closely monitored during its short life. Simultaneously, *duloticus* males in a mixed colony were monitored; *curvispinosus* males were not available at this time for quantitative study, but earlier studies had shown that the repertoires, if not the frequency distributions, were identical. The data were then analyzed by the method of Fagen and Goldman.

#### RESULTS

*Worker repertory.* The behavioral catalog and frequency data are presented in Tables 1 and 2 and Fig. 1. The estimates given were based on a fit of the data to the negative binomial distribution. Similar results were obtained with the lognormal Poisson distribution. In the case of *L. curvispinosus* workers, the estimated total repertory size is 29, with a 95 percent confidence interval of [27,35]. The sample coverage, defined as  $\sum_i p_i$ , where  $p_i$  is the probability of performance of each observed act  $i$ , is much greater, being 99.95%. This very high value means that the still missing behaviors have an aggregate probability of 0.0005.

*Male repertory.* The repertory of the *L. duloticus* males in the nest was extremely limited, and the two behaviors observed were not far from equiprobability. As a result the estimated repertory is identical to the observed repertory, a remarkable result in view of the small number of data utilized.

*Male-worker gynandromorph.* The observed repertory falls far short of the estimated repertory, especially the upper limit of the 95 percent confidence interval, a result that accords well with our intuitive feeling during the period

TABLE 2. Catalog and estimated total repertory of two castes and a worker-male gynandromorph of *Leptothorax*. Estimates were obtained by fitting the data of Table 1 to a negative binomial distribution

	No. of acts observed	No. of kinds of behaviors observed (observed repertory size)	Estimated total repertory size	Estimated 95% con- fidence inter- vals, total repertory size
<i>L. curvispinosus</i> workers	1962	27	29	[27,35]
<i>L. duloticus</i> males	65	2	2	[ 2,2 ]
<i>L. curvispinosus</i> gynandromorph	45	4	7	[ 4,27]

of observation. Because opportunities seldom arise for the observation of living gynandromorphs, further notes on this one individual will now be given. Data were taken on an almost daily basis from the time the ant was discovered as a one- or two-day-old callow until its death eleven days later. The total observation time was six hours.

The gynandromorph was the size of a small worker. The body behind the head was covered preponderantly by worker exoskeleton (easily distinguished by its yellow as opposed to blackish brown coloration). The only male portions were the left lateral edges of the pro- and mesothoraces and the left fore and middle legs. The two legs were mostly useless, ordinarily being carried folded beneath the body. We gained the impression that these two appendages, which were longer and more slender than their worker counterparts, were under the control of the worker part of the central nervous system. (Presumably the thoracic ganglia consisted of worker tissue.) The foreleg often moved in a nearly normal fashion down to about the level of the metatarsus, where a worker leg would have ended, but the terminal segments kept folding under the metatarsus when the leg was moved forward and down.

The division of the head was exactly bilaterally symmetrical. So precise was the line of demarcation that the median ocellus was half developed—on the male side. It is a reasonable supposition that the division extended through the brain. The behavior of the gynandromorph proved to contain an interesting mixture of male and worker elements, as follows.

1. *Level of activity.* The gynandromorph was quite inactive and spent most of its time resting in one position. In this respect it much more closely resembled males of the same age than workers. When nearby workers discovered honey and began to rush excitedly in and out of the tube nest while regurgitating to

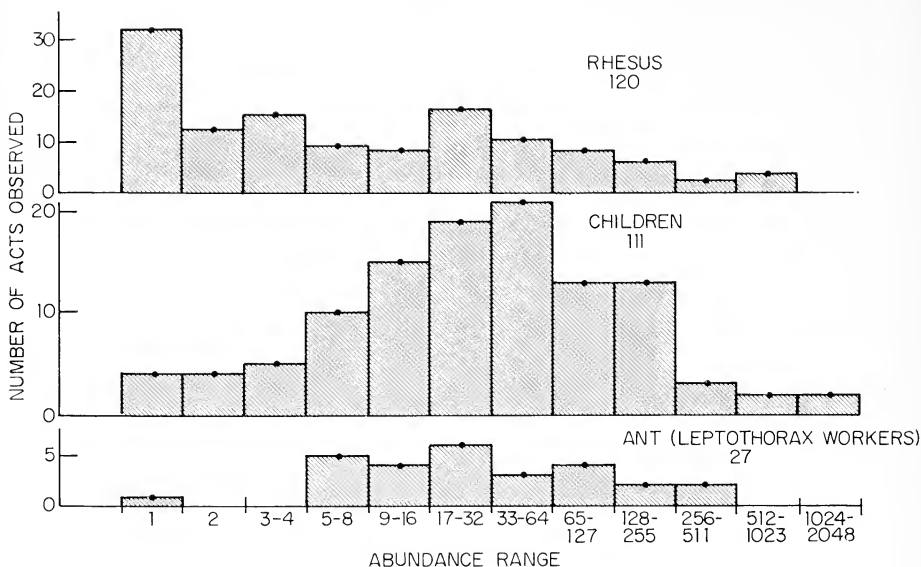

FIGURE 1. Frequency distributions of the 27 observed behaviors of *Leptothorax curvispinosus* workers, 111 behaviors of playing children, and 120 behaviors of rhesus monkeys. The mode has clearly emerged in the ants and children, indicating that most kinds of behaviors have been cataloged. This is particularly true of the ants, in which relatively few rare categories have so far been discovered. (Human and rhesus data from Fagen and Goldman, 1974.)

each other, the gynandromorph did not participate, a male-like rather than worker-like characteristic.

2. *Location.* The gynandromorph spent over 90 percent of its time at all hours of the day standing or walking around slowly within one cm of the nest entrance. This was a position sometimes taken by young workers but seldom if ever by males, which preferred to remain deep in the nest and especially near the brood. Males showed a circadian increase in activity, sometimes walking all the way out of the nest and attempting to escape from the foraging arena between about 9 PM and 1 AM. Males from wild colonies were captured at lights at 11 PM. Together, these data indicate that nuptial flights are conducted at night. No such circadian rhythm was noted in the gynandromorph.

3. *Allogrooming.* On three occasions the gynandromorph was observed to groom workers, a behavior commonly seen in workers but not in males. Significantly, the worker antenna was employed for orientation much more than was the male antenna during these bouts. On another occasion the gynandromorph regurgitated with a larva, another behavior characteristic of workers but not of males. The worker antenna was used to investigate and the worker fore

tarsus to stroke the larva; the corresponding male appendages were not employed. Although the allogrooming responses were worker-like, they occurred less frequently than in full workers.

4. *Antennal posture and general orientation.* The male antenna was held in a more extended position than the worker antenna; the postures of both were typical of the caste they represented. When the gynandromorph investigated a worker nestmate (as opposed to grooming it), both antennae were used equally.

5. *Investigation of solid food.* The gynandromorph was seen to explore a fragment of moth thoracic muscle being eaten by a larva, a behavior common in workers but not seen in males. During this brief episode only the worker antenna was used.

In summary, the gynandromorph displayed a mixture of male and worker traits. Its actual and estimated total repertory sizes were intermediate between those of males and workers. The estimation technique indicates that a smaller fraction of the total repertory was observed than in the case of the full males and workers. The worker behaviors were also displayed less frequently than in full workers. When the gynandromorph behaved as a worker, it used its worker antenna primarily or exclusively, suggesting a bilateral separation of effector control at the level of the central nervous system as opposed to a mixed control. This correspondence between anatomical and behavioral mosaicism is consistent with earlier findings on *Drosophila* and *Habrobracon* (Manning, 1967; Stern, 1968; Hotta and Benzer, 1972).

#### DISCUSSION

Let us next consider the strengths and weaknesses of the Fagen-Goldman catalog estimation method with special reference to ants and other insects. The obvious advantage of the technique is that it improves unaided intuition without forcing any new, unsupportable assumptions on the analysis. It is possible to judge more precisely the point of diminishing return during the preparation of ethograms.

This point came surprisingly early in the case of the ants. After only 51 hours of observation, during which 1,962 separate acts were recorded, the mode of the frequency curve emerged and the estimated sample coverage attained 99.95 percent. Thus the effort required to secure a nearly complete repertory seemed to be a full order of magnitude less than in the vertebrates. This result implies that comparative ethological studies can proceed much more rapidly in ants and other insects.

A reason of considerable potential biological interest exists for this relative tractability of ant studies. This is the scarcity of rare acts compared with common acts (see Fig. 1). In other words, whatever ants do they do rather frequently; few if any rare behaviors exist to surprise the investigator in the late stages of a study. We conjecture that the small size of the ant brain

precludes the storage of responses that are not used commonly. As one of us has pointed out previously (Wilson, 1971), a characteristic of behavior in social insects is the repeated use of the same communicative signals and responses in different contexts to achieve various purposes.

There are two disadvantages of the method which we do not regard as particularly serious. The first is the probability that the repertoires and frequency distributions change in different contexts. It remains for the biologist to define those contexts and to repeat the analysis within them. In the case of ants distinguishable contexts are not only finite but also probably quite limited in number. By far the greatest part of an ant's life is conducted in the homeostatic environment of the nest interior. Thus the lifetime sample coverage in the present study, defined as the cumulative probability of all behavior for all contexts, was probably very high in spite of the fact that it was limited to one environment. We suggest that the following list might exhaust the remaining contexts for the worker caste: extended foraging periods; major disturbances of the nest, including invasion by alien colonies, flooding, and overheating; emigration to a new nest site; and assisting during the initiation of nuptial flights on the part of the reproductive forms.

The second difficulty in repertory estimation is the arbitrariness of the definition of the behavioral act. One observer might see three distinct neuromuscular patterns where another sees only one. Thus "foraging" as defined in the present study could easily be broken down into several acts. This is essentially a problem of language, and different observers can solve it by a straightforward mapping procedure. One observer's acts *a*, *b*, and *c* will be recognized as comprising the second observer's act *a*; the first observer's act *h* will be seen as representing the second observer's acts *m* and *n*; and so forth. No great difficulty should occur when the same species is considered or closely related species are compared. Serious conceptual problems might exist, however, when an attempt is made to compare the size and frequency characteristics across radically different species.

#### Literature Cited

- FAGEN, R. M. AND GOLDMAN, R. N. 1974. Behavioral repertory size estimation. (In Fagen, R. M. 1974. Theoretical bases for the evolution of play in animals. Ph.D. Thesis, Harvard University, Cambridge, Mass. *xvi* + 255 pp.)
- HOTTA, Y. AND BENZER, S. 1972. Mapping of behaviour in *Drosophila mosaics*. *Nature*, **240**: 527-535.
- MANNING, A. 1967. Genes and the evolution of insect behavior. In J. Hirsch, ed., "Behavior-Genetic Analysis." McGraw-Hill, New York. Pp. 44-60.
- STERN, C. 1968. "Genetic Mosaics and Other Essays." Harvard University Press. *xiv* + 185 pp.
- WILSON, E. O. 1971. "The Insect Societies." Belknap Press of Harvard University Press. *x* + 548 pp.
- WILSON, E. O. 1974. *Leptothorax duloticus* and the beginnings of slavery in ants. Evolution, in press.



## Zoogeography of the Imported Fire Ants<sup>1</sup>

WILLIAM F. BUREN,<sup>2</sup> GEORGE E. ALLEN,<sup>2</sup> WILLARD H. WHITCOMB,<sup>2</sup>  
FRANCES E. LENNARTZ,<sup>3</sup> AND ROGER N. WILLIAMS<sup>4</sup>

RECEIVED FOR PUBLICATION FEBRUARY 14, 1974

**Abstract.** The present known ranges of the imported fire ants *Solenopsis richteri* and *S. invicta* in North America and South America are shown. Hypothetical answers are given to the questions of how far the species will spread in North America, why both species first became established in the Mobile, Alabama, area, why *S. invicta* has an extremely elongate, narrow, north-south range in South America, and why it is absent from areas of South America which appear ecologically favorable.

Key words: *Solenopsis, richteri, invicta*, ranges, homelands.

Buren (1972) recognized two species of imported fire ants in the United States, the black imported fire ant, *Solenopsis richteri* Forel, and the red imported fire ant, *S. invicta* Buren. Southernmost Brazil, Uruguay, and Argentina are the homelands of *S. richteri* (Creighton, 1930; Wilson, 1952; Buren, 1972; and authors) and the state of Mato Grosso, Brazil, has been proposed as the homeland of *S. invicta* (Buren, 1972; Allen, et al., 1974). *S. richteri* is thought to have been imported into the Mobile, Alabama, area as early as 1918 (Creighton, 1930) or perhaps even as early as the turn of the century (Lewis, 1951). A secondary spread of this species into the area near Starkville, Mississippi, probably by means of dirt ballast via railroad transport, may have occurred as early as 1935 to 1940 (Wilson, 1951). The black imported fire ant slowly increased its range in this northeastern area of Mississippi and by 1968 had occupied an area approximately 135 miles long (Tupelo to Meridian, Miss., personal records) and with eastern extensions into western Alabama (near Aliceville, Cochrane, Pickensville, and Ethelsville, and Vernon, Sulligent, Winfield, and Carbon Hill), plus an isolated record at Rogersville. This is the only known area in the United States where *S. richteri*, the original imported fire ant, is still extant.

The profound behind-the-scenes influence of Dr. William S. Creighton in the

---

**Acknowledgments:** The authors wish to thank Miss Debbie Brandt for drawing the maps and Dr. Murray S. Blum for kindly permitting us to reference information in a personal communication from the late Dr. William S. Creighton. This research was supported in large part by Cooperative Agreement 12-14-100-10, 952(33), Agriculture Research Service, U.S. Department of Agriculture, with the University of Florida.

<sup>1</sup> Florida Agricultural Experiment Station Journal Series No. 5327.

<sup>2</sup> Department of Entomology and Nematology, Univ. of Florida, Gainesville, Fla. 32611.

<sup>3</sup> Department of the Interior, Washington, D.C.

<sup>4</sup> Ohio Agriculture Research Station, Wooster, Ohio.

development of the two imported fire ant species concept is not apparent from the literature. Creighton (1930) had suggested that the then recognized subspecies of *Solenopsis saevissima* (F. Smith) were more than usually distinct and might one day need to be recognized as separate species. He privately held firm in this view even though later authors (Wilson, 1952; Ettershank, 1966) synonymized all but one of these taxa under *saevissima*. Dr. Creighton was the first myrmecologist in recent years to recognize that the black imported fire ant, identical with the original Mobile population, was still present in the United States. This was done in a personal letter (April, 1968) to Dr. Murray S. Blum after identifying some specimens from Tupelo, Mississippi. Dr. Creighton was also unstinting in his private encouragement and advice to the senior author in his taxonomic studies on the fire ants. The authors are indeed pleased that Dr. Creighton lived to see his 1930 viewpoints vindicated.

*S. invicta* appears to have invaded the United States in the Mobile, Alabama, area some time between 1933 and 1945, possibly between 1933 and 1941. This time span seems reasonably certain because Creighton (personal communication to Miss Lennartz, 1973) was actively collecting in the Mobile area and along the Gulf Coast until 1933 and found only *S. richteri*, whereas the first authentic specimens of *S. invicta* were not captured until 1945 (Buren, 1972), although Wilson (1951) believed he may have seen the "light phase" imported fire ant in the dock area at Mobile in 1941. In any case the new invader was quickly successful in expanding its territory, both by mating flight dispersal and by man's agency (Markin, et al., 1971; Culpepper, 1953). This species is now the dominant formicid in a very large area of the southern United States, with large infested areas in North Carolina, South Carolina, Georgia, Florida, Alabama, Mississippi, Louisiana, and Texas, plus a smaller area in Arkansas. Some of the early history was obfuscated by the unfortunate confounding of the two species and listing as a single taxon (as *Solenopsis saevissima richteri* Forel or as *S. saevissima* [F. Smith] by numerous authors).

While it is difficult to be certain which species is being discussed, it seems reasonable to suggest that the early reports about the spread of the fire ant up through the late 1930s and early 1940s probably apply to *S. richteri*. M. R. Smith (in an unpublished report, 1949) records *S. richteri* from several localities in Mobile County and one in Baldwin County in Alabama in 1931. By 1937 it had been seen in several localities in Jackson County in southern Mississippi. By 1947, Clay Lyle had found a large isolated population around Artesia, Mississippi, a small railroad stop east of Starkville. Another isolated population was found near Meridian, Mississippi. From specimens collected by E. O. Wilson, it is known that *S. richteri* still existed along with *invicta* in the Mobile area and at Foley, Alabama, in the late 1940s. During the 1950s, however, *richteri* was becoming sparse or appeared to be eliminated from many of its southern areas, and only *invicta* remained (Wilson and Brown, 1958).

The existence of two species rather than one makes it certain that two separate importations are involved and leads to the question of why both importations were in the Mobile, Alabama, area. One of us (Lennartz, 1973) has shown that no single imported commodity (Brazil nuts, quebracho, coffee, rubber, mahogany, etc.) can be definitely associated with the importation of *S. invicta*. Anemochore or hydrochore dispersal seems out of the question. It can only be stated that the species must have been aboard shipping from South America and came ashore in an unknown manner. If an established colony were aboard ship and happened to have a wedding flight involving both males and females while in port, then the mated females hypothetically could have flown ashore and established a number of colonies. To hypothesize this method, however, it also seems necessary to suppose that the biotic factors ashore were favorable for this type of invasion. Whitcomb, et al. (1973), believe that 99 percent or more of *S. invicta* females are destroyed by predation by other ants, other animals, and by other biotic and abiotic factors in north Florida during and after mating flights and during colony founding. With an annual production of circa 97,000 females per acre (Whitcomb, et al., 1973) this mortality may not be able to halt the spread of *S. invicta* from heavily infested areas but might be a serious impediment to the establishment of the species by a few females flying ashore from a wedding flight initiating aboard a ship in port.

It may be postulated, therefore, that the biotic conditions at Mobile at the time of the *invicta* invasion were somehow favorable to this species. Again we are led to the question of why both species of *Solenopsis* were first established at Mobile. Why not one of them at New Orleans? It is known (United States Shipping Board Report, 1926-1936) that New Orleans received more shipping from South America than Mobile during this period.

Our hypothetical answer is rooted in what we can piece together of the history of several ant invasions in southern United States. It seems reasonably established that *S. richteri* arrived in Mobile about 1918 or perhaps even earlier and that by 1928 was common there although it was not as numerous as *invicta* was to become approximately 20 years later. It is also known that another South American ant, *Iridomyrmex humilis* Mayr, the Argentine ant, became established in southern United States, probably first at New Orleans, before the turn of the century (Foster, 1908). By 1913 (Newell and Barber, 1913) and continuing to the early 1940s (personal observations), this ant had become overwhelmingly abundant at New Orleans and had completely eliminated all other ant species in its held territory.

It is doubtful that queens of *S. invicta* could have established new nests during those years at New Orleans. At Mobile, however, it is possible that *S. richteri* was keeping *I. humilis* in partial check. A hypothesis (reported in Wilson, 1951) that *I. humilis* had pushed the *S. richteri* population north of Mobile during the early 1920s seems doubtful to us, but in any case it is known

(Creighton, 1930) that the *S. richteri* population was back in place by 1928 and subsequently.

Possibly *S. richteri* not only helped to prevent *I. humilis* from reaching massive population levels at Mobile but was also having some effect on the abundance of native ants, in particular the native fire ants *S. geminata* (Fabr.) and *S. xyloni* McCook. However, *S. richteri* never fully occupied the territory available to it at Mobile as *invicta* was to do later and as *richteri* itself was to do later in northern Mississippi. Thus, in our view, the success of the initial invasion by *invicta* may have been caused by a "preconditioning" of the area by the original imported fire ant *richteri* in a manner which helped to alleviate some of the competition and predation from native ants and from *I. humilis*, while at the same time leaving an ecological niche partially open, a niche which *invicta* was to find eminently suitable for exploitation. These factors may even partially explain the early explosive buildup of *invicta* in the Mobile area. Northern United States seaports such as New York, which receives even more shipping from South America than either New Orleans or Mobile, can be excluded from consideration because of the obvious abiotic factor of winter severity.

The present areas of infestation of *S. richteri* and *invicta* in the United States are shown in Fig. 1. These areas are based on the identification of approximately 600 nest collections, plus data as given by the United States Department of Agriculture (Markin, et al., 1972). A few isolated locality records for *S. invicta* are known from farther south in Florida than shown. It is impossible to guess the eventual boundaries of the *richteri* infestation, but as the range of *richteri* probably extends from approximately 30° to 38° south latitude in South America, a more northward extension of the range of *richteri* in the United States could reasonably be expected, possibly northward into Tennessee and Kentucky. Control and eradication efforts, if continued, may negate or strongly modify this projection. The rate of expansion of the territory of *S. richteri* appears to be slow.

The northward progression of *S. invicta*, on the other hand, after a period of extremely rapid expansion well documented by various authors (see especially Wilson and Brown, 1958; Adkins, 1970), seems to have reached close to a northern limit, except for minor local enclaves. We believe this may be due mainly to winter kill conditions. *S. invicta* is a species in which hibernation apparently does not occur. Examinations of nests in near freezing or freezing temperatures (personal observations) reveal that the ants are up in the tumulus at about the same depth as in more favorable temperatures. Only in hot, dry conditions will the ants be down in the nest out of the tumulus. At Atlanta, Georgia, about on the northern boundary of the range, based on observations over a four-year period, the species is not abundant and its limited population appears to be maintained with difficulty. A few colonies in favorable situations, such as on southern slopes fully exposed to the winter sun, achieve fair size, but

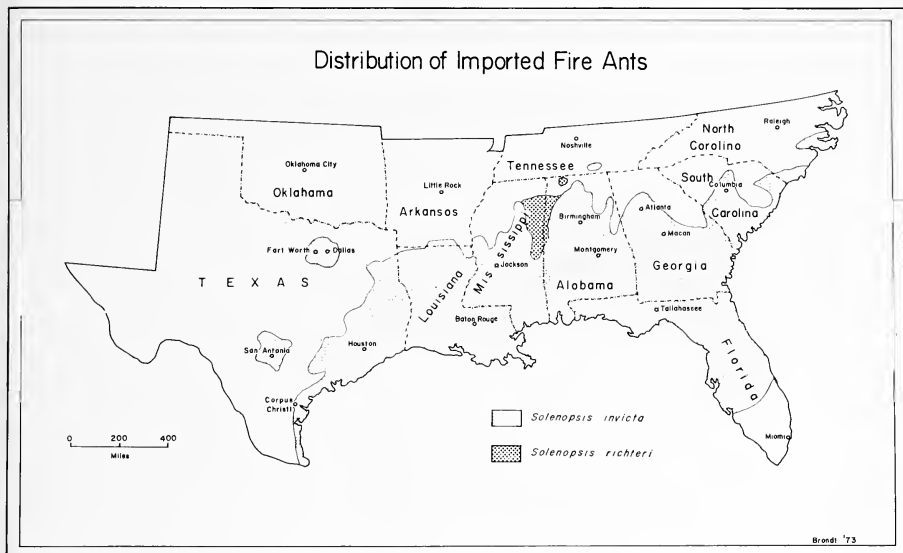

FIGURE 1.

almost all new colonies which arise during the summer do not appear to survive the winters. This contrasts strongly with the abundance of the species, prior to eradication and control programs, only approximately 100 miles south of Atlanta.

*S. invicta* is expanding its range to the west. The species has been taken as far west as San Antonio, Texas. There seems no doubt but that our previous prediction (Buren, 1972) regarding its possible establishment in the cities and favorable localities in the southwest eventually could come true. We know of no reason why *S. invicta* could not become established in the southwestern cities where *S. xyloni* is now common, displacing the latter as it has in the southeastern states. The native desert fire ant, *Solenopsis aurea* Wheeler, is small in size and lives in small colonies, and it seems inconceivable that this species could offer any resistance to the spread of *S. invicta* in those southwestern ecological niches where the latter could colonize. The distribution of *invicta* in the southwest could be expected always to remain sporadic, along canals, in irrigated fields, in watered lawns, etc. We would not expect it to become established in actual desert situations. It is possible that if it ever reached California, the species could become a pest there in irrigated areas, displacing *I. humilis* as it apparently now has done almost completely at New Orleans and other southeastern areas.

The hypothesis that winter kill is limiting the northward expansion of *S. invicta* seems reasonable and we can think of no other explanation which fits the data

as well. A previous tentative hypothesis that the northern boundary of the *S. invicta* range could be influenced by the range of *Lasius neoniger* Emery, a northern predator and competitor (Bhatkar, et al., 1972), or by a number of northern predators no longer seems reasonable to us. There is no northern ant species or series of species known to us which has a cohesive range that would fit in its southern limit the relative smoothness of the northern limit of *S. invicta*. As far as we are aware, *Lasius neoniger* is absent or rare in the southern Great Plains (northern Texas and Oklahoma) where *S. invicta* has not penetrated any farther north than in the southeastern states. *Lasius neoniger* is not present or is probably rare in Atlanta, Georgia, also, where, as previously stated, the *S. invicta* population appears to be in difficulty. From data given by Wilson (1955), *L. neoniger* appears to be very sporadic in the southern states. About all that may be postulated in regard to the biotic factors in this question is that the abiotic factor of winter kill from freezing temperatures possibly weakens the colonies sufficiently so that they are more subject to competition or predation from native ants, if they are not completely killed initially. It seems likely that the severity of winter kill is roughly proportional to the depth to which the soil becomes frozen. Freezes up to four inches, which can occur at Atlanta, possibly often kill most of the workers and brood of a colony and sometimes the queen. The combined biotic and abiotic factors are probably especially harsh on incipient colonies and thus there can be little or no population buildup or spread.

The South American ranges of *S. richteri* and *invicta* are shown in Fig. 2. Actual locality records of *S. invicta* seen and identified by the senior author are marked as well as the range postulated from these data. A large number of individual nests have been sampled at some of these localities. The differences between the shapes of the ranges in North and South America are striking for *S. invicta*, which has an enormously long north-south range in South America with only a narrow east-west distribution, whereas in North America the main axis is east-west. The combined biotic and abiotic factors which enforce these distributional differences are not fully understood and deserve further study.

The range of *S. richteri* shown represents our "guesstimate" for this species. We know that it occurs in southern Rio Grande du Sul, Brazil, probably throughout Uruguay, and south an unknown distance into Argentina. We have not seen specimens from Bahia Blanca, but this city is the type locality of *Solenopsis quinquecuspis* Forel, a species found in parapatric associations with *S. richteri* in Uruguay (Buren, 1972), and it seems reasonable that the two species would have fairly similar range extensions. The western limits of the range of *S. richteri* are not known, but we have seen no *Solenopsis* specimens which can be identified as *S. richteri* from Cordoba, from northwestern Argentina (provinces of Jujuy, Salto, Tucuman, Formosa, or Chaco), or from Paraguay. Therefore, our estimation of the range of *S. richteri* is considerably less extensive

# Homeland Areas of Fire Ants

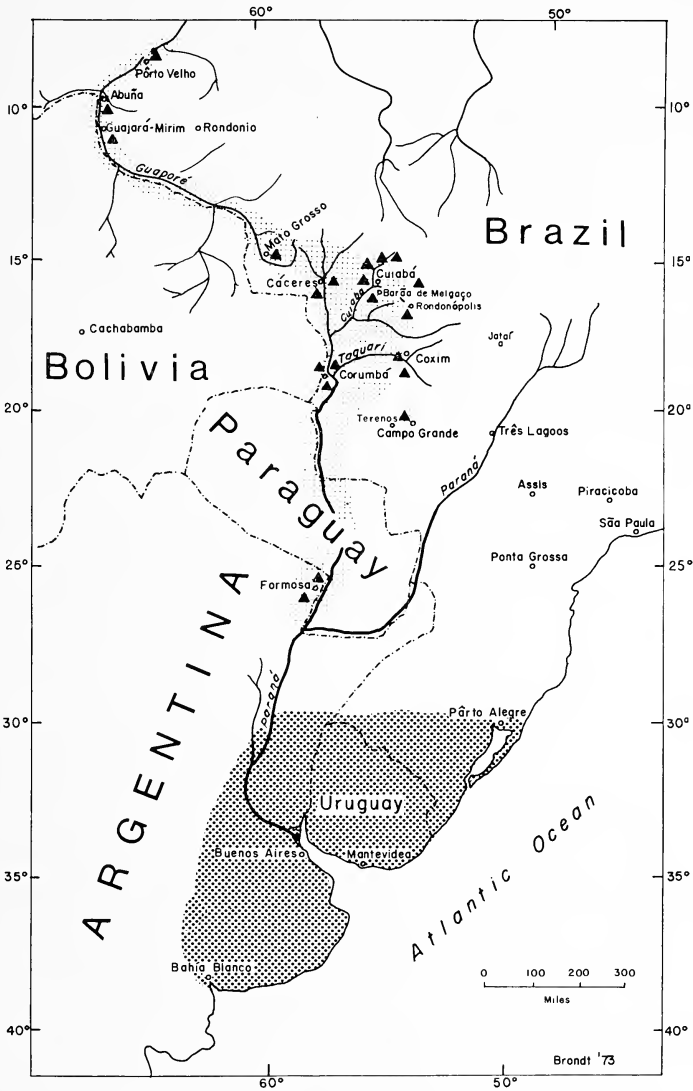

 *Solenopsis invicta*

 *S. invicta* collection sites

 *Solenopsis richteri*

 national boundaries

FIGURE 2.

than that given by Wilson (1952). Buren (1972) made similar remarks on the range of *S. interrupta* Santschi.

The northernmost record of *S. invicta* in South America is Porto Velho, Rondonia Territory, Brazil, and the southernmost record is near Resistencia, Chaco, Argentina, a distance of about 3,000 km. This compares with 1,345 miles or 2,250 km. in North America, the distance between the easternmost records of *invicta* in North Carolina and San Antonio, Texas. The width of the *invicta* range in South America appears to be relatively narrow and if exemplified by the distance between Corumba and Coxim, Mato Grosso, is only about 350 km. wide and possibly even considerably less wide in its southern arm into Argentina and Paraguay and its northern arm into the Amazon drainage along the Guapore River. Most of the available records are from localities which fringe the Pantanal (large flood plain [60,000,000 to 90,000,000 hectares] of the head waters of the Paraguay River), and although the interior of this area has not been sampled there seems little doubt but that the species occurs in favorable locales throughout the Pantanal. Otherwise we could not expect it to be so uniformly distributed around the periphery. The Pantanal has been proposed (Allen, et al., 1974) as the probable original homeland of *S. invicta* and this hypothesis still appears reasonable to us. Hydrochore dispersal via the well-known phenomena of massing together and floating downstream during flooding (Lennartz, 1973) could easily account for the far south and far north populations of *invicta* along the Paraguay and Guapore rivers, respectively.

The western extensions of the range of *S. invicta* are not known but we believe them to be rather limited. None of the *Solenopsis* material captured so far in Bolivia can be identified as this species. We would expect it to occur in easternmost Bolivia, however, since portions of the Pantanal extend into this country.

Why a vigorous species such as *invicta* has not penetrated farther to the east of its present area remains an ecological mystery about which we can only make guesses. The species has not yet been taken in the state of Sao Paulo and has not been found east of Rondonopolis or from Campo Grande eastward in Mato Grosso. Other species in the *S. saevissima* complex have been found (Allen, et al., 1974) in these areas, so it is obvious that the areas are not entirely insalubrious to *Solenopsis*. (These species are presently under taxonomic study by the senior author.) However, in effect, *invicta* has not been found either in the cerrado area to the east of the Pantanal, where Allen et al. (1974) and Lennartz (1973) have postulated that a lack of moisture during the prolonged dry season might halt its progress, or even in what would seem to be favorable limited areas along streams and rivers more than a short distance (approximately 50 to 100 kilometers) from the Pantanal. If the species is "at home" and fairly abundant in the flood plain of the Paraguay River, why, apparently, is it absent from the flood plain of the Parana River, which joins the Paraguay near



where *invicta* has been captured in Argentina? And if present there why could it not move thence into favorable areas of the state of Sao Paulo? Other species of *Solenopsis* have been collected along the Parana River, but not *S. invicta*.

It is easy to postulate that a combination of abiotic and biotic factors enforces these territorial limits without knowing the exact parameters or how they act precisely. One can logically postulate in a general way that *invicta* needs more soil moisture than certain other species in the *saevissima* complex and, therefore, is at a competitive disadvantage with these species in the campo cerrado and thus has not been able to expand eastward out of the Pantanal region.

Another hypothesis is that competitive action by other ants, possibly species of the genus *Pheidole*, may be of importance in limiting the spread of *S. invicta*. *Pheidole* is a large and predominant genus in the neotropics, with nearly 400 taxa (Kempf, 1973). Various species are numerous both in the forested areas and in the campo cerrado, where *Solenopsis* of the *saevissima* group is rare or is limited to ecologically disturbed areas. On the other hand, in our observations on the fringes of the Pantanal, *Pheidole* spp. do not seem very common in this area, possibly due to the annual flooding which *Solenopsis* can withstand by massing together and floating but which, perhaps, *Pheidole* cannot.

Mutual exclusiveness in the ranges of ants has not been studied in depth but is known to occur. See, for example, the remarks of Levins and Heatwole (1973) on the mutually exclusive ranges of *Solenopsis geminata* (Fabr.) and *Pheidole megacephala* (Fabr.) on islands in the West Indies, and also those of Buren (1968) on the mutually exclusive ranges of *Conomyrma bicolor* Wheeler and *Crematogaster larreae* Buren in the deserts near El Paso, Texas. In each case, the range limitations were due to a combination of abiotic and/or biotic factors.

It is the ground-patrolling activities of *Pheidole* which are suspected of being inimical to *Solenopsis* through efficient detection and attacks on the newly mated queens after wedding flights. The queens, unlike the workers, do not sting or effectively defend themselves. A number of adverse factors, such as the postulated attacks on the queens by *Pheidole* workers, lack of soil moisture for long periods of the year, and, perhaps, predation on incipient colonies by marauding ants (Dorylines) could severely limit even a vigorous species.

A time factor must also be considered. It is reasonable to suggest that a certain time must elapse before any two or more species which are in competition can come to equilibrium in the territory occupied. This time could be relatively short in a case where one species is clearly more aggressive than others or very long where the species are more or less evenly matched. Erickson (1972) has investigated the displacement of *Pogonomyrma californicus* Buckley by *Iridomyrma humilis* and finds that this has proceeded at the rate of about 100 meters per year in the old field studied. Other studies concerning the displacement of various ants by *I. humilis* have been comparable. The encroachment upon

native ants by *Solenopsis invicta* has been much more rapid, however, and occasionally may have been as much as 5 miles per year (Wilson and Brown, 1958). Even where very rapid, minor enclaves or pockets of the lesser species are likely to remain. For instance *S. invicta* appears to be having difficulty becoming predominant in parts of the central sandy uplands of Florida and *S. geminata* has remained the predominant ant in Alachua County and other locales of this region, in spite of the fact that *S. invicta* is found there sporadically. *S. geminata* also remains in small areas at Tall Timbers Research Station north of Tallahassee, Florida, where *invicta* has otherwise claimed exclusive usage of certain territory especially favorable to it, such as along the mucky shoreline of Lake Iamonia, where the water table is very close to the soil surface.

Where the several species are nearly evenly matched, the distribution patterns either can become sympatric, as in the case of *invicta* and one or more unknown *Solenopsis* species in the Pantanal, and in the case of *S. blumi* Buren, *interrupta* Santschi, and *quinquecupis* Forel in Uruguay or can assume parapatric patterns, as in the case of *richteri* and *quinquecupis* in Uruguay (Buren, 1972).

Ants, just as many other insects and other animals, have highly differing ranges. There are examples of ants with extremely extensive ranges such as the holarctic ranges of *Camponotus herculeanus* (Linne) and *Formica fusca* Linne or the extensive neotropical range of *Paraponera clavata* (Fabr.). These contrast with the very limited ranges of such species as *Crematogaster opuntiae* Buren (cholla cactus associations in the sonoran desert of southern Arizona), *C. navajoa* Buren (pinyon pine-juniper-grasslands of northern Arizona and southern Utah), and *Discothyrea testacea* Roger (in fern areas, coastal plains of the Carolinas and Georgia). In the case of species with extensive ranges, a long time span of existence as stable species seems to be the only explanation. In the case of species with small, limited ranges, it can be postulated, however, that their existence as separate species has either been relatively short (possibly the case with *Crematogaster navajoa* and *opuntiae* since the arid desert conditions of the southwest are relatively recent and the two species have not spread out of their small ranges to other ecologically similar areas), or they may be ancient, impoverished relict species, or they may have very restrictive cryptobiotic habits (as may be the case with *Discothyrea testacea*).

In South America the evidence is that the rain forests have not always occupied the extensive area now occupied but, owing to severe continent-wide drought conditions, have periodically retreated into isolated enclaves, the latest period only 2,600 years ago and the period previous to this only 11,000 years ago. The isolated enclaves are thought to have contributed to the complexity of speciation seen in the hylean forests. For a review of this subject see Vanzolini (1973) and Vuilleumier (1971). We submit, however, that if the hylean forests withdrew into enclaves during periods of severe drought, then very probably

other moist areas in South America were severely limited also, including the Pantanal. If *Solenopsis invicta* speciated in the recent geologic past within the Pantanal during a period of great isolation, then it follows that its range would have been severely limited, and our tentative hypothesis is that the species has not had time since these periods, considering the many biotic and abiotic factors mitigating against its spread, to reach all the areas which might be ecologically favorable to it. In North America, however, following its chance introduction, its spread was almost unbelievably rapid and unhampered by the factors which are operative in South America. The progress of the co-invader *S. richteri* does not seem conspicuously successful in the areas of the United States that it has invaded, but it can be wondered how it would have fared if it had reached the southern Great Plains, perhaps fairly similar to its homeland pampas.

#### Literature Cited

- ADKINS, H. G. 1970. The imported fire ant in the southern United States. *Ann. Assoc. Amer. Geograph.*, **60**(3): 578-592.
- ALLEN, G. F., BUREN, W. F., WILLIAMS, R. N., DEMENZES, M., AND WHITCOMB, W. H. 1974. The red imported fire ant *Solenopsis invicta*: Distribution and habitat in Mato Grosso, Brazil. *Ann. Ent. Soc. Amer.*, **67**(1): 43-46.
- BHATKAR, A., WHITCOMB, W. H., BUREN, W. F., CALLAHAN, P., AND CARLYSLE, T. 1972. Confrontation behavior between *Lasius neoniger* (Hymenoptera: Formicidae) and the imported fire ant. *Environ. Ent.*, **1**(3): 274-279.
- BUREN, W. F. 1968. A review of the species of *Crematogaster*, sensu stricto, in North America (Hymenoptera, Formicidae). Part II. Descriptions of new species. *J. Georgia Entomol. Soc.*, **3**(3): 91-121.
- BUREN, W. F. 1972. Revisionary studies on the taxonomy of the imported fire ants. *J. Georgia Entomol. Soc.*, **7**(1): 1-26.
- CREIGHTON, W. S. 1930. The new world species of the genus *Solenopsis* (Hymenoptera, Formicidae). *Proc. Amer. Acad. Arts Sci.*, **66**(2): 39-151, 8 plates.
- CULPEPPER, G. H. 1953. Status of the imported fire ant in the southern states in July, 1953. U.S. Department of Agriculture, Bureau of Entomology and Plant Quarantine. Special Report E-867, Washington, D.C.
- ERICKSON, J. M. 1971. The displacement of native ant species by the introduced Argentine ant *Iridomyrmex humilis* Mayr. *Psyche*, **78**(4): 257-266.
- ETTERSHANK, G. 1966. A generic revision of the world Myrmicinae related to *Solenopsis* and *Pheidologeton* (Hymenoptera: Formicidae). *Aust. J. Zool.*, **14**: 73-171.
- FOSTER, E. 1908. The introduction of *Iridomyrmex humilis* into New Orleans. *Jour. Econ. Ent.*, **1**(5): 289-293.
- KEMPF, W. W. 1972. Catálogo abreviado das Formigas da Região Neotropical (Hym. Formicidae). *Studia Entomologica*, **15**(1-4): 3-343.
- LENNARTZ, F. E. 1973. Modes of dispersal of *Solenopsis invicta* from Brazil to continental United States—A study in spatial diffusion. Unpublished master's degree thesis. Univ. of Florida.
- LEVINS, R. AND HEATWOLE, H. 1973. Biography of the Puerto Rican Bank: Introduction of species onto Palominos Island. *Ecology*, **54**: 1056-1064.
- LEWIS, L. F. 1951. Investigation in the biology of the imported fire ant. *In* U.S. Department of Agriculture Quarterly Report, April-June 1951.

- MARKIN, G. P., DILLIER, J. H., HILL, S. O., BLUM, M. S., AND HERMANN, H. R. 1971. Nuptial flight and flight ranges of the imported fire ant *Solenopsis saevissima richteri* (Hymenoptera: Formicidae). J. Georgia Entomol. Soc., **6**(3): 145-156.
- MARKIN, G. P., FORD, J. H., HAWTHORNE, J. C., SPENCE, J. H., DAVIS, J., COLLINS, H. L., AND LOFTIS, C. D. 1972. The insecticide Mirex and techniques for its monitoring. U.S. Department of Agriculture, Animal and Plant Health Inspection Service, 81-3.
- NEWELL, W. AND BARBER, T. C. 1913. The Argentine ant. U.S. Department of Agriculture, Bureau of Entomology, Bull. no. 122.
- REPORT ON THE VOLUME OF WATER-BORNE FOREIGN COMMERCE OF THE UNITED STATES BY PORTS OF ORIGIN AND DESTINATION. 1926-1936. U.S. Shipping Board, Bureau of Research, Maritime Records Division, Washington, D.C.
- SMITH, M. R. 1949. Report on imported fire ant investigations. U.S. Department of Agriculture, Bureau of Entomology and Plant Quarantine. Unpublished report, July 26, 1949.
- VANZOLINI, P. E. 1973. Paleoclimates, relief, and species multiplication in equatorial forests. In "Tropical Forest Ecosystems in Africa and South America: A Comparative Review." Smithsonian Institution Press.
- VUILLEUMIER, B. S. 1971. Pleistocene changes in the fauna and flora of South America. Science, **173**: 771-780.
- WHITCOMB, W. H., BHATKAR, A., AND NICKERSON, J. C. 1973. Predators of *Solenopsis invicta* queens prior to successful colony establishment. Environ. Ent., **2**(6): 1101-1103.
- WILSON, E. O. 1951. Variation and adaptation in the imported fire ant. Evolution, **5**: 68-79.
- WILSON, E. O. 1952. O complexo *Solenopsis saevissima* na America do Sul (Hymenoptera: Formicidae). Mem. Inst. Oswaldo Cruz., **50**: 49-68.
- WILSON, E. O. 1955. A monographic revision of the ant genus *Lasius*. Bull. Mus. Comp. Zool., **113**(1): 1-199, 2 plates.
- WILSON, E. O. AND BROWN, W. L. 1958. Recent changes in the introduced population of the fire ant *Solenopsis saevissima* (Fr. Smith). Evolution, **12**: 211-218.

## Microsporidan and Fungal Diseases of *Solenopsis invicta* Buren in Brazil<sup>1</sup>

GEORGE E. ALLEN AND WILLIAM F. BUREN

DEPARTMENT OF ENTOMOLOGY, UNIVERSITY OF FLORIDA, GAINESVILLE, FLORIDA 32611

RECEIVED FOR PUBLICATION FEBRUARY 14, 1974

**Abstract:** The first record of a microsporidan infection in the family Formicidae is presented. The organism, a *Thelohania* sp., was isolated from *Solenopsis invicta* Buren colonies in Brazil in 1973. Microsporidan spores were also observed in three other species of the *S. saevissima* complex. *Metarrhizium anasopliae* is also reported from *S. invicta* and the leaf-cutting ant *Atta sexdens rubropilosa*.

### DISCUSSION

Although the Formicidae has been one of the most extensively studied families of insects, our knowledge of pathogens associated with the ant group is one of the most deficient areas in insect pathology. Many of the pathogens described from ants were isolated from a small number of individuals since "epizootics," such as those that occur in the Lepidoptera, are rarely observed.

All levels of association, ranging from symbiotic to parasitic relationships, can be found between microorganisms and various ant groups. The association of members of the Tribe Attini and their respective fungal symbionts is a well-known phenomenon and is discussed in detail by Wheeler (1907) and Weber (1972). Another well-documented relationship is that of the Laboulbeniomyces fungi and the various insect orders including Formicidae. This group includes predominately obligate parasites which seem to have little or no effect on the well-being of their hosts (Benjamin, 1973). According to Smith (1946), *Formica* is the most common ant genus associated with members of the Laboulbeniomyces, especially the genus *Laboulbenia*. For further information the reader is referred to an excellent review by Benjamin (1971) which includes a summary of the studies of Thaxter and others on the Laboulbeniomyces.

A brief review of known pathogen involvement with the ant group is summarized in Table 1. An interesting disease of *Formica rufa* Linne in Western Siberia has been attributed to the fungus *Alternaria tenuis* Nes. (Dlusskii, 1967). The course of epizootics of the disease is vividly described by Marikovskiy (1962) and is the first report of *Alternaria* as an insect pathogen. There is,

---

**Acknowledgments:** We gratefully acknowledge the assistance of Mr. Ed Hazard, Insects Affecting Man Research Laboratory, United States Department of Agriculture, Gainesville, Florida, for verifying the *Thelohania* sp.

<sup>1</sup>Florida Agricultural Experiment Station Journal Series No. 5326.

however, reason to question the identity of the fungus, since members of the genus *Alternaria* have been reported only as common plant pathogens.

Several species of the fungus *Cordyceps* have been reported as "pathogens" of ants (Mains, 1948; Petch, 1932; and Van Pelt, 1958). However, McEwen (1963) raises the question of pathogenicity of *Cordyceps*, noting the lack of detailed accounts of pathological conditions in infected hosts.

Mains (1948) discusses two species of fungi as possible conidial or imperfect stages of bicolored species of *Cordyceps* pathogenic to ants. Included in this group are the genera *Stilbum* and *Hymenostilbi*.

In addition, the cosmopolitan fungal pathogens *Metarrhizium anasopliae* (Metchnikoff) Sorokin and *Beauveria bassiana* (Bals.) Vuill. have been described from ants (Steinhaus and Marsh, 1967). These two fungi appear to be very important ant pathogens in South America.

To date, no virus diseases in ants have been reported. However, Steiger et al. (1969) have observed "virus-like" particles in cell lines derived from the cephalic ganglionic center of *Formica lugubris* Zetterstadt. As in the case of viruses, pathogenic protozoa have not been reported in the Formicidae. Several groups, especially the microsporida, are important pathogens of other families in the order Hymenoptera. *Nosema apis*, the cause of "Nosema disease" in the honey bee, *Apis mellifera*, is an excellent example.

#### DISEASES ASSOCIATED WITH THE *Solenopsis saevissima* COMPLEX

Our knowledge of ant pathogens is no doubt related to the "economic importance" given to this group of insects. Generally speaking, no ant species is ranked as a "major" pest of agricultural crops, man, or animals. An exception to this is the "red imported fire ant," *Solenopsis invicta* Buren, which in recent years has been the target of an extensive research program in the southeastern United States.

Buren (1972) proposed a taxonomic model for the *Solenopsis saevissima* complex and showed that there are two species of imported fire ants in the United States (*S. richteri* Forel and *S. invicta* Buren), each from different homelands within South America. In 1971, the authors organized and coordinated a 17-day trip through western Brazil and established as the homeland of *S. invicta* certain areas of Mato Grosso, Brazil (Allen et al., 1974). One of the objectives of the trip was to isolate pathogens of the ant. The following is a report of primary pathogens isolated from specimens collected during the 1971 trip and later collections made by the senior author in February 1973 in and around the city of Cuiabá, Mato Grosso.

#### *Microsporida*

During a taxonomic examination of the 1973 collections, the junior author observed subspherical "cyst-like" bodies in the gasters of alcohol-preserved workers

TABLE 1. Fungi reported as pathogens of ants.

Ant Species	Fungus	Comments	References
<i>Formica rufa</i>	<i>Alternaria tenuis</i>	No known record of <i>Alternaria</i> entomopathogenic; well-known plant pathogen	Dlusskii (1967) Marikovsky (1962)
UNKNOWN	<i>Cordyceps</i> sp.		McEwen (1963)
UNKNOWN	<i>Cordyceps Australis</i> <i>Cordyceps bicephala</i> <i>Cordyceps necator</i> <i>Cordyceps proliferans</i>		Mains (1948)
<i>Megaponera foetens</i>	<i>Cordyceps bicephala</i>		Petch (1931)
<i>Camponotus pennsylvanicus</i>	<i>Cordyceps unilateralis</i>		Van Pelt (1958)
<i>Camponotus castaneus</i>	<i>Cordyceps</i> sp.		Allen (unpublished)
<i>Camponotus</i> sp.	<i>Stilbum burmense</i>		Steinhaus (1951); Mains (1948)
UNKNOWN	<i>Hymenostilbi australiensis</i>	Originally described <i>Stilbum formicarum</i> by Cooke and Masse (Cooke, 1889)	Mains (1948)
<i>Atta texana</i>	<i>Aspergillus flavus</i> <i>Beauveria bassiana</i>		Steinhaus and Marsh (1967)
<i>Solenopsis saevissima richteri</i> (= <i>S. richteri</i> )	<i>Metarrhizium anasopliae</i>		Steinhaus and Marsh (1967)
<i>Solenopsis invicta</i>	<i>M. anasopliae</i>		Allen (unpublished)
<i>Atta sexdens rubropilosa</i>	<i>M. anasopliae</i>		Allen (unpublished)
UNKNOWN	<i>Beauveria densa</i>	Placed in synonymy with <i>B. bassiana</i> by de Hoog, 1972	Leatherdale (1958)

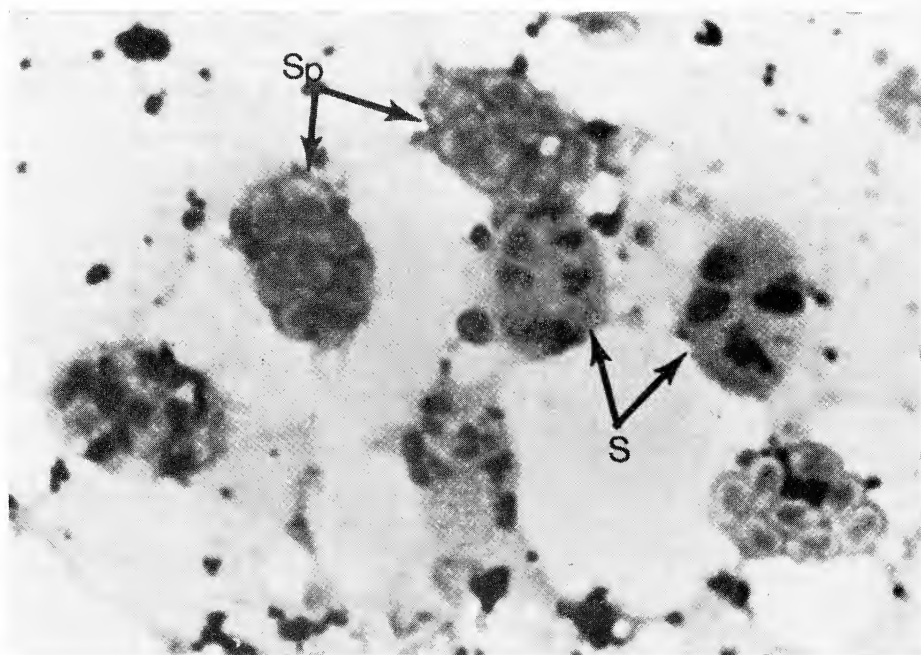

FIG. 1. Octonucleate sporonts (S) and spores within a sporont membrane (Sp) of *Thelohania* sp. in *S. invicta* workers, Giemsa smear,  $\times 2,200$ .

of *S. invicta*. Histological examination showed the bodies were not cysts but rather masses of microsporidia spores enclosed within fat body-cell membranes. These structures were not found in living ants examined later, even though both sporonts and spores were present.

The microsporidan isolated from living workers of *S. invicta* was *Thelohania* sp. Giemsa-stained smears showed that the octonucleate sporonts produce eight spores enclosed in a sporont membrane (Fig. 1). These characteristics place the microsporidan in the genus *Thelohania* Henneguy. Spores are pyriform with average fixed spore measurements of  $3.4 \mu \times 2.0 \mu$ . Schizonts of the microsporidan were also observed in Giemsa-stained smears of adult workers and queens of *S. invicta*. The primary site of infection was the fat body. To the best of the authors' knowledge, this is the first report of a microsporidan infection in the family Formicidae.

Every *S. invicta* colony sampled in 1973 showed a high infectivity rate. No mounds were evident and the colonies were found only after digging around large rocks, cement pillars, and other protective objects. Infected colonies appeared to have lower than normal populations and noticeable loss of vigor and pursuit when disturbed.

The potential of the *Thelohania* sp. as a biological control agent of *S. invicta*



in the United States can only be speculated at this point. The genus is well known and the associations of many of its species and their insect hosts have been described (Kudo, 1924; Weiser, 1961; Kellen et al., 1965; Chapman et al., 1966).

Microsporida spores were also observed in collections made in 1971 (Allen et al., 1974) from several localities, one of which appeared to be a *Nosema*. Collections of *S. invicta* from Cuiabá and Porto Velho were infected at the time of collection as well as three other species of the *S. saevissima* complex from Cuiabá, Mato Grosso, Campo Grande, Porto Manga, and Corumbá. Porto Velho is located in the Territory of Rondônia, which borders the state of Mato Grosso to the northwest. For a map depicting the location of these localities the reader is referred to Buren et al. (1974).

### Fungi

The fungus *Metarrhizium anasopliae* was isolated from *S. invicta* workers and *Atta sexdens rubropilosa* Forel queens collected during the 1971 trip. This cosmopolitan pathogen is a well-known entomogenous fungus (Steinhaus and Marsh, 1962; Charles, 1941; and Leatherdale, 1958) which attacks a wide range of insect hosts. It was also reported from *S. saevissima richteri* Forel (= *S. richteri* Forel) in Uruguay (Steinhaus and Marsh, 1967).

*Metarrhizium anasopliae* reportedly attacks only the queens of *A. sexdens rubropilosa* in Brazil, where it is known as "queens disease" by the local citizens. The fungus may also attack worker ants, but these are not observed because the infected individuals probably leave the colony when infection is apparent, as is the case with *Formica rufa* (Marikovsky, 1962).

The foregoing report establishes the presence of both microsporidan and fungal diseases in *S. invicta*. Although we can report only the involvement of the *Thelohania* sp. and *M. anasopliae* at this time, there are strong indications that we can expect to find other genera of microsporida as well as "virus-like" pathogens of members of the *S. saevissima* complex in Brazil. Current studies are being conducted to determine the interrelationship of *S. invicta* and its *Thelohania* parasite and other pathogens of the *S. saevissima* complex.

### Literature Cited

- ALLEN, G. E., BUREN, W. F., WILLIAMS, R. N., DE MENEZES, M., AND WHITCOMB, W. H. 1974. The red imported fire ant, *Solenopsis invicta*; distribution and habitat in Mato Grosso, Brazil. *Ann. Entomol. Soc. Am.*, **67**: 43-46.
- BENJAMIN, R. K. 1971. "Introduction and Supplement to Roland Thaxter's Contribution Towards a Monograph of the Laboulbeniaceae" (*Bibliotheca Mycol.*, Vol. 30). Cramer, Lehre.
- BENJAMIN, R. K. 1973. Laboulbeniomyces. In "The Fungi" (G. C. Ainsworth, F. K. Sparrow, and A. S. Sussman, eds.). Academic Press, New York. **4A**: 223-246.
- BUREN, W. F. 1972. Revisionary studies of the taxonomy of the imported fire ants. *J. Ga. Entomol. Soc.*, **7**: 1-26.

- BUREN, W. F., ALLEN, G. E., WHITCOMB, W. H., LENNARTZ, F. E., AND WILLIAMS, R. N. 1974. Zoogeography of the imported fire ants. *J. N.Y. Entomol. Soc.*, **82**: 113-124.
- CHAPMAN, H. C., WOODWARD, D. B., KELLEN, W. R., AND CLARK, T. B. 1966. Host-parasite relationships of *Thelohania* associated with mosquitoes in Louisiana (Nosematidae: Microsporidia). *J. Invertebr. Pathol.*, **8**: 452-456.
- CHARLES, V. K. 1941. A preliminary check list of the entomogenous fungi of North America. United States Dept. of Agric. Bur. Plant. Ind. Inst. Pest Survey Bull., **21**: 707-785.
- COOKE, M. C. 1889. New Australian fungi. *Grevillea*, **18**: 1-8.
- DE HOOG, G. S. 1972. The genera *Beauveria*, *Isaria*, *Tritirachium* and *Acrodontium* gen. nov. *Stud. Mycol.*, No. 1, pp. 1-41.
- DLUSSKII, G. M. 1967. "Ants of the genus *Formica*." (K. V. Arnol'di ed.), Izdatel'stvo "Nauka" ("Nauka" Press), Moscow. Pp. 232.
- KELLEN, W. R., CHAPMAN, H. C., CLARK, T. B., AND LINDEGREN, J. E. 1966. Transovarian transmission of some *Thelohania* (Nosematidae: Microsporidia) in mosquitoes of California and Louisiana. *J. Invertebr. Pathol.*, **8**: 355-359.
- KUDO, R. 1924. A biologic and taxonomic study of the microsporidia. Ill. Biol. Monogr., **9**: 1-268.
- LEATHERDALE, D. 1958. A host catalogue of British entomogenous fungi. *Ent. Mon. Mag.*, **94**: 103-105.
- MAINS, E. B. 1948. Entomogenous fungi. *Mycologia*, **40**: 402-415.
- MARIKOVSKY, P. I. 1962. On some features of behavior of the ants *Formica rufa* L. infected with fungous disease. *Insectes Sociaux*, **9(2)**: 173-179.
- MC EWEN, F. L. 1963. "Cordyceps Infections." *In* *Insect Pathology: An Advanced Treatise* (E. A. Steinhaus, ed.) Academic Press, New York. II. Pp. 273-290.
- PETCH, T. 1932. Notes on entomogenous fungi. *Trans. Brit. Mycol. Soc.*, **16**: 209-245.
- SMITH, M. R. 1946. Ant hosts of the fungus, *Loboulbenia formicarum* Thaxter. *Entomol. Soc. Wash.*, **48**: 29-31.
- STEIGER, U., LAMPARTER, H. E., SANDRI, C., AND AKERT, K. 1969. Virus-ähnliche Partikel im Zytoplasma von Nerven—und Gliazellen der Waldameise. *Arch. ges. Virusforsch.*, **26**: 271-282.
- STEINHAUS, E. A. AND MARSH, G. A. 1962. Report of diagnoses of diseased insects, 1951-1961. *Hilgardia*, **33**: 349-490.
- STEINHAUS, E. A. AND MARSH, G. A. 1967. Previously unreported accessions for diagnosis and new records. *J. Invertebr. Pathol.*, **9**: 436-438.
- VAN PELT, A. 1958. The occurrence of a *Cordyceps* on the ant *Camponotus pennsylvanicus* (De Geer) in the Highlands, N.C., region. *J. Tenn. Acad. Sci.*, **33**: 120-122.
- WEBER, N. A. 1972. "Gardening Ants, The Attines," *Mem. Amer. Phil. Soc. American Philosophical Society, Philadelphia*. **92**: Pp. 146.
- WEISER, J. 1961. Die Mikrosporidien als Parasiten der Insekten. *Monogr. z. Ang. Ent.*, **17**: Pp. 149.
- WHEELER, W. M. 1907. The fungus-growing ants of North America. *Bull. Amer. Mus. Nat. Hist.*, **23**: 669-807.

## A Supplement to the Revision of the Ant Genus *Basiceros* (Hymenoptera: Formicidae)

WILLIAM L. BROWN, JR.

DEPARTMENT OF ENTOMOLOGY, CORNELL UNIVERSITY, ITHACA, NEW YORK 14850

RECEIVED FOR PUBLICATION JANUARY 7, 1974

**Abstract:** The genus *Basiceros* is expanded to include *Aspididris* due to the finding of a new species, *B. conjugans* (Amazonian Ecuador and Colombia), which connects them. *Basiceros* is redefined and the male caste formally described, and keys are provided for the known forms of both sexes. The known distribution of *B. singularis* is extended to northern Mato Grosso and of *B. discigera* to Espirito Santo State, Brazil, and to subandean Colombia. *B. singularis* is confirmed as a termite predator.

### INTRODUCTION

The genera *Basiceros* and *Aspididris* were treated by Brown and Kempf (1960: 171–181) as part of a world revision of the myrmicine tribe Basicerotini. At that time, we said of the status of *Aspididris* (op. cit., p. 179):

This genus, known from workers and females, includes two neotropical species with the basic characters of *Basiceros*, but in which the posterior half of the head has been transformed into a disc-like structure, with the vertex convex, but the lateral and posterior occipital borders drawn out into a sharp, upturned, saucer-like margin that is ornamented with a row of clavate hairs. In *A. militaris*, this margin is continuous around the back of the head, from near one compound eye to the other, while in *A. discigera*, it is slightly interrupted posteromedially. . . . *A. discigera* has been placed in *Basiceros* by previous authors, and it is clearly transitional in head shape between a species like *B. convexiceps* and the extreme *Aspididris militaris*. Thus, while the generic split seems almost academic, the distinction can still be drawn rather clearly on a practical basis, and there seems to be no good reason to synonymize *Aspididris* unless further intergradient species are found.

The Wheelers have shown that the larva of *A. militaris* is very similar to that of *Basiceros*. The two *Aspididris* species are known from Trinidad and southeastern Brazil, and both are uncommon. We have no biological data on them beyond the fact that they are collected in moist forested areas.

### DISCUSSION

The "further intergradient species" has now been found, and it is described below as *Basiceros conjugans*. This new species so clearly and completely links *Basiceros* and *Aspididris* that there is no longer any excuse for recognizing the latter as a genus apart, and the formal generic synonymy is recorded here. The genus *Creightonidris*, with the sole species *C. scambognatha*, is closely related to *Basiceros* but is separated on the basis of its extremely aberrant mandibles.

The present paper, offered as a supplement to the revision of 1960, also

describes the adult male caste of *Basiceros* in modern terms and presents some new information on the distribution and biology of the species. A new key to the *Basiceros* species is appended.

This article is dedicated to the memory of Dr. William S. Creighton, who in 1950 breathed new life and reason into ant taxonomy with "The Ants of North America."

I should like to acknowledge the help of Dr. Henry Hermann, University of Georgia, and Drs. Stuart and Jarmila Peck, Carleton University, Ottawa, Canada, for furnishing material critical for this study. My own collecting and other aspects of the research contributing toward this paper were supported in large part by U.S. National Science Foundation, Grants GB-2175 and GB-31662X.

#### BASICEROS

*Basiceros* Schulz, 1906, Spolia Hymenopt., p. 156, *nom. pro Ceratobasis* F. Smith. Type: *Ceratobasis singularis* = *Meranoplus singularis* F. Smith.

*Basiceros*: Brown and Kempf, 1960: 171; see for complete synonymy; nomenclature and history on pp. 168-169.

*Aspididris* Weber, 1950: 3. Type: *Aspididris militaris* Weber, by original designation. New synonym.

*Aspididris*: Brown and Kempf, 1960: 179.

The diagnosis of the genus has to be modified in part to include the characters of the two *Aspididris* species.

*Worker*. Head trapezoidal, oblong or disc-like, the posterior and lateral borders separate and either rounded or crested, or else combined into a curving, continuous or near-continuous crest around the back of the cranium. Mandibles sub-parallel, triangular, with straight, opposable, multidenticulate masticatory borders; blade narrowed before insertion, the resulting peduncle either partly exposed or entirely hidden beneath clypeus, so that an interspace between basal mandibular and anterior clypeal borders is present or absent in varying degrees.

Propodeal teeth lamelliform, more or less acute.

Malpighian tubules 5.

*Queen*: Like worker, but more robust and with developed pterothorax bearing wings in virgins; ocelli present.

*Male*. (Generic description based on *B. discigera*, *B. conjugans*, and *B. singularis*): Size a little smaller than the conspecific queens and workers, and more slender. Head broadest across the large, bulging eyes (which are situated at or a little in front of midlength) rather suddenly narrowed in front of eyes and tapering moderately anteriorly; median vertex and ocelli prominent. Clypeus broad, its postero-median lobe convex and truncate or rounded, extending about to level of frontal lobes; its anterolateral lobes concave, free margin with a thin, sharp, yellowish edge, transverse or concave in front and rounded-divergent on sides. Frontal area variably distinct, semicircular or transverse, more or less impressed; rugose or carinate in the middle, and more or less distinctly delimited behind by an arched carina or rugulae that tend to connect the two frontal lobes. Frontal lobes prominent and projecting forward, laterad and dorsad, their free margins rounded sharply in front and broadly laterad, antennal insertions on their ventral faces. Lateral bases of lobes continued laterad as sharply

raised arching carinae running nearly to the eye on each side, then curving forward to bound deeply excavated, subreniform antennal scrobes, which are bounded in front by the cariniform posterior borders of the lateral wings of the clypeus. (Similar arrangements are found in many Attini, but in these the scrobes are usually not so deep or so sharply bounded.) Posterior vertex bordered along the cervical limit by a lamelliform margin bearing short longitudinal costulae; space between this and posterior ocelli either steep or gradual, depending on whether the head is much drawn out behind or not. A continuous or nearly continuous, sharp but irregular, ventrolateral carina extends from posterior corner of head to mandibular insertions, bordering a subrectangular piece of the cheek extending between eye and mandibular insertion, and bounded mesad by the carinate outer scrobe margin.

Mandibles subtriangular, with curved outer borders converging rapidly in the apical half, meeting along the masticatory borders, and the sharp apices crossing; gently downcurved and the dorsal faces gently convex. Masticatory borders serially 8-12-dentate. Mandibles petiolate or not, with or without anteclypeal space, and form of labrum in general as in conspecific workers.

Antennae long and slender, 13-merous. Scape very short, only about twice as broad as long, its base oblique, with the more acutely rounded angle on the outside, and the obtuse angle inside (mesal), tapered toward the truncate apex; a little thicker than the remaining segments. First funicular segment (pedicel) only about half as long as scape; succeeding segments all much longer than broad; apical segment longest, third antennal (funiculus II, counting from base) also very long.

Trunk robust; prescutum with a more or less distinct anteromedian carina; notauli deep and complete, the arms of the Y forming rows of deep punctures separated by the intercalated costulae. Parapsidal furrows in the form of fine shining lines; parapsides more or less impressed behind, but each with a sharp, raised posterolateral margin. Prescutellum separated from scutellum by an impression or transverse row of punctures, or else the middle part impressed and not distinct from scutellum; lateral wings of prescutellum with a laterally marginate, posteriorly pointed process or blunt hook on each side. Scutellum narrower than prescutellum, forming an elongate near-semicircle as seen from above, free borders marginate, but posteromedian portion concave; posterior aspect broadly Y- or U-shaped. Metanotum narrow, with a blunt median tumosity. Propodeum with dorsal face flat, rectangular, steeply sloping toward the rear, separated from rectangular declivitous face by a transverse carina. As seen from the side dorsal and declivitous faces of propodeum meeting at an obtuse angle; declivity marginate on each side.

Petiole clavate, with anterior peduncle and long, low rounded node, usually bent slightly downward near base of posterior peduncle; spiracles papillose, prominent. Postpetiole broader than long and a little broader behind than in front and broader than petiole; rounded above, sternum shallow; attached its full width behind to gaster, which is slightly concave in front to receive it. Gaster with first segment occupying most (70 percent or more) of its length; four visible apical segments subequal in length. Genital capsule slender; parameres slightly broadened, bluntly rounded and curved mesad at apices, but tapered to a blunt end as seen from the side; volsellae sock-shaped, as usual in Myrmicinae; pygidium and subgenital segment unremarkable, with moderately narrowly rounded apical margins.

Legs slender, tibiae of middle and hind pairs without apical spurs; tarsal claws slender and simple. Wings brownish, with opalescent bluish reflections (both sexes) and dense brown microtrichiation. Forewing veined as in queen of *Creightonidris* (Brown and Kempf, 1960: 173, fig. 8) except that m-cu is usually present as a spur from M, or as a complete crossvein. Hind wing with only two longitudinal veins issuing from the median cell (apical abscissae of R and Cu), with the tip of Sc branching off from fused Sc + R (Rf1 lacking) as in the

*Tranopelta* male (Kusnezov, 1962: 371, fig. 23). Anal loop (A + cu-a) short, without a spur of A, but with a break or weak place at a longitudinal fold line. Hamuli 5-9, submedian.

Sculpture very finely and densely punctulate, opaque or nearly so, including legs, mandibles and antennae. Vertex with overlying loose rugulae, especially behind compound eyes and in and around ocellar triangle; loose rugulation also on trunk, especially posterior half of mesonotum and sides of propodeum. In some species, varying parts of mesopleura smooth and shining, or rugulose.

Pilosity of fine tapered hairs, golden brown in color, mostly erect or suberect on body (some also appressed on gaster and clypeus in some species); mandibles, antennae and legs with hairs becoming shorter, more abundant and decumbent passing from base toward apices of these appendages. Mesal face of antennal scape with two or more long fine hairs and some shorter ones.

Color black; legs and antennae brown.

Contains six species as known at present: *conjugans* n. sp., *convexiceps*, *discigera*, *manni*, *militaris* and *singularis*. *Basiceros militaris* is a **new combination**.

#### DISTRIBUTION AND BIOLOGY

*Basiceros* has been found only in wet tropical and subtropical forests of Central and South America and Trinidad at low and moderate altitudes. All of the colonies for which data are available have been found in rotten logs, or at least in pieces of rotting wood of fairly substantial size. The adults usually move very slowly, and they feign death for long periods when disturbed, rivaling the attine *Apterostigma* in their ability to escape detection by this means in the forest gloom.

Weber (1950: 6) noted that he had found a worker of *B. singularis* near midday carrying a dead termite in Guyana, and I found headless termites in a nest of this species in Mato Grosso (see below under *B. singularis*). Food of the other species is unknown, but they are almost certainly predatory, perhaps on termites, judging by the hardened incrustations that many workers bear.

#### *Basiceros conjugans*, n. sp.

*Holotype worker*. TL 5.8, HL 1.24, HW 1.05 (CI 85), ML 0.43, greatest diameter of eye 0.13, scape L 0.82, WL 1.51 mm.

*Paratype worker from type locality*. TL 5.9, HL 1.29, HW 1.09 (CI 84), ML 0.42, greatest diameter of eye 0.14, scape L 0.84, WL 1.56 mm.

*Paratype workers (two) from near Leticia, Colombia*. TL 6.2, 6.1; HL 1.32, 1.33; HW 1.14, 1.12 (CI 86, 84); ML 0.44, 0.45; greatest diameter of eye 0.14, 0.16; scape L 0.85, 0.87, WL 1.63, 1.63 mm.

Form of head and body well shown by Figs. 1 and 2. Sides of head bordered by a distinct raised margin that continues around the posterior corners and across the back of the head as a less distinct margin with a shallow dip in the middle. Cephalic disc shallowly concave inside the lateral margins, convex in the middle, but the convexity itself with a shallow median impression running back from about the level of the eyes. Clypeus gently convex in both directions, with a feebly concave free margin. Mandibles with concave external borders in full-face view, eleven strong teeth on each, triangular except for the basalmost tooth,

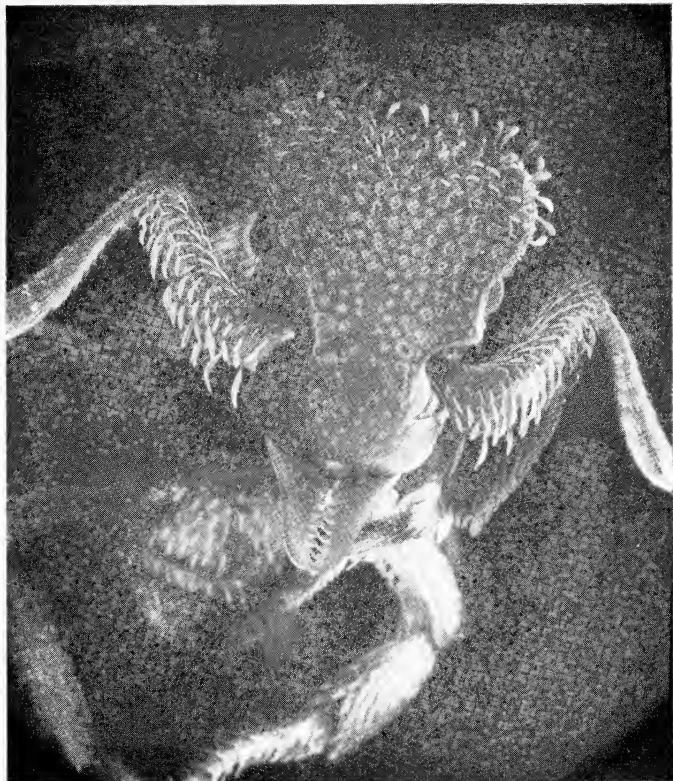
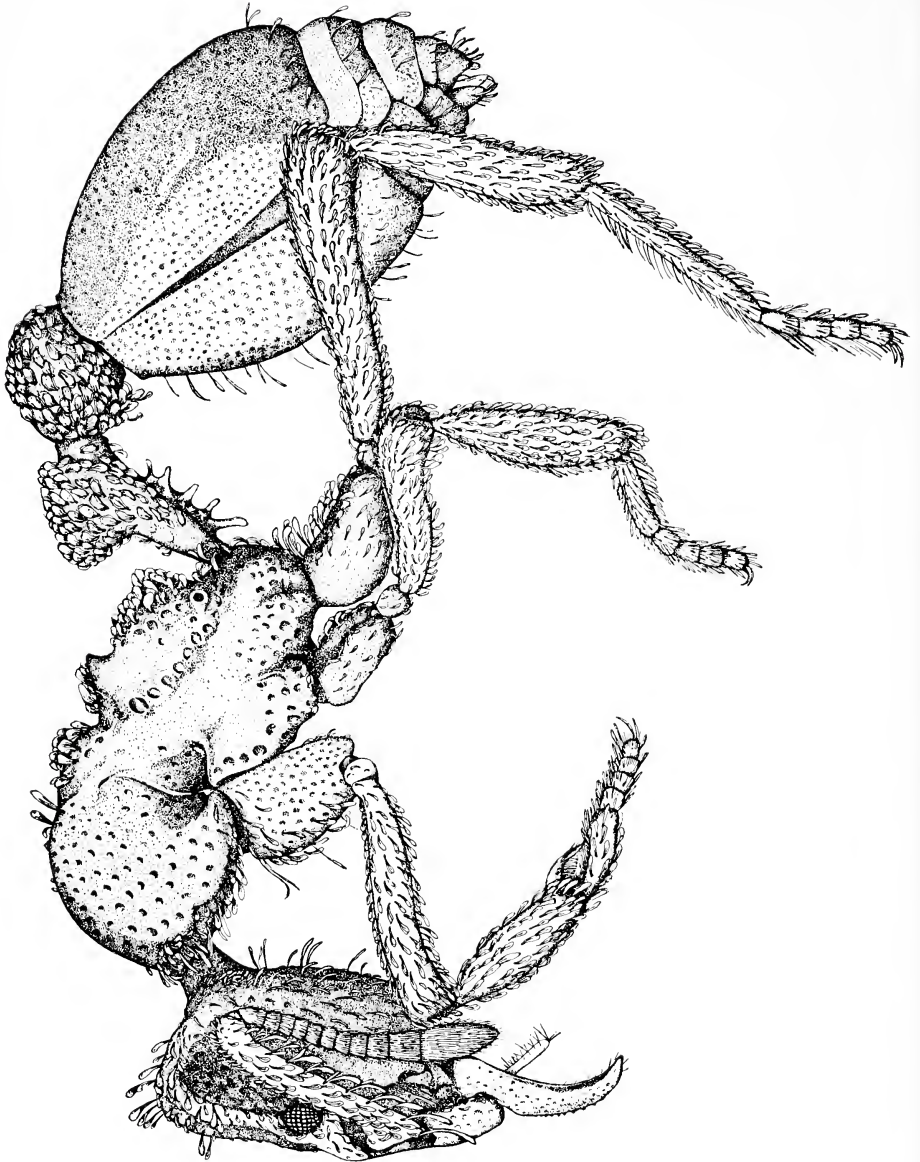

FIG. 1. *Basiceros conjugans*, new species. Head of paratype worker in slightly oblique face view; scanning electron micrograph,  $\times 40$ .

which is broad and rounded. Mandibular peduncles very short, mostly hidden under clypeus, leaving a short space between clypeal margin and basal borders. Extensor margin of scape with a broadly rounded, translucent, crenulate lobe around basal angle. Labrum elongate, tapered cuneiform, terminating in paired acute contiguous lobes separated by a narrow cleft. Palpi each consisting of two recognizable segments, which, however, are solidly fused in both maxillary and labial palpi to make one long crooked unit of each maxillary palpus, and one long, curved, clavate unit of each labial palpus. Cervical border of head with a strong raised margin.

Promesonotum forming a subglobular mass tapering sharply behind to the metanotum-propodeum, which is only a little more than half as wide seen from above. Promesonotal suture very faintly indicated above; metanotal groove broad and deeply impressed, longitudinally costate, succeeded posteriorly by a sloping, shelf-like propodeal dorsum that has a sharply downsloping declivitous face continuing into the final declivity of the propodeum. The declivity is bounded by carinae above and on each side; the transverse upper carina connects a pair of acute triangular teeth, hidden from side view by thick squamiform hairs. Bullae of metapleural glands prominent, projecting.

Petiolar node with a distinct anterior peduncle having a longitudinal carina on each side of dorsal surface; node distinct, with steep anterior face, mesally emerginate anterodorsal





border and posteriorly sloping rounded dorsum, the latter obscured by squamiform hairs, but its disc (without posterior peduncle) longer than broad. Subpetiolar processes 5 (4-6 in paratypes, sometimes adjacent processes partly fused). Postpetiole rounded in both directions, nearly twice as broad as petiole (pilosity excluded) and slightly broader than long, with a light-colored translucent anterior margin; attached behind its full width to concave anterior part of gaster as seen from above. Gaster with just the barest suggestion of a broad median longitudinal sulcus, visible only in certain lights. Sting retracted in holotype, but in a Colombian paratype worker, it is extended and has a shaft nearly 0.6 mm long.

Integument (where free of secretion and dense pilosity) prevailing smooth and shining, with coarse punctures, becoming smaller and spaced out on clypeus, and still smaller on mandibles. Punctures large and contiguous or subcontiguous in those areas bearing the dense heavy pilosity: posterior vertex, mesonotum, antero-dorsal shelf of propodeum, lateral edges of propodeal coxae, and both nodes of the waist. Propodeal declivity punctate-rugose, smoother ventrad. Pleural plates of meso- and metathorax and propodeum nearly free of punctures except along edges and sutural lines. Gastric segment I densely sown with closely spaced but separate medium punctures, less crowded along lateral curves of tergum; interspaces smooth and shining. Normally exposed tergal surfaces of terminal segments (abdominal V, VI, VII) finely and densely punctulate, opaque, but margins of these segments smooth and shining. Antennal scapes and legs smooth or with very fine superficial roughening, and coarse punctures for the hairs; in general shining; funiculi and distal halves of tarsi finely and densely punctulate, opaque to subopaque.

The shapes and location of the various kinds of pilosity are well shown in Figs. 1 and 2. The thicker squamiform and clavate hairs have a complicated microstructure. Under high magnification, the surfaces of these hairs appear fluffy, with ribs of free fibers running longitudinally, represented sometimes as fine lines in Fig. 2. A pair of erect clavate hairs on the vertex is not so easily distinguished in the figures, since they are close to the posterior borders of similar hairs on the vertex, but this pair straddles the ocellar triangle in the queen and corresponds to a similar pair in *B. discigera* and *B. militaris*. The pilosity is off-white, contrasting with the deep brownish-red (approaching mahogany) of the integument; appendages medium brownish-red.

*Queen (alate)*, one of eight alates and dealates from type nest series. TL 6.3, HL 1.32, HW 1.09 (CI 83), ML 0.46, greatest diameter of compound eye 0.24, scape L 0.86, WL 1.68, forewing L 4.9 mm.

*Male*, one of three from type nest series. TL 4.9, HL 0.92, HW across eyes 0.88 (CI 96), HW behind compound eyes 0.76, ML 0.25, greatest diameter of eye 0.30, scape L 0.14, WL 1.46, forewing L 3.8 mm.

Head of the short type, not produced behind, and with a narrow flange on cervical border. Rugulae behind eye shorter and weaker than in *B. discigera*. Most of mesanepisternum and upper middle part of mesokatepisternum smooth and shining. Petiole claviform, with node indistinctly set off from anterior peduncle; front of node bordered by a dorsolateral ruga on each side; subpetiolar processes: 1 large anterior tooth, plus 1-4 smaller teeth or lamellae, very inconstant.

---

←

FIG. 2. *Basicros conjugans*, new species. Lateral view of holotype worker. Drawing by Susan Poulakis,  $\times 40$ .

Holotype and a few other workers, queens and males were taken together at Limoncocha, Ecuador, by Dr. Henry R. Hermann, Sept. through Nov. 1964; a separate winged queen was taken at the same locality by Dr. Hermann. The paratype series also includes two workers taken in a rain forest leaf litter berlesate 7 km north of Leticia, Colombia, by S. and J. Peck (B-230) in February 1972.

This species is intermediate between *Aspididris discigera* and *Basiceros manni*, the latter representing the "typical" members of its genus. *B. conjugans* has partially developed ridges framing the posterior vertex in a manner intermediate between *discigera* and *manni*, and the erect clavate hairs on the back of the head are concentrated along the posterior edge in an intermediate kind of pattern. The exact shape of the head, the distribution of the peculiar broadened hairs on the trunk, and particularly their thick clustering on the petiole and postpetiole are sufficient characters to separate *B. conjugans* from all the other species.

#### *Basiceros discigera*

This species is widespread in southeastern Brazil, and I can extend the range northward into Espirito Santo State: Reserva Nova Lombardia, 4 km north of Santa Teresa, 900 m, 24 Feb. 1967 (W. L. Brown, Jr.). The nest was in a small fragment of a rotten log on the floor of wet upland forest, and contained two winged males.

A much greater and more surprising extension of the range is provided by a record from the eastern slope of the Andes in Colombia: Quebrada Susamuko, 23 km NW of Villavicencio, Dept. Meta, 1000 m, two workers in leaf litter berlesate (B-234), S. and J. Peck leg. The male is characterized in the key at the end of the paper.

#### *Basiceros manni*

I took a number of workers of this species in a large fragment of a rotten log found in the middle of a rain forest trail west of the bridge at Rio Toro Amarillo, near Guapiles, Costa Rica. The log fragment contained also workers of *Proceratium goliath*. The record represents only a northern "fill-in" of the range on the Atlantic Plain of Costa Rica; the species is known from Honduras and probably occurs through the forested lowlands of Nicaragua.

#### *Basiceros singularis*

In addition to the records of this species from the Guianas, Trinidad and Amazonas, Brazil, I collected it in the forest at the Fazenda Junqueira Vilela, Mun. Diamantino, northern Mato Grosso State, Brazil, on July 17, 1973. The nest was in a thoroughly rotten log in deep shade, and the headless bodies of three termites were found with the workers, winged queens and males in what appeared to be rude chambers. The adults simulate death for long periods when

disturbed and are exceedingly hard to distinguish by eye. Many are heavily encrusted with a light brownish or whitish material, apparently a hardened secretion. I take it that the material represents the hardened defensive allomones of prey termite species (nasutes?), although it is not altogether impossible that the secretion is produced by the ants themselves. Callow and near-callow workers and winged forms of both sexes in the nest lack the incrustation.

Some workers confined in a glass-topped plaster nest avoided or showed no apparent interest in live larvae of *Tribolium* and workers of *Zootermopsis* termites, though the latter are much larger than the ants and the termites found as apparent prey in the original nest. The ants did feed on crushed housefly pupae, and two eggs that must have been laid by workers in the queenless group developed to half-grown larvae in the six months I maintained the ants alive.

I dissected ten workers to determine how many Malpighian tubules were present. Of these, eight had five long tubules each, and two had four tubules. Evidently the counts of four represent specimens that lost a tubule during dissection, which is difficult because of the thick integument and the small size of the opening at the apex of the first gastric segment. At least some of the tubules are attached to the rectum.

The male of this species is characterized in the key to that sex below. In addition to the characters cited, the sides of the metanotum-propodeum and the dorsal surface of the scutellum are more heavily rugose than in the other two species keyed, and the body size is larger.

#### *Basiceros*—Revised Key to Workers and Queens

1. Posterior half or more of head disc-like, subcircular in outline, the margins forming a strong, continuous or nearly continuous raised crest ..... 2  
 Posterior half of head trapezoidal or subrectangular, not disc-like, the lateral borders of the vertex distinct from the posterior border, and not forming a continuous semicircular crest ..... 3
2. When head is viewed full-face, the arcuate crest or flange around the back of the vertex is medially emarginate and confluent at this point with the median convexity of the vertex (SE Brazil, subandean Colombia) ..... *discigera*  
 Arcuate crest around back of vertex continuous and entire, and separated from the median convexity of the vertex by a broad, uninterrupted sulcus that follows the crest (Trinidad) ..... *militaris*
3. Labrum a shield-shaped piece with rounded free margin, not divided medially, at least on its dorsal (extensor) face ..... 4  
 Labrum narrow, cuneiform, tapered apicad and with a distinct median division or groove ..... 5
4. Head narrow ( $CI < 75$ ) and nearly parallel-sided; clypeus and mandibles with abundant and conspicuous appressed squamiform hairs; petiole with 1-3 ventral processes, and usually at most 1 of these is well-developed and spiniform; base of first gastric sternite with a short but sharp, angulate longitudinal carina (Trinidad to N. Mato Grosso) ..... *singularis*

- Head wider ( $CI > 75$ ) and more triangular; clypeus and mandibles with punctures, but no appressed hairs; petiole with 4-7 ventral processes, usually all or nearly all slender spiniform; base of first gastric sternite without a sharp longitudinal carina (Central America) ..... *manni*
5. Posterior dorsal half of head (vertex) continuously convex except for median sulcus; head wide, worker  $CI > 90$ ; petiole and postpetiole with scanty pilosity, not hiding sculpture; 1 subpetiolar process (SE Brazil) ..... *convexiceps*
- Vertex with raised lateral margins and a median sulcate tumosity;  $CI < 90$ ; petiole and postpetiole covered densely with fat squamiform hairs that conceal the surface beneath; 4-6 subpetiolar processes (W. Amazon Basin, Figs. 1, 2) ..... **conjugans**

### *Basiceros*—Key to Males of Three Species

1. Viewed full-face, head with a broad drawn-out neck longer than space occupied by ocellar triangle; mesokatepisternum opaque, covered by strong interlocking rugae; petiole about  $3\times$  as long as postpetiole (Trinidad to N. Mato Grosso) ..... *singularis*  
(*B. manni* from Central America would probably key out here, though the head and petiole may be somewhat shorter than in *B. singularis*.)
- Viewed full-face, head not produced behind, though with a flange along the cervical margin that is much shorter than the ocellar triangle; mesokatepisternum finely punctate, sometimes with upper part smooth and more or less shining; petiole about twice as long as postpetiole ..... 2
2. Anterior border of clypeus concave in the middle; more than half of mesanepisternum smooth, and even the punctate part strongly shining; upper middle part of mesokatepisternum smooth and shining (W. Amazon Basin) ..... **conjugans**
- Anterior border of clypeus entire; only the anterior half of anepisternum smooth and shining, remainder densely punctate and nearly opaque; mesokatepisternum densely punctate throughout, only weakly shining in upper middle part between punctures (SE Brazil, subandean Colombia) ..... *discigera*  
(*B. militaris* from Trinidad, possibly occurring also on the mainland, and *B. convexiceps* from SE Brazil probably key to couplet 2, but I have seen no male specimens.)

### Literature Cited

- BROWN, W. L., JR. AND KEMPF, W. W. 1960. A world revision of the ant tribe Basicerotini. *Studia Entomol.* (n.s.), **3**: 161-250.
- KUSNEZOV, N. 1962. El ala posterior de las hormigas. *Acta Zool. Lilloana*, **18**: 367-378.
- WEBER, N. A. 1950. New Trinidad Myrmicinae, with a note on *Basiceros* Schulz (Hymenoptera, Formicidae). *Amer. Mus. Novitates*, **1465**: 1-6.

## Myrmicine Trail Pheromones: Specificity, Source and Significance

MURRAY S. BLUM

DEPARTMENT OF ENTOMOLOGY, UNIVERSITY OF GEORGIA, ATHENS, GEORGIA 30602

RECEIVED FOR PUBLICATION DECEMBER 22, 1973

**Abstract:** The poison gland secretion is the source of the trail pheromones in the myrmicine genera *Myrmica*, *Manica*, *Pogonomyrmex*, and *Veromessor*. Transposition studies demonstrate that poison gland products of *Myrmica*, *Manica*, and *Pogonomyrmex* species lack intra- and intergeneric specificity. The unpredictable lack of trail specificity identified with myrmicine venoms is discussed in terms of common trace natural products which may be utilized as trail pheromones by species in unrelated taxa. The persistence of chemical trails is discussed as a function of the foraging strategies employed by myrmicine species.

### INTRODUCTION

The sources of trail pheromones in the Formicidae are quite protean, especially in the large subfamily Myrmicinae. Releasers of trail-following behavior have been localized in the poison gland (Moser and Blum, 1963), Dufour's gland (Wilson, 1959) and metathoracic tibial glands (Fletcher and Brand, 1968) of a wide range of myrmicine species, which clearly emphasizes the polyphyletic origins of trail following in this subfamily. Indeed, with the exception of some ponerine species which generate trails with poison gland secretions (Fletcher, 1971), species in formicid subfamilies other than the Myrmicinae are not known to utilize the above named organs for producing these chemical releasers.

The variability in the glandular sources of trail following in the Myrmicinae is exceeded by the variability in specificity of the products synthesized in these social organs. In some cases constituents in the poison gland secretions release trail following in different species in the same genus (Blum, 1966), but in other cases these secretions may be completely species specific when evaluated among members of one genus (Blum and Ross, 1965). Furthermore, the natural product complex in the venoms of some myrmicines can release strong trail following in species in completely unrelated genera when assayed by an artificial trail technique (Blum and Ross, 1965; Blum and Portocarrero, 1966). On the other hand, it has not been ascertained whether these singular examples of non-specificity reflect the utilization of the same pheromone by unrelated species, or whether different poison gland secretions are enriched with common constituents, some of which may serve as trail pheromones for unrelated species.

---

**Acknowledgments:** I am very grateful to P. B. Kanno, G. L. Ayre, E. O. Wilson, G. Scherba, H. Spangler, and R. R. Snelling for providing many of the species used in this investigation. Special thanks go to P. B. Kanno for providing facilities at the University of North Dakota where some of this research was undertaken. The technical assistance of G. N. Ross is gratefully acknowledged.

TABLE 1. Percentage of *Myrmica* workers responding to artificial trails prepared from poison gland extracts

Source species	Test Species						
	<i>americana</i>	<i>brevinodis</i>	<i>brevispinosa</i>	<i>emeryana</i>	<i>fracticornis</i>	<i>monticola</i>	<i>rubra</i>
<i>americana</i>	90	70	—	65	90	90	90
<i>brevinodis</i>	80	90	—	50	80	85	55
<i>brevispinosa</i>	85	50	90	65	80	55	85
<i>emeryana</i>	90	80	80	95	60	80	60
<i>fracticornis</i>	40	60	—	90	90	75	—
<i>monticola</i>	10	0	—	0	0	15	0
<i>rubra</i>	70	90	—	10	75	0	90

The present investigation was undertaken in order to determine the source and specificity of the trail pheromones of myrmicine species in a wide range of genera. The results again clearly emphasize that these pheromonally-rich secretions have a remarkable lack of intra- or intergeneric specificity.

#### METHODS

Workers of the following myrmicine species were utilized for studies of either the source or specificity of trail pheromones: *Aphaenogaster fulva* Roger, *Myrmica americana* Weber, *M. brevinodis* Emery, *M. brevispinosa* Wheeler, *M. emeryana* Forel, *M. monticola* Wheeler, *M. fracticornis* Emery, *M. rubra* (L.), *Manica bradleyi* (Wheeler), *M. hunteri* (Wheeler), *M. mutica* (Emery), *Pogonomyrmex badius* (Latreille), *P. barbatus* (F. Smith), *Novomessor cockerelli* (E. André), *Veromessor pergandei* (Mayr), *Chelaner antarcticum* (Wheeler), *Pheidole dentata* Mayr, *Crematogaster lineolata* (Say), *Monomorium minimum* (Buckley), *Solenopsis invicta* Buren, and *Trachymyrmex septentrionalis* (McCook).

The presence of trail pheromones was examined by preparing methylene chloride extracts of poison glands, Dufour's glands, and hind guts. Four organs were crushed in 2 ml of solvent and 0.2 ml of this extract was applied to a circular trail 15 cm in diameter. Groups of ten workers were subsequently introduced into the center of the circle and if a worker traveled around the entire circumference after encountering it, a positive response was recorded (Moser and Blum, 1963).

Specificity studies were undertaken by using the same technique. Six replicates, consisting of ten workers each, were employed for each test species.

#### RESULTS

No evidence of trail following could be demonstrated when workers of *Aphaenogaster fulva* and *Novomessor cockerelli* were exposed to circular trails treated with extracts of their own sting-associated glands or hind guts. On the

TABLE 2. Percentage of myrmicine workers responding to artificial trails prepared from poison gland extracts

Source species	Test Species					
	<i>Myrmica americana</i>	<i>Myrmica brevinodis</i>	<i>Manica bradleyi</i>	<i>Manica hunteri</i>	<i>Manica mutica</i>	<i>Pogonomymex badius</i>
<i>A. fulva</i>	—	0	0	—	—	—
<i>Manica bradleyi</i>	—	80	80	—	—	—
<i>M. hunteri</i>	90	—	—	95	—	40
<i>M. mutica</i>	90	—	—	90	65	—
<i>Myrmica americana</i>	90	70	—	—	—	—
<i>M. brevinodis</i>	80	90	—	90	90	70
<i>M. brevispinosa</i>	85	50	—	95	90	—
<i>M. emeryana</i>	90	80	—	95	85	—
<i>M. fracticornis</i>	40	60	—	90	90	—
<i>M. monticola</i>	10	0	—	85	95	—
<i>M. rubra</i>	70	90	65	95	95	0
<i>N. cockerelli</i>	—	0	0	—	—	0
<i>P. badius</i>	95	—	55	90	60	50
<i>P. barbatus</i>	—	90	50	—	—	0
<i>V. pergandei</i>	—	0	0	—	—	—

other hand, workers of *Veromessor pergandei*, *Pogonomymex badius*, *Manica* spp., and six of the seven *Myrmica* spp. readily followed artificial trails generated with extracts of their own poison glands. None of the species responded to extracts of either their Dufour's glands or their hind guts.

The results of the specificity studies are presented in Tables 1 and 2. Table 1 presents the results of intrageneric studies utilizing the seven *Myrmica* spp. Table 2 illustrates the responses of two *Myrmica* spp., three *Manica* spp., and *P. badius* workers to artificial trails treated with poison gland extracts derived from 15 myrmicine species in six genera.

With the exception of *M. monticola*, *Myrmica* spp. were almost equally sensitive to trail extracts of each other's poison glands (Table 1). *M. monticola* workers showed almost no propensity to follow their own poison gland extracts, whereas the other *Myrmica* spp. readily followed trails prepared from glandular extracts of this species. *Myrmica* workers readily followed these artificial trails and often circled them repeatedly. Trails prepared from *M. americana* glandular extracts were strongly active 1 hr after their preparation but were only weakly active after 3 hrs. Males and females of *M. emeryana* followed artificial trails as faithfully as workers of this species.

Poison gland extracts of the three *Manica* spp. did not appear to possess any specificity for the species in this genus (Table 2). The *Manica* spp. also followed artificial trails prepared from *Myrmica* poison glands as effectively

as they did their own, and two *Myrmica* spp. were equally responsive to extracts of *Manica* poison glands. As in the case of the *Myrmica* spp., *Manica* workers exhibited sustained trail following when exposed to these artificial trails. Furthermore, *Myrmica americana* and *M. brevinodis* readily followed poison gland extracts prepared from *Pogonomyrmex badius* and *P. barbatus* workers. Similarly, workers of *Manica bradleyi* exhibited trail following when exposed to trails containing extracts of these two species of *Pogonomyrmex* (Table 2). On the other hand, neither *Myrmica* nor *Manica* workers responded positively when bioassayed with poison gland extracts prepared from *Aphaenogaster fulva*, *Novomessor cockerelli*, and *Veromessor pergandei*.

Workers of *V. pergandei* were somewhat responsive (40 percent) to their own poison gland extracts but they seldom adhered to the circular trail for more than one complete traversal of its circumference. Similarly, workers of *P. badius*, which showed moderate trail-following activity in the presence of their own poison gland extracts as well as those derived from *Manica bradleyi* and *Myrmica brevinodis* (Table 2), exhibited very ephemeral trail following.

Workers of *T. septentrionalis*, *M. minimum*, *C. antarcticum*, *P. dentata*, *S. invicta*, and *C. lineolata* did not react to poison gland extracts of *M. brevinodis*.

#### DISCUSSION

At this juncture, the poison gland appears to be the primary source of odor trail pheromones in the Myrmicinae. The presence of chemical releasers of trail following in the venoms of *Myrmica*, *Manica*, and *Pogonomyrmex* species brings to 12 the number of myrmicine genera in which the trail pheromone has been localized in the poison gland secretion. Furthermore, since pheromonally-rich venoms have been identified in both primitive (*Myrmica*) and highly advanced (*Atta*) myrmicine genera, it seems clear that the utilization of the poison gland as a social organ is widespread in the Myrmicinae. On the other hand, Dufour's gland has been demonstrated to be the source of the trail pheromone in only two myrmicine genera, *Solenopsis* and *Pheidole* (Wilson, 1959, 1963). The utilization of the metathoracic tibial glands to generate chemical trails appears to be limited to the genus *Crematogaster* (Fletcher and Brand, 1968; Leuthold, 1968) and probably reflects an evolutionary specialization correlated with the apparent unsuitability of the gaster to function in trail laying.

Since the poison gland secretions of *Myrmica* and *Manica* species are almost totally lacking in specificity, it would appear that they may be utilizing the same or very similar trail pheromones, which would be consistent with the close relationship of these two myrmicine genera (Creighton, 1950). On the other hand, the genus *Pogonomyrmex* is certainly not closely related to *Myrmica* and *Manica* and the ability of workers in the latter two genera to follow artificial trails prepared from *Pogonomyrmex* poison gland extracts, and vice versa, may simply indicate that these three genera share common natural products in their



venoms. Indeed, other investigations demonstrate that phylogenetic relationships are of little value in predicting the trail specificity of myrmicine poison gland secretions.

The poison gland secretion of the primitive ant *Daceton armigerum* (Latreille), a non-trail-laying myrmicine, releases strong trail following in attine species in three genera (Blum and Portocarrero, 1966). Similarly, the poison gland secretion of *Tetramorium guineense* (F.) is active as a trail pheromone for workers in two attine genera and vice versa. However, it is impossible to generalize about the specificity of the poison gland secretions of *Tetramorium* and the attines, since that of *T. caespitum* (L.) is not followed by workers of *T. guineense* or attine workers (Blum and Ross, 1965). Significantly, in transposition studies with poison gland secretions of *Monomorium* species, it has been established that the venom of one species releases strong trail following in another species but *not* vice versa (Blum, 1966). Thus, *M. minimum* workers will follow artificial trails prepared with *M. pharaonis* venom extracts as well as their own, but workers of *M. pharaonis* will not follow artificial *M. minimum* trails. Presumably, the venom of *M. pharaonis* contains the trail pheromone of *M. minimum*, but the latter species does not produce the trail pheromone of *M. pharaonis* in its poison gland secretion.

The trail pheromones derived from myrmicine venoms are certainly trace constituents which are not identified with the proteinaceous compounds which appear to dominate most of these secretions. The venoms of the *Manica*, *Myrmica*, and *Pogonomyrmex* species examined in this investigation are rich in proteins which are obviously not soluble in the solvent utilized to prepare active trail extracts. Tumlinson et al. (1971) have identified the major trail pheromone in the poison gland secretion of *Atta texana* (Buckley), methyl 4-methylpyrrole-2-carboxylate, as a trace constituent of a proteinaceous venom. Each ant is estimated to contain about 0.6 ng of this compound but four additional fractions are active in releasing trail following (Tumlinson et al., 1972). Possibly, these other trail pheromones may confer a degree of specificity which is unattainable with a single compound. It has also been suggested that the products of the Dufour's gland may be secreted in admixture with the poison gland secretion in order to obtain a more specific trail pheromone. Hölldobler and Wilson (1970) have demonstrated that *Pogonomyrmex badius* workers lay recruitment trails with the poison gland secretion, whereas the Dufour's gland products are utilized to set orientation marks. A combination of these two glandular exudates may produce a trail of much greater species specificity than could be obtained with either secretion alone.

Field studies with *M. brevispinosa* have demonstrated that trails are never laid by a foraging worker that is capable of bringing a food find back to the nest. Similarly, Eidmann (1927) noted that a worker of *M. rubra* did not lay a trail unless it was unable to transport the food to the nest by itself. Sig-

nificantly, *Myrmica* trails appear to be short lived both in the laboratory and in the field. In nature, the persistence of trails laid by myrmicine species varies greatly, which may be correlated with the recruitment strategies of the species as well as the vapor pressures of the trail pheromones. Thus, Ayre (1969) has demonstrated that workers of *M. americana*, after establishing a well-developed trail to a honey solution, quickly switch to topographical landmarks as a means of orienting between this food source and the nest. Since the trail is no longer being reinforced, it rapidly dissipates. Therefore, the relatively volatile trail pheromones which are characteristic of *Myrmica* species may be ideally suited to the foraging strategies employed by species in this genus. On the other hand, it would be selectively advantageous for those myrmicine species that do utilize the same trails daily to secrete trail pheromones which possess a relatively low vapor pressure. Indeed, artificial trails prepared from the poison gland secretion of *Atta texana* are highly active one week after their preparation (Blum et al., 1964). Members of this genus lay some of the most durable trails encountered in the Formicidae.

Among the species of *Myrmica*, *M. monticola* appears to be especially aberrant since it does not readily follow trails prepared from its own poison gland secretion or those of other *Myrmica* species. This species is also unusual because its mandibular gland chemistry is radically different from that of other *Myrmica* species which have been examined (Crewe and Blum, 1970). However, the singularity of *M. monticola* should serve to emphasize the variability in either behavior or natural product chemistry that may be encountered within the species in a genus. Ultimately, *M. monticola* may be demonstrated to be typical of many species which, because they lack some significant generic characters, are especially important as key indicators in the evolution of the genus.

#### Literature Cited

- AYRE, G. L. 1969. Comparative studies on the behavior of three species of ants (Hymenoptera: Formicidae). II. Trail formation and group foraging. *Can. Ent.*, **101**: 118-128.
- BLUM, M. S. 1966. The source and specificity of trail pheromones in *Termitopone*, *Monomorium* and *Huberia* and their relation to those of some other ants. *Proc. Roy. Ent. Soc. Lond. (A)*, **41**: 155-60.
- BLUM, M. S., MOSER, J. C., AND CORDERO, A. D. 1964. Chemical releasers of social behavior. II. Source and specificity of the odor trail substances in four attine genera (Hymenoptera: Formicidae). *Psyche*, **71**: 1-7.
- BLUM, M. S. AND PORTOCARRERO, C. A. 1966. Chemical releasers of social behavior. X. An attine trail substance in the venom of a non-trail laying myrmicine, *Daceton armigerum* (Latreille). *Psyche*, **73**: 150-155.
- BLUM, M. S. AND ROSS, G. N. 1965. Chemical releasers of social behaviour. V. Source, specificity, and properties of the odour trail pheromone of *Tetramorium guineense* (F.). *J. Insect Physiol.*, **11**: 857-868.
- CREIGHTON, W. S. 1950. The ants of North America. *Bull. Mus. Comp. Zool. Harvard*, **104**: 1-585.

- CREWE, R. M. AND BLUM, M. S. 1970. Alarm pheromones in the genus *Myrmica* (Hymenoptera: Formicidae). *Z. Vergl. Physiol.*, **70**: 363-373.
- EIDMANN, H. 1927. Die Sprache der Ameisen. *Rev. Zool. Russe*, **7**: 39-47.
- FLETCHER, D. J. C. 1971. The glandular source and social functions of trail pheromones in two species of ants (*Leptogenys*). *J. Ent. (A)*, **46**: 27-37.
- FLETCHER, D. J. C. AND BRAND, J. M. 1968. Source of the trail pheromone and method of trail laying in the ant *Crematogaster peringueyi*. *J. Insect Physiol.*, **14**: 783-788.
- HÖLLDOBLER, B. AND WILSON, E. O. 1970. Recruitment trails in the harvester ant *Pogonomyrmex badius*. *Psyche*, **77**: 385-399.
- LEUTHOLD, R. H. 1968. A tibial gland scent-trail and trail-laying behavior in the ant *Crematogaster ashmeadi* Mayr. *Psyche*, **75**: 233-248.
- MOSER, J. C. AND BLUM, M. S. 1963. Trail marking substance of the Texas leaf-cutting ant: source and potency. *Science*, **140**: 1228.
- TUMLINSON, J. H., MOSER, J. C., SILVERSTEIN, R. M., BROWNLEE, R. G., AND RUTH, J. M. 1972. A volatile trail pheromone of the leaf-cutting ant *Atta texana*. *J. Insect Physiol.*, **18**: 809-814.
- TUMLINSON, J. H., SILVERSTEIN, R. M., MOSER, J. C., BROWNLEE, R. G., AND RUTH, J. M. 1971. Identification of the trail pheromone of a leaf-cutting ant, *Atta texana*. *Nature*, **234**: 348-349.
- WILSON, E. O. 1959. Source and possible nature of the odor trail of fire ants. *Science*, **129**: 643-644.
- WILSON, E. O. 1963. The soil biology of ants. *Ann. Rev. Ent.*, **8**: 345-368.



a

## JOURNAL of the NEW YORK ENTOMOLOGICAL SOCIETY

The JOURNAL of the NEW YORK ENTOMOLOGICAL SOCIETY is devoted to the advancement and dissemination of knowledge pertaining to insects and their related forms.

SUBSCRIPTIONS are \$8.00 per year, in advance, and should be sent to the New York Entomological Society, the American Museum of Natural History, 79th Street at Central Park West, New York, N. Y. 10024. The Society will not be responsible for lost JOURNALS unless immediately notified of change of address. We do not exchange publications.

Please make all checks, money-orders, or drafts payable to the NEW YORK ENTOMOLOGICAL SOCIETY.

ORDERS and inquiries for back issues and complete sets should be sent to our agent, S-H Service Agency, Inc., 866 Third Ave. New York, N. Y. 10022. Complete files of back issues are in stock.

### INFORMATION FOR AUTHORS

Submit manuscript in duplicate (original and one carbon) to the Editor, New York Entomological Society, Boyce Thompson Institute, Yonkers, N.Y. 10701.

1. GENERAL POLICY. Manuscript submitted must be a report of unpublished research which is not being considered for publication elsewhere. A manuscript accepted and published in the JOURNAL must not be published again in any form without the consent of the New York Entomological Society.

A page charge of \$15 per printed page is assessed except that the charge may be reduced in the case of a member of the Society who cannot obtain institutional or grant funds for publication.

The page charge includes black and white illustrations and tabular material.

2. FORM OF MANUSCRIPT. Text, footnotes and legends must be typewritten, double or triple spaced, with margins of at least 1½ inches on all sides. The editorial style of the JOURNAL essentially follows the *CBE Style Manual* (3rd edition, A.I.B.S., 1972).

Genetic symbols: follow recommendations of Demerec, et al.  
(Genetics **54**: 61, 1969)

Biochemical abbreviations: follow rules of the U.I.P.A.C. -I.U.B.  
(J. Biol. Chem. **241**: 527, 1966)

Enzyme activity: should be expressed in terms of international units.  
(Enzyme Nomenclature. Elsevier Pub. Co., 1965)

Geographical names, authors names and names of plants and animals should be spelled in full.

The JOURNAL reserves the privilege of editing manuscript or of returning it to the author for revision.

3. **ABSTRACT.** Each manuscript must be accompanied by an abstract, typewritten on a separate sheet.

4. **TITLE.** Begin each title with a word useful in indexing and information retrieval (Not "Effect" or "New".)

5. **ILLUSTRATIONS.** Original drawings *should not be submitted*. Glossy prints are desirable—not larger than 8½ by 11 inches and preferably not smaller than 5 by 7 inches. When appropriate, magnification should be indicated by a suitable scale on the photograph.

6. **REPRINTS** (in multiples of 100) may be purchased from the printer by contributors. A table showing the cost of reprints, and an order form, will be sent with the proof.

7. **SUBSCRIPTION** to the JOURNAL is \$8.00 per year, in advance, and should be sent to the New York Entomological Society, The American Museum of Natural History, Central Park West at 79th Street, New York, New York, 10024. The Society will not be responsible for lost JOURNALS unless immediately notified of change of address. We do not exchange publications. Please make all checks, money orders and drafts payable to the NEW YORK ENTOMOLOGICAL SOCIETY.

8. **ORDERS** and inquiries for back issues and complete sets should be sent to our agent: S-H Service Agency, Inc., 866 Third Ave., New York, N.Y. 10022.

595.70673

Ent.

Vol. LXXXII

SEPTEMBER 1974

No. 3

**Journal**  
of the  
**New York**  
**Entomological Society**

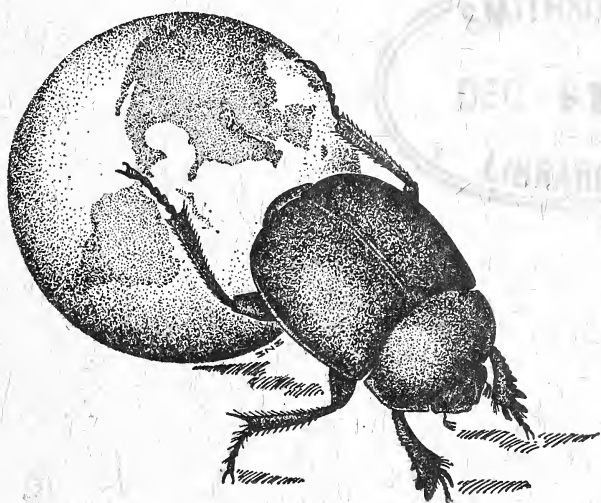

**Devoted to Entomology in General**

**The New York Entomological Society**  
**Incorporating The Brooklyn Entomological Society**  
**Incorporated May 21, 1968**

---

**The New York Entomological Society**  
**Organized June 29, 1892—Incorporated February 25, 1893**  
**Reincorporated February 17, 1943**

---

**The Brooklyn Entomological Society**  
**Founded in 1872—Incorporated in 1885**  
**Reincorporated February 10, 1936**

The meetings of the Society are held on the first and third Tuesday of each month (except June, July, August and September) at 8 P.M., in the AMERICAN MUSEUM OF NATURAL HISTORY, 79th St. & Central Park W., New York, N. Y. 10024.

Annual dues for Active Members, \$4.00; including subscription to the Journal, \$9.00.

Members of the Society will please remit their annual dues, payable in January, to the Treasurer.

---

**Officers for the Year 1974**

- President*, Dr. Daniel J. Sullivan, S.J.  
Fordham University, New York 10458
- Vice-President*, Dr. Peter Moller  
American Museum of Natural History, New York 10024
- Secretary*, Dr. Charles C. Porter  
Fordham University, New York 10458
- Assistant Secretary*, Dr. Louis Trombetta  
Pelham Manor, New York 10803
- Treasurer*, Dr. Winifred B. Trakimas  
State University of New York, Farmingdale, New York 11735
- Assistant Treasurer*, Ms. Joan DeWind  
American Museum of Natural History, New York 10024
- 

**Trustees**

- Class of 1974  
Dr. Lee Herman                      Mr. Edwin Way Teale
- Class of 1975  
Dr. Howard Topoff                      Dr. Pedro Wygodzinsky
- 

Mailed November 29, 1974

The Journal of the New York Entomological Society is published quarterly for the Society by Allen Press Inc., 1041 New Hampshire, Lawrence, Kansas 66044. Second class postage paid at New Brunswick, New Jersey and at additional mailing office.

Known office of publication: Waksman Institute of Microbiology, New Brunswick, New Jersey 08903.



# Journal of the New York Entomological Society

VOLUME LXXXII

SEPTEMBER 1974

No. 3

## EDITORIAL BOARD

*Editor* DR. KARL MARAMOROSCH  
Waksman Institute of Microbiology  
Rutgers University  
New Brunswick, New Jersey 08903

*Associate Editors* DR. LAWRENCE E. LIMPEL  
HELEN MCCARTHY

Publication Committee

Dr. Kumar Krishna

Dr. Ayodha P. Gupta

Dr. James Forbes, Chairman

## CONTENTS

<b>The Anthomyiidae and Muscidae of the Great Smoky Mountains and Mt. Mitchell, North Carolina (Diptera)</b> .....	H. C. Huckett	150
<b>Notes on the Life Cycle and Natural History of Butterflies of El Salvador. V. A. <i>Pyrrhogyra hypsenor</i> (Nymphalidae-Catonephelinae)</b> .....	Alberto Muysshondt	163
<b><i>Tenuicoris myrmeforme</i>: A New Genus and Species of Myodochini (Hemiptera: Lygaeidae)</b> .....	James A. Slater and Jane E. Harrington	173
<b>A New Genus and Two New Species of <i>Achipteriidae</i> from New York State (Acari: Cryptostigmata: Oribatei)</b> .....	F. Reese Nevin	177
<b>Two New Tabanidae from Southeastern United States (Diptera)</b> .....	L. L. Pechuman	183
<b>The Distribution of Brood Ten of the Periodical Cicadas in New Jersey in 1970</b> .....	John B. Schmitt	189
<b>Terrestrial Mites of New York (Acarina: Prostigmata), I—<i>Tarsocheylidae</i>, <i>Paratydeidae</i>, and <i>Pseudocheylidae</i></b> .....	Mercedes D. Delfinado and Edward W. Baker	202
<b>Book Reviews</b> .....	188, 201, 212,	213
<b>Announcement</b> .....		211
<b>Proceedings of the New York Entomological Society</b> .....		214
<b>New York Entomological Society Guest Speakers, 1974/1975</b> .....		219
<b>XV International Congress of Entomology</b> .....		220

## The Anthomyiidae and Muscidae of the Great Smoky Mountains and Mt. Mitchell, North Carolina (Diptera)

H. C. HUCKETT

LONG ISLAND VEGETABLE RESEARCH FARM, CORNELL UNIVERSITY  
RIVERHEAD, NEW YORK 11901

RECEIVED FOR PUBLICATION SEPTEMBER 25, 1973

**Abstract:** A preliminary listing is presented of the anthomyiid and muscid flies occurring in the Great Smoky Mountains National Park and in the vicinity of Mt. Mitchell. The data are based on collections made in the vicinities of Clingmans Dome and Mt. Mitchell in 1957 by members of the Entomology Research Institute at Ottawa, by the author when visiting Mt. Le Conte in 1958 and 1959 and Mt. Mitchell in 1960 and 1961 and also on an examination of additional material from these regions. Fifty-seven species of Anthomyiidae and one hundred and five species of Muscidae were recognized, of which fourteen and twenty-eight respectively were regarded as occurring chiefly within the eastern and midwestern areas of the United States and transition zones of the Canadian provinces; five anthomyiid and eight muscid species as boreal in habitat; two species of Anthomyiidae, namely, *Chirosia delicata* (Huckett), *Pegomya atlantis* Huckett, and one species of Muscidae, *Phaonia aberrans* Malloch, as restricted in their occurrence to the middle Atlantic states.

### INTRODUCTION

The following work was undertaken as a means of bringing together the little known records of anthomyiid and muscid flies captured within the boundaries of the Great Smoky Mountains National Park and in the region of Mt. Mitchell, and as a contribution in a series of studies toward a wider knowledge of their presence and distribution on the higher slopes of the Appalachian Range.<sup>1</sup>

The Great Smoky Mountains National Park lies within the southern limits of the Appalachian Range, extending from slightly west of longitude 83°W to longitude 84°W, and varying irregularly in width between the lower parallels of latitude 35°N. It is approximately 54 miles long, and at its widest point, 19 miles. The park extends over nearly 500,000 acres, or about 780 square miles, and contains 16 forested peaks over 6,000 feet in altitude. To the east, about 45 miles, lies Mt. Mitchell in the Black Mountains, where the terrain was sadly denuded of timber during the earlier decades of the century.

### PREVIOUS RECORDS

The present literature records of anthomyiid and muscid flies are few, scattered, and sometimes of an ambiguous nature. Brimley (1938) in his list of the insects of North Carolina refers to four species of Anthomyiidae from

<sup>1</sup>Huckett, H. C. 1972. The Anthomyiidae and Muscidae of Mt. Katahdin, Maine (Diptera). Journal New York Entomological Society, **80** (4): 216-233, 1 map.

the "mountain region," and four species of Muscidae as "Statewide." Later, under North Carolina, Wray (1967) in the third supplement to the above work, added 19 nominal species to the list of Anthomyiidae and 22 to the Muscidae, adopting the citations given for "N. C." by Stone et al. (1965) in "A Catalog of the Diptera of America North of Mexico."

Whittaker (1952), in a study of the summer foliage insect communities in the park, recorded the presence of 27 nominal species of Muscidae *sens. lat.* The labels on these specimens bear the name Gatlinburg, a town outside the boundaries of the park and contain much detailed information without mentioning the locality as given on maps of the park. Without actual reference to his paper it would be difficult to determine where specimens were collected. I have, therefore, with the cooperation of Dr. Whittaker, attempted to convert the topographical data on these labels to names of localities and trails indicated on official maps of the park.

Chillcott (1961) recorded 10 species of Fanniinae from locations in the park, although unwittingly the name Gatlinburg is cited in several instances. Three species are recorded from Mt. Mitchell.

#### MATERIALS

The survey is based on the following material that I have had the privilege of examining: the collections of Iowa State University, containing specimens taken by Dr. R. H. Whittaker in June and July 1947, and by the late Professor J. L. Laffoon in the same months of 1958, to whom I am greatly indebted for the extended loan of this and additional pertinent contributions from neighboring counties in the Piedmont region; specimens from the collections of the late Dr. R. R. Dreisbach, taken on a visit to the park in June 1946, and in August 1947, in company with Mr. D. S. Bullock; the small collection of anthomyiid and muscid flies preserved in the museum at park headquarters, containing the only records on hand of specimens from Mt. Buckley, taken by Dr. K. D. Snyder on July 21 and August 2, 1957, a loan made available through the courtesy of Mr. Arthur Stupka, Park Naturalist. Also there are my own collections during a brief visit to the park in May 1957 and to Mt. Le Conte during the latter half of May 1958 and 1959. I stayed at the lodge, situated at an altitude of 6,200 feet, and thus was able to work conveniently on the various trails traversing the extensive slopes of the mountain mass (see Map 1). From mid May to early June 1960 and 1961, I visited Mt. Mitchell, basing my operations from the inn at Stepps Gap, at an altitude of about 6,000 feet (see Map 2).

I have recently received a large assemblage of specimens from the Canada National Collection collected in the park during the summer of 1957 by various members of the Entomology Research Institute at Ottawa. The collections were made on numerous occasions from May to August, the bulk of the specimens

being taken by Dr. J. R. Vockeroth and the late Dr. J. G. Chillcott. The latter extended his visit to include a brief trip in mid August to Mt. Mitchell and Roan Mountain, 6,200 ft., in North Carolina, and to a return to Clingmans Dome on June 3, 1962, and May 22, 1965.

The collections in the park were chiefly made at the higher altitudes, between Indian Gap at 5,100 feet to the summit of Clingmans Dome at 6,642 feet. A few captures were made at lower levels from 2,000 to 2,100 feet at Greenbrier Cove, Mingus Creek and Cherokee. To all these collectors I am deeply indebted, and in particular to Dr. J. R. Vockeroth for his cooperation in having the specimens assembled and thus made available for study. Their names may be found among the list of collectors at the end of this article.

#### ABBREVIATIONS

In order to save space, the various locations in the Great Smoky Mountains National Park from which specimens were obtained have been assigned a letter, such as A, B, or C, and also for each species the numbers of specimens from all localities have been combined. Similarly, for each species the numbers of specimens captured on the various trails and logging roads in the Mt. Mitchell region have been combined and the number of locations reduced to the naming of three main collecting areas, as Mt. Mitchell, Clingman's Peak, Mitchell Falls, Roan Mountain in Mitchell County.

- A. Park Headquarters, 1,500 ft.
- B. Mt. Le Conte, upper trails, see map
- C. Mt. Le Conte, lower trails<sup>2</sup>
- D. Greenbrier Cove and Porters Creek, 2,000-3,000 ft.
- E. Ramsey Cascade trail
- F. Brushy Mountain, 4,911 ft. and Mountain trail
- G. The Chimneys and camp
- H. Newfound Gap, 5,048 ft.
- I. Indian Gap to Clingmans Dome, 5,200 to 6,600 ft.
- J. Indian Gap, 5,200 ft.
- K. Mt. Collins, 5,900 ft. and Collins Gap, 5,700 ft.
- L. Clingmans Dome, upper trail, 6,300 to 6,642 ft.
- M. Forney Ridge trail to Andrews Bald
- N. Mt. Buckley, summit, 6,100 ft.
- O. Sailers Bald, summit, 5,620 ft.
- P. Narrows, nr. Sailers Bald, 5,400 ft.
- Q. Elkmont
- R. Fighting Creek
- S. Cades Cove
- T. Spence Field trail camp, nr. Thunderhead Mtn.
- U. Mingus Creek and Cherokee, 2,000 to 2,100 ft.
- V. Smokemont
- W. Mt. Sterling, summit, 5,842 ft.

<sup>2</sup> Bullhead, Rainbow Falls, Cherokee Orchard, Trilium Gap, Alum Cave.

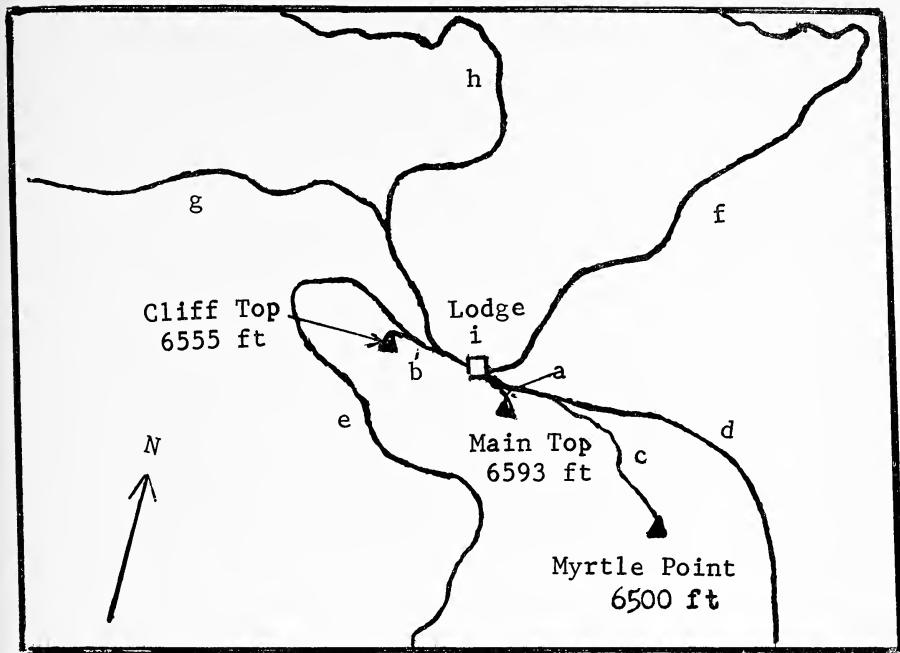

SKETCH MAP 1. The upper trails of Mt. Le Conte from the Lodge: a. Main Top, b. Cliff Top, c. Myrtle Point, d. Boulevard, e. Alum Cave, f. Trilium Gap, g. Bullhead, h. Cherokee Orchard, i. Lodge, stables, and campground. Distances from lodge to Cliff Top are one-third mile; to Main Top, one-quarter mile; to Myrtle Point, two-thirds mile (by letter, Arthur Stupka, Park Naturalist).

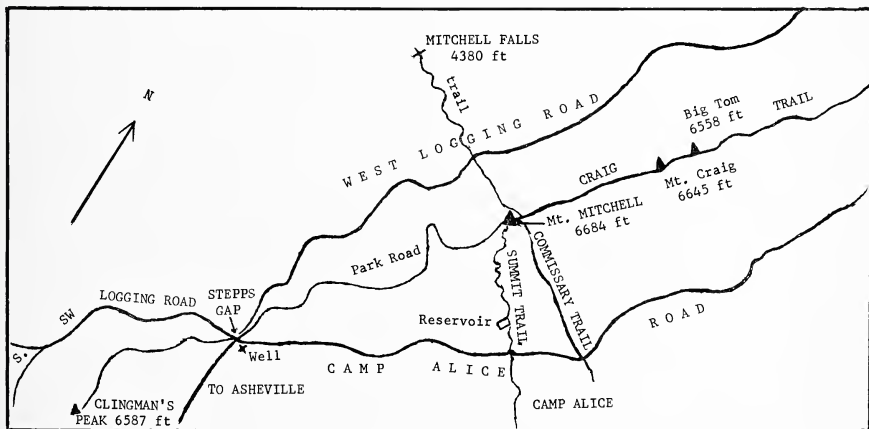

SKETCH MAP 2. Trails and logging roads at Mt. Mitchell and Clingman's Peak. Distances by trail from summit of Mt. Mitchell to Steps Gap are  $2\frac{1}{4}$  miles; to Mt. Craig,  $1\frac{1}{4}$  miles; to Mitchell Falls, 2 miles; to Camp Alice, 2 miles (North Carolina Department of Natural and Economic Resources); to Clingman's Peak,  $3\frac{3}{4}$  miles.

## LIST OF SPECIES AND LOCALITY RECORDS

Family Anthomyiidae *sens. str.**Chirosia delicata* (Huckett)

94 ♂, 309 ♀. B, K, L. Mt. Mitchell, 73 ♂, 31 ♀; Clingman's Peak, 61 ♂, 8 ♀.

*Chirosia hystrix* (Brüschke)

2 ♀. L, P.

*Chirosia pusillans* (Huckett) N. COMB.

2 ♂, 8 ♀. P.

*Chirosia stratifrons* (Huckett)

21 ♂, 13 ♀. Ba, d, g, I, J, K, L, M. Mt. Mitchell, 1 ♂.

*Hylemya alcathoe* (Walker)

38 ♂, 28 ♀. A, Bb, d, g, C, D, F, G, I-L, T. Mt. Mitchell, 1 ♂, 15 ♀; Roan Mtn. 1 ♀.

*Hylemya latifrons* (Schnabl)

1 ♂, 1 ♀. Bg, L. Mt. Mitchell, 1 ♀.

*Hylemyza partita* (Meigen)

1 ♂. Clingman's Peak.

*Delia antiqua* (Meigen)

1 ♀. Mt. Mitchell.

*Delia arnolitra* (Huckett)

5 ♂, 26 ♀. Ba-i, I, L. Mt. Mitchell, 20 ♂, 34 ♀; Clingman's Peak, 12 ♂, 14 ♀.

*Delia echinata* (Séguy)

1 ♂, 2 ♀. Ba, e, g. Mt. Mitchell, 10 ♂, 3 ♀; Clingman's Peak, 3 ♂, 1 ♀.

*Delia inconspicua* (Huckett)

2 ♂. Mitchell Falls.

*Delia laevis* (Stein)

1 ♂. A.

*Delia platura* (Meigen)

532 ♂, 365 ♀. A, Ba-i, C, F, G, I-P, T. Mt. Mitchell, 116 ♂, 108 ♀; Clingman's Peak, 44 ♂, 26 ♀; Mitchell Falls, 1 ♂; Roan Mtn. 2 ♀.

*Delia winnemana* (Malloch)

3 ♂. Bg.

*Botanophila inornata* (Stein)

8 ♂, 2 ♀. A, Bd, g, J, O, P. Mt. Mitchell, 2 ♂.

*Paregle cinerella* (Fallén)

1 ♂, 15 ♀. F, J, N, O. Mt. Mitchell, 1 ♀; Roan Mtn. 1 ♀.

*Paregle radicum* (Linnaeus)

2 ♀. L. Roan Mtn. 1 ♂.

*Lasiomma abietis* (Huckett)

1 ♂. Mitchell Falls.

*Lasiomma anthracinum* (Czerny)

8 ♂, 1 ♀. Bc, g. Mt. Mitchell, 1 ♂.

*Lasiomma octoguttatum* (Zetterstedt)

12 ♂, 29 ♀. Bb, c, f, g, h, I, L. Mt. Mitchell, 3 ♂; Roan Mtn. 1 ♂.

*Pegohylemyia fugax* (Meigen)

4 ♂, 6 ♀. Bb, d, f, g, L. Mt. Mitchell, 1 ♂, 1 ♀.

*Pegohylemyia trivittata* (Stein)

1 ♂, 1 ♀. C, J.

*Acrostilpna atricauda* (Zetterstedt)

5 ♂, 2 ♀. F, J, K.

*Acrostilpna latipennis* (Zetterstedt)

1 ♂. J.

*Alliopsis* species

3 ♀. Mt. Mitchell.

*Eremomyia pilimana* (Ringdahl)

16 ♂, 11 ♀. A, B, C. Mt. Mitchell, 3 ♂, 16 ♀; Clingman's Peak, 1 ♂, 5 ♀; Mitchell Falls, 9 ♂.

*Nupedia infirma* (Meigen)

1 ♂. J. Roan Mtn. 1 ♂, 1 ♀.

*Nupedia nigroscutellata* (Stein)

1 ♀. A. Mt. Mitchell, 1 ♂, 3 ♀; Clingman's Peak, 2 ♀.

*Pseudonupedia intersecta* (Meigen)

1 ♂, 3 ♀. Mt. Mitchell.

*Pegomya atlanis* Hockett

1 ♂. Clingman's Peak.

*Pegomya bicolor* (Wiedemann)

2 ♀. Bg, L.

*Pegomya carduorum* Hockett

1 ♀. Bb.

*Pegomya connexa* Stein

3 ♂, 4 ♀. A, Bg, D, L. Mt. Mitchell, 7 ♂, 1 ♀.

*Pegomya finitima* Stein

3 ♀. F.

*Pegomya flavifrons* (Walker)

1 ♀. J. Roan Mtn. 1 ♂.

*Pegomya frigida* (Zetterstedt)

1 ♂. P.

*Pegomya geniculata* (Bouché)

3 ♂, 5 ♀. A, C, D, J, L, U.

*Pegomya hyoscyami* (Panzer) var.

1 ♀. Bd.

*Pegomya incisiva* Stein

1 ♂, 1 ♀. J, U.

*Pegomya juvenilis* (Stein)

2 ♂, 3 ♀. A, Bg, D, K.

*Pegomya lipsia* (Walker)

6 ♂, 6 ♀. A, C, D, G, Q. Mt. Mitchell, 3 ♀; Clingman's Peak, 1 ♂.

*Pegomya mallochi* Hockett

2 ♀. J.

*Pegomya palposa* (Stein)

2 ♂, 4 ♀. Mt. Mitchell.

*Pegomya rubivora* (Coquillett)

1 ♂. Mt. Mitchell.

*Pegomya tabida* (Meigen) = *Anthomyza gilva* Zetterstedt (Hennig, 1973: 643)

1 ♂, 1 ♀. C, P.

*Pegomya univittata* (von Roser)

4 ♂. F, P, R.

*Pegomya winthemi* (Meigen)

1 ♂, 2 ♀. D, F.

*Emmesomyia apicalis* Malloch<sup>3</sup>

1 ♂, 6 ♀. A, Bb, d, g, i. Mt. Mitchell, 3 ♀; Clingman's Peak, 1 ♀.

*Emmesomyia socialis* (Stein)

2 ♀. A, K.

*Hydrophoria divisa* (Meigen)

1 ♂. Clingman's Peak.

*Hydrophoria subpellucida* Malloch

1 ♂. D.

*Hydrophoria uniformis* Malloch

27 ♂. A, Ba-c, g, i, J. Mt. Mitchell, 154 ♂; Clingman's Peak, 109 ♂; Mitchell Falls, 13 ♂.

*Anthomyia pluvialis* (Linnaeus)

1 ♀. D.

*Leucophora johnsoni* (Stein)

1 ♂, 2 ♀. Bf, F, J.

*Leucophora marylandica* (Malloch)

1 ♀. Clingman's Peak.

*Paraprosalpia silvestris* (Fallén)

4 ♀. J. Mt. Mitchell, 6 ♂, 2 ♀; Clingman's Peak, 1 ♂.

*Eustalomyia vittipes* (Zetterstedt)

1 ♂, 1 ♀. C, F.

## Family Muscidae

*Schoenomyza chrysostoma* Loew

1 ♂, 1 ♀. L.

*Schoenomyza dorsalis* Loew

36 ♂, 47 ♀. B, F, I, J, L, N, O, P. Mt. Mitchell, 1 ♂.

*Coenosia tigrina* (Fabricius)

1 ♀. Mt. Mitchell.

*Limosia atrata* (Walker)

217 ♂, 379 ♀. A-D, F, I, J-P, T, U. Mt. Mitchell, 40 ♂, 46 ♀; Clingman's Peak, 2 ♂, 7 ♀.

*Limosia conforma* Hockett

1 ♂, 2 ♀. C, K.

*Limosia errans* (Malloch)

5 ♂, 7 ♀. I, J, L. Mt. Mitchell, 1 ♀.

*Limosia frisoni* (Malloch)

4 ♀. J, L.

*Limosia lata* (Walker)

4 ♂, 8 ♀. Ba-d, g, F, O, P. Mt. Mitchell, 4 ♂, 2 ♀; Clingman's Peak, 1 ♂.

*Limosia nivea* (Loew)

10 ♂, 24 ♀. A, Bb-g, C, I, J, K, L. Mt. Mitchell, 1 ♂, 11 ♀.

*Hoplogaster intacta* (Walker)

1 ♂, 5 ♀. C, D, P.

<sup>3</sup>Steyskal (1973) has indicated that the two taxa *Emmesomyia apicalis* Malloch and *E. socialis* (Stein) are but color variants of the same species. In *apicalis* the palpi are brown, and in *socialis* yellow, and in the latter I find that the arisal hairs are slightly longer. Tentatively I list the two forms separately.



*Hoplogaster nigratarsis* Stein

25 ♂, 56 ♀. A, C, D, F, I, J, K, L, O, P, T, U.

*Neodexiopsis basalís* (Stein)

1 ♂, 2 ♀. Bb, C, L.

*Neodexiopsis calopyga* (Loew)

6 ♂, 29 ♀. A, Bb, d, g-i, C, D, F, I, J, L. Mt. Mitchell, 1 ♂, 10 ♀; Roan Mtn. 1 ♀.

*Neodexiopsis major* (Malloch)

1 ♂, 7 ♀. Bb, d, D, J, K, L, P. Mt. Mitchell, 1 ♀.

*Neodexiopsis occidentis* (Stein) = *Coenosia rufitibia* Stein (Huckett, 1972: 170)

2 ♂, 14 ♀. Bb, d, g, D, H, J, L. Mt. Mitchell, 1 ♂, 4 ♀.

*Neodexiopsis ovata* (Stein)

5 ♂, 16 ♀. A, Bc, g, C, F, H, I, J, L, O. Mt. Mitchell, 2 ♂, 1 ♀.

*Macrorchis ausoba* (Walker)

6 ♂, 7 ♀. Mt. Mitchell, 2 ♂. Clingman's Peak.

*Lispocephala alma* (Meigen)

2 ♂, 7 ♀. Bf, g, I, J, K. Mt. Mitchell, 1 ♀; Roan Mtn. 1 ♀.

*Lispocephala erythrocerá* (Robineau-Desvoidy)

1 ♂. Mt. Mitchell.

*Pentacricia aldrichii* Stein

1 ♂. Bi. Mt. Mitchell, 2 ♂; Clingman's Peak, 1 ♀.

*Lispe albitarsis* Stein

7 ♂, 10 ♀. A, Bb-e, g, i, L. Mt. Mitchell, 11 ♂, 19 ♀; Clingman's Peak, 4 ♂, 6 ♀; Mitchell Falls, 1 ♂, 2 ♀.

*Lispe sociabilis* Loew

1 ♀. Ba. Mt. Mitchell, 3 ♂, 2 ♀.

*Lispoidea aequifrons* (Stein)

2 ♂, 1 ♀. Mt. Mitchell.

*Spilogona caroli* (Malloch)

1 ♂, 7 ♀. C, L. Mt. Mitchell, 2 ♂.

*Spilogona parvimaçulata* (Stein)

6 ♂, 3 ♀. C, F, J.

*Spilogona torreyae* (Johannsen)

2 ♀. A.

*Limnophora discreta* Stein

2 ♀. Mt. Mitchell.

*Limnophora narona* (Walker)

3 ♂, 2 ♀. Bb, g. Mt. Mitchell, 1 ♂, 4 ♀; Clingman's Peak, 2 ♂, 1 ♀.

*Pseudolimnophora nigripes* (Robineau-Desvoidy)

1 ♀. H.

*Gymnodia arcuata* (Stein)

1 ♂, 29 ♀. Ba, b, d, g, C, D, J, U. Clingman's Peak, 1 ♀; Mitchell Falls, 1 ♂.

*Helina johnsoni* Malloch

2 ♀. A, L.

*Helina obscurinervis* (Stein)

2 ♂. F, J.

*Helina rufitibia* (Stein)

2 ♂, 2 ♀. C, I, P. Mt. Mitchell, 2 ♂, 1 ♀.

*Helina tröene* (Walker)

1 ♂. A.

*Quadrularia laetifica* (Robineau-Desvoidy)

22 ♀. I, J, K, L, N. Mt. Mitchell, 4 ♂, 2 ♀.

*Hebecnema affinis* Malloch

62 ♂, 35 ♀. Ba, b, d, f, g. Mt. Mitchell, 1 ♀.

*Hebecnema umbratica* (Meigen)

2 ♀. C, J. Mt. Mitchell, 1 ♀.

*Hebecnema vespertina* (Fallén)

8 ♀. A, I, J, L, U. Mt. Mitchell, 2 ♀; Clingman's Peak, 1 ♂, 2 ♀.

*Mydaea brevipilosa* Malloch

1 ♂, 1 ♀. Bg, C.

*Mydaea discimana* Malloch

1 ♀. L.

*Mydaea flavicornis* Coquillett

1 ♀. Bd.

*Mydaea neglecta* Malloch

15 ♀. Bb, g, D, F, J, L. Mt. Mitchell, 2 ♀.

*Mydaea neobscura* Snyder

6 ♀. A, Bg, D.

*Mydaea nubila* Stein

9 ♂, 3 ♀. A, I, J.

*Mydaea obscurella* Malloch

1 ♂, 5 ♀. Bg, C, F, T. Clingman's Peak, 1 ♀.

*Mydaea occidentalis* Malloch

1 ♂. C.

*Mydaea palpalis* Stein

15 ♂, 3 ♀. Bb, d, f, g.

*Mydaea urbana* (Meigen)

1 ♀. Mt. Mitchell.

*Xenomydaea otiosa* (Stein)

1 ♀. J. Roan Mtn. 1 ♂.

*Myospila mediatubunda* (Fabricius)

46 ♂, 115 ♀. Ba-d, g, i, D, J, L. Mt. Mitchell, 25 ♂, 25 ♀; Clingman's Peak, 7 ♀; Mitchell Falls, 2 ♀.

*Fannia americana* Malloch

3 ♂, 2 ♀. A, Bg, D.

*Fannia bifimbriata* Collin

1 ♂, 12 ♀. Bb, d, f, i, C, P.

*Fannia brevipalpis* Chillcott

1 ♂. A. Mitchell Falls, 3 ♂.

*Fannia brooksi* Chillcott

8 ♀. C, D, J.

*Fannia canicularis* (Linnaeus)

1 ♂, 1 ♀. Bb, D.

*Fannia ceringogaster* Chillcott

1 ♀. L.

*Fannia depressa* (Stein)

2 ♀. M, Q.

*Fannia fuscula* (Fallén)

8 ♂, 8 ♀. C, D, E, F, J, Q.

- Fannia immaculata* Malloch  
2 ♂, 1 ♀. I, J, L.
- Fannia manicata* (Meigen)  
1 ♀. Clingman's Peak.
- Fannia melanura* Chillcott  
1 ♀. J.
- Fannia metallipennis* (Zetterstedt)  
2 ♀. M, O. Mt. Mitchell, 1 ♂.
- Fannia pellucida* (Stein)  
1 ♀. Mt. Mitchell.
- Fannia penepretiosa* Chillcott  
1 ♀. C.
- Fannia postica* (Stein)  
4 ♀. D, L. Mt. Mitchell, 2 ♀.
- Fannia rondanii* (Strobl)  
2 ♂, 8 ♀. C, I, K, L, P. Mt. Mitchell, 2 ♀; Roan Mtn. 1 ♀.
- Fannia scalaris* (Fabricius)  
1 ♀. Mt. Mitchell, 1 ♀. Clingman's Peak.
- Fannia serena* (Fallén)  
1 ♂, 5 ♀. Bd, g. Mt. Mitchell, 4 ♂, 3 ♀.
- Fannia sociella* (Zetterstedt)  
2 ♂, 11 ♀. Bg, C, D, I, K, L, P. Mt. Mitchell, 1 ♂.
- Fannia spathiophora* Malloch  
7 ♀. Bf, g, D, J, L.
- Fannia unguolata* Chillcott  
2 ♀. A.
- Coelomyia subpellucens* (Zetterstedt)  
8 ♂, 2 ♀. Ba, f, g, L, M. Mt. Mitchell, 3 ♂; Clingman's Peak, 1 ♂.
- Azelia cilipes* (Haliday)  
2 ♂, 11 ♀. Bb, C, D, F, I, L. Mt. Mitchell, 1 ♀.
- Azelia gibbera* (Meigen)  
1 ♂. Q.
- Hydrotaea houghi* Malloch  
15 ♀. A, Ba, b, d, g, C. Mt. Mitchell, 2 ♀; Clingman's Peak, 6 ♀.
- Hydrotaea militaris* (Meigen)  
4 ♀. Bb, g. Mt. Mitchell, 6 ♀; Mitchell Falls, 1 ♂, 2 ♀; Roan Mtn. 4 ♂, 1 ♀.
- Hydrotaea occulta* (Meigen)  
1 ♀. Bg.
- Hydrotaea pilitibia* Stein  
9 ♀. A, F, J, K, L, T.
- Hydroteae spinifemorata* Hockett  
2 ♀. K, P.
- Lasiops innocuus* (Zetterstedt)  
1 ♂. L.
- Lasiops rufisquama* (Schnabl)  
2 ♂, 3 ♀. Bg; K, L.
- Dialyta flavitibia* Johannsen  
8 ♂, 7 ♀. Ba, g, J, K, L.
- Dendrophaonia marguerita* Snyder  
2 ♀. N.

- Dendrophaonia querceti* (Bouché)  
1 ♀. Mt. Mitchell.
- Dendrophaonia scabra* (Giglio-Tos)  
1 ♂. C.
- Phaonia aberrans* Malloch  
169 ♂, 12 ♀. Ba, b, d-g, i, L. Mt. Mitchell, 38 ♂, 4 ♀; Clingman's Peak, 14 ♂.
- Phaonia apicata* Johannsen  
16 ♂, 46 ♀. A, Bb-e, g, h, C, D, G, I-L. Mt. Mitchell, 7 ♀; Mitchell Falls, 4 ♂, 5 ♀.
- Phaonia apicata* var. *solitaria* Stein  
4 ♂. Mitchell Falls.
- Phaonia atlanis* Malloch  
1 ♀. A. Mt. Mitchell, 2 ♂, 1 ♀.
- Phaonia bysia* (Walker)  
4 ♂, 9 ♀. A, Ba, g, C, D, J, K, L, P, U. Mitchell Falls, 1 ♀.
- Phaonia cauta* Hockett  
12 ♂, 53 ♀. Bb, d, f, g, i, C, D, K, L, P. Mt. Mitchell, 1 ♀; Clingman's Peak, 1 ♀.
- Phaonia curvipes* (Stein)  
1 ♂, 31 ♀. Bb, d, f, g.
- Phaonia deleta* (Stein)  
1 ♀. A.
- Phaonia errans luteva* (Walker)  
6 ♀. I, J. Roan Mtn. 1 ♀.
- Phaonia fuscana* Hockett  
5 ♀. C, E, I, K, L. Mt. Mitchell, 1 ♂.
- Phaonia laticornis* Malloch  
1 ♀. A.
- Phaonia serva* (Meigen)  
5 ♂, 16 ♀. Bg, C, H, I, J, K. Mt. Mitchell, 1 ♀.
- Muscina assimilis* (Fallén)  
1 ♂, 6 ♀. Bb, g, D, L. Mt. Mitchell, 2 ♀.
- Muscina stabulans* (Fallén)  
1 ♂, 7 ♀. Bb, g, i.
- Pararicia pascuorum* (Meigen)  
1 ♂. Ba.
- Graphomya maculata* (Scopoli)  
1 ♀. Clingman's Peak.
- Mesembrina latreillii* Robineau-Desvoidy  
1 ♂, 91 ♀. A-D, H-L, N, P, W. Mt. Mitchell, 2 ♀; Clingman's Peak, 2 ♀.
- Morellia micans* (Macquart)  
1 ♂, 16 ♀. A, Ba, d, g, K, S, T.
- Pyrellia cyanicolor* Zetterstedt  
4 ♂, 17 ♀. A, Bf, g, D, I, L, N, U. Mt. Mitchell, 1 ♂, 4 ♀; Roan Mtn. 2 ♂, 3 ♀.
- Orthellia caesarion* (Meigen)  
1 ♀. L. Mt. Mitchell, 1 ♂, 2 ♀; Clingman's Peak, 2 ♂, 1 ♀.
- Stomoxys calcitrans* (Linnaeus)  
3 ♂, 9 ♀. A, Bb, c, f, g, i, G, J, V.

## RESULTS OF THE SURVEY

A total of 57 species of Anthomyiidae *sens. str.* and 105 species of Muscidae were collected. Fourteen anthomyiid and 28 muscid species were regarded as chiefly restricted in their

distribution to eastern and midwestern areas of the United States and the transition zones of the Canadian provinces, namely, Family Anthomyiidae: *Chirosia hystrix* (Brischke), *C. pusillans* (Huckett), *C. stratifrons* (Huckett), *Delia arnolitra* (Huckett), *D. laevis* (Stein), *D. winnemana* (Malloch), *Eremomyia pilimana* (Ringdahl), *Pegomya juvenilis* (Stein), *P. lipsia* (Walker), *P. mallochi* Huckett, *P. palposa* (Stein), *Emmesomyia apicalis* Malloch, *E. socialis* (Stein), *Leucophora johnsoni* (Stein). Family Muscidae: *Limosia errans* Malloch, *L. nivea* (Loew), *Hoplogaster intacta* (Walker), *H. nigratarsis* Stein, *Neodexiopsis basalis* (Stein), *N. calopyga* (Loew), *N. major* (Malloch), *N. occidentis* (Stein), *Lispe albitarsis* Stein, *L. sociabilis* Loew, *Spilogona caroli* (Malloch), *S. parvimaclata* (Stein), *S. torreyae* (Johannsen), *Helina johnsoni* Malloch, *H. obscurinervis* (Stein), *Mydaea flavicornis* Coquillett, *M. neglecta* Malloch, *M. neobscura* Snyder, *Fannia americana* Malloch, *F. brooksi* Chillcott, *F. ceringogaster* Chillcott, *Dialyta flavitibia* Johannsen, *Dendrophaonia marguerita* Snyder, *Phaonia apicata* Johannsen, *P. atlantis* Malloch, *P. cauta* Huckett, *P. curvipes* (Stein), *P. laticornis* Malloch.

Five anthomyiid and eight muscid species were regarded as boreal in habitat and as having reached their southern limits of distribution, namely, Family Anthomyiidae: *Acrostilpna atricauda* (Zetterstedt), *A. latipennis* (Zetterstedt), *Alliopsis* species, *Pegomya frigida* (Zetterstedt), *P. incisiva* Stein. Family Muscidae: *Mydaea obscurella* Malloch, *M. palpalis* Stein, *Fannia melanura* Chillcott, *Hydrotaea pilitibia* Stein, *H. spinifemorata* Huckett, *Lasiops rufisquama* (Schnabl), *L. innocuus* (Zetterstedt), *Mesembrina latreillii* Robineau-Desvoidy.

Two species of Anthomyiidae, namely, *Chirosia delicata* (Huckett), *Pegomya atlantis* Huckett, and one species of Muscidae, *Phaonia aberrans* Malloch, are known to be restricted in their occurrence to the middle Atlantic states, from Long Island to north Georgia.

#### NAMES OF COLLECTORS

Bullock, D. S.	Laffoon, J. L.
Chillcott, J. G.	Mason, W. R. M.
Dietrich, H.	Richards, W. R.
Dreisbach, R. R.	Shannon, R. C.
Durden, C. J.	Sharp, A. V.
Hines, C. D.	Snyder, K. D.
Huckett, H. C.	Stupka, A.
Kelton, L. A.	Vockeroth, J. R.
Kukowitch, R. F.	Whittaker, R. H.

#### Literature Cited

- BRIMLEY, C. S. 1938. "The Insects of North Carolina." North Carolina Dept. of Agriculture. 560 pp.
- CHILLCOTT, J. G. 1961. A revision of the nearctic species of Fanniinae (Diptera: Muscidae). *Canad. Ent.*, (1960) 92 (Suppl. 14), 1-295; 289 figs.
- HENNIG, W. 1973. In Lindner, E., *Die Fliegen der palaearktischen Region*, Bd. 7 63a. Anthomyiidae, Lief. 297, pp. 593-680, Taf. 78-85.
- HUCKETT, H. C. 1972. Francis Walker's little known North American specimens of the families Anthomyiidae and Muscidae (Diptera) in the British Museum (Natural History). *Ent. News*, 83: 169-172.
- STEYSKAL, G. C. 1973. The genus *Emmesomyia* Malloch in North America (Diptera, Anthomyiidae). *U. S. Dept. Agr. Coop. Econ. Ins. Rpt.*, 23(22): 331-332, 2 figs.

- STONE, ALAN, C. W. SABROSKY, W. W. WIRTH, R. H. FOOTE, J. R. COULSON. 1965. "A Catalog of the Diptera of America North of Mexico." Handbook No. 276. U. S. Dept. of Agriculture. 1696 pp.
- WHITTAKER, R. H. 1952. A study of summer foliage insect communities in the Great Smoky Mountains. *Ecological Monographs*, **22**: 1-44, 13 figs., 9 tabs.
- WRAY, D. L. 1967. Insects of North Carolina. Third Supplement. North Carolina Dept. of Agriculture. 181 pp.

**Notes on the Life Cycle and Natural History of Butterflies of  
El Salvador. V.A. *Pyrrhogyra hypsenor*  
(Nymphalidae-Catonephelinae)**

ALBERTO MUYSHONDT

101 AVE. NORTE #322, SAN SALVADOR, EL SALVADOR

RECEIVED FOR PUBLICATION DECEMBER 3, 1973

**Abstract:** For a period of three years eggs, larvae and pupae of *Pyrrhogyra hypsenor* Godman & Salvin have been collected, reared, observed, and photographed in El Salvador.

In this paper the results of the observations are published for the first time, placing emphasis on the morphological and behavioral similarities existent with other Catonephelinae and at least with some Callicorinae. Record is made of the larval food plants of the species in Central America. The strong probability that the species is protected against predators is inferred from the conspicuous coloration of the larvae and adults and from the known poisonous properties of the food plants. Finally it is noted that apparently there is a preference for parasitizing Diptera and Hymenoptera to deposit their eggs on the larvae of species protected against predators by the unpalatable and/or poisonous substances sequestered from their food plants, probably to ensure the safety of their own eggs and larvae.

INTRODUCTION

This is the fifth article of a series revealing our observations on the early stages, behavior, and food plants of local butterflies belonging to the Catonephelinae, group of the Nymphalidae. The series will include at least some of the Callicorinae to emphasize the close relation between the two groups, as evidenced by the many morphological and behavioral similarities existent in their respective early stages. This at the same time will establish the great differences that exist with other groups of the Nymphalidae, so as to make one wonder if the common characteristic of the adults having only two pairs of ambulatory legs is a criterion strong enough on which to base a family. Not long ago Papilionidae and Pieridae were grouped together on the basis of the two groups having three pairs of ambulatory legs.

We had observed and collected adults of *Pyrrhogyra hypsenor* Godman & Salvin, since 1958, in ravines and creeks running through coffee plantations in the neighborhood of San Salvador (600 to 900 m altitude), but owing to our deficient knowledge of butterflies, we had always placed them among the

---

**Acknowledgments:** Once again we, my sons and I, express our obligation to Dr. Alexander B. Klots, of the American Museum of Natural History, New York, for his generous advice in our studies and for reading and constructively criticizing our manuscript. We are thankful also to S. Stainhauser for kindly determining the butterfly species, and Drs. C. W. Sabrowski, B. D. Burks, and J. L. Herring, of the United States Department of Agriculture, who determined the parasites and predator mentioned in this article.

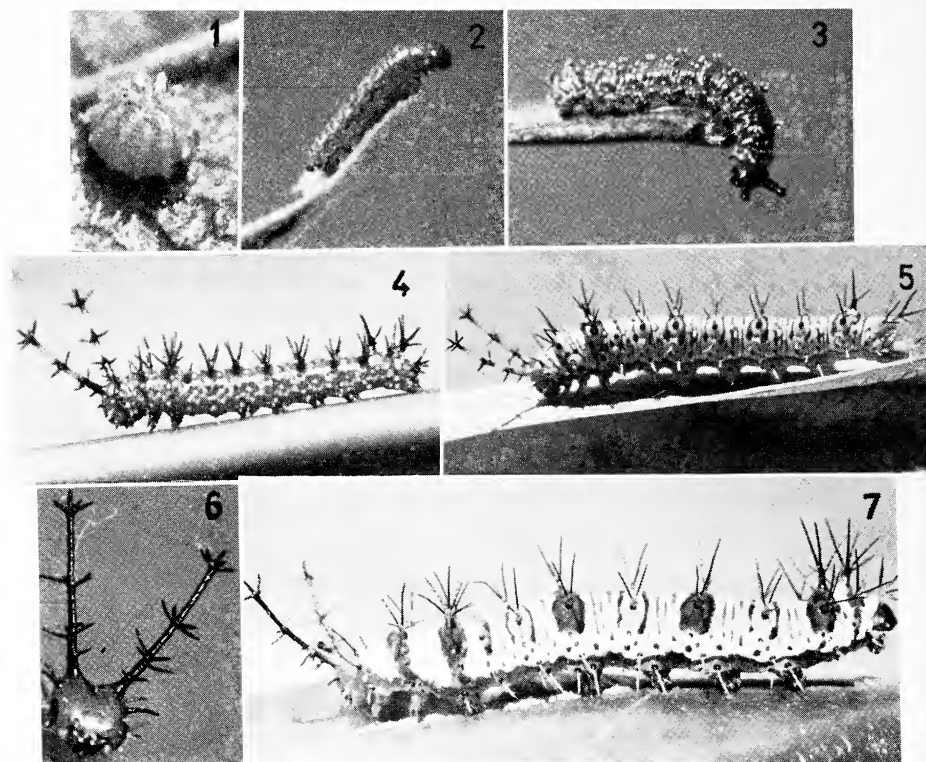

FIGS. 1 to 7. *Pyrrhogyra hypsenor* Godman & Salvin

1. Egg showing prominent ribs. About 1 mm.
2. First instar larva. About 2 mm.
3. Second instar larva. About 3.8 mm.
4. Third instar larva. About 7.5 mm.
5. Fourth instar larva. About 1.6 cm.
6. Close up of head of a fifth instar larva.
7. Fifth instar larva. About 3 cm.

local *Adelpha* species, which they somewhat resemble, and with which they share the habitat. It was not until late 1970, when we were searching a *Paulinia pinnata* L. vine for eggs and larvae of *Morpho polyphemus polyphemus* Doubleday and Hewitson, that we found one larva, which unmistakably pertained to a Catonephelinae and which eventually produced our "pseudo-*Adelpha*," that we realized our error. The butterfly was identified by S. Steinhauser.

Once the food plant was known, it was a matter of only a few weeks to find a female in oviposition. A number of eggs were collected and put in clear plastic bags. The larvae hatched from them were fed until pupation on leaves of the same plant. Photos were made of the eggs, the different larval instars, and



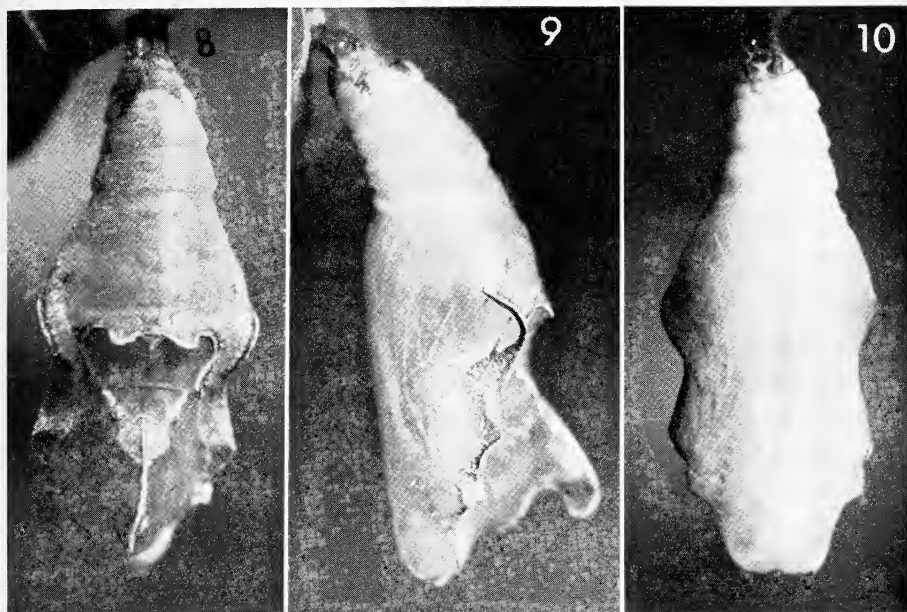

FIGS. 8 to 10. *Pyrrhogyra hypsenor* Godman & Salvin

8. Pupa dorsal view. About 2 cm. long.  
 9. Pupa lateral view.  
 10. Pupa ventral view.

the pupae. Measures of the different stages and the time spent in each one were recorded. The bags were kept at all times under ambient conditions of light and temperature. Specimens of the early stages were preserved in alcohol and sent to the American Museum of Natural History, New York, with specimens of the adults.

This is one of the species reared the most, with similar results every time.

#### LIFE CYCLE STAGES

*Egg.* Bright light yellow, truncated-cone-shaped, with 11 prominent yellow ribs from micropylar zone to base. About 1 mm long. Hatches in 5 days.

*First instar larva.* Head naked, roundish, light brown. Body greenish-yellow, cylindrical, naked, with light brown legs. About 1.5 mm when recently hatched, growing to 2.2 mm before moulting in 4-5 days.

*Second instar larva.* Head brown with short thick horns on epicrania. Body greenish-brown, with scattered whitish tubercles and small forked spines, growing to 3.5 or 4 mm in 5 days.

*Third instar larva.* Head cordiform, light brown, with dark brown, long horns on epicrania, bearing three rosettes of accessory spines, and slender spines on lateral margins. Body light brown, except for orange caudal segments, with whitish tubercles and black

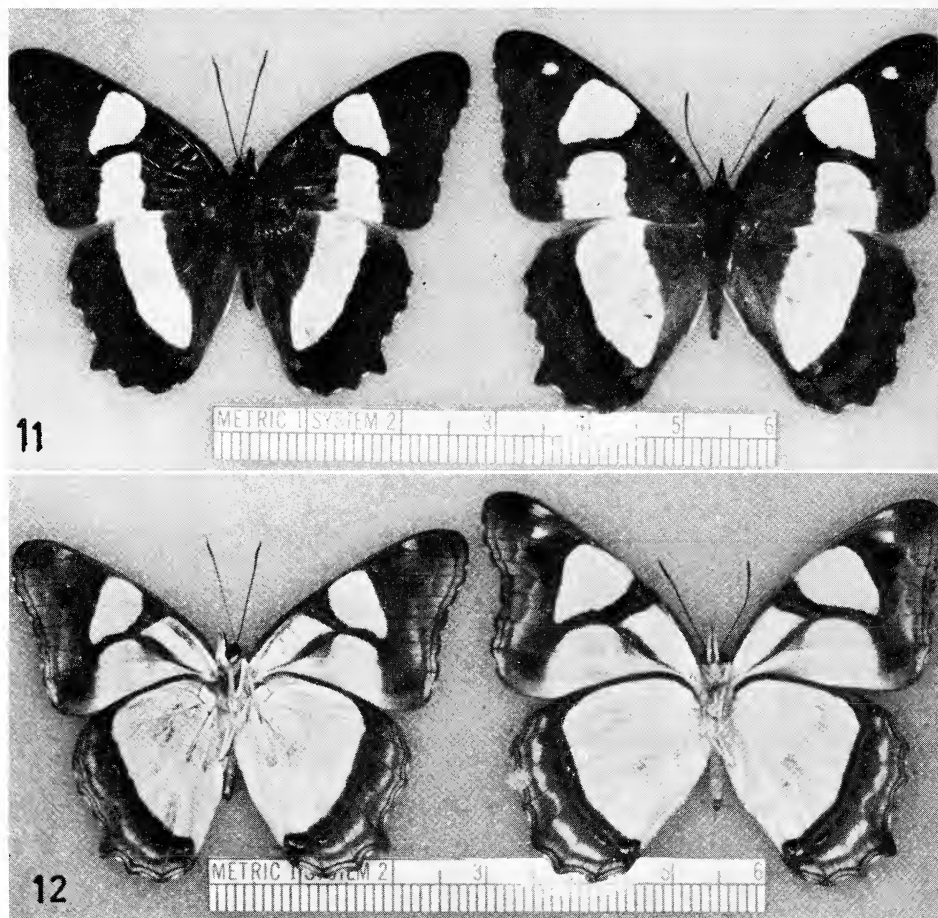

FIGS. 11 and 12. *Pyrrhogyra hypsenor* Godman & Salvin

11. Dorsal view of male and female adults.

12. Ventral view of male and female adults.

spines arranged as follows when seen laterally: on first thoracic segment (T-1), 2 subdorsal simple spines, 1 subspiracular simple spine. On T-2, 1 prominent forked subdorsal spine, 1 supraspiracular forked spine, 1 subspiracular simple spine. On T-3, 1 very prominent forked subdorsal spine, 1 forked supraspiracular spine, 1 subspiracular simple spine. On the first abdominal segment (A-1), 1 subdorsal simple spine, 1 supraspiracular simple spine, and 1 subspiracular simple spine. From A-2 to A-6, 1 subdorsal forked spine, 1 supraspiracular simple spine, 1 subspiracular simple spine, and 1 supraventral simple spine. On A-7 and A-8, 1 prominent forked spine at meson in addition. On A-9, 1 supraspiracular forked spine only, directed posterad. The larva grows to .75 cm in 4-5 days.

*Fourth instar larva.* Head as in third instar but reddish with black horns and spines. Body's ground color brownish-orange with rings of yellow spots mostly dorsally, with black

dorsal stripes across T-3, A-3, A-5, and A-7. Subdorsal spines on T-3, and median spines on A-7 and A-8 very prominent, the latter orange-colored. Spines on A-9 orange with black forks. Growing to 1.6 cm in 4-5 days.

*Fifth instar larva.* Head as in fourth instar, with longer horns. Body brownish-orange ventrally, mostly yellow above, with thin black rings across segments and red wide bands across T-2 and T-3 from base to base of subdorsal spines. Broad saddle-like zones on dorsum of A-3, A-5, and A-7. Growing to 3 cm in 4-5 days.

*Prepupa.* All colors but black turn into green. Shortens and thickens considerably. One day.

*Pupa.* All green except for dark brown cremaster and last abdominal segments. Body thickens gradually to first abdominal segments which are the thickest part of the body dorsoventrally and laterally. A projecting spur directed anterad on the dorsal part of the thorax. Head slightly bifid. Spiracula very inconspicuous brown. Measures 1.5 to 2 cm long, and lasts 7 days.

*Adults.* This species does not show a marked sexual dimorphism. Wingshape the same in both sexes. Front wing with costal margin slightly convex with rounded apex, slightly concave and sinuose outer margin, rounded tornus and almost straight inner margin. Hindwing with convex costal margin, rounded outer angle, sinuose outer margin, with a more pronounced curve projecting on M3 vein, forming almost a "tail," rounded anal angle and convex inner margin, with a slight fold. Dominant dorsal color dark brown, darker in males. Forewing with two squarish white bands aligned from midcostal margin to mid-inner margin. Females with, in addition, a small round white spot subapically. Hindwing with an elongated white stripe, continuing the white bands of the forewing, starting from midcostal margin, ending in a point before reaching the anal angle. Both sexes with a small red spot between the point of the white stripe and the anal angle.

Dominant color ventrally, white. Forewing with a light brown band covering the distal portion of the wing from  $\frac{2}{3}$  costal margin to  $\frac{3}{4}$  inner margin, covering the apex, outer margin, and tornus. A thinner brown branch arising from the brown zone, about the discal area, reaching the costal margin at a 60° angle. A secondary brown branch originating from the primary ending at the base of the wing. Basal third portion of the costal margin and all around the white island formed by primary branch, thinly lined with red. Hindwing mostly white with a brown zone alongside the outer margin, covering about  $\frac{1}{3}$  of the wing surface. On this brown area, alternately light and dark brown thin lines running parallel to the sinuose outer margin, with a row of dark brown spots alongside the basal limit. A thin red line running along the costal margin of the white area continuing along the basal limit of the brown zone.

Average size of adults about 5 cm from tip to tip of spread front wings. Total developmental time varying from 34 to 38 days.

#### NATURAL HISTORY

In El Salvador the eggs of *Pyrrhogyra hypsenor* are found exclusively on the tender shoots of at least two species of *Paullinia*, either on the new leaves or on the tendrils, and even if only one egg is deposited per location, several eggs per shoot are laid by a single female. As many as 15 eggs have been found on a single tender stem, probably resulting from several females visiting the same terminal.

The recently hatched larvae eat the upper surface of the eggshell and part of the adjacent wall also. They move afterward to the edge or to the tip of a tender leaf and feed thereon, using small pellets of excrement woven with silk to construct a resting perch that protudes from the leaf. The larvae quit this station only to feed, which they do early in the morning or late in the afternoon. While resting, the larvae usually have the head pointing outward, at times holding onto the perch with their prolegs and lifting the anterior part of the body. Second and at times third instar larvae behave similarly. From the third instar on, the larvae roam about the plant but always on the younger leaves on which they feed exclusively, even during later instars.

When the larvae are ready to pupate they move to older parts of the plant or even to neighboring shrubs, choose a place of their liking, weave a silk pad, clean their digestive tract, and affix their anal prolegs to it. Very often the chosen location is the upper surface of a leaf, and the larvae do not hang but lie parallel to the surface.

The pupae, usually found standing at an angle on top of a mature leaf, react when disturbed by wiggling vigorously from side to side, producing an audible squeaking sound. Shortly before adult emergence, the pupae become dark brown.

The adults rapidly abandon the shell and hang from a suitable place, while ejecting a reddish meconium, until the wings are rigid. The process takes about 15 minutes.

*Pyrrhogyra hypsenor* adults do not visit flowers but feed greedily on a variety of fallen and fermenting fruits, on juices flowing from tree wounds, on excrements and mud. After their long feeding sessions the adults fly to a nearby shrub and sit on top of a well-exposed leaf where they stay motionless except for occasional flappings of the wings, which might be held open most of the time. The adults of this species imitate not only the general color pattern of local *Adelpha* spp. but even their peculiar jerky and sliding flight. We have observed females of *P. hypsenor* alight repeatedly on leaves of a plant commonly used by at least two species of *Adelpha* for oviposition and act as if depositing eggs on it. Although we have observed the species for a number of years, we have never been able to witness copulations.

The tender shoots of the food plants of *P. hypsenor* are currently invaded by a species of aphid, which are tended by ants. The young parts of the plants are also used as food by several species of Theclinae (*T. marsyas*, *T. mykon*, and others).

The larvae and pupae of *P. hypsenor* quite often bring forth tachinid and chalcidid parasites. The tachinidae that were sent to the U.S. Department of Agriculture were determined by C. W. Sabrowski as "*genus sp.?*" [sic], the chalcidoidea were determined by B. D. Burks of the same institution as *Sphilo-chalcis persimilis* Ashmead. (Both parasites occur also in *Pseudonica flavilla*

*canthara* Doubleday.) We found, once only, a Pentatomidae nymph (determined by J. L. Herring, USDA, as "genus sp. ?") with a third instar larva of *P. hypsenor* impaled on its beak. A frequent cause of larval mortality, both in our insectarium and in the fields, is a disease that produces diarrhea, which is followed by softening of body tissues and death by bursting. Very often we find dead larvae in the fields hanging limp from a leaf, still holding on with their prolegs.

The food plants on which we have found eggs and larvae of *P. hypsenor* belong to the genus *Paullinia* (Sapindaceae); *P. pinnata* L. is by far the most usual, and *P. fuscescens* H.B.K. less usual. On both plants only the tender shoots are used for ovipositioning and feeding by this species.

*Paullinia pinnata* is a robust, semiscandent, tendril-bearing plant, with alternate, persistent, pinnate leaves consisting of 5 to 7 large (up to 10 cm long) lanceolate remotely dentate, slightly coriaceous leaflets on a broadly winged rachis. The inflorescence is an axilar raceme of small, whitish, 4-petaled flowers, which produce 3-celled, septicial, roughly pyriform, thick-walled capsular fruits about the size of a coffeebean that are green when young, becoming reddish-orange when mature and containing up to three shiny-black seeds, covered basally by a white arillum. This plant is widely used in the Neotropics for stupefying fish in streams and lakes, and, according to several authors (H. Baillon, 1874; L. Beille, 1909; P. Standley, 1923), it is reputed to be very poisonous and to contain an alkaloid, timboine. Standley says: "Some of the Indians are said to have used the juice to poison their arrows and it is reported that in the Antilles the Negroes have made use of the seeds for criminal poisonings."

*P. pinnata* and *P. fuscescens*, the alternate food plant, are very widely distributed in the country along wooded ravines and creeks from near sea level to about 1500 m altitude.

#### DISCUSSION

Seitz (1914) states that very little is known about the larvae of *Pyrrhogyra hypsenor* and although he does not describe the pupa in his work, he states that "The pupa shows the same peculiar attachment as that of *Myscelia*, because it is attached to the upper surface of the leaf." We are not aware of any other publication describing the early stages of the species, so it appears that this is the first mention of them.

Although this species is evidently in close relation to *Myscelia* and thence to the rest of the Catonephelinae, as grouped by Ebert (1969), we feel that it is a link between that group and the Callicorinae, a very closely related group, if we are to judge by the many similarities existent between the early stages and their behavior; the shape of the eggs of this species is more like the shape of the eggs of the latter group than the shape of the eggs of the Catonephelinae,

which are crowned by a series of protuberances around the micropylar area. It is also the only case we have found among the Catonephelinae with eggs colored other than white (the eggs of the Callicorinae are light green). As for the shape and behavior of the larvae and pupae, these conform to the general shape and behavior of the Catonephelinae we have studied.

It is true that the morphological and behavioral characteristics of the Callicorinae show abundant similarities to the other group, but in general the larvae of the Callicorinae are not armed with the profusion of spines peculiar to the Catonephelinae, so that it is an easy task to tell them apart under a superficial examination from the third stadium on.

A factor which is exclusive to this species and seems to indicate an evolutionary trend that may eventually lead the species to adopt a gregarious behavior is the discriminatory use of the young sprouts of the plant only for egg laying and larval feeding. This trait causes a concentration of eggs and larvae, not necessarily originating from one female only, but still usually several from one female, which are forced to live and grow within a limited space. As a result, larval encounters are common events. These do not result in larval fights nor in larval mortality that would be caused by wounds inflicted on each other by contenders. This peaceful coexistence is a total deviation from the individualistic behavior displayed by the rest of the Catonephelinae we have studied, whose larvae fight intransigently against other roaming larvae that accidentally come in contact with them. The larvae of *P. hypsenor* have learned also to accept impassively the continuous traffic of ants tending the aphids which often dwell in their domains, and the occasional disturbances caused by neighboring larvae of Theclinae which share their food.

The preference acquired by this species of feeding on young leaves might be an indication that the young leaves of the *Paullinia* vines are chemically quite different from the older ones, as is the case on *Prunus*, *Kalmia*, *Laurus*, *Quercus*, etc., whose young foliage is much more toxic than the older (Klots, personal communication). If this is the case the larvae feeding on young leaves of *Paullinia* would thus build up rapidly an effective predator-deterrent concentration of toxins.

For the rest, the behavior of the larvae of *P. hypsenor* is exactly like that of the larvae of the other Catonephelinae we have observed: The eggshell is disposed of in the same manner, the larvae build a similar resting perch with frass pellets, they feed at about the same times, and, in the later instars, they crawl about the upper surfaces of the leaves. The pupae stand on the leaves like those of the other species. So they use the cryptical strategy during the early larval stadia, and flaunt their presence in the late instars, even more than the others, on account of their showier colors. This seems to indicate that the protection they might derive from the noxious constituents sequestered from the food plants takes some time to reach the necessary concentration to protect

them effectively against predation. The adult behavior and coloration of *P. hypsenor* tends to support our speculation in this respect: They are the most conspicuous of all Catonephelinae.

In this species we again find that the alleged protection against predation derived from the poisonous properties of the food plant does not protect the larvae against parasitism. In fact the resultant immunity may be an advantage to the parasitic Diptera and Hymenoptera, whose larvae logically would benefit from the repellent properties of the host. The same phenomenon has been noticed in other species of butterflies classically accepted as protected against predation as a result of the food plant having poisonous and/or bitter components. Among these we count several local Danaidae (*D. plexippus*, *D. eresimus*, *D. gilippus*), Heliconiidae (*H. charitonius*, *H. petiveranus*, *H. talchinia*, *Eucides aliphera*, *E. cleobaea*), Ithomiidae (*Dircenna klugii*), Papilionidae (*Battus polydamas*, *Parides photinus*, *P. arcas*), feeding on Asclepiadaceae, Passifloraceae, Solanaceae, and Aristolochiaceae, respectively, plants known or reputed to contain noxious substances, and other species feeding on Sapindaceae, such as *Morpho polyphemus* (Young and Muysshondt, 1972), *Temenis laothoe liberia* (Muysshondt, 1973a), *Pseudonica flavilla canthara* (Muysshondt, 1973b); others on Piperaceae such as *Anaea (Consul) fabius* (Muysshondt, 1973c) and *Anaea (C.) electra* (Muysshondt, in prep.). All of these species produce, very often during the late larval instar or during pupation, quite a variety of Tachinidae or Hymenoptera parasites.

It is evident that the characteristic of most of the predation-protected larvae of crawling about exposed, displaying their gaudy colors, makes them an easy target for the parasitizing female. That could very well be nature's way of keeping in check the population of a species chemically protected against predation. Perhaps, after more evidence is gathered, it could be deduced that whenever a species is found to be very prone to parasitism, it is to be suspected that that species is chemically protected against predation by food-plant derivatives.

#### Literature Cited

- BAILLON, H. 1874. "Histoire des plantes." Hachette et Cie, Paris.
- BEILLE, L. 1909. "Précis de botanique pharmaceutique." A. Malone, Paris.
- EBERT, H. 1969. On the frequency of butterflies in Eastern Brazil, with a list of the butterfly fauna of Pocos de Caldas, Minas Gerais. Jour. Lep. Soc., **23**: Sup 3.
- EHRlich, A. H. AND EHRlich, P. R. 1961. "How to Know the Butterflies." Wm. C. Brown Co., Publishers, Dubuque, Iowa.
- KLOTS, A. B. 1960. "A Field Guide to the Butterflies." Riverside Press, Cambridge, Mass.
- MUYSHONDT, A. 1973a. Notes on the life cycle and natural history of butterflies of El Salvador. III. A. *Temenis laothoe liberia* (Nymphalidae-Catonephelinae). Jour. New York Entomol. Soc. In press.
- . 1973b. Notes on the life cycle and natural history of butterflies of El Salvador. IV. A. *Pseudonica flavilla canthara*. (Nymphalidae-Catonephelinae). Jour. New York Entomol. Soc. In press.

- . 1973c. Notes on the life cycle and natural history of butterflies of El Salvador. III. *Anaea (Consul) fabius* (Nymphalidae). Jour. Lep. Soc. In press.
- SEITZ, A. 1914. "Macrolepidoptera of the World." Vol. 5. Stuttgart.
- STANDLEY, P. C. 1923. Trees and shrubs of Mexico. Contrib. from the U.S. Nat. Herb., Vol. 23, Part 3, 701-3.
- YOUNG, A. M., AND MUYSHONDT, A. 1972. Biology of *Morpho polyphemus* (Lepidoptera-Morphidae) in El Salvador. Jour. New York Entomol. Soc., 80, 1: 18-42.



## *Tenuicoris* myrmeforme: A New Genus and Species of Myodochini (Hemiptera: Lygaeidae)<sup>1</sup>

JAMES A. SLATER AND JANE E. HARRINGTON

BIOLOGICAL SCIENCES GROUP, UNIVERSITY OF CONNECTICUT, STORRS, CONNECTICUT

RECEIVED FOR PUBLICATION DECEMBER 13, 1973

**Abstract:** *Tenuicoris myrmeforme* is described as a new genus and new species from Bolivia, Peru, and Brazil. Ant-mimetic characteristics are noted. The relationships of the genus are stated to be with such neotropical species as *Heraeus cincticornis* Stål. A dorsal view of the holotype is presented.

The tribe Myodochini is one of the largest taxa in the lygaeid subfamily Rhyparochrominae. It is the most diverse and dominant element in the neotropical rhyparochromine fauna.

Several Western Hemisphere myodochines are striking ant-mimics. As field information on lygaeid behavioral patterns increases, it is becoming evident that many additional species are also ant-mimics, although the morphological modifications are so limited that this is not readily evident in museum specimens.

In the present paper we describe a new ant-mimetic species from South America which represents an undescribed genus.

### *Tenuicoris*, NEW GENUS

Head elongate, acuminate, swollen and formicoid in lateral view; interocular area flattened, post-ocular area prolonged and tapering markedly but gradually from eye to insertion of head, lateral margins of juga forming a sharp ridge extending posterior to and above insertion of antennal segment 1; anterior pronotal lobe shining, strongly convex, with a distinct narrow ring-like anterior collar, lateral margins of anterior lobe evenly rounded, transverse impression deep and distinct, lateral margin of posterior lobe obtusely rounded, narrowing from humeri to transverse impression at a 45° angle, posterior margin straight, anterior lobe (except collar) impunctate, strongly polished, posterior lobe completely pruinose with anterior  $\frac{1}{3}$  thickly pale gray to silvery pruinose and posterior  $\frac{2}{3}$  strongly differentiated as less densely pruinose yellowish; scutellum convexly elevated across anterior  $\frac{2}{3}$ ; hemelytra attaining abdominal apex, clavus coarsely punctate, forming four or more very irregular intermixed rows of punctures, lateral corial margins strongly constricted at level of claval commissure; legs elongate and slender, fore femora only slightly incrassate, bearing one large

**Acknowledgments:** We wish to extend our appreciation to Mr. Johann Becker (Museu Nacional Brazil); Dr. R. C. Froeschner (National Museum of Natural History), and Dr. Peter Wygodzinsky (American Museum of Natural History) for the loan of material; to Drs. C. W. and L. B. O'Brien (Florida State University) for the gift of specimens; to Mrs. Kathleen Schmidt (University of Connecticut) for the execution of the illustration; and to Mrs. Darleen Wilcox and Mrs. Elizabeth Slater (University of Connecticut) for aid in the preparation of the manuscript.

<sup>1</sup> This work was supported by a grant-in-aid from the National Science Foundation.

and several small spines subdistally below; 1st metatarsal segment extremely elongate, three times as long as length of segments 2 and 3 combined; antennae very long, slender, terete; metapleural evaporative area extending well beyond scent gland orifice to occupy inner  $\frac{1}{2}$  to  $\frac{2}{3}$  of metapleuron, laterally truncate; abdominal spiracles 2, 3, and 4 located dorsally; scent gland scars present between abdominal tergites 3 to 4, 4 to 5, and 5 to 6; inner latero-tergites absent; abdomen moderately constricted basally.

This ant-mimetic genus belongs to the rhyarochromine tribe Myodochini. It has all of the typical tribal characters such as abdominal spiracles placed dorsally on segments two, three, and four, inner latero-tergites absent, conventional, generalized trichobothrial pattern and laterally rounded pronotum.

*Tenuicoris* is most closely related to *Heraeus* Stål and appears to be derived directly from species of the latter. *Heraeus* at present contains a rather diverse assemblage of species held together chiefly by the tendency of the head behind the eyes to be narrowed to form a short "neck." *Tenuicoris myrmeforme* is probably derived from a *Heraeus* stock rather similar to that at present represented by *Heraeus cincticornis* Stål. Like *Tenuicoris myrmeforme*, *cincticornis* is a large, slender species with very elongate legs and antennae. Its lateral jugal margins are noticeably carinate and the head, when viewed laterally, is rather myrmecoid in appearance. There is a conspicuous elongate white macula distally on the corium and another at the mesal apex of the membrane. The connexival area on sterna 4 and 5 is also pale. There are other large neotropical species of *Heraeus* that also have carinate lateral jugal margins so that *T. myrmeforme* seems to represent a highly derived taxon that has evolved from a *Heraeus cincticornis*-like ancestor.

*Tenuicoris myrmeforme* is readily distinguishable from any species of *Heraeus* by the striking condition of the pronotum. The anterior lobe is smooth and polished while the posterior lobe appears banded with its anterior third very heavily pruinose and its posterior two-thirds sharply demarked as less pruinose. *Heraeus* species generally have both pronotal lobes dull or subshining and never present the contrasting highly polished anterior lobe of *Tenuicoris*. The longitudinally oval eyes of *T. myrmeforme* are quite unlike the condition found in *Heraeus* species. The basally constricted abdomen and strongly mesally depressed head in the area of the eyes and juga are also distinctive features, and we have not examined any species of *Heraeus* which has such reduced armature of the fore femora as is found in *T. myrmeforme*.

Type species: *Tenuicoris myrmeforme*, n. sp., monobasic.

*Tenuicoris myrmeforme*, n. sp.

Please see Fig. 1. Head, antennal segment 1 and scutellum chestnut to tawny; antennal segments 2, 3, and 4 sordid buffy yellow with distal portions of 2 and 3 red, proximal and distal ends of segment 4 shaded with buffy brown; pronotum, thorax laterally and ventrally, femora and tibiae tawny, lightly suffused with brownish red, proximal  $\frac{1}{3}$  of femora pale, tarsi tawny to buffy yellow; clavus and corium cinnamon, membrane becoming buffy brown and fuscous along apical margins of corium, central area of clavus and on corium adjacent to claval suture and over most of membrane; hemelytra marked with strongly contrasting white coloration as follows: a narrow stripe along entire lateral claval margin adjacent to claval suture widened at distal end, a short narrow macula on corium adjacent to claval suture at level of anterior  $\frac{1}{2}$  of claval commissure, an oblique mesally tapering vitta near posterior end of corium running antero-mesad from lateral corial margin almost to middle

→

FIG. 1. *Tenuicoris myrmeforme*, n. sp. Dorsal view, holotype.

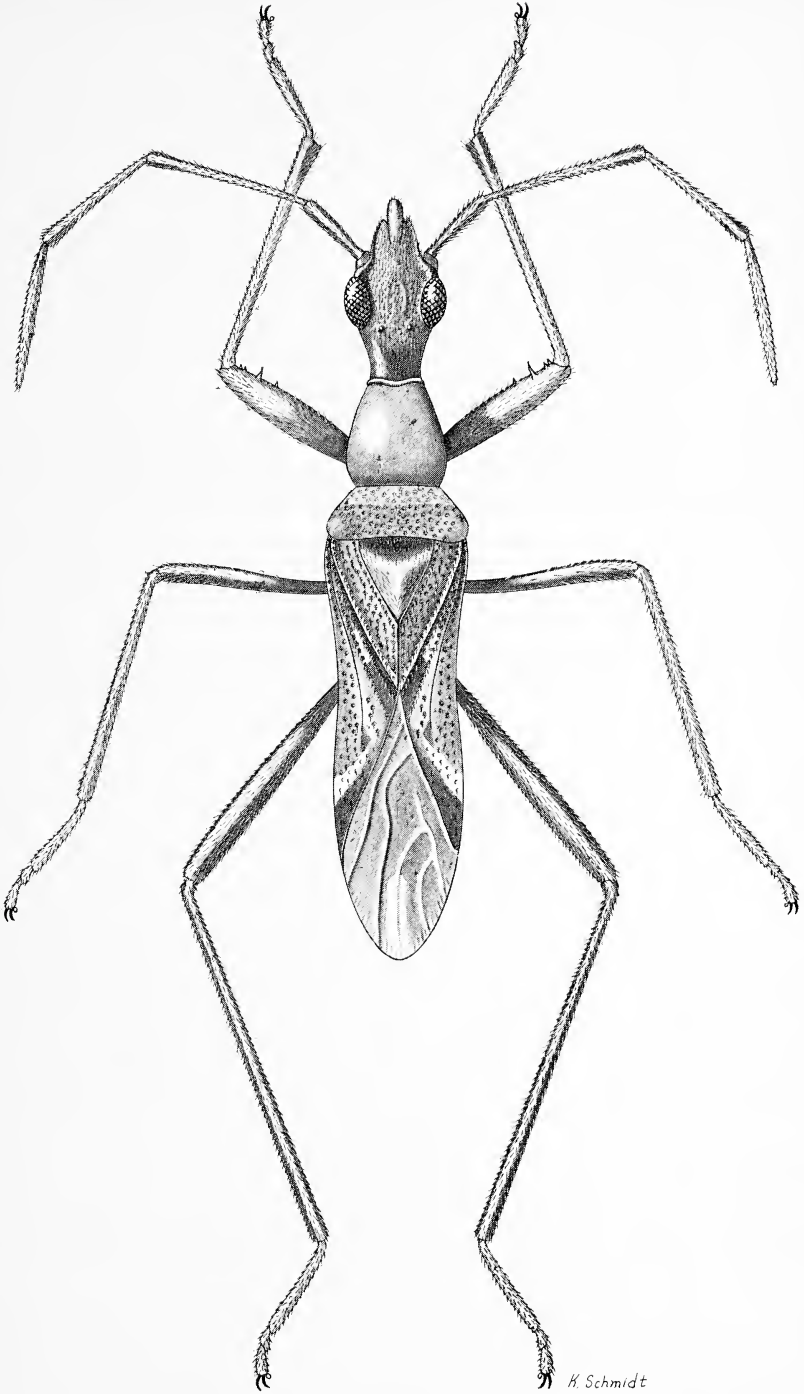

of apical corial margin, a broad white median stripe on distal  $\frac{1}{3}$  of membrane extending anteriorly almost to level of apex of corium; abdomen fuscous, becoming tawny on sternum 2, connexivum ventrally with sordid white macula covering most of segment 5 and central  $\frac{1}{2}$  of segment 6; head granulose and obscurely transversely rugulose, anterior pronotal lobe impunctate, shining, posterior lobe with distinct discrete punctures; scutellum shining with a few large scattered punctures on elevated area and coarsely punctate laterally; entire body surface except membrane clothed with fine short (*circa* 0.08)<sup>2</sup> decumbent hairs, hairs most dense on and lending a subshining appearance to antennae, tibiae, abdomen and laterally in transverse impression of pronotum, anterior pronotal lobe nearly glabrous; anterior pronotal collar pruinose and punctate ventrally.

Head slightly declivent anteriorly, eyes longitudinally oval, sessile, length head 1.86, width 1.23, interocular distance 0.61; length anterior pronotal lobe 1.14; length posterior lobe 0.61, maximum width anterior lobe 1.14; width across humeri 1.54; length scutellum 0.99, width 0.84; length corium 3.31, distance apex corium to apex membrane 1.38; labium extending beyond posterior margin of prosternum, length labial segments I 0.84, II 1.03, III 0.76, IV 0.38; bucculae very short, scarcely reaching over proximal end of 1st labial segment, extending beyond apex of tylus; length antennal segments I 0.95, II 1.80, III 1.48, IV 1.75; total length 8.24.

*Holotype*. Bolivia: ♂ Rurrenabaque Beni Oct. 1921 (W. M. Mann), Mulford Bio. Expl. 1921-22. In National Museum of Natural History No. 71224.

*Paratypes*. Bolivia: 1 ♀ Reyes-beni XII-12-1956—1 ♀ Prov. Sara (Steinbach). Peru: 1 ♂ Tingo Maria VII-10-1968 night (C. E. & L. B. O'Brien). Brazil: 1 ♂ Barbacena, M. Gerais, Feb. 1962 (M. Alvarenga) on Urticaceae—1 ♀ Caceres M. Gerais, Dec. 1955 (Alvarenga). In Museu Nacional Rio de Janeiro, American Museum of Natural History, J. A. Slater and J. E. Harrington collections.

The two Brazilian and the Peruvian paratypes are darker than the holotype and Bolivian paratypes. Their general coloration is between dark chestnut and dusky brown or fuscous rather than the light chestnut to tawny of the holotype. The number of small spines present ventrally on the fore femora also seems to be a variable condition. However, the body form and proportions, distinctive white color pattern of the hemelytra, and unique pruinose banding on the posterior pronotal lobe and all other significant morphological features are constant.

The Villalobos color chart (Palmer, 1962) has been used as a standard in the above description.

#### Literature Cited

- PALMER, R. S. 1962. "Handbook of North American Birds." Vol. I, Loons through Flamingos. New Haven and London, Yale University Press.

<sup>2</sup> All measurements are in millimeters.

## A New Genus and Two New Species of *Achipteriidae* from New York State (Acari: Cryptostigmata: Oribatei)

F. REESE NEVIN

DEPARTMENT OF BIOLOGICAL SCIENCES, STATE UNIVERSITY OF NEW YORK,  
COLLEGE OF ARTS AND SCIENCE, PLATTSBURG, NEW YORK 12901

RECEIVED FOR PUBLICATION MARCH 5, 1974

**Abstract:** *Dentachipteria*, a new genus, and two species of oribatid mites are described. Species are recognized by the large downward pointing lamellae the broad rostrum, and presence of denticles on the distal margins of the pteromorphs. In *D. ringwoodensis* there are many pteromorphic denticles, in *D. highlandensis* there is a single large denticle. In *D. ringwoodensis* leg 1 is held beneath the lamellae, in *D. highlandensis* leg 1 is free.

### INTRODUCTION

In the late thirties and early forties a number of collections of mites were made and preliminary studies started. Balsam mounts, specimens preserved in a killing-fixing and preserving fluid, and specimens preserved in beechwood creosote serve as the basis for the following study.

#### *Dentachipteria*, n. gen.

*Generic characteristics.* The body is truncated anteriorly giving a squared appearance. The prodorsum is strongly bent ventrally so that the tips of the lamellae point downward. The lamellae are broad and flat covering most of the prodorsum. The lamellar setae (1e) are rough and pressed against the lamellae. The interlamellar setae are long. The translamella is present or may be incomplete. The sensilli are rodlike. The notogaster is cup-shaped to more elongate, rounded posteriorly; the pteromorphs are bent strongly ventrally with the distal margin dentate and the anterior margin without a pronounced curve to the lateral tip. The notogaster bears 10 pairs of setae which decrease in size posteriorly. There are one to three pairs of sacculi. The ventral setae are long and geniculate. There are 6 pairs of genital setae, 2 pairs of anals, and 3 pairs of adanals. The fissure iad is near the anterior end of the anal field. The tarsi are tridactylous. Tarsus II bears a large branched seta on its ventral surface. The mandibles are chelate and the maxillary palps are five-jointed.

#### *Dentachipteria ringwoodensis*, n. sp.

*Color*, Mahogany red. *Size*, Mean for 19 adult specimens. Length: 0.674 mm; range: 0.62 mm–0.74 mm. Width: 0.516 mm; range: 0.47 mm–0.53 mm (Figs. 1–4).

Mean depth for three specimens 0.42 mm. The greatest width was in the posterior region of the hysterosoma through the anal plates.

**Acknowledgments:** I wish to thank Dr. Marie Hammer of Roland, Fredenborg, Denmark for the examination of some of the drawings and for her suggestion about generic status. I also wish to thank Dr. E. Piffel of the Zool. Inst. of University of Wien, Vienna, Austria for his interpretation of the position of *Parahyposzetes* into its correct family.

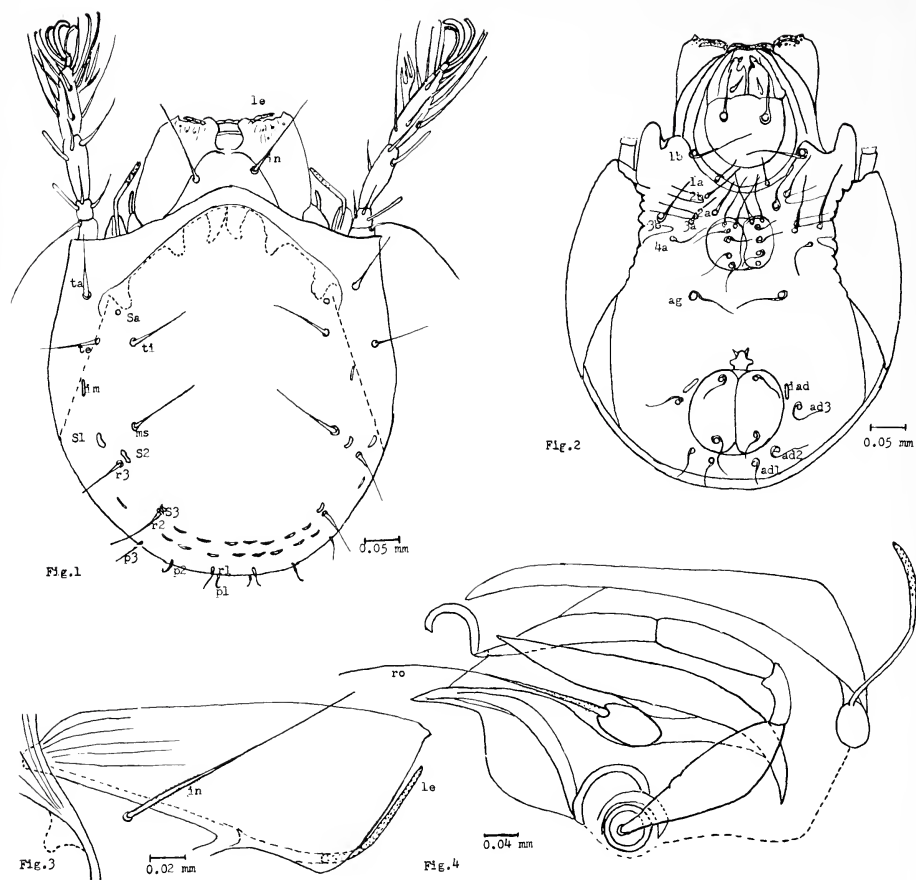

FIGS. 1-4. 1. *Dentachipteria ringwoodensis*, n. sp. Dorsal view. 2. *Dentachipteria ringwoodensis*, n. sp. Ventral view. 3. *Dentachipteria ringwoodensis*, n. sp. Lamella with lamellar and interlamellar setae. 4. *Dentachipteria ringwoodensis*, n. sp. Sketch of leg I held in position by the lamella and the rostrum and showing the rostral seta.

*Shape.* Oval, truncated anteriorly, the gnathosoma sharply bent ventrally.

*Prodorsum.* The broad lamellae with their broad thin cusps cover most of the prodorsum. Because of the bending of the gnathosoma the tips of the lamellae point downward and are not readily seen in dorsal view. Each lamellar cusp bears a pointed tip in an anterio-lateral position and a rounded median tip. A fleshy appearing lamellar hair arises as an extension from a thickened area along the median margin of the lamellar cusp and extends beneath the cusp or along its apical margin. It does not extend straight forward. The free ends of the lamellar cusps are wrinkled with a few small nodules among the wrinkles. The interlamellar setae are long and straight with a few short spines. Their origin is at the midpoint of the lateral margins of a clear area between the sratlike parts of the lamellae. The rostral bristle is not visible from the dorsum. It is almost smooth, is straight and directed anteriorly.

The rodlike sensillus originates from the mesial margin of the bothridium, curves laterally and anteriorly to a point opposite the genu of leg II, then bends inward toward the lamellae extending to a point opposite the middle of tibia II. The sensillus enlarges slightly from the bend to the tip and bears many short barbs especially toward the tip. The mandibles are well developed and are chelate in type.

*Notogaster.* The notogaster extends broadly anteriorly along the midline slightly beyond the anterior margins of the pteromorphs. The integument of the notogaster as well as of the pteromorphs is punctate and of a finer granular nature in the middorsal region which is rounded and in some specimens is marked off by its fine granularity from the rest of the notogaster. There are ten pairs of notogastral setae, the shorter setae being near the posterior end. What appears to be openings of the sacculi,  $S_a$ , are found anterior to seta  $t_i$  in some specimens but could not be seen in all.  $S_1$  is anterior to seta  $r_3$ ;  $S_2$  is near the base of  $r_2$ . Crescent shaped bodies appearing much like the openings of sacculi are found in the hypodermis near the posterior end of the notogaster and interfere with the detection of possible saccular openings. It is necessary to remove some of the pigment before the setae and sacculi can be studied. There is no lenticulus.

*Ventral Region.* The genital plates bear 6 pairs of setae arranged as follows:  $g_1$  and  $g_2$  are along the anterior border of the plate;  $g_3$ ,  $g_4$ ,  $g_5$  and  $g_6$  are arranged in a row extending in a line posterior to a point midway between the bases of  $g_1$  and  $g_2$ . In a few specimens  $g_3$  forms a line directly posterior to  $g_2$ . The space between  $g_4$  and  $g_5$  is slightly greater than the space between  $g_3$  and  $g_4$  or  $g_5$  and  $g_6$  which are evenly spaced from one another.

There are 2 setae on each anal plate, one near the center at the anterior end of the plate and one near the center at the posterior end of the plate. Seta  $ad_3$  is located midway between the anterior and posterior ends of the anal plates, posterior and lateral to the slit-pores  $iad$ . Each hair of the ventral surface is inserted beside a hair pore giving the appearance of the hair encircling the hair pore and described by Hammer (1967) in *Parahyposetes* as geniculate. The anal plates are larger than the genital plates. The distance between the genital and anal plates is greater than the length of the anal plates.

In the epimeral region the following setae are found:  $1_a$  and  $1_b$ ,  $2_a$  and  $2_b$ ,  $3_a$  and  $3_b$ , and  $4_a$ .

Clear less densely pigmented areas are found between the camerostome and the genital plates, anterior to the apodeme of leg I and also between the apodemes of leg I and leg II. Small circular, less deeply pigmented areas appear in the integument between the genital and anal plates.

*Legs.* All tarsi are tridactylous, the middle claw being much heavier than the other two. Leg I differs from the other legs in being held between the lamellae and the rostrum. The femur of leg I fits into a pocket of the propodosoma. The genu of leg I bends at near a 90° angle. The tarsus of leg II only bears one large branched ventral seta. Both the genu and tarsus of leg II bears a heavy blunt smooth spine.

*Materials.* The holotype and 30 paratypes (some dissected or crushed to study the structures) are adult specimens mounted individually in balsam on slides. All slides will be deposited in the collection of the New York State Museum in Albany, New York.

*Type locality.* Ringwood Preserve near Ithaca, New York. Specimens were collected by me on November 19, 1939 from among liverworts and mosses in a wooded area at the margin of a small muck pond just off the highway.

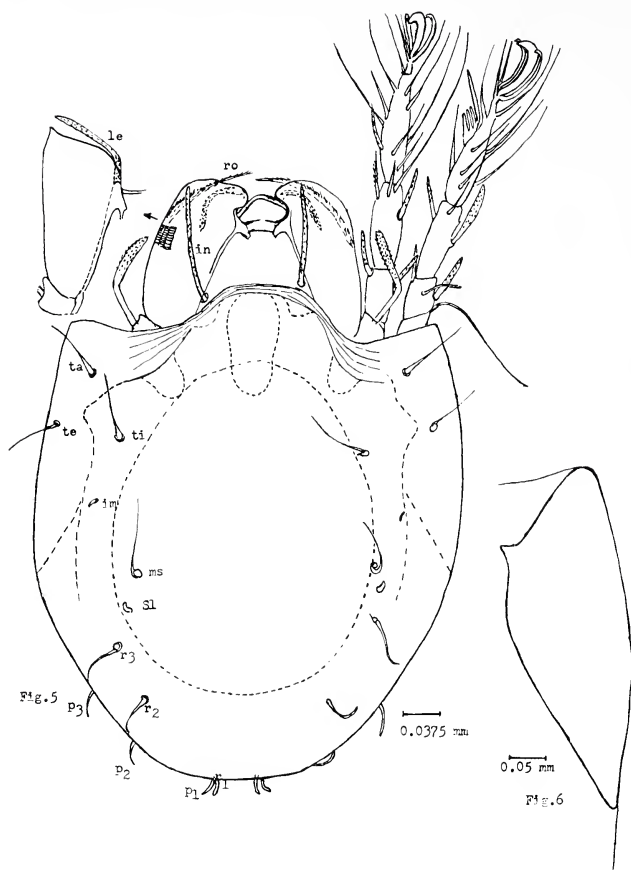

FIGS. 5-6. 5. *Dentachipteria highlandensis*, n. sp. Dorsal view. Enlargement of lamella and lamellar seta. 6. *Dentachipteria highlandensis*, n. sp. Ventral surface of pteromorphs to show single denticle.

*Dentachipteria highlandensis*, n. sp.

*Color*, Mahogany red. *Size*, length: 0.60 mm; width: 0.46 mm (Figs. 5-6).

*Shape*. Oval, truncated anteriorly.

*Prodorsum*. The lamellae are large, covering most of the prodorsum. Outer ends of the lamellar cusps are distinctly separated. Each cusp ends in a lateral point which may not be seen except in a semi-face view. The median margin of the cusp bears a lamellar seta visible through the cusp. It arises along the mesial margin of the lamella and may appear entirely ventral to the lamellae. It extends outward to a point near the lateral tip of the lamella. Rostral setae are attached far back on the rostrum and curve inward beneath the lamellae and extend slightly beyond the tip of the rostrum. The rostral setae are heavily plumose especially along the lateral margin. The long interlamellar setae are spinose from base to tip.



The sensilli bear several rows of short bristles. They are more abundant apically and disappear near the bend of the stalk of the sensillus.

*Notogaster.* The notogaster is longer than broad. It bears a distinct lenticulus. The notogastral setae are similar to those of *D. ringwoodensis*. Only one sacculus, S<sub>1</sub>, was found. The integument over the mid-notogaster is rounded up and is finely punctate. The entire dorsal surface including the upper surface of the pteromorphs is coarsely punctate. The large pteromorphs bear a single large denticle on the distal margin.

*Ventral surface.* The numbers and arrangement of the ventral setae are similar to those of *D. ringwoodensis*.

*Legs.* Leg I, free from the lamellae and the rostrum, is readily visible. Legs I and II each bear a heavy blunt spinous seta on the genu and on the tibia. The genu of leg IV also bears a similar heavy spinous seta. The tarsus of leg II bears a branched seta which is glovelike in appearance. The distal hairs of the tarsi are sharply pointed.

*Materials examined.* One female specimen designated as *holotype*. Collected by me from a sample of grasses and soil at 623 Highland Road, Ithaca, New York, on August 29, 1940. The type specimen will be deposited in the collection of the New York State Museum in Albany, New York.

#### REMARKS

The two new species of *Dentachipteria* may be separated readily by the concealed first pair of legs in *D. ringwoodensis* and by the presence of 1 to 14 or more denticles on the distal margin of the pteromorphs to only 1 denticle in *D. highlandensis*. A lenticulus is present in *D. highlandensis*.

*Dentachipteria* species closely resemble species of *Parahypozetes* Hammer 1967 and will key in Balogh (1972) to both *Parahypozetes* and to *Austrachipteria* Balogh and Mahunka 1966. I sent drawings of *Dentachipteria* species to Dr. Hammer and she has indicated her belief that the specimens described do represent a new genus. The following are some of the reasons for considering *Dentachipteria* a new genus. In *Parahypozetes* both the lamellae and the lamellar hairs point forward. The tips of the lamellae are always seen in dorsal view. The anterior end of *Dentachipteria* has a blunt squared off appearance due to the ventral bending of the gnathosome. In *Parahypozetes* the pteromorphs flair outward, but bend sharply ventrally in *Dentachipteria*. The distal margins of the pteromorphs are not dentate in known species of *Parahypozetes*. The ventral setae in particular are much longer in the new genus.

On the question of the position of the genus in its correct family I am indebted to Dr. Hammer, and to Dr. E. Piffel of the Zoologisches Institut of the University of Vienna, Austria who was referred to me by Dr. Hammer. Dr. Hammer had sent a specimen of *Parahypozetes bidentatus* to Dr. Piffel for comparative study. Dr. Piffel considers *Parahypozetes* distinct from *Austrachipteria* Balogh and Mahunka but none the less considers *Parahypozetes* a

member of the *Achipteriidae* rather than of the *Ceratozetidae* as originally described. According to Dr. Piffel a study of the immature forms is necessary for a definitive classification of the groups. Since the specimens which I have described appear to be closely related to the genus *Parahypozetes* considered by Dr. Piffel to be a genus of the *Achipteriidae* I have placed the specimens described in the *Achipteriidae* and have named them accordingly.

#### Literature Cited

- BALOGH, J. AND S. MAHUNKA. 1966. New Oribatids (Acari) from Australian Soils. *Folia Ent. Hungarica*, **19** (33): 553-568.
- BALOGH, J. 1972. "The Oribatid Genera of the World." Akad. Kaido, Budapest: 1-188, 71 plates.
- HAMMER, M. 1967. Investigations of the Oribatid Fauna of New Zealand, Part II. *Biol. Skr. Dan. Vid. Selsk.*, **15**(4): 1-64, 40 plates.

## Two New Tabanidae from Southeastern United States (Diptera)

L. L. PECHUMAN

DEPARTMENT OF ENTOMOLOGY, CORNELL UNIVERSITY, ITHACA, NEW YORK 14853

RECEIVED FOR PUBLICATION APRIL 8, 1974

**Abstract:** *Asaphomyia floridensis* from Highlands County, Florida, is described as new. *Asaphomyia* includes only one other described species, *A. texensis* Stone, known from three counties in Texas. *Chrysops dixonianus*, a species related to *Chrysops pudicus* Osten Sacken, is also described as new; specimens were seen from Virginia, North Carolina, South Carolina, Florida, Alabama, Mississippi, and Louisiana.

### INTRODUCTION

With really distinctive species, there is always a temptation when making determinations to spend little time looking at them. In the Tabanidae, I know of no Nearctic species more distinctive than *Asaphomyia texensis* Stone (1953). When specimens of what seemed to be this species, known only from three counties in Texas, were collected in Florida, I considered it only an interesting extension of range. It was only when I began a comparative study of the antennae of the Florida specimens that I found they represented a species quite distinct from the one in Texas.

For some years I had noted in routine identifications and had found in some collections under *Chrysops pudicus* Osten Sacken a southeastern *Chrysops* that was undescribed. I had hoped for the male of the species before describing it as new but now a name is needed for some manuscripts in preparation covering both a faunal study and the immature stages.

The types of both are retained in my collection for the present.

#### *Asaphomyia floridensis*, n. sp.

*Holotype* ♀. *Length*, 11 mm. *Wing*, 10 mm.

*Head.* First 2 antennal segments brown, each about as long as wide, with short black hairs; third antennal segment with basal annulus almost round, as wide as first segment, brown, slightly paler at base with a few black hairs and many very short silver hairs; remainder of annuli brown, in form of a style  $\frac{1}{4}$  width of first annulus at base and tapering to  $\frac{1}{8}$  of

**Acknowledgments:** The loan of a ♀ paratype of *Asaphomyia texensis* by Pedro Wygodzinsky of the American Museum of Natural History and a comparison of the holotype ♀ of *A. texensis* with the holotype ♀ of *A. floridensis* by George Steyskal of the Systematic Entomology Laboratory, U.S.D.A., is greatly appreciated. Specimens which made this study possible were received from the following: T. R. Adkins, R. G. Beard, W. B. Ezell, G. B. Fairchild, S. W. Frost, J. T. Goodwin, H. M. Henry, J. E. Lloyd, D. C. Sheppard, R. E. Silberglied, M. A. Tidwell, and R. L. Watson.

width near apex; the style of the right antenna has six apparent segments and that of the left five such segments and, in both, the last segment is equal in length to the total of the preceding style segments; the last style segment has a tuft of stiff black hairs at the tip. Frons brown pollinose with no trace of calli, 1.8 times as high as width below and slightly widened below; the ocelli are on a low, brown pollinose tubercle; vertex behind ocelli with a clump of stiff black hairs and a row of shorter black hairs which rim upper occipital margin. Clypeus and genae brown with black hairs. Beard black. Palpi dark brown, second segment stout at base tapering to a truncate apex, both segments with long black hairs. Proboscis shorter than palpi, brown with black and brown hairs.

*Thorax.* Dorsum brown, unstriped, with a few black hairs and many recumbent golden hairs. Pleurae uniformly brown. Legs brown, mostly brown and black haired with some scattered golden hairs; hind tibial spurs short. Wings uniformly brown; bifurcation of third longitudinal vein with a long appendix.

*Abdomen.* Rather uniformly brown dorsally and ventrally except seventh segment a darker shade of brown and incisures of second and third tergites slightly paler; with many dark brown and golden brown hairs.

*Allotype* (♂). *Length*, 10.5 mm. *Wing*, 10 mm.

*Head.* Antennae similar to ♀ except basal portion of third segment a bit narrower and slightly paler in color; 5 apparent segments in the style of each antenna. Frontal triangle, cheeks and genae dark brown pollinose, the latter and beard with long black hairs. Ocelli on a slightly raised, grayish brown pollinose tubercle, which posteriorly has a tuft of long stiff black and golden brown hairs. Palpi dark brown, second segment stouter and more acutely tapered than in ♀, with long black hairs. Proboscis subequal to palpi, dark brown with dark hairs.

*Thorax.* Dorsum, pleurae, wings, legs, and halteres as in ♀ except fewer golden hairs on dorsum and legs.

*Abdomen.* Incisures of second, third, and fourth tergites a little paler than in ♀; fifth and following tergites darker brown than anterior tergites. The proportion of golden to dark hairs is greater than in ♀.

*Holotype and Allotype.* Archbold Biological Station, Lake Placid, Highlands County, Florida, 7 June 1966, 15 w. UV blacklight (R. Silberglied).

*Paratypes.* 4♂♂ Archbold Biological Station, Highlands Co., Florida: 20 May 1968 (S. W. Frost), 8 June 1966 (Robert G. Beard), 20 June 1966, 15 w. UV blacklight (R. Silberglied); 2♂♂ 2 mi. NE of intersection of rte 70 and Fla. 27, Highlands Co., Florida, oak palmetto scrub, 9 July 1969 and 8-9 July 1969; the latter specimen carries notation "asleep" on twig of shrub 1 m. high."

Paratypes will be deposited in the collections of Cornell University, U.S. Museum of Natural History, and G. B. Fairchild.

*Variations.* The paratypes range in length from 9 to 12 mm with an average of 10.4 mm. The apparent segments of the antennal style range from 3 to 6 and these vary in the same specimen in number and distinctness; in all cases the terminal annulus is longer than any of the others.

*A. floridensis* is a more slender-appearing insect than *A. texensis* and differs in a number of characters: The tubercle on which the ocelli rest is less raised and is pollinose, including

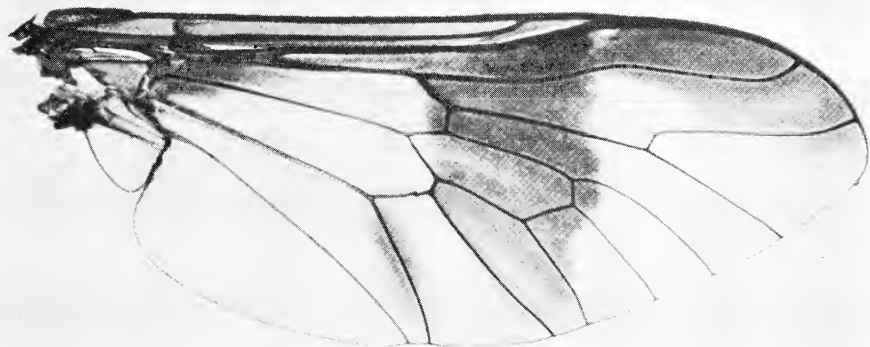

FIG. 1. Wing of *Chrysops dixianus*, n. sp.

the area between the ocelli, in considerable contrast to the high, shining tubercle in *texensis*; the antennal style is less slender, darker, and more likely to be subdivided. When viewed laterally the occiput is practically invisible, whereas in *texensis* it is wide and conspicuous; many of the recumbent hairs on the dorsum of the thorax are golden rather than black; the wings are uniformly brown rather than darker anteriorly. The wings of *floridensis* are narrower, the ratio of greatest width to greatest length in the ♀ holotype being 1:3.30 and in the ♂♂ ranging from 1:3.14 to 1:3.53 with an average of 1:3.34, whereas in *texensis* the ratio is 1:2.41 in the ♀ holotype, 1:2.77 in a ♀ paratype and 1:2.64 in a ♂ paratype.

The ♀ holotype of *A. texensis* is from Columbus (Colorado County), Texas, and carries no collection date. The type series included a ♂ from Victoria (Victoria County), Texas, 3 May 1913 and 2 ♀♀ and 2 ♂♂ from Weser (Goliad County), Texas, 11 May 1952. No specimens from Texas or elsewhere have been reported subsequent to Stone's description and it is somewhat of a surprise to encounter a second species in Florida.

*Chrysops dixianus*, n. sp.

*Holotype* (♀). *Length*: 8.25 mm (Fig. 1).

*Head*. First antennal segment yellow, second a deeper shade of yellow, basal portion of flagellum yellow-brown, annuli dark brown, nearly black; first two segments with black hairs. Frons grayish yellow pollinose with a scattering of fine yellow hairs, most dense near the vertex; frontal callus yellow,  $\frac{2}{3}$  as high as wide, somewhat pointed above. Frontoclypeus shining yellow with no dark spots; cheeks shining yellow below, yellow pollinose above. Palpi dark yellow with short black hairs and a few longer yellow hairs. Proboscis dark brown.

*Thorax.* Dorsum dark brown in ground color with a median brown pollinose stripe which is flanked by grayish yellow pollinose stripes; 2 sublateral subshining brown stripes merge with the median stripe near the scutellum; the stripes immediately above the wing bases are grayish yellow pollinose; scutellum dark brown with apical half orange-brown. Pleurae dark brown with 2 broad yellow pollinose stripes. Hairs of thorax pale yellow. Halteres dark brown. Forelegs with coxae and femora yellow, the latter somewhat darker at apex, tibiae with basal half yellow, apical half and tarsi dark brown; middle coxae dark brown, femora, tibiae, and metatarsi yellow, balance of tarsi dark brown; hind coxae and basal  $\frac{4}{5}$  of femora brown, apical  $\frac{1}{5}$  of femora and basal  $\frac{1}{3}$  of tibiae yellow-brown gradually shading in the latter to dark brown, metatarsi and adjoining segment yellow-brown, balance of tarsi dark brown. Hairs on legs match the ground color of the integument. Wing as figured; hyaline triangle not quite reaching second longitudinal vein, fifth posterior cell mostly hyaline, apical spot crossing slightly more than half of the upper branch of the third longitudinal vein.

*Abdomen.* First tergite yellow shading to yellow-brown beneath scutellum; second tergite yellow, the anterior half entirely so, the posterior half with a dark brown marking in the shape of a flattened inverted "V" which continues as a dark shadow to the posterior margins of the segment where the color is intensified to form a small brown spot; third tergite with a dark brown band, shading to chestnut brown laterally, covering the anterior half of the segment, shallowly indented by the yellow posterior border of the segment; fourth tergite similar to third but indentation even shallower and with chestnut brown portion more extensive; fifth and following tergites dark brown with a grayish yellow posterior border. Venter pale yellow with a vague indication of a dark median spot on third and fourth sternites, such a spot distinct on fifth sternite, sixth sternite dark brown.

I have seen two damaged specimens of what may be the male of this species but it seems advisable to withhold a description until specimens in better condition are available.

The name *dixianus* is derived from the area in which the species is found, known in the vernacular as "Dixie."

*Holotype.* Wedge Plantation, McClellanville, South Carolina, 28 May 1970 (LLP).

*Paratypes.* **Virginia:** Sussex Co, 8 June 1973 and Greensville Co., 20 June 1973 (Steve Jones). **North Carolina:** Williamston, 8 July (G. Fairchild). **South Carolina:** Wedge Plantation, McClellanville, 28 May 1970 (LLP); Hobcaw (Baruch) Plant., Georgetown, 29 May 1970 (Pechuman & Burton); Sumter, 24, 25 June 1970 (T. R. Adkins, Jr.); Boykin, Sumter Co., 27 June 1968 (W. B. Ezell, Jr.); Sumter Co., 27 July 1971 (D. C. Sheppard); Sweden, Orangeburg Co., 2 July 1968 (Adkins, Ezell, Krebs); Marlboro County, 5 June 1970 (Sheppard); Berkeley Co., 3 July 1970 (T. R. Adkins, Jr.); Berkeley Co., 1 July 1960, 6, 27 July 1971 (D. C. Sheppard). **Florida:** Cody, 18 May 1935; Wacissa, 5 June 1935; Greenville, 12 June 1935; Highlands Hammock St. Pk., Highlands Co., 11 May 1965 (LLP); Welaka, 11, 26 May 1961 (A. & H. Dietrich); Levy Co., 2 June 1960 (F. S. Blanton); Wakulla Springs, 5 July 1950 (A. G. B. Fairchild); Gainesville, Alachua Co., 8 May 1965, 21 May 1964 (J. E. Lloyd); Jackson Co., 31 May 1965 (F. J. Moore); 3 mi. SW of Cantonment, Escambia Co., 22 May 1965 (Ray Tidwell). **Alabama:** Blue Girth Creek, Dallas Co., 19 June, 18 August 1964 (R. L. Watson); Bear Creek, Autauga Co., 3 August 1966 (Hays and Watson). **Mississippi:** Logtown, Hancock Co., 23 June 1966 (Diamond and Bradford). **Louisiana:** Approx. 1 mi. S. of Pearl River, St. Tamany Par., 15 June 1969 (Mac Tidwell).

Paratypes will be deposited in the collections of: American Museum of Natural History, Auburn University, British Museum (Natural History), Canadian National Collection, Clemson University, Cornell University, Florida State Collection of Arthropods, Museum

of Comparative Zoology, Ohio State University, Pennsylvania State University, SUNY College of Environmental Science and Forestry, U.S. Museum of Natural History, John F. Burger, W. B. Ezell, G. B. Fairchild, J. T. Goodwin, C. B. Philip, R. H. Roberts, D. C. Sheppard, and Mac A. Tidwell.

*Variations.* The series of specimens is quite uniform. Length varies from 7.5 to 9 mm with an average of 8.25 mm. The wing pattern is uniform and the characters of the head and thorax show only slight variations; the proportion of brown and yellow-brown on the hind legs differs to some extent and the pale thoracic stripes in a few specimens have a greenish tinge. The dark marking on the second abdominal tergite in a few specimens is composed of two dashes connected by a brownish shadow; in others it is more extensive than in the type, nearly reaching the lateral margins of the segment. The size and intensity of the dark median markings on the venter differ but in all cases the first and second sternites are completely yellow.

As mentioned above, *Chrysops dixianus* was found in several collections under *C. pudicus*. From that species, *dixianus* may be separated by the brown thorax, pale tipped scutellum, broader apical spot, hyaline triangle not reaching the second longitudinal vein, completely yellow frontal callus, no distinct dark spot on abdomen under the scutellum and pale median markings of second and third abdominal tergites broader and less distinct. *C. pudicus* is a variable species and occasional specimens have a broader than usual apical spot and/or hyaline triangle not reaching the second longitudinal vein; the other characters mentioned above were found to distinguish *dixianus* from these specimens.

*Chrysops dixianus* will run to couplet 46 in my recent (1973) key to the species of *Chrysops* found in Virginia. A modification of this portion of the key to include *dixianus* follows:

46. Abdominal markings black and median marking of second segment usually reaches anterior margin; frontal callus normally black but sometimes yellow; usually at least basal portion of hind femora black ..... *dimmocki* Hine  
 Abdominal markings pale to dark brown, sometimes evanescent; median marking of second abdominal segment rarely attains anterior margin; frontal callus yellow; hind femora yellow to brown ..... 47
47. Thorax greenish-gray with fuscous stripes; outer margin of crossband usually sinuous ..... *celatus* Pechuman  
 Thorax brown or yellowish in ground color with brown stripes; outer margin of crossband concave, straight, bowed, or sinuous ..... 48
48. Dark median marking of second abdominal segment reaching about  $\frac{2}{3}$  across segment; outer margin of crossband usually straight or somewhat concave; hind femora yellow ..... *flavidus* Wiedemann  
 Dark median marking of second abdominal segment reaching only about half-way across segment; outer margin of crossband frequently bowed or sinuous; hind femora partly or all brown ..... 49
49. Apical spot occupying upper half of second submarginal cell and sharply outlined; fifth posterior cell largely hyaline; smaller species averaging 8.25 mm ... *dixianus*, n. sp.  
 Apical spot indefinite in outline, extending into lower half of second submarginal cell as a paler infuscation which may continue into apical portions of first, second, and third posterior cells; fifth posterior cell largely infuscated; larger species averaging 9.5 mm ..... *reicherti* Fairchild

That *Chrysops dixianus* can be a common pest is indicated by 124 specimens collected on 6 July 1971 in Berkeley County, South Carolina, by D. C. Sheppard.

### Literature Cited

- PECHUMAN, L. L. 1973. The insects of Virginia No. 6. The horse flies and deer flies of Virginia (Diptera: Tabanidae). V. P. I. and State Univ. Research Div. Bull., **81**: 1-92.
- STONE, ALAN. 1953. New tabanid flies of the tribe Merycomyiini. Wash. Acad. Sci. J., **43(8)**: 255-258.

---

### BOOK REVIEW

**The South Asiatic Olethreutini (Lepidoptera, Tortricidae).** A. Diakonoff. Zool. Mon. Rijksmuseum van Nat. Hist. No. 1. Brill, Leiden. 1973. XXI + 699 pp., 15 pls. (1 col.), 732 figs. 208 guilders.

This is a highly important taxonomic monograph of the southern Asiatic members of a large, worldwide group treated by various authors as a tribe, a subfamily, or even a family. It is based on all known material in the collections of the world. The author is a recognized authority on these and related moths, on which he has published voluminously. He himself lived and collected in Java for many years. The present work is especially valuable since the Palaearctic and Australian faunas are being intensively studied by other authors. The Nearctic fauna, long overdue for revision, is also being studied. The author's opinions of the taxonomy of the larger taxa will therefore be especially important. The present work covers 12 subtribes, 94 genera, 17 subgenera, 430 species, 14 subspecies, and 2 "formae." Of these, 11 tribes, 39 genera, 3 subgenera, 176 species, and 7 subspecies are described as new. Many new combinations are also made. Keys to these taxa are given, based on all usable characters, and very thorough descriptions of all taxa are included. Dates, localities, and institutional locations of specimens are given, including, of course, types when these are known. Both male and female genitalia are figured whenever possible, as well as many heads and venations. Food-plant records are also given for many species.

A preliminary section contains, among other things, a discussion of the general classification of the Tortricidae, past and present, and of the morphology of certain genitalic and scent organs. A discussion of the Palaearctic genera is given for comparison. A new term, "apallotype," is proposed for a supplemental type of the opposite sex from the type, a category sometimes confusingly, called "neallotype." It is hardly necessary to state that this is a taxonomic work of the highest quality, one that will be essential for all students of this and related groups anywhere in the world.

ALEXANDER B. KLOTS

The American Museum of Natural History



## The Distribution of Brood Ten of the Periodical Cicadas in New Jersey in 1970<sup>1</sup>

JOHN B. SCHMITT

RUTGERS—THE STATE UNIVERSITY, NEW BRUNSWICK, N. J.

RECEIVED FOR PUBLICATION APRIL 26, 1974

**Abstract:** The last thorough study of the distribution of Brood X of the periodical cicadas in New Jersey (*Magicicada* spp.) was made in 1902. Data collected on the distribution of the 1970 emergence indicates a disappearance since 1902 from the following localities: Mercer County except Princeton; eastern Somerset County; Prospertown-Colliers Mills, Ocean County; Jacobstown-Ellisdale, Burlington County; Cherry Hill Township, Camden County; Salem and Woodstown, Salem County; and Shiloh in Cumberland County. Hitherto unreported populations were found on Lower Powhatcong Mountain, Warren County; near Middletown, Monmouth County; and Quinton and Alloway in Salem County. Forty populations were found in Hunterdon County, west and south of the South Branch of the Raritan River. The chief factors in the disappearance of the insect since 1902 appear to have been the destruction of woodlands, forest fires, and urbanization. The possibility that forest losses caused by the gypsy moth may play a part in the loss of periodical cicada populations is suggested.

### INTRODUCTION

The periodical cicadas are well known for the fact that adults of the six species emerge from the soil after either 13 or 17 years of nymphal existence. Alexander and Moore (1962) provide a table showing past emergence dates since 1621 and predicting the future emergence dates until the year 2028, of all known broods of both the 13-year and the 17-year species. A "brood" may be defined as consisting of all the populations of the species complex (either 13-year or 17-year) emerging in any year. Since the years of emergence follow a well-defined cycle, the various generations of a brood may thus be recognized and identified by a Roman numeral. In New Jersey, six broods of the 17-year species were known to exist in the early decades of this century (Weiss, 1916; Davis, 1926). As predicted, adults of Brood X appeared in 1970. The preceding years of emergence of Brood X in this century were 1902, 1919, 1936 and 1953.

**Acknowledgments:** At various points in this paper, the writer has endeavored to recognize the individuals whose generous participation made possible a more complete or more satisfying solution of some questions regarding Brood X in 1970. The contributions of two individuals, however, should be especially acknowledged. I am particularly indebted to Dr. Lyle E. Hagmann and Mr. Joseph D. Stewart of the Department of Entomology at Rutgers for their very considerable help.

<sup>1</sup>Paper of the Journal Series, New Jersey Agricultural Experiment Station, Cook College, Rutgers University—The State University of New Jersey, Department of Entomology and Economic Zoology, New Brunswick, New Jersey 08903.

In 1969 the writer reviewed the literature which had been published on the distribution of Brood X in New Jersey since Smith (1903) described its distribution in the emergence of 1902. Weiss (1916) added nothing to Smith's data. Marlatt (1907) also described the 1902 emergence, and lists several counties and localities not cited by Smith. However, Smith was aware of these additions through correspondence with Marlatt, and in his 1903 report comments on them substantially as follows:

Middlesex County. Marlatt cited a report from Deans which stated that the cicadas occurred "by the millions." Smith says he searched the area and found no trace of them.

Morris County. Marlatt reported them from Boonton. Smith searched through Morris County, and especially Boonton, without being able to verify the record.

Gloucester County. Marlatt's record, according to Smith, was based on a newspaper report of an occurrence in the Swedesboro-Harrisonville area. Smith found no trace of the insect in Gloucester County. Although Smith failed to confirm Marlatt's records, the writer made a special effort to find these populations in 1970, without success.

Davis (1926) considerably extended the list of counties in New Jersey over that provided by Smith for Brood X. However, a careful reading of Davis' paper shows that he based his additions solely on the annual report of the Department of Entomology of the New Jersey Agricultural Experiment Station for 1919 (Headlee, 1919). Unfortunately, these records did not mean that actual specimens were received or identified, but only that correspondence concerning the cicada was received from residents in the various counties. Much of this correspondence was dated in months of the year when the insects were underground, and it seems very probable that such correspondence was prompted by newspaper accounts predicting the forthcoming emergence of the cicadas. However, as in the case of Marlatt's records, an intensive effort was made in 1970 to determine whether Brood X exists in the disputed counties. No literature could be found regarding the emergences of 1936 and 1953 which extended the distribution described by Smith in the 1902 emergence.

The writer decided to undertake a thorough study of the 1970 emergence to learn what, if any, changes in distribution had taken place since 1902, a period of time representing four cicada generations. It was obvious that some measure of public assistance in finding local populations would be valuable. Accordingly, in the spring of 1970 news stories alerting the public to the coming of the cicadas were distributed to the newspapers of the State through the courtesy of the Communications Center of our State Cooperative Extension Service. The writer also sent a personal letter to each county agricultural agent asking for records of cicada emergence and explaining the purpose of the study. A similar appeal was sent to the superintendent of each county mosquito control agency. Col-

leagues in the Department of Entomology and Economic Zoology at Rutgers were also reminded of the predicted emergence and their cooperation sought. During and after the emergence period, the writer made a number of field trips to check on distribution, and a record of adult cicada distribution in 1970 was thus obtained which the writer believes is fairly complete. This paper will compare that record with the observations of Smith (1903). It should perhaps be noted that in the study of these cicadas, it is the existence of large local populations that is significant, not the occurrence of individuals separated from a large population. Such large local populations typically contain many thousands of individuals of both sexes, and their presence is advertised by the daytime din of their song and by oviposition injury to deciduous trees.

#### OBSERVATIONS

Figure 1 summarizes the distribution of Brood X in New Jersey in 1902 (Smith's data) and in 1970. Isolated localities known to Smith are marked by circles. If cicadas appeared in a given locality in 1970 also, the circle is solid; if cicadas could not be found in 1970, the circle is open. The squares represent populations seen in 1970 in localities apparently not known to Smith. The numeral accompanying each locality marker serves to identify the locality in the text.

The large, lightly-shaded area in the central-western part of the map indicates the general distribution of Brood X in 1902 in that area. The smaller, heavily-shaded area represents the general distribution of Brood X in the area in 1970. The distribution of individual populations in 1970 in most of that area (Hunterdon County and adjoining areas) is shown in Figure 2 as numbered circles. These localities are also geographically identified by number in the text.

The isolated populations indicated in Figure 1 will be identified first. In 1902 Smith reported, from correspondence, a population at Roxbury, in Warren County. His map shows it extending inland from the Delaware, a few miles south of Belvidere. In 1970, the writer did find a small population at the western end of the area indicated by Smith, near Harmony Station (Fig. 1, 1). Roxbury itself is at the northern end of Scott's Mountain. No cicadas were found at Roxbury, but near the village of Montana, a few miles south, they were very abundant (Fig. 1, 2).

Other Warren County populations were observed in 1970 at Stewartville and New Village. These localities are part of the Lower Powhatcong Mountain forested area (Fig. 1, 3). Apparently Smith did not know of this locality; neither his text nor his map indicates it. Smith did list Carpentersville, Warren County, and a few cicadas were found there. However, the Delaware River at this point represents a gap in the woodland of no more than fifty yards. On the Pennsylvania side there was a large population (Fig. 2, 50); probably the cicadas seen at Carpentersville were only strayed individuals from the Pennsyl-

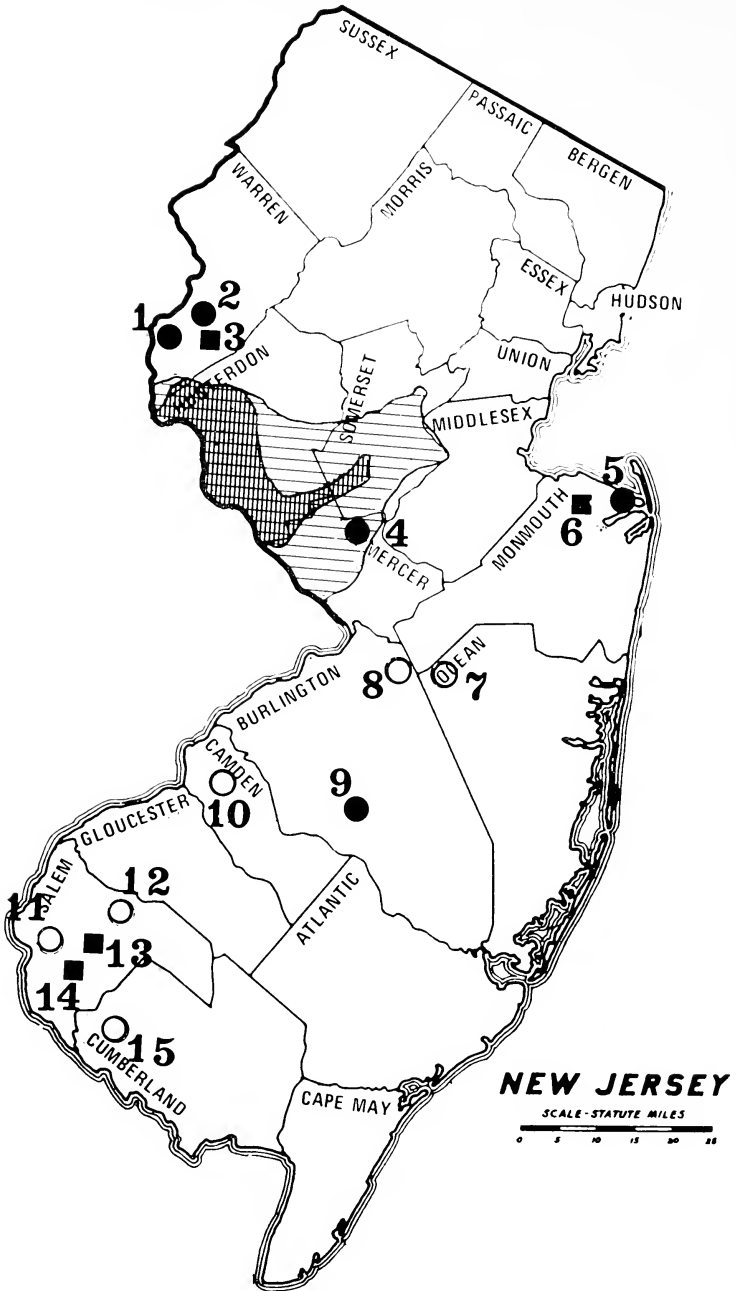

FIG. 1. Map of New Jersey showing distribution of Brood X in 1902 and 1970. See text for details.

vania population. Finesville, also in Warren County, is on the border of the great Hunterdon distribution (Fig. 2, 15).

Sussex County, just north of Warren, is one of the counties cited by Davis (1926) on the basis of the Headlee report (1919). Since it is heavily forested with oak, particular attention was given to the area. County agent John W. Raab, at the request of the writer, spent considerable effort in inquiries and travel, without finding a single population. The writer toured the localities cited by Headlee without uncovering any evidence of cicadas, and no correspondent provided knowledge of a single population. Neither could any resident be found who remembered ever hearing or seeing the insects within the county. Similar efforts in both Morris and Passaic Counties were equally unsuccessful. Brood II is well known to residents of these two counties, but Brood X is not. The County agents of both of these counties, and of Bergen, Union and Essex also could not find a single instance of Brood X, nor could the writer.

As Figure 1 shows, the locality of Princeton (Fig. 1, 4) was included in the general distribution of cicadas in Mercer County in 1902. Smith found the insects to occur abundantly as far south as the Pennsylvania Railroad main line, and westward along that line to Lawrence Station. He concluded that the cicadas were "pretty generally distributed" in Mercer County "except in the extreme south." In 1970, Mr. Charles M. Holmes, senior county agent, supplemented the writer's observations, and was unable to find any cicadas in Mercer County other than the large population on the western edge of Princeton Borough, and along the Mercer-Hunterdon line (Fig. 2, 38, 42). Also, no populations could be found in either Somerset or Middlesex County representing the former eastward extension of the great central area shown in Fig. 1. The only Somerset populations found were on the Sourland Mountain ridges, to be described later.

In Monmouth County, a population in the Navesink Highlands (Fig. 1, 5) had been described by Smith. In 1970, its decedents were very abundant in the same locality, and as the area has apparently changed very little during this century, the insects were probably nearly as abundant as they were in 1902. Individual cicadas were found in Fair Haven, separated from the Navesink Highlands population by about one-half mile of open water, but as no evidence of emergence could be found at Fair Haven, the writer assumes that these specimens were strays from the Highlands population. A second population was found in Monmouth County near Middletown, in the low wooded hills known as the Telegraph Hill formation (Fig. 1, 6). Smith apparently did not know of this colony, located about eight miles from the Navesink Highlands population.

Smith recorded a colony in 1902 in the northwestern corner of Ocean County, between Collier's Mills and Prospertown (Fig. 1, 7). In 1970 no trace could be found of that colony. This area is heavily wooded, with few access roads or human inhabitants. Searches and inquiries in both this area and in the nearby town of New Egypt failed to provide any evidence of the cicadas. It therefore is

probable that this colony has perished. One possible explanation is the fact that the area between Collier's Mills and Prospertown has been devastated by a number of very severe forest fires since 1902. The resulting tree loss might have destroyed the cicadas. However, the apparent disappearance of another population reported by Smith in nearby Burlington County, of which no descendants could be found in 1970, could not be accounted for. Smith reported (from correspondence) a population between Jacobstown and Ellisdale (Fig. 1, 8). Unable to find the cicadas himself, the writer enlisted the aid of Mr. Daniel Kensler, who had been the county agricultural agent in Burlington County for almost 40 years. Despite strenuous efforts on his part, no trace of this colony, either in 1970 or in the past, could be found; either it has become extinct, or Smith's correspondent was in error.

A second locality in Burlington County was described by Smith from the vicinity of Indian Mills. The writer was unable to find any trace of the insects or reports of them, and he is indebted to Dr. Lyle E. Hagmann for finally discovering them. They were found about halfway between Indian Mills and Tabernacle, about one mile east of Route 206 (Fig. 1, 9). The precise location was scaled from a Geological Survey map as  $39^{\circ}48'45''$  N and  $74^{\circ}42'30''$  W. It is a large colony, as more than 100 acres of trees showed evidence of oviposition.

The only colony of Brood X in Camden County in 1902 was recorded by Smith from Delaware Township, since renamed "Cherry Hill" Township. This area is now highly urbanized. No trace of the colony could be found in 1970, either by the county agent or by the writer. It is probable that the destruction of woodlands since 1902 has destroyed this colony.

As regards Gloucester County, Smith mentions correspondence with Marlatt, who, he says, sent him newspaper reports of the insects near Swedesboro and in the woods between Harrisonville and Swedesboro. In 1970, however, no trace of either of these colonies could be found.

Smith reported two colonies from Salem County in 1902. One of these was described by a correspondent from the town of Salem as "occupying a large tract of timber land which is, unfortunately, gradually becoming exterminated" (Fig. 1, 11). A second colony was described as being near Yorktown (Fig. 1, 12). Mr. Robert Gardner, the county agent in Salem County, became keenly interested in the matter of cicada distribution, and expended a great deal of effort in trying to find populations in 1970. Only two were found. One of these inhabited a woodland near the "Happy Hill" Nursery, Alloway (Fig. 1, 13), and the other was discovered near Quinton (Fig. 1, 14). No trace of the Yorktown colony could be found (Yorktown is about five miles from Alloway). Whether either of the two populations that were found represents the Salem colonies described by Smith is uncertain because of the vagueness of Smith's record, but if the locality was near either Alloway or Quinton, it is perhaps odd

that his correspondent did not use those names, as both communities are old and well-known localities.

Smith reported a single record in 1902 from Cumberland County, in the vicinity of the village of Shiloh (Fig. 1, 15). No trace could be found of this colony in 1970. Here again the writer was very fortunate in the fact that Mr. Kenneth E. Pickett, the county agent of Cumberland County, has lived most of his life in Shiloh and took a keen interest in the matter. Despite all his efforts, he could not find any trace of the Shiloh colony. No other evidence of Brood X in Cumberland could be found by Mr. Pickett or the writer.

Turning to the northwestern area of the state, Smith in 1902 found Brood X existed from just north of Trenton along the Delaware River upstream to a point just south of Phillipsburg in Warren County (Fig. 1). Eastward, the cicadas were found by Smith as far east as Bound Brook. The extent of Brood X distribution in Warren and Mercer Counties has already been considered. The disappearance of the cicadas from their eastern range in Somerset County is indicated in Figure 1.

In Hunterdon County, Smith described the insect in 1902 as "generally present from the Delaware River east to the line of the Central Railroad of New Jersey, and from the Mercer County line north to the Warren County line." The 1970 emergence in Hunterdon was found to be concentrated in three well-defined physiographic areas:

1. The Musconetcong Mountain and ridge area: populations numbered 1 through 21 (Fig. 2). This is a mountain of granitoid gneiss of Precambrian age and is heavily forested. Just south of the mountain in Union and Alexandra townships, there is a forested ridge area of rubbly, glaciated soils derived from the gneiss. These forests were also heavily populated by the cicadas.
2. The Hunterdon Plateau; populations numbered 24 through 30. This is an area of hard sandstone and argillite west of Flemington, about 8 miles wide at Baptistown. The southern portion of the plateau is heavily wooded, primarily because poor soil drainage tends to discourage agriculture, and it is this area which supports the cicadas.
3. The Sourland Mountain; populations numbered 33 through 42. This is a ridge of crystalline rocks, mostly diabase, which extends from the Delaware River to the vicinity of Belle Meade in Somerset County, a distance of about 16 miles. Its western part is a series of forested hills, but its eastern area, which extends into Somerset County, is a continuous plateau. Much of the land is wooded because of steep slopes and stoniness. Populations of the cicada extend a few miles east of the distribution shown in Fig. 2, into Somerset County as far as Belle Meade.

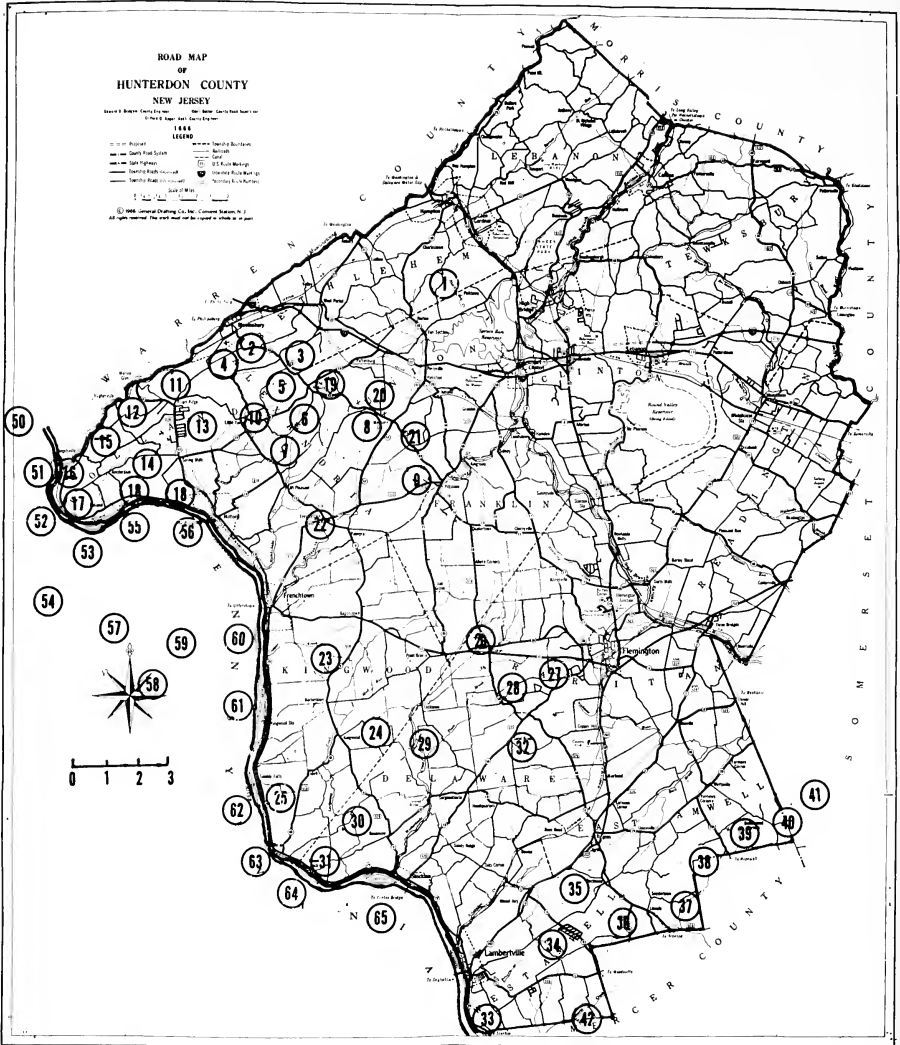

FIG. 2. Map of Hunterdon County and adjacent areas showing distribution of Brood X in 1970. See text for details.

The western boundary of Hunterdon County, along the Delaware River, is in most places a steep escarpment, usually wooded. Smith described the 1902 emergence along the river in these words: "Running south along the Delaware, the Warren County area of infestation extends into Hunterdon County and for its full length. It is broken, of course, at several points, notably at towns and settled areas, but practically the ridge back of the river is all cut by the Cicada." (His expression "cut by the cicada" refers to oviposition injury to trees.)



In 1970, very little cicada activity could be found along this same route. South of Milford, only three populations were found. One of these, No. 25, was found one mile north of Byram, and another, No. 31, was at Raven Rock but no other evidence could be found of the extensive emergence described by Smith as occurring between Raven Rock and Tumble Falls. The third population, No. 33, was found at Goat Hill, on the Hunterdon County line, at the end of the Sourland outcrop.

The total list of Hunterdon county localities is as follows (Fig. 2):

Hunterdon County Localities	
Figure 2	
No.	Locality
1.	Musconetcong Mountain, north of Polktown
2.	Musconetcong Mountain, route 41, 1 mile south of Bloomsbury
3.	Ridge, 3 miles south of Bloomsbury, on the Pattenberg-Bloomsbury road
4.	Musconetcong Mountain, portion known as "Bloomsbury Mountain"
5.	Ridge, west of route 579
6, 7.	Along township road, south of Hickory Corner
8.	West of route 579 at Mechlin's Corner
9.	One mile west of Pittstown
10.	Little York
11.	Musconetcong Mountain, north of Riegel Ridge
12.	Musconetcong Mountain, on the south side of route 519
13.	East of route 519, between Riegel Ridge and Spring Mills
14.	One mile west of Spring Mills, off the Amsterdam road
15.	Musconetcong Mountain, Finesville (Warren County)
16.	Along Delaware River, Musconetcong Mountain (Mt. Joy)
17.	Along Delaware River, Musconetcong Mountain (Riegelsville Curve)
18.	Along Delaware River, Milford-Holland road, continuous for 1 mile
19.	Hickory Corner, east side of route 579
20.	East side, route 579, north of Mechlin's Corner
21.	East side, route 579, Mt. Salem
22.	Everittstown, south side of route 513
23.	Kingwood Township, route 519, 2 miles south of Baptistown
24.	Kingwood Township, east of route 519, along Kingwood-Locktown Road
25.	Along Delaware River, 1 mile north of Byram
26.	Croton, north of state highway 12
27.	Hardscrabble Hill, 2 miles west of Flemington
28.	Route 579, 2 miles south of Croton
29.	One mile south of Locktown
30.	East of route 519, 1 mile north of Rosemont
31.	Along Delaware River at Raven Rock
32.	Route 523 at Sand Brook
33.	Along Delaware River at Goat Hill
34.	West of Hunterdon Hills Regional High School
35.	West of Rocktown
36.	West of Linvale, 1 mile
37.	West of route 518, Snyderdertown road

38. On the Mercer County line, west of the Wertsville-Hopewell road
39. One mile west of Buttonwood Corners
40. On the Mercer County line, Wertsville-Zion road
41. Zion (Somerset County)
42. On the Mercer County line, one mile west of Harbourton

Although Smith's map of the 1902 emergence bears some discrepancies with his text, it is clear that the extent of Brood X distribution in the Warren-Hunterdon-Mercer-Somerset region has been greatly reduced in the intervening 68 years. Whether the remaining populations have much prospect for continued existence is an interesting question. Since the Delaware River is no more than one hundred yards wide at Frenchtown, and becomes much narrower upstream, there is some possibility that future reestablishment from Pennsylvania might occur if ecological conditions permit, in the event of the loss of the Hunterdon populations. Accordingly, several field trips were made to scout for cicada populations within five miles of the river in Pennsylvania. In a single day of field work, 16 populations were found, shown on Figure 2 as follows:

Pennsylvania Localities:

50. Raubsville
51. Riegelsville (Pa.)
52. Durham Furnace (ruins)
53. Kintnersville
54. Ferndale
55. Opposite Holland, N. J.
56. Upper Black Eddy
57. Tohickon Park
58. Ralph Stover State Park
59. Erwinna-Ottsville road
60. Tinicum Park
61. Stover Mills
62. Lumberville
63. Opposite Byram, N. J.
64. Opposite Raven Rock, N. J.
65. Solebury

The extension of Musconetcong Mountain into Pennsylvania, sometimes called the "Reading Prong," was reported by various correspondents to be heavily populated by the cicadas, but no effort was made to determine their distribution at points more than five miles from the river.

#### DISCUSSION

In 1902, Smith gathered his information on the distribution of periodical cicada populations in three ways: (1) by general and professional correspondence, (2) from the reports of 127 "official crop correspondents" scattered throughout the state, and (3) by his own travels, chiefly by railroad. In 1970,

the relative ease of gathering information by automobile and the generous help of colleagues and county extension agents, as well as many letters from the general public, made the writer's undertaking both a much easier task and, presumably, a more thorough one. From the compared data it is at least clear that a very marked reduction in the number of Brood X populations has taken place between 1902 and 1970. This reduction involves both the loss of isolated populations and a considerable reduction in the extent of the regional distribution now centered in Hunterdon County.

With respect to these losses, it is of some interest to consider a statement made by Marlatt (1898): "The greatest check on the species has been the advent of European man on this continent and the accompanying clearing of woodland and the increase of settlement. The vast areas in the more-densely populated East which were once thickly inhabited by one or the other of the broods of the periodical cicadas, are rapidly losing this characteristic and the Cicada will doubtlessly appear in fewer and fewer numbers in all settled districts." Marlatt illustrated this prophecy with an account of the fate of Brood XI in the Connecticut Valley, which appeared in great abundance in 1869, but seemed doomed to virtual extinction by 1903 "as a result of the steady reduction of woodlands."

Some of the loss of Brood X in New Jersey since 1902 was very probably due to man's direct interference, especially in Mercer and Somerset. The loss of woodlands for agricultural use, however, has probably not been significant. Rather, the development of homesites, especially as large-scale undertakings, would appear to have been a more likely cause. Smith believed that both domestic fowl and the English sparrow played a significant part in the extermination of some populations, especially in the case of isolated counties.

The situation in Salem County, where two 1902 populations appeared to have been lost, and two "new" populations were found in 1970, may involve nothing more than a relocation of the 1902 populations in the four-generation interval. Lloyd and Dybas (1966) point out that female cicadas are very prone to oviposit in the young trees of an advancing forest edge. Whether such a mechanism could result in such extensive relocations is not easily decided.

Perhaps future study of the Indian Mills population (Fig. 1, 9) may provide some information on this question. This population was found in woodlands about one-half mile from the boundary of the State-owned Wharton Estate and coextensive with the State lands. It is very unlikely that there will be any future human activity deleterious to the cicadas.

The future of the Hunterdon County populations can be speculated upon only with considerable uncertainty. The three populated regions described in this paper (the Musconetcong Mountain and ridge area, the Hunterdon plateau, and the Sourlands outcrops) offer so little advantage to agriculture that further destruction of woodlands to that end seems unlikely. While there has been some home-building in all three regions, the pressure for home sites does not appear

to be very threatening. Also, a large part of the Sourlands area in Somerset County has been purchased and set aside as preserved land, and may permit the cicadas to endure in at least that much of the Sourlands.

Perhaps a more immediate threat exists in the destructiveness of another insect, the gypsy moth. Mr. John Kegg of the N. J. State Department of Agriculture has kindly supplied the writer with detailed maps of defoliation caused by the gypsy moth from 1971 through 1974. Past experience suggests that considerable loss of oak and other deciduous trees is likely to result from such defoliation after three successive years. The areas of heaviest defoliation in Hunterdon County correspond very closely with the greatest concentrations of periodical cicada populations (Fig. 2), but whether the cicada nymphs can survive such tree losses is uncertain.

Perhaps a more immediate evaluation of the possible impact of tree loss caused by gypsy moth defoliation on the periodical cicadas will be possible in 1979, when Brood II, the other major brood in New Jersey, would mature. Smith (1912) compiled fairly detailed records on the distribution of Brood II in 1911. The Wanaque Reservoir forests in Passaic County, an area heavily populated by Brood II of the cicadas, have been studied intensively by Mr. Kegg in an evaluation of gypsy moth activity, and have also, by virtue of being on a protected watershed, been fairly free of human activities detrimental to the cicadas. The fate of Brood II in this area in 1979 may therefore be of special interest in determining the impact of tree loss caused by the gypsy moth on the periodical cicada.

Apart from the possible effect of the gypsy moth on the Hunterdon County cicada distribution, it should be of interest to determine in 1987, 2004, 2021, *et seq.* what happens to the Hunterdon populations. It was primarily with the hope of providing a basis for such determinations that the writer sought to locate each Hunterdon population, although it must be admitted as quite possible that some populations were missed. At any rate, the behavior and ecology of an insect species with a 17-year life cycle offers an interesting challenge to the human species.

#### Literature Cited

- ALEXANDER, RICHARD D. AND THOMAS E. MOORE. 1962. The evolutionary relationships of 17-year and 13-year cicadas, and three new species (Homoptera, Cicadidae, *Magicicada*). Misc. Pub. Museum Zoology. Univ. Mich. No. 121; 59 pp., frontis (color) and 10 text f.
- DAVIS, WILLIAM T. 1926. The cicadas or harvest flies of New Jersey. Circular No. 97. N. J. State Dept. of Agriculture. 27 pp.
- HEADLEE, THOMAS J. 1919. Report of the Department of Entomology of the New Jersey Agricultural College Experiment Station for the year ending June 30, 1919. 375-519.
- LLOYD, MONTE AND DYBAS, HENRY S. 1966. The periodical cicada problem. I. Population ecology. *Evolution*, 20: 133-149.

- MARLATT, CHARLES L. 1898. The periodical cicada. Bull. No. **14**, New Series. USDA Division of Entomology. 147 pp.
- . 1907. The periodical cicada. Bull. No. **71**, USDA, Bureau of Entomology. 181 pp., frontis (color).
- SMITH, JOHN B. 1903. The periodical cicada. Twenty-third annual report of the New Jersey State Agricultural Experiment Station, pp. 474-489.
- . 1912. The periodical cicada. Thirty-second annual report of the New Jersey State Agricultural Experiment Station, pp. 454-466.
- WEISS, HARRY B. 1916. The distribution of the periodical cicada in New Jersey. Entomological News, **27**: 337-340. 1 plate.

---

### BOOK REVIEW

**Tissue Culture: Methods and Applications.** Paul F. Kruse, Jr., and M. K. Patterson, Jr., eds. Academic Press, New York. 868 pp. \$22.00.

This book describes the uses of tissue culture in a wide variety of disciplines. Entomologists will be particularly interested in Imogene Schneider's chapters, "Dipteran embryos and larvae (Diploid lines)" and "Characteristics of insect cells," E. P. Marks' "Cockroach and grasshopper embryo tissue," and Arthur E. Greene and Jesse Charney's "Invertebrate cell cultures." In addition, such chapters as Leonard Hayflick's "Screening tissue cultures for mycoplasma infections" and Michael F. Barile's "Mycoplasma contamination of cell cultures: Incidence, source, prevention, and problems of elimination" are of pertinent interest to all engaged in attempting to grow insect cells and tissues *in vitro*. More than 100 authors contributed to this volume; it should serve as a reference source for both experts and beginners using tissue culture for years to come. Its usefulness as a guide is enhanced by a detailed author and subject index, totaling 39 pages. Excellent illustrations of cultured cells and karyotypes, as well as of specialized equipment, add to the value of this book.

KARL MARAMOROSCH

**Terrestrial Mites of New York (Acarina: Prostigmata), I—  
*Tarsocheylidae, Paratydeidae, and Pseudocheylidae***

MERCEDES D. DELFINADO<sup>1</sup>

NEW YORK STATE MUSEUM AND SCIENCE SERVICE, ALBANY, NEW YORK 12224

EDWARD W. BAKER

SYSTEMATIC ENTOMOLOGY LABORATORY IIBIII, AGRICULTURAL RESEARCH SERVICE,  
USDA, BELTSVILLE, MARYLAND, 20705

RECEIVED FOR PUBLICATION JUNE 21, 1974

**Abstract:** The mites here described were collected from Long Island, Lake Champlain region, and the Mohawk Valley area, New York, in June–October of 1973. The new species described are: Tarsocheylidae, *Hoplocheylus similis*, *H. americanus*; Paratydeidae, *Scolotydaeus simplex*; Pseudocheylidae, *Anoplocheylus transiens*. Twenty-six figures are presented. The genus *Neotydeus* Baker is synonymized with *Scolotydaeus* Berlese.

For many years New York has been a favorite collecting ground for various arthropods, and extensive collections have been accumulated in different state institutions (Leonard, 1928). This has not been the case with mites, however, and our knowledge of the mite fauna of this area is almost nonexistent. A survey of terrestrial mites was started in New York in the summer of 1973 by M. D. Delfinado. This collection forms the basis of a proposed series of papers on the mites of New York and neighboring areas.

The present paper deals only with the free-living or primary-feeding and predaceous mites of the families Tarsocheylidae, Paratydeidae and Pseudocheylidae. Members of these families are rather uncommon and only rarely collected. They occur in soil, forest litter and debris, under tree bark and rotten wood, and in moss. One species of Tarsocheylidae, however, was found under the elytra of a passalid beetle in the Congo (Cooreman, 1951). Other Prostigmata collected will be dealt with in later papers.

The mites reported here were collected by the authors and M. Abbatiello from Long Island, the Lake Champlain region and the Mohawk Valley area in June–October 1973, by use of Tullgren-Berlese funnels from forest soil, litter and debris, tree holes and hollow tree trunk debris.

---

**Acknowledgments:** Sincere thanks are due Michael Abbatiello and the administration of the Biology Department at New York State University at Farmingdale, Long Island, who generously provided laboratory facilities and space.

<sup>1</sup>Published by permission of the Director, New York State Science Service, Journal Series No. 159.

## Family Tarsocheylidae

Genus *Hoplocheylus* Atyeo and Baker, 1964

*Hoplocheylus* Atyeo and Baker, 1964, Bull. Univ. Nebraska St. Mus. 4: 247. Type-species, *Tarsocheylus atomarius* Berlese, by original designation.

The genus *Hoplocheylus* has the following general characteristics of the family: presence of dorsal hysterosomal plates and a pair of pseudostigmatic organs on propodosomal plate; reduced palpal tarsus and absence of femoral division and pretarsal pedicels on all legs; and presence of simple peritremes with stigmata located on the shoulders of propodosoma as in the Tarsonemini. Atyeo and Baker (1964: 246) in a key to the genera used principally the presence or absence of empodia on legs I (absent in *Hoplocheylus*, present in *Tarsocheylus*) and the structure of palpal tarsus (papilliform in *Tarsocheylus*, indistinguishable or missing in *Hoplocheylus*). Seven species were known in *Hoplocheylus*. Two new species are present in the collection from New York.

*Hoplocheylus similis*, n. sp.

(Figures 1-11)

*H. similis* may be distinguished from the closely related species: *H. discalis* Atyeo and Baker, *H. pickardi* Smiley and Moser and *H. americanus*, n. sp. by having the distal solenidion short and not reaching beyond tarsal claws I; by the forked distal setae on tarsi II-IV; by the narrow first medial dorsal plate with sides bulging at the level of the setae, and by the very long posterior dorsal setae on the third hysterosomal plate surpassing the posterior margin of the fourth plate.

*Female.* Length of body including gnathosoma, 574 microns. Palpus with genu and femur completely fused and with a small inner protuberance; tibiotarsus with 5 simple, long setae, one rodlike solenidion and 2 small unequal subterminal spines as in figures 4 and 5. Chelicerae fused into a single unit and truncate at apex, with 2 pairs of dorsal setae; gnathosoma with two pairs of ventral setae, posterior pair about 3 times as long as anterior pair. Dorsal propodosomal plate bearing a pair of clavate pseudostigmatic organs near lateral margin and 3 pairs of dorsal setae. Peritremes as in figure 3, with stigmata on shoulders of propodosoma, distal ends of tracheae converging medially between propodosomal setae. Hysterosoma (figure 1) dorsally with 4 medial plates and a pair of lateral or humeral plates; first dorsal plate narrow, about twice as long as wide, with sides bulging at level of setae; second plate squarish, about as wide as long, with a pair of short setae; third plate slightly wider than long, with 2 pairs of unequal setae, posterior pair reaching beyond posterior margin of fourth plate; fourth plate with 2 pairs of posterior setae, median pair about 3 times as long as lateral pairs. Dorsal anal region with a pair of terminal setae. Venter as in figure 2, with large rectangular hysterosomal plate, 2 elongate plates between coxae IV each with 2 setae, and 2 large paragenital plates each bearing pair of setae. Leg chaetotaxy as follows; the numbers represent coxa, trochanter, femur, genu, tibia and tarsus:

Leg I. 4-1-4-5-6+2-13+2

Leg II. 3-1-3-4-5+1-8+1

Leg III. 3-2-2-4-5+1-8

Leg IV. 2-1-2-5-5-7

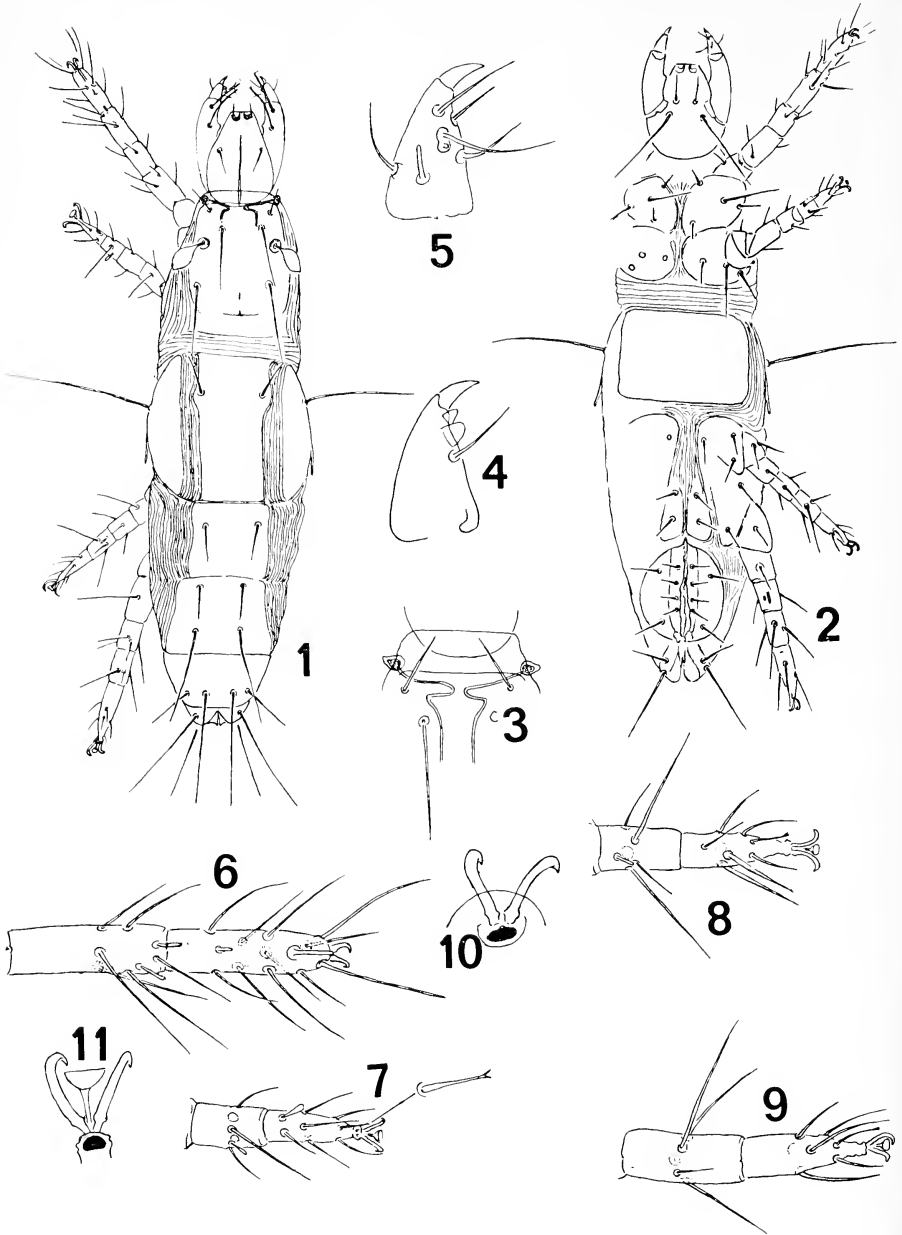

*Hoplocheylus similis*, n. sp. 1, dorsal surface of female; 2, ventral surface of female; 3, peritremes; 4, dorsum of palpal tibia-tarsus; 5, venter of palpal tibia-tarsus; 6, tibia and tarsus I; 7, tibia and tarsus II; 8, tibia and tarsus III; 9, tibia and tarsus IV; 10, claws of leg I; 11, claws and empodium of leg I.



Tarsus I lacks empodium; empodia present on tarsi II-IV; claws present on all legs; solenidion present on tibia I-III, absent on IV; anterior distal seta on tarsi II-IV forked apically; tarsi I and II with 2 and 1 short solenidia respectively; coxae III not entirely separated from coxae IV.

*Male.* Not known.

*Holotype.* Female, collected from tree hole debris, Sunken Meadow, North Shore, Long Island, New York, June 26, 1973, by M. D. Delfinado and M. Abbatiello, deposited in the New York State Museum and Science Service, Albany.

*Paratypes.* Four females, same data as holotype, in the U.S. National Museum and New York State Museum and Science Service collections.

*Hoplocheylus americanus*, n. sp.

(Figures 12-16)

This new species resembles *H. longispinus* Atyeo and Baker and *H. canadensis* Marshall in most respects, and the 3 species are evidently closely related morphologically. The most distinctive characters of *H. americanus* are the long solenidia on tarsus and tibia of leg I, and the very small subterminal spines on the palpal tibia and the shape of the ventral hysterosomal plate.

*Female.* Length of body including gnathosoma, 466 microns. Palpus with genu fused with femur; tibiotarsus with 5 simple setae, one rodlike solenidion and 2 very small, equal in size subterminal spines as in figure 15. Chelicerae fused into a single unit and truncate apically, with 2 pairs of dorsal setae; gnathosoma with 2 pairs of ventral setae, posterior pair only slightly longer than anterior pair. Dorsal propodosomal plate with a pair of pseudostigmatic organs near lateral margin and 3 pairs of dorsal setae. Peritremes situated on shoulders of propodosoma. Hysterosoma (figure 12) with 4 medial dorsal plates and a pair of lateral or humeral plates; first medial dorsal plate longer than wide, with 2 setae; second plate squarish, with 2 setae; third plate large, about as broad as long, with 2 pairs of setae, the posterior pair longer than anterior pair but not reaching posterior margin of fourth plate; fourth plate with 2 pairs of posterior setae nearly equal in length. Dorsal anal region with a pair of terminal setae. Venter as in figure 13; hysterosomal plate large with rounded posterior margin. Leg chaetotaxy as follows; the numbers represent coxa, trochanter, femur, genu, tibia and tarsus:

Leg I. 4 - 1 - 5 - 5 - 6 + 2 - 14 + 2

Leg II. 3 - 1 - 3 - 4 - 5 + 1 - 7 + 1

Leg III. 3 - 2 - 2 - 4 - 5 + 1 - 8

Leg IV. 2 - 1 - 2 - 5 - 5 + 1 - 7

Tarsus I lacking empodium; empodia present on tarsi II-IV; claws present on all legs; tibia I-IV each with a solenidion; tarsi I and II with 2 and 1 long solenidia respectively; the distal solenidion on tarsus I very long, reaching apices of claws; coxae III fused with coxae IV.

*Male.* Not known.

*Holotype.* Female, collected from soil and pine debris, Lake Champlain region, New York, October 15, 1973, by M. D. Delfinado and E. W. Baker, and deposited in the New York State Museum and Science Service, Albany.

*Paratypes.* Eight females, same data as holotype, in the U.S. National Museum and New York State Museum and Science Service collections.

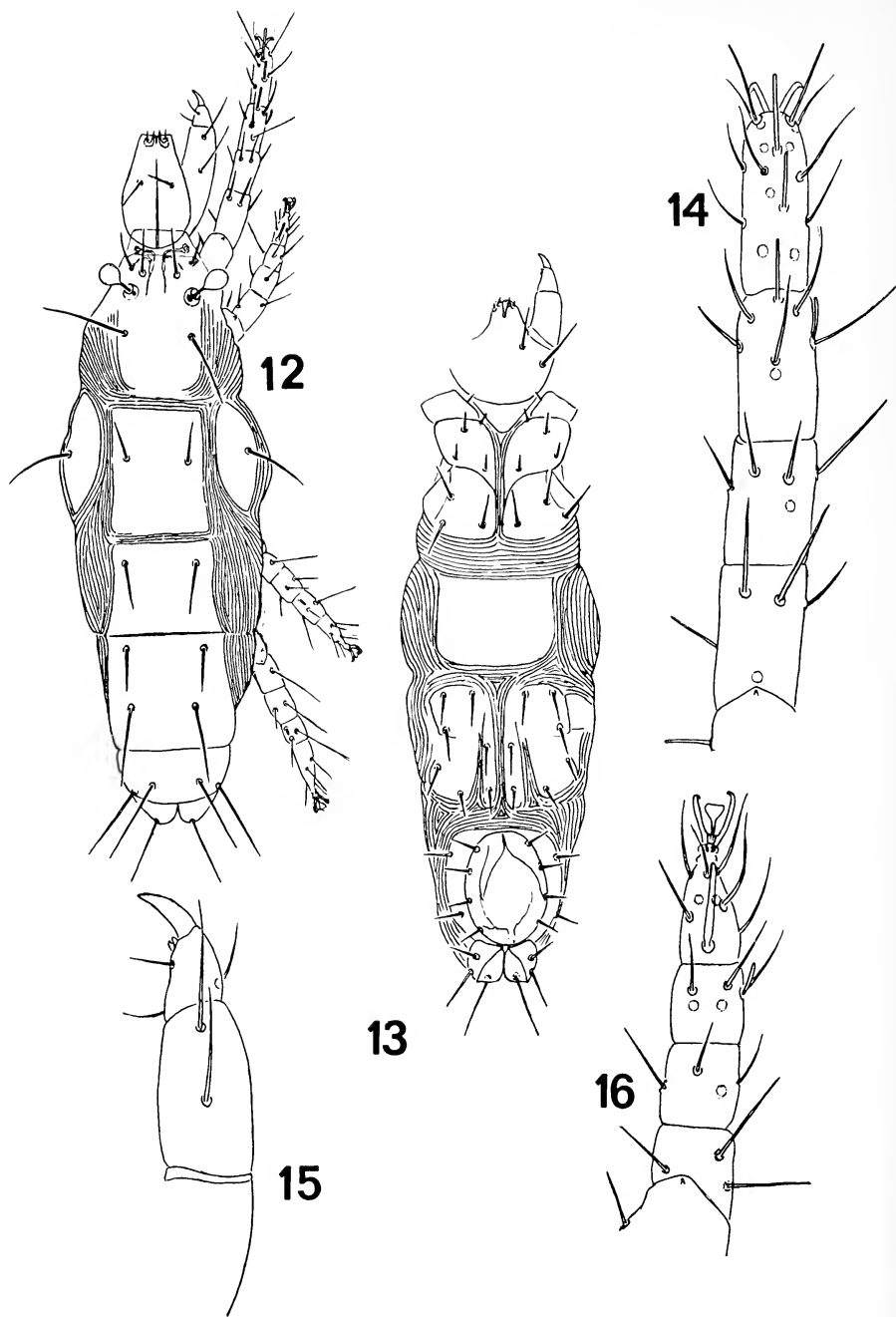

*Hoplocheylus americanus*, n. sp. 12, dorsal surface of female; 13, ventral surface of female; 14, leg I; 15, dorsal view of palpus; 16, dorsal view of leg II.

## Family Paratydeidae

Genus *Scolotydaeus* Berlese, 1910

*Scolotydaeus* Berlese, 1910, Redia 6: 214. Type-species, *Scolotydaeus bacillus* Berlese, by monotypy.

*Neotydeus* Baker, 1950, Jour. Wash. Acad. Sci. 40 (6): 289. Type-species, *Neotydeus ardisannae* Baker, by original designation. *New synonymy*.

The monotypic genus *Scolotydaeus* was previously known only from a brief description, figure and notes by Berlese (1910), Thor (1933), and Baker (1949) who placed it in the family Tydeidae. Baker (1950) later placed it in the Paratydeidae with *Paratydeus* Baker, 1949, and *Neotydeus* Baker, 1950. *Neotydeus* has proved to be a synonym of *Scolotydaeus*.

The genus *Scolotydaeus* primarily possesses the characters of the family (Baker, 1949, 1950) in that the hysterosoma is divided transversely at the third pair of legs; the palpus is simple; tarsal claws are present on all legs, with small, clawlike empodia, and the proximal venter of femora has a tiny, broadened dark 'seta.' The peritremes are simple, arising from the bases of the chelicerae. The propodosoma lacks the lenslike eyes of *Paratydeus*. The genus now includes 3 species; the one from New York is being described as new.

*Scolotydaeus simplex*, n. sp.

(Figures 17-22)

*Scolotydaeus simplex* is similar to *S. ardisannae* (Baker) in several respects. It is distinguished by its very long solenidia on tarsus and tibia of legs I and much longer posterior (third) propodosomal, humeral and posterior dorsal hysterosomal setae.

*Male*. Length of body including gnathosoma, 466 microns. Palpus 4-segmented, femur-genu and tibia each with 2 long setae, tarsus with 3 rodlike and 4 short slender setae and one small lateral solenidium. Chelicerae coalesced, suture obvious, movable chela curved and strong, fixed chela not developed (fixed and movable chelae not opposed); gnathosoma with 2 pair of setae, anterior pair shorter. Peritremes simple, short, lightly hooked distally and arising from cheliceral bases. Propodosoma with anterior lateral peglike solenidia; integument striate anteriorly, with 3 pair of slender setae, the anterior median pair long and slender, the posterior pair slightly longer than anterior pair; eyes lacking. Hysterosoma elongate, divided transversely at third pair of legs; humeral setae long, dorsal setae short and slender; areas posterior to third pair of legs with first 2 pairs of setae in longitudinal row; posterior setae in transverse rows, posterior lateral setae shorter. Venter as in figure 18, ventral hysterosomal setae longer than setae at genital region with 4 pairs of genital and 6 pairs of paragenital setae, transverse row of posterior ventral setae and 2 pairs of anal setae. Internally, genitalia with 5 pairs of short setae, and 4-5 pairs of short spines on internal "spermatophore" apparatus (not figured). Leg chaetotaxy as follows; the numbers represent coxa, trochanter, femur, genu, tibia and tarsus:

Leg I. 4-0-3 + 5 (\*) - 6-8 (7 + 1) - 12 + 1

Leg II. 3-1-2-2-4-7

Leg III. 2-1-3-2-3-5

Leg IV. 2-0-3 + 1 (\*) - 1-3-5

Claws large, uncinata; empodia of all legs small and uncinata; femora I and IV divided into basi- and telofemur with setal count as above (\*). All solenidia on tarsus and tibia of legs I very long and nearly equal in length.

*Female*. Similar to male, except genitalia much longer. Length same.

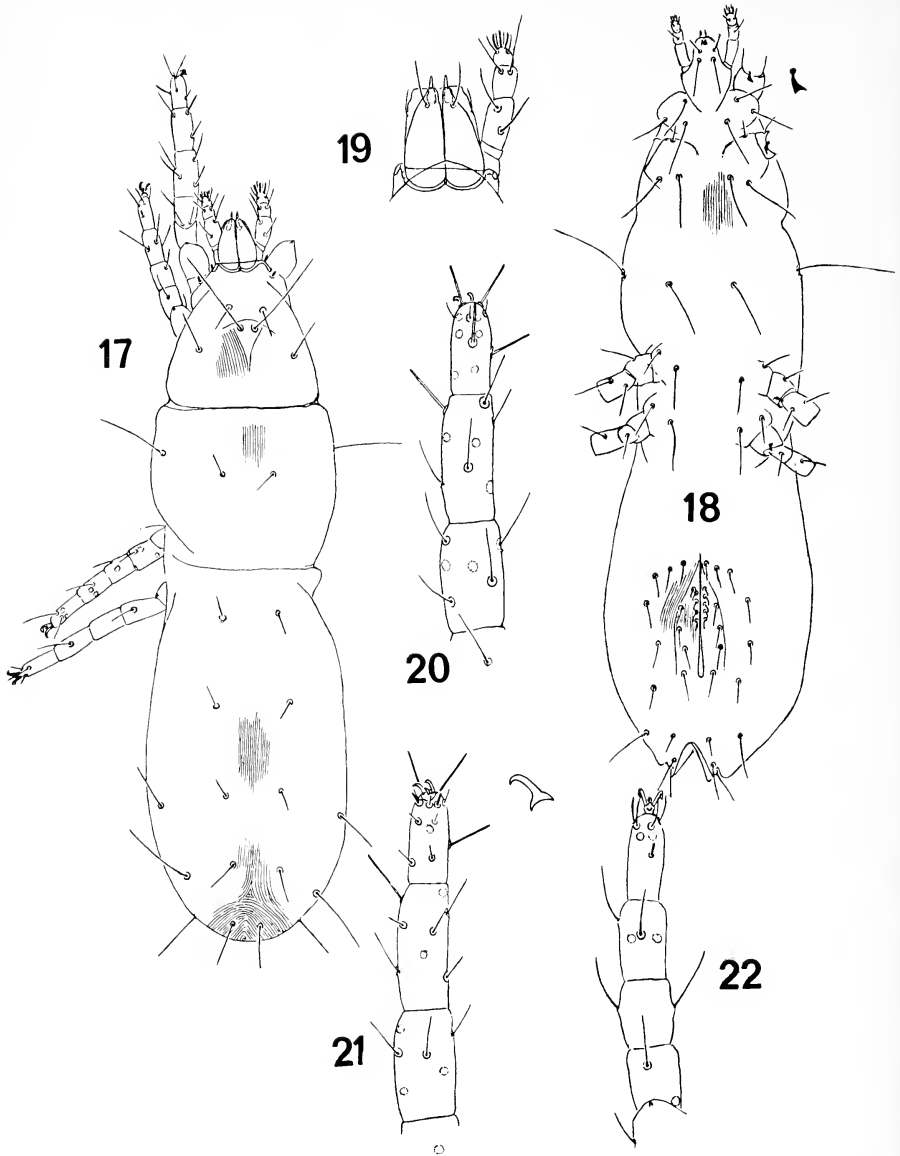

*Scolotydaeus simplex*, n. sp. 17, dorsal surface of male; 18, ventral surface of male; 19, details of gnathosoma; 20, dorsal view of leg I; 21, ventral view of leg I with detail of tarsal claw; 22, dorsal view of tibia II.

*Holotype*. Male, collected from pine debris, bark and roots, Hague, Lake George, Adirondack Park, New York, October 11, 1973, by M. D. Delfinado and E. W. Baker, deposited in the New York State Museum and Science Service, Albany, N.Y.

*Paratypes*. Two females, with the above data, in the U.S. National Museum and New York State Museum and Science Service collections.

## Family Pseudocheylidae

Genus *Anoplocheylus* Berlese, 1910

*Pseudocheylus*, subg. *Anoplocheylus* Berlese, 1910, Redia 6: 210. Type-species, *Pseudocheylus* (*Anoplocheylus*) *europaeus* Berlese, by original designation.

*Rhagina* Womersley, 1935, Rec. So. Australian Mus. 5 (3): 336. Type-species, *Rhagina protea* Womersley, by original designation.

This genus is characterized by the absence of claws on all legs which terminate with a stalked membranous empodia. The peritremes are simple, chambered and located in the membrane connecting the gnathosoma and propodosoma; the palpal tarsus complex is lacking; the chelicerae are attached basally and are movable laterally; a pair of lenslike eyes is located on the anterior outer margins of the propodosomal plate. Five species were previously known in the genus *Anoplocheylus*. The new species here described from New York is the first records of the genus in North America.

*Anoplocheylus transiens*, n. sp.

(Figures 23-26)

*Anoplocheylus transiens* is similar to *A. aegypticus* Baker and Atyeo and *A. tauricus* Livshitz and Mitrofanov in having the subcuticular reticulate bands on the propodosoma. It differs in having all dorsal hysterosomal setae of approximately equal length. We have examined adult and immature specimens of *aegypticus* and confirmed the presence of 3 coxal setae as figured. The text (Baker and Atyeo, 1964: 268) is in error stating that coxa II has 4 setae.

*Female* (?). Length of body including gnathosoma, 530 microns. Palpus without thumb-claw complex, with 4 distinct segments and a terminal claw. Peritremes chambered throughout, arising at bases of chelicerae and situated on membrane separating gnathosoma from propodosoma. Chelicerae hinged at bases and capable of lateral movement. Propodosomal plate with fine, longitudinal striae; a single pair of lenslike eyes; 4 pairs of short setae, the median pair located between anterior trichobothria; the posterior marginal pair quite long and slender; subcuticular reticulate bands on propodosoma posterior to trichobothria. Hysterosoma with transverse striae anteriorly and posteriorly, longitudinal in region of coxae III and IV; humeral setae long, slender; dorsal body setae all short except for posterior setae of varying lengths. Genitalia longitudinal, usually with 4 pairs of short genital setae and 3 pairs of paragenital plates. Sternal area with 2, 3 or 4 short setae. All legs ending in stalked membranous empodia, claws lacking. Leg chaetotaxy as follows, the numbers refer to coxa, trochanter, basifemur, telofemur, genu, tibia and tarsus:

Leg I. 5-1-8-6-7-8+1-19+4

Leg II. 3-1-2-4-5-5-9+1

Leg III. 3-2-2-3-4-5-9

Leg IV. 2-1-1-2-4-6-9

*Male*. Not known.

*Holotype*. Female (?), collected from leaf litter, Rensselaerville, New York, October, 1973 (no exact date), by M. D. Delfinado, deposited in the New York State Museum and Science Service, Albany.

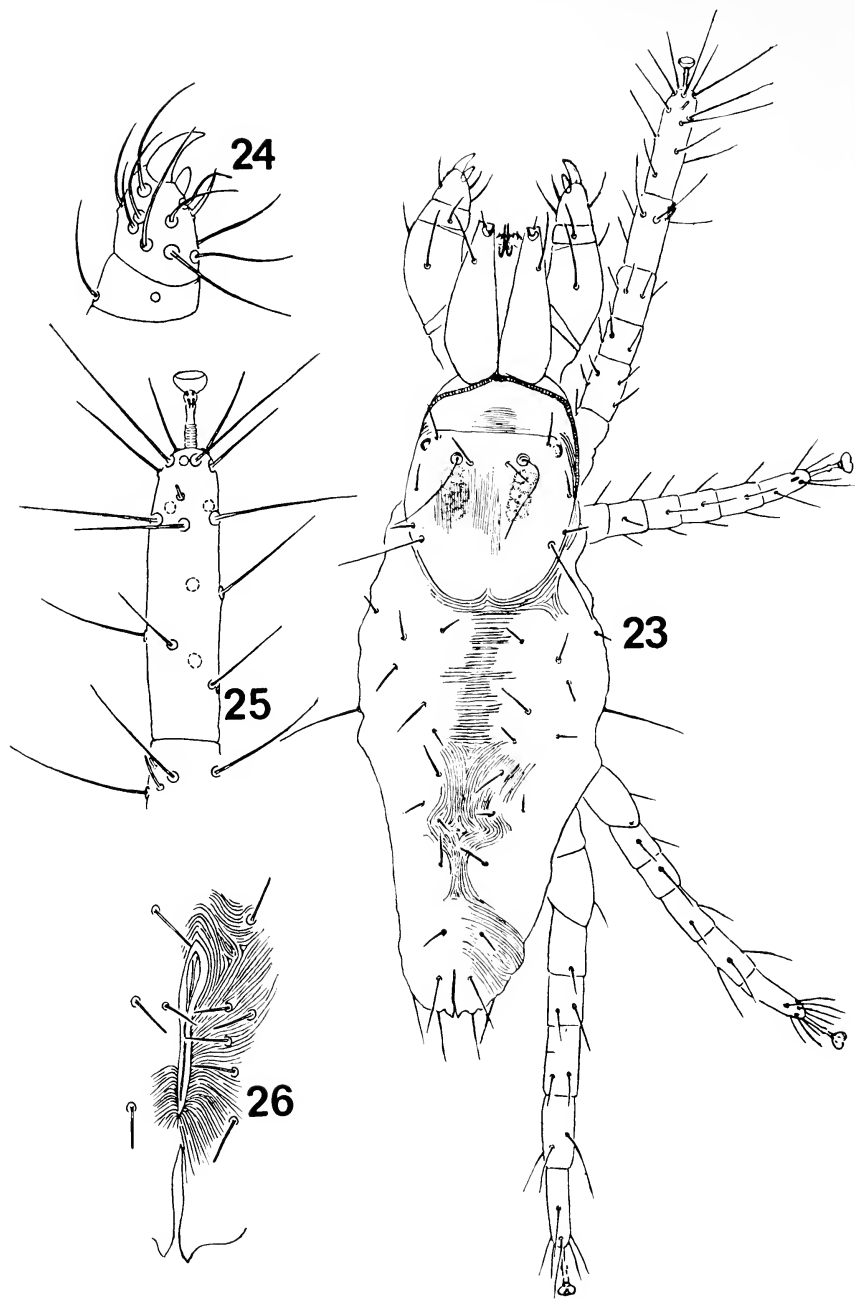

*Pseudocheylus transiens*, n. sp. 23, dorsal surface of female; 24, distal portion of venter of palpus; 25, palpus I and distal portion of tibia I; 26, genitalia.

*Paratypes*. Seven females (?), 4 with the above data; 1 from litter, Taconic Parkway, New York, June 16, 1973; 1 from litter, Heckscher Park, Long Island, New York, June 14, 1973; and 1 from debris, Rt. 87, 36 miles from New York City, July 22, 1973, all collected by M. D. Delfinado, deposited in the U.S. National Museum and New York State Museum and Science Service collections.

#### Literature Cited

- ATYEO, W. T., AND BAKER, E. W. 1964. Tarsocheylidae, a new family of Prostigmatic mites (Acarina). *Bull. Univ. Nebraska St. Mus.* **4**(11): 243-256, figs. 1-16.
- BAKER, E. W. 1949. Paratydeidae, a new family of mites. *Proc. Ent. Soc. Washington* **51**(3): 119-122, figs. 1-8.
- . 1950. Further notes on the family Paratydeidae (Acarina) with a description of another new genus and species. *Jour. Washington Acad. Sci.* **40**(9): 289-291, figs. 1-7.
- AND ATYEO, W. T. 1964. A review of the mites of the family Pseudocheylidae Oudemans, 1909 (Acarina, Prostigmata). *Bull. Univ. Nebraska St. Mus.* **4**(12): 257-272, figs. 1-30.
- BERLESE, A. 1910. Acari nuovi. *Redia* **6**: 200-234, pls. 17-21.
- COOREMAN, J. 1951. Notes et observations sur les Acariens (IV). *Bull. Inst. roy. Sci. nat. Belg.* **27**(1): 4-7.
- LEONARD, M. D. 1928. A list of the insects of New York. *Mem. Cornell Univ. Agric. Expt. Sta.* **101**: 5-1093.
- LIVSHITZ, I. Z., AND MITROFANOV, V. I. 1973. A new species of the genus *Anoplocheylus* (Trombidiformes, Pseudocheylidae) from Crimea. *Zool. Zh. Akad. Nauk SSSR* **52**(5): 770-771. (In Russian).
- MARSHALL, V.G. 1966. Une nouvelle espèce d'acarien (Tarsocheylidae: Prostigmata) du sud-est du Canada. *Acarologia* **8**(1): 45-48.
- SMILEY, R. L., AND MOSER, J. C. 1968. New species of mites from pine. *Proc. Ent. Soc. Washington* **70**(4): 307-317, figs. 1-14.
- THOR, S. 1933. Fam. Tydeidae, Ereyenetidae. *Das Tierreich*, 1fg.60, pp. 1-45.

---

### Centennial of Entomology at Cornell

The faculty of the Department of Entomology at Cornell University will celebrate 70 years of entomology at Cornell on October 14 and 15 with a special symposium. John Henry Comstock graduated from Cornell in 1874 and we take this opportunity to honor the man who founded our department.

The symposium will bring many invited guests to the University and affords an opportunity for persons to discuss the dynamic aspects of entomology. The complete program will be carried in the September issue of the *Bulletin* of the Entomological Society of America.

## BOOK REVIEW

**The Gunong Benom Expedition, 1967:** Parts 11–13. R. Traub. *Bulletin of the British Museum (Natural History) Zoology*, Vol. 23, No. 9–11. London, 1972. Notes on zoogeography, convergent evolution and taxonomy of fleas (Siphonaptera), based on collections from Gunong Benom and elsewhere in Southeast Asia. I. New taxa (Pygiopsyllidae, Pygiopsyllinae), pp. 201–305, 58 plates. II. Convergent evolution, pp. 307–387, 20 plates. III. Zoogeography, pp. 389–450.

In the first paper of this series a new genus for the *S. robinsoni* group is erected, the hosts and distribution of the Malayan peninsular species of the group are discussed, a new genus for the *S. ferinus* group is described, and keys to the new and old forms are provided. Heretofore unknown males and females of various species are described for the first time. The molding influence of the environment on these fleas and the principles involved in their evolution and adaptation are described in the second article. In the third paper the author presents evidence that fleas in the family Pygiopsyllidae originated in the Australian region and moved to the mainland of Asia. He gives convincing data concerning the Australian roots of the genus *Medwayella*, which probably originated in Borneo, thereafter moving to the Asian mainland and Indochina, as well as to the Philippines. The speculation and discussion concerning the transport by rats of Palearctic fleas from the west and northwest, with at least one species, *Sigmacteus*, reaching New Guinea, are most interesting. Malaya, Sumatra, Java, and Borneo share many faunal features, but there are significant differences between the mammals and fleas of Sarawak and those of Sabah, with those of the former resembling Malaya more than the latter.

The descriptions of methods of collecting fleas in the tropics will be of special interest to field workers. The major collecting areas were in forests, at elevations between 800 and 2000 feet, usually in primary jungle but also in secondary forests and bamboo areas. Rats, tree shrews, and tree and ground squirrels were trapped and examined by the author while he served as Commanding Officer of the U.S. Army Medical Research Unit in Malaya from 1948 to 1959. In addition, collections were made by others throughout the Southeast Asian region. There were inherent disadvantages so far as collecting fleas on trapped animals was concerned. Fleas tend to leave their hosts soon after feeding, or leave the animals when the animals become excited and agitated. Heavy rain, a daily occurrence in the tropical rain forest, also depletes the flea population on trapped animals. Even more disastrous is the situation when killed animals are examined, because, within minutes, dead rats or squirrels invariably attract swarms of ants, rarely leaving fleas on the carcasses. Therefore, trapping was supplemented by shooting, usually at night, when the eyes of mammals would glow in the light from powerful flashlights.

Entomologists will find the descriptions of the new taxa, the discussion of the convergent evolution, and the zoogeography of fleas a useful guide and reference source for every aspect of flea research.

The definitive descriptions of fleas of Southeast Asia and the Indo-Australian Archipelago contained in these three superbly illustrated issues of the *Bulletin of the British Museum* will be of interest not only to taxonomists but also to medical officers and students of evolution. Altogether this monumental work, containing 244 pages and 78 plates, is truly outstanding. It constitutes exciting reading for everyone interested in the intriguing aspects of collecting and handling fleas and the formidable difficulties that may be encountered. Throughout the vast area of collection, *Stivalius sensu lat.* is a potential vector of plague, and, in fact, it has been found infected with plague in India and Java.

KARL MARAMOROSCH



## BOOK REVIEW

**The Common Insects of North America.** Lester A. Swann and Charles S. Papp. 1972. Harper & Row, New York. xiii + 750 pp., 8 color plates, 2,450 drawings. \$15.00

All but four very minor orders and most suborders, superfamilies, and families (275) are covered and characterized in some detail. A total of 1,422 species are illustrated and treated in some detail, and a great many others are mentioned and described briefly. Not only the adults but the early stages (when known) are described and often are figured. The range and chief environment of each species are given, as well as much information about habits, economic importance, foods, and chief natural controlling agents such as predators, parasites, and virus and bacterial diseases. An introductory section covers such important features as the general characteristics of insects, the chief phyla of animals and classes of arthropods, insect development and metamorphosis, predators and parasites, structures and some physiology, insect defense mechanisms (unfortunately, too short) and "the value of insects." There is a very usable pictorial key to the orders and an excellent geologic time chart covering the main groups of plants and animals, as well as the insects. There is also a very good glossary and a bibliography (perhaps too long) that includes many small papers and references in economic entomology. Throughout, the authors have used as simple and nontechnical language as possible. The black and white illustrations are mostly excellent, although some Lepidoptera do not show the patterns very well and there is some distortion of wing shapes. The scales of magnification or reduction are quite erratic. This can be a bit confusing, even though the size measurements are given. In the copy at hand the color reproduction is not very good.

It is always a problem to a reviewer to decide how much he is justified in listing errors, a good many of which are liable to creep into a book of this magnitude. For example, is such notice useful for corrections in subsequent editions? A couple of slips in the Lepidoptera, with which I have some acquaintance, are: the anal prolegs are not lacking in notodontid larvae, although reduced or greatly modified in many; the tympana of "most moths" are not in the mesothorax but in the metathorax (Noctuoidea). No mention is made of the abdominal tympana of the very large superfamily Pyraloidea. The enormous family Noctuidae has been short-changed; more of the abundant and biologically interesting members should have been included. And why was a highly aberrant specimen used to illustrate the American Copper?

A very large proportion of the insects included are of economic importance. It is hard to fault this, especially since such species are often abundant and likely to be noticed. But as a result many more ecologically significant and interesting species have been left out. I feel, too, that much more should have been included about the ecologic status of insects in their communities and their great importance in energy cycles, subjects in which, it is good to note, very large numbers of people are becoming interested. There is much information about the control of many species by natural means but very little about insecticides, on which we are still dependent in a great many cases (many "instant ecologists" would benefit by some hard facts here).

The geographic coverage is extremely good and is a welcome change from books that give undue importance to Eastern species. Canada and the West are justly represented. The classification and nomenclature are up-to-date, although there will always be subjective differences of opinion in these fields. Undoubtedly this book will be valuable to anybody with an interest in natural history and environmental studies as well as to many entomologists, especially students and those engaged in economic work.

ALEXANDER B. KLOTS

The American Museum of Natural History

## Proceedings of the New York Entomological Society

(Meetings held in Room 129 of the American Museum of Natural History unless otherwise indicated.)

### Meeting of October 2, 1973

The meeting was called to order by Dr. Howard Topoff, President, at 8:10 P.M. 24 members and 19 guests were present.

The minutes of the meeting of Tuesday, May 15, 1973, were approved as read.

Dr. Lawrence Limpel of Yonkers, N.Y., was proposed for Active Membership. His entomological interests are insect control and insect physiology. Mr. Lamar Holsheimer of Portland State College was proposed for Student Membership. His interests are Lepidoptera and Hymenoptera. Ms. Rosa Montes of Pace College was proposed for Student Membership. Her interests are myrmecology and general entomology. Ms. Mercedes Delfinado was proposed for Active Membership; her interests are Diptera and free-living terrestrial mites.

#### PROGRAM.

After a couple of short announcements by members of the Society Dr. Topoff introduced Dr. Norman Lin who talked about social insects. The title of his paper was "Evolution of Sociality in Insects."

Father Sullivan announced that the speaker for the meeting on October 16, 1973, will be Dr. Louis D. Trombetta, Isaac Albert Research Institute, Kingsbrook Jewish Medical Center. His topic will be: "Abnormal development in *Tenebrio* caused by a juvenile hormone analogy."

PETER MOLLER, *Sec.*

### Meeting of October 16, 1973

The meeting was called to order by Dr. Howard Topoff, President, at 8:10 P.M. 7 members and 9 guests were present.

The minutes of the meeting of Tuesday, October 2, 1973, were approved as read.

Ms. Mercedes D. Delfinado, of Albany, N.Y., was elected to Active Membership; her interests are in taxonomy of Diptera and free-living mites. Dr. Lawrence Limpel, of Yonkers, N.Y., was elected to Active Membership; his interests are in insect control and insect physiology. Ms. Rosa M. Montes, of Pace College, was elected to Student Membership. Her interests are in myrmecology and general entomology. Mr. Lamar Holsheimer, of Portland State College, was elected to Student Membership; he is interested in Lepidoptera and Hymenoptera.

Ms. Betty Lane Faber, of New Brunswick, N.J., was proposed for Active Membership. She is interested in insect behavior. Mr. S. M. Ulagaraj, of the University of Florida, was proposed for Student Membership; he is interested in behavior and bionomics of Orthoptera. Mr. Henry M. Knizeski, Jr., of Fordham University, N.Y., was proposed for Student Membership; he is interested in systematics and ecology in Hymenoptera. Mr. Charles William Calmbacher, of Fordham University, N.Y., was proposed for Student Membership. His interests are in Hymenoptera, systematics, and ethology of Sphecidae. Mr. James Wangberg, of University of Idaho, was proposed for Student Membership.

## PROGRAM.

Father Sullivan introduced Dr. Louis D. Trombetta, of the Isaac Albert Research Institute of Kingsbrook Jewish Medical Center. Dr. Trombetta presented a fascinating paper on "Abnormal Development in *Tenebrio* caused by a juvenile hormone analog."

The first meeting in November was cancelled because of Election Day.

Father Sullivan announced that the speaker for the meeting on November 20, 1973, will be the Society's own secretary, Dr. Peter Moller, of the Department of Psychology, Hunter College, and the Department of Animal Behavior, American Museum of Natural History. His topic will be: "How does a spider find its way home?"

The meeting was adjourned at 9:20 P.M.

PETER MOLLER, Sec.

### THE EFFECTS OF A JUVENILE HORMONE ANALOG ON THE DEVELOPMENT OF THE ANTENNA OF *TENEBRIO MOLITOR*

The developmental morphology and histology of the antenna of *Tenebrio molitor* as well as its musculature were described and compared with antennae of insects treated with a juvenile hormone analog. The juvenile hormone analog was code labeled JM-1-46 (4-Ethylphenyl 2-(2-Etoxy Etoxy)Ethyl Acetal). It was topically applied with a microliter syringe to the frontoclypeal suture of the pupa at a dose concentration of  $3\mu\text{g}/\mu\text{l}$  of acetone.

Three extrinsic antennal muscles and three intrinsic antennal muscles were described. The intrinsic antennal muscles all originated on the same surface of the scape.

The histology of the adult antenna revealed that the cuticle of the newly emerged insect was composed of two layers, the exocuticle and endocuticle, separated in some regions by a mesocuticle that alters considerably during the first week of development. The cuticle of the intersegmental membrane consisted of two layers that were continuous with the endocuticle. The epidermis was a simple epithelium that varied from cuboidal- to columnar-shaped cells, depending on the location and density of the underlying nervous tissue. The changes in the epidermis from the newly emerged to the one-week-old insect were described. Johnston's organ and an antennal blood vessel were also described. The antennal nervous and respiratory systems were similar to those in other insects, and the changes that occurred in these systems from the newly emerged to the one-week-old insect were described.

The morphogenesis of the antenna was divided into three stages, each of which was marked by specific characteristics in the developmental sequence. The early stage extended for the first four days after the larval-pupal molt, the intermediate stage continued through days 5,6,7 postpupation, and the late stage was days 8 through 12. The cuticle, epidermis, nervous system, tracheae, and blood vessel were described histologically at the larval-pupal molt, 24 and 48 hours postpupation, and 7 and 12 days postpupation. All the above structures were shown to undergo significant alterations during development.

Contrasted to the above findings were insects treated with the juvenile hormone analog. The development of the antenna of a treated insect determined the degree of muscle development. The antennal pupal case was very delicate and much thinner than the normal one and had the same sensory structures that were present on the normal pupal cuticle. The antennae of the treated insects showed four different morphological conditions. First, the antenna of the adult resembled the antenna at the larval-pupal molt, but was highly convoluted and had a very irregular cuticle. The cuticle was said to be juvenilized. Second, the antenna had both juvenilized regions and regions that appeared adultlike. Third, the distal

segments of the antenna were rounded in a manner not characteristic of the adults. Juvenalized patches of cuticle were scattered over the antennal surface. Fourth, two pupal cases were covering the antenna. The outer case resembled the original pupal case but the inner one was not as well defined.

Two general histological patterns were described for the treated antennae. The first pattern was for antennae where the cuticle appeared morphologically pupal and the second pattern was for antennae of insects where the cuticle appeared morphologically adultlike. A few aberrant antennal forms unlike the above were described.

Reversal of metamorphosis by juvenile hormone as stated by some previous investigators was shown to be unlikely. Rather, it seems more probable that the juvenile hormone analog acts upon the cell nucleus to produce abnormal characteristics.

LOUIS D. TROMBETTA  
Kingsbrook Jewish Medical Center

### Meeting of November 20, 1973

The meeting was called to order by Dr. Howard Topoff, President, at 8:10 P.M. 15 members and 15 guests were present.

The minutes of the meeting of October 16, 1973, were approved as read.

The following membership elections were held:

Mr. Henry M. Knizeski of Fordham University was elected to Student Membership. He is interested in the systematics and ecology of Hymenoptera.

Mr. Charles W. Calmbacher of Fordham University was elected to Student Membership. Mr. Calmbacher works on the systematics and ethology of the hymenopterous family Sphecidae.

Mr. S. M. Ulagaraj of the University of Florida at Gainesville, who specializes in the behavior and bionomics of Orthoptera, and Mr. James Wangberg of the University of Idaho, were elected to Student Membership.

Ms. Betty L. Faber of New Brunswick, New Jersey, whose main interest is behavior, was proposed for Active Membership.

PROGRAM. Dr. Topoff introduced Dr. Peter Moller of the Department of Animal Behavior of the American Museum of Natural History. Dr. Moller, our Secretary, was greeted with vigorous and sustained applause. His talk provided us with brilliant and provocative answers to the question "How does a spider find its way home?" Making effective use of slides and other illustrative material, he considered various aspects of aranean orientation behavior. The lecture was followed by prolonged and heated debate.

Our next meeting is scheduled for December 4, 1973, at which time Dr. David C. Rentz of the Department of Entomology of the Academy of Natural Sciences of Philadelphia will consider the question of mechanical reproductive isolating mechanisms in a talk entitled "The lock and key as an isolating mechanism in katydid."

The meeting was adjourned at 9:30 P.M.

CHARLES C. PORTER, *Asst. Sec.*

### Meeting of December 4, 1973

The meeting was called to order by Dr. Howard Topoff, President, at 8:15 P.M. 10 members and 5 guests were present.

The minutes of the meeting of November 20, 1973, were approved as read.

PROGRAM. Father Sullivan introduced Dr. David C. Rentz, Department of Entomology, Philadelphia Academy of Natural Sciences, who told us briefly about his experiences as president of the Philadelphia Entomological Society before he started his interesting talk about "The lock and key as an isolating mechanism in katydid's." His talk was followed by a lengthy discussion.

Father Sullivan announced that the speaker for the next meeting on December 18 will be Dr. Ross H. Arnett, Department of Biology, Siena College. He will talk about "Pollen-feeding beetles."

The meeting was adjourned at 9:10 P.M.

PETER MOLLER, *Sec.*

### Meeting of December 18, 1973

The meeting was called to order by Dr. Howard Topoff, President at 8:20 P.M. 12 members and 7 guests were present.

The minutes of the meeting of December 4, 1973, were approved as read.

Mr. Alberto Muyschondt of San Salvador was proposed for Active Membership. His entomological interests are Rhopalocera of Tropical America.

PROGRAM. Father Sullivan introduced Dr. Ross H. Arnett, Department of Biology, Siena College. In a fascinating talk illustrated with color slides Dr. Arnett introduced his audience to the phenomenon of "pollen-feeding beetles." A very interesting and heated discussion followed.

It was announced that the next meeting will be held on January 15, 1974. The speaker will be Mr. Frederick H. Miller, Jr., Nassau County Medical Center, who will talk about "The scanning electron microscope—A tool for entomologists."

The meeting was adjourned at 9:45 P.M.

Secretary's note: For the records it should be mentioned that this meeting was the last one chaired by President Howard Topoff, who, after two years of office, leaves the ranks of officers in the New York Entomological Society. The Society is grateful for his many innovations and hard work.

PETER MOLLER, *Sec.*

### THE ROLE OF POLLEN FEEDING IN COLONIZATION OF SMALL POPULATIONS WITH PARTICULAR REFERENCE TO COLEOPTERA

An understanding of some of the problems of small populations of colonizing species has been gained through a study of the role of pollen feeding by quantitative experimental ecological population studies. Selected species of oedemerid beetles, all obligate pollen

feeders, and all well-known taxonomically, have been studied in particular, along with other pollen-feeding beetles in general, by field experimentation involving population sampling, feeding experiments, and karyotype determination.

Many plants suffer very heavy predispersal pollen predation by a large variety of animals. In spite of the generally held view that insects are the responsible and required pollinators for many plants, it is certain that most of the produced pollen in these and other, noninsect pollinated plants goes as insect food without any self- or cross-pollination. In fact, some plants develop feeding anthers that produce a degenerate pollen used solely for food consumption. The development of these special pollen-feeding, nonpollinating structures, the chemical secretions used as attractants, and the ethological patterns in beetles that make this a mutual relationship are very poorly understood.

Oedemerid beetles are ideally suited for such studies because: 1) They are now relatively well known taxonomically through the previous research on the group by this investigator; 2) the breeding populations of almost all the species are very small, and there is abundant evidence to show that they are actively colonizing; and 3) they are all obligate pollen feeders with a specialized pollen rumen used when pollen foraging.

Two things are clear from the sketchy studies made of the pollen-feeding phenomenon: It is 1) a highly evolved chemical, structural, and ethological process, and 2) a large and important but as yet not fully exploited field of study. This, coupled with the need to know more about the factors operating during colonization attempts, has resulted in the accumulation of a wealth of data, but many questions remain unanswered.

ROSS H. ARNETT, JR.  
Siena College

**New York Entomological Society**

## PROGRAM SCHEDULE 1974/75

Guest speakers at forthcoming regular meetings:

October	1, 1974	Robert R. Granados Boyce Thompson Institute, Yonkers, N.Y.
October	15, 1974	Bert Hölldobler Harvard University, Cambridge, Mass.
November	5, 1974	Thomas Eisner Cornell University, Ithaca, N.Y.
November	19, 1974	Vincent G. Dethier Princeton University, Princeton, N.J.
December	3, 1974	Kenneth D. Roeder Tufts University, Medford, Mass.
December	17, 1974	Jerome S. Rovner Ohio University, Athens, Ohio
January	7, 1975	Arthur H. McIntosh Rutgers University, New Brunswick, N.J.
January	21, 1975	Karl Maramorosch Rutgers University, New Brunswick, N.J.
February	4, 1975	Gary D. Bernard Yale University, New Haven, Conn.
February	18, 1975	Rudolf Jander University of Kansas, Lawrence, Kan.
March	4, 1975	Peter N. Witt N.C. Dept. Human Resources, Raleigh, N.C.
March	18, 1975	o p e n
April	1, 1975	Bertrand Krafft University of Nancy, France
April	15, 1975	Walter C. Rothenbuhler Ohio State University, Columbus, Ohio
May	6, 1975	Neal A. Weber Florida State University, Tallahassee, Florida
May	20, 1975	o p e n

All meetings will be held at the American Museum of Natural History, Central Park West at 79th Street, at 8:00 P.M. For further information (dinner reservation etc.) call Dr. Peter Moller (212-873-1300 ext. 385).

Washington DC  
USA  
August 19-27  
1976

**XV International Congress of Entomology**

**First Announcement**

The 15th International Congress of Entomology will be held in the beautiful capital city, Washington, D.C., U.S.A., August 19-27, 1976, under the sponsorship of the National Academy of Sciences and the Entomological Society of America. Sessions will be held in the excellent meeting facilities of the Washington Hilton Hotel. Special events are being planned at national scientific and cultural centers. Two international airports near Washington give direct access from abroad. University housing will be available in addition to hotel facilities.

The Organizing Committee for the Congress is composed of Curtis W. Sabrosky (Chairman and President of the Congress), Ernest C. Bay (Secretary-General), Wallace P. Murdoch (Treasurer), William G. Eden, Gordon E. Guyer, E. F. Knipling, Robert L. Metcalf, John V. Osmun, Ray F. Smith and Edward O. Wilson.

The program will emphasize plenary symposia, invitational speakers, specialized symposia/work groups/panel discussions, and special interest groups or informal conferences. Thirteen program sections cover Systematics, Genetics, Physiology and Biochemistry, Toxicology, Ecology, Behavior, Social Insects and Apiculture, Biological Control, Medical and Veterinary Entomology, Agricultural Entomology and Pest Management, Forest Entomology, Stored Products and Structural Insects, and Pesticide Development, Management and Regulation.

A Congress Brochure and application forms will be mailed in May, 1975. The Brochure will contain information on highlights of the scientific program, receptions, tours, ladies program, scientific, historical and other features of the Washington area, and useful data for visitors.

**PLEASE NOTE:** Announcements of this Congress are not being sent to individuals, but are being publicized in journals and circulated to museums, departments, and other institutions. If you are interested in receiving future information, including registration forms, please send a postcard to the undersigned with your name and address, **typed or in block letters**, and also the section of your major interest.

Dr. ERNEST C. BAY, **Secretary General**  
XV International Congress of Entomology  
P.O. Box 151  
College Park, Md.  
USA 20740



## **JOURNAL of the NEW YORK ENTOMOLOGICAL SOCIETY**

The JOURNAL of the NEW YORK ENTOMOLOGICAL SOCIETY is devoted to the advancement and dissemination of knowledge pertaining to insects and their related forms.

SUBSCRIPTIONS are \$8.00 per year, in advance, and should be sent to the New York Entomological Society, the American Museum of Natural History, 79th Street at Central Park West, New York, N. Y. 10024. The Society will not be responsible for lost JOURNALS unless immediately notified of change of address. We do not exchange publications.

Please make all checks, money-orders, or drafts payable to the NEW YORK ENTOMOLOGICAL SOCIETY.

ORDERS and inquiries for back issues and complete sets should be sent to our agent, S-H Service Agency, Inc., 866 Third Ave. New York, N. Y. 10022. Complete files of back issues are in stock.

### INFORMATION FOR AUTHORS

Submit manuscript in duplicate (original and one carbon) to the Editor, New York Entomological Society, Boyce Thompson Institute, Yonkers, N.Y. 10701.

1. GENERAL POLICY. Manuscript submitted must be a report of unpublished research which is not being considered for publication elsewhere. A manuscript accepted and published in the JOURNAL must not be published again in any form without the consent of the New York Entomological Society.

A page charge of \$15 per printed page is assessed except that the charge may be reduced in the case of a member of the Society who cannot obtain institutional or grant funds for publication.

The page charge includes black and white illustrations and tabular material.

2. FORM OF MANUSCRIPT. Text, footnotes and legends must be typewritten, double or triple spaced, with margins of at least 1½ inches on all sides. The editorial style of the JOURNAL essentially follows the *CBE Style Manual* (3rd edition, A.I.B.S., 1972).

Genetic symbols: follow recommendations of Demerec, et al.  
(Genetics 54: 61, 1969)

Biochemical abbreviations: follow rules of the U.I.P.A.C. -I.U.B.  
(J. Biol. Chem. 241: 527, 1966)

Enzyme activity: should be expressed in terms of international units.  
(Enzyme Nomenclature. Elsevier Pub. Co., 1965)

Geographical names, authors names and names of plants and animals should  
be spelled in full.

The JOURNAL reserves the privilege of editing manuscript or of returning it  
to the author for revision.

3. ABSTRACT. Each manuscript must be accompanied by an abstract,  
typewritten on a separate sheet.

4. TITLE. Begin each title with a word useful in indexing and information  
retrieval (Not "Effect" or "New".)

5. ILLUSTRATIONS. Original drawings *should not be submitted*. Glossy  
prints are desirable—not larger than 8½ by 11 inches and preferably not  
smaller than 5 by 7 inches. When appropriate, magnification should be indi-  
cated by a suitable scale on the photograph.

6. REPRINTS (in multiples of 100) may be purchased from the printer  
by contributors. A table showing the cost of reprints, and an order form, will  
be sent with the proof.

7. SUBSCRIPTION to the JOURNAL is \$8.00 per year, in advance, and  
should be sent to the New York Entomological Society, The American Museum  
of Natural History, Central Park West at 79th Street, New York, New York,  
10024. The Society will not be responsible for lost JOURNALS unless im-  
mediately notified of change of address. We do not exchange publications.  
Please make all checks, money orders and drafts payable to the NEW YORK  
ENTOMOLOGICAL SOCIETY.

8. ORDERS and inquiries for back issues and complete sets should be sent  
to our agent: S-H Service Agency, Inc., 866 Third Ave., New York, N.Y. 10022.

15.70673

4/22

Vol. LXXXII

DECEMBER 1974

No. 4

Journal

of the

New York

Entomological Society

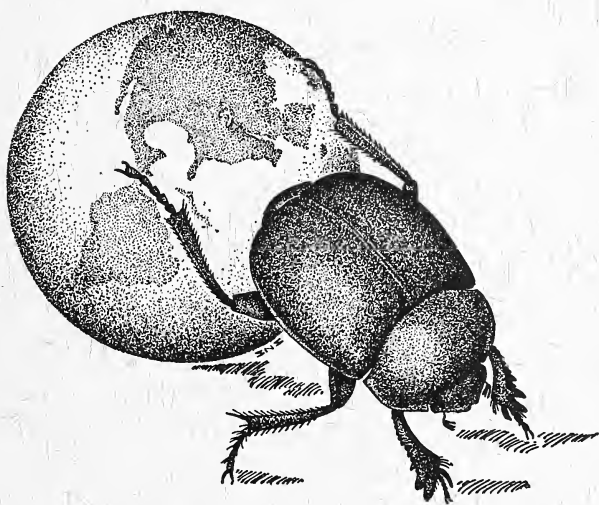

Devoted to Entomology in General

**The New York Entomological Society**  
**Incorporating The Brooklyn Entomological Society**  
**Incorporated May 21, 1968**

---

**The New York Entomological Society**  
**Organized June 29, 1892—Incorporated February 25, 1893**  
**Reincorporated February 17, 1943**

---

**The Brooklyn Entomological Society**  
**Founded in 1872—Incorporated in 1885**  
**Reincorporated February 10, 1936**

The meetings of the Society are held on the first and third Tuesday of each month (except June, July, August and September) at 8 P.M., in the AMERICAN MUSEUM OF NATURAL HISTORY, 79th St. & Central Park W., New York, N. Y. 10024.

Annual dues for Active Members, \$4.00; including subscription to the Journal, \$9.00.

Members of the Society will please remit their annual dues, payable in January, to the Treasurer.

---

**Officers for the Year 1974**

*President*, Dr. Daniel J. Sullivan, S.J.  
Fordham University, New York 10458

*Vice-President*, Dr. Peter Moller  
American Museum of Natural History, New York 10024

*Secretary*, Dr. Charles C. Porter  
Fordham University, New York 10458

*Assistant Secretary*, Dr. Louis Trombetta  
Pelham Manor, New York 10803

*Treasurer*, Dr. Winifred B. Trakimas  
State University of New York, Farmingdale, New York 11735

*Assistant Treasurer*, Ms. Joan DeWind  
American Museum of Natural History, New York 10024

---

**Trustees**

Class of 1974  
Dr. Lee Herman                      Mr. Edwin Way Teale

Class of 1975  
Dr. Howard Topoff                  Dr. Pedro Wygodzinsky

---

Mailed February 24, 1975

The Journal of the New York Entomological Society is published quarterly for the Society by Allen Press Inc., 1041 New Hampshire, Lawrence, Kansas 66044. Second class postage paid at New Brunswick, New Jersey and at additional mailing office.

Known office of publication: Waksman Institute of Microbiology, New Brunswick, New Jersey 08903.

# Journal of the New York Entomological Society

VOLUME LXXXII

DECEMBER, 1974

No. 4

## EDITORIAL BOARD

*Editor* DR. KARL MARAMOROSCH  
Waksman Institute of Microbiology  
Rutgers University  
New Brunswick, New Jersey 08903

*Associate Editors* DR. LOIS KELLER, RSM  
DR. HERBERT T. STREU

Publication Committee  
Dr. Kumar Krishna  
Dr. Ayodha P. Gupta  
Dr. James Forbes, Chairman

## CONTENTS

William Couper, Taxonomist-Entomologist .....	F. Martin Brown	222
Nest Biology of the Eucerine Bee <i>Thygater analis</i> (Hymenoptera, Anthophoridae) .....	Jerome G. Rozen, Jr.	230
Notes on the Natural History of a Rare <i>Adelpha</i> Butterfly (Lepidoptera: Nymphalidae) in Costa Rican High Country .....	Allen M. Young	235
Revision of the Genus <i>Holcostethus</i> in North America (Hemiptera: Pentatomidae) .....	F. J. D. McDonald	245
Digger Wasps as Colonizers of New Habitat (Hymenoptera: Aculeata) .....	Howard E. Evans	259
Seasonal Variation in <i>Tachysphex terminatus</i> (Smith) (Hymenoptera: Sphecidae, Larrinae) .....	Nancy B. Elliott and Frank E. Kurczewski	268
Two New Genera and Two New Species of Acanthosomatidae (Hemiptera) from South America, with a Key to the Genera of the Western Hemisphere .....	L. H. Rolston and R. Kumar	271
New or Little-Known Crane Flies from Iran. I (Diptera: Tipulidae) .....	Charles P. Alexander	279
Index of Scientific Names of Animals and Plants for Volume LXXXII .....		285
Index of Authors for Volume LXXXII .....		iii

## William Couper, Taxidermist-Entomologist

F. MARTIN BROWN

6715 So. MARKSHEFFEL ROAD, COLORADO SPRINGS, COLORADO 80909

RECEIVED FOR PUBLICATION DECEMBER 14, 1973

**Abstract:** Records are made of what little is known about William Couper, a Canadian field naturalist of the latter half of the 19th century. This is based upon the literature and Couper's letters to Herman Strecker. Couper's collecting trips to Labrador and Anticosti Island are recounted. Considerable information is given about the controversy involving *Papilio brevicauda* Saunders and *Papilio anticostiensis* Strecker, and that involving *Lycaena pembina* Edwards and *Lycaena couperi* Grote.

Some years ago while carrying out the N.S.F. mission of cataloging and preserving the thousands of letters that Herman Strecker accumulated, we found a small bundle of them written in the early 1870's by William Couper of Montreal. Since none of the usual sources of biographical material about entomologists contains information about Couper I thought it worth-while to present to you something about the man gained from his letters. Couper is memorialized by *Glaucopsyche lygdamus couperi* Grote, originally described from Anticosti Island.

Couper's activity in the province of Quebec was outlined by Comeau (1965) in an address, "A Glance at the History of Entomology and Entomological Collections in Quebec" presented at "The Lyman Entomological Semicentennial Symposium." This was delivered on December 30, 1964, as part of the A.A.A.S. meetings held at Montreal. Comeau noted that Couper built the third entomological collection for the province. The first, that of Pierre Boucher, Governor of the city of Three Rivers, was made around 1664 and lost. Pierre Chasseur's collection was bought by the government of Lower Canada in 1827 and lost by fire in 1832. Couper's was given to Morin's College in the city of Quebec in 1871 and was destroyed by pests.

While living in Quebec Couper helped found the first entomological society in the province. This occurred in June 1862 in league with Provancher and Leclerc. It affiliated with the Entomological Society of Ontario in 1868 but died in 1871 when Couper left Quebec. In 1873 Couper was instrumental in organizing what became the Montreal branch of the Entomological Society of Quebec. Couper had a falling out with William Saunders, the editor of CANADIAN ENTOMOLOGIST. This caused him to bring together a group of entomologists, who had accidentally met on a mountain side, to form the Montreal Entomological Society.

With his letter of December 8, 1873, to Strecker, he included a clipping from a newspaper—name and date unknown to me—that opens as follows:

“ENTOMOLOGICAL SOCIETY.—The monthly meeting of this Society was held on Wednesday night at the residence of the President, Mr. William Couper, No. 67 Bonaventure Street. The following members were present—The President, Messers Kolmar, Kuetzing, Caulfield, C. W. Pearson and G. B. Pearson. Mr. Alexander Gibbs was proposed for membership, and Mr. Andrew Johnson was elected a member . . .”

The “Commemorative Programme” for the 85th Annual Meeting of the Entomological Society of Ontario, 3–5 November 1948, celebrated the 75th anniversary year of the Montreal Branch of the society, the result of Couper’s original Montreal Entomological Society. In the program there is “Short History of the Montreal Branch . . .” and on p. 15 a photograph and the signature of Couper are reproduced. On p. 6 of the program it states “. . . he left Montreal for New York in 1884. . . it is thought that he died at his son’s residence at Troy in 1890.”

Couper made an early collecting trip in 1867 to Labrador and a second in 1872. Also in that year, 1872, and upon two other occasions, he visited and collected insects upon the Island of Anticosti. I have only found references to an earlier trip (in 1865?) to Labrador but there appears to be first-hand information in the contemporary newspapers of Montreal to which I do not have access. His letters to Strecker at least give us an outline of his second trip (1872) and of his trips to Anticosti.

In the late 1860’s and at least to March of 1871, Couper served as Assistant Curator and Taxidermist for “The Literary and Historical Society of Quebec.” He apparently lived at 38 Bonaventure Street, Montreal. In 1873 he decided to set up as an independent taxidermist and established himself at 67 Bonaventure Street in Montreal. This was done after his second trip to Anticosti Island. On that trip he had some official position with the Anticosti Company, the only way he could reside upon the island. He sailed from Montreal on May 15th on a vessel chartered for the trip by the Anticosti Company. A letter dated August 6th, 1873 opens “I have just returned from Anticosti.” Thus he spent about 9 or 10 weeks there on this trip. His subscribers, at \$12 a head, were Grote, W. H. Edwards, a Mr. Chase, and a Mr. Wassemann of England. Strecker, always parting with money only under duress, finally contributed his \$12 to Mrs. Couper after the vessel had sailed. Couper hoped to gain permanent employment with the Anticosti Company but this seems never to have materialized.

In addition to bringing to you something about one of the early Canadian collectors of Lepidoptera, these notes from Couper’s letters touch upon two interesting taxonomic problems: the relationships of *Papilio brevicauda* Saunders and *anticostiensis* Strecker, and the identity of *Lycaena pembina* Edwards. I will let Couper tell you of his travels and collecting experiences by means of direct quotations from his letters.

"September 30, 1872"

"I have returned home after an absence of over four months. I left Quebec on May 18 last on board the government schooner "Stella Maris", for Anticosti. I remained on the island two weeks, when I took passage for the coast of Labrador, arriving at Natashiquan, and collected between latitude 50 and 51 successfully, obtaining a good number of diurnal lepidoptera. Everything went on well until I turned my face homeward by the western North Shore route, traversed by me about 7 years ago, terminating at a place called Mingan. At the latter place, I wished to obtain *Argynnis Boisduvalli* and *Colias interior*, 2 species occurring there about the 22 July. While thus engaged, and during my absence from camp (at Mingan), the whole of my former collection, the result of 5 weeks work on the lower portion of that coast, was destroyed by the mountain Indians. These miserable beings not only destroyed my collections, but robbed me of provisions, etc. I appealed to the priest then in charge of the Mission, who told me that he had no control in the matter of this nature, but that he would make inquiry, and help me all in his power. The only relief obtained from him was that he wished me to leave their territory or the jurisdiction of their chief as soon as possible, as he would not be responsible for their actions regarding my life or property. The tribe indicated their determination to punish me, in fact, to shoot me down. They looked on me as a government spy, and I am since informed that some English person told them who I was, and that I wrote in the Quebec papers about 7 years ago, that they speared salmon on the spawning grounds. This statement is true, for I did describe their disgraceful *modus operandi* in destroying salmon, but never anticipated that it would end so unfortunately for me. As I am now situated, I cannot, this year, fulfill my agreement with you. The species collected on Anticosti are, however, safe as they were not in camp at the time. The Anticosti collection is not large in species, but will be honestly divided between the 5 subscribers who advanced money for the object. These are Mr. Edwards of San Francisco, Mr. Mead of N. York, the Ent. Soc. of Ontario, Mr. Morrison of Boston and yourself. In order to carry out my contract with you, I propose going to Labrador (but not to Mingan) next season at my own expense, and if God spares me, you will be furnished with the missing species. I will send you the box containing the Anticosti species in a few days. I remain,

Yours truly,  
/s/ William Couper"

"February 3, 1873  
"Montreal

"Your favor of 7th ult. came duly to hand, and I have delayed answering for the reason that on its receipt I communicated with the Rev. Cannon [sic] Innes and Mr. W. Saunders of London, Ontario, asking for information regarding



*Papilio brevicauda*. Up to this instant, no answer from either. It appears to me that both wish to evade my queries, and I enclose Mr. S.'s last to me in order to show that he makes no illusion to it. Now, I wish to inform you that I know something regarding how Mr. S. obtained his specimen of the insect which he has named as above. The Rev. Mr. Innes, who has a cabinet of Lepidoptera, lived at Quebec during my residence there. After my return from my northern tour, about 6 years ago, I presented him with 2 or 3 specimens of a *Papilio* taken in Labrador, which I then supposed was *P. asterias*. He had, at the time, a few similar, but smaller, specimens of the same insect from Newfoundland. Mr. Innes removed afterwards to London, Ontario, where Mr. Saunders resides and, of course, the *Papilio* attracted the attention of the latter. I have not seen Mr. S.'s description, and I wish you to inform me what locality is given. Thanks for your information regarding the *Lycaena*, I am so pleased that it is *new*, and long to see it described and figured by you."

W. H. Edwards in volume 2 of his superb "Butterflies of North America" figured the imagoes of *brevicauda* on Plate *Papilio* VIII. The models for female figures definitely are from specimens taken in Newfoundland and supplied to Edwards by Saunders. The source of the male figure is in question. It may have been based upon an *Anticosti* specimen from Couper. It conforms in color of the band on the upper sides of the wings better with *Anticosti* males than with Newfoundland males. The mature larva figured on this plate is erroneously colored. Edwards corrected this with Plate *Papilio* VIII B and noted the error in the text that accompanies that plate. The figures of the immature stages presented by Edwards as of *brevicauda* actually apply to *anticostiensis* Strecker. At the end of the text for Plate VIII B is a letter from T. L. Mead in which he compared the larvae and pupae of *brevicauda* with the figures on the plate. Males bred by Mead from Newfoundland larvae varied from some that were as free of fulvous suffusion as shown on Plate VIII, to some with a little fulvous suffusion. So the true source of the model for Edwards' figure of the male still is in doubt.

Edwards' Plate VIII was issued in December 1875. His notebooks for the period preceding this have been searched for information about *brevicauda*. He sent the pickled mature larva and egg shown on Plate VIII to Mrs. Peart on August 25, 1873. (ms Ent. Journal "1872" p. 235). In March of 1875 he paid Mrs. Peart for drawing the figures for Plate VIII (ms Ent. Journal "1872" p. 227). This notebook also contains quotations from Couper's letters to Edwards about *brevicauda*, but nowhere have I found any notation of the source of the male figured on Plate VIII.

The *Lycaena* mentioned in this letter of Couper later was named *couperi* by Grote. How Grote, not Strecker, came to name the taxon is explained in a letter that will be quoted further on.

The following are quotations from letter of April 15, 1873:

"*Pap. Anticostiensis* is what I may term an uncommon butterfly in every locality on the shores of the lower St. Lawrence visited by me. When I arrived at Fox Bay, Anticosti, last June, it was extremely rare, and I captured only 4 specimens in the course of 15 days. The specimens were apparently fresh on 20 June—they generally flew low, frequenting the flowers of a species of wild pea which occurs abundantly on the banks of the river on Anticosti and Labrador. I experienced great difficulty in approaching them with the net. On first appearance its flight is rapid and low extending along the margin of the rocky cliffs and grassy portions of the Bay, near tidemark. I never noticed them in the woods. They appeared to me to keep within the circuit of the Bay, and I remarked the same fact on the Labrador coast, where I also found them on the flowers of the wild pea. Indeed, they hovered about it so much that I expect to find its larva feeding on it this season. If I do, I will take descriptions of them, and then the difference between it and *Asterias* will be so far settled. I noticed toward the end of July, that their strength gives way and if the weather is cool, added specimens may be taken by hand from the flowers of the pea. It is the only species of *Papilio* so far noticed by me, either on Anticosti or Labrador."

“August 6, 1873

“Montreal

“I have just returned from Anticosti. The west end of the island so far visited by me, produced only 12 species of butterflies, viz. *P. anticostiensis* Strecker, which is found throughout the whole island; *P. Turnus* of which I took only 2, and I have not yet compared them with sp. taken here; an *Argynnis* not yet determined, and of which I have only 28 specimens. The only butterfly new to me is a *Colias* which was exceedingly rare at Ellis Bay, and I have taken notes on its habits. I have only 12 specimens of the latter, but you shall have a pair of the best. This *Colias* is evidently *different* from *Interior*. I fear that the last named does not occur south of the Labrador coast. The form which I have may be *Labradorensis*. I have also 9 specimens of *Hesperia paniscus* which was also rare. I took the same Lycaenidae which were met with last year: *M. Batesii*, *P. frigida*—the common nettle butterfly and a *Grapta*—the latter rare. However, I will do my best to distribute the material fairly. I am sorry that I have not met with a greater number of species, but that cannot be helped, perhaps I may have little better luck next time in a new locality. I will send such things as I believe will please you, and the rest of the material will be fairly distributed to my subscribers.

“I have discovered the food plant of *P. Anticostiensis* and have both eggs and larvae. The caterpillar feeds on two plants—viz.—*Archangelica antho-purpurea* or G. A. of Hoffmann, and *Heracleum lunatum* Michx. I have 4

notes regarding it. I have also discovered the food plant of *P. frigida*, and have eggs and larvae. The plant is the L. M.—*Larritis striata* Graham. I consider these investigations worth the time and trouble taken. I had a narrow escape from shipwreck on my way home.”

That is almost the entire letter. The rest of it goes into personalities.

I am recording a good deal of the next letter, of August 26, 1873.

“Ellis Bay is calculated to be 117 miles west from Fox Bay, as you can see on the map of Anticosti. I sent [send?] you a few extracts from my field book regarding the species remarked in your letter. *P. Anticostiensis* was noticed and a specimen taken at Ellis Bay on 14 June, the day of my arrival. From the latter date, as the weather became warmer, 40 specimens were taken up to 26 June. On 25 June I noticed a female depositing an egg on the food plant, *Archangelica anthopurpurea*, which occurs common throughout the section of the island. The egg, (one in bottle sent), is laid singly on the upper surface of the leaf, where it is exposed to the full force of the sun’s rays. The egg is spherical, pale yellow. On fine days, between 10 and 3 o’clock is the best time to capture them, but should the weather become cold or windy, not one would be seen. About half the specimens taken have short tails. I cannot say that the larvae sent to you is a full grown specimen. I took the largest which I could find only a day or two prior to leaving the Bay at the end of July. They are the only mature ones I could obtain, and have evidently the skin of the last moult. You can see that it differs from *Asterias* larva, by having oblique black lines on the sides of the body, besides other minute points. I have also sent you a young larva of about 10 days old, which shows the light yellow band in the center of the body. The regularity of the markings of the perfect insect (males and females) are to my observations of sufficient value to make a good species. The question remains what is the difference between it and *Brevicauda*. Saunders said that there is a vast difference, but time will settle that matter, and I will sift it next season. Every entomologist who has seen *P. Anticostiensis* since my return, believes that there is little or no connection between it and *Asterias*.

“I took 12 specimens of *Colias* at Ellis Bay—all in one locality— at different times. I extract the following from my notebook:—”

And then in columns he gives these dates each followed by “one specimen.” The dates are: June 3, 30, July 3, 5, 8, 14, 16, 19, 23, 24. “It is evidently a rare insect at Ellis Bay, another old resident informed me that it has never been common in that locality. Its flight differs from other species known to me. It is extremely restless, very zigzag and quick, and it goes over a great extent of ground in a short time; indeed, I had much difficulty to capture the few I obtained. It was only about 5 June that I noticed one light on a flower. It has a peculiarity when at rest, of lying half on its side, as if enjoying the heat

of the sun. I am sorry that the two examples sent you are both males, as it was not my intention to have done so; true, I did not think, as you have since informed me, they might be 2 species, and I have still doubts as to the likelihood of their being so. However, you will soon determine that when they are spread. It may be that the bright one is *Interior*. I have sent 2 to Edwards, 2 to Chase and 2 to Grote; the latter by the way called on me last week on his way to the Science Association at Portland. I do not think that the smaller one is *rubbed*—you better examine it closely.

Couper was a fairminded man. It irked Couper to read Strecker's intemperate remarks about other entomologists printed in his "Lepidoptera: Rhopaloceres—Heteroceres." The matter came to a head over Grote describing *Glaucopsyche couperi*. The first inkling of this trouble appears in the letter dated December 8, 1873, in which Couper wrote "Grote described the *Glaucopsyche* as I spoke to him about it when he visited Montreal this summer and I told him that you intended to name it *Couperi*. I did so because I deemed it necessary to present duplicate descriptions. I only wish that you will figure it in order to make the species *bona fide*." Strecker did figure the taxon (Lep. R.-H., pl. 10, f. 10, 11, 1874) but insisted that it was nothing more than *pembina* Edwards and that Grote was in error thinking it otherwise. This was said by Strecker in a vituperative manner. On March 28, 1874, Couper wrote Strecker "I note your decision that *Glaucopsyche couperi* Grote is identical with *Pembina* Edw. Still I cannot overlook the fact that you stated "It makes little difference who names a species, so long as it is well done." Of course, I am not prepared to say that Grote is wrong, as Mr. Edwards' description of *Pembina* is now before me and I cannot make it agree with the Ellis Bay *Lycaena*. There is also my knowledge of the species as a nondescript as far back as 1867, on my first visit to Labrador. You also informed me that Grote did what you intended to do. This was the cause of writing and quoting your statements and I trust you will excuse my being candid in saying that your answer to the above is comparatively vague. Moreover, Canadian entomologists of my acquaintance, who read your remarks on Mr. Grote, do not appreciate the style of epiplionema, considering in a scientific light, it would be well if they were omitted."

Strecker's reply to this was to terminate Couper's subscription to his book. Couper insisted upon reinstating the subscription a year later and there followed a few brief letters before the correspondence closed. This is an excerpt from a letter 17 April 1874, and what I quote is a quotation from a letter sent to Couper by W. H. Edwards.

"With regard to the *Lycaena* from Anticosti I presume Mr. Scudder is correct. The original *Pembina* came from Lake Winnipeg, a single specimen or a single pair, several years ago. These types were afterwards lost in a box of insects sent by me to California. I had forgotten them, and somehow another species

had been assumed to be *Pembina* by Scudder and others, and I had fallen into the error myself of thinking with them, that *Pembina* was allied to *Lygdamus*. I discovered the fact last year, and called Mr. Scudder's attention to it, while he was here on a visit. I think this *Couperi* was what had been thought to be *Pembina* and Grote was correct in naming of *Couperi*."

The problem of the identity of *pembina* Edwards is still unsettled. Currently, and for some time past, it has been accepted as a subspecies of *Plebejus icarioides* Boisduval. Dr. John Downey, who has been studying this complex species for many years has not been able to find any specimens anywhere in collections that hail from the reputed type locality. In the original description Edwards stated that the types were collected by Scudder at "Lake Winnipeg." Scudder himself stated that he took the specimens in a glade on the banks of the Saskatchewan River northwest of Lake Winnipeg. Dr. Downey has proven that the food plants of the larvae of the *icarioides* complex all are confined to the genus *Lupinus*. Dr. David Dunn, the ranking authority upon this genus for North America, tells me by letter that there are no known records of Lupines in the region published as the type locality of *pembina*. This blank area in the distribution of the genus *Lupinus* is a real one, not the result of insufficient collecting. All of this poses a problem, or three of them: first, is *pembina* an *icarioides* that has changed its food plant?; second, did Scudder really collect the types of *pembina* where he said he did or did Kennicott?; third, is *pembina* now applied to a taxon that is not the same species as that to which Edwards first applied the name?

Edwards' original description of *pembina* credited Kennicott with the capture of the type. This he had been told by Baird. However, research has given much greater support to John Pearsall being the captor and the locality being in western Montana, not "Lake Winnipeg." Apparently McDunnough had come to a similar conclusion about the type locality. (See Brown, 1970, pp. 397-402.) The name *pembina* Edwards now is used for *Icaricia icarioides* from Montana, Alberta and British Columbia in the foothills and mountains.

#### Literature Cited

- ANONYMOUS. 1948. Commemorative Programme, 85th Annual Meeting, Entomological Society of Ontario.
- BROWN, F. MARTIN. 1970. The types of lycaenid butterflies named by William Henry Edwards, Part III. Plebejinae. Transaction of the American Entomological Society, **96**: 353-433.
- COMEAU, NOEL-M. 1965. A glance at the history of entomology and entomological collections in Quebec. Annals of the Entomological Society of Quebec, **1965**: 85-90.
- COUPER, WILLIAM. Manuscript letters to Herman Strecker preserved in the Dept. of Entomology, Field Museum of Natural History, Chicago, Illinois.
- EDWARDS, WILLIAM H. Manuscript entomological journals. State Archives, Charleston, West Virginia.

**Nest Biology of the Eucerine Bee *Thygater analis*  
(Hymenoptera, Anthophoridae)**

JEROME G. ROZEN, JR.<sup>1</sup>

RECEIVED FOR PUBLICATION DECEMBER 20, 1973

**Abstract:** Details of the nest of *Thygater analis* are described and diagramed. Information on cell provisions, larval feeding activity, defecation and cocoons is also given.

I had an opportunity to excavate a nest of an unidentified bee at Antonina, Paraná, Brazil on November 7, 1971. Because of the fine texture and cohesive nature of the soil, the excavation was made with considerable accuracy and a rather clear understanding of the nest structure resulted. No adult female was associated with the nest but I was able to determine that the bee belonged to the Eucerini because of larval anatomy, cocoon structure and fecal pattern. Emergence of a female and a male from cocoons on November 7 and 12, 1972 respectively permitted Padre J. S. Moure of the Universidade Federal do Paraná to identify the species as *Thygater analis* (Lepelletier). Although a number of workers have described various aspects of the biology of this species (for references see Urban, 1967) none has described the nest in detail. For that reason and because of the unusual structure of the nest, I offer the following diagram and account to which I have added other information on nesting biology.

*Description of Nesting Site.* The nest was located on a moderately sloping barren stretch of ground (fig. 1) next to the roadway leading to Antonina, Paraná, Brazil. Only a single nest was located although a search was made for others. The nest entrance was unshaded by the tropical vegetation which surrounded the area. The soil was extremely fine, with almost no rock inclusions, and moist except on the surface.

*Description of Nest.* The nest entrance was located in a depression, presumably caused by a rock having been removed. The main burrow (fig. 2) entered the ground nearly horizontally in the side of the depression. The tumulus, which was abundant and moderately coarse, filled the lower part of the depression and partly obscured the nest itself. Circular in cross section and with a diameter of

---

**Acknowledgments:** I would like to thank Padre Moure and his staff, both for the species identification and for their hospitality and courtesies while I was in Brazil. The research was supported by National Science Foundation Grant GB32193. Specimens of cells, cocoons, larvae, as well as reared adults are in the collection of The American Museum of Natural History.

<sup>1</sup>Deputy Director for Research and Curator of Hymenoptera, The American Museum of Natural History, Central Park West at 79th Street, New York, New York 10024.



FIG. 1. Site of nest of *Thygater analis* near Antonina, Paraná, Brazil. Padre Moure is standing by the nest.

7.0 mm, the main burrow descended for the first several centimeters horizontally but then turned downward and descended vertically. The wall of the main burrow was extremely smooth and when examined under the microscope, faint markings, obviously created by the pygidial plate of the female, could be observed on all sides. Descending open and vertically to about the depth of 20 cm, the burrow then turned horizontally, rose somewhat, descended again, and ended blindly. A single branch, 3.5 cm long and filled with soil, entered the burrow near where it first started to curve horizontally. Connected to the branch was a single, nearly vertical cell (fig. 2, cell 13) containing a small feeding larva and provisions. Attached at the lower end of the cell was a tunnel that descended more or less vertically and then curved horizontally, rose over a distance of about 6 cm before bending downward, at which point it was lost. Three branches, again all filled and about 3.5 cm long, connected to this tunnel and each ended in a single nearly vertical cell. This tunnel was open except near where it attached to the cell 13. Cell 12, farther along in the series, contained a moderately small feeding larva, the next one (cell 11) held a somewhat larger one, and cell 10, closest to cell 13, contained the largest larva. Descending obliquely from the lower end of cell 10 was another more or less horizontal tunnel, filled near the cell with coarse soil but open for the rest of the way. This tunnel led to five filled branches and cells, very much as described for the above tier. Cell

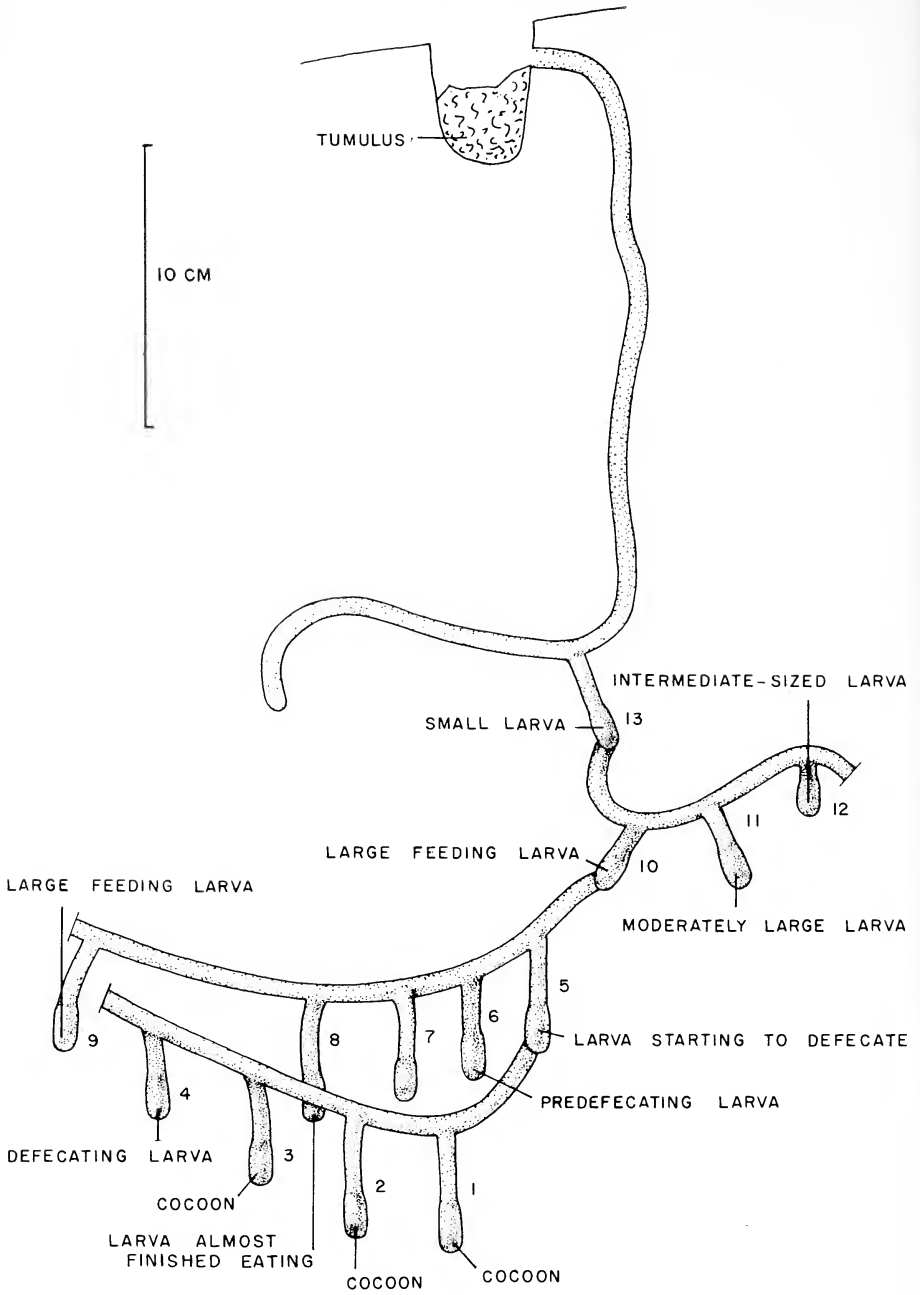

FIG. 2. Diagram of the nest of *Thygater analis*.



9, farthest along, contained a large feeding larva which, however, was the youngest in this series. Cell 5 at the other end held a larva that had finished feeding and was starting to defecate. Connected to this cell was yet another lower, more or less horizontal tunnel filled at the beginning but open elsewhere. This lowest tunnel gave rise to four cells with their filled branches, the one (cell 4) farthest from this connection holding the youngest larva, a form that was defecating but not yet cocoon spinning. The other three cells housed larvae that were either spinning or had spun their cocoons. This account seems to amplify the general description of the nest provided by Michener and Lang (1958).

On the assumption that a cell is constructed, provisioned, oviposited in and closed before the next cell is started, the order of cell construction and provisioning was from cell 1 to cell 13 because of the ages of the larvae. There is no evidence to determine whether the entire tunnel system was constructed before the first branch and the cell were excavated or whether the female dug a vertical tunnel and a lateral to form the tunnel of the lowest tier and then constructed, provisioned and oviposited in the first four cells all before excavating a lateral to form the tunnel of the next higher tier. In each tier the cell closest to the connection to the tier above was constructed and provisioned first; furthermore, the cell in the tier above that received the tier below also contained the oldest individual of the tier.

All tunnels and branches were approximately 7.0 mm in diameter; the fill in branches was loose, coarse soil.

The cells, similar to those of *Svastra obliqua* (Say) (Rozen, 1964), were elongate, 17–18 mm long and had a maximum diameter of 8 mm but little wider than the tunnel. Vertical or nearly so, they possessed an extremely smooth, shiny wall and there was no obvious indication of a built-in lining. The wall was faintly embossed, presumably with the pygidial plate of the female, and was coated with a special semitransparent lining which was obviously waterproof as evidenced by the nature of the provisions. The closures were a somewhat concave spiral on the inside with four to five rows to the radius. The deepest cell was about 44 cm from the surface, the highest, approximately 24 cm.

*Provisioning.* The source of the pollen was not known. Provisions occupied the lower part of the cell, gave off a faintly aromatic odor, and were approximately 7 mm in depth, at least in one instance. They were apparently stratified into an upper clear layer containing almost no pollen and having a slightly sweet taste, and a lower more opaque yellowish layer, only slightly less liquid and containing pollen.

*Development.* Young larvae rested on their side while feeding in the soupy provisions. Feeding actively, they curled so that their dorsum often adhered to the cell while they submerged their head and anterior part of their body into

the food. The orientation of older larvae was not ascertained except in one instance in which the larva was found curled around a small quantity of the semiliquid food. Upon finishing feeding, a larva defecates and applies the feces to the area of the cell cap, as was described for *Svastra obliqua* (Rozen, 1964). After the feces are attached to the cell cap, the larva begins to spin its cocoon.

The fecal material and the cocoon are similar to those of *Svastra obliqua* (Rozen, 1964, fig. 2). As in *Svastra* three layers of the cocoon can be detected, the outermost being actually the cell lining that adheres to the cocoon itself. The apparent middle layer is thin, brownish, semitransparent and nonfibrous. The inner layer, closely applied to the middle one, is thin, greyish brown, semi-opaque, fibrous and moderately thin. Also as in *Svastra* the top of the cocoon is domed by a moderately thick roof and there are a number of silken partitions separating air spaces between the roof and the feces.

The fact that adults emerged a year after they were collected as larvae seems to indicate that there is a single generation a year.

*Parasitism.* No parasitic bees were found in the vicinity of this nest and larvae of none were recovered from cells.

#### Literature Cited

- MICHENER, CHARLES D., AND RUDOLF B. LANGE. 1958. Observations on the ethology of neotropical Anthophorine bees (Hymenoptera: Apoidea). Univ. Kansas Sci. Bull., vol. XXXIX, 3: 69-96, figs. 1-24.
- ROZEN, JEROME G. JR. 1964. The biology of *Svastra obliqua obliqua* (Say), with a taxonomic description of its larvae (Apoidea, Anthophoridae). Amer. Mus. Novitates, 2170: 1-13, figs. 1-15.
- URBAN, DANÚNCIA. 1967. As espécies do genero *Thygater* Holmberg, 1884. (Hymenoptera, Apoidea). Bol. Univ. Federal do Paraná, II, 12: 177-309, figs. 1-22.

## Notes on the Natural History of a Rare *Adelpha* Butterfly (Lepidoptera: Nymphalidae) in Costa Rican High Country

ALLEN M. YOUNG

DEPARTMENT OF BIOLOGY, LAWRENCE UNIVERSITY, APPLETON, WISCONSIN 54911

RECEIVED FOR PUBLICATION JANUARY 16, 1974

**Abstract:** The nymphalid butterfly *Adelpha leucophthalma tegeata* Fruhstorfer is a rare member of the macrolepidopterous fauna in the central high (montane) country of Costa Rica. The life stages and developmental time are described for the first time, along with observations on the behavior of the larva and adult. The egg-to-adult developmental time is 51 days on *Pentagonia wendlandia* Hook (Rubiaceae). The egg is laid singly on the dorsal surface of older leaves of the food plant and both the larva and pupa (chrysalis) are very cryptic in morphology, color, and behavior. As with most species of this genus, the adults of *A. leucophthalma* are very skittish. This is one of the few reports on a Central American *Adelpha* from montane environments.

### INTRODUCTION

Many species of *Adelpha* butterflies (Lepidoptera: Nymphalidae) are well known by entomologists working in lowland tropical wet forests of Central and South America. It was Godman and Salvin (1870-1901) who originally pictured several of these species, followed by the descriptions of Fruhstorfer (1915). Most of the lowland tropical species of *Adelpha* are medium-sized butterflies with rich chocolate-brown wings bearing a single, bold white or combination orange and white band on the forewing (fractionated into an anterior orange section and posterior white section), and they are frequently encountered along sunny forest paths and edges where they rest on low vegetation. Although these butterflies are well-known in tropical lowlands, Miller and Miller (1970) have emphasized that very little is known about the more elusive species of this interesting genus in montane regions of the Neotropics. In fact, the apparent paucity of information even on the geographical distribution and taxonomy of montane species of *Adelpha* led Miller and Miller (1970) to their discovery of two rare species in the high country of Hidalgo, Mexico.

**Acknowledgments:** This research was funded by COSIP (College Science Improvement Program) Grant GY-4711 (National Science Foundation) through Lawrence University. The author is very grateful for this support. Dr. Lee D. Miller of Allyn Museum of Entomology (Sarasota, Florida) kindly identified the butterfly and provided background information of the species. The larval food plant was identified by Drs. Luis Diego Gomez P. (Museo Nacional de Costa Rica) and Dieter C. Wasshausen (National Museum of Natural History). Color transparencies (35 mm.) on the early stages of this butterfly may be borrowed from the author by interested researchers and collectors.



FIG. 1. *Adelpha leucophthalma tegeata* Fruhstorfer. Wild-caught female, dorsal view. Scale in mm.

*Adelpha leucophthalma tegeata* Fruhstorfer (which is taxonomically near *A. diocles* Godman & Salvin, Lee D. Miller, pers. comm.) belongs to that constellation of rare montane species of *Adelpha* in Central America. One of the few adults in my possession is shown in Figure 1. The color pattern of the wings of this little known species represents a significant departure from the more typical appearance of other members of the genus: the dorsal surface of the forewing has a thick, bright orange band and the round spot on each hindwing is vivid white. This species is said to be "rare" in the sense that there are very likely very few specimens in museum collections anywhere, and nothing was known about its natural history. The purpose of the present paper is to describe, for the first time, the early stages of the little known *Adelpha*, along with a larval plant food record, developmental time, and other aspects of natural history.

#### HABITAT AND METHODS

The high country to the northeast of San Jose, the capitol city of Costa Rica, includes a series of mountain valleys of virgin rain forest that lead into the foothills of the Caribbean drainage of these mountains (Central Cordillera). One

of the most prominent of these montane moist valleys is one that occurs east of Volcan Poas. The road that connects San Jose with Puerto Viejo runs along the western ridge of this valley. The altitude of the valley where this study was done is about 1000 m and the depth of the valley itself is about 150 m. The bottom of the valley is the Rio Sarapiquí, and at the study area this river is filled with very large boulders and it is several m in width with very swift current. On the western edge of the river, there is a small plains area that includes virgin forest and heavily-disturbed areas. The habitat ("study area") where oviposition by *A. leucophthalma* was observed consisted of a rectangular patch of very recently cut (1-2 weeks) old secondary forest. This site is just to the right before the girder bridge on the trail from the Puerto Viejo road, down the valley, across the river, and up the other side to a penal colony. Much of the forest had been cleared (machete) by a "squatter" farmer for bananas and cattle.

It was in this patch of freshly-cut forest trees that I saw oviposition by a single female of *A. leucophthalma* at 12:30 P.M. on July 2, 1971. The sky was very overcast with the threat of rain and this butterfly flew low and swiftly among the still fresh leaves of the various felled trees lying in the area. Two eggs were laid on two different old leaves of a sapling-size (4 m tall) individual of *Pentagonia wendlandi* Hook (Rubiaceae).

The two eggs were collected, confined to a clear plastic bag and allowed to hatch in San Jose. The two larvae from these eggs were reared in this manner and supplied with fresh leaves of the food plant. The big, papery, food plant leaves were always retrieved from this individual of *Pentagonia* at the study site and perhaps owing to the heavy rainfall at this time of year, several fresh leaves remained available on the cut tree. Photographs and color transparencies were made of the life stages. Although one larva died in the fourth instar, the other larva survived to adulthood. Measurements (in mm) were made on life stages and gross external features of morphology were noted. Searches were made on subsequent visits for other ovipositing adults and adults of both sexes in general, but to no avail. I was able, however, to observe some adult behavior from the girder bridge high over the Rio Sarapiquí: on two different dates during July 1971, I watched adults flying and resting among leaves of trees overhanging the river near the bridge and about ten m above the water. Other than these observations, adults were very seldom seen. The single adult obtained from rearing was eventually sent to Lee D. Miller of the Allyn Museum of Entomology for identification. Despite many other visits to the area (1972-1973), it was not until July 1973, that I was able to capture another specimen of this very elusive butterfly, and this specimen is shown in Figure 1. It was collected about 60 m from the study site.

Observations were also made on the feeding behavior of the larvae in the plastic bags. Interest here concerned perch construction for resting periods, and the pattern of leaf damage resulting from feeding.

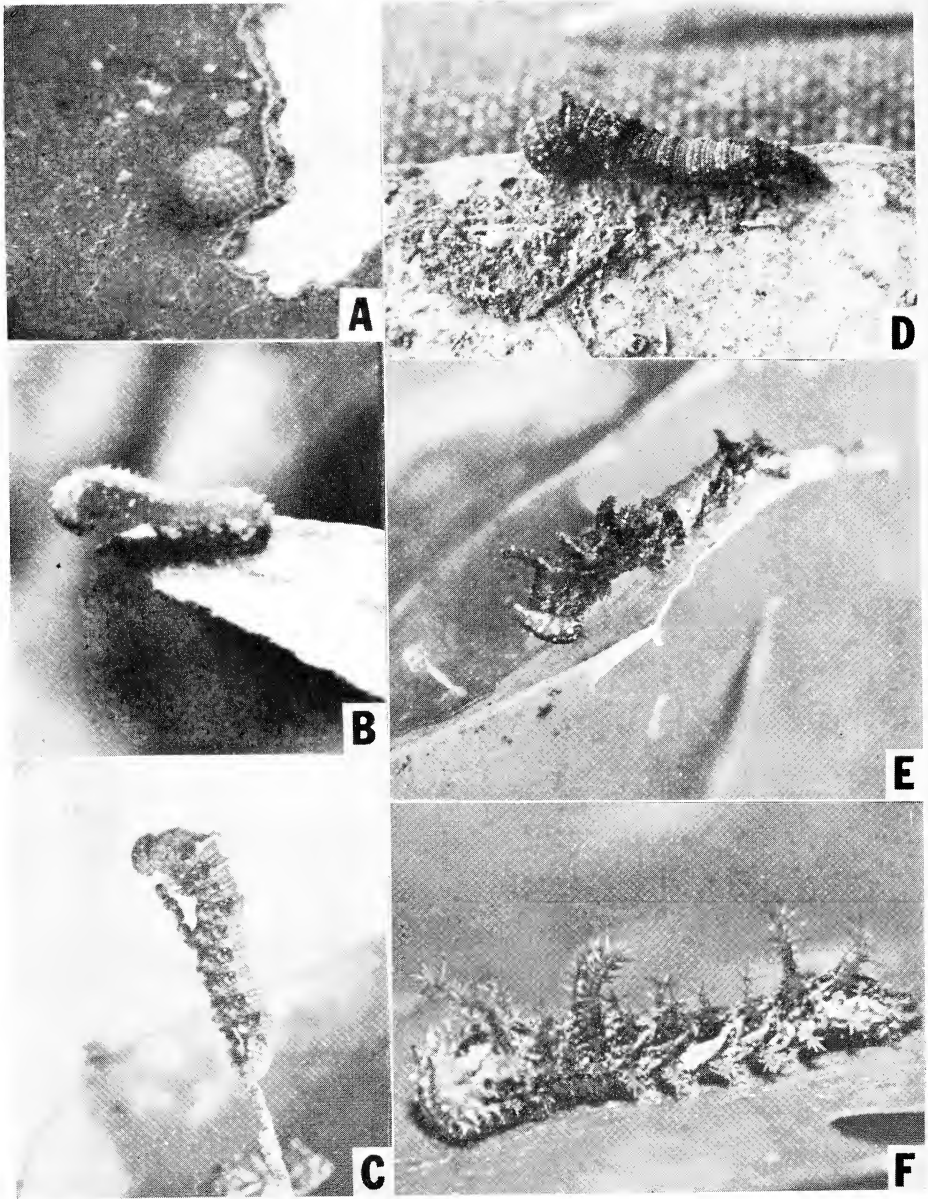

FIG. 2. Life stages and behavior of *A. leucophthalma*. (A) egg, (B) first instar (lateral) resting on perch constructed from the bared apical leaf midrib and silk, (C) second instar in similar position, (D) third instar, (E) fourth instar on perch, and (F) fifth instar (lateral), emphasizing the raised position of the spiracles and first thoracic segment and eighth abdominal segment.

## RESULTS

*Life stages.* The light bluish-green spherical egg (Fig. 2-A) is about 1.0 mm in diameter and the chorionic surface is highly sculptured with ridges forming distinct facets. Tiny hair-like projections arise from the facets, giving the egg a fuzzy appearance (Fig. 2-A). One day prior to hatching, the egg turns light tan in color.

The first instar larva (Fig. 2-B) is 3.0 mm long at the time of hatching, and it possesses a large, orange-yellow head and light green trunk region. Both the head and trunk are covered with rows of very small, tubercle-like scoli. Since I was unable to preserve larval specimens (due to small sample size), the precise distribution and structure of scoli for all instars could not be studied at this time. By the first molt, the larva is about 9.0 mm long. The second instar (Fig. 2-C) has a dark reddish-brown head and dark green body; sets of prominent tubercles become noticeable on the third thoracic segment, and first, third, and eighth abdominal segments (Fig. 2-C, and also Fig. 2-D, for third instar as well). This pattern of prominent, dorsal tubercles, and the arched condition of the third thoracic segment, is very reminiscent of the larva of the North American *Limenitis* (Nymphalidae). In fact, Lee Miller has told me (pers. comm.) that some authors place *Adelpha* as a subgenus of *Limenitis*. By the second molt, the active larva is about 13.0 mm long.

The third instar (Fig. 2-D) is characterized by a noticeable change in coloration: the head has become very dark brown bearing white tubercles, and the body is mottled in shades of dark brown and gray. This very cryptic instar attains a body length of about 17.0 mm by the third molt. The fourth instar (Fig. 2-E) retains the studded condition of the integument of the previous instar, the body being covered with many tiny whitish-gray tubercles, and it is also very cryptically colored in shades of brown and gray. A prominent light gray saddle-like area develops dorsally (but with lateral extensions) in the posterior abdominal region (visible but slightly out of focus in Fig. 2-E). A pronounced transformation has taken place in the size and shape of the prominent tubercles of thoracic and abdominal sectors: all tubercles have undergone considerable elongation, and the set of the metathoracic segment is curved anteriorly. The set of the third abdominal segment is strongly curved towards the posterior end of the body, as is the set on the eighth segment (Fig. 2-E). All of these tubercles bear many tiny stiff hairs. The rich brown color of the tubercles is continuous with the brown coloration of the body. Figure 2-E purposely emphasizes the morphology of the head capsule of this instar. The reasons for this are two-fold: (1) the general shape of the head capsule is now very different in that it is strongly forked dorsally whereas before it was round, and (2) the head capsule color pattern is very different since it now consists of a pair of prominent, vertical cream bands on an otherwise brown background, whereas before it was entirely brown. The head capsule retains the highly studded surface texture of previous instars and as before, all studs are white, cream, or very pale green. By the fourth molt, this instar attains a body length of about 21.0 mm.

As with the transformation to the fourth instar, the advent of the fifth instar is marked by new pronounced changes in gross external morphology. So profound are these changes in appearance that it is worthwhile to emphasize both head and body structure as shown in the series of Figures 2-F and 3-A through C. The system of prominent tubercles of thoracic and abdominal regions has become even more pronounced in this instar: the tubercles are greatly elongated and scoli appear on all of them as prominent projections (Fig. 2-F; Fig. 3-A). The set of lateral, sub-spiracular tubercles relatively reduced in previous instars is now elongated with similar spiny projections. All of these tubercles

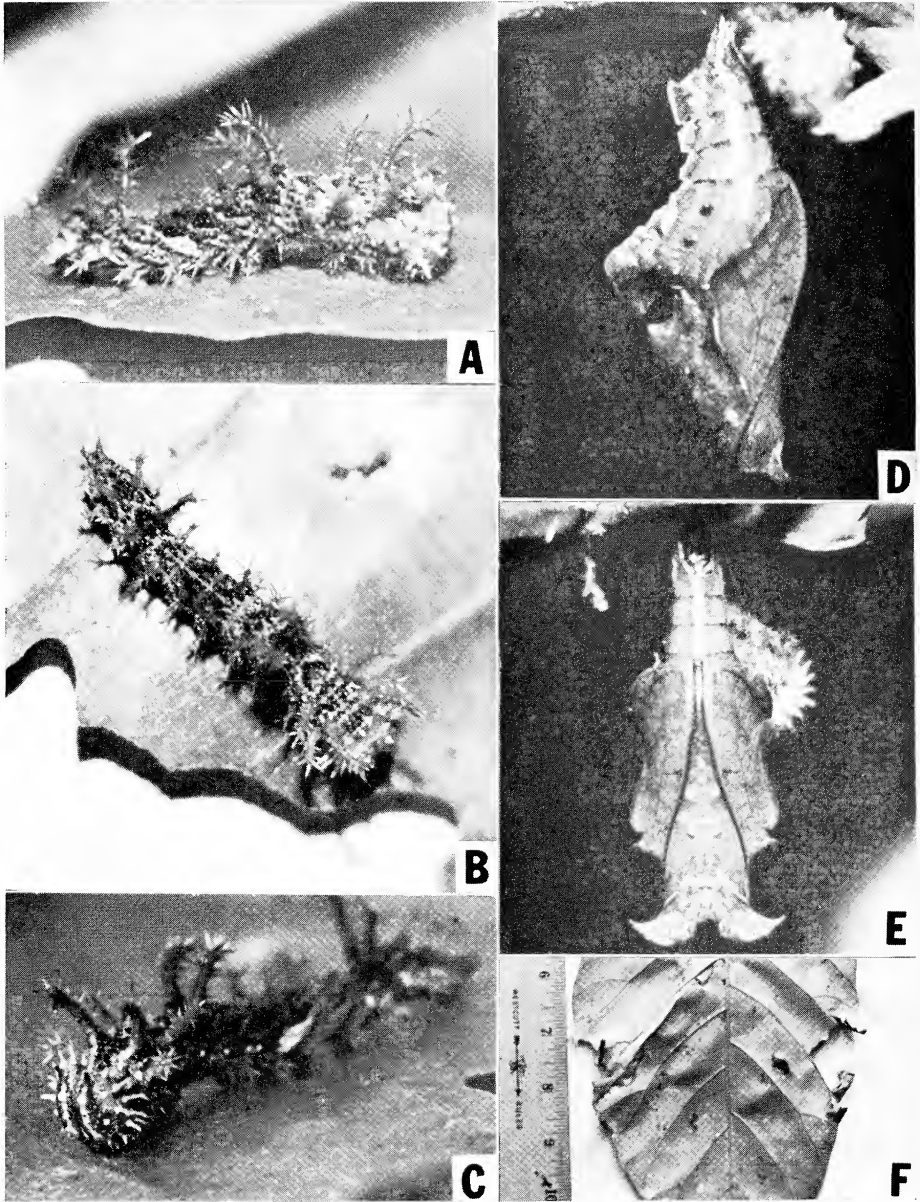

FIG. 3. Life stages and behavior of *A. leucophthalma*. (A) fifth instar, emphasizing the structure and distribution of trunk tubercles, (B) fifth instar (dorsal), emphasizing cryptic resemblance to a moss-covered twig, (C) fifth instar, emphasizing the morphology of the head capsule, (D, E) lateral and ventral of the chrysalis, respectively, and (F) leaf damage pattern by fifth instar larva.



are dull green and there are also green areas on lateral portions of the body. The fifth instar is very spiny in general appearance (Fig. 3-B).

There are also some changes in morphology of the head capsule of the fifth instar, as emphasized in Figure 3-C. Although the coloration remains the same as in the previous instar, there has been considerable expansion on the lateral row of studs that surround the head posteriorly. The two forks remain anterior to this pronounced row of studs on the dorsum, appearing as twin darkened cones. Just below these head capsule forks, there is a pair of large but stubby white tubercles, followed ventrally by a second, smaller pair.

Another conspicuous feature of the fifth instar is the raised condition of the spiracles on the first (prothoracic) thoracic segment and on the ninth abdominal segment (Fig. 3-A). The spiracles of these two segments are positioned more dorsally than those on other segments.

The position of tubercles and scoli deserves comment as they are very noticeable on the fifth instar. There are two rows of spiny tubercles: the uppermost row is dorso-lateral and the second row is sub-spiracular. The first pair of upper tubercles on the metathoracic segment is almost vertical to the body, while those of the first abdominal segment are smaller or more oblique to the body. The next pair is about the same length (7.5 mm) as those of the metathoracic segment, vertical, and positioned on the third abdominal segment. The several segments between this segment and the eighth bear short tubercles, all about the same length as those of the first abdominal segment (4.5 mm). The pair on the eighth abdominal segment is oblique and about the same length as the larger anterior ones; the set on the ninth segment is slightly shorter and more vertical. All of the sub-spiracular tubercles are about the same length (5.0 mm). Other details of tubercle position and structure are omitted since they were not studied due to a lack of preserved material.

Together, the coloration, studded integument of head and body, along with the structure and distribution of spiny tubercles, endows the fifth instar larva of *A. leucophthalma* with a very cryptic resemblance to a short section of moss-covered twig (Fig. 3-B). As to be outlined below, the behavior of the larva suggests further that crypsis in this insect is employed during both resting and feeding. The active fifth instar form attains a length of 26.0 mm prior to pupation.

There is no distinct prepupa, unlike several other neotropical Nymphalidae. The angular pupa (Fig. 3-D, E) is very dark brown but lustrous, with some irregular silver flecks on the ventral thoracic area. It is about 20.0 mm long and resembles a shriveled up dry leaf. The conspicuous lateral and ventral aspects of the pupa are self-explanatory in Figure 3-D, E.

The total egg-to-adult developmental time is 51 days for the single individual reared to the imago. The egg stage lasts eight days, the total larval period 31 days, and the pupa 12 days. This individual was a male.

*Larval Behavior.* Upon hatching, the first instar larva immediately devours the empty egg shell; how consistent this behavior pattern is among the species and subspecies cannot be determined from this study. As the egg is usually affixed to the leaf either at the edge or near a hole, the larva then moves to the very tip of the leaf. Throughout the first three or four instars, the larva when not feeding rests on a perch made from the bared midrib of the leaf. If the larva is disturbed experimentally while it is feeding, its immediate response is to crawl rapidly back to the perch and stay there for several minutes. This behavior pattern is very

consistent. Very interestingly, the larva during the first two instars weaves a thick, silvery mat of silk around the midrib section forming the perch, and the mat extends partially onto the intact leaf surface. This structure is very much reminiscent of the woven construction of the hibernating tube of first or second instar *Limenitis* at northern latitudes. But here there is no enclosure (tube) formed after the mat is built. The resting perch of younger instars is shown in Figure 2-B, C.

The fifth instar rests on both sides of food plant leaves under laboratory conditions. It generally rests near large brown spots on the edges of these leaves, and it feeds along the edges rather than from the tip (Fig. 3-F). During all instars the larva is a diurnal feeder. When disturbed, the fifth instar ceases to feed and folds the head down beneath the thoracic region. The spines on the prominent tubercles do not produce a rash on the back of the hand when they are rubbed against them, suggesting that the spines are functional as part of a general morphological adaptation for passive defense (crypsis) rather than for offensive chemical defense against attackers.

*Adult behavior.* What little can be stated concerning adult behavior in this butterfly has to do with oviposition and play. Oviposition is very fast: there is a rapid flight movement over the foliage with sudden stops to lay a single egg. It is so fast that I was not able to determine the stance assumed during oviposition. The egg is laid on the dorsal leaf surface: in the two instances observed, one egg was laid near the edge, and another (on a different leaf) was laid near a hole in the interior region of an old leaf (Fig. 2-A).

As typical with many species of *Adelpha*, adults of *leucophthalma* exhibit flying play behavior amidst sun-flecked leaves overhanging the Rio Sarapiquí. I define play behavior as the flitting among different leaves by adults, including momentary perching on leaves in sunny places. It is likely that both sexes are involved. Based on these observations, and the fact that oviposition occurred on the leaves of a felled *Pentagonia* that is four m tall, it is likely that adults are active primarily in forest strata that occur about four to six m above the ground. On the morning of July 4, 1973, a sunny day at the study site, I observed one fresh adult of *A. leucophthalma* resting on the broad leaf of an epiphytic palm about five m from the ground; this was in the uncut forest about 100 m from the cut (now regenerating) forest site. I was unable to net this individual. This individual was resting with the wings outstretched, possibly thermoregulating, as noted for other montane species of *Adelpha* (Miller and Miller, 1970). I have never seen adults resting with their wings closed in this species.

#### DISCUSSION

*Adelpha leucophthalma* is probably absent from the tropical lowlands of Costa Rica. I have never seen it either in Guanacaste or in Sarapiquí ("tierre

caliente"). As for high country, I have seen it both at Cuesta Angel, the site of the present study, and also southwest of here at Bajo la Hondura. At both of these localities, the insect is solitary, and I have seldom seen more than three adults on a given day. The factors contributing to the apparent "rarity" of this butterfly in Costa Rican high country are not known at this time. Based on these field observations, the scarcity of the species in museum collections is indicative of it being rare in the wild. In the tropical lowlands, many other species of *Adelpha* appear to be locally abundant.

Miller and Miller (1970) suggest that some *Adelpha* are *Quercus*-feeders as larvae; *Quercus* is a member of the Fagaceae (beech family). The present record of *A. leucophthalma* on a rubiaceaceous food plant may be a first record for a member of this genus on something other than oaks.

In terms of adjusting to the local community of plants and animals, the natural history of this *Adelpha*, as in other species of this genus, entails an adaptive response to some spectrum of potential predators in the form of crypsis. As perceived by humans, this crypsis is best expressed in this insect during the larval and pupal (chrysalis) periods of ontogeny. Such adaptations are very likely most effective against attacks by visual-hunting predators such as foliage-foraging insectivorous birds, lizards, and perhaps larger predatory arthropods possessing compound eyes capable of color discrimination. The behavior of the larva in returning to a thin, isolated perch upon disturbance is interpreted here as a means of positioning itself in a place where (1) crypsis is enhanced, and (2) it is less accessible to predators. It is doubtful, however, that the latter aspect is an adaptation to large vertebrate predators that glean leaves for insects, but rather it may be most effective against ants and other smaller predatory arthropods that hunt by odor and tactile means in addition to vision. A bird or lizard would gobble the larva very quickly should the crypsis be penetrated by the searching behavior of these forms, but there may be more time for escape when attack is by a single ant or beetle. The predator-defense adaptations of the egg and adult stages are obscure. The hair-like projections from the egg may be functional in discouraging attack by predatory insects. Depending on the size and diversity of the guild of leaf-chewing insects that attack the older leaves of *Pentagonia* at the study site, the eggs of this butterfly and those of other insects may be subject to varying degrees of predation through passive uptake as leaves are consumed. The adults are very swift, agile fliers, as are all members of the genus. The general habits of the adults of several insular species of *Adelpha* have been given in Barcant (1970), and those of adult *A. leucophthalma* conform closely to *A. naxia* (Fldr.).

#### Literature Cited

- BARCANT, M. 1970. "Butterflies of Trinidad and Tobago." London: Collins, 314 pp.  
FRUHSTORFER, H. 1915. *Adelpha*. In A. Seitz, Die Gross-schmetterlinge der Erde, 5: 510-533.

- GODMAN, F. D., AND O. SALVIN. 1870-1901. "Biologia Centrali-Americana. Insecta. Lepidoptera-Rhopalocera." London, 2 vols.
- MILLER, L. D., AND J. Y. MILLER. 1970. Notes on two rare Mexican *Adelpha* and related Central American species (Nymphalidae). J. Lepid. Soc., **24**: 292-297.

## Revision of the Genus *Holcostethus* in North America (Hemiptera: Pentatomidae)

F. J. D. McDONALD

DEPARTMENT OF PLANT PATHOLOGY AND AGRICULTURAL ENTOMOLOGY,  
UNIVERSITY OF SYDNEY, SYDNEY, AUSTRALIA

RECEIVED FOR PUBLICATION FEBRUARY 21, 1974

**Abstract:** A diagnosis is given for the genus *Holcostethus* and descriptions are provided for six species. A new species is described from Arizona and a key is provided for the identification of all North American species.

*Holcostethus* is a widespread genus with representatives in North America, Europe, North Africa and Asia. The holarctic distribution of the genus is confirmed by the similarity of the seven North American species to the two European species examined, *H. sphaecelatus* (the type species) and *H. vernalis* (Figs. 4-17).

All the species examined have a pair of structures lying dorsally in the base of the pygophore that are unusual but not unique to the genus. These structures have been observed by many authors and given many names (Tuxen, 1970). Here they are termed pseudoclaspers.

### *Holcostethus* Fieber, 1860

*Holcostethus* Fieber, 1860, Europ. Hem., p. 79; Kirkaldy, 1909, Cat. Hem., p. 47.

*Peribalus* Mulsant and Rey, 1866, Ann. Soc. Linn. Lyon (2) 14, p. 185; Stål, 1872, Ofv. Svenska Vet-Ak. Forh. 29 (3), p. 34; Distant, 1880, Biol. Cent. Amer. Het. 1, p. 65; Jakovlev, 1902, Ent. Obozr. 2, p. 158; Van Duzee 1904, Trans. Amer. Ent. Soc. 30, p. 32; Zimmer, 1912, Univ. Nebraska Studies 11, p. 221; Van Duzee, 1917, Cat. Hem., p. 32; Blatchley, 1926, Het. E. N. Amer., p. 105; Froeschner, 1941, Amer. Mid. Nat. 26, p. 127.

*Dryocoris* Mulsant and Rey, 1866, Ann. Soc. Linn. Lyon (2), 14 p. 190.

*Type species:* *Cimex sphaecelatus* Fabricius, 1794.

*Diagnosis.* Oval brown pentatomids ranging in size from 4-6 mm in width (across lateral angles) and 8-10 mm long (tip of head to membrane apex). *Head.* Jugae slightly longer

**Acknowledgments:** I should like to thank the following: Dr. P. Wygodzinsky of the American Museum of Natural History, Dr. Paul Arnaud, Jr. of the California Academy of Science, Dr. C. Triplehorn, Ohio State University, and Dr. R. C. Froeschner, United States National Museum for the loan of type and other material used in this study; Dr. Per. Inge Person, Swedish Museum of Natural History, and Dr. W. R. Dolling, British Museum (Natural History) for the loan of type material; Dr. David C. Renz, Academy of Natural Sciences of Philadelphia for the loan of original Uhler material.

I am especially grateful to Professor L. H. Rolston, Entomology Department, Louisiana State University, for suggesting this study and for the use of material and notes he had made on this genus. I am also indebted to him for reading and correcting the manuscript.

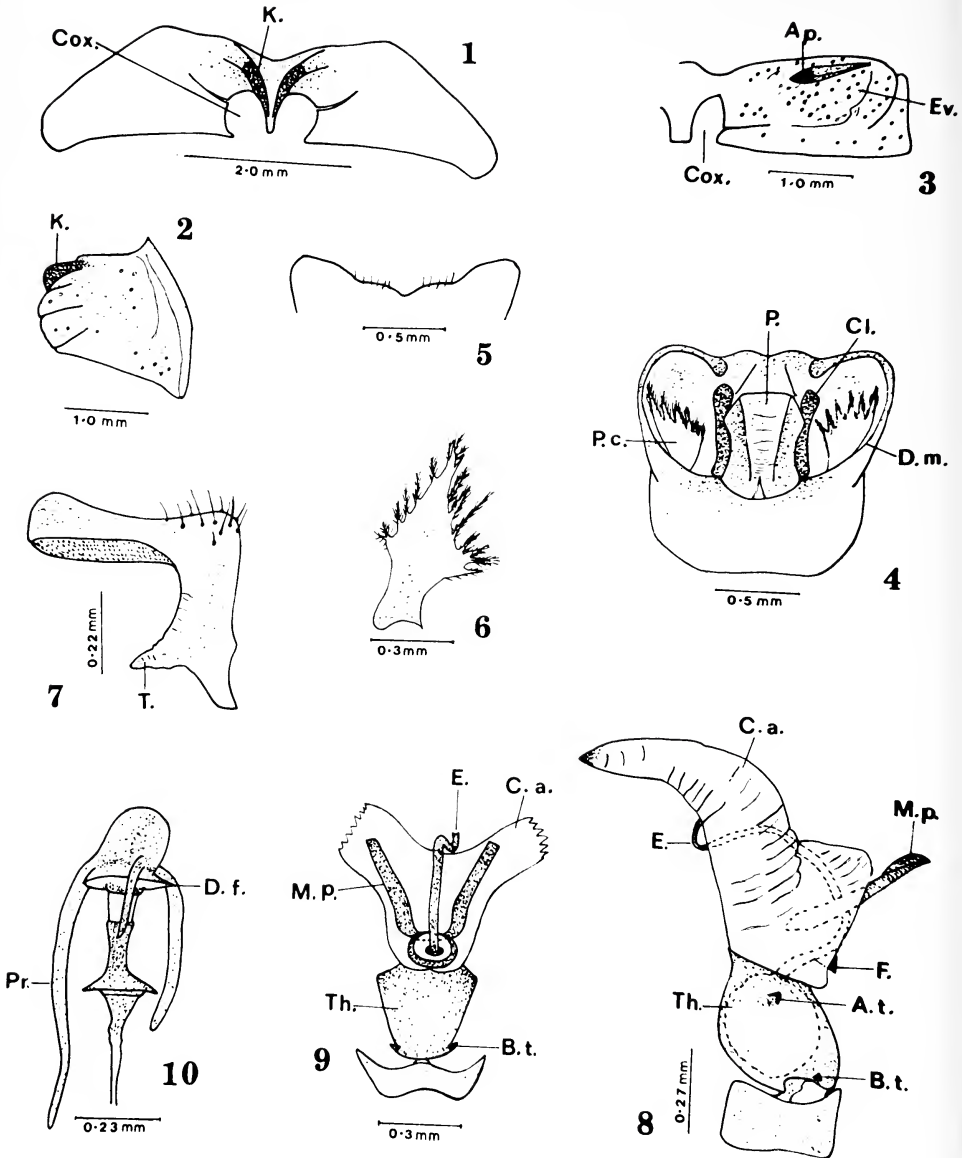

FIGS. 1-10. *H. sphacelatus*. 1. Prothorax. 2. Prothorax, lateral view. 3. Metasternum. 4. Pygophore, dorsal view. 5. Ventral margin of pygophore. 6. Right pseudo-clasper. 7. Right clasper. 8. Aedeagus, lateral view. 9. Aedeagus, ventral view. 10. Spermathecal bulb and pump, stink gland opening and sulcus (A. p.), apical tubercle (A. t.), basal tubercle (B. t.), conjunctival appendage (C. a.), clasper (Cl.), coxal cavity (Cox.), distal flange of pump (D. f.), dorsal margin (D. m.), endophallic duct (E.), evaporative area (Ev.), flange (F.), keel (K.), median penial lobe (M. p.), proctiger (P.), pseudo-clasper (P. c.), process (Pr.), tubercle (T.), theca (Th.).

than tylus, generally convergent apically, in some species meeting completely around tylus. Apex of rostrum generally reaching hind coxae. *Thorax*. Pronotum trapezoidal, deflexed between anterolateral margins. Scutellum extending two-thirds way down abdominal terga, apex narrowing beyond frena and bluntly rounded. Prosternum with two distinct keels forming a V between the coxal cavities (Figs. 1, 2). Metasternum with large granulose evaporative areas (Fig. 3); odoriferous gland openings with a long sulcus. *Abdomen*. Females generally with connexiva visible beyond folded hemelytra; males with connexiva covered by folded hemelytra.

*Male genitalia*. Pygophore with a pair of palmate pseudoclaspers, one on either side (Figs. 4, 6). Claspers L-shaped with a large basal tubercle (Fig. 7). Theca well-sclerotized with a pair of basal and apical tubercles, latter absent in one species (Fig. 8). One pair of conjunctival appendages present. Median penal lobes paired, plate-like, apically acute, united at base on either side of S-shaped endophallic duct (Fig. 9).

*Female genitalia*. External genitalia plate-like; eighth paratergites without spiracles; ninth paratergites oblong, well-separated (Fig. 26). Spermatheca typically pentatomoid; spermathecal bulb with 2 or 3 fingerlike processes (Fig. 10).

KEY TO THE SPECIES OF *HOLCOSTETHUS* IN N. AMERICA

1. Ventral surface of abdomen dark chocolate brown, margins may be outlined in yellow ..... 2  
 Ventral surface of abdomen either yellow or buff or reddish brown, with or without black markings ..... 5
2. Long gray setae found on dorsal surface especially on pronotum ..... *hirtus* (Van Duzee)  
 Dorsal surface without conspicuous setae ..... 3
3. Scutellum with distinct yellow tip; anterolateral margins of prothorax straight or slightly concave; ventral margin of pygophore as in Fig. 38; theca lacking apical tubercles ..... *piceus* (Dallas)  
 Scutellum concolorous or with very faint white tip; anterolateral margins of prothorax convex; theca with apical tubercles ..... 4
4. Small species, not more than 7.5 mm long (apex of head to tip of membrane) and 4.0 mm wide (between lateral angles of pronotum); ventral border of pygophore with a small protuberance below median notch (Fig. 53) ..... *ruckesi* McDonald  
 Larger species, over 7.5 mm long and 4.0 mm wide; ventral border of pygophore without protuberance (Fig. 46) ..... *tristis* (Van Duzee)
5. Reddish brown species with distinctive zig-zag black markings on ventral surface of abdomen; jugae not meeting in front of tylus; restricted to E. States ..... *fulvipes* (Ruckes)  
 Brown colored species without distinctive markings on abdomen ..... 6
6. Anterolateral margins of pronotum convex, submarginally impressed; connexiva with distinctly alternating pattern of yellow and black along margins (Fig. 19). Ventral border of pygophore as in Fig. 21; dorsal border bearing a large pair of spines (Fig. 20) ..... *abbreviatus* Uhler  
 Anterolateral margins of pronotum straight or slightly concave (Fig. 29); connexival margin entirely yellow (Fig. 30); ventral border of pygophore as in Fig. 31; dorsal border without spines ..... *limbolaris* (Stål)

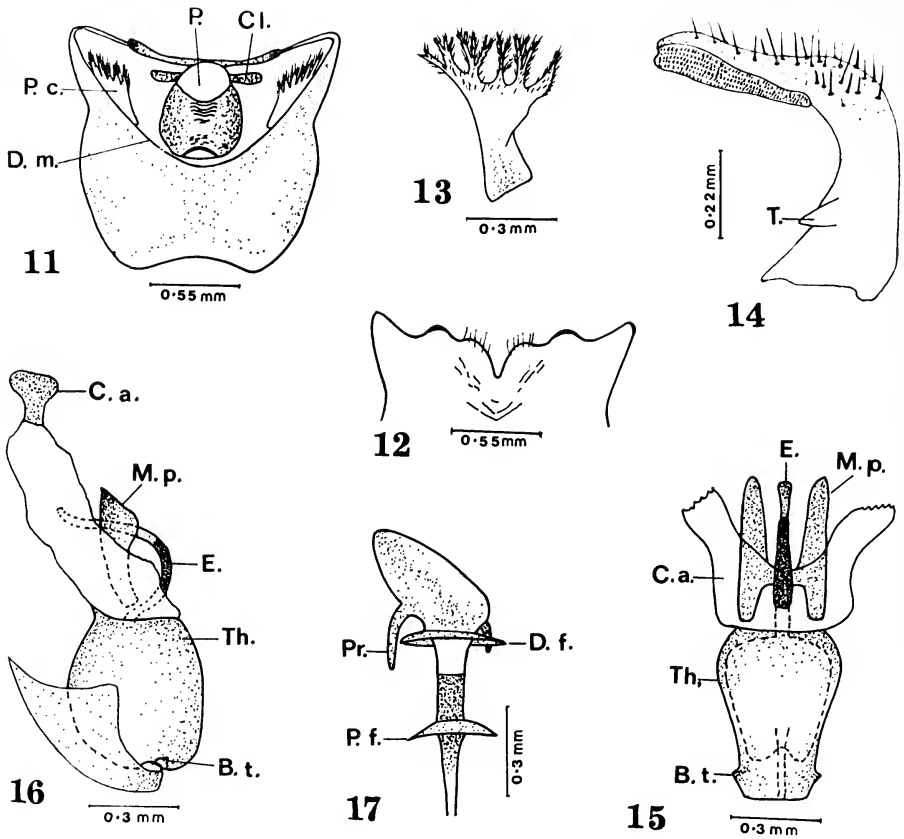

FIGS. 11-17. *H. vernalis*. 11. Pygophore, dorsal view. 12. Ventral margin of pygophore. 13. Left pseudoclasper. 14. Left clasper. 15. Aedeagus, ventral view. 16. Aedeagus, lateral view. 17. spermathecal bulb and pump, basal tubercle (B. t.) conjunctival appendage (C. a), clasper (Cl.), dorsal margin (D. m.), endophallic duct (E.), median penal lobe (M. p.), proctiger (P.), pseudoclasper (P. c.), tubercle (T.), Theca (Th.)

*Holcostethus abbreviatus* Uhler, 1872

*Holcostethus abbreviatus* Uhler, 1872, Prelim. Rep. U.S. Geol. Surv. Mont., p. 397; Uhler, 1876, Bull. U.S. Geol. Surv. 1, p. 289; Uhler, 1877, Bull. U.S. Geol. Surv. 3, p. 403; Uhler, 1895, Proc. Calif. Acad. Sci. (Ser. 2) 4, p. 230; Gillette and Baker, 1895, Hem. Colo., p. 16; Kirkaldy, 1909, Cat. Hem., p. 47.

*Peribalus abbreviatus* Van Duzee, 1904, Trans. Amer. Ent. Soc. 30, p. 33; Snow, 1906, Trans. Kan. Acad. Sci. 20(1), p. 177; Zimmer, 1912, Univ. Nebr. Stud. 11, p. 224; Van Duzee, 1917, Cat. Hem., p. 32.

*Peribalus eatoni* Bliven, 1960, Occ. Ent. 1, p. 36.

Jugae meeting in front of tylus. Anterolateral margins of pronotum distinctly bowed out and submarginally impressed (Fig. 18). Anterior face of pronotum very slightly sloping.



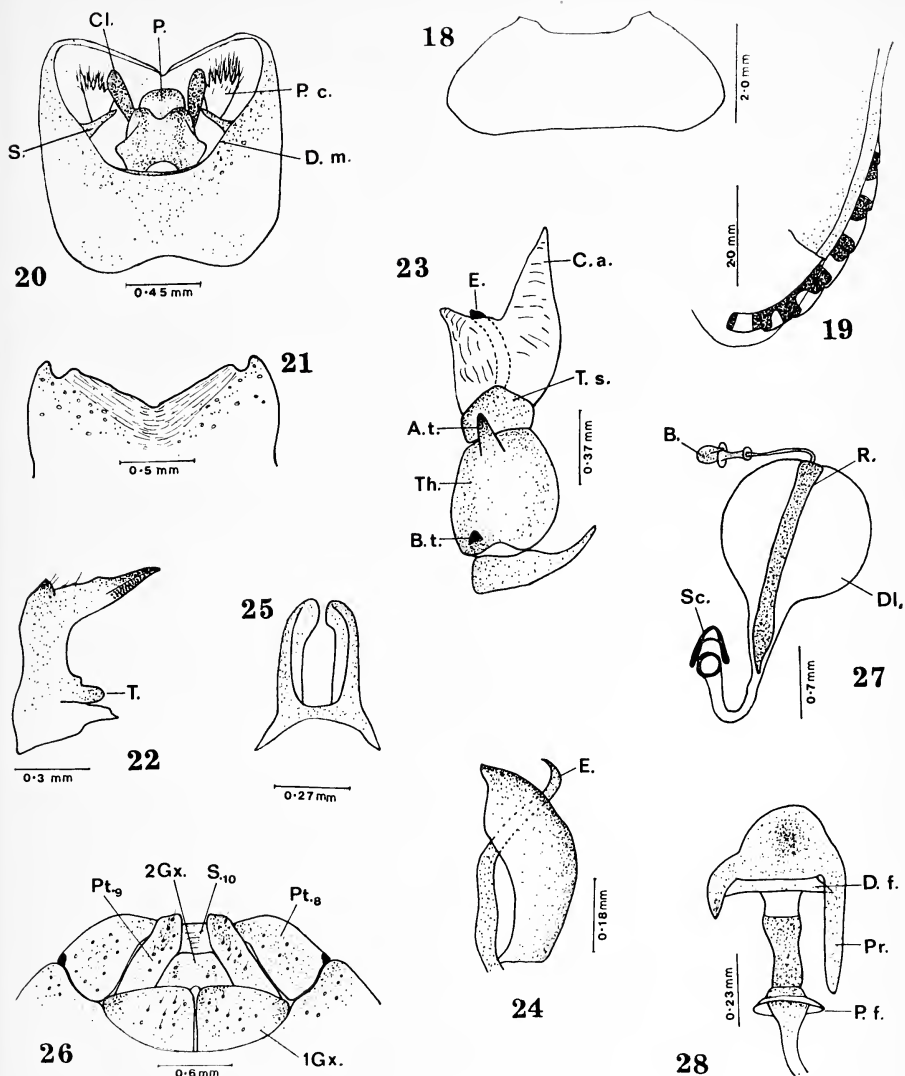

FIGS. 18-28. *H. abbreviatus*. 18. Pronotum. 19. Lateral margin of abdomen, dorsal view. 20. Pygophore. 21. Ventral margin of pygophore. 22. Left clasper. 23. Aedeagus, lateral view. 24. Right median penal lobe, lateral view. 25. Median penal lobes, ventral view. 26. Female genitalia. 27. Spermatheca. 28. Spermathecal bulb and pump, apical tubercle (A. t.), spermathecal bulb (B.), basal tubercle (B. t.), conjunctival appendage (C. a.), clasper (Cl.), distal flange (D. f.), dorsal margin (D. m.), dilation of spermathecal duct (DI.), endophallic duct (E.), first gonocoxae (1 Gx.), second gonocoxae (2 Gx.), median penal lobe (M. p.), proctiger (P.), pseudoclasper (P. c.), proximal flange (P. f.), paratergite 8 (Pt. 8), paratergite 9 (Pt. 9), sclerotized rod (R.), spine (S.), sternum 10 (S. 10), sclerite (Sc.), tubercle (T.), thecal shield (T. s.), theca (Th.).

Conspicuous pattern of alternating black and yellow squares along connexival margins visible beyond hemelytra in females (Fig. 19).

*Male genitalia* (Figs. 21–25). Ventral margin of pygophore broadly V-shaped with small emarginations at lateral extremities (Fig. 21); dorsal margin arched and bearing two large spines, one on each side of mid-line (Fig. 20). Proctiger box-like with a posterior lip. Claspers L-shaped, apically spatulate and serrate on inner surface, basally bearing a large rounded tubercle (Fig. 22). Theca well sclerotized, bearing laterally on each side a pair of small heavily sclerotized basal tubercles and a larger pair of anterior tubercles (Fig. 23); apical margin bearing a large thecal shield (Fig. 23). One pair of membranous conjunctival appendages present. Median penal lobes narrow leaf-like structures, apically acute, lying one on either side of S-shaped endophallic duct, basally fused by a cross bar around duct (Figs. 24, 25).

*Female genitalia* (Figs. 26–28). External genitalia plate-like (Fig. 26); paratergites 8 without spiracles; paratergites 9 oblong, lying widely separated on either side of second gonocoxae. Spermatheca typically consisting of a balloon-like dilation and apical spermathecal bulb (Fig. 27); latter bearing two finger-like processes, one short, the other longer and reaching proximal flange of pump (Fig. 28). Opening of spermathecal duct surrounded by a ring sclerite and a small U-shaped cap sclerite.

*Type*. Three specimens from P. R. Uhler's collection in the United States National Museum are identifiable as part of the syntype series. From these the following specimen is designated as the lectotype: ♀ S. Diego, Cal (segment 5 of left-antenna missing), United States National Museum, Washington. Paralectotypes: ♀ N.E. Col; ♀ Ks, 5, 80.

*Distribution*. Nebraska, Kansas, Colorado, Utah, Montana, Arizona, California, Nevada, Oregon, British Columbia.

*Synonymy*. The type of *H. eatoni* Bliven was not available for study. This name is placed in synonymy on the basis of the description and illustration of the pygophore.

*Holcostethus limbolarius* (Stål, 1872)

*Peribalus limbolarius* Stål, 1872, Svenska Vet.-Akad. Handl. 10(4), p. 34; Uhler, 1877, Bull. U.S. Geol. Survey 3, p. 403; Distant, 1880, Biologia Cent. Amer. Het. 1, p. 65, pl. 6, fig. 19; Van Duzee, 1894, Bul. Buf. Soc. Nat. Sci. 5, p. 171; Gillette and Baker, 1895, Hem. Colo., p. 16; Uhler, 1904, Proc. U.S. Nat. Mus. 27, p. 351; Van Duzee, 1904, Trans. Amer. Ent. Soc. 30, p. 32; Snow, 1906, Trans. Kan. Acad. Sci. 20(1), p. 177; Van Duzee, 1917, Cat. Hem., p. 33; Blatchley, 1926, Het. of E. N. Amer., p. 105; Froeschner, 1941, Amer. Mid. Nat. 26, p. 135; McDonald, 1966, Quaest. Ent. 2, pp. 18, 51 figs. 106–110, 469–470 (genitalia).

*Holcostethus limbolarius* Kirkaldy, 1909, Cat. Hem., p. 48.

*Peribalus modestus* Uhler, 1872, U.S. Geol. Surv. Mont., p. 396; Uhler, 1876, Bull. U.S. Geol. Surv. 1, p. 289.

Jugae meeting in front of tylus. Anterolateral margins of pronotum straight, sometimes slightly concave (Fig. 29). Anterior face of pronotum declivous. Connexiva with a continuous narrow yellow margin (Fig. 30).

*Male genitalia* (Figs. 31–33). Ventral margin of pygophore deeply incised on lateral extremities, less deeply incised medianly, forming two distinct oblong plates (Fig. 31). A pair of palmate pseudoclaspers present, these not observed in McDonald's (1966) description.

Remainder of male genitalia described by McDonald (1966) and Baker (1931).

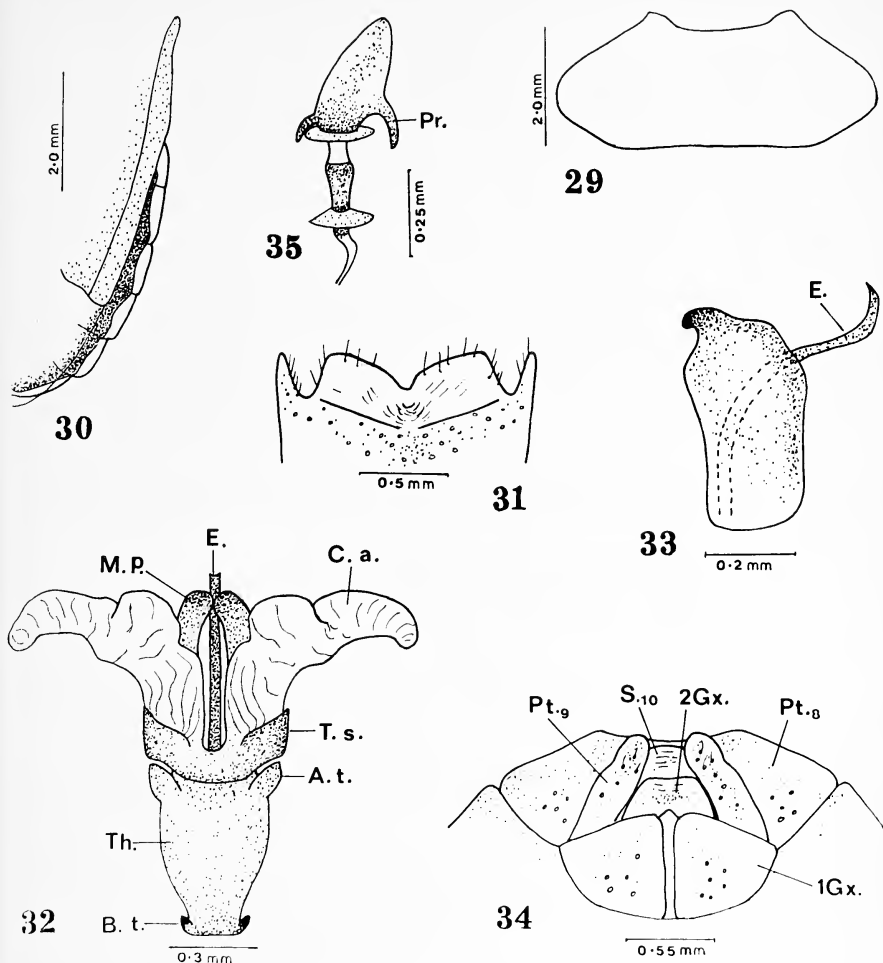

FIGS. 29–35. *H. limbolarius*. 29. Pronotum. 30. Lateral margin of abdomen, dorsal view. 31. Ventral margin of pygophore. 32. Aedeagus, ventral view. 33. Right median penal lobe, lateral view. 34. Female genitalia. 35. Spermathecal bulb and pump, apical tubercle (A. t.), basal tubercle (B. t.), conjunctival appendage (C. a.), endophallic duct (E.), first gonocoxa (1 Gx.), second gonocoxa (2 Gx.), median penal lobe (M. p.), process (Pr.), paratergite 8 (Pt. 8), paratergite 9 (Pt. 9), sternum 10 (S. 10), thecal shield (T. s.), theca (Th.).

*Female genitalia* (Figs. 34, 35). Described by McDonald (1966).

*Types*. From the syntype series the following specimen is designated as the lectotype: No. 202 ♂ Texas, Belfrage, Naturhistoriska Riksmuseet, Stockholm. 13 remaining specimens are designated paralectotypes: 192 ♂ N. York, Belfrage; 193–4 ♂ Illinois, Belfrage; 195 ♂ N. York, Belfrage; 196–199 ♀ Texas, Belfrage; 200–1, 3 ♂ Texas, Belfrage;

204 ♀ Mexico, Doucard; 205 ♂ Mexico, Salle. Specimen 192 has a label *Typus*; 192, 193 have been labelled *Paratypus* and 195 *Allotypus*. None of these can be considered valid designations.

*Distribution.* Throughout U.S.A., southern Canada and northern Mexico.

*Note.* This species can be distinguished from *H. abbreviatus* by the following features: Anterolateral pronotal margins straight (convex in *H. abbreviatus* and impressed behind); connexiva with a continuous yellow margin (alternating black and yellow in *H. abbreviatus*); pygophore with no spines on dorsal margin (two present in *H. abbreviatus*); spermathecal bulb with one process not much longer than the other (Fig. 35) (in *H. abbreviatus* one process much longer, reaching proximal flange of pump (Fig. 28).

*Holcostethus piceus* (Dallas, 1851)

*Pentatoma piceus* Dallas, 1851, List. Hem. 1, p. 236.

*Holcostethus piceus*; Kirkaldy, 1909, Cat. Hem., p. 48.

*Peribalus piceus*; Gillette and Baker, 1895, Hem. Colo., p. 16; Van Duzee, 1904, Trans. Amer. Ent. Soc. 30, p. 34; Van Duzee, 1917, Cat. Hem., p. 33; Blatchley, 1926, Het. E. N. Amer., p. 106.

Dark brown species. Anterolateral margins of pronotum straight as in *P. limbolarius*, margined with yellow (Fig. 36). Narrow continuous pale yellow margin on connexiva.

*Male genitalia.* (Figs. 37-41). Ventral margin of pygophore deeply cleft centrally and with a shallow emargination laterally on either side (Fig. 38); dorsal margin smoothly arched (Fig. 37). Proctiger resembling that of *H. abbreviatus*, differing slightly in shape. Claspers similar to *H. tristis* but bearing a distinct keel on the outer arm (Fig. 39). Aedeagus similar to *H. tristis*; no apical tubercles on theca (Figs. 40, 41).

*Female genitalia.* (Figs. 42, 43). Similar to *H. tristis*; two processes on spermathecal bulb approximately same length (Fig. 43).

*Type. Holotype.* British Museum, Type No. HEM 970. ♀ Hudsons Bay. Type examined.

*Distribution.* Iowa, S. Dakota, Colorado, Montana, Illinois, Alberta, Ontario.

*Note.* This species can be distinguished from *H. tristis* by the distinct yellow tip of the scutellum, straight anterolateral pronotal margins (convex in *H. tristis*), lack of distinct flanges on the ventral margin of the pygophore (in *H. tristis* the flanges are impressed) and absence of anterior tubercles on the theca (present in *H. tristis*).

*Holcostethus fulvipes* (Ruckes, 1957)

*Peribalus fulvipes* Ruckes, 1957, Bull. Brook. Ent. Soc. 52, p. 39.

*Holcostethus fulvipes.* New Combination.

Reddish brown species. Jugae not meeting in front of tylus. Femora red or rosy. Abdominal sterna with distinct black, zig-zag markings in two parallel lines on each side of mid-line.

*Male and Female genitalia.* Identical to those of *H. abbreviatus*.

*Type. Holotype.* The American Museum of Natural History, ♂ Lake George, N. Y., J. L. Zabriskie, 22 Aug. 1893; Paratype, ♀ (same data as holotype). Type examined.

*Distribution.* New York, New Hampshire.

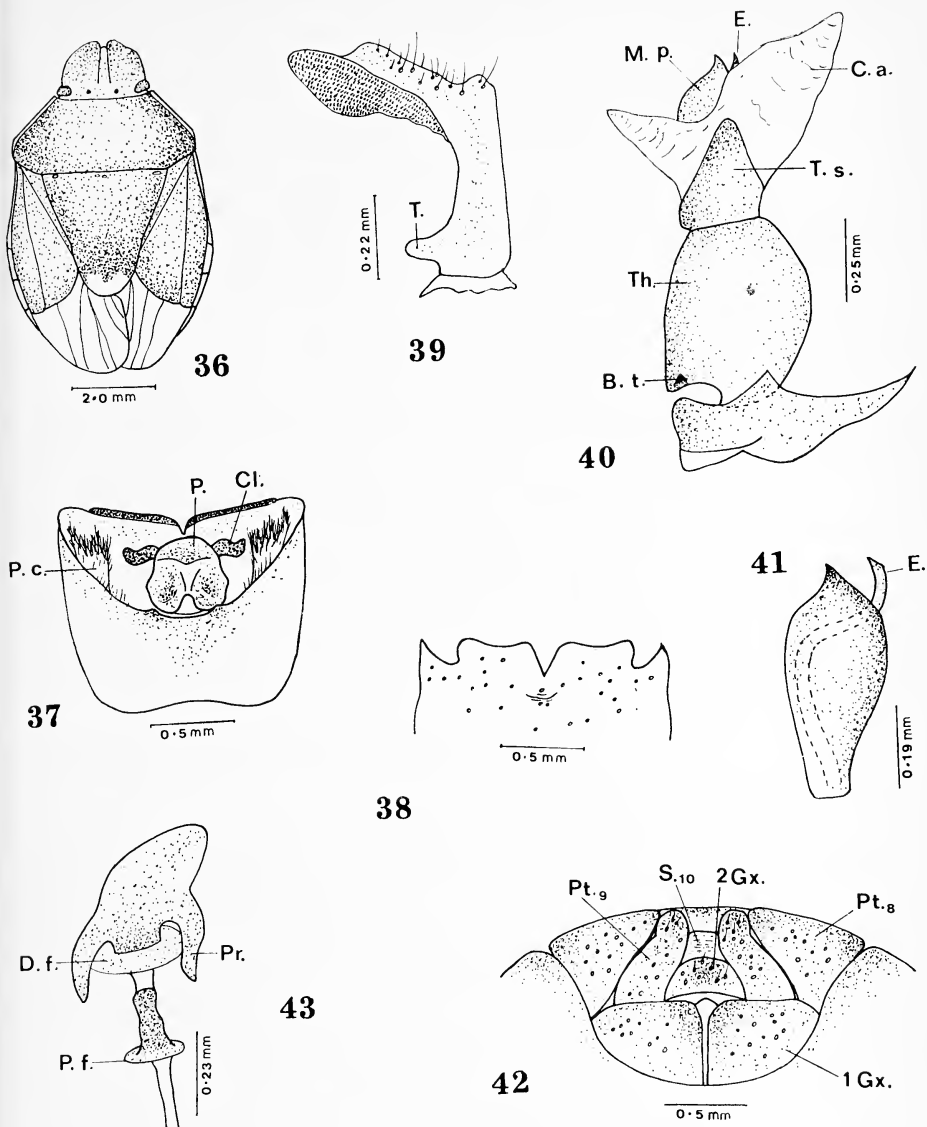

FIGS. 36-43. *H. piceus*. 36. Dorsal view. 37. Pygophore, dorsal view. 38. Ventral margin of pygophore. 39. Left clasper. 40. Aedeagus, lateral view. 41. Right median penal lobe, lateral view. 42. Female genitalia. 43. Spermathecal bulb and pump, basal tubercle (B. t.), conjunctival appendage (C. a.), clasper (Cl.), distal flange (D. f.), dorsal margin (D. m.), endophallic duct (E.), first gonocoxa (1 Gx.), second gonocoxa (2 Gx.), median penal lobe (M. p.), proctiger (P.), paratergite 8 (Pt. 8), paratergite 9 (Pt. 9), sternum 10 (S. 10), tubercle (T.), thecal shield (T. s.), theca (Th.).

*Holcostethus tristis* (Van Duzee, 1904)

*Peribalus tristis* Van Duzee, 1904, Trans. Amer. Ent. Soc. 30, p. 33; Van Duzee, 1917, Cat. Hem., p. 33.

*Holcostethus tristis*. New Combination.

Nearly unicolorous dark brown species with convex anterolateral margins of pronotum margined in lighter brown (Fig. 44). Alternating pattern of light brown or yellow and black squares along margins of connexiva.

*Male genitalia* (Figs. 45-48). Ventral margin of pygophore with a deep median notch and two smaller emarginations at lateral extremities (Fig. 46); dorsal margins evenly arched (Fig. 45). Claspers L-shaped; apex flattened on inner margin and bearing rows of minute serrations; base with a large prominent tubercle (Fig. 47). Theca heavily sclerotized; basal and apical tubercles present; apical margin produced into a thecal shield (Fig. 48). Conjunctival appendages membranous, bifid. Median penial lobes similar to *H. abbreviatus* but somewhat broader (Fig. 49).

*Female genitalia*. (Figs. 50, 51). Similar to *H. abbreviatus*. Usually two and sometimes three processes on spermathecal bulb (Figs. 50, 51).

*Type. Lectotype*. California Academy of Sciences, ♀ Vancouver Is., B.C., G. Taylor, 20 Aug. 1897. Type examined.

*Distribution*. California, Oregon, Washington, Idaho, Montana, British Columbia.

*Holcostethus hirtus* (Van Duzee, 1937)

*Peribalus hirtus* Van Duzee, 1937, Pan. Pacific Ent. 13, p. 25.

*Holcostethus hirtus*. New Combination.

Unicolorous dark brown species with long grey setae on dorsal and ventral surfaces. Anterolateral margins of pronotum convex. Connexiva with a continuous narrow lighter brown margin.

*Male genitalia*. No males available for examination.

*Female genitalia*. Similar to *H. abbreviatus*.

*Note*. This species resembles *H. tristis* but can be distinguished by the presence of long grey setae on the dorsal surface of the body and the narrow light brown margin of the abdominal connexiva (*H. tristis* has an alternating pattern of light brown and black squares).

*Type. Holotype*. California Academy of Sciences, ♀ Sequoia Nat. Pk., Calif. Alt. 3-5000 ft., Collector E. C. Van Dyke, 20 June 1929. Four paratypes, all ♀ (same data as holotype). Type examined.

*Distribution*. California.

*Holcostethus ruckesi* n. sp.

Dark brown species; male 7 mm long (apex of head to tip of membrane) 4 mm wide (between lateral angles of pronotum); female 6.5-7.3 mm long; 3.8-4.0 mm wide. Entire dorsal surface heavily punctate. Jugae longer than tylus, broadly rounded and sometimes meeting apically. Antennae dark brown. Rostrum light to dark brown, apex reaching

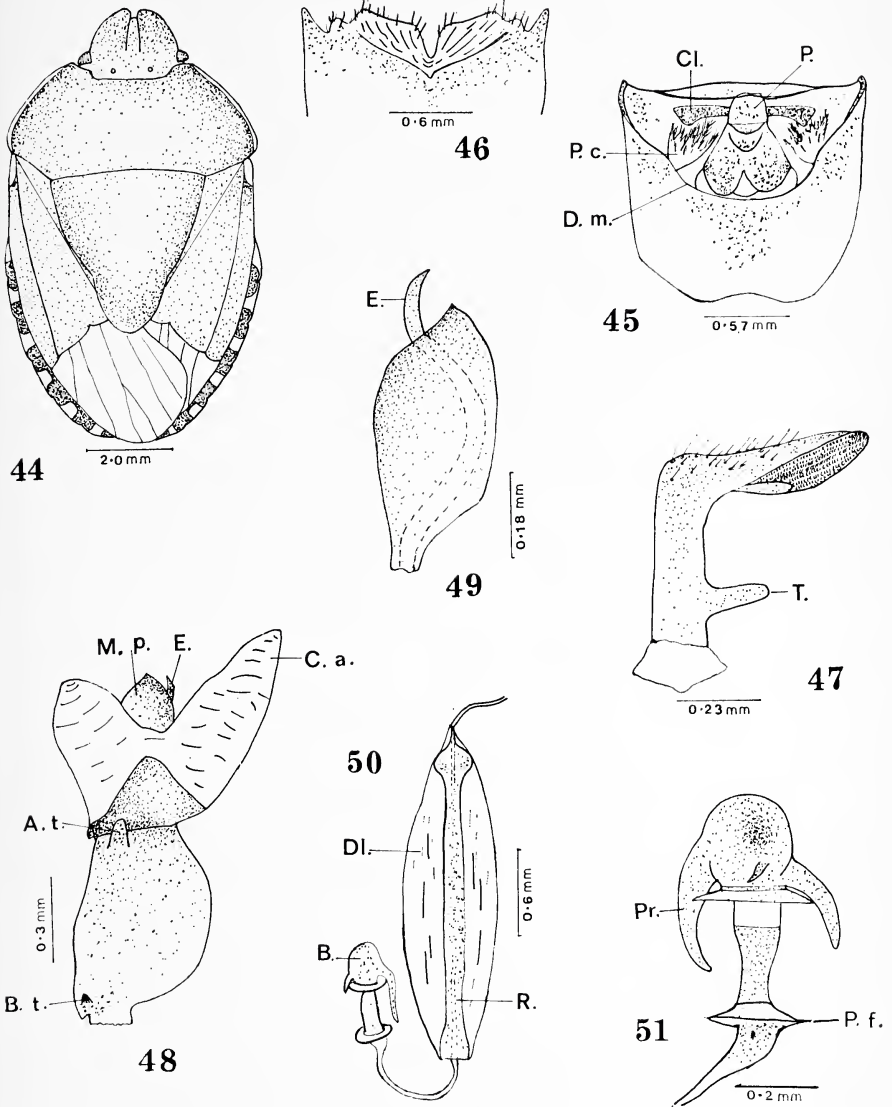

FIGS. 44-51. *H. tristis*. 44. Dorsal view. 45. Pygophore. 46. Ventral margin of pygophore. 47. Left clasper. 48. Aedeagus, lateral view. 49. Left median penal lobe, lateral view. 50. Spermatheca. 51. Spermathecal bulb and pump, anterior tubercle (A. t.), spermathecal bulb (B.), basal tubercle (B. t.), conjunctival appendage (C. a.), clasper (Cl.), dorsal margin (D. m.), endophallic duct (E.), median penal lobe (M. p.), proctiger (P.), pseudoclasper (P. c.), proximal flange (P. f.), process (Pr.), sclerotized rod (R.), tubercle (T.).

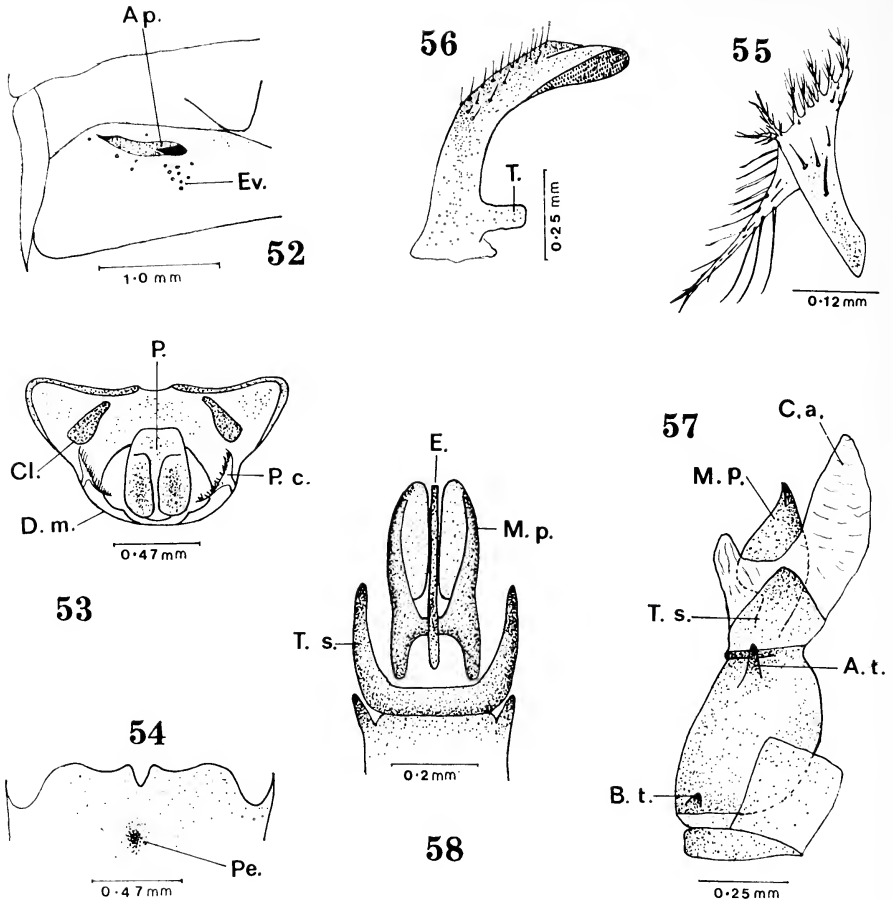

FIGS. 52-58. *H. ruckesi* n. sp. 52. Metasternum. 53. Pygophore, dorsal view. 54. Ventral margin of pygophore. 55. Right pseudoclasper. 56. Right clasper. 57. Aedeagus, lateral view. 58. Aedeagus, ventral view, stink gland opening and sulcus (Ap.), apical tubercle (A. t.), basal tubercle (B. t.), conjunctival appendage (C. a.), clasper (Cl.), dorsal margin (D. m.), endophallic duct (E.), evaporative area (Ev.), median penial lobe (M. p.), proctiger (P.), pseudoclasper (P. c.), protuberance (Pe.), tubercle (T.), thecal shield (T. s.), theca (Th.).

hind coxae. Ventrolateral margins of pronotum brown or yellow, bowed out and submarginally impressed; pronotal disk rugose. Scutellum bluntly rounded apically, narrowing only slightly beyond frena. Coxae and trochanters amber, femora and tibiae dark brown, tarsi light brown. Metapleural stink gland openings with a long apically acute sulcus (Fig. 52). Evaporative area extending onto mesopleuron. Connexiva with alternating markings on sternal margins of abdomen, a median light brown streak on sterna 3-6.

*Male genitalia* (Figs. 53-58). Ventral margin of pygophore sinuate with median and lateral notches forming two plates (Fig. 54); a small protuberance present below median



notch; dorsal margin smoothly arched (Fig. 53). Pseudoclaspers small, elongate and brush like (Fig. 55). Claspers L-shaped; upper surface with a keel bearing a number of setae (Fig. 56); apex flattened and inner surface finely serrate; a large tubercle present on base. Theca bearing large apical and small basal tubercles (Fig. 57); apical margin produced into a thecal shield. Conjunctiva with one pair of appendages, these broadly bifid (Fig. 57). Median penal lobes leaf-like apically acute and basally fused by a cross bar (Fig. 58); endophallic duct lying between margins of median penal lobes and not extending beyond them.

*Female genitalia.* External genitalia and spermatheca similar to *H. limbolarius*.

*Type. Holotype*, ♂, Rustlers Park, Chiricahua Mts. Ariz. VII-30-55; P. D. Hurd Collector. Deposited in The American Museum of Natural History. Left antenna minus segment 4 and 5, right antenna minus segment 5; forelegs minus tarsomeres 2 and 3. *Paratypes*, 3 ♀s: Rustlers Park, Chiricahua Mts. Ariz. VII-1-55, P. D. Hurd Collector; Chirc. Mts. Ariz. 9-11-35, E. D. Ball; McMillan Camp, 13 miles, N. Silver City, Grant Co., New Mexico, July 18, 1961, 6800 ft., F., P. and J. Rindge (Deposited in The American Museum of Natural History); 1 ♀ Rustlers Pk., Ariz., Chiricahua Mts., Cochise Co., July 27, 1955 (Deposited with L. H. Holston, Louisiana State University).

*Remarks.* This species is named after the late Dr. Herbert Ruckes who originally noted it in The American Museum of Natural History Collections.

#### Literature Cited

- BAKER, A. D. 1931. A study of the male genitalia of Canadian species of Pentatomidae. Canadian J. Research, **4**: 148-220.
- BLATCHLEY, W. S. 1926. "Heteroptera of Eastern North American." Nature Publishing Co., Indianapolis, 1116 pp.
- BLIVEN, B. P. 1960. Studies on insects of the Redwood Empire III New Hemiptera with notes on others. Occidental Entomologist, **1**: 34-42.
- DALLAS, W. S. 1851. List of the specimens of hemipterous insects in the collection of the British Museum 1. London, 368 pp.
- DISTANT, W. L. 1880. "Biologia Centrali-Americana Insecta, Rhynchota 1." London XX + 462 pp., 39 pls.
- FIEBER, F. X. 1860. "Die europaischen Hemiptera." Halbfluger (Rhynchota: Heteroptera). C. Gerold, Wien, 444 pp.
- FROESCHNER, R. C. 1941. Contributions to a synopsis of the Hemiptera of Missouri, Pt. 1. American Midland Naturalist, **26**: 122-146.
- GILLETTE, C. P. AND BAKER, C. F. 1895. A preliminary list of the Hemiptera of Colorado. Bull. Colorado Agr. Exp. Sta. **31**(1): 137 pp.
- JAKOVLEV, B. 1902. Les *Peribalus* (Hemiptera-Heteroptera, Pentatomidae) de la faune palearctique. Rev. Russe Ent. **2**: 157-159.
- KIRKALDY, G. W. 1909. "Catalogue of the Hemiptera (Heteroptera) Vol. 1, Cimicidae." Felix Dahms, Berlin, XL + 392 pp.
- MCDONALD, F. J. D. 1966. The genitalia of North American Pentatomoidea (Hemiptera: Heteroptera). Quaest. Ent. **2**: 7-150.
- MULSANT, E. AND REY, C. 1866. Histoire Naturelle des Punaises de France. Ann. Soc. Linn. Lyon (2) **14**: 1-288.
- RUCKES, H. 1957. New species of Pentatomidae from North and South America (Heteroptera). Bull. Brook. Ent. Soc. **52**: 39-41.

- SNOW, F. H. 1906. Some results of the University of Kansas entomological expeditions to Arizona in 1904 and 1905. *Trans. Kansas Acad. Sci.* **20**(1): 155-181.
- STÅL, C. 1872. Enumeratio Hemipterorum. *Svenska Vet.-Akad. Handlingar* **10**(4): 1-159.
- . 1872. Genera Pentatomidarum Europae disposuit. *Ofversigt Svenska Vet.-Akad. Forhandlingar.* **29**(3): 31-40.
- TUXEN, S. L. 1970. "Taxonomists Glossary of Genitalia in Insects." Munksgaard, Copenhagen. 359 pp.
- UHLER, P. R. 1872. Notices of the Hemiptera of the Western Territories of the United States. Preliminary Rept. U.S. Geol. Surv. Montana, 392-423.
- . 1876. List of Hemiptera of the region west of the Mississippi River including those collected during the Hayden explorations of 1873. *Bull. U.S. Geol. Geog. Surv.* **1**: 269-361.
- . 1877. Report upon the insects collected by P. R. Uhler during the explorations of 1875. *Bull. U.S. Geol. Geog. Surv.* **3**: 355-475.
- . 1904. List of Hemiptera-Heteroptera of Las Vegas, Hot Springs, New Mexico, collected by Messrs. E. A. Shwarz and Herbert S. Barber. *Proc. U.S. Nat. Mus.* **27**: 349-364.
- VAN DUZEE, E. P. 1904. Annotated list of the Pentatomidae recorded from America North of Mexico with descriptions of some new species. *Trans Amer. Ent. Soc.* **30**: 1-80.
- . 1917. "Catalogue of the Hemiptera of America North of Mexico." Univ. Cal. Publ. 2, Berkley, 902 pp.
- . 1937. A few new Hemiptera. *Pan Pacific Ent.* **13**: 25-31.
- ZIMMER, J. T. 1912. The Pentatomidae of Nebraska. *Univ. Nebraska Studies.* **11**: 219-251.

**Digger Wasps as Colonizers of New Habitat (Hymenoptera: Aculeata)**

HOWARD E. EVANS

DEPARTMENT OF ZOOLOGY AND ENTOMOLOGY, COLORADO STATE UNIVERSITY,  
FORT COLLINS, COLORADO 80521

RECEIVED FOR PUBLICATION FEBRUARY 22, 1974

**Abstract:** Twenty-nine species of solitary wasps occupied a newly bulldozed area of sandy soil at Bedford, Mass., during the summers of 1972 and 1973. Of these, 5 species built up large populations in only two years, having moved into the area from adjacent study plots. Another 17 species occupied the newly bulldozed area in smaller numbers, while the remaining 7 species, present in adjacent plots, failed to occupy the new substrate or did so with no increase in numbers.

## INTRODUCTION

Students of solitary wasps often seek out the nests of these insects in plots of soil made bare by man, either in excavations or fresh fills. In the more wooded parts of the country these wasps presumably once inhabited eroded slopes and banks along watercourses, but man's propensity for moving soil about has created many new areas of suitable substrate. On the whole these areas are probably no more or less permanent than the original nesting sites, for an eroded slope, no less than a man-made gravel pit, undergoes its own cycle of development. At first the soil is loose and bare; gradually mosses, grasses, and small herbs take root, reducing the bare spaces and bringing about consolidation of the soil; gradually a new topsoil is built up, and larger plants fill or shade the remaining bare spots. Thus ground-nesting insects must be able to colonize new exposures rapidly, to build up large populations, and to send out new colonizers. These statements are less true of beaches and dunes, but even such areas have their patterns of change to which ground-nesters must adjust.

Set against these facts is the common observation that aggregations of ground-nesting Hymenoptera sometimes persist in the same site for many years. Females tend to nest near the place they emerged, perhaps by some form of locality imprinting, or perhaps simply because the soil near their emergence site is the most suitable in the area. There is evidence that females of some species make a series of nests in the site where they emerged, but later make one or more nests some distance away (Evans, 1966). It is also evident that individual species vary in their tendency to adhere to one site year after year and in their ability to colonize new areas. Evidence on these points is, however, fragmentary.

**Acknowledgments:** This research was conducted at the Concord Field Station of the Museum of Comparative Zoology, Harvard University. For much assistance in the field work, I am indebted to Victoria Rowntree and to Fred Atwood. The flies were identified by Lloyd Knutson, the weevils by Janice White, the spiders by Herbert Levi.

## DESCRIPTION OF STUDIES

An opportunity to study the relative motility of ground nesters was presented to me in the spring of 1972, when an area was bulldozed at the Concord Field Station of the Museum of Comparative Zoology at Harvard (Bedford, Mass., site). I had been studying an area immediately adjacent for several years. The major occupant of this area was *Philanthus gibbosus* (Fabricius) (as reported by Evans, 1973), but I also recorded all nests of other species within the plot. The plot measured  $5 \times 9$  m and had evidently been bulldozed many years earlier; it had since become much overgrown with moss and herbs. It is here referred to as plot X.

The area newly bulldozed in May, 1972, was much larger and the freshly exposed, sandy soil was at first wholly devoid of vegetation, although parts had been filled in by grasses and herbs by late summer of 1973. This area had previously been occupied by a grass-covered bank about 3 m high by 8 m wide, the soil from the bank having been moved elsewhere. Hence the newly exposed soil was at first wholly devoid of ground-nesting insects. The most suitable nesting substrate, to which my studies were confined, was in a strip 8 m wide by 50 m long. For convenience this strip was arbitrarily divided into 3 plots, A, B, and C, A and B being separated by a narrow strip of less suitable substrate (Fig. 1). Plot A was studied intensively, B only slightly less so; C was visited for brief periods several times each day. Observations were recessed during inclement weather, but at other times (mid-June to mid-Aug.) at least one and usually two observers were on duty nearly full time during daylight hours.

Nests were marked with numbered stakes and followed from day to day. It was impossible to record all the activity at even a few nests, since so many were involved. However, there was little difficulty in identifying active nests by the appearance of the burrow and the soil at the entrance. A few females of each of several species were marked with paint of various colors to determine whether they made more than one nest, and if so where the additional nests were dug. Observations were also made on parasites, and a few selected nests were excavated to determine the number of cells and the incidence of successful parasitism.

During the summers of 1972 and 1973, 25 species of Sphecidae and 4 species of Pompilidae were found nesting in these plots. Of these 29 species, only 13 had been found nesting on plot X during the preceding several years. Of the 13, the majority merely moved into plot A without increasing notably in numbers, although 2 species increased greatly and extended over all three plots. The remaining 16 species presumably migrated in from other sandy areas nearby, although I am not aware of any major nesting sites within 1.5 km. Some of these wasps appeared in small numbers, while others became common in only two seasons.

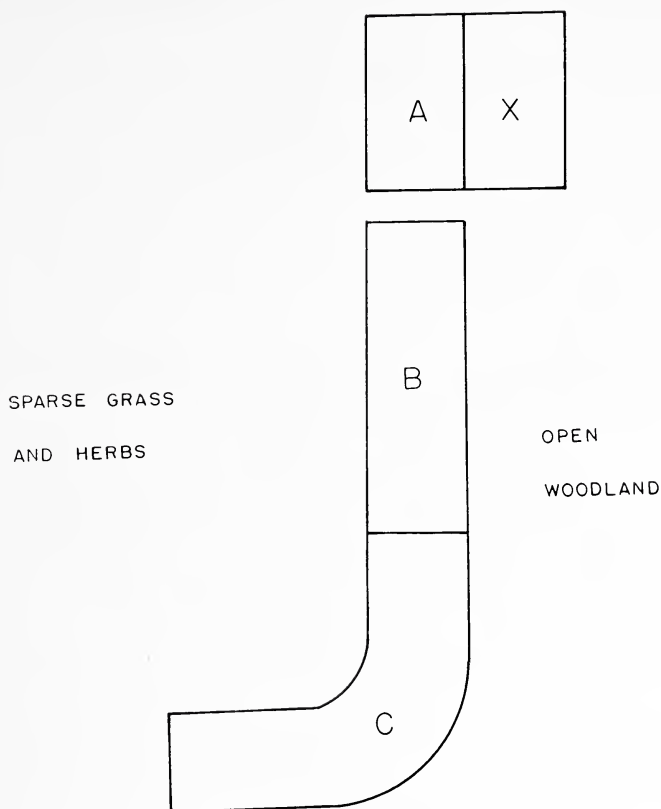

FIG. 1. Relative position of study plots, Bedford, Massachusetts.

In the following list, the species are grouped as rapid colonizers, slow colonizers, and noncolonizers. In each case a few notes are presented on the nature and abundance of the nests. Only a few biological notes are presented, since most of these are well-studied species and biological references can be found in the Synoptic Catalog of Hymenoptera North of Mexico and its supplements. The genera *Ageniella* and *Anoplius* are Pompilidae, all others Sphecidae.

#### RAPID COLONIZERS

*Crabro monticola* (Packard). From 1968 to 1971, the number of nests in plot X varied from 0 to 2, although others were noted in paths in nearby woods. In 1972, 28 nests were counted in plots A and B (none in C). In 1973, the number had increased to 123, of which a maximum of 88 were active at one time (22 June) (females commonly make a second nest after closing the first). Since the nests of this species are surmounted by a prominent ring of soil, they could be

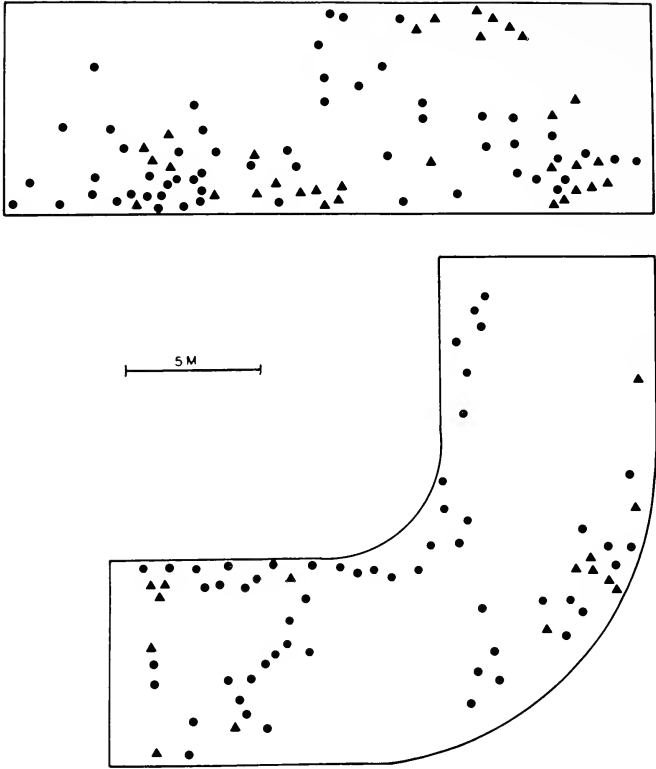

FIG. 2. Nests of *Crabro monticola* (circles) and *Aphilanthops frigidus* (triangles) in plots B and C during summer of 1973 (for correct relative position of plots, see Fig. 1).

easily marked and followed. Prey consisted of flies, mainly *Thereva frontalis* Say (Therevidae), which the *Crabro* found in abundance in the adjacent woods.

*Aphilanthops frigidus* (Smith). This species nested in plot X each year, 1968–71, the number of nests varying from 1 to 3. Only 4 were noted in the newly bulldozed plots in 1972, but in 1973 the number increased to 58. All of these were dug between 14 July and 2 August, the nesting cycle of the wasp being closely synchronized with mating flights of the prey, queen *Formica* ants. Numerous colonies of *Formica* became established in the newly bulldozed area during 1972 and 1973, and abundance of *Aphilanthops* was undoubtedly partly a consequence of the abundance of prey.

*Bicyrtes quadrifasciata* (Say). This is a common wasp in Massachusetts, but none had been seen at the Bedford site until 1973. On 23–25 July a number of males were seen flying over the ground in plot C, and over the next two weeks an estimated 12 females nested in plots A–C. It was not possible to keep an

accurate count of nests, since there is no distinctive pattern of soil at the entrance as in the preceding two species.

*Oxybelus bipunctatus* Olivier and *O. subulatus* Robertson. These two species made their first appearance in 1972, in plot A, but only a few were noted. In 1973, there were at least about 30 nests of each species in plots A and B. It was again impossible to make an accurate count, since these are very small wasps and the nests of short duration. *O. subulatus* preyed exclusively upon therevid flies, but used consistently a smaller species than *Crabro* (*Psilocephala frontalis* Cole), and only males, as reported by Peckham, Kurczewski, and Peckham (1973) in their excellent paper on members of this genus.

#### SLOW COLONIZERS

*Anoplius marginatus* (Say) and *A. semirufus* (Cresson). Females of the first species were observed 10 times and females of the second 3 times, in each case carrying spiders from the woodland into areas A and B during 1973. *A. marginatus* sometimes nested from the walls of inactive *Crabro* burrows. Both species had been seen in the area only rarely during previous seasons.

*Astata unicolor* Say. One nest was found in plot X and 1 in plot A during 1973. The species had not been observed during previous years.

*Tachysphex similis* Rohwer and *T. tarsatus* (Say). Both of these grasshopper-predators appeared in small numbers in plot A in 1972 and showed no increase in 1973.

*Chlorion aerarium* Patton. During 1973, 2 females constructed multicellular nests from pre-existing holes, provisioning them with *Gryllus* crickets. The species had not previously been observed in the area.

*Sphex ichneumoneus* (Linnaeus). This large wasp has nested in a gravel strip at the Bedford site each year, the number of nests varying from 2–10 each year. *Nysson plagiatu*s Cresson was seen entering nests on several occasions, and in 1970 we reared a female *N. plagiatu*s from cells of *S. ichneumoneus*. This species had been reported as a possible parasite by Ristich (1953), but the relationship had not been confirmed.

This nesting site was about 40 m from plots X and A. None were found nesting in these plots, but 2 females nested in plot B in 1973.

*Prionyx parkeri* Bohart and Menke. One nest of this wasp was noted in 1972, 2 in 1973; the species had not been seen during previous years. The nests are of short duration, and there were undoubtedly others that were not discovered.

*Gorytes canaliculatus* Packard and *Hoplisoides nebulosus* (Packard). These two related species, both predators on Homoptera, were seen in small numbers in 1972, but not previously. During 1973 we noted several nests of both species, but it is doubtful if there were more than 3–5 active females of each.

*Bembix americana spinolae* (Lepeletier). Two nests were noted in plot B in 1972, 8 in plots A and B in 1973. During 4 previous years, the species was sighted each summer, but no nests were ever found.

*Lindeniuss columbianus errans* (Fox). This is a minute wasp, but the nests are distinctive and are maintained for several days. We noted none until July, 1973, when 4 appeared within 2 m<sup>2</sup> in plot A.

*Ammophila procera* Dahlbom and *A. urnaria* Dahlbom. These wasps were seen only occasionally prior to 1973. During that season, we estimated 3–5 females of each species. They were often seen proceeding from the woodland into the newly bulldozed area carrying caterpillars. Most nests were in or near plot A.

*Philanthus politus* Say. One nest was found in plot B in 1972. None were found in 1973, although males were seen on several occasions on the flowers of *Achillea millefolium* and *Chrysanthemum leucanthemum*.

*Philanthus gibbosus* (Fabricius). This species maintained a nearly steady population of 32–40 nests in plot X over a period of 4 years (one female usually maintains one nest for the season) (Evans, 1973). In 1972, there were only 12 nests in plot X (now well overgrown with vegetation), but 11 females had established themselves in adjacent parts of plot A. In 1973, only one nest was dug in plot X, 20 in plot A (Fig. 3). Thus the number of females declined slightly over a three-year period, during which time there was a gradual shift into newly available bare soil, although over only a few meters.

*Cerceris prominens* Banks. This species was not recorded until 1973, when 3 nests appeared 8–14 July in area B, all within 1 m<sup>2</sup>. One of these nests was excavated on 14 July, at which time it contained 7 cells at depths of from 12 to 17 cm. Freshly provisioned cells each contained 18–19 weevils, and there were also 8 weevils at the bottom of the burrow, 8 cm deep, in compact soil. All weevils were Baridinae, the 38 specimens preserved belonging to 4 species: *Baris* sp. (17 ♂♂, 1 ♀, 10 of unknown sex), *Limnobaris* sp. (3 ♂♂, 3 ♀♀), *Pachygeraeus* sp. (2 ♂♂), and *Odontocorynus* sp. (1 ♂, 1 ♀).

It should be noted that this is quite a different complex of weevils than those employed by any of the three following species. The four species of weevil-hunting *Cerceris* occurring at this site showed no overlap in prey whatever, providing an excellent example of competitive exclusion.

#### NONCOLONIZERS

*Cerceris atramontensis* Banks, *C. halone* Banks, and *C. nigrescens* Smith. These three species all nested in small numbers in plot X during the summers of 1969–71 (Evans, 1971). However, they appeared to be absent during 1972 and 1973



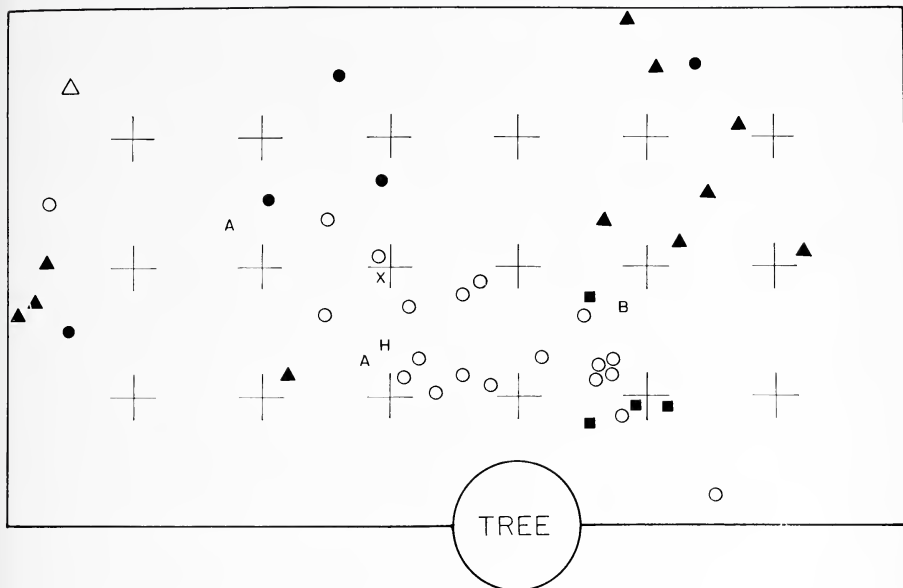

FIG. 3. Nests recorded in plot A during summer of 1973. Plot is marked off into squares 2 m each side. Solid circles: *Crabro monticola*; solid triangles: *Aphilanthops frigidus*; squares: *Lindenius columbianus errans*; hollow circles: *Philanthus gibbosus*; hollow triangle: *Bembix americana spinolae*; A: *Astata unicolor*; B: *Bicyrtes quadrifasciata*; H: *Hoplisoides nebulosus*; X: *Anacrabro ocellatus*.

except for one nest of *C. halone* each year, again in plot X. The original nesting sites were well covered by moss in 1973, but all 3 species failed to establish themselves in plots A-C.

*Lyroda subita* (Say). This wasp constructed its cells from the walls of the burrows of both *Philanthus gibbosus* and *Sphex ichneumoneus*. Only one female was noted during the summer of 1973, although the species had been fairly plentiful during previous summers.

*Ageniella conflicta* Banks. During the summers of 1968-71, this species was seen in some numbers within the *Philanthus gibbosus* nesting area. Females were seen carrying spiders into inactive *Philanthus* burrows on several occasions. These burrows were later closed by picking up small pebbles, bits of leaves, and grass blades and placing them in the burrow and in a small pile over the top. One cell was located at a depth of only 7 cm. Two prey spiders taken from wasps both proved to be female *Schizocosa bilineata* (Emerton) (Lycosidae). Both had all the legs amputated. This species was not observed in 1972, and only one female was seen in 1973.

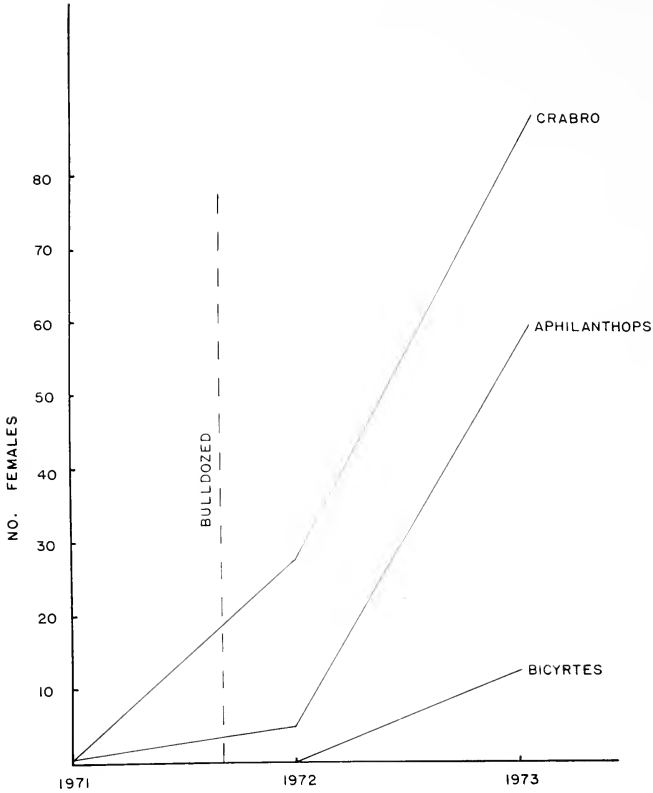

FIG. 4. Number of active females of three species over a 3 year period.

*Ageniella partita* Banks. This species was observed only in 1969, and like the preceding was closely associated with inactive nests of *P. gibbosus*. One spider taken as prey proved to be *Zelotes* sp., juvenile female (Gnaphosidae). The wasp ran over the ground with her prey and made several short, hopping flights, straddling the prey and holding it by the spinnerets. Only one leg had been amputated. This is evidently the first record of this species from Massachusetts.

*Anacrabro ocellatus* Packard. One or two females nested in plot X each year, 1968–71. In 1972 one female nested in plot X, one in plot A, only 3 m away. In 1973 one female nested in plot A. Thus the population remained essentially stable despite the large amount of new substrate available.

#### DISCUSSION

It is evident that in this limited area and over a limited time period, some wasps spread rapidly over newly available bare, sandy soil and increased their numbers greatly. Others increased in numbers only slightly or even showed a

decline. It is unlikely that exactly this same pattern would have been followed under different circumstances. The proximity of the study area to a woodland having a plentiful supply of therevid flies undoubtedly permitted *Crabro monticola* and *Oxybelus subulatus* to flourish. The sudden abundance of *Aphilanthops frigidus* was also very probably related to the fact that its host, *Formica fusca*, had also rapidly occupied the newly available substrate.

On the other hand, there were many blowflies and muscids around the nearby animal pens, and solitary bees abounded in and around plots A-C. Thus there appeared to be ample prey for species of *Bembix* and *Philanthus*. Members of these genera are, in fact, known to remain attached to their nesting sites for many years, and in this instance they showed little tendency to avail themselves promptly of new potential nesting sites.

The differential effect of parasites also undoubtedly plays a role in controlling the numbers of these insects. By colonizing new sites rapidly, species such as *Crabro monticola* and *Aphilanthops frigidus* may in some measure evade the attacks of miltogrammine flies. The latter species is known to be especially susceptible to attacks by these flies (Ristich, 1956). We did not excavate any *Aphilanthops* nests, but of the 7 *Crabro* nests excavated, all but 1 had at least one cell containing maggots of miltogrammine flies. In all, 15 of 37 cells were parasitized (40%). *Metopia argyrocephala* Meigen was reared from 3 nests, *Senotainia trilineata* Wulp from one. Neither species of wasp is known to be attacked by mutillid wasps, the behavior patterns of which seem especially adapted for more gregarious species which persist in one site from year to year. I believe the decline of *Philanthus gibbosus* to be related to the abundance of its parasite, *Dasymutilla nigripes* (Fabricius).

#### Literature Cited

- EVANS, H. E. 1966. "The Comparative Ethology and Evolution of the Sand Wasps." Cambridge, Mass.: Harvard Univ. Press.
- . 1971. Observations on the nesting behavior of wasps of the tribe Cercerini. Jour. Kansas Ent. Soc., **44**: 500-523.
- . 1973. Burrow sharing and nest transfer in the digger wasp *Philanthus gibbosus* (Fabricius). Anim. Behav., **21**: 302-308.
- PECKHAM, D. J., KURCZEWSKI, F. E., AND PECKHAM, D. B. 1973. Nesting behavior of nearctic species of *Oxybelus* (Hymenoptera: Sphecidae). Ann. Ent. Soc. Amer., **66**: 647-661.
- RISTICH, S. S. 1953. A study of the prey, enemies, and habits of the great golden digger wasp *Chlorion ichneumoneum* (L.). Canad. Ent., **85**: 374-386.
- RISTICH, S. S. 1956. The host relationship of a miltogrammid fly, *Senotainia trilineata* (VDW). Ohio Jour. Sci., **56**: 271-274.

**Seasonal Variation in *Tachysphex terminatus* (Smith)  
(Hymenoptera: Sphecidae, Larrinae)**

NANCY B. ELLIOTT, FRANK E. KURCZEWSKI

DEPARTMENT OF ENTOMOLOGY, STATE UNIVERSITY OF NEW YORK  
COLLEGE OF ENVIRONMENTAL SCIENCE AND FORESTRY, SYRACUSE, NEW YORK 13210

RECEIVED FOR PUBLICATION MARCH 11, 1974

**Abstract:** Comparisons of morphological characters between successive generations of males and females of *Tachysphex terminatus* (Smith) in upstate New York were made. Significant differences were found for the samples of females but not for those of males. However, the males showed greater variability within a generation than did the females.

INTRODUCTION

*Tachysphex terminatus* (Smith), a common North American digger wasp, is bivoltine in the Northeast with generations emerging in June and August. As part of a study of morphological variation in the species throughout its range (Elliott, 1971), it was deemed desirable to determine whether there was significant morphological variation between individuals of successive generations.

MATERIALS AND METHODS

Samples of males and females were collected near Chittenango, New York, in June and August, 1969. The following size-related characters were measured for each specimen: head width, interocular distance across vertex, clypeal width, forewing vein length along costal margin of the wing to the distal end of the marginal cell, and length of flagellomere 2. We tested for seasonal differences in these characters by using an F test for comparing two means.

RESULTS AND DISCUSSION

Results of comparisons for each sex are given in Table 1. Of the characters measured, only the length of flagellomere 2 showed significant differences between samples of males. Comparisons of the same characters in females demonstrated differences in interocular distance, clypeal width, forewing vein length, and length of flagellomere 2. This analysis did not show a significant difference for head width between samples of females. However, a one-way analysis of variance comparing several samples of females from various U.S. localities revealed significant differences for this character for June and August samples from Chittenango.

---

**Acknowledgments:** We thank G. C. Gaumer, Department of Entomology, Texas A. & M. University, for collecting many of the specimens used in this study.

TABLE 1. Seasonal Variation in Morphological Characters of *Tachysphex terminatus*

Character	♂ ♂	♀ ♀
Head width	M. S. Groups = 21.13	M. S. Groups = 31.04
	M. S. Ind. = 18.16	M. S. Ind. = 8.70
	F = 1.16	F = 3.56
Interocular Distance	M. S. Groups = 0.94	M. S. Groups = 9.04
	M. S. Ind. = 1.91	M. S. Ind. = 0.30
	F = 0.49	F = 6.93*
Clypeal width	M. S. Groups = 4.23	M. S. Groups = 14.08
	M. S. Ind. = 5.29	M. S. Ind. = 3.20
	F = 0.80	F = 4.40*
Forewing Vein length	M. S. Groups = 75.72	M. S. Groups = 190.48
	M. S. Ind. = 19.58	M. S. Ind. = 14.39
	F = 3.87	F = 13.24*
Flagellomere 2	M. S. Groups = 4.16	M. S. Groups = 6.05
	M. S. Ind. = 0.39	M. S. Ind. = 0.72
	F = 10.67*	F = 8.40*

\* = significant at  $\alpha = 0.05$ .

The fact that females showed greater morphological variation between generations than males leads one to ask whether or not females really are more variable. Lewontin (1966) suggested comparing relative variability of two samples by comparing variances of the logarithms of the measurements using F. Table 2 shows comparisons of this kind for our samples. Only in the case of forewing vein length for the June samples did females show greater variability than males. Conversely, males from the August sample were more variable than females in every character compared. A similar comparison for a sample from Lakin, Kansas, also showed more morphological variability among the males (Elliott, 1971). Eickwort (1969) compared variability of males and females of *Polistes exclamans* Viereck (Vespidae) and found the males to be more variable,

TABLE 2. Relative Variability of Morphological Characters in Males and Females of *Tachysphex terminatus*

	Head Width	F. V. L.	Femur 1
June, 1968			
S <sup>2</sup>	0.00267	0.00713	0.001
log ♀			
S <sup>2</sup>	0.00130	0.00291	0.00175
log ♂			
F	2.054	2.45*	1.75
August, 1968			
S <sup>2</sup>	0.0004	0.0002	0.000533
log ♀			
S <sup>2</sup>	0.00141	0.00264	0.00438
log ♂			
F	3.500*	13.00*	8.218*

\* = significant at  $\alpha = 0.05$ .

as expected, because they are haploid. She conceded that reports of other male Hymenoptera which are less variable than conspecific females might reflect decreased responsiveness to environmental selective pressures. In such species, the females are involved in food gathering and nesting while the primary function of the males is copulation.

Females of *T. terminatus* are continually subjected to the selective pressures of the environment, especially during nesting, hunting, and prey transport. Apparently selective pressures act upon them, resulting in greater seasonal variation than in males. The males, on the other hand, perhaps because they are haploid, show greater intrapopulational variation.

In *T. terminatus* females, August samples had larger mean values for size-related characters than June samples. Kurczewski (1964) observed that females of this species stored not only more prey per cell in June than in August but also a greater biomass; hence the individuals emerging in August have been reared on more food than those emerging in June, probably accounting for their larger size. Dow (1942) reported that larger cocoons of the cicada-killer were found in cells stocked with two cicadas and smaller cocoons in cells stocked with only one.

#### Literature Cited

- DOW, R. 1942. The relation of the prey of *Sphecius speciosus* to the size and sex of the adult wasp. *Ann. Entomol. Soc. Amer.*, **35**: 310-317.
- EICKWORT, K. R. 1969. Differential variation of males and females in *Polistes exclamans*. *Evolution*, **23**: 391-405.
- ELLIOTT, N. B. 1971. Morphological variation in *Tachysphex terminatus* (Smith) and *Tachysphex similis* Rohwer (Hymenoptera: Sphecidae, Larrinae). Syracuse, N.Y., S. U. N. Y. College of Environmental Science and Forestry. Ph.D. thesis.
- KURCZEWSKI, F. E. 1964. A comparative ethological study of some Nearctic digger wasps of the genus *Tachysphex* Kohl. (Hymenoptera: Sphecidae, Larrinae). Ithaca, N.Y., Cornell Univ. Ph.D. thesis.
- LEWONTIN, R. C. 1966. On the measurement of relative variability. *Syst. Zool.*, **15**: 141-142.

## Two New Genera and Two New Species of Acanthosomatidae (Hemiptera) from South America, with a Key to the Genera of the Western Hemisphere

L. H. ROLSTON<sup>1</sup> AND R. KUMAR<sup>2</sup>

RECEIVED FOR PUBLICATION JUNE 8, 1974

**Abstract:** Two new acanthosomatid genera, each with one new species, are described: *Mazanoma*, new genus, *M. variada*, new species and type species, type locality Guardia Vieja, Los Andes, Aconcagua, Chile; and *Tolono*, new genus, *T. decoratus*, new species and type species, type locality Loja Province, Ecuador. A key to the acanthosomatid genera of the Western Hemisphere is given. *Sinopla bicallosus* Stål is transferred to *Acrophyma*.

Two new genera of acanthosomatids from South America, each with one new species, are described. A key to the acanthosomatid genera of the Western Hemisphere, the first since that of Stål (1867), relates the new genera to those previously known in this region.

Synonymy and generic diagnoses will appear in a revision of the world genera of acanthosomatids now being completed by R. Kumar. The format of the generic descriptions given here and the terminology conform to that used in the revision of world genera.

*Tunaria* Pirán, 1957, (not Link, 1807; not Steinmann and Hoek, 1912), represented by *T. andicola* Pirán, 1957, was not available for study, and the description does not permit placing this genus in the key. From the description and figure *Tunaria* Pirán cannot be distinguished from *Blaudus* Stål.

One generically misplaced species was noted during the preparation of the key:

*Acrophyma bicallosa* (Stål) New Combination

*Sinopla bicallosus* Stål, 1872, Sv. Vet. Ak. Handl. 10(4): 62.

### KEY TO GENERA OF ACANTHOSOMATIDAE OF THE WESTERN HEMISPHERE

- |                                                                                                                                                                                       |                           |
|---------------------------------------------------------------------------------------------------------------------------------------------------------------------------------------|---------------------------|
| 1. Median tubercle or spine present at base of abdominal venter .....                                                                                                                 | 9                         |
| 1' Base of abdominal venter smoothly convex .....                                                                                                                                     | 2                         |
| 2(1). Distal end of first antennal segment clearly surpassing apex of head .....                                                                                                      | 3                         |
| 2' Distal end of first antennal segment reaching little if any beyond apex of head .....                                                                                              | 6                         |
| 3(2). Longitudinal sulcus on prosternum before coxae as deep as diameter of rostrum, little wider; distal diameter of first antennal segment usually about twice basal diameter ..... | <i>Cylindrocnema</i> Mayr |
| 3' Longitudinal sulcus on prosternum absent or much broader than diameter of rostrum; first antennal segment subcylindrical .....                                                     | 4                         |

<sup>1</sup> Department of Entomology, Louisiana State University, Baton Rouge, Louisiana 70803.

<sup>2</sup> Department of Zoology, University of Ghana, P. O. Box 67, Legon, Ghana.

- 4(3). Length of first antennal segment more than .8 length of head measured dorsally ..... *Planois* Signoret  
 4' Length of first antennal segment less than .6 length of head measured dorsally ..... 5
- 5(4). Prosternum shallowly depressed lengthwise ..... *No $\phi$ alis* Signoret  
 5' Prosternum transversely convex ..... *Ditomotarsus* Spinola
- 6(2). Paraclypei far surpassing anteclypeus, usually contiguous before anteclypeus ..... *Mazonoma* n. gen.  
 6' Paraclypei not or scarcely surpassing anteclypeus ..... 7
- 7(6). Scent gland spout reaching more than halfway from inner margin of ostiole to lateral margin of metapleuron ..... *Hyperbius* Stål  
 7' Scent gland spout short ..... 8
8. Mesosternum weakly carinate; female with one pair of Pendergrast's organs ..... *Tolono* n. gen.  
 8' Mesosternum without carina; female with two pairs of Pendergrast's organs ..... *Praesus* Stål
- 9(1). Mesosternal carina greatly produced, extending anteriorly beyond procoxae; abdominal spine appressed to right side of posterior portion of mesosternal carina ..... 10  
 9' Mesosternal carina weakly developed or absent ..... 11
- 10(9). Scent gland spout reaching a little more than halfway from inner margin of ostiole to lateral margin of metapleuron ..... *Elasmucha* Stål  
 10' Scent gland spout reaching about three-fourths distance from inner margin of ostiole to lateral margin of metapleuron ..... *Elasmostethus* Fieber
- 11(9). Abdominal spine surpassing mesocoxae ..... 12  
 11' Abdominal spine not reaching mesocoxae ..... 13
- 12(11). Scent gland spout reaching more than halfway from inner margin of ostiole to lateral margin of metapleuron; abdominal spine attaining procoxae ..... *Blandus* Stål  
 12' Scent gland spout reaching about one-third distance from inner margin of ostiole to lateral margin of metapleuron; abdominal spine attaining head ..... *Bebaeus* Dallas
- 13(11). Paraclypei contiguous before anteclypeus ..... *Sniploa* Signoret  
 13' Paraclypei not surpassing anteclypeus or if longer than anteclypeus neither markedly convergent nor contiguous ..... 14
- 14(13). Scent gland spout extending much farther than halfway from inner margin of ostiole to lateral margin of metapleuron ..... 15  
 14' Scent gland spout extending halfway or less from inner margin of ostiole to lateral margin of metapleuron ..... 16
- 15(14). Anterolateral pronotal margins serrate; first antennal segment not surpassing apex of head; mesosternum slightly depressed lengthwise ..... *Pseudobebaeus* Distant  
 15' Anterolateral pronotal margins entire, somewhat rugose; first antennal segment slightly surpassing apex of head; mesosternum weakly carinate ..... *Phorbanta* Stål
- 16(14). Scent gland spout reaching halfway from inner margin of ostiole to lateral margin of metapleuron ..... *Lanopis* Signoret  
 16' Scent gland spout reaching not more than one-third distance from inner margin of ostiole to lateral margin of metapleuron ..... 17
- 17(16). Spine at base of abdominal venter clearly extending onto metasternum ..... 19  
 17' Base of abdominal venter tuberculate, tubercle not or scarcely surpassing posterior margin of metasternum ..... 18



- 18(17). Apex of head broad, anteclypeus and each paraclypeus individually rounded, sides scarcely concave before eyes ..... *Ea* Distant  
 18' Apex of head a narrow smooth parabola, sides distinctly concave before eyes ..... *Acrophyma* Bergroth
- 19(17). Paraclypei clearly surpassing anteclypeus, dehiscent; mesosternum weakly carinate; first antennal segment slightly surpassing apex of head ... *Sinopla* Signoret  
 19' Anteclypei slightly longer than paraclypei; mesosternum without carina; first antennal segment not reaching apex of head ..... *Hellica* Stål

*Mazanoma*, n. g.

Type species: *Mazanoma variada*, n. sp.

*Head.* Antenniferous tubercles unarmed. Basal segment of antennae reaching almost to apex of head. Maxillary tubercle absent. Bucculae moderately elevated, covering about three-fourths of distance from their anterior limit to base of head, extending a little beyond distal end of first rostral segment, arcuately truncate at their posterior limit. Apex of rostrum resting on metasternum.

*Thorax and wings.* Prosternum somewhat produced on each side of broad median sulcus; rostrum lying in sharply defined sulcus of mesosternum; metasternum concave. Scent gland spout drop-shaped, expanding from ostiole, covering about one-third of distance from ostiole to lateral margin of metapleuron; evaporative area not defined (Fig. 4). Costal margin of coria arcuate with slight expansion above posterior limit of metapleura, radial vein plicately elevated; membranes nearly reaching or slightly surpassing apex of abdomen (Fig. 1).

*Abdomen and general body features.* Body obovate. Abdomen spatulate due to dorsad inclination of connexiva toward margins, broadest at fourth and fifth segments, appreciably wider here than pronotum. Connexiva broadly exposed. Pendergrast's organ covering sixth and basal half of seventh abdominal sterna. Abdomen lacking median spine or tubercle. One discernible trichobothrium caudad and mesad of each spiracle on sterna 3-7.

*Male genitalia.* Maximum diameter of phallosome near distal limit, no great ventral enlargement basad of conjunctiva (Fig. 7). Conjunctiva with partially sclerotized pair of dorsolateral processes. Seminal conducting canal tubular, not expanded into conducting chamber.

*Female genitalia.* 8th paratergites truncate apically, continuing contour of connexiva, bearing exposed spiracles; remaining genital plates together forming obovate area in deep emargination of seventh sternum (Fig. 3).

*Mazanoma variada*, n. sp.

Paraclypei rounded distally, contiguous or dehiscent before anteclypeus, lateral margins slightly sinuous. Elongate depression with black confluent punctures located on each side of disk between eye and anteclypeus and running from ocellus to level of distal end of antenniferous tubercle. Anterior to these depressions paraclypei slope upward from anteclypeus to lateral margins, forming disk on anterior half of head into trough. Punctuation other than in depressions moderately dense with punctures mostly discrete, black or castaneous. Antennae dark brown becoming fuscous on third segment or near base of fourth; second segment slightly bowed; length of segments 0.4-0.5; 1.2-1.3; 0.8; 0.8-1.0 mm.

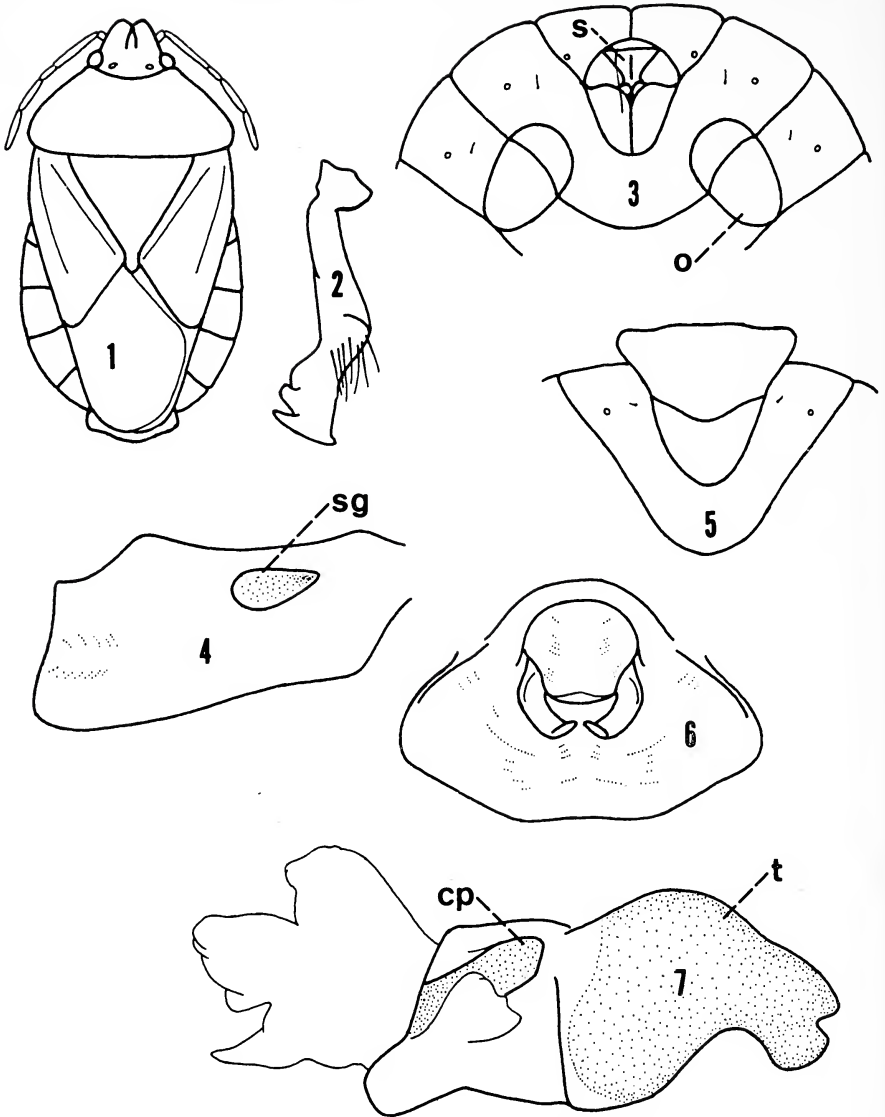

FIGS. 1-7. *Mazanoma variada* n. sp. FIG. 1. General dorsal aspect. FIG. 2. Right paramere. FIG. 3. Apex of female abdomen, ventral aspect; Pendergrast's organ (o); tenth sternite (s). FIG. 4. Right metapleuron; scent gland spout (sg); FIG. 5. Apex of male abdomen, ventral aspect. FIG. 6. Genital cup. FIG. 7. Aedeagus; conjunctival process (cp); phallosome (t).

Pronotum subtriangular, truncate apically (Fig. 1). Anterior emargination evenly concave behind head; anterolateral margins nearly straight, obtusely carinate, lacking denticle at anterolateral angles; humeri broadly rounded, protruding little beyond costal margin of hemelytra at base. Transverse tumescence on anterior pronotal disk includes

indistinct cicatrices and area between them, separated from anterior pronotal margin by narrow sulcus. Punctuation rather evenly distributed excepting scattered patches of dense black punctures, especially in and near anterior submarginal sulcus, in submarginal impression before each humerus and on humeri. Color predominately ivory, relieved by discrete or aggregated black punctures and caudad of tumescence by light castaneous punctures and blotches. Width at humeri 4.0-4.5, mesal length 1.7-1.9 mm.

Basal two-thirds of scutellar disk tumescent, elevated well above surface of coria, with large central impression. Color ivory excepting large light castaneous to brown basal patches on each side of impunctate median fascia dividing entire scutellum. Punctuation mostly black, usually aggregated along lateral borders and frequently in dark basal patches. Sides converging somewhat arcuately along frena, parallel beyond frena; apex subangulate. Width at base 2.4-2.6, length 2.3-2.6 mm.

Punctations of coria rather fine, brown or rufous or black, black and aggregated in broad irregular ivory band along membrane. Membrane vitreous, venation reticulate. Broadly exposed connexiva immaculate brownish yellow in females, broadly banded with fuscous along both sides of intersegmental sutures in males.

Head and thorax beneath brownish yellow, usually with some irregular rufous or castaneous infusion. Punctuation moderately strong and dense, concolorous to black. Lateral half of mesopleura with conspicuous broad transverse depression. Deep marginal depression on metapleura extending mesad about length of lateral lobe on posterior margin of mesopleura and located almost equidistant from anterior and posterior metapleural margins. Legs stout, predominately brownish to castaneous usually, with a broad pale band of varying width beginning near proximal end of tibiae; superior surface of tibiae flattened. Abdomen brownish yellow with dense concolorous punctuation; maximum width 4.2-5.2 mm.

Length of body 8.7-9.6 mm.

Posterior pygophoral margin sinuously truncate from ventral aspect (Fig. 5), sinuously rounded from dorsal aspect (Fig. 6). Floor of genital cup transversely rugose, with a low broad median elevation. Apical half of parameres arcuate beyond sublinear stem, forming setose cup proximally, bearing subapical truncate tooth and terminating in acute tooth, both teeth along mesal edge (Fig. 2). Distal margin of phallosome unpigmented, unclearly differentiated from conjunctiva, appearing deeply emarginated ventrally. Sclerotized rami of dorsolateral conjunctival processes ascending from W-shaped common base. Gonopore apparently located near dorsolateral conjunctival processes, encircled by multilobate ragged-appearing distal portion of conjunctiva.

Tenth sternum of females depressed mesially, subtriangular; tenth tergum visible, subventral.

*Types. Holotype.* Male, labeled Guardia Vieja, Cord. Aconcagua, 12 Dic-1958, Leg. G. Barria. Polyphore dissected; right antennae missing. Deposited in University of Chile, Santiago. (Facultad de Agronomia Museo)

*Paratypes.* 2 ♂♂, 4 ♀♀. Same data as holotype. Deposited as follows: ♂ Louisiana State Univ.; ♀, U.S. Nat. Museum; ♂, 2 ♀♀ Luis Peña collection; ♀ Univ. Nac. La Plata, Arg. (Museo La Plata)

*Tolono*, n. g.

Type species: *Tolono decoratus*, n. sp.

*Head.* Antenniferous tubercle unarmed. Basal segment of antennae nearly reaching to slightly surpassing apex of head. Maxillary tubercle absent. Bucculae moderately elevated, joined posteriorly, covering about three-fourths of distance from their anterior limit to

base of head, extending beyond distal end of first rostral segment, arcuately truncate at their posterior limit. Basal segment of rostrum and bucculae prominent, inclined about  $45^\circ$  from longitudinal axis of head (Fig. 9); apex of rostrum reaching onto metasternum. Eyes not contiguous with pronotum.

*Thorax and wings.* Prosternum with shallow impression on each side of weak median carina; impressions and carina narrowing toward procoxae; mesosternum and metasternum nearly flat, meson weakly carinate in former, shallowly sulcate in latter. Ostiole auriculate; auricle short, protruding, extending about one-sixth of distance from inner margin of ostiole to lateral margin of metapleuron; evaporative area well defined, matte, on metapleuron covering about half the distance from ostiole to lateral margin of metapleuron (Fig. 10). Costal margin of coria smoothly sigmoid; disk without hump or fold; membrane extending a little beyond apex of abdomen (Fig. 8).

*Abdomen and general body features.* Body ovoid, broadest across third abdominal segment, slightly wider here than across humeri. Connexiva not exposed. Pendergrast's organ small, one on each side near anterior margin of seventh abdominal sternum. Abdomen lacking median spine or tubercle. Paired trichobothria on each side of abdominal sterna 3-7 paralleling posterior margin of sterna and on posterior margin of narrow shallow transverse impression; outer trichobothrium of each pair on spiracular line (Fig. 13).

*Male genitalia.* Conjunctiva incompletely eversible, a dorsal and ventral fold remaining when sides completely extended, bearing dorsomedian membranous lobe and on each side one dorsolateral process, latter with pigmented ramus apparently arising within dorsal conjunctival fold. Seminal vesical except near distal end enclosed by median penal lobes, these curving abruptly ventrad at termination within phallosheca; portion of seminal vesical within phallosheca obscured.

*Female genitalia.* First gonocoxae large, convex, together forming approximately half of hemisphere; 8th paratergites cultriform, each bearing a spiracle; remaining genital plates little exposed (Fig. 12).

#### *Tolono decoratus*, n. sp.

Black, shiny, marked with shades of yellow. Dorsum broadly marked with ivory as follows: on pronotum a crescent curving from postero-lateral margins to anterior submargin; on scutellum a transverse basal band; on each corium a band along costal margin and along membrane, this marginal band connected by a diagonal band running from near base of costa to inner angle of corium. Ventrally, edge of coria ivory; broad subbasal band on tibiae, sometimes obscurely displayed on posterior tibiae only, and usually basal band on second rostral segment ivory or sordid yellow; broad band along lateral margins of abdomen and rectangular area on disk of abdominal sterna 4-6 pale orange, this area a little longer than wide, usually enclosing dark semicircular spot or band at base of one or more segments.

Anteclypeus longer than paraclypei, cuneiform, broadly rounded at apex. Lateral margins of paraclypei sigmoid, before eyes reflexed and concave, largely exposing antenniferous tubercles from above; distal portion of paraclypei sloping upward from anteclypeus to outer margins. Disk rugosely punctate excepting rather smooth basal area which includes ocelli and extends on each side to eye. Antennal segments 0.6-0.7; 0.6-0.7; 0.6-0.7; 0.9-1.1; 1.1-1.4 mm in length. Width of head across eyes 1.9-2.2; length 1.7-2.0 mm.

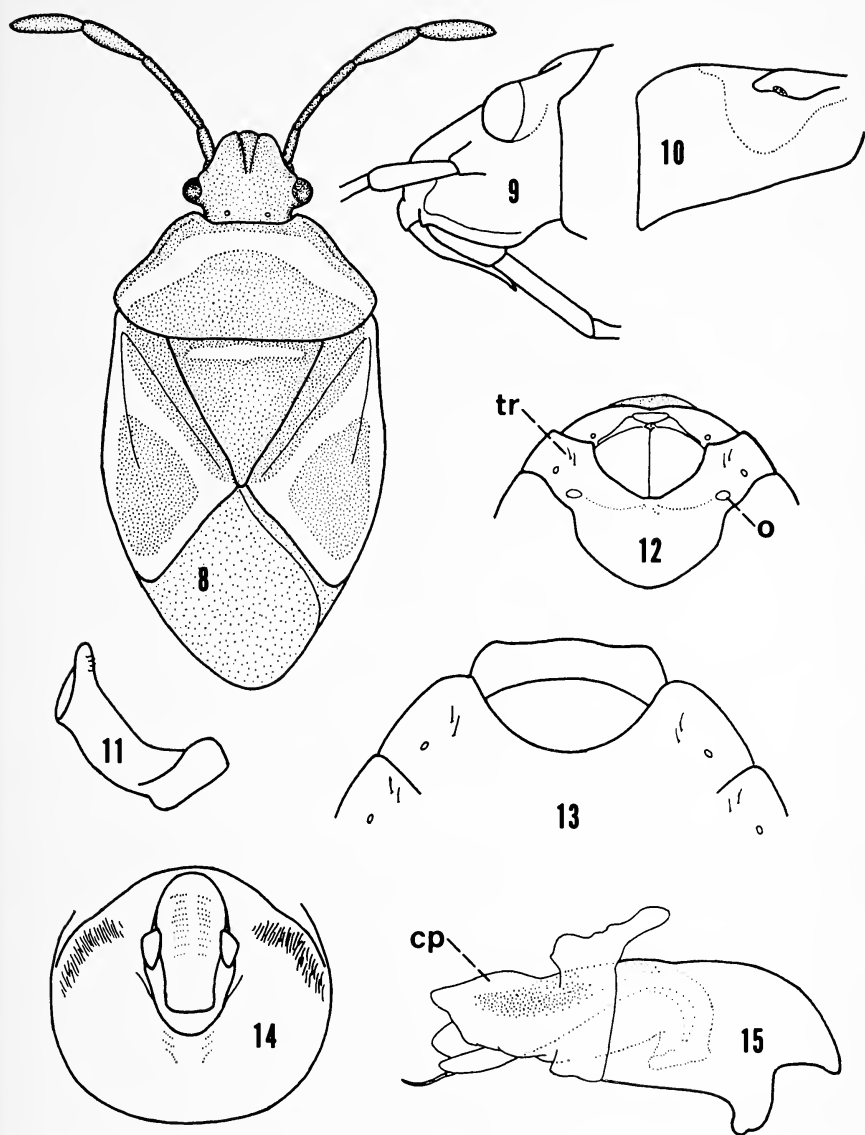

FIGS. 8-15. *Tolono decoratus* n. sp. FIG. 8. General dorsal aspect. FIG. 9. Head, lateral aspect. FIG. 10. Right metapleuron. FIG. 11. Right paramere. FIG. 12. Apex of female abdomen, ventral aspect; Pendergrast's organ (o); trichobothria (tr). FIG. 13. Apex of male abdomen, ventral aspect. FIG. 14. Genital cup. FIG. 15. Aedeagus; conjunctival process (cp).

Pronotum subtriangular, apically truncate and moderately emarginate; anterolateral margins slightly sinuous, narrowly reflexed, lacking denticle at anterolateral angles; humeri narrowly rounded, scarcely produced (Fig. 8). Shallow arcuate impression traversing disk about midway between anterior and posterior margins, paralleling basal margin of pronotum; no indication of cicatrices; punctation fine, sparse, excepting a line of strong close punctures along anterior margin which continues with diminishing strength along anterolateral margins and a similar line in impression of disk between arc of ivory band. Width at humeri 3.6–4.3, length at meson 1.5–1.9 mm.

Lateral margins of scutellum faintly convex along frena, curving sigmoidly from distal end of frena to subacute apex; disk convex basally; punctation fine, sparse. Width at base 2.1–2.5, length 2.0–2.4 mm. Hemelytra covering connexiva; costal margin of coria noticeably reflexed along basal half; punctation moderately strong and rather dense along clavical suture, elsewhere on coria fine, sparse; membrane dark, translucent, veins few, simple, inconspicuous.

Ventral surfaces of head and thorax with moderately strong sparse punctation; abdomen without obvious punctation. Legs of moderate size; superior surface of tibiae flattened toward apex; posterior tibiae bowed dorsoventrally. Seventh abdominal sternum of female slightly protruding mesally on posterior margin, a constriction extending laterad on each side from this point to Pendergrast's organ.

Length of body with membrane 7.4–9.2 mm.

Posterior margin of pygophore sinuately truncate from ventral aspect (Fig. 13), rounded from dorsal aspect (Fig. 14); dense patch of setae located along anterolateral borders within genital cup. Parameres small, subcylindrical, with rather flat production at apex extending cephalad and bearing a few transverse ridges opposite apical face (Fig. 11). Phallosome weakly sclerotized and little pigmented, indistinctly differentiated from conjunctiva. Seminal vesical terminating distally as hyaline flagellate penisfilum (Fig. 15).

In female, 9th paratergites narrowly exposed along posterior border of basal plates. Second gonocoxae projecting obscurely as carinate triangle. Tenth sternite small, subrectangular, transverse (Fig. 12).

*Types.* *Holotype.* Male, labeled E. Loja, Ecuador, 2800 m, 21-Nov. 1970, Coll. L. E. Peña. Pygophore dissected. Deposited in Univ. Chile, Santiago.

*Paratypes.* 26 ♂♂ and 36 ♀♀. Same data as holotype, 2 ♀♀ deposited in Univ. of Chile, ♀ in Luis Peña coll.; Colombia, Nariño, Laguna La Cocha, IX-26-71, G. E. Bohart, 2 ♂♂, 7 ♀♀ Utah State Univ., ♂, ♀ Univ. Nac. La Plata, ♂, ♀ Univ. Fed. Rio Grande do Sul, ♀ Naturhistoriska Riksmuseum, Stockholm, ♀ Univ. Zool. Mus. Copenhagen; Colombia, Nariño, Lago de La Cocha, 2600 m, Dec. 1–3, 1970, B. Malkin, 17 ♂♂, 20 ♀♀ Amer. Mus. Nat. Hist., 2 ♂♂, ♀ La. State Univ., ♂, ♀ Brit. Mus. (Nat. Hist.); (a) La Sierra, Jan. 29, 1931, W. A. Archer (b) Colombia, S. A., W. A. Archer, 2 ♂♂ U.S. Nat. Mus.

#### Literature Cited

- PIRÁN, A. A. 1957. *Tunaria andicola*, especie y genero nuevos de la fauna de Bolivia (Hemiptera: Pentatomidae). Rev. Chilena. Entomol. **5**: 19–21.
- STÅL, C. 1872. Enumeratio Hemipterorum II. Svenska Vet.-Ak. Handl. **10**(4):1–159.

**New or Little-Known Crane Flies from Iran. I (Diptera: Tipulidae)<sup>1</sup>**

CHARLES P. ALEXANDER

AMHERST, MASSACHUSETTS 01002

RECEIVED FOR PUBLICATION JUNE 24, 1974

**Abstract:** A short series of papers covering the crane flies of Iran, based on materials collected by Dr. Fernand Schmid in 1955 and 1956, is begun with Part I discussing certain species of the tribe Pediciini. The new species are *Pedicia (Tricyphona) persica*, *P. (T.) iranensis*, *P. (T.) elburzensis*, and *P. (T.) acuspica*, from the Elburz Mountains in northern Iran, and *P. (T.) luteicolor* from Jugoslavia, included here for completeness.

During 1955 and 1956 the distinguished entomologist, Dr. Fernand Schmid, of Ottawa, collected extensively in northern Iran, his materials including numerous Tipulidae that were acquired by the writer. Several undescribed species were represented as well as a surprisingly large number of described species that presently are known only from Europe. Most of the Schmid materials were from various stations in the Elburz Mountains, in the Province of Mazandéran, along the south shore of the Caspian Sea, taken at altitudes between 1700 and 2300 meters. In this initial paper I am describing five new species in the genus *Pedicia* and expect to discuss further materials in later papers under this general title. One species from this series was described earlier as *Erioptera (Psilononopa) iranica* Alexander (Journal N. Y. Ent. Soc., 81: 83-84; 1973). I wish to extend my sincere thanks to Dr. Schmid for his interest in collecting these flies throughout the Himalayas and adjoining regions to the west. All materials in this series of papers are preserved in the Alexander Collection.

*Pedicia (Tricyphona) persica*, n. sp.

Size medium (wing about 13 mm); general coloration of thorax yellow, very restrictedly patterned with darker; legs yellow; wings yellow, restrictedly patterned with brown, venation of outer radial field very variable; male hypopygium with dististyle very large, placed at apex of basistyle, outer surface with abundant erect black spinoid setae.

*Male.* Length about 13-14 mm; wing 12-13 mm; antenna about 1.8 mm.

*Female.* Length about 14-17 mm; wing 13-15 mm.

Rostrum yellow; palpi with basal segment yellow, remainder medium brown. Antennae yellow throughout; flagellar segments short and crowded, outer ones shorter than their verticils. Head pale gray, yellowed behind; anterior vertex broad, more than three times the diameter of scape.

Prothorax yellow. Mesonotum yellow, centers of scutal lobes pale brown. Pleura uniformly yellow. Halteres very pale yellow. Legs with coxae and trochanters clear light yellow; remainder of legs slightly darker yellow, outer tarsal segments pale brown.

<sup>1</sup>Contribution from the Entomological Laboratory, University of Massachusetts.

Wings (Figs. 1-3) yellow, costal border slightly darker yellow, stigmal region, cell *Sc* and base of cell *C* very faintly darkened; narrow brown seams at origin and fork of *R*<sub>s</sub> and adjoining veins, with less evident darkenings at *R*<sub>2</sub> and *m*. Venation: Radial field very variable, as discussed later; *r-m* before fork of *R*<sub>s</sub> in all available material; in holotype (Fig. 1) forking into a long *R*<sub>2+3</sub> and a short *R*<sub>4+5</sub>; in allotype (Fig. 3) vein *R*<sub>2+3+4</sub> preserved as a short suberect element, with *R*<sub>1</sub> on the upper fork; in paratype (Fig. 2) veins *R*<sub>2+3</sub>, *R*<sub>4</sub> and *R*<sub>5</sub> all at fork of *R*<sub>s</sub>; in holotype cell *M*<sub>1</sub> short, subequal to its petiole, in other specimens cell *M*<sub>1</sub> deep, its petiole subequal to or slightly shorter than *m*. Variation in this relatively small series is shown; a second paratype not figured has the fork of *R*<sub>s</sub> shortly beyond *r-m* and with two and three adventitious crossveins in cell *R*<sub>1</sub>.

Abdominal tergites with proximal segments brown medially, yellow laterally, in holotype more uniformly yellow; sternites clear light yellow; hypopygium darkened. Male hypopygium (Fig. 7) with tergite, *t*, broadly transverse, posterior border slightly produced. Basistyle, *b*, with interbase, *i*, a flattened pale blade with sparse setae. Dististyle, *d*, very large, flattened, placed at apex of basistyle; outer angle with two short spines, apical margin with abundant erect black spinoid setae, those of the inner group shorter and more abundant.

*Holotype*. ♂, Haradan, Iran, September 11, 1956 (Schmid). *Allotype*: ♀, Zanus, Iran, Elburz Mts., 2,000 meters, September 21, 1955 (Schmid). *Paratypes*, one ♂, one ♀, pinned with allotype.

In its hypopygial structure the present fly is generally similar to *Pedicia* (*Tricyphona*) *riedeli* (Lackschewitz), *P. (T.) straminea* (Meigen) and some other European species, differing most evidently in details of this structure, especially the very large dististyle. Edwards (1938) referred these species to the subgenus *Crunobia* Kolenati but I prefer to retain them in *Tricyphona*. The venation of the radial field of the wing is very variable as shown by the few figures here provided. Such conditions of variation in the subgenus are not rare and have been discussed and figured by several students, such as the Nearctic *P. (T.) inconstans* (Osten Sacken) by Johnson (*Psyche*, 34: 216-217, figs.; 1927) and the European *P. (T.) claripennis* (Verrall) and *P. (T.) immaculata* (Meigen) by Edwards (*Trans. Soc. British Ent.*, 5: 56-57; 1938).

*Pedicia (Tricyphona) iranensis*, n. sp.

General coloration of head and thorax gray, praescutum with four polished black stripes; halteres obscure yellow; legs with bases of femora yellow, passing into brownish yellow; wings pale brown, stigma slightly darker, prearcular field more yellowed; abdomen dark brown; male hypopygium with arms of tergal lobes slender, subapical in position.

*Male*. Length about 10 mm; wing 10 mm; antenna about 1.6 mm.

Rostrum and palpi black. Antennae of male 17-segmented, black; flagellar segments subcylindrical, proximal ones longer than their verticils; terminal segment one-half longer

→

(Symbols: Male hypopygium—*b*, basistyle; *d*, dististyle; *g*, gonapophysis; *i*, interbase; *p*, phallosome; *t*, 9th tergite.)

FIG. 1. *Pedicia (Tricyphona) persica*, n. sp.; venation, holotype.

FIG. 2. The same; venation, paratype, showing variation.

FIG. 3. The same; venation, allotype,

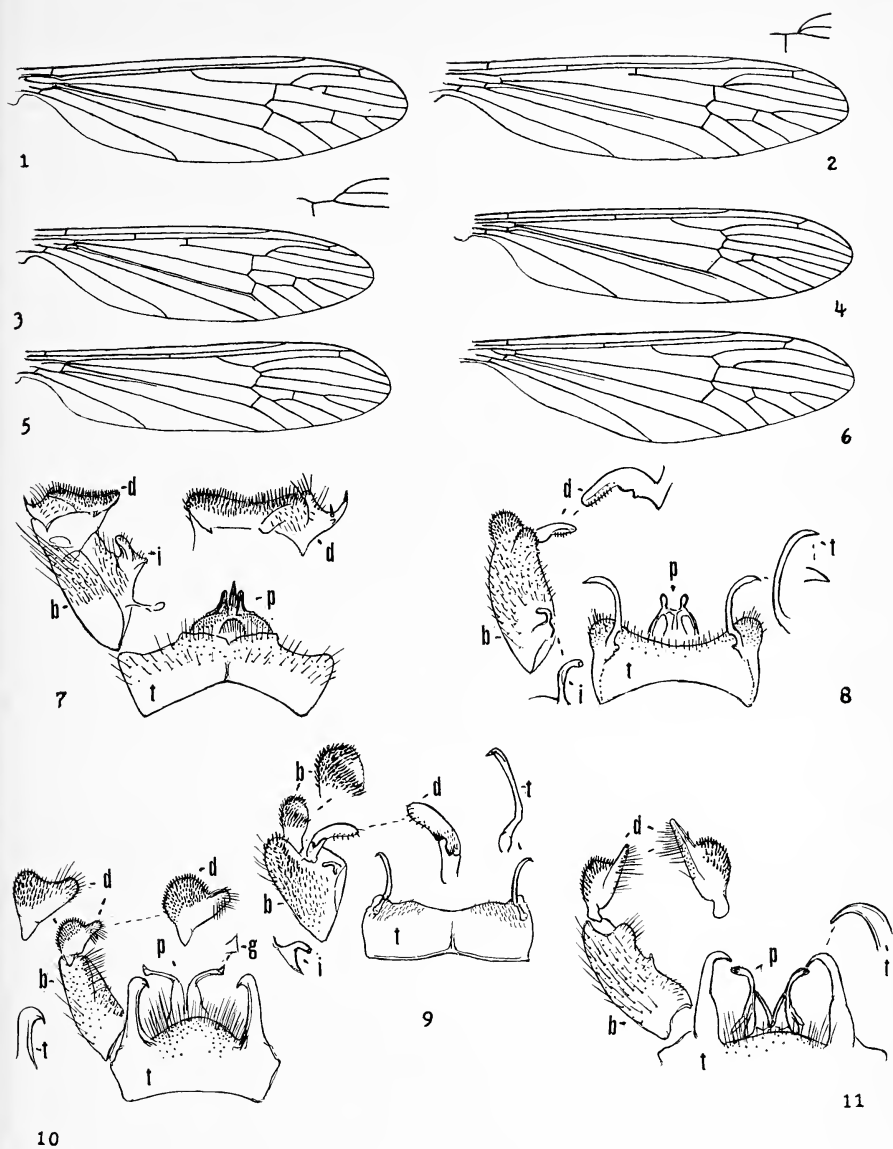

FIG. 4. *Pedicia (Tricyphona) iranensis*, n. sp.; venation.FIG. 5. *Pedicia (Tricyphona) luteicolor*, n. sp.; venation.FIG. 6. *Pedicia (Tricyphona) acuspica*, n. sp.; venation.FIG. 7. *Pedicia (Tricyphona) persica*, n. sp.; male hypopygium.FIG. 8. *Pedicia (Tricyphona) iranensis*, n. sp.; male hypopygium.FIG. 9. *Pedicia (Tricyphona) luteicolor*, n. sp.; male hypopygium.FIG. 10. *Pedicia (Tricyphona) elburzensis*, n. sp.; male hypopygium.FIG. 11. *Pedicia (Tricyphona) acuspica*, n. sp.; male hypopygium.

than the penultimate. Head gray, posterior vertex behind with a central darkening (perhaps artificially produced).

Pronotum gray. Mesonotal praescutum gray with four polished black stripes, intermediate pair nearly contiguous, ending some distance before suture; scutum gray, centers of lobes vaguely paler; scutellum and postnotum light gray, parascutella obscure yellow, deeply excavated. Pleura gray, dorsopleural membrane obscure yellow. Halteres yellow. Legs with coxae and trochanters yellow, fore coxae slightly more darkened basally; femora yellow basally, outwardly brownish yellow; tibiae light brown, darker distally; tarsi black; claws slender, yellow. Wings (Fig. 4) pale brown, stigma slightly darker, prearcular field more yellowed; veins dark brown. Longitudinal veins from slightly beyond the arculus with trichia. Venation: Branches of  $R_s$  consisting of the long  $R_{2+3}$  and very short  $R_{4+5}$ ,  $R_1$  and  $R_5$  subequal in length; cell  $1st\ M_2$  small;  $m-cu$  at near one-third  $M_{3+4}$ .

Abdomen dark brown. Male hypopygium (Fig. 8) with arms of the tergal lobes,  $t$ , basal in position, the lobes extended beyond their insertion. Basistyle,  $b$ , with the interbase a very small curved club, its outer end slightly dilated.

*Holotype*. ♂, Javardi, Iran, October 7, 1956 (Schmid).

The most nearly related regional species include *Pedicia (Tricyphona) sakkya* Alexander, of Sikkim and Assam, and three European species, *P. (T.) claripennis* (Verrall), *P. (T.) lucidipennis* Edwards, and the Corsican, *P. (T.) trifurcata* (Edwards, 1928), all differing in details of coloration and in hypopygial structure, especially the tergite and interbase. *P. (T.) luteicolor*, n. sp., is similar in venation and in the general structure of the hypopygium, differing evidently in the yellow body coloration.

*Pedicia (Tricyphona) luteicolor*, n. sp.

Generally similar to *lucidipennis*, differing in the light yellow thoracic coloration and hypopygial structure; legs yellow, tarsi darker; wings entirely light yellow, veins darker yellow; male hypopygium with tergal arms slender; basistyle with two terminal lobes, both with conspicuous black setae; dististyle a flattened yellow blade, the relatively few setae restricted to the lower margin.

*Male*. Length about 8 mm; wing 9.5 mm; antenna about 1.4 mm.

*Female*. Length about 9 mm; wing 9 mm.

Rostrum yellow; palpi dark brown. Antennae 16-segmented; scape and pedicel yellow, flagellum black; flagellar segments oval, gradually decreasing in size outwardly, terminal segment larger than the penultimate. Anterior vertex yellowish gray, posterior vertex light gray.

Thoracic dorsum light yellow, praescutum with four scarcely differentiated more orange stripes; pleura clear light yellow. Halteres yellow, knob very slightly more darkened apically. Legs with coxae and trochanters light yellow; femora darker yellow; tibiae and tarsi brown, the latter darker. Wings (Fig. 5) entirely light yellow, veins darker yellow. Venation:  $R_s$  about as long as cell  $1st\ M_2$ ;  $r-m$  connecting with  $R_5$  shortly before its base; cell  $1st\ M_2$  closed; cell  $M_1$  about one-third longer than its petiole;  $m-cu$  shortly before midlength of  $M_{3+4}$ .

Abdomen yellow. Male hypopygium (Fig. 9) with tergite,  $t$ , transverse, outer lateral angles not produced, tergal arms long and slender. Basistyle,  $b$ , with two terminal lobes, both with conspicuous blackened setae, those of the longer ventral lobe more abundant, arranged in a double row; interbase,  $i$ , a small curved rod, as in subfigure. Dististyle,  $d$ , a conspicuous flattened yellow blade, with very sparse small setae on the lower margin.

*Holotype*. ♂, Cipari, Jugoslavia, 1,400 meters, August 11, 1955 (Schmid). *Allotype*, ♀, pinned with type.

The species is most nearly allied to certain other European species including besides *Pedicia (Tricyphona) lucidipennis* Edwards, also *P. (T.) claripennis* (Verrall) and *P. (T.) trifurcata* (Edwards), all of which have the thoracic coloration dark brown or gray, with conspicuous brown or blackened stripes and all species differ among themselves in hypopygial details.

*Pedicia (Tricyphona) elburzensis*, n. sp.

Size medium (wing 7.5–9 mm); general coloration of thorax orange yellow, abdominal tergites yellowish brown, subterminal segments slightly darker; wings broad, nearly hyaline, cell *1st M*<sub>2</sub> closed, cell *M*<sub>1</sub> subequal to its petiole; male hypopygium with median region of tergal border produced, with very long pale setae, lateral arms erect, inner angle of apex produced into a slender acute spine; dististyle with rostrum broad, with conspicuous setae, apex obtuse; gonapophyses with apices slightly extended into hyaline subtriangular blades.

*Male*. Length about 6.5–7 mm; wing 7.5–9 mm; antenna about 1–1.2 mm.

*Female*. Length about 7–8 mm; wing 8–9 mm.

Rostrum light brown; palpi black. Antennae 15-segmented; scape and pedicel dark brown, flagellum yellowed; proximal flagellar segments short and crowded, transverse, outer segments more elongate. Head dark brown, heavily gray pruinose.

Thoracic dorsum orange yellow, including three vaguely indicated praescutal stripes and the scutal lobes; pleura clear yellow. Halteres light yellow. Legs with coxae and trochanters yellow; remainder of legs light yellow, tips of femora and tibiae and the outer tarsal segments light brown, claws long, appressed. Wings broadest opposite end of vein *2nd A*; nearly hyaline, prearcular and costal fields of light yellow, no evident stigma; veins light brown. Longitudinal veins of about the outer four-fifths of wing with abundant short trichia. Venation: *R*<sub>4+5</sub> relatively short, forking about opposite midlength of cell *1st M*<sub>2</sub>; cell *M*<sub>1</sub> subequal to its petiole; *m-cu* at or shortly beyond the fork of *M*, in cases about to one-fifth *M*<sub>3+4</sub>.

Abdominal tergites yellowish brown, subterminal two segments slightly darker, sternites and hypopygium clearer yellow. Male hypopygium (Fig. 10) with posterior border of tergite, *t*, conspicuously produced medially, provided with very long pale setae; lateral arms erect, very slightly enlarged at apex, the apical inner angle produced into a slender acute spine. Dististyle, *d*, with base moderately enlarged, with relatively short setae; rostrum broad, apex obtuse, surface with long conspicuous setae. Gonapophysis, *g*, with outer half more slender, apex slightly expanded into a hyaline subtriangular blade.

*Holotype*. ♂, Quattekas, Elburz Mts., Iran, 1,800 meters, September 19, 1955 (Schmid).

*Allotype*: ♀, Zanus, 2,000 meters, September 21, 1955, pinned with one paratype. *Paratypes*: 3 ♂♂, with the allotype; ♂, Barajan, 2,000 meters, September 15, 1955 (Schmid).

The present fly is most nearly related to *Pedicia (Tricyphona) acuspica*, n. sp., which differs chiefly in hypopygial characters, including the tergal arms, dististyle, and apex of the gonapophysis. As has been indicated by Savtshenko (in Mendl, Bull. Soc. Ent. Suisse, 46: 292; 1973) in Transcaucasia and also in Iran there are various generally similar species or races in this genus that are closely interrelated and whose exact relationships remain uncertain.

*Pedicia (Tricyphona) acuspica*, n. sp.

Size medium (wing about 9 mm); general coloration of thorax orange yellow, head and abdomen brown; halteres yellow; legs yellow; wings almost uniformly subhyaline, costal border light yellow, stigma lacking; vein  $R_{4+5}$  relatively short with  $r-m$  at near midlength, cell  $1st\ M_2$  closed; male hypopygium with beak slender, its lower margin with very long pale setae, each lateral tergal arm gradually narrowed into a curved acute point.

*Male.* Length about 9 mm; wing 9 mm; antenna about 1.3 mm.

Rostrum and palpi brown. Antennae 15-segmented; dark brown; proximal four or five flagellar segments short and crowded, outer segments more elongate with verticils that are subequal to the segments, the terminal one-third longer than the penultimate segment. Head dark brown.

Thorax almost uniformly orange yellow with a poorly indicated slightly darker central stripe, scutal lobes similarly patterned. Halteres yellow. Legs with coxae and trochanters orange yellow; remainder of legs yellow, outer tarsal segments very slightly darker; claws needlelike. Wings (Fig. 6) almost uniformly subhyaline, costal border light yellow, stigma not indicated; veins pale brown, yellow in the costal field. Longitudinal veins of outer three-fourths of wing with small inconspicuous trichia. Venation:  $R_{4+5}$  relatively short, with  $r-m$  at near midlength; cell  $1st\ M_2$  closed; cell  $M_1$  subequal in length to its petiole; vein  $Cu_2$  very faint to scarcely evident, ending about opposite one-third  $Cu_1$ .

Abdomen light brown, hypopygium slightly more yellowed. Male hypopygium (Fig. 11) with dististyle,  $d$ , relatively small, body suboval, dorsal half relatively low, with abundant blackened spinose setae; rostrum slender, its lower margin with a row of very long pale setae. Ninth tergite,  $t$ , with lateral arms distinctive, appearing as erect rods that narrow gradually into an acute curved point, median region of posterior border low convex. Phallosome,  $p$ , including a pair of slender apophyses, their apical third outcurved and slightly enlarged, roughened.

*Holotype.* ♂, Mughan, Iran, June 20, 1956 (Schmid).

The present fly is generally similar to the smaller *Pedicia (Tricyphona) zwicki* Mendl (Mitteil. Schweiz. Ent. Gesell., 46: 291-293, figs. 1-3, 1973), described from the Akiyama Pass, Turkey, and from *P. (T.) elburzensis*, n. sp. All three species are yellow flies having cell  $1st\ M_2$  of the wings present, differing from one another in relative size, details of venation, and in the male hypopygium, especially the dististyle and lateral tergal arms. *P. (T.) livida* (Madarassy) likewise agrees in its general yellow coloration, differing in the open cell  $M_2$  of the wings and in hypopygial characters.

**INDEX TO SCIENTIFIC NAMES OF ANIMALS AND PLANTS  
VOLUME LXXXII**

Generic names begin with capital letters. New genera, species, subspecies, and varieties are printed in italics. The following articles are not indexed: "The Sphingidae of Turrialba, Costa Rica," by Richard P. Seifert, pp. 45-56; "The Anthomyiidae and Muscidae of the Great Smoky Mountains and Mt. Mitchell, North Carolina (Diptera)," by H. C. Hockett, 150-162.

- Acrophyma bicallosa*, 271  
*Adelpha*, 164, 168  
     *diocles*, 236  
     *leucophthalma tegeata*, 235  
*Ageniella conflictata*, 265  
     *parfita*, 266  
*Agraulis*, 39, 63  
*Agraulis vanillae*, 33, 38, 62  
     *lucina*, 61  
     *maculosa*, 63  
     *moneta*, 62  
*Alternaria tenuis*, 125  
*Ammophila procera*, 264  
     *urnaria*, 264  
*Anacrabro ocellatus*, 265  
*Anaea electra*, 171  
     *fabius*, 171  
*Anasimyia*, 16  
*Anoplius marginatus*, 263  
     *semirufus*, 263  
*Anoplocheylus aegypticus*, 209  
     *tauricus*, 209  
     *transiens*, 202  
*Apanteles melanoscelus*, 2, 3, 4, 5  
*Aphaenogaster*, 95  
*Aphaenogaster megommatus*, 94  
     *pythia*, 94  
     *treatae*, 94, 96  
     *ashmeadi* and *floridana*, 96  
     *fulva*, 96, 142  
     *splendida*, 96  
     *longiceps*, 96  
     *megommatus*, 96  
     *pallida*, 96  
     *rudis picea*, 96  
     *tennesseensis*, 96  
*Aphilanthrops frigidus*, 262  
*Apis mellifera*, 6, 126  
*Archangelica anthopurpurea*, 226  
*Argynnis Boisduvalli*, 224  
*Asaphomyia floridensis*, 183  
     *texensis*, 183  
*Asiodidea*, 17  
*Aspergillus flavus*, 127  
*Aspididris*, 131  
     *militaris*, 131  
     *discigera*, 131  
*Astata unicolor*, 263  
*Asterias*, 227  
*Atopomyrmex mocquersyi*, 94  
*Atta sexdens rubropilosa*, 125  
     *texana*, 127  
*Austrachipteria*, 181  
  
*Baris*, 264  
*Basiceros conjugans*, 134  
     *singularis*, 131  
     *discigera*, 131  
     *convexiceps*, 131  
     *manni*, 138  
*Battus polydamas*, 171  
*Beauveria densa*, 127  
*Bebaeus*, 272  
*Bembix americana spinolae*, 264  
*Bicyrtes quadrifasciata*, 262  
*Blaudus*, 272  
*Bombus*, 24  
*Brevicaude*, 227  
  
*Calliopsis*, 12  
*Camponotus pennsylvanicus*, 127  
     *castaneus*, 127  
*Campanotus herculeanus*, 122  
*Caonabo casicus*, 57  
*Capicola*, 10  
     *braunsiana*, 6, 11  
*Cardiocondyla*, 73  
     *ectopia*, 76, 82

- emeryi, 81, 82  
 nuda, 81, 82  
 nuda minutior, 86  
 venustula, 81, 82  
 wroughtoni, 81  
   nuda mauritanica, 90  
*Carebara junodi*, 94  
   jauzei, 94  
*Castanea dentata*, 22  
*Ceanotheus*, 22  
*Cerapachys*, 103  
*Cerceris atramontensis*, 264  
   halone, 264  
   nigrescens, 264  
   prominens, 264  
*Cheloner antarcticum*, 142  
*Chlorion aerarium*, 263  
*Chrysops celatus*, 187  
   dimmocki, 187  
   dixianus, 183  
   flavidus, 187  
   pudicus, 183  
   reicherti, 187  
*Cimex sphacelatus*, 245  
*Circulifer tenellus*, 42  
*Colias interior*, 224  
*Conomyrma bicolor*, 121  
*Colobopsis*, 73  
*Cordyceps*  
   Australis, 127  
   bicephala, 127  
   necator, 127  
   proliferans, 127  
   unilateralis, 127  
*Crabro*  
   monticola, 261  
*Creightonidris*, 131  
*Crematogaster larreae*, 121  
   opuntiae, 122  
   navajoa, 122  
   lineolata, 142  
*Crunobia*, 280  
*Cylindrocnema*, 271  
  
*Danaus eresimus*, 171  
   gilippus, 171  
   plexippus, 171  
*Dasymutilla nigripes*, 267  
*Dasyptoda*, 9  
  
*Dentachipteria highlandensis*, 177  
   ringwoodensis, 177  
*Dialictus*, 8  
*Didea*, 17  
*Dideomimia*, 17  
*Dione*, 37, 39, 62  
   juno, 33, 61, 62, 63  
   andicola, 61, 62  
   huascama, 61, 62  
*Dircenna klugii*, 171  
*Discothyrea testacea*, 122  
*Ditomotarsus*, 272  
*Drosophila*, 111  
*Dryadula*, 39  
   phaetusa, 33  
*Dryas julia*, 33  
*Dryocoris*, 245  
  
*Ea*, 273  
*Elasmostethus*, 272  
*Elasmucha*, 272  
*Eueides aliphera*, 171  
   cleobaea, 171  
*Euphorbia*, 88  
   serpens, 87  
*Euschistus*, 59  
*Eusphinctus*, 103  
  
*Forelius*, 104  
*Formica*, 262  
   fusca, 267  
   rufa, 125  
   lugubris, 126  
*Froggattella*, 104  
  
*Glaucopsyche lygdamus couperi*, 222  
   pembina, 228  
*Gorytes canaliculatus*, 263  
*Grapta*, 226  
*Gryllus*, 263  
  
*Habrobracon*, 111  
*Haplomelitta*, 13  
   ogilviei, 6, 9, 10, 11, 13

- Heliconius charitonius*, 171  
   *dorus*, 33  
   *erato*, 37  
   *hecale*, 30  
   *isabella*, 37  
   *melpomene*, 37  
   *petiveranus*, 171  
   *ricini*, 37  
   *hermatheria*, 40  
   *talchinia*, 171  
*Helica*, 273  
*Helophilus*, 16  
*Heracleum lunatum*, 226  
*Heraeus cincticornis*, 173  
*Hesperapis*, 9  
*Hesperia paniscus*, 226  
*Holcostethus abbreviatus*, 246  
   *fulvipes*, 246  
   *hirtus*, 246  
   *limbolarius*, 246  
   *piceus*, 246  
   *ruckesi*, 246  
   *sphaecelatus*, 245  
   *tristis*, 246  
   *vernalis*, 245  
*Hoplisocles nebulosus*, 263  
*Hoplocheylus americanus*, 202  
   *canadensis*, 205  
   *discalis*, 203  
   *longispinus*, 205  
   *pickardi*, 203  
   *similis*, 202  
*Hymenostilbi australienses*, 127  
*Hyperbius*, 272  
  
*Icaricia icarioides*, 229  
*Iridomyrmex*, 89, 92, 104  
   *humilis*, 88, 115  
  
*Kalmia*, 170  
*Korinchia*, 17, 18  
  
*Laboulbenia*, 125  
*Lanopsis*, 272  
*Larritis striata*, 227  
*Lasius neoniger*, 118  
  
*Laurus*, 170  
*Leptothorax*, 106  
   *curvispinosus*, 106, 107, 108, 109, 110  
   *duloticus*, 107, 108  
*Limenitis*, 239  
*Limnobaris*, 264  
*Lindenius columbianus errans*, 264  
*Lioperna*, 103  
*Lupinus*, 229  
*Lycaena couperi*, 222  
   *pembina*, 222  
*Lyroda subita*, 265  
  
*Macropsis*, 9  
*Magiccada*, 189  
*Malotta*, 16, 27  
   *unicolor*, 16, 24  
*Manica bradleyi*, 96, 142  
   *hunteri*, 96, 142  
   *mutica*, 96, 142  
   *rubida*, 96  
*Mazonoma variada*, 273  
*Megaponera foetens*, 127  
*Melitta*, 9  
   *capensis*, 6  
*Mesembryanthemum sensu lato*, 8  
*Messor aegyptiacus*, 96  
   *alexandri*, 96  
   *arenarius*, 96  
   *barbarus*, 96  
   *capitatus*, 94  
   *caviceps*, 96  
   *orientalis*, 96  
   *semirufus concolor*, 94  
   *structor*, 94  
*Metarrhizum anasopliae*, 127  
*Metopia argyrocephala*, 267  
*Milesia*, 17  
   *bacuntius*, 15  
*Monomorium*, 92, 95  
   *chobauti*, 96  
   *niloticoides*, 96  
   *venustum*, 96  
   *salomonis*, 96  
   *minimum*, 142  
*Monopsis simplex*, 10, 12  
*Morpho polyphemus polyphemus*, 164  
*Myolepta simulans*, 27  
*Myrmica*, 141  
   *americana*, 142

- brevinodis*, 142  
*brevispinosa*, 142  
*emeryana*, 142  
*fracticornis*, 142  
*laevinodis*, 94  
*lobicornis fracticornis*, 94  
*monticola*, 142  
*rubra*, 96, 142  
*ruginodis*, 94  
*sabuleti americana*, 94  
*schenki emeryana*, 94  
*Myscelia*, 169
- Neotypeus*, 202, 207  
*Nopalis*, 272  
*Nosema apis*, 126  
*Novomessor albisetosus*, 97  
   *cockerelli*, 97, 142  
   *manni*, 97  
*Nysson plagiatus*, 263
- Odontocorynus*, 264  
 Ornithoptera, 37  
*Orthoprosopa*, 17  
*Oxybelus bipunctatus*, 263  
   *subulatus*, 263, 267
- Pachygeracus*, 264  
*Palumbia*, 17, 18  
*Pangonia lasiophthalma*, 28  
*Papilio anticostiensis*, 222  
   *asterias*, 225  
   *brevicauda*, 222  
   *turnus*, 226  
*Parahypozaetes*, 177  
   *bidentatus*, 181  
*Parides arcas*, 171  
   *arcas mylotes*, 31  
   *photinus*, 171  
*Parrhyngia*, 17  
*Passiflora*, 31, 62  
   *vitiflora*, 30  
   *lauriflora*, 38  
   *cyanea*, 38  
   *mucronata*, 38
- alata*, 38  
   *speciosa*, 38  
   *violacea*, 38  
   *jileka*, 38  
*Paullinia pinnata*, 164  
   *fuscescens*, 169  
*Pedicia acuspica*, 279  
   *claripennis*, 280  
   *elburzensis*, 279  
   *immaculata*, 280  
   *inconstans*, 280  
   *iranensis*, 279  
   *livida*, 284  
   *lucidipennis*, 282  
   *luteicolor*, 279  
   *persica*, 279  
   *riedeli*, 280  
   *sakkyia*, 282  
   *straminea*, 280  
   *trifurcata*, 282  
   *zwicki*, 284  
*Pentagonia wendlandia*, 235  
*Pentatoma piceus*, 252  
*Perdita*, 12  
*Peribalus*, 245  
   *abbreviatus*, 248  
   *eatoni*, 248  
   *fulvipes*, 252  
   *hirtus*, 254  
   *limbolarius*, 250  
   *modestus*, 250  
   *piceus*, 252  
   *tristis*, 254  
*Philaethria*, 30  
   *dido dido*, 30  
   *wernickei*, 30  
   *dido pygmaeon*, 30  
   *dido wernickei*, 30  
*Pheidole*, 92, 121  
   *bicarinata*, 94  
   *creightoni*, 94  
   *crassinoda*, 97  
   *dentata*, 86, 142  
   *megacephala*, 94, 121  
   *morrisi*, 97  
   *nari*, 94  
   *pilifera pacifica*, 93  
   *ridicula*, 97  
   *saxicola*, 97  
   *sculpturata*, 97



- sitarches, 94  
 xerophila, 97  
*Philanthus gibbosus*, 260, 264  
*Phorbanta*, 272  
 Phyracaces, 103  
*Planois*, 272  
*Plebejus icarioides*, 229  
*Podotricha*, 39  
*Pogonomyrmex*, 141  
   *badius*, 94, 142  
   *barbatus*, 94, 142  
   *californicus*, 94, 121  
   *desertorum*, 97  
   *imberbiculus*, 94  
   *magnacanthus*, 97  
   *maricopa*, 94  
   *occidentalis*, 94  
   *owyheci*, 97  
   *rugosus*, 94  
*Polistes exclamans*, 269  
*Porhethria dispar*, 2  
*Praesus*, 272  
*Prionyx parkeri*, 263  
*Prunus*, 170  
*Pseudobebaeus*, 272  
*Pseudocheylus europaeus*, 209  
   *transiens*, 210  
*Pseudodichroa*, 13  
*Pseudonica flavilla canthara*, 168, 171  
*Pseudozetterstedtia*, 15  
   *unicolor*, 15, 24  
   *thoracicus*, 16  
*Pсилоcephala frontalis*, 263  
*Pteralastes*, 15  
   *bomboides*, 18  
   *borealis*, 15  
   *colei*, 16  
   *literatus*, 27  
   *nubeculosus*, 15  
   *perfidious*, 15  
   *thoracicus*, 15  
   *unicolor*, 18  
*Pyrrhogyra hypsenor*, 163  
  
*Quercus*, 170, 243  
*Quichuana*, 27  
  
*Rhagina protea*, 209  
*Rhinotropidia*, 17  
  
*Salpingogaster*, 17  
*Schizocosa bilineata*, 265  
*Scolotydaeus ardisannae*, 207  
   *bacillus*, 207  
   *simplex*, 202  
*Scapter*, 10  
*Senofainia trilineata*, 267  
*Simopone*, 103  
*Sinopla bicallosus*, 271  
*Sniploa*, 272  
*Solenopsis*, 92, 115  
   *angulatus*, 94  
   *aurea*, 117  
   *blumi*, 122  
   *germinata*, 86, 116  
   *interrupta*, 120  
   *invicta*, 94, 113, 125, 142  
   *molesta*, 94  
   *quinquecupis*, 118  
   *richteri*, 94, 113  
   *saevissima*, 94, 114  
   *saevissima richteri*, 114  
   *xyloni*, 93, 116  
*Solidago*, 22  
*Spartina alterniflora*, 14  
*Sphecodes*, 13  
*Sphecodopsis*, 13  
*Sphenophorus pertinax*, 14  
   *pertinax peninsularis*, 14  
   *pertinax ludovicianus*, 14  
*Sphex ichneumoneus*, 263  
*Stenamma brevicorne*, 94  
*Stilbum burmense*, 127  
*Svastra obliqua*, 233  
*Syrittosyrphus*, 17  
  
*Tachysphex similis*, 263  
   *tarsatus*, 263  
   *terminatus*, 268  
*Tarsochelys atomarius*, 203  
*Temenis laothoe liberia*, 171  
*Temnostoma*, 17  
*Tenuicoris myrmeforme*, 173  
*Tetramorium caespitum*, 94  
*Tetrastylis ovalis*, 38  
*Teuchochocnemis lituratis*, 15  
*Thelohania*, 125  
*Thereva frontalis*, 262  
*Thygater analis*, 230  
*Tolono decoratus*, 275

- Trachymyrmex septentrionalis, 142  
Tribolium, 139  
Tricyphona, 280  
Tunaria andicola, 271  
Turneria, 103
- Viburnum nudum, 22  
Veromessor, 141  
    andrei, 94, 97  
    pergandei, 94, 142  
    juliana, 97
- lariversi, 97  
lobognathus, 97  
smithi, 97  
Victorina (Metamorpha) stelenes, 39
- Wasmannia, 92
- Zammara sp., 31  
Zelotes, 266  
Zootermopsis, 139

## INVITATION TO MEMBERSHIP

The New York Entomological Society was founded in 1892 and incorporated the following year. It holds a distinguished position among scientific and cultural organizations. The Society's **Journal** is one of the oldest of the leading entomological periodicals in the United States. Members and subscribers are drawn from all parts of the world, and they include distinguished professional naturalists, enthusiastic amateurs, and laymen for whom insects are only one among many interests.

You are cordially invited to apply for membership in the Society or to subscribe to its **Journal** which is published quarterly. Regular meetings are held at 8:00 P.M. on the first and third Tuesdays of each month from October through May at the American Museum of Natural History, the headquarters of the Society. A subject of general interest is discussed at each meeting by an invited speaker. No special training in biology or entomology is necessary for the enjoyment of these talks, most of which are illustrated. Candidates for membership are proposed at a regular meeting and are voted upon at the following meeting.

### CLASSES OF MEMBERSHIP AND YEARLY DUES

<i>Active member:</i> Full membership in the Society, entitled to vote and hold office; with <b>Journal</b> subscription .....	\$9.00
<i>Active member without <b>Journal</b> subscription</i> .....	4.00
<i>Sustaining member:</i> Active member who voluntarily elects to pay \$25.00 per year in lieu of regular annual dues.	
<i>Life member:</i> Active member who has attained age 45 and who pays the sum of \$100.00 in lieu of further annual dues.	
<i>Student member:</i> Person interested in entomology who is still attending school; with <b>Journal</b> subscription .....	5.00
<i>Student member without <b>Journal</b> subscription</i> .....	2.00
<i>Subscription to <b>Journal</b> without membership</i> .....	8.00

---

### APPLICATION FOR MEMBERSHIP

Date .....

I wish to apply for ..... membership (see classes above).

My entomological interests are: .....

If this is a student membership, please indicate school attending and present level.

Name .....

Address .....

---

(Zip Code *must* be included)

— Send application to Secretary —

## Change of Editors

The members of the New York Entomological Society wish to express their sincere thanks to Dr. Lawrence Limpel and Helen McCarthy, for their diligent service as Associate Editors of the Journal of the N. Y. Entomological Society, who completed their tenure during 1974.

**Dr. Karl Maramorosch**, who assumed the responsibilities of Editor-in-Chief in 1972, has joined the faculty of Rutgers University in March 1974. He continues his service as Editor, now based at the Waksman Institute of Microbiology, Rutgers University, New Brunswick, N.J. 08903. Serving with him as Associate Editors are Dr. Herbert T. Streu and Dr. Lois J. Keller, R.S.M.

As Research Professor of Entomology and Economic Zoology at Rutgers University, New Brunswick, N. J., **Herbert T. Streu** is engaged in research on control of pests of ornamental plants and turfgrass, as well as in teaching and advising both undergraduate and graduate students. Dr. Streu received his Ph.D. from Rutgers in 1960 and was Nematologist with the ARS, USDA, Beltsville, Md. before returning to Rutgers in 1962.

Dr. Streu has authored a variety of both popular and scientific papers on the control of insects and mites in ornamentals as well as presented numerous invited lectures to professional growers organizations throughout the country. He has served as editor of several Rutgers Turfgrass Research Bulletins as well as two Proceedings of the Scott's Turfgrass Research Conferences.

Dr. Streu is a member of the Entomological Society of America and serves as Secretary-Treasurer of the Eastern Branch, a position he has held since 1969. In addition to membership in the Ecological Society of America, Society of Nematologists and Sigma Xi he is an elected Fellow of the AAAS.

Presently teaching Entomology at SUNY Agricultural and Technical College, Farmingdale, N.Y., **Lois J. Keller** has been engaged in the study of hymenopteran parasitoids, focusing primarily on their mating and reproductive behavior. Dr. Keller received her Ph.D. from Fordham University in 1973, and has been elected to Phi Beta Kappa and Sigma Xi.

Her past experience in the editorial field includes association with Marcel Decker, Inc. In addition to membership in the N.Y. Entomological Society, Dr. Keller is a member of the Entomological Society of America.

## **JOURNAL of the NEW YORK ENTOMOLOGICAL SOCIETY**

The JOURNAL of the NEW YORK ENTOMOLOGICAL SOCIETY is devoted to the advancement and dissemination of knowledge pertaining to insects and their related forms.

SUBSCRIPTIONS are \$8.00 per year, in advance, and should be sent to the New York Entomological Society, the American Museum of Natural History, 79th Street at Central Park West, New York, N. Y. 10024. The Society will not be responsible for lost JOURNALS unless immediately notified of change of address. We do not exchange publications.

Please make all checks, money-orders, or drafts payable to the NEW YORK ENTOMOLOGICAL SOCIETY.

ORDERS and inquiries for back issues and complete sets should be sent to our agent, S-H Service Agency, Inc., 866 Third Ave. New York, N. Y. 10022. Complete files of back issues are in stock.

### **INFORMATION FOR AUTHORS**

Submit manuscript in duplicate (original and one carbon) to the Editor, New York Entomological Society, Boyce Thompson Institute, Yonkers, N.Y. 10701.

1. GENERAL POLICY. Manuscript submitted must be a report of unpublished research which is not being considered for publication elsewhere. A manuscript accepted and published in the JOURNAL must not be published again in any form without the consent of the New York Entomological Society.

A page charge of \$15 per printed page is assessed except that the charge may be reduced in the case of a member of the Society who cannot obtain institutional or grant funds for publication.

The page charge includes black and white illustrations and tabular material.

2. FORM OF MANUSCRIPT. Text, footnotes and legends must be typewritten, double or triple spaced, with margins of at least 1½ inches on all sides. The editorial style of the JOURNAL essentially follows the *CBE Style Manual* (3rd edition, A.I.B.S., 1972).

Genetic symbols: follow recommendations of Demerec, et al.  
(Genetics **54**: 61, 1969)

Biochemical abbreviations: follow rules of the U.I.P.A.C. -I.U.B.  
(J. Biol. Chem. **241**: 527, 1966)

Enzyme activity: should be expressed in terms of international units.  
(Enzyme Nomenclature. Elsevier Pub. Co., 1965)

Geographical names, authors names and names of plants and animals should be spelled in full.

The JOURNAL reserves the privilege of editing manuscript or of returning it to the author for revision.

3. **ABSTRACT.** Each manuscript must be accompanied by an abstract, typewritten on a separate sheet.

4. **TITLE.** Begin each title with a word useful in indexing and information retrieval (Not "Effect" or "New".)

5. **ILLUSTRATIONS.** Original drawings *should not be submitted*. Glossy prints are desirable—not larger than 8½ by 11 inches and preferably not smaller than 5 by 7 inches. When appropriate, magnification should be indicated by a suitable scale on the photograph.

6. **REPRINTS** (in multiples of 100) may be purchased from the printer by contributors. A table showing the cost of reprints, and an order form, will be sent with the proof.

7. **SUBSCRIPTION** to the JOURNAL is \$8.00 per year, in advance, and should be sent to the New York Entomological Society, The American Museum of Natural History, Central Park West at 79th Street, New York, New York, 10024. The Society will not be responsible for lost JOURNALS unless immediately notified of change of address. We do not exchange publications. Please make all checks, money orders and drafts payable to the NEW YORK ENTOMOLOGICAL SOCIETY.

8. **ORDERS** and inquiries for back issues and complete sets should be sent to our agent: S-H Service Agency, Inc., 866 Third Ave., New York, N.Y. 10022.







# Journal

of the

## New York

# ENTOMOLOGICAL SOCIETY

Devoted to Entomology in General

### VOLUME LXXXIII

Published by the Society  
New York, N. Y.

### INDEX OF AUTHORS

ADAMS, ROGER G., JR., JOHN H. LILLY, and ADRIAN G. GENTILE. Increased Gladiolus Spike Growth with use of Certain Systematic Insecticides .....	251
AHMAD, SAMI and ANDREW J. FORGASH. Changes in Tolerance of <i>Porthetria dispar</i> (L.) (Lepidoptera: Lymantriidae) to Insecticides in Relation to Larval Growth and Mixed-Function Oxidase Activity .....	271
ALEXANDER, CHARLES P. New or Little-Known Crane Flies from Iran. II (Diptera: Tipulidae) .....	2
ALEXANDER, CHARLES P. New or Little-Known Crane Flies from Iran. III (Diptera: Tipulidae) .....	121
ALEXANDER, CHARLES P. New or Little-Known Crane Flies from Iran. IV (Diptera: Tipulidae) .....	129
ALLEN, WILLIAM A. Results of an Insect Scouting Program in Virginia Soybeans .....	256
ASCERNO, M. E. Effects of the Insect Growth Regulator Altozar on the Parasitoid, <i>Microctonus aethiops</i> , and Its Host, <i>Hypera postica</i> .....	243
ASH, NOREEN and BERNARD GREENBERG. Differential Cold Survival of Two Sibling Species of Blow Flies, <i>Phaenicia sericata</i> and <i>Phaenicia pallescens</i> .....	33
BARROWS, EDWARD M. Territoriality in Male Bees (Hymenoptera: Apoidea) .....	280
BAUGHER, DOUGLAS G. and WILLIAM G. YENDOL. Intra-instar Respirometric and Phase Distribution Differences in <i>Trichoplusia ni</i> (Hübner) (Lepidoptera: Noctuidae) Larvae .....	273
BECKWITH, ROY C. Douglas-Fir Tussock Moth, <i>Orgyia pseudotsugata</i> (McD.) (Lepidoptera: Lasiocampidae): Influence of Host Foliage .....	282
BENTON, ALLEN H. and ANDREW J. CRUMP. The Relationship of <i>Coleomegilla maculata</i> (DeGeer) (Coleoptera: Coccinellidae) to the Cocoon of its Parasite <i>Perilitus coccinellae</i> (Schrank) (Hymenoptera: Braconidae) .....	60
BENTON, ALLEN H. and DANNY L. KELLY. An Annotated List of New York Siphonaptera .....	142
BODE, WILLIAM M. Bionomics of the Tufted Apple Budmoth, <i>Platynota idaeusalis</i> (Walker) (Lepidoptera: Tortricidae), in Pennsylvania Apple Orchards .....	268
BOWMAN, JAMES S. An Improved Insect Pest Management Program on Sweet Corn in New Hampshire .....	249
BRYANT, D. G. The Importance, Biology and Control of the Birch Casebearer, <i>Coleophora fuscedinella</i> Zeller (Lepidoptera: Coleophoridae), an Imported Pest in Insular Newfoundland .....	285

BUSH, G. L. Genetic Changes occurring in Flight Muscle Enzymes of the Screwworm Fly During Mass Rearing .....	275
CAMPBELL, ROBERT W. The Bimodality of Gypsy Moth, <i>Porthetria dispar</i> (L.) (Lepidoptera: Lymantriidae) Populations .....	287
CAPINERA, JOHN L. and PEDRO BARBOSA. Dispersal of First-Instar Gypsy Moth Larvae in Relation to Population Quality .....	258
CURL, G. D., P. P. BURBUTIS, and C. P. DAVIS. Rearing the European Corn Borer, <i>Ostrinia nubilalis</i> (Hübner) (Lepidoptera: Pyralidae) on a Lima Bean Medium .....	265
DELFINADO, MERCEDES D. and EDWARD W. BAKER. Mites (Acarina) associated with <i>Popilius disjunctus</i> (Illiger) (Coleoptera: Passalidae) in Eastern United States .....	49
DENNO, ROBERT F. Wing Polymorphism in Salt Marsh Inhabiting Fulgoroidea .....	253
DROOZ, A. T. Current Research with <i>Telenomus alsophilae</i> Viereck, an Egg Parasite of the Fall Cankerworm, <i>Alsophila pometaria</i> (Harris) (Lepidoptera: Geometridae) .....	283
ELDRIDGE, B. F., R. R. PINGER, JR., J. F. BURGER and D. E. HAYES. Environmental Control of Diapause in Three Species of North American Aedine Mosquitoes (Diptera: Culicidae) .....	249
FAIN, A. and K. E. HYLAND. Speleognathinae Collected From Birds in North America (Acarina: Ereyneidae) .....	203
FISHER, G. T. and J. TURMEL. Control of the Apple Leaf Curling Midge, <i>Dasyneura mali</i> (Kieff) (Diptera: Cecidomyiidae) in New Hampshire .....	244
FITZPATRICK, GEORGE and DONALD J. SUTHERLAND. Temefos Residues in the Salt Marsh Snail <i>Melampus bidentatus</i> Say (Bassomatophora: Ellobiidae) .....	267
GITTELMAN, STEVEN H. Depth Selection in <i>Buenoa</i> (Heteroptera: Notonectidae) ..	265
GORDH, GORDON. Some Evolutionary Trends in the Chalcidoidea (Hymenoptera) with Particular Reference to Host Preference .....	279
GRANETT, J., R. M. WESELOH and D. M. DUNBAR. Dimilin Toxicity to <i>Apanteles melanoscelus</i> (Ratzeburg) (Hymenoptera: Braconidae) and Effects on Field Populations .....	242
HARRIGAN, W. R. and J. L. SAUNDERS. Honeylocust Pod Gall Midge, <i>Dasyneura gleditschae</i> Osten Sacken (Diptera: Cecidomyiidae), Control with Dacamox® .....	259
HENDRICKSON, R. M., JR. Mass Rearing of <i>Diglyphus isaca</i> (Walker) (Hymenoptera: Eulophidae) on <i>Liriodomyza trifoliarum</i> Spencer (Diptera: Agromyzidae) .....	243
HOWER, A. A., JR. and J. E. LUKE. Response of the Alfalfa Weevil Parasitoid, <i>Microctonus colesi</i> (Drea) (Hymenoptera: Braconidae), to a Recommended Insecticide Treatment in Pennsylvania .....	263
HOY, M. A. Improving the Quality of Laboratory-Reared Insects .....	276
HUETTEL, M. D. Monitoring the Quality of Laboratory-Reared Insects .....	276
HULL, L. A., D. ASQUITH and P. D. MOWERY. Mite Consuming Capacity of <i>Stethorus punctum</i> (Leconte) (Coleoptera: Coccinellidae) .....	262
HUNG, A. C. F. and S. B. VINSON. Notes on the Male Reproductive System in Ants (Hymenoptera: Formicidae) .....	192
HUSSAIN, MANZOOR. Predators of the Alfalfa Weevil, <i>Hypera postica</i> in Western Nevada—a Greenhouse Study. (Coleoptera: Curculionidae) .....	226
JONES, JACK COLVARD and DOROTHY HOELZER. The Oenocytes of <i>Tenebrio molitor</i> Linnaeus (Coleoptera: Tenebrionidae) .....	274
JOWYK, EUGENE A. and ZANE SMILOWITZ. Growth and Development of <i>Hyposoter exiguae</i> (Viereck) (Hymenoptera: Ichneumonidae) on Two Instars of <i>Trichoplusia ni</i> (Hübner) (Lepidoptera: Noctuidae) .....	261
KOK, L. T. Survival of Aestivating Adult <i>Rhinocyllus conicus</i> Froelich (Coleoptera: Curculionidae) at Different Temperatures and Photophases .....	251
KOSTELC, J. G., L. B. HENDRY and R. J. SNETSINGER. A Sex Pheromone Complex of the Mushroom-Infesting Sciarid Fly, <i>Lycoriella mali</i> Fitch .....	255

LEONARD, DAVID E. Parasitization of the Spruce Budworm, <i>Choristoneura fumiferana</i> (Clemens) (Lepidoptera: Tortricidae) by <i>Brachymeria intermedia</i> (Nees) (Hymenoptera: Chalcididae) .....	269
McDANIEL, IVAN N. Is a Black Fly Survey Worthwhile? .....	245
McDONALD, JOHN L. Mosquito Control in Unusual Breeding Sites in Southern Italy (Diptera: Culicidae) .....	267
MILIO, JOHN and ELTON J. HANSENS. Evaluation and Control of a Nuisance Fly Problem (Diptera: Muscidae) at Monmouth Park Jockey Club, Oceanport, New Jersey .....	252
MILLER, RICHARD C. and FRANK E. KURCZEWSKI. Comparative Behavior of Wasps in the Genus <i>Lindenius</i> (Hymenoptera: Sphecidae, Crabroninae) .....	82
MINOT, MILDRED C. and DAVID E. LEONARD. Influence of Physical Factors on the Behavior and Development of <i>Brachymeria intermedia</i> (Nees) (Hymenoptera: Chalcididae) .....	269
MOORE, IAN and E. F. LEGNER. Revision of the Genus <i>Endeodes</i> LeConte with a Tabular Key to the Species (Coleoptera: Melyridae) .....	70
MOORE, RICHARD C. Determination of Seasonal Activity of Four Fruit Pests Using Pheromone and Other Traps .....	264
MORRIS, GLENN K., RON B. AIKEN and GORDON E. KERR. Calling Songs of <i>Neduba macneilli</i> and <i>N. sierranus</i> (Orthoptera: Tettigonidae: Decticinae) .....	229
MUYSHONDT, ALBERTO. Notes on the Life Cycle and Natural History of Butterflies of El Salvador. VI A.— <i>Diaethria astala</i> Guérin. (Nymphalidae-Callicorinae) .....	10
MUYSHONDT, ALBERTO and ALBERTO MUYSHONDT, JR. Notes on the Life Cycle and Natural History of Butterflies of El Salvador. I B.— <i>Hamadryas februa</i> (Nymphalidae-Hamadryadinae) .....	157
MUYSHONDT, ALBERTO and ALBERTO MUYSHONDT, JR. Notes on the Life Cycle and Natural History of Butterflies of El Salvador. II B.— <i>Hamadryas guatemalena</i> Bates (Nymphalidae-Hamadryadinae) .....	170
MUYSHONDT, ALBERTO and ALBERTO MUYSHONDT, JR. Notes on the Life Cycle and Natural History of Butterflies of El Salvador. III B.— <i>Hamadryas amphinome</i> L. (Nymphalidae-Hamadryadinae) .....	181
NORTON, ROY A. Elliptochthoniidae, A New Mite Family (Acarina: Oribatei) From Mineral Soil in California .....	209
PADHI, SALLY B. and ARTHUR H. McINTOSH. The Use of Autoradiography to Detect RNA in Polyhedral Inclusion Bodies of Insect Nuclear Polyhedrosis Viruses .....	270
PEAIRS, F. B. and J. H. LILLY. Parasites Reared from Larvae of the European Corn Borer, <i>Ostrinia nubilalis</i> (Hbn.), in Massachusetts, 1971-73 (Lepidoptera, Pyralidae) .....	36
RAIMO, BERNARD. Infecting the Gypsy Moth, <i>Porthetria dispar</i> (L.) (Lepidoptera: Lymantriidae) with Nuclear Polyhedrosis Virus Vectored by <i>Apanteles melanoscelus</i> (Ratzeburg) (Hymenoptera: Braconidae) .....	246
RALPH, CAROL PEARSON. The Milkweed Pod as an Obstacle to the Large Milkweed Bug, <i>Oncopeltus fasciatus</i> (Heteroptera: Lygaeidae) .....	260
RECHTORIS, CAROL and ARTHUR McINTOSH. A Toxic Factor from the Established Cell Line, CP-169 (Hink): <i>Carpocapsa pomonella</i> (Lepidoptera: Olethreutidae) .....	271
RICKLEFS, ROBERT E. Seasonal Occurrence of Night-Flying Insects on Barro Colorado Island, Panama Canal Zone .....	19
ROBACKER, DAVID, K. M. WEAVER and L. B. HENDRY. Visual Stimuli in the Host Finding Mechanism of the Parasitic Wasp <i>Itopectis conquisitor</i> (Say) (Hymenoptera: Ichneumonidae) .....	257
ROBERTS, JAMES E., SR. Control of External Parasites on Cattle by Means of Dust Bags .....	253
ROLSTON, L. H. A New Species and Review of <i>Sibaria</i> (Hemiptera: Pentatomidae) .....	218

SCRIBER, J. MARK and PAUL P. FEENY. Growth Form of Host Plant as a Determinant of Feeding Efficiencies and Growth Rates in Papilionidae and Saturniidae (Lepidoptera) .....	247
SIMMONS, G. A. and C. W. CHEN. Application of Harmonic Analysis and Polynomial Regression to Study Flight Activity of <i>Choristoneura fumiferana</i> (Clem.) (Lepidoptera: Tortricidae) in the Field .....	266
SMILOWITZ, ZANE, CAROL A. MARTINKA and EUGENE A. JOWYK. The Influence of a Juvenile Hormone Mimic (JHM) on <i>Trichoplusia ni</i> (Hübner) (Lepidoptera: Noctuidae) and <i>Hyposoter exiguae</i> (Viereck) (Hymenoptera: Ichneumonidae) .....	262
SMITH, COREY W. and ELTON J. HANSENS. The Effect of Temperature and Humidity on the Amount of Blood Ingested by the Stable Fly, <i>Stomoxys calcitrans</i> L. (Diptera: Muscidae) .....	235
SURLES, W. W. and L. T. KOK. Sequential Releases of <i>Rhinocyllus conicus</i> Froelich (Coleoptera: Curculionidae) for the Biocontrol of <i>Carduus</i> Thistles .....	250
TALLAMY, DOUGLASS W. and ELTON J. HANSENS. A Comparison of Malaise Trapping and Aerial Netting for Research on Houseflies and Deerflies (Diptera: Tabanidae) .....	245
TAUBER, CATHERINE A. and MAURICE J. TAUBER. Systematics and Ecology of Chrysopidae (Neuroptera): Theoretical and Applied Implications .....	277
THOMAS, J. H. and C. H. HILL. A Seasonal History of the Variegated Leafroller, <i>Platynota flavedana</i> (Clemens) (Lepidoptera: Tortricidae), in Virginia Apple Orchards .....	260
TINGEY, W. M., V. E. GRACEN, and J. M. SCRIBER. Leaf Feeding Resistance to the European Corn Borer, <i>Ostrinia nubilalis</i> (Hübner) (Lepidoptera: Pyralidae), in Tropical Maize .....	256
TOPOFF, HOWARD. Behavioral Changes in the Army Ant <i>Neivamyrmex nigrescens</i> during the Nomadic and Statory Phases .....	38
UEBEL, E. C., R. E. MENZER, P. E. SONNET, and R. W. MILLER. Identification of the Copulatory Sex Pheromone of the Little House Fly, <i>Fannia canicularis</i> (L.) (Diptera: Muscidae) .....	258
VANDENBERG, JOHN D. and RICHARD S. SOPER. Isolation and Identification of <i>Entomophthora</i> spp. Fres. ( <i>Phycomycetes: Entomophthorales</i> ) from the Spruce Budworm <i>Choristoneura fumiferana</i> Clem. (Lepidoptera: Tortricidae) .....	254
VANDERLIN, ROBERT L. and FREDERICK A. STREAMS. Reproductive Diapause in <i>Notonecta undulata</i> (Say) (Hemiptera: Notonectidae) .....	248
VOLNEY, J. The Role of Defoliators in the Arthropod Community of Red Maple Crowns .....	283
WARD, R. H. and R. L. PIENKOWSKI. <i>Cassida rubiginosa</i> Müller (Coleoptera: Chrysomelidae), a Potential Biocontrol Agent of Thistles in Virginia .....	247
WEINER, THOMAS J. and ELTON J. HANSENS. Species and Numbers of Blood-sucking Flies Feeding on Hogs and Other Animals in Southern New Jersey .....	198
WESELOH, R. M. Seasonal Variations in Activity of <i>Apanteles melanoscelus</i> Ratzeburg (Hymenoptera: Braconidae) Adults as Related to Seasonal Variations in Age Structure of its Host, <i>Porthetria dispar</i> (L.) (Lepidoptera: Lymantriidae) .....	242
WHALON, MARK E. and BRUCE L. PARKER. Oxygen Consumption of <i>Coleomegilla maculata lengi</i> Timberlake (Coleoptera: Coccinellidae) Measured in a Differential Respirometer .....	272
WOOLDRIDGE, DAVID P. A Phylogeny for <i>Paracymus</i> Thomson (Coleoptera: Hydrophilidae) Based on Adult Characters .....	273

595.70673

Entom

Vol. LXXXIII

MARCH 1975

No. 1

Journal  
of the  
New York  
Entomological Society

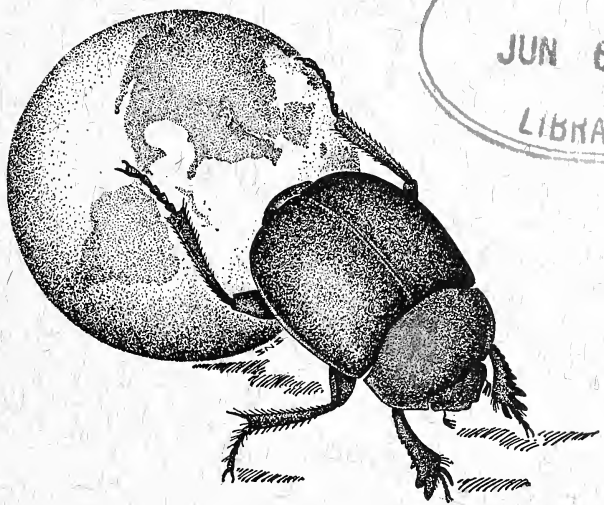

Devoted to Entomology in General

**The New York Entomological Society**  
**Incorporating The Brooklyn Entomological Society**  
**Incorporated May 21, 1968**

---

**The New York Entomological Society**  
**Organized June 29, 1892—Incorporated February 25, 1893**  
**Reincorporated February 17, 1943**

---

**The Brooklyn Entomological Society**  
**Founded in 1872—Incorporated in 1885**  
**Reincorporated February 10, 1936**

The meetings of the Society are held on the first and third Tuesday of each month (except June, July, August and September) at 8 P.M., in the AMERICAN MUSEUM OF NATURAL HISTORY, 79th St. & Central Park W., New York, N. Y. 10024.

Annual dues for Active Members, \$4.00; including subscription to the Journal, \$9.00.

Members of the Society will please remit their annual dues, payable in January, to the Treasurer.

---

**Officers for the Year 1975**

- President*, Dr. Daniel J. Sullivan, S.J.  
Fordham University, New York 10458
- Vice-President*, Dr. Peter Moller  
American Museum of Natural History, New York 10024
- Secretary*, Dr. Charles C. Porter  
Fordham University, New York 10458
- Assistant Secretary*, Dr. Louis Trombetta  
Isaac Albert Research Institute, Brooklyn, N.Y. 11203
- Treasurer*, Dr. Ivan Huber  
Fairleigh Dickinson University, Madison, N.J. 07940
- Assistant Treasurer*, Ms. Joan DeWind  
American Museum of Natural History, New York 10024
- 

**Trustees**

- Class of 1975  
Dr. Howard Topoff  
Dr. Pedro Wygodzinsky
- Class of 1976  
Dr. David C. Miller  
Dr. Norman Platnick
- 

Mailed May 28, 1975

The Journal of the New York Entomological Society is published quarterly for the Society by Allen Press Inc., 1041 New Hampshire, Lawrence, Kansas 66044. Second class postage paid at New Brunswick, New Jersey and at additional mailing office.

Known office of publication: Waksman Institute of Microbiology, New Brunswick, New Jersey 08903.

# Journal of the New York Entomological Society

VOLUME LXXXIII

MARCH 1975

No. 1

## EDITORIAL BOARD

*Editor* DR. KARL MARAMOROSCH  
Waksman Institute of Microbiology  
Rutgers University  
New Brunswick, New Jersey 08903

*Associate Editors* DR. LOIS J. KELLER, RSM  
DR. HERBERT T. STREU

Publication Committee

Dr. Kumar Krishna  
Dr. Ayodha P. Gupta  
Dr. James Forbes, Chairman

## CONTENTS

New or Little-Known Crane Flies from Iran II (Diptera: Tipulidae) .....	2
..... Charles P. Alexander	
Notes on the Life Cycle and Natural History of Butterflies of El Salvador. VI A.— <i>Diaethria astala</i> Guérin. (Nymphalidae-Callicorinae) .....	10
..... Alberto Muysshondt	
Seasonal Occurrence of Night-Flying Insects on Barro Colorado Island, Panama Canal Zone .....	19
..... Robert E. Ricklefs	
Differential Cold Survival of Two Sibling Species of Blow Flies, <i>Phaenicia sericata</i> and <i>Phaenicia pallescens</i> .....	33
..... Noreen Ash and Bernard Greenberg	
Parasites Reared from Larvae of the European Corn Borer, <i>Ostrinia nubilalis</i> (Hbn.), in Massachusetts, 1971–73 (Lepidoptera, Pyralidae) .....	36
..... F. B. Peairs and J. H. Lilly	
Behavioral Changes in the Army Ant <i>Neivamyrmex nigrescens</i> during the Nomadic and Statory Phases .....	38
..... Howard Topoff	
Mites (Acarina) Associated with <i>Popilius disjunctus</i> (Illiger) (Coleoptera: Passalidae) in Eastern United States .....	49
..... Mercedes D. Delfinado and Edward W. Baker	
The Relationship of <i>Coleomegilla maculata</i> (DeGeer) (Coleoptera:Coccinelli- dae) to the Cocoon of its parasite <i>Perilitus coccinellae</i> (Schrank) (Hymenop- tera:Braconidae) .....	60
..... Allen H. Benton and Andrew J. Crump	
Proceedings of the New York Entomological Society: Abstracts .....	64
Announcement .....	67
Book Reviews .....	67

## New or Little-Known Crane Flies from Iran II (Diptera: Tipulidae)<sup>1</sup>

CHARLES P. ALEXANDER  
AMHERST, MASSACHUSETTS 01002

RECEIVED FOR PUBLICATION JULY 17, 1974

**Abstract:** The initial part of this short series of papers concerning the crane flies of Iran was published in this *Journal* **82**: 279, 1974 and concerned the tribe Pediciini. At this time I am discussing the Eriopterine genus *Gonomyia* and provide descriptions of seven undescribed species, *Gonomyia (Idiocera) curticurva*, *G. (I.) laterospina*, *G. (I.) orthophallus*, *G. (I.) spinistylata*, *G. (Gonomyia) basilobata*, *G. (G.) elburzensis*, and *G. (G.) oxybeles*, from the Elburz Mountains in northern Iran.

As was discussed in the first part under this title the large series of Tipulidae from northern Iran was collected by Dr. Fernand Schmid in 1955 and 1956 and added greatly to the then poorly known Iranian crane fly fauna. I am very indebted to Dr. Schmid for his efforts in making known the Tipulidae of virtually all of southern Asia. The types of the new species are preserved in the Alexander collection.

### *Gonomyia (Idiocera) curticurva*, n. sp.

Mesonotal praescutum with three gray stripes, interspaces with two long pale brown lines, pleura light brown above, below chiefly yellow; femora yellowed with a narrow pale brown nearly terminal ring; wings faintly darkened, prearcular and costal regions pale yellow, stigma pale brown; *Sc* short, *Sc*<sub>1</sub> ending opposite origin of *Rs*, *Sc*<sub>2</sub> far retracted; *m-cu* more than its length before fork of *M*; male hypopygium with three dististyles, all terminating in blackened points; apex of aedeagus a very small curved hook.

*Male.* Length about 4 mm; wing 5 mm. Rostrum dark brown; palpi black. Antennae with scape brown, pedicel yellow, flagellum brownish black. Head with anterior vertex yellow, posterior vertex gray.

Pronotum brownish gray, scutellum and sides of scutum light yellow. Mesonotal praescutum with three gray stripes, the interspaces appearing as two long pale brown lines, pseudosutural foveae darkened; scutum gray, lobes slightly infuscated, posterior angles yellowed; scutellum obscure yellow; postnotal mediotergite brownish gray, pleurotergite light brown with a yellowed spot. Pleura light brown dorsally, sternopleurite and posterior sclerites yellow, ventral sternopleurite pale brown. Halteres with stem obscure yellow, knob pale brown. Legs with coxae yellow, bases of fore and middle pairs pale brown; trochanters yellow; femora yellowed, with a narrow pale brown nearly terminal ring; tibiae and basitarsi yellow, apices darkened, remainder of tarsi pale brown. Wings faintly darkened, prearcular and costal regions pale yellow; stigma light brown. Longitudinal veins beyond general level of origin of *Rs* with trichia, more sparse on vein *R*<sub>3</sub> and tips of

<sup>1</sup>Contribution from the Entomological Laboratory, University of Massachusetts.



the Anals. Venation:  $Sc$  short,  $Sc_1$  ending opposite origin of  $Rs$ ,  $Sc_2$  far retracted,  $Sc_1$  and  $Rs$  subequal in length; distance on costa between  $R_{1+2}$  and  $R_3$  about one-third the length of the latter;  $m-cu$  more than its length before the fork of  $M$ .

Abdominal tergites brown, sternites paler; hypopygium brownish yellow. Male hypopygium (Fig. 2) with outer lobe of basistyle,  $b$ , long, vestiture relatively short, inner lobe lacking. Three dististyles,  $d$ , all terminating in blackened points; outer style curved, narrowed gradually into a long slender spine; intermediate style largest, its outer angle a long gently curved spine, the inner angle short and stout; inner style straight, narrowed gradually into a long straight blackened spine, several long pale setae at base. Aedeagus,  $a$ , long, outer end slightly curved, apex a very small hook.

*Holotype*. ♂, Bar, Iran, June 30, 1956 (Schmid).

The species is generally similar to *Gonomyia (Idiocera) orthophallus*, n. sp., differing in hypopygial structure, especially the intermediate dististyle and the aedeagus.

*Gonomyia (Idiocera) laterospina*, n. sp.

General coloration gray, patterned with brown; femora yellow, tips narrowly brown; wings subhyaline, unpatterned except for the pale brown stigma,  $Sc_1$  very long; male hypopygium with four dististyles, the outermost a narrow rod with a small blackened spine at near midlength; aedeagus with apex slightly curved, subtended by two low points.

*Male*. Length about 5 mm; wing about 5 mm. Rostrum gray; palpi black. Antennae black. Head obscure gray.

Pronotal scutum dark gray, laterally light yellow, scutellum yellow. Mesonotal praescutum with disk gray, with two intermediate more brownish gray longitudinal stripes, humeral and lateral borders yellowed; scutum gray, centers of lobes vaguely more darkened; scutellum grayish brown; postnotum gray. Pleura brownish gray above, lower half yellowed, the ventral part slightly darker. Halteres with stem pale, knob dark brown. Legs with coxae and trochanters yellow; femora yellow, tips narrowly brown; tibiae yellow, tips very narrowly darkened; basitarsi yellowed, remainder of tarsi brown. Wings subhyaline, stigma pale brown, inconspicuous; veins pale brown,  $Sc$  more yellowed. Macrotrichia on most longitudinal veins beyond level of origin of  $Rs$ , lacking on  $R_2$ , present on apices of both Anal veins. Venation:  $Sc_1$  ending slightly beyond origin of  $Rs$ ,  $Sc_2$  far retracted,  $Sc_1$  nearly as long as  $Rs$ ; distance on costa between veins  $R_{1+2}$  and  $R_3$  about one-third to one-half the latter vein.

Abdominal tergites dark brown, sternites and hypopygium slightly paler. Male hypopygium (Fig. 3) with basistyle,  $b$ , produced into a longer outer and a small slender inner lobe. Four dististyles,  $d$ , the outermost a long nearly straight rod, its basal half stouter, at point of narrowing with a small blackened spine; second style largest, basal half slender, apically dilated into a subcircular blade that terminates in an acute spine, at base of blade with a smaller accessory projection that bears two unequal spines, the more basal one smaller; third style a long very slender nearly straight blackened spine; inner style slightly shorter, pale throughout, apex with a microscopic point. Aedeagus,  $a$ , with apex a slightly curved spine that is subtended by two low points.

*Holotype*. ♂, Bar, Iran, June 30, 1956 (Schmid). *Paratopotypes*. 3 ♂♂, with type.

From other regional species of *Idiocera* having the wings unpatterned except for the stigmal darkening, the present fly is most readily told by the hypopygial structure, including the four dististyles and the structure of the aedeagus. It is generally similar to *Gonomyia (Idiocera) alexanderiana* (Lackschewitz) of Albania, differing in hypopygial structure.

*Gonomyia (Idiocera) orthophallus*, n. sp.

Size relatively large (wing about 6 mm); thorax dark grayish brown, patterned with yellow, especially on pleura; wings subhyaline, stigma scarcely darker; *Sc* long, *Sc*<sub>1</sub> ending beyond one-third length of *Rs*; male hypopygium with three dististyles, the inner and outer similar to one another, their outer ends pointed; aedeagus long and straight, apex not decurved.

*Male*. Length about 5 mm; wing 6 mm. Rostrum and palpi black. Antennae with scape yellowed, flagellum black, the segments elongate. Front and orbits yellowed, vertex brown.

Pronotal scutum dark grayish brown, margins broadly yellow; scutellum obscure yellow. Mesonotal praescutum grayish brown with two intermediate brown stripes, lateral borders yellow; scutal lobes brown, each with two vague darker brown spots, median area anteriorly obscure yellow; scutellum obscure brownish yellow, base and a narrow central area darkened; postnotum brownish gray, sides of anterior half of mediotergite light yellow, pleurotergite light yellow above, lower third brownish gray. Pleura light yellow, propleura, dorsal mesopleura and ventral sternopleurite dark gray, meron yellow, narrowly darkened anteriorly. Halteres with stem yellow, knob brown. Legs with fore coxae light yellow, darkened basally, mid-coxae similar, the darkened part restricted, posterior coxae yellow; trochanters yellow; femora brownish yellow, tips darker; tibiae and tarsi brown. Wings subhyaline, very faintly tinted, stigma scarcely darker than the ground; veins light brown, *Sc* more yellowed. Longitudinal veins beyond general level of origin of *Rs* with long trichia, including also outer ends of both anal veins. Venation: *Sc* long, *Sc*<sub>1</sub> ending shortly beyond one-third *Rs*, *Sc*<sub>1</sub> long, about one-half *Rs*; veins *R*<sub>1+2</sub> and *R*<sub>3</sub> narrowly separated at costal border; *m-cu* about its own length or slightly more before the fork of *M*.

Abdomen brown. Male hypopygium (Fig. 4) with outer lobe of basistyle, *b*, large and fleshy, with long setae, inner lobe small. Three dististyles, *d*, the outer and inner generally similar in size and length, appearing as straight lobes, their pointed outer ends blackened, the amount less on the inner style; intermediate style much larger, with outer half more narrowed, at its base with a blackened point. Phallosome with the aedeagus, *a*, long and straight, apex not decurved; gonapophyses small, narrow, slightly curved outwardly, separated by a low setiferous cushion.

*Holotype*. ♂, Durbadam, Iran, July 3, 1956 (Schmid). *Paratypes*. ♂, Bar, Iran, June 30, 1956; ♂, Firouz Kuh, August 14, 1956 (Schmid).

→

FIG. 1. *Gonomyia (Gonomyia) basilobata*, n. sp.; venation.

FIG. 2. *Gonomyia (Idiocera) curticurva*, n. sp.; male hypopygium.

FIG. 3. *Gonomyia (Idiocera) laterospina*, n. sp.; male hypopygium.

FIG. 4. *Gonomyia (Idiocera) orthophallus*, n. sp.; male hypopygium.

FIG. 5. *Gonomyia (Idiocera) spinulistyla*, n. sp.; male hypopygium.

FIG. 6. *Gonomyia (Gonomyia) basilobata*, n. sp.; male hypopygium.

FIG. 7. *Gonomyia (Gonomyia) elburzensis*, n. sp.; male hypopygium.

FIG. 8. *Gonomyia (Gonomyia) oxybeles*, n. sp.; male hypopygium.

(Symbols: Male hypopygium—*a*, aedeagus; *b*, basistyle; *d*, dististyles; *id*, inner dististyle; *md*, middle dististyle; *p*, phallosome; *t*, 9th tergite).

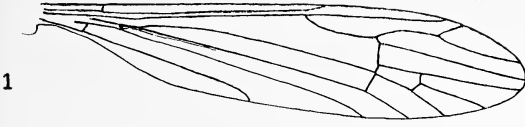

1

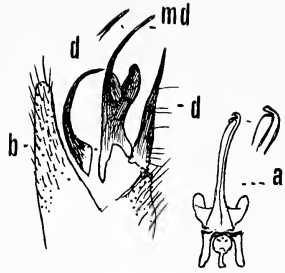

2

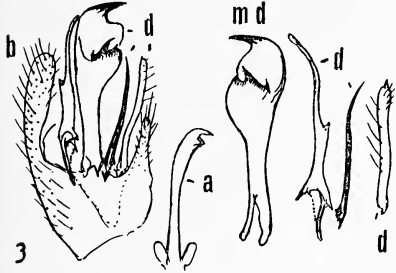

3

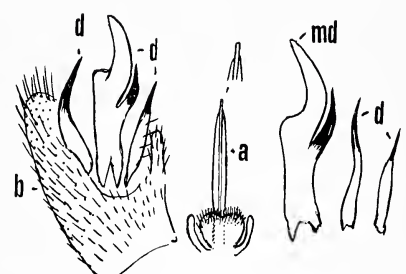

4

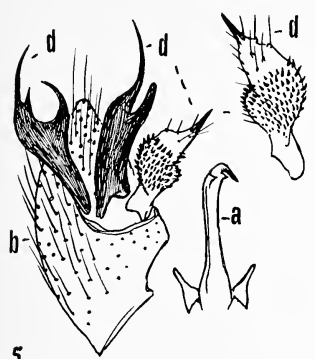

5

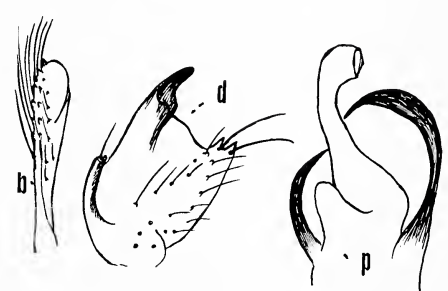

7

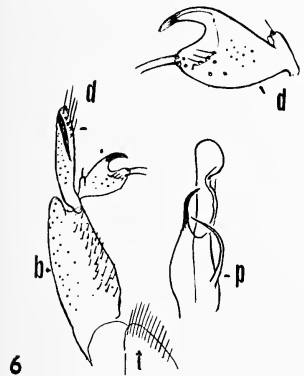

6

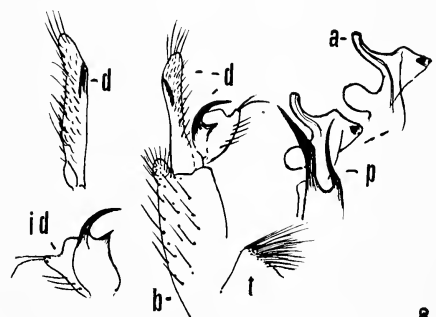

8

The present fly is most readily distinguished from generally similar regional species by hypopygial characters, especially the straight slender aedeagus and the conformation of the three dististyles. Such similar regional species include *Gonomyia (Idiocera) displosa* Alexander and *G. (I.) phallostena* Alexander, both from Kashmir, all differing among themselves in hypopygial structure.

*Gonomyia (Idiocera) spinulistyla*, n. sp.

General coloration of mesonotum brownish gray, praescutum with two longitudinal brown stripes; pleura brownish black with a whitened longitudinal stripe; knob of halteres black; femora yellow with a narrow pale brown nearly terminal darkening; wings whitened, with a restricted dark brown pattern beyond the cord; veins  $R_{1+2}$  and  $R_3$  contiguous at margin closing the cell; male hypopygium with three dististyles, the inner one distinctive; apex of aedeagus subtended by triangular points.

*Male*. Length about 6 mm; wing 5 mm. Rostrum and palpi black. Antennae broken. Head above gray, extensively light yellow posteriorly.

Mesonotal praescutum light gray with two longitudinal brown stripes that are narrower than the median interspaces; scutum brownish gray, each lobe with a large brown area; scutellum brownish gray, vaguely paler medially; postnotal mediotergite dark brownish gray, pleurotergite extensively light yellow, darker behind. Pleura brownish black, ventrally sparsely pruinose with a conspicuous whitened longitudinal stripe extending from fore coxae to the abdomen, widened behind, dorsopleural region whitish yellow. Halteres long, stem yellow, knob black. Legs with fore coxae as described, middle coxae blackened basally, remainder broadly white, posterior coxae obscure yellow, bases narrowly brownish black; trochanters yellow; femora yellow with a narrow pale brown nearly terminal darkening; tibiae and basitarsi yellow, extreme tips slightly darkened, remainder of tarsi brown. Wings whitened, prearcular and costal fields light yellow; a restricted dark brown pattern including  $h$ ,  $Sc_2$  and base of  $Rs$ , tip of  $Sc_1$ , stigma, and a more extensive apical area chiefly in cell  $R_1$ , the center of the marking with a whitened spot; other darkened seams over cord, including  $m-cu$ , and at arculus; veins brownish yellow, clearer yellow in the costal field, dark brown in the patterned areas. Venation:  $Sc$  long, ending nearly opposite midlength of  $Rs$ ,  $Sc_2$  retracted, placed shortly before  $Rs$ ;  $R_{1+2}$  and  $R_3$  confluent or contiguous at margin closing cell  $R_1$ ; vein  $R_4$  strongly upcurved on outer third;  $m-cu$  about one and one-half times its length before fork of  $M$ .

Abdominal tergites dark brown, incisures vaguely paler, sternites lighter brown. Male hypopygium (Fig. 5) with three dististyles,  $d$ , outer style expanded outwardly, divided into two major spines, the outer one long and slender with a smaller basal spinule, inner spine shorter, strongly curved; intermediate style bifid at apex into a long slender spine and a shorter spur; inner style distinctive, short and compact, terminating in a small spine, the base of style with very numerous blackened spinules. Aedeagus,  $a$ , curved at apex, at base subtended on either side by a small triangular point.

*Holotype*. ♂, Bar, Iran, June 30, 1956 (Schmid). *Paratopotype*, a fragmentary ♂, mounted on slide.

Regional species that are generally similar to the present fly include *Gonomyia (Idiocera) jucunda* Loew, *G. (I.) punctata* (Lackschewitz) and *G. (I.) schrenki* Mik, all differing among themselves in hypopygial structure, especially the dististyles.

*Gonomyia (Gonomyia) basilobata*, n. sp.

Rostrum light yellow; palpi and antennae black; mesonotal praescutum with disk dark brown, lateral margins light yellow, pleura yellow, striped longitudinally with pale

brown; wings with stigma slightly infuscated; male hypopygium with a small lobe at base of inner dististyle; phallosome with a single blackened apophysis, the second one entirely pale, apex of aedeagus obtusely rounded.

*Male.* Length about 5-5.5 mm; wing 4.5-5 mm. Rostrum light yellow; palpi black. Antennae brownish black, pedicel more intensely darkened. Head gray.

Prothorax light yellow, darker on sides. Mesonotal praescutum with disk dark brown, interspaces not or scarcely differentiated, humeral and lateral regions light yellow; scutum with lobes blackened, pruinose, posterior angles slightly reddened, median area yellow; scutellum brown, posterior border narrowly more darkened; postnotal mediotergite gray, sides yellow; pleurotergite yellowed. Pleura yellow, striped with pale brown, the dorsal area narrower and poorly delimited, sternal darkening more extensive. Halteres with stem pale yellow, knob brown. Legs with coxae pale brown, middle pair more yellowed; trochanters yellow; remainder of legs brown. Wings (Fig. 1) weakly darkened, stigma slightly infuscated, large; veins medium brown. Venation:  $Sc_1$  ending shortly beyond origin of  $R_s$ ;  $R_{2+3+4}$  long, gently arcuated;  $m-cu$  slightly before or beyond  $m-cu$ .

Abdomen brown, hypopygium slightly more yellowed. Male hypopygium (Fig. 6) with outer dististyle,  $d$ , narrow, apical flange elongate; inner style with dorsal spine stout, at base of style with a small lobe tipped with a strong seta. Phallosome,  $p$ , with two gonapophyses, one blackened, the more slender lower spine entirely pale; apex of aedeagus obtusely rounded.

*Holotype.* ♂, Mishgin, Iran, August 21, 1956 (Schmid). *Paratypes.* ♂, Bar, Iran, June 30, 1956; ♂, Durbadam, Iran, July 3, 1956 (Schmid).

The present fly is most readily distinguished from other generally similar regional species by the structure of the inner dististyle, with the reduced basal tubercle, and the single blackened gonapophysis of the phallosome. The genotype of *Gonomyia*, *tenella* (Meigen), has the inner dististyle generally similar but the phallosome has both gonapophyses blackened and the apex of the aedeagus different.

#### *Gonomyia (Gonomyia) elburzensis*, n. sp.

General coloration of thorax yellow, praescutum with disk dark brown, scutal lobes and mediotergite brown, pleura yellow, restrictedly patterned with brown; legs light brown; male hypopygium with gonapophyses unequal, both heavily blackened, terminating in slender spines, apex of aedeagus short and obtuse.

*Male.* Length about 4.5-4.6 mm; wing 5-5.3 mm. Rostrum, palpi and antennae brownish black. Head gray.

Prothorax clear light yellow. Mesonotal praescutum with disk dark brown, the interspaces concolorous with the stripes, lateral borders clear light yellow; scutal lobes dark brown, median region light yellow, narrowly darkened behind; scutellum light yellow; mediotergite brown, anterolateral portions and the pleurotergite light yellow. Pleura chiefly light yellow, including the dorsopleural membrane; ventral sternopleurite and a small area on lower anepisternum brown. Halteres with stem light yellow, apex of knob brown. Legs with fore coxae weakly darkened, remaining coxae light yellow; trochanters brownish yellow; remainder of legs light brown. Wings subhyaline, stigma not indicated; veins pale brown. Venation:  $Sc_1$  ending about opposite one-fourth to one-fifth  $R_s$ ;  $m-cu$  at fork of  $M$ .

Abdominal tergites brown, incisures pale; sternites light yellow medially and on extreme

margins, sublateral areas narrowly brown. Male hypopygium (Fig. 7) with lobe of basistyle, *b*, elongate, the apical glabrous flange elongate, outer setae long. Dististyle, *d*, about as shown; outer basal lobe long and slender, tipped with a single long seta; rostral prolongation short, the two modified setae elongate; summit of style blackened. Phallosome, *p*, with both gonapophyses blackened and extended into slender spines; apex of aedeagus short and obtuse, almost rounded.

*Holotype*. ♂, Lius, Iran, 2,200 meters, September 14, 1955 (Schmid). *Paratopotype*. ♂, pinned with type. *Paratypes*, ♂, Waliabad, Iran, September 24, 1956; ♂, Nandeh, Iran, June 10, 1956 (Schmid).

The most similar regional species include *Gonomyia* (*Gonomyia*) *tenella* (Meigen), Europe, *G. (G.) chalaza* Alexander, Pakistan, and some others, all differing in hypopygial details, particularly in the dististyles and phallosome.

*Gonomyia* (*Gonomyia*) **oxybeles**, n. sp.

Size large (wing over 6 mm); rostrum light yellow, palpi and antennae black; thoracic dorsum grayish brown and yellow, pleura conspicuously patterned with brown; wings light brown, stigma very pale, *Sc*<sub>1</sub> ending shortly beyond origin of *Rs*, cell *R*<sub>3</sub> large; male hypopygium with outer lobe of basistyle small; outer dististyle with lateral blade slightly darkened, lateral spine of inner dististyle with a small point at base; phallosome distinctive, especially the aedeagus beyond the gonapophyses.

*Male*. Length about 6.5 mm; wing 6.2 mm. *Female*. Length about 7.5 mm; wing 6.5 mm. Rostrum light yellow; palpi black. Antennae black; flagellar segments long-oval. Head light gray.

Pronotum light yellow, sides of scutum darkened. Mesonotal praescutum with disk chiefly dark gray, stripes margined with brown, sides broadly light yellow; scutum yellow, anterior and mesal parts of lobes dark brown, posterior ends yellowed; scutellum yellow; postnotal mediotergite dark brown medially, sides yellow, pleurotergite yellow, above and below vaguely margined with brown. Pleura chiefly light yellow, patterned with light brown, including a narrow stripe on propleura and mesopleura, ventral sternopleurite more extensively darkened. Halteres with stem light yellow, knob brown. Legs with coxae and trochanters yellow; remainder of legs broken. Wings very light brown, prearcular and costal fields light yellow, stigma very pale brown; veins pale brown, *Sc* yellow. Venation: *Sc*<sub>1</sub> ending shortly beyond origin of *Rs*, in type about opposite one-fifth the length of vein; cell *R*<sub>3</sub> large; *m-cu* varying slightly in position, from before to beyond the fork of *M*.

Abdomen dark brown, lateral borders of tergites yellowed, the posterior margins more narrowly so. Male hypopygium (Fig. 8) with outer lobe of basistyle, *b*, small. Outer dististyle, *d*, a straight blade, outer lateral margin slightly darkened; inner style, *id*, with outer spine large, slightly curved, with a small acute point at base; setae of rostral lobe long. Phallosome, *p*, distinctive, with two unequal black apophyses; aedeagus, *a*, distinctive, with a flattened rounded lobe near base and a larger outer lobe that bears a small darkened point or short spine at outer end, distal end of aedeagus bent at a strong angle, as shown.

*Holotype*. ♂, Mughan, Iran, June 20, 1956 (Schmid). *Allotopotype*. ♀, pinned with type. *Paratopotype*. ♀, pinned with types.

The present fly is similar to *Gonomyia* (*Gonomyia*) *sibyna* Alexander, of Sikkim and Assam, differing most evidently in hypopygial structure, especially the inner dististyle and phallosome.

## DISTRIBUTIONAL RECORDS

*Gonomyia (Idiocera) similior* Alexander

*Gonomyia (Idiocera) similior* Alexander; Ann. Mag. Nat. Hist. (12)9: 50-51; 1956.

Eastern Europe; southwestern Asia (Afghanistan, type).

Iran: Bagerabad, June 10, 1956; Kiakola, May 22, 1956; Persepolis, May 2, 1956;

Quattekas, 1800 meters, September 19, 1955; Tegan, July 5, 1956 (all Schmid).

*Gonomyia (Gonomyia) abbreviata* Loew

*Gonomyia abbreviata* Loew; Besch. Europ. Diptera, 3: 58; 1873.

*Gonomyia abbreviata* de Meijere; Tijd. v. Ent., 63: 84, fig. 84 (venation, ♂ hyp); 1920.

*Gonomyia (Lipophleps) abbreviata* Edwards, Trans. Soc. Brit. Ent., 5: 112, pl. 5, fig. 16 (wing); 1938.

*Gonomyia abbreviata* Lackschewitz; Ann. naturhist. Mus. Wien; 50: 60, fig. 9, p. 57, wing; 1940.

Europe.

Iran: Ardehjan, September 9 and 11, 1956 (Schmid).

**Notes on the Life Cycle and Natural History of Butterflies  
of El Salvador. VI A.—*Diaethria astala* Guérin.  
(Nymphalidae-Callicorinae)**

ALBERTO MUYSHONDT

101 AVENIDA NORTE #322. SAN SALVADOR. EL SALVADOR.

RECEIVED FOR PUBLICATION MAY 6, 1974.

**Abstract:** The results of observations carried on for a period of five years on one species of the Callicorinae, *Diaethria astala* Guérin, are presented. An account is given of the external morphological characteristics of the early stages, of the time elapsed in the metamorphosis, of the progressive sizes of each stage, and of the foodplants in El Salvador. The evident similarities between the early stages of this species and of *Catagramma titania* Salvin, and *C. pitheas* Latreille, on one hand, and the early stages of species belonging to the Catonephelinae are pointed out, suggesting a close phylogenetic relationship between the three groups. The probability of the species having developed impalatability against predators is deduced *a priori* from the noxious properties of the foodplants exploited by the larvae, and *a posteriori* from the brilliant coloration exhibited by the adults.

INTRODUCTION

Through several series of articles my sons and I intend to divulge the results of our observations on the early stages and adults of butterflies inhabiting the neighborhood of San Salvador, capital city of El Salvador. The present one is the sixth of the second series which was dedicated up to now to the Cato-nephilinae. This one deals with a species of Callicorinae, in order to evidence the close relation between the two groups which are widely accepted as Nymphalidae.

Even though two centuries ago Denis and Schiffermüller (1775) were conscious of the importance of the characteristics of the larvae as well as these of the butterflies when working up a system of the Lepidoptera, "Ein Auge auf den Schmetterling, das andere auf die Raupe," (one eye on the butterfly, the other on the larva), and modern authors still accept the validity of that concept, going even further: "any classification must take into account as many as possible of the external and internal structures not only of the adults but of the early stages" (Ford, 1945), it is evident that the early stages of many Neotropical Rhopalocera are still little known. As a result, some groupings have been arbitrarily made. We hope that our presentations will help, within their limitations, to fill the existing gap of information.

**Acknowledgments:** Again we express our gratitude to Dr. Alexander B. Klots of the American Museum of Natural History, New York, as without his valuable help and advice this publication would not have been possible. We also thank Dr. Frederick D. Rindge, of the same institution, who confirmed the tentative identification of the species.



We have reared *Diaethria astala* Guérin a number of times since early 1968 from eggs collected immediately after oviposition. Photos have been taken of them, of the subsequent larval instars and of the pupae. Record has been kept of the time spent on each individual stage and their respective measurements. Specimens of the early stages were preserved in alcohol and sent to the American Museum of Natural History, New York, where they are available to students of the group. In every instance we have reared this species, the eggs and larvae were kept in transparent plastic bags which were cleaned daily and maintained at all times under ambient light and temperature conditions. The identification of the butterfly was tentatively made by Miguel Serrano, and confirmed later by Dr. Frederick D. Rindge.

## LIFE CYCLE STAGES

*Egg.* Truncated cone shaped. Green with 14 lighter green ribs running from base to micropylar area. Ribs alternately reach the micropyle and vanish at the edge of the dome. About .75 mm. long. Hatches in 4 days.

*First instar larva.* Head brown, roundish, naked. Body yellowish-green, cylindrical, naked, with annulets between segments. 1.5 mm long when recently hatched, 3 mm before moulting in 4 days.

*Second instar larva.* Head brown with short, stubby, knobbed horns on each epicranial apex. Body yellowish-green profusely tuberculated by minute excrescences of lighter color. A lateral spine, deflected caudad, at each side of the 9th abdominal segment. 5.5 mm long before moulting in 4 days.

*Third instar larva.* Head brown, cordiform, with two long (nearly  $\frac{1}{2}$  of body length) slender, brown horns ornamented with three rosettes of accessory spines, bearing sparse thin setae. Body light green, finely tuberculate, with minute subdorsal, black, tri-furcated spines, from second abdominal segment to 8th abdominal segment. Lateral spines on 9th abdominal segment more developed and yellowish. About 10 mm long (not counting the horns). Moults in 6 to 8 days.

*Fourth instar larva.* Head and body as in third stadium, but horns  $\frac{1}{3}$  of body length, and subdorsal spines on yellow pinnacula. Grows to 15 mm in 5-7 days.

*Fifth instar larva.* Head reddish at base of horns and lateral margins, whitish in front. Horn shafts alternately reddish brown and dirty white. Accessory spines on horns bearing sparse dark setae at tips. Body light green with a scattering of tiny white tubercles and three rows of yellow tubercles, one along meson from 1st to 7th abdominal segments, and two subdorsally from 2nd thoracic segment to 8th abdominal segment. The subdorsal tubercles bear each a small but prominent black spine and two smaller ones. The median tubercles each bear one small black spine. The lateral furcated black spines on 9th abdominal segment are very prominent now on yellow scoli. Grows to 25 or 27 mm in 6-7 days.

*Prepupa.* No changes in appearance, but shorter. One day.

*Pupa.* Abdomen thickening from brown flat cremaster to wing cases. Indentation separating abdomen from humped and keeled thorax dorsally, terminating in bifid head. Color

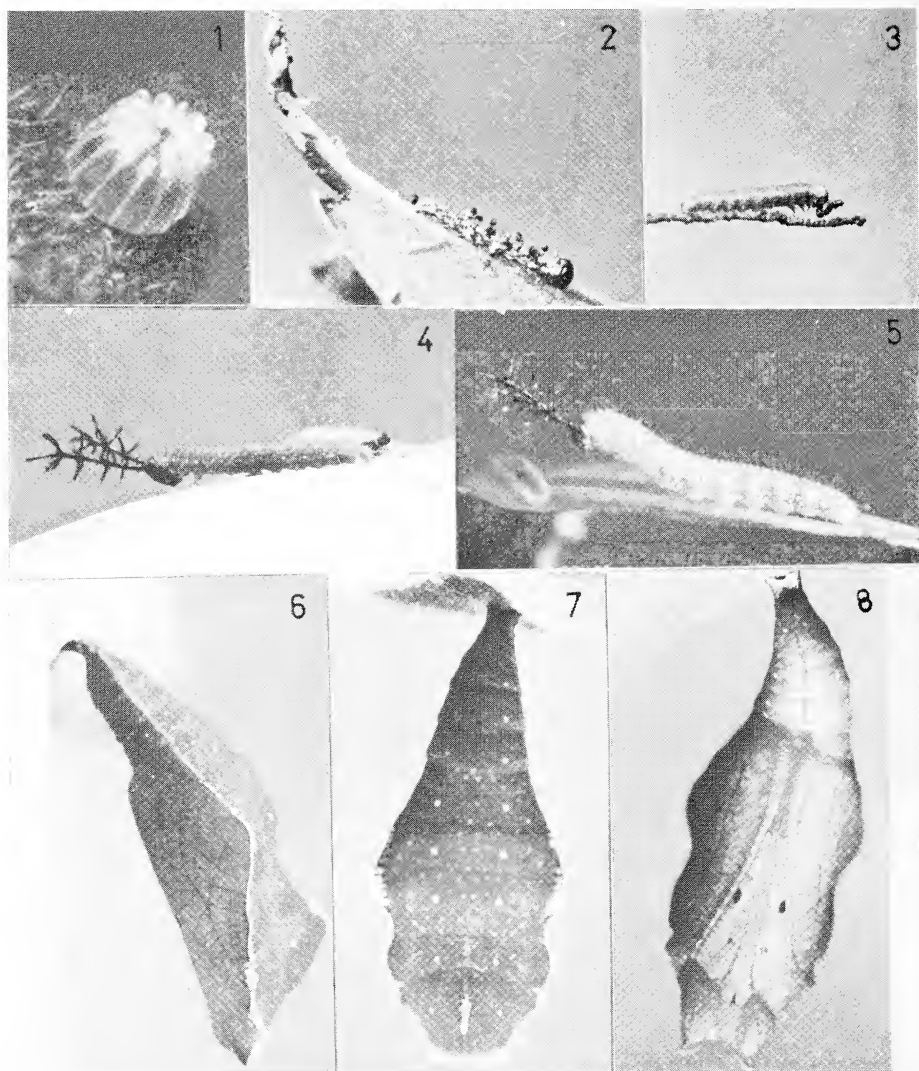

FIGS. 1-8. *Diaethria astala* Guérin. 1. Egg. 2. First instar larva with frass pellets stuck to its body. 3. Second instar larva on its perch, ready to moult. 4. Third instar larva. Notice body parallel to leaf. 5. Fifth instar larva with anterior part of the body raised. 6. Pupa. Lateral view. 7. Pupa. Dorsal view. 8. Pupa. Ventral view.

green with brown lining laterally from cremaster, wing cases and head. Thin brown vein-like markings ventrally on wingcases, and two dark spots about midway along the antennae. Spiracula small and inconspicuous green. The whole dorsal surface covered by very short, golden hair visible under a  $10\times$  magnification only. Wingcases turning dark before adult emergence. Duration 5-6 days.

*Adults.* There is sexual dimorphism in this species, even if not so drastic as in some Catonephelinae. The shape of the wings is the same in both sexes: front wing with a slightly convex costal margin, rounded apex, almost straight outer margin, rounded tornus and slightly concave inner margin. Hindwing almost round, with a humeral lobe and a fold at inner margin. Dorsal ground color of both fore- and hindwings is in both sexes velvety black, which in males gives a deep blue reflexion under direct sunlight. In front wings of males there is an iridescent blue slanting bar arising from inner margin, near tornus, towards mid-costal margin, disappearing around discal cell, and a white spot subapically. On females the slanting bar is narrower, iridescent greenish-blue and almost reaches the costal margin; there are two subapical white spots instead of one. Ventrally both sexes have the same striking combination of colors: forewing with a small gray basal area, followed by a triangular red zone lined by dark gray band along inner margin, then a thick, dull-black band from mid-costal margin to tornus, finally an apical white triangle with two thin black lines parallel to outer margin. Hind wing mostly white with the characteristic gray "89" surrounded by a thin black line; another thin, red line parallel to the black line midway between it and outer margin. Body black dorsally, white ventrally. Dark brown eyes and black, white-ringed antennae. Wing span averaging 44 mm in males, 50 mm in females. Total developmental time varies from 35 to 41 days.

#### NATURAL HISTORY

Oviposition in this species occurs usually between 10 and 15 hours. The females fly to the foodplant rather hesitantly. Once the foodplant has been located, they fly around a few times until a suitable place is chosen and alight on a mature leaf or a tender terminal. A single egg is deposited per location, either on the edge of a mature leaf or on the tendrils or terminal bud of a young shoot. Once the egg is deposited the females resume the circling flight and the process is repeated several times before moving away. We have seen eggs being laid from almost ground level on small rampant plants (which is the most usual method), to about 16 m from the ground on the young terminals of plants clinging to neighboring trees. This is done on vines belonging to the Sapindaceae; the genera *Serjania* and *Cardiospermum* seem to be preferred, even though we have collected eggs and larvae of *D. astala* on *Paullinia* spp. eventually. The eggs, due to their small size and green color, are rather hard to find. The tiny hatching larvae eat an exit hole through a wall of the eggshell, and at times eat afterwards a portion of the upper part of it, but always leaving an identifiable remnant. The small larvae move later to the edge of the leaf and feed on it, usually around a vein, which is prolonged with frass pellets affixed with silk, and this is used by the larvae as a resting place while not feeding. It is common to find small larvae with one or several pellets stuck to their own bodies. This might function as camouflage or to have material at hand to lengthen the perch as needed. The small larvae usually hold to the perch with just the prolegs, raising the anterior part of the body, the head pointing distally. Second instar larvae behave similarly. The larvae during these stadia leave the perches only to feed, which is done early in the morning or

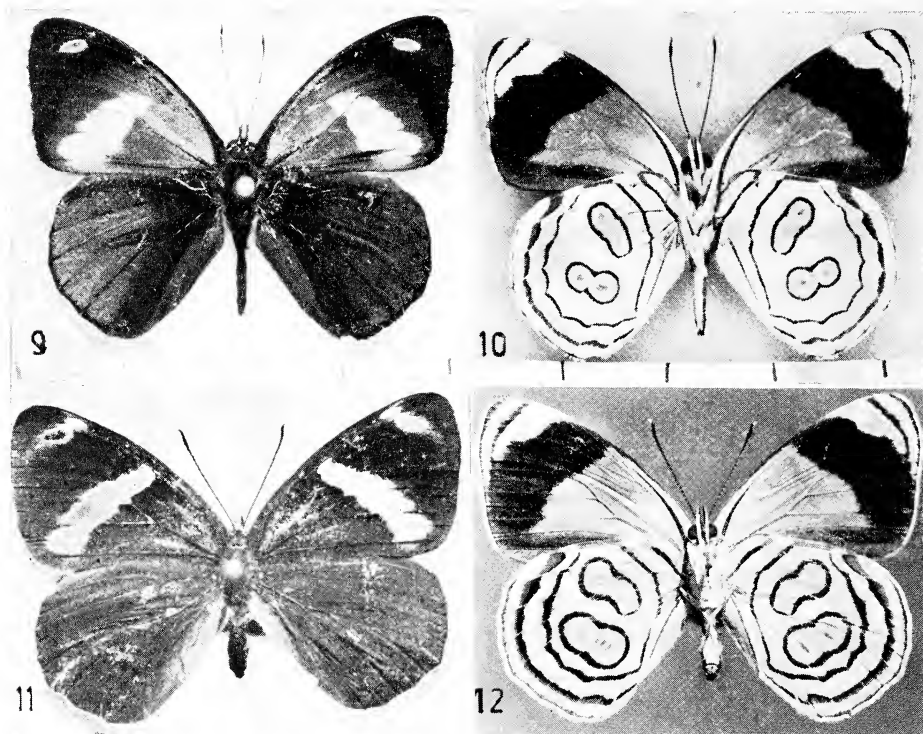

FIGS. 9-12. *Diaethria astala* Guérin. 9. Male dorsal side. Measures in cm. 10. Male ventral side. 11. Female dorsal side. 12. Female ventral side.

late in the afternoon, and once this is done they crawl back to the resting places. While walking, the larvae weave a foothold of silk, moving the head from side to side. From third instar on, the larvae abandon the perch and wander about the plant, usually on the upper surface of the leaves. Most of the time they stay motionless adopting two peculiar attitudes, one with the whole body in contact with the leaf surface, the head bent forward so that the horns are parallel to the leaf surface; and a second with only the abdominal segments parallel to the leaf surface, the thoracic segments raised, but as before the head bent forward in a similar manner. When the observer blows on a larva resting as described, it reacts by a continuous twitching motion of the thoracic legs. If prodded with a sharp object, the larva strikes violently with its horns. When by accident more than one larva move to the same leaf, a fight is certain to occur as one larva touches the other. As a rule one or both contestants will be punctured by the sharp spines of the horns, or their horns will lock in such a way that both larvae will not be able to feed and therefore will starve. One time we found a fifth instar larva moving about the plant with a dead

third instar larva looped around its thoracic segments, the horns of both larvae being firmly interlinked. The younger and weaker larva had succumbed to starvation while still fighting to disentangle its horns. The bigger larva died few days later as a result of an infection caused by the decaying body of the smaller one, although due to its greater strength it could feed normally.

When ready to pupate, the larvae look for a convenient place on the same vine or on a neighboring shrub or small tree and weave a silken pad usually on the upper surface of a leaf, less commonly on the lower surface, clean the digestive tract and hold to the silk with the anal prolegs. The larvae very seldom hang to pupate. The pupae in consequence, may be on either surface of a leaf, not hanging, but closely appressed to it. The pupae when disturbed can produce a faint creaking sound by wiggling sidewise or moving accordion-like. Shortly before the adult emergence the green pupae turn dark gray and the dorsal colors of the wings are visible through the shell.

The emerging adult rapidly abandons the pupa shell and hangs from it until the wings are rigid enough to fly, meanwhile expelling a rusty meconium. We have never observed the adults while in copula, nor have we seen them feeding on flowers nor on fermenting fruits, even though we suspect they do feed on the latter; but very often we have collected adults on vertebrate excrements or at mud puddles alongside creeks. When approached the butterflies fly swiftly in circles, their bluish flash being very conspicuous.

The foodplants of *Diaethria astala* larvae we have found up to the present all belong to the Sapindaceae, genera *Paullinia* (*P. pinnata*), *Serjania* (several species) and *Cardiospermum* (*C. halicacabum*). Many plants belonging to the genera *Paullinia* and *Serjania* are reported by various authors (Standley, 1924; Beille, 1909; Baillon, 1874) to contain poisonous or narcotic properties. *Cardiospermum halicacabum*, according to Beille (1909), is rich in saponine. All these plants are widely distributed in El Salvador. We have found them mostly between 500 and 1500 m along ravines and creeks which harbor very disturbed second growth plant communities in this densely populated country, whose land is almost completely under intensive cultivation. It is within this range (500–1200 m) that *Diaethria astala* is found. The adults favor the neighborhood of coffee plantations, ravines and creeks with heavy vegetation.

When rearing this species we have lost many individuals due to parasitism, usually by Tachinidae, but also by Hymenoptera. Others died when fed on slightly decaying leaves of the foodplants, which seem to become more toxic even for them.

#### DISCUSSION

Müller (1886) gives a description of the early stages of *Callicore meridionalis* Bates, using *Myscelia orsis* Drury as comparison model; and of *Catagramma*

*pygas* Godart comparing it with *C. meridionalis* which is cited by J. Röber (1915). Müller in his work reports the foodplant for *C. pygas* to be *Allophylus petiolatus* Radlkofer, (Sapindaceae), and amazingly *Trema micrantha* Dell, (Ulmaceae he places under Urticaceae), for *Callicore*. This is repeated by Röber (1915), by Bates (1923) for *Diaethria clymena* (Cramer) and quoted by Kimball (1965). *Trema micrantha*, a small tree, is found in this country in the same habitats in which we find the Sapindaceae vines used by *Diaethria astala* (as well as other species: *D. salvadorensis* Franz, *Catagramma titania* Salvin, *C. pitheas* Latreille) larvae as foodplants, yet not a single time have we found, or have been able to make the larvae accept *Trema micrantha* as food. Was a Sapindaceae tree misidentified? In any case, the species we have reared, feed locally and exclusively on a variety of plants of the family Sapindaceae. In our knowledge, this is the first time a complete description of the life cycle of *Diaethria astala*, illustrated with photographs, is presented.

Ebert (1969) lists under Callicorinae: *C. sorana* Godart, *Diaethria candrena* Godart, *D. clymena*, *D. eluina* Hewitson and *Paulogramma pyracmon* Godart as species existent in the Brazilian zone of Poços de Caldas, Minas Gerais. We do not find any *Catagramma* listed in that group, or in the closely related Catonephelinae. After having reared *Catagramma titania* from the egg and *C. pitheas* partially, we dare to suggest Callicorinae and Catagramminae are at least as closely related as Catonephelinae and Callicorinae, (if they should not be all aggregated into a single family, probably Catagrammidae, as Guenée and Burmeister did, separating the groups into subfamilies or tribes), as there is a great similarity between the eggs, larvae and pupae of *Catagramma titania* (and what we have seen of *C. pitheas*), and those of *Diaethria astala* and *D. salvadorensis*, (the latter using the same foodplants as *D. astala* but at higher altitudes: 1200 m and up). One time we observed a *C. titania* ovipositing on the young terminals of a *Serjania* vine high up in a supporting tree (16–20 m). The terminals were brought down and placed in a transparent plastic bag. Some greenish eggs were found on the younger parts of the terminals, along with some yellow ones, and under superficial examination were found similar, the difference of coloration being attributed to different ages, and all were reared to adult. To our surprise two kinds of larvae were noticed when at third stadium: some typical *Diaethria* and others without the tiny subdorsal spines, but with a thick scolus and with spines on meson of 8th abdominal segment! The head and its horns, the body shape and color, and the behavior of these larvae were almost the same as those of *Diaethria*. The pupae formed later were all also very similar. Some of these produced adults of *C. titania* others of *D. astala*. It is accepted that the egg, larval and pupal characteristics are the ones which resist to a greater degree the changes induced by divergent selection, and therefore are of extreme importance to determine

phylogenetic relationships between species, genera and families. In this case they seem to indicate the close relationship of *Catagramma-Diaethria*. As a result of the comparison of the external characteristics of the eggs, larvae and pupae of the two genera, reinforced by the similar behavior and the same foodplant association, we conclude that the two groups also evidence a close affinity with Catonephelinae. We refer to the descriptions of the early stages and behavior of *Catonephele numilia esite* Felder (Muysshondt, 1973), *Epiphile adrasta adrasta* Hewitson (Muysshondt, 1973a), *Temenis laothoe liberia* Fabricius (Muysshondt, 1973b) *Pseudonica flavilla canthara* Doubleday (Muysshondt, 1973c) and *Pyrrhogyra hypsenor* Godman & Salvin (Muysshondt, 1974) to support our contention, without having to be repetitious.

In our presentation of the Catonephelinae mentioned above we discussed the probability that at least some of them (*E. adrasta*, *T. laothoe*, *Pseudonica flavilla* and *Pyrrhogyra hypsenor*), which also feed on Sapindaceae, have developed a more or less strong impalatability to predators, basing our assertion not only on the poisonous properties of the foodplants, but on the gradually showier colors and slower flights these species show, following the sequence as above. Being that *Diaethria astala* larvae feed on the same plants the others do, that they behave similarly during the early stages and most of all that the adults have a brilliant coloration, we also suggest the probability of this species being protected against predation for the same reasons. In addition to this defense mechanism based on chemical properties, the adults of *D. astala* exploit the contrasting dorsal and ventral bright colors to produce a bewildering effect on attackers of "flash-and-substitute," as the fast moving blue streak suddenly disappears when the butterflies alight with their wings folded, and are replaced by an altogether different and immobile object, however bright and gaudy their coloration. In no case could these colors be considered cryptic or camouflaging, but on the contrary they seem to advertise the noxious properties of the butterflies to their potential enemies.

*Diaethria astala* is another species which appears to support our hypothesis that parasitizing Diptera and Hymenoptera will prefer hosts protected from predation as a means to guarantee the survival of their progeny, (Muysshondt 1973b, c and 1974) because this species also is decimated mostly by tachinid flies. We have found pupa shells in the fields also clearly showing exit holes similar to the ones caused by *Spilochalcis* sp. on pupae of *Pyrrhogyra hypsenor* in our insectarium.

#### Literature Cited

- BAILLON, H. 1874. Histoire des plantes. Hachette et Cie. Paris, 5: 389.  
BATES, M. 1923. Notes on Florida Lepidoptera. Fla. Ent., 7: 42-43.  
BEILLE, L. 1909. Précis de botanique pharmaceutique. A. Malone. Paris. 2: 645.  
DENIS AND SCHIFFERMÜLLER. 1775. "Syst. Verz." Schmett. Wien.

- EBERT, H. 1969. On the frequency of butterflies in Eastern Brazil with a list of the butterfly fauna of Poços de Caldas, Minas Gerais. *Jour. Lep. Soc.* **23**, Sup. 3.
- FORD, E. B. 1945. "Butterflies." Collins. London.
- KIMBALL, C. P. 1965. "Lepidoptera of Florida." State of Florida Dept. of Agriculture. Gainesville, Fla. p. 43.
- MÜLLER, W. 1886. Südamerikanische Nymphalidenraupen. *Zoologische Jahrbuch*, 461-475.
- MUYSHONDT, A. 1973. Notes on the life cycle and natural history of butterflies of El Salvador. I A.—*Catonephele numilia esite* (Nymphalidae-Catonephelinae) *Jour. New York Entomol. Soc.*, **81**: 164-174.
- . 1973a. Notes on the life cycle and natural history of butterflies of El Salvador. A.—*Epiphile adrasta adrasta*. (Nymphalidae-Catonephelinae) *Jour. New York Entomol. Soc.*, **81**: 214-223.
- . 1973b. Notes on the life cycle and natural history of butterflies of El Salvador. III A. *Temenis laothoe liberia* (Nymphalidae-Catonephelinae) *Jour. New York Entomol. Soc.*, **81**: 224-233.
- . 1973c. Notes on the life cycle and natural history of butterflies of El Salvador. IV A.—*Pseudonica flavilla canthar.* (Nymphalidae-Catonephelinae) *Jour. New York Entomol. Soc.*, **81**: 234-242.
- . 1974. Notes on the life cycle and natural history of butterflies of El Salvador. V A.—*Pyrrhogyra hypsenor* (Nymphalidae-Catonephelinae). *Jour. New York Entomol. Soc.* in press.
- RÖBER, J. 1915. In Seitz's *Macrolepidoptera of the World*. Vol. 5. Stuttgart.
- STANDLEY, P. C. 1924. Trees and shrubs of Mexico. *Contrib. from the U.S. Nat. Herb.*, **23**, Part 3, 701-3.



## Seasonal Occurrence of Night-Flying Insects on Barro Colorado Island, Panama Canal Zone

ROBERT E. RICKLEFS

DEPARTMENT OF BIOLOGY, UNIVERSITY OF PENNSYLVANIA, PHILADELPHIA, PA. 19174

RECEIVED FOR PUBLICATION JUNE 3, 1974

This report summarizes the seasonal occurrence of night-flying insects attracted to ultraviolet-emitting fluorescent lamps ("black lights") on Barro Colorado Island. Observations were made between November 1967 and August 1968, during March 1970, and during June and July, 1971. Captures of insects in a malaise trap, operated between November 1967 and June 1968 are also tabulated for comparison.

Many ecologists who lack long-term experience in the tropics hold the common misconception that the tropics are relatively aseasonal, but numerous reports have demonstrated strong seasonal cycles in the occurrence of organisms or aspects of their behavior. For examples, readers are referred to Skutch (1950), Ricklefs (1966), Snow and Snow (1964), and Miller (1963) for reproductive cycles in neotropical birds, to Janzen (1967) and Smythe (1970) for seasonal patterns of flowering and fruiting in plants, to Wilson (1971) for the seasonal occurrence of reproduction in bats, and to Fairchild (1942), Galindo *et al.* (1956), Pipkin (1965), and Owen (1969), for seasonal cycles of abundance in particular groups of insects. For the most part, seasonal cycles in the tropics are closely tied to abrupt changes of rainfall associated with the onset of marked wet and dry seasons, but even where rainfall is relatively abundant throughout the year, biological seasonality is still a predominant feature.

Although evidence for seasonality in tropical faunas and floras is accumulating rapidly, relatively little is known about year-to-year variation in population sizes and reproductive activity. Collections of arboreal mosquitoes over a six year period, reported on by Galindo *et al.* (1956), demonstrated considerable year to year variation in individual species. Observations reported here further substantiate this finding.

### METHODS

Two fluorescent black lights were positioned over screened windows in the laboratory clearing on Barro Colorado Island. The lights faced a ravine, covered with tall second growth vegetation near its top and with relatively mature forest farther down the slope. Thus the lights illuminated both canopy and understory vegetation. The vegetation remained essentially unchanged throughout the study.

Lights were turned on before dark and insects in several broad taxonomic groups were counted on the four window screens directly under the lights between 5 and 6 a.m. The numbers of individuals of several hundred species of moths, identified with photographic keys made during November 1967, were also recorded. Counts were made on 89 nights during the 10 months between November 1967 and August 1968, an average of almost 9 nights per month. The counts did not follow a regular schedule, and they varied between 4 and 12 per month in number.

A malaise trap with a cross-sectional area of 4 m<sup>2</sup> was also employed for 39 night periods and 29 day periods between November and June. The trap was located at ground level along a 5 m wide cleared path through second growth vegetation attaining about 5–10 m in height. The collecting bottle on the trap was usually emptied at dawn and dusk to separate day and night catches, but it was occasionally emptied every two hours during the day to obtain diurnal variation in flying insects. The wet weight of malaise trap collections was usually the only measurement of abundance recorded, but individuals of several orders were occasionally counted.

#### RESULTS

*Major groups of insects.* Monthly rainfall records for Barro Colorado Island, averaged for both 44 years and for the years during which this study occurred, are presented in Table 1. The climate is characterized by a rather severe dry season that usually begins abruptly in late December and ends somewhat more gradually in April. The timing and severity of the dry season vary considerably from year to year. Between 1926 and 1967, the rainfall during the period January through March varied by a factor of 27, between 0.6 and 16.3 in. (1.5 and 41.4 cm).

The seasonal occurrence of several conspicuous groups of insects attracted to the lights on Barro Colorado Island during the period November 1967 through August 1968 are presented in Table 2. Moths are divided into two size groups at a body length of 1 cm. Their seasonal occurrence will be discussed in detail below, although it is clear from Table 2 that the abundance of large species declined during the dry season months, and that the abundance of small species was least during the early part of the rainy season (April–June). Standard errors of the mean for the moth samples vary between 10 and 20% of the mean.

Patterns of abundance for other groups appeared to vary greatly. Katydid (Orthoptera: Tettigoniidae), beetles (Coleoptera), and both pentatomid and reduviid bugs (Hemiptera) occurred in fairly regular numbers throughout the year although katydids appeared to be more abundant during Feb–April, beetles exhibited a peak of abundance in May 1968, and reduviid bugs were relatively scarce in November 1967 and January 1968. Mantids (Orthoptera: Mantidae) were also scarce during November and December. Few bees, wasps,

TABLE 1. Seasonal distribution of rainfall on Barro Colorado Island.

RAINFALL (INCHES)	Month												
	JAN	FEB	MAR	APR	MAY	JUN	JUL	AUG	SEP	OCT	NOV	DEC	TOTAL
Average (1925-67)	2.2	1.3	1.2	3.5	10.8	11.0	11.5	12.4	10.3	13.6	18.1	10.5	106.4
1967	0.4	0.5	0.5	4.4	6.3	13.5	8.7	10.9	7.0	11.9	15.2	6.5	85.9
1968	0.1	1.8	3.6	0.6	11.5	10.2	6.5	15.9	7.1	18.7	10.2	1.8	88.1
1969	1.7	0.5	0.4	5.0	10.0	6.0	12.3	6.0	8.7	12.4	13.0	10.2	86.4
1970	11.8	2.8	1.3	4.2	18.0	8.5	13.3	14.1	5.2	10.9	20.0	16.8	127.0
1971	4.2	0.7	2.3	0.1	22.6	6.3	9.7	9.4	10.1	7.0	11.8	1.0	85.1

TABLE 2. Seasonal occurrence of certain groups of insects attracted to black lights on Barro Colorado Island, expressed as number of individuals per 10 nights of observation.

	MONTH									
	1967		1968							
	NOV	DEC	JAN	FEB	MAR	APR	MAY	JUN	JUL	AUG
Number of nights	12	4	6	10	11	9	10	4	7	5
Taxonomic group										
Moths										
Large	314	512	168	217	157	310	348	258	446	394
Small	404	655	413	912	616	243	219	175	321	310
Katydid	20	12	8	44	36	33	17	23	23	22
Mantids	1	0	5	21	5	3	8	18	17	8
Beetles	3	15	5	13	12	22	61	15	21	20
Bees, ants, and wasps	44	78	17	17	17	58	251	38	50	12
Pentatomid bugs	4	10	5	3	3	10	2	5	1	10
Reduviid bugs	0	18	2	52	14	14	44	33	16	30
Cicadas	0	0	0	1	9	8	6	13	6	0
Owl-flies	1	0	0	0	0	9	9	0	3	2

and flying ants (Hymenoptera) were attracted to the lights during the dry season months (January–March) although tree flowering reaches a peak during this period. A marked peak in the abundance of Hymenoptera at the lights occurred during May 1968. Two smaller taxonomic groups, the cicadas (Homoptera: Cicadidae) and the owl-flies (Neuroptera: Ascalaphidae) were completely absent during large portions of the sample period and were most abundant during the early part of the rainy season.

Moths (Lepidoptera) were attracted to the lights in far greater numbers than any other group. Seasonal trends in their occurrence are shown in Figure 1. Large moths were least numerous during the dry months, January through March, and their numbers increased abruptly with the onset of the rainy period. As a whole, small moths exhibited no decline in numbers during the dry season. In fact, they appeared to attain peak abundance at that time. This peak consisted mostly of individuals of one species that was present at no other time, however; when this species was subtracted from the total, small moth abundance can be seen to decline through the dry season, reaching low levels between March and June (Figure 1).

The numbers of moths attracted to the lights varied greatly from night to night. Coefficients of variation, calculated for each month's counts and presented in Figure 2, demonstrated that the magnitude of short-term variation in small moths paralleled that in large moths and tended to decline slightly between November and August.

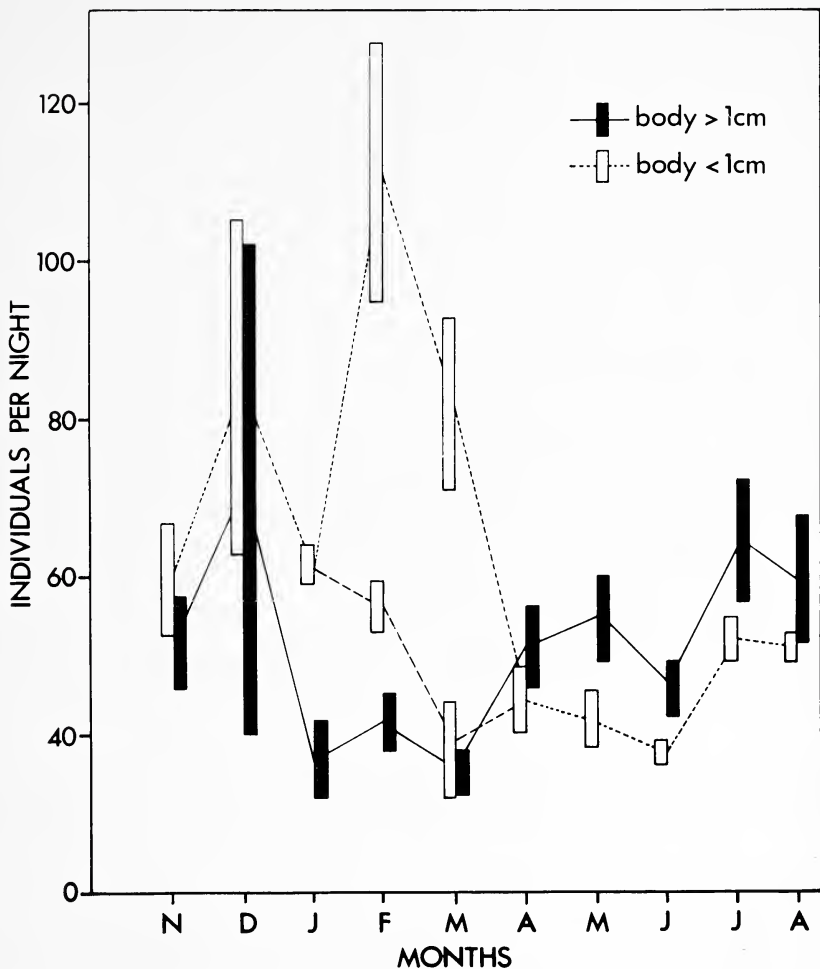

FIG. 1. Monthly averages of the number of individuals of moths attracted to the black lights on Barro Colorado Island between November 1967 and August 1968. Bars represent standard deviations. Solid bars and lines represent large species (body length greater than 1 cm); open bars and dashed lines represent small species. Two sets of figures are presented for small moths during February and March; one set includes, and the other does not include, a particularly abundant species present only during those months.

Daily records for the occurrence of moths at the lights indicate regular short-term cycles, particularly for large moths during the dry season (Figure 3). It is well known that the flight activity of moths varies more or less inversely with the brightness of the moon (Williams 1936, Brown and Taylor, 1971). The periods of the abundance cycles do appear to be roughly four weeks, but peaks

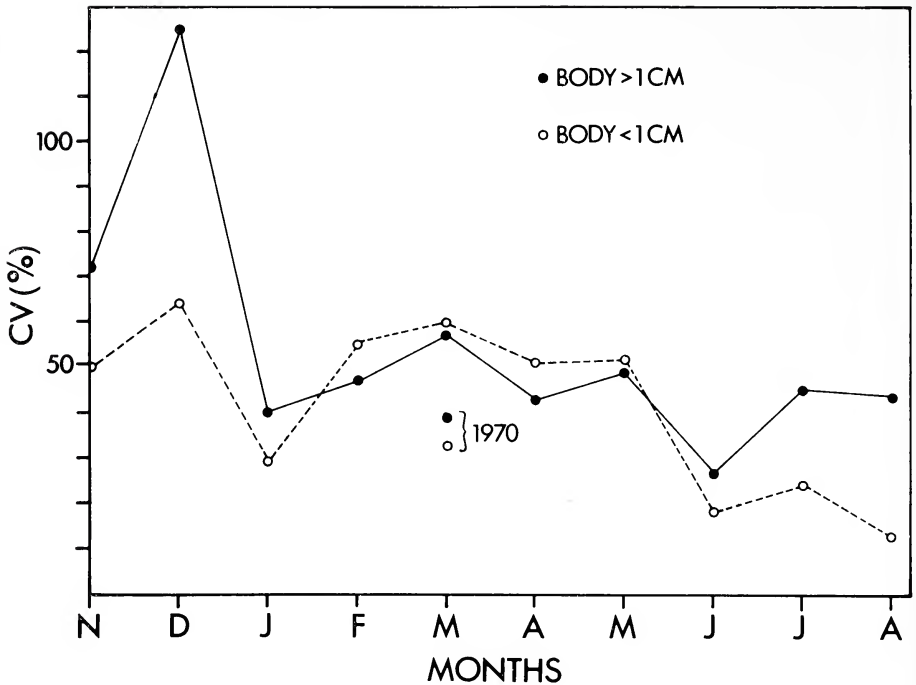

FIG. 2. Monthly coefficients of variation (standard deviation divided by the mean) of counts of moths attracted to black lights on Barro Colorado Island, November 1967 to August 1968. Large and small species are distinguished. Data for 1970 are also indicated.

and troughs are not particularly well coordinated with new and full phases of the moon. Peaks timed according to this same periodicity seem to occur during November–December and April–June periods, but are out of phase and less well marked during July and August.

*Individual species of moths.* Records were kept of the numbers of individuals of several hundred species that were attracted to the lights each night. None of the species were identified. Most of these species were too uncommon to discern the presence or absence of marked seasonal trends, and many species were noted only once. The monthly averages for several of the more common species, shown in Figure 4, demonstrate a variety of seasonal patterns, ranging from relatively uniform distribution throughout the study period to the occurrence of marked peaks in abundance falling at different times of the year. All the species represented in Figure 4 appeared at least once during November, when a photographic numbered key to the moth species was made. Other species clearly showed narrow peaks of abundance during the dry season or early portion of the wet season. For example, in Figure 5, the nightly abundance of one very abundant

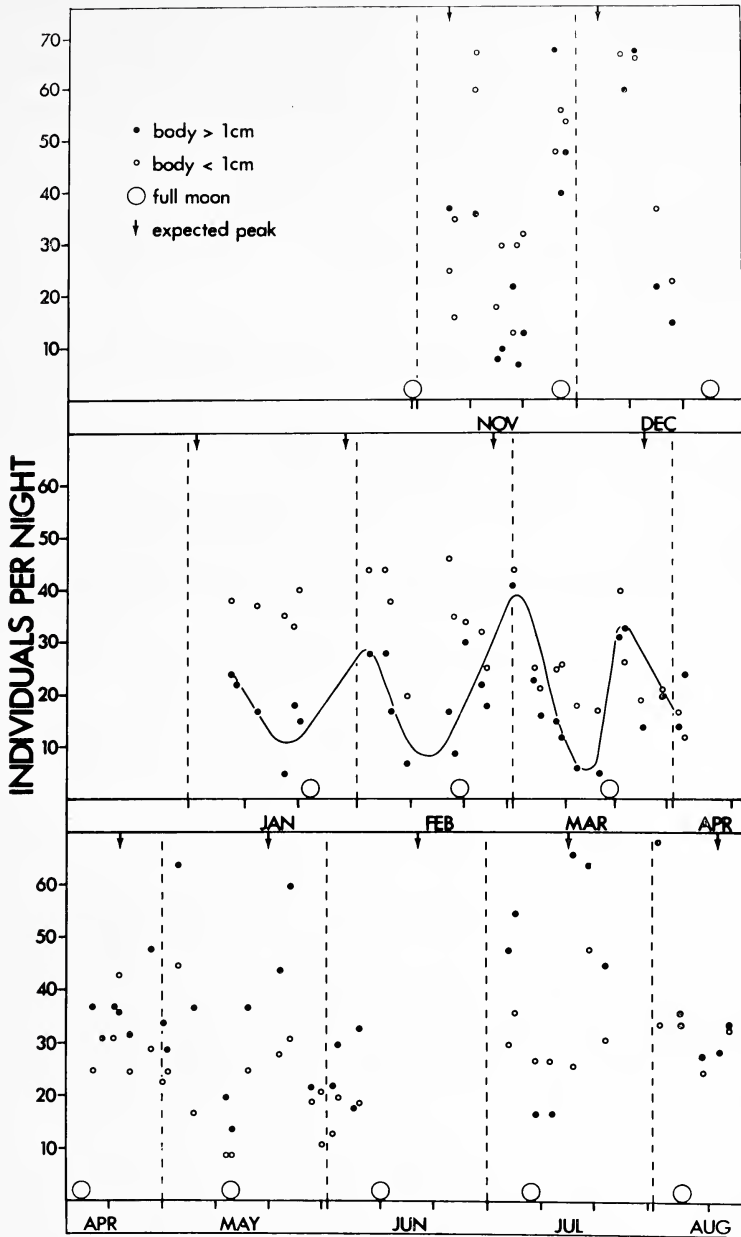

FIG. 3. Nightly occurrence of moths at the black lights on Barro Colorado Island, November 1967 through August 1968. Solid line in January through March suggests fluctuations in large bodied species. Arrows represent extrapolation of peaks of abundance at 4 week intervals throughout the sampling period.

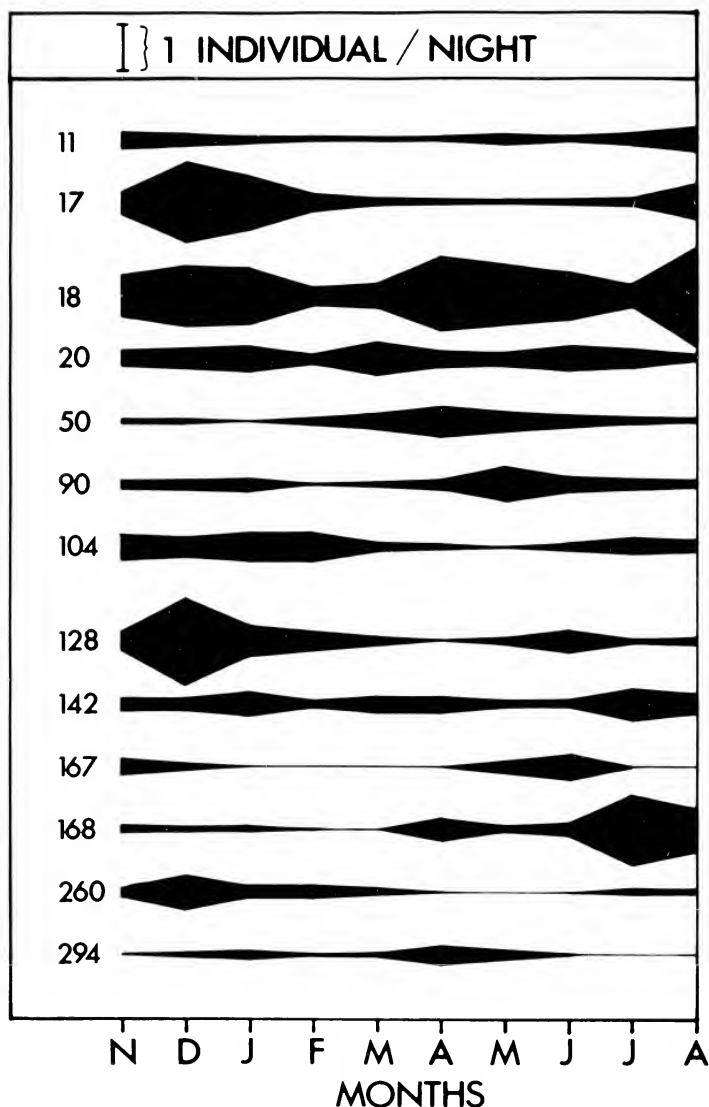

FIG. 4. Monthly average number of individuals of 13 selected species attracted to black lights on Barro Colorado Island, November 1967 to August 1968. Numbers refer to the photographic key used to distinguish the species.

small moth (unnumbered), present only during February and March, is compared to the more uniform seasonal distributions of the species of small moths numbered 17, 18, and 20. Fairchild (1942) also found great variety in the seasonal distributions of species of tabanid flies in Panama. By contrast, all the



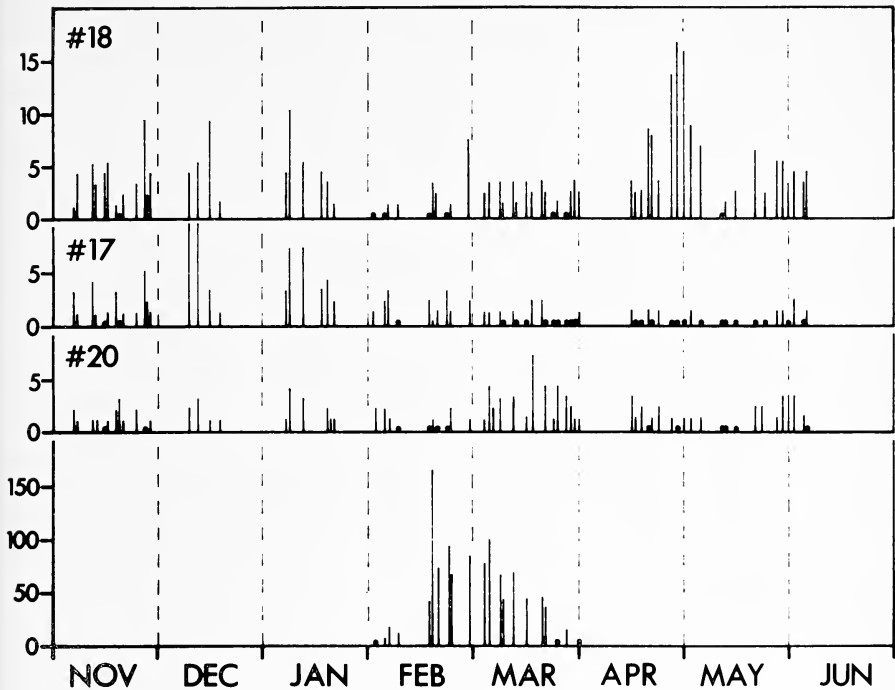

FIG. 5. Nightly occurrence of four species of small moths at the black lights on Barro Colorado Island, November 1967 to June 1968. Dots represent absence of a species on a particular night. Species numbers 17, 18 and 20 correspond to those species in Figure 4.

species of arboreal mosquitoes studied by Galindo *et al.* (1956) in the same region showed similar seasonal patterns of abundance, being almost completely absent during the dry season (January–April) and most abundant during the early part of the wet season (May–August). The seasonal pattern of abundance in these species is dictated by the fact that arboreal mosquitoes rely on the presence of standing water in tree holes and bromeliads for reproduction.

*Malaise trap samples.* Wet weights of insects caught during the night period were relatively high during November through January and about half as great during February through June (Figure 6). Daytime catches did not exhibit any marked seasonal pattern in total wet weight, however.

Most of the malaise trap sample collected during the night consisted of tiny diptera, which were not represented at the lights. So we should not be concerned over the lack of correspondence between the malaise trap samples and black light counts. Most of the daytime samples consisted of relatively large species of diptera and hymenoptera which reached peak abundance during midday (Tables 3 and 4).

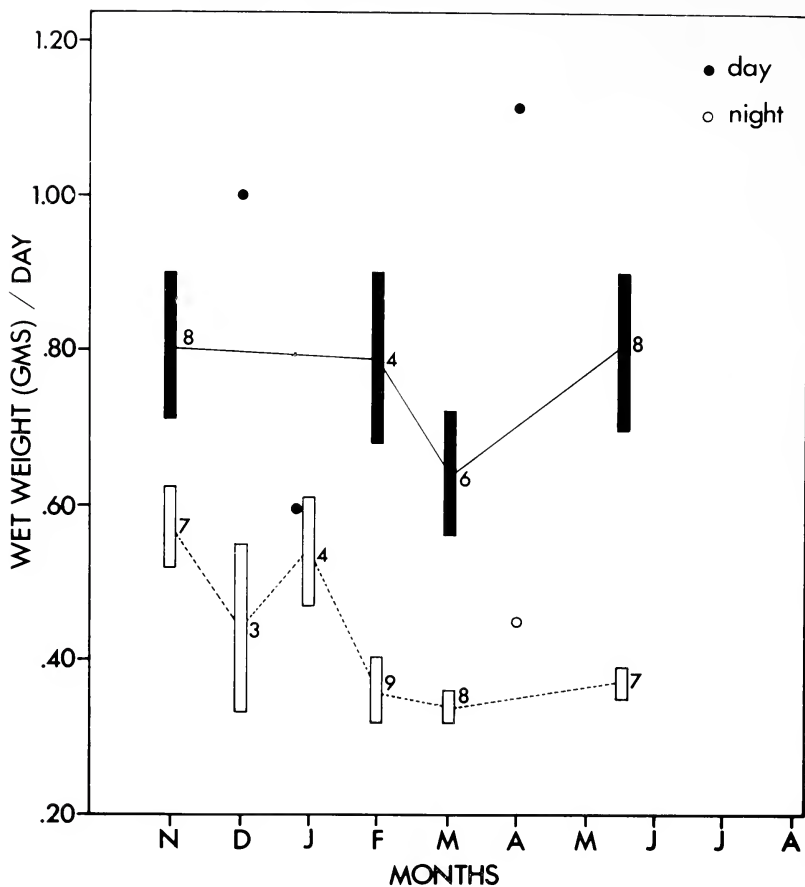

FIG. 6. Monthly averages of the wet weight of insects caught in a malaise trap on Barro Colorado Island. Daytime catches (0600–1800 hrs) and night-time catches (1800–0600 hrs) are distinguished. Solid and open circles represent single day or night samples. Bars represent standard deviations.

*Year-to-year variation.* Counts of insects attracted to the black lights during March 1970 and June and July 1971 are compared to samples counted during 1968 in Table 5. Differences between years are conspicuous for several groups. Comparing the month of March in 1968 and 1970, we note that large moths, mantids, beetles, and reduviid bugs were more abundant in 1970; no group was less abundant. The greatly increased number of beetles during 1970 was due to one species that had not been abundant at any time during the 1967–1968 sampling period.

Although the number of small lepidoptera counted during March 1970 was

TABLE 3. Diurnal variation in wet weight of malaise trap catch, November 1967 through May 1968.

Period	Samples	Hour of Day							Total
		6-8	8-10	10-12	12-14	14-16	16-18		
Nov. 6-Dec. 15	(7)	76 (13)	86 (19)	212 (32)	271 (38)	129 (15)	148 (20)	992 (92)	
Jan. 19-Feb. 29	(3)	58 (5)	114 (34)	148 (18)	246 (61)	136 (33)	62 (38)	766 (160)	
Apr. 30-May 27	(4)	28 (8)	167 (62)	250 (124)	356 (43)	110 (14)	73 (1)	1007 (123)	

Note: All weights in milligrams; standard errors of the mean included in parentheses.

TABLE 4. Diurnal variation in the number of insects with body lengths exceeding 2 mm caught in the malaise trap.

Date	Group	Hour of Day						Total
		6-8	8-10	10-12	12-14	14-16	16-18	
Feb. 23	LEP	3	0	0	0	0	0	3
	DIP	1	3	12	6	5	1	28
	HYM	1	2	9	7	1	0	20
	COL	0	0	0	0	0	1	1
	TOTAL	5	5	21	13	6	2	52
Feb. 29	LEP	2	1	1	3	1	4	12
	DIP	1	6	13	11	7	9	47
	HYM	2	1	4	10	5	1	23
	COL	0	1	2	4	1	2	10
	TOTAL	5	9	20	28	14	16	92
Apr. 30	LEP	0	3	0	1	1	2	7
	DIP	3	6	13	16	10	7	55
	HYM	8	17	14	16	9	19	83
	COL	0	0	1	1	0	2	4
	TOTAL	11	26	28	34	20	30	149
May 22	LEP	0	0	1	2	0	2	5
	DIP	3	5	11	15	13	12	59
	HYM	0	3	2	8	3	2	18
	COL	0	2	1	1	3	2	9
	TOTAL	3	10	15	26	19	18	93
May 24	LEP	0	0	1	1	1	0	3
	DIP	4	6	14	17	5	5	51
	HYM	0	0	7	5	2	0	14
	COL	0	2	1	3	1	1	8
	TOTAL	4	8	23	26	9	6	76
May 27	LEP	0	0	1	0	1	1	3
	DIP	3	7	16	11	11	16	64
	HYM	0	0	6	1	3	2	12
	COL	0	2	0	2	0	2	6
	TOTAL	3	9	23	14	15	21	85
Entire Period	LEP	5	4	4	7	4	9	33
	DIP	15	33	79	76	51	50	304
	HYM	11	23	42	47	23	24	170
	COL	0	7	5	11	5	10	38
	TOTAL	31	67	130	141	83	93	545

similar to the number observed two years earlier, the particular species that comprised more than two-thirds of the total sample in 1968 (see Figure 5), accounted for less than one-third of the sample in 1970.

Differences in June and July samples between 1968 and 1971 were even more striking. Considering only June, moths were 3 to 4 times as abundant in 1971 as in 1968; numbers of katydids, hymenoptera were greater by factors of about 2, and numbers of cicadas and beetles, by factors of 8 and 15, respectively. Only

TABLE 5. Comparisons of insects attracted to black lights on Barro Colorado Island during different years.

	Month and Year					
	March		June		July	
	1968	1970	1968	1971	1968	1971
Number of nights	11	11	4	10	7	10
Moths						
large	157	421	258	822	446	761
small	616	654	175	730	321	654
Katydids	36	47	23	43	23	32
Mantids	5	17	18	8	17	23
Beetles	12	104	15	224	21	93
Bees, wasps and ants	17	4	38	91	50	57
Pentatomid bugs	3	4	5	20	1	7
Reduviid bugs	14	43	33	19	16	37
Cicadas	9	15	13	107	6	19
Owl-flies	0	0	0	-	0	-

Note: All figures are number of individuals per 10 nights.

reduviid bugs and mantids were less abundant. Differences between July 1968 and July 1971 were of a similar nature, but less marked in most groups.

It is tempting to relate the greater abundance of insects in the 1970 and 1971 samples, compared to 1968, to the unusually heavy rainfall during the months of January 1970 (11.8 in. compared to 2.2 in. average) and May 1971 (22.6 in. compared to 10.8). But since there are too few samples to treat the relationship between abundance and rainfall statistically, and since so little is known about the responses of populations to variation in rainfall in the tropics, it would be unwise to pursue this apparent correlation here.

In summary, the numbers of insects attracted to black lights at the edge of a lowland seasonally wet tropical forest exhibited marked fluctuation during the course of one 10 month period. Different insect groups had different peak and low periods of abundance, but the most conspicuous component of the samples, the moths, were least abundant during the dry season months. In samples taken at the same locality several years later, most groups exhibited strikingly greater abundances although the character of the vegetation had not changed. It is tempting to relate these increases to months of abnormally high rainfall just preceding the samples, but regardless of their cause, year-to-year variations in populations do occur in the tropics.

#### Literature Cited

- BROWN, E. S. AND L. R. TAYLOR. 1971. Lunar cycles in the distribution and abundance of airborne insects in the equatorial highlands of East Africa. *J. Anim. Ecol.* **40**: 767-779.

- FAIRCHILD, G. B. 1942. The seasonal distribution of some Tabanidae (Dipt.) in Panama. Ann. Entomol. Soc. Amer. **35**: 85-91.
- GALINDO, P., H. TRAPIDO, S. J. CARPENTER, AND F. S. BLANTON. 1956. The abundance cycles of arboreal mosquitoes during six years at a sylvan yellow fever locality in Panama. Ann. Entomol. Soc. Amer. **49**: 543-547.
- JANZEN, D. H. 1967. Synchronization of sexual reproduction of trees within the dry season in Central America. Evol. **21**: 620-637.
- MILLER, A. H. 1963. Seasonal activity and ecology of the avifauna of an American equatorial cloud forest. Univ. Calif. Publ. Zool. **66**: 1-78.
- OWEN, D. F. 1969. Species diversity and seasonal abundance in tropical Sphingidae (Lepidoptera). Proc. R. Ent. Soc. London **44**: 162-168.
- PIPKIN, S. B. 1965. The influence of adult and larval food habits on population-size of neotropical ground-feeding *Drosophila*. Amer. Midl. Nat. **74**: 1-27.
- RICKLEFS, R. E. 1966. The temporal component of diversity among species of birds. Evolution **20**: 235-242.
- SKUTCH, A. F. 1950. The nesting seasons of Central American birds in relation to climate and food supply. Ibis **92**: 185-222.
- SMYTHE, N. 1970. Relationships between fruiting seasons and seed dispersal methods in a neotropical forest. Amer. Nat. **104**: 25-35.
- SNOW, D. W. AND B. K. SNOW. 1964. Breeding seasons and annual cycles of Trinidad landbirds. Zoologica **49**: 1-39.
- WILLIAMS, C. B. 1936. The influence of moonlight on the activity of certain nocturnal insects, particularly of the family Noctuidae, as indicated by a light trap. Phil. Trans. Roy. Soc. London (B) **226**: 357-389.
- WILSON, D. E. 1971. Ecology of *Myotis nigricans* (Mammalia: Chiroptera) on Barro Colorado Island, Panama Canal Zone. J. Zool. Lond. **163**: 1-13.

## Differential Cold Survival of Two Sibling Species of Blow Flies, *Phaenicia sericata* and *Phaenicia pallescens*

NOREEN ASH AND BERNARD GREENBERG

DEPARTMENT OF BIOLOGICAL SCIENCES, UNIVERSITY OF ILLINOIS AT CHICAGO CIRCLE,  
CHICAGO 60680

RECEIVED FOR PUBLICATION JUNE 3, 1974

**Abstract:** The overwintering capabilities of sibling calliphorid species *Phaenicia sericata* (Meigen) and *Phaenicia pallescens* (Shannon) are compared. *P. pallescens* is not capable of overwintering in the Chicago region in an unheated shelter while *P. sericata* can overwinter as larvae.

The synanthropic blow flies *Phaenicia sericata* (Meigen) and *Phaenicia pallescens* (Shannon) are sibling species similar in appearance and general habits. Within North America they differ in geographic range with *P. pallescens* a southern species and *P. sericata* in nearly every part of the United States and southern Canada. A comparative study was undertaken to determine if both species have the same ability to overwinter in a northern temperate region.

Flies were trapped in early spring using a modified U.S.D.A. fly trap. *P. sericata* was collected in Bensenville, Illinois, a western suburb of Chicago, and *P. pallescens* in Bokeelia, Florida. Females of the two species were placed in separate cages and allowed to lay eggs on raw hamburger. The colonies were maintained in Chicago and were routinely kept at room temperature on sugar, skim milk solution, and water. Maggots were raised on liver, hamburger, or dead mice.

Two cages were set up outdoors in an open shelter in Bensenville, Illinois, during the middle of August. Populations of *P. sericata* and *P. pallescens* were derived from the laboratory populations. For two generations the colonies were maintained in the usual manner and allowed to reproduce on hamburger in gallon jars half-filled with sawdust. Maggots produced in early October were placed in culture jars in an unheated closed shelter.

The maggots were checked on December 20. The *P. sericata* maggots were constricted similar to the pupariation stage described by Fraenkel and Bhaskaran (1973). Some of them moved slightly when the jar was disturbed. About 5% of the maggots were dead and no pupae were seen. The *P. pallescens* were not constricted and moved actively when disturbed; about 10% of these larvae were dead.

January and February are typically the coldest months of the year in this area of Illinois with night temperatures in the unheated shelter occasionally going below 0°F. No pupae were observed during these months. On April 22

the jars were taken into the laboratory and examined. In the *P. pallescens* colony there were 100% dead maggots (ca. 800) while in the *P. sericata* culture there were 46 (5.5%) live maggots, 157 (18.7%) dead maggots, and 635 (75.8%) pupae. After 6 days, eclosion began with most of the flies emerging. By June 1, of the 46 live maggots, half of them had formed apparently normal pupae and half had died; none of those that pupated from this latter group emerged.

Calliphoridae may overwinter in temperate regions as larvae, pupae, or adults. The calliphorids most commonly found as overwintering adults include *Phormia regina* (Dondero and Shaw, 1971), *Protophormia terraenovae* (Cousin, 1932), *Pollenia rudis* (Hall, 1948), and *Calliphora* species (Green, 1951; Sukhova, 1950). Most authors agree that *P. sericata* usually overwinters in the larval or post-feeding larval stage as reported by Zumpt (1965) in South Africa, Green (1951) in England, Norris (1959) in Australia, and James (1947) and Hall (1948) in the United States. The overwintering stage or stages of *P. pallescens* are less well documented.

Both *P. pallescens* and *P. sericata* have been reported to overwinter as larvae at least as far north as Charleston, West Virginia (Mail and Schoof, 1954) and diapausing *P. sericata* larvae have also been reported at New Brunswick, New Jersey (Hagemann and Barber, 1948). The Florida strain of *P. pallescens*, however, cannot overwinter in an unheated shelter in northern Illinois. Larvae enter quiescence as described by Andrewartha (1971) rather than the cold-hardy dormancy of true diapause. In this condition *P. pallescens* survives the milder part of the winter but not the more severe cold of January and February. Hall (1948) reports the fly to be numerous and active near Miami, Florida, in March but it does not reach population peaks until July in Charleston, West Virginia (Mail and Schoof, 1954), and the middle of August in Lawrence, Kansas (Schoof and Savage, 1955). This could result from a high mortality among overwintering larvae in areas with severe winters and annual re-colonization by incoming migrants from the south. The primary screwworm, *Cochliomyia hominivorax* (Coquerel), another sub-tropical calliphorid, is known to have this pattern.

By contrast, *P. sericata* becomes numerous in late spring and early summer (Mail and Schoof, 1954; Schoof and Savage, 1955), has a facultative diapause (Norris, 1965), and, as indicated in this study, is able to overwinter as larvae in severe cold. Additional evidence that *P. sericata* overwinters in a pre-adult stage is based on the earliest spring adults (about mid-April in the Chicago area) which contain pupal fat balls in the hemolymph, unfrayed wings, and a complete set of bulbous setae on the antennal pedicel (Greenberg, 1970). Observations of numerous adults flying in the beginning of May in Lawrence, Kansas, and Cohoes, New York (Schoof and Savage, 1955) suggest that *P. sericata* is capable of overwintering in most of its range in the United States. Analysis of early specimens should indicate the overwintering capability of this species in the northernmost regions of its distribution.



## Literature Cited

- ANDREWARTHA, H. G. 1971. Introduction to the study of animal populations. The Univ. of Chicago Press.
- COUSIN, G. 1932. Étude expérimentale de la diapause des insectes. Bull. Biol. Fr. Belg. Suppl. **15**: 1-341.
- DONDERO, L., AND F. R. SHAW. 1971. The overwintering of some muscoidean Diptera in the Amherst area at Massachusetts. Proc. Entomol. Soc. Wash. **73**: 52-53.
- FRAENKEL, G., AND G. BHASKARAN. 1973. Pupariation and pupation in cyclorrhaphous flies (Diptera): terminology and interpretation. Ann. Entomol. Soc. Am. **66**: 418-422.
- GREEN, A. A. 1951. The control of blowflies infesting slaughter-houses. I. Field observations of the habits of blowflies. Ann. Appl. Biol. **38**: 475-494.
- GREENBERG, B. 1970. Species distribution of new structures on fly antennae. Nature **28**: 1338-1339.
- HAGEMANN, L. E., AND G. W. BARBER. 1948. Overwintering habits of *Phaenicia sericata* (Mg.). J. Econ. Entomol. **41**: 510.
- HALL, D. B. 1948. The blowflies of North America. Thomas Say Foundation.
- JAMES, M. T. 1947. The flies that cause myiasis in man. U.S.D.A. Misc. Publ. No. 631.
- MAIL, G. A., AND H. F. SCHOOF. 1954. Overwintering habits of domestic flies at Charleston, West Virginia. Ann. Entomol. Soc. Am. **47**: 668-676.
- NORRIS, K. R. 1959. The ecology of sheep blowflies in Australia. In: Biogeography and ecology in Australia. Monographiae Biologicae **8**: 514-544.
- NORRIS, K. R. 1965. The bionomics of blowflies. Ann. Rev. Entomol. **10**: 47-68.
- SCHOOF, H. F., AND E. P. SAVAGE. 1955. Comparative studies of urban fly populations in Arizona, Kansas, Michigan, New York, and West Virginia. Ann. Entomol. Soc. Am. **48**: 1-12.
- SUKHOVA, M. N. 1950. Novye dannye po ekologii i èpidemiologiches komu znacheniru sinikh miasnykh mukh *Calliphora uralensis* Vill. and *Calliphora erythrocephala* Meig. (Diptera, Calliphoridae). Entomol. Obozrenie **31**: 90-94.
- ZUMPT, F. 1965. Myiasis in man and animals in the Old World. Butterworths, London.

**Parasites Reared from Larvae of the European Corn Borer,  
*Ostrinia nubilalis* (Hbn.), in Massachusetts, 1971-73  
(Lepidoptera, Pyralidae)<sup>1,2</sup>**

F. B. PEAIRS<sup>3</sup> AND J. H. LILLY<sup>4</sup>

DEPARTMENT OF ENTOMOLOGY, UNIVERSITY OF MASSACHUSETTS,  
AMHERST, MASSACHUSETTS 01002

RECEIVED FOR PUBLICATION JUNE 5, 1974

**Abstract:** Three exotic *Ostrinia nubilalis* parasites; *Eriborus terebrans*, *Macrocentrus grandii*, and *Sympiesis viridula* were detected in Massachusetts along with two native species; *Aplomya caesar* and *Lixophaga* sp. Of these, *M. grandii* was by far the most important, accounting for over 92 per cent of the borers parasitized.

During a 1971-73 study of natural control of the European corn borer, *Ostrinia nubilalis* (Hbn.), 1498 last instar borers were examined for parasites. These borers were collected from the 10 Massachusetts localities listed in Table 1 and held individually in shell vials. The parasites and the percentages of borers from which they emerged are summarized in Table 1.

Of the seven exotic *O. nubilalis* parasites listed as established in the United States by Baker *et al.* (1949), only two, *Eriborus terebrans* (Grav.) (Ichneumonidae) and *Macrocentrus grandii* (Goid.) (Braconidae) were reared from these borers. A third imported parasite, *Sympiesis viridula* (Thoms.) (determined by B. D. Burks) (Eulophidae), hitherto unreported from Massachusetts, was found overwintering as pupae, three in Amherst and two in West Bridgewater. Also *E. terebrans* was found only in two localities and only in limited numbers (Table 1). Conversely, *M. grandii* was found in all 12 collections, with percentages of parasitization ranging from 6.3 to 60. A number of colonies of this polyembryonic wasp failed to produce adults. The successful ones averaged 19.1 individuals for the 98 colonies containing only males, 18.0 for the 111 containing only females, and 29.0 for the 21 colonies containing both sexes.

Two native tachinid parasites were also reared. *Aplomya caesar* (Ald.) was present in five collections but accounted for less than one per cent of the over-all parasitization. A species of *Lixophaga* was found in one collection, killing at

<sup>1</sup>Part of a thesis submitted to the Graduate School of the University of Massachusetts, in partial fulfillment of the requirements for the M. S. degree.

<sup>2</sup>Published with the aid of a grant from the Guy Chester Crampton Research Fund of the University of Massachusetts.

<sup>3</sup>Formerly teaching assistant, Department of Entomology, University of Massachusetts. Present address: Department of Entomology, Cornell University, Ithaca, New York 14850.

<sup>4</sup>Professor

TABLE 1. Parasites reared from *Ostrinia nubilalis* in Massachusetts, 1971-73.

Location	Date	No. of borers	Per cent <i>M. grandii</i> (a)	Per cent <i>E. terebrans</i> (b)	Per cent <i>A. caesar</i> (c)	Per cent <i>Lixophaga</i> sp. (c)	Per cent unidentifed (d)	Total per cent parasitization
Barnstable Co. (E. Sandwich)	VII-23-73	60	30.0	0	0	0	0	30.0
Essex Co. (Danvers)	VII-24-73	11	9.1	9.1	9.1	0	0	27.3
(Ipswich)	VII-12-73	60	25.0	0	0	0	0	25.0
(Waltham)	VII-30-73	60	11.7	8.3	0	0	0	20.0
Franklin Co. (S. Deerfield)	X-1-71	300	25.7	0	1.0	0	0	26.7
Hampden Co. (Holyoke)	VIII-4-73	60	8.3	0	3.3	8.3	10	30.0
Hampshire Co. (Easthampton)	VII-28-72	60	15.0	0	0	0	0	15.0
Norfolk Co. (Attleboro)	VII-16-73	60	28.3	0	1.7	0	0	30.0
Plymouth Co. (Bridgewater)	VII-30-73	32	6.3	0	0	0	0	6.3
(W. Bridgewater)	VIII-3-72	60	10.0	0	0	0	0	10.0
	X-15-72	675	21.0	0	0.7	0	0	21.7
	VII-20-73	60	60.0	0	0	0	0	60.0
Over-all		1498	22.4	0.4	0.8	0.3	0.4	24.3

(a) *Macrocentrus grandii* (Goid) (= *gifuensis*) determined by P. M. Marsh.

(b) *Eriborus terebrans* (Grav.) (= *Horogenes punctorius*) determined by R. W. Carlson.

(c) *Aplomya caesar* (Ald.) and *Lixophaga* sp. determined by C. W. Sabrosky.

(d) Six dipterous puparia, possibly additional *Lixophaga*.

least 8.3% (18.3% if additional similar pupae which failed to emerge were *Lixophaga*).

The 4 parasites listed in Table 1 killed 24.3% of the borers. However, *M. grandii* accounted for over 92% of this mortality, with an over-all parasitization of 22.4% of all borers examined. It is obvious from these data that *M. grandii* is by far the most important parasite of the corn borer in Massachusetts.

#### Literature Cited

- BAKER, W. A., W. G. BRADLEY, AND C. A. CLARK. 1949. Biological control of the European corn borer in the United States. USDA Tech. Bull. 983: 185 pp.

## Behavioral Changes in the Army Ant *Neivamyrmex nigrescens* during the Nomadic and Statory Phases

HOWARD TOPOFF

DEPARTMENT OF PSYCHOLOGY, HUNTER COLLEGE OF THE CITY UNIVERSITY OF NEW YORK,  
AND DEPARTMENT OF ANIMAL BEHAVIOR, THE AMERICAN MUSEUM OF  
NATURAL HISTORY, NEW YORK, N. Y. 10024

RECEIVED FOR PUBLICATION JULY 1, 1974

**Abstract:** The responses of workers of the army ant *Neivamyrmex nigrescens* to illumination and to the presence of conspecifics were compared during the nomadic and statory phases. During the statory phase the ants were more photonegative and exhibited a stronger tendency to cluster together than during the nomadic phase. It is hypothesized that these differences in the ants' orientation are caused by corresponding changes in the level of the colony excitation during the two phases of each behavioral cycle.

### INTRODUCTION

Colonies of the army ant *Neivamyrmex nigrescens* Cresson exhibit cycles of alternating nomadic and statory phases. The nomadic phase, which lasts for 17–20 days, is one of high colony activity, in which large nightly raids typically end in emigrations to new nesting sites. During this phase raiding begins early in the evening, and a considerable portion of the adult worker population participates (Schneirla, 1958, 1963, 1971). As the raid progresses, one or more dendritic systems of interconnecting trails arise through the repeated division of small terminal foraging groups of ants. The outward movement of the ants from the nest may remain at a peak for up to several hours, because the ants' high level of excitement persists both at the raiding fronts and on the basal column extending to the nest (Schneirla, 1971).

The nomadic phase is followed by a statory interval of 17–20 days, characterized primarily by the absence of emigrations. Raiding is also less vigorous, with fewer individuals participating. Statory raids usually consist of a single, long basal column which ends in a small and localized terminal branching system. The outward surge of ants at the start of raiding usually peaks after only a few minutes. As a result, the basal column remains relatively thin throughout the night.

The cycles of activity in *N. nigrescens* are regulated by stimulative relationships between the colony's developing brood and the adult worker population. During the nomadic phase, the adult workers are aroused to a high level of excitement by stimuli originating from the newly eclosed callow workers and from the maturing larval brood. When the larvae pupate the excitatory stimuli decrease and the colony lapses into the "quieter" statory phase (Schneirla, 1957, 1971).

According to Schneirla's theory, workers of *N. nigrescens* are aroused to very different levels of excitement during the two phases of each behavioral cycle. It is possible that many aspects of each ant's physiological and behavioral condition are affected by changes in the stimulative relationships among all individuals in the colony throughout each cycle. These may include changes in the ants' responsiveness to a variety of physical and biotic stimuli. Accordingly, I conducted a series of tests designed to compare the responses of adult workers of *N. nigrescens* to photic stimulation and to stimuli arising from other workers during the nomadic and stately phases. The objective was to correlate phase-specific differences in the behavior of the ants in the laboratory tests with our observations of colony behavior in the field.

#### METHODS

Tests were conducted at the Southwestern Research Station of The American Museum of Natural History, in Portal, Arizona. The apparatus used to measure the ants' responses to light consisted of a cylindrical arena (30.0 cm diam  $\times$  2.5 cm high) that was divided into five equal areas by a combination of opaque rectangular partitions and a central cylindrical cartridge (Fig. 1). The arena was illuminated from above by a 22-watt fluorescent light ring, and the light was diffused through a disc of neutral ground glass. Two neutral density filters were placed on the lid of the arena to reduce the intensity of light in 2 opposite chambers of the arena (Fig. 1). The intensity of illumination in the central cartridge and in 2 opposite chambers of the arena was 16,000 lux; the intensity of illumination in the remaining 2 chambers was reduced to 160 lux.

The central cartridge had 4 equidistant slit-like openings at the bottom, which gave the ants simultaneous access to the brightly illuminated and dimly illuminated arena chambers. The cartridge also functioned as an aspirator for collecting the ants in the field (Fig. 2). As a result, the initial collection of the test ants was the only manipulation they received. When used as an aspirator, a tightly fitting plastic ring was slipped over the 4 exit slits. A piece of rubber tubing was attached to the upper end of a central vent in the lid of the cartridge, and an "L"-shaped tube was inserted into a hole near the edge of the lid.

For each test, 40-60 adult worker ants were collected from a raiding column near the bivouac. The cartridge was transported to the laboratory in a dark container. In the laboratory, the cartridge was lowered into the arena. Initially, the cartridge was supported above the floor of the arena by 4 cubes of plastic that projected centrally from the base of each vertical arena partition, far enough to support the outer slip ring. To start the test the cartridge was pushed down, which caused it to slide down through the slip ring, thus simultaneously opening the 4 exit slits.

To test the ants' responses to the presence of each other, another series of

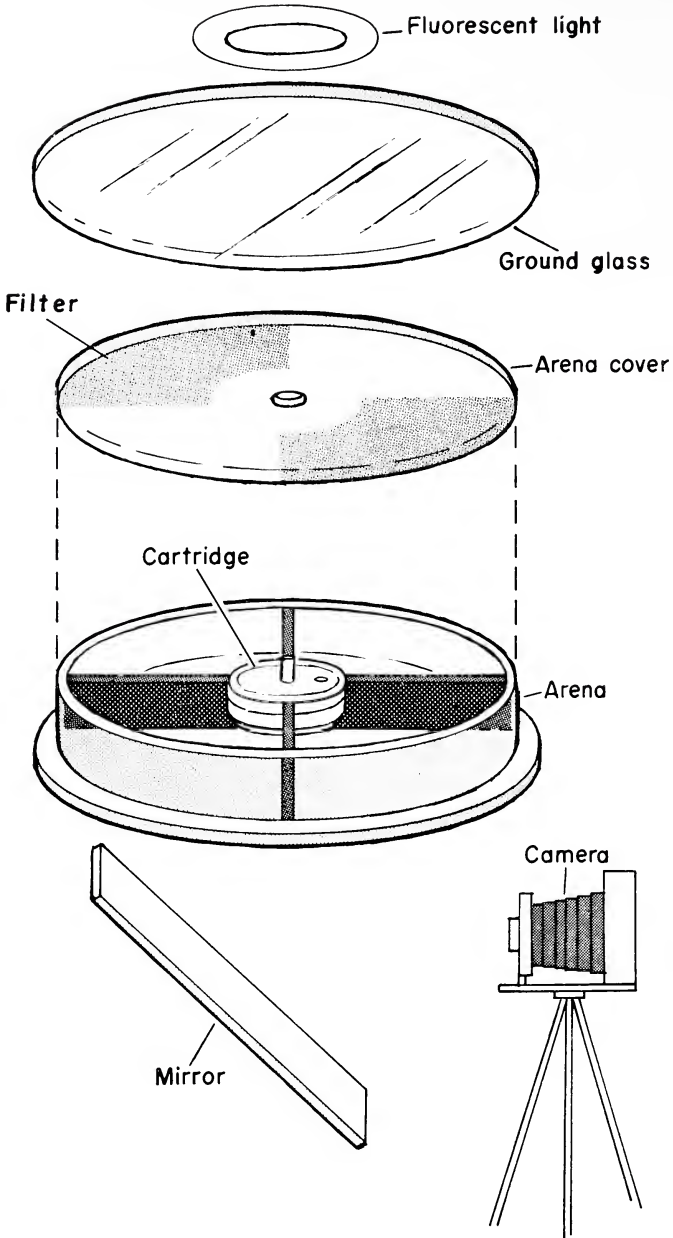

FIG. 1. Apparatus used to test responses of ants to illumination. The cartridge is shown in place in the arena. To test the responses of ants to the presence of each other, the fluorescent light was replaced with an infrared light source.

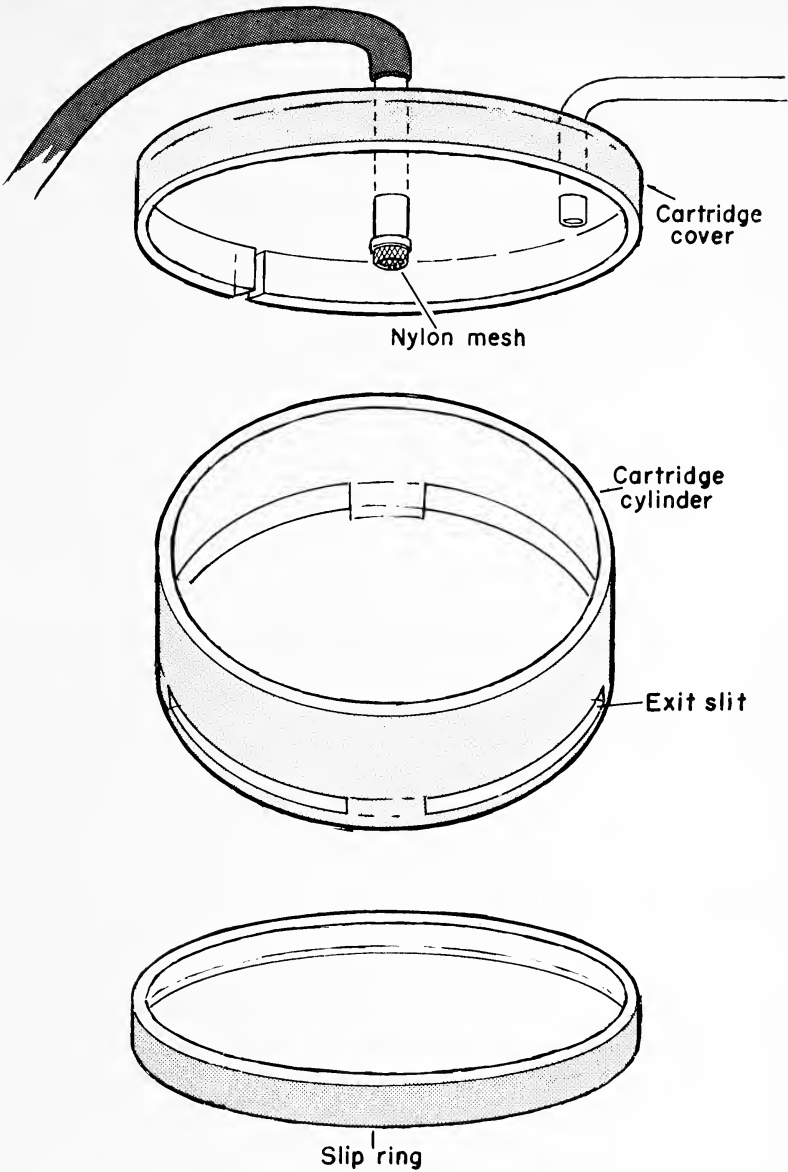

FIG. 2. Central cartridge used for behavioral tests. When used in the field as an aspirator, the plastic ring is slipped over the cartridge to seal the four exit slits. The rubber tubing and "L"-shaped plastic tube in the lid of the cartridge are removable.

experiments was conducted in an identical arena, but no visible light was used. Instead, illumination for photography was provided by 4 150-watt flood lamps that were sealed behind gelatin filters that passed only wavelengths greater than 720 m $\mu$ .

TABLE 1. Percentage of ants in central cartridge and arena quadrants after 1 minute.

Colony #	Phase day <sup>1</sup>	Bright-dim test			Infrared test % ants in cartridge	
		% ants in bright	% ants in dim	% ants in cartridge		
66N-2	N-3	33	47	20	47	
	N-7	33	48	19	—	
	N-10	26	33	41	28	
	N-17	11	49	40	48	
	S-2	—	—	—	58	
	S-8	0	17	83	49	
	S-9	2	65	33	44	
	S-10	0	48	52	51	
	S-14	—	—	—	58	
	S-15	—	—	—	48	
	S-16	0	0	100	100	
	S-18	0	0	100	—	
	66N-7	N-4	26	63	11	31
		N-11	29	42	29	16
S-2		0	0	100	—	
S-3		—	—	—	53	
S-5		0	0	100	53	
S-7		0	0	100	100	
S-14		0	0	100	—	
S-17		0	0	100	100	
66N-13	N-10	53	38	9	30	
	N-16	57	21	22	15	
	S-1	0	0	100	100	
	S-7	0	13	87	95	
	S-10	0	0	100	77	
	S-13	0	0	100	100	
72N-3	N-3	34	33	33	28	
	N-7	24	50	26	10	
	N-13	23	44	33	42	
	N-14	79	10	11	18	
	S-6	1	10	89	75	
	S-7	0	0	100	100	
	S-17	0	0	100	100	
	S-20	0	22	78	100	

<sup>1</sup>N—nomadic; S—statory

Each series of tests lasted for 2 min. To record the position of the ants throughout each test, a photograph was taken at 5 sec intervals from beneath the apparatus. In the "bright-dim" tests, the fluorescent light remained on throughout the test. In the "infrared" series, the infrared light source was electrically programmed to be on for 1.5 sec during each 5 sec interval. Because the infrared light was not visible to the experimenter, a buzzer that was synchronized with the light provided the signal to take a photograph.

#### RESULTS

Results of tests conducted with 4 colonies of *N. nigrescens* are presented in Table 1, which shows the percentage of ants in the central cartridge and arena quadrants of the "bright-dim" and "infrared" tests after 1 min of each 2 min





FIG. 3. Characteristic pattern of movement in "bright-dim" tests during nomadic phase. The ants are in the central cartridge and all 4 arena quadrants. They are well spaced and moving rapidly.

test. For reasons that will be discussed below, the best measure of the ants' response to illumination is the percentage located in the 2 brightly illuminated arena quadrants. The median percentage of ants taken from nomadic colonies is 31%, as compared to 0% for stately ants.

If we consider the percentage of ants in the dimly illuminated arena quadrants, we find that the median for nomadic ants is 44%, whereas the value for stately ants is again 0%. At first, this may seem to contradict the results obtained from analyzing the percentage of ants in the brightly illuminated quadrants. The discrepancy is resolved by considering the percentage of ants remaining in the central cartridge. During the nomadic phase, the median percentage of ants in the cartridge is 25%. During the stately phase, by contrast, the median is 100%. Thus, the data indicate that nomadic ants tend to leave the central cartridge and enter into either the brightly or dimly illuminated quadrants of the arena. Stately ants tend to remain in the central cartridge throughout the test. If they leave the cartridge they invariably enter into the dimly illuminated quadrants.

The large difference in the number of ants remaining in the central cartridge during the nomadic and stately phases also existed when the tests were conducted under conditions in which the central cartridge and all 4 arena quadrants were

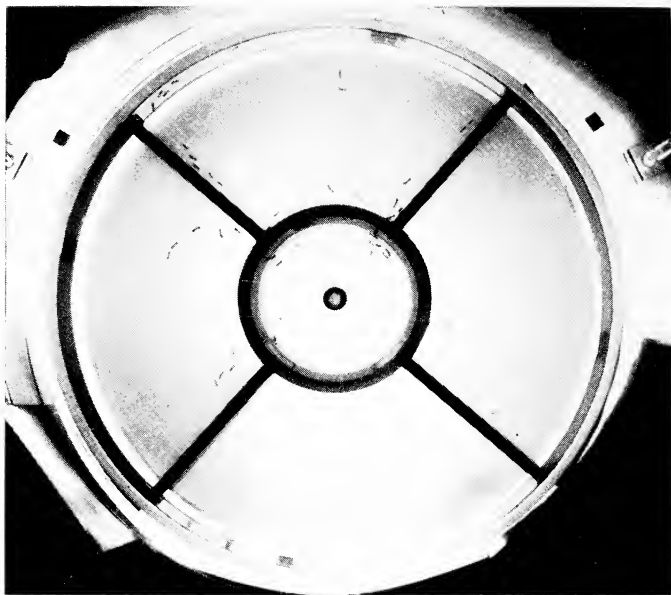

FIG. 4. Characteristic pattern of movement in "infrared" tests during the nomadic phase. As in the "bright-dim" series, the ants occupy all areas of the apparatus.

uniformly illuminated with infrared light. In this series of tests, the median percentage of ants remaining in the cartridge after 1 min was 28% for nomadic ants, as compared to 77% for statory ants.

In addition to the quantitative data presented in Table 1, the photographs used to record the location of the ants throughout each test also revealed striking qualitative differences in the behavior of the ants during the 2 phases. Before the start of a nomadic test, the ants were typically positioned uniformly around the edge of the central cartridge. When the test began, the ants left the cartridge and established columns in the arena quadrants. Regardless of which quadrants they were in, the ants ran rapidly, were well spaced, and exhibited no tendency to cluster. This pattern of behavior was exhibited by the ants during both the "bright-dim" and "infrared" tests (Figs. 3, 4).

The behavior of ants taken from statory colonies was quite different (Figs. 5, 6). Before the start of a test, the ants were usually clustered together in one small section of the cartridge. The clusters varied in degree, but the ants rarely occupied the entire cartridge. In 12 out of 18 "bright-dim" tests conducted with statory ants, the individuals formed into tight clusters that remained in the cartridge throughout the entire test. In 8 out of 19 statory "infrared" tests, similar clusters were formed. It is significant that no such clusters were ever observed during tests conducted with ants taken from nomadic colonies.

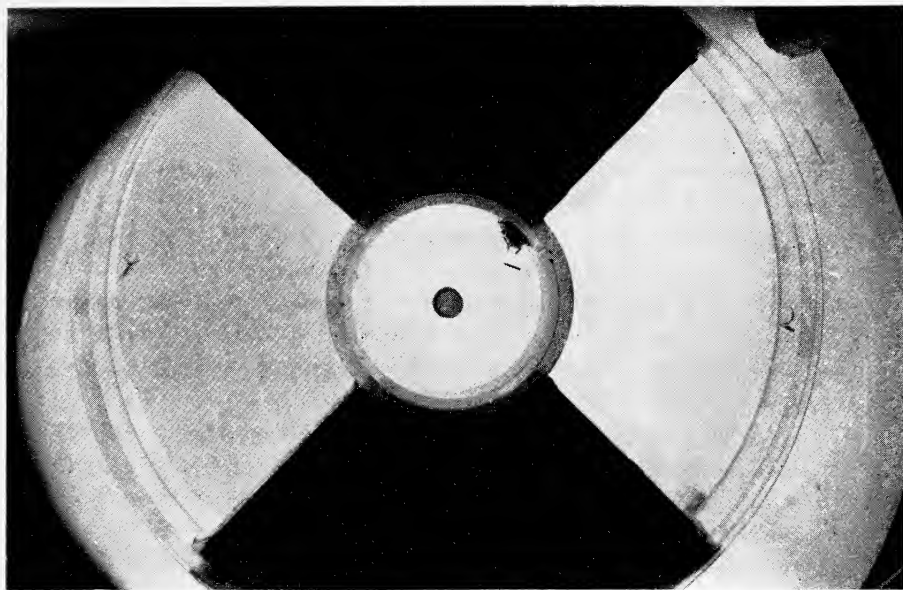

FIG. 5. Characteristic pattern of movement in "bright-dim" tests during statory phase. The ants are clustered tightly at the edge of the cartridge.

#### DISCUSSION

The results of these behavioral tests indicate that workers of *N. nigrescens* respond differently to illumination during the nomadic and statory phases. In southeastern Arizona, *N. nigrescens* has adapted to conditions of high temperatures and low humidity by conducting most of its raiding and emigration activities at night. This correlates with my findings that the ants are always photonegative, although the degree of their photonegativity shifts during the 2 phases of each behavioral cycle.

During the statory phase, the ants often exhibit a marked tendency to cluster tightly together in the central cartridge of the experimental apparatus, regardless of the intensity of illumination. Although the specific cause of the clustering behavior is not known, a reasonable hypothesis is that it is due to the ants' responsiveness to chemical and tactile stimuli arising from other workers. The results of this experiment indicate that the response of the ants to the presence of each other is so strong during the statory phase that it can often override their negative reaction to illumination.

It is well known that the responses of many species of insects to stimuli of constant physical intensity are influenced by environmental factors such as temperature and humidity, and by internal factors, including age, sex, and physiological condition. For example, studies of waterscorpions (Holmes, 1905),

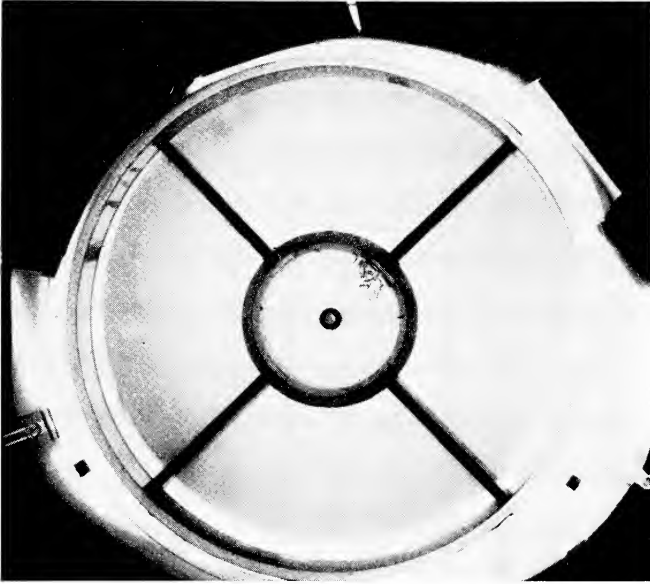

FIG. 6. Characteristic pattern of movement in "infrared" tests during the stary phase. As in the "bright-dim" series, the ants are clustered in the cartridge and remain there throughout the test.

mayflies (Allee and Stein, 1918), drone flies (Dolley and White, 1951), and mosquitoes (Chiba, 1967) indicate that decreasing temperatures result in a shift towards photonegativity. The general consensus of these investigators is that any environmental factor that lowers the organism's excitability tends to increase its negative photoreactivity.

Changes in patterns of orientation with respect to light can also be caused by corresponding changes in stimuli that originate within the organism. Newly hatched larvae of the hawk moth are strongly photopositive, but just prior to pupation the mature larvae become increasingly photonegative (Beetsma *et al.*, 1962). These investigators also showed that injection of the hormone ecdysone could induce the photonegative response. Similar changes in response to illumination as a function of physiological condition have been found in tabanid flies (Shamsuddin, 1966) and milkweed bugs (Barrett and Chiang, 1967).

Orientation towards chemical stimuli can also be influenced by external environmental and internal physiological factors. An investigation that is particularly relevant to the present study was conducted by Goldsmid (1967) on the blue tick, *Boophilus decoloratus*. Newly hatched tick larvae exhibit a strong negative reaction towards light. At this developmental stage, however, the larvae also aggregate together in clusters by orienting towards chemicals secreted by other larvae. This clustering tendency overrides the individuals' negative

response towards light. If the cluster is mechanically broken and the larvae scattered within their container, they invariably reaggregate in approximately the same location. After one week, changes in physiological conditions associated with maturation eliminate the tendency to aggregate, and at this time the larvae also become markedly photopositive.

The results of the present study show that workers of the army ant *N. nigrescens* respond differently to illumination and to the presence of conspecifics during the nomadic and statory phases. Based on the studies cited above, it is reasonable to hypothesize that the changes in the ants' responsiveness may be caused by corresponding changes in their degree of excitation during the 2 phases. The nomadic phase is initiated by intense stimulation imparted to the adult worker population by the eclosing callows, and is maintained by equivalent stimulation derived from the developing larval brood (Schneirla, 1957). It is possible that the resulting increase in adult worker excitation and activity causes them to be less photonegative and less responsive to chemicals secreted by other workers. When the larval brood completes its development and pupates, there is a sharp decline in the intensity of social stimulation in the nest. The overall level of excitation is lower, and this causes the workers to exhibit an increase in their photonegativity and in their sensitivity to conspecifics. In the case of the army ants, as in the blue tick, the ants' increased sensitivity to other ants seems to override their increased photonegativity.

#### Literature Cited

- ALLEE, W. C. AND STEIN, E. R. 1918. Light reactions and metabolism in may-fly nymphs. *Jour. Exp. Zool.*, **26**: 423-458.
- BARRETT, R. W. AND CHIANG, H. C. 1967. Changes of behavior pattern within the fifth nymphal instar of the Milkweed bug, *Oncopeltus fasciatus* (Dallas). *Amer. Mid. Nat.*, **78**: 359-368.
- BEETSMA, J. L., DERUITER, L., AND DEWILDE, J. 1962. Possible influence of neotenine and ecdyson on the sign of phototaxis in the eyed Hawk caterpillar *Smerinthus ocellata* L. *Jour. Insect Physiol.*, **8**: 251-257.
- CHIBA, Y. 1967. Activity of mosquitoes, *Culex pipiens* Pallens and *Aedes japonicus* under a step-wise decrease of light intensity. *Sci. Report, Tohoku Univ. ser. IV (Biol.)*, **33**: 7-13.
- DOLLEY, W. L. AND WHITE, J. D. 1951. The effect of illumination on the reversal temperature in the drone fly *Eristalis tenax*. *Biol. Bull.*, **100**: 84-89.
- GOLDSMID, J. M. 1967. Observations on the behaviour of the blue tick, *Boophilus decoloratus* (Koch) (Acarina: Ixodidae). *Jour. Ent. Soc. S. Africa*, **29**: 74-89.
- HOLMES, S. H. 1905. The reactions of *Ranatra* to light. *Jour. Comp. Neurol.*, **15**: 305-349.
- SCHNEIRLA, T. C. 1957. Theoretical consideration of cyclic processes in doryline ants. *Proc. Amer. Phil. Soc.*, **101**: 106-133.
- . 1958. The behavior and biology of certain nearctic army ants. Last part of the functional season, southeastern Arizona. *Insectes Sociaux*, **5**: 215-255.
- . 1963. The behaviour and biology of certain nearctic army ants: springtime resurgence of cyclic functions—southeastern Arizona. *Anim. Behav.*, **11**: 583-595.

- . 1971. "Army Ants: a Study in Social Organization." W. H. Freeman & Co., San Francisco, Calif.
- SHAMSUDDIN, M. 1966. Behaviour of larval tabanids (Diptera: Tabanidae) in relation to light, moisture, and temperature. *Quaestiones Entomol.*, **2**: 271-302.

**Mites (Acarina) associated with *Popilius disjunctus* (Illiger)  
(Coleoptera: Passalidae) in Eastern United States<sup>1</sup>**

MERCEDES D. DELFINADO

NEW YORK STATE MUSEUM AND SCIENCE SERVICE, ALBANY, NEW YORK 12224

AND

EDWARD W. BAKER

SYSTEMATIC ENTOMOLOGY LABORATORY, IIBIII U.S.D.A. AGRICULTURAL RESEARCH SERVICE,  
BELTSVILLE, MARYLAND 20705

RECEIVED FOR PUBLICATION AUGUST 9, 1974

**Abstract:** Sixteen species of mites are reported associated with *Popilius disjunctus* (Illiger) (Coleoptera: Passalidae) in eastern United States. Two new species are described: *Macrocheles disjunctus* and *M. whartoni*. Changes in nomenclature are as follows: *Cosmolaelaps passali* Hunter and Mollin = *C. trifidus* (Pearse and Wharton), new synonymy and new combination; *Dendrolaelaps passalorum* (Pearse and Wharton), new combination. Diagnostic features, as well as distributional and biological information are given for most species.

A surprisingly large and somewhat heterogenous group of mites is found in association with various species of passalid beetles (Coleoptera: Passalidae) (Pearse et al., 1936; Tragardh, 1946, 1950; Womersley, 1957; Schuster and Lavoipierre, 1970; Hunter and co-workers, 1964-1969). Either adults, immature stages, or all developmental stages of certain species are found attached to various parts of the beetle. The relationship between the mites and beetles is undoubtedly one of phoresy, *i.e.*, the mite utilizing the beetle as a means of transport from one habitat to another. The attractiveness of the beetle *Popilius disjunctus* (Illiger) to the mite has been observed by Mollin and Hunter (1964) and Hunter and Davis (1965) working with *Cosmolaelaps trifidus* (Pearse and Wharton) and *Euzercon latus* (Banks) respectively. They concluded that these mites react to an attractant present on the external surface of their beetle host. *Cosmolaelaps trifidus* reproduces only after a period of contact with the beetle. The feeding habits of the majority of these mites are unknown. But certain other species of Macrochelidae will feed on acarid mites (*Caloglyphus* spp.), fly eggs and larvae, and nematodes (Axtell, 1961, 1963, 1969). Probably many other species will also feed on the same hosts.

This study is based on material taken by M. D. Delfinado from pinned *P. disjunctus* beetles in the New York State Museum and Science Service collection through the courtesy of John Wilcox, and from beetles sent by Marcel

<sup>1</sup>Published by permission of the Director, New York State Museum and Science Service, Journal Series No. 164.

Reeves, University of New Hampshire. Other mite specimens examined are from the collection of Preston E. Hunter, University of Georgia at Athens.

This paper reports the following families of mites found on *P. disjunctus* in eastern United States: Diarthrophallidae (1 sp.), Diplogyniidae (1 sp.), Euzerconidae (1 sp.), Megisthanidae (1 sp.), Digamasellidae (1 sp.), Laelapidae (2 spp.), Macrochelidae (3 spp.), and Heterocheylidae (1 sp.). Also listed here, but not discussed, are immature specimens of 3 uropodine species described by Pearse and Wharton (1936) and unnamed species of Anoetidae and Acaridae. *Cosmolaelaps passali* (Hunter and Mollin, 1964), is synonymized with *Cosmolaelaps trifidus* (Pearse and Wharton, 1936), new combination. Two new species of *Macrocheles* are described.

#### Family Diarthrophallidae

##### *Diarthrophallus quercus* (Pearse and Wharton)

*Uroseius quercus* Pearse and Wharton 1936: 478.

*Diarthrophallus quercus*, Tragardh, 1946: 371 (taxonomy); Hunter and Glover, 1968: 193 (re-description).

*Passalobia duodecimpilosa* Lombardini, 1938: 46. Synonymy by Hunter and Glover (1968).

*Diarthrophallus similis* Tragardh, 1946: 380. Synonymy by Womersley (1961).

*Remarks:* This unique species, upon which the genus and family was based (Tragardh, 1946), is distinguished in all stages by having very long, barbed adanal and body setae; very short peritremes in the adult which are absent in the immature stages, by the sternal shield lacking lateral endopodal projections, and the tarsus of leg I without caruncle or claws and terminating in a series of short and long setae. All developmental stages are found on the beetle. Pearse and Wharton (1936) observed that this "mite is usually found on the outside of *Passalus*, where it lurks in the crevices between parts near the anterior end, but sometimes it creeps under the elytra." The present material was taken on the coxal regions and under the elytra.

*Distribution.* This is one of the commonest species of mites found on the venter of head and coxal regions and under the elytra of *P. disjunctus*. It is widely distributed in the eastern United States and has also been recorded from Brazil on an unknown passalid beetle and from Mexico on *Proculus goryi* Melly.

#### Family Digamasellidae

##### *Dendrolaelaps passalorum* (Pearse and Wharton). New combination.

(Figures 1-4)

*Zercon passalorum* Pearse and Wharton, 1936: 477.

*Remarks.* The type specimens of this species are presumably lost. Figures 28-30 (Pearse and Wharton 1936: 477) on *D. passalorum* are undoubtedly based on nymphs. We have adults of both sexes and nymphs taken from the beetle habitat and under the elytra of *P. disjunctus*. A brief description of the adults is as follows:

*Female.* All dorsal and body setae simple; posterior end of dorsal plate sculptured, punctate with scalloped margin; dorsal plate notched medially as shown on figure 1, with 2 small platelets above the slit; infundibulum foraminis extending entire length of



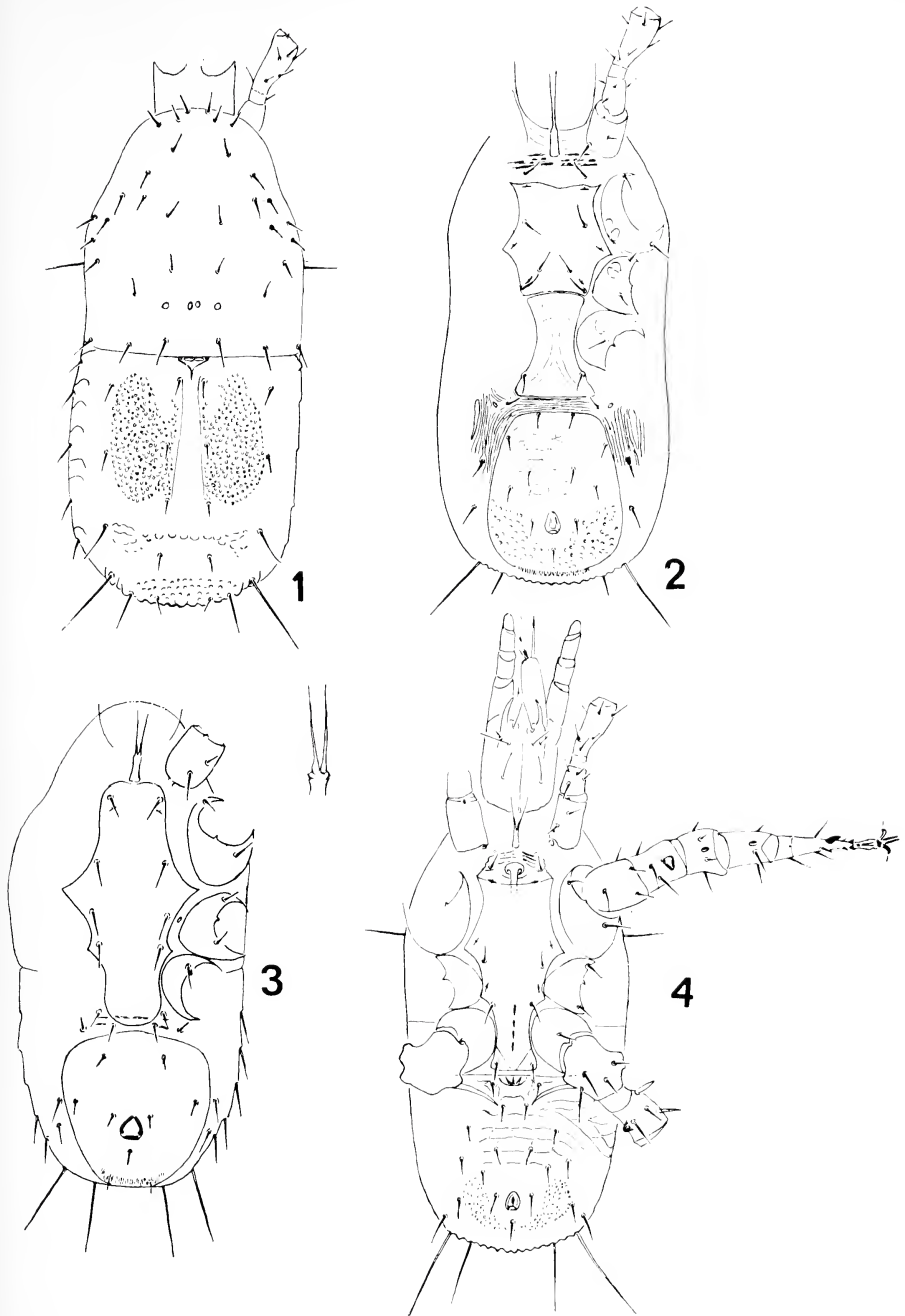

FIGS. 1-4. *Dendrolaelaps passalorum* (Pearse and Wharton). 1, dorsum of female; 2, venter of female; 3, venter of nymph with tritosternum; 4, venter of male.

trochanter and femur of Leg III; ventri-anal plate with 4 pairs of setae in addition to anal setae. *Male*. Spermatodactyl straight, shorter than fixed chela; genital opening located at anterior margin of sternal plate; femur, genu and tibia of leg II with ventral protuberances; trochanter and femur of leg IV with small, lateral protuberances as in figure 4; posterior end of dorsal plate as in female. Dorsal seta  $S_1$  as long as seta  $Z_6$  but stronger;  $S_5$  longest and most conspicuous of dorsal setae.

*Distribution*. Previously known only from North Carolina (type locality). We have examined a series of immatures taken under the elytra of *Popilius* from New York (Lintner, coll.), Ohio (P. Lowry, coll.), Iowa (L. C. Glover, coll.) and Virginia (E. W. Baker, coll.); adult males and females were collected from *Popilius* habitat under a log pile in Virginia.

#### Family Diplogyniidae

##### *Passalacarus sylvestris* Pearse and Wharton

*Passalacarus sylvestris* Pearse and Wharton: 475; Tragardh, 1950: 369 (re-description, taxonomy).

*Remarks*. *P. sylvestris* was re-described and figured in detail by Tragardh (1950) who placed it in the family Diplogyniidae. This species is distinguished in both sexes by having the anal plate fused with the ventral plate; the female has a pair of sternal setae placed close together at the middle near the posterior margin of the sternal plate, and a pair of triangular plates hinged laterally to the ventral plate bearing 2 pairs of long setae near the lateral margin. The male genital aperture is situated in front of the anterior margin of the sternal plate. The biology is not known.

*Distribution*. *P. sylvestris* was previously known from North Carolina (type locality). We have examined specimens taken in the anterior and hind coxal regions of *P. disjunctus* from Iowa (L. C. Glover, coll.), New York (Moore, coll.) and from Virginia collected in an alcohol jar with the beetles (E. W. Baker, coll.).

#### Family Euzerconidae

##### *Euzercon latus* (Banks)

*Celaenopsis latus* Banks, 1909: 135.

*Euzercon latus*, Hunter and Davis, 1965: 30 (biology).

*Remarks*. This euzerconid mite is characterized by having the lateral plates of the female fused with the ventral plate, by having a T-shaped genital opening and by having the anal plate separated from the ventral plate. No male or immature stage has been examined by us. Biology and descriptions of both sexes, including the immature stages are given by Hunter and Davis (1965).

*Distribution*. *E. latus* was originally found on a passalid beetle at Guelph, Ontario, Canada; it has been recorded since from North Carolina and Georgia. We have examined females taken on the anterior coxae of *P. disjunctus* from New York (Moore, coll.) and Iowa (L. C. Glover, coll.).

#### Family Laelapidae

##### *Cosmolaelaps trifidus* (Pearse and Wharton). New combination.

*Seiodes trifidus* Pearse and Wharton, 1936: 474.

*Cosmolaelaps passali* Hunter and Mollin, 1964: 247. New synonymy.

*Remarks.* We have remounted and examined the type specimens of *Seiodes trifidus*; it is now obvious that this species is a typical laelapid mite. Both sexes can be distinguished by the strong, lanceolate setae on the dorsal plate and by the short, strong ventral setae on the posterior region of the body. Mollin and Hunter (1964) and Hunter and Mollin (1964) gave detailed biology, descriptions and illustrations of this species as *Cosmolaelaps passali*, a synonym of *Seiodes trifidus*. We cannot find characters to separate them.

*Distribution.* Hunter and Mollin (1964) reported that the adults were usually found ventrally between the leg and prothoracic regions, or attached to the setae in front of legs I of *Popilius* from Georgia. One male was removed from the head region of *P. disjunctus* from Louisiana (L. C. Glover, coll.). Previously known only from North Carolina (type locality).

*Hypoaspis (Geolaelaps) disjuncta* Hunter and Yeh

*Hypoaspis (Geolaelaps) disjuncta* Hunter and Yeh, 1969: 97.

*Remarks.* *H. disjuncta* is a weakly sclerotized laelapid mite with simple body setae. It may be distinguished readily by the shape of the sternal plate which has a rounded posterior margin extending posteriorly to the region of coxae IV, and in that the dorsal plate possesses 32 pairs of simple setae and completely covers the dorsum. The biology of this mite was observed by Hunter and Yeh (1969).

*Distribution.* This species was found attached to the hairs on the venter of the prothorax of *Popilius* from Georgia; it was also found in decayed frass mixed with soil in the beetle tunnels. We have females taken on the coxal region and mouthparts of *P. disjunctus* from Ohio (P. Lowry, coll.) and Iowa (L. C. Glover, coll.).

Family Macrochelidae

*Macrocheles tridentatus* Pearse and Wharton

(Figures 5–11)

*Macrocheles tridentatus* Pearse and Wharton, 1936: 473.

*Remarks.* We have remounted and examined the type material (USNM Type No. 1172, male and female) of *M. tridentatus*. The type specimen labelled male proved to be a female as shown in figure 15 (Pearse and Wharton, 1936: 473). This mite represents a new species of macrochelid. Figure 17 (Pearse and Wharton, loc. cit.) represents the type female of *M. tridentatus*. Brief descriptions of the adults of *M. tridentatus* are as follows:

*Female.* Dorsal plate finely punctate and with reticulate pattern of punctate lines diminishing at midregion. Vertical setae  $D_1$  and all marginal (except  $M_2$ ) and lateral setae pectinate; seta  $D_8$  and all other medial and dorsal setae simple, slender and lanceolate. Sternal plate punctate with ridges of polygonal design. Genital and ventri-anal plates with reticulate patterns of punctate lines. All setae on these plates simple. Fixed and movable chelae of chelicerae with 4 and 2 teeth respectively; arthrodial brush reaching to  $\frac{1}{2}$  length of movable chela. Leg I with tibia shorter than tarsus. Genu of leg IV with 6 setae pectinate apically; all other leg setae simple.

*Male.* Dorsal plate ornamentations similar to those of female. Holoventral plate densely punctate and with faint polygonal pattern, ventri-anal plate punctate, with reticulate pattern of punctate lines. All setae on these plates simple. Fixed chelae with 4 teeth, movable chelae with 1 tooth, spermatodactyl about the length of movable chela. Femur, genu and tibia of leg II each with a spur, largest on femur. Femur of leg IV as figured.

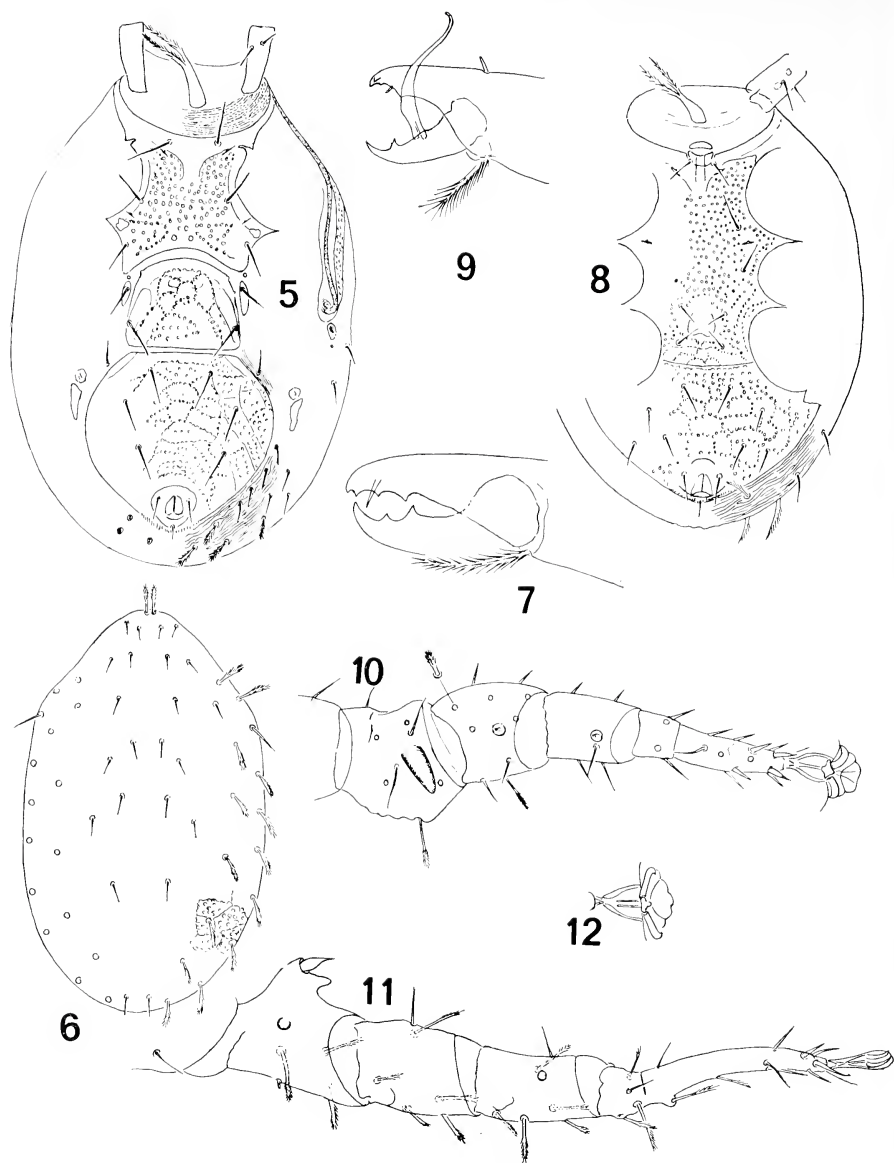

FIGS. 5-12. *Macrocheles tridentatus* Pearse and Wharton. 5, venter of female; 6, dorsum of female; 7, chelicera of female; 8, venter of male; 9, chelicera of male; 10, leg II of male; 11, leg IV of male; 12, ambulacra of leg III of male.

*Distribution.* *M. tridentatus* was previously known only from North Carolina (type locality). We have examined females taken on the coxal region of *P. disjunctus* from Ohio (P. Lowry, coll.) and Georgia (Y. T. Chiu, coll.) and males collected in beetle frass from Georgia.

*Macrocheles disjunctus*, n. sp.

(Figures 12-15)

*Female*. Length of body 735 microns. Dorsal plate heavily ornamented with circular and polygonal pits of varying sizes; all dorsal setae clublike and strongly plumose, with most marginal, lateral and anterior dorsal setae stoutest and longest; extra marginal (integumental) setae also plumose; integument outside plate rugose, granular. Sternal plate pitted, all setae pectinate. Genital plate small, rounded posteriorly, with pitted reticulate pattern; setae pectinate. Ventri-anal plate small, longer than wide, pitted; all setae on this plate pectinate; 3 anal setae simple; integument between these plates rugose; 2 pairs of sclerotized platelets located between genital and ventri-anal plates. Metasternal plates very small, each with a pectinate seta. Metapodals not seen. Chelicerae with movable chelae unidentate, fixed chelae tridentate; arthrodial brush reaching to  $\frac{1}{2}$  length of movable chela. Legs rugose; most setae strong, either plumose or pectinate. Tarsus of leg I longer than tibia.

*Male*. Not known.

*Holotype*. Female, Duncan Falls, Ohio, June 18, 1916 (P. Lowry, coll.), taken on venter of *P. disjunctus*, deposited in the New York State Museum and Science Service at Albany.

*Paratypes*. 1 female with same data as holotype; 1 female, Ft. McPherson, Georgia, July 22, 1946 (no coll.); 1 female, McRae, Georgia, November 7, 1959 (H. O. Lund, coll.), both taken on passalid beetle, deposited in the U.S. National Museum and New York State Museum and Science Service collections.

*Remarks*. The pitted ornamentation of the dorsal plate and the plumose setae, the rugose legs and the small genital and ventri-anal plates are distinctive for this species.

*Macrocheles whartoni*, n. sp.

(Figures 16-18)

*Female*. Length of body 370 microns. Dorsal plate finely punctate and weakly ornamented with a network of fine punctate lines. Vertical setae D<sub>1</sub> short, spinelike, simple and close to each other; setae D<sub>2</sub> finely pectinate; remainder of setae on dorsal plate simple, long, thin, and lanceolate; extra marginal setae on integument simple. Sternal plate with characteristic granular and knobby ornamentation; all sternal setae simple. Genital plate truncate posteriorly, and nearly touching anterior margin of ventri-anal plate, with concentric pattern of small granular lines. Ventri-anal plate truncate anteriorly, with punctate polygonal and concentric ornamentation, all setae on this plate simple. Metasternal setae simple, located on small elongate plates. Metapodal plates very small, elongate and weakly sclerotized. Chelicerae with bidentate fixed chelae and unidentate movable chelae; arthrodial brush reaching to  $\frac{1}{2}$  length of movable chela. Leg I with tibia shorter than tarsus. All leg setae simple.

*Male*. Not known.

*Holotype*. Female, Athens, Georgia, August 10, 1965 (Y. T. Chiu, coll.), on passalid beetle, deposited in the New York State Museum and Science Service at Albany. *Paratypes*. 6 females with same data as holotype; 1 female, Clarke Co., Georgia, October 4, 1960, inside rotten log, and 1 female, Athens, Georgia, University Farm, January 12, 1961, in tunnel of passalid beetle, both collected by P. E. Hunter; 1 female, Duke Forest, Durham, North Carolina, June 12, 1933, "on *Passalus cornutus* Fabr." (A. S. Pearse, coll., labelled USNM type no. 1172); 3 females, Stafford, Virginia, August 23, 1973, in *Popilius* habitat under oak log, and 2 females on *Popilius* same locality, all collected by E. W. Baker, deposited in the U.S. National Museum and New York State Museum and Science Service collections.

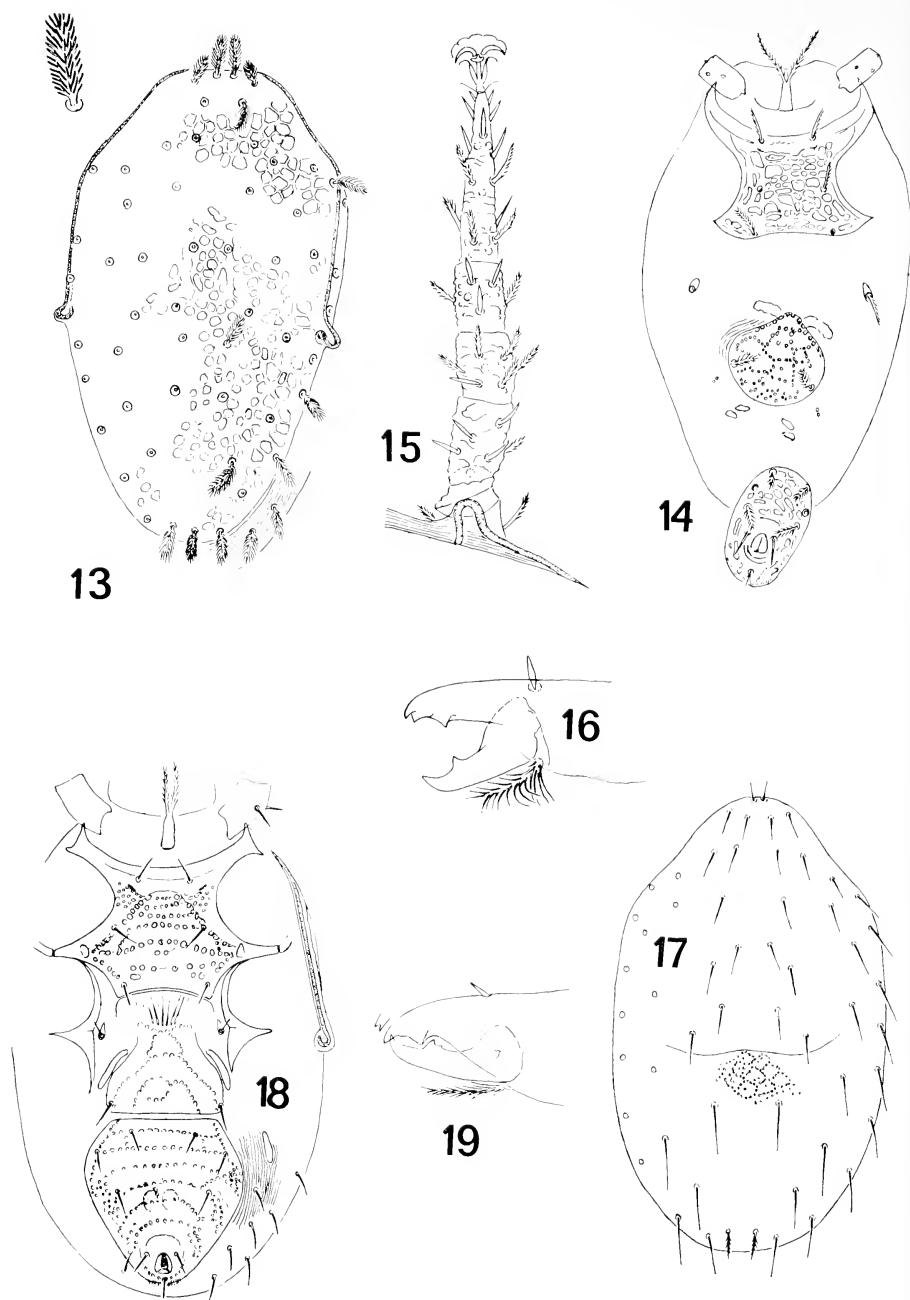

FIGS. 13-16. *Macrocheles disjunctus*, n. sp. 13, dorsum of female; 14, venter of female; 15, leg III of female; 16, chelicera of female.

FIGS. 17-19. *Macrocheles whartoni*, n. sp. 17, dorsum of female; 18, venter of female; 19, chelicera of female.

*Remarks.* *M. whartoni* is distinguished by having only the  $D_s$  setae pectinate, the remainder of body setae being simple, and by the characteristic knobby and granular ornamentation of the sternal plate. It is the common macrochelid species found on *P. disjunctus*.

This mite is named for G. W. Wharton of the Ohio State University.

#### Family Megisthanidae

##### *Megisthanus floridanus* Banks

*Megisthanus floridanus* Banks, 1904: 145; Baker and Wharton, 1952: 45; Krantz, 1971: 130.

*Remarks.* Pearse and Wharton (1936) reported that this mite has never been taken in abundance and none has actually been taken on the beetles which were examined each month. Our present collection contains 2 females and 1 male collected in *P. disjunctus* habitat under a log pile in Virginia. None was found on the beetle. Baker and Wharton (1952), and recently Krantz (1971), figured *M. floridanus*. It is distinguished by its unique genital opening: crescent shaped in the female and placed just below the sternal plate, whereas the male genital opening is located in the sternal plate aperture.

*Distribution.* Florida, Georgia and North Carolina. It was collected in Virginia in the beetle habitat by E. W. Baker.

#### Family Uropodidae

In the collection are immatures of 3 species of uropodine mites which were named by Pearse and Wharton (1936). Adults are not known.

*Uroobovella spinosa* Pearse and Wharton, 1936: 480. Genus uncertain.

*Distribution.* North Carolina, Ohio, New York, Iowa and Georgia. These mites were found on the front and hind coxal region of the beetles and under the elytra.

*Uroobovella setosa* Pearse and Wharton, 1936: 479. Genus uncertain.

*Distribution.* North Carolina, Louisiana, Ohio, New York and Georgia. The specimens were taken on the front coxal region of *Popilius*.

*Uroobovella levis* Pearse and Wharton, 1936: 481. Genus uncertain.

*Distribution.* This species is the most common of the uropodine mites found on the beetle in North Carolina, New York, Ohio, Iowa, Virginia, Georgia and Connecticut. It is found attached to the hollow areas beneath the head of *Popilius* and on the front coxal region.

#### Family Heterocheylidae

##### *Heterocheylus proximus* Schuster and Lavoipierre

*Heterocheylus proximus* Schuster and Lavoipierre, 1970: 26.

*Heterocheylus fusiformis* Lombardini, of Pearse and Wharton, 1936: 747. Misidentification.

*Remarks.* *H. proximus* is obviously the heterocheylid mite reported by Pearse and Wharton (1936) from North Carolina. It is distinguished from other North and South American species in that tarsus IV has 4 setae; the dorsal seta of tarsus IV is located on the distal portion of the segment which lacks the small basal posterior seta. Seta  $I_m$  is anterior to seta IM (after Schuster and Lavoipierre, 1970: 22).

The biology is not known.

*Distribution.* *H. proximus* is found under the elytra of *P. disjunctus*, and is common and widely distributed in the eastern United States. It has also been recorded on a number of passalid species from Mexico, Central and South America.

#### Family Anoetidae

*Histiostoma* sp.

*Remarks.* The figure of the hypopus by Pearse and Wharton (1936) readily places this mite in the above family. They gave it no generic name and placed it in the family 'Tyroglyphidae.' The mites collected on the beetles are *Histiostoma* sp., and probably represent an undescribed species.

*Distribution.* North Carolina, Connecticut and Iowa. The mites were found on the coxal region and under the elytra of the *P. disjunctus*.

#### Family Acaridae

Genus nr. *Forcellinia*.

*Remarks.* Only the hypopial forms were found, and they are probably an undescribed genus. Pearse and Wharton (1936) gave a rough figure of this form.

*Distribution.* North Carolina, New York, Iowa, Connecticut, Virginia and Louisiana. They were found on the front and hind legs, coxal region and under the elytra of *Popilius*.

#### Literature Cited

- AXTELL, R. C. 1961. New records of North American Macrochelidae (Acarina: Mesostigmata) and their predation rates on the house fly. *Ann. Entomol. Soc. Amer.* **54**: 748.
- . 1963. Manure inhabiting Macrochelidae (Acarina: Mesostigmata) predaceous on the house fly. *Adv. Acarology* **1**: 55-59.
- . 1969. Macrochelidae (Acarina: Mesostigmata) as biological control agents for synanthropic flies. *Proc. 2nd Int. Cong. Acarology (1967)*: 401-416.
- BAKER, E. W., AND G. W. WHARTON. 1952. *Introduction to Acarology*. The Macmillan Co. New York. 465 pp.
- BANKS, N. 1904. The Arachnida of Florida. *Proc. Acad. Nat. Sci. Phil.*: 120-147.
- . 1909. New Canadian Mites [Arachnoidea, Acarina]. *Proc. Entomol. Soc. Wash.* **9**: 133-143.
- EVANS, G. O., AND E. BROWNING. 1956. British Mites of the subfamily Macrochelinae Tragarth (Gamasina-Macrochelidae). *Bull. Br. Mus. (Nat. Hist.) Zool.* **4**(1): 3-55.
- HUNTER, P. E., AND K. MOLLIN. 1964. Mites associated with *Passalus* beetle I. Life stages and seasonal abundance of *Cosmolaelaps passali* n. sp. (Acarina: Laelaptidae). *Acarologia* **6**: 247-256.
- , AND R. DAVIS. 1965. Mites associated with *Passalus* beetle III. Life stages and observations on the biology of *Euzercon latus* (Banks) (Acarina: Euzerconidae). *Acarologia* **7**: 30-42.
- , AND L. BUTLER. 1966. New *Klinckowstroemia* mites from Costa Rican passalid beetles (Acarina: Klinckowstroemiidae). *J. Georgia Entomol. Soc.* **1**: 24-30.
- , AND S. GLOVER. 1968. The genus *Passalobia* Lombardini 1926, with descriptions of a new species (Acarina: Diarthrophallidae). *Proc. Entomol. Soc. Wash.* **70**: 193-197.



- , AND W. M. YEH. 1969. *Hypoaspis (Geolaelaps) disjuncta* n. sp. (Acarina: Laelapidae) associated with horned *Passalus* beetles. J. Georgia Entomol. Soc. **4**: 97-102.
- KRANTZ, G. E. 1962. A review of the genera of the family Macrochelidae Vitzthum 1930 (Acarina: Mesostigmata). *Acarologia* **4**: 143-173.
- LOMBARDINI, G. 1938. Acari nuovi. Mem. Soc. Entomol. Ital. **17**: 44-46.
- MOLLIN, K. AND P. E. HUNTER. 1964. Mites associated with *Passalus* beetle II. Biological studies of *Cosmolaelaps passali* Hunter and Mollin (Acarina: Laelapidae). *Acarologia* **6**: 421-431.
- PEARSE, A. S. AND G. W. WHARTON in Pearse, A. S., M. T. Patterson, J. S. Rankin, and G. W. Wharton. 1936. The ecology of *Passalus cornutus* Fabricius, a beetle which lives in rotting logs. *Ecolog. Monogr.* **6**: 455-490.
- SCHUSTER, R. O., AND M. M. J. LAVOPIERRE. 1970. The mite family Heterocheylidae Tragarth. Occ. Pap. Calif. Acad. Sci. **85**: 1-42.
- TRAGARDH, I. 1946. Diarthrophallina, a new group of Mesostigmata found on passalid beetles. *Entomol. Medd.* **24**: 369-394.
- . 1950. Studies on the Celaenopsidae, Diplogyniidae and Schizogyniidae. *Arkiv Zool.* **1**(25): 361-451.
- WOMERSLEY, H. 1957. On some acarina from Australia and New Guinea paraphagic upon millipeds and cockroaches, and on beetles of the family Passalidae. *Trans. R. Soc. N. S. W.* **81**: 13-29.
- . 1961. On the Family Diarthrophallidae (Acarina-Mesostigmata-Monogynaspida) with particular reference to the genus *Passalobia* Lombardini 1926. *Trans. Roy. Soc. S. Austral.* **84**: 27-46.

**The Relationship of *Coleomegilla maculata* (DeGeer)  
(Coleoptera:Coccinellidae) to the Cocoon of Its parasite  
*Perilitus coccinellae* (Schrank) (Hymenoptera:Braconidae)**

ALLEN H. BENTON AND ANDREW J. CRUMP

DEPARTMENT OF BIOLOGY, STATE UNIVERSITY COLLEGE, FREDONIA, NEW YORK, 14063

RECEIVED FOR PUBLICATION JULY 5, 1974

**Abstract:** Evidence is presented to indicate that clasping of the occupied cocoon of the parasitic wasp, *Perilitus coccinellae* (Schrank) by adult ladybird beetles, *Coleomegilla maculata* (DeGeer) is voluntary. There appears to be an attraction of the occupied cocoon for the adult beetle.

The braconid wasp, *Perilitus coccinellae* (Schrank) (Fig. 1) is a common parasite of many beetles, including a variety of Coccinellidae. The distribution, host records and ecology of this wasp have been studied in some detail by Balduf (1926), Smith (1953), Sluss (1968) and others. The adult wasp parasitizes adult or larval beetles (David and Wilde, 1973) and the larva feeds upon the fat bodies and gonads of its host. It emerges through the suture between posterior abdominal tergites, and upon emergence immediately spins a cocoon.

Many workers have noted that an adult beetle is often found clasping the cocoon of this parasite (Fig. 2). Several of them (e.g. Balduf, 1926; Smith, 1960) have noted that the larval wasp, as it spins its cocoon, often entangles the legs of the beetle, either by intent or by accident. Recent observations in our laboratory and in the field suggest that this interpretation is in error. The cocoon is often, if not always, attached to the substrate (usually a leaf) and the beetle clasps it voluntarily.

Our belief that the association of the adult beetle with the cocoon is voluntary is based upon studies of specimens observed or collected in a corn field near Fredonia, Chautauqua County, New York, from July to September, 1973. In the field, and later in the laboratory, we found adult beetles clasping a small cocoon, which, upon emergence of its occupant, proved to be that of *P. coccinellae*. Adults found clasping a cocoon usually died soon after emergence of the wasp, or even before emergence in a few cases. Several workers have reported that parasitized beetles survived, but we suspect that these reports are based on

---

**Acknowledgments:** This research has been supported by National Science Foundation Grant B036435. We are grateful to Dr. W. R. M. Mason and Dr. C. C. Loan, Biosystematics Research Institute, Ottawa, Ontario, Canada, for identification of the parasite. Dr. Bernard C. Smith, Research Station, Harrow, Ontario, Canada, gave us helpful comments on the first draft of this paper.



FIG. 1. *Perilitus coccinellae* (Schrank) Newly emerged adult.

cases in which the cocoon was clasped by a beetle other than the parasitized individual. Thus, after emergence of the wasp, the beetle was sufficiently healthy to leave the cocoon and go its way. Sluss (1968), tracing the life cycle of the parasite in *Hippodamia convergens* Guerin, reported that parasitized individuals died within 3 to 4 days of emergence of the wasp.

Three sorts of observations suggest that the association of the beetle with the cocoon is voluntary. First, we have observed adult beetles abandoning a cocoon, and we have found abandoned cocoons in the field. On two occasions, abandonment occurred while the pupa was still in the cocoon, but this occurred only while we were collecting and transporting beetles from field to laboratory, indicating that it resulted from disturbance. On a few other occasions, the beetle abandoned the cocoon after the emergence of the wasp. This would be impossible if the cocoon were attached to the beetle.

Second, we observed, on one occasion, one beetle clasping a cocoon and another beetle trying to grasp it from the other side. For some time, both beetles held the cocoon at opposite ends, but eventually the "intruder", which may have been unparasitized and hence stronger, took over the cocoon. This

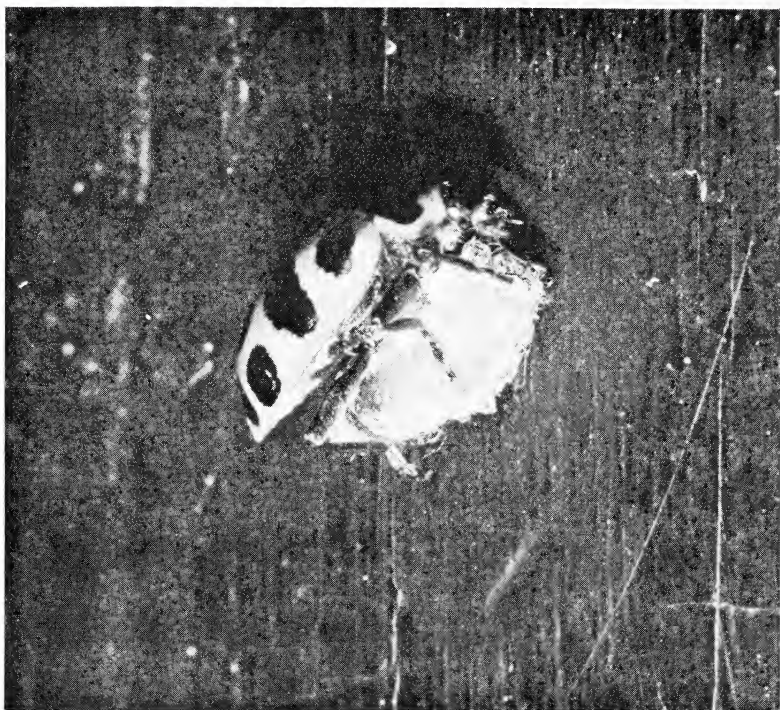

FIG. 2a. Lateral view of adult *Coleomegilla maculata* claspng a cocoon of *P. coccinellae*. Note both here and in Fig. 2b that the beetle's legs appear to be actively claspng the cocoon and that there is no noticeable entanglement of the legs in threads of the cocoon.

may explain previous observations that "parasitized" beetles lived after the parasite emerged.

Third, if the cocoon is indeed attached to the beetle by the larval wasp, it would not be attached to the substrate. We found, in the field, two cocoons\* from which the wasp had emerged. Both were attached to corn leaves. In one case the attaching threads were primarily at one end, while the other cocoon was attached by threads which extended over the leaf in all directions. There was no doubt that the threads of the cocoon were firmly attached to the leaf. We were never able to find any evidence that a cocoon was actually attached to a beetle. We regularly observed beetles shifting their legs about on the cocoon, but their legs were never entangled to any significant degree.

It appears, therefore, that the claspng of the cocoon of *P. coccinellae* is a voluntary act on the part of adult *C. maculata*. The occupied cocoon seems to

---

\* While this paper was in press, Mr. Jules Silverman conducted further field studies. He found numerous cocoons attached to corn leaves, several of them with dead beetles still claspng the cocoon.

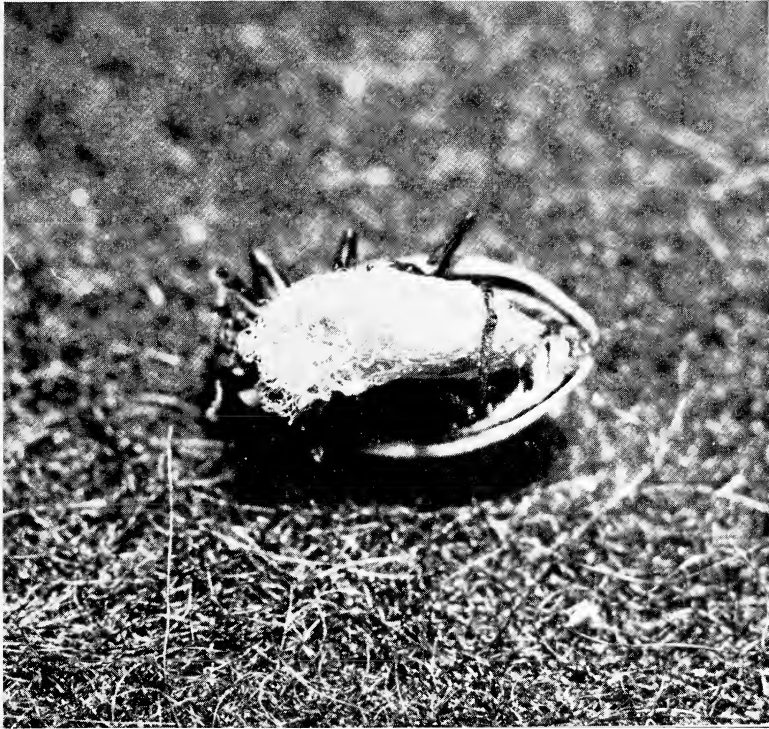

FIG. 2b. Ventral view of adult *Coleomegilla maculata* clamping a cocoon of *P. coccinellae*.

have a positive attraction for the adult beetle, but this attraction is apparently lost when the wasp emerges. It would seem most likely that this attraction is chemical in nature, although we have thus far no direct evidence for this. Further olfactory experiments are planned.

#### Literature Cited

- BALDUF, W. V. 1926. The bionomics of *Dinocampus coccinellae* Schrank. *Ann. Entomol. Soc. Amer.*, **19**: 465-489.
- DAVID, MENTER H., AND WILDE, GERALD. 1973. Susceptibility of the convergent lady beetle to parasitism by *Perilitus coccinellae* (Schrank) (Hymenoptera: Braconidae). *J. Kansas Entomol. Soc.*, **46**: 359-362.
- SLUSS, R. 1968. Behavioral and anatomical responses of the convergent lady beetle to parasitism by *Perilitus coccinellae* (Schrank) (Hymenoptera: Braconidae). *J. Invertebr. Pathol.*, **10**: 9-27.
- SMITH, B. C. 1960. Note on parasitism of two coccinellids, *Coccinella trifasciata perplexa* Muls. and *Coleomegilla maculata lengi* Timb. (Coleoptera: Coccinellidae) in Ontario. *Canad. Entomol.*, **92**: 652.
- SMITH, OWEN J. 1953. Species distribution and host records of the Braconid genera *Microctonus* and *Perilitus* (Hymenoptera: Braconidae). *Ohio J. Sci.*, **53**: 173-177.

## Proceedings of the New York Entomological Society

### Abstracts of Talks Presented at Meetings

#### FEEDING IN COCKROACHES

The environment of the cockroach was structured so that they could alter their eating when the environment changed. Three parameters of the environment were altered: temperature, water supply, and light. Two of these, temperature (35°, 30°, and 25°), and water supply, are conditions which directly effect energy usage of the animal. The third environmental parameter, light, has no direct energy usage relationship. Within the light parameter, the light-dark cycle was changed from 16:8 to constant light, and a change from a transparent to an opaque retreat greatly affected cockroach behavior.

Higher temperatures decreased meal length, but decreased meal number. Females demonstrated this increase more than did males; however, males decreased the amount they ate at low temperatures much more than did females. Patterns of feeding varied at different temperatures. Males particularly reacted more to the light-dark cycle at 35° than at 30° or at 25°. The animals showed some evidence of acclimation to higher and lower temperatures. The relationship between temperature and meal parameters (meal length, meal number, intermeal interval) were real, but less pronounced in animals maintained three weeks at the new temperature.

Light-dark cycles and nature of the provided retreat greatly effected feeding patterns. When provided an opaque retreat, cockroaches eat most frequently during scotophase. When given a transparent retreat, the animals eat a number of meals during photophase. In constant light, with an opaque retreat, both sexes ate irregularly. Meal number is greatly reduced in constant light.

To determine the effects of a limited water supply on cockroaches, they were given a specified quantity of water at various intervals from one to four days. Water was given only during photophase. It was found that female cockroaches will eat in the light, often after drinking. A few males will eat like females, but most will feed only during the dark.

BETTY FABER

## **“Invertebrate Tissue Culture: Applications in Medicine, Biology and Agriculture”**

is the theme of the IV International Conference on Invertebrate Tissue Culture to be held at Mont Gabriel, Quebec, Canada, June 5–8, 1975. For details, write to the Chairmen of the Conference: Prof. E. Kurstak (Department of Microbiology, Faculty of Medicine, University of Montreal, P.O. Box 6128, Montreal 101, Canada) or Prof. K. Maramorosch (Waksman Institute of Microbiology, Rutgers University, New Brunswick, N.J. 08903).

Travel support is available to U.S. scientists through a grant from NIH. Submit applications to Professor Maramorosch, specifying: (1) cost of economy round-trip plane fare from airport nearest your home to Dorval Airport, Montreal; (2) mode of participation (main speaker, discussion leader, session chairman; whether presenting a paper—indicate title; or other); (3) date of birth; (4) citizenship; (5) area of special interest (endocrinology, parasitology, genetics, virology, embryology, neurophysiology, plant pathology, etc.). Applications will be evaluated by an outside committee and the awards made before the conference. Those interested in invertebrate tissue culture, and particularly young scientists and graduate students are urged to apply. Federal employees are not eligible.

Abstracts of papers will be required by May 1, 1975. The Proceedings will be published.

---

### **BOOK REVIEW**

**Family Sphingidae of the Palaearctic and Chinese-Himalayan Faunas.** N. Ya. Kuznetsova. 1972. Amerind Publishing Co., Ltd., New Delhi. 43 pp., 1 table.

This is a translation from the Russian of an article originally published in *Horae Societatis Entomologicae*, Vol. 37, pp. 293–346, in 1916. The translation, by Dr. M. M. Haque, was published for the Smithsonian Institution in agreement with the National Science Foundation. In 1916 the classification of the Sphingidae, largely by Rothschild and Jordan, and Tutt, was not generally known, so that one purpose of the author was to make this readily available to Russians. The author consequently prepared an outline of the world classification. However considerable additional material was added, based in part, on specimens (especially southern Asiatic) not previously studied. Nomenclature and classification changes were suggested. Keys for all taxa from species-level up are given, as well as much discussion of Palaearctic subspecies. Generic and specific synonymies are given and discussed. This little known work was considered important enough to warrant its translation and modern publication. Although the classification of the Sphingidae has come a long way since 1916, this work has enough value in itself, as well as historical interest, to be a necessity even for modern and future workers in the group, especially in the higher taxa.

ALEXANDER B. KLOTS  
American Museum of Natural History

### BOOK REVIEW

**The Physiology of Insecta.** 2nd ed. Vol. I. Morris Rockstein, ed. Academic Press, Inc. 1973. \$38.

Eight years after the publication of the impressive 3 volumes of the 'Physiology of Insecta' the first of a 6-volume new and vastly expanded, second edition appeared. In recent years there has occurred a very rapid increase in the knowledge of insect biology and physiology, fully justifying this ambitious venture. The first new volume, a superb book, is completely revised and up to date. In its preface, Prof. Rockstein reveals the secret of the success of this impressive treatise: it brings together not only the known facts about insects, but also discusses the controversial subjects, and many still unsolved and unsettled problems of insect physiology.

In the introductory chapter on the biology of insects, Rockstein calls attention to the nearly one million species of insects and their successful evolution, as well as their adaptation to diverse habitats. The second chapter, by de Wilde and de Loof, deals with the male and female reproductive systems. The same authors discuss endocrine control of reproduction in the third chapter. Physiological and biochemical changes during development are dealt with by Agrell and Lundquist, and the endocrine aspects of growth and development by Lawrence Gilbert and David Shaw King. The last chapter, by Rockstein and Jaime Miguel, includes physiological, histological, and microanatomical interpretations of the aging process in insects. Those interested in gerontology of vertebrates will also be interested in this chapter and the fascinating basic problems presented.

All authors display impressive expertise in describing diverse and intriguing phenomena, and they do a very good job in presenting complex problems so that not only insect physiologists, but also general biologists can profit from their discussions. The book is well illustrated and produced, and it can be highly recommended. It is a very useful addition to the entomological literature. Understandably this new, revised edition will become a major reference work, indispensable to teachers and students alike, and a source of information and inspiration to all engaged in insect physiology research.

KARL MARAMOROSCH

---

### BOOK REVIEW

**A Systematic Monograph of New World Ethmiid Moths (Lepidoptera, Gelechioidea).** Jerry A. Powell. 1973. Smithsonian Contrib. Zool. No. 120. iv + 302 pp., 294 figs., 22 pls. Superintendent of Documents, U.S. Govt. Printing Office, Washington, D.C. \$3.85.

The Ethmiidae are a small, but distinctive, worldwide family of small moths, consisting of about 250 described species. They show their greatest diversity in the Neotropical region. A majority of the species occupy relatively small niches, chiefly in xeric areas, and feed mostly on plants of the large family Boraginaceae and, to a lesser extent, the North American Hydrophyllaceae. Only 48 species are Nearctic, of which one is a recent introduction from the Palearctic and one in California is a probable introduction. The life histories of many of the Nearctic species are at least partially known, those of the Neotropical ones far less so. They have essentially no economic importance, although one Hawaiian species is at times a pest on ornamentals.



In all 133 species are covered, of which 49 are described as new. These are placed in only 3 genera (none new) since the author very wisely decided that the present knowledge of the Neotropical fauna is too scanty to justify a generic classification. The great majority of the species are placed in the genus *Ethmia*, as they have always been. All available material was studied (including the majority of the types) and all discoverable taxonomic characters were used and are fully illustrated. Numerical taxonomic analyses were extensively made.

The extensive studies of geographical distribution are especially interesting, although handicapped by a paucity of Neotropical material. The eastern Nearctic is depauperate, the majority of the species occurring in California and the Southwest. The largest number of Neotropical species occur in the northern mainland region, with a goodly number in the Greater Antilles. These West Indian species suggest a strong faunal connection with the Yucatan Peninsula. Some especially interesting features appear in the life histories of Southwestern and Californian species. Such features as diurnal adults flying during only very short periods around midday (correlated with small eyes) apparently enable some species to occupy niches in regions probably unsuitable for them at other times of year because of xeric conditions or high altitudes.

Professor Powell has produced an excellent monograph on a group heretofore little (and chaotically) known. It will serve as a firm basis for the great amount of work needed in the Neotropics.

ALEXANDER B. KLOTS

American Museum of Natural History

### INVITATION TO MEMBERSHIP

The New York Entomological Society was founded in 1892 and incorporated the following year. It holds a distinguished position among scientific and cultural organizations. The Society's **Journal** is one of the oldest of the leading entomological periodicals in the United States. Members and subscribers are drawn from all parts of the world, and they include distinguished professional naturalists, enthusiastic amateurs, and laymen for whom insects are only one among many interests.

You are cordially invited to apply for membership in the Society or to subscribe to its **Journal** which is published quarterly. Regular meetings are held at 8:00 P.M. on the first and third Tuesdays of each month from October through May at the American Museum of Natural History, the headquarters of the Society. A subject of general interest is discussed at each meeting by an invited speaker. No special training in biology or entomology is necessary for the enjoyment of these talks, most of which are illustrated. Candidates for membership are proposed at a regular meeting and are voted upon at the following meeting.

#### CLASSES OF MEMBERSHIP AND YEARLY DUES

<i>Active member:</i> Full membership in the Society, entitled to vote and hold office; with <b>Journal</b> subscription .....	\$9.00
<i>Active member without Journal</i> subscription .....	4.00
<i>Sustaining member:</i> Active member who voluntarily elects to pay \$25.00 per year in lieu of regular annual dues.	
<i>Life member:</i> Active member who has attained age 45 and who pays the sum of \$175.00 in lieu of further annual dues.	
<i>Student member:</i> Person interested in entomology who is still attending school; with <b>Journal</b> subscription .....	5.00
<i>Student member without Journal</i> subscription .....	2.00
<i>Subscription to Journal without membership</i> .....	8.00

---

#### APPLICATION FOR MEMBERSHIP

Date .....

I wish to apply for ..... membership (see classes above).

My entomological interests are: .....

If this is a student membership, please indicate school attending and present level.

Name .....

Address .....

(Zip Code *must* be included)

— Send application to Secretary —

## **JOURNAL of the NEW YORK ENTOMOLOGICAL SOCIETY**

The JOURNAL of the NEW YORK ENTOMOLOGICAL SOCIETY is devoted to the advancement and dissemination of knowledge pertaining to insects and their related forms.

SUBSCRIPTIONS are \$8.00 per year, in advance, and should be sent to the New York Entomological Society, the American Museum of Natural History, 79th Street at Central Park West, New York, N. Y. 10024. The Society will not be responsible for lost JOURNALS unless immediately notified of change of address. We do not exchange publications.

Please make all checks, money-orders, or drafts payable to the NEW YORK ENTOMOLOGICAL SOCIETY.

ORDERS and inquiries for back issues and complete sets should be sent to our agent, S-H Service Agency, Inc., 866 Third Ave. New York, N. Y. 10022. Complete files of back issues are in stock.

### INFORMATION FOR AUTHORS

Submit manuscript in duplicate (original and one carbon) to the Editor, New York Entomological Society, Waksman Institute of Microbiology, Rutgers University, New Brunswick, N.J. 08903.

1. GENERAL POLICY. Manuscript submitted must be a report of unpublished research which is not being considered for publication elsewhere. A manuscript accepted and published in the JOURNAL must not be published again in any form without the consent of the New York Entomological Society.

A page charge of \$15 per printed page is assessed except that the charge may be reduced in the case of a member of the Society who cannot obtain institutional or grant funds for publication.

The page charge includes black and white illustrations and tabular material.

2. FORM OF MANUSCRIPT. Text, footnotes and legends must be typewritten, double or triple spaced, with margins of at least 1½ inches on all sides. The editorial style of the JOURNAL essentially follows the *CBE Style Manual* (3rd edition, A.I.B.S., 1972).

Genetic symbols: follow recommendations of Demerec, et al.  
(Genetics **54**: 61, 1969)

Biochemical abbreviations: follow rules of the U.I.P.A.C. -I.U.B.  
(J. Biol. Chem. **241**: 527, 1966)

Enzyme activity: should be expressed in terms of international units.  
(Enzyme Nomenclature. Elsevier Pub. Co., 1965)

Geographical names, authors names and names of plants and animals should be spelled in full.

The JOURNAL reserves the privilege of editing manuscript or of returning it to the author for revision.

3. **ABSTRACT.** Each manuscript must be accompanied by an abstract, typewritten on a separate sheet.

4. **TITLE.** Begin each title with a word useful in indexing and information retrieval (Not "Effect" or "New".)

5. **ILLUSTRATIONS.** Original drawings *should not be submitted*. Glossy prints are desirable—not larger than 8½ by 11 inches and preferably not smaller than 5 by 7 inches. When appropriate, magnification should be indicated by a suitable scale on the photograph.

6. **REPRINTS** (in multiples of 100) may be purchased from the printer by contributors. A table showing the cost of reprints, and an order form, will be sent with the proof.

7. **SUBSCRIPTION** to the JOURNAL is \$8.00 per year, in advance, and should be sent to the New York Entomological Society, The American Museum of Natural History, Central Park West at 79th Street, New York, New York, 10024. The Society will not be responsible for lost JOURNALS unless immediately notified of change of address. We do not exchange publications. Please make all checks, money orders and drafts payable to the NEW YORK ENTOMOLOGICAL SOCIETY.

8. **ORDERS** and inquiries for back issues and complete sets should be sent to our agent: S-H Service Agency, Inc., 866 Third Ave., New York, N.Y. 10022.

595.70673  
Ent.

Vol. LXXXIII

JUNE 1975

No. 2

Journal  
of the  
New York  
Entomological Society

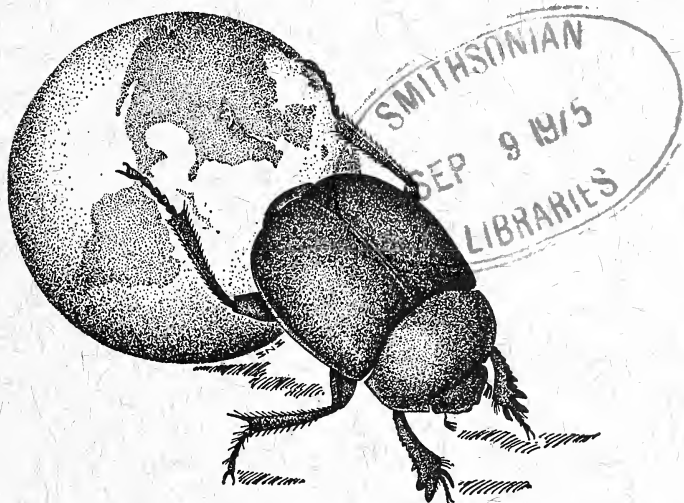

Devoted to Entomology in General

**The New York Entomological Society**  
**Incorporating The Brooklyn Entomological Society**  
**Incorporated May 21, 1968**

---

**The New York Entomological Society**  
**Organized June 29, 1892—Incorporated February 25, 1893**  
**Reincorporated February 17, 1943**

---

**The Brooklyn Entomological Society**  
**Founded in 1872—Incorporated in 1885**  
**Reincorporated February 10, 1936**

The meetings of the Society are held on the first and third Tuesday of each month (except June, July, August and September) at 8 P.M., in the AMERICAN MUSEUM OF NATURAL HISTORY, 79th St. & Central Park W., New York, N. Y. 10024.

Annual dues for Active Members, \$4.00; including subscription to the Journal, \$9.00.

Members of the Society will please remit their annual dues, payable in January, to the Treasurer.

---

**Officers for the Year 1975**

*President*, Dr. Daniel J. Sullivan, S.J.  
Fordham University, New York 10458

*Vice-President*, Dr. Peter Moller  
American Museum of Natural History, New York 10024

*Secretary*, Dr. Charles C. Porter  
Fordham University, New York 10458

*Assistant Secretary*, Dr. Louis Trombetta  
Isaac Albert Research Institute, Brooklyn, N.Y. 11203

*Treasurer*, Dr. Ivan Huber  
Fairleigh Dickinson University, Madison, N.J. 07940

*Assistant Treasurer*, Ms. Joan DeWind  
American Museum of Natural History, New York 10024

---

**Trustees**

Class of 1975  
Dr. Howard Topoff  
Dr. Pedro Wygodzinsky

Class of 1976  
Dr. David C. Miller  
Dr. Norman Platnick

---

Mailed August 29, 1975

The Journal of the New York Entomological Society is published quarterly for the Society by Allen Press Inc., 1041 New Hampshire, Lawrence, Kansas 66044. Second class postage paid at New Brunswick, New Jersey and at additional mailing office.

Known office of publication: Waksman Institute of Microbiology, New Brunswick, New Jersey 08903.

# Journal of the New York Entomological Society

VOLUME LXXXIII

JUNE 1975

No. 2

## EDITORIAL BOARD

*Editor* DR. KARL MARAMOROSCH  
Waksman Institute of Microbiology  
Rutgers University  
New Brunswick, New Jersey 08903

*Associate Editors* DR. LOIS J. KELLER, RSM  
DR. HERBERT T. STREU

Publication Committee  
Dr. Kumar Krishna                      Dr. Ayodha P. Gupta  
Dr. James Forbes, Chairman

---

## CONTENTS

Revision of the Genus <i>Endeodes</i> LeConte with a Tabular Key to the Species (Coleoptera: Melyridae) .....	Ian Moore and E. F. Legner	70
Comparative Behavior of Wasps in the Genus <i>Lindenius</i> (Hymenoptera: Sphecidae, Crabroninae) .....	Richard C. Miller and Frank E. Kurczewski	82
New or Little-Known Crane Flies from Iran. III (Diptera: Tipulidae) .....	Charles P. Alexander	121
New or Little-Known Crane Flies from Iran. IV (Diptera: Tipulidae) .....	Charles P. Alexander	129
Book Reviews .....		81, 128, 139

## Revision of the Genus *Endeodes* LeConte with a Tabular Key to the Species (Coleoptera: Melyridae)

IAN MOORE AND E. F. LEGNER

DIVISION OF BIOLOGICAL CONTROL, UNIVERSITY OF CALIFORNIA, RIVERSIDE 92502

RECEIVED FOR PUBLICATION JUNE 17, 1974

**Abstract:** Species of the genus *Endeodes* are known only from the seashore of Pacific North America. *E. fasciatus*, *E. rothi* and *E. intermedius*, n. spp., are from the upper Gulf of California. A tabular key to the nine known species is given. The pronotum and elytron of each species is illustrated.

LeConte (1859) included three species from California when he described the genus *Endeodes*. Blackwelder (1932) reviewed the genus and added two more California species, Moore (1954) reviewed the genus, added a new species from the Pacific Coast of Baja California Norte, Mexico and reduced one of LeConte's species to synonymy. Marshall (1957) described a new species from the south end of the Gulf of California, and Moore (1964) reviewed the genus again adding another species from Sonora, Mexico.

The species of this genus are rather unusual in their intertidal habitat. Some are found on the sandy Pacific beaches of southern California and Baja California where they are usually encountered under debris, often patches of dried seaweed. Other species occur from California northward on reefs exposed at low tide. The Gulf of California supports another group of species which is also found on rocky shores at low tide.

The genus *Endeodes* may be distinguished from other members of the family Melyridae by the combination of the following characters (Arnett 1962): first sternite not keeled between the coxae, eye simple, head neither rostrate nor excavated, protrusible vesicles present on prothorax and between metathorax and abdomen, abdomen without bristles, elytra strongly abbreviated, protarsus 5-segmented, antenna 11-segmented.

Males of *Endeodes* may be distinguished from females by the presence on the protarsus of an elongated swollen second segment which terminates in a comb of thick black setae.

---

**Acknowledgments:** We are indebted to Paul Arnaud and David Kavanaugh of the California Academy of Sciences, San Francisco for loan of a holotype and several paratypes, to Milton Campbell of the Entomology Research Institute, Ottawa, Canada, for loan and gift of material and to R. E. Orth, of the University of California, Riverside, for criticism and technical help. We particularly thank Vincent D. Roth of the Southwestern Research Station of the American Museum of Natural History, Portal, Arizona, for allowing us to study intertidal beetles collected by him in the Gulf of California.



The larva of *insularis* was described by Moore (1956) and a key to the larvae of three species was given by Moore (1964). A pupa doubtfully identified as *insularis* was figured by Moore (1954).

In this paper we describe three new species from the upper Gulf of California, reduce one species to synonymy and present a tabular key to the species. Drawings are given of the pronotum and an elytron of each species. The pronota and elytra offer the best characters for specific separation.

The construction and use of tabular keys, developed by I. M. Newell, were discussed in two recent papers (Newell 1970, 1972).

#### STATEMENT OF CHARACTERS

1. Ratio of length to width of elytron = RAT. LEN. WID. ELY.  
(5.4 to 12.4)
  2. Shape of apex of elytra = SHAPE APEX ELY.  
ARCU = arcuate  
TRUN = subtruncate, apex straight centrally with the angles broadly rounded
  3. Color of elytra = COL. ELY.  
PICE = piceus  
FERR = entirely ferruginous  
BASE = piceus with the base ferruginous  
APEX = piceus with the apex ferruginous  
MIX = general mixture of piceus and ferruginous
  4. Sculpture of elytra = SCUL. ELY.  
ROUG = surface rough and microreticulate  
SMOO = surface not rough except for microreticulation
  5. Ratio of width to length of pronotum = RAT. WID. LEN. PRON.  
(6.4 to 4.4)
  6. Shape of pronotum = SHAPE PRON.  
TRAN = transverse, not constricted at base  
CORD = cordate, not or hardly transverse, constricted at base
  7. Color of head = COL. HEAD  
PICE = entirely piceus  
FERR = yellow to ferruginous  
VARI = variable from ferruginous to ferruginous with dark areas  
Distribution = DISTR.  
NoPac = California and Pacific Northwest  
Cal = California  
C & B = California and Pacific Baja California  
Baja = Pacific Baja California  
Son = Sonora, Mexico  
Gul = Baja California gulf coast
- Source  
SPM = specimen  
Par = paratype  
Hol = holotype

Tabular key to the species of *Endeodes*

1	2	3	4	5	6	7			
RAT. LENG. WID. ELY.	SHAPE APEX ELY.	COL. ELY.	SCUL. ELY.	RAT. WID. LEN. PRON.	SHAPE PRON.	COL. HEAD	Distr.	Source	Name
12.4	Trun	Mix	Smoo	5.4	Tran	Ferr	Son	Hol	<i>fasciatus</i>
12.4	Arcu	Apex	Smoo	5.4	Tran	Ferr	Gulf	Spm	<i>terminalis</i>
9.4	Arcu	Mix	Roug	4.4	Cord	Ferr	Son	Hol	<i>rothi</i>
8.4	Arcu	Ferr	Smoo	4½.4	Tran	Ferr	Son	Hol	<i>sonorensis</i>
8.4	Arcu	Base	Roug	4.4	Cord	Ferr	C & B	Spm	<i>basalis</i>
8.4	Trun	Ferr	Roug	4.4	Cord	Ferr	Baja	Par	<i>blaisdelli</i>
7.4	Arcu	Mix	Smoo	4½.4	Tran	Ferr	Son	Hol	<i>intermedius</i>
5.4	Arcu	Pice	Roug	6.4	Tran	Pice	NoPac	Spm	<i>collaris</i>
5.4	Arcu	Ferr	Roug	6.4	Tran	Ferr	Cal	Par	<i>insularis</i>

*Endeodes fasciatus* n. sp.

Description of holotype, male.

*Color.* Head, pronotum and appendages ferruginous; clypeus testaceous; eyes black; elytra ferruginous with a common piceus spot at inner apical angles which also embraces apical two-thirds of scutellum, and a piceus band across just below the middle leaving the apices bright ferruginous; beneath largely dark except head which is ferruginous.

*Head.* Oval, about as wide as long, tempora about as long as eye; surface rather strongly microreticulate, very finely punctured and pubescent, the punctures generally separated by more than their diameters; antennae semi-monilliform, second segment about as long as third, tenth segment very little longer than wide.

*Pronotum.* About one-fourth wider than long, widest centrally; apex and base each evenly arcuate into sides so that the angles are not prominent; surface rather strongly microreticulate, very finely and sparsely punctured and pubescent, the punctures separated by more than twice their diameters.

*Elytra.* Each elytron a little more than twice as long as wide; humerus rather narrowly rounded, sides straight to the just perceptibly inflated apex; outer apical angles broadly rounded into the briefly truncate apex; inner apical angles more narrowly rounded. Surface smooth except for a dense but fine microreticulation. Pubescence very fine, short and sparse.

*Abdomen.* Upper surface concealed by the elytra either due to deformity or damage, the abdomen being displaced forward so that the basal segments override the metathorax.

*Length.* About 2.5 mm. This specimen would probably be about 3 mm long except for the abnormal abdomen.

*Specimen described.* Holotype, male, Mexico, Sonora, Punta Cirio (29.53°-112.50°) 20 March 1974, from seaweed lying on a 2" to 6" boulder strewn beach, V. Roth and W. Brown collectors. Deposited in American Museum of Natural History, New York City.

*Notes.* This species is distinct in its small size, relatively long semitruncate elytra and the color pattern of the elytra.

*Endeodes terminalis* Marshall

*Endeodes terminalis* Marshall 57-13; Moore 64-58; Moore 71-278.

*Color.* Head ferruginous with the disc near base infumate; pronotum yellow; elytra piceus

in basal three-fourths with apex abruptly yellow, dividing line between the two colors oblique; abdomen and scutellum piceus; legs and antennae ferruginous and infumate.

*Head.* Oval, about one-fourth wider than long; tempora about as long as eye; surface densely microreticulate, pubescence fine and moderately dense, punctures imperceptible; antenna with second segment not quite as long as third, tenth segment short, as wide as long.

*Pronotum.* About one-fifth wider than long; apex arcuate, evenly rounded into the broadly rounded apical angles, sides briefly straight and convergent, basal angles broadly rounded into the arcuate base, base narrower than apex. Surface sculpture and pubescence very similar to that of head.

*Elytra.* Each elytron about two and two-thirds times as long as wide; humerus broadly rounded, sides straight and somewhat divergent, outer apical angles broadly rounded into the arcuate apex, inner apical angles broadly rounded. Surface sculpture and pubescence very similar to that of foreparts.

*Abdomen.* As finely but not as densely sculptured and pubescent as elytra.

*Length.* About 3.5 mm.

*Specimen examined.* One female, Mexico, Baja California Norte, Puertocito, 31 May 1963, T. Palmer collector. This specimen is accompanied by a larva and a pupa.

*Notes.* The elytra are the longest in the genus leaving little more than two abdominal segments exposed. The type locality was given as "Baja California, Mexico, S.E. and Isla Caballo, III-30-53." This locality proved to be an error for Isla Ceralbo at the very southern part of the Gulf of California (Moore 1971). The new locality for the specimen described above is five hundred and fifty miles north in the upper Gulf of California.

*Endeodes rothi* n. sp.

Description of holotype, female.

*Color.* Head, pronotum and appendages bright ferruginous; clypeus testaceous; eyes black; elytra with base, apex and marginal beeding ferruginous, disc piceus; abdomen largely piceus with the basal, lateral and apical margins of anterior segments ferruginous; beneath ferruginous except for patches of piceus on terminal abdominal segments.

*Head.* Oval, a little longer than wide; tempora about one and one-half times as long as eye; surface finely microreticulate, very finely punctured and pubescent, the punctures generally separated by more than their diameters; antennae with all the segments longer than wide, second segment almost as long as third, tenth segment half again as long as wide.

*Pronotum.* About as wide as long, widest at apical third; apex broadly rounded, evenly rounded into apical angles, thence sharply constricted in basal third to the narrowly rounded basal angles; base gently arcuate; surface somewhat impressed in center of base; base four-fifths as wide as pronotum. Surface very finely microreticulate and shining. Punctures very fine, generally separated by about twice their diameters.

*Elytra.* Each elytron a little more than twice as long as wide; humerus broadly rounded, sides thence nearly straight for a short distance, thence widened and broadly arcuate to the widest point at about four-fifths of the length, thence broadly rounded into the evenly arcuate apex. Elytra conjointly appear sharply constricted at basal third and widely inflated in basal two-thirds, the surface flattened in basal third. Sculpture rough and rather strongly

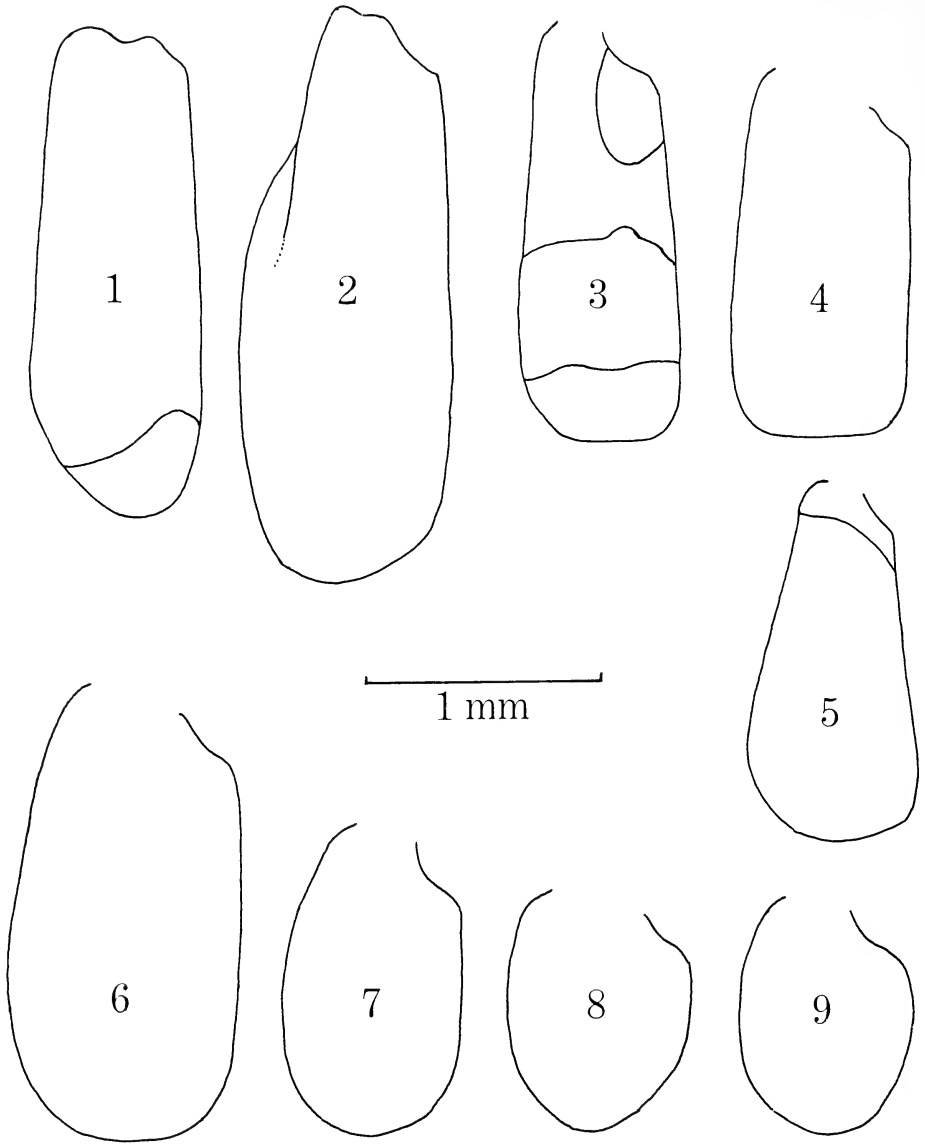

FIGS. 1-9, elytra of *Endeodes*:

1. *terminalis*
3. *fasciatus*
5. *basalis*
7. *intermedius*
9. *collaris*

2. *rothi*
4. *blaisdelli*
6. *sonorensis*
8. *insularis*

microreticulate with fine punctures separated generally by at least twice their diameters. Pubescence of fine decumbent pale hairs and sparse coarse long dark setae.

*Abdomen.* About as wide as elytra. Microreticulation a little finer than on elytra. Punctures very sparse. Pubescence very fine.

*Length.* About 4.8 mm.

*Specimen examined.* Holotype, female, Mexico, Sonora, Punta Cirio (29.53°-112.50°), March 20, 1974, from seaweed on 2"-6" boulder strewn beach, V. Roth and W. Brown collectors, in collection of The American Museum of Natural History, New York City.

*Notes.* This is the most distinctive species in the genus. It differs from the other species particularly in its longer tempora, elongate antennomeres and the fact that the elytra are conjointly constricted at the base and inflated in the apical two-thirds. The shape of the pronotum is similar to that of the Pacific Coast species *basalis* and *blaisdelli*. This species is named in honor of one of its collectors, Vincent D. Roth.

*Endeodes sonorensis* Moore

*Endeodes sonorensis* Moore 64-57, 58.

*Color.* Head and pronotum ferruginous; legs ferruginous with the femora infumate, antennae ferruginous becoming darker apically; elytra piceus with humerus very narrowly ferruginous; abdomen largely ferruginous with a piceus central cloud on each segment, last segment mostly piceus; beneath ferruginous except for piceus metasternum and last abdominal segment.

*Head.* Oval, a little wider than long; tempora about as long as eyes; surface without ground sculpture, finely punctured, the punctures generally separated by about their diameters; pubescence very fine. Antennae semi-monilliform, second segment slightly shorter than third, tenth a little longer than wide.

*Pronotum.* A little wider than long, widest at apical fourth; apex arcuate, anterior angles broadly rounded, sides thence straight and convergent to broadly rounded basal angles, base straight, narrower than apex; without ground sculpture; punctures and pubescence very similar to that of head.

*Elytra.* Each elytron about twice as long as wide; humeral angle narrowly rounded, sides gently arcuate into broadly arcuate apex. Surface sculpture a dense but fine microreticulation, otherwise smooth except for a small central slightly rough patch.

*Abdomen.* A little wider than conjoint elytra; punctures and pubescence similar to that of pronotum.

*Length.* About 4 mm.

*Specimen examined.* Holotype, female, Mexico, Sonora, Punta De Los Cuervos, San Carlos Bay, near Guaymas, 18 November 1962, intertidal reef, Ian Moore collector, in collection of California Academy of Sciences, San Francisco.

*Notes.* This species resembles *intermedius* but differs in its longer elytra and other details. We have also seen one male and one female from Mexico, Sonora, Kino Bay, 21-22 September 1973, V. Roth and W. Brown collectors. These specimens are similar to the holotype except that the abdomen and metasternum of one are entirely ferruginous and in the other slightly infumate.

*Endeodes basalis* (LeConte)

*Atelestus basalis* LeConte 52-168.

*Atelestus abdominalis* LeConte 52-168, **New Synonym.** (This synonymy was suggested by Moore, 1954, but not clearly indicated.)

*Endeodes basalis* LeConte 59-122; Horn 72-112; Blackwelder 32-134; Moore 54-196, 197; Moore 57-140; Moore 64-158.

*Endeodes abdominalis* LeConte 52-122; Horn 72-112; Blackwelder 32-134.

**Color.** Head, pronotum and antennae ferruginous, legs ferruginous with the femora infumate, elytra largely piceus with the base ferruginous, abdomen piceus.

**Head.** Oval, about as wide as long; tempora about one and one-half times as long as eye; surface very finely, densely microreticulate; pubescence fine, short and moderately dense, punctures imperceptible; antenna with second segment slightly more than half as long as third, tenth segment slightly longer than wide.

**Pronotum.** About as long as wide; widest at about apical third; apex arcuate into the broadly rounded apical angles; sides briefly constricted just before the rounded basal angles; base slightly emarginate. Sculpture and pubescence very similar to that of head.

**Elytra.** Each elytron about twice as long as wide, humeral angle narrowly rounded, sides straight and diverging to the broadly rounded outer apical angles, apex arcuate, inner apical angles narrowly rounded. Surface rough and with dense microreticulation. Punctures and pubescence much as on the elytra with added long scattered erect setae.

**Abdomen.** Sculpture, punctures and pubescence very similar to that of elytra.

**Length.** About 3.5 mm.

**Specimen described.** Female, California, San Luis Obispo County, Cambria, 21 August 1972, under dry seaweed on berm of beach, Ian Moore collector.

**Notes.** This species is distinct in the combination of its long piceus elytra with the base pale and its cordate pronotum. The color of the abdomen is variable, ranging from entirely ferruginous to entirely piceus with many intergrades (Moore 1954) which led LeConte to describe one color form under the name *abdominalis*. It is reported from Ensenada, Baja California, Mexico to Monterey County. It is most commonly found under dried seaweed and other debris on the berm of the sandy beaches.

*Endeodes blaisdelli* Moore

*Endeodes blaisdelli* Moore 54-196; Moore 64-58.

**Color.** Entirely dull ferruginous except eyes, tips of mandibles black and abdomen above and beneath piceus.

**Head.** Oval, about as wide as long; tempora slightly longer than eye; finely densely microreticulate throughout; finely pubescent but not perceptibly punctured. Antenna with the second segment about half as long as third, tenth segment slightly longer than wide.

**Pronotum.** About as wide as long, widest at about apical third; apex arcuate into the broadly rounded apical angles, sides briefly constricted just before the rounded basal angles base very slightly emarginate. Sculpture and pubescence similar to that of head.

**Elytra.** Each elytron about twice as long as wide; humeral angles narrowly rounded, sides straight and slightly diverging to the broadly rounded outer apical angles; apex straight,

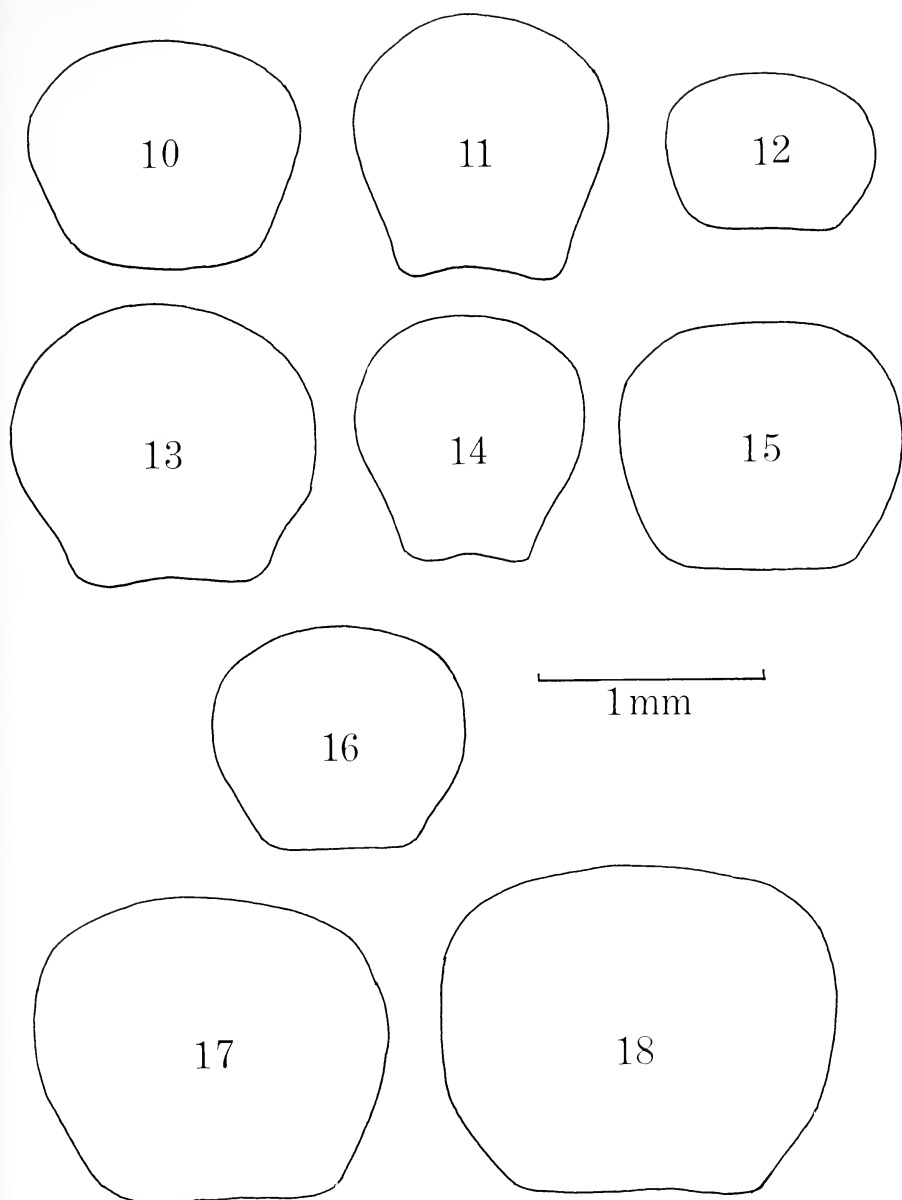

FIGS. 10-18, pronota of *Endeodes*:

- 10. *terminalis*
- 12. *fasciatus*
- 14. *basalis*
- 16. *intermedius*
- 18. *collaris*

- 11. *rothi*
- 13. *blaisdelli*
- 15. *sonorensis*
- 17. *insularis*

inner apical angles broadly rounded. Surface rough and with dense microreticulation. Pubescence fine and sparse with a few long, erect, pale setae.

*Abdomen.* Microreticulation more sparse than that of foreparts, punctures and pubescence very fine and sparse.

*Length.* About 3 mm.

*Specimens examined.* Seven paratypes, Mexico, Baja California, Colonia Guerrero, 19 August 1950, Ian Moore collector.

*Notes.* This species is easily known from all the others except *fasciatus* by its long, truncate elytra; it differs from *fasciatus* in its cordate pronotum and concolorous elytra. It is known only from the type locality.

*Endeodes intermedius* n. sp.

Description of holotype, female.

*Color.* Head, pronotum, legs and under surface of abdomen ferruginous; eyes and tips of mandibles black; antenna largely ferruginous becoming darker apically; elytra piceus on disc with a narrow ferruginous rim, a little widest as base; abdomen largely piceus with edges of basal segments testaceous.

*Head.* Oval, very slightly longer than wide; tempora about one-half longer than eyes; surface just perceptibly microreticulate, shining; moderately, coarsely punctured, the punctures generally separated by about their diameters; antennae semi-monilliform, second segment two-thirds as long as third, tenth segment hardly longer than wide.

*Pronotum.* Slightly wider than long, widest at apical third, apex gently arcuate into the broadly arcuate anterior angles, sides thence convergent and nearly straight to the more narrowly rounded basal angles, base nearly straight but slight emarginate centrally; base about four-fifths as wide as apex. Surface without microsculpture; punctures dense, separated by less than their diameters; pubescence short and dark.

*Elytra.* Each elytron a little less than twice as long as wide: humerus narrowly rounded, sides briefly straight, thence arcuate into the very broadly rounded outer apical angles; surface vaguely impressed near scutellum; surface finely microreticulate; punctures and pubescence much like those of pronotum.

*Abdomen.* Reticulation a little finer than on elytra; punctures and pubescence a little more dense and fine than on elytra.

*Length.* About 4 mm.

*Specimen described.* Holotype, female, Mexico, Sonora, Punta Cuevas (29.42°–112.35°), 24–5 September, 1973, V. Roth and W. Brown collectors, on algae covered pitted rhyolite, at night during low tide, in the collection of The American Museum of Natural History, New York City.

Allotype, male, Mexico, Sonora, Puerto de Lobos (30.16°–112.50°), March 18–19, 1974, V. Roth and W. Brown collectors.

Paratype, one female, same data as holotype.

*Notes.* The name *intermedius* was chosen for this species because the elytra are intermediate in length between those of *collaris* and *insularis* and those of the other species. The shape of the pronotum along with that of *sonorensis* is intermediate between that of *basalis* and



*blaisdelli* and that of the other species. The lengths of the antennal segments along with those of *sonorensis* are intermediate between those of *rothi* and the other species.

*Endeodes collaris* (LeConte)

*Atelestus collaris* LeConte 52-168.

*Endeodes collaris* LeConte 59-122; Horn 72-112, Blackwelder 32-134; Moore 54-196; Moore 56-220 (Larva); Moore 64-58.

*Color.* Piceus with the bases of the antennae, bases of the tibiae, the tarsi and trophi paler and the pronotum testaceous.

*Head.* Oval, one-third wider than long; tempora almost twice as long as eyes; surface densely, finely microreticulate; punctures moderately large, separated by less than their diameters; impressed in center of apical half; second antennal segment almost as long as third, tenth segment almost as wide as long.

*Pronotum.* One-third wider than long; widest in the middle; apex arcuate, apical angles broadly rounded, sides arcuate into the broadly rounded basal angles, base nearly straight but perceptibly emarginate in center. Surface without microreticulation, punctures feeble, generally separated by about their diameters, with a few dark scattered setae.

*Elytra.* One-fifth wider than long; humeral angles obsolete, sides arcuate into the broadly rounded outer apical angles and arcuate apex, inner apical angles broadly rounded. Surface rough and densely microreticulate, with fine pubescence and scattered erect setae. Punctures not apparent.

*Abdomen.* Feebly microreticulate with punctures generally separated by a little more than their diameters, with sparse pale decumbent pubescence.

*Length.* About 4.75 mm.

*Specimen described.* Female, Nanaimo, British Columbia, Canada, 16 June 1927, L. G. Saunders collector.

*Notes.* This species is distinct in the combination of the very small elytra and the piceus head. The elytra are very much smaller in relation to the pronotum than those of the other species except *insularis*. It is known from Vancouver Island, British Columbia to San Mates County, California. It is usually taken under drift on the beach below high tide mark.

*Endeodes insularis* Blackwelder

*Endeodes insularis* Blackwelder 32-134; Moore 54-196, 198; Moore 56-229 (Pupa?); Moore 64-58.

*Endeodes rugiceps* Blackwelder 32-135; Moore 54-196; Moore 56-220 (Larva); Moore 64-58

**New Synonym.**

*Color.* Entirely pale ferruginous except tip of mandibles black, eyes grey and abdomen entirely piceus.

*Head.* Oval, two-fifths wider than long; tempora slightly shorter than eye; surface very densely finely microreticulate; pubescence short, dense and fine with scattered short dark setae in basal half; flattened in center of apical half; antenna with second segment a little more than half as long as third, tenth about as wide as long.

*Pronotum.* One-half wider than long, widest at apical fourth, apex arcuate, apical angles broadly rounded, sides rounded into broadly rounded basal angles, base arcuate; surface feebly microreticulate, punctures dense, separated by less than their diameters, pubescence as on head with scattered short dark setae throughout.

*Elytra.* Each elytron very small, about one-fourth longer than wide, conjointly much narrower than pronotum; humeral angle hardly apparent, sides very weakly arcuate, apex broadly arcuate; surface rough, sculpture and pubescence similar to those of head; numerous short dark erect setae throughout.

*Abdomen.* Sculpture a fine dense microreticulation; pubescence fine, pale, decumbent, moderately dense.

*Length.* About 4.5 mm.

*Specimen described.* Paratype female, San Miguel Island, Santa Barbara County, California, 20 June 1910, V. W. Owen collector.

*Notes.* This species is distinct in its very small elytra combined with its red head. The elytra are very much smaller in relation to the head than any other species in the genus except *collaris*.

We have also examined one male and one female paratype with the same data as above and one male paratype from Prince Island, Santa Barbara County, California, 19 May 1919, E. P. Van Duzzee collector.

We have seen four paratypes of *E. rugiceps* Blackwelder from Carmel, Monterey County, California taken in March, May and June from 1912 to 1923. Two of these are males and two females. We can find no difference between these and the paratypes of *insularis* except that the femora and antennae of two of them are somewhat darker than those parts in *insularis*, a character that is variable in some species of the genus. Blackwelder (1932, p. 135) said of *rugiceps* "Male genitalia as in *collaris*." However, we have dissected a male paratype (Carmel, III-25-23, Blaisdell collection) and find the aedeagus to be the same as that of *insularis* as figured by Blackwelder (1932, p. 133, figs. 3F). Therefore, we conclude that *rugiceps* is a synonym of *insularis*.

#### Literature Cited

- ARNETT, ROSS H. JR. 1962. The Beetles of the United States (A Manual for Identification). Pt. V, pp. 648-850. The Catholic University of America Press. Washington.
- BLACKWELDER, RICHARD E. 1932. The genus *Endeodes* LeConte. Pan-Pac. Ent., **8**: 128-136, 3 Figs.
- HORN, GEORGE H. 1872. Synopsis of the Malachiidae of the United States. Trans. American Ent. Soc., **4**: 109-127.
- LECONTE, JOHN L. 1852. Catalogue of the Melyrids of the United States, with description of new species. Proc. Acad. Nat. Sci. Philadelphia, **6**: 163-171.
- . 1859. Descriptions of some species of Coleoptera from the vicinity of the southern boundary of the United States of America. Arcana Naturae, **1**: 121-128.
- MARSHALL, M. Y. 1957. Studies in Malachiidae VII. Coleopt. Bull., **11**: 13-16.
- MOORE, IAN. 1954. Notes on *Endeodes* with a description of a new species from Baja California (Coleoptera: Malachiidae). Pan-Pac. Ent., **30**: 195-198.
- . 1956. Notes of some intertidal Coleoptera with descriptions of the early stages (Carabidae, Staphylinidae, Malachiidae). Trans. San Diego Soc. Nat. Hist., **12**: 207-230, pls. 14-17.
- . 1957. A northern extension of range for *Endeodes basalis* LeConte. Pan-Pac. Ent., **33**: 140.

- . 1964. A new species of *Endeodes* from Sonora, Mexico. (Coleoptera: Melyridae). Pan-Pac. Ent., **40**: 57-58.
- . 1971. The type locality of *Endeodes terminalis* Marshall (Coleoptera: Malachiidae). Pan-Pac. Ent., **47**: 278.
- NEWELL, IRWIN M. 1970. Construction and use of tabular keys. Pac. Insects **12**: 25-37, 3 Figs.
- . 1972. Tabular keys, further notes on their construction and use. Trans. Conn. Acad. Arts Sci., **44**: 259-267. 4 Figs.

---

### BOOK REVIEW

**PEST CONTROL: A Survey.** Arthur Woods, Halsted Press, John Wiley & Sons, New York, 407 p. \$29.50. 1974.

This book can be recommended highly to all interested in the principles and methods of pest control. It is written as an introductory text, with carefully chosen examples of insect pests, diseases of plants, technological advances, and biological means of control. The author first defines pests and their control, as well as the economics of pest control and of methods used. Factors such as population density, death rate, and community stability are analyzed in the second chapter. The third chapter deals with the uses of chemical pesticides, as well as the economics of their production. Drawbacks of chemical control receive due attention in the fourth chapter. Biological control, including the use of insects, bacteria, viruses, fungi, higher plants, to mention the main ones, are outlined in the following 3 chapters, followed by newer approaches, such as sterilization, genetic control, pheromones, attractants, repellents, and the use of miscellaneous other control methods. Finally, integrated control is presented in proper perspective. The book is so written that it can be used not only by the professional scientist, interested in biology, agriculture, entomology, or ecology, but also by the general reader. To achieve this and not to oversimplify has been a difficult task solved by the author admirably. The book can be used as a text in university and college courses on pest control, conservation, and courses dealing with the impact of man on his environment. References are well chosen and the index is divided into 3 parts, listing separately diverse names and subjects, scientific names of species, including viruses, and Latin names.

I admired the readability of this excellent volume, a feature seldom found in technical books. Perhaps the fact that the author has written numerous articles for technical journals and that he has produced 6 courses on biological topics for the Australian television network have been responsible for this feature. The book would make a valuable addition to school libraries and public libraries everywhere.

Although the author modestly states that a book like his rapidly becomes out of date, this volume contains so much valuable information and presents it so well that it will be used as a reference in the years to come. Efficient pest control is urgently needed and if adequate awareness of population control becomes a reality, mankind might find a way of survival. Otherwise, even the best control methods will merely postpone the doom. Producing more food is a necessity but producing adequate amounts of food for an uncontrolled population of the world is an impossibility.

KARL MARAMOROSCH  
Waksman Institute of Microbiology  
Rutgers University  
New Brunswick, New Jersey

**Comparative behavior of wasps in the genus  
*Lindenius* (Hymenoptera: Sphecidae, Crabroninae)**

RICHARD C. MILLER<sup>1</sup> AND FRANK E. KURCZEWSKI

DEPARTMENT OF ENTOMOLOGY, STATE UNIVERSITY OF NEW YORK, COLLEGE OF  
ENVIRONMENTAL SCIENCE AND FORESTRY, SYRACUSE, NEW YORK 13210

RECEIVED FOR PUBLICATION JUNE 17, 1974

**Abstract:** Observations on the nesting behaviors of the Nearctic *Lindenius armaticeps*, *L. buccadentis*, and *L. columbianus errans* are presented and the world literature on the ethology of the Palaearctic *L. albilabris*, *L. panzeri*, and *L. pygmaeus* is reviewed. Behavioral features shared by all species include construction of nests 3–12 cm deep in firmly-packed sand or fine gravel, presence of a vertical main burrow leading frequently to a short horizontal passage, absence of a temporary nest closure during provisioning, attachment of the egg to the neck of a prey along the ventral midline, and distribution of the prey remains evenly over the surface of the cocoon. Valuable characteristics for separating species or species groups include the kinds, proportions, and stages of the prey, chronological placement of cells in the nest, method of prey storage, absence or presence of impalement of the prey during transport, exiting behavior, and number of prey per cell.

INTRODUCTION

The genus *Lindenius* currently includes 48 species of small ground-nesting wasps, 37 in the Palaearctic and 11 in the Nearctic and Neotropical regions (DeBeaumont, 1956; Court and Bohart, 1958; Leclercq, 1954, 1959, 1960). The majority of the Palaearctic species are found along the Mediterranean, especially at the western end (DeBeaumont, 1956). The southwestern U.S. is a secondary stronghold for the genus because all the New World species except *L. montezuma* (Cameron), known only from Mexico, occur there (Muesebeck

---

**Acknowledgments:** We are grateful to D. L. Dindal and E. O. Price for critically reading parts of the manuscript, and to S. E. Ginsburg and C. J. Lane for their assistance in the field. We are indebted to R. A. Norton and D. J. Peckham for many of the photographs, and to H. E. Evans for prey records from Blackjack Creek, Kansas, and nest provisions from Lexington, Massachusetts. We are especially grateful to the following persons for their help in identifying the unusually large number of prey insects: E. F. Cook, University of Minnesota; K. V. Krombein, Smithsonian Institution; B. D. Burks, R. W. Carlson, R. J. Gagne, J. L. Herring, L. V. Knutson, P. M. Marsh, A. S. Menke, L. M. Russell, C. W. Sabrosky, R. I. Sailer, D. R. Smith, G. C. Steyskal, and W. W. Wirth, all of the Systematic Entomology Laboratory, USDA, ARS. This work was supported by a Grant-in-Aid from the Research Foundation of the State University of New York (No. 10-7116-A) and an NSF Undergraduate Research Participation Program Grant, summer 1970 (No. GY-7286).

<sup>1</sup>Present address: Department of Entomology, Cornell University, Ithaca, New York 14850.

*et al.*, 1951; Leclercq, 1954; Krombein, 1958; Krombein and Burks, 1967). The only species with ranges extending into the eastern U.S. are the 3 treated in this paper: *L. armaticeps* (Fox), *L. buccadentis* Mickel, and *L. columbianus errans* (Fox).

The nesting behaviors of the Nearctic species are essentially unknown. In contrast, the Palaearctic *L. albilabris* (Fabricius), *L. panzeri* (Van der Linden), and *L. pygmaeus* (Rossi) have been studied over a period of 90 years. The purpose of this paper is to review the world literature on the nesting behavior of *Lindenius*, to present original results on *L. armaticeps*, *L. buccadentis*, and *L. c. errans*, and to determine the ethological characters most useful in distinguishing species and those of potential value in separating *Lindenius* from other sphecid genera. A detailed account of male behavior and intraspecific interactions in aggregations of *Lindenius* has been presented elsewhere (Miller and Kurczewski, 1973).

#### LITERATURE REVIEW

##### *Lindenius (Lindenius) albilabris* (Fabricius)

Kohl (1915) reported this species as the most common and widespread member of the genus in the Palaearctic region. Nests have been found from June to October in level, often compact, sand, sandy-gravel, loess, or chalk of paths and sandpits (Adlerz, 1903, 1910; Grönblom, 1925; Minkiewicz, 1931, 1933; Chambers, 1949; Blüthgen, 1955; Bonelli, 1967). The wasps often aggregated with as many as 16 nests per sq yd (Nielsen, 1900).

The circular nest entrance, 2–3.5 mm in diameter, was surrounded by a transitory tumulus, 30 mm wide  $\times$  10 mm high, that was periodically renewed during burrow construction (Minkiewicz, 1931, 1933; Bonelli, 1967). The main burrow, straight or somewhat curved depending on subterranean obstacles, descended vertically 3–10 cm and usually turned horizontally into a passage, 1–10 cm long (Nielsen, 1900; Adlerz, 1910; Minkiewicz, 1931, 1933; Bristowe, 1948). From 1 to 7 cells, 5–6  $\times$  6–13 mm, were positioned around the horizontal burrow or the lower half of the vertical shaft at depths of 4–10 cm (Adlerz, 1910; Minkiewicz, 1931, 1933). Bonelli (1967) described an unusual nest in which the vertical burrow forked into 2 branches, each terminating in 3 cells. Straight or winding side burrows, 1–6 cm long, were plugged with sand and led from the main burrow to completed cells (Minkiewicz, 1933). The cells were either strongly inclined (Bonelli, 1967) or nearly horizontal (Minkiewicz, 1933; Bristowe, 1948), and were occasionally separated by only 1–2 mm (Minkiewicz, 1931).

In the first nest figured by Minkiewicz (1931, Tab. XI, Fig. 6) the incompletely provisioned cell was the shallowest, whereas in his second example (1933, Tab. XII, Fig. 7) it was the deepest one in the nest. Bonelli (1967)

excavated a nest having the older cells nearer the entrance. Newly-captured prey were stored in open, incompletely provisioned cells rather than in the burrow (Adlerz, 1910; Minkiewicz, 1931, 1933).

One female observed in Italy by Bonelli (1967) opened her nest entrance at 0830 hrs but did not exit until 0900 hrs, whereupon she made an orientation flight facing the entrance. Such orientation was not repeated subsequently unless the female experienced difficulty in entering the nest or was about to begin provisioning a newly-excavated cell. After the full complement of prey had been gathered, the female closed the entrance with sand, sealed off the completed cell, and constructed a deeper new cell. The sand was pushed outside, increasing the size of the tumulus. Within 30–45 min after plugging the entrance, the female emerged and began provisioning the new cell. She made 15 trips for prey before plugging the entrance again and spending the night in the burrow. Two cells were completed per day, the excavation and provisioning of each taking about 3 hrs. Adlerz (1910) noted that the female rested in the burrow not only at night but also at mid-day and during bad weather. He observed that the nest entrance was plugged only when the female was excavating a new cell. Minkiewicz (1931) believed that each female constructed only a single nest.

Provisioning wasps returned to their nests in flight, diving in without hesitation (Adlerz, 1910; Bristowe, 1948; Blüthgen, 1955; Bonelli, 1967). Adlerz (1910) reported that the prey was held with the middle legs when the wasp was on the ground, whereas Bristowe (1948), Hertzog (1954), and Blüthgen (1955) observed impaling of the prey on the sting. Bonelli (1967) believed that the female held the prey with the posterior claws. Bristowe (1948) and Blüthgen (1955) observed the impaling only after capturing the wasp and its prey in a container. The former noted that the [tibial] spurs of the middle legs were used to hold the impaled prey in position under the abdomen.

The average time required to capture a prey and return to the nest, calculated from Bonelli's (1967) data, was 4.3 min (1–12, N = 19). The average time needed to store a prey and return to the surface was only slightly less ( $\bar{x}$  = 4 min, 2–6, N = 18). Hamm and Richards (1926) and Bristowe (1948) found prey discarded near the nest entrances but disagreed on the underlying causes.

Although *L. albilabris* stores mainly adult and nymphal Miridae, it occasionally captures adult flies of the families Empididae, Dolichopodidae, and Chloropidae (Table 1). Twenty-two genera of mirids made up 95% of all prey records. Possibly the numerous undetermined Diptera found by Adlerz (1903, 1910) included representatives of families other than those mentioned. In 13 of 20 areas where *L. albilabris* was studied, only mirids were found as prey. Unfortunately, detailed records of nest contents were not made in the

TABLE 1. Prey of *Lindenius albilabris*.

Family	Species	Source
Hemiptera		
Miridae	<i>Adelphocoris</i> sp.	Hamm and Richards, 1926
	<i>Amblytylus nasutus</i> (Kirschbaum)	Hamm and Richards, 1926;
	[ <i>affinis</i> Fieber] <sup>1</sup>	Bristowe, 1948
	<i>Calocoris norvegicus</i> (Gmelin)	Hamm and Richards, 1926;
		Bonelli, 1967
	<i>Calocoris roseomaculatus</i> (DeGeer)	Hamm and Richards, 1926
	<i>Conostethus roseus</i> (Fallén)	Hamm and Richards, 1926
	<i>Globiceps flavomaculatus</i> (Fabricius)	Bouwman, 1911
	<i>Halticus apterus</i> (Linnaeus)	Grönblom, 1925
	<i>Heterotoma merioptera</i> (Scopoli)	Bristowe, 1948
	<i>Hoplomachus thunbergi</i> (Fallén)	Nielsen, 1900
	<i>Leptopterna ferrugata</i> (Fallén)	Grönblom, 1925
	<i>Lygocoris pabulinus</i> (Linnaeus)	Bristowe, 1948
	<i>Lygus pratensis</i> (Linnaeus)	Minkiewicz, 1931, 1933
	<i>Lygus</i> sp.	Grönblom, 1925
	<i>Megaloceroea recticornis</i> (Geoffroy)	Bristowe, 1948
	[ <i>linearis</i> Fuessly]	
	<i>Megalocoleus molliculus</i> (Fallén)	Hamm and Richards, 1926
	<i>Miris</i> sp.	Adlerz, 1910; Hamm and
		Richards, 1926
	<i>Notostira erratica</i> (Linnaeus)	Hamm and Richards, 1926
	<i>Orthotylus ericetorum</i> (Fallén)	Hamm and Richards, 1926
	<i>Orthotylus</i> sp.	Bristowe, 1948
	<i>Pithanus maerkeli</i> (Herrich-Schaeffer)	Bristowe, 1948
	<i>Plagiognathus</i> sp. nr. <i>albipennis</i>	Blüthgen, 1955
	(Fallén)	
	<i>Plagiognathus arbustorum</i> (Fabricius)	Bristowe, 1948
<i>Plagiognathus chrysanthemii</i> (Wolff)	Grönblom, 1925; Hamm and	
	Richards, 1926; Bristowe,	
	1948	
<i>Polymerus unifasciatus</i> (Fabricius)	Hamm and Richards, 1926	
<i>Stenodema calcaratum</i> (Fallén)	Bouwman, 1911; Grönblom,	
	1925	
<i>Stenotus binotatus</i> (Fabricius)	Hamm and Richards, 1926;	
	Bristowe, 1948	
<i>Trigonotylus ruficornis</i> (Geoffroy)	Grönblom, 1925; Hamm and	
	Richards, 1926; Bristowe,	
	1948	
Diptera		
Empididae	<i>Empis aestiva</i> Loew	Bristowe, 1948
	<i>Empis albinervis</i> Meigen	Bristowe, 1948
Dolichopodidae	<i>Diaphorus latifrons</i> Loew	Sickmann, 1893
Chloropidae	<i>Meromyza pratorum</i> Meigen	Hamm and Richards, 1926
	<i>Meromyza saltatrix</i> (Linnaeus)	Hamm and Richards, 1926;
	[ <i>laeta</i> Meigen]	Bristowe, 1948

<sup>1</sup> [ ] indicates synonyms given by original authors.

3 areas where only flies were reported so that one may doubt whether *L. albilabris* ever stores flies exclusively. In 1 area of Poland *L. albilabris* appeared to be prey-specific, taking only *Lygus pratensis* (Linnaeus) (Minkiewicz, 1933), whereas in England it captured 10 species of mirids as well as

3 species of chloropid and empidid flies (Bristowe, 1948). Bonelli (1967) observed prey specificity in Italy on a different mirid, *Calocoris* sp., probably *norvegicus* (Gmelin). The claims of certain compilers (Iwata, 1942; Dupuis, 1947) that *L. albilabris* preys on Hymenoptera are in error.

The most extensive observations on the number of prey per complete cell were made in Sweden by Adlerz (1910) who found 6–23 ( $\bar{x} = 16.1$ ) prey in 23 cells. Minkiewicz (1931) found as few as 4 per complete cell, whereas Bonelli (1967) found as many as 25. Data on the number of genera and species of prey per nest and cell were lacking except in the 2 instances of prey specificity cited above. Hamm and Richards (1926) and Bristowe (1948) found more female than male mirids. The prey were stacked one atop another in the cell, all heads facing in the same direction (Adlerz, 1910). They were paralyzed (Nielsen, 1900; Adlerz, 1910; Bouwman, 1911; Minkiewicz, 1933; Bristowe, 1948; Bonelli, 1967), and the egg-bearer was not mutilated (Minkiewicz, 1931).

The egg was attached to the neck of a mirid along the ventral midline and extended obliquely backward at an angle of  $45^\circ$  to the body axis of the prey (Minkiewicz, 1931, Tab. XIV, Fig. 7; Bonelli, 1967, Tab. II), or was nearly transverse (Adlerz, 1910). According to Minkiewicz (1931), the egg was white,  $2-3 \times 0.6$  mm, and followed the curvature of the bug's prosternum. It was laid after the full complement of prey had been gathered (Minkiewicz, 1933) and was borne by 1 of the first prey placed in the cell (Bonelli, 1967).

The development of the larva and the construction of the cocoon were discussed by Bonelli (1967). The egg hatched in about 40 hrs in an artificial cell in the laboratory and the larva reached maturity in 4 days, consuming even the more sclerotized parts of the nymphal mirids. The larva enveloped itself in a silken cocoon in 12 hrs and, during the next 24 hrs, spread a secretion over the inside that cemented the threads and sand grains together. The yellow-brown cocoons, covered only with sand, were  $4 \times 7-8$  mm (Fig. II). Grönblom (1925) found smaller, darker cocoons in Finland and noted that they were covered with prey remains as well as with larval excrement and gravel particles. According to Bonelli (1967), *L. albilabris* is monovoltine in at least part of Italy and overwinters in the larval stage.

#### *Lindenius (Trachelosimus) panzeri* (Van der Linden)

Kohl (1915) recorded this species from central and southern Europe, England, northern Africa and western Asia. Nests were found from July to September in flat, hard-packed sand and loess of garden walks and woods' paths or, less commonly, in sloping banks (Marchal, 1893; Bouwman, 1911; Kohl, 1915; Hamm and Richards, 1926; Minkiewicz, 1932, 1933; Guichard and Yarrow, 1947; Abrahamsen, 1950).



TABLE 2. Prey of *Lindeni* *panzeri*.

Family	Species	Source
Simuliidae	<i>Simulium ornatum</i> Meigen	Sickmann, 1893
Tephritidae	<i>Dithryca guttularis</i> (Meigen)	Sickmann, 1893; Kohl, 1915
	<i>Orellia jaceae</i> (Robineau-Desvoidy)	Minkiewicz, 1932
	<i>Tephritis</i> sp.	Bouwman, 1911
	<i>Trupanea stellata</i> (Fuessly)	Minkiewicz, 1932
Milichiidae	<i>Madiza glabra</i> Fallén	Minkiewicz, 1932
Chloropidae	<i>Chlorops hypostigma</i> Meigen	Bouwman, 1911
	<i>Chlorops pumilionis</i> (Bjerkander)	Marchal, 1893; Hamm and Richards, 1926
	[ <i>lineata</i> Fabricius, <i>taeniopus</i> Meigen]	
	<i>Chlorops rufina</i> (Zetterstedt)	Hamm and Richards, 1926
	<i>Chlorops troglodytes</i> (Zetterstedt)	Hamm and Richards, 1926
	<i>Chlorops</i> sp.	Abrahamsen, 1950
	<i>Meromyza saltatrix</i> (Linnaeus)	Hamm and Richards, 1926
	[ <i>laeta</i> Meigen]	
	<i>Thaumatomyia glabra</i> (Meigen)	Minkiewicz, 1932
	undetermined sp.	Guichard and Yarrow, 1947

The circular entrance, 3–3.5 mm in diameter, was surrounded by a small tumulus of soil that soon eroded (Minkiewicz, 1932, 1933). The main burrows were vertical, slightly inclined, or tortuous as a result of stones in the soil, and descended to depths of 4–12 cm (Bouwman, 1911; Minkiewicz, 1932; Abrahamsen, 1950; Olberg, 1959). Abrahamsen (1950) noted that nests were shallower in a heavily used, somewhat clayey footpath than in the sand alongside a forest road. From 2 to 9 cells per nest were found at depths of 3–11 cm and were joined to the main burrow by short, nearly horizontal burrows (Bouwman, 1911; Abrahamsen, 1950, Figs. 10–11). Bouwman (1911) schematically illustrated a nest having 9 cells in 2 horizontal planes cutting through a vertical burrow, the lower level of cells being constructed before the upper one. He believed that the sand from the excavation of a new cell was used to plug the side burrow leading to the previously provisioned cell.

Prey-laden females returned to their open nest entrances in flight, carrying the prey head-forward beneath them. The prey was held with the middle and hind legs of the wasp before landing, but only the middle legs were used on the ground (Olberg, 1959, p. 372). In contrast, Hertzog (1954) observed *L. panzeri* carrying its prey impaled on the sting.

With one exception, the prey of *L. panzeri* were flies of the acalyptrate muscoid Cyclorrhapha (Table 2). Chloropidae was the family most commonly stored, but it was not represented by as many genera as the Tephritidae. Hamm and Richards (1926) found only Chloropidae as prey in 3 areas in England, whereas Minkiewicz (1932) obtained Chloropidae, Tephritidae, and Milichiidae from nests in Poland. Bouwman (1911) and Minkiewicz (1932) indicated that non-chloropid flies were seldom captured. The fact that only 2 species of prey have been reported from more than 1 locality seems to

indicate that additional prey records are necessary for a more realistic appraisal of the prey limits of *L. panzeri*.

The number of prey per complete cell ranged from 11 (Abrahamsen, 1950) to 22 (Bouwman, 1911). Hamm and Richards (1926) found that 85 (98%) of 87 chloropids were males. Although Marchal (1893) believed the prey were killed outright, Abrahamsen (1950) asserted that they were paralyzed and moved their legs for several days after capture. Minkiewicz (1933) noted that the egg was attached ventrally to the neck of 1 of the prey, but only after the full complement had been gathered. In the Netherlands, the larva consumed the provisions in 1-5 days (Bouwman, 1911).

#### *Lindenius (Trachelosimus) pygmaeus* (Rossi)

Leclercq (1954) recorded this species from central and southern Europe, England, northern Africa, and southern Russia. Nests were found from June to September in level or gently sloping sand, compact sandy-clay, and loess (Ferton, 1901; Grandi, 1928, 1961; Minkiewicz, 1932, 1933; Maneval, 1937). The circular entrance, 2 mm in diameter, was surrounded by a small tumulus of soil that was often obliterated by wind and rain (Minkiewicz, 1932, 1933). The main burrows, vertical or slightly inclined, descended 8-10 cm and were seldom winding (Ferton, 1901; Grandi, 1928, 1961; Minkiewicz, 1932, 1933; Maneval, 1937). The burrow figured by Minkiewicz (1932, Tab. VI, Fig. 1) ended blindly, whereas that described by Grandi (1928, 1961) bent to the side after descending. Two cells excavated by Grandi (1928, 1961) were 4 × 7 mm and only 1 cm apart at a depth of 10 cm. Minkiewicz (1932) stated that the cells were all at about the same [unspecified] depth.

Ferton (1901) observed a female of *L. pygmaeus* capture a braconid on a flower, sting it for a long time, and carry it away. According to Minkiewicz (1932, 1933), females were slow in provisioning their nests and hovered cautiously above the open entrances before diving in. Olberg (1959, p. 375) photographed females holding the prey ventral-side-up and head-forward, using the middle pair of legs on the ground and both middle and hind legs in flight.

At least 95% of the prey of *L. pygmaeus* were Chalcidoidea and Ichneumonoidea (Hymenoptera) although nematocerous and acalyptrate flies were occasionally captured (Table 3). Chalcidoids were the most common provisions, constituting 88% of all prey records. The most common prey family, Pteromalidae, was represented by 15 genera, whereas the second in importance, Eulophidae, was represented by only 3 genera. A winged ant (Maneval, 1937) was an exceptional prey from the order Hymenoptera. The same author obtained 2 nematocerous flies, a sciarid and a ceratopogonid from the cell containing the ant, thereby confirming Grandi's (1928) observation that *L. pygmaeus* hunts Diptera as well as Hymenoptera. Olberg (1959) also found flies

TABLE 3. Prey of *Lindenius pygmaeus*.

Family	Species	Source
Hymenoptera		
Braconidae	<i>Apanteles</i> sp.	Ferton, 1901; Minkiewicz, 1932; Maneval, 1937
Ichneumonidae	Ophioninae sp.	Ferton, 1901
Chalcidoidea	undetermined sp.	Ferton, 1901; Maneval, 1937
Eulophidae	<i>Euplectrus bicolor</i> (Swederus)	Minkiewicz, 1932
	<i>Necremnus hippia</i> (Walker)	Minkiewicz, 1932
	<i>Tetrastichus</i> sp.	Grandi, 1928, 1961; Minkiewicz, 1932
Torymidae	<i>Torymus verbasci</i> Ruschka	Minkiewicz, 1932
Pteromalidae	<i>Cecidostiba collaris</i> Thomson	Minkiewicz, 1932
	<i>Coelopisthia cephalotes</i> (Walker)	Grandi, 1928, 1961; Minkiewicz, 1932
	<i>Coelopisthia</i> spp.	Grandi, 1928, 1961
	<i>Conomorium eremita</i> Förster	Grandi, 1928, 1961; Minkiewicz, 1932
	<i>Cyclogastrella deplanata</i> (Nees) [domesticus Walker]	Minkiewicz, 1932
	<i>Dibrachys cavus</i> (Walker) [bouchéanus Ratzeburg]	Minkiewicz, 1932
	<i>Diglochis silvicola</i> (Walker) [complanatus Thomson]	Minkiewicz, 1932
	<i>Habrocytus artemisiae</i> Förster	Minkiewicz, 1932
	<i>Habrocytus psittacinus</i> Förster	Minkiewicz, 1932
	<i>Habrocytus</i> spp.	Grandi, 1928, 1961; Minkiewicz, 1932
	<i>Homoporus</i> sp.	Minkiewicz, 1932
	<i>Mesopolobus modestus</i> (Walker)	Minkiewicz, 1932
	<i>Mesopolobus</i> sp. [Eutelus Walker]	Grandi, 1928, 1961
	<i>Pachyneuron formosum</i> Walker	Minkiewicz, 1932
	<i>Pteromalus</i> sp.	Marchal, 1893
	<i>Sphegigaster</i> sp.	Grandi, 1928, 1961
	<i>Stenomalina subfumatus</i> Thomson	Minkiewicz, 1932
	<i>Systasis encyrtoides</i> Walker	Minkiewicz, 1932
	<i>Systasis longicornis</i> Thomson	Grandi, 1928, 1961
	<i>Trichomalus punctinucha</i> Thomson	Minkiewicz, 1932
	<i>Trichomalus</i> sp.	Grandi, 1928, 1961; Minkiewicz, 1932
Formicidae	<i>Leptothorax nylanderi</i> Förster	Maneval, 1937
Diptera		
Ceratopogonidae	<i>Forcipomyia bipunctata</i> Linnaeus	Maneval, 1937
Sciaridae	<i>Sciara</i> sp.	Maneval, 1937
	acalyprate muscoid Cyclorrhapha	Olberg, 1959 (in photograph, not stated)
	undetermined specimen	Grandi, 1928, 1961

as prey but neglected to point out that the ones being carried by the females he photographed (p. 375) included acalyprates, a group not previously reported as prey of *L. pygmaeus*.

The number of prey per complete cell ranged from 17 (Minkiewicz, 1932) to 42 (Grandi, 1928, 1961), whereas the number of prey families per cell ranged from 3 (Grandi, 1928, 1961) to at least 5 (Maneval, 1937). The only

cell whose contents were completely identified (Minkiewicz, 1932) held 12 species belonging to 10 genera. Of the 45 prey Chalcidoidea listed by Minkiewicz (1932), 78% were females. Grandi (1928) also found that a majority of the chalcidoids were females. Marchal (1893), Ferton (1901), and Grandi (1928, 1961) found the prey to be paralyzed to varying degrees.

Minkiewicz (1933) noted that the egg was placed on the prey only after the provisions had been gathered. The elongate egg was attached ventrally to the neck of a chalcid along the midline, and curved obliquely backwards at an angle of 30–45° to the longitudinal axis of the prey's body (Minkiewicz, 1932, Tab. VI, Fig. 2). Grandi (1928, 1961) found the egg-bearer lying supine near the surface of the mass of provisions. The egg, 1.6 × 0.4 mm, was curved and off-white in color. Marchal (1893) and Grandi (1928) observed that the cocoon was covered with chalcid remains and had a metallic sheen. It was elongate, 4 × 8 mm, and had the aboral end more acute (Grandi, 1928).

#### RESULTS

##### *Lindenius (Trachelosimus) armaticeps* (Fox)

This species occurs in southern Canada and the U.S. east of the Cascade and Sierra Nevada Mountains (Muesebeck, *et al.*, 1951). Twenty-five nests were excavated as follows: 17, Selkirk Shores St. Pk., Oswego Co., N.Y., 15 June–4 August 1971–72; 5, Penny Settlement Rd., Lewis Co., N.Y., 18 August–19 September 1971; 2, Medford Lakes, Burlington Co., N.J., 22–23 July 1972; and 1, Great River, Suffolk Co., N.Y., 7 August 1972. Nests were usually found in level, firm and heavily-vegetated or extremely hard-packed and bare sandy roadbeds. The roads were bordered by wild grasses and annual herbs. At Selkirk, nests were located in a 6-ft-high sand cliff (Fig. 1).

The entrances of most active nests in level sand were surrounded by roughly circular tumuli, averaging 21 mm in diameter and 3 mm high (15–25 × 2–5, N = 13). Tumuli were often lacking in older nests. The burrows (Figs. 2A–H), 2 mm wide, entered the roadbed perpendicularly and descended more or less vertically to depths of 4.0–9.0 cm ( $\bar{x}$  = 6.1, N = 25). Pebbles and rocks were responsible for deviations of burrows from the vertical. Terminal horizontal passages, 1.0–3.0 cm long ( $\bar{x}$  = 1.6), were present in 18 of 23 nests in flat sand. The cliff nests at Selkirk entered the bank at nearly right angles and descended obliquely for 6.5–10.0 cm (Fig. 2H). One of 2 nests possessed a 1-cm-long horizontal passage extending parallel to the cliff face from the apex of the main burrow. Tumuli were not present around such entrances because the sand fell down the slope.

All nests had the cells arranged radially around the lower half or two-thirds of the main shaft, the lowest cell never being deeper than the open burrow. With one exception, the oldest cell in a nest was the shallowest and the

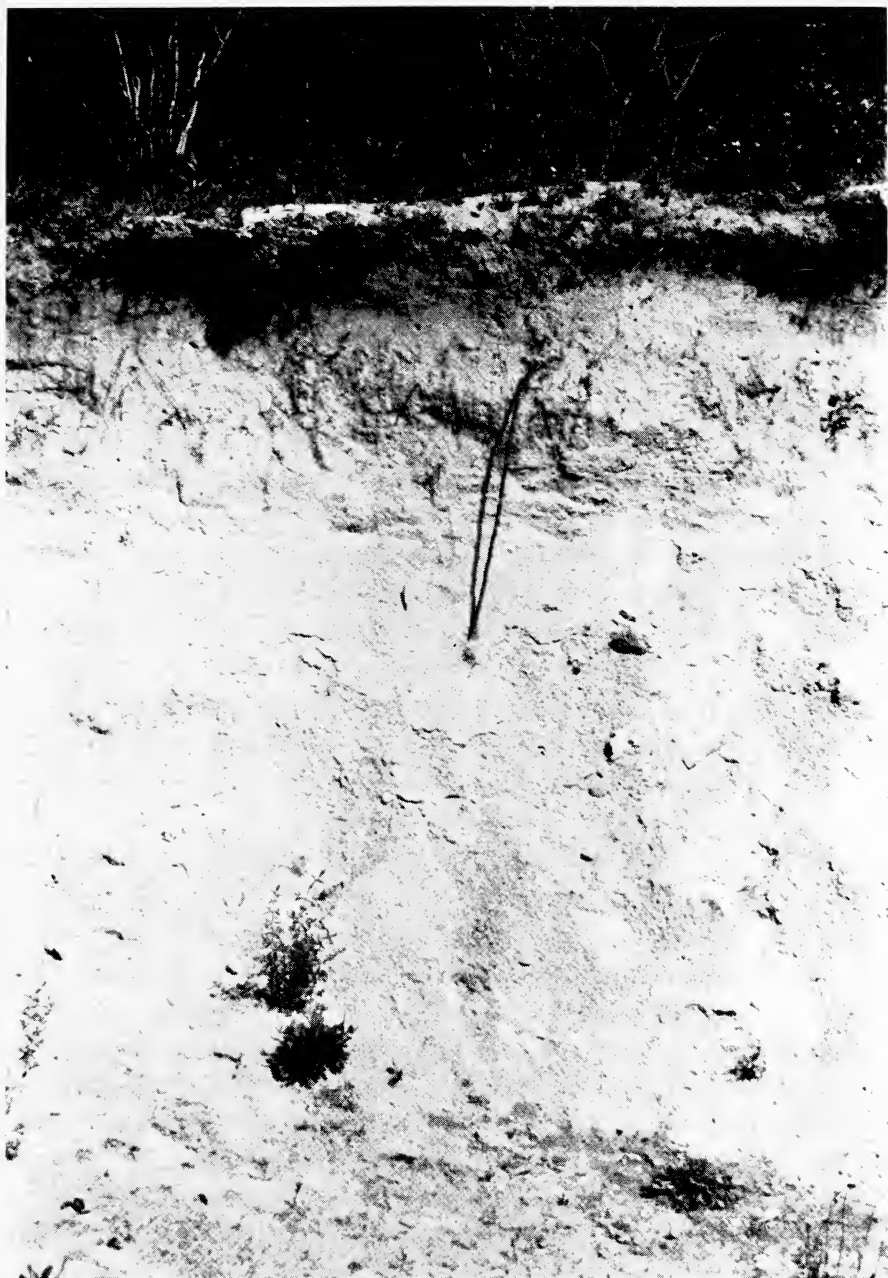

FIG. 1. Six ft high sand cliff at Selkirk Shores St. Pk., Oswego Co., N.Y. Females of *Lindeni* *armaticeps* nested in the lower 4 ft.

newest, the deepest (Figs. 2A-H). In level sand the distance of the cells from a vertical line through the entrance ranged from 0.3-4.2 cm ( $\bar{x} = 1.8$ ,  $N = 48$ ); pairs of cells separated by 1 cm or less were common. Cells in flat sand were unearthed at an average depth of 5.2 cm (2.7-8.0,  $N = 57$ ), whereas in cliffs they were 2-9 cm ( $\bar{x} = 4.9$ ,  $N = 7$ ) below the level of the entrance and 3.5-7.5 cm ( $\bar{x} = 4.8$ ) into the bank from a vertical line through the entrance. An average cell measured  $3.2 \times 7.4$  mm (2.5-4.0  $\times$  6.0-9.0,  $N = 47$ ).

Temporary storage of prey in an unwidened section of the burrow was common in nests being actively provisioned. However, in two nests, prey were stored in a slightly or conspicuously widened area at the end of the burrow. Storage of prey at the bottom of the vertical shaft was most common (Figs. 2A-D, F), but sometimes the flies were stored beyond the bend (Fig. 2G).

The nest resident plugs the upper burrow with sand when she has obtained enough prey to complete a cell. In such nests, a terminal horizontal passage has usually already been constructed and the female forms a cell at its apex. By opening nests at the appropriate time, it was ascertained that the female takes the prey from burrow storage and places them head-inward in the cell before ovipositing. Whether or not she removes them again before affixing an egg to the innermost fly is unknown. The vertical burrow is extended deeper and a new side passage is usually constructed prior to the female's reappearance at the surface. The entire process from entry to reappearance, including prey positioning, oviposition, and construction of a new side burrow took 88 min for one female and 108 for another.

Completed nests contained from 3 to 11 cells. Many nests were abandoned after periods of rain, and the entrances were subsequently obliterated. Females took 60 to 100 min to finally close their nest. The wasp removed sand from the upper walls of the vertical burrow with the mandibles and used its forelegs to push this sand down the burrow. One female exited every 5-15 sec during the final stage of nest closure and pushed sand from around the entrance backward into the burrow. When nest closure was complete, all that remained was a small conical depression, 5-7 mm wide and 5-15 mm deep. Each female then made an orientation flight above her closed nest before flying off and beginning a new nest elsewhere.

The prey were placed head-inward in the cells, but at least 1 fly was usually oblique or head-outward. The majority of prey on the bottoms of the cells were ventral-side-up while those on top were commonly dorsum-up. An egg-bearer, either male or female, was found at the inner end of the cell and was positioned dorsum-up, on its side, or venter-up. The white, slightly curved egg,  $1.5 \times 0.4$  mm, was attached to the neck of a fly along the ventral midline and was directed obliquely backward at an angle of 30-50° to its longitudinal

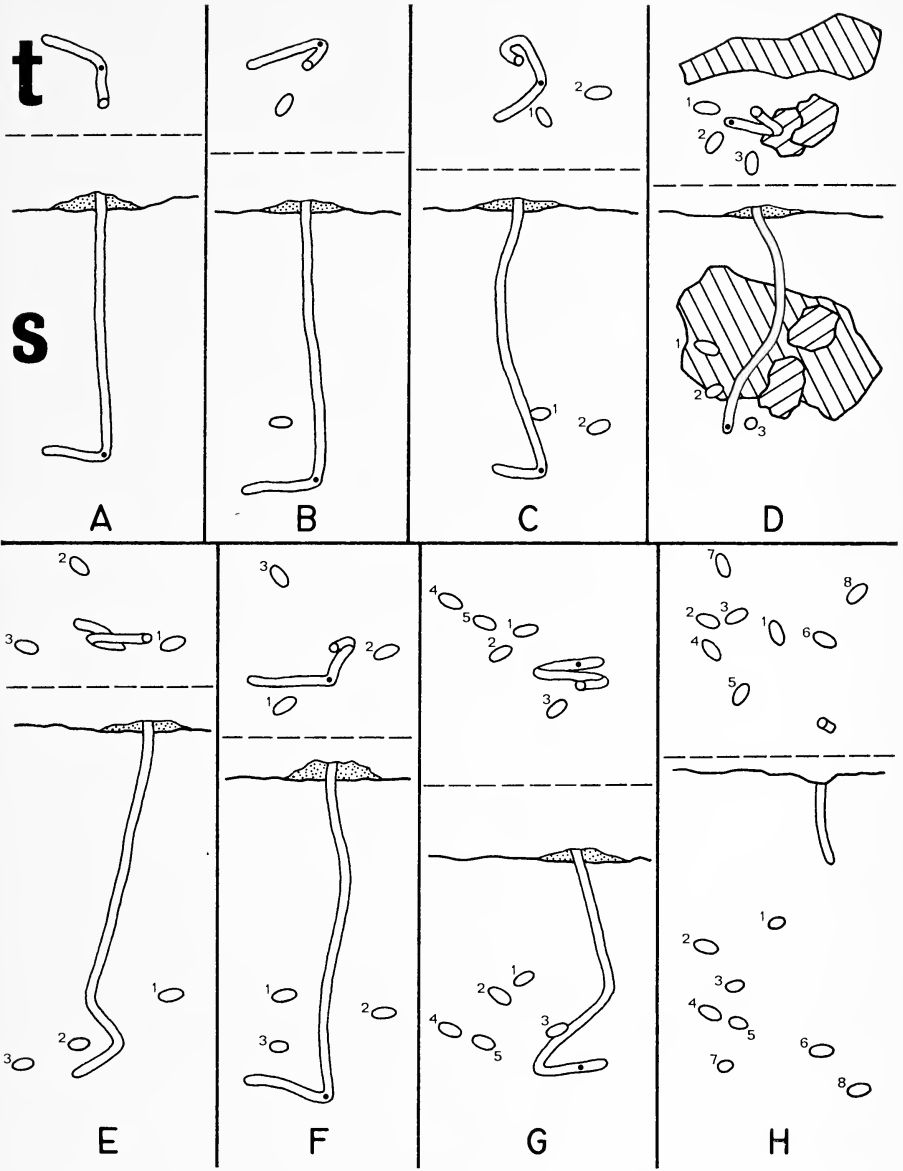

FIG. 2. Top (t) and side (s) views of nests of *Lindenius armaticeps*. Stippling indicates tumulus and sand fill; ●, burrow storage. Cells are numbered in apparent chronological order, according to contents.

TABLE 4. Prey of *Lindenius armiticeps* and their relative importance as provisions.

Species	N	% total	♂ ♂	♀ ♀
Selkirk Shores St. Pk., Oswego Co., N. Y.				
<i>Diplotoxa versicolor</i> (Loew)	3	0.7	2	1
<i>Meromyza</i> sp. nr. <i>pratorum</i> Meigen	14	3.1	7	7
<i>Parectecephala eucera</i> (Loew)	341	76.6	228	113
<i>Parectecephala sanguinolenta</i> (Loew)	80	18.0	26	54
<i>Thaumatomyia glabra</i> (Meigen)	7	1.6	6	1
Penny Settlement Rd., Lewis Co., N. Y.				
<i>Parectecephala eucera</i> (Loew)	163	100.0	107	56
Great River, Suffolk Co., N. Y.				
<i>Parectecephala eucera</i> (Loew)	42	100.0	38	4
Medford Lakes, Burlington Co., N. J.				
<i>Chlorops</i> sp.	3	27.3	1	2
<i>Diplotoxa versicolor</i> (Loew)	8	72.7	4	4

axis. It extended across either side of the fly with equal frequency, and the wing of the prey nearest its caudal end was spread as often as not.

The prey comprised flies of the family Chloropidae (Table 4). *Parectecephala eucera* (Loew) was especially prominent, making up 77% of the provisions at Selkirk and 100% of the provisions at Penny Sett. Rd. and Great River. At Selkirk, 228 (67%) of 341 prey of this species were males compared to 107 (66%) of 163 flies at Penny Sett. Rd. On the other hand, only 26 (33%) of 80 *Parectecephala sanguinolenta* (Loew) from nests at Selkirk were males. *P. sanguinolenta* was abundant in the fresh, low grass in the road between the nests, whereas *P. eucera* was common in the older, taller grass to the sides. The former species was captured as prey only in June and early July, while the latter was obtained from nests throughout the summer. Prey capture was observed several times within 15 ft of the midline of the road. During hunting, the wasps either walked on the grass blades or flew in circles around the stems and darted at dark objects on the green background including imperfections of the plants.

The average weight of a single prey was 1.1 mg (0.4-5.1, N = 202), the lightest being a male of *P. eucera* and the heaviest a female of *P. sanguinolenta*. The prey were rarely as heavy as their female captors which weighed 2.8-5.2 mg ( $\bar{x}$  = 4.4, N = 9). The average total weight of the flies in a fully-provisioned cell was 12.1 mg (7.4-18.8, N = 19). The number of prey per complete cell ranged from 3 to 15 ( $\bar{x}$  = 9.9, N = 39). The average number of genera per nest and cell were 1.5 (1-3, N = 20) and 1.2 (1-2, N = 46) at Selkirk and Penny Sett. Rd., while the average number of species per nest and cell were 1.8 (1-4) and 1.5 (1-3), respectively. Except for the nests in New Jersey, each cell contained some *Parectecephala*.



Two females were observed digging nests from the sand surface in mid-June. Each burrowed inward in a slow spiral, pushing up sand for slightly more than an hour before their tumuli remained stationary. These wasps stayed inside for the rest of the day and started provisioning the next morning. One female completed 2 cells and began provisioning a third during that day. She provisioned cells much slower a week later, and during her third and final week she brought no prey to the nest. She opened the nest each morning and closed it every evening but was rarely seen in the nest vicinity. A similar senescence was observed in another female who opened and closed her nest which contained only cocoons! Two other females showed a different kind of aging: newly-captured flies walked or flew out of the entrance shortly after the female dove down the burrow with them. After the non-paralyzed flies escaped, the wasp began backing up and down the burrow or repeatedly exiting and reentering in flight.

Females made orientation flights above their nests before the first provisioning trip of the day, after completion of a cell, or after disturbances such as a passing insect kicking sand into the entrance or an ant entering the burrow. In flat sand, an orientation lasted 3–15 sec and consisted of 1 to many obverse and reverse half-circles, 15 cm in diameter, above the nest. During lengthy orientations, the semi-circular flights changed to linear, spring-like movements which gradually increased in length from the entrance. Females inhabiting cliffs made transverse flights above and in front of their entrances, the flights gradually increasing in length up to 20 cm.

Provisioning females returned to their nests in flight, holding the prey ventral-side-up and head-forward with the middle legs (Fig. 3). A female approached her nest with little or no hovering and dove into the open entrance from a distance of 3–4 cm. Occasionally a female with prey landed in front of her entrance and simply walked into the burrow. Abandoned prey were not found near *L. armaticeps* nests.

Many females displayed an unusual method of prey transport—impalement of the fly on the sting—if they returned to their nests and found the entrances obstructed. Obstructed entrances often occurred naturally; however, comparable observations were made by artificially blocking openings with sand or bits of leaves. In either case, the female approached the nest holding the prey with her middle legs but then landed and impaled the fly in the region of the mesosternum. One wasp walked around looking for her naturally obstructed entrance for several minutes with the fly trailing from the end of her abdomen. She even made a brief, wavering flight with the prey still impaled. After locating the entrance, she walked into her nest with the prey extending head-forward from the under-curved tip of the abdomen. Significantly, wasps began carrying their prey into the nests in the usual manner on later trips when the entrances were unobstructed. A few females never impaled flies at arti-

ficially-blocked entrances but continued to hold their prey with the middle legs as they dug in with the forelegs.

Females provisioned nests from 0900 to 1950 hrs, but the majority of wasps were active between 1030 and 1600 hrs. At night, they plugged the upper burrows with sand and remained inside. The plug was removed in the morning, often as much as 1 hr before the first provisioning trip, and fresh sand was pushed out of the entrance if the nest was relatively new.

The average time required by 8 females at Selkirk to capture a fly and return to the nest was 11.3 min (0.8–35.0,  $N = 50$ ). One female averaged only 9.0 min (1.7–35.0,  $N = 10$ ), whereas a second took 12.5 min (2.1–21.5,  $N = 13$ ). The average time needed to store a prey in the burrow and return to the surface at Selkirk was 2.2 min (0.8–8.0,  $N = 52$ ), 1 female averaging only 1.8 min (1.0–5.1,  $N = 17$ ) and another 2.9 min (1.5–6.6,  $N = 11$ ). Females usually spent several seconds looking out of the entrance upon returning to the surface (Fig. 4). The average time spent in the entrance before flying off to obtain prey was 10 sec (0–30,  $N = 46$ ) at Selkirk, the extremes being 0–15 sec ( $\bar{x} = 6$ ,  $N = 10$ ) for one individual and 4–30 sec ( $\bar{x} = 17$ ,  $N = 19$ ) for another. With rare exception, *L. armaticeps* walked out of the nest, partly or entirely, before taking flight (Fig. 5).

One individual required 7 days to develop from an egg to a mature larva ready to spin a cocoon. The same rate of development was observed for specimens reared in sand-filled plastic containers in the laboratory. Mature larvae were positioned head-inward in the cells, facing away from the side passages leading to other cells.

The brown, ellipsoidal cocoons, averaging  $2.5 \times 6.0$  mm ( $2-3 \times 5-7$ ,  $N = 12$ ), were completely and evenly covered with the wings, legs, and thoracic sclerites of the prey. These remains were firmly attached to the exterior in a matrix of silk and sand. Cocoons removed from cells provisioned in late June and early July contained pupae, not resting larvae. These individuals would have comprised the August–September generation of *L. armaticeps*.

The sarcophagid *Phrosinella fulvicornis* (Coquillett) was observed larvipositing in closed nest entrances and was reared from a puparium found in a cell at Selkirk.

#### *Lindenius (Trachelosimus) buccadentis* Mickel

This species has been recorded from New York, Pennsylvania, Virginia, Iowa, Nebraska, Kansas, and Arizona (Muesebeck, *et al.*, 1951; Krombein and Burks,

→

FIG. 3-5. Female of *Lindenius armaticeps* carrying a chloropid fly with the middle legs; 4. pausing in entranceway before exiting; and, 5. walking out of nest.

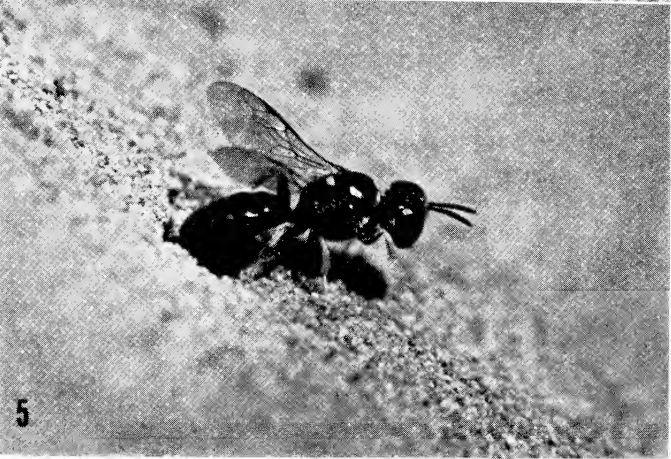
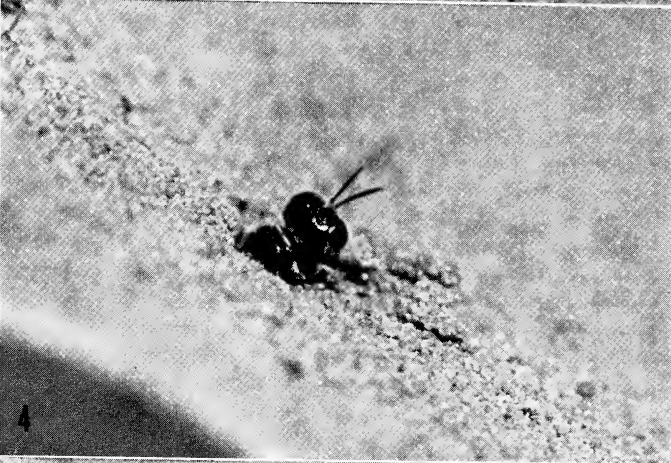
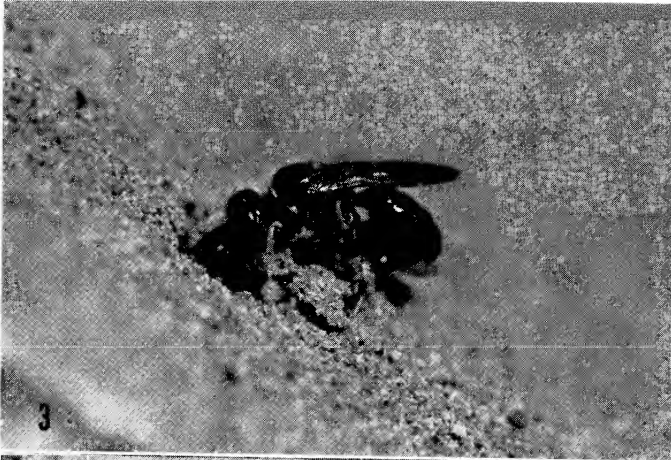

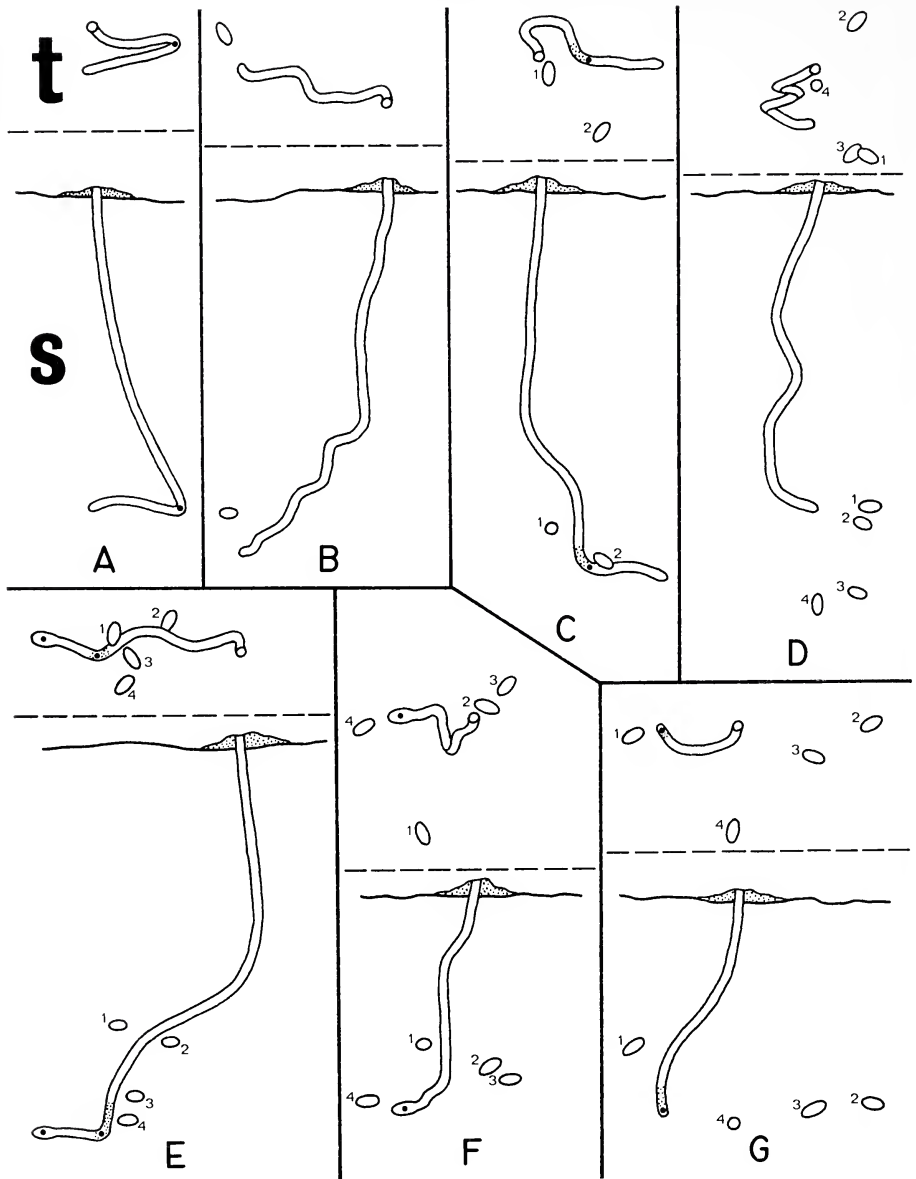

FIG. 6. Top (t) and side (s) views of nests of *Lindenius buccadentis*.

1967). The Cornell University Museum contains specimens from Vermont, New Hampshire, New Jersey, and Texas. Two nests were excavated at Medford Lakes, Burlington Co., N.J. on 8 August 1971, and 6 were dug at Bohemia, Suffolk Co., N.Y. from 7 to 9 August 1972. In both areas, nests were

found in the pine barrens in level hard-packed roadbeds of coarse sand margined by patches of wild grasses.

Nest entrances were surrounded by roughly circular tumuli, averaging 22 mm in diameter and 3 mm high ( $18-25 \times 2-5$ ,  $N = 8$ ). The main burrows descended vertically or in weak spirals to depths of 4.8–9.0 cm, and often curved 5–6 cm below the surface (Figs. 6A–G). Five nests had short horizontal passages, 1.0–2.5 cm long, at the apices of the main burrows. Nest entrances and burrows were 1.75–2.00 mm in diameter.

The oval cells were arranged radially around the lower third of the main burrow and were 0.2–3.8 cm from a vertical line through the entrance ( $\bar{x} = 1.9$ ,  $N = 21$ ). The average cell depth was 6.0 cm (3.5–10.5) and the average cell size,  $2.9 \times 6.8$  mm ( $2.5-3.5 \times 5.5-8.0$ ). Side burrows could not be traced. Active nests usually contained recently captured prey in temporary storage at the bottom of the main burrow (Figs. 6A, C, E–G), and these were occasionally sealed off by a loose plug of sand (Figs. 6C, E, G). Sections containing prey were no wider than other parts of the burrow. However, 2 nests at Bohemia (Figs. 6E, F) had prey temporarily stored in an open cell at the end of a short side passage. Neither nest contained enough prey for the female to complete the cell. The maximum number of cells per nest was 4, the cells decreasing in age with increasing depth.

Provisioning females returned to their nests in flight, holding the prey tightly against the sternum with the middle legs. They dove into their entrances from distances of 3–5 cm. The average time required to capture a prey and return to the nest, based on the activities of 2 females at Bohemia, was 4.4 min (0.7–13.5,  $N = 34$ ). One female took an average of only 3.7 min (0.9–10.6,  $N = 23$ ), whereas the other required an average of 5.7 min (0.7–13.5,  $N = 11$ ). The average time needed to store a prey was 41 sec (12–360,  $N = 38$ ), one female taking 36 sec (12–80,  $N = 13$ ) and the other 44 sec (16–360,  $N = 25$ ). Storage times did not exceed 80 sec with the exception of one 360 sec. This unusually long storage time occurred when a worker ant, *Monomorium minimum* (Buckley), fell into a nest seconds before the wasp returned with prey. The ant failed to reappear and, when the nest was dug open, 2 such worker ants lay paralyzed with other prey at the bottom of the main burrow. Exiting behavior of females varied greatly with the same individual either pausing or failing to pause in the entrance and either walking out of the nest or not before taking flight. The average time spent looking out of the entrance before flying off was 6 sec (0–55,  $N = 34$ ). Females made brief orientation flights over their nests when disturbed by male or female searchers (see Miller and Kurczewski, 1973), and they sometimes made 2–3 sec orientations without apparent cause.

After gathering sufficient prey to complete a cell, the female plugged the

TABLE 5. Prey of *Lindenius buccidentis* and their relative importance as provisions.

Family	Species	N	% total	♂♂	♀♀
Medford Lakes, N. J.					
Diptera					
Empididae	<i>Drapetis</i> sp. nr. <i>divergens</i> Loew	1	1.7	1	
Hymenoptera					
Braconidae	<i>Agathis</i> sp.	1	1.7		1
	<i>Apanteles paralechia</i> Muesebeck	37	61.7	16	21
	<i>Orgilus</i> sp.	6	10.0	5	1
Eulophidae	<i>Achrysocharella silvia</i> Girault	5	8.3		5
	<i>Euplectrus</i> sp.	1	1.7	1	
	<i>Tetrastichus</i> sp.	2	3.3		2
Pteromalidae	Pteromalinae sp.	2	3.3	2	
Eurytomidae	<i>Bruchophagus</i> sp.	1	1.7	1	
Ormyridae	<i>Ormyrus brunneipes</i> Provancher	1	1.7		1
Cynipidae	<i>Chariops</i> sp.	1	1.7		1
Bethylidae	<i>Apenesia parapollita</i> Evans	1	1.7	1	
Formicidae	<i>Monomorium minimum</i> (Buckley)	1	1.7		1 <sup>1</sup>
Bohemia, N. Y.					
Hymenoptera					
Braconidae	<i>Agathis</i> sp.	2	0.7	1	1
	<i>Apanteles</i> sp.	2	0.7		2
	<i>Bracon</i> sp.	3	1.1	2	1
	<i>Diaeretus</i> sp.	2	0.7	1	1
	<i>Pausia</i> sp.	1	0.4	1	
	<i>Phanerotoma</i> sp.	1	0.4		1
	<i>Rhaconotus cressoni</i> Muesebeck & Walkley	1	0.4	1	
Ichneumonidae	<i>Acrolytina</i> , n. gen.	1	0.4	1	
	<i>Mesochorus</i> sp.	1	0.4	1	
	<i>Toxophoroides scitulus</i> (Cresson)	1	0.4		1
Eulophidae	<i>Achrysocharella silvia</i> Girault	1	0.4		1
	<i>Chrysocharis</i> sp.	2	0.7		2
	<i>Closterocerus tricinctus</i> (Ashmead)	3	1.1		3
	<i>Euderus</i> sp.	2	0.7		2
	<i>Eulophus anomocerus</i> (Crawford)	1	0.4		1
	<i>Hysopus</i> sp.	2	0.7		2
	<i>Tetrastichus whitmani</i> (Girault)	1	0.4		1
	<i>Tetrastichus</i> sp.	4	1.4	3	1
Perilampidae	<i>Perilampus fulvicornis</i> Ashmead	3	1.1	2	1
	<i>Perilampus robertsoni</i> Crawford	1	0.4		1
Ormyridae	<i>Ormyrus brunneipes</i> Provancher	8	2.9	4	4
Pteromalidae	<i>Capellia</i> sp.	1	0.4		1
	<i>Erythromalus</i> sp.	5	1.8	4	1
	<i>Gastrancistrus aphidis</i> (Girault)	216	77.7	175	41
	<i>Pachyneuron siphonophorae</i> (Ashmead)	1	0.4		1
Eurytomidae	<i>Eudecatoma</i> sp.	1	0.4	1	
Chalcididae	<i>Spilochalcis</i> sp.	1	0.4	1	
Cynipidae	<i>Chariops</i> sp.	1	0.4		1
	<i>Cynipinae</i> sp.	4	1.4	3	1
Bethylidae	<i>Goniozus</i> sp.	2	0.7		2
Formicidae	<i>Monomorium minimum</i> (Buckley)	2	0.7		2 <sup>1</sup>
	<i>Tapinoma sessile</i> (Say)	1	0.4	1	

<sup>1</sup> Worker.

upper burrow with sand. She did not push quantities of sand out of the entrance during extension of the burrow. One female required 75 min to complete a cell and reopen the burrow. The number of cells constructed and provisioned each day varied between individuals. One female completed a cell containing 29 prey between 0930 and 1300 hrs whereas another female required most of 2 days for completion of 2 cells containing 77 and 74 prey.

Over 92% of the prey, comprising 1 family of Diptera and 11 families of Hymenoptera (Table 5), were from the superfamilies Ichneumonoidea and Chalcidoidea. Braconidae was the main prey family at Medford Lakes, whereas Pteromalidae was the main source of prey at Bohemia. Selection of exclusively one sex of prey was not apparent, but high percentages of male pteromalids and female eulophids were noted. The average number of prey per complete cell was 42 (22–77,  $N = 7$ ) and the average weight of the cell contents, at Medford Lakes, was 7.25 mg (6.45–8.05,  $N = 2$ ). A minute eulophid, *Achrysocharella silvia* Girault, was the lightest prey while a braconid, *Agathis* sp., was the heaviest. The average weight of an individual prey was 0.30 mg (0.10–1.15,  $N = 49$ ), whereas the average weight of 5 female wasps was 3.1 mg (2.6–3.4). The average number of prey families per nest and cell were 7.0 (4–10,  $N = 4$ ) and 5.4 (3–9,  $N = 7$ ), while the average number of genera and species per cell was 8.4 (4–14,  $N = 7$ ).

Most of the larger prey were positioned head-inward in the cell, away from the main burrow, whereas smaller prey, especially chalcids, were found in various positions. The egg-bearer was at the innermost end of the cell and was ventral-side-up, if large, but randomly-positioned, if small. The off-white, slightly curved egg,  $1.5 \times 0.3$  mm, was attached to the neck of a braconid or chalcid along the ventral midline and extended longitudinally backward at an angle of  $10^\circ$  to the body axis of the prey. The brown, ellipsoidal cocoons, averaging  $2.5 \times 6.0$  mm ( $2.0\text{--}3.0 \times 5.5\text{--}7.0$ ,  $N = 5$ ), were completely covered with the heads, thoraces, legs, and wings of the prey. These remains were firmly embedded in the cocoon.

#### *Lindeni* (*Trachelosimus*) *columbianus errans* (Fox)

*L. c. errans* is found in southern Canada and the U.S. east of the Rockies, while the nominate subspecies occurs in B.C., Washington, Idaho, Utah, and Wyoming (Muesebeck, *et al.*, 1951; Evans, 1970). In Massachusetts *L. c. errans* provisioned nests with minute Diptera, Hymenoptera, and Hemiptera (Evans, 1963), whereas in Wyoming the nominate subspecies stored a chalcid wasp (Evans, 1970).

Our behavioral studies were made in sandpits in 4 areas of central New York: Auburn and Sennett, Cayuga Co.; Chittenango, Madison Co.; and Selkirk Shores St. Pk., Oswego Co. The major part of the study was per-



FIG. 7. Level area of compact, sparsely-vegetated sand at Chittenango, Madison Co., N.Y. in which *Lindenius columbianus errans* nested.

formed during the summers of 1969–71 at a large commercial sand and gravel pit near Auburn where a dense aggregation dotted a  $3 \times 14$  ft ridge of firm clayey-sand (see Miller and Kurczewski, 1973, Fig. 1). A shallow pond 50 ft southwest of the ridge, annual herbs, grasses, and eastern cottonwood seedlings bordered the nesting site. The nests at Chittenango were located in a flat  $4 \times 20$  ft area of sparsely vegetated sand compacted by a payloador and surrounded by a dense growth of annual herbs and grasses (Fig. 7). For other characteristics of this site see Kurczewski, *et al.* (1969). At Selkirk Shores, nests were found not only in the steep bank (Fig. 1) but also in a level area of sand packed down intentionally by the senior author. The nests at Sennett were scattered in tire ruts among the annual herbs and grasses that had overgrown a recently bulldozed area of level sand.

Entrances to newly-constructed nests were surrounded by roughly circular tumuli averaging  $19 \times 2.5$  mm ( $12\text{--}26 \times 1\text{--}4$ ,  $N = 17$ ). Rain and wind rapidly weathered these tumuli so that only vestiges remained around the 1.75–2.00-mm-wide openings. In nests constructed in flat sand, the main burrow descended vertically for 3.5–11 cm ( $\bar{x} = 6.8$ ,  $N = 40$ ) and, in 31 (78%) of 40 nests, turned into a horizontal passage, 1–5 cm long ( $\bar{x} = 2.2$ ,  $N = 29$ ) (see Figs. 8A–H). Bank nests, such as that depicted in Fig. 8H, were uncommon. The ellipsoidal cells were arranged radially around the lower half of the vertical



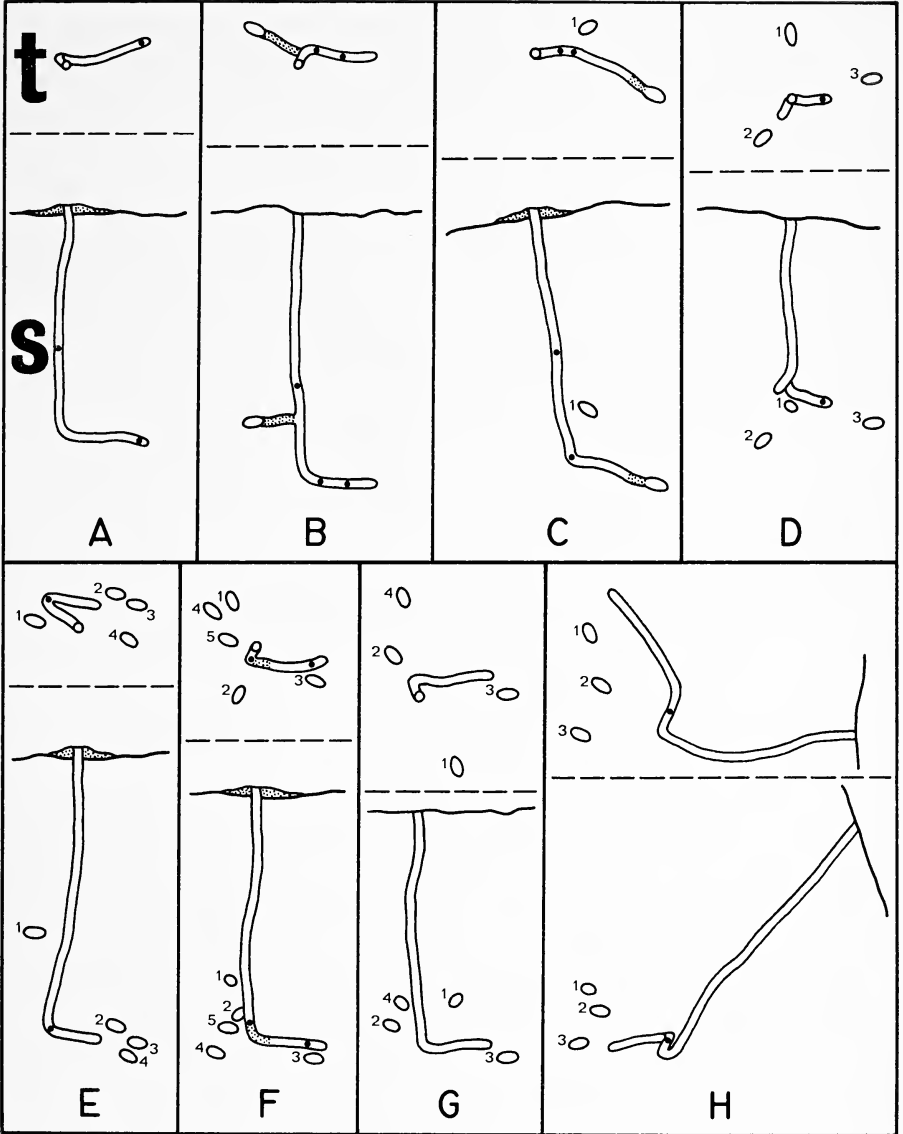

FIG. 8. Top (t) and side (s) views of nests of *Lindenius columbianus errans*.

shaft (Fig. 8F) or, less commonly, around the apex of the horizontal burrow (Fig. 8E). They averaged  $2.8 \times 6.8$  mm ( $2.5\text{--}3.5 \times 3.5\text{--}8.0$ ,  $N = 60$ ) and were separated from the main burrow by straight or winding side burrows, 1–5 cm long (Fig. 8B). Cell depths ranged from 3.5 to 11.5 cm ( $\bar{x} = 6.7$ ,  $N = 131$ ), the extreme means being 5.8 cm (4.5–8.0,  $N = 11$ ) at Sennett and

6.9 cm (3.5–11.5,  $N = 101$ ) at Auburn. This difference reflected the greater compaction of the sand at Sennett.

The first cell provisioned in a nest was usually the shallowest (Figs. 8B, C, E–H). Cell 3 was generally deeper than cell 2 but there was no discernible pattern in the depths of cells beyond the third. Although as many as 10 cells were found in a single nest, it was not possible to determine whether this was the work of one female. For example, the nest in Fig. 8G was taken over and provisioned for a day by a second female after the original resident was removed. Cell 4, constructed by the new female, was at almost the same depth as cell 1 made by the original female but was on the opposite side of the main burrow.

Burrow storage of prey was observed at all 4 areas in 36 of 39 nests which were being provisioned. Recently-captured prey were found half-way down against the walls of the vertical shaft (Figs. 8A–C), near the juncture of the vertical and horizontal burrows (Figs. 8B, C, E, F, H), or in the apical half of the horizontal gallery (Figs. 8B, D, F). As indicated, several nests contained prey in 2 or more storage locations in the burrow. Occasionally, a loose plug of sand was found in front of prey stored in the horizontal passage (Fig. 8F).

The resident plugs the entrance and upper burrow with sand when she has gathered enough prey for a cell. Before ovipositing, she positions the burrow storage prey in a cell at the end of the horizontal burrow and then excavates a new side passage. She may or may not excavate a cell at the end of this passage before ovipositing. The passage is usually unmodified during provisioning (Figs. 8A, B, D–H), but occasionally a completely-formed empty cell, temporarily sealed off by a loose plug of sand, is found at the end of the new burrow (Fig. 8C). The sand blocking the vertical burrow during cell completion is apparently used to fill the passage leading to the completed cell because, when the entrance is reopened, the female can be seen working her mandibles against the walls of the burrow and pushing sand downward. The entire process, from the time of entry with prey to reappearance at the surface, required 45–90 min ( $N = 3$ ).

Upon removing the sand plug from the entrance in the morning or after completing a cell, the female exited and, while facing the entrance, made a 5–10 sec orientation consisting of increasingly longer, transverse flights. On subsequent trips, except as indicated below, the wasp did not reorient but flew directly away from the nest. The entrance remained open during her absence except when a searching female entered and plugged the nest from inside. After being disturbed by searchers or passing insects, the wasp usually made a short orientation flight prior to hunting. Final nest closure was not observed but it was noted that inactive nests always had the horizontal passage filled in. The vertical burrows remained open until the first hard rain.

Although some females dug their entire nests beginning from the sand surface, it was not clear whether all females were able to do so. One female, working in short spurts interspersed with 2-3 min rests, dug an L-shaped burrow in 25 min. During interruptions, the wasp flew around the entrance or landed on the sand nearby. She appeared to dig with the front legs in unison, her body moving into the sand in a slow spiral. Upon completing the nest, she plugged the entrance by pushing up columns of sand with her abdomen. The entrance remained closed throughout the afternoon.

Some females began hunting as early as 0900 hrs on sunny days at Auburn, but the majority were not active until 1030 hrs. Provisioning reached a peak between 1100 and 1400 hrs, decreasing noticeably after 1430. A few nests remained active all afternoon and, on occasion, provisioning continued until 1830 hrs. Females spent the night inside their closed nests while males rested in vacant nests or abandoned burrows of other insects (see Miller and Kurczewski, 1973). Nesting females were seldom active on damp or cloudy days. Although females were collected from June to October, the most intensive provisioning took place during July and August.

Females were observed hunting at Auburn in a patch of white sweet clover, *Melilotus alba* Desvaux, growing at the edge of the nesting ridge. They hovered slowly around the stems, maintaining their body in a horizontal position. At Sennett, many females similarly circled umbels of Queen Anne's lace, *Daucus carota* (Linnaeus), occasionally darting at small objects. The flowers were only a few feet from the nest entrances. One wasp caught a small fly as it landed on an umbel, taking only 3 sec to sting it, position it, and fly away. The prey were paralyzed and moved their legs or antennae when they were removed from the cell.

Provisioning females returned to their nests in flight and dove rapidly into their entrances (Fig. 9). On windy days wasps carrying heavy prey often landed near their entrances until the wind subsided. In flight, large prey such as *Chironomus* midges were held ventral-side-up and head-forward with the wasp's middle and hind legs. Small prey, especially Chalcidoidea, were held obliquely with only the middle legs. On the ground, all prey were held with the middle legs (Fig. 10). Some *Chironomus* were so large that they became lodged in the entrance when the female dove in. From 2-5 sec were required for the wasps to turn around and pull such flies inside. Abandoned prey were common around nest entrances (see Miller and Kurczewski, 1973).

Before departing to hunt, the female usually spent several seconds in the entrance looking out with the head or head and upper thorax exposed (Fig. 11). The average time so spent was 8 sec (0-60, N = 77), the extremes in means for 2 Auburn females being <1 sec (0-1, N = 24) and 22 sec (10-60, N = 7). If a male or searching female interfered with the nesting female at this time, she would back down into the nest or even plug the entrance with sand. The

female having the longest mean provisioning and prey storing times also spent the longest mean time in the entrance. The resident with the shortest mean provisioning time spent the shortest mean time in the entrance but did not have the shortest mean storing time. After looking around the entrance, nesting females of *L. c. errans* did not walk out on the sand but flew directly out of the burrow.

The average time taken to capture a prey and return to the nest was 3.0 min (0.4–12.6,  $N = 93$ ). The extremes in mean provisioning times for 2 Auburn females were 7.2 (5.0–12.6,  $N = 9$ ) and 1.5 min (0.4–3.4,  $N = 24$ ). Provisioning times tended to vary more between different females than between successive hunting trips of a single female. On several occasions, provisioning females continually returned to hunt in the same vegetation. The average time spent inside the nest between trips was 42 sec (5–250,  $N = 95$ ). One Auburn female took an average of only 22 sec (5–50,  $N = 13$ ) to store a prey while another from the same area required an average 71 sec (30–250,  $N = 10$ ). The differences may be attributed to the varying distances of burrow storage areas from the entrance.

*L. c. errans* provisioned nests with 29 families of Diptera, Hymenoptera, Hemiptera, and Homoptera. Table 6 lists the prey families and indicates their relative importance as provisions in terms of numbers of individuals captured and percent total catch. The species of prey and the areas from which they were obtained are given in Table 7. The data from Lexington, Mass. and Blackjack Creek, Kans. were provided by H. E. Evans. Overall, Diptera was the order most commonly preyed upon, making up 29–90% of the total catch depending on the area. Hymenoptera, comprising 9–59% of the prey, was more important than Diptera as a source of provisions only at Chittenango, N.Y. and Lexington, Mass. Nevertheless, more families and genera of Hymenoptera were captured than Diptera. Hemiptera was regularly preyed upon in small numbers, never exceeding 17% of the total catch, whereas Homoptera (Aphididae) was represented from only 2 areas.

Chironomidae was the most common prey family at Auburn, Selkirk Shores, and Blackjack Creek. Chalcids of the family Pteromalidae were the main source of provisions at Chittenango while Scatopsidae and Chloropidae (Diptera) were the most important prey at Sennett and Lexington, respectively. Other families making up 10% or more of the prey in an area during a given season were, in decreasing order of their significance, Eulophidae, Ceratopo-

→

FIG. 9–11. Provisioning female of *Lindenius columbianus errans* diving into nest; 10. holding prey with middle legs as she enters partly closed nest; and, 11. pausing in entrance before leaving.

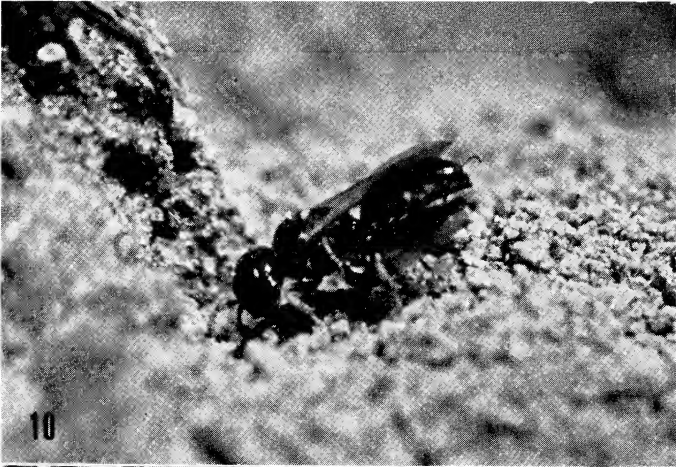

TABLE 6. Families of Prey of *Lindeni* *columbianus errans* and their relative importance as provisions.

Family	1969 Auburn		1970 Auburn		1971 Auburn	
	N	%	N	%	N	%
DIPTERA	448	79.29	850	76.85	196	76.87
Ceratopogonidae	7	1.24	104	9.40	23	9.02
Chironomidae	421	74.51	667	60.31	155	60.78
Sciaridae			2	0.18		
Scatopsidae			1	0.09	1	0.39
Cecidomyiidae	1	0.18	20	1.81	5	1.96
Empididae	4	0.71	3	0.27	1	0.39
Chamaemyiidae			2	0.18		
Milichiidae						
Ephyridae			1	0.09	2	0.78
Chloropidae	7	1.24	26	2.35	2	0.78
Agromyzidae	8	1.41	24	2.17	7	2.75
HEMIPTERA	1	0.18	41	3.71	2	0.78
Anthocoridae	1	0.18	39	3.53	1	0.39
Miridae			1	0.09	1	0.39
Lygaeidae			1	0.09		
HOMOPTERA	1	0.18	2	0.18		
Aphididae	1	0.18	2	0.18		

Family	1970 Chittenango		1962 Lexington		1971 Sennett	
	N	%	N	%	N	%
DIPTERA	105	29.17	22	40.74	170	84.58
Ceratopogonidae	5	1.39			43	21.39
Chironomidae	5	1.39			1	0.50
Sciaridae					2	1.00
Scatopsidae	17	4.72			103	51.24
Cecidomyiidae	14	3.89	4	7.41	3	1.49
Empididae						
Chamaemyiidae						
Milichiidae	1	0.28			3	1.49
Ephyridae						
Chloropidae	60	16.67	18	33.33	15	7.46
Agromyzidae	3	0.83				
HEMIPTERA	42	11.67	9	16.67	4	1.99
Anthocoridae	36	10.00	4	7.41	4	1.99
Miridae	6	1.67	5	9.26		
Lygaeidae						
HOMOPTERA						
Aphididae						

gonidae, Milichiidae, Cecidomyiidae, Eucharitidae, and Anthocoridae. Only 4 families, Cecidomyiidae, Braconidae, Eulophidae, and Anthocoridae were recorded as prey at all 6 areas.

It is significant that the prey families from Massachusetts and Kansas were represented among the New York prey and that the relative importance of

TABLE 6 (cont.). Families of Prey of *Lindenus columbianus errans* and their relative importance as provisions.

Family	1971 Selkirk Shores		1952 Blackjack Cr.		Grand Totals	
	N	%	N	%	N	%
DIPTERA	219	89.75	33	84.62	2043	72.34
Ceratopogonidae	13	5.33			195	6.90
Chironomidae	98	40.16	23	58.97	1370	48.51
Sciaridae	1	0.41			5	0.18
Scatopsidae	1	0.41			123	4.36
Cecidomyiidae	44	18.03	6	15.38	97	3.43
Empididae	6	2.46	1	2.56	15	0.53
Chamaemyiidae					2	0.07
Milichiidae	46	18.85	3	7.69	53	1.88
Ephydriidae					3	0.11
Chloropidae	10	4.10			138	4.89
Agromyzidae					42	1.49
HEMIPTERA	3	1.23	2	5.13	104	3.68
Anthocoridae	3	1.23	2	5.13	90	3.19
Miridae					13	0.46
Lygaeidae					1	0.04
HOMOPTERA	1	0.41			4	0.14
Aphididae	1	0.41			4	0.14
Family	1969 Auburn		1970 Auburn		1971 Auburn	
	N	%	N	%	N	%
HYMENOPTERA	115	20.35	213	19.26	57	22.34
Braconidae	4	0.71	67	6.06	23	9.02
Ichneumonidae	1	0.18				
Mymaridae			1	0.09		
Eulophidae	9	1.59	69	6.24	11	4.31
Encyrtidae			3	0.27		
Eupelmidae	1	0.18	2	0.18		
Eucharitidae	71	12.57	16	1.45	6	2.35
Torymidae	3	0.53	6	0.54	1	0.39
Pteromalidae	24	4.25	44	3.98	16	6.27
Eurytomidae	1	0.18	4	0.36		
Chalcididae						
Ceraphronidae						
Formicidae			1	0.09		
Sphecidae	1	0.18				
Total prey	565		1106		255	

the prey orders was not very different from that of certain New York areas. Lexington, Mass. and Chittenango, N.Y., the 2 areas where Hymenoptera exceeded Diptera as a source of provisions, were remarkably alike in terms of prey families captured and percent total catches, suggesting that these habitats are rather similar. Likewise, the prey tallies from Blackjack Creek, Kans. and Selkirk Shores, N.Y. were very similar. The 3 areas where Chironomidae

TABLE 6 (cont.). Families of Prey of *Lindeni* *columbianus errans* and their relative importance as provisions.

Family	1970 Chittenango		1962 Lexington		1971 Sennett	
	N	%	N	%	N	%
<b>HYMENOPTERA</b>	213	59.17	23	42.59	27	13.43
Braconidae	24	6.67	1	1.85	3	1.49
Ichneumonidae						
Mymaridae						
Eulophidae	43	11.94	15	27.78	11	5.47
Encyrtidae	2	0.56				
Eupelmidae	9	2.50				
Eucharitidae	1	0.28				
Torymidae	7	1.94				
Pteromalidae	120	33.33	7	12.96	10	4.98
Eurytomidae	2	0.56			3	1.49
Chalcididae						
Ceraphronidae	1	0.28				
Formicidae	4	1.11				
Sphecidae						
Total prey	360		54		201	
Family	1971 Selkirk Shores		1962 Blackjack Cr.		Grand Totals	
	N	%	N	%	N	%
<b>HYMENOPTERA</b>	21	8.61	4	10.25	673	23.83
Braconidae	4	1.64	1	2.56	127	4.50
Ichneumonidae					1	0.04
Mymaridae					1	0.04
Eulophidae	9	3.69	3	7.69	170	6.02
Encyrtidae					5	0.18
Eupelmidae					12	0.42
Eucharitidae					94	3.33
Torymidae					17	0.60
Pteromalidae	5	2.05			226	8.00
Eurytomidae	2	0.82			12	0.42
Chalcididae	1	0.41			1	0.04
Ceraphronidae					1	0.04
Formicidae					5	0.18
Sphecidae					1	0.04
Total prey	244		39		2824	

formed the main prey were near sizable bodies of water. Despite the great differences in prey sample sizes during the 3 years of investigations at Auburn, the relative importance of each of the prey orders remained very stable.

Non-specificity in prey selection was quantified by determining the numbers of orders and families per nest and per cell. The average number of prey orders per nest and per cell were, respectively, 2.4 (1-3, N = 39) and 2.1 (1-3, N = 64). Cells containing a single order of prey were found only at Auburn and were rare. The average number of prey families per nest and



TABLE 7. Prey of *Lindenius columbianus errans*.

Family	Species	Area
DIPTERA		
Ceratopogonidae	<i>Dasyhelea grisea</i> (Coquillett)	A,C,D
	<i>Dasyhelea</i> spp.	A,S <sup>1</sup>
	<i>Forcipomyia brevipennis</i> (Macquart)	A,C,D,S <sup>1</sup>
	<i>Jenkinshelea magnipennis</i> (Johannsen)	A <sup>1</sup>
Chironomidae	<i>Chironomus</i> spp.	A <sup>2</sup>
	<i>Cricotopus</i> sp.	C,S
	<i>Orthocladius</i> spp.	A,C,D <sup>2</sup>
	<i>Paratendipes subaequalis</i> (Malloch)	B
	<i>Pentaneura</i> sp.	A
	<i>Procladius</i> spp.	A,D
	<i>Psectrocladius</i> sp.	A <sup>2</sup>
	<i>Tanytarsus</i> sp.	A <sup>1</sup>
Sciaridae	<i>Bradysia</i> sp.	A,D,S
Scatopsidae	<i>Swammerdamella obtusa</i> Cook	A,C,D,S <sup>1</sup>
	<i>Swammerdamella sagittata</i> Cook	S
	<i>Scatopse fuscipes</i> Meigen	S
Cecidomyiidae	<i>Anarete johnsoni</i> (Felt)	A,C
	<i>Anarete pritchardi</i> Kim	A,C
	<i>Anarete</i> spp.	A,B,L,S
	<i>Asteromyia carbonifera</i> (Osten Sacken)	A
	<i>Clinodiplosis</i> sp.	A,C
	<i>Dasineura</i> sp.	A,C
	<i>Mayetiola</i> sp.	A,C
	<i>Neolasioptera</i> spp.	A,S
	<i>Ozirhincus millefolii</i> (Wachtl)	S
	<i>Porricondyla</i> sp.	A
<i>Procytiphora</i> n. sp.	D <sup>1</sup>	
Empididae	<i>Drapetis septentrionalis</i> Melander	A
	<i>Drapetis</i> sp.	B
	<i>Platypalpus trivialis</i> Loew	A
	<i>Platypalpus</i> sp.	A
	<i>Rhamphomyia</i> sp.	D
Chamaemyiidae	<i>Chamaemyia juncorum</i> (Fallén)	A
	<i>Leucopis</i> sp.	A
Milichiidae	<i>Madiza parva</i> (Adams)	B
	<i>Leptometopa halteralis</i> (Coquillett)	D,S <sup>1</sup>
	<i>Leptometopa latipes</i> (Meigen)	C,S
	<i>Paramyia nitens</i> (Loew)	D
Ephydriidae	<i>Philygria debilis</i> Loew	A
	<i>Hydrellia</i> sp.	A
Chloropidae	<i>Conioscinella melancholica</i> (Becker)	A,D
	<i>Conioscinella minor</i> (Adams)	L,S
	<i>Conioscinella triorbiculata</i> (Sabrosky)	A
	<i>Diplotoxa versicolor</i> (Loew)	D
	<i>Hippelates bishoppi</i> Sabrosky	L
	<i>Hippelates</i> n. sp. nr. <i>bishoppi</i>	C <sup>1</sup>
	<i>Meromyza</i> sp.	D

## Area Code:

A = Auburn, N. Y.

B = Blackjack Creek, Kans.

C = Chittenango, N. Y.

D = Selkirk Shores St. Pk., N. Y.

L = Lexington, Mass.

S = Sennett, N. Y.

<sup>1</sup> Indicates species or genus made up 1-4% of total number of prey (2824) from all areas.<sup>2</sup> Indicates 4% or more.

TABLE 7. (cont.)

Family	Species	Area
	<i>Ocella cinerea</i> (Loew)	C
	<i>Ocella parva</i> (Adams)	S
	<i>Ocella quadrivittata</i> Sabrosky	A
	<i>Ocella trigramma</i> (Loew)	D,S
	<i>Oscinella carbonaria</i> (Loew)	S
	<i>Oscinella frit</i> (Linnaeus)	A,D,L
	<i>Oscinella luteiceps</i> Sabrosky	A,L
	<i>Oscinella soror</i> (Macquart)	A,S
	<i>Oscinella umbrosa</i> (Loew)	A
	<i>Oscinella</i> sp.	L
Agromyzidae	<i>Siphonella nigripalpis</i> (Malloch)	A,C,S
	<i>Agromyza</i> sp.	A
	<i>Cerodontha (Cerodontha) dorsalis</i> (Loew)	A
	<i>Cerodontha (Cerodontha)</i> sp.	A
	<i>Liriomyza</i> sp.	A
	<i>Ophiomyia</i> sp.	A
	<i>Phytoliriomyza arctica</i> (Lundbeck)	A
	<i>Pseudonapomyza lacteipennis</i> (Malloch)	C
HEMIPTERA		
Anthocoridae	<i>Orius insidiosus</i> (Say)	A,B,C,D,S <sup>1</sup>
	<i>Orius tristicolor</i> (White)	A,D,L,S
Miridae	<i>Chlamydatus associatus</i> (Uhler)	C,L
	undetermined nymphs	A
Lygaeidae	undetermined nymph	A
HOMOPTERA		
Aphididae	<i>Aphis</i> sp.	A
	<i>Capitophorus elaeagni</i> (Del Guer.)	A
	<i>Rhopalosiphum maidis</i> (Fitch)	D
	<i>Schizaphis</i> sp.	A
HYMENOPTERA		
Braconidae	<i>Agathis</i> spp.	C
	<i>Apanteles limentidis</i> Riley	D
	<i>Apanteles xylinus</i> (Say)	A
	<i>Apanteles</i> spp.	A,B,C,D,S <sup>1</sup>
	<i>Aphidius obscuripes</i> Ashmead	A
	<i>Aphidius</i> spp.	A,C,L <sup>1</sup>
	<i>Bracon</i> sp.	A
	<i>Chelonus (Microchelonus)</i> sp.	A
	<i>Dacnusa</i> sp.	A
	<i>Diaeretiella</i> spp.	A
	<i>Elasmosoma</i> sp.	A
	<i>Euphoriana uniformis</i> Gahan	S
	<i>Lysaphidus</i> sp.	C
	<i>Lysiphlebus</i> spp.	A,C
	<i>Microplitis</i> sp.	A
	<i>Orgilus gelechia</i> (Ashmead)	C
	<i>Orgilus</i> sp.	C
	<i>Praon</i> spp.	A
	<i>Trioxys</i> sp.	A,C <sup>1</sup>
Ichneumonidae	<i>Adelognathus flavopictus</i> Davis	A
Mymaridae	<i>Polynema</i> sp.	A
Eulophidae	<i>Aprostocetus</i> sp.	S
	<i>Chrysocharis</i> sp.	A

TABLE 7. (cont.)

Family	Species	Area
	<i>Diadlinopsis callichroma</i> Crawford	B
	<i>Euderus subopacus</i> (Gahan)	B
	<i>Euderus</i> sp.	A,C
	<i>Hemiptarsenus americanus</i> (Girault)	A
	<i>Hyssopus novus</i> Girault	A
	<i>Necremnus</i> sp.	A
	<i>Notanisomorpha ainsliei</i> Crawford	C
	<i>Pnigalio</i> sp.	A,S
	<i>Sympiesis bimaculatipennis</i> (Girault)	A
	<i>Tetrastichus bruchophagi</i> Gahan	A,D,S
	<i>Tetrastichus chlamytis</i> Ashmead	A,C
	<i>Tetrastichus funipennis</i> (Girault)	A
	<i>Tetrastichus incertus</i> (Ratzeburg)	A
	<i>Tetrastichus semilongifasciatus</i> (Girault)	A
	<i>Tetrastichus tesserus</i> Burks	A
	<i>Tetrastichus</i> spp.	A,C,D,L,S <sup>2</sup>
	Entedontini	C
Encyrtidae	<i>Copidosoma</i> sp.	A,C
	Anagyrini	A
	Bothriothoracini	A
Eupelmidae	<i>Eupelmella vesicularis</i> (Retzius)	A
	<i>Eupelmus allynii</i> (French)	C
	<i>Eupelmus</i> sp.	A,C
Eucharitidae	<i>Pseudometagea schwarzi</i> (Ashmead)	A,C <sup>1</sup>
Torymidae	<i>Eridontomerus isosomatis</i> (Riley)	A
	<i>Pseudotorymus lazueli</i> (Ashmead)	A,C
Pteromalidae	<i>Asaphes lucens</i> (Provancher)	A,C
	<i>Ecrizotes</i> sp.	C
	<i>Erixestus winnemanna</i> Crawford	A
	<i>Habrocytus</i> sp.	C,D,L
	<i>Halicoptera patellanna</i> (Dalman)	A
	<i>Halicoptera</i> sp.	A,C
	<i>Heteroschema</i> sp.	A
	<i>Homoporus chalcidiphagus</i> (Walsh & Riley)	A,C,L,S <sup>1</sup>
	<i>Homoporus febriculosus</i> (Girault)	A,C
	<i>Mesopolobus</i> sp.	C,L,S
	<i>Pachyneuron allograptae</i> Ashmead	A
	<i>Pachyneuron siphonophorae</i> (Ashmead)	A,C
	<i>Pachyneuron</i> sp.	A
	<i>Parecrizotes marylandensis</i> Girault	C
	<i>Pteromalus puparum</i> (Linnaeus)	S
	<i>Pteromalus vanessae</i> Harris	S
	<i>Systasis</i> sp.	D
	<i>Tridymus</i> sp.	A,D
	Pirenini	A,S
	Pteromalini	A
	Tridymini	A
Eurytomidae	<i>Bruchophagus</i> sp.	A
	<i>Eudecatoma</i> sp.	D,S
	<i>Eurytoma</i> sp.	A,C
	<i>Harmolita</i> sp.	A,D
	<i>Systole</i> sp.	A
Chalcididae	<i>Spilochalcis albifrons</i> (Walsh)	D
Ceraphronidae	<i>Lygocerus</i> sp.	C
Formicidae	<i>Lasius</i> sp. (♂♂)	A,C
Sphécidae	<i>Spilomena pusilla</i> (Say)	A

per cell were 6.9 (1-13, N = 39) and 4.6 (1-13, N = 64), while the average number of prey genera per cell was 6.0 (2-15, N = 60). One cell from Selkirk containing 15 genera, 13 families and 3 orders of prey represented the extreme in non-specificity. The other extreme was exemplified by a 2-celled nest at Auburn containing only 2 genera of chironomids, mostly of a single species.

Selection of a particular sex of prey was marked in only a few instances. At Auburn, 98% of the *Tanytarsus* midges and 88% of the ceratopogonid *Jenkinshelea magnipennis* Johannsen were males. At Selkirk Shores, 100% of the cecidomyiid *Procystiphora* n. sp. and 95% of an undetermined chironomid were females. All prey were invariably smaller and lighter than their captors, weighing an average of 0.24 mg (.05-1.05, N = 1100) compared to 2.90 mg (1.25-4.15, N = 65) for the wasps. Minute ceratopogonids of the genus *Dasyhelea* were the smallest prey, whereas the largest were females of the genera *Chironomus* (Chironomidae) and *Forcipomyia* (Ceratopogonidae). The weight of the provisions in a fully-provisioned cell ranged from 2.0 to 13.3 mg ( $\bar{x}$  = 7.2, N = 33). From 8 to 76 prey ( $\bar{x}$  = 25.5, N = 77) were stored per cell.

Large prey were stored head-inward in the cell, facing away from the burrow, whereas tiny prey were stacked more randomly, their bodies often turned obliquely or backwards. The egg-bearer was 1 of the innermost prey and was usually ventral-side-up. The off-white, slightly curved egg was 1.4-1.6 mm long and 0.3-0.4 mm wide in the middle. Its larger cephalic end was attached to the neck of the prey along the ventral midline. The direction in which the egg extended varied with the prey. Eggs on chironomids and ceratopogonids extended transversely across the prosternum at nearly right angles to the body of the prey (Fig. 12). Eggs were more obliquely-placed on chloropids and agromyzids and were distinctly longitudinally-placed on small pteromalids and eulophids. The caudal end was normally free but occasionally appeared tightly fastened to the spread wing of the prey. The egg-bearer was usually a common prey in the nest, regardless of size. For example, egg-bearing Hemiptera and Homoptera were not found.

The egg hatched in 1-2 days and the larva grew to a length of 3 mm during the first 3-4 days. At this time the larva was relatively slender and had consumed only a single prey. During the next 2 days it increased rapidly in girth and devoured all of the provisions, facing away from the main burrow and pushing the discarded sclerites into a compact mass at the other end. Within 7-9 days after the egg was laid the larva had spun a cocoon of silk and sand, distributing the excrement and sclerotized prey remains evenly over the surface. The resultant cocoons were brown, ellipsoidal, and averaged  $2.3 \times 5.8$  mm (2-3  $\times$  4-7, N = 21). The species overwinters in the cocoon as a diapausing larva, pupates in late spring, and the adults begin to emerge in early summer. Although pupae and teneral adults were dug up in early Au-



FIG. 12. Egg of *Lindenius columbianus errans* on male *Forcipomyia brevipennis* (Macquart) (Ceratopogonidae).

gust, it is uncertain whether they represent a second generation or late emerging individuals from cells provisioned the year before.

#### DISCUSSION

Viewed collectively the behavioral features possessed by species of *Lindenius* distinguish this genus from other sphecid genera, although these features may be modified extensively when more of the 48 described species are studied. The 6 species examined in this paper construct nests 3–12 cm deep in sand, fine gravel, loess, or chalk. They prefer hard-packed ground such as garden paths, roads, and compacted areas. The nests have a vertical or slightly in-

clined burrow which often leads to a short horizontal passage whose distal end marks the location of the next cell.

The sequence of nest orientation behaviors is essentially identical for *L. albilabris*, *L. armaticeps*, and *L. c. errans*. The females orient in flight, facing the entrance, before the first provisioning trip but not prior to subsequent trips unless the entrance has been obstructed on the return flight. Normally, the nests of all 6 species remain open during provisioning trips. In aggregations of *L. c. errans*, however, searching conspecific females may enter a nest and plug the entrance with sand, creating difficulties for the provisioning female when she returns. Also, the resident may plug the entrance from within if searchers interfere with her when she is preparing to exit. Otherwise, the entrances are closed only at night and when the females are excavating new passages and cells, ovipositing, or filling burrows.

The 6 species of *Lindenius* store adult insects, but *L. albilabris* and *L. c. errans* sometimes capture nymphal Hemiptera. Diptera is the only order preyed upon by all. In each species, the egg is not laid until the full complement of prey for a cell has been gathered. The heads of most of the prey face in the same direction and the egg is attached to 1 of the first prey placed in the cell. Egg placement is similar in all species, the egg being fastened to the neck of a prey along the ventral midline.

*L. albilabris*, *L. armaticeps*, *L. c. errans*, and *L. panzeri* develop from egg to mature larva in 5–8 days. All 6 species spin cocoons of silk and sand and distribute the sclerotized remains of the prey evenly over the surface. Cocoons of the mirid-hunter *L. albilabris* occasionally lack prey remains as a result of utilizing nymphal prey (Bonelli, 1967).

Other behavioral features have potential value in separating species or species groups. In nests of *L. armaticeps* and *L. buccadentis*, the oldest cells were the shallowest and the newest cells, the deepest (Figs. 2, 6). The nests of *L. c. errans* were more irregular, with the first cell usually being the shallowest but the third and fourth being located either above or below the second (Figs. 8B–H). A similar lack of uniformity in cell placement was reported for *L. albilabris* by Minkiewicz (1931, 1933), who found an incompletely provisioned cell to be the shallowest in 1 nest but the deepest in another. Bowman (1911) schematically illustrated a 9-celled nest of *L. panzeri* in which a lower level of cells was constructed before an upper one. If the latter arrangement is characteristic of this species, it is one of the few clearcut differences between *L. panzeri* and its Nearctic relative *L. armaticeps*.

Transport of prey with the middle legs is probably the common method in *Lindenius*. Many of the conflicting reports on prey transport in *L. albilabris* and *L. panzeri* may be attributed to capturing prey-laden wasps in boxes or vials and expecting them to show normal prey transport behavior. For ex-

ample, *Crossocerus maculiclypeus* (Fox) always carries its prey with the middle legs but, when enclosed in a vial, sometimes impales its prey on the sting and walks around on all 6 legs. Other conflicting reports may result from the investigator tampering with the nest entrance in an attempt to slow down the wasp for closer observation. *L. armaticeps* normally carries its prey with the middle legs but will often impale the prey on the sting at an obstructed nest entrance. In contrast, *L. c. errans* was never observed impaling its prey at an obstructed entrance during 3 summers of extensive observation.

A comparison of mean provisioning times and number of prey per cell may be of value in separating species. On the average, *L. armaticeps* stores fewer prey per cell than the other species and has the longest mean provisioning time. The mean numbers of prey per cell for both *L. buccadentis* and *L. c. errans* are well over twice that for *L. armaticeps*, and their mean provisioning times are well under half that of *L. armaticeps*. However, this inverse relationship between number of prey per cell and provisioning time is not perfect. *L. buccadentis* stores, on the average, more prey per cell than *L. c. errans*, yet the former species has a longer mean provisioning time.

A possible group difference in prey storage behavior is strengthened by a comparison of prey-storing times for *L. albilabris*, *L. armaticeps*, *L. buccadentis*, and *L. c. errans*. The last 3 species usually store newly-captured prey head-inward in an unmodified part of the burrow whereas *L. albilabris* is reported to place its prey directly in a cell at the end of a side passage. Perhaps, as a result, the average storing time is longer in *L. albilabris* than in *L. armaticeps*, *L. buccadentis*, or *L. c. errans*. The last species often releases its prey only part way down the vertical burrow so that a "line" of prey is gradually formed. This type of storage has not been reported for the other species.

After storing the prey and returning to the surface, *L. armaticeps*, *L. buccadentis*, and *L. c. errans* often spend several seconds in the entrance looking around. *L. c. errans* typically flies out of the burrow directly from the head-in-entrance position, whereas *L. armaticeps*, in both sloping and horizontal sand, walks out and then flies away. *L. buccadentis* is intermediate in this respect because the same individual may walk out of the entrance on one trip and fly out on the next.

Weights of cell contents and of individual prey are available only for the 3 Nearctic species. The average weight of the contents of 19 cells of *L. armaticeps* was 12.1 mg, whereas that of 33 cells of *L. c. errans* was only 7.2 mg. Two cells of *L. buccadentis* were similar in weight to an average cell of *L. c. errans*. The average weight of a single prey of *L. armaticeps* was about 4 times that of either *L. c. errans* or *L. buccadentis*. Only the first species was observed carrying prey heavier than itself. *L. albilabris* is the largest species yet studied

and undoubtedly has greater mean cell and individual prey weights than any of the others.

One may readily distinguish the 6 species by the kinds and proportions of prey stored. The Palaearctic *L. albilabris* is a mirid-hunter which at times stores empidid, dolichopodid, and chloropid flies. Both the Nearctic *L. armaticeps* and the Palaearctic *L. panzeri* are chloropid-hunters, the latter occasionally capturing simuliid, tephritid, and milichiid flies. The Nearctic *L. buccadentis* and the Palaearctic *L. pygmaeus* store mainly chalcidoids and braconids but occasionally hunt flies. The Nearctic *L. c. errans* is the most polyphagous species yet studied, preying on 11 families of Diptera, 14 of Hymenoptera, 3 of Hemiptera, and 1 of Homoptera. Overall, Diptera was the most important food source of this species. Although the specific differences in degree of polyphagy are quite useful, individual females of a given species may be very specific in their choice of prey. Instances approaching host-specificity can be cited for all but *L. pygmaeus* whose nesting behavior has not been investigated thoroughly.

The use of Hymenoptera as provisions by 3 species of *Lindenius* deserves special attention because the behavior is not common in the Crabroninae. *Encopognathus* and *Tracheliodes* are soil-nesting ant hunters, the latter preying specifically on workers of the genera *Liometopum* and *Tapinoma* (Muesebeck, *et al.*, 1951). Krombein (1958) noted an undescribed species of *Crossocerus* from Utah nesting in twigs and storing chalcidids, while Hamm and Richards (1926) found a tenthredinid as exceptional prey of the wood-nester *Crossocerus leucostomoides* (Richards). Janvier (1928) reported winged ants among the dipterous and lepidopterous prey of the sand-nester *Euplilis rufo-taeniatum* (Kohl). Thus, *L. buccadentis*, *L. c. errans*, and *L. pygmaeus* are the only crabronines known to prey on diverse groups of Hymenoptera.

In summary, the 6 species of *Lindenius* exhibit similar behavior in constructing nests with vertical burrows in compact sand or sandy-gravel, leaving the entrance open during provisioning trips, diving into the entrance with prey in flight, including Diptera among the provisions (but not necessarily in each nest or study area), ovipositing only after the full complement of prey has been gathered, affixing the egg to the neck of a prey along the ventral midline, and distributing the prey remains evenly over the surface of the cocoon in a matrix of silk and sand. Collectively, these features distinguish *Lindenius* from all other sphecid genera.

The 6 species differ most clearly in the kinds and proportions of prey. Other facets of behavior useful in separating the species but generally more difficult to measure include sequence/depth of cell placement, method of prey transport at obstructed entrances, provisioning and storing times, number of prey per cell, type of prey storage, exiting behavior, stages of prey, weights



of cell contents and individual prey, frequency of discarded prey, male behavior, and kinds of intraspecific interactions. As the remaining 42 species are investigated, these other features must be relied upon increasingly. The inevitable overlap in prey families, already so conspicuous between *L. armaticeps* and *L. panzeri*, indicates the importance of having the prey thoroughly identified as well as the precariousness of depending solely on prey differences to distinguish species.

#### Literature Cited

- ABRAHAMSEN, S. E. 1950. Grævehvepsen *Crabro Lindenius panzeri* v.d. Lind. Redekolonier fundet i Danmark. Flora og Fauna **56**: 125-130.
- ADLERZ, G. 1903. Lefnadsförhållanden och Instinkter inom Familjerna Pompilidae och Sphegidae. I. K. Svenska Vet.-Ak. Handl. **37(5)**: 1-181.
- . 1910. Same title. III. K. Svenska Vet.-Ak. Handl. **45(12)**: 1-75.
- BLÜTHGEN, P. 1955. Zur Biologie von *Lindenius albilabris* (F.) (Hym., Sphecidae). Deutsche Ent. Zeitschr. (N.F.) **2**: 158.
- BONELLI, B. 1967. Osservazioni biologiche sugli Imenotteri melliferi e predatori della Val di Fiemme. XXV. Boll. Ist. Ent. Bologna **28**: 291-303.
- BOUWMAN, B. E. 1911. Crabro's. Levende Natuur **16**: 121-126, 173-177, 199-204.
- BRISTOWE, W. S. 1948. Notes on the habits and prey of twenty species of British hunting wasps. Proc. Linn. Soc. London **160**: 12-37.
- CHAMBERS, V. H. 1949. The Hymenoptera Aculeata of Bedfordshire. Trans. Soc. Brit. Ent. **9(4)**: 197-252.
- COURT, H. K. AND R. M. BOHART. 1958. New species of *Lindenius* from western North America (Hymenoptera: Sphecidae). Pan-Pacif. Ent. **34(3)**: 161-167.
- DE BEAUMONT, J. 1956. Notes sur les *Lindenius* paléarctiques (Hym. Sphecid.) Mitt. Schweiz. Ent. Ges. **29(2)**: 145-185.
- DUPUIS, C. 1947. Les Proies des Sphérides chasseurs d'Hétéroptères. Feuille Nat. N.S. **2(1947)**: 111-113.
- EVANS, H. E. 1963. Predatory wasps. Sci. Am. **208(4)**: 145-154.
- . 1970. Ecological-behavioral studies of the wasps of Jackson Hole, Wyoming. Bull. Mus. Comp. Zool. **140(7)**: 451-511.
- FERTON, C. 1901. Notes détachées sur l'instinct des Hyménoptères mellifères et ravisseurs avec la description de quelques espèces. (1<sup>o</sup> série). Ann. Soc. Ent. Fr. **70**: 83-148.
- GRANDI, G. 1928. Contributi alla conoscenza biologica e morfologica degli Imenotteri melliferi e predatori. VII. Bull. Lab. Ent. Bologna **1**: 259-326.
- . 1961. Studi di un entomologo sugli imenotteri superiori. Boll. Ist. Ent. Univ. Bologna **25**: 1-659.
- GRÖNBLOM, T. 1925. Bidrag till kännedom om Levnadssättet hos våra rovsteklar (Hymenopt., Sphegidae). I. Notulae Ent. **5**: 1-9.
- GUICHARD, K. M. AND I. H. H. YARROW. 1947. The Hymenoptera aculeata of Hampstead Heath and the surrounding district, 1832-1947. London Nat. (1947): 81-111.
- HAMM, A. H. AND O. W. RICHARDS. 1926. The biology of the British Crabronidae. Trans. Ent. Soc. London **74**: 297-331.
- HERTZOG, L. 1954. Hyménoptères prédateurs et mellifères de Camargue. Terre et Vie **101(1)**: 95-110.
- IWATA, K. 1942. Comparative studies on the habits of solitary wasps. Tenthredo **4**: 1-146.

- JANVIER, H. 1928. Recherches biologiques sur les prédateurs du Chili. Ann. Sci. Nat. Zool. **11**(10): 67-207.
- KOHL, F. F. 1915. Die Crabronen (Hymenopt.) der paläarktischen Region. Ann. K. K. Nat. Hofmus. **29**: 1-453.
- KROMBEIN, K. V. 1958. Hymenoptera of America north of Mexico. Synoptic catalog. First supplement. U.S.D.A., Agri. Mono. **2**: 1-305.
- KROMBEIN, K. V. AND B. D. BURKS. 1967. Hymenoptera of America north of Mexico. Synoptic catalog. Second supplement. U.S.D.A., Agric. Mono. **2**: 1-584.
- KURCZEWSKI, F. E., N. A. BURDICK AND G. C. GAUMER. 1969. Observations on the nesting behavior of *Crossocerus* (*C.*) *maculiclypeus* (Fox) (Hymenoptera: Sphecidae). J.N.Y. Ent. Soc. **77**(2): 92-104.
- LECLERCQ, J. 1954. Monographie systématique, phylogénétique et zoogéographique des Hyménoptères Crabroniens. Thèse, Fac. Sci. Univ. Liège. 371 p.
- . 1959. *Lindenius ceballosi* sp. nov., Crabronien nouveau d'Espagne. Eos. **35**: 267-268.
- . 1960. Crabroniens d'Espagne appartenant aux genres *Crabro*, *Lindenius* et *Entomognathus* (Hym. Crabronidae). Eos. **36**: 417-426.
- MANEVAL, H. 1937. Notes sur les Hyménoptères (5° série). Rev. Fr. Ent. **4**(3): 162-181.
- MARCHAL, P. 1893. Observations biologiques sur les Crabronides. Ann. Soc. Ent. Fr. **62**: 331-338.
- MILLER, R. C. AND F. E. KURCZEWSKI. 1973. Intraspecific interactions in aggregations of *Lindenius* (Hymenoptera: Sphecidae, Crabroninae). Insectes Sociaux **20**(4): 365-378.
- MINKIEWICZ, R. 1931. Nids et proies des Sphégiens de Pologne. Fragments éthologiques (1° série). Polskie Pismo Ent. **10**: 196-218.
- . 1932. Same title. (2° série). Polskie Pismo Ent. **11**: 98-112.
- . 1933. Same title. (3° série). Polskie Pismo Ent. **12**: 181-261.
- MUESEBECK, C. F. W., K. V. KROMBEIN AND H. K. TOWNES. 1951. Hymenoptera of America north of Mexico. Synoptic catalog. U.S.D.A., Agri. Mono. **2**: 1-1420.
- NIELSEN, J. C. 1900. Biologiske Studier over Gravehvepse. Vid. Med. Nat. Foren. (1900): 255-280.
- OLBERG, G. 1959. Das Verhalten der Solitären Wespen Mitteleuropas. Berlin, VEB Deutsch. Verl. Wiss. 402 p.
- SICKMANN, F. 1893. Die Hymenopteren-fauna von Iburg und seiner nächsten Umgebung, mit biologischen und kritischen Bemerkungen. I. Abteilung die Grabwespen. Jahresber. Nat. Ver. Osnabrück **9**: 39-112.

## New or Little-Known Crane Flies from Iran. III (Diptera: Tipulidae)<sup>1</sup>

CHARLES P. ALEXANDER  
AMHERST, MASSACHUSETTS 01002

RECEIVED FOR PUBLICATION JULY 23, 1974

**Abstract:** Part II of this series of papers concerning the crane flies of Iran was published in this Journal (82: 279-284, 1974). In that report various species of the Eriopterine genus *Gonomyia* were considered and in the present paper further new species and records in the Eriopterini are provided. The species here described are *Lipsothrix iranica*, *Cheilotrichia (Empeda) gnoma*, *Erioptera (Pseuderioptera) schmidi*, *E. (Psiloconopa) canceriformis*, and *Molophilus (Molophilus) pallidipes*, all from the Elburz Mountains in northern Iran. Additional to the above novelties, 13 further previously described European species are added to the list of species of Tipulidae from Iran.

In the preceding two reports on the crane flies of Iran that were collected by Dr. Fernand Schmid in 1955 and 1956 a portion of the species belonging to the tribes Peciini and Eriopterini were treated. At this time I am discussing the remaining members of the Eriopterini contained in the collection and supplying several records of previously described species hitherto known from Europe. I again extend my deepest thanks to Dr. Schmid for his work in collecting this valuable series of crane flies from a scarcely known area of southern Asia.

One of Schmid's important papers on the Trichoptera of Iran provides full information concerning the various stations in the Elburz Mountains where the present series of flies was taken and should be consulted (*Trichoptères d'Iran*. Beiträge zur Entomologie, 9: 200-219, 376-389; 1959). This paper includes a map showing itinerary and collecting stations, and complete geographical data for this expedition, September 1955 and April to October 1956, with eight photographs showing especially important collecting localities.

### *Lipsothrix iranica*, n. sp.

Mesothorax orange, pronotum yellow, narrowly brownish black medially; legs yellow, femoral tips narrowly black, tibiae yellow, extreme bases and tips darkened; wings pale yellow, stigma dark brown, conspicuous, vein  $R_{2+3+4}$  short and straight, longer than the strongly arcuated basal section of  $R_5$ ; abdomen yellowed, patterned with black, outer two segments yellow.

*Female.* Length about 11 mm.; wing 9.5 mm.; antenna about 1.8 mm.

Rostrum orange; palpi brownish black, unusually long, nearly one-half the antennae; terminal segment about one-third longer than the more slender third segment. Antennae

<sup>1</sup>Contribution from the Entomological Laboratory, University of Massachusetts.

with scape and pedicel brownish yellow, flagellum light yellow, outer segments pale brown; segments long-oval with a circlet of about six black setae that are shorter than the segment. Head light brown; posterior vertex with long black setae.

Pronotum yellow, anteriorly narrowly brownish black. Mesothorax almost uniformly orange, without dark pattern. Halteres with stem whitened, knob slightly more yellowed. Legs with coxae orange; trochanters yellow; femora yellow, tips abruptly brownish black, including about the outer twelfth of segment; tibiae yellow, extreme bases and tips dark brown; tarsi yellow, outer two segments light brown. Wings (Fig. 1) pale yellow, prearcular and costal fields clearer yellow; stigma dark brown, conspicuous; veins of base and costal region yellowed, remaining veins brown. Longitudinal veins beyond general level of origin of  $R_s$  and cord with strong trichia, lacking on both Anals except for a very few at tips. Venation:  $R_s$  straight,  $R_{2+3+4}$  short and straight, slightly longer than the strongly arcuated basal section of  $R_5$ ; veins beyond cord straight, generally parallel.

Basal abdominal segment yellowed, tergites two to six obscure yellow medially, lateral and posterior borders more blackened, seventh segment black; sternites yellowed medially, blackened on sides, especially posteriorly, seventh sternite black, remainder, including ovipositor, yellow.

*Holotype*. ♀, Ardehjan, Iran, September 11, 1956 (Schmid).

The most similar European species that have the apices of the femora blackened and the stigma of the wing dark are *Lipsothrix nobilis* Loew, *L. nervosa* Edwards and *L. nigristigma* Edwards, all with the thoracic dorsum conspicuously patterned with black. Of the above, *nervosa* has the darkened wing pattern somewhat less conspicuous, including the stigma, differing from the present fly in other characters, including the venation, the longitudinal veins beyond the cord being much shorter, with vein  $R_{2+3+4}$  long, about two-thirds  $R_s$ .

*Cheilotrichia (Empeda) gnoma*, n. sp.

Size very small (wing about 3–3.5 mm.); head and thorax dark gray; halteres yellow; legs brown; wings faintly tinted, stigma scarcely indicated; cell  $R_3$  small, triangular in outline, cell *1st M*<sub>2</sub> closed; male hypopygium with both dististyles uniformly pale, outer style bifid, both arms expanded outwardly, inner style a long slender pale rod.

*Male*. Length about 3–3.3 mm.; wing 2.8–3.4 mm.

*Female*. Length about 3.4–3.7 mm.; wing 3–3.2 mm.

Rostrum and palpi black. Antennae black; pedicel much enlarged, verticils of basal flagellar segments very long. Head dark gray.

Thorax almost uniformly dark gray, praescutal stripes slightly darker. Halteres yellow. Legs with coxae and trochanters light brown; remainder of legs brown. Wings (Fig. 2) faintly tinted, stigmal darkening scarcely indicated; veins pale brown. Longitudinal veins beyond general level of origin of  $R_s$  with small trichia, including also about the outer half of *2nd A*. Venation:  $Sc_1$  ending about opposite one-third to one-half  $R_s$ ,  $Sc_1$  about four to five times  $Sc_2$ ; cell  $R_3$  triangular in outline, vein  $R_3$  oblique, straight or nearly so; cell *1st M*<sub>2</sub> closed; *m-cu* shortly beyond fork of *M*.

Abdomen brown, pleural region slightly darker. Male hypopygium (Fig. 5) with both dististyles, including the vestiture, pale; outer style large, bifid, the arms longer than the base, inner blade more cleaver-shaped, as shown, outer arm more oval; inner style about four-fifths as long, appearing as a long, very slender pale rod. Phallosome, *p*, about as figured, the aedeagus with an erect lateral darkened lobe near apex.

*Holotype*. ♂, Ardehjan, Iran, September 11, 1956 (Schmid).

*Allotopotype*. ♀. *Paratopotypes*. 14 ♂ ♀, on five pins.

The present fly appears certainly to belong to *Empeda* despite the venation which is very similar to that of *Gonempeda flava* (Schummel) and certain species in the typical subgenus *Cheilotrichia*. However the structure of the male hypopygium, including the dististyles, are much as in *Empeda* and I consider the reference to this subgenus to be correct. The fly is readily told by the very small size, venation, and in hypopygial details.

*Erioptera* (*Pseuderioptera*), n. subgen.

Wing (Fig. 3) with vein  $R_2$  before the outer radial fork, leaving an element  $R_{3+4}$ ; cell 1st  $M_2$  closed; vein 2nd  $A$  with a low terminal bend. Trichia of wing veins very short and sparse, including the costal fringe; marginal setae of proximal two-thirds of posterior wing margin long and delicate; legs with elongate pale scales additional to the normal setae. Male hypopygium (Fig. 6) with both dististyles simple, subterminal; gonapophyses appearing as flattened paddlelike blades.

**Type of subgenus.** *Erioptera* (*Pseuderioptera*) **schmidi**, n. sp.

Other subgenera of *Erioptera* having interpolated scales on the legs include *Meterioptera* Alexander, *Tasiocerodes* Alexander, and *Teleneura* Alexander, all having the venational details and wing trichiation distinct.

*Erioptera* (*Pseuderioptera*) **schmidi**, n. sp.

Mesonotal praescutum yellow with a cinnamon brown median stripe, posterior sclerites of mesonotum and the pleura chiefly light yellow; femora yellow, tips brownish black; wings pale yellow with a very restricted pale brown pattern that includes the cord and apices of outer radial veins; vestiture of veins unusually short, including the costal fringe, lacking on nearly the basal third of wing;  $R_2$  before fork of cell  $R_3$ , cell 1st  $M_2$  present; abdominal tergites light brown basally, yellowed posteriorly; male hypopygium with two simple dististyles; gonapophyses appearing as flattened blades, apices with microscopic spines.

*Male*. Length about 4 mm.; wing 4 mm.; antenna about 0.75 mm.

Rostrum and palpi light yellow. Antennae with scape and pedicel brownish black to black, flagellum light brown; flagellar segments oval, progressively smaller outwardly, verticils subequal in length to the segments. Front and anterior vertex silvery white, posterior vertex abruptly light brown; anterior vertex broad.

Pronotum light yellow, scutellum narrowly more darkened medially. Mesonotal praescutum with a cinnamon brown central stripe that ends some distance before suture, lateral stripes short and narrow, sides broadly light yellow; scutum light yellow, lobes chiefly cinnamon brown; scutellum and anterior mediotergite light yellow, posterior parts light brown. Pleura light yellow. Halteres yellow. Legs with coxae and trochanters light yellow; femora yellow, the relatively broad tips brownish black; remainder of legs yellow, outer tarsal segments darkened; legs with long narrow interpolated pale scales among the normal setae. Wings (Fig. 3) pale yellow, with very small and inconspicuous pale brown spots at  $Sc_2$ ,  $R_1$ ,  $R_{2+3}$ ,  $R_3$  and cord; veins yellow, darker in the patterned areas. Venation:  $Sc_2$  far retracted,  $Sc_1$  about opposite two-thirds  $R_5$ ;  $R_2$  before the radial fork,  $R_{2+4}$  variable in length, in the holotype longer than  $R_2$ , shorter in the paratype;  $m-cu$  before fork of  $M$ ; vein 2nd  $A$  conspicuously sinuous on outer fifth. Vestiture of veins unusually short, including the costal fringe; trichia of veins short and inconspicuous as compared with the normal condition in *Erioptera*, lacking on veins of about the basal third of wing.

Abdominal tergites bicolored, basally light brown, lateral and posterior borders light yellow,

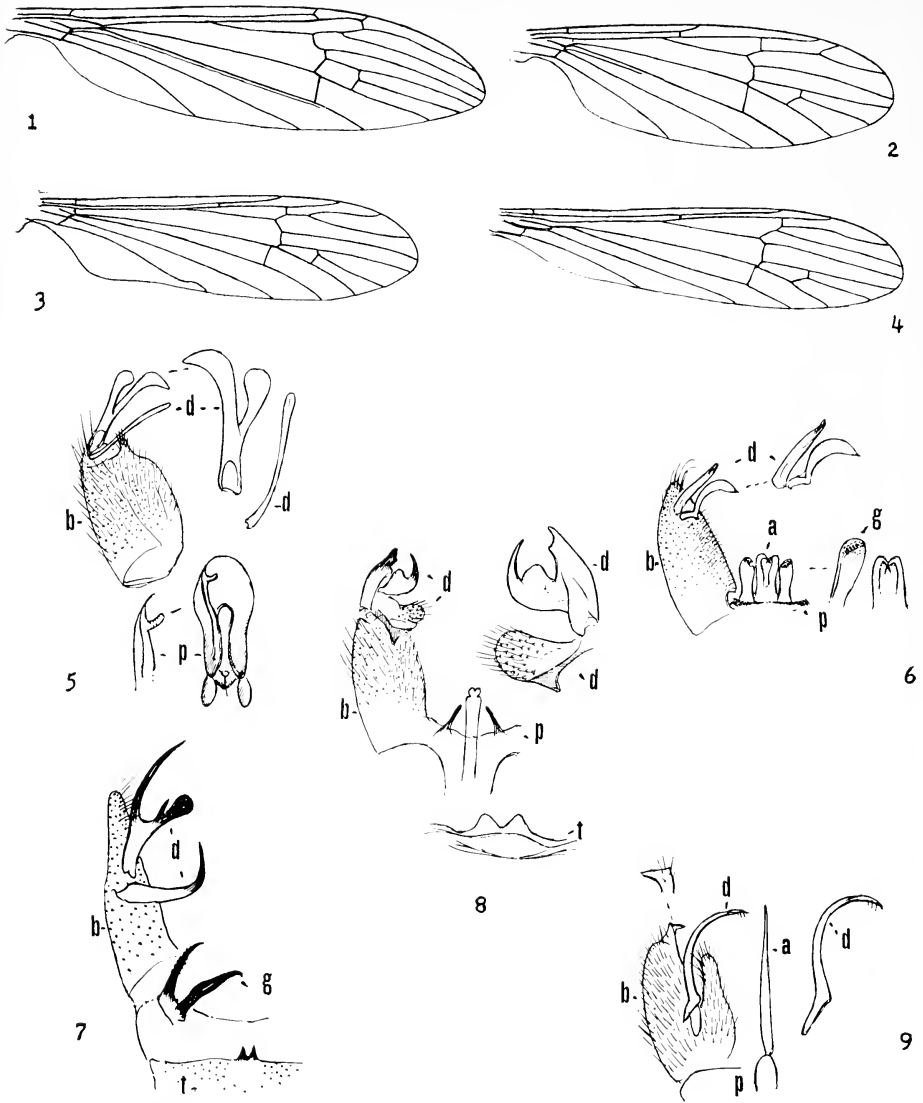

FIG. 1. *Lipsothrix iranica*, n. sp.; venation.

FIG. 2. *Cheilotrichia (Empeda) gnoma*, n. sp.; venation.

FIG. 3. *Erioptera (Pseuderioptera) schmidi*, n. sp.; venation.

FIG. 4. *Erioptera (Psiloconopa) cancriformis*, n. sp.; venation.

FIG. 5. *Cheilotrichia (Empeda) gnoma*, n. sp.; male hypopygium.

FIG. 6. *Erioptera (Pseuderioptera) schmidi*, n. sp.; male hypopygium.

FIG. 7. *Erioptera (Psiloconopa) iranica* Alexander; male hypopygium.

FIG. 8. *Erioptera (Psiloconopa) cancriformis*, n. sp.; male hypopygium.

FIG. 9. *Molophilus (Molophilus) pallidipes*, n. sp.; male hypopygium.

(Symbols: Male hypopygium—*a*, aedeagus; *b*, basistyle; *d*, dististyles; *g*, gonapophysis; *p*, phallosome; *t*, 9th tergite.)

sternites more uniformly yellow. Male hypopygium (Fig. 6) with the simple dististyles subterminal, apex of basistyle, *b*, short, narrowly obtuse, with long yellow setae, outer face of style subglabrous, mesal face with abundant shorter pale setae. Outer dististyle, *d*, a nearly straight slender rod, apex blackened; inner style subequal in length, appearing as a slightly curved flattened yellow blade, the apex a short acute point. Gonapophyses, *g*, appearing as a pair of flattened blades, apices with a row of microscopic spines; aedeagus, *a*, divided into paired rods, tips recurved into points.

*Holotype*. ♂, on slide, Dashte Maghan, Iran, September 29, 1956 (Schmid).

*Paratopotype*. Broken ♂, with the type.

This distinct fly is named for the collector of this fine series of Iranian Tipulidae, Dr. Fernand Schmid. It is readily separated from other generally similar members of the genus by the subgeneric characters as listed above, especially the retracted vein  $R_2$  and the hypopygial structure.

*Erioptera (Psiloconopa) cancriformis*, n. sp.

General coloration of thorax light yellow, patterned with brown, pleura with a very narrow brown central stripe; knobs of halteres brown; wings whitened, without a stigmal darkening, veins light brown, *Sc* white;  $R_2$  about one-half its length beyond the basal fork of *Rs*, cell *1st M*<sub>2</sub> closed; male hypopygium with outer dististyle bilobed, the lobes blackened and pointed, together suggesting a crabs claw; gonapophyses appearing as slender blackened rods.

*Male*. Length about 5 mm.; wing 4.2 mm.

*Female*. Length about 5.5–6 mm.; wing 5–5.2 mm.

Rostrum light brown; palpi black. Antennae light brown; flagellar segments oval, verticils short. Head buffy yellow, vertex more darkened medially, more intensely on anterior vertex.

Prothorax light yellow. Mesonotal praescutum very light brown, darker medially, with a still darker central vitta, humeral region light yellow; scutum brown, narrowly more darkened medially, the outer parts of lobes more diffusely darkened; scutellum light yellow, in male with a narrow darker central line. Pleura light yellow, ventral sternopleurite light brownish gray, central area of pleura with a very narrow brown line extending from base of fore coxa to beneath the root of haltere. Halteres with stem yellow, knob brown. Legs with coxae and trochanters light yellow; femora and tibiae obscure yellow, apices pale brown; tarsi light brown. Wings (Fig. 4) whitened, without a stigmal darkening; veins light brown, *Sc* whitened. Venation:  $Sc_1$  ending about opposite or slightly before  $R_2$ ,  $Sc_1$  subequal to  $Rs$ ;  $R_2$  about one-half its length beyond the radial fork; cell *1st M*<sub>2</sub> closed; *m-cu* at or shortly before fork of *M*; vein *2nd A* virtually straight to slightly extended on distal fifth.

Abdomen yellow, tergites striped longitudinally with dark brown, posterior borders of segments narrowly yellow, sides more broadly so. Male hypopygium (Fig. 8) with the tergite, *t*, having the posterior border produced into two small triangular lobes, subequal in size to the median emargination. Outer dististyle, *d*, conspicuously bilobed into blackened points, the two lobes taken together suggesting a crabs claw, the outer part more obtuse with a smaller lobule on inner margin; inner style pale and fleshy, with abundant setae. Phallosome, *p*, including slender blackened rodlike apophyses; aedeagus slender, straight.

*Holotype*. ♂, Tegan, Iran, July 5, 1956 (Schmid).

*Allotype*. ♀, Durbadam, Iran, July 3, 1956.

*Paratype.* ♀, with the allotype.

*Erioptera (Psiloconopa) idiophallus* (Savtchenko), described as an *Ilisia* (1973) from the district Irshava, Transcarpathia, U.S.S.R., is generally similar but differs evidently in hypopygial structure.

*Molophilus (Molophilus) pallidipes*, n. sp.

General coloration of head light gray; thorax brownish gray, pleura brown; antennae short, brown; halteres light yellow; legs with femora and tibiae yellow, tips narrowly light brown; wings brownish yellow; male hypopygium with outer lobe of basistyle extended into a narrow pale plate; a single long slender dististyle.

*Male.* Length about 4.5–5 mm.; wing 4.5–5 mm.; antenna about 1.2–1.3 mm.

Rostrum and palpi dark brown. Antennae brown, scape and pedicel more yellowed; flagellar segments oval. Head light gray.

Pronotal scutum brown, scutellum light yellow. Mesonotal praescutum light to darker brownish gray, with darker brown stripes, lateral pair short and ill-defined; scutum brownish gray; scutellum yellowed, postnotum brownish gray. Pleura brown, dorsopleural membrane yellowed. Halteres light yellow. Legs with coxae and trochanters yellow; femora and tibiae yellow, tips narrowly light brown; tarsi brown. Wings brownish yellow, veins slightly darker, the vestiture darker brown.

Abdomen medium brown. Male hypopygium (Fig. 9) with outer lobe of basistyle, *b*, extended into a narrow pale plate, the apical margin farther produced into a point; inner lobe of style small and narrow, apically with long pale setae. A single dististyle, *d*, appearing as a long rod, gradually narrowed and curved to the acute twisted tip, apex acute. Aedeagus, *a*, subequal in length and diameter to the dististyle, outer fourth more narrowed.

*Holotype.* ♂, Pul-i-Zoghal, Iran, May 18, 1956 (Schmid).

*Paratopotype.* ♂, pinned with type.

*Paratypes.* 2 ♂♂, Barajan, Iran, 2000 meters, September 15, 1955; ♂, Mughan, June 20, 1956; ♂, Luis, September 14, 1955 (all Schmid).

The most similar regional species is *Molophilus (Molophilus) stroblianus* Nielsen (Zeitschr. Wien. Ent. Gesell., 38: 36, figs.; 1953), known from Austria and Czechoslovakia, a dark colored fly with uniformly black legs, differing further in details of the male hypopygium.

DISTRIBUTIONAL RECORDS

*Cheilotrichia (Empeda) cinerascens* (Meigen)

*Erioptera cinerascens* Meigen; Klass., 1: 114; 1804.

*Cheilotrichia (Cheilotrichia) cinerascens* Edwards; Trans. Soc. Brit. Ent., 5: 119, pl. 5, fig. 12 (wing); text fig. 23b (hypopygium); 1938.

*Europe. Iran:* Kamalabad, October 1955 (Schmid).

*Ormosia bivittata* (Loew)

*Rhypholophus bivittatus* Loew; Beschr. Eur. Dipt., 3: 41; 1873.

*Rhypholophus bivittatus* de Meijere; Tijds. v. Ent., 63: 50, fig. 40 (hypopygium); 1920.

*Rhypholophus (Rhypholophus) bivittatus* Lackschewitz; Ann. naturhist. Mus. Wien, 50: 28; 1940.

*Central Europe. Iran:* Pul-i-Zoghal, October 12, 1956 (Schmid).

*Erioptera (Erioptera) fuscipennis* Meigen



*Erioptera fuscipennis* Meigen; Syst. Besch. 1: 111; 1818.

*Erioptera fuscipennis* de Meijere; Tijd. v. Ent., 63: 75, fig. 70 (hypopygium); 1920.

*Erioptera (Erioptera) fuscipennis* Edwards; Trans. Soc. Brit. Ent., 5: 124, text fig. 24 g (hypopygium); 1938.

*Europe. Iran:* Babal, May 21, 1956; Emaret, May 21, 1956; Lius, 2200 meters, September 14, 1955; Quattekas, 1800 meters, September 19, 1955; Zanus, 2000 meters, September 21, 1955 (Schmid).

*Erioptera (Erioptera) trivialis* Meigen

*Erioptera trivialis* Meigen; Syst. Besch. 1: 112; 1818.

*Erioptera trivialis* de Meijere; Tijd. v. Ent., 63: 75, 76, fig. 71 (hypopygium); 1920.

*Erioptera (Erioptera) trivialis* Edwards; Trans. Soc. Brit. Ent., 5: 125, text fig. 24 n (hypopygium); 1938.

*Europe. Iran:* Baranjan, 2000 meters, September 15, 1955; Lius, 2200 meters, September 14, 1955 (Schmid).

*Erioptera (Symplecta) hybrida* (Meigen)

*Limnobia hybrida* Meigen; Klass., 1: 57; 1804.

*Symplecta punctipennis* de Meijere; Tijd. v. Ent., 63: 77, 78, fig. 75 (hypopygium); 1920.

*Erioptera (Symplecta) hybrida* Edwards; Trans. Soc. Brit. Ent., 5: 126, pl. 5, fig. 5 (wing); text fig. 24 A, g (hypopygium); 1938.

*Europe; Asia; Northwestern North America. Iran:* Bar, June 30, 1956; Barajan, 2000 meters, September 15, 1955; Gurgan, April 1, 1956 (Schmid).

*Erioptera (Symplecta) stictica* (Meigen)

*Limnobia stictica* Meigen; Syst. Besch. 1: 158; 1818.

*Symplectomorpha stictica* de Meijere; Tijd. v. Ent., 63: 78, fig. 76 (hypopygium); 1920.

*Erioptera (Symplecta) stictica* Edwards; Trans. Soc. Brit. Ent., 5: 128, pl. 5, fig. 4 (wing); 1938.

*Eurasia; western North America. Iran:* Cheshme, Ali, April 23, 1956; Ghulaman, July 8, 1956; Marus, June 28, 1956; Sefid Khok, June 1, 1956 (Schmid).

*Erioptera (Ilisia) maculata* Meigen

*Erioptera maculata* Meigen; Klass., 1: 61; 1804.

*Acyphona maculata* de Meijere; Tijd. v. Ent., 63: 67, 68, fig. 62 (hypopygium); 1920.

*Erioptera (Ilisia) maculata* Edwards; Trans. Soc. Brit. Ent., 5: 130-131, pl. 5, fig. 21 (wing); text fig. 25 a (hypopygium); 1938.

*Europe*, widespread. *Iran:* Ardehjan, September 9, 1956; Bar, June 30, 1956; Mughan, June 20, 1956; Pul-i-Zoghal, May 18, 1956 (Schmid).

*Erioptera (Psiloconopa) czizeki* (Bangerter)

*Ilisia czizeki* Bangerter; Mitteil. Schweiz. Ent. Gesell., 20: 353-354; 1947.

*Erioptera (Ilisia) czizeki* Starý; Časopis Moravského Musej, 55: 165, 166, fig. 19 (hypopygium); 1971 (not 1970, as printed).

*Central and Eastern Europe. Iran:* Nandeh, May 29, 1956 (Schmid).

*Erioptera (Psiloconopa) iranica* Alexander

*Erioptera (Psiloconopa) iranica* Alexander; Jour. New York Ent. Soc., 81: 83-85; 1973.

*Iran:* Zanus, Mazanderan, September 21, 1955 (Schmid). Male hypopygium (Fig. 7).

*Molophilus (Molophilus) bifidus* Goetghebuer

*Molophilus bifidus* Goetghebuer; Bull. Soc. Ent. Belgique, 2: 135-136, fig. 9 (hypopygium); 1920.

*Europe. Iran:* Ochrid, 800 meters, August 9, 1955 (Schmid).

*Molophilus (Molophilus) pleuralis* de Meijere

*Molophilus pleuralis* de Meijere; Tijds. v. Ent., 63: 60-61, fig. 53 (hypopygium); 1920.

*Molophilus pleuralis* Edwards; Trans. Soc. Brit. Ent., 5: 144, text fig. 29 g (hypopygium); 1938.

*Europe. Iran:* Bar, June 30, 1956; Emaret, May 21, 1956; Lius, 2200 meters, September 14, 1955; Quattekas, September 19, 1955; Zanus, 2000 meters, September 21, 1955 (Schmid).

---

### BOOK REVIEW

**INSECT PHYSIOLOGY.** Vincent B. Wigglesworth, 7th ed., 166 p. 1974. John Wiley & Sons. \$4.95 paperbound (\$8.95 cloth).

Sir Vincent's paperbound 7th edition is a real bargain at current book prices. Nearly 40 years after publishing the first edition, this new, revised little book is as readable an introductory account of insect physiology as only this masterful author can present. The brief, but complete survey of the subject can be recommended as a stimulating introduction to insect physiology for naturalists, biology students in high schools and colleges, and to scientists in other disciplines who would like to become acquainted with an authoritative and clear treatment of insect physiology. Each chapter is followed by a list of references, from Dietrich Bodenstern to J. de Wilde, with a fair sprinkling of Wigglesworth's own contributions to almost all subjects. There are adequate drawings, illustrating anatomical details. A subject index completes the book.

KARL MARAMOROSCH  
Waksman Institute of Microbiology  
Rutgers University  
New Brunswick, New Jersey

## New or Little-Known Crane Flies from Iran. IV (Diptera: Tipulidae)<sup>1</sup>

CHARLES P. ALEXANDER  
AMHERST, MASSACHUSETTS 01002

RECEIVED FOR PUBLICATION JULY 23, 1974

**Abstract:** Part III of this series of papers that concern the crane flies of Iran was published in this Journal. In this paper species belonging to the tribe Eriopterini were treated. In the final report here provided I am treating species in the major tribes Limoniini and Hexatomini. The new species here described are *Limonia* (*Dicranomyia*) **nigritorus**, *L. (D.) schmidiana*, *L. (D.) subdidyma*, *Dicranota* (*Dicranota*) **ophidia**, and *Limnophila* (*Elaeophila*) **albofascia**. In addition to the above novelties about a score of other species in these two tribes are added to the previous limited list of crane flies presently known from Iran.

The three preceding papers on the crane flies of Iran that were collected by Dr. Fernand Schmid in 1955 and 1956 discussed species in the tribes Pediciini and Eriopterini. In this final report the tribes Limoniini and Hexatomini are stressed and rather numerous species are added to the poorly known fauna of Iran. The detailed report by Schmid on the *Trichoptera* of Iran was cited in the previous paper in this series. It includes an excellent account of the various collecting stations where he studied the chiefly aquatic groups of insects in 1955 and 1956 and the paper should be consulted by all students working on this particularly interesting part of southwestern Asia. As had been stressed before, the Schmid collections of crane flies made in southern Asia have provided the great majority of the species presently known. All types of Tipulidae from these collections are preserved in the Alexander Collection.

### LIMONIINI

*Limonia* (*Dicranomyia*) *decemmaculata* (Loew)

*Limnobia decemmaculata* Loew; Berlin. Entomol. Zeitschr., 17: 35; 1873.

*Dicranomyia decemmaculata* Lackschewitz; Ann. naturhist. Mus. Wien; 42: 205-206, pl. 5, fig. 6 (hypopygium); 1928.

*Limonia* (*Dicranomyia*) *decem-maculata* Edwards; Trans. Soc. Brit. Ent., 5: 30-31, pl. 2, fig. 12 (wing); 1938.

Wide-spread in Europe. *Iran*: Lius, 2200 meters, September 14, 1955; Ramsar, October 2, 1956 (Schmid). Wing (Fig. 1); hypopygium (Fig. 3).

It should be noted that Lackschewitz in the above reference shows the male hypopygium with two rostral spines on the ventral dististyle, presumably in error. All other specimens known to me have the single spine as shown in the figure. The Oriental *Limonia* (*Dicranomyia*) *flavocincta* (Brunetti), *L. (D.) vibishana* Alexander and *L. (D.) whitei*

<sup>1</sup>Contribution from the Entomological Laboratory, University of Massachusetts.

Alexander, of South India and Ceylon evidently are allied despite the virtually unpatterned wings.

*Limonia (Dicranomyia) nigritorus*, n. sp.

Size medium (wing of male 8.5 mm); mesonotum gray, patterned with darker; knobs of halteres dark brown; legs yellow, tips of femora narrowly dark brown; wings whitish, conspicuously patterned with brown, *Sc* long, *Sc*<sub>1</sub> ending opposite one-third *Rs*; abdomen dark brown, posterior borders of segments broadly light yellow; male hypopygium with dorsal dististyle long and slender, sinuous; ventral dististyle with two separated rostral spines, face of style near base of prolongation with a subconical black lobe that is provided with numerous black spines, mesal face of style at apex with dense microscopic setae.

*Male*. Length about 8.5 mm; wing 8.5 mm; antenna about 1.6 mm.

Rostrum and palpi dark brown. Antennae with scape and pedicel dark brown, flagellum brown, the bases of proximal two segments narrowly yellowed; proximal flagellar segments oval with truncated ends, outer ones elongate; verticils shorter than the segments. Head dark brown.

Pronotal scutum dark brown, scutellum paler. Mesonotal praescutum gray with darker stripes; scutum blackened, gray pruinose, lobes darker; scutellum brownish gray, narrowly more blackened medially, parascutella light yellow; postnotum brown, light gray pruinose. Pleura light gray, dorsopleural membrane more brownish yellow. Halteres with stem light yellow, knob large, dark brown. Legs with coxae and trochanters light yellow; femora yellow, tips narrowly dark brown; tibiae yellow, extreme tips darkened; tarsi yellow, outer segments darkened. Wings whitened, conspicuously patterned with brown; cells *C* and *Sc* with three darker areas, placed at base, near midlength and at outer end of vein *Sc*; stigma brown, confluent with a large concolorous spot; other major paler brown clouds in cell *M*<sub>4</sub> and at ends of both anal veins, with a further broken series in cell *M*, chiefly along vein *Cu*; smaller darkened seams over cord, outer end of cell *1st M*<sub>2</sub>, and at tips of veins *R*<sub>3</sub> and *M*<sub>3</sub>; veins chiefly brown, darker in the more heavily patterned areas, yellowed in the costal interspaces. Venation: *Sc* long, *Sc*<sub>1</sub> ending opposite one-third *Rs*; cell *1st M*<sub>2</sub> subequal to vein *M*<sub>1+2</sub>; *m-cu* shortly before fork of *M*.

Abdomen dark brown, posterior borders of segments broadly light yellow. Male hypopygium (Fig. 4) with tergite, *t*, transverse, posterior border shallowly emarginate, the low lobes more thickened, with long setae. Basistyle, *b*, and ventral dististyle nearly subequal in area or the latter slightly larger. Dorsal dististyle, *d*, very long and slender, sinuous; ventral style with rostral prolongation slender, with two separated subequal spinoid setae, the outer one about one-half its length from apex of rostrum; apex of mesal face of body of style with a concentration of very short blackened erect setulae, much smaller than the normal setae; face of style near base of the prolongation with a subconical black lobe, its apex provided with several strong spines, the lobe placed in the curvature of the outer style. Gonapophyses, *g*, with mesal-apical lobe slender. Aedeagus, *a*, narrow, especially the lateral flanges, apex simple.

*Holotype*. ♂, Barajan, Iran, 2000 meters, September 15, 1955 (Schmid).

The present species is readily told from other regional members of the subgenus that have patterned wings and long *Sc* by the body coloration and especially the hypopygial structure. The distinctive blackened lobe on the ventral dististyle is particularly noteworthy and has suggested the specific name. *Limonia (Dicranomyia) modesta* (Meigen), widely distributed throughout the Holarctic region, has the hypopygium with somewhat similar but longer

modified setulae on the ventral dististyle but differs in many other regards, including the unpatterned wings, short *Sc*, and details of the hypopygium.

*Limonia (Dicranomyia) schmidiana*, n. sp.

Allied to *mitis*; general coloration of thoracic dorsum brownish gray, pleura yellow; rostrum light yellow, antennal scape brownish yellow, remainder brown; legs light brown; wings subhyaline, virtually unpatterned, stigmal region scarcely darker; *Sc*<sub>2</sub> retracted, at near two-thirds *Sc*; male hypopygium with ninth tergite pale, posterior border with two broadly rounded lobes, the setae short; ventral dististyle small and rounded, only slightly larger than the basistyle; rostral spines long, about twice the prolongation; mesal-apical lobe of gonapophyses small, slender.

*Male*. Length about 7.5–8 mm; wing 7–8 mm; antenna about 1.2 mm.

Rostrum clear light yellow, palpi and mouthparts dark brown. Antennae with scape brownish yellow, remainder of antenna brown, the extreme bases of proximal flagellar segments more yellowed; segments short-oval, the outer ones longer, terminal segment strongly narrowed on outer third. Anterior vertex yellowed, remainder of head chiefly light gray, paler behind; anterior vertex relatively broad.

Pronotum obscure yellow. Mesonotal praescutum with three brownish gray stripes that virtually cover the dorsum; scutal lobes chiefly brownish gray, central area pale; scutellum pale yellow; postnotal mediotergite yellowed, pleurotergite more whitened or light gray. Pleura yellow, including the dorsopleural membrane. Halteres with stem yellow, the large knob brown. Legs with coxae and trochanters yellow; femora light brown, tips not darker; tibiae and tarsi light brown. Wings subhyaline, virtually unpatterned, the stigmal region scarcely darker than the remainder; veins pale, *Sc*<sub>2</sub> and base of *Rs* slightly darker. Vein *Sc* without trichia; sparse trichia at end of 2nd *A*. Venation: *Sc*<sub>1</sub> ending about opposite origin of *Rs*, *Sc*<sub>2</sub> retracted, at near three-fifths to two-thirds *Sc*; *m-cu* at or shortly before fork of *M*.

Abdominal tergites yellowish brown, sternites and hypopygium yellow. Male hypopygium (Fig. 5) combining the characters of *mitis* (long rostral spines) and *chorea* (small ventral dististyle), differing in details. Ninth tergite, *t*, pale, posterior border with two broadly rounded lobes, the median emargination acute; setae short and pale. Basistyle, *b*, in area slightly less than the ventral dististyle; ventromesal lobe with moderately long setae. Dorsal dististyle, *d*, long and slender, sickle-shaped, curved and narrowed to the acute more or less recurved apex: ventral style short-oval to rounded; rostral prolongation small, the two spines approximated, long and straight, about twice the length of the prolongation. Gonapophysis, *g*, with mesal-apical lobe small, relatively slender. Aedeagus, *a*, with apertures subterminal, median lobe conspicuous.

*Holotype*. ♂, Darband, Iran, April 22, 1956 (Schmid). *Paratopotypes*, 2 ♂♂, pinned with type.

The species is dedicated to the collector, Dr. Fernand Schmid. It is most nearly related to *Limonia (Dicranomyia) mitis* (Meigen) and allied species, as shown by the hypopygial structure, especially the relative lengths of the rostral spines of the hypopygium. In the small ventral dististyle it agrees more nearly with *L. (D.) chorea* (Meigen) but is quite distinct from this and other members of this group as delimited by Lackschewitz (Ann. naturhist. Mus. Wien, 42: 209–217; 1928). Other particularly important papers on this group of flies include Edwards (Trans. Soc. Brit. Ent., 5: 28–44; 1938) and de Meijere (Tijd. voor Ent., 62: 65–90; 1919). Attention may be called to the species *L. (D.) lutea* Meigen (see Edwards, above, p. 37; de Meijere, p. 78) that was placed as a race or variety

of *mitis*, differing in coloration of the body and wings and in hypopygial structure, including the ventral dististyle, as discussed. Lackschewitz (1928, above) considered this as being a yellowish autumnal form of *chorea*.

*Limonia (Dicranomyia) subdidyma*, n. sp.

General coloration of mesonotal praescutum and scutal lobes dull light brown, posterior sclerites of notum and the pleura more yellowed; knobs of halteres blackened; legs with femora yellow, tips very narrowly dark brown; wings pale yellow with a pale brown pattern including four costal areas that are narrower than the interspaces, other darkenings on wing paler;  $Sc_2$  far retracted, at near midlength of  $Sc$ ; male hypopygium with rostral prolongation of dististyle triangular in outline, with two short spines near base on face of style.

*Male*. Length about 8 mm; wing 9 mm.

Rostrum and palpi brown. Antennae brown; flagellar segments oval with truncated ends; terminal and penultimate segments subequal in length. Head brown.

Pronotal scutum pale brown, scutellum more yellowed. Mesonotum dull light brown with vague indications of light gray stripes; scutal lobes light brown, median area and the scutellum pale yellow; postnotum brownish yellow. Pleura dull brownish yellow, dorsopleural region clearer yellow. Halteres with stem yellow, knob almost black. Legs with coxae and trochanters yellow; femora obscure yellow, tips very narrowly dark brown; tibiae brownish yellow, extreme tips faintly darkened; tarsi brownish yellow, outer segments darker. Wings pale yellow with a relatively inconspicuous pale brown pattern that includes four costal areas, much narrower than the interspaces, the first area above the arculus, second at  $Sc_2$ , the third slightly larger, involving the tip of  $Sc_1$  and origin of  $Rs$ ; fourth darkening comprises the pale brown stigma, nearly confluent with a smaller area over the fork of  $Rs$ ; further more restricted markings over remainder of cord, outer end of cell *1st*  $M_2$  and tip of  $R_2$ ; still smaller marginal clouds at ends of veins  $M_3$  to *2nd*  $A$ , the last more extensive and slightly paler; veins yellow, light brown in the clouded areas. Venation:  $Sc_1$  ending opposite origin of  $Rs$ ,  $Sc_2$  far retracted, close to midlength of  $Sc$ ; free tip of  $Sc_2$  and  $R_2$  in transverse alignment; *m-cu* shortly before the fork of  $M$ .

Abdomen pale brown, the extreme posterior borders of segments more yellowed; hypopygium with basistyle darker brown. Male hypopygium (Fig. 6) with tergal lobes, *t*, rounded, vestiture pale and inconspicuous. Basistyle, *b*, with ventromesal lobe rounded, vestiture long. Dorsal dististyle, *d*, bent at midlength, the narrowed outer end slender, tip decurved; ventral style about twice the basistyle, rostral prolongation triangular in outline; spines short, placed on face of prolongation near base. Gonapophyses, *g*, with mesal-apical lobe erect.

*Holotype*. ♂, Darband, Iran, April 22, 1956 (Schmid).

The most similar Palaearctic species include *Limonia (Dicranomyia) chorea* (Meigen), *L. (D.) didyma* (Meigen) and *L. (D.) mitis* (Meigen), all with the wings patterned and with  $Sc_1$  very long. The single most similar species is *didyma* which differs evidently in wing

FIG. 1. *Limonia (Dicranomyia) decemmaculata* (Loew); venation.

FIG. 2. *Dicranota (Dicranota) ophidia*, n. sp.; venation.

FIG. 3. *Limonia (Dicranomyia) decemmaculata* (Loew); male hypopygium.

FIG. 4. *Limonia (Dicranomyia) nigritorus*, n. sp.; male hypopygium.

FIG. 5. *Limonia (Dicranomyia) schmidiana*, n. sp.; male hypopygium.

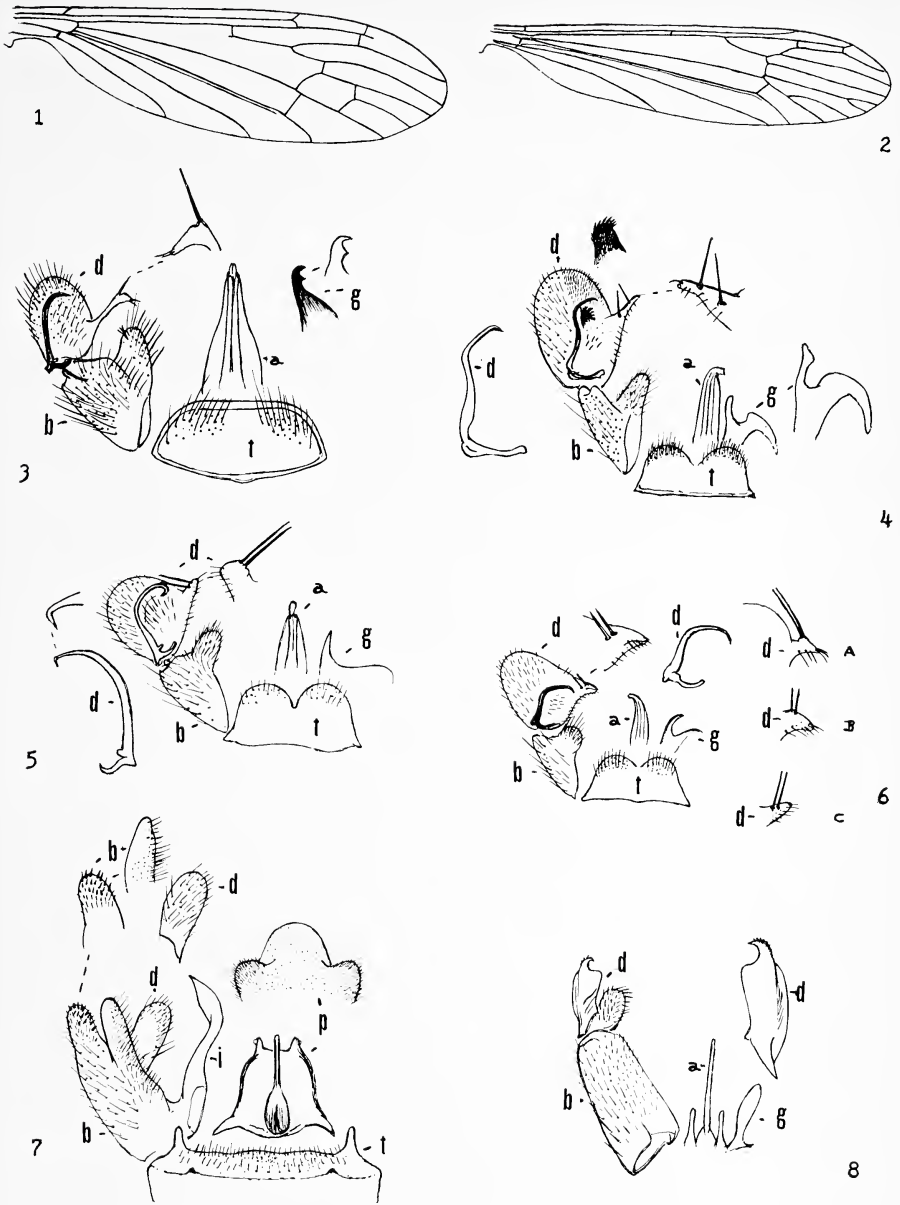

FIG. 6. *Limonia (Dicranomyia) subdidyma*, n. sp.; male hypopygium. Subfigures: A, *didyma* (Meigen); B, *chorea* (Meigen); C, *mitis* (Meigen).

FIG. 7. *Dicranota (Dicranota) ophidia*, n. sp.; male hypopygium.

FIG. 8. *Limnophila (Elaeophila) albofascia*, n. sp.; male hypopygium.

(Symbols: Male hypopygium—*a*, aedeagus; *b*, basistyle; *d*, dististyles; *g*, gonapophysis; *i*, interbase; *p*, phallosome; *t*, 9th tergite.)

pattern, as the undarkened arcular region, and especially in hypopygial details. I have provided illustrations of the rostral prolongations of the above three species in subfigures, *didyma*, 6A; *chorea*, 6B; *mitis*, 6C.

PEDICINI

*Dicranota (Dicranota) ophidia*, n. sp.

Size relatively large (wing 7–8 mm); antennae short; general coloration of thorax light brownish gray, praescutum with a darker central stripe, pleura brownish yellow, sparsely pruinose; halteres and legs yellow; wings faintly infuscated, stigma only slightly darker,  $R_{2+3+4}$  subequal to or shorter than basal section of  $R_5$ ; male hypopygium with lateral tergal blades short, posterior border truncate, setae short; dorsal lobe of basistyle with short blackened subspinoid setae; interbase a sinuous snakelike rod, slightly constricted before the pointed head.

*Male*. Length about 7–8 mm; wing 7–8.5 mm; antenna about 1–1.2 mm.

*Female*. Length about 8.5–9 mm; wing 7–8 mm.

Rostrum brownish gray, palpi black. Antennae short, brownish black, scape pruinose. Head brownish gray.

Pronotum light brown, pretergites and posterior borders of scutum and scutellum light yellow. Mesonotal praescutum light brownish gray with a conspicuous darker brown central stripe, lateral stripes much narrower; scutum light gray, centers of lobes extensively light brown; scutellum brown, light gray pruinose; postnotum brownish yellow, slightly pruinose. Pleura brownish yellow, slightly pruinose. Halteres light yellow. Legs with coxae yellow, fore and middle pairs slightly pruinose; trochanters yellow; remainder of legs brownish yellow, outer tarsal segments slightly darker; claws long, gently curved. Wings (Fig. 2) faintly infuscated, stigma only slightly darker; veins light brown. Macrotrichia of veins beyond cord long and delicate; basal veins, including  $M$  and both Anals with much shorter trichia on outer two-thirds or more, less extensive on  $Cu$ . Venation:  $R_{2+3+4}$  variable in length, in cases subequal to or shorter than basal section of  $R_5$ , in cases twice as long; cell  $M_1$  present.

Abdominal tergites light to darker brown, sternites slightly paler, hypopygium darker brown. Male hypopygium (Fig. 7) with tergite,  $t$ , truncate, with abundant short setae, lateral tergal ends produced into short slender blades. Basistyle,  $b$ , with dorsal lobe stouter, vestiture short, blackened, subspinoid; ventral lobe glabrous above, lower margin with numerous pale setae, the more basal ones shorter. Interbase,  $i$ , distinctive, appearing as a long sinuous snakelike rod, slightly constricted before the long pointed head. Phallosome,  $p$ , with details generally as figured, aedeagus short and slender.

*Holotype*. ♂, Zanus, Iran, 2000 meters, September 21, 1955 (Schmid).

*Allotopotype*, ♂, pinned with type. *Paratypes*, ♂ ♀, Lius, 2200 meters, September 14, 1955; Rayne, 1800 meters, September 2–5, 1955; Waliabad, September 16–24, 1956 (Schmid).

The more similar species include *Dicranota (Dicranota) capillata* Lackschewitz and the larger *D. (D.) fuscipennis* Lackschewitz, of central Europe, especially the former. I possess a paratype of *capillata* received in an exchange with Lackschewitz (Salzburg, Gastein, 1879, collected by Joseph Mik). This differs from the present fly in the very distinct venation of the radial field but this feature may well represent an individual variation only. In the specimen *r-m* is before the fork of  $R_5$  that forks into a trident and cell  $M_1$  is very reduced. The details of the male hypopygium are quite distinct, especially the produced tergal border



and the shape and vestiture of the dististyle. The interbase is generally as in the present fly, differing in the outer conformation.

## HEXATOMINI

*Limnophila (Elaeophila) albofascia*, n. sp.

General coloration of head and thorax brownish gray, praescutum conspicuously patterned with darker brown; knobs of halteres dark brown; wings with distinctive pattern, including darker costal areas, with a complete unbroken pale band at midlength between the third and fourth darkened areas; no darkened spots or dots on veins; male hypopygium with outer dististyle narrowed at apex into a short curved point; dorsal crest long and low; gonapophyses large; aedeagus long and slender.

*Male.* Length about 7.5 mm; wing 6.5 mm.

*Female.* Length about 8 mm; wing 7 mm.

Rostrum light brown; palpi black. Antennae with scape and pedicel light brown; flagellum broken. Head brownish gray.

Pronotum brownish gray. Mesonotal praescutum brownish gray, patterned with brown, including six longitudinal lines, intermediate pair broader on anterior half, directed laterad anteriorly to form lateral marginal stripes, posterior halves of intermediate stripes much narrower and paler, sublateral darkenings broader; pseudosutural foveae brownish black; posterior sclerites of notum pale yellowish gray with very inconspicuous darker markings on scutal lobes and at median line. Pleura pale brown, vaguely patterned with darker. Halteres with stem yellow, outer end of the large knob dark brown. Legs with coxae and trochanters yellow; remainder of legs broken. Wings with ground pale yellowish white, the darkened areas subequal in size; a series of about six darker brown marks in costal field, with a very broad continuous ground crossband at midlength of wing that completely divides the darkened areas; costal darkenings darker, with three marks before the dividing ground band, the basal one at and near the arcular area; second darkening small, in cell *R* narrowed; third band complete, in the type narrowed at the supernumerary crossvein in cell *M*, behind expanded and more or less divided at end of vein *2nd A*; beyond the intermediate ground band with the fourth darkened area in costal field expanded to include the forks of veins *Sc* and *R*<sub>1</sub>, almost confluent, narrowed posteriorly over *r-m* and posterior cord, more or less confluent with darkenings at end of cell *1st M*<sub>2</sub>; two outer darkened areas at ends of veins *R*<sub>3</sub> and *R*<sub>4</sub>, more extensive in holotype, in outer radial cells separated by a circular ground mark in outer end of cell *R*<sub>3</sub>; behind the dark pattern more extensive in the holotype, involving much of outer ends of cell *R*<sub>4</sub> and *R*<sub>5</sub>, with only the tip pale; in the female the dark pattern at wing apex more restricted, appearing as seams over fork of *M*<sub>1+2</sub> and the apices of all longitudinal veins excepting *R*<sub>5</sub>; no supplementary spots or dots on longitudinal veins as in several species in this subgenus; veins yellow in the ground areas, darkest in the costal darkenings, paler behind. Venation: Supernumerary crossvein in the third darkened area; *R*<sub>2+3+4</sub> about one-half longer than basal section of *R*<sub>5</sub>.

Abdomen yellow, patterned with brown, most evident as darkenings at posterior ends of segments, broader outwardly. Male hypopygium (Fig. 8) with outer dististyle, *d*, as shown, the apex narrowed into a short curved point; outer margin with a row of small appressed spines, dorsal crest long and low. Gonapophyses, *g*, appearing as long paddles that are more than one-half the length of the long slender aedeagus.

*Holotype.* ♂, Durbadam, Iran, July 3, 1956.

*Allotype.* ♀, Chenes, Iran, May 19, 1956 (Schmid).

From other regional members of the subgenus *Elaeophila* with somewhat comparable wing patterns, especially with no darkened spots or dots along the veins, the present fly is most readily told by the broad continuous pale ground fascia at near midlength of the wing and in details of hypopygial structure, especially the outer dististyle and phallosome. The most similar such species is *Limnophila (Elaeophila) submarmorata* (Verrall) which differs in the above respects. The great variation found in the wing pattern in *submarmorata* has been discussed by Edwards and various forms have been named by him (Trans. Soc. Brit. Ent., 5: 81-84, pl. 4, figs. 1-7, wings; 1938).

## DISTRIBUTIONAL RECORDS

## LIMONIINI

*Helius (Helius) hispanicus* Lackschewitz

*Helius hispanicus* Lackschewitz; Ann. naturhist. Mus. Wien, 42: 242-243; 1928.

Described from Algeciras, Andalusia, Spain (Hanns Zerny). *Iran*: Mughan, June 20, 1956 (Schmid).

*Helius (Helius) pallirostris* Edwards; Trans. Ent. Soc. London 1921: 206; 1921.

*Europe*: Britain; Sweden; Denmark, and others. *Iran*: Kia Kola, May 22, 1956 (Schmid).

*Antocha (Antocha) libanotica* Lackschewitz

*Antocha (Antocha) libanotica* Lackschewitz; Ann. naturhist. Mus. Wien, 50: 8, pl. 1, figs. 4; 1939 (1940).

Type from Libanon; paratype in Alexander Collection.

*Iran*: Ardehjan, September 11, 1956; Dazdban, May 18, 1956; Lius, 2200 meters, September 14, 1955; Meyur, August 23, 1956; Mishgin, August 21, 1956; Rayne, 1800 meters, September 2, 1955; Shirgah, May 23, 1956; Zanus, 2000 meters, September 21, 1955; Zirab, May 23, 1956 (Schmid).

*Limonia (Limonia) hercegovinae* (Strobl)

*Limnobia hercegovinae* Strobl; Glasnik Zem. Mus. Bosni i Hercegov., 10: 610; 1898.

Central and Eastern Europe. *Iran*: Barajan, 2000 meters, September 15, 1955; Hassankif, September 28, 1956; Khazlak, June 6, 1956; Lius, 2200 meters, September 14, 1955; Zanus, 2000 meters, September 21, 1955 (Schmid).

*Limonia (Limonia) neonebulosa* Alexander

*Dicranomyia nebulosa* Alexander; Canad. Ent., 45: 203; 1913 (preoccupied by Zetterstedt, 1838).

*Limonia (Dicranomyia) neonebulosa* Alexander; Philippine Jour. Sci., 24: 555; 1924.

Eastern Asia; Eastern North America. *Iran*: Baharistan, August 20, 1956 (Schmid).

*Limonia (Melanolimonia) morio* (Fabricius)

*Tipula morio* Fabricius; Mantissa Ins., 2: 324; 1787.

Europe (widespread). *Iran*: Daiband, April 22, 1956; Khozlok, June 6, 1956 (Schmid).

*Limonia (Dicranomyia) chorea* (Meigen)

*Limnobia chorea* Meigen; Syst. Besch. 1: 134; 1818.

*Dicranomyia chorea* de Meijere; Tijds. v. Ent., 62: 74, fig. 7 (hypopygium); 1919.

*Dicranomyia chorea* Lackschewitz; Ann. naturhist. Mus. Wien, 42: 211, fig. 8 (hypopygium); 1928.

*Limonia (Dicranomyia) chorea* Edwards; Trans. Soc. Brit. Ent., 5: 35, pl. 2, fig. 20 (wing); text fig. 5 a (hypopygium); 1938.

Europe (widespread). *Iran*: Lius, 2200 meters, September 14, 1955 (Schmid).

*Limonia (Dicranomyia) didyma* Meigen

*Limonia didyma* Meigen; Klass., 1: 55; 1804.

Europe (widespread). *Iran*: Aliabad, 1800 meters, September 7, 1955; Ardehjan, September 11, 1956; Barajan, 2000 meters, September 15, 1955; Lius, 2200 meters, September 14, 1955; Waliabad, September 16 and 24, 1956 (Schmid).

*Limonia (Dicranomyia) fusca* (Meigen)

*Limnobia fusca* Meigen; Syst. Besch. 6: 274; 1830.

Widespread in Europe and North America. *Iran*: Baharistan, 2000–3000 feet, September 10, 1956; Barajan, 2000 meters, September 15, 1955; Harandan, 100 feet, September 11, 1956 (Schmid).

*Limonia (Dicranomyia) longipennis* (Schummel)

*Limnobia longipennis* Schummel; Beitr. zur Ent., 1: 104; 1829.

Holarctic; widespread. *Iran*: Barajan, 2000 meters, September 15, 1955; Gulugah, September 8, 1956; Mishgin, August 21, 1956; Javardi, 4000 feet, October 7, 1956; Quattekas, 1800 meters, September 19, 1955 (Schmid).

*Limonia (Dicranomyia) modesta* (Meigen)

*Limnobia modesta* Meigen; Syst. Besch., 1: 134; 1818.

Europe. *Iran*: Gach-i-Lai (name faulty), May 17, 1956; Lius, 2200 meters, September 14, 1955; Mishgin, 4500 feet, August 21, 1956; Ziarat, 2000 feet, July 13, 1956 (Schmid).

*Limonia (Dicranomyia) ventralis* (Schummel)

*Limnobia ventralis* Schummel; Beitr. zur Entomol., 1: 136; 1829.

*Limonia (Dicranomyia) pristomera* Alexander; Oriental Insects, 1: 204–205, fig. 8 (hypopygium); 1967 (synonym).

Europe; Afghanistan; South India (Kerala; Madras; Mysore). *Iran*: Fumen, 50 feet, August 18, 1956; Pul-i-Zoghal, 1760 feet, October 12, 1956 (Schmid).

#### HEXATOMINI

*Paradelphomyia (Oxyrhiza) czizekiana* Starý

*Paradelphomyia (Oxyrhiza) czizekiana* Starý; <sup>^</sup>Časopis Moravskeho Musee, 55: 135–137, figs.; 1971.

Types from Moravia, Czechoslovakia. *Iran*: What appears to be this species from Ardehjan, September 11, 1956; Baharistan, circa 2000–3000 feet, September 10, 1956; Lius, circa 7000 feet, September 14, 1955 (Schmid). The most important difference from Starý's description and figures is in the hypopygium, especially the ventral fork where the two spines are widely separated basally, being placed on a horizontal connecting rod. Despite this difference I believe the identification is correct.

*Paradelphomyia (Oxyrhiza) fuscula* (Loew)

*Cladura fuscula* Loew; Berlin. Ent. Zeitschr., 17: 35; 1873.

Europe. *Iran*: Quattekas, circa 4500 feet, September 19, 1955 (Schmid).

*Austrolimnophila ochracea* (Meigen)

*Limonia ochracea* Meigen; Klass., 1: 55; 1804.

Europe. *Iran*: Ardehjan, September 11, 1956; Bozak, 1800 meters, September 11, 1955 (Schmid). The present fly and the Nearctic *Austrolimnophila toxoneura* (Osten Sacken) are very similar and perhaps will be found to be identical.

*Pseudolimnophila lucorum* (Meigen)

*Limnobia lucorum* Meigen; Syst. Besch. 1: 125; 1818.

Europe. *Iran*: Ardehjan, September 9, 1956; Baharistan, September 10, 1956; Barajan, 2000 meters, September 15, 1955; Chalus, May 19, 1956; Zanus, 2000 meters, September 21, 1955 (Schmid).

*Limnophila (Elaeophila) submarmorata* (Verrall)

*Ephelia submarmorata* Verrall; Ent. Mo. Mag., 23: 264; 1887.

*Limnophila (Elaeophila) submarmorata* Edwards; Trans. Soc. Brit. Ent., 5: 81-84, pl. 4, figs. 1, 2; text fig. 15 b; 1938.

Europe. *Iran*: Gurgan, April 1, 1956; Zanus, 2000 meters, September 21, 1955 (Schmid).

*Pilaria discicollis* (Meigen)

*Limnobia discicollis* Meigen; Syst. Besch., 1: 125; 1818.

Europe. *Iran*: Quattekas, 1800 meters, September 19, 1955 (Schmid).

*Pilaria scutellata* (Staeger)

*Limnophila scutellata* Staeger; in Krojer, Naturhist. Tidsskr. 3: 34; 1840.

Europe. *Iran*: Chalus, May 19, 1956 (Schmid).

#### TIPULINAE

*Tipula (Acutipula) maxima transcaucasica* Savtshenko

*Tipula (Acutipula) maxima transcaucasica* Savtshenko; Fauna U. S. S. R., Diptera II, No. 3: 413; 1961.

U.S.S.R.: Transcaucasia. *Iran*: Lius, 2200 meters, September 14, 1955 (Schmid).

*Tipula (Tipula) orientalis* Lackschewitz

*Tipula (Tipula) orientalis* Lackschewitz; Konowia, 9: 272-273, fig. 7; 1930.

South Europe; Egypt; Kurdistan; Caucasus. *Iran*: Rayne, 1800 meters, September 5, 1955 (Schmid).

## BOOK REVIEW

**The Pest War.** W. W. Fletcher, Halsted Press, John Wiley & Sons, N. Y. 218p., 1974. \$11.95.

The problems associated with control of insects and other pests are complex. The author discusses man's war against the major pests that threaten human health and the supply of food. The book is primarily dealing with insects, weeds, fungi and certain vertebrates. Methods of pest control, from mechanical ones, crop rotation, quarantine and eradication, to biological and chemical methods are outlined. The development of insecticides from its early days, through the dramatic period following the application of DDT, cyclodienes, carbamates, organophosphorus and systemic insecticides, the resistance to these compounds, the synergistic effects, as well as diverse uses of herbicides are discussed in brief. I was intrigued by the description of the discovery of 2,4 D in this book, since it differed strikingly from the story I knew. According to Fletcher, 3 scientists at Rothamsted Experimental Station, Nutman, Thorton and Quastel hit upon 2,4 D, and the result of their preliminary work was communicated in 1942 to the Agricultural Research Council, who asked Prof. G. E. Blackman of Oxford University to initiate a program of field trials. These results appeared as late as 1945 in NATURE, having been held up until then for security reasons. The author then mentions that in 1942 two Americans, Zimmerman and Hitchcock, described the use of 2,4 D as a plant growth regulator, but not as a herbicide. Also in the United States, Marth and Mitchell, as well as Hamner and Tukey described the herbicidal uses in 1944. It might be difficult to establish precedence for the precise discovery of the herbicidal activity from these quotations, but I recall that the patent was applied for, and given, to Zimmerman and Hitchcock at Boyce Thompson Institute. It was not contested by the workers at Rothamsted, and the American scientists deserve full credit for this discovery. The various fungicides, including thiram, captan, quinones, as well as antibiotics such as streptomycin and griseofulvin are briefly mentioned. A whole chapter is devoted to methods of application of insecticides and herbicides.

Among the vertebrate pests, the rabbit eradication attempts in Australia and Europe by the myxomatosis virus are described. The resistance to the virus forced the reintroduction of effective chemical control methods. While rabbits seem to be regarded with some affection, rats are generally despised and the most drastic eradication methods are sometimes proposed, and used. Among them is the application of anticoagulant agents, to which, unfortunately, rats can develop resistance. Several species of birds, such as pigeons, gulls, and others also are listed as pests, and their control discussed. The impressive success of biological control methods, as well as integrated biological and chemical control, and novel methods of control are presented in a very stimulating manner. Sterilization by chemicals and radiation, pioneered by Knipling, use of sex attractants, repellents, electromagnetic energy, ionizing radiation, as well as the use of insect hormones as insecticides are all briefly presented. A whole chapter is devoted to the effects of pesticides on the environment. The book ends with an appendix, listing additional sources of information for interested readers, as well as a list of common and scientific names of pests, and of pesticides. A good index, on 18 pages, is provided.

The author should be congratulated for his comprehensive and well balanced presentation of this complex subject, in a manner understandable by laymen as well as by experts.

KARL MARAMOROSCH  
Waksman Institute of Microbiology  
Rutgers University  
New Brunswick, New Jersey

## INVITATION TO MEMBERSHIP

The New York Entomological Society was founded in 1892 and incorporated the following year. It holds a distinguished position among scientific and cultural organizations. The Society's **Journal** is one of the oldest of the leading entomological periodicals in the United States. Members and subscribers are drawn from all parts of the world, and they include distinguished professional naturalists, enthusiastic amateurs, and laymen for whom insects are only one among many interests.

You are cordially invited to apply for membership in the Society or to subscribe to its **Journal** which is published quarterly. Regular meetings are held at 8:00 P.M. on the first and third Tuesdays of each month from October through May at the American Museum of Natural History, the headquarters of the Society. A subject of general interest is discussed at each meeting by an invited speaker. No special training in biology or entomology is necessary for the enjoyment of these talks, most of which are illustrated. Candidates for membership are proposed at a regular meeting and are voted upon at the following meeting.

### CLASSES OF MEMBERSHIP AND YEARLY DUES

<i>Active member</i> : Full membership in the Society, entitled to vote and hold office; with <b>Journal</b> subscription .....	\$9.00
<i>Active member without <b>Journal</b> subscription</i> .....	4.00
<i>Sustaining member</i> : Active member who voluntarily elects to pay \$25.00 per year in lieu of regular annual dues.	
<i>Life member</i> : Active member who has attained age 45 and who pays the sum of \$175.00 in lieu of further annual dues.	
<i>Student member</i> : Person interested in entomology who is still attending school; with <b>Journal</b> subscription .....	5.00
<i>Student member without <b>Journal</b> subscription</i> .....	2.00
<i>Subscription to <b>Journal</b> without membership</i> .....	8.00

---

### APPLICATION FOR MEMBERSHIP

Date .....

I wish to apply for ..... membership (see classes above).

My entomological interests are: .....

If this is a student membership, please indicate school attending and present level.

Name .....

Address .....

(Zip Code *must* be included)

— Send application to Secretary —

# **JOURNAL of the NEW YORK ENTOMOLOGICAL SOCIETY**

The **JOURNAL** of the **NEW YORK ENTOMOLOGICAL SOCIETY** is devoted to the advancement and dissemination of knowledge pertaining to insects and their related forms.

**SUBSCRIPTIONS** are \$8.00 per year, in advance, and should be sent to the New York Entomological Society, the American Museum of Natural History, 79th Street at Central Park West, New York, N. Y. 10024. The Society will not be responsible for lost **JOURNALS** unless immediately notified of change of address. We do not exchange publications.

Please make all checks, money-orders, or drafts payable to the **NEW YORK ENTOMOLOGICAL SOCIETY**.

**ORDERS** and inquiries for back issues and complete sets should be sent to our agent, S-H Service Agency, Inc., 866 Third Ave. New York, N. Y. 10022. Complete files of back issues are in stock.

## **INFORMATION FOR AUTHORS**

Submit manuscript in duplicate (original and one carbon) to the Editor, New York Entomological Society, Waksman Institute of Microbiology, Rutgers University, New Brunswick, N.J. 08903.

1. **GENERAL POLICY.** Manuscript submitted must be a report of unpublished research which is not being considered for publication elsewhere. A manuscript accepted and published in the **JOURNAL** must not be published again in any form without the consent of the New York Entomological Society.

A page charge of \$15 per printed page is assessed except that the charge may be reduced in the case of a member of the Society who cannot obtain institutional or grant funds for publication.

The page charge includes black and white illustrations and tabular material.

2. **FORM OF MANUSCRIPT.** Text, footnotes and legends must be typewritten, double or triple spaced, with margins of at least 1½ inches on all sides. The editorial style of the **JOURNAL** essentially follows the *CBE Style Manual* (3rd edition, A.I.B.S., 1972).

Genetic symbols: follow recommendations of Demerec, et al.  
(Genetics **54**: 61, 1969)

Biochemical abbreviations: follow rules of the U.I.P.A.C. -I.U.B.  
(J. Biol. Chem. **241**: 527, 1966)

Enzyme activity: should be expressed in terms of international units.  
(Enzyme Nomenclature. Elsevier Pub. Co., 1965)

Geographical names, authors names and names of plants and animals should  
be spelled in full.

The JOURNAL reserves the privilege of editing manuscript or of returning it  
to the author for revision.

3. ABSTRACT. Each manuscript must be accompanied by an abstract,  
typewritten on a separate sheet.

4. TITLE. Begin each title with a word useful in indexing and information  
retrieval (Not "Effect" or "New".)

5. ILLUSTRATIONS. Original drawings *should not be submitted*. Glossy  
prints are desirable—not larger than 8½ by 11 inches and preferably not  
smaller than 5 by 7 inches. When appropriate, magnification should be indi-  
cated by a suitable scale on the photograph.

6. REPRINTS (in multiples of 100) may be purchased from the printer  
by contributors. A table showing the cost of reprints, and an order form, will  
be sent with the proof.

7. SUBSCRIPTION to the JOURNAL is \$8.00 per year, in advance, and  
should be sent to the New York Entomological Society, The American Museum  
of Natural History, Central Park West at 79th Street, New York, New York,  
10024. The Society will not be responsible for lost JOURNALS unless im-  
mediately notified of change of address. We do not exchange publications.  
Please make all checks, money orders and drafts payable to the NEW YORK  
ENTOMOLOGICAL SOCIETY.

8. ORDERS and inquiries for back issues and complete sets should be sent  
to our agent: Harry Lubrecht, Bookseller, 4672 Broadway, New York, N.Y.  
10040.



595.70673

Ent.

Vol. LXXXIII

SEPTEMBER 1975

No. 3

Journal  
of the  
New York  
Entomological Society

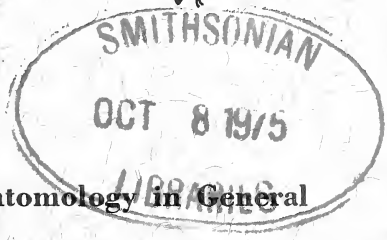
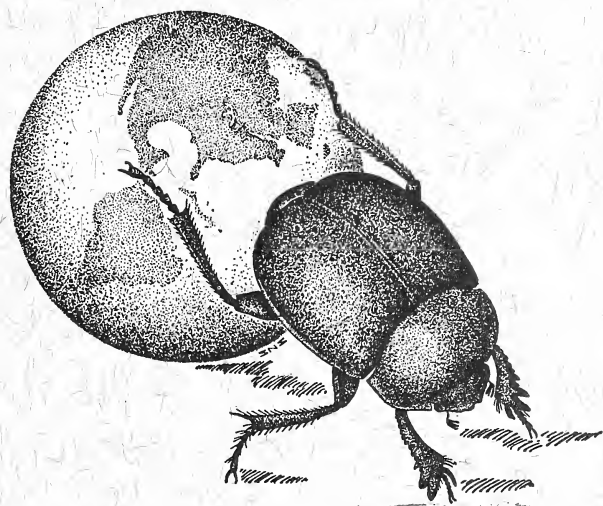

Devoted to Entomology in General

**The New York Entomological Society**  
**Incorporating The Brooklyn Entomological Society**  
**Incorporated May 21, 1968**

---

**The New York Entomological Society**  
**Organized June 29, 1892—Incorporated February 25, 1893**  
**Reincorporated February 17, 1943**

---

**The Brooklyn Entomological Society**  
**Founded in 1872—Incorporated in 1885**  
**Reincorporated February 10, 1936**

The meetings of the Society are held on the first and third Tuesday of each month (except June, July, August and September) at 8 P.M., in the AMERICAN MUSEUM OF NATURAL HISTORY, 79th St. & Central Park W., New York, N. Y. 10024.

Annual dues for Active Members, \$4.00; including subscription to the Journal, \$9.00.

Members of the Society will please remit their annual dues, payable in January, to the Treasurer.

---

**Officers for the Year 1975**

- President*, Dr. Daniel J. Sullivan, S.J.  
Fordham University, New York 10458
- Vice-President*, Dr. Peter Moller  
American Museum of Natural History, New York 10024
- Secretary*, Dr. Charles C. Porter  
Fordham University, New York 10458
- Assistant Secretary*, Dr. Louis Trombetta  
Isaac Albert Research Institute, Brooklyn, N.Y. 11203
- Treasurer*, Dr. Ivan Huber  
Fairleigh Dickinson University, Madison, N.J. 07940
- Assistant Treasurer*, Ms. Joan DeWind  
American Museum of Natural History, New York 10024
- 

**Trustees**

- Class of 1975  
Dr. Howard Topoff  
Dr. Pedro Wygodzinsky
- Class of 1976  
Dr. David C. Miller  
Dr. Norman Platnick
- 

Mailed September 26, 1975

The Journal of the New York Entomological Society is published quarterly for the Society by Allen Press Inc., 1041 New Hampshire, Lawrence, Kansas 66044. Second class postage paid at New Brunswick, New Jersey and at additional mailing office.

Known office of publication: Waksman Institute of Microbiology, New Brunswick, New Jersey 08903.

# Journal of the New York Entomological Society

VOLUME LXXXIII

SEPTEMBER 1975

No. 3

## EDITORIAL BOARD

*Editor* DR. KARL MARAMOROSCH  
Waksman Institute of Microbiology  
Rutgers University  
New Brunswick, New Jersey 08903

*Associate Editors* DR. LOIS J. KELLER, RSM  
DR. HERBERT T. STREU

Publication Committee

Dr. Kumar Krishna  
Dr. Ayodha P. Gupta  
Dr. James Forbes, Chairman

## CONTENTS

An Annotated List of New York Siphonaptera .....	Allen H. Benton and Danny L. Kelly	142
Notes on the Life Cycle and Natural History of Butterflies of El Salvador. I B.— <i>Hamadryas februa</i> (Nymphalidae-Hamadryadinae) .....	Alberto Muyschondt and Alberto Muyschondt, Jr.	157
Notes on the Life Cycle and Natural History of Butterflies of El Salvador. II B.— <i>Hamadryas guatemalena</i> Bates (Nymphalidae-Hamadryadinae) .....	Alberto Muyschondt and Alberto Muyschondt, Jr.	170
Notes on the Life Cycle and Natural History of Butterflies of El Salvador. III B.— <i>Hamadryas amphinome</i> L. (Nymphalidae-Hamadryadinae) .....	Alberto Muyschondt and Alberto Muyschondt, Jr.	181
Notes on the Male Reproductive System in Ants (Hymenoptera: Formicidae) .....	A. C. F. Hung and S. B. Vinson	192
Species and Numbers of Bloodsucking Flies Feeding on Hogs and Other Animals in Southern New Jersey .....	Thomas J. Weiner and Elton J. Hansens	198
Speleognathinae Collected From Birds In North America (Acarina: Erey-netidae) .....	A. Fain and K. E. Hyland	203
Elliptochthoniidae, a New Mite Family (Acarina: Oribatei) From Mineral Soil in California .....	Roy A. Norton	209

## An Annotated List of New York Siphonaptera

ALLEN H. BENTON AND DANNY L. KELLY

DEPARTMENT OF BIOLOGY, STATE UNIVERSITY COLLEGE, FREDONIA, NEW YORK. 14063

RECEIVED FOR PUBLICATION JULY 29, 1974

**Abstract:** Geary (1959) listed 42 species of Siphonaptera from New York. The present list includes numerous additional distributional records, and adds three species to Geary's list: *Peromyscopsylla h. hamifer* (Rothschild), *Ceratophyllus diffinis* Jordan (previously reported but missed by Geary), and *Epitedia (cavernicola* Traub?). Geary also removed from the state list *Echidnophaga gallinacea* (Westwood), but we consider the published record to be a valid one.

New York is one of the most thoroughly studied of states with respect to its flea fauna. Many of the specimens studied by Carl F. Baker near the turn of the century were from New York, largely through the collecting of G. S. Miller, Jr., whose home was in Madison county. The type localities of four fleas described by Baker are in that vicinity, and seven other forms have been described from type localities in New York.

The first state list of fleas from any eastern state was that of Stewart (1928), listing 26 species from New York. Jordan (1929) made some corrections which reduced Stewart's list to 22, and added nine more species, bringing the list to 31 forms. He predicted that about 50 species would eventually be discovered in the state, and presented a hypothetical list comprising 11 species. Of these, seven have since been recorded in the state, two are not to be expected in light of current knowledge, and two remain on the hypothetical list.

Stewart (1933) revised the list once again, recording 36 forms and including one which Jordan had discredited in 1929. Fox (1940) based his New York list primarily on the 1933 list of Stewart, adding three species and eliminating one species and one subspecies. His list thus totalled 37 forms.

The most recent summary of New York collections was that of Geary (1959), which included 42 forms with definite records and four species which had been previously recorded but which Geary considered to be of doubtful validity.

Since 1960, we have had access to more than 4,000 flea specimens from New York, covering many areas which had been poorly represented in collections up to that time. We are grateful to the New York State Museum and Science Service and Dr. Paul Connor for the use of collections from Lewis, Otsego, Schoharie, St. Lawrence and Suffolk counties. In addition, more than a thousand specimens from the Catskill Mountain area have been loaned by Daniel Smiley, John New and Robert Fisher. Numerous students and friends have supplied additional collections and have assisted in the preparation of specimens. Part of the work has been supported by grants from the Research

Foundation of State University of New York, the Atmospheric Sciences Research Center of State University of New York, and Health Research Incorporated, Albany, N. Y.

The present list is undoubtedly incomplete, and it is likely that Jordan's estimate of about 50 species is extremely accurate. Although much remains to be learned about local and ecological distribution, it is unlikely that more than a half-dozen species remain to be discovered within the state.

Nomenclature of the Siphonaptera follows the classification of Hopkins and Rothschild (1953 et seq.) so far as available, except for a few taxonomic changes which have occurred since the pertinent volume was published. Mammal names follow Hall and Kelson (1959). Host relationship data follow the plan of Sakaguti and Jameson (1962): true hosts permit the flea to carry out its life cycle indefinitely; secondary hosts are commonly parasitized, but are not considered biologically adequate as permanent hosts; accidental hosts are those which result from accidental coming together of host and parasite, and such relationships are not likely to occur frequently. Since our knowledge of host relationships is far from complete, these designations should be taken as considered opinions, which may prove to be wrong in the light of further data.

Host records listed are those which are known from New York. In most cases, the true host is the same throughout the range of the species, but this is not always true. In New York, for example, *Monopsyllus vison* is rarely found on any host except the red squirrel. In Minnesota, however, large numbers occur on the eastern chipmunk, and the species is known from southern Illinois, beyond the range of the red squirrel. It is evident that host relationships as they occur in our area are not necessarily the same throughout the range of the flea in question.

The most serious gap in our knowledge of flea distribution is the almost complete lack of information about the influence of factors other than the presence of the host. The puzzling distribution patterns of such species as *Stenoponia americana*, *Peromyscopsylla scotti*, *Peromyscopsylla hamifer* and others cannot be explained on the basis of host distribution. Detailed study of the life history and ecology of almost any flea species would be extremely rewarding, but such studies have been undertaken for only a few species which have great medical or veterinary importance.

#### FAMILY PULICIDAE

##### *Echidnophaga gallinacea* (Westwood)

This species is included on the basis of a record reported by Fox and Sullivan (1925). While there is probably no resident population within the state, we see no reason to doubt the validity of this record, or to doubt that the species may occasionally be brought into the state on rats or domestic animals.

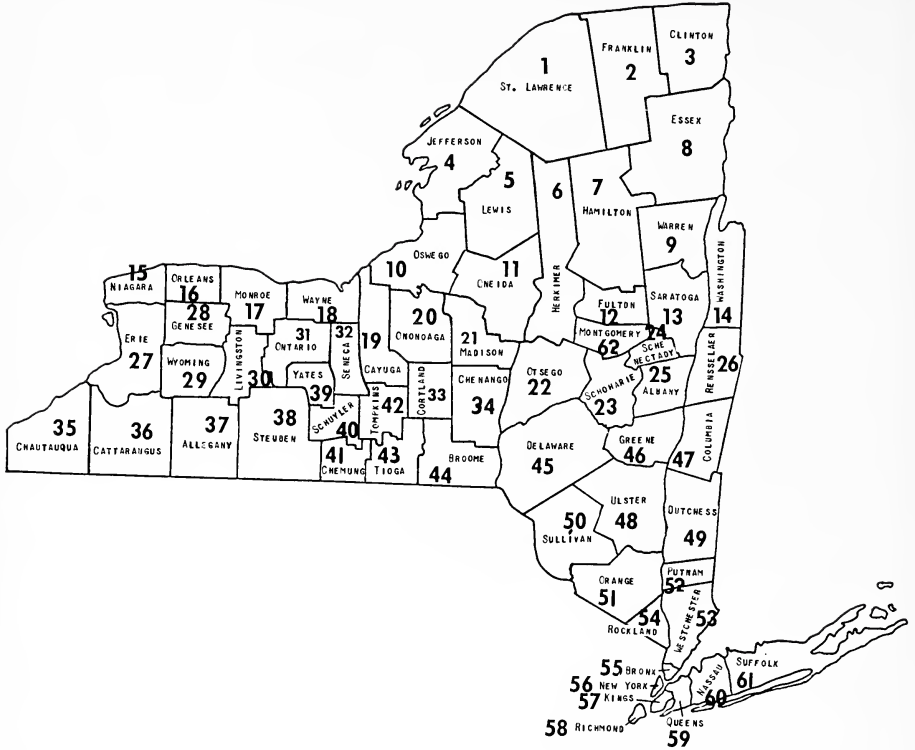

FIG. 1. Map of New York State showing counties. Numbers are the code used for distributional data under species accounts.

Host: *Rattus* sp.

County: 56<sup>1</sup>.

Range within the state: Probably restricted to occasional accidental introductions

*Pulex irritans* Linnaeus

Although human fleas are undoubtedly brought into the state often, records are few. We have not seen specimens from the state, and thus cannot evaluate the possibility that some or all of the records may refer to *P. simulans* Baker.

True host: *Homo sapiens*

Counties: 22, 24, 26

Range within the state: Unknown; possibly there is no permanent population

<sup>1</sup>The map of New York, Figure 1, has the counties coded by number for economy of space. Please refer to this map for identification of the counties indicated in the species accounts.

*Ctenocephalides canis* (Curtis)

True hosts: *Canis familiaris*, *Vulpes fulva*, *Urocyon cinereoargenteus*

Accidental hosts: *Mephitis mephitis*, *Rattus norvegicus*

Counties: 8, 20, 24, 25, 50, 51, 56

Range within the state: Probably all of the state, with the possible exception of the highest elevations

*Ctenocephalides felis felis* (Bouché)

True hosts: *Felis domestica*, *Canis familiaris*, *Vulpes fulva*, *Urocyon cinereoargenteus*

Secondary host: *Homo sapiens*

Accidental hosts: *Blarina brevicauda*, *Didelphis marsupialis*, *Procyon lotor*, *Rattus norvegicus*, *Sylvilagus floridanus*, *Tamiasciurus hudsonicus*

Counties: 2, 7, 11, 13, 17, 19, 20, 21, 24, 25, 26, 28, 35, 36, 38, 42, 47, 50, 53, 56

Range within the state: Throughout the state.

*Cediopsylla simplex* (Baker)

This species occurs in great numbers on all species of Leporidae occurring within the state. In the higher mountains of the Adirondacks, however, where *Sylvilagus floridanus* does not occur, we have been unable to find this flea. Whether its absence is due to the absence of the cottontail, or whether it is due to some other ecological factor, is not yet clear.

True hosts: *Sylvilagus floridanus*, *S. transitionalis*, *Lepus americanus*, *L. europaeus*

Secondary and accidental hosts: *Canis familiaris*, *Didelphis marsupialis*, *Felis domestica*, *Mustela frenata*, *Rattus norvegicus*, *Tamiasciurus hudsonicus*

Counties: 2, 9, 10, 19, 20, 21, 22, 23, 25, 26, 27, 30, 31, 35, 36, 42, 44, 45, 46, 47, 48, 49, 50, 52, 56, 61

Range within the state: Throughout the state, except for the higher mountain areas. Additional collecting at high elevations is needed to determine whether it is indeed absent from those areas.

*Xenopsylla cheopis* (Rothschild)

The Oriental rat flea is the major carrier of bubonic plague, and is therefore of great medical importance. Undoubtedly, the species is brought into the state occasionally on rats, but the records are so few as to suggest that the species is only a sporadic entrant, but permanent populations may persist in the extreme southeastern counties.

True host: *Rattus norvegicus*

Counties: 20, 56

Range within the state: Uncertain; possibly there is no permanent population

#### FAMILY VERMIPSYLLIDAE

##### *Chaetopsylla lotoris* (Stewart)

Although named for its type host, the raccoon, this species is also very frequently taken from foxes (Zeh, 1973).

True hosts: *Procyon lotor*, *Vulpes fulva*, *Urocyon cinereoargenteus*

Secondary hosts: *Martes pennanti*, *Didelphis marsupialis*

Counties: 7, 15, 17, 18, 19, 25, 26, 29, 30, 42, 45, 46, 49, 50, 51, 52

Range within the state: Throughout the state

#### FAMILY HYSTRICHOPSYLLIDAE

##### *Hystrichopsylla tahavuana* Jordan

True hosts: *Parascalops breweri*, *Condylura cristata*

Secondary host: *Blarina brevicauda*

Accidental hosts: *Microtus pennsylvanicus*, *M. pinetorum*, *Peromyscus leucopus*

Counties: 1, 5, 8, 17, 23, 25, 26, 42, 48

Range within the state: Probably wherever its true hosts occur; because moles are not usually taken in large numbers by collectors, records are relatively few

##### *Atyphloceras bishopi* Jordan

This is a winter flea, most commonly taken from nests, and hence rather rare in collections. Most New York records are from the meadow vole, but it is taken on the red-backed vole in more northern areas.

True hosts: *Microtus pennsylvanicus*, *Clethrionomys gapperi*

Secondary hosts: *Microtus pinetorum*, *M. chrotorrhinus*

Accidental hosts: *Peromyscus leucopus*, *Blarina brevicauda*

Counties: 17, 22, 28, 34, 42, 48

Range within the state: Probably throughout the state; it may have ecological limits as yet unknown

##### *Stenoponia americana* (Baker)

This species shows little host specificity, occurring on a variety of small mammals. Since it occurs up the Atlantic coast as far as New Brunswick,



there seems no reason why it should not occur in parts of New York where it has not yet been recorded.

Hosts: *Peromyscus leucopus*, *Blarina brevicauda*, *Microtus pennsylvanicus*,  
*M. pinetorum*, *Clethrionomys gapperi*, *Sorex cinereus*, *Scalopus aquaticus*

Counties: 25, 48, 61

Range within the state: So far as known, confined to Long Island and the Hudson valley.

*Tamiohila grandis* (Rothschild)

True host: *Tamias striatus*

Accidental hosts: *Tamiasciurus hudsonicus*, *Vulpes fulva*

Counties: 1, 5, 8, 12, 19, 22, 26, 33, 35, 36, 42, 45, 48

Range within the state: Throughout the state

*Catallagia borealis* Ewing

True host: *Clethrionomys gapperi*

Secondary and accidental hosts: *Microtus chrotorrhinus*, *Napeozapus insignis*, *Peromyscus maniculatus*, *Blarina brevicauda*

Counties: 8, 22, 42, 46, 48, 50

Range within the state: Throughout the state where its host occurs

*Epitedia (cavernicola* Traub?)

From Pennsylvania to Alabama, *Epitedia cavernicola* occurs as a nest parasite of the eastern woodrat, *Neotoma floridana*. We have examined one female *Epitedia* from a woodrat, collected by Daniel Smiley in Ulster county. While it does not agree perfectly with *E. cavernicola*, it is obviously not *E. wenmanni*, so we tentatively assign it to this species until further specimens can be secured. It is possible that the population of woodrats in eastern New York is sufficiently isolated to have permitted the development of a distinct species or subspecies of flea.

Host: *Neotoma floridana*

County: 48

Range within the state: Unknown. Woodrats occur only in southeastern counties, so far as known.

*Epitedia faceta* (Rothschild)

True hosts: *Glaucomys volans*, *G. sabrinus*

Secondary host: *Tamiasciurus hudsonicus*

Accidental host: *Mustela* sp.

Counties: 23, 26, 33, 42, 48

Range within the state: Probably throughout the state; it is rarely collected, being primarily a nest flea

*Epitedia wenmanni wenmanni* (Rothschild)

Some authorities have expressed doubt of the validity of the division of this species into two subspecies, whose distribution is unlike that of any other American form. However, the differences in the male genitalia are quite distinct, and both forms, along with intergrades, occur along a line at least to the Rocky Mountains. In New York, the nominate subspecies occupies most of the state, with *E. w. testor* occurring in Long Island, the Hudson valley as far north as Albany county and Rensselaer county. The type locality of *testor* is at Lansingburg, Rensselaer county, an unfortunate occurrence, since intergrades are found only a few kilometers away.

True hosts: *Peromyscus leucopus*, *P. maniculatus*

Secondary hosts: *Microtus pennsylvanicus*, *M. chrotorrhinus*, *Clethrionomys gapperi*, *Napeozapus insignis*, *Parascalops breweri*

Accidental hosts: *Didelphis marsupialis*, *Mustela erminea*, *Sylvilagus* sp., *Urocyon cinereoargenteus*

Counties: 1, 4, 5, 7, 8, 19, 20, 22, 23, 28, 34, 35, 44, 46, 48, 51

Range within the state: All of the state except the Hudson valley and its tributaries and Long Island

*Epitedia wenmanni testor* (Rothschild)

True host: *Peromyscus leucopus*

Secondary and accidental hosts: *Blarina brevicauda*, *Sorex fumeus*, *Clethrionomys gapperi*, *Glaucomys volans*, *Mustela* sp.

Counties: 23, 25, 26, 48, 61

Range within the state: Hudson valley and valleys of its tributaries, and Long Island

*Corrodopsylla hamiltoni* (Traub)

True host: *Cryptotis parva*

Accidental host: *Microtus pennsylvanicus*

Counties: 35, 42

Range within the state: The true host is known from the lake plain of Lake Erie and Lake Ontario, as far north as Oswego county, from parts of the Finger Lakes region, and from Long Island. The flea should be expected throughout these areas.

*Corrodopsylla curvata curvata* (Rothschild)

True hosts: Shrews of the genus *Sorex*; possibly also *Blarina brevicauda*

Accidental host: *Zapus hudsonius*

Counties: 1, 5, 12, 23, 26, 48, 50

Range within the state: Probably throughout the state, though possibly confined to higher elevations or colder sections

*Ctenophthalmus pseudagyrtes pseudagyrtes* Baker

This species appears to be completely non-specific in its choice of hosts, occurring on virtually every mammalian species in the area. It shows some preference for rodents and insectivores, carnivores being, perhaps, accidental hosts.

Hosts: *Sorex fumeus*, *S. cinereus*, *Blarina brevicauda*, *Condylura cristata*, *Scalopus aquaticus*, *Parascalops breweri*, *Peromyscus leucopus*, *P. maniculatus*, *Clethrionomys gapperi*, *Microtus pennsylvanicus*, *M. chrotorrhinus*, *M. pinetorum*, *Synaptomys cooperi*, *Ondatra zibethica*, *Erethizon dorsatum*, *Tamias striatus*, *Tamiasciurus hudsonicus*, *Glaucomys volans*, *Rattus norvegicus*, *Napeozapus insignis*, *Sylvilagus floridanus*, *Mustela erminea*, *M. frenata*, *Mephitis mephitis*, *Vulpes fulva*

Counties: 1, 2, 4, 5, 7, 8, 9, 12, 17, 19, 21, 22, 23, 25, 26, 27, 28, 35, 36, 40, 42, 46, 48, 50, 53, 61

Range within the state: Throughout the state, though scarce or absent at the highest elevations

*Doratopsylla blarinae* C. Fox

True host: *Blarina brevicauda*

Secondary and accidental hosts: *Condylura cristata*, *Parascalops breweri*, *Sorex fumeus*, *S. dispar*, *Microtus pinetorum*, *Peromyscus leucopus*, *Clethrionomys gapperi*, *Napeozapus insignis*, *Tamiasciurus hudsonicus*

Counties: 1, 4, 5, 7, 8, 17, 19, 20, 22, 23, 25, 26, 27, 35, 36, 42, 46, 48, 50, 51, 61

Range within the state: Throughout the state

*Nearctopsylla genalis genalis* (Baker)

The taxonomy of this genus has been a point of disagreement for many years, and many earlier records were referred to *N. g. laurentina*.

True hosts: *Scalopus aquaticus*, *Parascalops breweri*, *Condylura cristata*, *Blarina brevicauda*

Secondary and accidental hosts: *Sorex fumeus*, *Clethrionomys gapperi*, *Synaptomys cooperi*

Counties: 5, 8, 23, 25, 42, 48, 50, 61

Range within the state: Probably throughout the state. No specimens have

been taken in the western counties, but there are records from adjacent counties in western Pennsylvania (Holland and Benton, 1968).

*Conorhinopsylla stanfordi* Stewart

Although the type specimen was found on the red squirrel, this species is typically a parasite of the flying squirrels, *Glaucomys volans* and *G. sabrinus*. Its rarity in collections is probably due to the fact that it is primarily a nest flea, seldom staying on the host when it leaves the nest.

True hosts: *Glaucomys volans*, *G. sabrinus*

Secondary hosts: *Sciurus carolinensis*, *Tamiasciurus hudsonicus*

Accidental host: *Vulpes fulva*

Counties: 19, 23, 42, 48

Range within the state: Unknown at present; its rarity in collections makes it impossible to determine its range accurately

FAMILY CERATOPHYLLIDAE

*Ceratophyllus diffinis* Jordan

Jordan (1937) reported this species from "Long Island," and Parkes (1954) collected one from a robin in Hamilton county, but Geary (1959) was unaware of these earlier records. In addition, we have seen two females from Essex county, in the collection of the New York State College of Environmental Science and Forestry, and one in our own collection taken from a deer mouse in Franklin county.

True hosts: *Hylocichla ustulata*, *Turdus migratorius*

Accidental host: *Peromyscus maniculatus*

Counties: 2, 7, 8, 61(?)

Range within the state: Unknown at present

*Ceratophyllus gallinae* (Schrank)

True hosts: *Gallus gallus*, *Passer domesticus*, *Troglodytes aedon*

Accidental hosts: *Tamias striatus*, *Canis familiaris*, *Homo sapiens*, *Rattus norvegicus*, *Peromyscus maniculatus*

Counties: 8, 12, 15, 17, 20, 29, 35, 42, 47, 48, 50, 53, 61

Range within the state: Throughout the state

*Ceratophyllus celsus celsus* Jordan

True hosts: *Petrochelidon pyrrhonota*, *Riparia riparia*

Counties: 21, 25, 26

Range within the state: Probably wherever cliff swallows nest, although none were present in numerous nests from Essex county

*Ceratophyllus idius* Jordan and Rothschild

True hosts: *Progne subis*, *Iridoprocne bicolor*

Accidental host: *Troglodytes aedon*

Counties: 2, 4, 25, 27, 35

Range within the state: Probably throughout the state

*Ceratophyllus styx riparius* (Jordan and Rothschild)

True hosts: *Riparia riparia*, *Stelgidopteryx rufipennis*

Secondary and accidental hosts: *Hirundo rustica*, *Megaceryle alcyon*, *Sturnus vulgaris*

Counties: 2, 8, 18, 19, 21, 27, 35, 36, 42

Range within the state: Throughout the state

*Megabothris acerbus* (Jordan)

True host: *Tamias striatus*

Secondary host: *Tamiasciurus hudsonicus*

Accidental hosts: *Napeozapus insignis*, *Microtus pennsylvanicus*, *Sciurus carolinensis*, *Marmota monax*, *Sylvilagus floridanus*

Counties: 1, 5, 7, 8, 12, 19, 20, 23, 26, 27, 36, 42, 48

Range within the state: The true host occurs throughout the state, but we have made or examined extensive collections in several counties which failed to produce this species. Apparently ecological factors limit its distribution

*Megabothris asio asio* (Baker)

True host: *Microtus pennsylvanicus*

Secondary host: *Microtus chrotorrhinus*

Accidental hosts: *Mustela erminea*, *Blarina brevicauda*, *Zapus hudsonius*, *Synaptomys cooperi*, *Clethrionomys gapperi*, *Sylvilagus floridanus*, *Vulpes fulva*

Counties: 1, 4, 8, 17, 19, 20, 23, 25, 26, 27, 35, 42, 50, 53, 61

Range within the state: Throughout the state

*Megabothris quirini* (Rothschild)

Although its host is common in suitable habitats throughout the state, this species is unaccountably rare in western counties. The species was also absent from extensive collections in western Pennsylvania (Holland and Benton, 1968). A single collection from a gray fox in Livingston county is the only record from the western half of the state.

True host: *Clethrionomys gapperi*

Secondary and accidental hosts: *Microtus chrotorrhinus*, *M. pennsylvanicus*,

*Peromyscus leucopus*, *P. maniculatus*, *Napeozapus insignis*, *Urocyon cinereoargenteus*

Counties: 5, 7, 8, 26, 30, 46, 48, 50

Range within the state: Would be expected throughout the state, but see above

*Monopsyllus vison* (Baker)

True hosts: *Tamiasciurus hudsonicus*, *Tamias striatus*

Accidental hosts: *Mustela vison*, *M. frenata*, *Procyon lotor*, *Peromyscus maniculatus*, *Vulpes fulva*

Counties: 1, 2, 5, 7, 8, 9, 19, 20, 21, 22, 23, 26, 33, 36, 42

Range within the state: Throughout the state except for Long Island and the lower Hudson valley

*Nosopsyllus fasciatus* (Bosc)

True host: *Rattus norvegicus*

Accidental hosts: *Microtus pennsylvanicus*, *Mustela frenata*, *Vulpes fulva*, *Tamiasciurus hudsonicus*, *Didelphis marsupialis*

Counties: 19, 21, 25, 26, 35, 42, 56, 61

Range within the state: Throughout the state

*Orchopeas caedens durus* (Jordan)

This transcontinental species is a northern form, and has thus far been taken only in the Adirondack counties in this state. It might reasonably be expected in the high Catskills and in the Alleghenies, but no records are currently available from these areas.

True host: *Tamiasciurus hudsonicus*

Secondary host: *Tamias striatus*

Accidental host: *Peromyscus maniculatus*

Counties: 1, 2, 3, 4, 5, 6, 7, 8

Range within the state: Adirondack and Tug Hill counties at elevations above 1000 feet

*Orchopeas howardii howardii* (Baker)

True hosts: *Sciurus carolinensis*, *S. niger*

Secondary hosts: *Tamias striatus*, *Tamiasciurus hudsonicus*, *Glaucomys volans*, *G. sabrinus*

Accidental hosts: *Blarina brevicauda*, *Procyon lotor*, *Urocyon cinereoargenteus*, *Mustela erminea*, *M. vison*, *M. frenata*, *Didelphis marsupialis*, *Myocastor coypu*, *Marmota monax*, *Peromyscus maniculatus*, *P. leucopus*,

*Synaptomys cooperi*, *Clethrionomys gapperi*, *Sylvilagus floridanus*, *Vulpes fulva*, *Urocyon cinereoargenteus*

Counties: 1, 2, 4, 6, 7, 8, 9, 13, 19, 20, 22, 23, 25, 26, 33, 35, 36, 42, 45, 47, 48, 49, 50, 53, 56, 61

Range within the state: Throughout the state except at high elevations where its principal hosts do not occur

*Orchopeas leucopus* (Baker)

True hosts: *Peromyscus leucopus*, *P. maniculatus*

Secondary and accidental hosts: *Microtus pennsylvanicus*, *M. pinetorum*, *Clethrionomys gapperi*, *Neotoma floridana*, *Zapus hudsonius*, *Napeozapus insignis*, *Tamias striatus*, *Tamiasciurus hudsonicus*, *Marmota monax*, *Sciurus carolinensis*, *Glaucomys volans*, *Didelphis marsupialis*, *Blarina brevicauda*, *Mustela erminea*, *Urocyon cinereoargenteus*, *Sylvilagus floridanus*

Counties: 1, 2, 3, 5, 7, 8, 12, 17, 18, 19, 20, 21, 22, 23, 25, 26, 27, 33, 34, 35, 36, 42, 46, 47, 48, 49, 50, 51, 53, 61

Range within the state: Throughout the state

*Orchopeas sexdentatus pennsylvanicus* (Jordan)

True host: *Neotoma floridana*

Counties: 48, 51

Range within the state: Those areas of southeastern New York where the wood rat occurs

*Opisodasys pseudarctomys* (Baker)

True hosts: *Glaucomys volans*, *G. sabrinus*

Secondary and accidental hosts: *Tamiasciurus hudsonicus*, *Marmota monax*

Counties: 1, 6, 8, 21, 22, 23, 26, 42, 48

Range within the state: Throughout the state

*Oropsylla arctomys* (Baker)

True host: *Marmota monax*

Secondary and accidental hosts: *Didelphis marsupialis*, *Vulpes fulva*, *Urocyon cinereoargenteus*, *Mephitis mephitis*, *Canis latrans*, *Sylvilagus floridanus*, *Erethizon dorsatum*, *Tamiasciurus hudsonicus*, *Dama virginiana*, *Homo sapiens*

Counties: 1, 2, 3, 4, 8, 10, 17, 18, 19, 20, 21, 23, 24, 25, 26, 27, 30, 31, 32, 33, 35, 36, 39, 42, 45, 47, 48, 49, 50, 51, 52, 53, 61

Range within the state: Throughout the state

## FAMILY LEPTOPSYLLIDAE

*Leptopsylla segnis* (Schonherr)

The only records of this species are very old, and it seems unlikely that there is any permanent population in the state, though it must often be brought in by its hosts.

True host: *Mus musculus*

Secondary host: *Rattus norvegicus*

County: 56

Range within the state: Thus far collected only in New York City

*Peromyscopsylla catatina* (Jordan)

True host: *Clethrionomys gapperi*

Secondary hosts: *Microtus chrotorrhinus*, *M. pennsylvanicus*

Accidental hosts: *Blarina brevicauda*, *Parascalops breweri*

Counties: 1, 5, 7, 8, 21, 23, 26, 42, 45, 46, 48, 50

Range within the state: Probably throughout the state, although not yet taken in western counties, where its host occurs

*Peromyscopsylla hamifer hamifer* (Rothschild)

True host: *Synaptomys cooperi*

County: 1

Range within the state: Should occur on Microtinae throughout the state, but evidently has precise ecological requirements (Miller and Benton, 1970)

*Peromyscopsylla hesperomys hesperomys* (Baker)

True hosts: *Peromyscus leucopus*, *P. maniculatus*

Secondary hosts: *Microtus pennsylvanicus*, *M. chrotorrhinus*, *Clethrionomys gapperi*, *Blarina brevicauda*

Accidental hosts: *Neotoma floridana*, *Tamiasciurus hudsonicus*

Counties: 4, 8, 12, 17, 19, 20, 22, 23, 26, 27, 35, 36, 40, 42, 46, 48, 50

Range within the state: Throughout the state except on Long Island, where extensive trapping has not yet revealed it

*Peromyscopsylla scotti* (I. Fox)

True host: *Peromyscus leucopus*

Secondary and accidental hosts: *Blarina brevicauda*, *Microtus pennsylvanicus*

Counties: 25, 42, 48, 61

Range within the state: Long Island and the Hudson valley, with an isolated record from Tompkins county; apparently has precise ecological requirements, replacing the previous species in appropriate areas.



*Odontopsyllus multispinosus* (Baker)

True host: *Sylvilagus floridanus*

County: Suffolk

Range within the state: Long Island, probably lower Hudson valley

## FAMILY ISCHNOPSYLLIDAE

*Nycteridopsylla chapini* (Jordan)

True host: *Eptesicus fuscus*

County: 62

Range within the state: Unknown; its host occurs throughout the state, but this flea occurs only in certain types of caves

*Myodopsylla insignis* (Rothschild)

True host: *Myotis lucifugus*

Secondary hosts: *Myotis subulatus*, *Eptesicus fuscus*

Counties: 7, 11, 20, 23, 33, 36, 42

Range within the state: Throughout the state

## Hypothetical List

The following species have been taken from states or provinces adjacent to New York, on hosts which occur in New York. Thus it is reasonable to expect that they may eventually be found within the state.

## PULICIDAE

*Hoplopsyllus glacialis lynx* (Baker). Taken in Vermont from the snowshoe hare, *Lepus americanus*

## HYSTRICHOPSYLLIDAE

*Rhadinopsylla orama* Smit. Taken in Pennsylvania and Connecticut from the pine vole, *Microtus pinetorum*

## CERATOPHYLLIDAE

*Ceratophyllus rossitensis swansoni* (Liu). Taken in Ontario, Canada from nests of the crow, *Corvus brachyrhynchos*

*Ceratophyllus garei* Rothschild. Taken in Quebec, Canada, from "eider down," which probably simply means a duck nest. It occurs in dry or bulky nests, most often on the ground.

## Literature Cited

FOX, CARROLL, AND E. C. SULLIVAN. 1925. A comparative study of rat-flea data for several seaports of the United States. Publ. Health Repts., **40**: 1909-1934.

- FOX, I. 1940. The fleas of eastern United States. Iowa State College Press, Ames, Iowa. 191 pp.
- GEARY, JOHN M. 1959. The fleas of New York. Cornell Univ. Agric. Exp. Sta. Memoir **355**: 104 pp.
- HALL, E. RAYMOND, AND KEITH KELSON. 1959. The mammals of North America. The Ronald Press Co., N. Y. Vol. **1**: 1-546; Vol. **2**: 547-1083.
- HOLLAND, G. P., AND A. H. BENTON. 1968. Siphonaptera from Pennsylvania mammals. Amer. Midland Naturalist, **80**: 252-261.
- HOPKINS, G. H. E., AND MIRIAM ROTHSCHILD. 1953-1971. An illustrated catalogue of the Rothschild collection of fleas (Siphonaptera) in the British Museum (Natural History). Vol. 1: Tungidae and Pulicidae, 1953, xv + 361 pp.; Vol. 2: Vermipsyllidae to Xiphopsyllidae, 1956, xi + 560 pp.; Vol. 3: Hystrichopsyllidae (in part), 1961, ix + 560 pp.; Vol. 4: Hystrichopsyllidae (in part), 1966, viii + 549 pp.; Vol. 5: Leptopsyllidae and Ancistropsyllidae, 1971, viii + 530 pp. British Museum Nat. Hist., London.
- JORDAN, KARL. 1929. On a small collection of Siphonaptera from the Adirondacks with a list of the species known from the state of New York. Novit. Zool., **35**: 168-177.
- . 1937. On some North American Siphonaptera. Novit. Zool., **40**: 262-271.
- MILLER, DONALD H., AND ALLEN H. BENTON. 1970. Ecological factors in the distribution of *Peromyscopsylla h. hamifer* (Rothschild). Amer. Midland Naturalist, **83**: 301-303.
- PARKES, KENNETH C. 1954. Notes on some birds of the Adirondack and Catskill Mountains, New York. Annals Carnegie Mus., Art. **7**: 178 pp.
- SAKAGUTI, K., AND E. W. JAMESON, JR. 1962. The Siphonaptera of Japan. Bernice P. Bishop Mus., Pac. Insects Monograph **3**: 169 pp.
- STEWART, M. A. 1928. Siphonaptera. In "A list of the insects of New York," by M. D. Leonard. Cornell Univ. Agric. Exp. Sta. Memoir **101**: 1868-1869.
- . 1933. Revision of the list of Siphonaptera from New York State. J. N. Y. Entomol. Soc., **41**: 253-262.
- ZEH, JOHN B. 1973. A survey of the ectoparasitic fauna of the red fox, *Vulpes fulva* (Desmarest) and the gray fox, *Urocyon cinereoargenteus* (Schreber). Unpublished thesis, State Univ. College, Geneseo, New York: 71 pp.

Notes on the Life Cycle and Natural History of Butterflies of  
El Salvador. I B.—*Hamadryas februa* (Nymphalidae-Hamadryadinae)

ALBERTO MUYSHONDT AND ALBERTO MUYSHONDT, JR.

101 AVE. N. 322, SAN SALVADOR, EL SALVADOR

RECEIVED FOR PUBLICATION AUGUST 23, 1974

**Abstract:** Observations carried on in the neighborhood of San Salvador since 1970 on eggs, larvae, pupae and adults of *Hamadryas februa* Hübner are presented, giving an account of the early stage characteristics and developmental times, with photographic illustrations. The foodplants of this and related species are recorded for El Salvador. The behavior of the species is compared with the behavior of other local and South American *Hamadryas* spp. emphasizing the progressive change from solitary to gregarious behavior which the whole group exhibits, with the corresponding adaptations that such a change requires. Impalatability of the species to predators is suggested by the larval foodplant characteristics and the typical non-palatable way the larvae behave.

This is the first article of a third series in which we present our observations on the early stages and adult behavior of butterflies of El Salvador, Central America. Elsewhere a first series has been presented dealing with the local Charaxinae, and in this same journal a second on the Catonephelinae-Calli-corinae, all of them subfamilies of the Nymphalidae. Even though there have been earlier descriptions and some illustrations of the early stages of species belonging to this group, e. g. Müller's (1886) and Frühstorfer's (1916), we expect our contribution will be of interest, since new elements are presented.

Our studies on this species started on August 1st, 1970, when one of us (A. M., Jr.) while walking down a road bordering pasturelands, observed a female *Hamadryas februa* Hübner ovipositing on a vine, near the village of Zaragoza (some 15 km SSW of San Salvador). Some eggs were collected and eventually two adults were obtained the 1st and 2nd of September. Since then the species has been reared from the egg a number of times. The eggs and larvae have been put in transparent plastic bags, fresh leaves of the foodplant have been supplied every three days, and the bags cleaned of old leaves and frass every day until pupation. The pupae were transferred to a mosquito-net covered cage until adults emerged. Measurements of each stage and the times elapsed in each phase were recorded, and photos taken of the whole process.

**Acknowledgments:** We are deeply grateful to Dr. Alexander B. Klots for dedicating his time to read and criticize this paper and for giving his valuable advice to improve it. We are thankful also to Dr. A. H. B. Rydon for the wealth of information obtained from his correspondence and from the reference material kindly supplied by him. Our gratitude also to Dr. F. D. Rindge, of the American Museum of Natural History, New York, for determining many of the species mentioned and to Dr. C. W. Sabrosky, of the USDA, for determining the tachinid parasite.

During the development of the larvae, and during pupation, the bags and cage were kept at all times under ambient light and temperature conditions. Samples of eggs, larvae in the different instars and pupae have been preserved in alcohol to be sent to the American Museum of Natural History, New York, where the adults were determined.

#### LIFE CYCLE

*Egg.* Roughly spherical with flattened base and irregular sculpturings; white when recently deposited, darkening before hatching in 5 days. About 1 mm.

*First instar larva.* Head faintly cordiform, naked, shiny black. Body cylindrical, brown with scattered white tubercles, legs and prolegs dark brown. About 2.5 mm when recently hatched, 4 mm in 3 days when ready to moult.

*Second instar larva.* Head shiny black with tiny white spines on anterior and lateral areas of epicrania, sparse short setae on frons and thick, short horns on epicranial apices. The horns are armed basally by 4 tiny spines, and thicken distally. Body brown with transverse rows of furcated spines, very short and alternately dark and light colored. About 7 mm before moulting in 3-5 days.

*Third instar larva.* Head black with two long black spines laterally and several light and short spines anterad and between the base of the long and slender horns (about three times as long as head), which show basally two short accessory spines directed forward, two longer spines a little higher on the horn shaft and directed outwards, and about the middle of the horn shaft still two other longer spines directed inwards. The horns are each armed distally with a spiny sphere with short setae. Body black with a longitudinal, broken, orange stripe supraventrally, and a profusion of black, forked spines arranged in the following order: on first thoracic segment (T-1) a black cervical shield with two short white spines, one long black forked spine supraspiracularly and a shorter black simple spine subspiracularly; on T-2, a 5-forked black spine subdorsally, a 4-forked supraspiracular spine and a simple spine supraspiracularly; on T-3 a prominent 5-forked subdorsal spine, a 4-forked supraspiracular spine and a simple spine subspiracularly. On first abdominal segment (A-1) a dorsal 3-forked spine, a subdorsal 4-forked spine, a supraspiracular simple spine, a subspiracular 3-forked spine, a supraventral simple spine and finally a simple spine in line with legs and prolegs; A-2 presents one 5-forked dorsal spine, a 5-forked subdorsal spine, a 3-forked supraspiracular spine, a 3-forked subspiracular spine sided by a simple spine, supraventrally one simple spine and two simple spines in line with prolegs. From A-3 to A-6, a 3-forked spine dorsally, a 4-forked subdorsal spine, a 3-forked supraspiracular spine, a 3-forked subspiracular spine sided by a simple spine, and a row of 3 simple spines over the proleg. A-7 as A-6 but with two dorsal forked spines (one behind the other), the first one similar to the preceding ones, the second twice as big and 4-forked. A-8, as A-6 but with only one dorsal, prominent, 5-forked spine deflected posterad. A-9 has only two lateral 5-forked spines directed posterad. Grows to 12 mm in 3-4 days.

*Fourth instar larva.* Head as in third instar with longer horns. Body as in third instar also, but with several yellow, longitudinal, broken lines dorsally and subdorsally, and orange spots between dorsal and subdorsal spines. Subspiracular and supraventral spines light colored, the rest black. Grows to 18-20 mm in 4-5 days.

*Fifth instar larva.* Head, when recently moulted, red, turning usually to black after a time. Body mostly black with light green spines, and six yellow, longitudinal, thin stripes from

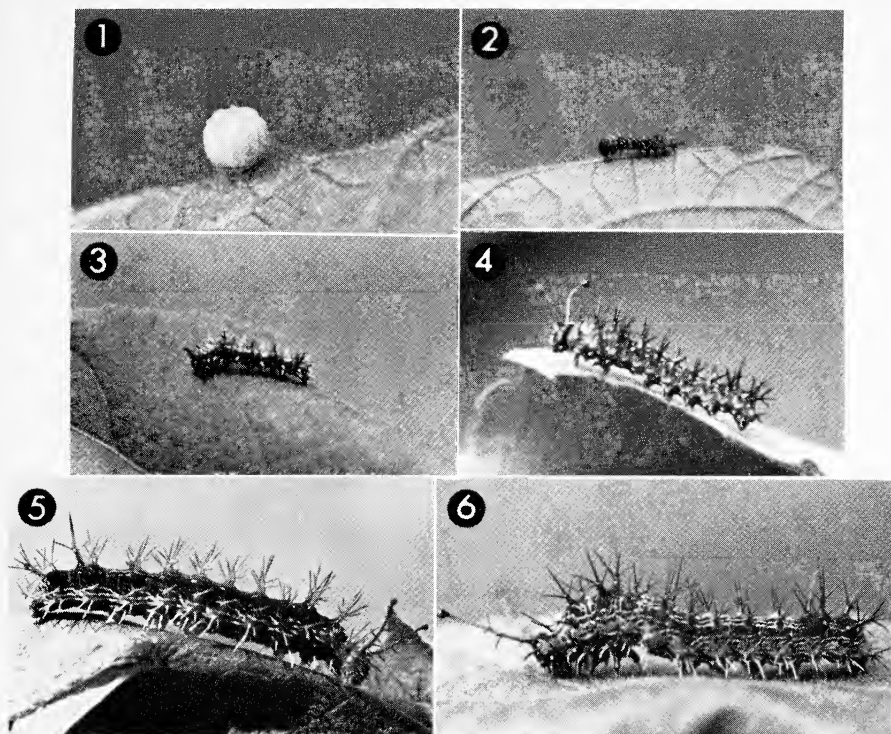

FIGS. 1-6. *Hamadryas februa* Hübner. 1. Egg, about 1 mm. 2. First instar larva, 3.5 mm. 3. Second instar larva, 6 mm. 4. Third instar larva, 12 mm. 5. Fourth instar larva, 18 mm. 6. Fifth instar larva, 30 mm.

thorax to abdominal tip, located one at either side of each row of spines; two orange spots at either side of abdominal median spine. At times during this instar, some individuals keep the head red permanently. When this occurs, body shows a reduction of the basic black color, which is substituted by orange. Subdorsal spines prominent, especially T-2, T-3 and A-2, where they have developed a number of small accessory spines on the shaft of the scoli. The same happens on the dorsal spines A-7 and A-8. Grows to 30-32 mm in 4-6 days.

*Pre-pupa*. Considerably shorter than 5th instar and showing a notable discoloration of the darker shades. In the case of the "orange" morph, becomes almost solid orange. Hangs incurved during 1 day.

*Pupa*. Variable in color, depending on individuals: some are light brown, some, greenish-brown, some, reddish-brown, with darker touches dorsally and fine, vein-like lines of darker shade ventrally on wingcases. The body thickens gradually from the flat cremaster to the posterior end of the wingcases, which point is the thickest part of the body, then has a dorsal and lateral concavity, then thickens again laterally and forms a slightly keeled hump dorsally. From there the body narrows down to the head, which terminates in two flat, partly fused, then diverging, prolongations, which follow the longitudinal axis of the body,

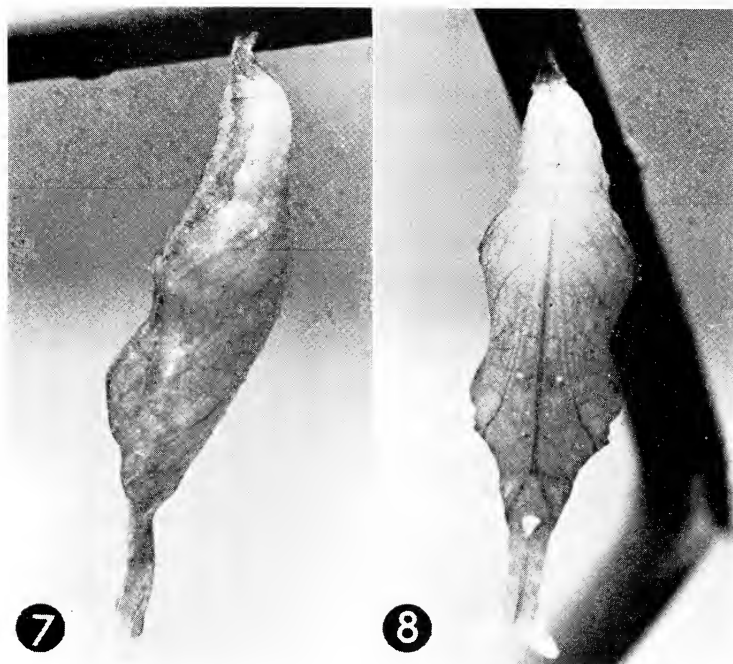

FIGS. 7-8. *Hamadryas februa* Hübner. 7. Pupa, lateral view, 30 mm. long. 8. Pupa, ventral view.

being about  $\frac{1}{4}$  of the total length of the body. Ventrally three small warts are noticeable along either side of the antenna-cases. Measures about 30 mm long by 8.5 mm laterally and 7.5 mm dorso-ventrally at widest points. Durations 6-9 days.

*Adults.* No sexual dimorphism has been noticed in this species. Forewing shape: costal margin slightly convex, rounded apex, almost straight but sinuose outer margin directed a little inwards, rounded tornus and straight inner margin. Hindwing: almost straight costal margin, rounded outer angle continuing in a convex and faintly sinuose outer margin, rounded anal angle and straight, folded inner margin.

Color dorsally, dominantly light grayish-brown, lighter towards forewing apical zone, with darker brown, sinuose, broken lines and a few circles, forming all a very complicated, practically undescribable pattern. Ventrally mostly whitish-gray with fewer dark brown markings and circles in both wings distally, more so in front wings. Faint orange and yellow bordering basally the crescent shaped spots in the two circles closer to anal angle. Wingspan averages 65 mm in males, 72 mm in females. Complete metamorphosis took from 29 to 38 days.

#### NATURAL HISTORY

The females of *Hamadryas februa* search for the foodplant along low brushed, open land, flying close to the ground in the neighborhood of wooded areas, until one vine is located. A mature leaf is chosen where the female alights, usually on its underside, and one egg is deposited around the middle of the

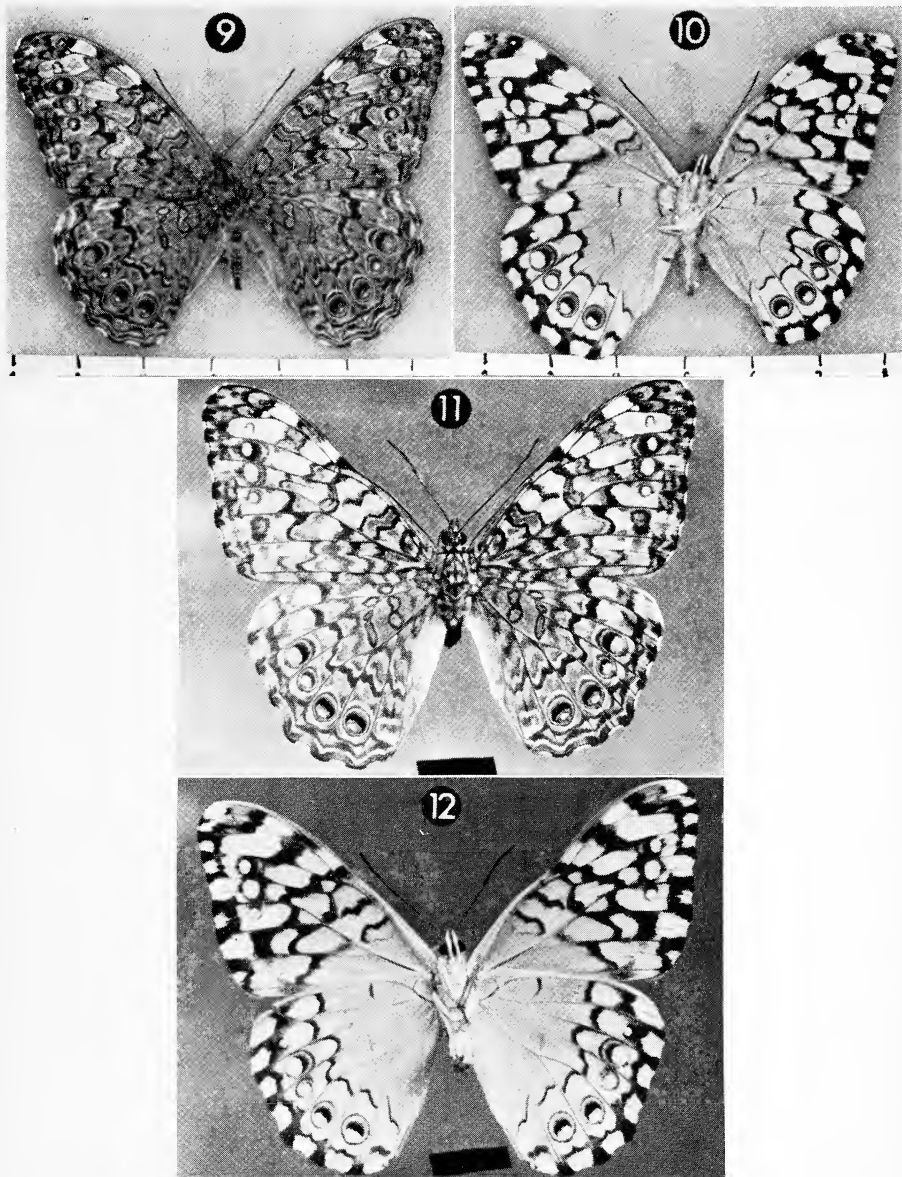

FIGS. 9-12. *Hamadryas februa* Hübner. 9 and 10. Male, dorsal and ventral sides. 11 and 12. Female, dorsal and ventral sides. Black bar 10 mm.

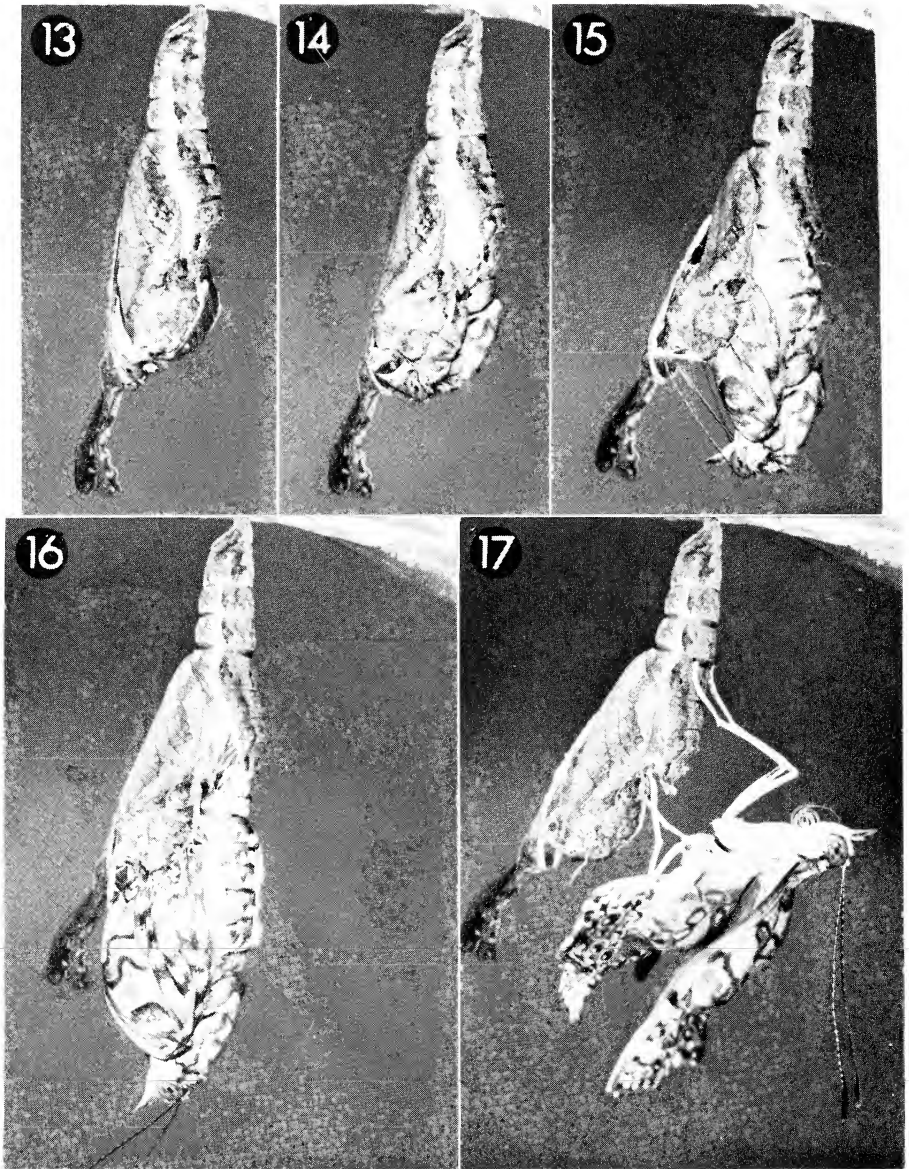

FIGS. 13-17. *Hamadryas februa* Hübner. Sequence showing phases of emergence of adult.

leaf. Several eggs are thus deposited on the same plant. It is not unusual that two eggs are laid one on top of the other by the same female (and eventually three), but never have we seen the same female deposit two eggs side by side on the same leaf. In some instances the female alights on top of



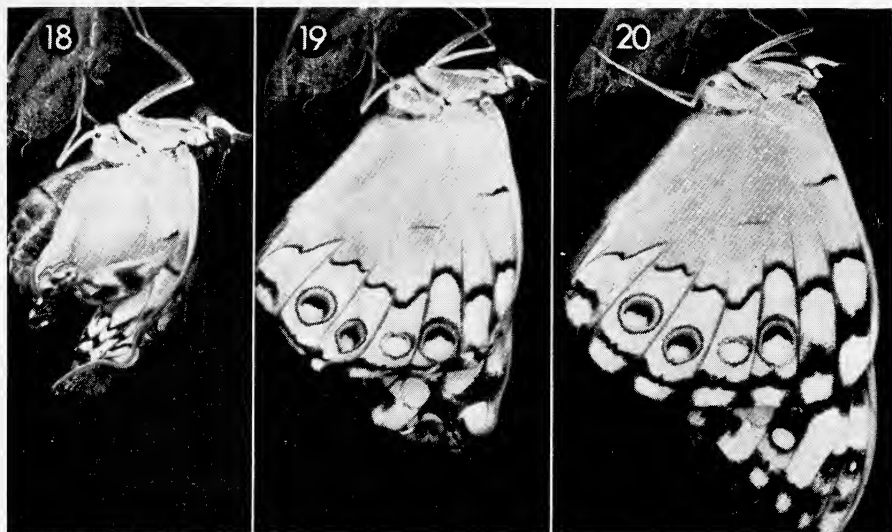

FIGS. 18-20. *Hamadryas februa* Hübner. Sequence showing gradual expansion of wings following emergence of adult.

a leaf to oviposit. When this occurs, the female moves near the edge of the leaf, and incurving the abdomen, deposits one egg on the underside of the leaf, close to the border.

The tiny larvae, upon hatching, eat from the eggshell just an exit hole, located at the side of it, and leave the rest untouched. They then move to the edge of the leaf and start feeding around a vein (usually at the apex), boring it. The larvae prolong the vein affixing to it their own small frass pellets using their silk as agglutinant. Quite often first, and eventually second instar larvae, are found with several excrement pellets adhering to their own bodies. This behavior might serve a double purpose: camouflage and reserve of materials to lengthen the resting vein when needed. First and second instar larvae are seen through the daylight period resting on their prolonged veins, motionless, head pointing outwards. They only move back to the leaf, late in the afternoon to feed on it. From third instar on, the larvae abandon their perch and move slowly about the plant, on the upper surface of the leaves, weaving a foothold of silk as they crawl, but staying motionless most of the time, with the third thoracic segment humped and the head bent so as to place the horns parallel to the leaf surface. It is not unusual to find more than one larva on the same leaf, but no interaction has been noticed even when they accidentally come in contact. If the larvae are prodded with a blunt object, or teased with a thin flexible one, they end by striking with their horns. When ready to enter pupation, which is announced by a shortening and decoloration of the body,

the larva weaves a mat of silk usually around a thin twig of the foodplant, but at times under a leaf, cleans the digestive tract and hangs from the silken mat by its anal prolegs with head and thorax incurved. After a day the larval skin splits dorsally behind the head and after many body contractions the larval skin is shed and the cremaster anchored firmly by actively wiggling. At first the capital prolongations are limply apposed to the thorax, but after a few minutes they expand forward and position themselves along the longitudinal axis of the body, fusing together their midpart, separated at the base and diverging from each other at the tips. The pupae, usually hanging straight down, wiggle laterally and violently when molested. Their wiggling lasts a few seconds and they then stay bent to one side or the other for a long period of time afterwards. The cremaster of this species (and other related species of the genus), has a flattened base, somewhat as in *Catonephelinae*, so that it is rigidly applied to the silk button. When the twig is turned upside down, the pupa turns with it staying standing upwards, straight or bent to one side. The day the adult is ready to emerge, the pupa becomes dark gray and the pattern of the wing colors is visible through the pupashell.

The adults rapidly emerge from the pupashell and hang from it ejecting a reddish meconium and unfolding their wings, which are held close together until rigid. It is after their first flight that they learn to keep them spread open most of the time. The adults of *Hamadryas februa* fly actively in, or in the neighborhood of, wooded areas, from about 500 to 1500 m altitude mostly, alighting on tree trunks with their wings spread open and tightly hugging the tree surface, where their gray and brown complicated pattern merges perfectly with the lichen growths which spatter the bark. Males can produce a peculiar loud clicking sound as they fly when meeting other males in flight near their chosen tree, and after an interchange of excited and repeated click-clicks plus many swift circumvolutions, without actually coming in contact, the intruder is chased and the defendant goes back to rest on his lookout, most commonly with the head down. This clicking sound, combined with the aggressive flight, is used also to pursue other approaching butterflies of diverse species, and even dogs, as per repeated observations of one of us (A. M., Jr.). The adults in our cages keep their wings folded at night. In the fields we have seen individuals resting among shrub leaves with their wings folded also, but when alerted by the sound or the shadow of the observer they immediately spread them open. When the adults come to the ground to feed on fermenting fruits, (mangoes, guayavas, rubber-tree fruit, etc.) they sometimes keep their wings open, but at other times the wings are folded. When they feed at wounds on tree-trunks, the wings are always kept spread. We have not noticed the males' clicking sound when they court females, although there is a lot of chasing around.

The preferred local larval foodplant, *Dalechampia scandens* L. and the very

seldom used alternate foodplant, *Tragia volubilis* L. are scandent vines belonging to the Euphorbiaceae, and both have urticant properties when touched with the back of the hand. Either plant is used by other local species of butterflies as larval food. *Dalechampia* besides at least two other species of *Hamadryas*, (probably all of them), is used by *Dynamine* spp., *Catonephele nyctimus* Westwood and *Mestra amymone* Ménétries. *Tragia* is used by *Biblis hyperia* Cramer, *Mestra amymone* and *Dynamine* spp.

The *Dalechampia scandens* vine has coarse, slightly pubescent, alternate, petiolate, tri-lobate and cordate at the base of the leaves; the flower is monocious, apetalous, with 3 long stemmed pistils surrounded by a host of short stemmed stamens, inside two tri-lobed bracts. The schizocarpous fruits split into three carpels, each bearing one black and brown seed. The fruits are surrounded by long and thin segments covered by a profusion of sharp, fulvous spinulets, which penetrates the skin at the faintest touch.

The *Tragia volubilis* vine shows alternate, petiolate, conspicuously dentate, densely pubescent, shallowly cordate, long leaves. The flowers grow in racemes, and are small, apetalous and produce 3-lobate capsules.

Both plants grow on sunny ground, in low brushed habitats near ravines, road fences and abandoned pieces of land, mostly near wooded areas or coffee plantations. We have found them from about 500 m to about 1500 m altitude. People use them for folklore medicine.

#### DISCUSSION

The butterflies pertaining to this group have been called at different times by different authors *Peridromia* (Boisduval, 1836), *Ageronia* (Hübner, 1810) and *Hamadryas* (Hübner, 1806), as per information supplied by Dr. A. H. B. Rydon (personal communication). We use the last, which is the older of the three, even if according to Hemming (1967) all three are available generic names.

We are aware of at least two authors describing the early stages of several species belonging to this group (Müller, 1886 and Frühstorfer, 1916), under the name of *Ageronia*. They mention as foodplants for the species they describe, other species of *Dalechampia*. Still, to our knowledge, this is the first description with photographic illustrations of *Hamadryas februa*.

Modern authors usually lump the genus *Hamadryas* within the Nymphalidae, whether in the subfamily Ergolinae (Klots, 1960); in the tribe Ergolini of the subfamily Nymphalinae (Ehrlich & Ehrlich, 1961); or under the subfamily Hamadryadinae (Ebert, 1969). If we were to follow the rule of thumb, which uses egg characteristics to separate the families, we would advocate a family status for this group, as was done, using various nominations, by several authors: Seitz (1915), group K, Ageronidae, which was first used by Doubleday in 1847, and Peridromiidae used by Boisduval in 1836, the latter thus

having priority. The egg shape of the butterflies of the group is quite different from any other egg of the local butterflies. The larvae also are easily recognized, from the third instar on, just by examining the horns of their head. The pupae, even if there are differences in the shape of the head prolongations and the colors between the several species we have seen, are easily identified as *Hamadryas* upon seeing them on account of their peculiar shape.

The females of *H. februa* and its close relative *H. guatemalena* have the same ovipositing behavior: they usually lay one egg at a time, but quite often two, and seldom even three are deposited one on top of the other. According to Müller (1886) (observations on one undetermined species of *Ageronia* and on *A. arete* Doubleday) some species deposit one egg exclusively at a time. His own observations on *A. fornax* were that this species forms a single string of several eggs, one under the other, so that the whole string hangs perpendicularly from the underside of the leaf. Our own observations (and Müller's as well) on *H. amphinome* show that the eggs of this species are also deposited on long strings, forming groups of 3 to 6 strings. It is our feeling that this group of species (*Hamadryas* spp.) is a living example of how natural selection operates: some of the species still have solitary behavior (*arete*); some are in the very process of changing from solitary to gregarious behavior (*februa* and *guatemalena*); one has partially adopted it, forming small groups of 5 to 10 individuals (*fornax*) and another (*amphinome*) has fully adopted gregariousness, with groups up to 45 individuals. Ford (1945) states: "the gregarious habit, determined by the method of egg-laying, is exceptional and carries with it certain noteworthy adaptations." We feel that before the egg-laying method can lead the species to gregarious behavior, there must be a prerequisite *sine qua non* in the larval behavior: the larvae must first abandon the habit of devouring the eggshell upon hatching. If that condition did not pre-exist to the oviposition in clusters, the first individual hatched could destroy at least some, if not many, of the adjacent eggs of the same group, as is the case in solitary species of Lepidoptera, such as *Heliothis zea*, when several females deposit one egg each on the silks of a single corn-ear and the first larva hatched dispose of many eggs close by and even later larvae, (personal observations). We have noticed that this necessary trait of eating just an exit hole from the eggshell is existent in all the local species with gregarious behavior that we have reared: *Battus polydamas* L., *B. laodamas* Felder, *Papilio anchisiades idaeus* Fabr. (Papilionidae); *Chlosyne* spp., *Phyciodes* spp., *Microtia elva* Bates, *Thesalia theona* Ménétries (Melitaeinae); *Actinote* spp. (Acraeinae); *Mechanitis isthmia isthmia* Bates (Ithomiidae); *Caligo memnon* Felder (Brassolidae); *Manataria maculata* Hopff. (Satyridae ?); *Dione juno huascama* Reakirt (Muyshondt, Young & Muyshondt, 1973) (Heliconiidae); *Gynaecia dirce* L. (Coloburinae); *Theritas lisus* (Stoll) (Lycaenidae) and *Hamadryas amphinome* L. In all of these species the hatching larvae eat

just an exit from the micropylar zone of the egg. The exception is *H. amphinome*, which cuts it from the side of the egg, which is of great importance as the eggs are deposited one on top of the other, not side by side as the others do. The same characteristic of not eating the eggshell has also been adopted by several species, which, if not strictly gregarious, have learned to live in a loose community without bellicose interaction, as a result of the need of ovipositing on such restricted areas of the plant as the tender shoots. Even if the females lay only a single egg per location, several females often visit the same plant and thence a number of eggs from several females are accumulated within a very small area. In this group we mention: *Dircenna klugii* Geyer, *Hyposcada virginiana nigricosta* Forbes & Fox, *Tithorea harmonia salvadores* Staudinger, *Hymenitis oto oto* Hewitson (Ithomiidae); *Narope cyllastros testaceae* Godman & Salvin (Brassolidae), all the local species of Heliconiidae (except *Dione juno*, which is gregarious), all the local species of Danaidae (except *Anetia thirsa*, which we have been unable to rear); *Precis genoveva* Stoll, *Anartia fatima* Fab., *A. jatrophae luteipicta* Früh., *Hypanartia lethe* Fab. (which at times deposits one egg on top of another also, as per own observations) (Nymphalidae); *Biblis hyperia* Cramer (Bibliinae); *Marpesia* spp. (Marpesiinae); *Pyrrhogyra hypsenor* Godman & Salvin (Muyshondt, 1974 a) (Catonephelinae); *Dynamine* spp. and several species of *Adelpha* (some *Adelpha* very occasionally deposit one egg on top of another also) (Limenitinae), and many species of Pieridae and Lycaenidae. All of these eat the exit hole from the eggshell, and at the most consume a small portion of its wall. Still there are other species which do not devour the eggshell, but have not acquired the tolerance towards other individuals and maintain strict individualistic behavior as larvae, fighting when coming in contact with a neighboring one, with often fatal results to one or the other.

The adaptation of not feeding on the eggshell mentioned, is more remarkable in *Hamadryas februa*, *H. guatemalena*, *Hipanartia lethe* and some *Adelpha* sp. where two or more eggs are deposited one on top of the other, as they make the exit hole through the side of the eggshell, which is very important to prevent damage for the egg on top. When two or three eggs are thus laid, the ensuing larvae might at times be found living in the same leaf, even if each one has made its own perch, until the last instar. However they pupate separately.

The habit of baring a vein and prolonging it with excrement pellets (a characteristic shared with several other Nymphalidae) is shown only by the species of *Hamadryas* which deposit the eggs singly (occasionally in twos and threes). This habit has been lost by the gregarious *Hamadryas*, which have developed in place of the cryptical defense against predation that characterizes individualistic species, a rather unpleasant odor, enhanced by the multitude of larvae living in community, plus an irritable temperament which causes the

whole congregation to wiggle convulsively at the faintest provocation. These peculiarities are evidently some of the "noteworthy adaptations" Ford (1945) refers to, that the gregarious species have gone through.

The need to conceal themselves shown by first and second instar larvae of *H. februa* as a defense against predation seems to cease being indispensable to their survival when they reach the third stadium, as evidenced by the desertion of their resting place and crawling openly on the leaves. This unconcerned exposure of themselves seems to indicate that a new means of protection against predation has been acquired in the meantime. Since their foodplants are *Dalechampia scandens* (and *Tragia volubilis*) Euphorbiaceae, which are renown as containing considerable amounts of fluids with poisonous or very caustic properties in many cases, it would not be too daring to deduce that *H. februa* larvae derive from their foodplant predator-deterrent qualities, which take some time to become effective (the time to reach third stadium). Another factor sustaining this notion is the fact that the species is subject to massive parasitism, mostly by Tachinidae. Muysshondt (1973 a, b, 1974, 1975) has pointed out the apparent relationship which exists between parasites and chemically protected larvae, and the behavior of the early stages and adults. Specimens of one tachinid sent to the USDA was determined by Dr. C. W. Sabrosky as "Tachinidae—Gen. sp.—intermediate Eryciinae and Sturniini" with the comment: "Odd species!!". We have obtained up to 4 parasites out of a single larva or pupa.

Even if these factors suggest impalatability, the adult color pattern can be considered a very effective camouflage when they are perched on the sides of tree-trunks with the wings spread open. They seem to have thus a dual defense mechanism: chemical and cryptic.

One of Müller's observations (mentioned also by Seitz) has failed to prove true in our experience. Müller states that the pupae of several *Ageronia-Hamadryas* in his experience are light-sensitive, and would bend their bodies to one side or the other depending on the direction of the sunlight. We have tried several times, at different hours of the day, to induce a reaction from many pupae of various species of *Hamadryas*, including *februa*, exposing them to direct sunlight, then masking the light, for various periods of time, with negative results. What we have noticed is that upon the slightest disturbance the pupae violently wiggle laterally for a short time, and then stop moving with the body bent to one side or the other, which position is kept for long periods of time afterwards.

#### Literature Cited

- EBERT, H. 1969. On the frequency of butterflies in Eastern Brasil with a list of the butterfly fauna of Poços de Caldas, Minas Gerais. Jour. Lep. Soc., **23**, Suppl. 3.
- EHRlich, P. R. AND A. H. EHRlich. 1961. How to know the butterflies. Wm. C. Brown Co. Publishers. Dubuque, Iowa.

- FORD, E. B. 1945. Butterflies. Collins, London.
- FRÜHSTORFER. 1916. In Seitz's Macrolepidoptera of the World. Vol. 5. Stuttgart.
- HEMMING, F. 1967. Generic names of the butterflies and their type-species. Bull. Br. Mus. Nat. Hist. (Ent.), Suppl. 9.
- KLOTS, A. B. 1960. A field guide to the butterflies. Riverside Press. Cambridge, Mass.
- MÜLLER, W. 1886. Südamerikanische Nymphalidenraupen. Versuch eines natürlichen Systems der Nymphaliden. Zoologische Jahrbuch. 453-461.
- MUYSHONDT, A. 1973a. Notes on the life cycle and natural history of butterflies of El Salvador. III A.—*Temenis laothoe liberia* Fabricius (Nymphalidae-Catonephelinae). Jour. N. Y. Ent. Soc. **81**: 224-233.
- . 1973b. Notes on the life cycle and natural history of butterflies of El Salvador. IV A. *Pseudonica flavilla canthara* (Nymphalidae-Catonephelinae). Jour. N. Y. Ent. Soc. **81**: 234-242.
- . 1974. Notes on the life cycle and natural history of butterflies of El Salvador. V A.—*Pyrrhogyra hypsenor* (Nymphalidae-Catonephelinae). Jour. N. Y. Ent. Soc. **82**: 163-172.
- . 1975. Notes on the life cycle and natural history of butterflies of El Salvador. VI A.—*Diaethria astala* Guérin (Nymphalidae-Callicorinae). Jour. N. Y. Ent. Soc. **83**: 10-18.
- , A. M. YOUNG AND A. MUYSHONDT, JR. 1973. The biology of the butterfly *Dione juno huascama* (Nymphalidae-Heliconiinae) in El Salvador. Jour. N. Y. Ent. Soc. **81**: 137-151.
- SEITZ, A. 1915. Macrolepidoptera of the World. Vol. 5. Stuttgart.

Notes on the Life Cycle and Natural History of Butterflies of  
El Salvador. II B.—*Hamadryas guatemalena* Bates  
(Nymphalidae-Hamadryadinae)

ALBERTO MUYSHONDT AND ALBERTO MUYSHONDT, JR.

101 AVE. N. #322, SAN SALVADOR, EL SALVADOR

RECEIVED FOR PUBLICATION OCTOBER 1, 1974

**Abstract:** Observations on the adults and early stages of *Hamadryas guatemalena* Bates have been carried out in the vicinity of San Salvador, El Salvador, for a period of 4 years. In this article the results are presented for the first time, with a detailed account of the life cycle, illustrated with photographs, of the larval behavior and the plant used as food.

The characteristics of the species are compared with the characteristics of other closely related species. The contention that there should be several genera within the group is discussed.

As in other Nymphalidae, in this species the gaudy coloration and daring behavior of the larvae, and the use of a foodplant belonging to the Euphorbiaceae (*Dalechampia scandens* L.) reputedly poisonous, suggest impalatability of the adults.

This is the second article of a series dealing with butterflies belonging to the genus *Hamadryas*, found in El Salvador. In this article we give an account of our observations on the early stages and adults of *Hamadryas guatemalena* Bates carried on since August 1970 in various zones of the country, mostly within 15 km from the capital city San Salvador. The first time we found larvae of this species was shortly after we started studies on a close relative, *H. februa* Hübner, during August 1970. As both species feed on the same plant, we ended up studying the two species simultaneously, which caused at first some confusion, as eggs collected produced at times two different kinds of larvae. The problem was solved when a female of *Hamadryas guatemalena* was observed ovipositing also on the same plant as *H. februa*. It is practically impossible to tell apart the eggs of one species from the other. As usual, eggs were collected just after oviposition and put in transparent plastic bags fastened with rubber bands. Emerged larvae were fed on fresh leaves of the foodplant replaced every three days until pupation. The bags were cleaned every day of excrement and excess humidity. The pupae were transferred to a wooden cage with mosquito-net covering, where the adults emerged. Bags and cage were kept indoors at all times under ambient light and temperature

---

**Acknowledgments:** We express our gratitude to Dr. Alexander B. Klots, for the great help he has given us to make this article presentable, criticizing our manuscript and suggesting valuable improvements to it. We are also thankful to Dr. A. H. B. Rydon and Col. C. F. Cowan for their information on this group of butterflies and for supplying reference literature; to Dr. F. D. Rindge of the American Museum of Natural History for kindly determining the adults of *H. guatemalena*.



conditions. Notes were kept of the measurements and the duration of each phase of the metamorphosis. Specimens in alcohol were sent to the American Museum of Natural History, New York, where the adults were determined.

#### LIFE CYCLE STAGES

*Egg.* Pure white, almost round with small flat base and sculpturings starting basally with thick ribs which disappear about a third from the base and are substituted by irregular, rounded or sharp protuberances covering part of the wall and the micropylar area. About 1 mm diameter. Hatches in 3-5 days.

*First instar larva.* Head shiny black, slightly cordiform, naked. Body cylindrical, greenish-brown with lighter tubercles and sparse short setae. Legs and prolegs dark brown. About 3 mm when recently hatched, about 4 mm before moulting in 3 days.

*Second instar larva.* Head black with small white spines on lateral margins and frontal area. Short thick horns on apices of epicrania. Body dark brown with longitudinal rows of furcate short spines and four rows of white dots, two subdorsally and two supraspiracularly. About 7 mm long before moulting in 4 days.

*Third instar larva.* Head black with long and slender horns on epicrania, two spines between their bases, three long spines on lateral margin of head and several short spines frontally; ocelli black, surrounded by sparse, short golden setae. The horns have basally on the shaft two accessory spines directed forward, a little higher two spines directed laterally and about the middle of the shaft two more spines directed inwards; the horns are tipped by a sphere armed with tiny spines. The body's ground color is black with longitudinal rows of yellow spots subdorsally and supraspiracularly. The spine arrangement is as follows: on first thoracic segment (T-1): one bifurcate subdorsal spine, one bifurcate supraspiracular spine and one simple subspiracular spine; on T-2: one prominent subdorsal 6-furcate spine, and 6-furcate supraspiracular spine, one small spiracular simple spine and one longer spine subspiracularly; on T-3: one most prominent 6-furcate subdorsal spine, one 5-furcate supraspiracular spine, one small, spiracular simple spine and two simple spines subspiracularly. On first abdominal segment (A-1): one 4-furcate subdorsal spine, one simple supraspiracular spine, one 4-furcate subspiracular spine and two supraventral simple spines. On A-2: one prominent 5-furcate subdorsal spine, one 3-furcate supraspiracular spine, one 4-furcate subspiracular spine sided by a simple spine, 3 supraventral simple spines. From A-3 to A-6: one 5-furcate subdorsal spine, one 3-furcate supraspiracular spine, one 4-furcate subspiracular spine sided by a simple spine and 2 simple spines supraventrally. On A-7 one very prominent dorsal 3-furcate spine, one 6-furcate subdorsal spine, one 3-furcate supraspiracular spine, one 5-furcate subspiracular spine sided by a simple spine and two simple supraventral spines. On A-8: one prominent 6-furcate dorsal spine, one prominent 6-furcate subdorsal spine, one 3-furcate supraspiracular spine, one 5-furcate subspiracular spine sided by a simple spine and two simple supraventral spines. On A-9: one 8-furcate subdorsal spine deflected caudad. On A-10: two simple spines, side by side, on anal plate. Grows to 1.3 cm in 4 days.

*Fourth instar larva.* Head as in third instar, with longer horns. Body ground color black with light yellow, very conspicuous dorsal oval patches forming an irregular and broken stripe from T-1 to A-9, and two supraspiracular light yellow dots on each abdominal segment. The shafts of the prominent subdorsal spines on T-2, T-3, A-2 and A-8, and of the median spines on A-7 and A-8 are armed by a host of small brown spinulets directed distally. Grows to 2.5 cm in 3-4 days.

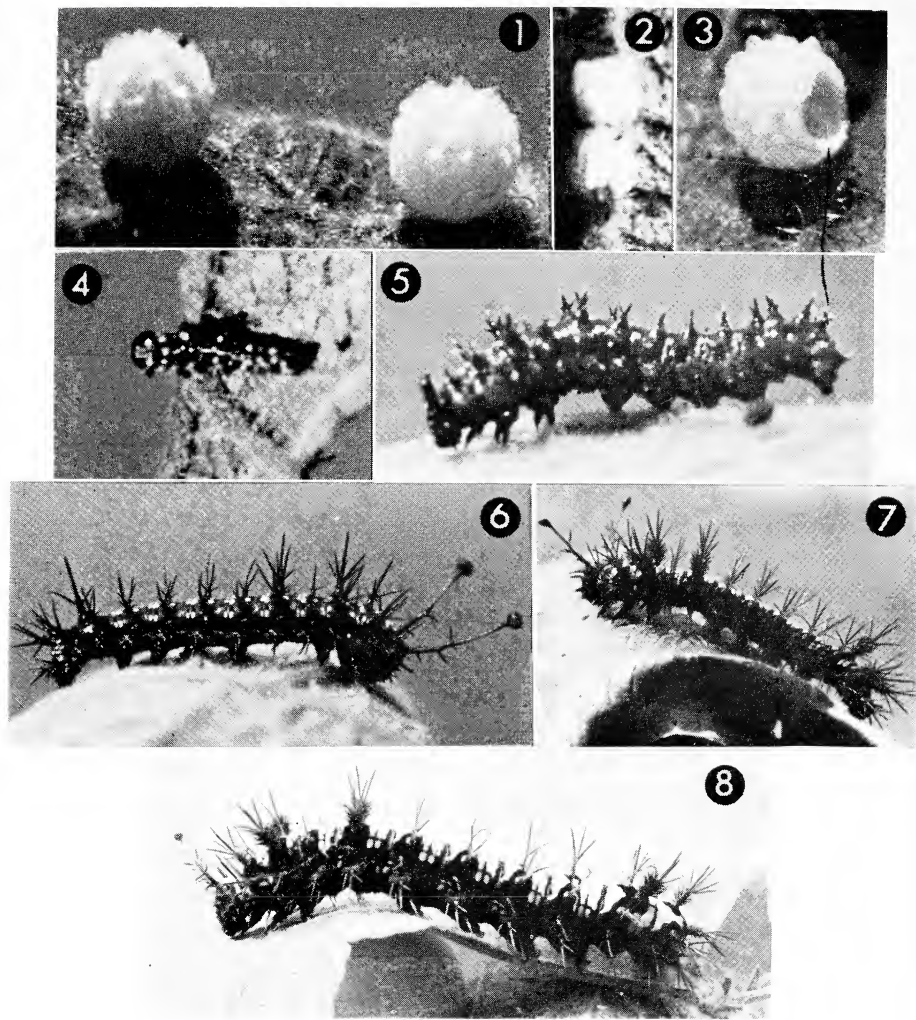

FIGS. 1-8. *Hamadryas guatemalena* Bates. 1. Two eggs side by side. Notice the left is grayish, the other pure white. One hatched one day before the other. 2. Two eggs one on top of the other. Both hatched the same day. 3. Eggshell showing the exit hole on the side. 4. First instar larva. Notice frass pellets stuck on the body. 5. Second instar larva. 6. Third instar larva. 7. Fourth instar larva. Notice spinulets on some spines. 8. Fifth instar larva.

*Fifth instar larva.* The only change is that the body markings become bright deep yellow, and the horns on the head and spines on the body are dull yellow. Prominent subdorsal spines on T-2, T-3, A-2 and A-8 and dorsal spines on A-7 and A-8 look "hairy" due to the profusion of dark accessory spines on the shaft of the scoli. Grows to 4.2 cm in 4-5 days.

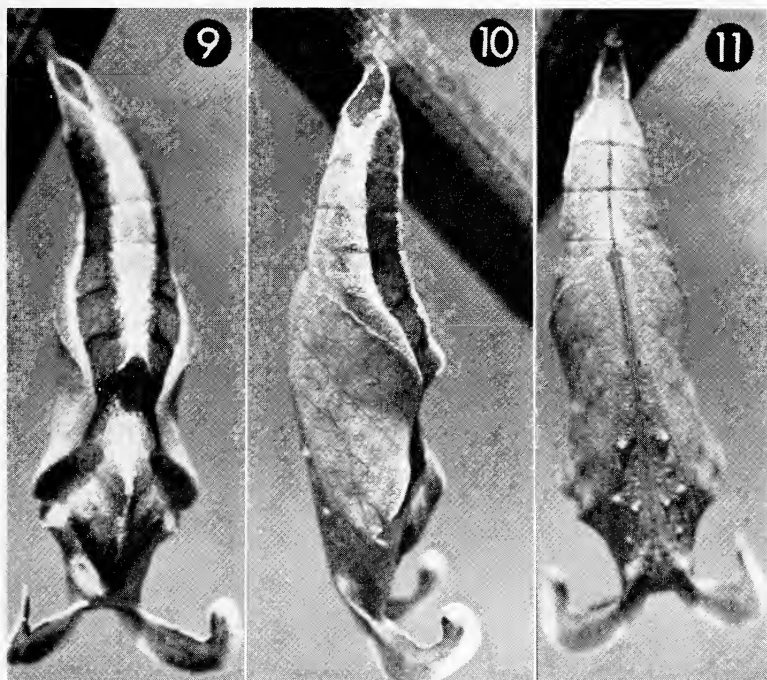

FIGS. 9-11. *Hamadryas guatemalena* Bates. 9. Pupa, dorsal view. 10. Pupa, side view. 11. Pupa, ventral view.

*Prepupa.* Does not change in aspect, but for slight shortening of the body. Hangs from anal prolegs, with thorax incurved ventrally, for one day.

*Pupa.* Hangs rigidly anchored from flat cremaster. Abdomen thickens abruptly from cremaster and then gradually to base of wings, then narrows laterally and dorsally, forming a slight indentation, thickening again on thoracic segments, then narrows abruptly to head, which terminates in two flat prolongations diverging laterally from each other and incurved dorsally. The edges of the wingcases get very close to each other dorsally around the union of the thoracic with the abdominal segments, which is the narrowest point. Color light green ventrally with fine criss-crossing, vein-like pattern, darker lines on wing cases. Along each antenna there are two lighter warts. Dorsally light green also with a subdorsal dark green longitudinal stripe on either side from cremaster to distal end of wingcases, giving the impression of a partly rolled leaf. Measurer 3.8 cm long, 1 cm laterally at widest point and .8 cm dorso-ventrally at widest point. Lasts 11 days.

*Adults.* No noticeable sexual dimorphism in this species. Shape of forewing: slightly convex costal margin, rounded apex, almost straight but faintly sinuose outer margin, rounded tornus and straight inner margin. Hindwing with almost straight costal margin, rounded outer angle, continuing in the rounded and faintly sinuose outer margin, rounded anal angle and almost straight and folded inner margin.

Colors dorsally mostly dark gray with bluish tinge on forewing apex and along hindwing outer margin, with whitish markings, mostly on forewing, forming a complicated pattern of bars, lines and circles. There is a conspicuous S-shaped reddish marking at the mid-

costal margin directed towards the center of the forewing. Ventrally the dominant color is beige, which covers the basal third of forewing and two-thirds of the hind wing. There is a replica of the dorsal pattern of dark brown and yellowish white on the apical zone of both wings. The reddish S marking is also present, even more conspicuous, due to the sharp contrast of the reddish color with the ventral lighter coloration. The body is dark gray dorsally, cream colored ventrally; eyes reddish-brown; proboscis orange; antennae black with white ventral spots on each segment; and a tiny orange spot at the tip. Average wing span 7 cm in males, 7.5 cm in females. Total developmental time varies between 33 and 37 days.

#### NATURAL HISTORY

The adults of *Hamadryas guatemalena* in El Salvador frequent wooded areas bordered by open, low brushy land, and are usually seen perching on tree trunks with their wings spread open, head pointing down. Several individuals might thus be seen in neighboring trees and from time to time aerial encounters occur, with many "click-clicks" emitted while rapidly chasing each other. This characteristic is limited to the males. The adults do not feed on flowers, but come often to the ground to suck the juices of fermenting fruits. Mangoes, guayavas, jocotes (hog plums) and the fruit of a local rubber-tree (*Castilla gummiifera* Pittier) seem to be preferred. They also feed from exudations from various trees. When they feed on the ground, the wings are at times held perpendicular to the back. When they are feeding on the tree-trunks, the wings are always spread open. The females ready to oviposit fly close to the ground, more slowly than usual, until a foodplant is located. They alight usually under a mature leaf and deposit one egg while the wings are apposed dorsally. Several eggs might be deposited on a single vine, always on the underside of a leaf. At times two, and rarely three eggs are deposited one on top of the other, but never have we seen a female deposit two or more eggs side by side on the same leaf. When more than one egg has been found side by side under the same leaf, their hatching is not simultaneous, but separated by a day or two, indicating successive ovipositions by the same or different females.

The hatching larvae eat an exit hole from the wall of the shell and might eat part of a wall. They never consume the whole eggshell. The small larvae move to the edge of the leaf, bare a vein by eating the tissues around it, and prolong the bared vein by affixing to it, with silk, small frass pellets, using this artificial perch as a resting place during first and second instars. Very often the small larvae affix excrement pellets to their own body, probably for protective purposes. It is worthy of mention that when two or three eggs have been deposited one on top of the other the hatching larvae do not damage the ones on top due to their acquired habit of eating the exit hole on the side of the eggshell. Damage to the egg on top would be unavoidable if the larvae should eat the exit hole from the upper part of the eggshell as is usual in most species of butterflies. The larvae are usually solitary, but when two

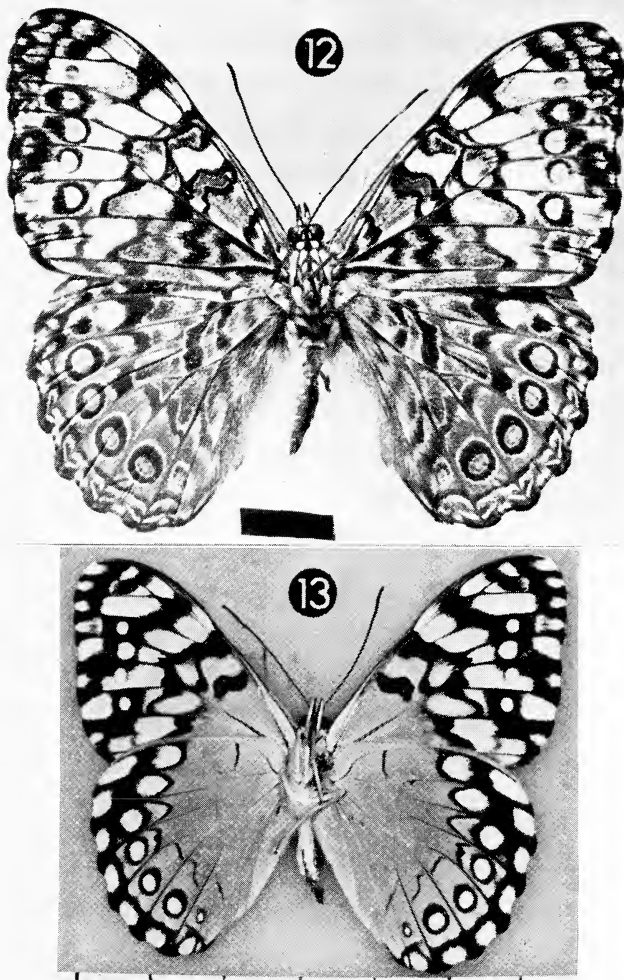

FIGS. 12 and 13. *Hamadryas guatemalena* Bates. 12. Male, dorsal view. Black bar 1 cm. 13. Male, ventral view. Scale in cm.

or three eggs are deposited as described, the ensuing larvae make their resting perches independently, but on the same leaf, and might stay together during the whole larval stage without bellicose interaction. When the third instar is reached, the resting perch is abandoned and the larvae spend most of the day motionless on top of a leaf, with the thoracic segments humped and the head bent so that the horns are parallel to the leaf surface. The larvae of *H. guatemalena* are slow moving and rather passive. The spines which cover most of the body do not have urticant properties. When ready to pupate the larvae

weave a silken mat on the stem of the vine or under a leaf, clean their digestive tract and hang from the chosen spot for a day with their thorax and head incurved ventrally and shed their larval skins. The pupae are firmly anchored to the silk pad, due to the flat surface of the cremaster. If the supporting stem is rolled one way or another the pupae will follow the movement rigidly, "standing" on their cremaster. When disturbed the pupae wiggle laterally and vigorously for a few seconds and stop moving, usually bent to one side. After a time, they revert to the vertical position.

The adults emerge rapidly from the pupashell and hang from it while ejecting a reddish meconium and expanding their wings. When the wings are rigid enough, the butterflies take flight. From then on the wings are usually kept spread while at diurnal perching.

This species is subject to heavy parasitism by tachinid flies, which abandon the host as larvae and pupate on the ground. This happens during the last larval instar or during pupation of the host.

The larval foodplant in El Salvador is *Dalchampia scandens* L., an Euphorbiaceae vine which in our own experience is used by other species of *Hamadryas* (Muysshondt & Muysshondt, 1974) and other species of Nymphalidae, such as *Catonephele nyctimus* Westwood, at least two species of *Dynamine*, and *Mestra amymone* Ménétries. The plant is quite abundant along fences, ravines and in the borders of wooded land, up to about 1500 m altitude, which is also the range where *H. guatemalena* is found. The leaves and bracts of the plant have urticant properties.

It is to be noted that *H. guatemalena*, *H. februa* and *H. amphinome* share not only the foodplant but the habitat as well. It is quite common to see these species, especially *guatemalena* and *februa*, fly in the same neighborhood.

#### DISCUSSION

Descriptions of the early stages of species belonging to this group of butterflies have been published in the past under the generic name of *Ageronia* (Müller, 1886; Seitz, 1916), but to our knowledge this is the first description illustrated with photographs ever published on the early stages of *Hamadryas guatemalena*.

Butterflies belonging to this group have been called by various authors under different generic names as a whole: *Ageronia* (Müller, 1886; Holland, 1914), *Hamadryas* (Klots, 1960; Ehrlich & Ehrlich, 1961) and have been usually grouped under subfamily Ergolinae (Klots, *op. cit.*), or tribe Ergolini (Ehrlich & Ehrlich, *op. cit.*). The adult shape, coloration and behavior is so peculiar and similar in all of the species that it is only natural to consider the various species as forming a well defined group within the Nymphalidae. Even during the early stages the different species share many characteristics:

the egg shapes of *H. guatemalena* and *H. februa* (Muysshondt & Muysshondt, 1975), and according to Müller (1886) the eggs of other species also, are so similar as to make it hard to tell apart, if at all possible, one egg from another. The same thing is true, to a point, with larvae and pupae; they all use the same group of foodplants (*Dalechampia* spp.), and exploit about the same habitats. Yet there are also marked differences among them, which might prove true some authors' contention (Müller, 1886; Burmeister, as cited by same Müller, *op. cit.*) that there are marked sub-groups within the genus *Hamadryas* Hübner, which might make it convenient to determine the proper placement of the species within the group and the use of the names *Ageronia* Hübner, *Peridromia* Boisduval, *Amphichlora* Felder in addition to *Hamadryas* itself. All these are available generic names according to Hemming (1967).

We will point out the differences we have observed between *H. februa*, *H. guatemalena* and *H. amphinome* and will use the observations made by Müller on some of these and on other species to make the point evident. The eggs of *guatemalena*, *februa*, *sp. ign.* (in Müller), *fornax* and *arete* have the same kind of sculpturing. Not so the eggs of *amphinome*, which are almost smooth. The larvae of *guatemalena*, *fornax*, *epinome* and *amphinome* have dorsal spines only on segments A-7 and A-8, whereas these dorsal spines are present on all abdominal segments in *februa*, *arete* and *sp. ign.* The pupal head prolongations vary also from species to species: they are about the same in *guatemalena* and *arete*, being laterally divergent and incurved dorsally. In *februa* they are partially fused and follow the axis of the body. Then in *epinome*, *sp. ign.*, *fornax* and *amphinome* they are divergent laterally, but follow the axis of the body, as seen laterally.

As for larval behavior, *guatemalena*, *februa*, *epinome*, *sp. ign.* and *arete* have solitary habits and all of them construct the resting perch with frass pellets on the edge of the leaf. This is not the case with *fornax* nor with *amphinome*, which have acquired gregarious behavior during the larval stage and have given up the perch-making practice. *Amphinome* in addition has developed a very angry and excitable disposition. Pupal behavior is the same in all species we have observed, and corresponds with Müller's description except for his reported light sensibility. They all wiggle violently when disturbed and might remain bent to one side for some time afterwards. Contrary to this, the adults we have observed (Müller does not mention adults behavior) of *guatemalena*, *februa*, *amphinome*, *fornax* and *glaucanome* Bates, all show the same peculiar jerky flight, the frantic clicking when males encounter each other, or when chasing intruders, the feeding on fermenting fruits and tree wounds plus the characteristic wing-spread attitude while perching on tree-trunks.

According to Müller, Burmeister grouped the species in the following manner: 1) *feronia*, *ferentina* and *fornax*. 2) *amphinome*, *arete*, *arethusia*, related

to *chlöe*. Müller himself did it as follows: 1). a.—*amphinome*, b.—*epinome*, *sp. ign.*, *fornax* (*ferentina*); 2).—*arete*, *arethusia*, proposing to put back in use the genus *Peridromia* for the latter. For him *chlöe* (the type species of *Ageronia*, according to Hemming) would be an intermediate form between *amphinome* (which is the type-species for *Hamadryas*) and *epinome* (which he places with *fornax*). So it looks as though *Hamadryas* should apply to *amphinome* and whichever species are found to be congeneric with it; *Ageronia* to *chlöe* and whichever species are congeneric with it; *Amphichlora* to *feronia* and whichever species are its congeneric and *Peridromia* to *arethusia* and its congenics. Unfortunately we do not have reference material against which to compare our species, so we are not in a position to establish which is the type-species corresponding to *guatemalena*. We leave that to the taxonomists.

It is worthwhile to point out that there is interbreeding between closely related species in nature: *Limenitis arthemis astyanax* Fabricius  $\times$  *L. archippus* Cramer (Klots, 1959; Platt & Greenfield, Jr., 1971), *Vanessa atalanta rubria* (Frühstorfer)  $\times$  *Cynthia annabella* Field (Dimock, 1973), and as a consequence hybrids have been found to result under natural conditions. Hybrids have also been produced in the laboratory from crosses between species naturally separated by great distances, such as *Papilio asterias*  $\times$  *P. machaon* (Clarke & Knudsen, 1953), *Papilio polyxenes asterias*  $\times$  *P. maackii* (Clarke & Sheppard, 1964), and several others, what seems to prove close specific relationship between them, even if living far apart from each other under natural conditions. Yet, even if *H. guatemalena*, *H. februa* and *H. amphinome* dwell in the same habitat, during all months of the year, and are in addition grossly similar to each other, we have never found evidence of interbreeding, nor have we seen interspecific copulations, nor have we known of any report thereof. That by itself would seem to indicate these species are not so closely related, as their aspect and other characteristics suggest, as to belong to the same genus. Unfortunately our efforts to have males and females of the different species copulate in captivity have failed (actually, even attempts to obtain copulation with males and females of the same species have proved unsuccessful), so we can not bring forth proofs in either way.

We emphasize that in *H. guatemalena* the color of the larva during the 4th and 5th instars becomes very conspicuous by its contrasting colors, which makes it an easy task to locate the larvae against the green leaves of the foodplant on which they usually rest quite in the open. This daring behavior would seem to advertise impalatable conditions, bad flavor or poisonous properties, to eventual predators. In this respect *H. guatemalena* seemingly has an advantage over *februa*, whose colors are not so gaudy. Probably an increased impalatability compensates for the loss of the additional mechanical protection the dorsal spines (missing in *guatemalena*) provide *februa*. The pupae of



this species, as in many other protected species, are exceedingly cryptic, imitating to perfection a partly rolled leaf, but rely also on the vigorous wiggling, which might scare away predators, as protection. The adults, even though they display an aggressive disposition by rushing at any intruder in their territory, exploit camouflage to perfection, blending their complicated wing color pattern to moss and lichen growing on the tree-trunks on which they rest with the wings spread open.

Euphorbiaceae plants have been historically reputed for their caustic and/or poisonous fluids. *Dalechampia scandens* belongs to this family, and the leaves and bracts have urticant properties. It would seem logical to deduce from this and from the larval coloration and behavior, that *H. guatemalena*, which feed exclusively on that plant, could have developed chemical protection against predators derived from noxious components of the plant. Furthermore we find that the species is heavily parasitized by tachinid flies during its larval stage. We have pointed out in the past (Muysshondt 1973 a, b; Muysshondt & Muysshondt, 1974) the repeated coincidence of heavy parasitism suffered by many species generally accepted as protected by poisonous plant derivatives and species suspected as protected. *Hamadryas guatemalena* is another species which might be added to the list.

#### Literature Cited

- CLARKE, C. A. AND J. P. KNUDSEN. 1953. A hybrid swallowtail. An account of the "cross" *Papilio asterias* ♀ (North American Black Swallowtail) × *Papilio machaon* ♂ (The Swallowtail, of European-Malta-Stock) and a note on the "machaon complex" of the North American Continent. Entom. Record, **65**: 76-80.
- AND P. M. SHEPPARD. 1964. The hybrid between *Papilio polyxenes asterias* Fabr. female and *Papilio maackii* Men. male (Lepidoptera, Nymphalidae) [sic]. Entomologist, 131-133.
- DIMOCK, T. E. 1973. Three natural hybrids of *Vanessa atalanta rubria* × *Cynthia annabella* (Nymphalidae). Jour. Lep. Soc. **27**: 274-278.
- EHRLICH, P. R. AND A. H. EHRLICH. 1961. How to know the butterflies. Wm. C. Brown Co. Publishers. Dubuque, Iowa.
- HEMMING, F. 1967. Generic names of the butterflies and their type-species. Bull. Br. Mus. Nat. Hist. (Ent.) Suppl. 9.
- HOLLAND, W. J. 1914. Butterflies. Doubleday, Page & Co. New York, N. Y.
- KLOTS, ALEXANDER B. 1959. A mixed mating of two species of *Limenitis* Fabricius (Lepidoptera, Nymphalidae). Jour. New York Ent. Soc. **67**: 20.
- . 1960. A field guide to the butterflies. Riverside Press. Cambridge.
- MÜLLER, W. 1886. Südamerikanische Nymphaliden Raupen. Versuch eines natürlichen Systems der Nymphaliden. Zoologische Jahrbuch. 453-461.
- MUYSHONDT, A. 1973a. Notes on the life cycle and natural history of butterflies of El Salvador. III A.—*Temenis laothoe liberia* Fabricius (Nymphalidae-Catonephelinae). Jour. N. Y. Ent. Soc. **81**: 224-233.
- . 1973b. Notes on the life cycle and natural history of butterflies of El Salvador. IV A.—*Pseudonica flavilla canthara* (Nymphalidae-Catonephelinae). Jour. N. Y. Ent. Soc. **81**: 234-242.

- AND A. MUYSHONDT, JR. 1975. Notes on the life cycle and natural history of butterflies of El Salvador. I B.—*Hamadryas februa* (Nymphalidae-Hamadryadinae). Jour. N. Y. Ent. Soc. **83**: 157-169.
- PLATT, A. P. AND J. G. GREENFIELD, JR. 1971. Interspecific hybridization between *Limenitis arthemis astyanax* and *L. archippus* (Nymphalidae) Jour. Lep. Soc. **25**: 278-284.
- SEITZ, A. 1915. Macrolepidoptera of the World. Vol. 5. Stuttgart.

**Notes on the Life Cycle and Natural History of Butterflies of  
El Salvador. III B.—*Hamadryas amphinome* L.  
(Nymphalidae-Hamadryadinae)**

ALBERTO MUYSHONDT AND ALBERTO MUYSHONDT, JR.  
101 AVE. NORTE 322, SAN SALVADOR, EL SALVADOR

RECEIVED FOR PUBLICATION NOVEMBER 18, 1974

**Abstract:** The complete life cycle of *Hamadryas amphinome* L. is presented in this article with photographic illustrations, with a record of the foodplant exploited by the larvae in El Salvador, *Dalechampia scandens* L., and an account of the larval and adult behavior. This species apparently is the most evolved of the *Hamadryas* complex as evidenced by the notable deviations from the behavior of the other species studied: *H. februa* and *H. guatemalena*, which are solitary during all phases of the metamorphosis, and *H. amphinome*, which is gregarious in the larval stage and shows consistent group behavior of the adults. Emphasis is made of the behavioral adaptations the different species of the genus have gone through which gradually change from fully solitary to fully gregarious larval habits.

This is the third article of a series on butterflies of the Hamadryadinae group of the Nymphalidae, presenting our observations on the developmental time and behavior of the early stages and the adults of *Hamadryas amphinome* L. The field studies were conducted in the area of Los Chorros (a tourist resort, about 12 km W of San Salvador, capital city of El Salvador), where the species is fairly abundant throughout the year. During the dry season 1972/73 (November through April), a group of second instar *Hamadryas* larvae were found feeding on *Dalechampia scandens* L., which were different from those of *H. februa* and *H. guatemalena*. It was a surprise to us to notice that these larvae, unlike the others just mentioned, which have solitary behavior, were feeding in a tight group on the underside of the leaf, showing thus gregarious habits. The resulting adults were *H. amphinome*. Searches for eggs were made every weekend from that time with negative results until 26 August 1973, when one peculiar group of "strings" formed by eggs one on top of the other was found and collected. These were reared and the adults emerged about one month later. Since then the species has been reared several times up to this date. The rearing of the larvae in our insectarium was in transparent plastic bags, sealed with rubber bands, in which fresh leaves of the foodplant were supplied every third day until pupation of the larvae.

**Acknowledgments:** We are greatly obliged to Dr. Alexander B. Klots for his unflinching guidance in our efforts and for reading, criticizing and otherwise rendering our manuscript apt for publication. We are thankful also to Dr. A. H. D. Rydon for the valuable reference material he kindly supplied. We give deserved credit to the youngest member of the team, Pierre, for his tremendous help in the field work.

Some colonies were kept together during the whole larval stage; others were split in half after every moult starting from the second instar, so as to end up with 4 to 6 individuals per bag. When ready to pupate the larvae were transferred to a wooden box with windows of mosquito-netting and kept there until the adults emerged. Records were kept of the developmental time and size of each instar; photos were taken of all phases of the metamorphosis; and specimens of eggs, larvae in the different instars and of the pupae have been preserved in alcohol to be sent to the American Museum of Natural History, New York.

#### LIFE CYCLE STAGES

*Egg.* About 1 mm in diameter, round with slightly flattened base, yellowish-white when recently deposited, turning to gray when ready to hatch. Surface almost smooth except for faint sculpturing on the upper part of the walls. Eggs in groups of strings of eggs one on top of the other, totalling 30 to more than 100 eggs per group. Hatch in 4-5 days.

*First instar larva.* Head shiny black, slightly cordiform, naked. Body whitish before feeding, turning to olive green, with transverse rows of dark setae. Grows to 4 mm in 2-3 days.

*Second instar larva.* Head shiny black with short horns on apices of epicrania. Body brownish-green with transverse rows of short furcate spines. Grows to 8 mm in 2-3 days.

*Third instar larva.* Head shiny black with two lateral spines and long slender horns on apices of epicrania each terminating in a clubbed tip. The shafts of the horns are armed basally with one secondary spine directed anterad, a little higher a second spine directed slightly inwards, then higher a third directed outwards, still higher a fourth parallel to the first and finally, about the middle of the shaft, a fifth spine parallel to the second. The rest of the shaft is covered by sparse short setae. Body dark greenish-brown with short furcate spines placed in the following order: on first thoracic segment (T-1) one subdorsal bifurcate spine, one supraspiracular bifurcate spine and one subspiracular simple spine; T-2 with one 5-furcate subdorsal spine, one 5-furcate supraspiracular spine sided by a simple spine, one subspiracular simple spine sided by another very small simple spine; T-3 with one prominent 6-furcate subdorsal spine, one 4-furcate supraspiracular spine sided by a simple spine, and one subspiracular simple spine sided by another small one. First abdominal segment (A-1) with one 4-furcate subdorsal spine, one small supraspiracular simple spine, one bifurcate subspiracular spine, one supraventral simple spine in line with the legs. From A-2 to A-6, one 4-furcate subdorsal spine, one 4-furcate supraspiracular spine, one 3-furcate subspiracular spine sided by a simple spine, and two supraventral simple spines. Segments A-7 and A-8 show in addition one 5-furcate dorsal spine. Segment A-9 has only one 6-furcate supraspiracular spine deflected posterad. A-10 has an anal plate with a crown of 4 small simple spines. Grows to 1.2 cm in 2-3 days.

*Fourth instar larva.* As in third instar, but the head is orange-red, has longer lateral spines and longer horns, which are incurved slightly caudad. Body spines longer than in third instar, the subdorsal ones on segments A-2 to A-6 taking an orangish tinge. Grows to 2.6 cm in 4-6 days.

*Fifth instar larva.* Main change is body color, which is black; from A-2 to A-6 bright yellow dorsal design of circles and bars forming paired O T O s. Subspiracularly these

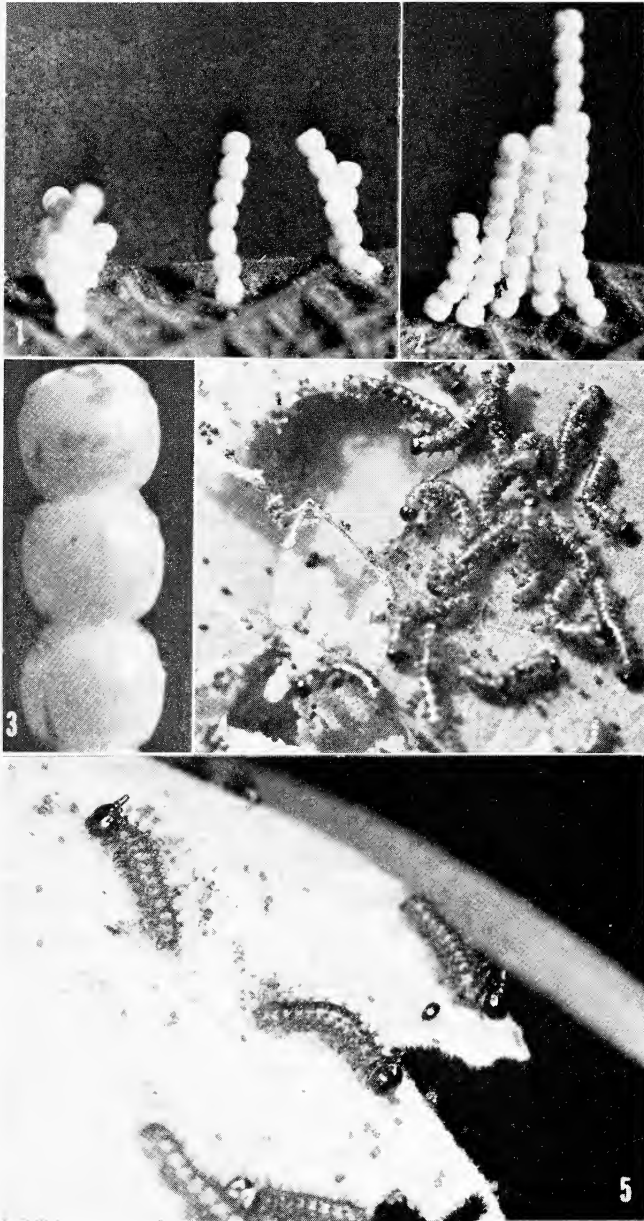

FIGS. 1-5. *Hamadryas amphinome* L. 1 and 2. Typical ovipositions of *Hamadryas amphinome* in groups of strings. Note that they are upside down, the strings being actually pendant from the lower surface of the leaves. 3. Close-up of eggs. 4. Group of first instar larvae ready to moult. 5. Group of second instar larvae. The rest had dropped to the ground when disturbed while taking the photo. Notice the reflection of the ring-flash on the shiny head capsule.

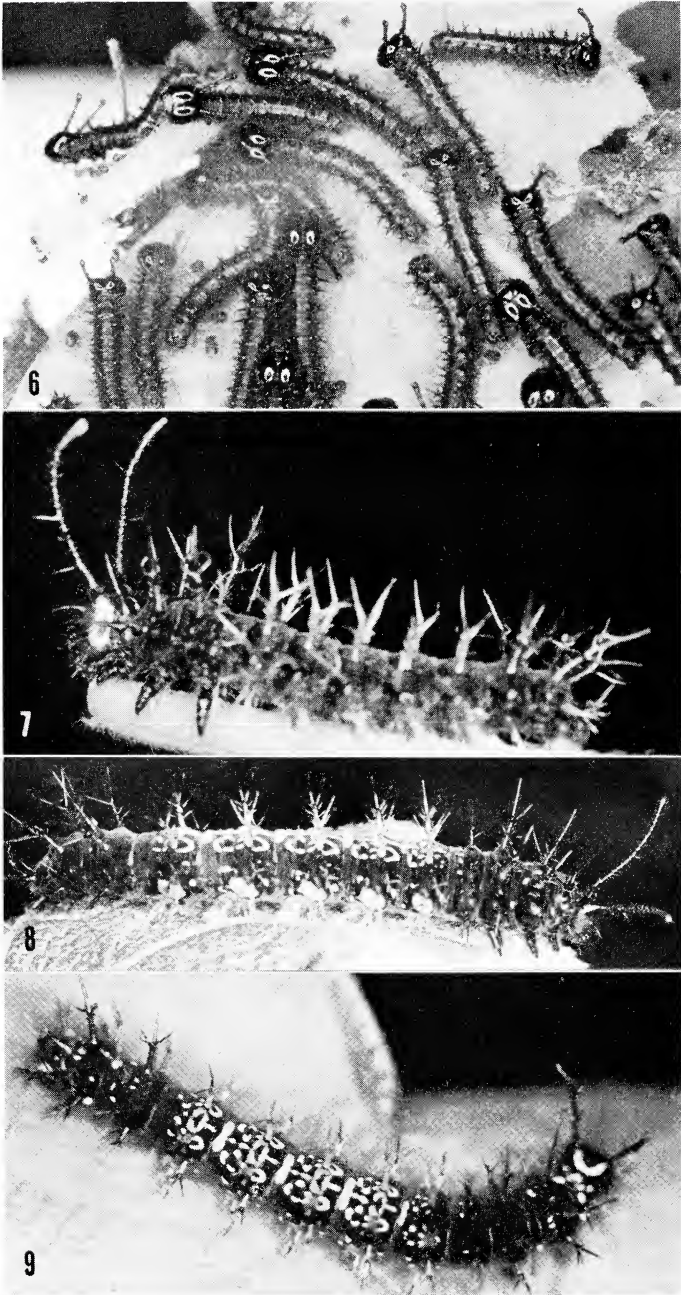

FIGS. 6-9. *Hamadryas amphinome* L. 6. Group of third instar larvae. Ovals on head are the ring-flash reflections. 7. Fourth instar larva. 8 and 9. Lateral and dorsal view of fifth instar larva where subspiracular orange spots and paired O T O marks are clearly visible.

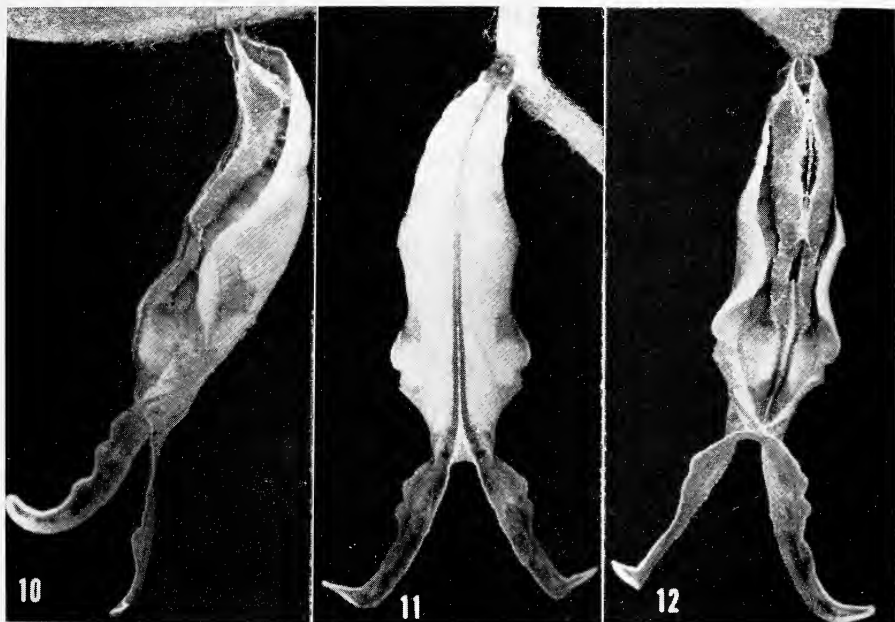

FIGS. 10-12. *Hamadryas amphinome* L. 10. Pupa, lateral view. 11. Pupa, ventral view. 12. Pupa, dorsal view.

segments show a large bright orange spot which contributes to make the larva very conspicuous. The spines on these segments are also reddish-orange. The subdorsal spines on T-2 and T-3, and to a lesser degree the ones on A-2, A-7 and A-8, as well as the dorsal spines on the last two, present small secondary spines on the shaft of the scoli. Grows to 4.5-4.7 cm in 5-6 days.

*Pre-pupa.* No change in coloration. It is slightly shorter. Hangs with head and thorax incurved ventrally for one day.

*Pupa.* Thickens abruptly from flat cremaster, then gradually to A-2 and A-3, narrowing then dorsally and laterally to A-1, thickening again to T-2, narrowing finally towards the head, which is provided with two long, flattened and incurved prolongations. The prolongations are diverging laterally and incurved outwards at the tips. Usual color dorsally light brown with green bordering along wingcases and on thoracic segments; darker brown, bordered by very light brown lines along abdominal meson. Ventrally light green, except cremaster and head prolongations, which are brown. There is a darker morph on which the green is substituted by light brown, the rest being darker brown than usual. It looks very much like a rolled decaying leaf. Measures up to 4.5 cm long (including head prolongations) and lasts 7-8 days.

*Adults.* No marked sexual dimorphism in this species, the females having front wings larger than males. Ground color dorsally black with many dark blue squares, half-moons, round spots and bars forming a complicated pattern, covering both front and hindwings, except for a subapical row of elongated light gray spots running from mid-costal margin to tornus of front wing. The blue color of both wings is highly re-

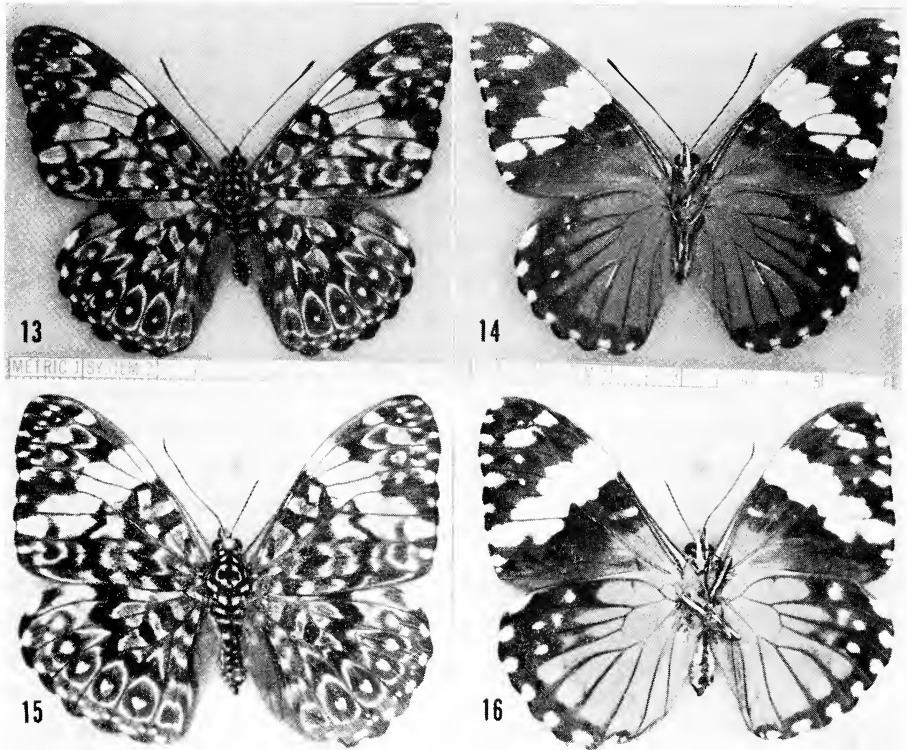

FIGS. 13-16. *Hamadryas amphinome* L. 13 and 14. Male, dorsal and ventral view. 15 and 16. Female, dorsal and ventral view.

flectant. Front wing ventrally mostly dull black with orange basal triangle, and a subapical reproduction of the dorsal gray spots in light yellow. Hindwing mostly bright orange with a black area along the outer margin, which shows a row of cream colored round spots. Body dorsally matching the black and blue colors of the wings, ventrally thorax orange and abdomen black with two longitudinal cream stripes. Antennae and proboscis black. Wing span varies from 6 to 7 cm. Total development in captivity takes from 27 to 35 days. The colonies kept together during the entire larval stage do not develop as big a larva as the ones split gradually into smaller groups from the second instar on, consequently the adults from the large groups are also much smaller than normal, even though the time elapsed is about the same.

#### NATURAL HISTORY

The foodplant of *Hamadryas amphinome* in El Salvador is the same foodplant used by *H. februa* and *H. guatemalena*: *Dalechampia scandens* L., a vine belonging to the Euphorbiaceae, which we mentioned in detail in previous articles on other *Hamadryas* spp. (Muyshondt & Muyshondt 1975 a and b). It is to be noted that *H. amphinome* appears to have a more restricted range



than the species mentioned before, which are found within the whole range of the foodplant (500 to 1500 m altitude). *H. amphinome* is rather common around 1000 m altitude, always in the close neighborhood of wooded land surrounded by pastures or low-brushy plant communities.

The females of *H. amphinome* oviposit on the undersides of leaves of medium development of *D. scandens*, from about two meters to very close to the ground. The females perform outstanding acrobatics while depositing the strings of eggs, spending close to 45 minutes to deposit some 50 eggs. The eggs are laid one by one, one below another, forming perfect pendant strings. There is no consistent norm of the number of eggs per string. We have found groups of eggs with strings from 1 to 13 eggs. Müller (1886) records two groups containing strings from 10 to 15 and from 2 to 13. In our experience most of the strings consist of 5 to 10 eggs. The range of eggs per oviposition is from 30 to more than 100, but most of the groups average 40 to 50 eggs. The strings are rather rigid and keep the same angle in relation to the leaf surface, even if the leaf is turned upside down, contrary to what Müller (1886) observed about *Ageronia* (= *Hamadryas*) *forax* Hübner, whose eggs are deposited in one single flexible string which always hangs perpendicular to the ground. The eggs of *H. amphinome*, white or cream-white when recently deposited, turn to dark gray before hatching.

The hatching larvae eat their way out from the lateral wall of the eggshell which is an important adaptation acquired by the species to avoid damaging an adjacent egg and also prevents the rest of the eggs from falling to the ground, which would occur if the exit hole was eaten from the micropylar area as is customary in many other species. The small larvae have to crawl up the string to reach the leaf surface and there the group is formed. They start eating the lower layer of leaf tissue. Their excrements adhere to the thin layer of silk formed while the larvae weave a silken foothold as they move about. The small larvae also affix some pellets to their bodies. The resultant accumulation of excreta seems to be a protective device adopted by this species against its enemies. Later, but still during the first instar, the larvae move in a group to the edge of the leaf, and form a tight line of individuals perpendicular to the edge. As the larvae grow in the subsequent moults, the group starts segregating into smaller groups mainly due to space limitations of the leaf, somewhat similar to what happens with *Dione junonia huascama* Reakirt (Muysshondt, Young and Muysshondt, 1973), but also due to the habit of *H. amphinome* larvae of wiggling convulsively at the least disturbance, which if continued provokes a massive dropping of the larvae from the leaf to lower levels of the plant or to the ground. In the act of crawling back to the plant and reforming the group some larvae end up forming smaller communities, far from each other. By the end of the larval stage, the groups are usually reduced to three to seven individuals. When

ready to pupate the small groups dissolve and the larvae wander about the plant independently until a suitable location is chosen. This is normally on the same vine or on a supporting plant, among the thick foliage, where the larvae weave a silken mat and after cleaning their digestive tract, hang from their anal prolegs, with head and thorax incurved ventrally, until pupation. We have never found groups of pupae in the fields. The pupae of *H. amphinome*, except for the head prolongations and the body color, look very much like the pupae of *H. februa* and *guatemalena*, and behave very much like them, swinging violently from side to side at the faintest provocation, ending bent to one side. The vertical position is resumed some time afterwards. As with the other species mentioned, the pupae are firmly anchored on the flat cremaster so that they keep vertical to the supporting object even when this is turned upside-down.

The emerging adults hang from the pupashell while ejecting the reddish meconium and expanding the wings, which are held folded dorsally. After the first flight the wings are usually kept spread open, except for night resting. Even then at the slightest movement of the plant, the wings are immediately spread, but after some flappings are folded again. The adults are seen, at times, flying rapidly one following another in groups from five to eight individuals, as if playing "follow-the-leader." When so acting, they alight, eventually, separately on contiguous fence poles or trees. When one flies again, the whole group follows and after some fast maneuvers, the group alights again on the same places or close by. This apparent game has been observed for considerable periods of time, until the group moves away. When in this playful mood, no "clicking" has been noticed. At other times, when two males encounter each other, frantic circumvolutions and excited clicking do occur. Sometimes the fighting males fly up vertically, while circling, more than 100 meters high, coming down vertically also. One of us (A.M., Jr.), timed one such a fight, and it lasted about 45 minutes, while continuous clicking was audible. Females ready to oviposit fly more slowly than usual until they locate a foodplant, and land on the underside of a medium sized leaf. They stay there for a long period of time until a considerable number of eggs are deposited as described, moving away afterwards with their customary swift flight. In both males and females the blue reflection seems to hover over the flying adults, somewhat as in the blue *Morphos*. In all other respects the adults of this species behave like the rest of the *Hamadryas* group, and it would be repetitious to further describe their habits. The species is also subject to heavy parasitism by tachinid flies.

#### DISCUSSION

W. Müller (1886) describes, briefly, the life cycle of *Hamadryas* (= *Ageronia*) *amphinome* and gives the time spent during the larval stage as 19 to

22 days, not determining the pupal time. He gives for the egg period 3 days, which in our experience has taken from 4 to 5 days. The times for the different instars of the larva are more in accordance with our findings, which makes us believe he found the eggs a day or two after they were deposited. Müller does not mention the foodplant when dealing with *H. amphinome*, but when he treats the genus *Ageronia* Hübner, he states that all the species included therein, feed, in Brazil, on *Dalechampia* (*triphyla* Lam., *ficifolia* Lam., *stipulacea* Müll. Arg.), which agrees with our findings. Young (1974) records *Dalechampia heteromorpha* as the foodplant of *H. februa* in Costa Rica. Amazingly Barcant (1970) mentions *Aristolochia trilobata* (an Aristolochiaceae) as the foodplant of *H. amphinome*! In El Salvador where Aristolochiaceae are well represented by several species, we have never found any *Hamadryas* on them. Aristolochiaceae seem to be exploited in El Salvador exclusively by various species of *Battus* and *Parides* (Papilionidae). Most probably Barcant's record is a case of plant misidentification. The present is apparently the first complete life cycle description of *H. amphinome*, with photographic illustrations, ever published.

*Hamadryas amphinome*, which is the type species of the genus *Hamadryas* Hübner, teste Hemming (1967), is of extreme interest to specialists in evolution studies as it seems to be the most advanced species of the *Hamadryas* complex. This is evidenced by the gradual changes in various aspects of the behavior of the various species, and in the shape of the eggs. *H. arete* Doubleday deposits one very sculptured egg at a time (Müller, 1886), and the larva is solitary. *H. februa* Hübner and *H. guatemalena* Bates (Young, 1974; Muysshondt & Muysshondt 1975 a and b), usually deposit their sculptured eggs individually, the larvae then being solitary also, but these two species might deposit two or even three eggs one on top of the other, the resulting larvae then leading a loose communal life. All these species share the peculiar perch-making habit during the first larval instars. *H. fornax* (Müller, 1886) deposits the sculptured eggs in one string containing up to 10 eggs at a time (one egg on top of the other), and the ensuing larvae have gregarious habits. Finally *H. amphinome* deposits its almost round, little sculptured eggs in groups of several strings totalling at times more than 100 eggs per group, and the larvae also are gregarious. The last two species have abandoned the perch-making habit. In *H. amphinome* even the adults seem to maintain a sort of loose gregariousness, as their "follow-the-leader" game seems to indicate.

The shift from solitary to gregarious behavior of the *Hamadryas* complex, taken as a whole, has produced the following remarkable deviations from the probable original solitary behavior: 1) the egg laying technique, which has affected the shape of the eggs, 2) prerequisite to the massive egg laying, the larvae must have acquired the habit of eating the exit hole from the side of

the eggshell instead of the micropylar area, a trait existent already in the solitary species. 3) The abandonment of the perch-making habit, shown by the solitary species, in favor of the frass-pellet sticking on the underside of the leaves. 4) the angry disposition of the gregarious species, contrasting with the rather passive attitude of the solitary species. 5) The gradual increase in gaudiness of the larval coloration in the gregarious species, as compared to the solitary ones, and 6) the ability to produce disagreeable scent, enhanced by the number of individuals in close association exhibited by the gregarious species.

It is probable that the acquisition of the gregarious larval behavior is a relatively recent event, as apparently the species is not yet fully adapted to some of its consequences (ochlesis), as would be suggested by the readiness of the groups to part company at the faintest motivation, as if to avoid overcrowding of individuals. Overcrowding in captivity, has led to a drastic reduction in the size of the adults. In other gregarious species of butterflies we have observed (*Actinote* spp., *Phyciodes* spp., *Chlosyne* spp., *Thessalia theona* Ménétries, *Microtia elva* Bates, *Mechanitis isthmia* Bates, *Colobura dirce* L. *Manataria maculata* Hopff.) there seems to be a better adaptation to the crowding resulting from the communal life, and the individuals only disperse just prior to pupation. In one case (*Dione juno huascama* Reakirt) we have even found communal pupation in the fields (Muyshondt, Young and Muyshondt, 1973). If in these species there is a certain amount of segregation of the original group into smaller ones, it is mostly due to space limitation. It is true that these species, if deprived of sufficient food and space to move about, do also produce midget adults, but not when they have enough food and ample space. We emphasize also the contrast between the angry convulsions of the larvae of *H. amphinome* with the coordinated twitchings of a mass of *Dione juno huascama*. All these factors indicate that most of the gregarious species acquired such behavior much longer ago than *Hamadryas amphinome*, and are better adapted to it.

It seems to us that the conspicuous larval coloration of *H. amphinome*, added to the unpleasant odor emitted by the larvae, the adults' aggressive disposition and the bright orange coloration of their underwings, suggest impalatability to predators (orange color in insects is usually associated with such condition), even though there is still some crypsis in the dorsal coloration of the wings. The urticant properties of the foodplant *Dalechampia scandens*, which belong to the Euphorbiaceae family reputed to comprise plants with caustic or otherwise poisonous constituents (Standley, 1923, says about Euphorbiaceae: "The sap usually has purgative and often poisonous properties"), would seem to sustain our assumption, even though Young (1974) has observed, in relation to *Dalechampia heteromorpha* Pax and Hoffmann, which

is one of the foodplants of *H. februa* in Costa Rica: "I chewed several leaves (both young and old) and found no signs of bitter tastes." In our experience some alkaloid (supposedly poisonous) bearing plants are not bitter when chewed, and on the other hand some which are bitter when chewed do not contain alkaloids. Furthermore, alkaloids are not the only poisonous materials found in plants: saponins, cyanogenetic and cardiac glycosides are others (Brower & Brower, 1964), and are not necessarily associated with bitter tastes.

*H. amphinome*, as is the case with *H. guatemalena* (Muyshondt & Muyshondt, 1975 b) has lost all the dorsal spines with the exception of the one on segments A-7 and A-8, which are present on all abdominal segments (except the A-9 and A-10) of other species of *Hamadryas*, probably as a result of the increased protection obtained from the more efficient exploitation of the noxious components of the foodplant, enhanced in this case by the gregarious behavior of the larvae.

#### Literature Cited

- BARCANT, M. 1970. Butterflies of Trinidad and Tobago. London. Collins.
- BROWER, L. P. AND J. V. Z. BROWER. 1964. Birds, butterflies and plant poisons: a study in ecological chemistry. *Zoologica* **49**: 137-159.
- HEMMING, F. 1967. Generic names of the butterflies and their type-species. *Bull. Br. Mus. Nat. Hist. (Ent.) Supl.* 9.
- MÜLLER, W. 1886. Südamerikanische Nymphalidenraupen. Versuch eines natürlichen Systems der Nymphaliden. *Zoologische Jahrbuch* 453-461.
- MUYSHONDT, A. AND A. MUYSHONDT, JR. 1975a. Notes on the life cycle and natural history of butterflies of El Salvador. I B.—*Hamadryas februa* (Nymphalidae-Hamadryadinae). *Jour. N. Y. Ent. Soc.* **83**: 157-169.
- . 1975b. Notes on the life cycle and natural history of butterflies of El Salvador. II B.—*Hamadryas guatemalena* Bates (Nymphalidae-Hamadryadinae) *Jour. N. Y. Ent. Soc.* **83**: 170-180.
- , A. M. YOUNG AND A. MUYSHONDT, JR. 1973. The biology of the butterfly *Dione juno huascama* (Nymphalidae: Heliconiinae) in El Salvador. *Jour. N. Y. Ent. Soc.* **81**: 137-151.
- STANDLEY, P. 1923. Trees and shrubs of Mexico. *Contrib. from the U. S. Nat. Herb.* Vol. **23** Part 3.
- YOUNG, A. M. 1974. On the biology of *Hamadryas februa* (Lepidoptera: Nymphalidae) in Guanacaste, Costa Rica. *Zool. ang Ent.* **76**: 845-856.

## Notes on the Male Reproductive System in Ants (Hymenoptera: Formicidae)<sup>1</sup>

A. C. F. HUNG AND S. B. VINSON

DEPARTMENT OF ENTOMOLOGY, TEXAS A&M UNIVERSITY, COLLEGE STATION, TEXAS 77843

RECEIVED FOR PUBLICATION OCTOBER 31, 1974

**Abstract:** The gross morphology of the male reproductive system of *Pachycondyla harpax* (Fabr.), *Eciton hamatum* (Fabr.), *Neivamyrmex* sp., *Pogonomyrmex barbatus* (F. Smith), *Crematogaster laeviuscula* Mayr, *Solenopsis invicta* Buren, *Atta texana* (Buckley), *Iridomyrmex pruinosum* (Roger), *Conomyrma insana* (Buckley), *Formica canadensis* Santschi, *F. subintegra* Emery and *Polyergus breviceps* Emery was studied. As the ants matured the spermatozoa descended into the vas deferens and were retained there while the testes progressively decreased in size. The dilated vasa deferentia where mature spermatozoa are retained should be called "seminal vesicles" and what was formerly called "seminal vesicle" should be referred to as "accessory gland." Two types of accessory glands were found in ants. In the first type which is found so far only in the Ecitonini, the glands are long, coiled and both enclosed in a single capsule. In the second type the glands consist of two distinct bodies and are either ball-shaped, bean-shaped, or elongated.

There have been very few studies on the male reproductive system in ants. Janet (1902) in his study of the anatomy of the gaster of *Myrmica rubra* L. depicted the male reproductive organs. This classic illustration has been reproduced in such famous myrmecological monographs as "Ants" by Wheeler (1910), "British Ants" by Donisthorpe (1915), and "Le monde social des fourmis" by Forel (1921-1923). Forbes (1954) gave a comprehensive review on this subject. Trakimas (1968) reinvestigated the anatomy and histology of *M. rubra*. Unfortunately, only the abstract of her work was published.

According to Janet (1902), the male reproductive system of ants consists of the testes, the vasa deferentia, the seminal vesicles, the ejaculatory duct and the external genitalia. An aedeagal bladder was later found in *Camponotus* and *Formica* (Forbes 1954), *Eciton* (Forbes 1958), *Rhytidoponera* (Hagopian 1963), *Neivamyrmex* (Forbes and Do-Van-Quy 1965), *Solenopsis* (Tice 1967), and *Myrmica* (Trakimas 1968). Although a pair of accessory glands was found in *Dorylus labiatus* Schuck (Mukerjee 1926), *Eciton hamatum* (Fabr.) (Forbes 1953), and *Neivamyrmex harrisi* (Haldeman) (Forbes and Do-Van-Quy 1965), no mention of accessory glands has been made in other ants (Janet 1902,

---

<sup>1</sup>Approved as TA 11481 by the Director of the Texas Agricultural Experiment Station. Supported in part by Sigma Xi Grant-in-Aid of Research award to Hung and by the Texas Department of Agriculture Interagency Agreement IAC (74-75)-0448. We also thank Dr. John C. Moser and Dr. Carl W. Rettenmeyer for their generous contributions of specimens.

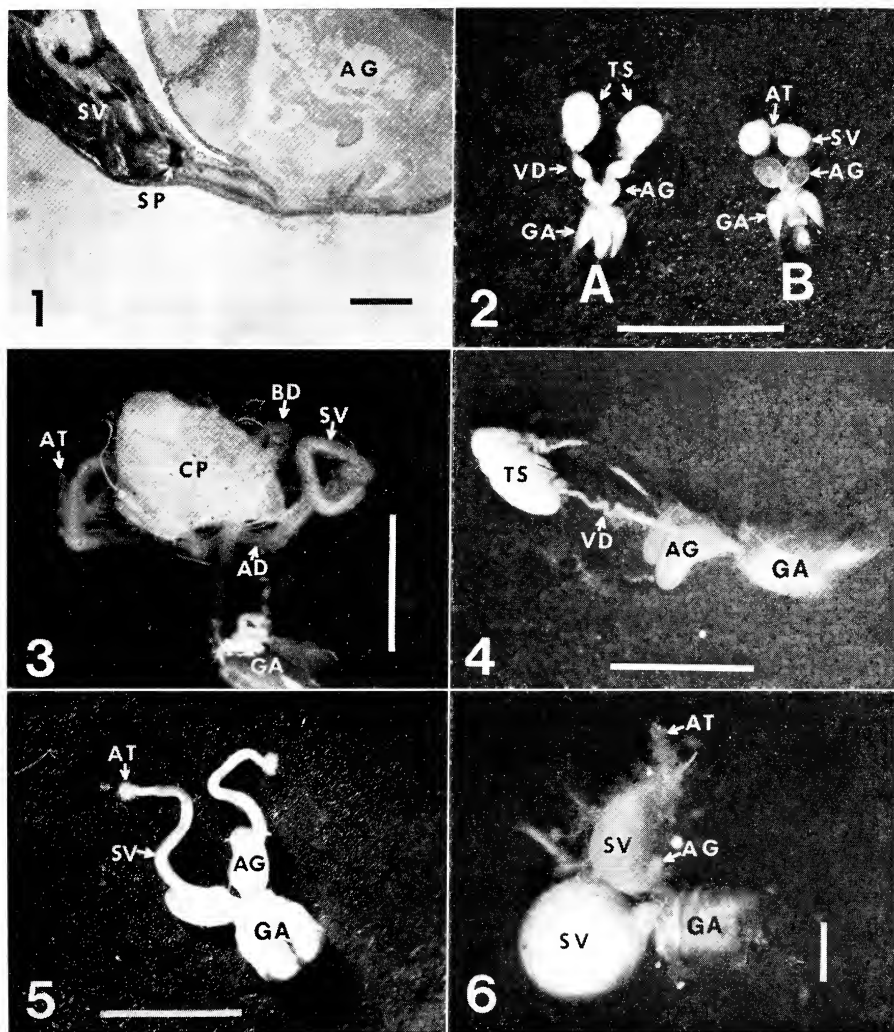

FIG. 1. Longitudinal section of seminal vesicle and accessory gland of *F. subintegra*. (Scale line = 0.1 mm).

FIGS. 2-6. Male reproductive system in ants (scale lines = 1 mm). 2. *I. pruinosum*. A, newly emerged; B, matured. 3. *Neivamyrmex* sp., matured. 4. *Pachycondyla harpax*, newly emerged. 5. *Pogonomyrmex barbatus*, matured. 6. *A. texana*, matured.

Abbreviations: AD, duct of accessory gland; AG, accessory gland; AT, atrophied testis; BD, bound accessory gland ducts; CP, capsule of accessory gland; GA, genitalia; SP, sperm plug; SV, seminal vesicle; TS, testis; VD, vas deferens.

Forbes 1954, Hagopian 1963, Dlussky 1967, Tice 1967, Trakimas 1968). Therefore, according to Forbes (1954) the mature sperm in *Camponotus pennsylvanicus* (DeGeer) are stored in the vasa deferentia and prevented from moving into the seminal vesicles by a granular plug. A similar plug was also found in *Formica subintegra* Emery (Fig. 1).

The above citations suggest that army ants differ from other ants in having accessory glands and further, that ants other than army ants do not store the mature sperm in the seminal vesicles like other insects. We suggest the assumption is false. The discrepancy appears to have been created by the use of incorrect terminology.

According to Snodgrass (1935), the vesicula seminalis is a dilatation of the vas deferens in which spermatozoa may be retained. Therefore, the seminal vesicle could be any portion of the vas deferens. For example, in *Oncopeltus fasciatus* (Dallas) it is located at the upper portion of the vas deferens immediately following the vas efferens (Bonhag and Wick 1953).

We studied the male reproductive system of the following 12 species: *Pachycondyla harpax* (Fabr.) (Ponerinae); *Eciton hamatum* (Fabr.) (Dorylinae); *Neivamyrmex* sp. (Dorylinae); *Pogonomyrmex barbatus* (F. Smith) (Myrmicinae); *Crematogaster laeviuscula* Mayr (Myrmicinae); *Solonopsis invicta* Buren (Myrmicinae); *Atta texana* (Buckley) (Myrmicinae); *Iridomyrmex pruinosum* (Roger) (Dolichoderinae); *Conomyrma insana* (Buckley) (Dolichoderinae); *Formica canadensis* Santschi (Formicinae); *F. subintegra* Emery (Formicinae); and *Polyergus breviceps* Emery (Formicinae).

In *Pogonomyrmex barbatus*, *S. invicta* (Hung et al. 1974), *I. pruinosum*, and *F. subintegra* in which we had freshly killed male pupae and alates of different ages, we found that as the ants matured the spermatozoa descended into the vas deferens and were retained there while the testes progressively decreased in size (Fig. 2). According to the definition of Snodgrass (1935), these dilated vasa deferentia (or portions of the vas deferens) should be called "seminal vesicles." Consequently, what was previously called "seminal vesicle" should be referred to as "accessory gland."

Our studies further revealed that there are 2 types of accessory glands in ants. In the first type the glands are long, tightly coiled and both enclosed in a single capsule (Figs. 3 and 7). This type is found so far only in *Eciton* and *Neivamyrmex*. Although Forbes (1958) and Forbes and Do-Van-Quy (1965) did not mention any capsule enclosing the coiled accessory glands in their preserved material, our dissection of two fresh specimens of *Neivamyrmex* males showed the presence of this capsule (Figs. 3 and 7, CP). In the second type, the glands consist of two distinct bodies. They are ball-shaped in the dolichoderines (Fig. 2), but are elongated in *Dorylus* (Mukerjee 1926) and bean-shaped in ponerines (Fig. 4), myrmicines (Figs. 5-6) and formicines.



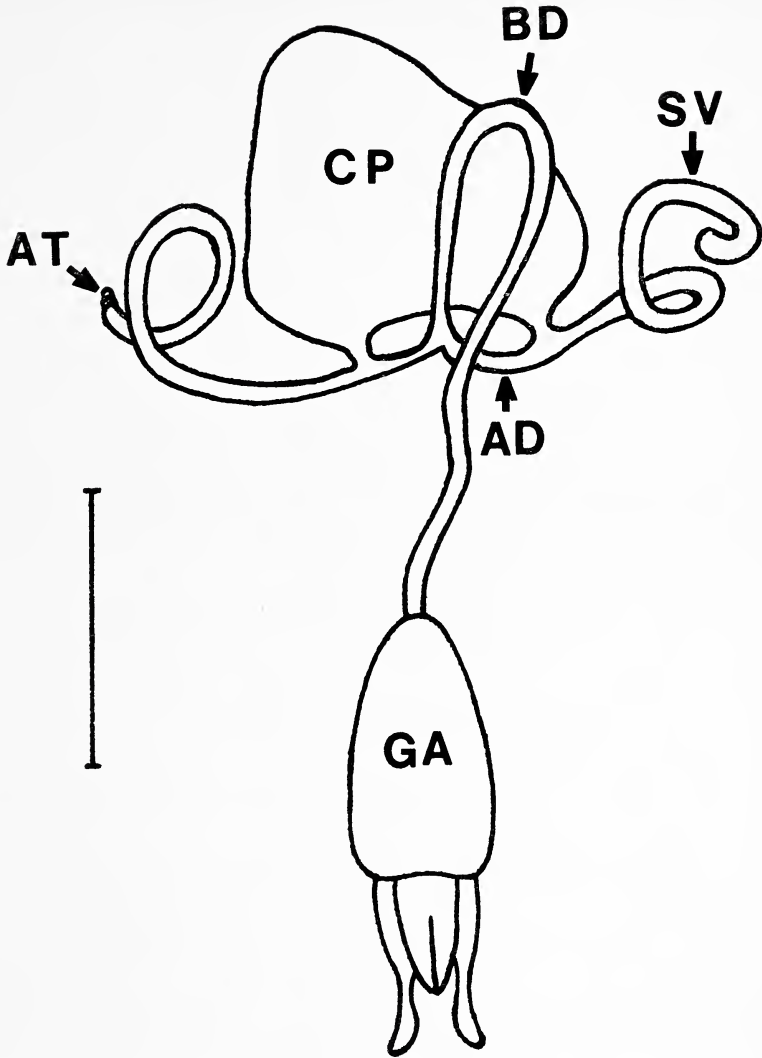

FIG. 7. Diagram of male reproductive system in *Neivamyrmex* sp. (scale line = 1 mm).

In mature males of some ants the glands are sometimes much smaller than the seminal vesicles and are easily overlooked (Fig. 6).

Brown (1954) has suggested that Dorylinae might be diphyletic and Gotwald (1969) goes further to state that the dorylines are tripartite. This preliminary study on the gross morphology of the male reproductive system in ants certainly supports the polyphyletic nature of the dorylines. As has previously been pointed out, the coiled, enclosed accessory glands are so far found only

in *Eciton* and *Neivamyrmex*. According to Mukerjee (1926) the accessory glands of *D. labiatus* are conspicuous bodies due to their large size and thick wall. His illustrations further show that the shape of these glands are very similar to those of the myrmicines and formicines. We have also studied male alates of *Aenictus* from Taiwan. Although the entire reproductive system in our material was beyond recognition due to poor preservation, two distinct bodies of accessory glands can still be recognized. Therefore, the accessory gland of the Dorylini appears to have a closer resemblance to that of the Myrmicinae and Formicinae than to Ecitonini.

There have been both anatomical and behavioral evidences supporting the phylogenetic affinities between Ponerinae and Dorylinae (Wilson 1958, Hermann 1969). As far as the accessory glands are concerned, our study of *Pachycondyla* and that of *Rhytidoponera* by Hagopian (1963) certainly indicate that ponerines are closer related to Dorylini than to Ecitonini.

#### Literature Cited

- BONHAG, F., AND J. R. WICK. 1953. The functional anatomy of the male and female reproductive systems of the milkweed bug, *Oncopeltus fasciatus* (Dallas) (Heteroptera, Lygaeidae). *J. Morph.* **93**: 177-283.
- BROWN, W. L. 1954. Remarks on the internal phylogeny and subfamily classification of the family Formicidae. *Insectes Sociaux* **1**: 21-31.
- DLUSSKY, G. M. 1967. Ants of the genus *Formica* (in Russian). Izdatel'stve "Nauka", Moscow. 211 pp.
- DONISTHORPE, H. ST. J. K. 1915. British ants, their life-history and classification. William Brendon and Son, Ltd., Plymouth, England. 379 pp.
- FORBES, J. 1954. The anatomy and histology of the male reproductive system of *Camponotus pennsylvanicus* DeGeer (Formicidae, Hymenoptera). *J. Morph.* **95**: 523-556.
- . 1958. The male reproductive system of the army ant, *Eciton hamatum* Fabricius. *Proc. 10th Internat. Congr. Entomol.* **1**: 593-596.
- , AND D. DO-VAN-QUY. 1965. The anatomy and histology of the male reproductive system of the legionary ant, *Neivamyrmex harrisi* (Haldeman) (Hymenoptera, Formicidae). *J. New York Entomol. Soc.* **73**: 95-111.
- FOREL, A. 1921-1923. Le monde social des fourmis du globe comparée à celui de l'homme, 5 vols. Librairie Kundig, Geneva. 948 pp.
- GOTWALD, W. H. 1969. Comparative morphological studies of the ants, with particular reference to the mouthparts (Hymenoptera: Formicidae). *Mem. Cornell Univ. Agric. Exper. Sta., Ithaca, N. Y.* **408**: 1-150.
- HAGOPIAN, M. 1963. An anatomical and histological study of the male ponerine ant, *Rhytidoponera metallica* F. Smith (Formicidae, Hymenoptera). Dissertation, Fordham Univ., Xerox Univ. Microfilms, Ann Arbor, Mich. 124 pp.
- HERMANN, H. R. 1969. The hymenopterous poison apparatus: Evolutionary trends in three closely related subfamilies of ants (Hymenoptera: Formicidae). *J. Georgia Entomol. Soc.* **4**: 123-124.
- HUNG, A. C. F., S. B. VINSON, AND J. W. SUMMERLIN. 1974. Male sterility in the red imported fire ant, *Solenopsis invicta* Buren. *Ann. Entomol. Soc. Amer.* **67**: 909-912.

- JANET, C. 1902. Anatomie du gaster de la *Myrmica rubra*. Georges Carré et C. Naud, Paris. 68 pp.
- MUKERJEE, D. 1926. Digestive and reproductive systems of the male ant *Dorylus labiatus* Schuck. J. Proc. Asiatic Soc. Bengal, n. s., **22**: 87-92.
- SNODGRASS, R. E. 1935. Principles of insect morphology. McGraw-Hill, New York. 667 pp.
- TICE, J. E. 1967. The anatomy and histology of some of the systems of the male of the imported fire ant, *Solenopsis saevissima richteri* Forel (Hymenoptera: Formicidae). Dissertation, Fordham Univ., Xerox Univ. Microfilms, Ann Arbor, Mich. 122 pp.
- TRAKIMAS, W. B. 1968. An anatomical and histological study of the male myrmicine ant, *Myrmica rubra* L. (Hymenoptera: Formicidae). Dissertation Abstr. 28B: 4360.
- WHEELER, W. M. 1910. Ants: Their structure, development and behavior. Columbia Univ. Press, New York. 663 pp.
- WILSON, E. O. 1958. The beginnings of nomadic and group-predatory behavior in the ponerine ants. *Evolution* **12**: 24-31.

## Species and Numbers of Bloodsucking Flies Feeding on Hogs and Other Animals in Southern New Jersey<sup>1,2</sup>

THOMAS J. WEINER AND ELTON J. HANSENS<sup>3</sup>

DEPARTMENT OF ENTOMOLOGY AND ECONOMIC ZOOLOGY,  
COOK COLLEGE, RUTGERS UNIVERSITY, NEW BRUNSWICK, N. J. 08903

RECEIVED FOR PUBLICATION JANUARY 20, 1975

**Abstract:** Tabanidae of 19 species were recorded feeding on hogs of 8 herds in 1973. Species and feeding location on the animals were recorded. Though small numbers of tabanids fed on hogs, herds in wooded areas were more subject to attack by Tabanidae and *Stomoxys calcitrans* than those in open fields. *Stomoxys calcitrans*, *Haematobia irritans*, and 13 Tabanidae were noted on horses, 2 Tabanidae on goats and 6 on dogs.

In areas adjacent to the New Jersey coastal wetlands, female horse flies and deer flies are serious pests of domestic animals and man. Recently Tidwell et al (1972) reported the capability of Tabanidae in transmitting hog cholera and named 8 different *Tabanus* species feeding on North Carolina hogs under field and laboratory conditions. The present study sought to identify the species and assess the numbers of Tabanidae found on hogs and other animals under farm conditions in New Jersey.

### MATERIALS AND METHODS

Eight New Jersey farms, including 7 located in Cumberland and 1 in Cape May county, were visited at least twice a week from June 6 to August 10, 1973. At each location, 20 hogs were chosen randomly and counts of feeding Tabanidae and *Stomoxys calcitrans* were made. The appearance of the animal was also noted—clean, dirty or muddy—as well as whether it was in the sun, shade or shelter. Not only were numbers of flies tabulated, but also on which part of the hogs' body a particular fly was feeding. A portion of the flies were collected and identified in the laboratory to confirm field identification. Whenever an unfamiliar fly was seen, a special effort was made to capture it. Only once during the season did such a fly escape. This particular fly was recognized as a *Chrysops* species.

Black box traps such as that described by Decoster (1968) were set up at 5 farms to monitor the fly population. Beach balls sprayed black were used

<sup>1</sup> Diptera: Tabanidae, Muscidae.

<sup>2</sup> Paper of the Journal Series, New Jersey Agricultural Experiment Station, Rutgers University—The State University of New Jersey, New Brunswick, N.J. This investigation is part of an undergraduate George H. Cook Scholar Project and was supported in part by USDA—APHIS, Contract No. 12-16-100-189.

<sup>3</sup> Undergraduate Student and Research Professor, respectively.

TABLE 1. Numbers of Tabanidae species collected from hogs and box traps throughout the summer of 1973 in southern New Jersey.

Species	Number on Hogs	Number in Traps
<i>Tabanus lineola</i> F.	306	1515
<i>T. nigrovittatus</i> Macquart	136	554
<i>T. atratus</i> Fabricius	88	3
<i>T. trimaculatus</i> Palisot de Beauvois	26	21
<i>Chrysops fuliginosus</i> Wiedemann	20	0
<i>C. niger</i> Macquart	11	0
<i>C. cincticornis</i> Walker	7	1
<i>C. atlanticus</i> Pechuman	1	41
<i>C. montanus</i> Osten Sacken	0	15
<i>T. nigripes</i> Wiedemann	6	16
<i>T. pumilus</i> Macquart	2	53
<i>T. melanocerus</i> Wiedemann	1	21
<i>Diachlorus ferrugatus</i> (F.)	4	21
<i>T. sparus milleri</i> Whitney	1	0
<i>T. americanus</i> Forster	2	1
<i>T. imitans</i> Walker <sup>1</sup>	1	0
<i>T. sulcifrons</i> Macquart	0	1
<i>Hybomitra daeckei</i> (Hine)	19	2
<i>H. lasiophthalma</i> (Macquart)	4	0
<i>C. obsoletus</i> Wiedemann	1	9
<i>C. dimmocki</i> Hine	1	4
<i>C. flavidus</i> Wiedemann	0	6
<i>C. brunneus</i> Hine	0	2
<i>C. vittatus</i> Wiedemann	0	2
<i>C. celatus</i> Pechuman	0	1
<i>C. geminatus</i> Wiedemann	0	1
<i>Stomoxys calcitrans</i> (L.)	3119	302

<sup>1</sup>The first recorded specimen found north of Maryland—identification made by L. L. Pechuman, Cornell University.

as targets hung under the traps. Each time these farms were visited, trapped flies were collected and later identified.

Clean clothing was worn at all times and rubber boots were disinfected before and after visiting each location.

#### RESULTS

*Hogs.* Of the 19 Tabanidae species (Table 1) found to feed on hogs in southern New Jersey, *Tabanus lineola*, *T. nigrovittatus* and *T. atratus* fed in the largest numbers. *T. lineola* made up 48% of the total number of horse flies counted on the animals and 66% of those Tabanidae collected from the box traps. *T. nigrovittatus* contributed 21% and 24% of these totals, respectively. *T. atratus* fed freely on the hogs but would rarely enter the traps.

TABLE 2. Comparison of the number of Tabanidae and *Stomoxys calcitrans* found on hogs in woods versus fields, Cumberland County, N.J.

Farms	Tabanidae	Total Tabanidae/Hog	<i>Stomoxys</i>	Total <i>Stomoxys</i> /Hog
A (woods)	99	0.29	1359	4.00
C (woods)	13	0.04	182	0.61
D (fields)	4	0.01	25	0.08
F (woods)	169	0.56	168	0.56
F (fields)	117	0.34	697	2.05

The number of deer flies feeding was generally lower than the horse flies. *Chrysops fuliginosus*, *C. niger* and *C. cincticornis* were those species which fed most frequently. *Chrysops atlanticus*, *C. montanus*, *T. nigripes*, *T. pumilus*, *T. melanocarus* and *Diachlorus ferrugatus* were present in the vicinity of the hogs in substantial numbers but were not inclined to feed. The stable fly, *Stomoxys calcitrans*, was more common on the hogs than any of the tabanids and made up 83% of the flies found in the box traps.

The stable fly was present throughout the entire season and fed all over the body of the hog, as did most of the *Tabanus* spp. However, *T. atratus* concentrated on the back of the animal and *T. trimaculatus* had a predilection for the sides and legs. *Hybomitra lasiophthalma* fed on the legs and *Diachlorus ferrugatus* fed only on the lower half of the pig. The feeding activity of most *Chrysops* spp. was limited to the hog's back.

In general, more Tabanidae and *S. calcitrans* fed on animals kept in wooded

TABLE 3. Species and numbers of Tabanidae found on hogs in the fields and woods of Farm F.

Species	Fields (17) <sup>1</sup>	Woods (15) <sup>1</sup>
<i>Tabanus lineola</i>	61	95
<i>T. atratus</i>	37	25
<i>T. nigrovittatus</i>	14	10
<i>T. trimaculatus</i>		4
<i>T. nigripes</i>		2
<i>T. americanus</i>		1
<i>Chrysops niger</i>	1	10
<i>C. cincticornis</i>		4
<i>C. atlanticus</i>		1
<i>Hybomitra daeckei</i>	4	15
<i>H. lasiophthalma</i>		1
<i>Diachlorus ferrugatus</i>		1

<sup>1</sup> Number of visits.

TABLE 4. Numbers of Tabanidae species, *Stomoxys calcitrans*, and *Haematobia irritans* collected from horses during the summer of 1973 in Millville, New Jersey.

Species	Number on Horses
<i>Chrysops niger</i>	4
<i>Tabanus lineola</i>	543
<i>T. atratus</i>	43
<sup>1</sup> <i>T. fulvulus</i> Wiedemann	10
<i>T. nigripes</i>	10
<i>T. americanus</i>	4
<i>Hybomitra lasiophthalma</i>	4
<sup>1</sup> <i>T. petiolatus</i> Hine	2
<i>T. pumilus</i>	1
<sup>1</sup> <i>H. cincta</i> (F.)	1
<i>T. nigrovittatus</i>	1
<i>H. daeckei</i>	1
<sup>1</sup> <i>H. trispila</i> (Wiedemann)	2
<sup>1</sup> <i>T. pallidescens</i> Philip	1
<sup>1</sup> <i>T. stygius</i> Say	1
<i>Stomoxys calcitrans</i>	1376
<sup>1</sup> <i>Haematobia irritans</i> (L.)	54

<sup>1</sup> Not seen on hogs.

areas than in non-wooded areas (Table 2). This trend is shown for farms C and D located in Cedarville and 0.5 mile apart. The wooded farm C had 4 Tabanidae and 61 *S. calcitrans* for every 100 hogs compared to 1 Tabanidae and 8 *S. calcitrans* in the field of farm D.

Farm F was unique in that it had 2 distinct herds separated by 0.7 mile. The wooded area had 56 tabanids and 56 stable flies feeding on every 100 pigs, whereas the field area had 34 tabanids and 205 stable flies per 100 pigs. *S. calcitrans* showed a greater tendency to enter shelters than the tabanids. This is a possible explanation for the more abundant stable flies found feeding in the field of farm F. Each time this area was visited counts were taken from hogs maintained in 2 pens. One pen contained the younger and smaller animals while the other housed the larger breeding sows which stayed inside a shelter with one completely open side. The *S. calcitrans* were largely on the breeding sows inside the shelter. Throughout the summer only 3 Tabanidae entered the shelter to obtain a blood meal, namely *T. lineola*, *T. nigrovittatus*, and *T. atratus*. In addition to finding larger numbers of flies feeding on hogs housed in wooded areas, more species were also found (Table 3).

Only 5 horse fly species fed on swine in the fields of farm F while 12 species were found in its wooded area. The smaller number of *T. atratus* and *T. nigrovittatus* found in the woods is because the hogs in this area were removed on July 24 (due to theft), whereas counts on the swine in the fields continued

until August 10 and on that particular day 11 *T. atratus* and 7 *T. nigrovittatus* were seen. The most abundant species in both areas were *T. lineola* and *T. nigrovittatus*.

The 7 Tabanidae species which appeared in South Jersey early in the season were: *Chrysops cincticornis*, *C. fuliginosus*, *C. niger*, *Tabanus nigripes*, *T. trimaculatus*, *Hybomitra daeckei* and *H. lasiophthalma*. Those ubiquitous species present throughout the entire summer were *Tabanus lineola*, *T. nigrovittatus* and *T. atratus*.

*Horses.* A horse ranch located in Millville, New Jersey was observed 13 times during June to August 1973. Fifteen horses were chosen at random and feeding flies were counted.

In addition to *Stomoxys calcitrans* and *Haematobia irritans*, 15 species of Tabanidae were recorded on horses (Table 4).

*Chrysops niger* fed on the head and neck of the horse. *Tabanus lineola* and *T. fulvulus* fed on the legs while *T. nigripes* fed on the upper part of the animal (head, neck and side). *T. atratus* was counted on the back and legs and *Hybomitra lasiophthalma* in the genital area. *S. calcitrans* fed all over the horse but predominantly on the side and legs, while *H. irritans* fed on the horse's belly.

Present throughout the season were *Tabanus lineola*, *T. atratus*, *T. nigripes*, *S. calcitrans* and *H. irritans*.

While riding in wooded areas in the evening the senior author noted feeding on the horse's ears by *Chrysops macquarti*, *C. nigribimbo*, *C. vittatus* and *C. celatus*.

*Other Animals.* On hog farm A, where 9 different Tabanidae species were recorded on hogs, observations were also made of those flies found on 8 goats and 2 dogs.

The total number of flies attracted to the goats included 2 *C. fuliginosus*, 1 *T. nigrovittatus* and 28 *S. calcitrans*. The dachshund, kept in an open area, had 1 *T. nigrovittatus* and 18 *S. calcitrans*. The German shepherd, kept in a wooded area, had 24 *T. nigrovittatus*, 353 *S. calcitrans*, 2 *C. atlanticus*, 2 *C. vittatus* and 1 each of *C. callidus* Osten Sacken, *C. fuliginosus* and *C. montanus*.

#### Literature Cited

- DECOSTER, A. A. 1968. How to catch a greenhead fly. Down East—The Magazine of Maine **13**(3): 54.
- TIDWELL, M. A., W. D. DEAN, G. P. COMBS, D. W. ANDERSON, W. O. COWART, AND R. C. AXTELL. 1972. Transmission of hog cholera virus by horse flies (Tabanidae: Diptera). American Journal of Veterinary Research **33**(3): 615-622.



## Speleognathinae Collected From Birds In North America (Acarina: Ereyenetidae)<sup>1</sup>

A. FAIN

INSTITUT DE MÉDECINE TROPICALE PRINCE LÉOPOLD, ANTWERPEN, BELGIUM

and

K. E. HYLAND

DEPARTMENT OF ZOOLOGY, UNIVERSITY OF RHODE ISLAND, KINGSTON, R. I. 02881

RECEIVED FOR PUBLICATION OCTOBER 21, 1974

**Abstract:** Fourteen species and subspecies of nasal mites belonging to the subfamily Speleognathinae and taken from birds are reported, including eight new host records. Two new subspecies are described: *Neoboydaia philomachi thalasseus* from *Thalasseus maximus* (royal tern) and *Sterno hirundo* (common tern) from Perry, Florida, and E. Sandwich Mass., respectively; and *Boydaia cyanerpes hylocichla* from *Hylocichla ustulata* (russet-backed thrush) taken at Big Falls, Newfoundland.

The speleognathine fauna is not exceedingly abundant in North American birds nor has it been the subject of wide-spread investigation. Except for the original descriptions there is relatively little literature establishing additional host records or distributional patterns. Two works, those of Fain and Hyland (1970) and Pence (1973), have added significant new records, and it is our intention that the present work augment the existing host and distributional lists.

The mites which form the basis of this study have been collected from the nasal passages of a variety of avian hosts and from several widely separated localities in North America. Two new subspecies are described and several new host records have been noted. Fourteen species and subspecies have been recorded.

---

<sup>1</sup>This investigation was supported in part by a National Science Foundation Grant (GB-1295) to the junior author.

**Acknowledgments:** We wish to thank those persons who assisted with the collection of specimens, especially W. T. Atyeo, Department of Entomology, University of Georgia, Athens, Georgia; George West, Laboratory of Zoophysiology, University of Alaska, College, Alaska; and Arnold Moorhouse, U.S. Department of Agriculture, Animal and Plant Health Inspection Service, Clifton Animal Import Center, Clifton, N.J.

We wish to acknowledge the assistance of Shashi K. Nagar, University of Delhi, Delhi, India, in the preparation of the material and for some of the preliminary determinations.

Genus *Neoboydaia* Fain, 19581. *Neoboydaia philomachi eroliae* (Fain & Hyland, 1970)

This subspecies was described from *Erolia minutilla* and *Actitis macularia* in Mexico. It is distinguished from the type female by the following characters:

- (1) Setae *ic2* and coxal II are toothed (Da), whereas in the types they are very fine and piliform (Na). See Fain (1970) for setal nomenclature.
- (2) In the typical form femora I and II bear three foliate and striate setae (Sd) and femur III bears one seta Sd in addition to the other setae. In the specimens of *N. p. eroliae* collected from the type hosts (*E. minutilla* and *A. macularia*) these setae (Sd) are replaced by cylindrical and dentate setae (Da).

We have collected this form from:

- (1) *Erolia minutilla* (least sandpiper) in Galilee, R. I. (No. H62-08-21-3; Coll. G. West) 11 females, 3 larvae;
- (2) *Actitis macularia* (spotted sandpiper) in Charlestown, R. I. (No. H61-07-24-15; Coll. L. TerBush) 1 female;
- (3) *Arenaria interpres* (ruddy turnstone) in Witless Bay, Newfoundland (No. H62-08-07-4; Coll. K. Hyland et al.) 11 females and 1 male;
- (4) *Limnodromus griseus* (dowitcher) in Charlestown, R. I. (No. H61-07-24-8; Coll. L. TerBush) 5 females and in South Kingstown, R. I. (No. H61-08-09-6; Coll. L. TerBush) 16 females, 2 larvae;
- (5) *Tringa solitaria* (solitary sandpiper) in Rushville, Nebr. (No. A59-08-31-10; Coll. W. Atyeo and N. Braasch) 6 females.

*Arenaria interpres*, *Limnodromus griseus* and *Tringa solitaria* appear to be new host records.

Those specimens taken from *Arenaria* and *Limnodromus* carry two type Sd and one type Da setae on femora I and II. On femur III one seta of type Sd is present. The other characters compare favorably with those of the subspecies *eroliae*.

Clark (1964) redescribed *N. philomachi* from specimens which he collected from the hosts *Totanus melanoleucus*, *Totanus flavipes*, and *Pisobia melanotos* in Texas. The drawings which he gave with this redescription apparently are of the subspecies *eroliae*.

Pence (1973) reported *N. philomachi* from several charadriiform hosts without indicating the subspecies. Hosts included the type host, *Erolia minutilla*, plus *Capella gallinago* (common snipe), *Totanus melanoleucus* (greater yellowlegs) and *Limnodromus scolapaceus* (long-billed dowitcher). Since the host genus *Philomachus* is not represented in North America it seems reasonable to expect that *N. philomachi philomachi* is absent from North American birds and to consider that *N. p. eroliae* is distinct.

2. *Neoboydaia philomachi thalasseus* subsp. nov.

This new subspecies can be distinguished from the other two subspecies by the presence of only three pairs of genital setae in the female (one pair of internals and two pairs of externals, all of type Na) whereas in both *N. p. philomachi* and *N. p. eroliae* there are six

pairs of setae of which the three externals are of type Na and the three internals are of type Da. Coxal setae and *ic2* are similar to subspecies *eroliae*. Idiosoma of holotype female 455 microns in length and 142 microns maximum width.

This subspecies was collected from:

- (1) *Thalasseus maximus* (royal tern) in Perry, Florida (No. A60-07-14-4; Coll. W. Atyeo et al.) holotype and 14 paratype females plus 2 paratype larvae;
- (2) *Sterna hirundo* (common tern) in E. Sandwich, Mass. (No. H61-08-12-3; Coll. K. Hyland et al.) 4 females, 1 male, 1 larva.

Holotype deposited in the U.S. National Museum, Washington, D. C.; paratypes in the Institut de Médecine Tropicale Prince Léopold, Antwerpen, Belgium and University of Rhode Island, Museum of Zoology, Kingston, R. I.

### 3. *Neoboydaia colymbiformi* Clark, 1964

This species was described from *Colymbus nigricollis californicus* (eared grebe) in California. We recorded it earlier from *Podilymbus podiceps* (pied-billed grebe) in Mexico (Fain & Hyland, 1970) and Pence (1973) has reported it from the same host in Louisiana.

We have also found it in a new host, *Podiceps caspicus* (eared grebe) in Rushville, Nebr. (No. A59-08-31-6; Coll. N. Braasch and W. Atyeo) 9 females, 1 larva.

#### Genus *Astrida* Fain, 1955

##### Subgenus *Neastrida* Fain, 1963

#### 1. *Astrida* (*Neastrida*) *coccyzae* Pence, 1973

We have collected this species from the type host *Coccyzus americanus* (yellow-billed cuckoo), as follows:

- (1) Hebron, Nebraska (No. A59-07-08-3; Coll. N. Braasch) 3 females; and
- (2) North Kingstown, R. I. (No. H62-08-23-4; Coll. A. Hawkes) 8 larvae.

#### Genus *Trispeleognathus* Fain, 1958

#### 1. *Trispeleognathus womersleyi* (Fain, 1955)

This species has been taken from *Anas discors* (blue-winged teal) collected in both Rhode Island and Nebraska as follows:

- (1) Allenton, R. I. (No. H62-09-03-4; Coll. L. TerBush) 10 females;
- (2) Valentine, Nebr. (No. A59-09-02-1; Coll. W. Atyeo) 1 female;
- (3) Rushville, Nebr. (No. A59-08-31-1; Coll. N. Braasch and W. Atyeo) 2 females.

To our knowledge it has not been reported from the blue-winged teal previously.

#### Genus *Boydaia* Womersley, 1953

##### Subgenus *Boydaia* Womersley, 1953

#### 1. *Boydaia* (*Boydaia*) *hirundoae* Fain, 1956

This species has been collected from the type host, *Hirundo rustica* (barn swallow), as follows:

- (1) Richmond, R. I. (No. H62-07-06-1; Coll. A. Moorhouse) 6 females and 1 male;
- (2) Waterford, Conn. (No. H62-05-12-1; Coll. D. Blake) 3 females and 1 male.

Pence (1973) has recently reported this same species from the type host in Louisiana.

2. *Boyaia (Boyaia) tyrannis* Ford, 1959

Specimens of this species have again been taken from the type host, *Tyrannus tyrannus* (kingbird), from Michigan as follows: Co. Rd. 400, Kellogg Gull Lake Biol. Sta., Mich. (No. 59-08-10-5; Coll. K. Hyland et al.) 2 females and 5 larvae.

Although Fain and Aitken (1968, 1970) and Fain and Hyland (1970) have reported this species from various tyrannids, cotingids and pipnids from Trinidad, Mexico and Brazil, only the type host has been found infested with this species north of Mexico.

3. *Boyaia (Boyaia) colini* Clark, 1958

We have taken this species from the type host, *Colinus virginianus* (bobwhite), collected in Charlestown, R. I. (No. H62-09-01-1; Coll. A. Moorhouse) 2 females and 4 larvae. This host is the only host thus far reported harboring *B. colini*.

4. *Boyaia (Boyaia) agelaii* Fain and Aitken, 1968

This species is distinguished from *B. (B.) quisicali* Clark, 1960 by the character of the claws on tarsi II of the larva. The elongate claw has a different shape and the short claw is much shorter than in *quisicali*.

Our collection includes the following hosts:

- (1) *Spiza americana* (dickcissel) from Grand Island, Nebr. (No. A59-06-10-14; Coll. N. Braasch and W. Atyeo) 9 females, 1 male, and 1 larva.
- (2) *Molothrus ater* (brown-headed cowbird) from El Paso, Texas (No. H62-11-24-4; Coll. G. West) 3 females.
- (3) *Cassidix mexicana* (boat-tailed grackle) from Lake Placid, Florida (No. A60-07-25-2; Coll. W. Atyeo and N. Braasch) 1 female.

It should be noted that Pence (1973) placed material collected from *Molothrus ater* in *B. quisicali* rather than in this species. Apparently he did not examine the larvae collected from *M. ater* which is the type host for *B. quisicali*. He also assigned material from *Cassidix mexicanus* to *B. quisicali* rather than to *B. agelaii*.

The dickcissel (*Spiza americana*) constitutes a new host record.

5. *Boyaia (Boyaia) loxiae* Fain, 1963

Eight female specimens collected from *Icterus galbula* (Baltimore oriole) (No. A60-05-15-9; Coll. W. Atyeo) taken at Nebraska City, Nebr., have been assigned to this species. In the absence of larvae it is impossible to distinguish with certainty this species from others belonging to the "statulata" group; however, this is apparently the first record of this species in North America. See Fain, 1971.

6. *Boyaia (Boyaia) cyanoerpes hylocichla* subsp. nov.

This subspecies can be distinguished from the type by the following characters in the female:

- (1) Femur I has 6 or 7 setae (compared with 5 in the type):
- (2) Pattern of lines on the base of gnathosoma differs from the type particularly in having two bands in the middle which converge posteriorly (instead of two bands which diverge posteriorly);
- (3) Setae on the body and legs are longer: setae *d1-d4* are 18 microns long compared with 13-15 microns in *B. h. hylocichla*; posterior intercoxal setae 15 microns compared with 12 microns; setae on tibia I are 21-25 microns compared with 15-18; and setae on femur I 12-24 microns in contrast to 8-15.

- (4) Palpal solenidion is vestigial, thinner and shorter (1 micron) instead of 3-3.5 microns as in *B. h. hylocichla*.

Idiosoma of holotype female is 405 microns long by a maximum of 315 microns wide.

Host: Holotype and 5 paratype females were taken from *Hylocichula ustulata* (russet-backed thrush) collected at Big Falls, Newfoundland (No. H62-08-01-9; Coll. K. Hyland et al.). Holotype in the U.S. National Museum, Washington; paratypes in the collections of the authors.

#### Subgenus *Coboydaia* Fain, 1971

##### 7. *Boydaia* (*Coboydaia*) *nigra nigra* Fain, 1955

The type host of this species is *Serinus sulphuratus shelleyi* (Fringillidae) from Rwanda. We have recorded the same species from the following hosts in North America:

- (1) *Carpodacus mexicanus* (house finch) from El Paso, Texas (No. H62-11-24-10; Coll. G. West) 5 females, 1 male and 2 larvae.
- (2) *Spizella passerina* (chipping sparrow) El Paso, Texas (No. H62-11-24-14; Coll. G. West) 5 females, 2 males, and 3 larvae.

Both are new host records.

##### 8. *Boydaia* (*Coboydaia*) *nigra icteri* Fain and Hyland, 1970

This subspecies was described earlier by us from *Icterus spurius* (orchard oriole) in Mexico. We have also identified it from the same host from Lincoln, Nebr. (No. A59-06-05-1; Coll. W. Atyeo and N. Braasch) one female. We have also recorded it from *Icterus galbula* (Baltimore oriole) in St. Joseph Co., Michigan (No. C60-08-23-13; Coll. Unknown) 7 females.

##### 9. *Boydaia* (*Coboydaia*) *sturnellae* Clark, 1960

We have recorded this species from the type host, *Sturnella magna* (meadow lark) collected at:

- (1) Lake Placid, Fla. (No. A60-07-23-10; Coll. W. Atyeo et al.) 8 females, 4 males, and 4 larvae; and
- (2) Hope Valley, R. I. (No. H62-07-18-1; Coll. A. Moorhouse) 2 larvae.

*B. (C.) sturnellae* is close to *B. (C.) nigra nigra* Fain, 1955. In the female it can be distinguished from *B. nigra* principally by the slightly thinner sensillae, which measure 42 microns in our specimens. In the larva, claws I-III resemble those of *B. nigra* in form but they are shorter. Claw III is 33 microns long (hook included) compared with 45 to 53 microns for *nigra*.

*B. (C.) sturnellae* can be distinguished from *B. (C.) amandavae* Fain, 1962, in the larval form by the shape of claw I which is recurved apically and terminates in a point whereas in *B. amandavae* the claws are not recurved apically and they are dilated (see Fain, 1971, fig. 41). They can be distinguished in the female by the greater elongation of the leg segment, by the different chaetotaxy and by the sensillae.

*B. (C.) sturnellae* appears to be specific for the meadow lark.

#### Literature Cited

- CLARK, G. M. 1958. One new and one previously unreported species of nasal mite (Acarina, Speleognathidae) from North American birds. Proc. Helm. Soc. Wash. **25**(2): 78-86.

- . 1960. Three new nasal mites (Acarina: Speleognathidae) from the gray squirrel, the common grackle, and the meadowlark in the United States. *Proc. Helm. Soc. Wash.* **27**(1): 103–110.
- . 1964. One new and one previously unreported nasal mite (Acarina: Speleognathinae) from North American birds, with observations on speleognathid taxonomy. *J. Parasit.* **50**(1): 158–162.
- FAIN, A. 1955. Sur le parasitisme des fosses nasales chez les mammifères et les oiseaux par les Speleognathidae. *Ann. Soc. Belge Méd. Trop.*, **35**(6): 689–700.
- . 1956a. Les acariens de la famille Speleognathidae Wom. au Ruanda-Urundi. *Rev. Zool. Bot. Afr.* **53**(1–2): 17–50.
- . 1956b. Nouvelles observations sur les Acariens de la famille Speleognathidae parasites des fosses nasales chez les batraciens, les oiseaux et les mammifères. *Ann. Parasit. Hum. et Comp.* **31**: 643–662.
- . 1956c. Notes sur les Acariens du genre *Boydaiia* Wom. avec description d'une espèce nouvelle. *Riv. Parasitol.* **17**: 27–34.
- . 1963. Chaetotaxie et classification des Speleognathinae. *Bull. Inst. Roy. Sci. Nat. Belg.* **39**(9): 1–80.
- . 1970. Nomenclature des poils idiosomaux et description de trois espèces nouvelles dans la famille Ereyneidae (Trombidiformes). *Acarologia.* **12**(2): 314–325.
- . 1971. Clé et liste des espèces du genre *Boydaiia* Womersley (Ereyneidae: Trombidiformes). *Acarologia.* **13**(1): 98–112.
- , AND T. H. G. AITKEN. 1968. Les Acariens parasites nasicoles des oiseaux de Trinidad (Indes Occidentales). II. Ereyneidae: Speleognathinae. *Bull. Ann. Soc. Roy. Ent. Belg.* **104**: 80–84.
- , AND ———. 1970. Acariens nasicoles d'oiseaux et de mammifères du Brésil. IV. Nouveaux Ereyneidae (Trombidiformes) et Turbinoptidae (Sarcoptiformes) de la région de Belém (Nord Brésil). *Acarologia.* **12**(2): 1326–1338.
- , AND K. E. HYLAND. 1970. Acariens nasicoles des oiseaux du Mexique. III. Familles Ereyneidae et Turbinoptidae. *Bull. Ann. Soc. Roy. Ent. Belg.* **106**: 37–46.
- FORD, H. G. 1959. *Boydaiia tyrannis* n. sp. (Acarina, Speleognathidae), a new mite from the nasal cavity of the Eastern Kingbird, *Tyrannus tyrannus* (Linnaeus). *Trans. Amer. Micros. Soc.* **78**(4): 379–385.
- PENCE, D. B. 1973. The nasal mites of birds from Louisiana. VII. The Ereyneidae (Speleognathinae). *J. Parasit.* **59**(2): 364–368.

## Elliptochthoniidae, A New Mite Family (Acarina: Oribatei) From Mineral Soil In California

ROY A. NORTON

DEPARTMENT OF FOREST ZOOLOGY, S.U.N.Y. COLLEGE OF ENVIRONMENTAL SCIENCE  
AND FORESTRY, SYRACUSE, NEW YORK 13210

RECEIVED FOR PUBLICATION DECEMBER 27, 1974

**Abstract:** A new oribatid mite, *Elliptochthonius profundus* n. gen., n. sp., is described from mineral soil in a coniferous ecosystem in northern California, and a new family, the Elliptochthoniidae, is proposed. Relationships with the Parhypochthonoidea and Enarthronota are discussed.

Grandjean (1947) proposed the Enarthronota, without giving it a specific hierarchic rank, to include all the diverse macropyline oribatid families in which the notogaster is provided with one to three transverse sutures. In his revision of major groups in the Oribatei (Grandjean, 1969), the Enarthronota was divided into seven superfamilies. Another macropyline superfamily, the Parhypochthonoidea Hammen, was considered as having rank, again unspecified, equivalent to the Enarthronota. Balogh (1972) more conservatively placed both these groups, with some deletions from the Enarthronota, in the Arthronota. The purpose of this paper is to describe an unusual new family, genus and species of oribatid mite related to these groups, which may prove important in future studies of higher categories in the Oribatei.

The specimens were part of a quantity of oribatids sent to me for identification by John M. Wenz, University of California, Berkeley, in conjunction with a study of the effects of air pollutants on a coniferous ecosystem in California, sponsored by the Environmental Protection Agency. The site was a mixed stand of ponderosa and jeffrey pines (*Pinus ponderosa* Laws. and *P. jeffreyi* Grev. & Balf.) at Likely Mill, Modoc Co. The new species, collected in June, 1972, appears restricted to the deeper soil strata. It was never collected in the organic layers or in the upper 10 cm of mineral soil.

The nomenclature and descriptive terminology used below are primarily those formulated by Grandjean (1935, 1939, 1940, 1947, 1949).

### **Elliptochthoniidae** n. fam.

This family is distinguished from other families of the Macropylina by the following combination of characters:

1. The notogaster has a single transverse dorsal suture which continues laterally and ventrally to form a membranous delineation between the genital-agenital plate and epimere IV. The result is a completely movable opisthosoma, or pygidium.

2. The division of the genital and aggenital plates is incomplete, and disappears in the posterior third. The adanal plates are broadly fused posteriorly.

3. The latero-opisthosomal gland is present.

4. The gnathosoma is stegasime and has undergone structural and chaetotaxic modifications, including the presence of a single pair of adoral setae, the fusion of the palpal trochanter and femur, and the reduced setation of the palp (see description).

Type genus: *Elliptochthonius* n. gen.

The name is derived from the Greek *elleipsis*, meaning oval, and *chthon*, meaning earth. Because of the monotypic nature of the family, I make no attempt here to delineate generic characters.

Type species: *Elliptochthonius profundus* n. sp.

*Elliptochthonius profundus* n. sp.

The specific epithet is the Latin *profundus*, meaning deep.

#### *Female*

Body elongate, oval, dorso-ventrally flattened. Average length of 5 slide-mounted specimens  $576\mu$  (range  $565\mu$ – $595\mu$ ). Average width at level of seta *d3*  $202\mu$  (range  $200\mu$ – $209\mu$ ). Color in alcohol is light yellow.

*Prodorsum*: Prodorsum roughly triangular in shape from above (Fig. 1); rostrum rounded centrally, but laterally with irregular teeth (Fig. 3). Integument very finely pitted, with small superimposed tubercles in the postero-medial region. Podocephalic canal (*cpc*) extends from the point of lateral articulation with infracapitulum to level of acetabulum I.

Normal setation present: rostral setae (*ro*), lamellar setae (*le*) and exobothridial setae (*exa*, *exp*) fine, simple, short; interlamellar setae (*in*) elongate, lanceolate, similar to notogastral setae; sensillus (*ss*) clavate, distal portion heavily barbed.

*Notogaster*: Notogaster widest at level of seta *d3*, tapering posteriorly (Fig. 1). Integumental pitting inconspicuous anterior to setal row *e* or *f*, increasing in strength posteriorly; strong pitting abruptly stops ventrally at constriction line running parallel to setal row *ps* (Figs. 2, 3).

Dorsal suture centrally located between setal rows *d* and *e*, continuing latero-ventrally until joining the ventral membranes. Anterior half (notaspis) with six pairs of minutely barbed setae (*c1*, *c2*, *c3*, *d1*, *d2*, *d3*) and one pair of cupules (*ia*). An expansion suture (*su*) is present laterally. Posterior half (pygidium) with 10 pairs of setae (*e1*, *e2*, *f1*, *f2*, *h1*, *h2*, *h3*, *ps1*, *ps2*, *ps3*) and four pairs of cupules (*im*, *ip*, *ih*, *ips*). Latero-opisthosomal gland (*gla*) present, its opening dorsal to cupule *ip* and separated from it by a ridge-like thickening. Another thickening present dorsal to seta *h2*. Two expansion sutures present laterally (*sud*, *suv*) on either side of cupule *im*. Posteriorly, a sharp dorso-ventral constriction gives appearance of a thickened rim (Fig. 3).

*Ventral Plates*: Epimeres I and II separated medially by membrane; epimeres III and IV completely fused medially (Fig. 2). Laterocoxal seta *eI* present. Setal formula 3-2-3-4 for epimeres I-IV (not including *eI*).

Genital plates with eight simple setae each, six in paraxial row, two in antiaxial row; posteriorly fused with aggenital plates, which have one seta (*ag*). Anal plates each with three simple setae and one cupule (*ian*). Adanal plates posteriorly fused; each with four setae, longer than anal setae, and one cupule (*iad*).



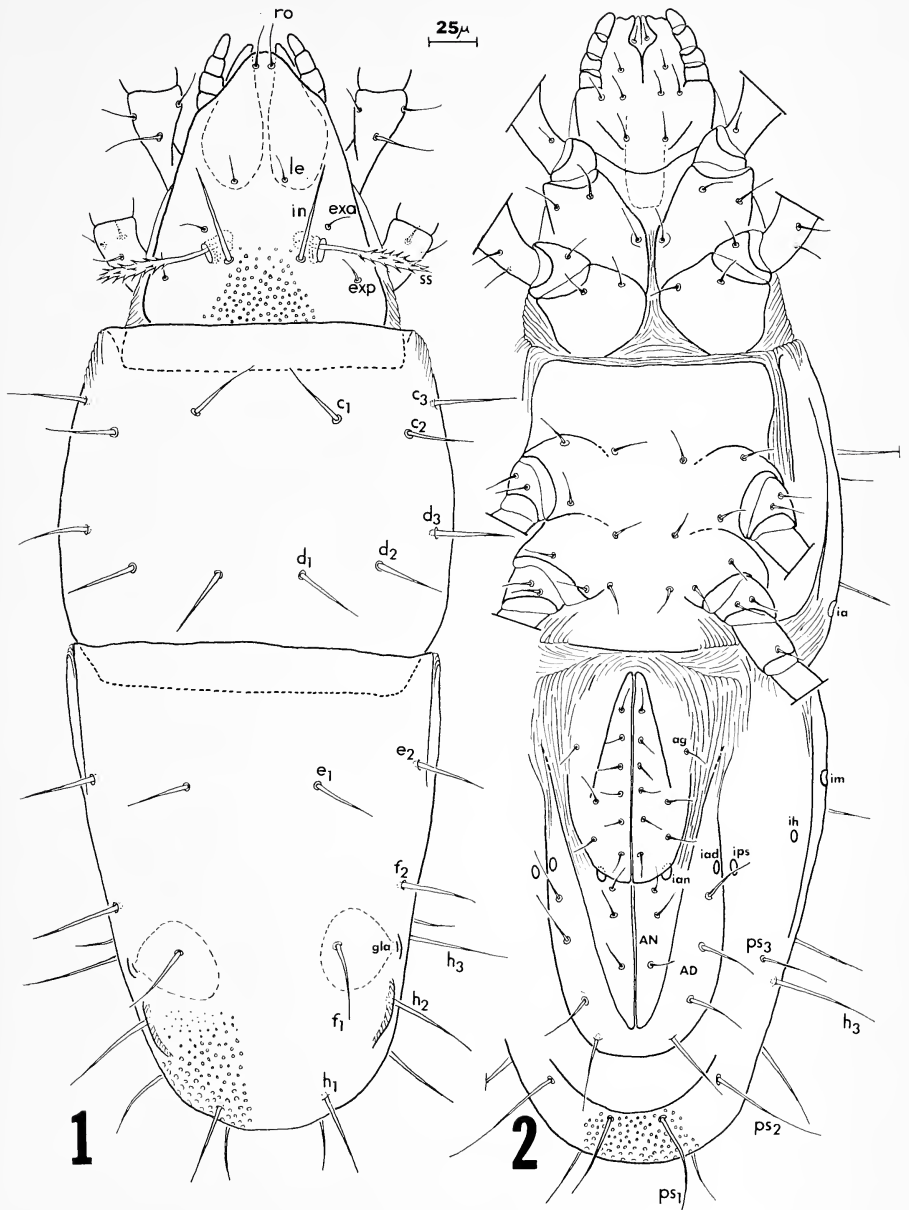

*Elliptochthonius profundus* n. gen., n. sp.: Fig. 1. Adult female, dorsal aspect. Fig. 2. Same, ventral aspect.

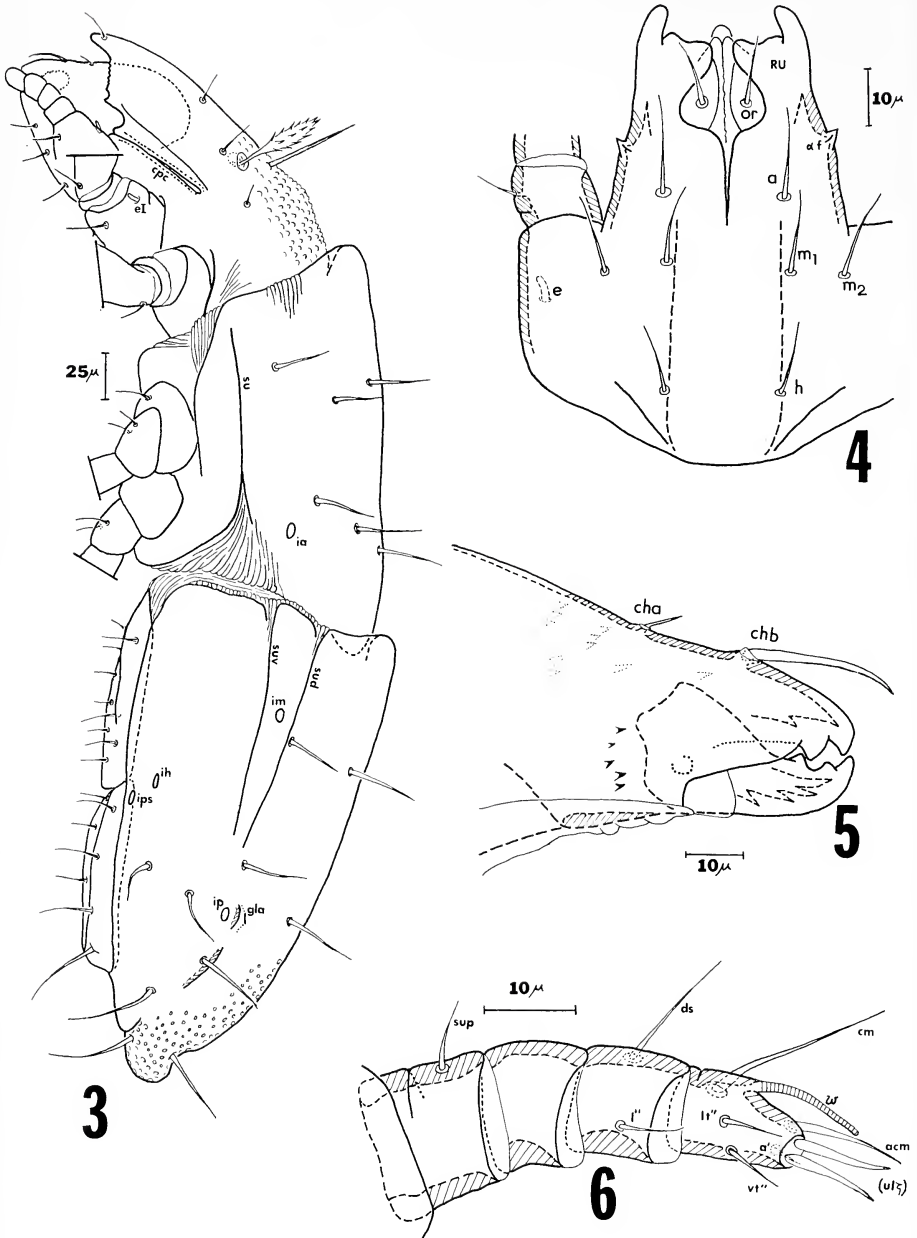

*Elliptochthonius profundus* n. gen., n. sp.: Fig. 3. Adult female, lateral aspect (slightly laterally flattened). Fig. 4. Infracapitulum. Fig. 5. Right chelicera, antiaxial aspect. Fig. 6. Right palp, antiaxial aspect (slightly from below).

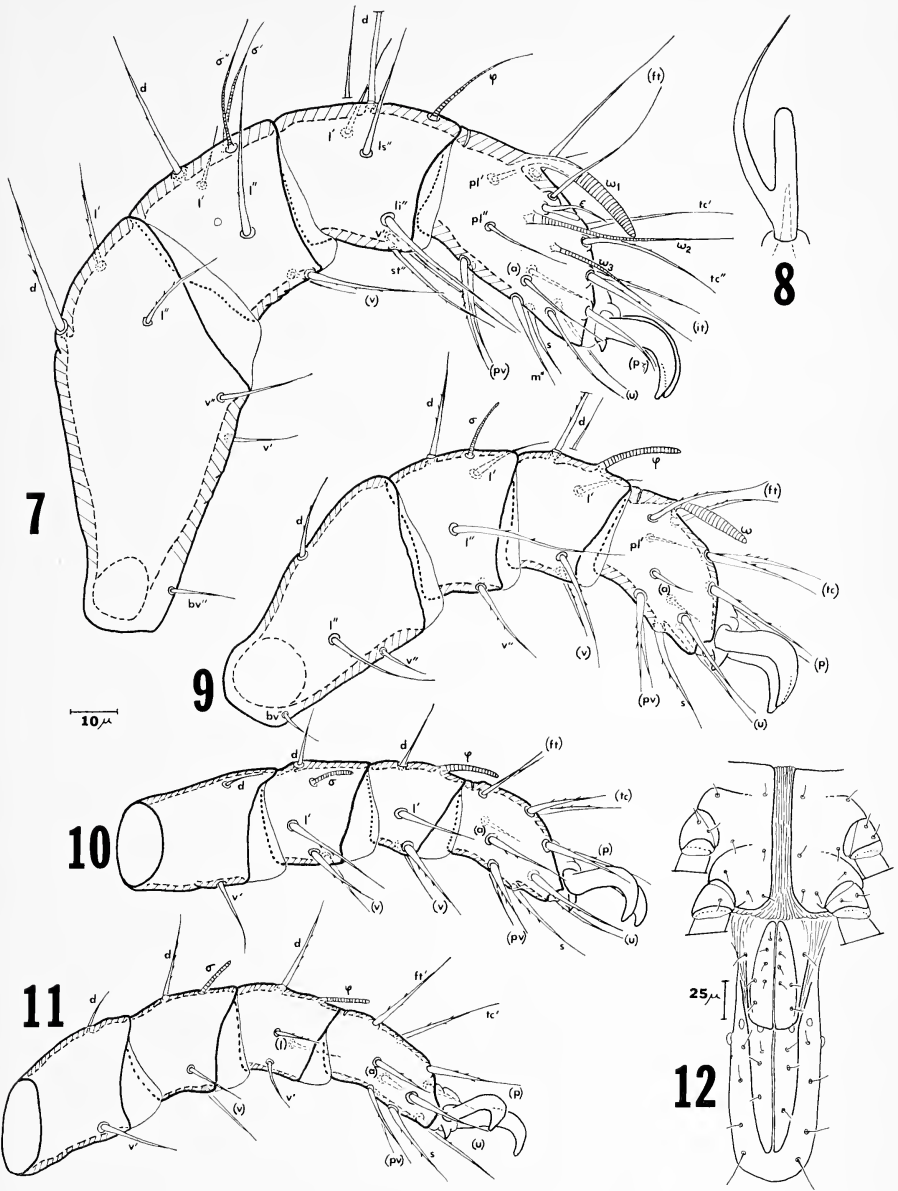

*Elliptochthonius profundus* n. gen., n. sp.: Fig. 7. Right leg I, anti-axial aspect. Fig. 8. Famulus. Fig. 9. Right leg II, anti-axial aspect. Fig. 10. Left leg III, anti-axial aspect. Fig. 11. Left leg IV, anti-axial aspect (slightly from below). Fig. 12. Tritonymph, epimera III-IV and ventral plates. All legs to same scale.

*Gnathosoma*: Infracapitulum simple, without secondary articulation (Fig. 4); four pairs of setae on ventral surface (*a*, *m1*, *m2*, *h*); one pair of adoral setae (*or*) on lateral lips. Rutellum (*RU*) with a large thumb-like projection dorso-laterally. Antiaxial fissure (*α f*) associated with lateral tooth-like structure. Laterocoxal seta *e* thick, blunt.

Chelicerae chelate-dentate (Fig. 5); fixed digit bidentate, movable digit tridentate. Seta *cha* small, simple; seta *chb* about four times as long, rapidly tapering distally. Chitinous barbs present on both antiaxial and paraxial faces; numbers and placement somewhat variable.

Palp four-segmented; trochanter and femur fused (Fig. 6). Femur with one seta, genu with none, tibia with two, tarsus with seven setae (two of them, *ul'* and *ul''* eupathidic) and one solenidion (*ω*).

*Legs*: Setal formulas for the legs, from trochanter to tarsus, are as follows (not including the famulus on tarsus I): leg I (0-6-5-6-18); leg II (1-4-4-4-14); leg III (2-2-4-4-13); leg IV (2-2-3-4-11). Setae distributed as in Figs. 7, 9, 10, 11. Most setae are inconspicuously barbed. Only proral setae (*p*) on tarsus I appear to be eupathidic, but this is not certain.

Famulus (*ε*) of tarsus I spatulate, with single long lateral bract (Fig. 8).

Solenidial formulas for genu, tibia and tarsus as follows: leg I (2-1-3); leg II (1-1-1); leg III (1-1-0); leg IV (1-1-0). Ambulacrum of all legs tridactylous, with a highly reduced central claw.

#### *Tritonymph*

Very similar to adult female with exceptions as follow. Length and width of single specimen 450 $\mu$  and 177 $\mu$ , respectively. Epimeres III and IV longitudinally divided by wide membranous band (Fig. 12). Genital plate with six setae, only four in paraxial row. Leg chaetotaxy identical to adult. Ambulacrum of all legs monodactylous.

#### MATERIAL EXAMINED

Seven specimens, six adult females and one tritonymph, were studied. Deposition will be as follows: holotype female (slide preparation) to the U.S. National Museum, Washington, D.C.; paratype female (alcoholic) and tritonymph (slide preparation) to the Museum of Comparative Zoology, Cambridge, Massachusetts; paratype female (slide preparation) to the Canadian National Collection, Ottawa, Ontario; three paratype females retained by author.

#### REMARKS

1. In five of the females examined there was identical leg setation, and these were the specimens utilized in the leg descriptions. In the sixth there was variability, specifically the lack of seta *a''* on tarsus III, seta *d* on genu IV and seta *v'* on tibia IV. Each loss was restricted to a single leg, the other of the pair being typical.

2. There does not seem to be a true correspondence between the sutures which I call expansion sutures (*su*, *sud*, *suv*) on the notogaster and the supra-pleural band described by Grandjean (1947) in the *Enarthronota*. This band is dorsal to cupule *ia* in the latter group.

3. Grandjean (1969) discusses at length the types of body articulations (holoidy, dichoidy, ptychoidy) in sclerotized oribatids. To these I now add the term *trichoidy*, defined as the condition of having both the protero-hysterosomatic articulation and a podo-opisthosomatic articulation, exemplified by the Elliptochthoniidae.

4. The placement of this family in a major group is difficult. If we assume that the Parhypochthonoidea and Enarthronota are part of the same monophyletic series, the Arthronota, then the placement of the Elliptochthoniidae in this series seems certain. Based on available information it is more likely that Grandjean's (1969) system is correct, that is, the Arthronota is biphyletic.

Grandjean (1969) has listed the principal characters utilized in delineating his major macropyline groups. To gain insight on relationships let us examine those characters which differ among the three groups in question from the standpoint of ancestral versus derived states.

The latero-opisthosomal gland is present (ancestral) in the Parhypochthonoidea and Elliptochthoniidae; it is absent (derived) in the Enarthronota. The cupules *iad*, *ian* are present (ancestral) in the former two groups and lacking (derived) in the Enarthronota. The adult leg ambulacra have a regressive central claw (derived) in the Elliptochthoniidae and *Parhypochthonius*; the Enarthronota are primarily monodactylous (also derived). The Parhypochthonoidea have three pairs of adoral setae (ancestral); the Elliptochthoniidae have one pair, as do the Brachychthoniidae of the Enarthronota (Grandjean, 1963; Reeves and Marshall, 1971). The latter family also often has a derived solenidiotaxy identical to the Elliptochthoniidae, whereas that of the Parhypochthonoidea is ancestral in comparison. Sclerotization is a derived state, present in the Enarthronota and Elliptochthoniidae and lacking in the Parhypochthonoidea, but it has obviously occurred in a number of unrelated acarine lineages.

Hennig (1966) states that relationships must be proven on the basis of shared derived (synapomorphic) characters, not shared ancestral ones. Of the similarities noted above, synapomorphy can be shown between the Elliptochthoniidae and the Brachychthoniidae for the number of adoral setae and solenidiotaxy. It is risky, however, to base relationships on similar degrees of numerical regression, as Grandjean (1935) observed with solenidiotaxies. The other synapomorphic character to be considered is the tridactylous adult ambulacrum with a regressive central claw, shared by the Elliptochthoniidae and *Parhypochthonius*; the central claw is lacking in the second parhypochthonoid genus, *Gehypochthonius*. Although both this and the monodactylous condition are the result of regression from ancestral tridactyly, they are obviously of two different lineages.

Inclusion of the Elliptochthoniidae in the Parhypochthonoidea would be acceptable if the diagnostic criteria of unsclerotized integument and the related

stegasime condition were omitted. If future workers do not wish to do so, a separate superfamily for the new family seems unescapable.

5. I am familiar, and often agree, with criticisms of the present "top-heavy" classification of oribatids caused by the erection of many monotypic higher taxa. However, such problems are most significant in the Brachyphylina. Here there is extensive development of secondary integumental structures in the adult stage which confuse relationships, combined with a general lack of knowledge of immatures, as discussed by Balogh (1972). For the most part, the Macropylina presents little difficulty in this regard, and monotypic taxa are more readily accepted. In fact, they are expected in relict groups such as the one described here.

#### Literature Cited

- BALOGH, J. 1972. The oribatid genera of the world. Akademiai Kiado, Budapest. 188 pp. 71 pl.
- GRANDJEAN, F. 1935. Les poils et les organes sensitifs portés par les pattes et le palpe chez les oribates. Bull. Soc. zool. France **60**: 6-39.
- . 1939. Les segments post-larvaires de l'hysterosoma chez les oribates (Acarions). Bull. Soc. zool. France **64**: 273-284.
- . 1940. Les poils et les organes sensitifs portés par les pattes et le palpe chez les oribates. Deuxieme partie. Bull. Soc. zool. France **65**: 32-44.
- . 1947. Les Enarthronota (Acarions). Premiere série. Ann. Sci. natur. Zool. (11) **8**: 213-248.
- . 1949. Formules anales, gastronomiques, génitales et aggénitales du développement numérique des poils chez les oribates. Bull. Soc. zool. France **74**: 201-225.
- . 1963. Sur deux espèces de Brachychthoniidae et leur développement. Acarologia **5**(1): 122-151.
- . 1969. Considerations sur le classement des oribates. Leur division en 6 groups majeurs. Acarologia **11**(1): 127-157.
- HENNIG, W. 1966. Phylogenetic systematics. University of Illinois Press, Urbana. 263 pp.
- REEVES, R. M. AND V. MARSHALL. 1971. Redescription and chaetotaxy of *Brachychthonius lydiae* adults and nymphs (Acarina: Oribatei). Ann. Ent. Soc. Amer. **64**(2): 317-325.

## JOURNAL of the NEW YORK ENTOMOLOGICAL SOCIETY

The JOURNAL of the NEW YORK ENTOMOLOGICAL SOCIETY is devoted to the advancement and dissemination of knowledge pertaining to insects and their related forms.

SUBSCRIPTIONS are \$8.00 per year, in advance, and should be sent to the New York Entomological Society, the American Museum of Natural History, 79th Street at Central Park West, New York, N. Y. 10024. The Society will not be responsible for lost JOURNALS unless immediately notified of change of address. We do not exchange publications.

Please make all checks, money-orders, or drafts payable to the NEW YORK ENTOMOLOGICAL SOCIETY.

ORDERS and inquiries for back issues and complete sets should be sent to our agent, S-H Service Agency, Inc., 866 Third Ave. New York, N. Y. 10022. Complete files of back issues are in stock.

### INFORMATION FOR AUTHORS

Submit manuscript in duplicate (original and one carbon) to the Editor, New York Entomological Society, Waksman Institute of Microbiology, Rutgers University, New Brunswick, N.J. 08903.

1. GENERAL POLICY. Manuscript submitted must be a report of unpublished research which is not being considered for publication elsewhere. A manuscript accepted and published in the JOURNAL must not be published again in any form without the consent of the New York Entomological Society.

A page charge of \$15 per printed page is assessed except that the charge may be reduced in the case of a member of the Society who cannot obtain institutional or grant funds for publication.

The page charge includes black and white illustrations and tabular material.

2. FORM OF MANUSCRIPT. Text, footnotes and legends must be typewritten, double or triple spaced, with margins of at least 1½ inches on all sides. The editorial style of the JOURNAL essentially follows the *CBE Style Manual* (3rd edition, A.I.B.S., 1972).

Genetic symbols: follow recommendations of Demerec, et al.  
(Genetics **54**: 61, 1969)

Biochemical abbreviations: follow rules of the U.I.P.A.C. -I.U.B.  
(J. Biol. Chem. **241**: 527, 1966)

Enzyme activity: should be expressed in terms of international units.  
(Enzyme Nomenclature. Elsevier Pub. Co., 1965)

Geographical names, authors names and names of plants and animals should be spelled in full.

The JOURNAL reserves the privilege of editing manuscript or of returning it to the author for revision.

3. ABSTRACT. Each manuscript must be accompanied by an abstract, typewritten on a separate sheet.

4. TITLE. Begin each title with a word useful in indexing and information retrieval (Not "Effect" or "New".)

5. ILLUSTRATIONS. Original drawings *should not be submitted*. Glossy prints are desirable—not larger than 8½ by 11 inches and preferably not smaller than 5 by 7 inches. When appropriate, magnification should be indicated by a suitable scale on the photograph.

6. REPRINTS (in multiples of 100) may be purchased from the printer by contributors. A table showing the cost of reprints, and an order form, will be sent with the proof.

7. SUBSCRIPTION to the JOURNAL is \$12.00 per year, in advance, and should be sent to the New York Entomological Society, The American Museum of Natural History, Central Park West at 79th Street, New York, New York, 10024. The Society will not be responsible for lost JOURNALS unless immediately notified of change of address. We do not exchange publications. Please make all checks, money orders and drafts payable to the NEW YORK ENTOMOLOGICAL SOCIETY.

8. ORDERS and inquiries for back issues and complete sets should be sent to our agent: Harry Lubrecht, Bookseller, 4672 Broadway, New York, N.Y. 10040.

**From January 1, 1976 the journal subscription rate will be \$12.— per year. Members of the N.Y.E.S. will be billed \$12.—, which includes the \$4.— membership and \$8.— subscription rate to N.Y.E.S. members.**



595.70673  
Ent.

Vol. LXXXIII

DECEMBER 1975

No. 4

Journal  
of the  
New York  
Entomological Society

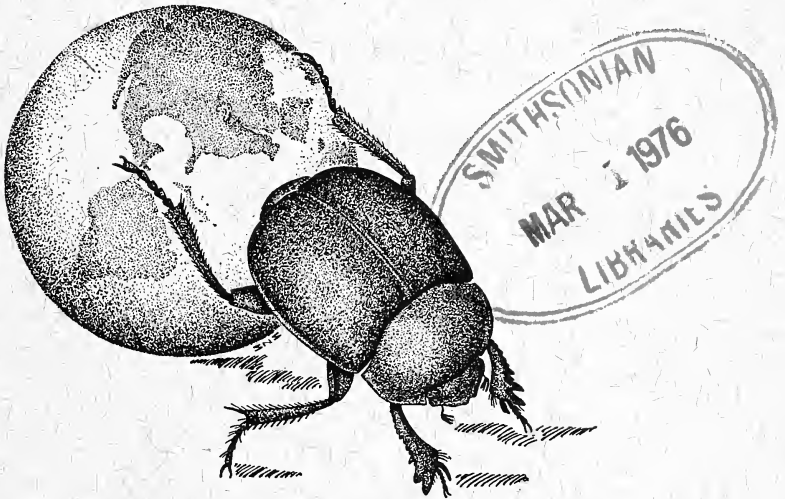

Devoted to Entomology in General

**The New York Entomological Society**  
**Incorporating The Brooklyn Entomological Society**  
**Incorporated May 21, 1968**

---

**The New York Entomological Society**  
**Organized June 29, 1892—Incorporated February 25, 1893**  
**Reincorporated February 17, 1943**

---

**The Brooklyn Entomological Society**  
**Founded in 1872—Incorporated in 1885**  
**Reincorporated February 10, 1936**

The meetings of the Society are held on the first and third Tuesday of each month (except June, July, August and September) at 8 P.M., in the AMERICAN MUSEUM OF NATURAL HISTORY, 79th St. & Central Park W., New York, N. Y. 10024.

Annual dues for Active Members, \$4.00; including subscription to the Journal, \$9.00.

Members of the Society will please remit their annual dues, payable in January, to the Treasurer.

---

**Officers for the Year 1975**

- President*, Dr. Daniel J. Sullivan, S.J.  
Fordham University, New York 10458
- Vice-President*, Dr. Peter Moller  
American Museum of Natural History, New York 10024
- Secretary*, Dr. Charles C. Porter  
Fordham University, New York 10458
- Assistant Secretary*, Dr. Louis Trombetta  
Isaac Albert Research Institute, Brooklyn, N.Y. 11203
- Treasurer*, Dr. Ivan Huber  
Fairleigh Dickinson University, Madison, N.J. 07940
- Assistant Treasurer*, Ms. Joan DeWind  
American Museum of Natural History, New York 10024
- 

**Trustees**

- Class of 1975  
Dr. Howard Topoff  
Dr. Pedro Wygodzinsky
- Class of 1976  
Dr. David C. Miller  
Dr. Norman Platnick
- 

Mailed February 12, 1976.

The Journal of the New York Entomological Society is published quarterly for the Society by Allen Press Inc., 1041 New Hampshire, Lawrence, Kansas 66044. Second class postage paid at New Brunswick, New Jersey and at additional mailing office.

Known office of publication: Waksman Institute of Microbiology, New Brunswick, New Jersey 08903.  
Journal of the N.Y. Entomological Society, total No. copies printed 750. Paid circulation 490, mail subscription 470, free distribution by mail 23, total distribution 493, left-over 257 copies each quarter.

# Journal of the New York Entomological Society

VOLUME LXXXIII

DECEMBER 1975

No. 4

## EDITORIAL BOARD

*Editor* DR. KARL MARAMOROSCH  
Waksman Institute of Microbiology  
Rutgers University  
New Brunswick, New Jersey 08903

*Associate Editors* DR. LOIS J. KELLER, RSM  
DR. HERBERT T. STREU

Publication Committee

Dr. Kumar Krishna  
Dr. Ayodha P. Gupta  
Dr. James Forbes, Chairman

---

## CONTENTS

A New Species and Review of <i>Sibaria</i> (Hemiptera: Pentatomidae) .....	218
..... L. H. Rolston	
Predators of the Alfalfa Weevil, <i>Hypera postica</i> in Western Nevada—a Greenhouse Study (Coleoptera: Curculionidae) .....	226
..... Manzoor Hussain	
Calling Songs of <i>Neduba macneilli</i> and <i>N. sierranus</i> (Orthoptera: Tettigoniidae: Decticinae) .....	229
..... Glenn K. Morris, Ron B. Aiken and Gordon E. Kerr	
The Effect of Temperature and Humidity on the Amount of Blood Ingested by the Stable Fly, <i>Stomoxys calcitrans</i> L. (Diptera: Muscidae) .....	235
..... Corey W. Smith and Elton J. Hansens	
Abstracts of papers presented at the Eastern Division Annual Meeting, Entomological Society of America .....	241
Acknowledgment .....	241
Book Reviews .....	234, 288
Index of Scientific Names of Animals and Plants for Volume LXXXIII .....	289
Index of Authors for Volume LXXXIII .....	i

## A New Species and Review of *Sibaria* (Hemiptera: Pentatomidae)

L. H. ROLSTON

DEPARTMENT OF ENTOMOLOGY, LOUISIANA STATE UNIVERSITY,  
BATON ROUGE, LOUISIANA 70803

RECEIVED FOR PUBLICATION NOVEMBER 5, 1974

**Abstract:** The genus *Sibaria* is redefined, a diagnosis given for the two species previously known, and *S. englemani* new species, which ranges from Mexico to Colombia, is described.

*Sibaria* is distinguished among American genera of Pentatomini by the unique combination of armed femora and a short rostrum. A pair of preapical spines, of considerable size on the anterior femora at least, constitute the principal femoral armament; and the rostrum terminates distally at or just beyond the mesocoxae rather than at or beyond the metacoxae as is usual in the tribe.

Three species of *Sibaria* are known: *S. armata*, inhabiting much of South America, *S. andicola*, collected in Bolivia, Ecuador and Peru, and a species ranging from southern Mexico into Colombia. The latter species has been confused with *S. armata* and until now has been unnamed.

A generic description, key to the species, description of the new species and diagnoses of the other two follow. The three species are so much alike that a description of more than one would be largely redundant.

*Sibaria* Stål, 1872

*Sibaria* Stål, 1872, Sv. Vet. Ak. Handl. 10(4):23.

Eyes large, together about as wide as interocular distance (Fig. 1); width of head little greater than length; juga subequal in length to tylus, their lateral margins narrowing

**Acknowledgements:** Specimens pertinent to this study were graciously loaned by Mssr. W. R. Dolling of the British Museum (Natural History), R. D. Engleman, R. C. Froeschner of the U.S. National Museum, P. Van Doesburg of the Rijksmuseum van Natuurlijke Historie, and P. Wygodzinsky of the American Museum of Natural History. I am especially grateful to Dr. G. Petersen of the Akademie der Landwirtschaftswissenschaften for lending the type series of *Sibaria andicola*.

Depositories for paratypes are designated as follows: Akademie der Landwirtschaftswissenschaften (AL), American Museum of Natural History (AMNH), British Museum (Natural History) (BMNH), California Academy of Sciences (CAS), R. D. Engleman collection (RDE), Field Museum of Natural History (FMNH), author's collection (LHR), Museu Rio Grandense de Ciencias Naturais (MRCN), Naturhistoriska Riksmuseum, Stockholm (NR), Rijksmuseum van Natuurlijke Historie (RNH), Texas A & M Univ. (TAMU), U.S. National Museum (USNM), Universidad Nacional de La Plata (UNLP), Washington State Univ. (WSU).

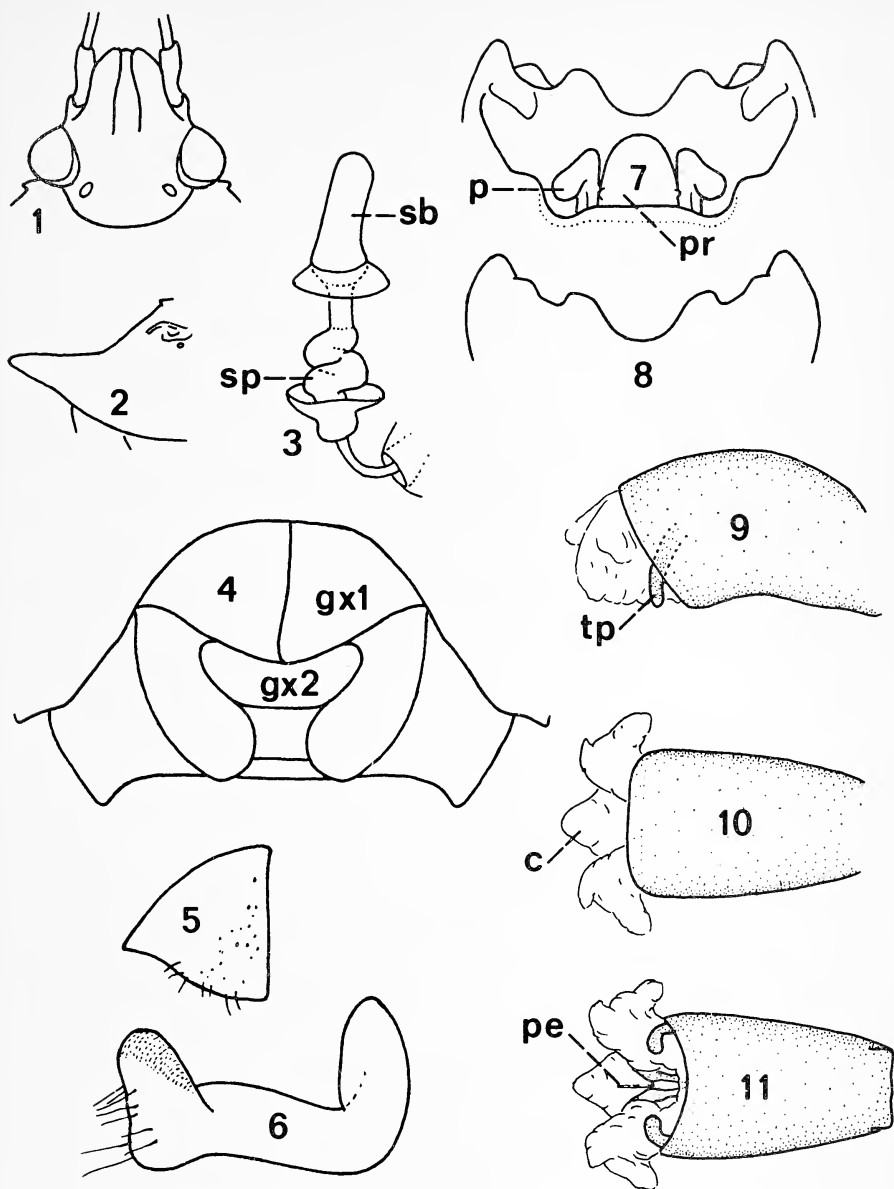

FIGS. 1-11. *Sibaria englemani* n. sp. Fig. 1. Head. Fig. 2. Pronotum. Fig. 3. Distal portion of spermatheca; spermathecal bulb (sb), spermathecal pump (sp). Fig. 4. Genital plates, viewed with anterior and posterior margins of last sternite on same focal plant; first gonocoxa (gx 1), second gonocoxae (gx 2). Fig. 5. First gonocoxa, viewed with three angles on same focal plant. Fig. 6. Right paramere. Fig. 7. Genital cup; paramere (p), proctiger (pr). Fig. 8. Posterior margin of pygophore, ventral view. Fig. 9. Theca and related structures, lateral view; thecal process (tp). Fig. 10. Same, dorsal view; conjunctiva (c). Fig. 11. Same, ventral view; penisfilum (pe).

rapidly before eyes, exposing antenniferous tubercles from above; distal end of first antennal segment reaching apex of head. Pronotum contiguous with eyes; anterolateral margins entire, obtusely rounded vertically. Scutellum as long as wide; frena extending along basal two-thirds. Costal angle of coria acute, surpassing scutellar apex by about one-third length of scutellum.

Bucculae roundly truncate at base of head, extending to distal end of first rostral segment; apex of rostrum reaching or just surpassing mesocoxae. Sterna neither sulcate nor carinate along meson excepting low broad mesosternal carinae produced notably only near anterior mesosternal margin. Inferior surface of femora armed with stout pair of preapical spines and pair of tubercles basad of spines, these often reduced progressively on middle and posterior femora, the latter then armed only with preapical pair of tubercles (Fig. 22); all tibiae sulcate. Abdomen without basal spine or tubercle.

Tubercles of proctiger nearer base than apex (Fig. 21). Thecal processes arising within theca, compressed, curving ventrad (Figs. 9, 18, and 26); penisfilum lying on median vertical plane, surrounded by median penial lobes.

Spermathecal pump convoluted; spermathecal bulb digitiform (Figs. 3 and 15).

*Type species: Mormidea armata* Dallas, 1851, by monotypy.

*Relationship:* The form of the aedeagus and spermatheca, as well as the armament of the proctiger and femora, suggest a close phylogenetic relationship between this genus and *Ladeaschistus* Rolston, 1973.

#### Key to the Species

1. More than basal half of fifth antennal segment pale ..... *S. andicola* Breddin
- 1' Less than basal half of fifth antennal segment pale .....
2. Median emargination in posterior edge of pygophore broad, deep, subquadrate, flanked on each side by stout tubercle projecting caudad beyond posterolateral angles of pygophore (Figs. 12 and 13); first gonocoxae (basal plates) each concavely emarginate posteriorly at lateral limit of second gonocoxae (Figs. 14 and 16) ..... *S. armata* (Dallas)
- 2' Median emargination in posterior edge of pygophore little wider than proctiger, flanked on each side by shallower bisinuate emargination (Figs. 7 and 8); posterior margin of each first gonocoxae sinuous, without emargination at lateral limit of second gonocoxae (Figs. 4 and 5) ..... *S. englemani* n. sp.

#### *Sibaria englemani*, n. sp.

*Sibaria armata*; Distant, 1880-1890, p. 57 (in part), Pl. 5, fig. 17 (1880) and p. 329 (1890) (misidentification); Lethierry and Severin, 1893, p. 126 (in part); Kirkaldy, 1909, p. 62 (in part).

Overall light brown to fuscous above with black humeri, yellowish white beneath; punctuation of dorsum rather dense, black, on pronotum and scutellum arranged mostly in irregular rows with a general transverse orientation; usually eight pale spots on dorsum, one along posterior margin of each cicatrice near mesial limit, three along base of scutellum, one of these mesial and one beside small black fovea in each basal angle (some or all occasionally obscure), a spot on apex of scutellum, another on each corium near distal end of radial vein. Antennae mostly black, ventral and mesial surfaces (except distally) of first segment, basal ring on segments three and four, basal .2 to .4 of segment five, and sometimes longitudinal streaks on segments two and three, pale; length of segments 0.4 to 0.5; 0.8 to 0.9; 0.9 to 1.1; 1.5 to 1.8; 1.5 to 1.7 mm; width of head across eyes 1.8 to 2.0 mm, length 1.6 to 1.7 mm. Humeri acutely produced laterad and somewhat cephalad (Fig.

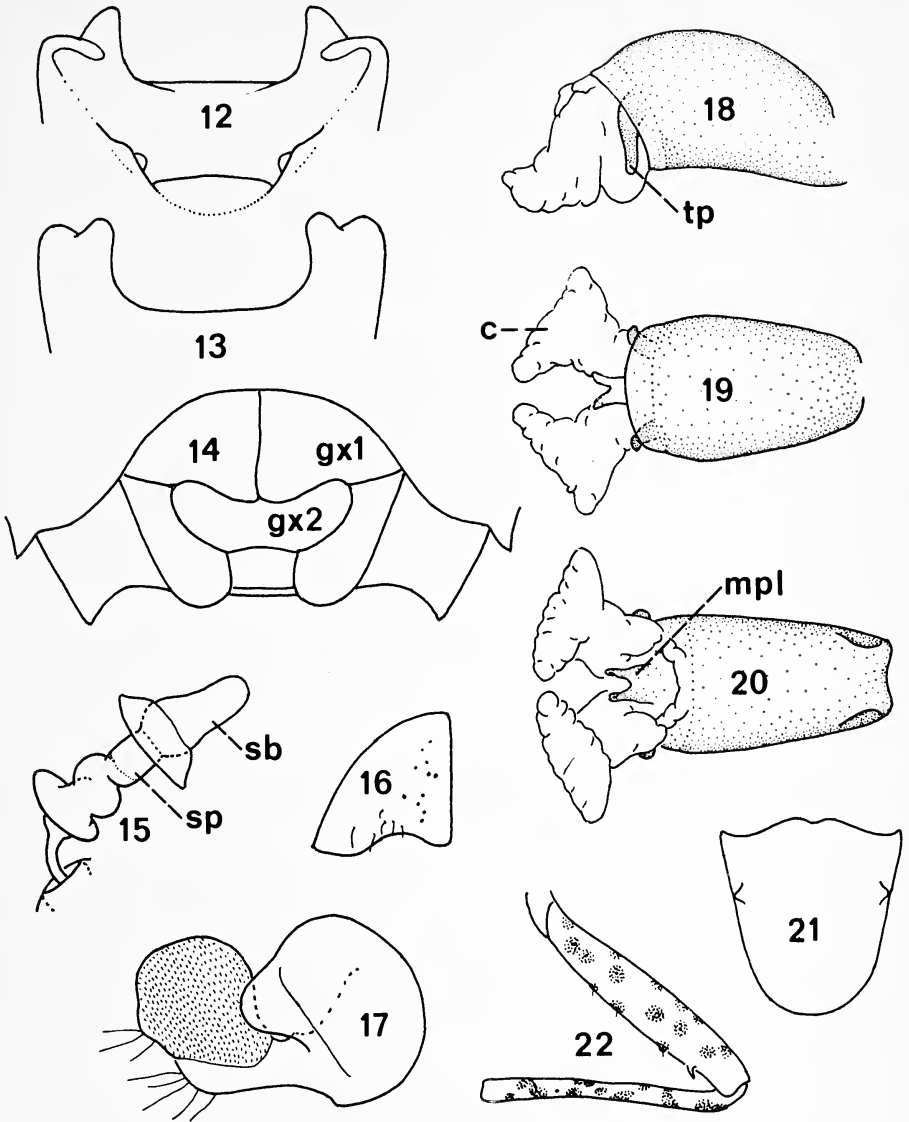

FIGS. 12-22. *Sibaria armata*. Fig. 12. Genital cup, parameres and proctiger removed. Fig. 13. Pygophore, ventral view. Fig. 14. Genital plates; first gonocoxa (gx 1), second gonocoxae (gx 2). Fig. 15. Distal portion of spermatheca; spermathecal bulb (sb), spermathecal pump (sp). Fig. 16. First gonocoxa, viewed with three angles on same focal plant. Fig. 17. Right paramere. Fig. 18. Theca and related structures, lateral view; thecal process (tp). Fig. 19. Same, dorsal view; conjunctiva (c). Fig. 20. Same, ventral view; median penal lobe (mpl). Fig. 21. Proctiger. Fig. 22. Posterior face of right front femur and tibia.

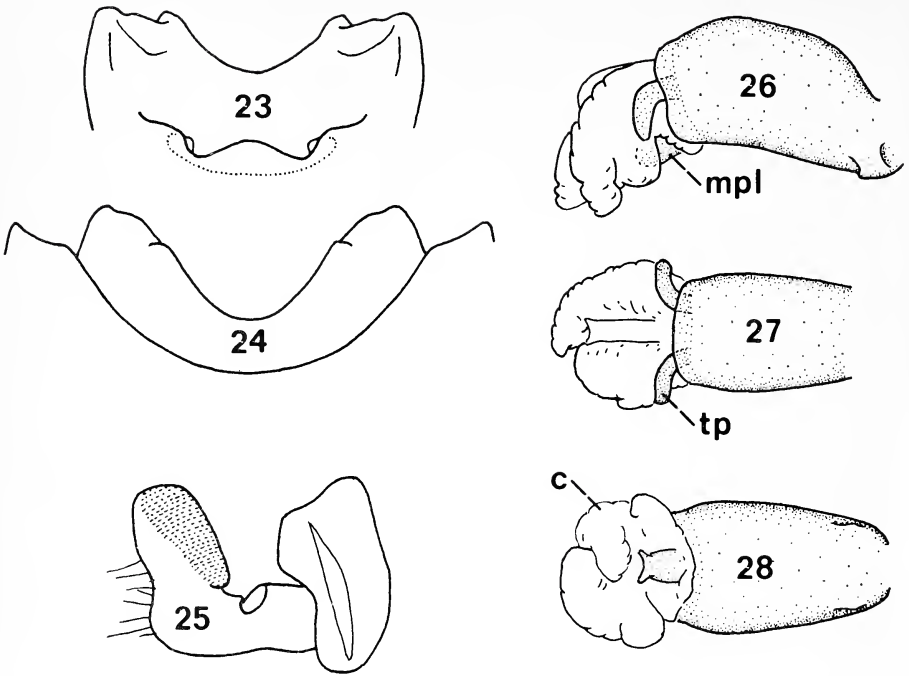

FIGS. 23-28. *Sibaria andicola*. Fig. 23. Genital cup, parameres and proctiger removed. Fig. 24. Posterior margin of pygophore, ventral view. Fig. 25. Right paramere. Fig. 26. Theca and related structures, lateral view; median penal lobe (mpl). Fig. 27. Same, dorsal view; thecal process (tp). Fig. 28. Same, ventral view; conjunctiva (c).

2); pronotal width at humeri 7.3 to 8.3 mm, length at meson 2.3 to 2.7 mm. Scutellar width 3.2 to 3.6 mm, length subequal; apex narrowly rounded. Boundary of coria and their membrane slightly sinuous; membrane fuscous, veins simple or bifurcate, varying considerably in number. Connexiva narrowly exposed; punctation dense, fine; color pale at sutures and in subquadrate marginal area in middle of each segment, otherwise dark; posterior angle of each segment produced as small acute spine.

Venter of head punctate only along bucculae, immaculate but for fuscous mark extending from eye over superior surface of antenniferous tubercle and continuing briefly cephalad. Pleura impunctate in irregular areas, most consistently so laterad of procoxae. Evaporative area on each side matte, sparingly rugose, extending about halfway from ostiole toward lateral margin of metapleuron. Legs with large fuscous spots and maculae. Abdominal venter sparsely and weakly punctate about spiracles and large subspiracular callouses, otherwise virtually impunctate; black edge of lateral margins interrupted in middle of each segment.

Posterior edge of pygophore pentasinuate, with a deep median concavity about as wide as proctiger and on each side two lesser concavities (Figs. 7 and 8); margin between lateral and median concavities expanded, this portion dorsad of intermediate convexity and with elongate black impression. Anterolateral margins of genital cup produced near apex of parameres, concealing from above a thin subvertical carina on wall of genital cup. Head and base of parameres bent rather abruptly from lateral view, shaft entire (Fig. 6).



Conjunctiva trilobed, a small median lobe above median penal lobes and bifid lateral lobes (Figs. 9, 10 and 11).

First gonocoxae each evenly sinuous along posterior edge, without emargination above lateral limits of second gonocoxae (Figs. 4 and 5), *Types*: Holotype. Male, labeled Panama, Gatun Dam, 2-IX-1973, D. Engleman, Coll. Deposited in U.S. National Museum, type no. 72134.

*Paratypes*: 33 ♂♂, 23 ♀♀. *Colombia*: (a) Magdalena, 11°10'N, 76°08'W, Apr. 1973, 800M, M. Madison, Coll. (b) on piper. (♀ AMNH; ♂ BMNH; 2♂♂, ♀ LHR; ♂, ♀ MRCN, ♂, ♀ UNLP). *Costa Rica*: (a) Dec. 20, 1949, Darwin Norby. (b) Finca Los Cusingos, San Isidro del General, Quizarra. (♀ WSU); Collection Schild-Burgdorf, San Carlos (♀ USNM); (a) Turrialba, (b) Tukurriquel (♀ USNM). *El Salvador*: No. 71458, 10.23.56, Santa Tecla, Col. PAB. (♂ USNM). *Guatemala*: (a) Morales, Jan. 1930, J. J. White. (b) 103 (c) J. C. Lutz Collection, 1961. (♀ USNM). *Mexico*: Tolosa, Oaxaca, Aug. 25, 1947, B. Malkin. (♂ AMNH). *Panama*: (a) Bugaba, 800-1500 ft., Champion. (b) Ex Godman and Salvin. (♂ AMNH); (a) as above (b) P. R. Uhler Collection (c) *Sibaria armata*. (♂ USNM); Cerro Campina, 800M, Panama Prov., 1 July 72, Coll. D. Engleman (♂ RDE); (a) Portobella, 18.4.12, Pan. (b) A. Busch Coll. (♂ USNM). *Panama Canal Zone*: Barro Color., V-5-37 (♀ USNM); Barro Colorado So., VII-8-33 (♂ USNM); Coco Solo Hospital, 9°21'N, 79°51'W, 28-I-73, Engleman. (♀ RNH); (a) Corozal, I-21-1929 (b) Collector, C. H. Curran. (♂ AMNH); Fort Kobbe, 8°54'N, 79°35'W, 22-IX-73, Col: D. Engleman (♀ AL); Ft. Sherman, 30 July 72, Coll: Engleman, (♀ RDE); Fort Sherman, 9°20'N, 79°58'W, 2 June 73, Col: D. Engleman. (♀ BMNH; 3 ♂♂ RDE); Galeta Is., 9°32'N, 79°53'W, 30-VIII-73, Col: D. Engleman. (♀ FMNH; ♂ RDE; ♀ TAMU); 5 mi. E. Gamboa, 1 Oct. 72 (♂ RDE); same data as holotype (♂, ♀ CAS; 4 ♂♂ LHR); Gatun Spillway, 9°20'N, 79°58'W, 2 June 73, Col: D. Engleman. (3 ♂♂ RDE, ♂ RNH); Madden Reservoir, 29-IX-73, Col: D. Engleman. (♂ RDE); Margarita, 25-28-X-1972, L. H. Rolston. (♂ AL; ♂ FMNH; ♂ LHR; ♂, ♀ NR; ♂ TAMU); Pipeline Road, 2 January 72, Col: D. Engleman. (3 ♀♀ RDE); Piña Road, 9°15'N, 79°57'W, 2-IX-73, Col: D. Engleman. (3 ♀♀ RDE).

*Distribution*: From Vera Cruz, Mexico, to Magdalena, Colombia. The southern distribution may prove more extensive when northwestern South America is better collected.

*Comments*: Distant mistook this species for its common South American congener, and all of his records of *S. armata* in Middle America pertain to *S. englemanni*, as does his illustration of a specimen from Guatemala.

Adult specimens have been taken feeding on the inflorescence of piper plants in Panama and Colombia.

This species is named with pleasure for R. Dodge Engleman, M.D., whose interest in biology extends beyond medicine and continues a tradition that has contributed much to the systematics of insects.

#### *Sibaria armata* (Dallas, 1851)

*Mormidea armata* Dallas, 1851, p. 125; Walker, 1867, p. 255.

*Sibaria armata*; Stål, 1872, p. 23; Distant, 1880, p. 57 (in part); Lethierry & Severin, 1893, p. 126 (in part); Van Duzee, 1901, p. 344 (list); Kirkaldy, 1909, p. 62 (in part); Becker & Grazia-Vieira, 1971, p. 20 (list).

From none to basal. 40 of fifth antennal segment pale.

Emargination in posterior edge of pygophore deep, wide, subquadrate, flanked on each

side by tubercle projecting posteriorly beyond posterolateral angle of pygophore (Figs. 12 and 13). Small tubercle beneath production on anterolateral margins of genital cup partially visible from above. Reticulate face of parameres ovoid, shaft incised shallowly near head, base greatly expanded and crested on ventral face (Fig. 17). Lateral conjunctival lobes each with ventral diverticulum near base and toward apex a second diverticulum directed obliquely mesad, the opposed apical diverticula overlapping when fully inflated; median conjunctival lobe small, bifid; thecal processes largely concealed except from lateral view (Figs. 18, 19 and 20).

Posterior edge of first gonocoxae concavely emarginate at lateral limits of second gonocoxae (Figs. 14 and 16).

*Distribution*: Probably present throughout most of South America. Recorded or seen from Argentina (Misiones), Bolivia, Brazil, Ecuador, French Guiana, Guyana, Paraguay, Peru, Surinam, Trinidad, and Venezuela.

*Comment*: The pale basal ring on the fifth antennal segment of a minority of specimens does not seem characteristic of any region since specimens so marked came from widely separated places: Guyana, Bolivia, Brazil and Paraguay.

This species has been reared on the inflorescence of piper.

#### *Sibaria andicola* Breddin

*Sibaria andicola* Breddin, 1904, p. 49; Kirkaldy, 1909, p. 62; Gaedike, 1971, p. 79.

Basal .60 to .85 of fifth antennal segment whitish, apex dark.

Posterior edge of pygophore arcuately concave with short posteriorly directed projection on each side nearer lateral angles than meson (Figs. 23 and 24); pygophoral margin at projection somewhat expanded, not impressed. Carina beneath production on anterolateral margins of genital cup oblique, directed posteroventrally from production. Shaft of parameres incised near head; base crested on ventral face (Fig. 25). Median lobe of conjunctiva quite long, each lateral lobe diverticulate ventrally (Figs. 26, 27 and 28).

Genital plates of female as in *S. armata*.

*Distribution*: Known so far from the eastern slopes of the Andes: Napo province in Ecuador; Amazonas, Cusco and Huanuco departments in Peru; and El Beni department in Bolivia.

*Comment*: No distinction between females of *S. andicola* and *S. armata* has been found other than the proportion of pale to dark color on the fifth antennal segment. This proportion varies in both species and too few specimens of *S. andicola* are available to establish useful confidence limits on variability. The reliability of this character in separating all females of the two species is therefore suspect. In describing *S. andicola*, Breddin mentioned the darker dorsum and obscurity of the pale dorsal spots relative to *S. armata*, but neither the general color nor clarity of the spots are diagnostic.

In the few specimens examined, the femoral spines are reduced on the middle femora and represented by small tubercles on the posterior femora.

A single specimen lacking the fifth antennal segments, in the British Museum (Natural History), is apparently this species, but it differs from the males of the type series in having the projections on the pygophoral margin more prominently developed.

#### Literature Cited

- BECKER, M., AND J. GRAZIA-VIEIRA. 1971. Contribuição ao conhecimento da superfamília Pentatomoidea na Venezuela (Heteroptera). *Iher. (Zool.)* **40**: 3-26.

- BREDDIN, G. 1904. Neue Rhynchotenausbeute aus Sud-Amerika. *Soc. Entomol.* **19**: 49-50, 58.
- DALLAS, W. S. 1951. List of the specimens of hemipterous insects in the collection of the British Museum. London.
- DISTANT, W. L. 1880-1892. Insecta. Rhynchota, Hemiptera-Heteroptera. *In* Godman, F. D. and O. Salvin, *Biologia Centrali Americana*. London, Vol. I.
- GAEDIKE, H. 1971. Katalog der in dem Sammlungen des ehemaligen Deutschen Entomologischen Institutes aufbewahrten Typen V. *Beitr. Ent.* **21**(1/2): 79-159.
- KIRKALDY, G. W. 1909. Catalogue of the Hemiptera (Heteroptera). Vol. I Cimicidae. Berlin.
- LETHIERRY, L. AND G. SEVERIN. 1893. Catalogue général des Hémiptères. Vol. 1. Brussels & Berlin.
- ROLSTON, L. H. 1973. A new South American genus of Pentatomini (Hemiptera:Pentatomidae). *J. N. Y. Entomol. Soc.* **81**(2): 101-110.
- STÅL, C. 1872. Enumeratio hemipterorum II. *Kongliga Svenska Vetenskaps-Akademiens Handlingar.* **10**(4):1-159.
- VAN DUZEE, E. P. 1901. Notes on some Hemiptera from British Guiana. *Trans. Am. Entomol. Soc.* **27**: 343-352.
- WALKER, F. 1867. Catalogue of the specimens of Hemiptera-Heteroptera in the collection of the British Museum. **2**: 241-417.
- 

ADDENDUM: Since the author of "A new genus and two new species of Achipteriidae from New York State (Acari: Cryptostigmata; Oribatei)" in Vol. 82: pp. 177-182 of the *Jour. N.Y. Ent. Soc.* failed to indicate a type species for the genus *Dentachipteria* he wishes to correct this by designating *Dentachipteria ringwoodensis* as the type species. He wished to thank Dr. M. D. Definado of the N.Y. State Museum and Science Service for bringing this to his attention.

**Predators of the Alfalfa Weevil, *Hypera postica* in  
Western Nevada—a Greenhouse Study.  
(Coleoptera: Curculionidae)**

MANZOOR HUSSAIN<sup>1</sup>

DIVISION OF BIOCHEMISTRY AND AGRICULTURAL PEST CONTROL,  
UNIVERSITY OF NEVADA, RENO, NEVADA 89507

RECEIVED FOR PUBLICATION DECEMBER 2, 1974

**Abstract:** Some insect predators of the alfalfa weevil commonly found in the alfalfa fields of Western Nevada were screened for their predatory efficiency against the alfalfa weevil larvae and the pea aphids. By offering each predator species a combination of the alfalfa weevil larvae and pea aphids as diet, their preference for the host insects was determined.

The three lady beetle species, the big eyed bug and the nabid bug preferred to feed upon the pea aphids; whereas, the soft winged flower beetle, *Collops bipunctatus* Say, significantly preferred to feed upon the alfalfa weevil larvae and hence could be of importance in the biological control of the alfalfa weevil.

INTRODUCTION

Biological control of the alfalfa weevil, *Hypera postica* (Gyllenhal), has been given considerable attention but most of the studies in this field have been confined to the weevil parasites. Only a limited number of studies have been done involving insect predators of this pest. In an alfalfa field in Utah, Webster (1912) observed that the darkling ground beetle, *Eleodes sulcipennis* Mann., the soft winged flower beetle, *Collops bipunctatus* (Say), the imperfect tiger beetle, *Cicindela imperfecta* Lec., larvae and adults of *Hippodamia sinuata* var. *spuria* and larvae of *Hippodamia convergens* and *Coccinella nine-notata* fed on the alfalfa weevil larvae. Adults of *H. convergens* were reported by Essig and Michelbacher (1933) to feed upon the larvae of the alfalfa weevil. Kaddou (1960) found that *H. quinquesignata* (Kirby) preyed upon small alfalfa weevil larvae in Utah. Clausen (1962) also reported that *C. bipunctatus* fed on the alfalfa weevil larvae; and Yadava and Shaw (1968) studying predatory behavior of some Coccinellids, found them to prefer pea aphids over the alfalfa weevil larvae. This report includes a greenhouse study of the predatory efficiency of some of the entomophagous insects commonly found in the alfalfa fields of Nevada, against the alfalfa weevil larvae; and if these predators ex-

---

**Acknowledgement:** I thank Dr. W. H. Arnett of the Division of Biochemistry and Agricultural Pest Control, University of Nevada, Reno, Nevada for his valuable advice and suggestions during this work.

<sup>1</sup>Present address: Department of Plant Protection, College of Agriculture, Pahlavi University, Shiraz, IRAN.

hibited any preference for the pea aphids, *Acyrtosiphon pisum* (Harris) or the alfalfa weevil larvae.

#### METHODS

Six species of entomophagous insects were used in this study. These were three lady beetle species; *Hippodamia convergens* (G-M), *Hippodamia sinuata disjuncta* (Timberlake) and *Coccinella transversoguttata* (Fald.); a soft winged flower beetle, *Collops bipunctatus* (Say); a big eyed bug, *Geocoris pallens pallens* (Stal) and a nabid bug, *Nabis americoferus* Carayon. The alfalfa weevils and the predators were collected from the alfalfa fields in Gardnerville, Fallon and Lovelock, Nevada. The alfalfa weevil larvae were reared on alfalfa plants in the greenhouse. Adult weevils were allowed to oviposit in the caged alfalfa stems, eggs were removed and incubated at  $81 \pm 1$  F and 70% relative humidity in a temperature controlled cabinet. Larvae hatching out of these eggs were transferred to caged alfalfa plants in the greenhouse and were used for feeding experiments. The pea aphids were reared on potted alfalfa plants in the greenhouse. The feeding experiments were conducted in the greenhouse where the temperature ranged between 50 F at midnight to 85 F at midday, and the relative humidity ranged between 30 and 50%. The feeding behavior of the predators was studied in petri dishes with screened tops.

The predators were starved for a period of 12 hours prior to the feeding study. Each sex of a predator species was individually allowed to feed upon a combination of 40 pea aphids and 40 alfalfa weevil larvae for a period of 8 hours, but an observation was made every two hours. Small sized pea aphids were used in combination with the first instar weevil larvae, medium sized pea aphids with the second instar larvae and large pea aphids with the third instar weevil larvae. Ten replicates were obtained for each experiment and the average so obtained was used to interpret the results. The student "t" test was used to statistically analyse the results at 0.05% level.

#### RESULTS

The feeding of the predators on the two host species, in terms of number of each host eaten, is shown in the table. When a combination of small pea aphids and the first instar weevil larvae were offered, the three lady beetle species and *C. bipunctatus* showed no significant preference for either of the two hosts and each host was preyed upon at random. The two Hemiptern predators, however, decidedly preferred to feed upon the pea aphids. Similarly, *H. convergens* and *C. transversoguttata* did not show any significant preference for either host when a combination of second instar weevil larvae and medium sized pea aphids were offered as diet. *H. sinuata disjuncta*, *G. pallens pallens* and *N. americoferus* preferred to feed upon pea aphids, while *C. bipunctatus* significantly preferred to feed upon the weevil larvae. In case when the third

TABLE 1. Average number of host insects eaten by the predator species in a period of 8 hours when a combination of the host species was offered as diet.

Host combination	Predator species											
	<i>H. convergens</i>		<i>C. transversoguttata</i>		<i>H. sinuata disjuncta</i>		<i>C. bipunctatus</i>		<i>G. pallens pallens</i>		<i>N. americoferus</i>	
	Male	Fe-male	Male	Fe-male	Male	Fe-male	Male	Fe-male	Male	Fe-male	Male	Fe-male
Small aphids	16.3	21.0	19.5	18.2	9.0	13.3	7.1	5.7	2.9*	6.1*	6.4*	10.3*
1st instar larvae	14.3	17.1	16.1	15.8	7.4	9.7	8.1	7.1	1.3	3.0	3.2	6.3
Medium aphids	4.2	6.3	8.6	8.7	4.9*	5.9*	4.2	4.0	2.0*	2.7*	4.3*	4.4*
2nd instar larvae	3.6	4.4	7.1	7.2	1.7	2.5	6.4*	6.5*	0.9	1.3	1.3	2.0
Large aphids	4.2*	5.2*	3.9*	5.3*	3.1*	3.2*	1.7	0.8	1.8*	1.8*	3.1*	2.7*
3rd instar larvae	1.0	0.9	1.8	1.6	0.3	0.9	1.9	3.1*	0.6	0.8	0.0	0.6

\* Significant preference at 0.05% level, using student "t" test.

instar weevil larvae and large pea aphids were presented together, all the predator species except *C. bipunctatus*, preferred to feed upon the pea aphids; whereas the female *C. bipunctatus* preferred to feed upon the weevil larvae and the male did not show preference for either of the two hosts.

Although all the predator species used in this study feed upon the alfalfa weevil larvae in the presence of the pea aphids, a host of great competitive importance to the alfalfa weevil larvae, the *Collops* beetles distinctly prefer the weevil larvae as opposed to the pea aphids and could be of importance in the biological control of the alfalfa weevil. These studies were conducted in the greenhouse conditions and hence may not truly represent the behavior of these predators in the field.

#### Literature Cited

- CLAUSEN, C. P. 1962. Entomophagous Insects. Hafner Publishing Co. N.Y., N.Y. 545 pp.
- ESSIG, E. O., AND MICHELbacher, A. E. 1933. The alfalfa weevil. California Agr. Exp. Sta. Bull. **567**: 3-99.
- KADDOU, I. K. 1960. The feeding behavior of *Hippodamia quinquesignata* (Kirby) larvae. U. of Calif. Pub. in Entomol. No. **5**, 181-232.
- WEBSTER, F. M. 1912. Preliminary report on the alfalfa weevil. U.S.D.A. Bur. Entomol. Bull. **112**: 1-47.
- YADAVA, C. P., AND SHAW, F. R. 1968. The preference of certain Coccinellids for pea aphids, leaf hoppers and alfalfa weevil larvae. J. Econ. Entomol., **61**: 1104-5.

## Calling Songs of *Neduba macneilli* and *N. sierranus* (Orthoptera: Tettigoniidae: Decticinae)

GLENN K. MORRIS, RON B. AIKEN AND GORDON E. KERR  
DEPARTMENT OF ZOOLOGY, ERINDALE COLLEGE, UNIVERSITY OF TORONTO,  
MISSISSAUGA, ONTARIO

RECEIVED FOR PUBLICATION JANUARY 16, 1975

**Abstract:** The calling songs of decticines remain largely undescribed. Songs of *Neduba macneilli* and *N. sierranus* were recorded and analysed. These species have mirror-image tegmina and individual specimens exhibit reversed wing overlap. Wing symmetry and the elaborate pronotum characteristic of this genus are discussed as adaptations which increase the efficiency of sound radiation.

### INTRODUCTION

The calling songs of many shield-backed katydids (Decticinae) remain undescribed. Rentz and Birchim (1968), in a comprehensive revision of nearctic decticines, indicate the potential value of such calls in the resolution of the still confused taxonomy of Decticinae. The songs are also of interest in their own right as elements of communicative behaviour. Rentz and Birchim provide sonograms of eight decticine species, including *Neduba macneilli* Rentz and Birchim. The present paper contains a detailed description of calling song in *N. macneilli* and *N. sierranus* Rehn and Hebard, together with comments on the tegminal structure of these insects.

### MATERIALS AND METHODS

Male specimens of *N. macneilli* were collected on 24 July 1972, 1 mile west of Tom's Place, California, the type locality of this species. They were located by their stridulation just after dusk (2200 hr) on pinyon pines, 1–2 m above the ground (temperature 15–16°C).

Males of *N. sierranus* were taken during the early part of the night (16–18°C) in Yosemite National Park, California, on 28 July 1972. Singers of this second species were perched near ground level in an open cedar forest dominated by sugar pine (*Pinus lambertiana*) and incense cedar (*Libocedrus decurrens*). The collection site was at an elevation of 4000 ft.

Songs were collected in the field with a Uher 4000 Report-L tape recorder and, subsequently, living males of both species were transported to Toronto.

---

**Acknowledgements:** The authors express their appreciation for the help of Dr. Tom Wood, Dr. Warren Cothran, Dr. D. C. Rentz and Mr. James Fullard. The work was made possible by a grant (operating 4946) from the National Research Council of Canada.

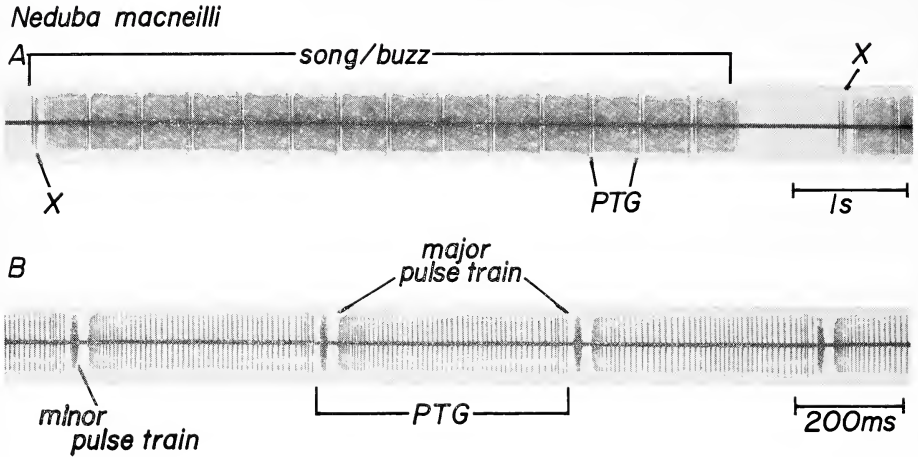

FIG. 1. Oscillographs of *N. macneilli* calling song, laboratory recorded at 22°C with the microphone positioned 4.5 cm dorsal to the insect.

Stridulations were recorded in the laboratory using a Bruel and Kjaer quarter-inch condenser microphone (4135) and power supply (2801): during the laboratory recording, the insects were caged as described by Pipher and Morris (1974). The signal from the microphone was amplified (Keithley 102B) and then recorded at 76.2 cm/sec on an instrumentation recorder (Philips ANA-LOG 7). Oscillograms were obtained with a Tektronix oscilloscope (564) and Nihon Kohden oscillograph camera; carrier frequency spectra were determined with a Tektronix 3L5 spectrum analyser. Specimens of both species were examined periodically for changes in tegminal overlap.

#### RESULTS

*N. macneilli* calling song is a buzz (Fig. 1A) made up of identical pulse train groups (PTGs), each group comprised of a minor (short-duration) and major (long-duration) pulse train (Fig. 1B). The major pulse train of a specimen with 72 file teeth contained 52 pulses (based on an average of 10 successive major trains from a single song). At 16°C, the PTGs are easily resolved by the human ear, each PTG lasting about 0.5 sec.

One individual, recorded in the field at this temperature, produced buzzes of 5–12 PTGs at a rate slightly above 1 PTG/sec, with brief pauses of 3–4 sec between the buzzes. In the laboratory, at temperatures near 23°C, buzzes were often of much longer duration. The buzz ends abruptly with the completion of a major pulse train and maintains a uniform level throughout. Slightly in advance of the beginning of the buzz, there occurs a distinctive pulse pattern (X of Fig. 1A) which appears to be a minor pulse train together with an initial few pulses from the subsequent major pulse train.



*Neduba sierranus*

FIG. 2. Oscillographs of *N. sierranus* caling song, laboratory recorded at 23°C with the microphone 4.5 cm dorsal to the insect.

*N. sierranus* has a bimodal (two-part) song. A specimen recorded in the field at 16°C repeated its song at a rate of about one song per second. The human ear resolves the song as a few brief stuttering ticks, leading without pause into a buzz (Fig. 2A). The buzz is a single pulse train (Fig. 2B). A specimen with 170 file teeth produced 107 pulses in each buzz pulse train (averaged over 10 consecutive songs). The tick mode consists of a PTG repeated (usually) 3 or 4 times as the song is initiated. Each group is comprised of a low-rate pulse train preceding a sharp-fronted, more intense, high-rate pulse train (Fig. 2B).

The most intense carrier frequencies of both species lie near 20 kHz (Fig. 3A, B). *N. macneilli* has a main intensity peak between 15 and 22 kHz with a lesser peak centred on 35 kHz. The dominant peak of *N. sierranus* occurs within the range of 16–23 kHz and is particularly pronounced at 19 kHz. These frequencies exceed the response capability of most tape recorders and microphones; thus sonograms, such as that given by Rentz and Birchim (1968) for *N. macneilli*, may present only a small fraction of the sound energy actually produced by the animal.

In both species the tegmina are mirror images of each other. Swollen lateral and mesal veins diverge from the wing base (A and B of Fig. 4) and subtend a plateau of transparent cells, comprised of relatively stiff, thin cuticle. A membranous (flexible) skirt (C) hangs ventrally from the lateral vein. The medial margin of each tegmen functions as a scraper (D). The file (E) lies toward the midline between the massive veins and is only weakly attached to them. This stridulatory apparatus encloses a chamber of air on the dorsum

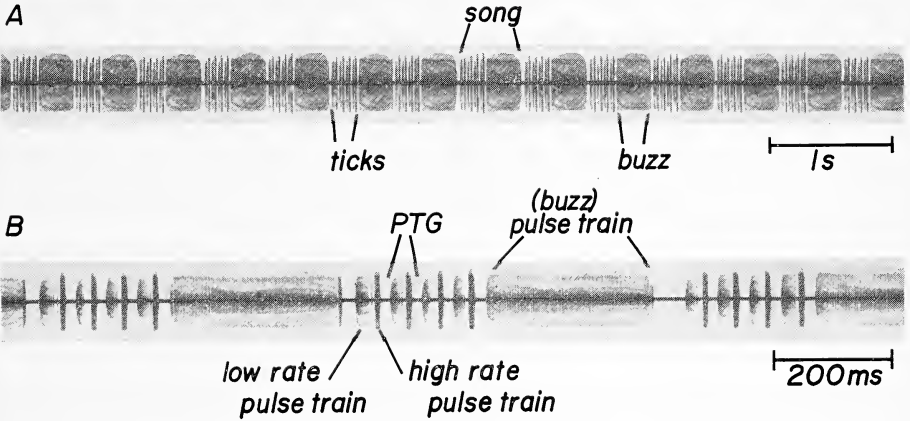
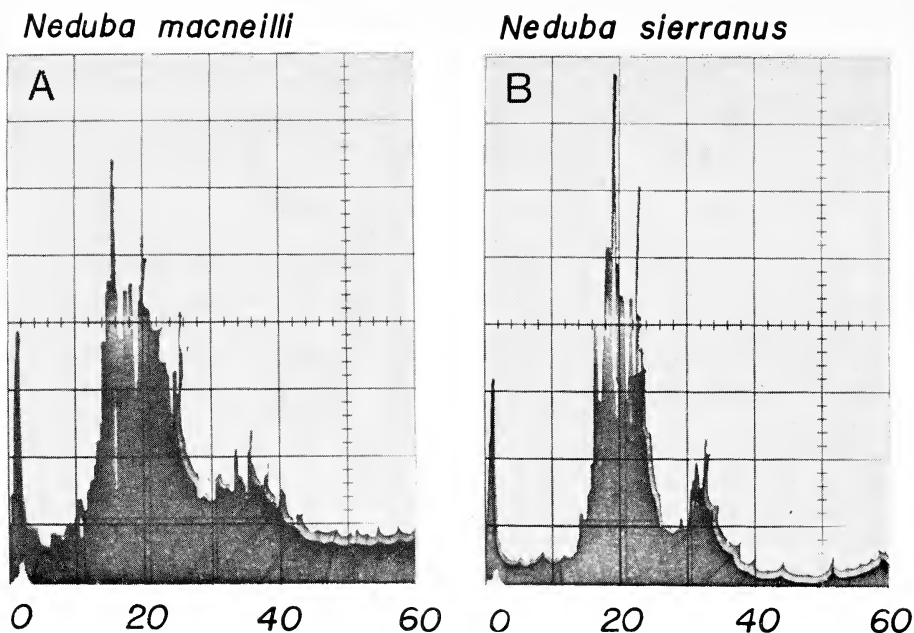

FIG. 3. Spectrograms of carrier frequencies in the calling songs of *N. macneilli* (A) and *N. sierranus* (B); each record is a series of traces superimposed on the screen of a storage oscilloscope during a 10 second sample of the insect's song at a sweep rate of 20 ms/division; horizontal scale in kHz; a 0 kHz marker appears at the extreme left.

of the insect. The floor of this chamber is the terga of the meso- and metathorax and the first few abdominal segments. Each tegmen contributes the region bounded by the two large veins as half of the chamber roof. The skirt reaches and trails out upon the insect's back, delimiting the sides of the chamber and closing it off posteriorly. Tegminal structure is essentially the same in both species; they differ only in the far greater number of teeth occurring on the file of *N. sierranus*.

Tegminal overlap was found to be variable in these insects. Of five specimens of *N. sierranus*, three exhibited the left over right tegminal orientation typical of most katydids, but two males had reversed overlap—right over left. Of four specimens of *N. macneilli*, two exhibited 'normal' overlap and two the reverse. Over a one week period, none of these animals were observed to alter their original overlap. Manual manipulation of the tegmina of freshly killed specimens resulted in sound production of an identical nature with either orientation.

#### DISCUSSION

Left on right overlap of dimorphic tegmina has been considered universal in Tettigoniidae (Ragge 1955). *N. macneilli* and *N. sierranus* are exceptions to

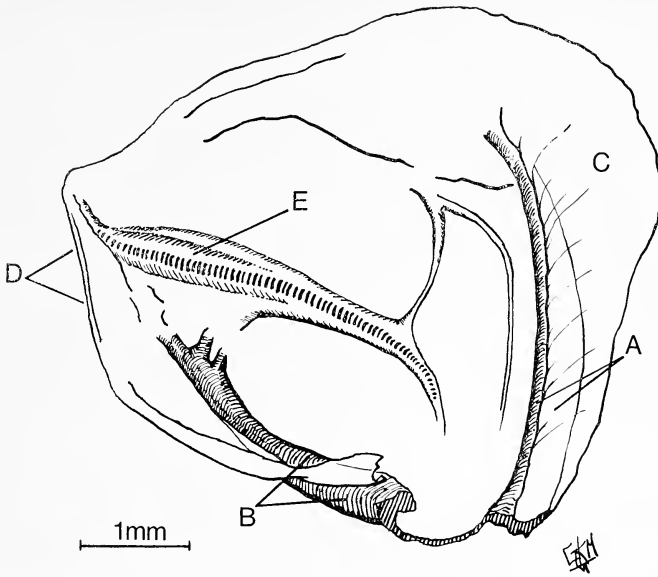

FIG. 4. Ventral view of excised right tegmen of *N. macneilli*; lateral vein (A), mesal vein (B), skirt (C), scraper (D), file (E).

this rule, but they are not alone in varying overlap of identical forewings. They share this distinction with *Cyphoderris monstrosa* Uhler and *C. buckelli* Hebard, survivors of a largely extinct family of primitive katydids (Prophalangopsidae) (Spooner 1973).

*Neduba* species have a remarkably enlarged pronotum which projects rearward above the tegmina. When singing the animal adopts a characteristic posture with the abdomen dorsally concave and lowered and the pronotum elevated, forming an acoustic horn. The plateaux of the tegmina may be considered collectively as the driver or diaphragm. Wing symmetry may then be seen as an adaptation promoting synchronous displacement of the tegmina, allowing them to function as a single diaphragm. The air chamber enclosed by the tegmina is very small relative to the wavelength involved ( $\lambda$  20 kHz = 172 mm; chamber dimensions approximately  $1 \times 4 \times 5$  mm) which means that the chamber will act as a pure acoustic compliance (Beranek 1954), and not as a resonating tube, although its presence will affect the resonance frequency of the diaphragm.

The horn is too irregular to be considered an exponential horn so calculation of its throat inductance is not possible. However, as in the case of the mole cricket (Bennet-Clark 1970) a properly chosen compliance behind the driver will improve its efficiency. Since the diaphragm is small relative to the wavelength ( $kr = .01$ ) even without the horn the presence of a closed box behind

(beneath) the diaphragm will greatly increase the efficiency of sound radiation by preventing acoustic short-circuiting between the front and back of the diaphragm (Michelsen and Nocke 1974).

#### Literature Cited

- BENNET-CLARK, H. C. 1970. The mechanism and efficiency of sound production in mole crickets. *J. Exp. Biol.*, **52**: 619-652.
- BERANEK, L. L. 1954. *Acoustics*. McGraw-Hill, New York. 481 pp.
- MICHELSEN, A. AND H. NOCKE. 1974. Biophysical aspects of sound communication in insects. *Adv. Insect Physiol.*, **10**: 247-296.
- PIPHER, R. E. AND G. K. MORRIS. 1974. Frequency modulation in *Conocephalus nigropleurum*, the black-sided meadow katydid (Orthoptera: Tettigoniidae). *Can. Ent.*, **106**: 997-1001.
- RAGGE, D. R. 1955. The wing-venation of the Orthoptera Saltatoria with notes on Dictyopteran wing-venation. *Brit. Mus. Nat. Hist. London*. 159 pp.
- RENTZ, D. C. AND J. D. BIRCHM. 1968. Revisionary studies in the nearctic Decticinae. *Mem. Pac. Coast Ent. Soc.*, **3**: 1-173.
- SPOONER, J. D. 1973. Sound production in *Cyphoderris monstrosa* (Orthoptera: Prophalangopsidae). *Ann. Ent. Soc. Amer.*, **66**: 4-5.

#### BOOK REVIEW

**Geographic Variability in *Speyeria*.** Arthur H. Moeck. 1975 (reprint of 1957 original). Entomological Reprint Specialists, Los Angeles. 48 pp., 7 maps, 2 photographic plates. \$3.50.

The nymphalid genus *Speyeria* is one of the most distinctively Nearctic of all butterfly groups. It consists of no great number of species (the count varying greatly depending on who is doing the classifying) but of a thoroughly bewildering mass of so-called subspecies, local forms and varieties. Some of these are practically indistinguishable from some assigned to other species, and can be identified only in the context of the wide-ranging species to which they are assigned. The basic work in the modern taxonomy of the group was done by dos Passos and Gray. Arthur Moeck made their study practically his lifework, collecting widely and accumulating an enormous and highly valuable collection. The article here reprinted, rare in its original form, is very important, setting forth his chief opinions about the classification and geographic variation of the major species. It will be essential to all students of the group, and valuable to all interested in butterfly geography.

ALEXANDER B. KLOTS  
The American Museum of Natural History.

**The Effect of Temperature and Humidity  
on the Amount of Blood Ingested by the Stable Fly,  
*Stomoxys calcitrans* L. (Diptera: Muscidae)<sup>1</sup>**

COREY W. SMITH AND ELTON J. HANSENS<sup>2</sup>

DEPARTMENT OF ENTOMOLOGY AND ECONOMIC ZOOLOGY,  
RUTGERS UNIVERSITY, NEW BRUNSWICK, N.J. 08903

RECEIVED FOR PUBLICATION FEBRUARY 1, 1975

**Abstract:** The amount of blood ingested by the female stable fly, *Stomoxys calcitrans*, was studied in all combinations of 23, 32, and 38°C and 7, 43, 75, and 97% relative humidity. No significant differences existed in the amount of blood ingested between the 12 temperature-humidity combinations. Data show that the percentage of flies which feed is dependent on temperature-humidity relations. The percentage of flies feeding is greatest at high temperature and low humidity and lowest at low temperature and high humidity.

The stable fly, *Stomoxys calcitrans* L., is an important blood-sucking pest of man and animals. In resort areas many people recognize that annoyance varies greatly with temperature and relative humidity. The behavior of flies and the rate at which food reserves are expended depend to a large extent on temperature and relative humidity.

While a large body of literature exists showing the effects of the environment on mortality, growth, and fecundity of insects, little research has been done to determine the effects of the environment on the amount of food ingested. The purpose of this research was to determine if high temperature and low humidity increase feeding and the amount of blood ingested by the stable fly, *S. calcitrans*.

The investigations of Voegtline et al. (1965) and Wang and Gill (1970) on the biting activities of stable flies along Lake Superior demonstrated that the feeding activity of *S. calcitrans* is determined largely by the day to day interaction between temperature and humidity. The constancy of these conditions in the laboratory achieves the same result as the flies changing resting places under field conditions in order to obtain the best temperature-humidity combination.

According to Bursell (1964), for insects the interval between meals is longer at cold than at hot temperatures. Applying that observation to the feeding

---

<sup>1</sup>Paper of the Journal Series, New Jersey Agricultural Experiment Station, Rutgers University—the State University of New Jersey, New Brunswick, N.J. 08903. This investigation is part of a George H. Cook Scholar Project by the senior author.

<sup>2</sup>Undergraduate student and Research Professor, respectively.

habits of *S. calcitrans*, temperature obviously plays an important role in determining the frequency with which a stable fly feeds.

A portion of the literature has been devoted to defining "bloodmeal" as it applies to the stable fly. The confusion which exists results in conflicting data. Thus, Suenaga (1965) found that adults having been previously fed "one or two times after emergence" ingested on the average 16.43 mg of blood if they were female and 9.45 mg if they were males while Parr (1962) found that "hungry adults" from a laboratory culture maintained at 26.6°C and 80% relative humidity took bloodmeals averaging 25.8 mg, about three times their mean weight.

A number of laboratory procedures for feeding stable flies have been suggested. Starnes (1949)<sup>3</sup> fed flies horse blood through eyedroppers fitted into holes in the cages; Granett (1960) used animal membranes in the evaluation of chemical repellents. Kashin (1965) used an electronic recording device to detect the various phases of the mosquito bite.

#### MATERIALS AND METHODS

Tests were conducted using humidity chambers (Fig. 1) consisting of two clear plastic dishes 13 cm diam  $\times$  1.5 cm fitted together to make an enclosed chamber. In the bottom of the chamber a cardboard disc served as a base for 17 cages glued to its perimeter. The cages, holding one fly each, were made of 16  $\times$  16 mesh aluminum screen and measured 2  $\times$  1.5  $\times$  1.5 cm. Flies were inserted through small openings in the tops of the cages which were then plugged with pieces of cotton. In the center of the disc a small dish was placed containing 40 ml of a saturated salt solution. Saturated solutions of NaOH, K<sub>2</sub>CO<sub>3</sub>, K tartrate, and K<sub>2</sub>SO<sub>4</sub>, were used to provide relative humidities of 7, 43, 75, and 97%, respectfully as recommended by Winston and Bates (1960). Feeding was accomplished by inserting 3.2 cm lengths of glass tubing with citrated beef blood through holes in the sides of the humidity chamber corresponding in position with the cages.

Stable flies were reared under standard conditions of  $27 \pm 1^\circ\text{C}$  ranging from 46 to 69% RH. Freshly emerged females were supplied with 5% dextrose solution for 2 days and then with citrated bovine blood for 10 hours. Then the flies were anesthetized with CO<sub>2</sub> and placed in the individual cages in the humidity chambers. After receiving flies the humidity chambers were equipped with the saturated salt solutions, sealed with cloth tape, and placed in an incubator containing a 7½ watt light bulb and set at one of the three temperature levels, 24, 32, or 38°C. Approximately 10 tests were run at each of the three temperatures and four relative humidities.

<sup>3</sup>Starnes, E. 1949. Ecology and biology of *Stomoxys calcitrans* in temperate climates. Ph.D. Thesis. Rutgers Univ. 120 pp.

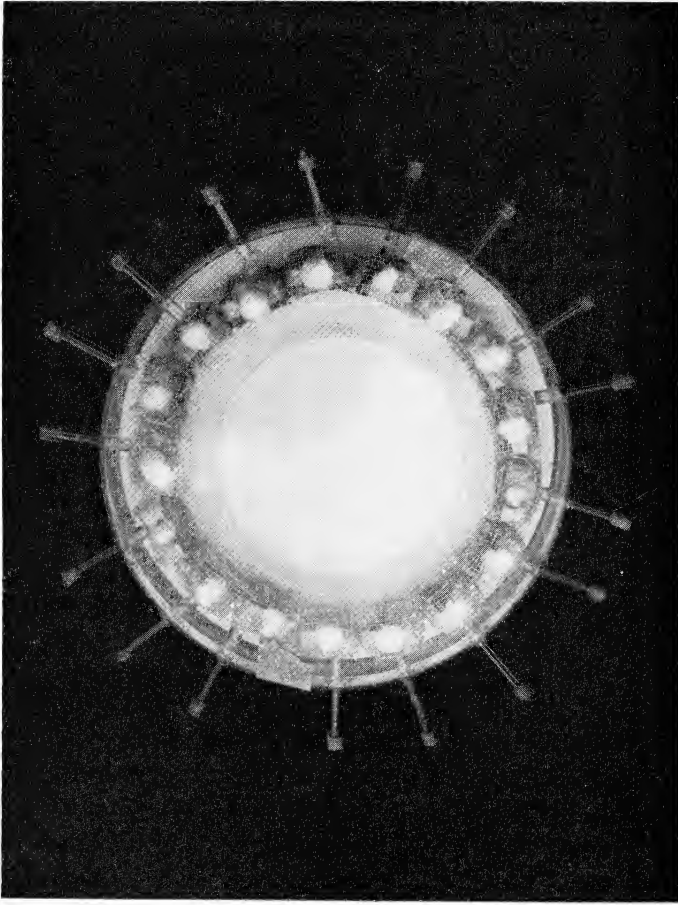

FIG. 1. Humidity chamber.

After 17 hours of starvation, the chambers were taken out of the incubator, one at a time, and the tape removed. Glass tubes containing blood (which entered by capillary action) were weighed on an analytical balance and the weight recorded to the nearest 0.1 mg. The tubes were then inserted into the chambers. Each humidity chamber was returned to the incubator as soon as it had been supplied with a complete set of feeding tubes. Each humidity chamber remained in the incubator for a feeding period of 70 min after which each capillary was weighed again. The difference between the weights obtained before and after feeding gave a value for each tube.

Controls without flies were included in each test. The average weight of blood lost to evaporation was determined for each temperature-humidity combination and subtracted from value for each tube to determine the amount of blood

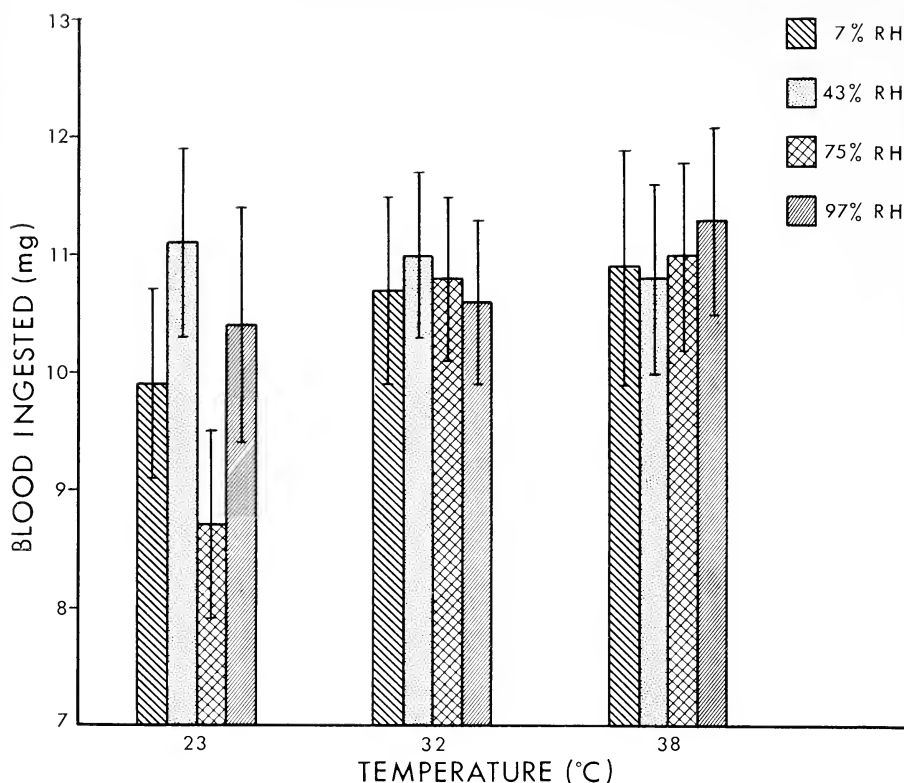

FIG. 2. Effect of temperature-humidity on blood ingested.

ingested by each fly. Each fly tested was crushed on a paper towel to confirm blood feeding.

#### RESULTS AND DISCUSSION

In calculating the amount of blood ingested at a given temperature and humidity, the data from approximately 10 replicates were grouped. Sample size was not constant because numbers of available female flies varied and high mortality occurred at some temperature-humidity combinations. Mean values of blood ingested (Fig. 2) were determined by dividing the total amount of blood consumed at a given temperature and humidity by the total sample size for that combination of factors. 95% confidence intervals were calculated by use of the formula,  $x \pm t_{0.05}S$ , where  $x$  is the mean value of blood ingested,  $t$  is the  $t$  value determined by the sample size, and  $s$  is the standard deviation. This was done to determine the significance of differences between the means obtained at the various temperature-humidity combinations and also to determine the significance of consumption differences between temperatures and between humidities.



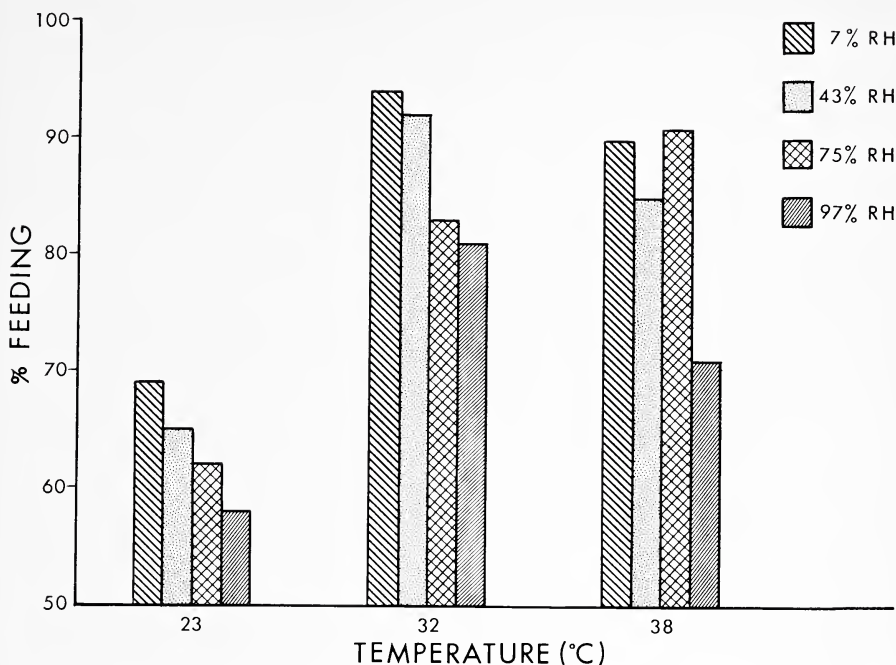

FIG. 3. Effect of temperature-humidity on percent feeding.

There were no significant differences in amount of blood ingested between the 12 temperature-humidity interactions except at the 23°C-75% RH combination. A hypothesis formed prior to the collection of data and based on the fact that the rate at which food reserves are expended and the drying power of unsaturated air are temperature dependent was proven to be incorrect, even though it seemed logical to predict that more blood would be ingested at high temperature and low humidity than at low temperature and high humidity.

To determine what effect the feeding apparatus had on the amount of blood ingested as compared to a live host, the senior author fed 15 stable flies on his arm. Flies were weighed before and after feeding to find the amount of blood ingested. Results showed that the amount of blood ingested on a live host (9.6 mg) did not differ significantly from the amount of blood ingested from an artificial source (10.6 mg).

Though the amount of blood ingested by *S. calcitrans* was not dependent on temperature and humidity interactions, the percentage of flies that feed was dependent (Fig. 3). For temperatures of 23 and 32°C the greatest percentage of flies took a bloodmeal at the lowest relative humidity (7%). The lowest percentage of flies feeding at these same two temperatures occurred at the highest relative humidity (97%). Though the greatest percent feeding

at the 38°C temperature occurred at 75% RH, the lowest percent feeding again occurred at the highest relative humidity. At all humidity levels except for 75%, the largest percentage of flies feeding was to be found at a temperature of 32°C. These results compare favorably to those reported by Voegtline et al. (1965). If we assume that the percentage of flies feeding at a given temperature is proportional to biting activity, then the percentage of flies that feed must share an inverse relationship with relative humidity. This is exactly the case at both 23 and 32°C. Considering the percent feeding data obtained at the 23 and 32°C levels, percent feeding increased as temperature increased at all humidities. This, too, agrees with Voegtline's observations.

Differences in behavior were observed between flies exposed to different humidities prior to feeding. The least amount of activity occurred in flies held at the 97% humidity while the greatest activity was observed at the 7% humidity. Flies that were subjected to the 7% humidity and did not feed during the test were extremely hard to catch when attempts were made with forceps to remove them from the chambers. However, those flies which did feed were inactive regardless of the humidity. In fact, engorged flies made no attempt to escape when forceps were inserted into their cages.

#### Literature Cited

- BURSELL, E. 1964. Environmental Aspects: Humidity. p. 324-58. In Rockstein, M. [ed.]. *The Physiology of Insecta*. Vol. 1. Academic Press, N.Y.
- GRANETT, P. 1960. Use of an animal membrane in the evaluation of chemical repellents against the stable fly. *J. Econ. Ent.*, **53**: 432-5.
- KASHIN, P. AND H. G. WAKELEY. 1965. An insect bitometer. *Nature (London)*, **208**: 462-4.
- PARR, H. C. M. 1962. Studies on *Stomoxys calcitrans* in Uganda, East Africa. Notes on life history and behavior. *Bull. Entomol. Res.*, **53**: 437-43.
- SUENEGA, O. 1965. A rearing method of stable flies and quantity of blood taken by a fly. (In Japanese). *Endem. Dis. Bull. Nagasaki Univ.*, **7**: 296-301. (*Rev. App. Entomol. B*, 56: 709).
- VOEGLTINE, A. C., G. W. OZBURN, AND G. D. GILL. 1965. The relation of weather to biting activity of *Stomoxys calcitrans* along Lake Superior. *Mich. Acad. Sci., Arts Lett.* **50**: 107-14.
- WANG, TU-HWA E. AND G. D. GILL. 1970. Effect of temperature and humidity on mortality of adult stable flies. *J. Econ. Entomol.*, **63**: 1666-8.
- WINSTON, P. W. AND D. H. BATES. 1960. Saturated solutions for the control of humidity in biological research. *Ecology*, **41**: 232-7.

**ABSTRACTS**  
**FORTY-SEVENTH ANNUAL MEETING**  
**EASTERN BRANCH**  
**ENTOMOLOGICAL SOCIETY OF AMERICA**

This year for the first time we are publishing **ABSTRACTS** of papers, as well as of symposium presentations, of the Forty-seventh Annual Meeting of the Eastern Branch, Entomological Society of America, held Oct. 1975, in Philadelphia, Pa. The New York Entomological Society and the Eastern Branch, ESA, hope that publication of **ABSTRACTS** will become a regular procedure and that future December issues will be devoted, in part, to subjects presented at the Annual Meeting of the Eastern Branch.

**ACKNOWLEDGMENT**

The Editors wish to express their appreciation to all those who have helped in reviewing manuscripts submitted during 1975 for publication in the Journal: Marion Brooks-Wallace, Elmer P. Catts, Mercedes Delfinado, Robert F. Denno, C. Clayton Hoff, Alexander B. Klots, Evert E. Lindquist, Arthur H. McIntosh, Glenn K. Morris, Sally B. Padhi, Radclyffe B. Roberts, John B. Schmitt, Daniel J. Sullivan, Robert Traub, Asher E. Treat, George W. Wharton, and Pedro Wygodzinsky.

**Seasonal Variations in Activity of *Apanteles melanoscelus* Ratzeburg (Hymenoptera: Braconidae) Adults as Related to Seasonal Variations in Age Structure of its Host, *Porthetria dispar* (L.) (Lepidoptera: Lymantriidae)**

R. M. WESELOH

DEPARTMENT OF ENTOMOLOGY, CONNECTICUT AGRIC. EXP. STATION,  
NEW HAVEN, CONN. 06504

*Apanteles melanoscelus* Ratzeburg does not develop successfully in large larvae of the gypsy moth, *Porthetria dispar* (L.). This study was conducted to determine if the effectiveness of the second field generation of the parasitoid is reduced because of this. Field attack frequency of female *A. melanoscelus* was monitored weekly by confining laboratory reared 1st and 2nd stadia gypsy moth larvae to branches of trees and then rearing them in the laboratory to see if they were parasitized. Also, weekly collections of 100 gypsy moths were taken in the field, their stadia recorded, and reared to determine percent parasitism. First and 2nd stadia gypsy moth larvae were abundant in the field from May 20 up to June 13. Third instars, which *A. melanoscelus* does attack but with difficulty, occurred through June 19. Attack frequency of *A. melanoscelus* on confined, laboratory-reared small larvae was low until June 10–13, when it increased dramatically and then declined in subsequent weeks. This peak was probably due to second generation emergence of the parasitoid. Thus, *A. melanoscelus* adults are most abundant when most gypsy moth larvae are too large to be suitable hosts (by June 13, 79.3% of the field-collected caterpillars were 4th instars and larger). This could be expected to influence considerably the parasitoids, ability to control the pest.

**Dimilin Toxicity to *Apanteles melanoscelus* (Ratzeburg) (Hymenoptera: Braconidae) and Effects on Field Populations**

J. GRANETT, R. M. WESELOH AND D. M. DUNBAR

THE CONNECTICUT AGRICULTURAL EXPERIMENT STATION, BOX 1106, NEW HAVEN 06504

In the laboratory *Apanteles melanoscelus* (Ratzeburg) larvae were treated with Dimilin®, 1-(4-chlorophenyl)-3-(2,6-difluorobenzoyl)-urea, by feeding treated artificial diet to the gypsy moth host. The parasitoid EC<sub>50</sub> was 0.0059 ppm in comparison with 0.0075 ppm for the unparasitized gypsy moth. At low treatment rates the parasitoids died during the pupal-adult molt within the cocoon. At high treatment rates, however, the parasitoids died as larvae within the gypsy moth larvae. Treatments while the parasitoids were 2nd-3rd stadia larvae had less effect than treatments earlier in the parasitoids' develop-

ment. Dimilin did not apparently affect parasitoids treated as adults. The toxicity of Dimilin was a direct effect of the chemical and not due to host morbidity. These results indicate that Dimilin may be used in an integrated approach to gypsy moth control. To test this, orchard sprays of Dimilin were made while gypsy moth larvae were at: 1) the 1st-2nd larval stadium, 2) 2nd-3rd stadium and 3) 3rd-4th stadium. No parasitoids emerged from larvae collected from treated trees 1 week after the first spraying. However, there was little effect on numbers of emerged parasitoid cocoons when larvae were collected from trees sprayed thereafter. Dimilin had no marked effect on adult emergence from cocoons. Thus if timed properly Dimilin should have little effect on populations of *A. melanoscelus* and yet still control the gypsy moth.

### **Effects of the Insect Growth Regulator Altozar on the Parasitoid, *Microctonus aethiops*, and Its Host, *Hypera postica***

M. E. ASCERNO

PESTICIDE RESEARCH LABORATORY, DEPT. ENTOMOLOGY, PENN STATE UNIVERSITY,  
UNIVERSITY PARK, PA. 16802

The insect growth regulator Altozar<sup>®</sup> terminated sexual diapause of adult alfalfa weevils when topically applied. In addition, it terminated the diapause of *M. aethiops* when applied to parasitized adult weevils. Parasitoid survival and morphological condition were influenced by various Altozar<sup>®</sup> concentrations. An interaction was also found between age of non-diapausing parasitoids at the time of treatment and concentrations of Altozar<sup>®</sup> employed.

### **Mass Rearing of *Diglyphus isaea* (Walker) (Hymenoptera: Eulophidae) on *Liriomyza trifoliarum* Spencer (Diptera: Agromyzidae)**

R. M. HENDRICKSON, JR.

U.S. DEPARTMENT OF AGRICULTURE, ARS, 501 SOUTH CHAPEL ST.,  
NEWARK, DELAWARE 19713

The object of the study was to find a method of rearing large numbers of the parasite, *Diglyphus isaea* (Walker), for release against its target host, alfalfa blotch leafminer, *Agromyza frontella* (Rondani). Mass rearing of *D. isaea* on alfalfa blotch leafminer proved difficult because of the time and inconvenience of handling the puparia of the fly which pupates in the soil, the small numbers of larvae (50-100) available for parasite oviposition per 6" pot of alfalfa, several troublesome pest contaminants of alfalfa, and the lengthy time required to grow alfalfa from seed or allow its regrowth after

cutting. *Liriomyza trifoliarum* Spencer was found to be a host acceptable to the parasite. It was reared on Burpee™ Bountiful bush beans, a host plant on which no contaminant species have as yet been found in culture. The first pair of true leaves of the bush bean are suitable for oviposition by the fly 6–7 days after planting, at 78°F. A 5" × 8" pot of 20 plants will produce 1000–1500 larvae. At 78°F the host larvae eclose and reach the final (3rd) instar in 6 days, at which time they are placed in cages with parasites. It is important to provide the parasite with 3rd instar host material only. They sting and kill earlier instars, but no oviposition has been observed. Maturation of the parasite requires 13–23 days at 73°F. Thus in about a month it is possible to go from host plant seed to mature parasite. The use of *L. trifoliarum* as an alternate host on bush beans (as opposed to using alfalfa blotch leafminer on alfalfa) saves time and space and results in far larger numbers of *D. isaca*.

### **Control of the Apple Leaf Curling Midge, *Dasyneura mali* (Kieff) (Diptera: Cecidomyiidae) in New Hampshire**

G. T. FISHER AND J. TURMEL

ENTOMOLOGY DEPARTMENT, UNIVERSITY OF NEW HAMPSHIRE, DURHAM,  
NEW HAMPSHIRE 03824

A block of apples in Durham, New Hampshire, heavily infested with the apple leaf curling midge, was treated with several regularly recommended and experimental materials. Treatments were made on the following dates: 5/1/75 (Green Tip); 5/8/75 (Tight Cluster); 5/15/75 (Pink); 5/26/75 (Petal Fall); 6/5/75 (1st Cover); 6/11/75 (2nd Cover), before efficacy data was recorded (6/23/75). Treatments were randomized, replicated two or three times, and applied in 350 gal. H<sub>2</sub>O/A at 300 psi. Materials applied were: Zolone 3EC 1 pt/100; Furadan 4F 0.25 lb.ai/100; Parathion 2S 0.5 lb.ai/100; N2596 4EC 1.0 lb.ai/100; Imidan 1S 0.5 lb.ai/100; Lannate 0.5 lb.ai/100; Lannate 0.25 lb.ai/100 plus Guthion 50WP 0.25 lb.ai/100; Guthion 50WP 0.5 lb.ai/100; Mobil 9087 2EC 0.75 lb.ai/100; TH6042EC 0.5 oz.ai/100; TH6042EC 0.132 oz.ai/100; Bayhox 1901 40WP 4oz.ai/100; FMC 3329 3EC 0.1 lb.ai/100; Bayntn 9306 6EC 4oz.ai/100. Data was obtained by counting the number of curled leaves per tree. These counts were totaled, replicate averages made and percent control corrected with Abbotts formula. The commonly used insecticides, Guthion, Zolone and Imidan gave 100% control which probably accounts for the minor occurrence of this pest in New England commercial orchards. Parathion 2S and Lannate gave poor control. Treatments with Mobil 9087, TH6082, Bayhox 1901, FMC 3329, Bayntn 9306 resulted in 100% control, N2596, 99% control, and TH6082 at 0.132 gave 92% control.

## Is a Black Fly Survey Worthwhile?

IVAN N. McDANIEL

UNIVERSITY OF MAINE, ORONO, MAINE 04473

The town of Jackman, Maine, was surveyed to determine the sources of black flies that cause severe annoyance from May to July. Prior attempts at larval control requiring treatment of all swift-water areas had met resistance from environmentalists since they felt the ecology of the area might be disturbed. It was suggested that a survey might reveal localized areas of high productivity in certain streams. Therefore, all streams within a 259 m<sup>2</sup> area surrounding the town were monitored during 1970 to determine productivity and species present. Numerous biting collections supplemented larval and pupal collections. Results of the survey showed that *Simulium venustum* Say accounted for more than 98% of the annoyance in the area and an estimated 85% of this species was found to develop in two separate stretches of Wood Stream. Heald Stream and certain areas of several other streams were productive although they are considered rather minor sources of *S. venustum*. Some streams did not produce this species and others produced very few. Results of the study suggest that a black fly survey can be as useful as a mosquito survey in locating breeding sites for source reduction. The cost of a survey should be considered minor as compared with the savings realized if a larval control program should be implemented. Since the amount of insecticide required for control would be markedly reduced, the risks to non-target organisms also would be minimized.

## A Comparison of Malaise Trapping and Aerial Netting for Research on Houseflies and Deerflies (Diptera: Tabanidae)

DOUGLASS W. TALLAMY AND ELTON J. HANSENS

DEPARTMENT OF ENTOMOLOGY, RUTGERS UNIVERSITY, NEW BRUNSWICK,  
NEW JERSEY 08903

Fifty species of Tabanidae were collected near Deer Lake, Booton, N.J. during the summer of 1974 while comparing the effectiveness of malaise trapping and aerial netting for sampling tabanids. Five sites in the study area were sampled by malaise traps and by sweeping (netting) about the head with an insect net. Comparisons were made of 4 community and 4 population parameters. Differences between the species richness of the malaise-trapped community, which collected 44 species with a mean of 22.2 species/site, and that of the netted community, which collected 44 species with a mean of 27.2

species/site, were not significant ( $P > 0.5, \alpha = 8$ ). Analysis of trapping data for species diversity, 2.34 for malaise vs. 1.30 for netting, and the species evenness, .08 and .40 for malaise and netting respectively, showed both were significantly different ( $P < 0.01, \alpha = 8$ ). The community similarity index, .08, indicated that the structure of the tabanid community trapped by each method differed substantially. The relative densities of the species trapped by each method were significantly different for most *Chrysops* and the dominant *Tabanus* and *Hybomitra*, although a site  $\times$  method interaction existed with *H. losiophthalmus*, *H. sodalis*, *T. lineola*, and *T. pumilus*, which statistically masked this significance. Though the seasonal ranges found by each trapping method did not closely coincide, the seasonal niche breadths were not significant except for 4 species: *H. sodalis* and *C. macquarti* ( $P < 0.01, \alpha = 8$ ), *C. geminatus* and *T. lineola* ( $P < 0.05, \alpha = 8$ ). Neither trapping method should be used alone in studies concerning the entire tabanid community but can be used effectively together.

**Infecting the Gypsy Moth, *Porthetria dispar* (L.) (Lepidoptera: Lymantriidae) with Nuclear Polyhedrosis Virus Vectedored by *Apanteles melanoscelus* (Ratzeburg) (Hymenoptera: Braconidae)**

BERNARD RAIMO

U.S. FOREST SERVICE, NEFES, 151 SANFORD STREET, HAMDEN, CONNECTICUT 06514

This study was undertaken to determine the ability of *Apanteles melanoscelus* (Ratzeburg) contaminated with nuclear polyhedrosis virus (NPV), to infect gypsy moth larvae and to determine the feasibility of using this method of virus dissemination as an alternative to topical foliar application. Three methods of contaminating the parasitoids with virus were tested. The first method involved exposing female parasitoids to first, second, and third-stage gypsy moth larvae that had been feeding on artificial diet containing  $1 \times 10^7$  polyhedral inclusion bodies (PIB)/ml for a period of 48 hr. In the second method virus was applied directly to the ovipositor at a concentration of  $1 \times 10^9$  PIB/ml. A topical application of virus at a concentration of  $1 \times 10^9$  PIB/ml by means of an atomizer was the final method of contamination of parasitoids that was tested. Percent mortality due to virus was found to be higher among larvae exposed to contaminated female parasitoids than larvae that were exposed to uncontaminated female parasitoids and the transmission of virus does not appear to diminish with each successive sting. The most promising method of contaminating the parasitoids with NPV was found to be manual application of the virus to the ovipositor, however, none of the contamination techniques seemed to have any effect on the parasitoids.



***Cassida rubiginosa* Müller (Coleoptera: Chrysomelidae), a  
Potential Biocontrol Agent of Thistles in Virginia**

R. H. WARD AND R. L. PIENKOWSKI

DEPARTMENT OF ENTOMOLOGY, VIRGINIA POLYTECHNIC INSTITUTE AND STATE UNIVERSITY,  
BLACKSBURG, VIRGINIA 24061

*C. rubiginosa*, accidentally introduced into North America and first reported in 1901, presently has a geographical range encompassing most of eastern North America north of central Virginia. During 1973 and 1974, life stages of the beetle were collected from 15 sites in the northern Virginia counties of Frederick, Clarke, and Warren. The purpose of this study was to isolate this beetle from a major obligate gregarious exotic larval and pupal endoparasitoid *Tetrastichus rhosaces* (Walker) (Hymenoptera: Eulophidae). Immature cassid life stages were reared to the adult stage and released 100 miles south of its southernmost range in the southwest counties of Montgomery and Giles. A total of 7840 adults were released at 9 sites with 3 replicates each for the three thistle species *Carduus nutans* (L.)—musk, *C. acanthoides* L.—plumeless, and *Cirsium arvense* (L.) Scop.—Canada thistle. In 1975, cassids were recovered from all release sites with Canada thistle sites having the highest rate of recovery followed by musk and plumeless thistles. Cassids dispersed less than 30m in any one direction from the release point at most sites. Periodic observations of cassid life stages at one musk and Canada thistle sites revealed only one possible case of parasitism, probably by the solitary facultative native parasitoid *Eucelatoriopsis dimmocki* (Aldrich) (Diptera: Tachinidae). Predation by spiders, assassin and stink bugs, chrysopids, and other arthropods was the major biotic mortality factor.

**Growth Form of Host Plant as a Determinant of Feeding  
Efficiencies and Growth Rates in Papilionidae and  
Saturniidae (Lepidoptera)**

J. MARK SCRIBER AND PAUL P. FEENY

DEPARTMENT OF ENTOMOLOGY, CORNELL UNIVERSITY, ITHACA, N. Y. 14850

Larval growth performance of butterflies and moths was studied on leaves of their normal host plants to test whether specialized, stenophagous herbivores utilize their food resources more efficiently than do generalists. *Graphium marcellus*, *Battus polydamas*, *B. philenor*, *Papilio zelicaon*, and *P. polyxenes* are specialized primarily on one plant family. *P. palamedes*, *P. troilus*, and *P. multicaudatus* are intermediate (2 to 5 families), and *P. glaucus* is very generalized, feeding on at least 13 families. For both the penultimate and

final instars the efficiency of conversion of ingested food into larval biomass of the specialists was significantly higher than that of the intermediate and generalized species. Growth rates for specialized papilionids were more than twice as great as those for generalists. Among the swallowtail species the trend from specialized to generalized feeding paralleled a trend from herb-feeding to tree-feeding. No significant differences were found in feeding efficiencies of the final two instars of tree-feeding moths *A. pernyi*, *S. cynthia*, *C. angulifera*, and *B. mori* (specialized), *C. promethea*, *A. luna*, and *C. regalis* (intermediate), and *E. imperialis*, *H. cecropia*, *A. io*, and *A. polyphemus* (generalized). Growth rates were also nearly identical for specialists and generalists. Regardless of their degree of feeding specialization, tree-leaf feeding larvae of both butterflies and moths grew at lower rates than herb-feeders. This indicates that growth form of the host plant has at least as important effect on the overall ecology and life history of a papilionid or saturnid species as has the degree of feeding specialization of its larva.

### **Reproductive Diapause in *Notonecta undulata* (Say) (Hemiptera: Notonectidae)**

ROBERT L. VANDERLIN AND FREDERICK A. STREAMS

BIOLOGICAL SCIENCES GROUP, UNIVERSITY OF CONNECTICUT, STORRS, CONN. 06268

*Notonecta undulata* (Say) completes two generations annually in Connecticut. The first generation, produced by overwintered adults, reaches maturity in early July. The second generation of adults develops in late summer and early fall and enters reproductive diapause. The reproductive activity is regulated by photoperiod and temperature. Photoperiod seems to be more important than temperature. Over 75% of the females raised in the laboratory under a 15-hr photoperiod (LD) and 22°C oviposited within 21 days after adult emergence, while less than 25% of the females raised under a 12-hr photoperiod (SD) and 22°C oviposited. When half of the latter group were subsequently placed under LD conditions, 75% of the females commenced oviposition within 21 days. The remaining half of the SD group was continued under SD conditions and less than 25% of these commenced ovipositing during the next 30 days. Females reared under SD and LD conditions were vivisected and terminal oocytes measured. Females reared under both conditions had terminal oocytes measuring less than 0.4 mm upon emergence as adults. Within 3 weeks LD females attained an oocyte length of 1.7 mm while females reared under SD conditions rarely exceeded .9 mm. Oosorption was observed in the few SD females with terminal oocytes as long as 1.7 mm. Low temperatures tend to inhibit reproductive development. When *N. undulata* was reared under LD conditions but

at 15°C, only 50% of the females oviposited within 7 weeks of adult emergence. Photoperiods under which nymphs are reared appear to have no effect on subsequent reproductive development of adults.

### **Environmental Control of Diapause in Three Species of North American Aedine Mosquitoes (Diptera: Culicidae)**

B. F. ELDRIDGE, R. R. PINGER, JR., J. F. BURGER AND D. E. HAYES

DEPARTMENT OF ENTOMOLOGY, WALTER REED ARMY INSTITUTE OF RESEARCH,  
WASHINGTON, D.C. 20012

Environmental factors influencing diapause were studied under field and laboratory conditions for three species of North American aedine mosquitoes: *Aedes atlanticus* (Dyar and Knab), *A. canadensis* (Theobald) and *Psorophora ferox* (Humboldt). To detect naturally occurring diapause, soil samples were collected in forest depressions in eastern Maryland at five different times of the year: March, May, September, November and December. Samples were divided into two equal parts—one part was held under long photoperiod conditions, the other under short photoperiod conditions, both at 25°C. Portions of each sub-sample were flooded weekly for four weeks. The proportion of viable eggs which hatched upon flooding varied with the species, the time of year collected, and the length of time held under experimental conditions. The results indicate that all three species undergo embryonic diapause which is terminated only after exposure to chilling temperatures. Photoperiod does not appear to play a role in diapause termination. Prolonged exposure to moderate temperatures appears, in addition, to be a necessary antecedent to hatching in *A. atlanticus* and *A. ferox*. Experiments were conducted in the laboratory to determine the influence of photoperiod on induction of diapause. Results indicated that short photoperiod exposure of the developing embryo of *A. canadensis* induces diapause, whereas similar exposure of *P. ferox* females results in the oviposition of diapausing eggs.

### **An Improved Insect Pest Management Program on Sweet Corn in New Hampshire**

JAMES S. BOWMAN

DEPARTMENT OF ENTOMOLOGY, UNIVERSITY OF NEW HAMPSHIRE, DURHAM,  
NEW HAMPSHIRE 03824

Three years of field research studies on the detection and control of the European corn borer *Ostrinia nubilalis* (Hübner) and the corn ear worm *Heliothis zea* (Boddie) on sweet corn demonstrated the feasibility of an improved

insect pest management program for New Hampshire. First brood European corn borer can be controlled using whorl-stage treatments of either a granular insecticide applied once or liquid sprays applied twice. Since the arrival time of the corn earworm's northern migration can vary from year to year (August 1 to September 1), early detection with light traps for moth flights and inspection of silks for newly laid eggs is used to alert growers to the necessity for spraying. In years when the earworm arrives late, considerable reduction in the use of insecticides and a resulting savings to the grower is realized. Small plot research comparing directed granular applications at planting time (soil applications) and at what stage with spray treatments indicates Dyfonate 10GK, carbofuran 10G, N-2596 10Gk, and Sandose 197 give acceptable economic control of the European corn borer. A comparison of granular treatments applied either directly into the whorl or as a broadcast indicates a slight loss in effectiveness as a broadcast but acceptable economic control.

### **Sequential Releases of *Rhinocyllus conicus* Froelich (Coleoptera: Curculionidae) for the Biocontrol of *Carduus* Thistles**

W. W. SURLS AND L. T. KOK

DEPARTMENT OF ENTOMOLOGY, VIRGINIA POLYTECHNIC INSTITUTE AND STATE UNIVERSITY,  
BLACKSBURG, VA 24061

*Rhinocyllus conicus*, an introduced thistle-head feeding weevil, which has been established on *Carduus* thistles in Virginia has shown more effective control of *Carduus nutans* (musk thistle) than of *Carduus acanthoides* (plumeless thistle). This is apparently due to better synchronization of overwintering weevil emergence in spring with bud development of musk thistles than with plumeless thistles. Sequential field releases of overwintered weevils on individually-caged thistles were conducted to investigate the advantages of extending the ovipositional period and improving synchronization of the weevil with thistle development. Each of the releases produced an initial surge in oviposition of progressively decreasing magnitude on both *Carduus* thistles. The later releases successfully extended the ovipositional period, but were less effective due to reduced fecundity. Weevils also suffered increased mortality during prolonged caging prior to release. Regular monitoring of egg deposition on the developing thistle blooms revealed that *R. conicus* preferred the earlier stages of musk thistle capitula. This was not evident on the plumeless thistles which had eggs equally distributed on the buds as well as the fully developed heads. Preference for earlier bloom stages resulted in higher survival of larvae on musk thistles than on plumeless thistles. Eggs deposited on the later stages of plumeless thistle blooms failed to complete development, and had high larval mortality because of the inadequate period for development.

## Survival of Aestivating Adult *Rhinocyllus conicus* Froelich (Coleoptera: Curculionidae) at Different Temperatures and Photophases

L. T. KOK

DEPARTMENT OF ENTOMOLOGY, VIRGINIA POLYTECHNIC INSTITUTE AND STATE UNIVERSITY,  
BLACKSBURG, VA 24061

Successful field establishment of *Rhinocyllus conicus*, an introduced weevil for the biological control of *Carduus* thistles, is best obtained by spring releases at the initial stages of thistle bud development. To insure an adequate supply of ovipositing weevils at the time of release, senescent infested thistle heads collected from an established site in Virginia were held for weevil emergence. The newly emergent, aestivating weevils were caged with thistle leaves, and/or thistle heads, or artificial diet. These were exposed to different thermoperiods ranging from 10°–32°C with either declining or constant photophases of 0–16 h to determine conditions optimum for their survival until the following spring. Day-night thermoperiods of 21°–15°C synchronized with short photophases resulted in relatively lower mortality than treatments of 26°–15°C, and 32°–15°C with similar photophases. Aestivating weevils survived better when caged with thistle leaves at constant temperatures of 10 or 15°C, and continuous darkness. Best survival was obtained for weevils placed on artificial diet subjected to photophase of 0 or 10 h at 10°C. Mortality rate increased at higher temperatures and longer photophases. In the absence of thistle leaves or artificial diet, no weevils survived the entire duration of the experiment (August through April of the following year); those weevils subjected to the higher temperatures of 26°C or 32°C did not survive beyond December.

## Increased Gladiolus Spike Growth with Use of Certain Systemic Insecticides

ROGER G. ADAMS, JR., JOHN H. LILLY, AND ADRIAN G. GENTILE

DEPARTMENT OF ENTOMOLOGY, UNIVERSITY OF MASSACHUSETTS,  
AMHERST, MASSACHUSETTS 01002

Previous aphid control experiments suggested that treatments with certain systemic insecticides might improve gladiolus growth. A replicated field experiment was conducted near Suffield, Connecticut in 1972 to test this hypothesis. The experimental area was divided into 60 5-ft.-long plots, each of which was planted with 10 corms of the gladiolus cultivar "Peter Pears". The following 10 treatments were replicated 6 times in a randomized complete block design: dimethoate 2EC, oxydemeton-methyl 2EC, carbofuran 4F, carbofuran

10G, pirimicarb 50WP, acephate 75S, disulfoton 15G, aldicarb 10G, oxamyl 10G, and untreated control. All materials were applied at 1 lb ai/acre. Two granular soil treatments and 3 foliar spray applications were made with the respective materials. No significant differences were detected in plant emergence or height 17 and 23 days, respectively, after planting. At peak bloom granular soil treatments of aldicarb, oxamyl, and disulfoton showed significant effects on gladiolus growth as indicated by increased plant heights, flowerhead lengths, and bud numbers. Cucumber mosaic virus disease-infected plants in both aldicarb and disulfoton-treated plots showed growth benefits. We conclude it may be possible for gladiolus growers to obtain both increased plant growth and flower production as well as insect control through utilization of aldicarb, disulfoton, or oxamyl as soil insecticides.

### **Evaluation and Control of a Nuisance Fly Problem (Diptera: Muscidae) at Monmouth Park Jockey Club, Oceanport, New Jersey**

JOHN MILLO AND ELTON J. HANSENS

DEPARTMENT OF ENTOMOLOGY AND ECONOMIC ZOOLOGY, RUTGERS UNIVERSITY,  
NEW BRUNSWICK, NEW JERSEY 08903

Throughout the 1973 summer racing schedule, Monmouth Park personnel experienced an acute fly problem. In 1974, inspections of 10 randomly chosen horse barns made 3 times per week from July to October, revealed a predominance of house flies, *Musca domestica* (L.), and stable flies, *Stomoxys calcitrans* (L.), in addition to small numbers of Tabanidae. Potential breeding sites of the predominant species were manure pits, hay barns, horse corrals, horse stalls, grass clippings and beached tidal creek vegetation. Larvae or pupae occurred at all but the latter two sites. Of 92 samples, manure pits and hay barns yielded the highest proportion of house flies and stable flies per sample. Layers of moist, decayed hay or alfalfa in front of the hay barns were particularly productive of stable flies. Manure pits containing STAZ-DRI (horse bedding derived from sugar cane refuse), horse manure, or a combination of both, produced large numbers of house flies. Evaluations of ULV applications with a Cardinal 150 sprayer (Northeastern Associates), using formulations of 1% pyrethrins (Dubois Chemical Co.), 5% pyrethrins (Northeastern Associates), and 40% resmethrin (S.B. Penick & Co.) diluted 18 fl. oz./gal. with light mineral oil, showed the latter superior, though variable winds to 5 mph, cool morning temperatures, and lack of penetration into barns limited control. Proper disposal of manure and hay barn refuse remains the most practical and effective means of fly control.

## Control of External Parasites on Cattle by Means of Dust Bags

JAMES E. ROBERTS, SR.

DEPARTMENT OF ENTOMOLOGY, VIRGINIA POLYTECHNIC INSTITUTE AND STATE UNIVERSITY,  
BLACKSBURG, VIRGINIA 24061

Dust bags have been used for approximately 15 years for the control of external parasites on cattle. When properly installed and maintained, use of this type of self-treatment device will result in near-complete control of horn flies, *Haematobia irritans* (L.), and cattle lice and will effectively reduce face fly *Musca autumnalis* (DeGeer) populations. Two recent tests with 5% fenthion in dust bags resulted in 41% and 60% reduction in cattle grub infestation. Numerous field tests have shown that forced use of dust bags will result in more effective insect control. A shelter should be provided for any dust bags that are not water repellent. However, some good water repellent bags are now available from commercial sources. Protection from rainfall is necessary to prevent caking of the dust. To obtain the most effective face fly control, bags must be suspended within 18 to 24 inches from the ground. The efficacy of insect control is also enhanced when the bag swings freely so that as the animals pass under them they will bump the bags with their heads and again with their shoulders, thereby insuring a more thorough dust coverage of the head and body.

## Wing Polymorphism in Salt Marsh Inhabiting Fulgoroidea

ROBERT F. DENNO

DEPARTMENT OF ENTOMOLOGY AND ECONOMIC ZOOLOGY, RUTGERS UNIVERSITY,  
NEW BRUNSWICK, N.J. 08903

The vegetation of New Jersey tidal salt marshes is composed primarily of two grasses, *Spartina alterniflora* Lois. (Smooth Cordgrass) and *Spartina patens* (Ait.) Muhl. (Salt Meadow Cordgrass). *S. patens* occupies a narrow elevational zone of well drained marsh above mean high water level (MHW). *S. alterniflora*, an intertidal species, occurs throughout most of the elevational range of *S. patens*, but also extends to levels far below MHW. Near MHW, where the marsh is flat and poorly drained, *S. alterniflora* occurs as a dwarfed form, but along depressed borders of creeks well below MHW, it may grow to the height of 2m. Structurally (culm height, width, density), *S. alterniflora* is more diverse than *S. patens* and ecologically occupies a more extensive elevational range which receives frequent tidal inundations. Fulgoroids, dimorphic for wing length, feed upon these salt marsh grasses. The purpose of this work

was to investigate the ecological significance of wing polymorphism strategies employed by the fulgorids to cope with the structural variability and stability of food resources. The delphacid, *Prokelisia marginata* (Van Duzee), which is host specific on *S. alterniflora*, produced highly vagile macropters and brachypters with less efficient flight capability. In short form *S. alterniflora*, macropters and brachypters were sweep-netted in equal numbers. The following commonalities were evident for *S. patens* inhabiting fulgoroids [*Delphacodes detecta* (Van Duzee), *Tumidagena minuta* McDermott, *Aphelonema simplex* Uhler]: Brachyptery was extreme, preventing flight. Brachypters significantly outnumbered macropters. The density of brachypters correlated well with the seasonal pattern of standing crop biomass of the food resource. Macropter density was poorly correlated with standing crop biomass; however, seasonal macropter density occurred just prior to peak standing crop biomass of the grass. On the high marsh, which is less subject to tidal inundation and is occupied by a structurally monotonous food resource, fulgoroids have evolved a brachypterous strategy. On the intertidal marsh, where the food resource is structurally diverse and occasionally unavailable (tidal inundation), population mobility is at a premium and fulgoroids have evolved a strategy relatively skewed toward the production of macropters in order to efficiently exploit resources.

**Isolation and Identification of *Entomophthora* spp. Fres.  
(Phycomycetes: Entomophthorales) from the Spruce Budworm  
*Choristoneura fumiferana* Clem. (Lepidoptera: Tortricidae)**

JOHN D. VANDENBERG

DEPARTMENT OF ENTOMOLOGY, UNIVERSITY OF MAINE, ORONO, MAINE 04473

RICHARD S. SOPER

N.E. PLANT, SOIL AND WATER LABORATORY, USDA-ARS, ORONO, MAINE 04473

*Entomophthora sphaerosperma* Fres. and *E. egressa* MacLeod and Tyrrell were isolated from field-collected spruce budworm in Aroostook and Washington counties, Maine. An 18" branch tip was taken from the upper and lower crowns of 5 trees at each of 13 locations. Living larvae were reared on artificial diet to determine disease prevalence. Fungi from diseased larvae were isolated on egg yolk plus Sabouraud maltose agar medium and then identified. Both species were tested for growth on several media and over a range of pH and temperature levels. Prevalence of infection was greater in the lower crown (7.4% vs. 2.6%) with an overall prevalence of 5.0% (90% level of significance). The conidia of *E. sphaerosperma* are slender, papillate at the base, rounded and tapered at the apex;  $19.50 \pm 2.14 \mu \times 7.64 \pm 1.06 \mu$  (Mean  $\pm$  Standard



deviation) from larvae, and  $22.43 \pm 4.90 \mu \times 7.24 \pm 0.46 \mu$  from specimens grown on artificial media. Conidiophores are branched and digitate. Rhizoids, secondary conidia and cystidia are present. Resting spores are hyaline, spherical and measure  $24.90 \mu \pm 2.18 \mu$  from larvae, and  $26.30 \mu \pm 2.71 \mu$  from media-reared specimens. The conidia of *E. egressa* are obovate to pyriform with a broad papillate base and an evenly rounded apex. They measure  $38.56 \pm 8.33 \mu \times 31.59 \pm 7.26 \mu$ , and are multinucleate (8–10). Conidiophores are branched. Resting spores, secondary conidia, rhizoids and cystidia were not observed. Mycophil yeast agar (MYA) at 20°C was found to produce the best growth of *E. sphaerosperma*. MYA at 20°C was then tested at a pH range of 5.0–7.5 at intervals of .5. Mycelial growth was predominant above pH 6.5, while abundant conidia production occurred below pH 6.0. Growth of *E. sphaerosperma* was also tested in shaker cultures on liquid media with Sabouraud liquid broth (SLB) within the range 5.5–8.0 pH and 25°C giving the best growth. Optimum growing conditions for *E. egressa* as determined in a like manner, were at 25°C on AK agar throughout a pH range 6.0 to 7.5.

### **A Sex Pheromone Complex of the Mushroom-Infesting Sciarid Fly, *Lycoriella mali* Fitch**

J. G. KOSTELC, L. B. HENDRY AND R. J. SNETSINGER

DEPARTMENTS OF CHEMISTRY AND ENTOMOLOGY, PENNSYLVANIA STATE UNIVERSITY,  
UNIVERSITY PARK, PA. 16802

The sex pheromone complex of the sciarid fly, *Lycoriella mali* Fitch consists of a homolog series of saturated, straight chain, aliphatic hydrocarbons. Sciarid males are attracted to hydrocarbons pentadecane to hexacosane and octacosane ( $C_{15}$ – $C_{26}$ ,  $C_{28}$ ) when tested in a biological assay chamber. Heptadecane is the most active hydrocarbon. In addition, statistical testing of heptadecane and neighboring hydrocarbons ( $C_{15}$ – $C_{19}$ ) support this finding. Concentration studies of heptadecane show that the best overall response (80%) and the best attractive response (79%) occur at the 1.0 nanogram level. Abdomens of culture males and females were analyzed for the presence of hydrocarbons pentadecane to octadecane. Isolation and identification of hydrocarbons was accomplished by thin layer chromatography, gas chromatography and computerized gas chromatography-mass spectrometry with mass fragmentography. Hydrocarbons ( $C_{15}$ – $C_{18}$ ) were found in both male and female abdomens. Female abdomens had greater concentrations of these hydrocarbons than male abdomens. The major attractant, heptadecane, was found in the female sciarids at a concentration of 5–6 times larger than found in the male sciarids. Recent results from our laboratory have shown that some lepidopteran and hymenopteran pheromones are present in the host plant. Therefore, the cultivated mushroom,

*Agaricus bisporus* Lange was analyzed for hydrocarbons. Hydrocarbons pentadecane to heneitriacontane were identified and their relative concentrations determined. It has been shown that the sex pheromone of the sciarid fly is not a single component but a complex mixture. Host plants are implicated as a possible origin of the pheromones.

### **Results of an Insect Scouting Program in Virginia Soybeans**

WILLIAM A. ALLEN

DEPARTMENT OF ENTOMOLOGY, VIRGINIA POLYTECHNIC INSTITUTE AND STATE UNIVERSITY,  
BLACKSBURG, VIRGINIA 26061

After 2 years of monitoring insect control decision-making practices in eastern Virginia, 2 test demonstrations were undertaken to encourage adoption of a pest management system. Unlike the 2 previous studies, a vigorous educational program was conducted with farmers. Mean per acre scouting costs were higher in both counties (Isle of Wight \$0.52; Westmoreland \$0.59) than in previous years, reflecting higher labor costs and a difference in scouting efficiency. Due to a change in objectives, it was not possible to measure the potential saving or net return on investment as in past years. Premature insecticide application was reduced from 87.2% in 1972 and 89.7% in 1973 to 0% in 1974. In addition to the demonstrations mentioned above, the first grower-financed scouting service in Virginia was adopted in Northumberland and Lancaster counties in 1974. The program included 11 farmers and 43 fields. A subjective evaluation conducted at the conclusion of the program showed the following results. Most farmers (72.9%) estimated that they saved \$4.98/acre using the scouting system. Only 8.3% of the farmers thought yields were reduced; 85% of the farmers said they would subscribe to a scouting service on a "pay as you go" basis in 1975 if it were available but only 62.5% said they would use the system if they had to do the scouting themselves. The overall response indicated grower approval.

### **Leaf Feeding Resistance to the European Corn Borer, *Ostrinia nubilalis* (Hübner) (Lepidoptera: Pyralidae), in Tropical Maize**

W. M. TINGEY, V. E. GRACEN, AND J. M. SCRIBER

DEPARTMENTS OF ENTOMOLOGY AND PLANT BREEDING, CORNELL UNIVERSITY,  
ITHACA, NEW YORK 14853

First generation or leaf-feeding resistance of maize to the European corn borer has generally been attributed to 2,4-dihydroxy-7-methoxy (2H)-benzoxazin-3 (4H)-one (DIMBOA), an aglycone that suppresses larval development and increases larval mortality. Tropical maize genotypes as low in DIMBOA

as the susceptible inbred WF9, have been shown to be as resistant to leaf feeding in field trials, as high-DIMBOA inbreds. We studied leaf feeding activity of 1st instar *O. nubilalis* on 3 inbred (WF9, B68, B49) and 2 tropical (6006: San Juan-3 × Antigua-8D; 6008: Puerto Rico-1 × Antigua-2) genotypes using free-choice and no-choice laboratory caging methods, to determine the resistance mechanisms. Using no-choice Plexiglas<sup>®</sup> tube cages or dialysis tube cages on rolled leaves, feeding rates at 12 hr intervals over a 60 hr post-caging observation period, were consistently reduced on the high DIMBOA inbred, B49, and on the tropical genotype, 6006, as compared to a susceptible inbred, WF9. Feeding was intermediately reduced on 6008 and B68, compared to WF9. When given a choice between 2 genotypes, larvae consistently preferred WF9 over the other 4 genotypes. Thus, we concluded that feeding suppression of *O. nubilalis* during the 1st stadium is probably a significant component of resistance in field-resistant tropical and inbred genotypes. Moreover, suppression of larval leaf feeding by the tropical lines, 6006 and 6008, is mediated by plant factors other than DIMBOA.

### **Visual Stimuli in the Host Finding Mechanism of the Parasitic Wasp *Itopectis conquisitor* (Say) (Hymenoptera: Ichneumonidae)**

DAVID ROBACKER, K. M. WEAVER AND L. B. HENDRY

DEPARTMENT OF CHEMISTRY, PENNSYLVANIA STATE UNIVERSITY, UNIVERSITY PARK, PA.  
16802

An investigation into the kinds of visual cues utilized by *I. conquisitor* during host finding was conducted by measuring attraction, discrimination (antennal tapping) and acceptance (probing) responses to various host and host-shelter models. To demonstrate the presence of a visual attractive stimulus, wasps were tested with sealed glass cylinders each containing a dead host pupa near one end. The other end, which remained empty, served as a control. The number of attractions to the pupa containing side was found to be significantly greater than to the empty end of the same tubes. No discriminatory behavior was elicited by these glass models. A further elucidation of visual stimuli was accomplished using construction paper and cellophane models which differed in shape and degree of transparency. All opaque models were found to be superior to their transparent counterparts in visual attracting capability. Moreover, all cylindrical models were superior to their flat counterparts in this property. With regard to discriminatory and acceptance responses, however, only cylindrical shapes appeared to be of any significant importance. The possibility that a host finding mechanism other than of a chemical nature is in operation was confirmed by the following experiment. Newly emerged females with no ovipositional experience were individually isolated for 7 days

in a chemically clean environment. After this isolation period, the wasps were released into glass beakers containing aluminum foil cylinders and their responses were recorded. Typically, the wasps showed aggressive discriminatory and acceptance behavior in less than 1 hour of testing.

## Dispersal of First-Instar Gypsy Moth Larvae in Relation to Population Quality

JOHN L. CAPINERA AND PEDRO BARBOSA

DEPARTMENT OF ENTOMOLOGY, UNIVERSITY OF MASSACHUSETTS, AMHERST, MASS. 01002

Investigations by D. E. Leonard indicated that the behavioral and physiological ecology of the gypsy moth, *Porthetria dispar* (L.), varied with the size of the eggs from which the larvae originated. Also, the ecological patterns could be shifted by certain environmental stimuli. This principle was termed population quality. Leonard suggested that dispersal was the most important parameter affected. Our investigation examined the effect of population quality on dispersal by first-instar larvae. Eggs deposited by the female gypsy moth vary in size. The first eggs deposited are largest in diameter and subsequent eggs are smaller. Laboratory dispersal studies indicate that larger eggs produce larvae that disperse more frequently than larvae from smaller eggs. However, small larvae unable to locate adequate food will disperse as frequently as large larvae. Dispersal ability of larvae declines rapidly as larvae feed and become heavier. Except at low wind velocities (less than .9 m/s), large larvae disperse greater distances than small larvae. Egg size is inversely proportional to the number of eggs per mass. Factors favoring development of large adults will induce large egg masses and lead to populations of non-dispersing larvae. Failure of large numbers of larvae to disperse from a site can lead to localized population outbreaks. In turn, high density populations produce small egg masses which produce relatively more dispersing larvae, thereby providing the inoculum for new outlying infestations.

## Identification of the Copulatory Sex Pheromone of the Little House Fly, *Fannia canicularis* (L.) (Diptera: Muscidae)

E. C. UEBEL, R. E. MENZER, P. E. SONNET, AND R. W. MILLER

DEPARTMENT OF ENTOMOLOGY, UNIVERSITY OF MARYLAND, COLLEGE PARK, MARYLAND 20742  
AND USDA, ARS, AEQI, BELTSVILLE, MARYLAND 20705

A sex pheromone that stimulates *F. canicularis* males to copulate with females was identified as (*Z*)-9-pentacosene. Cuticular lipids obtained from virgin 5-day-old female flies were used for the isolation of the active compound.

Materials were bioassayed by counting the number of copulatory attempts that occurred during a 5-minute period when pseudoflies constructed from knots of black yarn were treated with 100 or 200  $\mu\text{g}$  of the test material and presented to unmated males. Isolation, identification, and synthesis procedures were similar to those reported by Uebel et al. in 1975 (J. Chem. Ecol. 1: 195-202). All major materials in the female cuticular lipid are hydrocarbons. The major components of the unsaturated hydrocarbon are (*Z*)-9-pentacosene and (*Z*)-9-heptacosene, which make up 66.5 and 3.4% of the cuticular lipid, respectively. Approximately 25% of the cuticular lipid is straight chain saturated hydrocarbon, and 4% is branched chain saturated hydrocarbon. Five-day-old males have a "non-hydrocarbon" that makes up 27% of the total cuticular lipid. Approximately 27% of the male cuticular lipid is straight chain paraffin, 20% is branched saturated hydrocarbon, and 19% is unsaturated hydrocarbon. The pentacosene present on the male constitutes 7% of the cuticular lipid and is present as two isomers: (*Z*)-9-pentacosene (5%) and (*Z*)-7-pentacosene (95%). Only fractions containing the unsaturated hydrocarbon from the female stimulated the males to copulate, and tests with the two synthetic monoolefins found on the female showed that only (*Z*)-9-pentacosene was active.

### **Honeylocust Pod Gall Midge, *Dasyneura gleditschae* Osten Sacken (Diptera: Cecidomyiidae), Control with Dacamox®**

W. R. HARRIGAN AND J. L. SAUNDERS

DEPARTMENT OF ENTOMOLOGY, CORNELL UNIVERSITY, ITHACA, NEW YORK 14853

Increased planting of thornless honeylocust as street and shade trees and nursery production of popular varieties in large blocks has intensified problems caused by the honeylocust pod gall midge. Three varieties (Shademaster, Sunburst, and Skyline) of thornless honeylocust were side dressed with systemic insecticides on May 1 & 2, 1975 at rates of ozAI per 1000 ft. of row as follows: aldicarb 7.2 and 14.4, carbofuran- 4.4 and 8.8, disulfoton- 22.5 and 45, acephate- 6.0 and 12, and Dacamox® (3,3- Dimethyl- 1- methylthio- 2 butanone 0-methylcarbamoyloxime)- 6.0 and 12. The soil, a sandy loam with good field moisture, was cultivated just prior to treatment. It rained immediately after treatment. The granules were applied in a 2-in.-wide band and covered with ca.  $\frac{1}{2}$  in. of soil. Counts made June 17, 1975 of the number of galls on 10 shoots (each shoot had 5-10 leaves with ca. 20 leaflets per leaf) on each of 5 trees from the center of each plot indicated that only Dacamox showed promise of giving economically practical protection. Dacamox, at the high rate, reduced the number of leaf galls on the different varieties as follows: Shademaster 82%, Sunburst 50%, Skyline 71%. Percent defoliation estimated on July 23,

1975 for Dacamox vs. check, respectively, was: Shademaster 40% vs. 53%, Sunburst 17% vs. 52%, Skyline 32% vs. 54%. None of 13 toxicants applied May 2, 1975 as hydraulic sprays gave economically effective protection.

### **A Seasonal History of the Variegated Leafroller, *Platynota flavedana* Clemens (Lepidoptera: Tortricidae), in Virginia Apple Orchards**

J. H. THOMAS AND C. H. HILL

VIRGINIA POLYTECHNIC INSTITUTE AND STATE UNIVERSITY, WINCHESTER FRUIT RESEARCH LABORATORY, WINCHESTER, VIRGINIA 22601

The variegated leafroller overwinters as dormant larvae in leaf litter on the apple orchard floor. In early March larvae feed on ground cover sprouts and apple root suckers. Spring moths begin emerging in early May and are present in orchards until early July. Egg masses are laid on upper sides of apple leaves from May to July and again in late July to September. A fecundity study of 21 second generation females indicates an average of 205.7 eggs per female with 53.4 eggs per mass and 91.8% hatch. The incubation period averages 12.8 days for first generation eggs and 9.3 days for the second. Study of 154 individuals shows that most first generation larvae have 5 instars; however, some have an occasional sixth. The average time for larval development is 29.8 days. The pupal period averages 6.5 days. First generation moths begin emerging the third week of July and are present in orchards until mid-September. The life cycle averages 42.4 days for the males and 47.1 days for the females. Fruit is damaged toward summer's end and early fall by late instar larvae of the first generation and younger larvae of the following generation. These second generation leafrollers reduce their activity but continue feeding through early November. When autumn leaves fall the larvae range from second to fourth instar. In 1974 at Winchester, Virginia there occurred the end of the overwintering generation, one complete generation, and the beginning of a second generation of *P. flavedana*.

### **The Milkweed Pod as an Obstacle to the Large Milkweed Bug, *Oncopeltus fasciatus* (Heteroptera: Lygaeidae)**

CAROL PEARSON RALPH

DEPARTMENT OF ENTOMOLOGY, CORNELL UNIVERSITY, ITHACA, N. Y. 14850

In the eastern United States *Asclepias syriaca* is a common host of the monophagous *Oncopeltus*. In greenhouse experiments nymphs fed only vegetative shoots of *A. syriaca* could not grow or mature, but those provided *A. syriaca*

seeds readily did. In the field adults and nymphs feed almost exclusively on pods. However, measurements of nymph mouthparts, feeding punctures, and the spongy pod walls showed that the mouthparts of the first three nymphal instars are too short to reach seed in most mature pods. By exploring, these young nymphs sometimes find sites with thin walls where they can reach the seed. Usually they live on poorer food tapped from the green tissues and placenta of the pod. Communal feeding may be especially important during this stage in increasing food intake. Thus *Oncopeltus* can exploit this milkweed, even though the bug's critical food, the seed, is inaccessible to the young nymphs. Although adults and fifth instar nymphs can reach seed through almost any pod wall, many seeds escape *Oncopeltus* damage because pods are abundant and the bugs preferentially feed where the pod wall is thinnest, on the seeds nearest the suture and the tip.

**Growth and Development of *Hyposoter exiguae* (Viereck)  
(Hymenoptera: Ichneumonidae) on Two Instars of *Trichoplusia ni*  
(Hübner) (Lepidoptera: Noctuidae)**

EUGENE A. JOWYK AND ZANE SMILOWITZ

PESTICIDE RESEARCH LABORATORY AND GRADUATE STUDY CENTER, THE PENNSYLVANIA  
STATE UNIVERSITY, UNIVERSITY PARK, PA. 16802

Larvae of *Trichoplusia ni* (Hübner) were parasitized during phase II of either their 2nd or 4th instar by the solitary endoparasitoid, *Hyposoter exiguae* (Viereck). Beginning at 36 hr post-parasitism and continuing at 8 hr intervals thereafter, hosts were dissected and measurements of the contained parasitoid taken. *Hyposoter* larvae eclosed from eggs between 36 and 44 hr post-parasitism in both 2nd and 4th instar hosts. Four larval instars were observed, the first lasting about 2 days, the 2nd and 3rd lasting 1½ days and the 4th less than 1 day. Parasitoid head capsule widths measured 0.15, 0.34, 0.51 and 0.61 mm for those reared on 2nd instar hosts, and 0.15, 0.35, 0.54 and 0.67 mm for those reared on 4th instar hosts. Parasitoids reared on 4th instar hosts emerged to spin their cocoons between 6½ and 7½ days post-parasitism at  $26 \pm 1^\circ\text{C}$ , while those reared on 2nd instar hosts emerged a few hr later. Parasitoid adults reared on both age groups emerged 6–7 days after spinning. Adult parasitoids reared from 2nd instar hosts weighed 4.81 and 5.17 mg for males and females, respectively, while those reared from 4th instar hosts weighed 6.25 and 6.91 mg. Since host age has been shown to affect parasitoid size and developmental rate, it is important that it be taken into account when performing experiments on parasitoid fecundity, fertility and development. Otherwise a wide range of values may occur for these parameters.

## Mite Consuming Capacity of *Stethorus punctum* (Leconte) (Coleoptera: Coccinellidae)

L. A. HULL, D. ASQUITH AND P. D. MOWERY

THE PENNSYLVANIA STATE UNIVERSITY, FRUIT RESEARCH LABORATORY, BIGLERVILLE, PA.  
17307

The functional response of the predator *Stethorus punctum* (Leconte) was tested at various densities of the European red mite, *Panonychus ulmi* (Koch). One *S. punctum* adult or larva was caged with adult female mites at the following density levels: 4, 8, 12, 16, 20, 50, 80 mites/cage. The number of mites consumed was recorded every hour and the mites replenished back to the original levels. All feeding tests were conducted in a screened insectary to simulate orchard conditions. The rate of consumption of overwintered adults (spring feeding rate) rose at first with prey density, but leveled off at higher densities. The rate of consumption of the 2nd and 3rd generation adults (summer feeding rate) increased with increasing prey density with no leveling off attained. *S. punctum* larvae also exhibited an increased consumption rate as prey density was increased. At the lower density levels the larval feeding rate was higher than for male adults. As prey density increased beyond 20 mites/cage the adults were able to consume more mites. *S. punctum* adults and larvae stop feeding at dusk and resume feeding ca. 2 hrs. after sunrise. The ability of *S. punctum* to functionally respond to increasing prey density plays an important role in keeping the European red mite below economic injury levels in Pennsylvania.

## The Influence of a Juvenile Hormone Mimic (JHM) on *Trichoplusia ni* (Hübner) (Lepidoptera: Noctuidae) and *Hyposoter exiguae* (Viereck) (Hymenoptera: Ichneumonidae)

ZANE SMILOWITZ, CAROL A. MARTINKA AND EUGENE A. JOWYK

PESTICIDE RESEARCH LABORATORY AND GRADUATE STUDY CENTER, THE PENNSYLVANIA STATE UNIVERSITY, UNIVERSITY PARK, PA. 16802

The influence of Altozar<sup>®</sup>, a juvenile hormone mimic (JHM), on parasitized and unparasitized cabbage looper, *Trichoplusia ni* (Hübner), was studied. Parasitized and unparasitized *T. ni* larvae were reared on standard wheat germ diet until early 4th instar then on diet containing 0.1, 1, 2 and 4 ppm of Altozar. Larval development was essentially the same on all treatments from the 4th to the 5th instar. The 1, 2 and 4 ppm treatments of the JHM had a decided influence on the development of the unparasitized 5th stage larvae. Individuals on diet containing the higher dosages remained in the larval stage



up to 2 weeks longer than the controls and 0.1 treatment. Approximately 75% of these began a supernumerary molt into a 6th instar, but none of them pupated. About 20% of the remainder pupated. No adults were obtained from 2 and 4 ppm treatments and 2.5% from the 1 ppm treatment. *T. ni* larvae parasitized by *Hyposoter exiguae* (Viereck) developed the same on JHM and control diets. Parasitoids emerged from hosts on both diets at the same time and immediately began to spin cocoons. When JHM was topically applied at 2 and 20  $\mu\text{g}$  prior to parasitoid emergence, development was extended and adult mortality ranged from 5 to 95%. JHM generally disrupts insect development prior to the larval pupal molt. Since the parasitoids' last larval molt occurs after the host ceased feeding, apparently insufficient JHM is available to influence parasitoid development. Topical application of the JHM nearing the time of parasitoid emergence allows sufficient material to reach the parasitoid and influence development. Thus the developmental pattern of a beneficial insect must be known in order to determine the impact of a JHM.

### **Response of the Alfalfa Weevil Parasitoid, *Microctonus colesi* (Drea) (Hymenoptera: Braconidae), to a Recommended Insecticide Treatment in Pennsylvania**

A. A. HOWER, JR., AND J. E. LUKE

DEPARTMENT OF ENTOMOLOGY, THE PENNSYLVANIA STATE UNIVERSITY, UNIVERSITY PARK,  
PENNSYLVANIA 16802

Studies were conducted from 1971 to 1974 to determine the impact of recommended insecticide treatments on *Microctonus colesi*, a parasitoid of the alfalfa weevil, *Hypera postica* (Gyll) (Coleoptera: Curculionidae). Two adjacent multifarm complexes were chosen for the study. Methyl parathion was applied on all fields in one region in accordance with the recommended threshold level of 50 to 75% alfalfa tip injury or 2 wk before normal first crop harvest date. Alfalfa weevil and *M. colesi* populations were monitored weekly in 10 fields in each region during first crop growth. Immediate impact of a first crop spray of methyl parathion at  $\frac{1}{2}$  lb AI/acre 2 wk preharvest was a substantial reduction in both parasitoid and host populations in each of the 3 years of application, 1971-1973. *M. colesi* larvae in the adult weevils were the most prevalent stages of the parasitoid at the time of spraying. The impact on *M. colesi* in the adult weevils was obvious as the sprayed area contained in excess of 98% fewer adult weevils than the non-sprayed area one week post spray in each of the 3 spray years. Consequently, each spray year a significant reduction in the *M. colesi* larval population in adult weevils was observed in the sprayed region. *M. colesi* adults and immatures in weevil

larvae had just begun to materialize in the parasitoid population when the spray was applied. However, any postspray decline in adult *M. colesi* in the sprayed area resulted indirectly from earlier mortality of adult weevils harboring these parasitoids. *M. colesi* larvae in host larvae were not influenced by the spray. Their reduced numbers in the sprayed area resulted from few adult *M. colesi* available for parasitization and fewer host larvae available to be parasitized. Better coordination of insecticide sprays and *M. colesi* development is essential if *M. colesi* is to realize its maximum potential in Pennsylvania.

### **Determination of Seasonal Activity of Four Fruit Pests Using Pheromone and Other Traps**

RICHARD C. MOORE

DEPARTMENT OF ENTOMOLOGY, CONNECTICUT AGRICULTURAL EXPERIMENT STATION,  
NEW HAVEN, CONNECTICUT 06504

Pheromone traps were used for three successive seasons (1972-74) to determine activity peaks of codling moth *Laspeyresia pomonella* (L.), red-banded leafroller *Argyrotaenia velutinana* (Walker) and oriental fruit moth *Grapholitha molesta* (Busck) while traps combining attractive baits and colors were used to capture apple maggot *Rhagoletis pomonella* (Walsh) flies in sprayed and unsprayed apple trees. Oriental fruit moth, codling moth and apple maggot were more abundant in unsprayed than in sprayed apple trees. Red-banded leafroller was as abundant or more abundant in sprayed than unsprayed trees. Oriental fruit moth was captured over a period of 20 weeks with 3 activity peaks occurring in May, July and September. Capture of red-banded leafroller indicated 3 activity peaks for male moths occurring during a 22-week emergence period. Emergence and peaks of first generation moths occurred one month earlier in 1974 than in 1972. Codling moth adults were active over a 16-week period with 2 peaks in early June and August. Apple maggots emerged over a 9-week period with a single peak occurring in mid-July or early August. Comparison of activity peaks of these moths over a 3-year period with spray intervals currently being used in Connecticut orchards indicated that modifications could be made using alternate middle row or extended interval spraying to reduce pesticide use while controlling the apple orchard pests. A reduced spray program in 1973 and 1974 resulted in less than 1.0% fruit damage by these pests.

## Depth Selection in *Buenoa* (Heteroptera: Notonectidae)

STEVEN H. GITTELMAN

DEPARTMENT OF ECOLOGY, BIOLOGICAL SCIENCES DIVISION, UNIVERSITY OF CONNECTICUT,  
STORRS, CONN. 06268

The coexistence of similar species depends on the division of resources. While resource sharing between sympatric congeneric species has attracted much attention, little information exists on how species of *Buenoa* coexist. This study documents micro-habitat separation in *B. margaritacea* and *B. confusa* by selection of different swimming depths. *Buenoa confusa* swims closer to the surface than *B. margaritacea*. Generally, nymphs of these species swim deeper as they mature. The duration of a dive changes ontogenetically and differs between species in a manner similar to that of swimming depth. The two phenomena seem related. It is proposed that swimming depth and dive duration depend on the amount of hemoglobin carried rather than physical gill efficiency. Selection of the depth of water for swimming (as opposed to swimming depth below the surface) differs between life-history stages and species. Nymphs and species that swim closer to the surface enter shallow water more often. Swimming depth affects prey selection. In shallow water (12cm) both species prefer the same prey (*Daphnia*). In deep water (28cm) prey selection differs, with each predator preferring prey items in its preferred depth range.

## Rearing the European Corn Borer, *Ostrinia nubilalis* (Hübner) (Lepidoptera: Pyralidae) on a Lima Bean Medium

G. D. CURL, P. P. BURBUTIS, AND C. P. DAVIS

DEPARTMENT OF ENTOMOLOGY AND APPLIED ECOLOGY, UNIVERSITY OF DELAWARE,  
NEWARK, DELAWARE 19713

Our attempts (1971-72) to rear European corn borer, *Ostrinia nubilalis* (Hübner), collected in southern Delaware, on the meridic diet used at the Corn Borer Investigations Laboratory, Ankeny, Iowa, were unsuccessful. With modifications, an oligidic diet, previously used to rear cabbage looper, *Trichoplusia ni* (Hübner), has proven highly satisfactory. The primary ingredient is dried "baby" lima beans. Brewer's yeast, agar, methyl *p*-hydroxybenzoate, ascorbic acid, Fumidil B, formaldehyde (37%), and distilled water constitute the remainder of the diet. The larvae are reared at LD 15:9, 30°C and 20°C, respectively. The following characterizes the colony under routine rearing conditions. Egg viability averages over 90%. Eighty-one percent of the larvae pupate in corrugated cardboard rolls above the media. Adult emergence averages 91%. Individual females lay an average of 22.1 egg masses (ca. 20 eggs/

mass) over a period of 12.5 days. A comparison of the first seven generations of a colony started in 1974 with the last seven generations (i.e. F26-F32) of a colony started in 1971 showed no significant ( $p = .05$ ) difference in number of egg masses produced per female. Larvae, from one colony, were tested for survival on corn plants after 20 and 30 laboratory generations. Results indicate no difference in survival as compared to "wild" borers. Diapause induction and termination studies showed no significant ( $p = .05$ ) difference between a colony reared for 31 generations and a colony reared for five generations.

**Application of Harmonic Analysis and Polynomial Regression to  
Study Flight Activity of *Choristoneura fumiferana* (Clem.)  
(Lepidoptera: Tortricidae) in the Field**

G. A. SIMMONS AND C. W. CHEN

DEPARTMENT OF ENTOMOLOGY AND DEPARTMENT OF MATHEMATICS, UNIVERSITY OF MAINE,  
ORONO 04473

Counts of male and female budworm moths captured in aerial Malaise traps were obtained every hr continuously for 1344 trap hrs over 14 days of study. Captures averaged 12.6/h and 4.4/h and ranged from 0 to 183/h and from 0 to 82/h per trap respectively for males and females. Harmonic analysis showed the circadian rhythm of male activity could be described by  $P_t = 12.560 - 11.431 \cos(2\pi t/24) - 6.156 \sin(2\pi t/24) + 5.273 \cos(4\pi t/24) + 6.199 \sin(4\pi t/24)$  and the circadian rhythm of female activity by  $P_t = 4.438 - 5.789 \cos(2\pi t/24) - 0.558 \sin(2\pi t/24) + 3.598 \cos(4\pi t/24) + 0.941 \sin(4\pi t/24)$  where  $P_t$  is the mean number of captures in the hr interval and  $t = 0$  corresponds to 0800 EDST (and  $t = 0, 1, 2, \dots, 23$ ). Peak activity occurs at 2152 EDST and 2021 EDST respectively for males and females. The amplitude of male activity is ca. twice that of the female. Polynomial stepwise regression of residuals ( $r_t = P_t - Y_t$ ) vs weather identified inter-correlated variables influencing activity. A study of partial derivatives with respect to weather variables showed complex interactions with humidity, cloudiness, rainfall, wind velocity, and barometric pressure change. Males and females differed considerably in their response. Circadian rhythms are interpreted as gross adjustments to average environmental conditions; and reaction to weather is interpreted as fine adjustments of the population to specific environmental conditions.

## Mosquito Control in Unusual Breeding Sites in Southern Italy (Diptera: Culicidae)

JOHN L. McDONALD

NAVY ENVIRONMENTAL AND PREVENTIVE MEDICINE UNIT No. 7, Box 41, FPO,  
NEW YORK 09521

Mosquito problems in the Mediterranean area are characteristically influenced by both climate and culture. Irregular rainy periods have resulted in the use of a variety of cisterns, irrigation systems (often aqueducts) and catchment areas for water storage during dry periods. Unusual mosquito breeding sites are found in many buildings, caves and temples, commonly referred to as "ancient ruins." In some instances, some of these "ancient ruins" have become altered by age or partly sunken over long periods of time due to nearby geological activity causing the formation of lakes, ponds and slow-moving streams, all which have become ideal mosquito breeding sites. Because so many of the mosquito breeding sites are contained within historical landmarks, mere access to them often requires significant effort. Conventional remedial means such as draining, filling or spraying with insecticide would be imprudent, contaminating, or impractical. Use of mosquito fish, *Gambusia affinis* has been useful in resolving some of the mosquito breeding site problems. In the many elaborate irrigation systems, mosquito breeding sites coexist with water wastage or poorly managed water. Increasing cost of water for irrigation has done much to mitigate this problem.

## Temefos Residues in the Salt Marsh Snail *Melampus bidentatus* Say (Bassomatophora: Ellobiidae)

GEORGE FITZPATRICK AND DONALD J. SUTHERLAND

DEPARTMENT OF ENTOMOLOGY AND ECONOMIC ZOOLOGY, RUTGERS UNIVERSITY,  
NEW BRUNSWICK, N.J. 08903

Uptake of the mosquito larvicide temefos by populations of the salt marsh snail *Melampus bidentatus* in the field was measured by gas chromatographic analysis. Snails exposed in the field to temefos treatments as applied in normal mosquito control work were placed on ice and taken to the laboratory for analysis. Temefos was extracted in dichloromethane and cleanup was performed with hexane and acetonitrile. Uptake of measurable levels of temefos occurred within one day after the first treatment of a 2% granular formulation. A longer period of time, 3 weeks, elapsed before uptake following treatment with a temefos emulsion. Residues in samples of snails exposed to the granular

formulation were generally around 1 ppm, with residues measured as high as 8.75 ppm in one sample. Residues were considerably lower in snails exposed to the emulsion. The highest residue was 0.059 ppm in this case. Residues in snails exposed to the emulsion fell below detectable levels in less than 3 weeks following cessation of treatments, while measurable amounts were found in snails exposed to the granular formulation for more than 5 weeks after the last treatment. Detection of temefos in *M. bidentatus* for such long periods suggests the potential for movement of this insecticide through food webs exposed to the granular formulation.

**Bionomics of the Tufted Apple Budmoth, *Platynota idaeusalis*  
(Walker) (Lepidoptera: Tortricidae), in Pennsylvania  
Apple Orchards**

WILLIAM M. BODE

PENNSYLVANIA STATE UNIVERSITY FRUIT RESEARCH LABORATORY, BIGLERVILLE, PA. 17307

*P. idaeusalis* is a leafroller which is a major pest of apple in Pennsylvania and areas to the south. Larvae consume tissue from leaves and the surface of fruit. Larvae are difficult to control with insecticides because many are hidden in protected places which spray does not reach. There are two broods annually with second brood larvae overwintering. Eggs are laid on the upper surface of apple leaves in flat green masses which contain an average of 70 to 80 eggs. Eggs for the first brood are laid during June and the first half of July. First brood larvae develop during June and July, and some even into August. Eggs for the second brood are laid during August and September. Second brood larvae do more damage to apples because they are more numerous and the apples are larger. Also, growers tend to terminate insecticide applications too early to protect fruit from all larvae. Larval feeding on apples is finally ended by the harvesting of the fruit. Larvae of all instars overwinter in leaf litter under trees; they do not diapause, and may feed on ground vegetation whenever the temperature is high enough to permit activity. Natural biological control agents include some hymenopterous parasites of eggs and larvae, a tachinid parasite of larvae, some virus diseases, and probably some predators. A synthetic sex attractant may be used to detect male moths and monitor their seasonal flight periods.

**Parasitization of the spruce budworm, *Choristoneura fumiferana* (Clemens) (Lepidoptera: Tortricidae) by *Brachymeria intermedia* (Nees) (Hymenoptera: Chalcididae)**

DAVID E. LEONARD

DEPARTMENT OF ENTOMOLOGY, UNIVERSITY OF MAINE, ORONO 04473

The introduced parasitoid *Brachymeria intermedia* attacks the gypsy moth in Maine, and laboratory studies (Minot and Leonard, p. 269) show that it will parasitize spruce budworm pupae. No recoveries were made in spruce budworms after limited field releases of this parasitoid in mature stands of spruce and balsam fir in 1973 and 1974. To facilitate observations and sampling, the 1975 release was made in a spruce budworm infested 2 ha plantation of 3 to 5 m white spruce in Shin Pond, ME. On 23 Jun, when 35% of the budworm had pupated, 14,000 *B. intermedia* were released along a 28 m transect. The weather during the period of spruce budworm pupation and adult emergence was warm, with highs in the 33°C range, and clear or partially cloudy days. Activity of the released parasitoids was assessed by counting the number of adults observed in 10 min searching of trees in the area of release. Parasitism was determined by collecting and rearing 5453 spruce budworm pupae in the release area, and 2743 pupae in trees 10 to 20 m from the release points. Two days after release, *B. intermedia* were observed up to 74 m from the nearest release site, but most adults were observed in or immediately adjacent to the release area, flying about the tree terminals and occasionally landing. Ten min counts of parasitoids between 24 Jun and 2 Jul ranged from 1 to 53, with the lowest counts in the morning between 0830 and 1030 hr. In the release area, 18.2% of the spruce budworm pupae yielded *B. intermedia* adults, and in the adjacent area, 11.7%. The percentage mortality is considerably higher than the total native pupal parasitoid complex. The sex ratio of the recovered parasitoids favored males by 3:1, and may be related to the smaller size and limited food reserves of the host pupae. This aspect is currently being studied.

**Influence of Physical Factors on the Behavior and Development of *Brachymeria intermedia* (Nees) (Hymenoptera: Chalcididae)**

MILDRED C. MINOT AND DAVID E. LEONARD

DEPARTMENT OF ENTOMOLOGY, UNIVERSITY OF MAINE, ORONO 04473

*B. intermedia* is a polyphagous endoparasite of Lepidoptera pupae. This primary, solitary parasitoid has been successfully introduced into gypsy moth populations in North America. This study tested the response of the parasitoid

to physical factors and developmental rates in gypsy moth pupae at different temperatures. Adult parasitoids were exposed to a temperature gradient that ranged from 22° to 31°C. They were exposed to a humidity gradient that ranged from 11% to 90% relative humidity. Geotactic, phototactic and olfactory reactions, and diel periodicity were also investigated. *B. intermedia* preferred temperatures between 26.5° and 28.5° and preferred the dry end of the humidity gradient. They were positively phototactic and inactive in the dark. No geotactic or olfactory responses were detected. They were most active between 1300 and 1700 hr. There was considerable unexplained mortality among pupae exposed to the parasitoid. The same number of hosts were killed at all 3 developmental temperatures, but twice the number of *B. intermedia* emerged at 28° as at 23°. At 18° only 3 parasitoids emerged from 120 exposed pupae. These experiments confirm field observations of several workers that *B. intermedia* is attracted to a warm, dry physical environment subjected to high lux. Adults are most active in the afternoon when the above conditions are more likely to be encountered. Development is most rapid and successful at the highest temperature investigated, 28°.

### **The Use of Autoradiography to Detect RNA in Polyhedral Inclusion Bodies of Insect Nuclear Polyhedrosis Viruses**

SALLY B. PADHI AND ARTHUR H. MCINTOSH

WAKSMAN INSTITUTE OF MICROBIOLOGY, RUTGERS UNIV., NEW BRUNSWICK, N.J. 08903

Nuclear polyhedrosis viruses (NPVs) which infect Lepidoptera are DNA viruses of potential use as biological control agents. There have been several reports that RNA is in the polyhedral protein which surrounds the NPV particles but definite proof of its presence and/or source is lacking. An attempt was therefore made to apply autoradiography to ascertain whether RNA is present in PIBs. The *Trichoplusia ni* (cabbage looper) cell line of Hink was infected with *Autographa californica* (alfalfa looper) NPV and labeled with H<sup>3</sup>-uridine (RNA specific). Tritium labeled thymidine was used as a positive control and H<sup>3</sup>-glutamic acid and H<sup>3</sup>-glucosamine were used in other treatments. Procedures were developed for extraction of PIBs from the cells, and slides were prepared for autoradiography. Because of the small size of PIBs and their adherence to the cells, difficulties prevented the gathering of conclusive results. Autoradiograms contained labeled cellular debris which prevented a clear demonstration of whether or not the PIBs are labeled. Indications are that there is little or no labeling on PIBs produced in the uridine labeled cells, thus suggesting that PIBs do not contain RNA. However, owing to cellular debris on the slides it was quite difficult to detect labeled PIBs in the positive control (thymidine treatment). In conclusion, it is necessary



to improve methods of PIB purification without losing portions of the PIB which might be labeled. Autoradiography should then be a useful method to apply to the question of whether or not RNA is present in PIBs.

**A Toxic Factor from the Established Cell Line, CP-169 (Hink):  
*Carpocapsa pomonella* (Lepidoptera: Olethreutidae)**

CAROL RECHTORIS AND ARTHUR McINTOSH

BOYCE THOMPSON INSTITUTE, YONKERS, N.Y. 10701, AND RUTGERS UNIVERSITY,  
NEW BRUNSWICK, N.J. 08903

Spent media recovered from 5 out of 8 different insect cell lines contain factors toxic to the established cell line, TN-368 (Hink) (*Trichoplusia ni*) (Lepidoptera). The highest concentration was detected in media from CP-169 cultures. Both the TN-368 and the CP-169 lines have been adapted to TC199-MK (McIntosh *et al.*, 1973). Vertebrate cell lines proved not to elaborate material toxic to TN-368 cells. The toxic factor, designated CpT, is elaborated by CP-169 cells into the growth media. Supernatant media from freshly washed cultures were non-toxic for TN-368 cells. However, if such treated cultures were incubated for 24 hours, the toxic factor could be detected in the media. In addition, extracts from ruptured washed cells proved to be toxic. TC199-MK incubated at 30°C. for 3 months was non-toxic. CpT is filterable (.22 $\mu$ m Millipore filter), and is inactivated at 80°C. for 30 minutes. It has a low molecular weight, as shown by centrifugation, and the Cytotoxic Dose Fifty of a pooled sample is 10<sup>3.25</sup> units/ml. CpT is believed to be a non-infectious agent since it cannot be passaged in TN-368 cells. Furthermore, electron microscopy of inoculated cultures revealed no virus or other infectious microbes, and cultures tested negative for mycoplasmas. The early appearance of a toxic effect 6 hours post inoculation, suggests a toxin.

**Changes in Tolerance of *Porthetria dispar* (L.) (Lepidoptera:  
Lymantriidae) to Insecticides in Relation to Larval Growth  
and Mixed-Function Oxidase Activity**

SAMI AHMAD AND ANDREW J. FORGASH

DEPARTMENT OF ENTOMOLOGY AND ECONOMIC ZOOLOGY, RUTGERS UNIVERSITY,  
NEW BRUNSWICK, N.J. 08903

*In vitro* investigations have demonstrated mixed-function oxidase (MFO) activity in several tissues of gypsy moth larvae (Insect Biochem. 3:263, 1973; Int. J. Biochem. 5:11, 1974). The gut MFO activity, which is 67.8% of the total activity, rises markedly during larval development. The increase in the

specific activity of this enzyme system in the fifth instar is ca. fivefold over the third instar (J. Insect Physiol. 21:85, 1975). The present communication reports the investigations on the effects of increase in the MFO activity on the susceptibility of advancing instars of gypsy moth larvae to carbaryl and diazinon. Topical tests showed that there is a continued increase in tolerance to carbaryl and diazinon with larval growth, with the result that 5th-instar larvae can tolerate 25× as much carbaryl and 50× as much diazinon as 2nd instars at the LD<sub>50</sub> level; on a weight basis the tolerances are 1.9 and 4.5×, respectively. There is also a substantial increase in tolerance with growth within instars, but this is largely correlated with size. Piperonyl butoxide and 2,6-dichlorobenzyl-2-propynyl ether, inhibitors of MFO activity, are ineffective against 2nd instars, but with subsequent instars the activity increases greatly so that by the 5th instar only one-fifth the usual dose of carbaryl is needed to kill a larva when applied in combination with the propynyl synergist. The increase in tolerance to carbaryl and diazinon with larval growth, as well as increase in synergist efficacy, therefore, correlates with increases in MFO activity in advanced instars.

### **Oxygen Consumption of *Coleomegilla maculata lengi* Timberlake (Coleoptera: Coccinellidae) Measured in a Differential Respirometer**

MARK E. WHALON AND BRUCE L. PARKER

DEPARTMENT OF ENTOMOLOGY, UNIVERSITY OF VERMONT, BURLINGTON, VERMONT 05401

A Gilson differential respirometer was used to measure O<sub>2</sub> consumption of adult female *C. maculata*. The respirometer had the capability of simultaneously measuring O<sub>2</sub> uptake in 14 separate vials. Field-collected beetles were tested singly and in groups of 10. Their respiration was monitored for 6 hr at 15 min intervals at each of 4 different temperatures; 6°, 12°, 18° and 24°C. At 24°C the respiration of beetles tested singly could accurately be determined. At reduced temperatures the differential respirometer fluctuated significantly thus introducing variation in excess of 0.01 μl O<sub>2</sub>/mg/15 min. If 10 beetles were placed in each vial at 6°C variation was minimized and O<sub>2</sub> consumption could be measured. An O<sub>2</sub> consumption curve was established. Q<sub>10</sub> values were similar to those reported for other insects. Oxygen consumption for *C. maculata* was 0.042 ± 0.013 μl O<sub>2</sub>/mg/15 min at 6°C, 0.10 ± 0.005 at 12°C, 0.158 ± 0.011 at 18°C, and 0.316 ± 0.046 at 24°C. A Gilson respirometer can be used to measure O<sub>2</sub> consumption (at 24°C) of adult female *C. maculata* tested individually, but accuracy was decreased and variation increased as temperatures were reduced. If 10 beetles per vial were used the variation in O<sub>2</sub> consumption measurements was minimized. Adult

female field-collected *C. maculata* respired at levels from  $0.042 \pm 0.013 \mu\text{l O}_2/\text{mg}/15 \text{ min}$  at  $6^\circ\text{C}$  to  $0.316 \pm 0.046 \mu\text{l O}_2/\text{mg}/15 \text{ min}$  at  $24^\circ\text{C}$ .

## **A Phylogeny for *Paracymus* Thomson (Coleoptera: Hydrophilidae) Based on Adult Characters**

DAVID P. WOOLDRIDGE

PENNSYLVANIA STATE UNIVERSITY, OGONTZ CAMPUS, ABINGTON, PA. 19001

An analysis of adult characters reveals that the 69 known world species of *Paracymus* fall into 6 distinct groups which, on the basis of distribution data, appear likely to be monophyletic. The characters examined included the form of the male genitalia, modifications of the male protarsi, the number of antennal segments, the form of the mesosternal modifications, the extent of mesofemoral pubescence, dorsal punctation and pigmentation, and the extent of development of a carina on the first visible abdominal sternite. Two species groups, restricted to the New World, have the penis very flattened in cross-section, the antennae 7 segmented and the mesosternal lamina well developed and reaching the mesosternal crest. In the *elegans* group, containing 15 species, the mesofemoral pubescence reach nearly to the knees, while the *nanus* group, with 7 species has the mesofemoral pubescence restricted to a basal triangle. In all other groups, the penis is thickened in cross-section, the antennae have from 7 to 9 segments, and the mesosternal lamina is less well developed. The *evanescens* group consists of 23 Old World species with rounded parameres and reduced mesofemoral pubescence. Two groups with extended mesofemoral pubescence are found in both hemispheres, although both are primarily New World. The *aeneus* group with 8 species has the parameres flattened in cross-section. The *subcupreus* group consists of 15 species with rounded parameres. The *secretus* group contains a single New World species with no mesofemoral pubescence.

## **Intra-instar Respirometric and Phase Distribution Differences in *Trichoplusia ni* (Hübner) (Lepidoptera: Noctuidae) Larvae**

DOUGLAS G. BAUGHER AND WILLIAM G. YENDOL

PESTICIDE RESEARCH LABORATORY AND GRADUATE STUDY CENTER AND DEPARTMENT OF  
ENTOMOLOGY, THE PENNSYLVANIA STATE UNIVERSITY, UNIVERSITY PARK,  
PENNSYLVANIA 16802

When investigations dealing with lepidopterous larvae are reported, the age, instar, or weight are used for identification. With *Trichoplusia ni*, larvae of a

given age have weights which are normally distributed, but the individuals may be distributed into more than one instar. Since the physiological state of a larva is not necessarily represented by age or instar, it is important to delineate any metabolic differences among larvae, and to determine the daily distributions of larvae by instar and phase within the stadium. A Gilson Differential Respirometer was used to measure respirometric rates of 4th and 5th instar *T. ni* 8 through 14 days post-eclosion. Larvae were morphologically segregated into 5 phases for each instar. Larval phase distribution within 4th and 5th instar could not be reliably predicted by age, and random selections did not yield reproducible phase proportions. Respirometry demonstrated significant differences between instars, and phases within the instars when rates were determined by  $\mu\text{l O}_2/\text{mg wet weight/hr}$ . When respiratory activity was assessed by accumulating the respiratory rates and fitting a regression line,  $y = bx + c$ ,  $c = 0$ , the slopes ranged from 0.41 to 0.93, depending upon the phase and instar. All regression lines had low residual mean squares,  $r\text{-squared} > 0.95$ , and were significant at  $p < 0.01$ . *T. ni* larvae did not follow a general trend of reduced respiration as age or weight increased. Respiratory rate appeared to be phase dependent. Since the phases within an instar were neither predictable by age nor were they metabolically homogeneous, experimental precision may be increased by designing tests with similar phase distributions of larvae in each treatment. This may be necessary to obtain meaningful comparisons or reproducible results if the physiological states of the insects can alter treatment effects.

### **The Oenocytes of *Tenebrio molitor* Linnaeus (Coleoptera: Tenebrionidae)**

JACK COLVARD JONES AND DOROTHY HOELZER

DEPARTMENT OF ENTOMOLOGY, UNIVERSITY OF MARYLAND, COLLEGE PARK, MARYLAND  
20742

The large, conspicuous, naturally yellow-colored, ectodermally derived oenocytes of *Tenebrio molitor* were studied in freshly dissected larvae, pupae and adults in unstained saline whole mounts, and were examined with ordinary light and with phase optics at magnifications of 50 to 1,000 times. The cells did not pick up any of a series of dyes (neutral red, ammonia carmine, pure carmine, trypan blue, alcian blue, methylene blue, toluidine blue or India ink) after these had been injected in varying concentrations into the hemolymph. On the other hand, the pericardial cells quickly absorbed these dyes. The fat bodies did not incorporate any of the dyes. The oenocytes showed no con-

spicuous cytological changes in either number, color or configuration relative to larval ecdysis, pupation, or maturation of eggs. Females with undeveloped, developing, and fully developed oocytes had oenocytes which were of the same general appearance as those in females which had recently laid their eggs. It is concluded from this study that the oenocytes of the mealworm do not form a part of an atrophic system. Although the oenocytes are reported to produce a cuticular material near the time of ecdysis, and are said to be important in the development of the eggs, and are supposed to secrete a hemolymph protein, and are claimed to secrete ecdysone in some species, these cells in the mealworm exhibit no striking changes in their general anatomy which would lend support to their participation in any of these activities.

### **Symposium: "Solving Insectary Production Problems"**

M. A. HOY, MODERATOR

THE GENETIC IMPLICATION OF INSECT MASS REARING PROGRAMS,  
G. BUSH, UNIVERSITY OF TEXAS, DEPARTMENT OF ZOOLOGY,  
AUSTIN, TEXAS

MONITORING THE QUALITY OF LABORATORY-REARED INSECTS,  
M. B. HUETTEL, USDA, ARS, GAINESVILLE, FLORIDA

IMPROVING THE QUALITY OF LABORATORY-REARED INSECTS,  
M. A. HOY, USDA, FOREST SERVICE, NEFES,  
HAMDEN, CONNECTICUT

### **Genetic Changes Occurring in Flight Muscle Enzymes of the Screwworm Fly During Mass Rearing**

G. L. BUSH

DEPARTMENT OF ZOOLOGY, UNIVERSITY OF TEXAS, AUSTIN, TEXAS 78712

A preliminary population genetic study of genetic variation in laboratory and natural populations of the screwworm fly by gel electrophoresis of enzymatic and non-enzymatic proteins representing 36 presumptive loci revealed extensive differences in both allele frequency and the degree of heterozygosity. Further analysis indicated that the most rapid changes occurred during factory colonization in enzymes important to flight muscle metabolism and flight activity such as  $\alpha$ -GDH and PGM. The fact that all factory-adapted strains eventually end up with similar genetic structure and greatly reduced genetic variability indicates that factory rearing conditions are exerting strong selection pressures for a "factory type."

Because screwworm adults are capable of dispersing long distances and mating may occur in the air or require some flight activity, monitoring for changes in enzyme systems essential to normal flight activity could prove to be a sensitive system for maintaining vigorous factory strains. Lab strains could also be tailored to fit changing environmental conditions between summer and winter using specific alleles.

### **Monitoring the Quality of Laboratory-Reared Insects**

M. D. HUETTEL

INSECT ATTRACTANTS, BEHAVIOR AND BASIC BIOLOGY RESEARCH LABORATORY,  
USDA-ARS, GAINESVILLE, FLORIDA 32601

The process of monitoring implies the use of a warning system with an element of periodicity. To be useful a monitoring system must be applicable on a routine basis, subject to the constraints of reproducibility, simplicity and economy. The quality of any particular trait may be defined as the difference between the trait in a wild insect and a laboratory insect. The overall quality of the laboratory insect, however, can only be measured in terms of how well it functions in its intended role when released into the field. It is the quality of traits which we usually attempt to measure with a monitoring system.

Laboratory insects should possess certain rather specific traits to perform well in the field. They should have life histories similar to the wild population. They must be able to disperse from the release site, find and utilize locally available nutrients, and locate mating sites (host plants and pheromones) or hosts or prey. They must be able to court and mate successfully in most cases. During their life span in the field they must also be able to survive local climatic conditions and avoid predators.

Each of these traits should be amenable to monitoring in the laboratory or field. Emphasis will be placed on identifying the monitoring system most applicable to each trait and its state of development as a useful method. Finally the possibilities for, and difficulties of, extrapolation from trait quality to field performance will be discussed.

### **Improving the Quality of Laboratory-Reared Insects**

M. A. HOY

USDA, FOREST SERVICE, NORTHEASTERN FOREST EXPERIMENT STATION,  
HAMDEN, CONNECTICUT 06514

Genetic improvement of insects has generated only a moderate amount of discussion in recent years because the problems of *maintaining* genetic quality have not been solved. However, certain insects have been improved genetically.

"Domesticated" insects such as honeybees and silkworms have long associations with man and have been improved in many ways. Some parasitoids have also undergone selection to improve insectary production and/or field effectiveness.

Parasitoids, or any insects destined to survive and reproduce in a natural environment, present particularly difficult problems for an improvement program. Desirable attributes to be selected must be clearly definable. Adequate genetic variability must be provided to allow selection to operate. Adequate selection procedures are a must. Finally, maintenance of the integrity of the improved strains under field conditions may need to be provided for.

Heterosis has been largely ignored in genetic improvement programs, except for the spectacular improvements exhibited in silkworm and honeybee improvement programs. Some data suggest that heterosis may be useful to improve the effectiveness of inoculative or inundative releases of parasitoids or predators. There is yet inadequate experimental evidence to judge the *general* value of selection and hybridization for improving insects. Future field testing will demonstrate the value of such improvement methods.

### **Symposium: Biosystematics**

GORDON GORDH, MODERATOR

SYSTEMATICS AND ECOLOGY OF CHRYSOPIDAE (NEUROPTERA): THEORETICAL AND APPLIED IMPLICATIONS. CATHERINE A. TAUBER AND MAURICE J. TAUBER, DEPARTMENT OF ENTOMOLOGY, CORNELL UNIVERSITY, ITHACA, N.Y. 14853

SOME EVOLUTIONARY TRENDS IN THE CHALCIDOIDEA (HYMENOPTERA) WITH PARTICULAR REFERENCE TO HOST PREFERENCE. GORDON GORDH, SYSTEMATIC ENTOMOLOGY LABORATORY, AGR. RES. SERV., USDA.

TERRITORIALITY IN MALE BEES (HYMENOPTERA: APOIDEA). EDWARD M. BARROWS, DEPARTMENT OF BIOLOGY, GEORGETOWN UNIVERSITY, WASHINGTON, D.C. 20057

### **Systematics and Ecology of Chrysopidae (Neuroptera): Theoretical and Applied Implications**

CATHERINE A. TAUBER AND MAURICE J. TAUBER  
DEPARTMENT OF ENTOMOLOGY, CORNELL UNIVERSITY, ITHACA, N.Y. 14853

The family Chrysopidae—green lacewings—is a member of one of the most primitive holometabolous orders (Neuroptera), and clarification of the evolu-

tionary changes within the Neuroptera is not only of intrinsic value and interest, but it can contribute to an understanding of the evolution of the more highly evolved insect orders. In addition to their taxonomic value, many chrysopid species are useful as subjects in ecological-physiological studies, and as important predators in integrated control programs in various agricultural ecosystems.

Our recent investigations with the Chrysopidae encompass 4 categories: systematics, phenology, behavior, and biological control. The systematics work is based on a classical, comparative morphological approach and on data derived from experimental studies in phenology and behavior. By combining the results of morphological and experimental studies, we not only broaden the basis for the classification and thus advance the systematics of the group, but we also provide information essential to the use of Chrysopidae (e.g. chrysopid strains) as biological control agents (1).

Specifically, in the area of systematics, our studies with the Chrysopidae represent the 3 levels or stages of biological classification:

1. *alpha* taxonomy—The larvae of most North American species have not been described. To promote species identification, we have reared and studied larvae of most North American species and the process of description is well underway (2,3,4).
2. *beta* taxonomy—Comparative analyses of the larval morphology (3,4) and the biological characteristics of adults and larvae (5,6) provide a basis for a sound classification and for keys to the taxa.
3. *gamma* taxonomy—The phenological adaptations of geographically diverse populations are valuable indicators of species-complexes and evolutionary trends within the genus *Chrysopa*. Phenological studies, in combination with hybridization tests, contribute to an understanding of the genetic diversity and the evolutionary history of geographic populations (7).

Success or failure of biological control projects depends in large part on the degree to which selected strains of beneficial species are adapted to biotic and abiotic factors of particular environments. Our recent investigations have led to the recognition of strains or races within geographically diverse chrysopid species that are currently used as biological control agents. These strains are characterized on the basis of morphological, phenological and behavioral criteria (7,8), and our studies show that some of these strains are better adapted than others to particular localities and particular agricultural ecosystems (9).

#### Literature Cited

- TAUBER, M. J., AND TAUBER, C. A. 1976. *Ann. Rev. Entomol.*, **21**: (in press).  
TAUBER, C. A. 1969. *Univ. Calif. Publ. Entomol.*, **58**: 1-94.  
———. 1974. *Canad. Entomol.*, **106**: 1133-1153.



- . 1975. *Ann. Entomol. Soc. Amer.*, **68**: 695–700.
- TAUBER, M. J., AND TAUBER, C. A. 1974. *Canad. Entomol.*, **106**: 921–925.
- . 1974. *Canad. Entomol.*, **106**: 969–978.
- TAUBER, C. A., AND TAUBER, M. J. 1973. *Canad. Entomol.*, **105**: 1153–1167.
- TAUBER, M. J., AND TAUBER, C. A. 1973. *J. Insect Physiol.*, **19**: 729–736.
- . 1975. *Canad. Entomol.*, **107**: 589–595.

## Some Evolutionary Trends in the Chalcidoidea (Hymenoptera) with Particular Reference to Host Preference

GORDON GORDEH

SYSTEMATIC ENTOMOLOGY LABORATORY, IIBIII, AGR. RES. SERV., USDA  
c/o U.S. NATIONAL MUSEUM, WASHINGTON, D.C. 20560

Taxonomically, the parasitic hymenopteran superfamily Chalcidoidea is among the most poorly known within the Insecta because the number of systematists working on the group is small, the group is large, and progress has been slow. Presently, we recognize about 1,220 genera and 9,950 species of chalcidoids. Hosts for 27% of the genera are unknown.

I believe this superfamily ultimately will be recognized as numerically the largest and biologically most diverse insect group. Several sources of information and lines of reasoning lead me to this conclusion: (1) the chalcidoid host spectrum extends from ticks and spiders to aculeate Hymenoptera. (2) Rapid genetic recombination of superior genotypes and subsequent speciation has been accelerated among chalcidoids because generation time is short (sometimes less than 8 days), they possess several modes of parthenogenesis (arrhenotoky, thelytoky, deuterotoky), and intensive inbreeding via sibmating is widespread. (3) Chalcidoids demonstrate several host-exploitation strategies: they develop as obligate egg parasites, larval parasites, pupal parasites, egg-larval parasites, larval-pupal parasites, and many species are obligate or facultative hyperparasites. Thus, each insect species represents several potential niches for parasitic chalcidoids. Also, phytophagy has evolved several times in the Chalcidoidea. (4) Chalcidoids display a finite number of morphological types, but there are no *a priori* reasons why morphological criteria must accompany the species status; sibling species are abundant in the Chalcidoidea. (5) The Neotropical, Ethiopian, Oriental and Australian faunas are almost totally unknown.

Analysis of generic and suprageneric levels in the taxonomic hierarchy shows that different taxa of chalcidoids have adopted different progenative strategies, which are categorized as specialists, generalists and opportunists. Specialists attack a specific host-taxon, such as a genus or family (*Desantisca* spp. on *Latrodectus* spp.; *Chalcis* spp. on Stratiomyiidae); generalists prefer a habitat rather than a taxonomically cohesive group of hosts (*Zagrammosoma* spp. on

leaf mining Lepidoptera and Diptera); opportunists also have host spectra that transcend ordinal and class limits, but they are not restricted to a particular habitat (*Dibrachys* spp., *Tetrastichus* spp.).

Analysis of chalcidoid biotic potential at the family level, based on parasite-taxa size, indicates that some exploitation strategies are more successful than others. Two families (Trichogrammatidae, 64 genera, 369 species; Mymaridae 59 genera, 794 species) are exclusively egg parasites and attack many host orders. The Encyrtidae (491 genera, about 1,700 species) have focused on the Homoptera, especially scale insects, and are among the most successful groups of parasites. The Pteromalidae (233 genera, about 1,400 species), while attacking innumerable taxa of hosts, most commonly parasitize Coleoptera and Lepidoptera. Extreme specialization does not necessarily reflect much generic diversity. Thus, the Leucospidae (4 genera, 127 species), parasites of solitary bees and wasps, and Eucharitidae (11 genera, 193 species), parasites of ants, have not evolved in great numbers.

Some phylogenetic considerations are made based on host preference, geographical distribution, taxon size and morphology.

### **Territoriality in Male Bees (Hymenoptera: Apoidea)**

EDWARD M. BARROWS

DEPARTMENT OF BIOLOGY, GEORGETOWN UNIVERSITY, WASHINGTON, D.C. 20057

Territoriality in male bees is their continued occupancy and defense of a topographic area or landmark against conspecific males. Their territories vary in size and in durations of ownership. Types of landmarks included are nests of conspecific females, all or certain parts of plants, pebbles, rocks, and patches of bare earth. Any of these landmarks may be rendezvous places, locations where a bee is likely to find a mate. Males, conspecific females, or both have been observed feeding, mating, and nesting in territories. The smallest territory is held for 3 to 10 days by the sweat bee, *Lasioglossum rohweri* (Ellis). It is a microterritory which is only about as large as the bee which defends it. Male *Centris pallida* Fox have digging microterritories above virgin females in soil. *Calliopsis andreniformis* Smith guards a territory 2 to 5 meters long and chases away its parasite, *Holcopasites*. Males of both *Calliopsis* and *L. rohweri* may function in nest defense. *Protoxaca gloriosa* (Fox), like other species, defends plants where it is likely to encounter females. The longest territory (38 m long) is held by *Anthidium banningense* Cockerell for at least 3 days and males of *A. manicatum* L. are among the most aggressive of all male bees. They chase and sometimes harm almost any insect except conspecific females encountered in territories. In the Galapagos Islands, the carpenter bee,

*Xylocopa darwini* Cockerell, chases *Geospiza* finches as well as other insects. A European mason bee, *Hoplitis anthocopoides* (Schenck), varies the size of its territories with regard to its food plant and the numbers of conspecific males in a given area. These males hold territories for a median of about 16 days.

Factors believed to affect the cost/benefit ratio of territoriality include distribution and detectability of female emergence sites, detectability of nest entrances, distribution and quality of foraging areas, and the number of conspecific male competitors in an area.

Territoriality in male bees probably has manifold functions. It may function to increase the efficiency of natural resource utilization and of escaping from predators because males learn the topography of their territories quite well. Territoriality may space individuals over the available habitat, reducing competition for food and females. Furthermore, this behavior may reduce the incidence of disease and parasites and the time spent in agonistic encounters. Finally, if territories of a particular species cannot be compressed, territoriality may function in population regulation. Territoriality represents a group of adaptations that differ from one species of bee to the next.

Bee species with territorial males usually have relatively large males.

Territoriality in male bees is probably a result of convergent evolution. Because this behavior is found in isolated genera, in 7 of the 9 families of bees, it appears to be a derived, rather than an ancestral, type of behavior.

### **Symposium: Ecology of Forest Defoliators**

DOUGLAS C. ALLEN, MODERATOR

THE IMPORTANCE, BIOLOGY AND CONTROL OF THE BIRCH CASEBEARER, AN IMPORTED PEST, IN INSULAR NEWFOUNDLAND. DR. DAVID G. BRYANT, NEWFOUNDLAND FOREST RESEARCH CENTER, CANADIAN FORESTRY SERVICE, P. O. BOX 6028, ST. JOHN'S, NEWFOUNDLAND, CANADA A1C 5X8

THE ROLE OF DEFOLIATORS IN THE ANTHROPOD COMMUNITY OF RED MAPLE CROWNS. MR. JAN VOLNEY, MARITIMES FOREST RESEARCH CENTER, CANADIAN FORESTRY SERVICE, P. O. BOX 4000, FREDERICTON, NEW BRUNSWICK, CANADA E3B 5G4

THE DOUGLAS-FIR TUSSOCK MOTH—INFLUENCE OF HOST FOLIAGE. MR. ROY BECKWITH, USDA, FOREST SERVICE, PACIFIC NW FOREST AND RANGE EXPERIMENT STATION, 3200 JEFFERSON WAY, CORVALLIS, OREGON 97331

CURRENT RESEARCH WITH *TELENOMUS ALSOPHILAE* VIERECK, AN EGG PARASITE OF THE FALL CANKERWORM. MR. ARNOLD T. DROOZ, USDA, FOREST SERVICE, FOREST SCIENCES LABORATORY, P. O. BOX 12254, RESEARCH TRIANGLE PARK, NORTH CAROLINA 27709

THE BIMODALITY OF GYPSY MOTH POPULATIONS. DR. ROBERT W. CAMPBELL, USDA, FOREST SERVICE, PACIFIC NW FOREST AND RANGE EXPERIMENT STATION, 3200 JEFFERSON WAY, CORVALLIS, OREGON 97331

**Douglas-fir Tussock Moth, *Orgyia pseudotsugata* (McD.)  
(Lepidoptera: Lasiocampidae): Influence of Host Foliage**

ROY C. BECKWITH  
FORESTRY SCIENCES LABORATORY, CORVALLIS, OREGON 97331

The Douglas-fir tussock moth, *Orgyia pseudotsugata* (McD.) is one of the more important defoliators of Douglas-fir, *Pseudotsuga menziesii* var. *glauca* (Beissn.) Franco and true firs, *Abies* spp., in Western North America. Past outbreaks have occurred in fir forests from British Columbia south to Arizona. A resume of tussock moth biology is presented with special emphasis on host effects.

Tussock moth outbreaks are characterized by a rapid increase, followed by a sudden and complete collapse; the outbreak cycle usually spans a 3-year period in any one location. Endemic populations are extremely difficult to find by present standard sampling techniques.

The 1972-74 Blue Mountain outbreak in Oregon and Washington prompted a laboratory study on the effects of host foliage on the tussock moth. Three common hosts were used in the test; high density field populations were simulated by forcing one-half the population to feed upon old growth foliage following the second instar. This "stress factor" had the most significant effect upon the population, resulting in increased development time, frass production and mean number of instars, and a decrease in larval size, pupal weight, and egg production.

It appears that populations can increase equally well on grand fir and Douglas-fir; the degree of acceptance of old growth foliage may govern survival rate and ultimate tree damage. Although fed upon, subalpine fir will not support dense populations.

Only current foliage will be consumed during the release phase of a proposed hypothetical outbreak model (1), but larvae are forced to feed on old-growth foliage under high density populations in the outbreak phase which is detri-

mental to population survival. New foliage depletion in early instars leads to mass starvation, delayed development, increased exposure to biotic controls and general population collapse.

#### Literature Cited

WICKMAN, B. E., MASON, R. R., AND THOMPSON, C. G. 1973. USDA Forest Serv., Pac. NW For. & Ran. Exp. Sta., Gen. Tech. Rep. PNW-5. 18 p.

### The Role of Defoliators in the Arthropod Community of Red Maple Crowns

J. VOLNEY

CANADIAN FORESTRY SERVICE, P.O. BOX 4000, FREDERICTON, N.B., CANADA

The arthropod community on red maple foliage is organized into 5 guilds each of which remains comparatively simple throughout the growing season. The simplicity of the community may be a reflection of the comparatively simple structure of red maple crowns. Lepidopterous defoliators in 2 guilds dominate this community both in terms of biomass and their impact on the community. Leaf rollers, principally *Cenopsis acerivorana* (MacK.), provide shelter for a variety of organisms in the leaf roll and thereby tend to increase the number of species in the community. *Itame pustularia* (Gn.), a solitary defoliator, which occurred in high numbers in one plot, initially reduced the species diversity of the community. However, the reaction of the host trees to heavy defoliation resulted in an arthropod community with a higher index of diversity towards the end of the season. Population levels of those defoliators which dominate the community also have a considerable influence on the composition of this community. Trophic bonds between the defoliator guilds are practically non-existent in the populations studied. Similarly, trophic bonds with the arthropod communities on other host species in the same stands seem tenuous. The implications of these results on the process of stand succession in central New Brunswick is speculated upon.

### Current Research with *Telenomus alsophilae* Viereck, an Egg Parasite of the Fall Cankerworm, *Alsophila pometaria* (Harris) (Lepidoptera: Geometridae)

A. T. DROOZ

FORESTRY SCIENCES LABORATORY, P.O. BOX 12254, RESEARCH TRIANGLE PARK, N.C. 27709

By way of background information, the rationale for our work on *Telenomus alsophilae* Viereck takes us back over 20 years, when an outbreak of the elm

spanworm, *Ennomos subsignarius* (Hübner) arose in northern Georgia. This outbreak lasted 10 years, covering 1.6 million gross acres in the southern Appalachian Mountains at its peak in 1960. Spanworm populations declined in 1963, and egg masses could not be located after the hatch of 1964. At that time an egg parasite determined to be *T. alsophilae* was found in an average of 85% of the spanworm eggs; few of these loopers became final instars, and pupae could not be found. Hardly any information was available about *T. alsophilae* at that time. It obviously was time to examine the details of the biology of so important a parasite. However, the spanworm outbreak was over and little could be done to initiate work on *T. alsophilae*. What could be done would have to be carried out with a more common host, the fall cankerworm and laboratory-reared spanworm eggs. The inevitable problem arose when at that time it was impossible to rear the fall cankerworm and the cankerworm parasites would not attack the spanworm eggs. These problems, and the observation that cankerworm eggs are attacked in the late fall through winter in the mountains of North Carolina, while the spanworm eggs are only attacked in April/May, prior to hatch, needed to be resolved. Therefore, a research program was developed whose objectives were:

1. Rear the fall cankerworm for use as host material.
2. Study the relationships between *T. alsophilae* attacks on the cankerworm and spanworm in the field.
3. Rear *T. alsophilae* upon demand.

Work was begun in the winter of 1970/71 to rear the cankerworm and learn about parasite emergence, sex ratios and longevity. We succeeded in our efforts to rear the cankerworm, but so far the results are not worth the effort. It can be reared either on an artificial diet or on host foliage, but prolonged emergence and the predominance of females, which also occur in natural populations, defeat the purpose. G. F. Fedde tested the eggs of numerous potential hosts, and found a number of geometrid and noctuid hosts were satisfactory, but he found that a relatively unimportant forest geometrid, *Abbotana clemataria* (J. E. Smith) is an excellent laboratory host for *T. alsophilae*. V. H. Fedde has reared this geometrid with little difficulty on a diet she developed for the spanworm. This breakthrough was much needed, and has permitted us to achieve our goal of producing *T. alsophilae* and some other species of egg parasites on demand, as well as investigate details of the biology of *T. alsophilae* in the laboratory.

Where are we in our work with the field relationships between *T. alsophilae*, the cankerworm and spanworm? Through our field observations on time of parasite attack on eggs of these hosts, arena studies in the laboratory, and reexamination of specimens from the 2 geometrids, USDA specialists indicate

that the *Telenomus* attacking the elm spanworm is a new species. Therefore, we have another potentially useful insect to investigate if we can obtain a starter culture and can rear it in the laboratory.

Along practical lines, being able to rear *T. alsophilae* has permitted us to send quantities of parasitized eggs to A. E. Bustillo in Medellín, Colombia where he has made successful sleeve-cage tests with *T. alsophilae* against *Oxydia trychiata* (Guenée). This insect is one of several geometrid species killing the introduced cypress, *Cupressus lusitanica* Miller.

Within the next few years a number of scientific papers should be published by our group concerning details of the biology of *T. alsophilae*. We believe that they will provide much useful information to the field of biological control about a valuable species or two which were neglected in the past.

### **The Importance, Biology and Control of the Birch Casebearer, *Coleophora fuscedinella* Zeller (Lepidoptera: Coleophoridae), an Imported Pest in Insular Newfoundland**

D. G. BRYANT

ENVIRONMENT CANADA, NEWFOUNDLAND FOREST RESEARCH CENTRE, BOX 6028,  
St. JOHN'S, A1C 5X8

The birch casebearer, *Coleophora fuscedinella* Zeller, was introduced into North America from Europe about 1920 (1) and has been found attacking several broad-leaved tree species such as birch, *Betula*, and alder, *Alnus*, causing severe browning of foliage, branch mortality and occasionally death of host trees. It was first found in Newfoundland in 1953 and occurs on its principal host white birch, *B. papyrifera* Marsh.

The Province is in the Boreal Forest region and white birch comprises about 12% of the standing tree volume. The tree is little used for either lumber or pulp and has its greatest importance as an aesthetically valued component of the landscape. Over 30% damage to leaves (defoliation) brings public enquiries (2). At over 90% defoliation, branch and twig mortality becomes apparent. There is a high variation in total defoliation among trees in a stand and we have not been able to identify the cause of the variation. Within trees, defoliation is concentrated in the peripheral 25 cm of crown and is least variable in the 2 middle crown quarters.

The casebearer has one generation a year. Eggs are laid on the leaves in July and larvae hatch 3 weeks later. These larvae mine leaves in August and molt to the second instar and construct a case from the leaf epidermis in September. The casebearers overwinter at a crevice on the bark and molt to the third instar in the spring before feeding. The fourth instar larvae construct

a new case in June, feed for a short period, then pupate on the tree or ground vegetation (3).

Larvae are distributed throughout the tree but at any instar the majority are situated in the outer 25 cm of the middle half of the tree crown (4). The majority of leaves in a tree are in the 25 cm periphery and are the cause of the casebearer population concentrating in this portion. There is a high and sometimes significant ( $P \leq 0.05$ ) variation in larval numbers between trees. The cause of the variation is unknown and is not related to tree variables of height, size, form, exposure, or dominance. Within trees, differences in larval numbers are most pronounced ( $P \leq 0.05$ ) among 25 cm shells and occur occasionally among crown quarters.

Inter-tree variation was too high to obtain significant correlations of casebearer numbers and defoliation within stands. For data from all stands however, there was a significant correlation ( $0.48 < r < 0.74$ ;  $P \leq 0.05$ ) between defoliation and eggs, overwintering cases and late-instar larvae. The precision of defoliation prediction is low because of high inter-tree variation. Methods are being prepared to forecast defoliation classes from casebearer abundance.

Survival of casebearers during a generation appears to be constant at all population levels. About 40% of larvae survive winter (5) and about one-fifth of these pupate. This constant mortality suggests that the causes are intra-specific or relate to the insect-host interaction. High egg mortality of 90%, especially at high population levels, has been recorded (6) but the cause is unknown. Parasitism of larvae and pupae was extremely low at less than 5%, and parasites, native to European populations, are being introduced (7). Where defoliation is expected to affect aesthetic values, spraying at first green in the spring is recommended (8). On large ornamental trees systemic insecticides are suggested.

#### Literature Cited

1. REEKS, W. A. 1951. Canada Agric., *Bi-mon. Prog. Rep.*, 7(4).
2. BRYANT, D. G., AND RASKE, A. G. 1975. *Canad. Entomol.*, **107**: 217-223.
3. COCHRAN, S. G. 1974. The birch casebearer in Newfoundland. M.Sc. Thesis, McGill Univ., 126 pp.
4. RASKE, A. G., AND BRYANT, D. G. *Canad. Entomol.* (In Press)
5. RASKE, A. G. 1975. Environ. Can., For. Serv., *Bi-mon. Res. Notes*, **31**: 9-10.
6. ———. 1974. Environ. Can., For. Serv., *Bi-mon. Res. Notes*, **30**: 1-2.
7. ———. 1974. Environ. Can., Newfoundland For. Res. Centre, Inform. Rep., N-X-108.
8. CLARK, R. C., AND RASKE, A. G. 1974. Environ. Can., Newfoundland For. Res. Centre, Nfld. For. Notes No. 7.



## The Bimodality of Gypsy Moth, *Porthetria dispar* (L.) (Lepidoptera: Lymantriidae) Populations

ROBERT W. CAMPBELL

NORTHEASTERN FOREST EXPERIMENT STATION, FOREST SERVICE, U. S. DEP. AGRICULTURE,  
6816 MARKET STREET, UPPER DARBY, PA. 19082

Populations of the gypsy moth (*Porthetria dispar* (L.)) in North America have 2 numerical phases. A population may remain in the innocuous phase for many years, and the outbreak phase may continue within a general area for as much as a decade. Changes from the innocuous phase to the outbreak one and vice versa, however, usually take place within 2 or 3 years. Our records, which span a sizeable sample of natural gypsy moth populations in the northeastern United States between 1911 and 1975, show no tendency among these populations toward the regular oscillations characteristic of gypsy moth populations across much of Europe.

A procedure was developed to determine at what point during the generation the numerical differences appear between a sparse population in an outbreak area and one in an innocuous area. This study led to the following conclusions:

1. From 50 to 100 times as many eggs were produced by initially sparse populations in the outbreak area (Glenville, N. Y., 1958-1964) as by equally sparse populations in the innocuous area (Eastford, Conn., 1965-1968).

2. More than 90% of the difference between the 2 areas in mean number of eggs produced was caused by differential mortality during instars I to III, IV to VI, and the pupal stage, and by a lower proportion of females among the adults in Eastford.

3. The apparent survival during instars I to III was much lower in Eastford than in Glenville when egg density at the start of the generation was low. Survival was about equal in the 2 areas, however, when egg density increased.

4. Survival during instars IV to VI was about the same in the 2 areas when egg density was low, but it decreased rapidly in Eastford when egg density increased.

5. Survival of pupae was much lower in Eastford across the entire range of egg densities that was common to the 2 areas. Interestingly, the survival of pupae was relatively invariant *within* each area.

6. Differences between the 2 areas in the proportion of females among adults were minor when egg density was low, but increased as egg density increased. Since the sex ratio of gypsy moth eggs is known to be constant at 50:50 (2), and since the sex ratio of instar IV larvae is known to have been relatively invariant in the areas studied at about 65% females (1), it seems safe to assume that the significant differences between the 2 areas in the proportion of females among adults were determined during instars IV to VI, the

pupal stage, or both. Thus, not only do substantially more insects in the outbreak area survive instars IV to VI and the pupal stage, but more of the survivors are females.

#### Literature Cited

- CAMPBELL, R. W. 1963. *Can. Entomol.*, **95**: 465-474.  
 ———. 1967. *For. Sci.*, **13**: 19-22.

#### BOOK REVIEW

**Man against Tsetse: Struggle for Africa.** John J. McKelvey, Jr. Cornell University Press, Ithaca and London. 1973. 306 pp. \$12.50.

Entomologists will be fascinated by the author's analysis of the development of knowledge on sleeping sickness and nagana disease of cattle, and how the large continent of Africa was influenced by contributions of medical entomologists. But this book is not merely an account of historical and scientific events and discoveries; it analyses in depth the complicated interrelations that the author, who has spent many years in Africa, has known from his own experience. The book is written by a scientist, who, as readers will find, is also an extremely accomplished writer and master of the language. The book thus provides many enjoyable hours. I am certain that my colleagues who read it will find perusal of this volume to be both informative and pleasurable. It gives much useful data to entomologists, epidemiologists, physicians and microbiologists. The author, a Director for Agriculture of the Rockefeller Foundation, is a knowledgeable medical entomologist (Ph.D., Cornell U.), a scholar, and an expert on Africa.

This book should be read by anyone who plans a trip to Africa—be it for scientific reasons, business, or for pleasure. No special training in entomology is required and the book will be enjoyed by entomologists as well as by laymen who want an authoritative, up-to-date view of the field. The author has succeeded admirably in bringing together for the first time the information on the tsetse fly, the trypanosomes, and the development of African nations. It will therefore serve both as a thorough review of the history and present status of the problem for college students, and as a guide to the literature for serious researchers. The Chapter Notes (pp. 239-292) are very valuable for the latter. An index of 13 pages completes the volume.

There was a definite need for a book on sleeping sickness and at last we have one, written by an extremely competent authority. It ought to be in every public and highschool library so as to become for young men and women interested in Africa's future and medical entomology what Paul DeKruif's "Microbe Hunters" became for future microbiologists—the stimulus to devote one's life to a deserving cause. I found "Man against Tsetse" as stimulating as DeKruif's book, and at the same time more accurate and up-to-date. Years of careful research have been spent by the author in searching and checking all the data and facts.

The tsetse fly had an enormous impact on Africa's development. Great strides have been made in controlling the insects and in chemotherapy of the disease. Nevertheless, there remains the dangerous potential for an epidemic, as demonstrated in recent, new outbreaks of sleeping sickness. This is pointed out succinctly by McKelvey. The book will remain invaluable for a long time to come to those engaged in biological, medical and agricultural research.

KARL MARAMOROSCH

Institute of Microbiology, Rutgers University

**INDEX TO SCIENTIFIC NAMES OF ANIMALS AND PLANTS  
VOLUME LXXXIII**

Generic names begin with capital letters. New genera, species, subspecies, and varieties are printed in italics. The following are not indexed: Figs 1-8, pp. 4-5, "New or little-known crane flies from Iran II (Diptera: Tipulidae)" by Charles P. Alexander; Table I, p. 37, "Parasites reared from larvae of the European corn borer, *Ostrinia nubilalis* (Hbn.) in Massachusetts 1971-73 (Lepidoptera: Pyralidae) by F. B. Peairs and J. H. Lilly; "Mites (Acarina) associated with *Popilius disjunctus* (Illiger) (Coleoptera: Passalidae) in Eastern United States" by Mercedes D. Delfinado and Edward W. Baker, pp. 49-59; "Revision of the genus *Endeodes* LeConte with a tabular key to the species (Coleoptera: Melyridae)" by Ian Moore and E. F. Legner, pp. 70-80; Tables 1-7 and Figs. 1-11, "Comparative behavior of wasps in the genus *Lindenius* (Hymenoptera: Sphecidae, Crabroninae)" by Richard C. Miller and Frank E. Kurczewski, pp. 82-120; Figs. 1-9 and Distributional Records, pp. 124, 126-128, "New or little-known craneflies from Iran III (Diptera: Tipulidae)" and Figs. 1-8, pp. 132-133, 136-138 (Iran IV), by Charles P. Alexander; pp. 142-156, "An annotated list of New York Siphonaptera," by Allen H. Benton and Danny L. Kelly; pp. 176-179, "Notes on the life cycle and natural history of butterflies in El Salvador. II *B.-Hamadryas amphinome* L. (Nymphalidae-Hamadryadinae)" by Alberto Muysshondt and Alberto Muysshondt, Jr.; Tables 1-4, "Species and numbers of bloodsucking flies feeding on hogs and other animals in southern New Jersey," pp. 199-201, by Thomas J. Weiner and Elton J. Hansens; "Speleognathinae collected from birds in North America (Acarina: Ereyneidae)," by A. Fain and K. E. Hyland, pp. 203-208.

- |                                  |                              |
|----------------------------------|------------------------------|
| Abbotana clemataria, 284         | Argyrotaenia velutinana, 264 |
| Abies, 282                       | Aristolochia trilobata, 189  |
| Achrysocharella silvia, 101      | Asclepias syriaca, 260       |
| Actinote, 166, 190               | Atta texana, 192             |
| Adelpha, 167                     | Autographa californica, 270  |
| Aedes atlanticus, 249            |                              |
| canadensis, 249                  |                              |
| Aenictus, 196                    | Battus, 189                  |
| Agaricus bisporus, 256           | laodamas, 166                |
| Agathis, 101                     | philenor, 247                |
| Ageronia, 165, 187               | polydamas, 166, 247          |
| arete, 166                       | Betula papyifera, 285        |
| fornax, 166, 187                 | Biblis hyperia, 165          |
| Agromyza frontella, 243          | Boophilus decoloratus, 46    |
| Allophylus petiolatus, 16        | Brachymeria intermedia, 269  |
| Alnus, 285                       | Buenoa confusa, 265          |
| Alsophila pometaria, 283         | margaritacea, 265            |
| Anartia fatina, 167              |                              |
| jatrophae luteipicta, 167        | Caligo memnon, 166           |
| Anetia thirsa, 167               | Callicore, 16                |
| Anthidium banningense, 280       | meridionalis, 15, 16         |
| manicatum, 280                   | sorama, 16                   |
| Apanteles melanoscelus, 242, 246 | Calliopis andreniformis, 280 |
| Aphelonema simplex, 254          | Calliphora, 34               |
| Aplomya caesar, 36               |                              |

- Calocoris*, 86  
     *norwegicus*, 86  
*Camponotus*, 192  
     *pennsylvanicus*, 194  
*Cardiospermum*, 13  
     *halicacabum*, 15  
*Carduus*, 250, 251  
     *acanthoides*, 247, 250  
     *nutans*, 247, 250  
*Carpocapsa pomonella*, 271  
*Cassida rubiginosa*, 247  
*Castilla gummifera*, 174  
*Catagramma pitheas*, 10, 16  
     *pygas*, 15  
     *titania*, 10, 16  
*Catonephele numilia estite*, 17  
     *vyctimus*, 165, 176  
*Cenopsis acerivorana*, 283  
*Centris pallida*, 280  
*Chalcis*, 279  
*Cheilotrichia*, 123  
     (*Empeda*) *gnoma* n. sp., 121  
*Chirosomus*, 105, 114  
*Chlosyne*, 166, 190  
*Choristoneura fumiferana*, 266, 269  
*Chrysopa*, 278  
*Chrysops*, 198, 246  
     *atlanticus*, 200  
     *callidus*, 202  
     *celatus*, 202  
     *cincticornis*, 200  
     *fuliginosus*, 200  
     *geminatus*, 246  
     *macquarti*, 202, 246  
     *montamus*, 200  
     *niger*, 200  
     *nigribimbo*, 202  
     *vittatus*, 202  
*Cicindela imperfecta*, 226  
*Cirsium arvense*, 247  
*Coccinella nine-notata*, 226  
     *transversoguttata*, 227  
*Cochliomyia hominivorax*, 34  
*Coleomegilla maculata*, 60, 272  
*Coleophora fuscedinella*, 285  
*Collops*, 228  
     *bipunctatus*, 226  
*Colobura dirce*, 190  
*Conomyrma insana*, 192  
*Crematogaster laevirescula*, 192  
*Crossocerus*, 118  
     *leucostomoides*, 118  
     *maculiclypeus*, 117  
*Cuprossus lusitanica*, 285  
*Cyphoderris buckelli*, 233  
     *monstrosa*, 233  
  
*Dalechampia ficifolia*, 189  
     *heteromorpha*, 189  
     *scandens*, 164, 170, 181  
     *stipulacea*, 189  
     *triphylla*, 189  
*Daphnia*, 265  
*Dasyhelea*, 114  
*Dasyneura gleditschae*, 259  
     *mali*, 244  
*Daucus carota*, 105  
*Delphacodes detecta*, 254  
*Desantisca*, 279  
*Diachlorus ferrugatus*, 200  
*Diaethria astala*, 10  
     *candrena*, 16  
     *clymena*, 16  
     *eluina*, 16  
     *salvadorensis*, 16  
*Dibrachys*, 280  
*Dicranomyia demmaculata*, 129  
*Dicranota (Dicranota) capillata*, 134  
     (*Dicranota*) *fuscipennis*, 134  
     (*Dicranota*) *ophidia* n. sp., 129  
*Diglyphus isaea*, 243  
*Dione juno huascama*, 166, 187  
*Dircenna klugii*, 167  
*Dorylus*, 194  
     *labiatus*, 192  
*Dynamine*, 165, 176  
  
*Eciton*, 192  
     *hamatum*, 192  
*Elaeophila*, 136  
*Eleodes sulcipennis*, 226  
*Elliptochthonius profundus* n. gen., n. sp.,  
     209  
*Empeda*, 123  
*Encopognathus*, 118  
*Ennomos subsignarius*, 284  
*Entomophthora egressa*, 254  
     *sphaerosperma*, 254

- Epiphile adrasta adrasta*, 17  
*Eriborus terebrans*, 36  
*Erioptera* (*Pseuderioptera*) n. subgen., 123  
     (*Pseuderioptera*) *schmidi* n. sp., 121  
     (*Psiloconopa*) *cancriformis* n. sp., 121  
     (*Psiloconopa*) *idiophalleus*, 126  
*Eucelatoriopsis dimmocki*, 247  
*Euphilis rufotaesiatum*, 118
- Fannia canicularis*, 258  
*Forcipomyia*, 114  
*Formica*, 192  
     *canadensis*, 192  
     *subintegra*, 192
- Gambusia affinis*, 267  
*Gehyochthonius*, 215  
*Geocoris pallens pallens*, 227  
*Geospiza*, 281  
*Gonempeda flava*, 123  
*Gonomyia*, 2, 121  
     (*Gonomyia*) *abbreviata*, 9  
     (*Gonomyia*) *basilobata* n. sp., 2  
     (*Gonomyia*) *chalaza*, 8  
     (*Gonomyia*) *ebburzensis* n. sp., 2  
     (*Gonomyia*) *oxybeles* n. sp., 2  
     (*Gonomyia*) *sibyna*, 8  
     (*Gonomyia*) *tenella*, 7  
     (*Idiocera*) *alexanderiana*, 3  
     (*Idiocera*) *curticurva* n. sp., 2  
     (*Idiocera*) *disposa*, 6  
     (*Idiocera*) *jucunda*, 6  
     (*Idiocera*) *laterospina* n. sp., 2  
     (*Idiocera*) *orthophallus* n. sp., 2  
     (*Idiocera*) *phallostena*, 6  
     (*Idiocera*) *punctata*, 6  
     (*Idiocera*) *schrenki*, 6  
     (*Idiocera*) *similior*, 9  
     (*Idiocera*) *spinistylata* n. sp., 2  
     (*Idiocera*) *spinulistyla* n. sp., 6  
*Graphium marcellus*, 247  
*Grapholitha molesta*, 264  
*Gynaecia dirce* (h), 166
- Haematobia irritans*, 198, 253  
*Hamadryas*, 165, 170, 181  
     *amphinome*, 166, 176, 181  
     *arete*, 189  
     *februa*, 157, 170, 181  
     *fornax*, 166, 187  
     *guatamalena*, 166, 170, 181  
*Heliothis zea*, 166, 249  
*Hippodamia convergens*, 61, 226  
     *quinesignata*, 226  
     *sinuata disjuncta*, 227  
     *sinuata spuria*, 226  
*Holcopasites*, 280  
*Hoplitis anthocopoides*, 281  
*Hybomitra*, 246  
     *daeckii*, 202  
     *lasiophthalma*, 200  
     *losiophthalmus*, 246  
     *sodalis*, 246  
*Hymenitis oto oto*, 167  
*Hypanartia lethe*, 167  
*Hypera postica*, 226, 243, 263  
*Hypocada virginiana nigricosta*, 167  
*Hyposoter exiguae*, 261, 263
- Idiocera*, 3  
*Ilisia*, 126  
*Iridomyrmex pruinosum*, 192  
*Itame pustularia*, 283  
*Itoplectis conquisitor*, 257
- Jenkinshelea magnipennis*, 114
- Lasioglossum rohweri*, 280  
*Laspeyresia pomonella*, 264  
*Latroectus*, 279  
*Libocedrus decurrens*, 229  
*Limnobia demmaculata*, 129  
*Limonia* (*Dicranomyia*) *chorea*, 131, 134  
     (*Dicranomyia*) *demmaculata*, 129  
     (*Dicranomyia*) *decem-maculata*, 129  
     (*Dicranomyia*) *didyma*, 132, 134  
     (*Dicranomyia*) *flavocincta*, 129  
     (*Dicranomyia*) *lutea*, 131  
     (*Dicranomyia*) *mitis*, 131, 134  
     (*Dicranomyia*) *modesta*, 130  
     (*Dicranomyia*) *nigritorus* n. sp., 129  
     (*Dicranomyia*) *schmidiana* n. sp., 129  
     (*Dicranomyia*) *subdidyma* n. sp., 129  
     (*Dicranomyia*) *vibishana*, 129

- (*Dicranomyia*) *whitei*, 129  
 (*Elaeophila*) *submarmata*, 136  
*Liminophila* (*Elaeophila*) *albofascia* n. sp.,  
 129  
*Lindenius*, 82-83, 115-119  
   *montezuma*, 82  
   (*Lindenises*) *albilabris*, 82  
   (*Trachelosimus*) *armaticeps*, 82  
   (*Trachelosimus*) *buccadentis*, 82  
   (*Trachelosimus*) *columbianus errans*, 82  
   (*Trachelosimus*) *panzeri*, 82  
   (*Trachelosimus*) *pygmaeus*, 82  
*Liometopum*, 118  
*Lipsothrix iranica* n. sp., 121  
   *nervosa*, 122  
   *nigristigma*, 122  
   *vobilis*, 122  
*Liriomyza trifoliarum*, 243  
*Lixophaga*, 36  
*Lycoriella mali*, 255  
*Lygus pratensis*, 85
- Macrocentrus grandii*, 36  
*Manataria maculata*, 166, 190  
*Marpesia*, 167  
*Mechanitis isthmia isthmia*, 166, 190  
*Melampus bidentatus*, 267  
*Meliolotus alba*, 105  
*Mestra amymone*, 165, 176  
*Meterioptera* (subgen.), 123  
*Microctonus aethiops*, 243  
   *colesi*, 263  
*Microtia elva*, 166, 190  
*Molophilus* (*Molophilus*) *pallidipes* n. sp.,  
 121  
   (*Molophilus*) *stroblianus*, 121  
*Monomorium minimum*, 99  
*Morinedea armata*, 220  
*Musca autumnalis*, 253  
   *domestica*, 252  
*Myrmica*, 192  
   *rubra*, 192  
*Myscelis orsis*, 15
- Nabis americanoferus*, 227  
*Narope cyllastros testaceae*, 167  
*Neduba*, 233  
   *macneilli*, 229  
   *sierranus*, 229
- Neivamyrmex*, 192  
   *harrisi*, 192  
   *nigrescens*, 38  
*Notonecta undulata*, 248
- Oncopeltus fasciatus*, 194, 260  
*Orgyia pseudotsugata*, 282  
*Ostrinia nubilalis*, 36, 249, 256, 265  
*Oxydia trychiata*, 285
- Pachycondyla*, 196  
   *harpax*, 192  
*Panonychus ulmi*, 262  
*Papilio anchisiades idaeus*, 166  
   *glaucus*, 247  
   *multicaudatus*, 247  
   *palamedes*, 247  
   *polyxenes*, 247  
   *troilus*, 247  
   *zelicaon*, 247  
*Paracymus*, 273  
*Parectcephala eucera*, 94  
   *sanguinolenta*, 94  
*Parhypochthonius*, 215  
*Parides*, 189  
*Paullina*, 13  
   *pinnata*, 15  
*Paulogramma pyracmon*, 16  
*Peridromia*, 165  
*Perilitus coccinellae*, 60  
*Phaenicia pallescens*, 33  
   *sericata*, 33  
*Phormia regina*, 34  
*Phrosinella fulvicornis*, 96  
*Phycoides*, 166, 190  
*Pinus jeffreyi*, 209  
   *lambertiana*, 229  
   *ponderosa*, 209  
*Platynota flavedama*, 260  
   *idaeusalis*, 268  
*Pogonomyrmex barbatus*, 192  
*Pollenia rudis*, 34  
*Polyergus breviceps*, 192  
*Popilius disjunctus*, 49  
*Porthetria dispar*, 242, 258, 271, 287  
*Precis genoveva*, 167

- Procystiphora* n. sp., 114  
*Prokelisia marginata*, 254  
*Protophormia tenaenovae*, 34  
*Protoxaea gloriosa*, 280  
*Pseudonica flavilla canthara*, 17  
*Pseudotsuga menziesii* var. *glauca*, 282  
*Psorophora ferox*, 249  
*Pyrrhogyra hypsenor*, 17, 167
- Rhagoletis pomonella*, 264  
*Rhinocyllus conicus*, 250, 251  
*Rhytidoponera*, 192
- Serjania*, 13, 15, 16  
*Sibaria*, 217
  - andicola*, 217
  - armata*, 217
  - englemani*, 217
- Simulium venustum*, 243  
*Solenopsis*, 192
  - invicta*, 192
- Spartina alterniflora*, 253
  - patens*, 253
- Spilochalcis*, 17  
*Stethorus punctum*, 262  
*Stomoxys calcitrans*, 198, 235, 252  
*Sympiesis viridula*, 36
- Tabanus*, 198, 246
  - atratus*, 199
  - fulvulus*, 202
  - lineola*, 199, 246
  - melanocarus*, 200
  - nigripes*, 200
  - nigrovitatus*, 199
  - pumilus*, 200, 246
  - trimaculatus*, 200
- Tanytarsus*, 114  
*Tapinoma*, 118  
*Tasioceroles* (subgen.), 123  
*Teleneura* (subgen.), 123  
*Telenomus alsophilae*, 282, 283  
*Temenis laothoe liberia*, 17  
*Tenebrio molitor*, 274  
*Tetrastichus*, 280
  - rhosaces*, 247
- Theritas lisus*, 166  
*Thesalia theona*, 166, 190  
*Tithorea harmonia salpadores*, 167  
*Tracheliodes*, 118  
*Tragia volubilis*, 165  
*Trema micrantha*, 16  
*Trichoplusia ni*, 261, 262, 265, 270, 271, 273  
*Tumidagena ruinuta*, 254
- Xylocopa darwini*, 281
- Zagrammosoma*, 279









## **JOURNAL of the NEW YORK ENTOMOLOGICAL SOCIETY**

The JOURNAL of the NEW YORK ENTOMOLOGICAL SOCIETY is devoted to the advancement and dissemination of knowledge pertaining to insects and their related forms.

SUBSCRIPTIONS are \$12.00 per year, in advance, and should be sent to the New York Entomological Society, the American Museum of Natural History, 79th Street at Central Park West, New York, N. Y. 10024. The Society will not be responsible for lost JOURNALS unless immediately notified of change of address. We do not exchange publications.

Please make all checks, money-orders, or drafts payable to the NEW YORK ENTOMOLOGICAL SOCIETY.

ORDERS and inquiries for back issues and complete sets should be sent to our agent. Complete files of back issues are in stock.

### **INFORMATION FOR AUTHORS**

Submit manuscript in duplicate (original and one carbon) to the Editor, New York Entomological Society, Waksman Institute of Microbiology, Rutgers University, New Brunswick, N.J. 08903.

1. GENERAL POLICY. Manuscript submitted must be a report of unpublished research which is not being considered for publication elsewhere. A manuscript accepted and published in the JOURNAL must not be published again in any form without the consent of the New York Entomological Society.

A page charge of \$15 per printed page is assessed.

The page charge includes black and white illustrations and tabular material.

2. FORM OF MANUSCRIPT. Text, footnotes and legends must be typewritten, double or triple spaced, with margins of at least 1½ inches on all sides. The editorial style of the JOURNAL essentially follows the *CBE Style Manual* (3rd edition, A.I.B.S., 1972).

Genetic symbols: follow recommendations of Demerec, et al.  
(*Genetics* **54**: 61, 1969)

Biochemical abbreviations: follow rules of the U.I.P.A.C. -I.U.B.  
(*J. Biol. Chem.* **241**: 527, 1966)

Enzyme activity: should be expressed in terms of international units.  
(*Enzyme Nomenclature*. Elsevier Pub. Co., 1965)

Geographical names, authors names and names of plants and animals should be spelled in full.

The JOURNAL reserves the privilege of editing manuscript or of returning it to the author for revision.

3. **ABSTRACT.** Each manuscript must be accompanied by an abstract, typewritten on a separate sheet.
4. **TITLE.** Begin each title with a word useful in indexing and information retrieval (Not "Effect" or "New".)
5. **ILLUSTRATIONS.** Original drawings *should not be submitted*. Glossy prints are desirable—not larger than 8½ by 11 inches and preferably not smaller than 5 by 7 inches. When appropriate, magnification should be indicated by a suitable scale on the photograph.
6. **REPRINTS** (in multiples of 100) may be purchased from the printer by contributors. A table showing the cost of reprints, and an order form, will be sent with the proof.
7. **SUBSCRIPTION** to the JOURNAL is \$12.00 per year, in advance, and should be sent to the New York Entomological Society, The American Museum of Natural History, Central Park West at 79th Street, New York, New York, 10024. The Society will not be responsible for lost JOURNALS unless immediately notified of change of address. We do not exchange publications. Please make all checks, money orders and drafts payable to the NEW YORK ENTOMOLOGICAL SOCIETY.
8. **ORDERS** and inquiries for back issues and complete sets should be sent to our agent.

**From January 1, 1976 the journal subscription rate will be \$12.— per year. Members of the N.Y.E.S. will be billed \$12.—, which includes the \$4.— membership and \$8.— subscription rate to N.Y.E.S. members.**







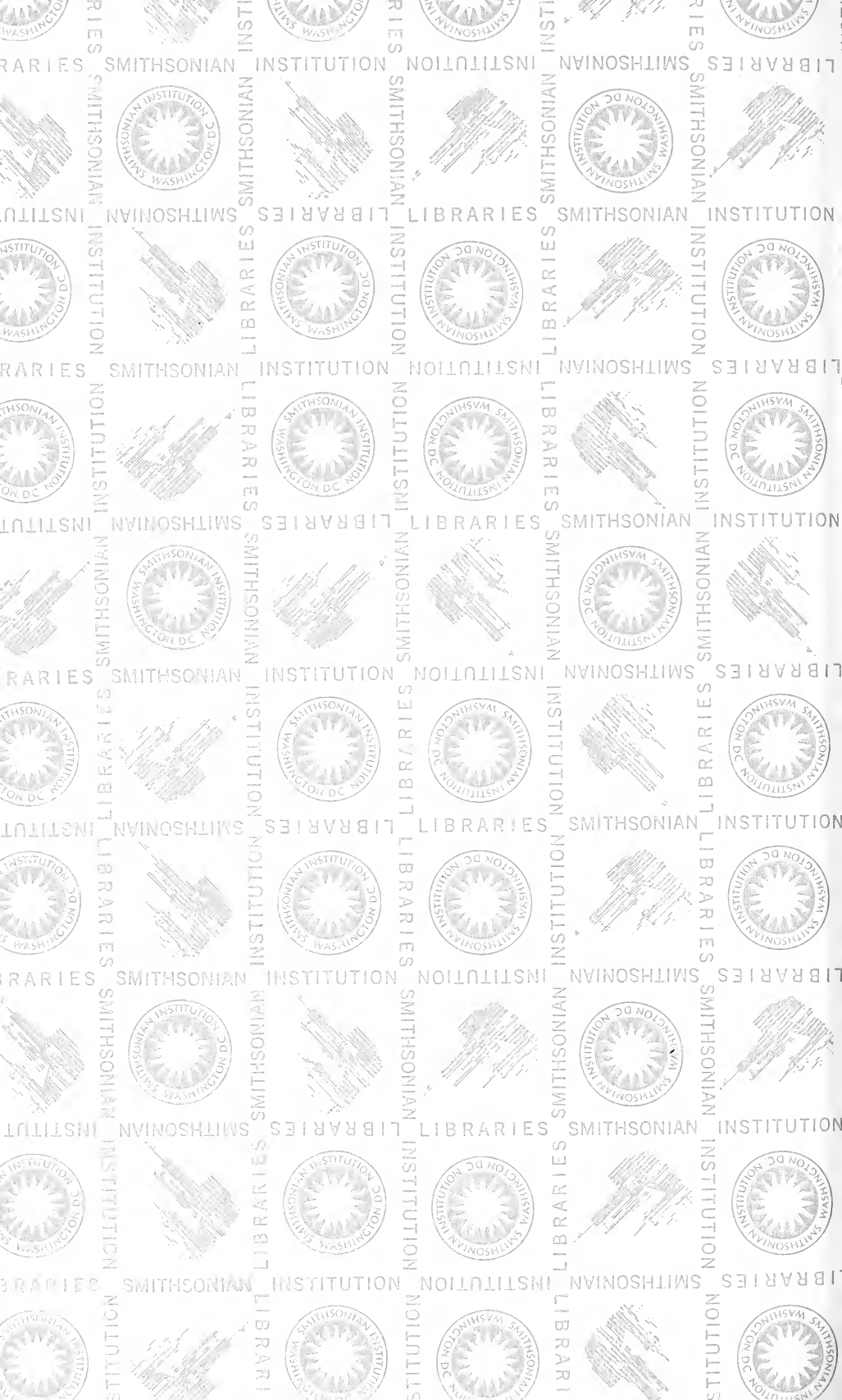



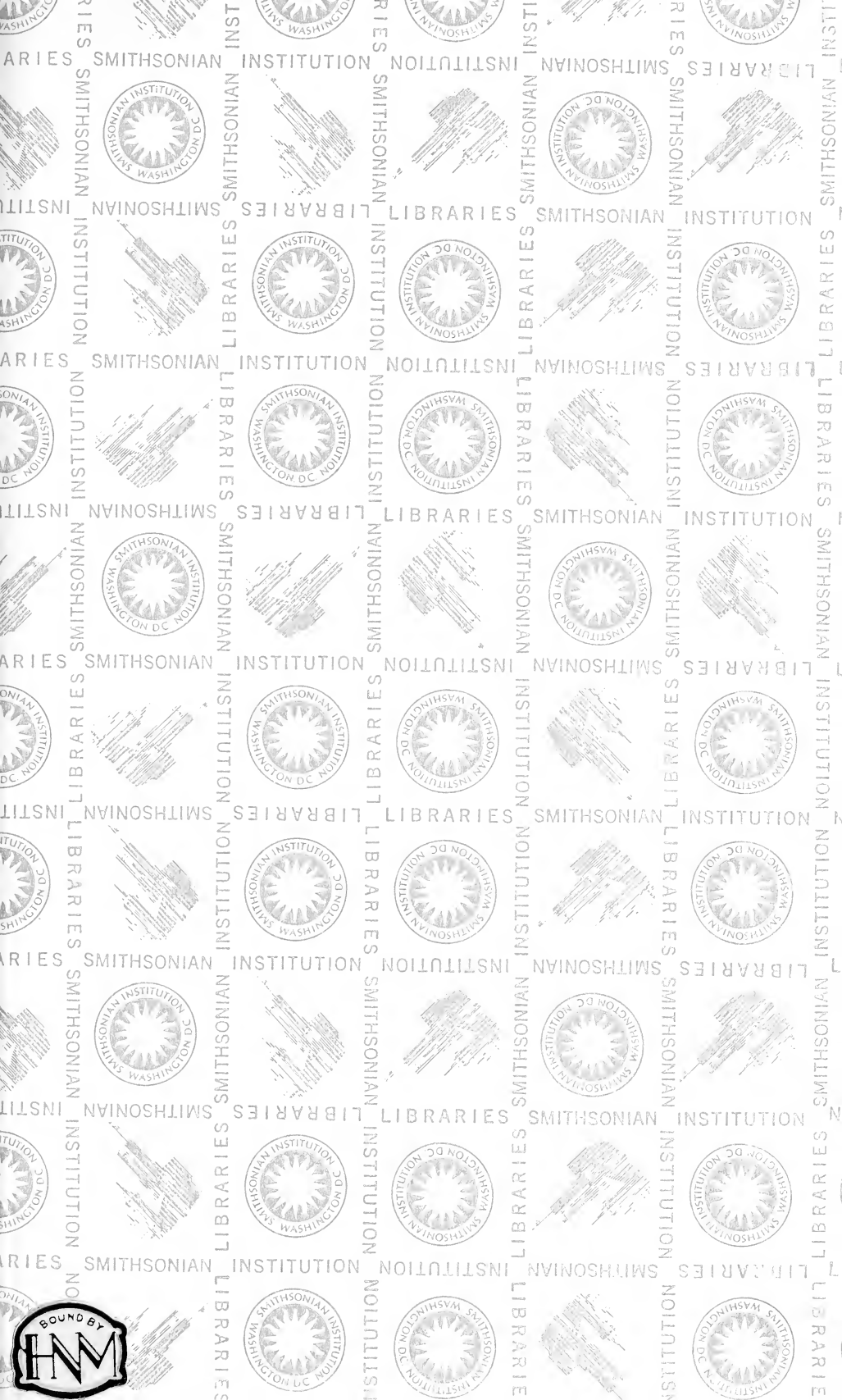

SMITHSONIAN INSTITUTION LIBRARIES



3 9088 00832 8320