

bacillus which the authors regard as the true *coli bacillus*. Finding this bacillus in such large numbers, the authors were led to experiment with it, and succeeded in demonstrating that cultures of the bacillus were pathogenic for the horse. By the use of these cultures, partly with food and partly by intravenous inoculation, they succeeded in reproducing the disease in experimental animals. They are of the conclusion, therefore, that the widespread *coli bacillus* is occasionally the cause of serious and fatal epidemics among horses.

H. W. C.

Bienstock. Du rôle des Bactéries de l'intestin. The author gives a very suggestive paper upon the functions of the ordinary intestinal bacteria. He has previously shown in the intestine of animals the presence of a *Bacillus putrificus*, which produces a putrefying action on proteids. He now finds that, under normal conditions, such putrefaction of the contents of the intestine does not occur. This fact seems surprising, inasmuch as *B. putrificus* is constantly present in the intestine, and the conditions are apparently proper for its growth. Bienstock is of the opinion that putrefactive action is checked by the presence, in the intestine, of certain aerobic bacteria, such as *lactic* and the *coli* bacilli. Experiments show that the putrefaction produced by *B. putrificus* does not take place when a quantity of these aerobic bacteria are present. The author concludes, therefore, that these aerobic bacteria, which are uniformly found in the normal intestine, are of direct value to the human body in preventing the putrefaction of the intestinal contents. He points out the fact that sterilized, and even pasteurized, milk is not so readily digested as raw milk, especially by persons with intestinal disturbances, and this he attributes to the fact that since the heat has destroyed the lactic organisms, these organisms are not present in the intestine to prevent the *putrificus* from producing putrefaction. In short, the author concludes that the reason why ordinary micro-organisms are needed in the intestine is to prevent the putrefaction which would otherwise occur in the intestinal contents, owing to the presence of certain putrefying micro-organisms which are always found.

H. W. C.

Reed, Carroll and Agramonte. The Etiology of Yellow Fever. Med. Rec., Feb. 16, 1901. These authors have presented a further report upon their conclusions in regard to the relation of yellow fever to mosquitoes. The results reached are of immense importance and are too numerous to be summarized. The most important are, that the disease is transmitted from yellow fever patients to healthy persons by the bites of mosquitoes, there being a period of incubation from 41 hours to 5 days. They have repeatedly succeeded in reproducing the disease by allowing mosquitoes (*Culex fasciatus*) to bite patients and, subsequently, healthy individuals. They find that an attack of yellow fever conveyed by a mosquito bite confers immunity against disease. A house is only infested with yellow fever when containing no mosquitoes. Yellow fever is not distributed by soiled articles of clothing or bedding, as has been supposed. The spread of yellow fever may be most effectually prevented by protecting the patient from mosquito bites. These conclusions, which represent only a few of





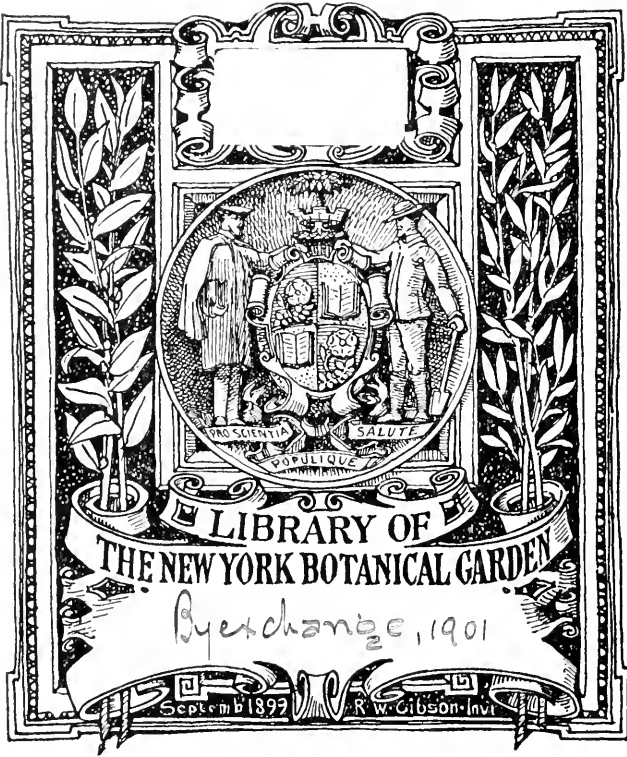

Journal of
Applied Microscopy
and
Laboratory Methods

VOLUME IV

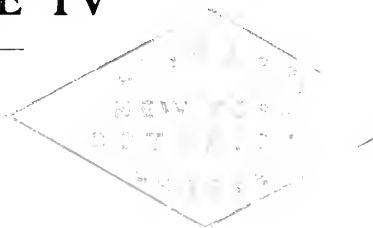

JANUARY TO DECEMBER
1901

ROCHESTER, N. Y.

Issued by the Publication Department of the Bausch & Lomb Optical Co.

INDEX.

- Absorbent cotton in the study of Infusoria, 1580.
Absorption of iron through the intestine, 1537.
Absorption of proteids, 1426.
Acanthocephali, collection and preservation of, 1582.
Accelerating effect of heat upon growth, cause of, 1221.
Accessory adrenal body in the broad ligament, 1342.
Achromatic spindle in the spore mother cells of *Osmunda regalis*, 1255.
Acid resisting bacteria in lower animals, 1391.
Actinomycosis in man, 1428.
Action of anilin stains on animal and plant cells, 1334.
Acute and chronic laryngitis, 1544.
Acute interstitial nephritis, character of exudation in, 1422.
Adaptation of bacteria to alexines of the blood, 1143.
Agglutination of the tubercle bacillus by the various exudations of tuberculous animals, 1142.
Alchemilla arvensis, fertilization in, 1381.
Alexines in the blood, 1429.
Alumosilicates, 1589.
Aluminum, micro-chemical analysis of, 1530.
Amitotic division, 1336.
Amitotic division in the cells of Sertoli, 1303.
Ammonium, micro-chemical analysis of, 1189.
Amphipoda, phototaxis in, 1547.
Amphithe longimana, habits and natural history of, 1219.
Anatomy of the Cat, 1420.
Animal life in the deep sea, 1541.
Anthrax in food, virulence of, 1551.
Anurida maritima, development of mouth parts in, 1210.
Apochromat (5 mm.) after Prof. C. S. Hastings in the photography of diatoms, 1442.
Apparatus :
 An improvised microtome, 1162.
 Combined condenser and polarizer for petrographical microscopes, 1155.
 Combined ureometer and saccharometer, 1286.
 Cone net, Birge, 1405.
 Cone net, Birge, modification of, 1407.
 Damp chamber for use on the klinostat, 1499.
 Device for paraffin embedding, 1595.
 Device for supporting Pasteur flasks, 1157.
 Fermentation tubes for bacteriological investigations of fermentation, 1286.
 For photographing diatoms, 1439.
 For phototaxis work, 1184.
 Hand "crab" used in dredging, 1232.
 Improved automatic microtomes, 1317.
 Improved photo-micrographic apparatus, 1366.
 Laboratory camera stand, 1202.
 New freezing microtome for use with carbon dioxide tanks, 1320.
 Normal electrode for physiological work, 1471.
 Sealing stone jar for zoological laboratories, 1261.
 Simple washing device, 1297.
 Staining large numbers of sputum specimens, 1594.
 Stereo-photo-micrographic camera, 1113.
 U-cell for filtration in study of Infusoria, 1579.
 Ureometer, 1156.
 Ventilated dish for bacteria cultures, 1197.
Arrangement of cilia on *Paramecium*, 1566.
Arthropod vision, 1540.
Arthropoda, depigmenting the eyes of, 1580.
Aspergillus oryzae, 1536.
Atlas of medulla and mid-brain, 1543.
Bacillus coli as the cause of intestinal troubles in horses in west Prussia, 1348.
Bacillus coli in water, 1552.
Bacteria, relation of, to other fungi, 1391.
Bacteria, role of, in the intestine, 1349.
Bacteria concerned in urea fermentation, 1347.
Bacteria in a swimming bath, 1350.
Bacteria in milk of cows suffering from mastitis, 1187.
Bacterial self-purification of streams, 1266.
Bacterial treatment of London sewage, 1430.
Bacteriology of healthy organs, 1266.
Barium, micro-chemical analysis of, 1293, 1323.
Beale's carmine for staining isolated nerve cells, 1564.
Biological Laboratories of Ripon College, 1149.
Biology wall charts, 1172.
Bird Life: a guide to the study of our common birds, 1418.
Birge collecting net, 1405.
Birge collecting net, modification of, 1407.
Blood examination, 1514.
Blood forming organs, investigation of, 1462.
Blood vessels in Annelids, structure of, 1213.
Botanical Laboratory and Botanical Garden of the Tokyo Imperial University, Japan, 1477.
Botany at the Biological Laboratory at Wood's Holl, 1486.
Brain of the turtle, function of, 1546.
Bronchitis, bacteriology of, 1141.
Cadmium, micro-chemical analysis of, 1456, 1499.
Calcite, crystallization of, from copper mines of Lake Superior, 1313.
Calcites from the Bad Lands, 1144.

- Calcium, micro-chemical analysis of, 1242.
- Calliphora erythrocephala, development of, 1578.
- Camera, stereo-photo-micrographic, 1113.
- Cancer, etiology of, 1136.
- Cancer, miscellaneous studies in, 1428.
- Casts found in urine, how to preserve as permanent specimens, 1476.
- Cell division in Protozoa, 1382.
- Cell plate in higher plants, development of function of, 1132.
- Centrosome, the kinetic center of the cell, 1302.
- Centrosome and sphere in Crepidula, 1505.
- Centrosomes in the higher plants, 1461.
- Ceramothamnion codii, a new rhodophyceous alga, 1412.
- Cesium and rubidium, 1125.
- Cestodes, collection and preservation of, 1581.
- Cestodes, development of, 1340.
- Chalcopyrite, experiments on, 1394.
- Châmpignons, sexual reproduction in, 1535.
- Changes that take place in the bacterial contents of water during transportation, 1553.
- Charcot-Leyden crystals associated with eosinophilic cells, 1387.
- Chemical analysis of the sexual products of sea urchin, 1185.
- Chemical quantitative analysis of proteids in stomach contents, 1216.
- Chemical relationship of colloid, mucoid, and amyloid substances, 1426.
- Cholera bacillus, spores of, 1392.
- Chrome-silver impregnation for nerve tissue, 1560.
- Chromosomes of the germ cells of Metazoa, 1578.
- Cirrhosis of the Liver, nature and distribution of new tissue in, 1263.
- Cleistogamous flowers, 1536.
- Columbia University, growth in ten years, 1567.
- Combined condenser and polarizer for petrographical microscopes, 1155.
- Combined slide and cover-glass forceps, 1436.
- Combined ureometer and saccharometer, 1286.
- Cone net, Birge, 1405.
- Connecting threads in the tissues of Pinus sylvestris, 1502.
- Constant current on organisms, effect of, 1140.
- Contact irritability produced by salt solutions, 1584.
- Contributions to our knowledge of color in photo-micrography, 1489.
- Corundum, formation of, 1144.
- Course in biology in the Horace Mann High School, 1249.
- Course of study in invertebrate zoology in the Marine Biological Laboratory at Wood's Holl, 1481.
- Crocodylians, Lizards, and Snakes of North America, 1340.
- Crystallography of cadmium and zinc, 1224.
- Current Bacteriological Literature, reviews, 1141, 1186, 1222, 1266, 1310, 1347, 1391, 1427, 1472, 1548, 1587.
- Current Botanical Literature, reviews, 1131, 1174, 1206, 1255, 1299, 1332, 1381, 1411, 1460, 1502, 1535, 1573.
- Current Zoological Literature, reviews, 1212, 1260, 1339, 1385, 1418, 1465, 1506, 1541, 1570.
- Cycas revoluta, tuber-like rootlets of, 1334.
- Cytology, Embryology and Microscopical Methods, reviews, 1133, 1176, 1208, 1257, 1301, 1334, 1382, 1414, 1462, 1504, 1537, 1576.
- Damp chamber for use with klinostat, 1499.
- Daphnia magna, reactions of, to certain changes in its environment, 1140.
- Demarcation current of a resting nucleus, 1425.
- Demonstration of reactions of unicellular organisms, 1222.
- Demonstration of reticulate vessels, 1356.
- Description of the new wing of the laboratory of hygiene at the University of Pennsylvania, 1234.
- Development of embryo of mouse up to time it is encapsuled in the decidua reflexa, 1386.
- Development of pollen grain of Carex, 1175.
- Device for leveling the microscope, 1458.
- Device for rearing dragon flies, 1277.
- Device for supporting Pasteur flasks, 1157.
- Diatoms, modern conception of the structure and classification of, 1413.
- Diffugia, experiments on, 1464.
- Digestive processes and functions of the anterior part of the alimentary tract in selachians, 1470.
- Diphtheria bacillus in the mouths of healthy individuals, 1145.
- Directing marks in microscopical sections for the purpose of reconstruction by wax plate modeling, 1537.
- Directions for Beginners in Bacteriology, 1310.
- Double fertilization in maize, 1411.
- Drones from the unfertilized eggs of bees, 1577.
- Easy method of mounting and preserving mosquitoes, 1120.
- Echinococcus alveolaris and multilocularis, 1544.
- Ehrlich's triacid mixture for staining blood, 1314.
- Ehrlich-Weigert anilin methyl-violet method for staining tubercle bacilli, 1395.
- Elastic fibers of the skin, method of staining, 1423.
- Elastic tissue in the lung, methods of demonstrating, 1338.
- Electrical conductivity of the blood, 1423.
- Embryochemical studies, 1426.
- Embryo sac of Peperomia, 1299.
- Endurance of pest bacilli in pure cultures, 1472.
- Enzymes in cheese, 1186.
- Eosinophilic cells, origin of, 1422.
- Eosinophilic cells, staining, 1417.
- Eosinophilic leucocytes in tumors, 1508.
- Epilepsy parasite, 1188.
- Epithelial cells in mouth and pharynx of salamander larvæ, 1383.
- Erigenia bulbosa, morphological and anatomical study of, 1175.
- Essentials of Practical Bacteriology, 1310.
- Examination of blood, 1593.
- Exclusion and elimination of pathogenic bacteria from sewage, 1551.
- External osmotic pressure upon green algae, effect of, 1574.
- Eye spot of Euglena viridis, 1133.

- Eyes of hydromedusæ, structure of, 1213.
 Eyes of lower vertebrates, histology and physiology of, 1586.
 Fermentation of bread, abnormal, 1222.
 Fermentation tube adapted to rapid handling in routine work, 1404.
 Fermentation tubes for bacteriologic investigations of fermentation, 1286.
 Flagellata in Engler & Prantl's "Die Naturlichen Pflanzenfamilien," 1261.
 Flattening and fixing paraffin sections on slide, 1196.
 Formalin as a preservative of zoological material, 1339.
 Formalin as a reagent in blood studies, 1211.
 Formalin solutions, table of, 1435.
 Formol as a fixing fluid, 1257.
 Formulæ:
 Culture medium for germination of spores, 1148.
 Decolorizing solution for staining in toto with Delafield's hæmatoxylin, 1172.
 Ehrlich's tracid mixture for staining blood, 1314.
 Fluid for pure cultures of Infusoria, 1221.
 Fluids for fixing and preserving zoological specimens and anatomical material, 1582.
 Hydrochloric acid alcohol, 1146.
 Kresylechtviolett, 1492.
 Kultschitzki's hæmatoxylin, 1179.
 Mallory's stain for tumors, 1137.
 Nutrient gelatin, 1165.
 Nutrient salt solution, 1148.
 Phloxin-methylen blue for blood, 1305.
 Preservative for Crustacea, 1341.
 Saturated solutions of anilin stains, 1397.
 Unna-Tanzer's orcein solution, 1146.
 Fresh water micro-fauna and flora, treatise on, 1212.
 Gabbett's method for staining tubercle bacilli, 1395.
 General methods for the study of the nervous system, 1557.
 General Physiology, reviews, 1138, 1182, 1218, 1264, 1307, 1343, 1389, 1423, 1470, 1510, 1546.
 General Physiology for high schools, based upon the nervous system, 1346.
 Gill clefts in the lizard, origin, growth, disappearance and derivations of, 1419.
 Ginkgo biloba, fertilization in, 1332.
 Gland-like carcinoma of epidermic origin, 1180.
 Glands of stomach in different stages of activity, 1504.
 Glicinum, micro-chemical analysis of, 1373, 1497.
 Glycogen in parasitic worms, 1346.
 Golden calcite, 1313.
 Golgi's rapid method for chrome-silver impregnation, 1561.
 Gram's method for staining diphtheria bacilli, 1476.
 Gregarines, cellular changes caused by, 1506.
 Growing tip of Allium, 1396.
 Gymnosperms, morphology and development of, 1503, 1573.
 Hæmolymph glands, normal histology and pathology of, 1387.
 Haine's list for sugar in urine, 1353.
 Hair-cells and ciliated-cells, 1133.
 Handbook of systematic botany, 1460.
 Harlequin fly, structure and life history of, 1506.
 Harriman Alaska expedition, 1385.
 Helosis guayanensis, embryo sac of, 1461.
 High power photo-micrography, 1158.
 Hippolyte varians, color changes in, 1182.
 Home life of wild birds, 1419.
 Home made wall charts, 1195.
 Hydroids of the Wood's Holl region, 1541.
 Illinois Gulch meteorite, 1352.
 Immersion oil in collapsible tubes, 1567.
 Immunity, Buchner on, 1427.
 Improved automatic microtomes, 1317.
 Improvised microtome, 1162.
 Indium in Tungsten minerals, 1394.
 Individuality of the germ nuclei during the cleavage of the egg of Crepidula, 1577.
 Inflammation, histology of, 1421.
 Infusoria, acclimatisation of, to chemical media, 1220.
 Infusoria, ciliatæ, galvanotaxis and chemotaxis of, 1510.
 Inhibition by artificial section of the fission plane in Stenostoma, 1308.
 Inoculation against rinderpest, 1143.
 Intravascular growth of certain endotheliomata, 1469.
 Introduction to Practical Bacteriology for Students and Practitioners of Comparative and Human Medicine, 1142.
 Introduction to Study of Zoology for use of High Schools and Academies, 1578.
 Invertebrates of North America, Synopses of, 1420.
 Iodine compounds in the tissues after the administration of potassium iodide, 1426.
 Iron hæmatoxylin and orange-G, staining nerve tissue with, 1557.
 Irritable phenomena in living organisms, 1425.
 Isopods of Atlantic coast of North America, 1420.
 Kaiserling method for the preservation of pathological specimens, 1592.
 Karyokinetic spindle in pollen-mother-cells of Lavatera, development of, 1131.
 Koch's new views concerning bovine and human tuberculosis, 1548.
 Kresofuchsin, a new stain, 1414.
 Kresylechtviolett, a new general stain, 1492.
 Labeling mounted specimens, 1566.
 Laboratory camera stand, 1202.
 Laboratory courses by correspondence, 1437.
 Laboratory equipment of the "Bahama Expedition" from the University of Iowa, 1229.
 Laboratory Guide in Elementary Bacteriology, 1310.
 Laboratory photography:
 An improved photo-micrographic apparatus, 1366.
 Contributions to our knowledge of color in photo micrography, 1489.
 High power photo-micrography, 1158.
 Laboratory camera stand, 1202.
 Photographing diatoms, 1439.
 Photo-micrography: I, Introductory, 1399;
 II, Apparatus, 1525.

- Processes of photo-micrography, 1199.
 Stereo-photo-micrography, 1113.
 The ortol developer, 1487.
 The photo-micrography of tissues with simple apparatus, 1283.
 The value of the telephoto lens, 1241, 1568.
- Lepra bacilli in nasal cavities of lepers, 1391.
 Leucocytes, methods for fixation and differentiation of, 1177.
 Leucocytes in the thymus in bony fishes, origin of, 1301.
 Lichens, association of alga and fungus in, 1208.
 Lime cysts on the surface of the kidney, 1306.
 Lithium, micro-chemical analysis of, 1191.
 Lymph cells in the marrow of the bones, 1258.
 Magnesium, micro-chemical analysis of, 1376, 1495, 1497.
 Magnifiers, 1448.
 Malarial parasitology, 1304.
 Marine Biological Laboratory at Cold Spring Harbor, L. I., 1279.
 Melonite, 1226, 1351.
 Mercury in urine, estimation of, 1146.
 Mesogamy in *Cucurbita*, 1413.
 Metallic sodium in blowpipe analysis, 1393.
 Method for collection and preservation of parasitic worms, 1580.
 Method for rearing *Amœba*, 1566.
 Method of determining the comparative gravity of alcohol when dehydrating by osmosis, 1409.
 Method of injecting small vessels, 1282.
 Methods for use in the study of Infusoria, 1579.
- Methods:
- Beale's carmine for isolated nerve cells, 1564.
 - Chenzinski's method for staining gonococcus, 1515.
 - Chrome-silver impregnation for nerve tissue, 1560.
 - Clinical quantitative analysis of proteids in stomach contents, 1216.
 - Contrast staining of blood corpuscles, 1335.
 - Cultivating and staining the diphtheria bacillus, 1314.
 - Demonstrating arrangement of cilia on *Paramecium*, 1566.
 - Detection and determination of sugar in urine, 1353.
 - Determining the comparative gravity of alcohol when dehydrating by osmosis, 1409.
 - Differentiation of blood of various animals, 1268.
 - Double staining of cartilage, 1337.
 - Embedding in celloidin, 1539.
 - Estimation of mercury in urine, 1146.
 - Examination of blood, 1145.
 - Experiments upon the formation of enzymes by bacteria, 1587.
 - Finishing laboratory desk tops, 1240.
 - Flattening and fixing paraffin sections on slides, 1196.
 - Germination of spores, 1147.
 - Golgi's rapid method for chrome-silver impregnation, 1561.
 - Gram's method for staining diphtheria bacilli, 1476.
 - Hardening nerve tissue with formaldehyde, 1562.
 - Injecting small vessels, 1282.
 - Kresyllichtviolett, staining with, 1492.
 - Labeling mounted specimens, 1566.
 - Making preparations of bone marrow, 1259.
 - Making slides of *Amœba*, 1450.
 - Malarial parasitology, 1304.
 - Measuring crystals, 1225.
 - Methylen blue and erythrosin method for nerve cells, 1560.
 - Mounting and preserving mosquitoes, 1129.
 - Mounting mouth parts of cray fish, 1435.
 - Neisser's method of staining gonococcus, 1515.
 - Nissl's method for staining nerve cells, 1558.
 - Orienting and cutting small opaque objects, 1505.
 - Osmic acid for staining peripheral nerve fibers, 1564.
 - Phenyl-hydrazin test for sugar, 1268.
 - Preparing permanent specimens to demonstrate structure of earthworms, 1409.
 - Preservation of pathological specimens, 1592.
 - Preservation of sputum for microscopical examination, 1268.
 - Preserving bacteria for museum specimens, 1268.
 - Preserving Crustacea, 1341.
 - Quantitative test for bacteria in milk with low magnifying power, 1596.
 - Rearing *Amœba*, 1566.
 - Schütz method of staining gonococcus, 1515.
 - Simultaneous staining of blood smears with eosin and methylen blue, 1227.
 - Staining bacteria in root tubercles of leguminous plants, 1528.
 - Staining connective and elastic tissue, 1262.
 - Staining echinococcus, 1545.
 - Staining elastic fibers of the skin, 1423.
 - Staining elastic fibers in sputum, 1146.
 - Staining eosinophile cells, 1417.
 - Staining fat, 1178, 1227, 1508.
 - Staining flagella, 1472.
 - Staining gonococcus, 1515.
 - Staining in toto with Delafield's hæmatoxylin, 1172.
 - Staining Infusoria, 1435.
 - Staining large numbers of sputum specimens, 1594.
 - Staining malaria parasite, 1435.
 - Staining nerve cells, 1180.
 - Staining nerve tissue, 1557.
 - Staining sections for class work, 1194.
 - Staining sections of tumor, 1137.
 - Staining sections while embedded in paraffin, 1212.
 - Staining tubercle bacilli, 1395, 1472.
 - Studying Infusoria, 1579.
 - Tallqvist's method of hæmoglobin estimation, 1596.
 - Testing for *B. coli* in water, 1403.

- Weigert's myelin stain for nerve fibers, 1563.
- Widal test in diagnosis of typhoid fever, 1434.
- Methods in Plant Histology, 1412.
- Micro-chemical analysis:
- X. Potassium, 1121.
 - XI. Ammonium, 1189.
 - XII. The analytical reactions of group, II; calcium, 1242.
 - XIII. Strontium, barium, 1289.
 - XIV. Barium, continued, 1323.
 - XV. Magnesium group; glaucinum, 1373.
 - XVI. Zinc, 1451.
 - XVII. Magnesium group separations; glaucinum, magnesium, zinc, cadmium, 1495.
 - XVIII. Aluminum, 1529.
- Microtome, an improvised, 1162.
- Microtome, automatic wheel, 1317.
- Microtome, new freezing, for use with carbon dioxide tanks, 1320.
- Microtome, precision, 1318.
- Mitosis in the spore-mother-cells of *Lilium*, 1175
- 1206.
- Mitotic division in unfertilized *Arbacia* eggs, 1139.
- Modern Photography in Theory and Practice, 1204.
- Mollusks, monograph on the Tectibranches, 1507.
- Mosquitoes, 1465.
- Mosses with a Hand Lens, 1299.
- Mucous plug in surface epithelium of stomach, origin of, 1134.
- Multiple primary malignant tumors, 1583.
- Multiplication of nuclei in striated muscle of vertebrates, 1336.
- Muscle fibers, methods in study of, 1211.
- Muscles in frogs of both sexes at different seasons of the year, 1309.
- Mycetozoa, preliminary study of, 1119.
- Myeloma, case of multiple, 1181.
- Mycocarditis, relation of, to sclerosis of coronary arteries, 1341.
- Naias major, fertilization in, 1575.
- Natrolite, 1144.
- Nature and distribution of the new tissue in cirrhosis of the liver, 1263.
- Nelumbo, embryogeny of, 1575.
- Nematodes, collection and preservation of, 1581.
- New biological laboratories of Ripon College, 1149.
- New blood stain, 1305.
- New freezing microtome for use with carbon dioxide tanks, 1320.
- New medical laboratories of the University of Pennsylvania, 1445.
- New meteoric iron, 1312.
- New stain for fibrin, 1227.
- New test for chlorine for use with blow pipe, 1352.
- New thermo-regulator, 1449.
- New York botanical garden, 1115.
- Nissl's method for staining nerve tissue, 1558.
- Nodule organisms in leguminous plants, 1551.
- Non-nucleated organisms, cytology of, 1207.
- Normal and Pathological Histology, reviews, 1136, 1180, 1214, 1262, 1304, 1341, 1387, 1421, 1468, 1508, 1544.
- Normal electrode for physiological work, 1471.
- Nostoc commune, heterocysts in, 1381.
- Notes on examination of blood, 1145.
- Notes on Recent Mineralogical Literature, reviews, 1144, 1224, 1312, 1350, 1393, 1431, 1474, 1513, 1553.
- Notes on testing for *B. coli* in water, 1403.
- Nuclear division in Protozoa, 1464.
- Nucleoproteids of the brain, 1426.
- Nucleus, function of, 1135.
- Oedogoniaceæ, morphology, and taxonomy of, 1535.
- Oligocheta, anatomy and histology of nervous system of, 1542.
- Organography of plants, 1131.
- Orcein in the demonstration of elastic fibers in sputum, 1146.
- Organisms of nitrification, 1347.
- Orientation of organisms, 1425.
- Origin of the cones of the multipolar spindle in *Gladiolus*, 1413.
- Ortol developer, 1487.
- Osmic acid for staining peripheral nerve fibers, 1564.
- Osmotic pressure as a factor in biological phenomena, 1345.
- Otter seine for the exploration of the deeper seas, 1542.
- Pachymeningitis hæmorrhagica interna, 1214.
- Parthenogenesis in *Antennaria alpina*, 1255.
- Pellia, nuclear studies on, 1333.
- Pelomyxa, notes on rearing, 1260.
- Pelomyxa, some results of feeding, 1260.
- Permeability of red blood corpuscles for different substances, 1424.
- Pfehl's method of staining the malaria parasite, 1435.
- Phenyl-hydrazen test for sugar in urine, 1353.
- Photo-micrography, 1399, 1525.
- Photo-micrography of tissues with simple apparatus, 1283.
- Phototropism in some arthropods, 1390.
- Physiological characteristics of the cell, 1307.
- Physiological studies on the blood of animals deprived of the adrenals, 1586.
- Physiology in the Detroit High School, 1585.
- Physiology of growth, 1343.
- Pigment of brown induration of the lung, 1584.
- Pigmentation cirrhosis of the liver in hæmochromatosis, 1342.
- Plan for a ureometer, 1156.
- Planaria maculata*, physiology of, with special reference to regeneration, 1265.
- Planarians, with and without eyes, reactions of, 1138.
- Plimmer's bodies in carcinoma, 1138.
- Pneumonia fibrosa chronica, 1262.
- Point in the technique of blood counting, 1226.
- Poisonous effects of pure NaCl solution, 1221.
- Polarity among marine Algæ, 1333.
- Polarity of the ovocyte, egg and larva of *Strongylocentrotus lividus*, 1576.
- Potassium, micro-chemical analysis of, 1121.
- Preliminary study of Mycetozoa, 1119.
- Pre-Medical course at Purdue University, 1591.

- Preservation of sputum for microscopical examination, 1268.
- Primary endotheliomata of the left superior pulmonary vein, 1468.
- Protozoa, morphology, taxonomy and ecology of, 1418.
- Pseudo diphtheria bacilli, varieties of, 1430.
- Pseudomonas hyacinthi* (Wakker), hyacinth germ, 1267.
- Pseudo tetanus bacillus, 1473.
- Pulmonary gangrene, bacilli of, 1223.
- Pupation of larvæ of insects under limited amount of air, 1546.
- Purdy's method for quantitative determination of sugar in urine, 1353.
- Pus, causes for formation of, 1588.
- Pycnogonids, habits of, 1308.
- Pycnopodia helianthoides, multiplication of the rays and bilateral symmetry in, 1214.
- Quantitative test for bacteria with low magnifying power, 1506.
- Quartz, 1145.
- Queen torch, 1228.
- Quick and simple method of fixing the blood corpuscles for differential staining, 1306.
- Rapid method of making slides of *Amœba*, 1450.
- Reaction of Entomostraca to stimulation by light, 1183.
- Regeneration in Cystopteris, 1300.
- Relative susceptibility of domestic animals to the contagion of human and bovine tuberculosis, 1310.
- Respiration of *Desmognathus*, 1135.
- Rheumatic fever, etiology of, 1473.
- Rhythmic activity of the œsophagus, influence of various media on, 1585.
- Ringing slides, 1505.
- Root tubercles in leguminous plants, 1348.
- Rubidium and cesium, 1125.
- Scarlet fever, etiology of, 1142.
- Schizea pusilla*, life history of, 1206.
- Scrofulous glands, study of, 1428.
- Sealing stone jar for zoological laboratories, 1261.
- Secretion and absorption, morphological changes in the intestinal epithelium during, 1415.
- Separation of alumina from molten magmas, 1144.
- Septic vibrio and symptomatic anthrax, comparative study of, 1420.
- Short method for the Widal test, 1565.
- Silage, causes operative in formation of, 1186.
- Silicate, theory of, 1553.
- Silicates, action of ammonium chloride on, 1393.
- Simple washing device, 1207.
- Smegma bacillus*, 1223.
- Soft rot on carrot and other vegetables, 1267.
- Source of leucocytes and the true function of the thymus, 1208.
- Species *hepaticarum*, 1535.
- Spermatogenesis in *Batrachoseps*, 1540.
- Spermatogenesis in *Staphylinus*, 1577.
- Spermatozoa of ferns, physiology of, 1536.
- Spermatozoa in man, domestic animals, and rodents, 1360.
- Sphalerite crystals from Galena, Kansas, 1352.
- Spiral swimming of organisms, 1512.
- Sporodinia, nuclei of the zygospores in, 1332.
- Stain for simultaneous staining of blood smears with eosin and methylen blue, 1227.
- Staining bacteria in the root-tubercles of leguminous plants, 1528.
- Staining in toto with Delafield's hæmatoxylin, 1172.
- Staining the diphtheria bacillus, 1476.
- Staining sections for class work, 1194.
- Staining nerve tissue, 1557.
- Staphylococci, production of toxins by, 1589.
- Staphylococcus albus*, morphology of, 1143.
- Static diffusion of gases and liquids in relation to the assimilation of carbon and translocation in plants, 1256.
- Stereo-photo-micrography, 1113.
- Sterilized air, physiological effects of, on animals, 1346.
- Stokesite, 1145.
- Striated muscles, cancers and sarcomas in, 1215.
- Striated muscles, normal and pathological histology of, 1215.
- Strontium, micro-chemical analysis of, 1280.
- Study of bacteria in the public schools, 1164.
- Studying and photographing the wild bird, 1517.
- Substitutes for hydrochloric acid in testing carbonates, 1352.
- Sulvanite, a new mineral, 1352.
- Swarm spore formation in *Hydrodictyon utriculatum*, 1300.
- System der Bacterien, Migula's, 1347.
- Table of specific gravities of saturated solutions and solubilities of anilin stains, 1397.
- Tallqvist's method of hæmoglobin estimation, 1506.
- Technic for malaria blood, 1382.
- Technic of blood preparations, 1524.
- Technic of the Widal test, 1434.
- Telephoto lens in photography, value of, 1241, 1568.
- Tetrad division in a hybrid plant, 1174.
- Tetrad formation in the ovule of *Larix*, 1174.
- Theory of phototactic response, 1264.
- Thigmotaxis in Protozoa, 1184.
- Thyroid gland, experiments on, 1583.
- Thyroid gland, pathology and diseases of, 1509.
- Tobacco, fermentation of, 1186.
- Tourmaline, constitution of, 1312.
- Tracheal cells of the Oestride, 1176.
- Transmission of tuberculosis by postage stamps, 1429.
- Trematodes, collection and preservation of, 1580.
- Tropical dysentery, etiology of, 1141.
- Tube filter for concentrating Infusoria in small amount of liquid, 1579.
- Tubercle bacilli in dairy products, 1311.
- Tubercle bacillus, life duration of, in cheese, 1187.
- Tubercle bacillus, thermal death point of, 1223.
- Tuberculosis of the heart, 1215.
- Tubularia mesembryanthemum*, regulatory processes of, 1218.
- Tulipa gesneriana*, life history of, 1381.
- Tunicate, alternation in direction of heart beat in, 1387.
- U-cell, for filtration in study of Infusoria, 1579.

- University of Montana Biological Laboratory, 1260, 1354.
Ureometer, plan for, 1156.
Vaccinia and variola, etiological agent in, 1429.
Value of methylen blue as an intravital stain in the Tunicata, 1357.
Value of the telephoto lens, 1241.
Ventilated dish for bacteria cultures, 1197.
Vertebrates, development of, 1212.
Veterinary College at Cornell, fire in, 1111.
Walnut bacteriosis, 1587.
Weigert's Myelin stain for nerve fibres, 1563.
Weigert's neuroglia method in demonstration of fat necrosis, 1416.
Welsbach light in high power microscopy, 1356.
White, Moses C., life of, 1109.
Widal test, short method for, 1565.
Widal test, technic of, 1434.
Xylariaceæ, Minnesota, 1535.
Yarn siphon, for separating Infusoria from culture water and debris, 1579.
Yellow fever, etiology of, 1349.
Ziehl-Neelson method for staining tubercle bacilli, 1395.
Zinc, micro-chemical analysis of, 1451, 1498.
Zoölogisches Addressbuch, 1419.

INDEX OF AUTHORS.

- BARDEEN, CHARLES R.
New Freezing Microtome for use with Carbon-dioxide Tanks, 1320.
- BEAL, W. J.
Demonstration of Reticulate Vessels, 1356.
- BESSEY, CHARLES E.
Home Made Wall Charts, 1105.
- BIRGE, E. A.
The Cone Net, 1405.
- BOSTON, L. NAPOLEON.
Spermatozoa of Man, Domestic Animals and Rodents, 1360.
- BUXTON, B. H.
An Improved Photo-micrographic Apparatus, 1366.
- CHAMBERLAIN, CHARLES J.
Current Botanical Literature, reviews, 1131, 1174, 1206, 1255, 1299, 1332, 1381, 1411, 1460, 1502, 1535, 1573.
Laboratory Courses by Correspondence, 1437.
- CHAMOT, E. M.
Micro-Chemical Analysis :
X. Potassium, 1121.
XI. Ammonium, 1180.
XII. Analytical Reactions of Group II, 1242.
XIII. Strontium, Barium, 1280.
XIV. Barium (continued), 1323.
XV. Magnesium Group, 1373.
XVI. Zinc, Cadmium, 1451.
XVII. Magnesium Group Separations, 1405.
XVIII. Aluminum, 1529.
- CLAYPOLE, AGNES M.
Cytology, Embryology and Microscopical Methods, reviews, 1133, 1176, 1208, 1257, 1301, 1334, 1382, 1414, 1402, 1504, 1537, 1507.
- COLE, LEON J.
A Method for Injecting Small Vessels, 1282.
- COGN, H. W.
Current Bacteriological Literature, reviews, 1141, 1186, 1222, 1266, 1310, 1347, 1391, 1427, 1472, 1548, 1587.
- COOK, MEL T.
Method for Rearing Amoeba, 1566.
- DAVIS, B. M.
Flattening and Fixing Paraffin Sections on Slide, 1196.
- DEARNESS, J.
Magnifiers, 1448.
- DENNIS, D. W.
Photo-Micrography: Introduction, 1399 ; An Apparatus adapted to All Kinds of Work, 1525.
- DODGE, CHARLES WRIGHT.
A Short Method for the Widal Test, 1565.
Immersion Oil in Collapsible Tubes, 1567.
The Arrangement of Cilia on Paramecium, 1566.
- ELROD, MORTON J.
The University of Montana Biological Station, 1260.
The Value of the Telephoto Lens, 1241.
Further Note on the Use of the Telephoto Lens, 1568.
- EVANS, NEWTON.
Staining in Toto with Delafield's Haematoxylin, 1172.
Staining Sections for Class Work, 1194.
- FLEXNER, SIMON.
The New Medical Laboratories of the University of Pennsylvania, 1445.
- FRENCH, G. H.
The Epilepsy Parasite, 1188.
- FULTON, W. A.
Note on Examination of Blood, 1145.
- GAGE, S. H.
Fire in the Veterinary College at Cornell, 1111.
Moses C. White, 1109.
- GAGE, STEPHEN DEM.
Notes on Testing for B. Coli in Water, 1403.
- GOLDEN, KATHERINE E.
A Device for Supporting Pasteur Flasks, 1157.
- GRAVE, CASWELL.
The Course of Study in Invertebrate Zoölogy in the Marine Biological Laboratory at Wood's Holl, 1481.
- HERRICK, FRANCIS H.
Studying and Photographing the Wild Bird, 1517.
- HIGGINS, F. W.
A Point in the Technic of Blood Counting, 1226.
- HOUSER, GILBERT L.
General Methods for the Study of the Nervous System, 1557.
- HOWARD, ORSON.
Biology Wall Charts, 1172.
- HUNTER, GEORGE W., JR.
The Value of Methylene Blue as an Intra-vitam Stain in the Tunicata, 1357.

- KOFOID, CHARLES A.
Current Zoölogical Literature, reviews,
1212, 1260, 1339, 1385, 1418, 1465, 1506,
1541, 1578.
- LANGENBECK, CLARA.
Preliminary Study of Mycetozoa, 1119.
- LATHAM, V. A.
Easy Method of Mounting and Preserv-
ing Mosquitoes, 1129.
- LEAVITT, ROBERT G.
Simple Washing Device, 1297.
- LEROY, LOUIS.
Table of Specific Gravities of Saturated
Solutions and Solubilities of Anilin
Stains, 1397.
- MACDOUGAL, D. T.
The New York Botanical Garden, 1115.
- MARSH, C. DWIGHT.
The New Biological Laboratories of Ripon
College, 1149.
- MCCLUNG, C. E.
High Power Photo-Micrography, 1158.
The Processes of Photo-Micrography, 1199.
- MINOT, CHARLES S.
Improved Automatic Microtomes, 1317.
- MUYAKE, KIICHI.
The Botanical Laboratory and the Botani-
cal Garden of the Tokyo Imperial
University, Japan, 1477.
- MORSE, RALPH L.
Kresylechtviolett, 1492.
- MOSES, ALFRED J. and LUQUER, LEA MCL.
Notes on Recent Mineralogical Literature,
reviews, 1144, 1224, 1312, 1350, 1393,
1431, 1474, 1513, 1553, 1589.
- MYERS, P. C.
Photographing Diatoms, 1439.
- NICHOLS, J. B.
A Plan for a Ureometer, 1156.
- NUTTING, C. C.
The Laboratory Equipment of the "Ba-
hama Expedition" from the University
of Iowa, 1229.
- PALMER, THOS.
A New Thermo-Regulator, 1449.
- PATTERSON, W. L.
A Combined Condenser and Polarizer for
Petrographical Microscopes, 1155.
- PEABODY, JAMES E.
The Study of Bacteria in the Public
Schools, 1164.
- PEARCE, RICHARD M.
Normal and Pathological Histology, re-
views, 1136.
- PEARL, RAYMOND.
General Physiology, reviews, 1138, 1182,
1218, 1264, 1307, 1343, 1398, 1423, 1470,
1510, 1546, 1584.
- PERCE, GEORGE J.
Staining Bacteria in the Root-tubercles of
Leguminous Plants, 1528.
- POWERS, IRWIN LAV.
An Improvised Microtome, 1162.
- PRATT, H. S.
The Marine Biological Laboratory at
Cold Spring Harbor, L. I., 1279.
- PRATT, JOSEPH H.
Normal and Pathological Histology, re-
views, 1180, 1214, 1262, 1304, 1341,
1387, 1421, 1468, 1508, 1544, 1583.
- RAWLINS, B. L.
A Few Remarks on the Technic of Blood
Preparations, 1524.
- REED, HOWARD S.
A Damp Chamber for Use on the Klino-
stat, 1490.
- REYNOLDS, T. O.
Device for Leveling the Microscope, 1458.
- ROBIN, A.
Combined Ureometer and Saccharometer,
1286.
- ROLES, P. H.
A Laboratory Camera Stand, 1202.
- SHAW, C. H.
Botany at the Biological Laboratory at
Wood's Holl, 1486.
- WALMSLEY, W. H.
The Photo-Micrography of Tissues with
Simple Apparatus, 1283.
- WHIPPLE, GEORGE C.
A Ventilated Dish for Bacteria Cultures,
1197.
- WILLCOX, M. A.
A Rapid Method of Making Slides of
Amœba, 1450.
- WOLCOTT, ROBT. H.
A Modification of the Birge Collecting
Net, 1407.
- WOODFORD, R. P.
A Method of Determining the Compara-
tive Gravity of Alcohol when Dehydrat-
ing by Osmosis, 1409.
The Ortol Developer, 1487.

INDEX OF AUTHORS REVIEWED.

- ABBOTT, H. S.
Modern Photography in Theory and Practice, 1204.
- ABBOTT, M. E.
Pigmentation Cirrhosis of the Liver in a case of Haemochromatosis, 1342.
- ARNOLDI, W.
Beiträge zur Morphologie einiger Gymnospermen, 1503, 1573.
- ARRIGO, G.
Ueber die Gegenwart und über die Phasen des Kochschen Bacillus in den sogenannter skrophulösen Lymphdrüsen, 1428.
- ATKINSON, ELIZABETH A.
Indium in Tungsten Minerals, 1394.
- BABCOCK AND RUSSEL.
Causes Operative in the Formation of Silage, 1186.
Relation of the Enzymes of Rennet to Ripening of Cheddar Cheese, 1186.
- BARDEEN, C. R.
On the Physiology of the Planaria maculata with especial reference to the Phenomena of Regeneration, 1265.
- BARROWS, A. S.
Respiration of Desmognathus, 1135.
- BATAILLON, E.
La pression osmotique et les grands problèmes de la Biologie, 1345.
- BAUM, E.
Ueber die punktförmigen Kalkkörperchen (sogen-veerkalkte Glomerule) der Nierenrinde, 1306.
- BAUM, J.
Beiträge zur Kenntniss der Muskelspindeln, 1211.
- BEARD, J.
The Source of Leucocytes and the True Function of the Thymus, 1208.
- BEER, TH.
Ueber primitive Sehorgane, 1586.
- BEHRENS.
Ueber die oxydierenden Bestandtheile und die Fermentation des Deutschen Tabaks, 1186.
- BEIJERINCK.
Anhäufungsversuche mit Ureumbakterien, 1347.
- BENDA, C.
Eine Makro- und Mikrochemische Reaction der Fettegewebnecrose, 1416.
- BENEDICT, A. L.
Clinical Quantitative Analysis of Proteids in Stomach Contents, 1216.
- BERGII, R. S.
Beiträge zur Vergleichende Histologie 11. Ueber den Bau der Gefässe bei den Anneliden, 1213.
Kleinere histologische Mittheilungen, 1385.
- BERNARD, CH.
Recherches sur les sphères attractives chez Lilium candidum, Helosis guayanaensis, etc., 1461.
- BESSEY, CHARLES E.
The Modern Conception of the Structure and Classification of Diatoms, with a Revision of the Tribes and a Rearrangement of the North American Genera, 1413.
- BICKEL, A.
Beiträge zur Gehirnphysiologie der Schildkröte, 1546.
- BIELSCHOWSKY AND PLIEN.
Zur Technik der Nervenzellenfärbung, 1180.
- BIENSTOCK.
Du rôle des Bacteries de l'intestin, 1349.
- BLIESENER.
Beitrag zur Lehre von Sporenbildung, 1392.
- BOCK, M. de.
Observations Anatomiques et Histologiques sur les Oligochètes spécialement sur leur Système Musculaire, 1542.
- BONNIER, P.
L'Orientation, 1425.
- BOSTON, L. NAPOLEON.
How to Preserve as Permanent Specimens Casts found in Urine, 1476.
- BOVERI, TH.
Die Polarität von Ovocyte, Ei und Larve des Strongylocentrotus lividus, 1576.
- BRAND, F.
Bemerkungen über Grenzzellen und über spontanrothe Inhaltkörper der Cyanophyceæ, 1381.
- BRITTON, ELIZABETH G., AND TAYLOR, ALEXANDRIA.
Life History of Schizea pusilla, 1206.
- BROWN, H. T., AND ESCOMBE, F.
Static Diffusion of Gases and Liquids in Relation to the Assimilation of Carbon and Translocation in Plants, 1256.

- BUCHNER.
Immunitat, 1427.
- BULLER, A. H. R.
Contribution to our Knowledge of the Physiology of the Spermatozoa of Ferns, 1536.
- BURKHARD, G.
Die Implantation des Ei der Mans in die Uterusschleimhaut und die Umbildung derselben zur Decidua, 1386.
- BUSQUET.
Transmission de la tuberculose par les timbrespast, 1429.
- BUTTERS, F. K.
A Preliminary List of Minnesota Nylar-iaceæ, 1535.
- BYXEE, EDITH S.
The Development of the Karyokinetic Spindle in the Pollen-mother-cells of *Lavatera*, 1131.
- CADE, A.
Les Éléments Sécréteurs des glandes gastriques du fond chez les mammifères, 1504.
- CAMPBELL, D. H.
The Embryo-sac of *Peperomia*, 1299.
- CARLGRÉN, O.
Ueber die Einwirkung des constanten galvanischen Stromes auf niedere Organismen, 1140.
- CHAMBERLAIN, CHARLES J.
Methods in Plant Histology, 1412.
- CHAPMAN, F. M.
Bird Life: A Guide to the Study of Our Common Birds, 1418.
- CHODAT, R., AND BERNARD, C.
Sur le sac embryonnaire de l'*Helosis guayanensis*, 1461.
- CLARKE, F. W.
The Constitution of Tourmaline, 1312.
- CLARKE, F. W., AND STEIGER, G.
Experiments Relative to the Constitution of Pectolite, Pyrophyllite, Calamine, and Alalcite, 1513.
The Action of Ammonium Chloride upon Alalcite and Leucite, 1393.
The Action of Ammonium Chloride upon Natrolite, Scolecite, Prehnite, and Pectolite, 1393.
- CLOETTA, M.
Kann das Medicamentöse Eisen nur im Duodenum resorbiert werden? 1537.
- CLOWES AND HOUSTON.
The Bacterial Treatment of London Sewage, 1430.
- COE, W. R.
Papers from the Harriman Alaska Expedition, XX, The Nemerteans, 1385.
- COLE, L. J.
Notes on the Habits of Pycnogonids, 1308.
- CONKLIN, E. G.
Centrosome and Sphere in the Maturation, Fertilization, and Cleavage of *Crepidula*, 1505.
Individuality of the Germ Nuclei during the Cleavage of the Egg of *Crepidula*, 1577.
- CONN, H. W.
How can Bacteria be Satisfactorily Preserved for Museum Specimens? 1268.
- COPE, E. D.
The Crocodilians, Lizards, and Snakes of North America, 1340.
- COULTER, STANLEY.
Pre-medical Course at Purdue University, 1591.
- COURMANT.
L'agglutination der bacille de Koch des epauchements tuberculeux, 1142.
- COURTADE, D.
L'Irritabilité dans la Serie Animale, 1425.
- CURTIS, H. J.
Essentials of Bacteriology, 1310.
- DAINS.
A Pseudo Tetanus Bacillus, 1473.
- DALE, H. H.
Galvanotaxis and Chemotaxis of Ciliate Infusoria, 1510.
- DANGEARD, P. A.
La reproduction sexuelle des Champignons, 1535.
Nuclear division in Protozoa, 1464.
- DAVIS, BRADLEY M.
Nuclear Studies on *Pellia*, 1333.
- DELAGE, Y., AND DELAGE, M.
Sur les relations entre la constitution chimique des produits sexuels et celle des solutions capables de déterminer la parthénogenèse, 1185.
- DEWITZ, J.
Verhinderung der Verpuppung bei Insektenlarven, 1546.
- DINWIDDIE.
The Relative Susceptibility of Domestic Animals to the Contagion of Human and Bovine Tuberculosis, 1310.
- DIXON, H. H.
On the first mitosis of the spore-mother-cells of *Lilium*, 1206.
- DOFLEIN, F.
Cell division in Protozoa, 1382.
- DRIESCH, H.
Studien über das Regulationsvermögen der Organismen, 1218.
- DU SABLON, LECLERC.
Recherches sur les fleurs cléistogames, 1536.
- EASTES, G. L.
Note on the Phenyl-Hydrazin Test for Sugar, 1268.
- ECKLES.
An Abnormal Fermentation of Bread, 1222.
- EDMUNDS, N.
The Pathology and Diseases of the Thyroid Gland, 1569.

- EIJKMANN.
Ueber Enzyme der Bakterien und Schimmelpilzen, 1587.
- EISEN, G.
The Spermatogenesis of Batrachoseps, 1540.
- EISMOND, J.
Ueber die Natur der Sogenannten Kinetischen Centren der Zellen, 1302.
- ERBEN, F., AND CEJPEK, L.
Analyse der Albits von Amelia, 1514.
- ERNST, A.
Beiträge zur Kenntniss der Entwicklung des Embryo-sackes und des Embryo (Polyembryonie) von Tulipa Gesneriana, 1381.
- EWING, J.
Malarial Parasitology, 1304.
- FARRINGTON, O. C.
Publications Field Columbian Museum, 1313.
- FELDBAUSCH, F.
Ueber das Vorkommen von eosinophilen Leucocyten in Tumoren, 1508.
- FISHER, ALFRED.
Die Empfindlichkeit der Bakterienzelle und das baktericide Serum, 1429.
- FLETCHER, L.
On a Mass of Meteoric Iron from the neighborhood of Caperr, Rio Senguerr, Patagonia, 1226.
- FLEXNER.
The Etiology of Tropical Dysentery, 1141.
- FLEXNER, S.
Nature and Distribution of the New Tissue in Cirrhosis of the Liver, 1263.
- FOLSON, J. W.
The Development of the Mouth Parts of Anurida maritima, 1210.
- FOOTE, K., AND STROBEL, E. C.
Egg of Allolobophora fetida, 1338.
- FOOTE, W. M.
Note on New Meteoric Iron, 1312.
- FORD.
The Bacteriology of Healthy Organs, 1266.
- FOUQUÉ, F.
Contribution à l'étude des minéraux de group de la méilélite, 1351.
- FRAENKEL.
Zur Kenntniss der Smegma bacillus, 1223.
- FRIEDEL, G.
Nouveaux essais sur les Zeolites, 1144.
- FROST, W. D.
A Laboratory Guide in Elementary Bacteriology, 1310.
- FUCHS, E.
Beiträge zur Kenntniss der Entstehung des Vorkommens und der bedeutung "eosinophiler" Zellen, mit besonderer Berücksichtigung des Sputums, 1422.
- FUJINAMI.
Ueber das Histologische Verhalten des Quergestreiften Muskels an der Grenze bösartiger Geschwülste, 1215.
- Ueber die Beziehungen der Myocarditis zu den Erkrankungen der Arterienwandungen, 1341.
- FÜLLEBORN.
Ueber Formalinconservierung, 1339.
- FUNCK.
A Preliminary Note on the Etiological Agent in Vaccinia and Variola, 1429.
- FURST, C. M.
Haarzellen und Flimmerzellen, 1133.
- GALLOWAY, T. W.
Studies on the Cause of the Accelerating Effect of Heat upon Growth, 1221.
- GAMBLE, F. W., AND KEEBLE, F. W.
Hippolyte varians; a Study in Color Changes, 1182.
- GAREISS, A.
Ueber Pseudomorphosen nach Cordierit & Tschermak's, 1475.
- GAULE, J.
Ueber den Einfluss der Jahreszeit auf das Gewicht der Muskeln bei Fröschen, 1309.
- GLINSKI, L. K.
Zur Kenntniss des Nebenpankreas und verwandter Zustände, 1387.
- GODELEWSKI, E.
O, roznmazanin jader w niesniach prazkowanych zwierzat kregowych, 1336.
O wypywie tlenu na rozwoj organizmow i o wymianie gazow w pierwszych stadiach rozwoju zarodka u Rana temporaria, 1586.
- GOEBEL, K.
Organographie der Pflanzen insbesondere der Archegoniaten und Samenpflanzen, 1131.
- GOLDEN, KATHERINE E.
Aspergillus oryzae, 1536.
- GOLDHORN L. B.
A Rapid Method of staining the Chromatin of the Malaria Parasite, 1306.
- GOLDSCHMIDT, V.
Chrysoberyllzwilling von Ceylon, 1433.
Ueber Erkennung eines Zwillinges, 1225.
Ueber Trägerit und künstlechen Uranocpinit, 1394.
Zur Theorie der Zwilling- und Viellingsbildungen, 1433.
- GONNARD, F.
Etude cristallographique du quartz des géodes des marnes oxfordiennes de Meylan, 1145.
Sur un groupe de cristaux de quartz de Striegan, 1145.
- GOGDER, G. A.
Sulvanite, a new mineral, 1352.
- GREENOUGH, R. B.
On the Presence of the So-called "Plimmer Bodies" in Carcinoma, 1138.
- GRIMSLEY, G. P., AND BAILEY, E. H. S.
Report on Gypsum and Gypsum Cement, 1394.

- GROMAKOWSKY.
Varieties of Pseudo Diphtheria Bacilli, 1430.
- GROUT, A. J.
Mosses with a Hand-lens, 1299.
- GRUBER, EDUARD.
Ueber das Verhalten der Zellkerne in den Zygosporen von *Sporodinia grandis*, Link., 1332.
- GRÜNLING, FR.
Ueber die Mineralvorkommen von Ceylon, 1432.
- GUIART, J.
Les Mollusques Tectibranches, 1507.
- GUIGNARD, L.
La Double Fertilization dans le Maïs, 1411.
La double fécondation dans le Naïas Major, 1575.
- GURWITSCH, A.
Die Vorstufen der Flimmerzellen und ihre Beziehungen zu Schleimzellen, 1383.
- HALL, H. O.
The Etiology of Scarlet Fever, 1142.
- HARRIS, H. F.
A New Method of Staining Elastic Tissue, 1422.
- HARRISON.
Die Lebensdauer des Tuberkel Bacillus im Käse, 1187.
- HARTLEY, E. G. G.
Communications from the Oxford Mineralogical Laboratory on the Constitution of the Natural Arsenates and Phosphates, 1513.
- HARVEY, N. A.
Introduction to the Study of Zoölogy for the use of High Schools and Academies, 1578.
- HAUCK, L.
Untersuchungen zur Normalen und Pathologischen Histologie der Quergestreiften Musculatur, 1215.
- HEIDENHAIN, M.
Ueber die erste Entstehung der Schleimpfröpfe beim Oberflächenepithel des Magens, 1134.
- HENNINP, C.
Depigmenting the Eyes of Arthropoda, 1578.
- HERRICK, F. H.
The Home Life of Wild Birds; a New Method of the Study and Photography of Birds, 1419.
- HILL, A. W.
The Distribution and Character of Connecting Threads in the Tissues of *Pinus sylvestris* and other allied species, 1502.
- HILLEBRAND, M. F.
Mineralogical Notes: Melonite, Coloradoite, Petzite, Hessite, 1226.
- HILSUM.
Bakteriologische Untersuchung eines Schwimmbades in Bezug auf Selbstreinigung, 1350.
- HILTNER.
Ueber die Ursachen, welche die Grösse, Zahl, Stellung und Wirkung der Wurzelknöllchen der Leguminosen bedingen, 1348.
- HINTERBERGER.
Eine Modifikation des Geisselfärbungsverfahrens nach Ermengen, 1472.
- HIRN, KARL E.
Monographie und Iconographie der Oedogoniaceen, 1535.
- HIRSCHMANN, A.
Pathologisch-anatomische Studien über acute u. chronische laryngitis nicht-spezifischen Ursprungs nebst Bemerkungen über Vorkommen von Plasma- und Mastzellen, 1544.
- HIS, W.
Ueber Sogenannte Amitosis, 1336.
- HOFFMAN.
Die Rolle des Eisen bei der Blutbildung. Zugleich ein Beitrag zur Kenntniss des Wesens der Chlorose, 1462.
- HOFFMAN, R. W.
Ueber das Orientiren und Schneiden mikroskopisch kleiner, undurchsichtiger und dotterreicher Objecte, 1505.
- HOLM, THEODORE.
Erigenia bulbosa, Nutt., 1175.
- HOLMES, S. J.
Observations on the Habits and Natural History of *Amphithoe longimana*, Smith, 1219.
Phototaxis in the Amphipoda, 1547.
- HOLMGREN, N.
Ueber den Bau der Hoden und die Spermatogenese von *Staphylinus*, 1577.
- HOLT, E. B., AND LEE, F. S.
The Theory of Phototactic Response, 1264.
- HOWARD, L. O.
Mosquitoes, 1465.
- HOWARD, W. T.
Observations on the Character of the Cells in the Exudation in Acute Interstitial Nephritis, with Special Reference to the Presence of Cells with Eosinophilic Granulations, 1422.
- HUTCHINSON, A.
Stokesite, 1145.
- IKENO, S.
Contribution a l'étude de la fécondation chez le *Ginkgo biloba*, 1332.
- JENNINGS, H. S.
Demonstrations of the Reactions of Unicellular Organisms, 1222.
On the Significance of the Spiral Swimming of Organisms, 1512.
- JENSEN.
Studien über die Enzyme im Käse, 1186.

- JOHNSTON, J. B.
A Sealing Stone Jar for Zoological Laboratories, 1261.
- JOLLY, M. J.
Recherches sur la division indirecte des cellules lymphatique granuleuses de la mole des os, 1258.
- JONES.
Soft Rot on Carrot and other Vegetables, 1267.
- JORDAN.
Some Observations upon the Bacterial Self-purification of Streams, 1266.
- JUDD, HIDDEN, AND PRATT.
On a New Mode of Occurrence of Ruby in North Carolina, 1514.
- JUCKENACK, A.
Beitrag zur Kenntniss des fädenziehenden Brotes, 1222.
- JUEL, H. O.
Beiträge zur Kenntniss der Tetradenbildung, 1174.
Vergleichende Untersuchungen über typische und parthenogenetische Fortpflanzung bei der Gattung *Antennaria*, 1255.
- KARLINSKI.
Zur Kenntniss der säurefesten Bakterien, 1391.
- KEIBEL, F., AND ABRAHAM, K.
Normentafel zur Entwicklungsgeschichte des Huhnes, 1212.
- KIJANITZIN, J. J.
Weitere Untersuchungen über den Einfluss sterilisirter Luft auf Thiere, 1346.
- KIZER, E. J.
Formalin as a Reagent in Blood Studies, 1211.
- KOBER.
The Presence of Diphtheria Bacilli in the Mouths of Healthy Individuals, 1145.
- KOCKEL.
New Stain for Fibrin, 1227.
- KORN, OTTO.
Weitere Beiträge zur Kenntniss der säurefesten Bakterien, 1223.
- KREIBICH.
Ueber bakterien frei Eiterung beim Menschen, 1588.
- KROMPECHER.
Glandlike Carcinoma of Epidermic Origin, 1180.
- LAMERIS AND HARREVELT.
Bakterienbefund in Kuhmilch nach geheilter Mastitis, 1187.
- LAWSON, A. A.
Origin of the Cones of the Multipolar Spindle in *Gladiolus*, 1413.
- LECHAINCHE AND VALLÉE.
Etude comparee du vibron septique et de la bacteries du charbon symptomatique, 1429.
- LEVENE, P. A.
Embryo-Chemical Studies, 1426.
- Iodine Compounds in the Tissues after the Administration of Potassium Iodide, 1426.
On the Absorption of Proteids, 1426.
On the Nucleoproteids of the Brain, 1426.
The Chemical Relationship of Colloid, Mucoïd, and Amyloid Substances, 1426.
- LEVIN, J.
Physiological Studies on the Blood of Animals deprived of the Adrenals, 1586.
- LEWINSON, J.
Zur Methode der Fettfärbung, 1178, 1227.
- LEWY.
Die Beziehungen der Charcot-Leyden'schen Krystalle zu den eosinophilen Zellen, 1387.
- LIFE, A. C.
The Tuber-like Rootlets of *Cycas revoluta*, 1334.
- LINKO, ALEX.
Ueber den Bau der Augen bei den Hydro-medusen, 1213.
- LINSER, P.
Ueber den Bau und die Entwicklung des Elastischen Gewebes in der Lung, 1338.
- LIVINGSTON, B. E.
On the Nature of the Stimulus which Causes the Change of Form in Polymorphic Green Algae, 1574.
- LOEB, J.
On an apparently New Form of Muscular Irritability (Contact Irritability ?) produced by Solutions of Salts whose Anions are Liable to form Insoluble Calcium Compounds, 1584.
- LONGO, B.
La mesogamia nella commune Zucca, 1413.
- LOOSS, A.
Zur Sammel- und Conservierungstechnik von Helminthen, 1580.
- LYON, H. L.
Observations on the Embryogeny of *Nelumbo*, 1575.
- MACALLUM, A. B.
On the Cytology of Non-nucleated Organisms, 1207.
- MACCALLUM, W. G.
On the Intravascular Growth of Certain Endotheliomata, 1469.
- MACY, M. L., AND NORRIS, H. W.
A General Physiology for High Schools Based upon the Nervous System, 1346.
- MALKES, J.
Estimation of Mercury in Urine, 1146.
- MAJLET, F. R.
On Langbeinite from the Punjab Salt Range, 1226.
- MARPMANN, G.
Eine neue Vorschrift zum Konserviren von Zoologischen und Anatomischen Präparaten, 1582.

- MARTIN, FR.
Ueber Scheinbar spaltbaren Quarz von Karlsbad, 1514.
- MATTHEWS, A. P.
Some Ways of Causing Mitotic Division in Unfertilized Arbacia Eggs, 1139.
- MAY, RICHARD.
The Use of Orcein in the Demonstration of Elastic Fibers in the Sputum, 1146.
- MEEK, E. R.
Method of Staining the Elastic Fibers of the Skin, 1423.
- MELCZER, G.
Ueber einige Mineralien vorwiegend von Ceylon, 1432.
- MELNIKOW-RASWEDENKOW.
Pachymeningitis Hæmorrhagica Interna, 1214.
Studien über den Echinococcus alveolaris sine multilocularis, 1544.
- MIALL, L. C., AND HAMMOND, A. R.
Structure and Life-history of the Harlequin Fly, 1506.
- MICHELEIS, L.
Ueber Fett-Farbstoffe, 1508.
- MIGULA, W.
System der Bakterien, 1347.
- MOLL, A.
Zur Histochemie der Korpels, 1337.
- MONTGOMERY, T. H.
A Study of the Chromosomes of the Germ Cells of Metazoa, 1578.
- MOORE, A.
Further Evidence of the Poisonous Effects of a Pure NaCl Solution, 1221.
- MOORE, VERANUS A.
An Introduction to Practical Bacteriology for Students and Practitioners of Comparative and Human Medicine, 1142.
Directions for Beginners in Bacteriology, 1310.
- MORGAN, LEONARD P., AND SMITH, E. F.
Experiments on Chalcopyrite, 1394.
- MOSER, A.
Tuberculosis of the Heart, 1215.
- MÜHLMANN, M.
Ueber die Ursache des Alters. Grundzüge der Physiologie des Wachstums mit besonderer Berücksichtigung des Menschen, 1343.
- MÜLLER.
Über Tuberkelbacillen und Sporenfärbung unter Anwendung von Kaliumpercarbonat und Wasserstoffsperoxyd, 1472.
- MURBACH, L.
Physiology in the High School, 1585.
- MURBECK, S.
Ueber das Verhalten des Pollenschlauches bei *Alchemilla arvensis* und das Wesen der Chalazogamie, 1381.
- MURRAY.
A Preliminary Report on acid resisting bacilli with special reference to their occurrences in the lower animals, 1391.
- NEISSER AND WECHSBERG.
Ueber das Staphylotoxin, 1589.
- NEUMANN, E.
Das Pigment der braunen Lungeninduration, 1584.
- NEUWIRTH, V.
Titanit von der Hüttellehne bei Wermisdorf un Mähren, 1514.
- NEWFELD.
Beitrag zur Kenntniss der Smegma bacillus, 1223.
- NICHOLS, E. H.
On the Etiology of Cancer, 1136.
- NICHOLS, HENRY W.
A New Test for Chlorine for Use with the Blow-pipe, 1352.
- NIKOLSKY.
Charbon chez des animaux nourris avec leur ailments habituel, mêlés de spores charbonneuses, 1551.
- NOACK, W.
Beiträge zur Entwicklungsgeschichte der Musciden, 1578.
- NGESKE, H.
Eosinophile Zellen und Knochenmark, insbesondere bei chirurgischen Infektionskrankheiten und Geschwülsten, 1417.
- NOLL, F.
Ueber die Umkehrungsversuche mit Bryopsis, nebst Bemerkungen über ihren zelligen Aufbau (Energiden), 1333.
- NUSSEBAUM, J., u. PRYMAK, T.
Zur Entwicklungsgeschichte der eymphoiden Elemente der Thymus bei dem Knochenfischen, 1301.
- NUTTING, C. C.
The Hydroids of the Wood's Holl Region, 1541.
- OBERMULLER.
Ueber neuere Untersuchung des Vorkommen echter Tuberkuloseereger in der Milch und dem Molkereiprodukten betreffend, 1311.
- OKER-BLOM, M.
Eine Normal Electrode für physiologische Zwecke, 1471.
Thierische Säfte und Gewebe in physikalisch-chemischer Beziehung, 1423.
- OVERTON, E.
Studien über die Aufnahme der Anilinfarben durch die lebende Zelle, 1334.
- PALACHE, CHARLES.
The Crystallization of Calcite, from the Copper Mines of Lake Superior, 1313.
- PALISA, J.
Die Entwicklungsgeschichte der Regenerationsknospen, welche an den Grundstücken isolirter Wedel von *Cystopteris*-Arten entstehen, 1300.

- PAPPENHEIM, A.
Ueber das Vorkommen einkerniger Zellen
ein gonorrhöischen Urethralsecret, 1421.
- PARKER, G. H., AND BURNETT, F. L.
The Reactions of Planarians with and
without Eyes, 1138.
- PARSONS, CHARLES L.
The Use of Metallic Sodium in Blow-pipe
Analysis, 1393.
- PEIRCE, G. J.
The Nature of the Association of Alga
and Fungus in Lichens, 1208.
- PENARD, E.
Experiments on *Diffugia*, 1464.
- PENFIELD, S. L., AND FORD, W. E.
Calceites (Siliceous) from the Bad Lands,
1144.
- PETERS, A. W.
Some Methods for Use in the Study of
Infusoria, 1579.
- PETERS, K.
Mittheilungen zur Entwicklungsgeschichte
der Eidechse, 1419.
- PETERSEN, C. G. J.
An Otter-seine for the Exploration of the
Deeper Seas, 1542.
- PETROFF, M.
Neue Färbungsmethoden zur rothe Blutkörper-
chen in Schnittpreparaten, 1335.
- PETRUNKEWITSCH, A.
Die Richtungskörper und ihr Schicksal
im befruchteten und unbefruchteten
Bienenel, 1577.
- PIERCE, NEWTON B.
Walnut Bacteriosis, 1587.
- PIORHÓWSKÁ.
The Staining of Diphtheria Organisms,
1476.
- PIORKOWSKI AND JESS.
Bacterium coli als Ursache eines seuchen-
artigen Pferdesterbens in Westpreussen,
1348.
- POYNTON AND PAINE.
The Etiology of Rheumatic Fever, 1473.
- PRATT, J. H.
On the Separation of Alumina from Mol-
ten Magmas, and the Formation of Cor-
undum, 1144.
On the Crystallography of the Rubies from
Macon Co., N. C., 1514.
- PRENANT, A.
Cellules Trachéales des Oestres, 1176.
- PRESTON, H. L.
Illinois Gulch Meteorite, 1352.
- PRIOR, G. T., AND SPENCER, L. J.
The Identity of Binnite with Tennantite,
and the Chemical Composition of Fab-
lerz, 1513.
- PÜTTER, A.
Studien über Thigmotaxis bei Protisten,
1184.
- RABINOWITSCH, L.
Befund von säurefesten Tuberkelbacillen
ährlichen Bakterien bei Lungengangrän,
1223.
Ueber die Gefahr der Uebertragung der
Tuberkulose durch Milch und Milch-
produkte, 1311.
- RÁDL, EM.
Arthropod Vision, 1540.
Ueber den Phototropismus einiger Arthro-
poden, 1390.
- REED, CARROLL, AND AGRAMONTE.
The Etiology of Yellow Fever, 1349.
- REGAUD, CL.
Quelques détails sur la division amitotique
des Noyaux de Sertoli chez le rat, 1303.
- REICHENBACH.
Ueber Verzweigung bei Spirillen, 1391.
- REIGHARD, J., AND JENNINGS, H. S.
Anatomy of the Cat, 1420.
- REITTERER, E.
Transformation de la cellule cartilagineuse
en tissue conjunctiv réticulé, 1335.
- REUTER, K.
Zur Frage der Darmsresorption, 1415.
- RICHARDS, H. M.
Ceramothamnion codii, a new Rhodophy-
ceous alga, 1412.
- RICHARDS, JOSEPH W., AND POWELL, NOR-
MAN S.
Substitutes for Hydrochloric Acid in Test-
ing Carbonates, 1352.
- RICHARDSON, HARRIET.
Key to the Isopods of the Atlantic Coast
of North America with descriptions of
new and little known species, 1420.
Synopsis of North American Inverte-
brates, VIII, The Isopoda, 1420.
- RITCHIE.
The Bacteriology of Bronchitis, 1141.
- RITTER, W. E., AND CONGDON, EDNA M.
On the Inhibition by Artificial Section of
the Normal Fission Plane of *Stenosto-
toma*, 1308.
- RITTER, W. E., AND CROCKER, G. R.
Multiplication of the Rays and Bilateral
Symmetry in the 20-Rayed Starfish,
Pycnopodia helianthoides, 1214.
- ROBIN, A.
A Contribution to the Technic of the Wi-
dal Test, 1434.
Preservation of Sputum for Microscopic
Examination, 1268.
- ROGERS.
Schutzimpfung gegen Rinderpest, 1143.
- ROGERS, A. F.
Sphalerite crystals of a peculiar habit and
with one new form from Galena, 1352.
- ROSENBERGER, R. C.
A New Blood Stain, 1305.
- ROTHIG, P.
Ueber einen neuen Farbstoff Namens
Kresofuchsin, 1414.

- RUSSELL AND HASTINGS.
The Thermal Death Point of Tubercle Bacilli, 1223.
- SABIN, FLORENCE R.
An Atlas of the Medulla and Mid-brain, 1543.
- SAILER, J.
Primary Endothelioma of the Left Superior Pulmonary Vein, 1468.
- SAINT-REMY, G.
Contribution à l'étude du développement des Cestodes, 1340.
- SAND, RENÉ.
Étude Monographique sur le Groupe des Infusoires tentaculifères, 1418.
- SAUL.
Beiträge zur Morphologie des Staphylococcus albus, 1143.
- SAVCE, O. A.
A Method of Preserving Crustacea, 1341.
- SCHENCK, F.
Physiologische Charakteristik der Zelle, 1307.
- SCHENCK, R.
Ueber die Dynamik der Krystalle, 1432.
- SCHÖNICHEN, W., UND KALBERLAH, A.
B. Eyerth's Einfachste Lebensformen des Tier- und Pflanzenreiches, 1212.
- SCHULTZ.
Ueber die Lebensdauer von Bacillus pestis hominis in Reinkulturen, 1472.
- SCHULTZE, L. S.
Untersuchungen über den Herzschlag der Salpen, 1389.
- SEELIGER, O.
Tierleben der Tiefsee, 1541.
- SENN, G.
Flagellata in Engler and Prantl "Die Natürlichen Pflanzenfamilien," 1261.
- SIEDLECKI, M.
Contribution à l'étude des changements cellulaires provoqués par les Gregarines; 1506.
- SJÖBRING, N.
Ueber das Formol als Fixierungsflüssigkeit. Allgemeines über den Bau der lebenden Zellen, 1257.
- SMITH.
The Nodule Organism of the Leguminosæ, 1551.
- SMITH, G. F. H.
A Three-circle Goniometer, 1433.
Note on the Identity of Paralaurionite and Rafaelite, 1433.
- SMITH, R. WILSON.
The Achromatic Spindle in the Spore-mother-cells of *Osmunda regalis*, 1255.
- SMITH, S.
Note on Staining of Sections while Imbedded in Paraffin, 1212.
- STASSANO, H.
Function of the Nucleus, 1135.
- STEPANOW, E. M.
Eine neue Einbettungsmethod in Celloidin 1539.
- STEPHANI, F.
Species Hepaticarum, 1535.
- STEPHENS, J. W. W., AND CHRISTOPHER, R. S. R.
Technique for Malaria Blood, 1382.
- STERNBERG, CARL.
Zur Kenntniss des Aktinomycespilzes, 1428.
- STILES, P. G.
On the Rhythmic Activity of the Oesophagus and the Influence upon it of Various Media, 1585.
- STÖBER, F.
Sur un procédé pour tailler des grains minéraux en lames minces, 1226.
- STOLC, A.
Beobachtungen und Versuche über die Verdauung und Bildung der Kohlenhydrate bei einem amöbenartigen Organismus, *Pelonyxa palustris* Greef, 1260.
- STUTZER.
Die Organismen der Nitrifikation, 1347.
- SULTAN, C.
Beitrag zur Kenntniss der Schilddrüsen Function, 1583.
- TEN SIETHOFF, E. G. A.
Eine einfache Construction der sogenannte Interferenzkreuzes der zweiaxigen-Krystalle, 1431.
- TERMIER, P.
Nouvelle contribution à l'étude crystallographique du cadmium et du zinc métalliques, 1224.
Sur la composition chimique et les propriétés optique de la leverrière, 1312.
- TIMBERLAKE, H. G.
Swarm Spore Formation in *Hydrodictyon utriculatum* Roth., 1300.
The Development and Function of the Cell Plate in Higher Plants, 1132.
- TOBLER, MARIA.
Beitrag zur Frage des Vorkommens von Tuberkel bacillen und anderen Saurefesten Bacillen in der Marktbutter, 1311.
- TROMMSDORFF.
Ueber Gewöhnung von Bakterien an Alexin, 1143.
- UHLENHUTH.
Method for the Differentiation of the Blood of various Animals with especial Reference to the Demonstration of Human Blood, 1268.
- VATER, HEINRICH.
Ueber den Einfluss der Lösungsgossen auf die Krystallization des Calciumcarbonates, 1394.
- VERNADSKY, W.
Zur Theorie der Silicate, 1553, 1589.

- VIOLA, C.
 Ueber das "Glaukisiren" verschiedener
 Feldspäthe, 1350.
 Ueber optische Erscheinung am Quarz und
 am Turmalin von Elba, 1474.
 Zur Kenntniss des Anorthits vom Vesuv,
 1394.
- VOGEL, K.
 Zur Histologie der Pneumonia fibrosa
 chronica, 1262.
- WAGER, H.
 The eye spot of *Euglena viridis*, 1133.
- WAKKER.
 Wakker's Hyacinth Germ, *Pseudomonas*
hyacinthi (Wakker), 1267.
- WALLERANT, F.
 Perfectionnement au réfractomètre pour
 les cristaux microscopiques, 1226.
- WARD, H. L.
 New Meteorite from Murphy, 1144.
 Notice of an Aerolite that recently fell at
 Allegan, Mich., 1394.
- WARREN, E.
 On the Reaction of *Daphnia magna*
 (Straus) to certain changes in its en-
 vironment, 1140.
- WARTHIN.
 Accessory Adrenal Body in the Broad
 Ligament, 1342.
- WARTHIN, A. S.
 A Contribution to the Normal Histology
 and Pathology of the Hæmolymp
 Glands, 1387.
- WASMANN, E.
 Nervenphysiologie und Tierpsychologie,
 1587.
- WEINLAND, E.
 Ueber den Glykogengehalt einiger para-
 sitischer Würmer, 1346.
 Zur Magenverdauung der Haifische, 1470.
- WEISENFELD.
 Der Befund des Bakterium coli in Wasser
 und das Thierexperiment sind keine
 brauchbaren Hilfsmittel für die hygien-
 ische Beurteilung des Wassers, 1552.
- WELLS, H. G.
 Multiple Primary Malignant Tumors;
 Primary Sarco-carcinoma in the Thyroid
 of a Dog, with Mixed Sarcomatous and
 Carcinomatous Metastasis, 1583.
- WETTSTEIN, R. VON.
 Handbuch der Systematischen Botanik,
 1460.
- WHIPPLE, GEO. C.
 Changes that Take Place in the Bacterial
 Contents of Waters during Transporta-
 tion, 1553.
- WHITNEY, W. F.
 A Quick and Simple Method for Fixing
 the Blood Corpuscles for Differential
 Staining, 1306.
- WILLEBRAND, E. H.
 Stain for Simultaneous Staining of Blood
 Smears with Eosin and Methylen Blue,
 1227.
- WILSON, H. V.
 Notes on a Species of *Pelomyxa*, 1260.
- WILSON, J. T.
 A New System of Obtaining Directing
 Marks in Microscopical Sections for the
 Purpose of Reconstruction by Wax-plate
 Modeling, 1537.
- WOROBIEFF, V. VON.
 Krystallographische Studien über Turma-
 lin von Ceylon und einiger anderen
 Vorkommen, 1433.
- WRIGHT, J. H.
 A Case of Multiple Myeloma, 1181.
- WÜLFUNG, E. A.
 Ueber die Lichtbewegung im Turmalin,
 1474.
- YASUDA, A.
 Studien über die Anpassungs fähigkeit ein-
 iger Infusorien an concentrirte Lösun-
 gen, 1220.
- YERKES, R. M.
 Reactions of Entomostraca to Stimulation
 by Light, 1183.
- ZOLLIKOFER, R.
 Kammerfärbung der Leucocyten, 1177.

Journal of Applied Microscopy and Laboratory Methods.

VOLUME IV.

JANUARY, 1901.

NUMBER 1

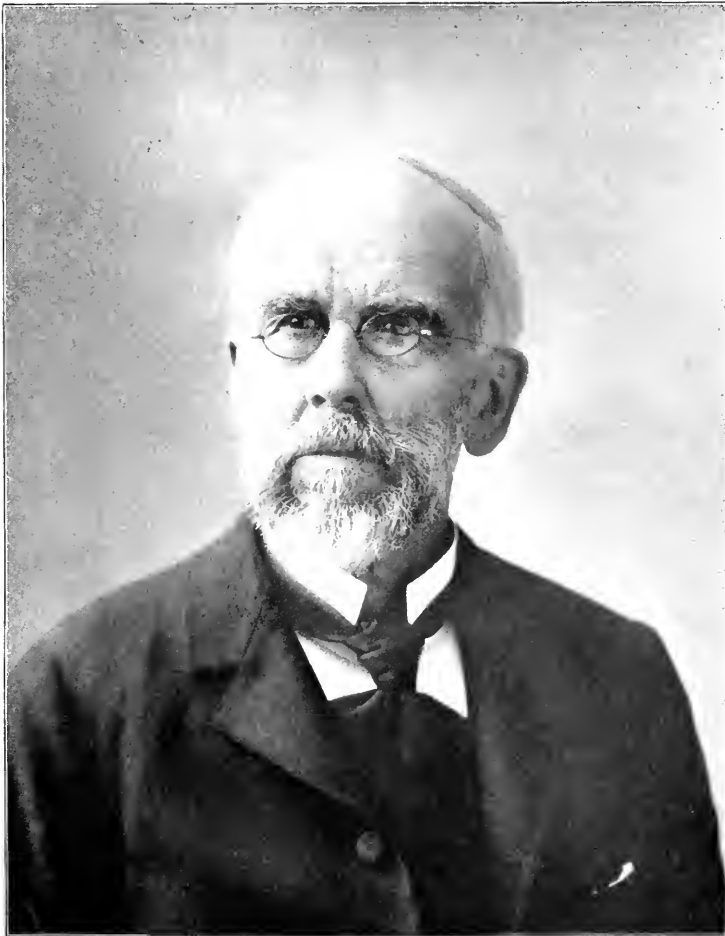

MOSES C. WHITE.

Moses C. White.

Moses Clark White, born in Paris, Oneida county, N. Y., July 24, 1819, died in New Haven, October 24, 1900. It will be seen from this brief summary that Dr. White was in his eighty-second year. His life is one pleasant to reflect upon. Like the career of so many Americans, it was full, and showed the vitality of this new world. In 1840 he went to the Cazenovia Seminary—the seminary which has given a start to so many noble men and women in the central part of New York State. Here he prepared for college and entered Wesleyan, graduating with the class of 1845. For the next two years he studied medicine and theology at Yale, and in 1847 went as a medical missionary to Foo Chow, China. Here he took charge of a public dispensary, and gained the confidence of all classes of the people. Owing to illness in his family he was compelled to return to America in 1853. He settled as a physician in New Haven, Ct., and in 1857 became a teacher in the Yale Medical School, and at the time of his death still held an honored place in the faculty. His work in this school, dealing with the microscopic structure and pathology of the body, naturally made him one of the ardent advocates of the microscope in medicine, and his work outside the college had much dependence on the microscope as the instrument of research or demonstration. Thus from 1869 to 1875 we find him giving lectures in his alma mater, Wesleyan, on the microscopic structure of animals and plants. He was naturally led to consider various medico-legal questions in which the microscope played a principal role. When the great Reference Hand-Book of the Medical Sciences appeared some ten years ago, one of its most accomplished articles was the one on “Blood-Stains,” by Dr. White. Since that time he has written one or more monographs on blood and the determination of the corpuscles of different animals. He has also presented papers before the American Microscopical Society on various topics, in which especially difficult phases of the subject were handled with rare skill and success. Even at the last meeting of the society in New York he presented a paper which gave in the clearest manner the difficulties of photographing absorption bands in certain parts of the spectrum. His exposition was an inspiration to the younger members, for it showed how the human mind could triumph over difficulties by intelligent persistence. Not only has he presented admirable papers before the Microscopical Society, but his discussion of the papers of his fellow members was always full of interest and sympathy, and it was rare that he did not add some exceedingly good suggestion which helped the writer of the paper and impressed all with the fertility of his mind and its thorough grounding in experience as well as in fundamental principles.

The men who built the foundations of American science are fast passing away. Dr. White has an honorable share in that relating to microscopy. “He assisted largely in the preparation and publication of Silliman’s Physics, and wrote the chapter on optics.” His efforts to make clear to classes the microscopic structure of organisms led him naturally to try to so improve the projection microscope that all could see at once, and the teacher be able to point out

exactly what feature he wished to be observed. For this he conceived of special projection lenses, as one can see by consulting p. 194 of the first volume of this JOURNAL. The projection microscope will ultimately be a perfect instrument by the loyal and intelligent investigation of the problem, such as he gave.

It would be cruel to begrudge the repose which a full and noble life has earned; but we can rightfully hold fast to the inspiration which his earnest, helpful life gives, and like him strive to advance knowledge, and "lend a hand."

Cornell University.

S. H. GAGE.

Fire in the Veterinary College at Cornell.

November 13th, in the early morning, the New York State Veterinary College took fire and the Bacteriological and Histological laboratories situated on the third floor were completely destroyed. Pictures of these laboratories were published in the JOURNAL OF APPLIED MICROSCOPY, Vol. I, p. 23.

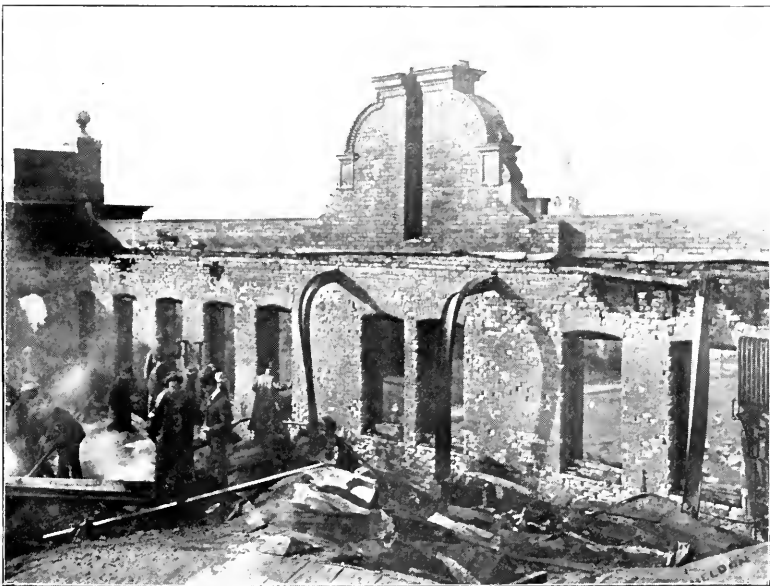

The origin of the fire is supposed to have been the extinguishment of the gas owing to low gas pressure in some of the incubators. Upon an increased pressure the room was filled with gas and ignited by the flame of the incubator, which did not go out. This is simply hypothesis, however.

The two pictures show very well the conditions existing Tuesday forenoon. In the laboratory, the twisted girders which supported the roof, and numerous people engaged in clearing the wreck or students trying to discover some of their lost property. The other picture shows the east side of the building before the fire was extinguished.

The slow burning construction enabled the fire company to hold the flames

to the middle part of the third floor, the two ends of this floor being injured only by smoke and water, and the lower floors only by water. Only the building was insured. The material, microscopes and movable furniture were not insured. Over forty microscopes, each completely equipped with two-thirds, one-eighth dry and one-twelfth oil immersion objectives, triple nose-piece, Abbe condenser, and two oculars, were completely destroyed. The material for the courses in Pathology, Bacteriology, Histology and Embryology were all burned, besides much valuable material for research which had been collected with much care and no little expense during the last ten years.

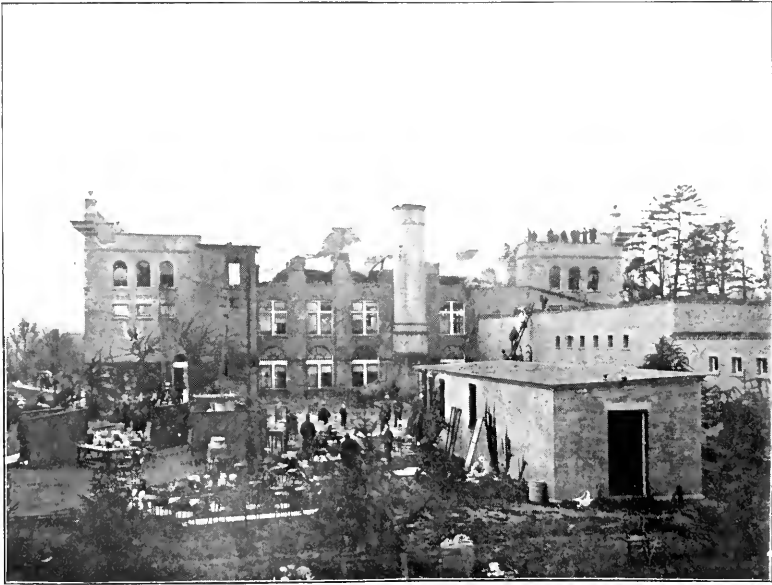

While much was lost, much more was saved. Fortunately the most valuable microscopes and apparatus were stored in the wings or ends of the main building, and these escaped except some blackening by the dense smoke.

By Friday evening a temporary roof had been put over the burned part, and by utilizing the museum space on the first floor for a laboratory, the work was in full progress the next Monday morning. The professors in charge wish to express their grateful appreciation to their colleagues all over the country for their generous offers of assistance; they are also grateful to the manufacturers and optical companies which supplied them immediately with needed apparatus, or repaired damaged instruments.

S. H. GAGE.

Cornell University.

A recent writer on Fat-necrosis finds alcohol with celloidin imbedding preferable to formaldehyde (4 per cent. solution), Müller's fluid, Flemming's solution or osmic acid as a fixative for necrotic adipose tissue and specimens of pancreas. Hæmatoxylin and eosin were found the most satisfactory for staining.

LABORATORY PHOTOGRAPHY.

STEREO PHOTO-MICROGRAPHY.

Mr. John G. Baker has sent us a number of very interesting micro-stereographs of insects and the following description of the apparatus and methods employed in making them. The work was first publicly exhibited and described June 6th, 1899, before the Photographic and Microscopical Branch, Chemical Section, of the Franklin Institute.

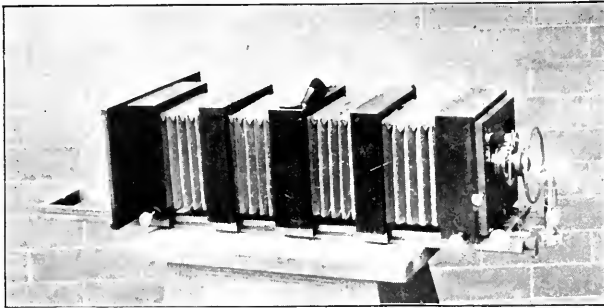

Figure 1.

This camera was constructed for the purpose of making stereoscopic pictures of small objects.

My first attempt was in fitting up a stereoscopic camera for the purpose, but the result was not at all satisfactory, although it made some very fair negatives. The camera proved to be very much too short, and the lens and object had to be changed from one side to the other, all of which made it very inconvenient.

The next attempt is embodied in the instrument shown in the illustration. It was originally a lantern slide camera, which was altered to what you now see. The shutter used is a 4 x 5 "Victor." To the front of this was fitted an attachment to carry the lens and also to hold a reflector for properly illuminating the object. In the rear of the shutter, instead of a lens, a ring was placed to cut off any reflected light. The rear end of the camera has been fitted up to receive a 5 x 7 plate-holder, but in such a way that it may be used in two positions, so that each end of the plate may be exposed independently of the other. The plate-holder rests against a partition with an opening in it of a size just sufficient to cover one-half of the plate.

The lenses for very small objects are achromatic objectives that are used in the microscope, but for this work are changed somewhat, to better answer the requirements.

The trouble found with them for the work was their narrow angle of view and extremely small depth of focus, and each of these faults had to be remedied before it was possible to make a satisfactory negative. It was also found that the rays of light, in passing through the lens, had a tendency to fog the plate by coming in contact with flat surfaces, even when these were blackened with the

greatest care. This trouble was overcome satisfactorily by dispensing with the flat surfaces: i. e., by making them on a bevel, with only the sharp edge to reflect the light.

To do away with the difficulty arising from the small depth of focus, the only way found was to stop down the lens.

As the depth of some objects is very great in proportion to the focal length of the lens, it necessitates the use of a very small stop. The smallest stop used by me for this work has a diameter of $\frac{1}{10000}$ of an inch, and the edges of the opening are made nearly sharp and carefully blackened. The rear of the lens has also to be guarded to prevent reflections which in this work would be very serious. Of course, the time of exposure requires to be lengthened in proportion to the size of stop; many times the exposure has taken over thirty minutes, and as each exposure must be made separately on the plate, the time will be doubled.



Figure 2.

Suppose the object to be photographed is a small living insect. It is placed under a tumbler which has a small hole drilled through the bottom. Through this opening is injected a small quantity of ether. This soon places the insect in a condition to be handled. We then set it up on its feet in a position as nearly life-like as possible on a small piece of opalin glass, and, to hold it in position, each of its feet is fastened down by means of wax. This is done by using a very small tool, heated in the flame of a spirit lamp. After the feet are fastened properly, the insect is placed in strong fumes of cyanide of potassium to end its life. The surplus wax is now carefully removed by scraping it away with a fine pointed knife.

The object is now ready for the camera, and upon the pedestal in front of the lens the mounted object is made fast. The pedestal, upon which the mounted object is fastened, has a rack and pinion movement, so as to elevate the object to the required height, and has also a ball-and-socket joint on the top, so that the object can be placed in any desired position. The image on the focusing

screen is brought in position horizontally by sliding the lens and board, which can be done by turning the milled head on the top of the camera.

To make the exposure, place the object in its best position and focus as sharply as possible. With the image in the proper place on the screen, fasten front and rear of camera by means of the clamp screws at the side, run in the plate-holder until it drops into the *first* groove. Set the camera in position, with the reflector facing a northern sky, and make the first exposure.

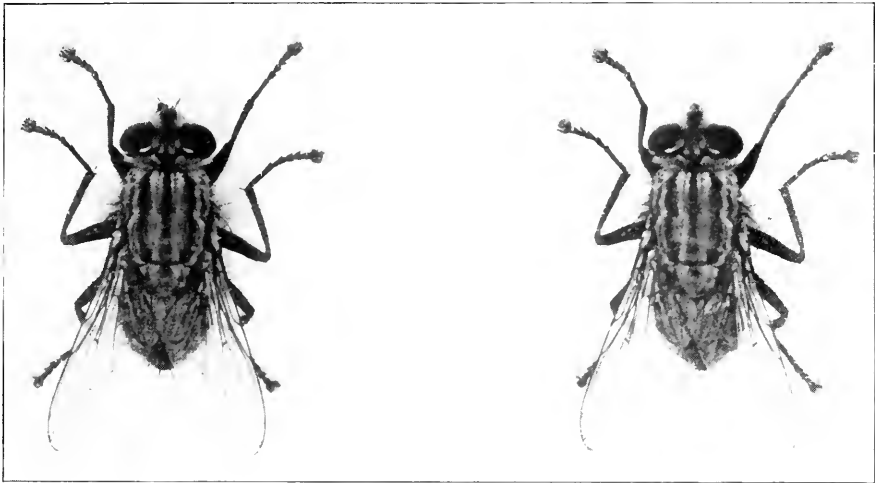

Figure 3.

After the first exposure has been made the object has to be rotated. Upon the pedestal will be found a graduated circle, divided into parts of five degrees each, and also a pointer. The insect has now to be rotated one of the graduations (five degrees), from left to right, and then the image on the screen is again placed in position, plate-holder is returned and run back as far as possible until it drops into the *second* groove, the exposure repeated for the other end of the plate. By revolving the object in the direction just mentioned, the negative itself is made stereoscopic, and can be placed in the stereoscope and examined to see if it is perfect.

The New York Botanical Garden.

“The advancement of botanical science and knowledge and the prosecution of original researches therein and kindred subjects” are some of the primary purposes set forth in the charter of the New York Botanical Garden, and it may be of interest to botanists and biologists in general to note to what extent and in what manner research work may be prosecuted in this institution.

A prerequisite to all successful botanical work consists in the possession of typical specimens, and in experimental work it is important that normal conditions of growth should be available, as well as facilities for producing and controlling experimental factors.

MUSEUM BUILDING
NEW YORK BOTANICAL GARDEN

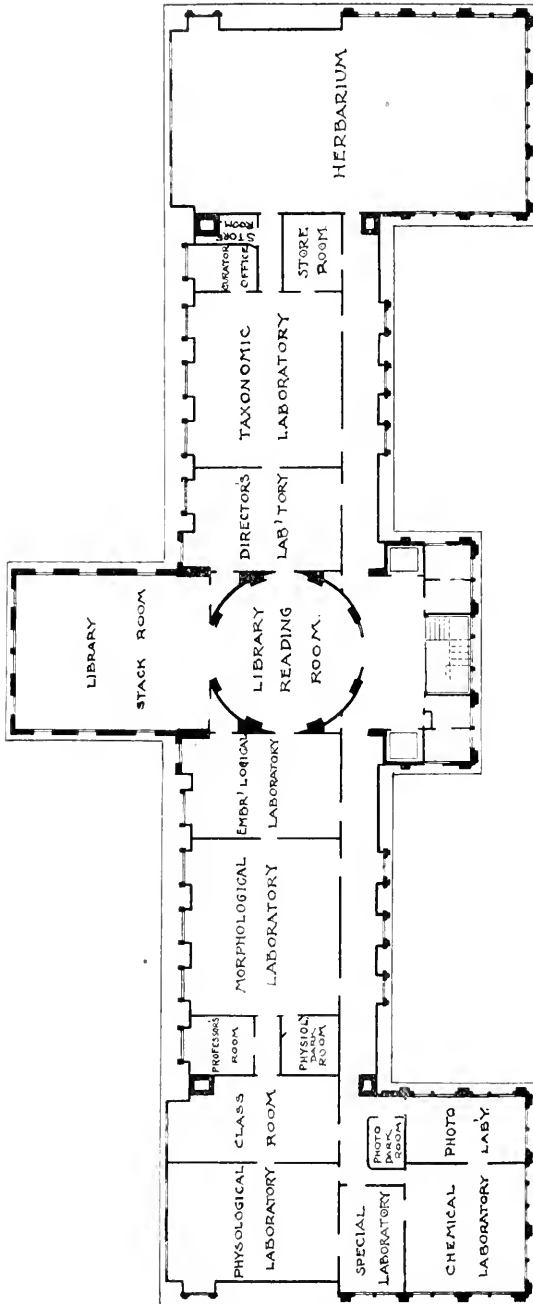

1/27

ROBERT W. GIBSON
ARCHITECT
54 BROAD STREET NEW YORK

PLAN OF THIRD FLOOR

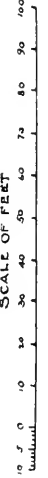

The herbarium contains nearly a million specimens, and is composed largely of plants which have been subjected to critical study, and are consequently well identified. Some very notable collections are embraced, and it is especially rich in American forms, and in ferns, fungi, and mosses. In addition to being the primary means of research bearing upon the natural affinities of plants, it is invaluable as a reference collection in morphological studies. The herbarium is increasing at the rate of fifty to a hundred thousand specimens annually.

The living plants include the species native to the Garden tract, the introduced forms from the temperate zone in the herbaceous grounds, pinetum, fruticetum, arboretum, viticetum, nurseries and boundary plantations, and the tropical and desert forms in the horticultural and propagating houses, amounting to about six thousand species.

Before beginning an investigation of any botanical subject it is of the greatest importance that the worker should familiarize himself with its botanical history to learn what other botanists may have written concerning it. To this end he must search the volumes in the library. Periodicals, books, pamphlets, and manuscripts must be examined, and the extent of known facts gotten well in mind. The library of the Garden now contains nearly nine thousand volumes, and is increasing at the rate of over fifteen hundred volumes annually.

The facilities of the Garden are open only to students who have demonstrated their ability to carry on independent research work, and no attention is given to elementary instruction. The intending investigator, having complied with the regulations of the institution and secured a table, is placed in consultation with the member of the staff, or other attending botanists most familiar with the subdivision of the subject in which his problem lies, from whom he receives only so much help and advice as may be necessary to enable him to carry his work to a successful end. The student is free to offer the results of his work in the form of a thesis to any university at which he might become a candidate for a degree.

The actual arrangement and extent of laboratory space and organization of the equipment of the laboratories have been carefully worked out. The upper floor of the museum building, with an area of nineteen thousand square feet, and some special rooms in the basement, are devoted to research work. The library is housed under the dome and in a stack room extension to the rear. The physiological and morphological laboratories occupy the western end, and the taxonomic laboratories and herbarium the eastern end. The laboratories include a suite of fourteen rooms, giving separate facilities for work in the main divisions of the subject. The equipment includes a supply of the apparatus necessary for research. Microscopes of the most approved patterns of Bausch & Lomb, Leitz, and Zeiss, with batteries of objectives of a wide range, are found to meet the needs of the workers who have used the laboratories to this time. The photographic room contains professional stands with the best anastigmatic lenses of Zeiss, Goerz, and Leitz, projecting and photomicrographic apparatus, field cameras and accessories; space is also afforded for the precision balances of the chemical laboratories. The physiological dark-room is constant to temperatures between 16° and 21°C. The chemical laboratories are as yet only supplied with the more elemental apparatus. The experimental room has an aquatic tank,

is skylighted and has a cemented floor; its contiguity to the other laboratories is a great advantage. A constant temperature room in the basement has been found to furnish a satisfactory thermographic curve, although it has not yet been used in research work.

A compartment in the propagating houses, comprising about a thousand feet of floor space, is equipped for experimental work in connection with the laboratories, and ample space is afforded in the plantations for the same purpose.

It is to be seen that the Garden affords opportunity for research in all of the broader questions of botany, inclusive of climatological influences, acclimatization, history of species, development of races and varieties, hybridization and horticultural practice, development, general morphology, embryology, physiology and environmental relationships in general, and natural affinities of species and groups.

The presence of a number of investigators in different phases of the subject has a most stimulating effect upon the individual student, and the mutual interchange of views does much to counteract the tendency to over-specialization. The number of registered students using the laboratories, library, or herbarium during the past year was twenty-eight, and most of them were graduates of colleges and universities. Botanists from other institutions using the facilities of the institution, for periods from a day to over a month, numbered more than a score.

An especially profitable feature exists in the weekly conventions, at which the worker gives an account of his own results, a review of some recent book or article, or a visiting botanist gives an address upon some subject of general interest. Subjects have been recently presented as follows:

"A Summer's Work at the Royal Herbarium at Kew," by Professor L. M. Underwood.

"Life-history and Development of the Gametophyte of *Schizæa pusilla*," by Mrs. Elizabeth G. Britton and Miss A. Taylor.

"The Genus *Lycopodium*," by Professor F. C. Lloyd.

"*Confervæ*," by Dr. Tracy Hazen.

"Marine Flora of Bermuda," by Dr. M. A. Howe.

"Some Features of the Flora of the Great Plains," by Professor C. E. Bessey.

"Effect of Low Temperature upon the Growth of *Sterigmatocystis nigra*," by Miss Ada Watterson.

"Plants and Poisons," by Dr. R. H. True.

"Spore Dissemination in the *Sordariaceæ*," by Dr. David Griffiths.

"Flora of Montana and Yellowstone National Park," by Dr. P. A. Rydberg.

"Anatomy of the Flowers of Certain Grasses," by Mr. G. V. Nash.

"*Mycorrhizas* of *Monotropa*," by Dr. D. T. MacDougal.

"Embryology of *Viburnum*," by Miss Nellie Hewins.

"Vegetative Reproductions of the *Hepaticæ*," by Dr. M. A. Howe.

"Substances Isolated from Cocoanuts," by Mr. J. E. Kirkwood.

The following outline shows the special subjects in which investigations may be carried on, together with the name of the person under whose guidance the work may be done. It is to be said, however, that almost any problem in botany may be taken up by trained botanists of sufficient experience who may resort to

the laboratories with the expectation of finding the material facilities for their work. The laboratories never close, and the worker may find here opportunity for work during the summer vacation season.

The guidance of research work is distributed as follows:

Physiology of the Cell—Doctor MacDougal.

Ecology—Professor Lloyd.

Morphology of Algæ—Doctor Howe, Doctor Richards.

Morphology of Fungi—Professor Underwood.

Morphology of Bryophyta—Professor Underwood, Mrs. Britton.

Morphology of Pteridophyta—Professor Underwood.

Morphology of Spermatophyta—Doctor Rydberg.

Experimental Morphology—Professor Lloyd, Doctor MacDougal.

Taxonomy of Algæ—Doctor Howe.

Taxonomy of Fungi—Professor Underwood.

Taxonomy of Bryophyta—Professor Underwood, Mrs. Britton.

Taxonomy of Pteridophyta—Professor Underwood.

Taxonomy of Spermatophyta—Doctor Britton, Doctor Small, Doctor Rydberg.

Taxonomy of Graminæ—Mr. Nash.

Embryology of Spermatophyta—Professor Lloyd.

Special Taxonomy (critical study of a family or genus)—Professor Underwood, Doctor Britton, Doctor Howe, Doctor Small, Doctor Rydberg, Mr. Nash, Mrs. Britton, Professor Burgess.

Regional Botany—Professor Underwood, Doctor Britton.

Physiology of Nutrition—Doctor Richards.

Ecological Physiology—Doctor MacDougal, Doctor Curtis.

Physiological Anatomy—Doctor Curtis.

General Physiology—Doctor MacDougal, Doctor Curtis.

D. T. MACDOUGAL.

Preliminary Study of Mycetozoa.

As a preliminary to the study of slime moulds, as suggested in the article of T. H. MacBride⁽¹⁾, reviewed in the September number of this JOURNAL, a modification of the method given by Caspar O. Miller⁽²⁾ may be of interest, especially as by it slime moulds in all phases of development can be obtained at any season desired, and in such a form as to be suited to study in the laboratory.

Miller discovered that plasmodia were developed in all cultures made by filling a beaker half full of hay and covering the hay with ordinary tap water. Care must be taken to allow some of the stalks of hay to project above the water, to serve as a support upon which the plasmodia may climb. The beaker was covered with a cotton plug to prevent the dust in the air from entering. The ordinary moulds which appear after a few days were removed with sterilized forceps, care being taken to loosen the under layers of hay, so that some of the

(1) Jour. N. Eng. Bot. Club, 2: 1900.

(2) Quar. Jour. Min. Science, Vol. 41, N. S., p. 43.

stalks always projected above the water. After five or six weeks, plasmodia from several centimeters to several inches in length were seen to spread out upon the surface of the beaker. They seem to prefer the smooth surface of the glass, perhaps because it offers the only large surface above the water upon which the plasmodia can spread. From two to twelve days after their appearance on the glass above the water, the protoplasm collects at one or a number of the points at the periphery of the network and forms sporangia, leaving behind the so-called hypothallus.

Acting upon this suggestion, a series of cultures were made by partly filling beakers with hay, then slipping glass slides between the hay and the surface of the beaker, and adding water until it stood a little above the middle of the slides. Each beaker was covered with a glass plate to prevent too rapid evaporation (Fig. 1). The beakers were allowed to stand undisturbed until the plasmodia appeared. During the time, however, the glass plate was removed for an hour each morning, for fear there might otherwise be too great an accumulation of CO_2 in the beaker. But no further precautions were taken. Other cultures of the same hay were prepared every five days, in that way the various stages of development could be studied or compared at any desired time. It was found that the plasmodia spread as readily

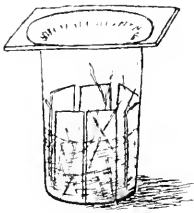

Fig. 1.

upon the glass slide, on the side turned toward the surface of the beaker, as on the beaker itself. At any time, therefore, a slide could be taken from the beaker and studied under the microscope in its undisturbed condition. It is better not to cover the plasmodium with a cover-glass, as it does not live under water, but just at the surface, and either from the pressure of the cover-glass or the excess of water, it is apt to go all to pieces. Very little of the hay infusion need be added from time to time to keep the uncovered plasmodium moist.

A form which was found most suitable to study the streaming movements of the protoplasm developed in cultures made from hay gathered in Aurora, N. Y., during 1898. This same hay is still used in the laboratory, and produces plasmodia as rapidly as it did the first year it was gathered. I have not been able

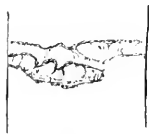

Fig. 2.

to identify the form illustrated two-thirds its natural size in Fig. 2 and enlarged in Fig. 3. It is of an opaque cream white color and always forms as figured, with a strong branch just at the surface of the water, sending down secondary branches somewhat smaller in size, which connect by still smaller branches with a very vacuolated network just within the water. Under the microscope the clear hyaloplasm zone and the granular inner zone can be easily distinguished;

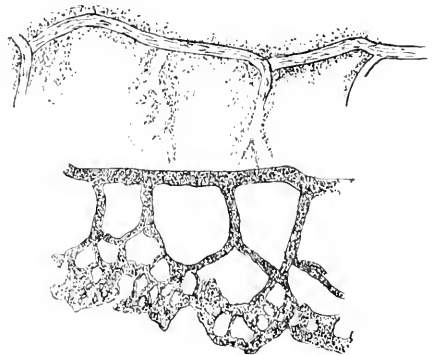

Fig. 3.

also the formation of new branches by the coalescence of the pseudopodia can be observed. It will not be necessary to go into further details, for I have nothing new to add to the general description given in the English edition of DeBary's Comparative Morphology and Biology of Fungi, Mycetozoa, etc. (p. 425); all that is spoken of there can be readily seen and followed. In fact, for laboratory demonstration of the streaming movements of protoplasm to beginners, this plasmodium has proved of far more use than the *Amœba* or the other objects usually used, as *Chara* tips, *Tradescantia* hairs, etc.; because, being macroscopic in size, you waste no time finding it, and not having any very dense cell walls, at the ends of the network at least, the motion of the protoplasm can be clearly seen; besides, being able to put one's hands on it any time one wishes is not the least of its advantages.

If the water is allowed to evaporate, the course of the plasmodium, following the surface of the water, can be easily traced by the "envelope" of DeBary, or the "hypothallus" of Miller, which remains behind, and the outlines of which are accentuated by the refuse gathered around it, as shown in Fig. 3.

Permanent mounts of plasmodia may be made by plunging the slides upon which they are spread into strong alcohol, or a solution of picric acid in strong alcohol. The alcohol seems to be necessary to coagulate the albuminous substances, and so fix the plasmodium to the slide at the same time that it is killed. If aqueous killing fluids are used, such as micro-sulphuric or corrosive acetic, a considerable evolution of gas is seen to arise from the plasmodium (probably CO_2 from the CaCO_2), and sooner or later it floats down from the slide, and it is difficult to successfully remount it. With the alcohol the most delicate threads remain intact. The slides may then be transferred to some aqueous stain (Grübler's hæmatoxylin gave good results), and if desired the stain may be differentiated with acid alcohol without harm. The vacuolated structure of the protoplasm is very beautifully shown, but it is difficult to distinguish between nuclei, ingested food particles, or refuse composed of unicellular organisms, bacteria, etc., which sticks all over the plasmodium. This last difficulty might be largely obviated. I should think, if Miller's directions on the Aseptic Cultivation, etc., were carefully followed. Bacteria, according to Miller, are always present, but they would be easily distinguished.

CLARA LANGENBECK.

Wells College.

MICRO-CHEMICAL ANALYSIS.

X.

POTASSIUM—Continued.

VI. With Stannic Chloride.

The hydrated stannic chloride is employed, since this hydrated salt is much more easily handled than the anhydrous liquid compound SnCl_4 . In the hydrated salts $\text{SnCl}_4 \cdot x\text{H}_2\text{O}$, x may be either 3, 5, or 8. All three of these salts are crystalline, and are to be referred to the monoclinic system.

When stannic chloride is added to quite concentrated solutions of potassium

salts, slightly acidified with hydrochloric acid, beautiful, large, colorless, octahedral crystals of the compound K_2SnCl_6 sometimes separate. Generally the conditions which obtain are such that owing to the solubility of the potassium stannic salt, nothing is seen until the test drop has evaporated almost to dryness, or until alcohol is added.

There seems to be some doubt as to whether we should call this salt a true chlorstannate or a double salt of the formula $2KCl \cdot SnCl_4$. If it is true that we have chlorplatinic acid in solutions of platinum chloride, by analogy we can consider that in the case of the potassium-tin compound we have to do with a salt of chlorstannic acid. Moreover, the similarity of the chlorstannates of K, Rb, Cs, and NH_4 to the chlorplatinates of these elements is very striking.

Properly speaking, stannic chloride is not a suitable reagent for potassium, since the salt formed is too soluble. This reagent is, however, one of our most valuable salts for the detection of cesium (q. v.).

The chlorstannates of ammonium, rubidium and cesium (and thallium) are far more insoluble than the potassium salt.

VII. With Cerous Sulphate.

Cerous sulphate added to solutions of salts of potassium acidified with sulphuric acid, gives rise to the formation of potassium cerous sulphate.

The reagent is most easily obtained in the form of the ceric oxide, and can be kept for use in this state. It can be brought into the proper condition for use by being treated as follows: Place a small drop of sulphuric acid on platinum foil, add a little of the oxide, and heat until most of the acid has been driven off. Add more acid and heat again. This treatment should produce a product almost completely soluble in water. Add a drop or two of hydrogen peroxide, and warm the preparation; the solution being acid, the H_2O_2 acts as a reducing agent, and a clear, colorless liquid results. Evaporate, and then dissolve in sufficient water to make a dilute solution.

A drop of a solution of the reagent is allowed to flow into a drop of that of the substance to be tested. Both drops must be dilute. The preparation is warmed very gently at the zone of union. The salt $K_2SO_4 \cdot Ce_2(SO_4)_3 \cdot 2H_2O$ rapidly separates as very minute, more or less spherical masses. When the solutions are sufficient-

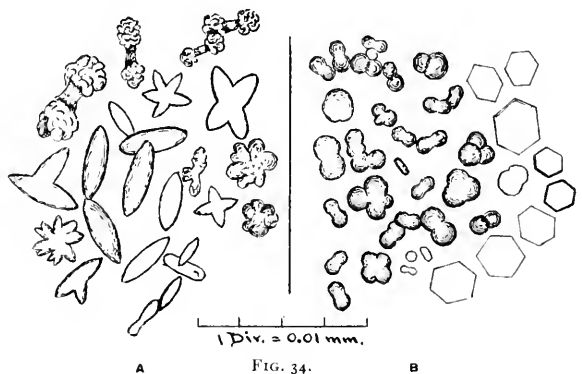

ly dilute, or if the preparation is allowed to evaporate spontaneously, tiny but well formed colorless hexagonal plates are obtained (Fig. 34 B).

Sodium treated in the same way gives, as has already been stated under the head of this element, very small lenticular and fusiform crystals, and dumb-bell-

like aggregates (Fig. 34 A). Rarely, tiny four-sided prisms, with pyramidal ends, are formed.

If a sufficiently high power is employed, there is generally no difficulty in distinguishing the double salt of potassium from that of sodium.

Owing to the fact that higher powers must be employed than is usual in micro-chemical work, it is necessary that the drop be spread out in a thin layer, it being impossible to examine a well-rounded deep drop. The usefulness of the test is therefore restricted.

VIII. With Sodium-Cobalt Nitrite.

This reagent produces, in neutral solutions of potassium salts or solutions acidified with acetic acid, a very difficultly soluble double nitrite of potassium and cobalt of the formula $3\text{KNO}_2 \cdot \text{Co}(\text{NO}_2)_3$.

It is greatly to be regretted that this interesting and delicate reaction can seldom be made to yield more than very minute globular grains. While it is a convenient and generally reliable reaction for potassium in ordinary qualitative analysis in the wet way, it is not to be recommended for micro-chemical testing.

Either the standard reagent, all prepared, can be employed, or what is perhaps more convenient for our purposes, the sodium nitrite, is added to the neutral test drop and a solution of cobalt acetate, weakly acidified with acetic acid, is allowed to flow in. The formation of yellow spheroids, octahedra, or the skeletons of octahedra, will indicate the presence of potassium, providing that ammonium, rubidium, and cesium are absent, these elements giving an identical reaction.

IX. With Sodium Tartrate or Tartaric Acid.

The reaction taking place can be expressed as follows: $\text{KCl} + \text{HNaC}_4\text{H}_4\text{O}_6 = \text{HKC}_4\text{H}_4\text{O}_6 + \text{NaCl}$. Since the product of the reaction, primary potassium tartrate (potassium bi-tartrate), requires a neutral or only slightly acid solution, and is, moreover, fairly soluble, it is convenient to proceed as follows: Evaporate

the test drop so as to obtain a thin uniform film of material. Place, near by, a drop of water into which introduce a little tartaric acid and a slightly greater quantity of sodium tartrate, stir until all has dissolved; then draw the reagent thus prepared across the film of substance. If no crystals appear after a short time, add a drop of weak alcohol. The potassium salt separates as transparent, highly refractive prisms. The crystal forms are quite varied, those most frequently obtained are shown in Fig. 35. Primary potassium tartrate crystallizes in the orthorhombic system, and exhibits a great tendency to assume hemihedral and skeleton forms.

Tartaric acid alone can be employed with good results, but primary sodium tartrate is better. The addition of the free acid suggested above is for the purpose of assuring the presence of the primary compound.



FIG. 35.

Rubidium and cesium give an identical reaction, their primary tartrates being even more insoluble than that of potassium, hence the salts of these two elements will separate first. In fact, this last property can be utilized for detecting rubidium or cesium in the presence of potassium, if a sufficiently dilute solution be employed.

Ammonium sometimes gives crystals not to be distinguished from those of potassium; at other times, when treated as above, the precipitate is distinctly different.

Many other elements yield relatively insoluble tartrates, which, while differing from the potassium salt, yet resemble it sufficiently to lead to confusion (see Calcium and Strontium).

Double tartrates are also apt to be formed. This is far more liable to happen when large drops are employed and the reagent added at once to the test drop, than when evaporation to dryness is practiced, and the reagent then drawn across.

X. Perchloric acid added to solutions of salts of potassium precipitates Potassium Perchlorate.



Method.—Next to the dilute solution of the substance to be tested place a tiny drop of water, and to the latter add a drop of perchloric acid or a little ammonium perchlorate. Cause the drop of the reagent to flow into the drop to be tested. In a few seconds colorless, highly refractive, clear cut crystals of potassium perchlorate separate (see Fig. 36). These crystals belong to the orthorhombic system, but at first sight those first formed seem to be isometric, while later, what would be mistaken for monoclinic prisms appear.

Remarks.—The solutions must be dilute, otherwise the potassium perchlorate is precipitated at once.

If the solution is too dilute, crystals may not appear for a considerable period. The addition of alcohol will, in such cases, greatly hasten matters.

Rubidium and cesium give a like reaction; their perchlorates are more insoluble than that of potassium. Thallium forms a still more insoluble perchlorate.

The perchlorates of the elements of the other groups which are generally met with in ordinary work, are sufficiently soluble not to interfere.

Behrens* has recently shown that in the presence of potassium permanganate, the perchlorate of rubidium is colored pink.

Advantage can be taken of a similar property of the potassium salt to obtain an exceedingly beautiful test, for if the test drop contains sodium permanganate, the potassium perchlorate separating therefrom will be colored. To obtain this reaction, add to the test drop a little sodium manganate, so as to impart a dis-

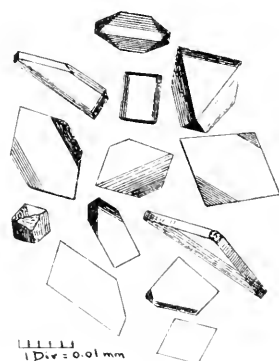

FIG. 36.

* van Brukeleveen, Rec. trav. chim. Pays-Bas. XVII, 1, 94.

tinct green, then add a tiny drop of hydrochloric acid, thus converting the manganate into permanganate. The reagent is then allowed to flow in. The crystals of potassium perchlorate which separate have the same form as before, but are a beautiful deep rose color, the intensity varying with the amount of permanganate present. In a few moments the liquid is completely decolorized, and the precipitated crystals deeply colored. Performed in this way the test is an elegant and very striking one.

Exercises for Practice.

Try reaction with different salts of potassium.

Introduce sodium permanganate into the test drop, and test as above.

Try the reaction on the other members of Group I.

Make a mixture of K and Na salts. Treat a drop of a solution of this material with perchloric acid, evaporate, treat with the reagent again, and again evaporate, extract the dry residue with alcohol, and test the alcoholic extract for sodium.

Try the action of perchloric acid on members of the magnesium group, and the calcium group.

XI. Ammonium Fluosilicate.

As performed in the ordinary manner, with solutions of moderate concentration, no separation of crystals results. It is only under unusual conditions, or by evaporation, that potassium fluosilicate can be made to appear. From a practical standpoint, therefore, this reagent is without value for the detection of potassium. The salt K_2SiF_6 crystallizes as cubes, octahedra, and combinations of these forms.

XII. Conversion into Sulphate, Double Sulphates, etc.

The remarks made under Sodium, with reference to a similar method, apply with equal force to potassium. This method requires too much care and great experience, and is therefore impracticable save for the expert crystallographer.

RUBIDIUM AND CESIUM.

It is seldom, indeed, that the chemist is called upon to make tests upon a substance containing rubidium or cesium. For this reason, and also because the present series of articles purports to give merely an introduction to the methods of micro-chemical analysis, these elements can be discussed together and dismissed with but few words.

Among the reagents which can be employed for the detection of these two elements, three can be selected as being the most satisfactory.

I. Potassium Chlorplatinate.

II. Ammonium Silicomolybdate.

III. Stannic Chloride.

Of these, I and II serve for the detection of both rubidium and cesium, and III for cesium alone.

I. Potassium Chlorplatinate.

Since the chlorplatينات of rubidium and cesium are so much more insoluble than that of potassium, it is more convenient to employ a saturated solution of the potassium salt than to make use of a solution of chlorplatinic acid. The employment of this salt renders it possible to test for the two elements under consideration even in the presence of salts of potassium and ammonium.

Allow a drop of a saturated solution of potassium chlorplatinate to flow into a drop of a *dilute* solution of the material to be tested. The test drop should be neutral or only slightly acid with hydrochloric acid (see Potassium, Method I). If cesium is present its chlorplatinate separates immediately as exceedingly minute crystals of the same form as those of the potassium salt. The crystals are always so small that a high power is required to enable one to ascertain that the precipitate is not an amorphous one. Rubidium chlorplatinate being a trifle more soluble, separates later in crystals again of the same form, but at least twice as large, though still much smaller than those of the corresponding potassium compound.



FIG. 37.

If the solution to be tested is not exceedingly dilute, skeleton crystals almost invariably result, resembling crosses or 5- and 6-pointed stars; careful focusing will reveal with the latter the fact that the branches of the stars do not lie in one plane, but are arranged in the three dimensions of space corresponding to the axes of an octahedron. In the case of rubidium, these skeleton forms often attain a considerable size.

The usual forms assumed by rubidium chlorplatinate have been sketched in Fig. 37. The crystal forms given by the cesium salt are the same, but much smaller.

Exercises for Practice.

Try the reaction of chlorplatinic acid on dilute, and on concentrated solutions of K, NH₄, Rb, Cs.

Repeat the experiments in the presence of considerable free sulphuric acid.

Try, as directed under Rubidium and Cesium, the action of potassium chlorplatinate on these two elements. Then try on solutions of K salts and of NH₄ salts.

Make a mixture of Rb and Cs, and attempt to decide upon the presence of both elements. Then try a mixture of NH₄ and Rb, and one of NH₄ and Cs.

II. Ammonium Silicomolybdate.

This reagent, which can be prepared according to the method given in a previous article*, forms very insoluble compounds with rubidium and cesium. The following reaction is supposed to take place:

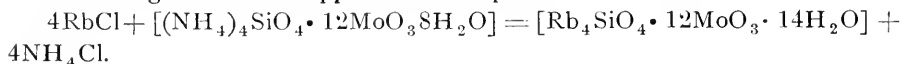

* Jour. App. Micro., Vol. III, 821.

As in the case of the phosphomolybdates (see Potassium IV), the composition of the silicomolybdates is still in doubt.

When the following method is employed, there is generally no difficulty in distinguishing between rubidium and cesium. A drop of an *exceedingly dilute* solution of the substance is spread out in a thin layer, and evaporated in the usual manner. A drop of a dilute solution of ammonium silicomolybdate containing a trace of free nitric acid is drawn across the dry film and the slide held



FIG. 38.

inclined for a second or two, placed on the stage of the microscope, and a tiny drop of a saturated solution of the reagent added to the reagent drop on the slide. The rubidium salt separates at once along the edges of the streak of reagent in the form of lemon-yellow, highly refractive cubes, octahedra, dodecahedra, and the usual combinations of these forms, often rapidly passing into spheroidal granules (Fig. 38). In size these crystals approximate those of rubidium chlorplatinate.

When cesium is present, and the test is thus performed, the cesium salt is instantly precipitated in the form of grains so minute that even a high power fails to reveal any definite form other than what appear to be minute disks. The solubility of the cesium salt is therefore so far below that of the corresponding rubidium compound, that there is little difficulty in distinguishing between them even when both are present in the same substance. So delicate is the reaction that it is essential that there be only the smallest possible amount of these two elements present.

It is advisable to have no salts of ammonium present, since these compounds seem to lower the solubility of the reagent sufficiently, at times, to cause the appearance of octahedra of ammonium silicomolybdate. According to Ladenberg* the octahedra of ammonium silicomolybdate act feebly on polarized light, and hence are not to be referred to the isometric system.

Potassium salts treated in the above manner give after a time, near the edges, neat prisms, which under favorable conditions may attain a considerable size. These crystals are far too soluble, and their form so different from the rubidium compound that it is impossible for them to be mistaken for the latter.

Silver, thallos, and mercurous salts are also precipitated by this reagent. Sodium and lithium yield no crystals; the same is true of the magnesium and the calcium groups.

Better crystals of rubidium silicomolybdate can be obtained by the addition of a dilute solution of the reagent to a dilute solution of the rubidium compound than by the method suggested above, but this process does not permit of so easily distinguishing between rubidium and cesium.

Exercises for Practice.

Try the above method on salts of Na, K, Rb, Cs, NH_4 , Li.

Test mixtures of K and Rb; K and Cs; NH_4 and Rb; NH_4 and Cs; Rb and Cs; K, Rb, and Cs.

*Handwörterbuch, VII, 361.

Make a mixture of Na, K, Ca, and a trace of Rb, and test. Repeat the last experiment, after having introduced Cs.

III. Stannic Chloride.

Solutions of stannic chloride added to hydrochloric acid solutions of cesium salts give rise, even in dilute solutions, to the precipitation of cesium chlorstannate Cs_2SnCl_6 .

In order to avoid the possible interference of other salts, it is advisable to first convert the substance to be tested into the form of a chloride by repeatedly evaporating with hydrochloric acid.

Place near a drop of the moderately dilute solution of the substance, previously acidified with hydrochloric acid, a drop of a concentrated solution of the reagent, also acidified with hydrochloric acid. Cause the drops to unite. Cesium chlorstannate is almost immediately precipitated as colorless transparent crystals. The usual forms obtained are the cube, octahedron, and combinations of the two. In fact, crystal forms identical with those spoken of in the discussion of potassium chlorplatinate (q. v.). Fig. 29 will, therefore, also represent the appearance of these crystals.

Ammonium salts must first be removed by gentle ignition, since ammonium chlorstannate is a salt of almost as low solubility as that of the corresponding cesium compound.

The chlorstannates of potassium and rubidium are much more soluble than that of cesium, hence there is little danger of their separating from dilute solutions. If, however, the solution employed has not been of sufficient dilution, the rubidium salt Rb_2SnCl_6 will first separate in forms identical with those of the cesium salt, but of slightly larger size, then after a time, when the drop has evaporated sufficiently, the potassium salt K_2SnCl_6 will also appear in yet larger crystals.

If iron is present in any considerable amount the crystals of cesium chlorstannate which separate are generally colored yellow.

The sodium salt $\text{Na}_2\text{SnCl}_6 \cdot 5\text{H}_2\text{O}$ is too soluble to separate under the conditions which obtain in the test. The same is true of the chlorstannates of the calcium group.

In cases where no crystals of the cesium salt appear after some time, a little sodium iodide can be added, thus inducing the formation of cesium iodostannate, which is considerably less soluble than the chlorstannate. Cesium iodostannate appears as tiny lemon or orange-yellow octahedra.

In the place of stannic chloride, the chlorides of the closely related elements, antimony and bismuth, can be employed, either with or without the addition of sodium iodide. Thus, chlor- or iodo- antimonates or bismuthates are obtained. The iodo- compounds thus produced yield very beautiful reactions.

Exercises for Practice.

To chlorides, in HCl solution, of Na, K, Rb, Cs, NH_4 , add stannic chloride, first trying the reaction on concentrated, then on dilute solutions.

Make a mixture of K and Cs, test. Then try one of Rb and Cs.

Try the reaction of chlorides of bismuth and of antimony on cesium chloride.

Easy Method of Mounting and Preserving Mosquitos.

The present impetus given to malarial investigation requires the collection and identification of these insects, and it is of importance that scientists and physicians in this country should collect and identify such specimens as they can obtain in their immediate vicinity, and more especially if malarial fever is known to be present and *proved microscopically*. The calling of any and all diseases malarial, or coupling them to typhoid or pneumonia, is to be discouraged, and all physicians should have a positive blood test before treating or calling a case such.

Papers concerning this work will be found in *British Medical Journal* No. 2054, May 12, 1900, pp. 1183-1188; No. 2060, June 23, 1900; and in Prof. Adann's Report on Tropical and Subtropical Diseases of Canada, p. 1544.

A pamphlet on "How to Collect Mosquitos" has been issued by the Montreal Natural History Society, and edited I believe from the British Museum. The insects must be carefully pinned out or preserved, or they are injured in shipping. The method used by Dr. D. C. Rees, in the London Tropical School, is as follows:

- (1) Kill in ordinary killing bottle, or chloroform, or tobacco.
- (2) When dead turn specimen on its back, separate legs, place large drop of thick xylol balsam on slide, invert this gently on to the mosquito so as to pick it up and not injure.
- (3) With fine needle spread and arrange wings and legs, and if necessary press thorax down *gently*.
- (4) Pour on thin xylol balsam and straighten the antennæ and proboscis as it runs out.
- (5) Set aside to harden; chip off excess.
- (6) Place a glass ring about $\frac{1}{16}$ to $\frac{1}{12}$ inch deep over specimen, and fill up the chamber thus formed with balsam, the upper surface of which should be convex, so that when cover is applied no air bubbles are included.
- (7) Let it harden, and then mail if desired.

N. B.—If glass rings are not handy, balsam alone will do. (I use zinc carpet rings.) If desired to photograph the insect, its parts must lie as nearly in one plane as possible. This method is due to Dr. G. D. Freer, Colonial Surgeon, Penong Hospital.—*B. M. J.*, p. 1468.

Dr. John Reid, Redhill, Surrey, Eng., adds a note in regard to above. In place of killing aphides, mosquitos, etc., coax them to get entangled in a drop of glycerin, and with fine needles put in best position. Chemistry explains how glycerol menstrum exhibits structure better than balsam, which refuses absolutely to mix with aqueous media. Care and patience are required to prevent injury and air bubbles. Glycerol jelly may be used if preferred, and the insects die in more natural positions than in balsam.—*B. M. J.*, p. 1592.

In reply to both, I prefer the carbolic acid method, or if desired carbolic and glycerol, which I published some years ago. Glycerin is not always to be relied on, especially if any chitinous or limy deposits are present.

Journal of
Applied Microscopy
 and
Laboratory Methods.

Edited by L. B. ELLIOTT.

Issued Monthly from the Publication Department
 of the Bausch & Lomb Optical Co.,
 Rochester, N. Y.

SUBSCRIPTIONS:

One Dollar per Year. To Foreign Countries, \$1.25
 per Year, in Advance.

The majority of our subscribers dislike to have their files broken in case they fail to remit at the expiration of their paid subscription. We therefore assume that no interruption in the series is desired, unless notice to discontinue is sent.

demonstration, just as the microscope has been elevated from the function of a toy to that of the biologist's right hand assistant.

The camera, popularly employed for recreation, now supplies one of the readiest, most useful and reliable means for illustration and the recording of facts and conditions.

The stereopticon has advanced from the companionship of children to the control of the lecture room.

The countryside with its ponds and ditches, once the exclusive territory of the naturalist, sneered at by the section cutter, is again sought by biologists, and without a knowledge of the life of its denizens his work is balked.

So through the list the index points to a JOURNAL OF APPLIED MICROSCOPY AND LABORATORY METHODS in which the microscope shall be the principal subject and the related methods be given their proper share of consideration. In this decision our contributors and friends to whom the matter was first referred have unanimously agreed. It is not proposed to lessen the amount of material devoted to the microscope, but rather to give an additional number of pages each month printed on a finer grade of paper suitable for the illustrations required.

* * *

Beginning with this number, Mr. Raymond Pearl, Zoölogical Laboratory, University of Michigan, will conduct a department of General Physiology, which will be devoted to the reviewing of current literature in the field of general physiology, using the term in its broadest sense. No attempt will be made to keep abreast of the enormous literature of medical physiology as ordinarily defined, but we shall rather have to do with that physiology which treats of the life phenomena of all organisms. A special feature will be made of the topics of animal reactions and behavior which are now exciting such general interest. The effort will be made to give practical accounts of all new methods of work along the lines indicated, especially such as can be used by teachers in secondary schools or colleges in demonstrating to classes.

WITH the beginning of our fourth volume the scope of the JOURNAL is broadened so as to include general laboratory methods in those branches of science and industry in which the microscope is used.

The microscope is the central figure around which a host of contributory subjects group themselves, and a record of microscopical progress is, to the worker, incomplete and of comparatively little value without a record of developments in the accessory processes upon which his work depends. To-day the museum is transformed from a curiosity shop to a substantial aid in

CURRENT BOTANICAL LITERATURE.

CHARLES J. CHAMBERLAIN.

Books for review and separates of papers on botanical subjects should be sent to
Charles J. Chamberlain, University of Chicago,
Chicago, Ill.

REVIEWS.

Goebel, K. Organographie der Pflanzen insbesondere der Archegoniaten und Samenpflanzen, Zweiter Teil. Spezielle Organographie. 8vo, pp. xiii-xvi + 385-648; 173 illustrations. Gustav Fischer, Jena. M. T.

The first volume of this work has already been reviewed in the JOURNAL. The present volume deals with the gametophyte and sporophyte genera-

tions of the Pteridophytes, and with the sporophyte generation of the Spermatophytes. The gametophyte of the Pteridophytes is discussed under the headings (1) Structure and Development of Sex Organs and (2) The Form of the Prothallia.

In treating the development of antheridia the author advances views which are at variance not only with the views of Belajeff and others, but also with his own previous accounts. According to his present interpretation we have within the microspore wall of *Isetes* a prothallium, consisting of three sterile cells and one antheridium, the wall being represented only by the cover cell. In treating the development of antheridia and archegonia, the transition from free to imbedded forms is described in some detail. The peculiar prothallia of *Ophioglossum*, *Botrychium*, and *Lycopodium*, receive particular attention. In the second part of the book, which is devoted to the sporophyte generation of the Pteridophytes and Spermatophytes, the various organs are discussed in great detail. Some of the most interesting topics are: The Comparative Morphology of the Embryo; The Transition Between Leaf and Shoot; Leaf Formation; The Relation between Leaf Venation and Leaf Development; Transformed Leaves; Branching, etc. The treatment throughout is dominated by experimental morphology, and cannot fail to be a great help to all investigators, and especially to those who are too rigid in their morphology. While constantly calling attention to the variation which occurs in nature, and which may be induced artificially, the author also recognizes the large part which heredity plays in determining the plant form. An English translation will appear soon.

C. J. C.

Byxbee, Edith S. The Development of the Karyokinetic Spindle in the Pollen-mother-Cells of *Lavatera*. Proc. Cal. Acad. Sci., Ser. III, Bot. 2: 63-82, pls. 10-13, 1900.

Miss Byxbee's work on *Lavatera* is an addition to the very interesting series of contributions on spindle formation

recently issued from the laboratory of the University of California. While differing in certain minor details, the writer's conclusions confirm the more important points previously observed in *Cobaea*, *Passiflora*, *Gladiolus*, etc., by other investigators. Her observations are briefly as follows: The meshes of the network, close to the nuclear wall, form a felt of fibers about the nucleus. The granular constituent of the cytoplasm collects in a wide, dense zone about the nucleus.

The linin increases in quantity, the nuclear wall breaks down, and the fibers outside begin to grow into the nuclear cavity. The cytoplasmic and linin fibers form a mass in which the chromosomes lie. The mass of fibers projects out at a number of points, forming the multipolar spindle. Two of the cones become more prominent than the others, which they finally absorb, thereby forming the bipolar spindle. Just how this absorption of the cones is brought about is not made clear either in the description or in the figures. Flemming's strong solution of chrom-osmo-acetic acid was used almost exclusively as a fixing agent, but fair results were also obtained with palladium chloride and iridium chloride to which a small amount of glacial acetic acid had been added. Of the stains used the safranin-gentian-violet-orange G. combination gave the best results. The paper is well illustrated by four beautiful lithographic plates.

Chicago.

A. A. LAWSON.

Timberlake, H. G. The Development and Function of the Cell Plate in Higher Plants. Bot. Gaz. 30: 73-99, 154-170, pls. 8-9, 1900.

This work was undertaken to determine in detail the exact sequence of events during the division of the cell body, and

to correlate, as far as possible, the facts thus brought out from the point of view of the physiology of cell reproduction. The formation of new radiating fibers around the daughter nuclei in the diaster stage, and the formation of a spindle around a single chromosome, as described by Juell for *Hemerocallis*, are taken to indicate that the chromatin is the real center for the formation of kinoplasmic fibers. Having formed as fibers around the nucleus as a center, the kinoplasm takes part in the process of nuclear division, and later divides the cell by a part of the fibers being transformed into a membrane which becomes, in splitting, the plasma membranes of the daughter cells. Prior to the formation of the cell plate the equatorial zone becomes filled with a substance which stains strongly with the orange of the triple stain. The similarity in staining of this substance, together with its presence in the region of the spindle in which the cell wall appears later, is taken to signify the presence of a carbohydrate substance destined for the formation of the new cell wall. The relation of the carbohydrate material to the process of division would seem to show that the substance for the formation of the cell wall is held in a reserve form in the protoplasm before it is actually needed for the process of wall formation. If the relation of the carbohydrate material to the spindle fibers be taken in connection with the facts shown by Klebs and Townsend, that the presence of a nucleus is necessary for the formation of a cell wall, there would be some evidence for the hypothesis that the nucleus forms the cell wall substance.

The material used for investigation was *Allium cepa*, *Lilium longiflorum*, *Fritillaria imperialis*, *Hyacinthus orientalis*, *Vicia faba*, *Phaseolus vulgaris*, *Pisum sativum*, *Larix Americana*, *Larix Europæa*, *Iris versicolor*, and *Hemerocallis fulva*. Several fixing fluids were employed: Flemming's chrom-osmo-acetic acid; Hermann's platinum chlorid-chrom-acetic acid; Vom Rath's platinum chlorid-picro-osmo-acetic acid; Keiser's mercuric chlorid-acetic-acid, etc. Of these methods the material fixed in Flemming's stronger solution gave the best results. The triple stain, safranin-gentian-violet-orange, was used to stain the material fixed in fluids containing osmic acid, while Zimmermann's fuchsin iodine green and

Heidenhain's hæmatoxylin, preceded by Bordeaux red as a ground stain, were used to stain material fixed in the fluids containing mercuric chlorid. The paper is poorly illustrated by a series of reproductions of photographs. While photography is a convincing method of illustrating points in gross histology, it has so far proved a failure as a means of illustrating protoplasmic structures within the cell. Lithographic drawings, or even diagrams, are much more satisfactory. The work is a valuable contribution, as it adds much to our knowledge of the origin and function of the cell plate.

A. A. LAWSON.

Chicago.

Wager, H. The Eye Spot of *Euglena viridis*.
 Jour. Linn. Soc., 27: 463-481, 1900.

This paper gives us an interesting account of investigations on the structure and behavior of *Euglena viridis*. On the general structure of *Euglena*, Mr. Wager gives nothing new, merely summarizing what is already known, but he reports a striking feature in the vacuole system, namely, that the gullet is in permanent connection with the principal vacuole or "excretory reservoir," as he calls it. The eye spot he believes to be derived from chlorophyll, because the action of its granules when in alcohol shows the same behavior as do the rusty, red granules of *Fucaceæ*, which are known to be derived from chlorophyll. His most interesting discoveries were on the flagellum and its relation to the eye spot. He found, by the use of osmic acid, that the flagellum passed into and was attached to the excretory reservoir instead of terminating in the gullet. The base of the flagellum is bifurcate, and on one of the limbs, in close (but not organic) connection with the concave side of the eye spot, is a large oval swelling or enlargement. Quoting Englemann's experiments on the behavior of *Euglena* in a spectrum, he notes that the greatest gathering of the *Euglenæ* is in the blue end. Since the red pigment of the eye spot allows the blue rays of normal light to pass, he suggests, tentatively, that there is possibly a definite stimulus exerted by the blue rays upon the swelling, and hence on the flagellum. The other hypothesis which he brings forward is that the eye spot merely causes a definitely unequal illumination of the sensory spot, and orientation follows. Further experiments along that line would prove interesting.

Chicago.

P. G. WRIGHTSON.

CYTOLOGY, EMBRYOLOGY, AND MICROSCOPICAL METHODS.

AGNES M. CLAYPOLE.

Separates of papers and books on animal biology should be sent for review to
 Agnes M. Claypole, Sage College,
 Ithaca, N. Y.

CURRENT LITERATURE.

Furst, C. M. Haarzellen und Flimmerzellen.
 Anat. Anz. 18: 190-203, 1900. (6 figs. in text.)

This investigation was carried out to show definitely the resemblances and differences between the so-called "hair-cell" and the ciliated cell. The material used was principally embryonic

salmon. It was fixed in Perenyi's fluid and stained in Heidenhain's hæmatoxylin and Orange G. Especially careful study was made of hair-cells from the crista and macula acoustica. In a salmon embryo of 150 days every cell from this region has a black staining layer on its upper border, against the lymph space. Next inside to stain is a similarly staining cone with a clearly marked apex reaching down toward the nucleus. The hair-cell complete, possesses an internal point or hair which can clearly be shown to be formed of cilia fastened together; a basal layer shown by iron hæmatoxylin to be composed of deeply staining round bodies; and a cone continued into the cell and staining deeply. This whole series of parts, the hair, the layer, the cone, forms a definite organ, the "hair apparatus or organ." The different parts of this organ correspond to the special parts of the ciliated cell, the cilia, the basal bodies, the ciliary cone; as if it were a specialized or modified ciliated cell. The hair cell is, due to the "hair organ," a specific form of cell which keeps the principal morphological features of the ciliated cell. Probably this "hair apparatus" is the sensory organ of the cell. The opponents of the Lenhossek-Henneguy hypothesis, concerning the origin of the basal bodies from the centrosome, have not yet deprived that theory of its probability.

A. M. C.

Heidenhain, M. Ueber die erste Entstehung der Schleimpröpfe beim Oberflächenepithel des Magens. *Anat. Anz.* 18: 417-425 (4 abb.), 1900.

It is customary to see the surface epithelium of the stomach with its cells full of mucous, a condition true of all animals from fishes upward throughout the vertebrate series. In view of this fact special interest was aroused by finding the epithelial cells in the stomach of a full grown specimen of *Triton teniatus* contain only a small quantity of mucous. The mucous free cells showed on the free surface a striated border similar to the well known "brush-border" described by Tovnier in different glandular epithelia. In all these preparations the brush-borders show clearly in the cells of the stomach glands, but in spite of the great resemblance of the structures it is doubtful whether the border of fine protoplasmic hairs of the surface epithelium is identical with the "brush-border" of gland cells. However, the term will still be used in this article.

It is evident that the width of the border varies in different cells and the striated border shows still more differences. The origin of the mucous plug commonly seen in cells is by the pouring out of the mucous substance between the rods of the brush-border, by which means the border increases in width with an increase in the amount of mucous poured out. In this way forms the convex mucous "goblet" without the direct participation of the original protoplasmic cell body. These preparations were stained in iron hæmatoxylin and rubin, the hæmatoxylin being bleached until it remained only in the nucleus centrosome and granules of glandular secretion; the protoplasm stained solely by the rubin.

Very instructive preparations were obtained from a specimen of *Triton teniatus* which showed a larger quantity of mucous. The brush-borders stand in a close relation to the mucous and to the formation of the well known mucous plug of the surface epithelium. Black-tinted protoplasmic threads rise from the surface of the cell and are here thickened into root-like processes; these latter

show no particular regularity of form. These "roots" are connected at the inner limit of the border by protoplasmic fibres. At their free ends the little rods swell to fine irregular knots, a condition not observed for the brush-borders. Between the rods lies the mucous which may be aided in its separation by them. At first the surface of the cell is flat, but with the increasing amount of mucous it becomes more and more arched until the familiar beaker-cell is formed, the fine striations still remaining visible on its outer border and sending plasmic threads downward. When this form has been obtained the cell-body, hitherto free from mucous, shows a large drop which appears below the striated border. The whole presents a curious appearance. In the layer of mucous coming from the cell-protoplasm are seen many fine protoplasmic columns. These support on their outer ends many branches looking like candelabra, the original rods of the brush-border. Continuing, the formation of mucous causes first the destruction of the protoplasmic columns, leaving the branches only. Then these too disappear, leaving the mucous clear and unlined. These thickened "roots" of the rods in these mucous cells are not to be compared with the basal pieces of ciliated epithelium. The centrosome lies in these cells within the mucous.

The special reason for publishing these observations in such detail is a recent article by A. Gurwitsch (review in *JOURNAL OF APPLIED MICROSCOPY*, iii, 805, 1900), on the development of ciliated cells. According to his observations, the earliest stages show a border of purely alveolar structure and later on the full surface of the border is a fine protoplasmic network. These, according to the present writer, are both impossible. The distal thickenings observed by Heidenhain account for the distal network.

A. M. C.

Barrows, A. S. Respiration of *Desmognathus*. The views already advanced to account for respiration in lungless salamanders, of which this forms a type, claim extensive "buccopharyngeal" respiration, excluding the skin from an important part in respiration. The discovery later of blood vessels in certain lunged forms that reached to the pharyngeal epithelium supported this view. It has been shown for *Spelerpes fuscus*, a lungless form, that there is a similar nearness to the surface of the pharyngeal capillaries. In the work done on *Desmognathus fusca* a warm carmin injection mass was introduced through the ventricle of the heart by means of a hypodermic syringe. A remarkable network of capillaries was found to extend through the entire wall of the esophagus. These were found to be from the arteriæ maxillares externæ on the dorsal wall and of the arteriæ pharygeæ on the ventral wall. On each side the arteriæ pulmonales anastomosing with the arteriæ gastrica send branches to the esophagus. The blood is collected especially in the venæ esophagæ. A more complete consideration will follow this preliminary paper.

A. M. C.

Stassano, H. Function of the Nucleus. *Compt. Rend.* 1, 30: 1780-1783, 1900. (Review in *Jour. Roy. Micr. Soc.* pt. 5, 1900.) The author finds cells of the vascular endothelium manifest a strong affinity for mercury and other poisons introduced into the circulation, and believes that this is effected by the nucleus by virtue of its nucleins, which form compounds with metals and bases analogous

to salts. His evidence is under five heads: 1. Leucocytes, which are very rich in nuclein, show a strong affinity for metals. 2. In young dogs the endothelial cells contain granulations shown by Kowalewsky to present the characters of nuclear granulations. Organs of these young dogs absorb more mercury by weight than those of older dogs in which the granules are absent. 3. It has been shown that the amount of nuclein in an organ depends on the number of cell nuclei present, and the author's experiments show that the amount of mercury absorbed depends on the amount of nuclein present. 4. The non-nucleated red-blood corpuscles of mammals are the only cellular elements that do not absorb mercury. 5. An intravenous injection of methyl-violet reduces the absorption of mercury by the cells of the vascular endothelium. With this may be compared the fact that cells treated with such substances as osmic acid do not stain. The affinity of the nucleus for basic stains is itself a proof of the author's view.

A. M. C.

RECENT LITERATURE.

- Aichel, Otto.** Vergleichende Entwicklungs-geschichte und Stammesgeschichte der Nebennieren. Ueber ein neues normales organ des Menschen und der Säugethiere. 3 Taf. 1 fig. Arch. f. Mikrosk. Anat. u. Entwicklungsgesch. **56**: 1-80, 1900.
- Grosser, O.** Mikroskopische injectionen mit Eiweiss-Tusche. Zeitschr. f. wiss. Mikrosk. **17**: 178-181, 1900.
- Marcus, H.** Zur "intravitalen" Neutralroth färbung der Leukocyten. Wiener klin. Wochenschr. **13**: 871-873, 1900.
- Mühlmann, M.** Atrophie und Entwicklung. Deutsche med. Wochenschr. **26**: 655-657, 1900.
- Plato, J.** Ueber die "vitale" Färbbarkeit der Phagocyten des Menschen und einiger Säugethiere mit Neutralroth. 1 Taf. Arch. f. Mikrosk. Anat. u. Entwicklungsgesch. **56**: 868-917, 1900.
- Doflein, F.** Studien zur Naturgeschichte der Protozoen. iv. Zur Morphologie und Physiologie der Kern- und Zelltheilung. Nach Untersuchungen an Noctiluca und anderen Organismen. Zool. Jahrb. Abtheil f. Anat. u. Ontog. v. Thiere. **14**: 1-60, 1900.
- Phisalix-Picot.** Recherches embryologiques, histologiques et physiologiques sur les glandes à venin de la salamandre terrestre. Thèse de doctorate en. méd. Paris, 1900.
- Brunn, Max von.** Zur Histologie der Epithelien der serösen Häute. 2 fig. Centralbl. f. Allg. Pathol. u. pathol. Anat., **11**: 604-607, 1900.
- Reinke, Johannes.** Die Entwicklung der Naturwissenschaften, insbesondere der Biologie, im neunzehnten Jahrhundert. (Rede zur Feier des Jahrhundertmechsels am 13 Jan., 1900, Zu Kiel.) Kiel. Univ.-Buchh. 1900 (215).

NORMAL AND PATHOLOGICAL HISTOLOGY.

RICHARD M. PEARCE, M. D.

University of Pa., Philadelphia, Pa., to whom all books and papers on these subjects should be sent for review.

- Nichols, E. H.** On the Etiology of Cancer. First Annual Report of the Cancer Investigation Committee to the Surgical Department of the Harvard Medical School. Journal of the Boston Society of Medical Sciences. Vol. V, No. 2, 1900.
- Nichols investigated this subject along four lines:

1. A histological study of tumors in order to determine whether the characteristic bodies claimed to be the cause of cancer were constantly present.

2. The inoculation of animals with portions of tissue from fresh cancer.

3. The inoculation of animals with the blastomycetes of Sanfelice and Plimmer.

4. Attempts to isolate parasitic micro-organisms from malignant tumors.

First. In the histological study tissues were hardened in alcohols of various strengths, Hermann's solution, Flemming's solution, corrosive sublimate, and Zenker's fluid. Zenker's fluid gave the best results. Paraffin imbedding was used.

For staining, the methods recommended by Sanfelice and Plimmer were tried at first, but as they did not give satisfactory results, the following method suggested by Mallory was used :

1. Ten per cent. aq. sol. ferric chloride, two minutes.
2. Aq. sol. hæmatoxylin (1-2 per cent.), freshly made, two minutes.
3. Wash in water.
4. One per cent. sol. ferric chloride until blue color is removed from protoplasm and nuclear stain is distinct. (Watch under microscope.)
5. Wash in water.
6. In the following solution for two minutes.
1 per cent. aq. sol. acid fuchsin, one part.
Sat. aq. sol. picric acid, two parts.
7. Wash in water.
8. Ninety-five per cent. alcohol.
9. Xylol, three changes, blotting between each change.
10. Mount in Xylol balsam.

This stain colors nuclei black, protoplasm a faint greenish pink, and connective tissue a brilliant red. The peripheral and central portions of inclusions stain a brilliant red, the intermediate portion a faint pink.

The stain is simple in manipulation, constant and even in its results.

Thirty-five carcinomata and five sarcomata were examined. In seventeen cases, bodies similar to those described by Sanfelice and Plimmer were found. They were found principally in cancer of the breast, in thirteen out of sixteen cases. They were never found in epidermoid cancer (thirteen cases) nor in sarcoma (five cases).

Although the writer makes no definite negative statement, he apparently believes that these bodies have nothing to do with the causation of cancer.

Second. Inoculations were made from tumors which were received within two hours after operation, and which were not ulcerated. Under aseptic precautions portions of tumor were removed and placed in the peritoneal cavity of a rabbit and a guinea-pig. In all, nine rabbits and three guinea-pigs were inoculated, chiefly with tissues from cancer of the breast. All inoculations were negative.

Third. Subcutaneous and intraperitoneal inoculations and injections into ear vein, liver, and anterior chamber of the eye of rabbits and of guinea-pigs, of the "Saccharomyces neoformans" of Sanfelice and the micro-organism of Plimmer produced only inflammatory and proliferative changes. No tissue resembling cancer was produced.

Fourth. Cultures were made from thirteen cases. In three, pyogenic cocci grew, the other ten remained sterile.

The writer states that his work is not yet completed; and he therefore cannot give definite conclusions. The results so far, however, have been definitely negative.

R. M. P.

Greenough, R. B. On the Presence of the So-called "Plimmer's Bodies" in Carcinoma. *Journal of the Boston Society of Medical Sciences.* Vol. V, No. 2, 1900.

In this work Greenough examined twenty-three carcinomata of the breast. The tissue was preserved in Zenker's or Hermann's fluid, the former giving the best results. Sections were stained according to Plimmer's directions with iron hæmatoxylin and counterstained with either Orange G and fuchsin or with Bordeaux red.

Conclusions:

1. The appearances known as "Plimmer's bodies" were found in each of twenty-three cases of breast cancer.
2. They were more numerous in the periphery of the tumors and in the metastases.
3. They were not found in areas which had undergone even slight degeneration, whether before or after removal.
4. They were more numerous in the slow growing carcinomata, and less frequently found in the rapid growing ones.
5. They were more numerous in scirrhus than in medullary or adeno-carcinoma types of cancer.
6. They were not found in three cases of epithelioma (one of which was a typical Paget's disease of the breast).
7. They were present in one case of ovarian cancer and absent in another case of general peritoneal cancer, of probable ovarian origin.

R. M. P.

GENERAL PHYSIOLOGY.

RAYMOND PEARL.

Books and papers for review should be sent to Raymond Pearl, Zoological Laboratory, University of Michigan, Ann Arbor, Mich.

Parker, G. H., and Burnett, F. L. The Reactions of Planarians, with and without Eyes, to Light. *Amer. Jour. Physiol.* 4: 373-385, 1900.

This paper gives an account of a study with very exact methods of the reactions to light of normal planarians as compared with specimens from which the eyes had been removed. The species used was *Planaria gonocephala* Dugès. The method employed was such as to admit of an exact statistical treatment of the problem, and is on that account very valuable. In detail it was as follows: A planarian was placed in a shallow rectangular glass dish containing water to a depth of about one centimeter. After the animal had begun to creep along the bottom, the dish was placed on a black board on which was inscribed a circle 55 millimeters in diameter. This circle was divided into quadrants by mutually perpendicular diameters, and the arc of each quadrant was further divided by short cross lines into intervals of ten degrees. "These lines were designated in degrees, the one at the end of one of

the diameters being taken as zero, and those in the semicircles to the right and to the left of this zero being numbered in corresponding series till they met at 180° ." The dish containing the animal was placed over this circle in such a way as to bring the center of the animal over the center of the circle, and its head directed towards the zero point on the circumference. The apparatus was set up in a dark chamber in order to exclude extraneous light, and the illumination for the experiment was obtained from a Welsbach burner placed at a constant distance from the center of the circle. The heat rays were absorbed by an alum solution contained in a parallel-sided glass vessel, which was placed between the light and the dish containing the animal. The light was made to enter horizontally only, or, by the use of a screen and reflector, vertically from above. The anterior end of the animal and zero point of the circle were towards the source of light entering horizontally in one set of experiments, and away from it in another set, while in a third the light entered from above. For one series the eyes were removed by cutting off the head with a sharp scalpel. In each experiment the animal was observed from the time it left the center till it crossed the circumference of the circle. Its path was marked free-hand on a circle which was a duplicate of the one on the black board, and later measured in millimeters. The angle on the circumference at which the animal crossed was read directly, and the time taken in the passage from center to circumference was obtained by means of a stop-watch.

This method, with modifications to suit particular cases, will undoubtedly prove very valuable in work in phototaxis. Exact records can be obtained of the angle of deviation in the path caused by light coming from one direction; of the form of the path taken and the distance travelled; and of the rate of travel under constant light stimulation. The principal result of the investigation was to show that planarians, with or without eyes, when moving *horizontally towards* a source of light are more deflected from an ideal course (to zero on the scale) than when moving under a vertical light, and conversely, when moving *horizontally away* from a source of light they keep nearer to an ideal course. The animals without eyes are affected by light in the same way as those with eyes, but their reaction is less precise. The rate of movement of the decapitated animals is slower than that of the normal. The reactions are believed to be due to a dermatoptic function.

R. P.

Matthews, A. P. Some Ways of Causing Mitotic Division in Unfertilized *Arbacia* Eggs. Amer. Jour. Physiol. 4: 343-347, 1900.

Several new methods are given in addition to those which have already been described for producing cell division in

the sea urchin egg. Lack of oxygen is first discussed. Unfertilized *Arbacia* eggs were placed in an Engelmann gas chamber in sea water, and hydrogen gas, carefully freed from acid, was passed through the preparation. After twenty to thirty minutes' exposure to the hydrogen, oxygen was admitted for ten minutes, and then again hydrogen was allowed to act for twenty minutes. The eggs were then transferred to fresh sea water, and in a comparatively short time clear areas appeared in the cytoplasm, and division into from two to eight cells took place. Continuous exposure to hydrogen kills the eggs before any segmentation occurs. Eggs which have been too long exposed immediately liquify completely

when oxygen is admitted. Warming the eggs to 32° or 33° C. for from two to four minutes causes the clear areas to appear, and segmentation to occur, after the return to sea water of ordinary temperature. Segmentation is also caused by exposing the eggs to the action of sea water in which either ether, or alcohol, or chloroform has been dissolved. In all cases division did not occur until the eggs were brought back into ordinary sea water. In his theoretical conclusions, drawn from these experiments, the author is inclined to abandon his earlier view that karyokinesis is allied to the process of blood clotting, and states that he believes "that whatever the details of the process may prove to be, the essential basis of karyokinetic cell division is the production of localized areas of liquefaction in the protoplasm." In view of the great ease with which *Arbacia* eggs can be made to segment by a variety of stimuli of different physical and chemical character, such a broad generalization, having as a basis the phenomena shown by these eggs under a particular set of conditions, seems to be of uncertain value.

R. P.

Carlgrén, O. Ueber die Einwirkung des constanten galvanischen Stromes auf niedere Organismen. Arch. Anat. u. Physiol. Abth., 1899, pp. 49-76, 1 Taf.
Ueber die Einwirkung u. s. w.: Zweite Mitth. Versuche an Verschiedenen Entwicklungsstadien einiger Evertrebraten. Ibid, 1900, pp. 465-480.

The first of these papers makes a noteworthy advance in our knowledge of the effect of the constant current on organisms, since it demonstrates the importance of the kataphoric, or so-called "osmotic" action of the current.

It is principally given to an account of the electrotactic response of *Volvox*. The sense of the reaction is at first cathodic, but later changes to anodic. Striking changes in the form of the body are produced by the current. The anode side of the colony becomes crumpled, while the kathode side is correspondingly swollen out. The parthenogonidia move to the anode side of the colony. These changes in body forms and movements of the parthenogonidia are entirely passive phenomena, the anode crumpling and kathode swelling occurring in colonies which have been killed in formalin in the same way as in living specimens. Various Protozoa killed in weak formalin or ether solution show the same changes in form under the action of the current. Carlgrén concludes that the purely physical, kataphoric action which produces these results is of very great significance as a factor in the effect of the current on organisms.

In the second paper descriptions are given of the electrotactic responses of a number of marine invertebrates. The point of most general interest is in regard to the reactions of the larvæ of certain echinoderms (*Strongylocentrotus lividus*, *Sphaerechinus granularis*, *Ophiothrix fragilis*, and *Asteracanthion glacialis*). Young, free-swimming stages of these forms gave no response whatever, while older larvæ, *Plutei* and *Bipennariæ*, became oriented and went to the kathode. Theoretical discussion of the results is left for a later paper. No new methods of work are described.

R. P.

Warren, E. On the Reaction of *Daphnia magna* (Straus) to Certain Changes in its Environment. Q. J. Mic. Sci. N. S. 43: 199-224, 1900.

The experiments described in this paper have to do with the effect on *Daphnia* of certain changes in the conditions of life. It was found that the time of killing in solutions of NaCl of

different strengths (.8 per cent. to 6.0 per cent.) seems to depend quite exactly on the number of molecules of salt which strike the animal in a unit of time. The relation of time of killing and strength of solution is represented by the rectangular hyperbola $y(x-8)=277$. An increase in temperature causes the molecules to move faster and strike with greater momentum, and hence the time of killing is reduced in high temperatures. The physiological condition of the animal is a most important factor in determining its power of resistance to NaCl. Perhaps the most striking result of the investigation is that animals which have become acclimatised to a .25 per cent. salt solution show *less* resistance capacity than do normal, unacclimatised specimens, to solutions of greater concentrations. The author thinks that this is probably due to some constitutional weakness resulting from the acclimatising process. *Daphnia* living in a confined volume of water were shown to have shorter caudal spines, and to reproduce less vigorously than those that had lived in an unlimited bulk. Water in which *Daphnia* has lived for some time has a poisonous effect on individuals from other cultures. This paper is of interest in connection with the recent work of Miss Enteman (Amer. Nat. **34**: 879-890) on the extreme variability of a related species *Daphnia hyalina* under differing natural environmental conditions.

R. P.

CURRENT BACTERIOLOGICAL LITERATURE.

H. W. CONN.

Separates of papers and books on bacteriology should be sent for review to
H. W. Conn, Wesleyan University, Middletown, Conn.

Flexner. The Etiology of Tropical Dysentery. The author has made an extensive series of studies of dysentery occurring in the Philippines, and comes to the conclusion that dysentery is of two distinct types. One, the chronic form, is accompanied by the presence of amœbæ in the intestines in large quantities, and is, therefore, what has been called amœbic dysentery. The other, the acute form, is not accompanied by these protozoa, and appears to be produced by bacteria. The author finds universally present in these cases, a bacillus which he describes and with which he experiments. This bacillus is pathogenic for small animals, producing symptoms quite similar to those of dysentery, and is believed by the author to be unquestionably the cause of acute dysentery in eastern countries. The organism is identical with that isolated by Shiga from the epidemic of dysentery prevailing in Japan. Flexner regards this cause of dysentery as widely distributed in nature.

H. W. C.

Ritchie. The Bacteriology of Bronchitis. The author makes a bacteriological study of a number of cases of bronchitis. In most instances they were made by post mortem examinations, and were bacteriological studies of the lung tissue. Numerous bacteria are found in the lungs under the circumstances, most of which, as would be expected, have nothing to do with the disease. The general conclusion of the author is as

follows: Acute bronchitis is an infective disease but not due to any specific organism. Various bacteria are found in the secretions, some of which are the exciting causes of the disease. The disease is more often due to a mixed infection than to the action of bacteria. The most important causal bacteria are the *Diptococcus pneumone* and streptococci. The author also believes that the influenza bacillus is not, infectionally, the cause of bronchitis, independent of the ordinary form of influenza.

H. W. C.

Moore, Veranus A., B. S., M. D. Professor of Comparative Pathology and Bacteriology, New York State Veterinary College, and of Bacteriology, Cornell University Medical College, Ithaca, N. Y. An Introduction to Practical Bacteriology for Students and Practitioners of Comparative and Human Medicine. Second edition, enlarged and revised. Boston, U. S. A., Ginn & Co., Publishers. The Athenæum Press, 1900.

This excellent manual, originally published in 1898 (reviewed in the JOURNAL, Vol. 1, No. 9, page 172), has already gone into a second edition, and the author has taken the opportunity to revise the exercises and to add several more, as well as an appendix, the book being now twice the former size. The new chapters are on the morphology of the coccus forms, bacilli and spirilla, a study of *Pseudomonas pyocyaneus*, of *Bacillus tetani*, and of the bacteria of the healthy mouth. The appendix contains a reprint of the method of determining the reaction of the culture media recommended by the committee of the American Public Health Association in 1897, together with brief directions for inoculation experiments on animals. All of the exercises are exceedingly practical and practicable, the directions are concise while being sufficiently explicit, and references to standard literature lead the student to extend his knowledge by consulting the authorities in the science. The selection of exercises amply justifies the title of the book.

University of Rochester.

CHARLES WRIGHT DODGE.

Hall, H. O. The Etiology of Scarlet Fever. New York Medical Record, 56: 697, 1899.

The feature of this paper consists in a study of the geographical distribution of scarlet fever and its relation to the use of milk as a food. The author finds that the disease occurs in all countries where cow's milk is an important article of diet, especially for children. It is lacking, however, in those countries where cow's milk is not used. In China and Japan, where cow's milk is not used as food, the disease is unknown. In India, where cow's milk is used for adults but not for children, the disease is extremely rare. In countries where asses' milk or goat's milk is used, scarlet fever is unknown. The author is of the opinion that this is a disease primarily distributed by milk.

H. W. C.

Courmant. L'agglutination der bacille de Koch des epauchements tuberculeux. Arch. de Med. Exp. 12: 697, 1900.

The author has studied the problem of the agglutination of the tubercle bacillus by the various exudations from tuberculous animals. He finds that the exudations of tuberculous animals always produce an agglutination of the bacillus, but that the amount of agglutination is not proportioned to the extent of the disease. Advanced cases of the disease produce little agglutination, while incipient cases produce a very marked effect. The author believes that the phenomenon may be of a decided diagnostic value.

If the serous exudations of a suspected individual produce an agglutination, it indicates the presence of the disease. The absence of the reaction, however, does not necessarily indicate the absence of the disease, for advanced cases produce no reaction. The agglutinative power of the seral exudations is greater than that of the blood of the same animal, and, hence, the author concludes that the power of agglutination is developed in the exudations, and are not simply a phenomenon transferred from the blood.

H. W. C.

Rogers. Schutzimpfung gegen Rinderpest. The experiments here mentioned describe a long series of investigations upon the value of the method of inoculating against rinderpest. The author experiments not only with the method of Koch, but with two or three other methods that have recently been devised. His general conclusion is that inoculation by the gall method produces an immunity in cattle against this disease, but that the immunity is quite fleeting, lasting only about four months. He finds, further, that different classes of cattle behave quite differently towards this inoculating test. Mountain cattle and lowland cattle are very different in their sensitiveness to immunization and to the disease. The former are not easily immunized by the gall method. Of the several methods used the author believes that some are best for certain breeds of cattle, and others for other breeds of cattle. The paper hardly admits of summary.

H. W. C.

Saul. Beiträge zur Morphologie des Staphylococcus albus. Berl. Klin. Woch., p. 1058. 1900. This paper consists of a somewhat unique study of the gelatin colonies of this well known organism. The author makes his studies in gelatin plates inoculated in such a way that each plate contained only one or two colonies, and preserved under conditions to retain their moisture so that the colonies could continue growing for months. The gelatin, with the contained colony, was hardened and sectioned, and careful studies made of the sections. Some excellent figures are given of the colonies. The important conclusion is that the colonies are not simply irregular aggregates of cells, but appear to be units, and should be regarded, therefore, rather as "cell states" than as irregular aggregations. The colonies, though varying widely in form, are always reducible to a fundamental type which appears to be based upon the principle of dichotomous branching.

H. W. C.

Trommsdorff. Ueber Gewöhnung von Bakterien an Alexin. Arch. f. Hyg. 39: 31, 1900. The evidence for a germicidal action of freshly drawn blood has been, in recent years, subject to criticism. It has been pointed out that micro-organisms, when transferred from one medium to another, commonly suffer some injurious influence, and for a time fail to increase,—or may even decrease. It has been suggested, therefore, that diminution of bacteria in freshly drawn blood is due to the change from bouillon culture to blood, and not to any poisonous alexin. The author tests this theory by cultivating the typhoid cholera bacteria in the blood and serum of animals whose blood is inactive by heat at 56° for one hour. After cultivation in this inactive blood the bacteria are inoculated in active blood, and are found to be just as rapidly killed

by the fresh blood as they are in a control test when they are taken directly from bouillon. To determine whether the bacilli could adapt themselves to the alexins in the active blood, Trommsdorff cultivated the organism in fresh blood. After being cultivated in this active blood for a time, they were transferred to fresh active blood, and were found to suffer no diminution in numbers. He found, further, that organisms thus adapted to the alexins of the ordinary blood are checked in their growth if transferred to a pleuralexuadite which has the alexins present in larger quantities than ordinary blood. He concluded, therefore, that bacilli quickly adapt themselves to the alexins in the blood.

H. W. C.

NOTES ON RECENT MINERALOGICAL LITERATURE.

ALFRED J. MOSES AND LEA MCI. LUQUER.

Books and reprints for review should be sent to Alfred J. Moses, Columbia University, New York, N. Y.

Friedel, G. Nouveaux essais sur les Zeolites (Suite 1). Bull. Soc. Min. **22**: 84, 1899. *Natrolite (Mesotype)*. Author treats of the manner in which water is expelled during heating, and gives a plate showing dehydration curves. Concludes that all the water of natrolite is of the same nature ("zeolitic"). L. McI. L.

Pratt, J. H. On the Separation of Alumina from Molten Magmas, and the Formation of Corundum. Am. Jour. Sci. iv, **8**: 227, 1899. Author treats of the differentiation of igneous magmas upon cooling, and of the genesis of minerals. The separation of corundum from molten magmas is "dependent upon the composition of the chemical compounds that are the basis of the magma; upon the oxides that are dissolved with the alumina in the magma, and upon the amount of alumina itself." L. McI. L.

Ward, H. L. New Meteorite from Murphy, Cherokee Co., N. C. Am. Jour. Sci. iv. **8**: 225, 1899. Neuman lines noted, also the presence of troilite and daubreelite. L. McI. L.

INDIVIDUAL SPECIES.

Calcites (Siliceous) from the Bad Lands, Washington Co., So. Dakota. S. L. Penfield and W. E. Ford. Am. Jour. Sci. iv. **9**: 352, 1900. The specimens resemble in character the Fountainbleau limestone, and are gray in color. They consist of about 40 per cent. of calcite, enclosing 60 per cent. of quartz sand. The crystals occur singly, but more often in groups, and evidently have formed in a stratified deposit of sand, representing a phase of sand cementation with the crystalline form of the calcite preserved. The crystal forms are steep hexagonal pyramids of the second order (rare in calcite), which are somewhat barrel-shaped, with rounded ends. The Fountainbleau crystals show the acute rhombohedron $f(0221)$.

L. McI. L.

Quartz. Sur un groupe de cristaux de quartz de Striegan (silésie). F. Gonnard. Bull. Soc. Min. **22**: 92, 1899.

The group consists of three crystals with vertical axes parallel, and peculiar arrangement of faces. Eight forms are

noticed, of which three [(13.0. 13.1), (5051), (2577)] are probably new, one being a new plagiohedron.

L. McL. L.

Quartz. Etude cristallographique du quartz des géodes des marnes oxfordiennes de Meylan (Isère). F. Gonnard. Bull. Soc. Min. **22**: 94, 1899.

Quartz occurs in clear, pellucid bipyramids, modified by very small prism faces, and also showing a large number

of new or rare forms. Tabulation of these forms given. Liquid inclusions with air bubbles also noticed, and the fissuring of the crystals, sometimes observed, is thought to be due to the expansion of this liquid.

L. McL. L.

Stokesite. A. Hutchinson. Phil. Mag., Nov., 1899, p. 480.

Description from a single crystal (10 mm. long) in Cambridge Mineralogical

Museum. Orthorhombic, with forms b (010) and v (121). $a:b:c=0.3479:1:0.8117$. Cleavage perfect, parallel to b , and also good parallel to prism, taken as unite; fracture, conchoidal; H.=6—6.5; G.=3.185; lustre, vitreous, pearly on b ; colorless. Partial chemical examination determines it as a hydrated silicate of Na and Ca, with about 6 per cent. of tin oxide, replacing part of the SiO_2 .

L. McL. L.

Medical Notes.

NOTE ON EXAMINATION OF BLOOD.—A microscopical examination of the stained specimen of pathological blood implies a comparison with the appearance of normal blood when subjected to the same straining process. The experienced observer unconsciously makes use of his mental picture of the normal specimen in doing this work, and to him it is sufficient. In fixing and staining blood spreads, however, a slight variation in technique may produce a decided difference in results, consequently those who have had comparatively little experience in such work will find it difficult to secure uniform results without a considerable laboratory equipment. In preparing pathological specimens in such cases a spread of normal blood may, at the same time, be subjected to the same technique and mounted on the slide with the pathological specimen, making exact and reliable comparison a very easy matter. Dried blood spreads can be kept indefinitely, so a supply of normal specimens can easily be kept constantly in readiness for use.

W. A. FULTON, M. D.

Burlington, Wis.

Kober. The Presence of Diphtheria Bacilli in the Mouths of Healthy Individuals. Zeit. f. Hyg. **31**: 433.

Examinations were made in 128 cases which were known to have been exposed to diphtheria, and in 600 cases

which were supposedly not so exposed. The investigations included microscopical study, cultivation upon serum, and inoculation of guinea pigs. Of the 128 cases,

only 10, or about 8 per cent., gave evidence of infection; while of the 600 cases, but 15, or 2.5 per cent., showed the presence of bacilli, and 10 of these later gave evidence of having been previously exposed, thus greatly reducing the percentage in the last experiment. It is generally estimated that diphtheria bacilli are found in the mouths of about 18 per cent. of all healthy individuals. The results above cited would indicate that this per cent. is very much too high.

C. W. J.

May, Richard. The Use of Orcein in the Demonstration of Elastic Fibres in the Sputum. Deut. Archiv. f. Klin. Med. **68**: 427.

The sputum is thoroughly mixed with an equal amount of 10 per cent. caustic potash solution, care being exercised

that no more heat is used than is needed to dissolve the sputum. When thoroughly dissolved, centrifugalize and pour off the liquid portion. Add to the sediment about 2 c. c. of Unna-Tanzer's orcein solution, the composition of which is as follows:

| | |
|------------------------------|------|
| Orcein, | 1.0 |
| Alcohol, absolute, | 80.0 |
| Water, dist., | 40.0 |
| HCl, conc., | 40.0 |

This solution has a red color, which changes to violet when the solution comes in contact with the potash of the sediment. The original color is regained by adding three to five drops of HCl.

Place the centrifuge tube in boiling water for three to five minutes, as heat is necessary to hasten the staining process. Hydrochloric acid alcohol is then added, and after gently shaking the solution, it is centrifugalized by a few turns of the machine; the same process being repeated twice with fresh acid alcohol. The formula for the hydrochloric acid alcohol decolorizing solution is as follows:

| | |
|-------------------------------------|--------|
| Hydrochloric acid, conc., | 5.0 |
| Alcohol, 95 per cent., | 1000.0 |
| Water, dist., | 250.0 |

Malkes, J. Estimation of Mercury in Urine. Chem. Zeit. **35**: 816, 1900.

500 c. c. of urine are mixed with 5 c. c. of egg albumin and 15 drops of acetic

acid, and heated for fifteen minutes on the water bath. The mixture is poured into a beaker, allowed to settle, and the deposit collected in a filter. The paper and its contents are laid on a porous tile for a few minutes. The precipitate is removed to a small cylinder and covered with 50 c. c. strong HCl, a spiral of Cu being immersed in the liquid. After about fourteen hours all the Hg has amalgamated with the Cu, and the acid is dark in color. The wire is washed with water, alcohol, and ether, then dried, after which it is dropped into a tube 5 mm. in diameter with a crystal of iodine, and heated until the sublimate of HgI₂ appears on the wall of the tube. The amount of mercury is compared with that produced by a ring obtained in the same manner from a urine to which a known quantity of HgCl₂ has been added.

C. W. J.

NEWS AND NOTES.

Mr. F. B. Kilmer gives the following report of the December meeting of the New Brunswick Society :

Under the reports of sections, Dr. Henry R. Baldwin announced that experiments were being made with luminous bacteria.

Prof. F. C. Van Dyck explained a new application of the microscope to ascertain the tensile strength of metals.

The President, F. B. Kilmer, delivered a paper entitled "A Study of Cotton," which was illustrated by lantern slides and by slides under the microscope. He showed that cotton fibre had been in use in some form since very ancient times; that while the principal use for cotton fibre is the manufacture of thread and cloth, in recent years many new and important uses have been devised. It forms a component part of the high explosives which are known as gun cotton, smokeless powder, tonite, blasting gelatin, etc. In the form of nitrated cotton, which is soluble in certain liquids, varnishes and lacquers for metal, paper, wood and cloth, imitation leather and silk, substitutes for India rubber and gutta percha are manufactured. Materials of this character made of cotton were exhibited by the speaker. A modern application for cotton is its use as a dressing for wounds.

Cotton for surgical purposes is known as absorbent cotton, which means that the oil, wax and varnish-like coating of the fibre have been removed, and the fibre thereupon absorbs water and other liquids.

The speaker explained the minute structure of a cotton fibre, and while this appeared to the naked eye as a solid cylindrical hair, under the microscope it was found to be a more or less collapsed tube with an outer sheath and an inner opening to the center of the tube. This sheath was associated with a varnish or oily substance and the whole permeated with wax and coloring matter. He stated that while this was the accepted construction of the fibre, he had reason to believe there was much yet to be learned, and slides were exhibited to show that the structure was very complex. A number of slides showed the cotton plant in the various stages of growth; its cultivation, picking and preparation for the market and shipping. Among the slides were those which gave the typical cotton staples of the world.

The second annual meeting of the Society of American Bacteriologists was held in the Pathological Laboratory of Johns Hopkins University on December 27 and 28. A full programme of papers was presented and four sessions of the society were held. The society elected Prof. W. H. Welch of Johns Hopkins University as its president for the year 1901. Information concerning the society may be obtained by writing the secretary, H. W. Conn, Middletown, Ct.

METHODS IN GERMINATION OF SPORES.—The hanging drop culture is undoubtedly the most convenient method of observing spore germination. It is desirable to employ large rings, which should be cemented to the glass slips by a

mixture of refined beeswax and pure vaseline. The cover should be cemented to the ring with vaseline. The same character of liquid should be used at the bottom of the cell as employed in the drop.

This form of cell culture, although highly accurate for culturable forms in nutrient media, will not give best results when a careful study is to be made of particular stimulants in water, or in a medium not ordinarily causing abundant germination. Any volatile or soluble substance besides the medium employed is apt to reduce the trustworthiness of the results. Even the purest vaseline may have an effect on sensitive forms. As a modification of the above method, the cells may be used in Petri dishes, on the bottom of which is placed filter paper with holes for the insertion of cells, thus securing them against movement. The covers are laid on without vaseline and the whole kept in moist chambers. Petri dishes with ground glass tops are preferable.

A decoction of green string beans or of sugar beet is recommended as the best culture medium for most readily culturable fungi; 392 grams of green beans per liter of water, or about 50 grams of dry matter per liter, have been found satisfactory proportions.

As a standard nutrient salt solution, the following formula is well known. It may be used without the sugar, the osmotic influence being neglected as of little consequence in comparison with the desirability of having equivalent salt constituents:

| | | |
|-------------------------|-----------------|---------------|
| Ammonium nitrate | - - . - - - - - | 1.0 gram. |
| Acid potassic phosphate | - - - - - - | 0.5 " |
| Magnesium sulphate | - - - - - - | 0.25 " |
| Iron | - - - - - - | trace. |
| Cane sugar | - - - - - - | 3 to 5 grams. |
| Water | - - - - - - | 100 c. c. |

We shall be very glad to have our readers avail themselves of the opportunity which we have previously offered in the JOURNAL and as herein suggested by Dr. Bessey.

Waterville, Me., January 13, 1901.

Journal of Applied Microscopy:

SIRS:—I note that you asked your patrons to suggest anything that might occur to them as of interest in making the JOURNAL more interesting. It occurs to me that if you should set apart a column giving the subscribers a chance to ask questions of a scientific nature, and have them answered, either by the editors or by other subscribers, that it might add to the general interest. I think almost any person having laboratory work would like to ask some question that is not in publication, and could be answered by another doing such work. I merely suggest this. Very likely you have already considered it.

Most sincerely yours,

M. W. BESSEY, M. D.,
Instructor in Zoölogy.

Colby College.

Journal of Applied Microscopy and Laboratory Methods.

VOLUME IV.

FEBRUARY, 1901.

NUMBER 2

The New Biological Laboratories of Ripon College.



INGRAM HALL FROM THE NORTH.

The Biological Laboratories of Ripon College are located in the first story and basement of Ingram Hall, which was occupied for the first time at the beginning of the present school year.

Ingram Hall contains, besides the department of biology, the departments of physics and chemistry, physics being on the second floor and chemistry on the third floor. The building, which was named from the principal donor, Mr. O. H. Ingram of Eau Claire, is 73 by 121 feet in its outside dimensions, and is located at the brow of the hill on the campus in such a way that the south side

is four stories in height. The longer dimension of the building is east and west—the entrance to the first floor being on the north side, and to the basement on the south side. The material of the building is dark red vitrified brick, with rustications of Roman brick and trimmings of Bedford stone. The building is in form a rectangle, with only such projections as are necessary to relieve the monotony of its exterior surface. The architect was instructed to make as many windows as the character of the structure would permit, and the result is that all the rooms are amply lighted. A feature of the construction is the character of the partitions. There are two solid brick partitions running through the whole height of the building. The other partitions are only two inches in thickness, the necessary support being given by heavy pillars. These partitions, a device of the architect, Mr. H. K. Holsman of Chicago, have a core of wood, which is plastered solid on both sides. At first thought, they would seem to be very unsubstantial, but as a matter of fact, after the adamant plaster is applied, not only are the walls firm and substantial, but sound is not carried through them to any disturbing extent. The manifest advantages of the partitions are the economy of floor space and the fact that they are practically fire-proof.

The building is finished in oak throughout, and while very plain, presents an attractive interior. The total cost was about \$33,000. All the plumbing is "open."

The laboratories for the department of biology are so located as to use north light so far as possible. To that end, the room for museum purposes is on the south side of the building, as shown in the annexed floor plan. A similar museum room on the second floor is also devoted to the department of biology. These museum rooms are not large, and were not intended for display purposes, but mainly for the convenient storage of materials used in illustrating the lectures of the department. A lift runs through the entire height of the building, and by this it is easy to convey material from the second floor to the first, as it is required for use.

Between the museum and the lecture room is an apparatus room, or preparation room, which is used both in connection with the work of the museum and in preparing material for lecture work. The lecture room, in the southeast corner of the building, has the floor raised in four steps, so that all students can see the lecture table with clearness. The blackboard is a sliding one, and back of it is a fixed plate of ground glass which can be used for illustrative purposes in the lecture, or can be used in connection with the lantern work. The windows are fitted with opaque shades, so arranged as to exclude the light, in order that the room may be used for lantern work.

Adjoining the lecture room, on the north, is the bacteriology room. This is intended as a place where the various forms of apparatus connected with the work in bacteriology can be permanently set up. The room is large enough, also, so that small special classes in bacteriology can do their work there.

The two rooms at the west end of the building are the general laboratories, used for the more elementary work, and for the vertebrate work. They are so arranged that by a movable screen the two rooms can be used separately or as one large room for especially large classes.

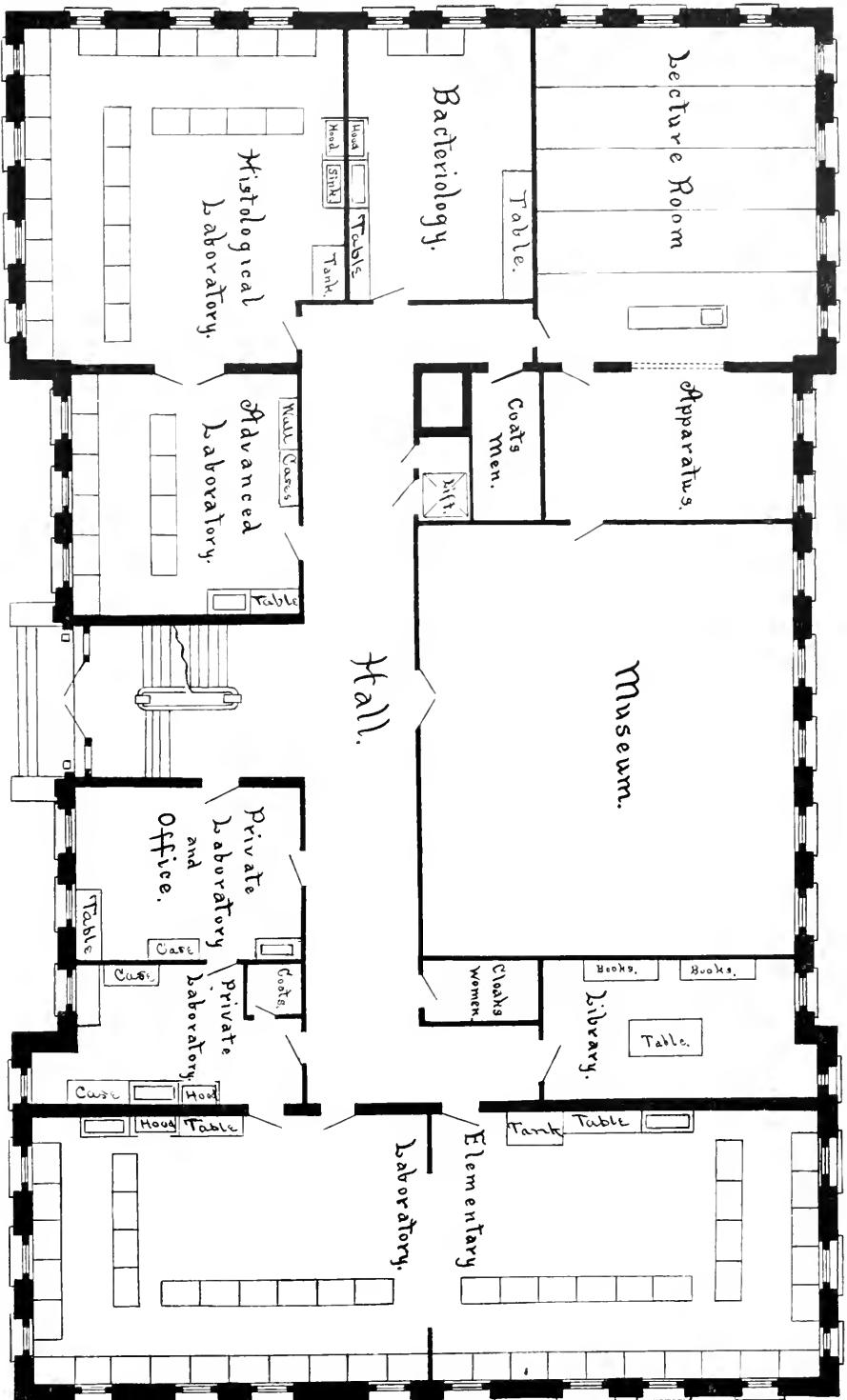

At the right of the north entrance is the private laboratory and office of the head of the department. Adjoining this on the west is another private laboratory, from which a door opens immediately into the general laboratory. At the left of the north entrance is a room used for the more advanced classes in microscopical work. This opens by double doors into the laboratory in the northeast corner of the building, which is also used for microscopical work. By means of the double doors these two rooms can be thrown together, in case of exceptionally large classes. Inasmuch as the building is seldom used in the evening, and as it was necessary to have gas in all parts of the building in any case, the building has not been wired for electric light.



PRIVATE LABORATORY AND OFFICE.

In the laboratories for microscopical work, each table is supplied with gas jets, and when it is necessary to use artificial light for class work, portable gas lamps with Welsbach burners are furnished the students. In the author's experience, the Welsbach burner is by far the most pleasant light for microscopical work. The plans show clearly the position of the sinks and the acid closets, which are distributed freely in the various laboratories. In the arrangement of the tables all are so placed as to face the windows. The author has a personal objection to microscopical work with a side light. It is to him extremely annoying, and it seems desirable that the student should work under the best conditions; consequently, in the various laboratories, the tables are arranged in two lines, one on the wall immediately facing the windows, and the other a few feet back. It is found that this gives much better working light than to arrange the tables in alcove fashion from the walls, and it is also fully as economical of floor space. Our room is so ample at present that it is possible in all our classes to

furnish students with tables which become their permanent property for the term's work. This has a great many advantages, as it is not necessary to clear the table after every work period, and it is possible, in the case of enthusiastic students, to put in more than their required time upon their laboratory work. As a matter of fact, in many cases, more than double the amount of required time is spent by many of the students in the laboratory.

For laboratory tables, after a good deal of thought, we have used hard wood kitchen tables. The essential points in a laboratory table for an under-graduate student seems to be a sufficient amount of room, and stability. These tables are well made—each has a drawer—and have the virtue of cheapness, and we prefer to spend our money in other forms of apparatus rather than in elaborate laboratory tables. The tops of the tables are painted a dull black.



ELEMENTARY LABORATORY.

For laboratory chairs, we have used a form which we have seen in no other laboratory. Many of our best laboratories supply stools for their students. It has always seemed to us rather hard that the student, who is working two hours or more continuously at the laboratory table, should have nothing more comfortable than a stool without a back. It is very desirable that whatever chairs are used should be adjustable in height, because of the varying heights of the students as well as the requirements of the different kinds of work. We have finally adopted in all of our biological laboratories a chair which is easily understood from the illustrations. The base is a swivel stool, upon which is placed the seat of an ordinary kitchen chair. These chairs are very comfortable, and at the same time very durable, and we have found them extremely satisfactory for the laboratory work.

In both the general laboratory and the histological laboratory, is a large drip tank (one of them is shown in the illustration of the elementary laboratory) so arranged that jars of living material can be kept alive by means of tubes from the overhanging water pipe, or the tank can be used as a large fish tank by plugging the outlet with a hollow plug of slightly less depth than the tank itself. In the general laboratory this tank is used for keeping such animals as fresh water mussels at the times when the classes are using them.

For storage of the thousand and one things that are in constant use in the laboratories, as well as the working collections in homeopathic vials and similar small receptacles, we have a series of tray cases (one of which is shown in the picture of the private laboratory). The trays are made of uniform size, and are



HISTOLOGICAL LABORATORIES.

interchangeable in position, or in the different cases. They run on one-half inch cleats on the sides of the cases, and each one has a label holder upon the front. In the trays that are used for homeopathic vials, partitions are inserted parallel with the front and back of the trays. For such collections we use the ordinary eight-drachm homeopathic vials. Arranged in this way, these trays will hold 195 vials each, thus being extremely economical of room. Where the trays are used for miscellaneous material, they are arranged alphabetically, so that it is easy to place one's hand upon corks of various sizes, bottles, etc. For the collections in homeopathic vials an accession catalog is kept, and the bottles are arranged according to the numbers of this catalog. By means of a subject catalog upon cards, it is easy to find any desired material. The trays are of such a size that they hold a definite number of Pillsbury slide boxes, so that they can be used also for packing away slide collections. The collection

of slides is also arranged numerically, the accession catalog being the one devised by Dr. Ward. The subject card catalog makes it comparatively easy to locate the slides of any particular subject.

Between the museum and the general laboratory is a room in which is placed the department library, where are kept all the working books on biology. To this the students of the department have free access at all times.

The storerooms of the department are located upon the north side of the basement. Upon the south side of the basement are two rooms for botanical laboratories. On the south side of the basement, also, is located the vivarium, in which are kept the animals which must be kept in stock for the biological laboratory. This room is floored with cement, inclining towards an opening in the center which is connected with the sewer, so that by means of a hose the room can be thoroughly flushed and cleansed. Connected with this room is the injection room, which has a cement floor arranged in the same manner. In this room all the dirty work of killing large animals and of injection, in fact all work which would be liable to foul the laboratories, is taken care of. In this way a large part of the disagreeable work is kept out of the laboratory rooms.

Ripon College.

C. DWIGHT MARSH.

A Combined Condenser and Polarizer for Petrographical Microscopes.

The attachment consists of a double lens condensing system, and a Nicol prism mounted as shown in the following illustration.

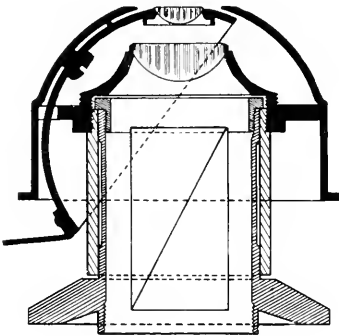

The upper condensing lens is mounted on a revolving arm so that it may, at the will of the operator, be instantly thrown in or out of the optical axis by a lever; a suitable stop being provided to bring it to a central position.

The lower lens is mounted at the proper distance below the upper surface of the apparatus so that when the upper lens is moved out of optical axis, the lower lens focuses upon the slide, thus avoiding the necessity of re-focusing the condenser system when changing from the double to single combination. The Nicol prism is mounted in revolving sleeve with graduated collar and a stop to indicate zero or the position of Nicol prisms when crossed.

The advantages of this arrangement over others for accomplishing the same results are, briefly, as follows:

First—It is not necessary to increase the size or thickness of the microscope stage.

Second—The attachment is always in focus whether one or both lenses are used.

Third—Compactness and freedom from liability of disturbance while operating stage or slide.

W. L. PATTERSON.

A Plan for a Ureometer.

The plan for a ureometer (or modification of Doremus' apparatus) here presented would, it is believed, offer some advantages as to accuracy and facility of manipulation over other methods of estimating urea.

C is a tube of about 25 cubic centimeters capacity, closed at the upper end, and accurately graduated from the upper end downward for 16 c. c., to tenths of a cubic centimeter. The graduation also gives urea percentages to tenths per cent., at 20°C, and barometric pressure of 760 mm. of mercury. At the bottom of tube *c* is a curved neck communicating with a bulb *b*, which opens into a tube *a*; this has a funnel top, and is of the same length as tube *c*. The capacity of bulb *b* is about 30 c. c., which quantity is indicated by a mark on tube *a*.

Tube *c* communicates near its lower end with a small tube *d*, joined at such an angle and position that gas generated in *d* will rise easily into tube *c* and none pass into bulb *b*. A removable accurately fitted glass stopper and stop-cock *e* separates tube *d* from the cavity of tube *c*, and the capacity of tube *d* below the stopper is exactly 1 cubic centimeter when the stopper is inserted. A transverse perforation *n*, rather large, passes through the stopper, so that when turned in the right direction it opens free communication between tubes *d* and *c*. When the stopper is so turned that it shuts off tube *d*, the perforation *n* should open into the cavity of tube *c*.

A glass cross-bar *h* strengthens the apparatus, which is entirely of glass. A separate base or stand for the support of the instrument can be provided.

METHOD OF USE. — The stopper, being removed, the tube *d* is by means of a dropper filled with urine. The stopper *e* is then inserted with opening *n* so placed as

to cut off tube *d* from tube *c*. Tube *d* then contains exactly 1 c. c. of urine. The usual sodium-hypobromite solution is then poured into tube *a*, up to the 30 c. c. mark. The apparatus is then tilted so that the solution runs into tube *c*, entirely filling it; the perforation *n* should also be filled with the solution. The apparatus being held upright, the stopper *e* is turned so as to

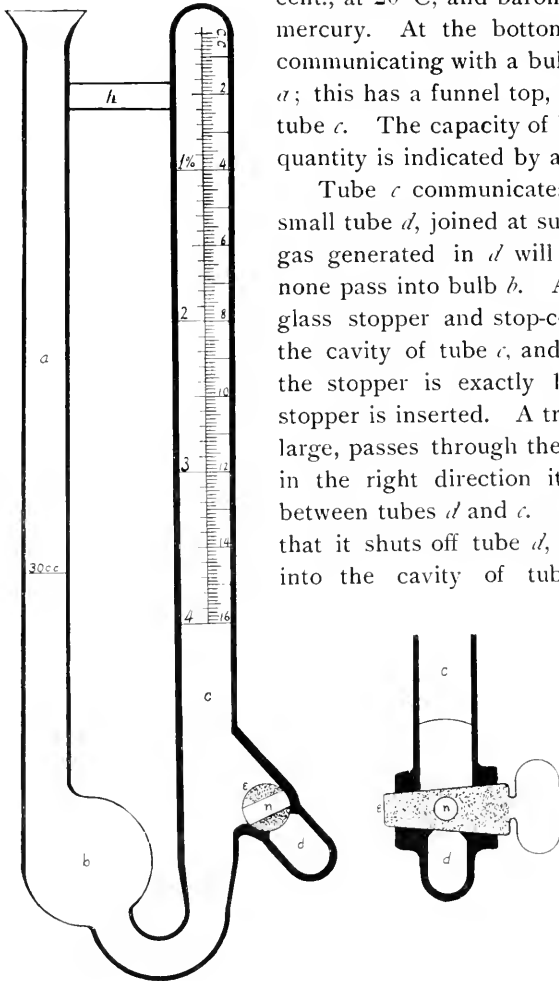

make communication between tubes *d* and *c*. Tube *d* and perforation *n* should be large enough to enable the fluids to mix readily. The rapidity with which the fluids mix can be controlled by the stop-cock. The urine mixes with the test solution, the urea is decomposed, and the nitrogen evolved rises into the upper part of tube *c*. When the reaction is complete and the temperature has subsided to that of the room, water is added to (or removed from) tube *a* until the level of the fluid in the two arms is the same. The amount of gas in tube *c* is then read off, and from it the amount of urea can be calculated: or the percentage of urea can be read directly from the graduation.

The advantages of this method would be as follows: The measured amount of urine (1 c. c.) is obtained accurately and easily, as it were automatically. None of the gas generated is lost, but all is saved in tube *c* for measurement. The equalization of the level of the fluid in the two arms equalizes the hydrostatic pressure and thus gives an accurate reading of the amount of gas free from that source of error. The graduation in cubic centimeters enables the urea to be calculated with the greatest nicety, applying any corrections for temperature and barometric pressure; while for localities near the sea level and ordinary room temperatures the percentage graduation on the tube (in the sketch given on the theoretical basis) gives a direct reading of sufficient accuracy. The apparatus is compact, not cumbersome, easily kept clean, and always in working order. It combines accuracy with facility of manipulation.

J. B. NICHOLS, M. D.

Washington, D. C.

A Device for Supporting Pasteur Flasks.

Pasteur flasks are difficult to handle on account of their peculiar shape. A collar of asbestos, cork, or straw is ordinarily used, but has to be fitted closely to the base in order to keep the flask erect.



The photograph shows a device for supporting these flasks, which permits greater freedom and safety in manipulation than is obtained with the ordinary collar support. The device consists of a solid disk of wood about $5\frac{1}{2}$ inches in diameter and 2 inches in thickness. This is hollowed out in the center, leaving a concavity into which the base of the flask fits. One end of a piece of heavy brass wire is fastened into the margin of the base, the other end of the wire is bent so that the bend of the tube of the flask fits into it loosely. The wire supports the flask in the erect position, so that the base of the flask need not fit closely into the hollowed wooden base.

KATHERINE E. GOLDEN.

LABORATORY PHOTOGRAPHY.

HIGH-POWER PHOTO-MICROGRAPHY.

There is a fascination about the use of the microscope and camera together that can hardly be experienced when either instrument is operated alone. In its simpler aspects, moreover, photo-micrography may be enjoyed by any one who possesses the ordinary microscopical and photographic apparatus. By makeshift adjustments and adaptations, it is possible to arrange the separate parts into a workable series so that the amateur photographer may add the making of enlarged pictures of small objects to his other accomplishments and the microscopist may secure permanent records of the transitory images that have so often delighted him.

It is otherwise, however, with those who attack the problem of producing photo-micrographs which represent a high amplification of the object—1000 diameters or over. This branch of the work should not be undertaken without serious purpose and the best of apparatus.

Here makeshifts are out of place. The great degree of accuracy and the nicety of adjustment demanded of each part of the apparatus makes it necessary to employ an installation that is especially designed for its own particular purpose. With such assistance, only, can the scientist achieve any valuable results, for it is only the scientist who would have the time and patience requisite for work of this character. There must be some end in view aside from the mere gratification of an idle curiosity to see how big a picture of a small object can be made. This purpose finds itself in the desire of investigators to present to their fellows as accurate and as complete a conception of their material as it is possible to give. The value of photography as an aid in this direction is being more and more appreciated and nowhere more than among those who have to deal with the almost ultra-microscopic structure of the organic cell.

Not that photographs are designed to supercede the customary drawings. Both sun image and pencil image have their places as aids in the elucidation of the text. The former exhibits, often in a bewilderment of detail, the whole field of the study; the latter presents concretely the investigator's interpretation of the essential facts. A comparison of the two by one acquainted with the subject will enable him to reach an opinion as to the validity of the writer's conclusions such as would be impossible if only one method of delineation had been used.

In recognition of this fact, many writers upon histological and cytological subjects now enrich their papers by supplementary plates of photographs and drawings, which, with the text, enable a reader to obtain as complete a mental image of the subject as can be acquired without a personal examination of the specimens. Such a work as Wilson's "Fertilization and Karyokinesis of the Ovum," wherein the author's skill in observation is supplemented by the beautiful photographs of Dr. Leaming, is an excellent example of what may be done in this direction.

As a realization of the importance of this class of illustration grows, the

demand for information concerning the methods employed increases until microscopical journals find it advantageous to assign a separate department to the discussion of methods and apparatus involved in the production of scientific photographs. It is a matter of congratulation that workers in this country are now afforded such a means of communication through the columns of the *JOURNAL OF APPLIED MICROSCOPY AND LABORATORY METHODS*.

The department here being new, it is but natural that matters of an elementary nature should be discussed. With this in mind, I have thought to describe an actual installation of apparatus for high-power photo-micrographic work and to exhibit some of the results attained by its use. In Vol. III, No. 5, of the *JOURNAL* appeared an account of the outfit employed in the Johns Hopkins laboratory. The one at the University of Kansas is very similar, but it has been

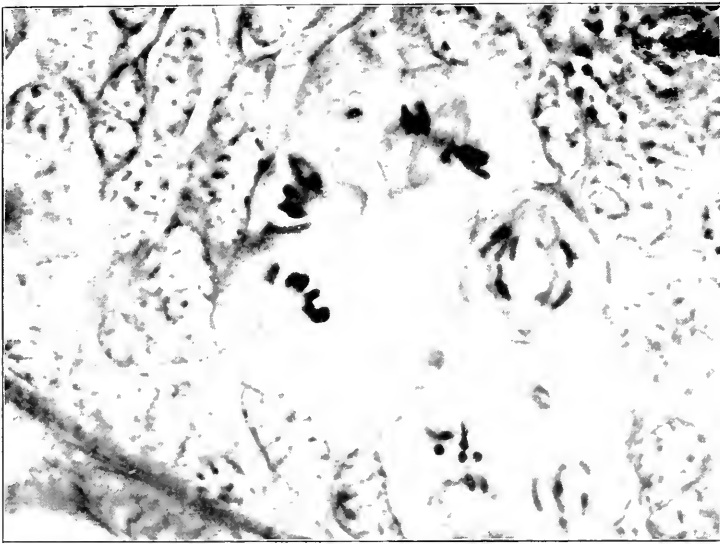

FIGURE 1.—Spermatogonial mitoses of the grasshopper, *Hippiscus phanicopterus*, in the metaphase and anaphase. These divisions take place very rapidly and the archoplasmic threads of previous spindles may still be seen between the centrosomes of different cells. 1000 diameters.

further modified from the original Zeiss arrangement than has the one at Baltimore. Upon the optical bench are placed the illuminating apparatus, two iris diaphragm supports, and the microscope. The other accessories furnished with the complete outfit are not employed. The camera itself has not been altered.

Following is the arrangement of the apparatus: The microscope—I use a Van Heurck—Watson stand—is firmly clamped on the end of the bench nearest the camera. Next, the carbons of the arc light are roughly adjusted so as to lie approximately within the optical axis of the microscope. With a low power objective focused upon the object, the arc is projected upon a small screen suspended upon the front of the camera which is pushed back on its sliding bed to a distance. By means of the adjustment screws, the arc is then brought into such a position that the glowing crater occupies the center of the field. Prelim-

inary to this, however, the substage condenser has been racked up with the coarse adjustment until it brings the image of the crater into focus at the level of the object. If the camera has not been adjusted with reference to the optical bench, it is now arranged so that the image of the crater falls in the center of the ground glass. Provided the substage condenser is properly centered, the linear adjustment of the combination is complete.

The next step is to arrange the object with reference to the condenser and the objective which is to be used in making the negative. I have found it advantageous to connect these three elements with homogeneous immersion fluid and for a condenser employ the "parachromatic" oil immersion form made by Watson & Sons. The objective is an apochromatic 2 mm. of Zeiss.

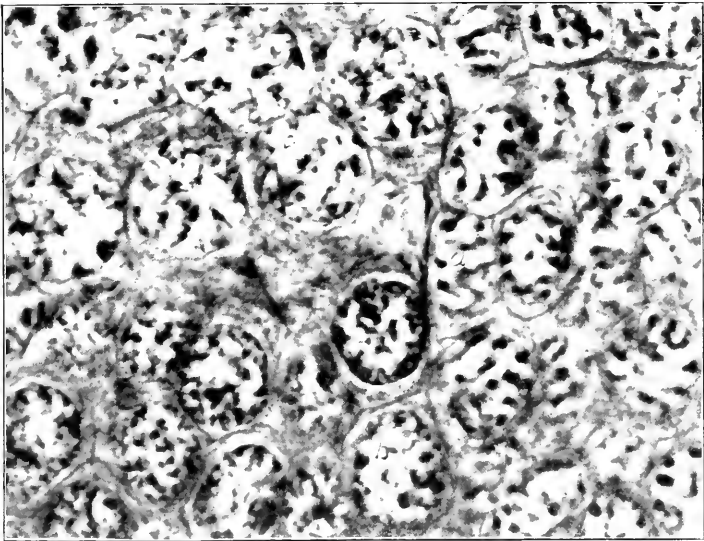

FIGURE 2.—Transformation stages between the telophase of the spermatogonia and the prophase of the first spermatocytes. The gradual accumulation of the chromatin into a thread may be noted. Successive stages shown at "a", "b", and "c". Same object, 1000 diameters.

For a number of reasons, it is convenient to interpose temporarily an incandescent gas lamp in the substage series while getting the proper focus and adjustment of the object with the eye. When this adjustment has been accomplished, it remains only to get the final projection of the image upon the ground glass of the camera before the exposure is made.

The projection eyepiece is now substituted for the observation ocular, which has been used up to this time, and an image thrown upon the small screen which still hangs upon the front of the camera. Here an approximate focus of both object and source of illumination is obtained and the composition of the picture studied. If this is satisfactory, the screen is removed, the camera pulled forward and joined to the microscope, and connections made between the fine adjustments of the tube and of the substage condenser with rods that lead back to the

end of the camera carriage. Here these may be manipulated while the image is being examined and focused on the screen.

At this stage of the proceedings, there are visible upon the ground glass indistinct images of the incandescent carbon and of the object. By means of the fine adjustments, these are brought into a sharp focus upon the glass. Owing to the nature of the crater, the illumination is not uniform over the whole field and it is necessary to place a piece of ground glass between the source of illumination and the object. This should not be more than dense enough to properly diffuse the light, otherwise it unduly lengthens the time of exposure.

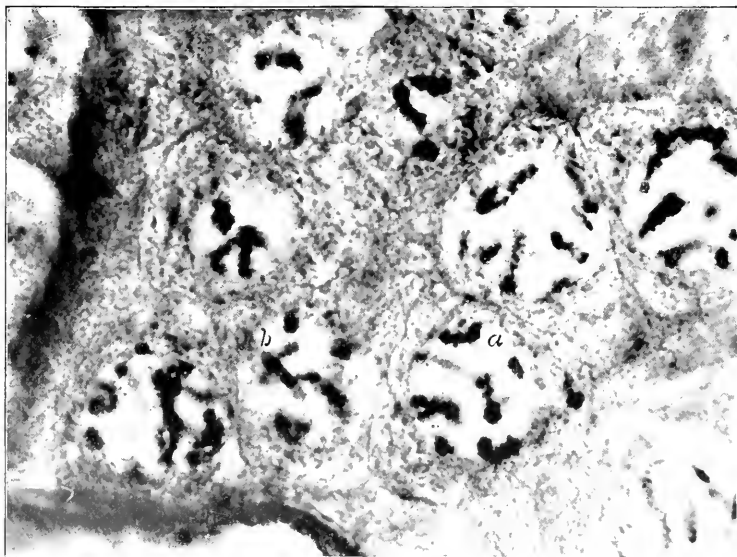

FIGURE 3.—Prophase of the first spermatocyte. The chromatin thread has broken into segments. Between these run delicate linen fibers as at "a". At "b" an element distinguishable from the others by its greater transparency and sharper outline. In these cells it is known as the accessory chromosome. Same object. 1000 diameters.

There should now be visible a sharply defined, evenly illuminated image of the object wherein the details are neither obliterated by excessive illumination, nor rendered granular and obscure by deficient light.

In obtaining a good negative, the manipulation of the substage iris diaphragm is as important as the proper adjustment of the objective. No pains are spared, accordingly, to bring about the appropriate arrangement of the cone of light, and the lever of the diaphragm is swung back and forth until the very best possible result is obtained. The Watson condenser above mentioned has a graduation upon the mounting indicating the numerical aperture afforded by the opening of the diaphragm. This is a convenience which should find a place upon the condensers of other manufacturers.

The further stages of the process are those which pertain to photographic manipulations in general, and the limits of this article will not permit their consideration. Summing up the steps to be followed, we have :

1. Linear adjustment of substage condenser, crater, and center of camera-back to obtain their coincidence with the optical axis of the microscope.
2. Focus of source of illumination upon object by means of substage condenser.
3. Focus of objective upon object.

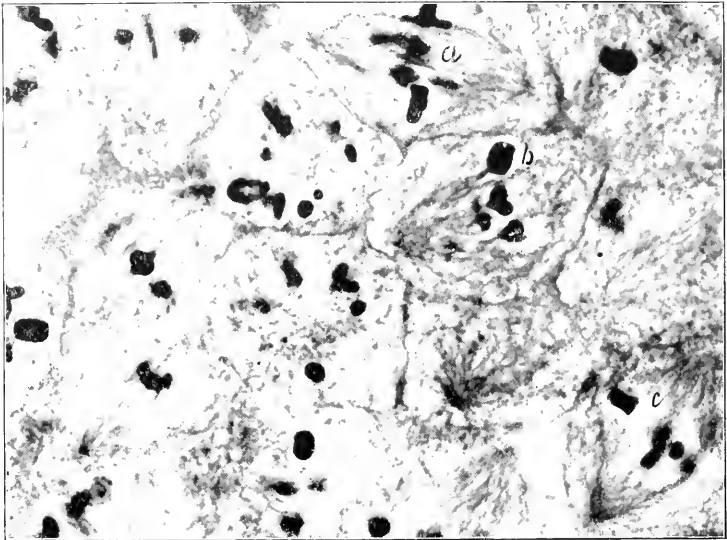

FIGURE 1.—Metaphase of the first spermatocyte. The chromosomes of the same cell do not divide simultaneously, as may be seen at "a". Sometimes they form rings as seen at "b". In the cell marked "c" the archoplasmic fibers are sharply in focus. Same object. 1000 diameters.

4. Final simultaneous projection of crater and object images upon ground glass of camera.
5. Diffusion of light by ground glass between source of illumination and object.
6. Adjustment of substage iris diaphragm.
7. Exposure of plate.

C. E. McCLUNG.

University of Kansas.

An Improvised Microtome.

On a recent visit to the College of Physicians and Surgeons in Boston, the writer saw, among other ingenious contrivances, a microtome devised by Dr. Shurtleff, of the above named institution, and made by him at a cost of fifty cents, for cutting the micrometer screw. Since my visit I have myself made a similar microtome at the small cost of two hours' work, since a common screw was employed instead of a micrometer. Thinking that possibly the idea may be of use to some other investigator, I will venture to offer the following description:

The first essential is, of course, a knife; and, while a regular section razor is preferable, an ordinary razor will answer. In the absence of either, however, I

have seen a shoe knife successfully used; but in this case the back was strengthened by soldering a knitting needle on one side and a rod cut from a stove poker on the other. Assuming, then, that a knife is at hand, the next requisite is the holder, which consists of a piece of wood about four by seven inches, having a U-shaped cut-out at the top, two inches wide and three inches deep. This leaves two prongs each an inch wide into which small wire nails are driven so that the razor (R) may rest upon them when it is in position. Spring clips of some sort hold the razor firmly in place. For the clips, stout wire an eighth of an inch thick is good. Each wire may be fastened to the board by double-pointed tacks. Near the bottom of the board and in the center is the screw (S). A common screw will answer, but a fine threaded screw passing through a nut is better. In either case, however, a large disc may be soldered to the screw head for increased delicacy in operation. The "holder" complete is now, by means of a pair of hooks and eyes, to be made attachable to the end of a box so that turning the screw

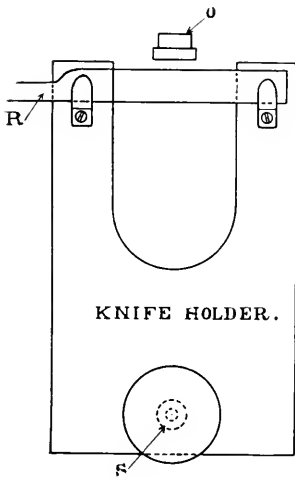

Fig. 1.

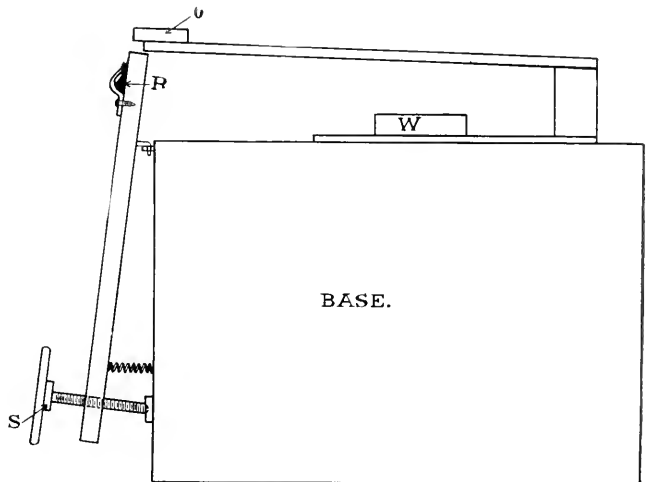

Fig. 2.

gives a delicate movement to the razor. The screw point should work against a small metal plate on the box. Tension is secured with a rubber band or spiral spring. (Reference to the diagram will make the idea clear.) The "holder" should be so placed that the razor edge will be two or more inches higher than the top of the box. Now, when an adjustable object-holder is provided, the microtome is completed. To make the object-holder, a board somewhat shorter than the box, a block, and a straight-grained stick about one-half an inch in cross section are necessary. Fasten the block near one end of the board, nail the stick to the block (as indicated in the diagram), and the microtome is ready for service.

In use, the paraffin block (O) is fastened to the end of the stick with melted paraffin, and proper adjustments are made with reference to the razor. Then, downward pressure on the stick cuts the section, while clockwise movement of the screw regulates the thickness. Serial sections are readily made, if the

paraffin block is carefully squared; but, for this work, the object-holder should be steadied by a weight of five or six pounds (W).

While the microtome can by no means take the place of such a splendid instrument as the Bausch & Lomb "Student," yet it is a practical and serviceable apparatus, and its usefulness has been demonstrated in everyday histological work.

IRWIN LAVERNE POWERS.

Randolph, Mass.

The Study of Bacteria in the Public Schools.

The highest aims in "municipal housekeeping" can never be attained by Boards of Health or by Departments of Street Cleaning alone, however efficient these organizations may be. Unless these city departments are backed by a strong, intelligent public sentiment we shall experience nothing better than sporadic reform in the cleaning of our streets, in the construction of tenement houses, and in the general care for the public health. When conditions get sufficiently bad in a community, it is comparatively easy to arouse the voters and roll in a reform administration by big majorities. But alas! we soon tire of our attempts at public virtue, we reverse our votes at the next election, and sink back into easy toleration of filth and its resulting disease. One might indeed become pessimistic with reference to the future of our cities were it not true that democracy possesses a most powerful means of developing a public sentiment which may be at once intelligent and lasting. Gathered in our schools of to-day are the boys and girls who will be the voters and the home-makers of to-morrow. Hence to the teacher, especially in the public schools, is given the opportunity to exert a telling influence in developing the better city of the future.

The discoveries in bacteriology within a few years have made new sciences of surgery, medicine, and sanitation. Epidemics of typhoid fever have ceased to be regarded as "a dispensation of an all-wise Providence," for we have come to know that the presence of this disease usually means a contaminated water supply or imperfect sewerage. Scientific men have learned, too, how to check the ravages of yellow fever and cholera, and even consumption is found to be a preventable disease. To make these discoveries of practical use, however, this knowledge must be possessed by a large majority of the citizens in a community, and the most effective means of attaining this end is by educating the pupils in our public schools. With this object in view, in the Peter Cooper High School, New York City, we devote considerable time in the course in biology to the study of bacteria, yeast, and moulds.

In this study, it is necessary at the very first to impress the pupil with some idea of the omnipresence of these micro-organisms in everyday life; and for this purpose an experiment performed by the boy or the girl is always more telling than a talk by the teacher or a dozen pages of description. We begin with the study of a hay infusion. The work is done by each pupil at home, and the report presented at the next recitation. The following account is selected from the one hundred and fifty papers received from the first year pupils:

“STRAW INFUSION. I procured about a handful of straw at a livery stable and put it in a Mason jar three-quarters full of water, and put it in a warm place where the temperature was on an average of 75°, on Thursday, March 22. Its color was tan and the mixture smelt like musty straw.

“The 23d, temperature 73°, mixture getting darker in color, and smell becoming more noticeable. Saturday, temperature 74°. A thin scum is forming and small things are coming up from the bottom and straw. The smell is getting very strong.

“Sunday, temperature 74°, scum becoming thicker and bubbles appearing in it.”

Discussion and microscopical examination in the class room brought out the fact that the scum was composed of countless bacteria and other micro-organisms which had grown from the germs on the dried hay. The inference was drawn from the experiment that bacteria grow rapidly in a warm temperature, when water and organic matter are present, and that decay is one of the results of their activity.

The cultivation of bacteria in the laboratory was the topic next considered. Nutrient gelatin, the most useful medium in which to grow all kinds of bacteria, may be readily prepared in the laboratory or in the home kitchen. The ingredients necessary are the following: one pound of lean beef chopped fine (or better run through a meat cutter); 60 grams (2 oz.) of the best French gelatin; 6 grams (1-5 oz.) of peptone, which can be bought for 10 cents at any drug store; a teaspoonful of salt, and a little baking soda. Put the beef in a porcelain or agate dish, add a pint of cold water, and allow the mixture to boil slowly for a half hour. Strain the broth through muslin and then allow the liquid to run through filter paper. Pour in enough water to make the quantity of broth equal to about a pint and a half.* The gelatin, cut into small pieces, is then added to the broth, together with the peptone and salt. The mixture should be heated sufficiently to cause the gelatin to dissolve, but should not be allowed to boil. Just enough cooking soda is added to cause red litmus paper dipped in the mixture to turn blue, that is, the liquid should be faintly alkaline. Filtering the hot gelatin sometimes involves more or less difficulty. The process can be easily carried on, however, within a steam cooker. A glass funnel should be put in the mouth of a Florence flask (used commonly in a chemical laboratory) and one or two layers of absorbent cotton placed within the funnel. If the gelatin, flask, and funnel are kept hot within the cooker the liquid will readily pass through the cotton. After filtering, close the mouth of the flask with a plug of absorbent cotton, and boil for a few moments. The flask may be set aside as stock gelatin until needed for use. (If the gelatin mixture is not clear, it should be filtered through the same cotton a second time.)

Some of the liquid gelatin was poured into clean Petri dishes (Fig. 1), or test tubes plugged with cotton may be used. After the gelatin had solidified some of the dishes were opened to the air. Several days after this exposure the cultures were placed upon the desks of the pupils, and they were asked to make drawings of the bacteria colonies, and to answer certain

*This broth may be prepared more easily from Liebig's beef extract. Four grams should be dissolved in the pint-and-a-half (750 c. c.) of water, and the solution should be filtered through filter paper.



By Robert H. Whith cover.

March 1 Vol. 2.
Nov 1897

View of the Dactylus

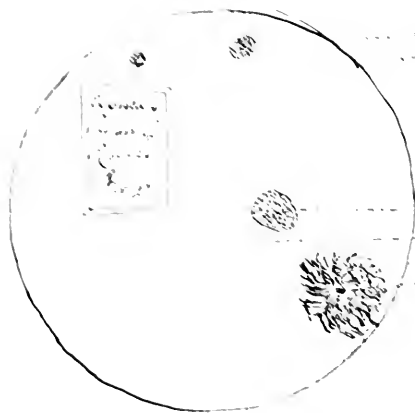

Column of dactylus (yellow)
Dactylus is not seen in section
(viewed, same)

Column of dactylus (yellow)
Dactylus is not seen in section
(viewed, same with flagellum
in center)

This dactylus has not been observed to remain in
contact with the host but has been observed in
sections of dactylus and in sections of the dactylus
in the presence of the host when the dactylus is seen in
section. Dactylus was studied in these same sections and in
some drawings showing the development of the dactylus. The
sections around these dactylus have been designated by the
section of the dactylus upon it.

Fig. 1

questions stated in the Laboratory Manual. One of the papers prepared during a recitation period is reproduced in Fig. 2. Figures 3 and 4 are drawings of Petri dish cultures made by two other pupils.

One of the boys, not satisfied with the amount of laboratory work given in school, prepared nutrient gelatin at home. He writes thus of his experiences:

"I took about a half pound of lean beef and after cutting into pieces placed in a pot and covered with water, then brought to a boil. I should also mention that I used a moderate fire so that the process occupied about twenty minutes. After obtaining my broth I added gelatin and brought again to a boil. Here I added some salt and carbonate of soda, after which I strained the broth through cotton into a sterilized bottle and corked.

"I experienced such trouble in clearing the gelatin of colonies that I finally melted the gelatin and poured it into test tubes and in them brought it to a boil with the result of one tube burnt and five cleared. In three of the tubes Mr. Peabody inoculated pure cultures; one of the tubes has produced a very large red colony, the others have not grown."

This laboratory work on the growth of bacteria was followed by an experiment performed at home by the pupils. One of the girls gives the following report of her work:

"THE STUDY OF BACTERIA IN MILK. I procured three bottles of about the same size. I then thoroughly cleansed each bottle before I used it. Two of the bottles had stoppers; the other had none. One of the bottles I half filled with good fresh milk, put the stopper on, and set it outside the window. I labeled this bottle 'No. 1.'

"Into the second bottle I poured about the same amount of milk, and set it aside in a warm temperature of about 70°. I labeled it 'No. 2.'

"The third bottle I cleaned in very hot water. I then boiled the same amount of milk that I put in each of the other bottles. I allowed it to boil for about three minutes. After the milk had cooled a little I poured it into the third bottle. I placed it beside bottle No. 2, and labeled it 'Sterilized Milk.'

"At the end of fifteen hours I examined each of the bottles. I noticed that No. 1 had very little smell at all. No. 2 had a sour like smell. It smelled as if the milk were turning. No. 3 had hardly any smell at all. If there was any smell at all, it was a sweet one. I now boiled the milk in No. 3 again. I first thoroughly cleansed the bottle and cork before I put the milk in. I then placed it beside No. 2, and put No. 1 again outside the window.

"At the end of twenty-four hours I again examined my bottles. I found that No. 1 had not any smell at all. No. 2 had a very decidedly sour smell, and No. 3 had a sweet smell.

"The changes in the milk are due to the growth of the bacteria from the air, or on the bottles, or the stoppers. As far as my experiment has worked I do not think a cold temperature kills the bacteria, but I think it numbs them. I think a boiling temperature kills the bacteria, and I think a moderate temperature increases the growth of the bacteria."

Successful microscopical work was done with magnifying powers of about 500 diameters. Pure cultures of spherical-, rod-, and spiral-shaped bacteria growing in test tubes of gelatin were supplied us by Dr. T. Mitchell Prudden of the

College of Physicians and Surgeons, to whom I am much indebted for help in this bacteriological work. Microscopical slides are easily prepared thus: Hold upside down the test tube in which bacteria are growing, and carefully remove the cotton from the mouth. Touch one of the colonies of bacteria with the point of a needle, and then rub the needle point on a clean glass slide; add a drop of water to the spot touched by the needle, cover with a cover-glass. Stains (Loeffler's methylen blue and Ziehl's carbol fuchsin) bring out more clearly the structure of the bacteria. Each of the thirty-five pupils in a division examined the stained bacteria, and watched under another microscope the motion of the living forms. One pupil's written account of this study is here given:

"MICROSCOPIC STUDY OF BACTERIA. 1. The bacteria which I saw under the microscope last Wednesday were of red and blue colors. This was caused by the coloring matter (stains).

"2. They were of three different shapes, round, pencil-shaped, and corkscrew.

"3. The bacteria which I saw to-day under the microscope are moving around.

"4. There were also under the microscope egg-shaped animals which were moving around." (This slide was prepared from the hay infusion and contained infusoria.)

A little mathematical problem worked out by each student helped to make real the rapidity of multiplication among these micro-organisms. The pupils were told that a rod-shaped bacterium, when conditions are favorable, divides in about an hour to form two bacteria. The problem was stated something like this: Suppose we start with a single bacterium this morning at 10 o'clock; if conditions are favorable, how many cells would be seen at 11 o'clock? The answer was "two." Between 11 and 12 o'clock each of the two would divide to form two; hence at 12 o'clock it was evident that there would be four bacteria in place of the single cell at 10 o'clock. The pupils, continuing the calculation, found that if the process were to go on until 10 o'clock the next morning, the original bacterium would give rise to 16,776,216. The completion of this calculation for a second day's crop of bacteria was not attempted for obvious reasons.

Thus far the experiments and discussions had made real to the pupils the existence of countless millions of micro-organisms. They had learned something of the form, size, and motions of the individual bacteria; and they had become acquainted with some of the results of their activity in causing decay, in souring milk, and in producing colors.

Some of the conditions which tend to check the growth of bacteria were learned from the milk experiment performed at home. A laboratory demonstration developed this subject still further. One of the boys described the experiment thus:

"STERILIZATION. Mr. Peabody took three test tubes and inoculated some of the bacteria from the hay infusion. The first test tube contained nourishment in a solid form (nutrient gelatin), and after the bacteria had been inoculated it was set aside. The second test tube was prepared the same way, but Mr. Peabody poured some corrosive sublimate over the surface of the gelatin. The third test tube was prepared in the same way as the first, but was put in the (steam) sterilizer for five minutes, and then set aside.

The Study of Bacteria

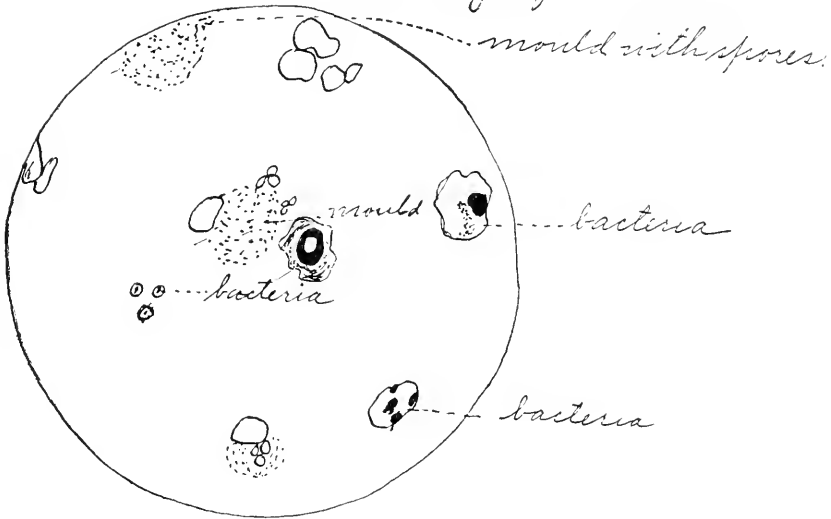

Fig. 3.

Study of Bacteria.

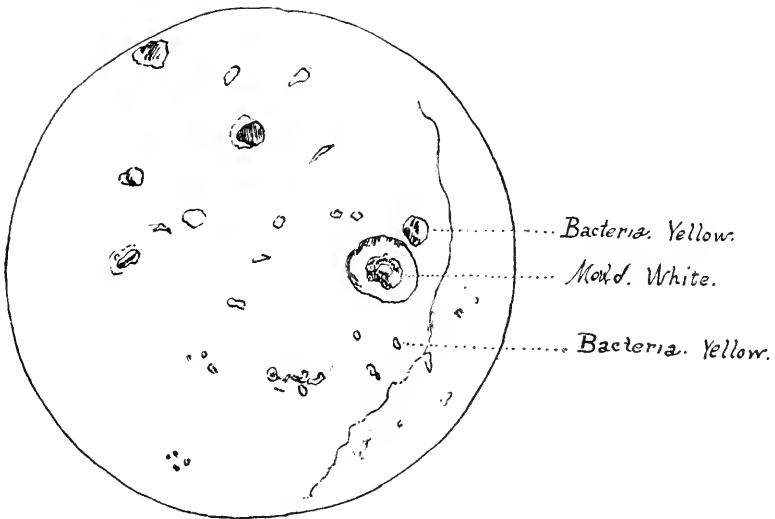

Fig. 4.

“At the end of five days we examined the tubes and found that the two tubes, one sterilized by heat and the other by poison, were perfectly clean, while the other had a large colony growing. From this I infer that corrosive sublimate and the heat killed the bacteria.”

We are fortunate in possessing a hundred copies of “The Story of Bacteria” and a like number of “Dust and its Dangers” by Dr. T. M. Prudden. These books were loaned to the 192 pupils who were studying the subject, and about one-fourth of the chapters were assigned for text-book lessons. One may judge of the interest in this study by the following figures: When the books were returned it was found that 103 pupils had read the whole book; that the books had been read by 197 parents or friends of the pupils; and that various topics in bacteriology had been discussed in over half of the homes.

The practical applications of the subject were brought out in discussion of a list of questions from which the following are selected:

1. From all your experiments state—
 - a. What conditions seem to favor the growth of bacteria?
 - b. What conditions seem to hinder the growth of bacteria?
2. Why are fruits cooked before canning?
3. Why should fruit jars be filled completely before screwing on the cover?
4. Why is grass dried before putting it in the barn?
5. Why are milk, meat, etc., put in the refrigerator in summer time?
6. Why should the prohibition against spitting in public places be rigidly enforced?
7. Why should sweeping be done as far as possible without raising a dust?
8. Why are hard wood floors more healthful than carpets?
9. Why should the teeth be brushed often?
10. Why should the refuse be removed from the streets every morning early, especially in summer time?
11. Why should sink drains be carefully inspected?
12. Why should wounds be carefully cleansed and dressed at once?
13. Why are typhoid fever, diphtheria, and other infectious diseases often best treated in hospitals?

The tables of the New York Board of Health give figures and charts which serve to clinch the argument in favor of good city housekeeping. The pupils copied into their note-books the following figures giving the annual death-rate per thousand of the population in New York City, 1886 to 1896 inclusive:

| | |
|-----------------------------------|-------------|
| 1886, 25.99 | 1891, 26.31 |
| 1887, 26.32 | 1892, 25.95 |
| 1888, 26.39 | 1893, 25.30 |
| 1889, 25.32 | 1894, 22.76 |
| 1890, 24.87 | 1895, 23.11 |
| 1896, 21.52 (first part of year). | |

There was little need to suggest that the sudden decrease in death-rate in 1894 and in succeeding years was doubtless due in no small measure to the efficiency of the Street Cleaning Department organized and directed by the late Col. Waring.

After reading Dr. Prudden's books, and after class-room discussions, each pupil was asked to outline at home the arguments in favor of and against the bacteria. The case is stated thus in one of the papers:

"BENEFITS OF BACTERIA TO MANKIND. They construct food-stuffs for plants out of the nitrogen gas and the solutions absorbed from the soil.

"They ripen the cream before churning and thus form butter.

"They give flavor to butter.

"They are an absolute necessity in making cheese.

"In making vinegar from cider, yeast and bacteria work together.

"Bacteria perform a very necessary work in the process of 'retting' flax in the linen industry, without which we would not have our fine linen and delicate laces.

"Bacteria play a prominent part in the curing of tobacco.

"Sprouting of seeds is promoted by bacteria.

"Streams and lakes are cleared by bacteria.

"They decompose dead animals into the dust from whence they came.

"THE WAYS BACTERIA PROVE TO BE 'MAN'S INVISIBLE FOES.' Bacteria cause the diseases, consumption, typhoid fever, scarlet fever, pneumonia, leprosy, lock-jaw, influenza, cholera.

"They cause blood poisoning.

"They destroy foods."

The primary aim of these eight lessons in bacteriology, as already stated, was a practical one, namely, to present to the boys and girls of our city a most telling argument for cleanliness in the care of the home and in the care of the city. The colored charts portraying the cases of consumption in the region of Mott street and of diphtheria in the Tenth and Twelfth wards will not soon be forgotten. Hence the New York of to-morrow will doubtless number among its citizens at least a few more staunch supporters of an efficient Board of Health; a few more homes will probably be free from the danger of disease contagion, and a few more house-wives will exercise greater care to secure abundance of light and of fresh air in their homes and to select and prepare nutritious foods.

The treatment of the subject, however, was not allowed to leave in the minds of the pupils the lasting impression that we have discovered in bacteria an omnipresent and well-nigh omnipotent enemy. They were led to see that consumption, cholera, typhoid, and all the other diseases charged to these micro-organisms are due to the ignorance or carelessness of man, and that these diseases can be prevented. While, on the other hand, they learned that the bacteria are toiling incessantly to clear our earth from the debris of decay, and to prepare the soil and the air for the growth of the higher plants. Thus this study becomes a part of the great study of biology, and in this fact lies the deeper interest of the subject. In the hay infusion all the functions of living nature are in full operation. There one may study assimilation, oxidation, respiration, excretion, the life and death struggle for food, reproduction, and even something akin to sensation; for who of us, after an hour at the microscope, watching the varying movements in this world of micro-organisms, is prepared to deny absolutely all sentient impressions even among bacteria? Biological study of this sort should

not only result in more healthy bodies for our pupils and in a more healthful community, but it should contribute largely to broaden and deepen the mental life of the student.

JAMES E. PEABODY.

The Peter Cooper High School, New York City.

Biology Wall Charts.

"A Method of Making Biology Wall-Charts," by F. D. Heald of Parsons College, Fairfield, Iowa, published in the *JOURNAL OF APPLIED MICROSCOPY* for November, 1900, induces me to speak of a method of chart making which I have adopted with considerable satisfaction, to myself at least.

The method is not original with me, but was suggested by Prof. H. P. Johnson of the University of California. My charts are made of material such as is used by "millers" for the manufacture of flour sacks. It is well known that this sack muslin has incorporated in the meshes of the cloth a filling of paste material which renders the surface smooth and very suitable to draw upon. Instead of a pen I use an ordinary paint brush of suitable size and shape. My pigments are such as painters use for the ordinary canvas advertising streamers and are procured ready mixed at the paint shop at a cost of a few cents. With these materials, charts of all sizes, colors, and kinds may be readily made. I find these "home-made" charts more satisfactory in my classes than any others that I have heretofore used, as there can be represented upon them exactly what it is wished to illustrate. These charts are so inexpensive and so easily made that any school may provide itself with a sufficient number for illustration in Physiology, Zoölogy, Botany, and other subjects. As they are made in water-colors, when not in use they should be kept in a dry place.

ORSON HOWARD.

University of Utah, Salt Lake City.

Staining in Toto with Delafield's Haematoxylin.

The stain is prepared according to the method found in Huber's "Directions for Work in Histological Laboratory," p. 153; except that, before using, it is diluted with an equal amount of distilled water, instead of five to ten times with water, as according to the directions.

The specimens, which should not be of too great size—not more than one-fourth inch in thickness—are left in the stain five days. After rinsing in water they are decolorized for two hours in acid alcohol made as follows:

| | |
|-------------------------------|----------|
| Hydrochloric Acid, | 1 part |
| Alcohol, 96 per cent. | 70 parts |
| Water, | 30 parts |

They are then washed in running water for at least two hours to remove all the acid. Dehydrate, and imbed in paraffin.

NEWTON EVANS, M. D.

American Medical Missionary College.

Journal of
Applied Microscopy
 and
Laboratory Methods.

Edited by L. B. ELLIOTT.

Issued Monthly from the Publication Department
 of the Bausch & Lomb Optical Co.,
 Rochester, N. Y.

SUBSCRIPTIONS:

One Dollar per Year. To Foreign Countries, \$1.25
 per Year, in Advance.

The majority of our subscribers dislike to have their files broken in case they fail to remit at the expiration of their paid subscription. We therefore assume that no interruption in the series is desired, unless notice to discontinue is sent.

demonstrated indisputably their ability to cope with problems of the greatest practical and economic value. Industrial progress is more and more dependent upon the results of their labors.

The policy of our government has always been to support liberally men and institutions which undertake to promote the welfare of the people; and yet we must admit that we have not met our highest possibilities, for we have but to look to certain other progressive nations to see points wherein we can make decided improvement. It is no longer a theory that governmental support of scientific work pays in every sense of the word, for Germany has long since demonstrated it to be a fact. Her scientific instruments have been brought to the highest degree of perfection, by coöperation with individuals capable of improving them, and through them her industrial progress has been most advanced. "Made in Germany" has been a key to every market in the world. This development must be attributed to the coöperation of science and government; a condition of mutual support, toward which our own country is rapidly trending.

The work accomplished by our science departments and bureaux is only the preface of what may be expected in the near future. Nation, state, university, and individual are forming one great combination for the pursuit of pure and applied science. In this coöperation the needs of science will be largely brought to light by individuals who are actually engaged in the work. These needs must be met by the institution, state, or nation in whose interest the individual pursues his investigations.

There are now needs which handicap our progress and place us at a disadvantage in the competition with other nations. Governmental coöperation in the development of the methods of chemical glass, and many other manufactures, and in the standardizing and control of apparatus used for weighing and measuring, together with the adoption of the metric system of weights and measures, would produce practical results.

Scientific men have adopted the metric system in their work. The industries, recognizing its advantages, do not wait for the adoption of the system by the government, but are rapidly introducing it into their various calculations.

"MEN of science form, as it were, an organized army, laboring on behalf of the whole nation, and generally under its direction and at its expense, to augment the stock of knowledge as may serve to promote industrial enterprise, to increase wealth, to adorn life, to improve political and social relations, and to further the moral development of individual citizens." The full significance of these words, written by Helmholtz nearly half a century ago, is now only beginning to be fully appreciated. Scientific men, in spite of the old popular idea to the contrary, have

CURRENT BOTANICAL LITERATURE.

CHARLES J. CHAMBERLAIN.

Books for review and separates of papers on botanical subjects should be sent to Charles J. Chamberlain, University of Chicago, Chicago, Ill.

REVIEWS.

Juel, H. O. Beiträge zur Kenntniss der Tetradenbildung. Jahrb. f. wiss. Bot. **35**: 626-659, pls. 15-16, 1900.

This important contribution really consists of three distinct papers, which can be considered separately.

I. Tetrad formation in the ovule of Larix.

The homologies between the reproductive organs of the vascular cryptogams and the phanerogams have long been known in their grosser features. The pollen chambers in the anther are microsporangia and the pollen grains are microspores. The ovule is a modified megasporangium and the embryo-sac is a megaspore; but while it is accepted that the pollen grain, like the spore of a vascular cryptogam, arises by a tetrad division, it is generally believed that the embryo-sac is formed without a tetrad division.

Dr. Juel investigated the ovule of *Larix sibirica* from an early stage in the development of the mother cell of the megaspore up to the beginning of endosperm formation. The paper is of particular interest because it is the first to treat this portion of the life history of a Gymnosperm from the standpoint of modern cytology.

In material collected about the middle of April, before the snow had disappeared, the mother cell of the megaspore was easily distinguished by its large size and by the abundance of starch which it contained. The first division is heterotypic and shows the reduced number of chromosomes (12). At the poles of the spindle are granular masses which may possibly represent centrosomes. During the anaplaste the starch disappears, a cell wall is formed and each of the daughter nuclei divides again by a homotypic division and thus gives rise to a row of four megaspores, the lowest of which germinates and produces the prothallium.

By comparing these series with the development of the microspore from the mother cell, which has already been thoroughly studied in *Larix*, Prof. Juel comes to the conclusion that the two series are homologous, the megaspore arising like the microspore by a tetrad division. While this conclusion is not new, the evidence supporting it is a real contribution.

II. The tetrad division in a hybrid plant.

It has long been known that hybrids are generally sterile, and it has also been known that the pollen of hybrid plants is commonly imperfect. The present writer investigated the formation of the tetrad in *Syringa rothomagensis*, a hybrid between *S. persica* and *S. vulgaris*. The form did not prove to be a favorable one for such a problem, because the pollen of both parents is poor, in *S. vulgaris* about 50 per cent. of the pollen grains appearing to be incapable of

functioning, and in *S. persica* normal pollen grains being quite rare. The latter form is almost as sterile as the hybrid.

In all three forms the development is normal up to the formation of the pollen mother cells. In the hybrid *S. rothomagensis* it was found that while most of the divisions in the pollen mother cells were mitotic, there were also numerous cases of amitotic division, and abnormalities in the chromatin and in the achromatic figure were frequent.

III. *The development of the pollen grain of Carex.*

As a rule the pollen mother cell of a flowering plant gives rise to four pollen grains, but it has been reported that in the Asclepiadaceæ and Cyperaceæ the mother cell gives rise to but one pollen grain.

A careful examination of *Carex acuta* gave the following results: The wall of the pollen mother cell becomes the wall of the pollen grain. The tetrad divisions take place, but the walls separating the four cells are imperfect and only one cell of the tetrad develops into a pollen grain, the other three being crowded out, just as in the megaspore series three potential megaspores are crowded out by the one functioning megaspore.

C. J. C.

Dixon, H. H. On the first mitosis of the spore mother cells of *Lilium*. Notes from the Botanical School of Trinity College, Dublin. No. 4, pp. 129-140, pls. 7-8, 1901.

The author states very clearly the points in regard to which there is essential agreement among cytologists,

and outlines the debated questions. While admitting that there is still ample room for dispute, he concludes that in both the first and second nuclear divisions by which the spores are formed from the mother cell, the splitting of the chromosomes is longitudinal and that, consequently, there is no reducing division.

C. J. C.

Holm, Theodore. *Erigenia bulbosa*, Nutt. A Morphological and Anatomical Study. Am. Jour. Sci. IV. II: 63-72. 6 figs.

Mr. Holm, who has done more than any one else in this country on the minute anatomy of plants, presents in

his latest paper some interesting morphological and anatomical facts on this unique plant. The *Erigenia* possesses a single cotyledon. The blade of the cotyledon is held in a horizontal position and raised above the ground by a long slender petiole. In the second year after germination the first proper leaf appears and has a ternately decompound leaf, with divisions of the same shape as those of the mature leaf. The third year's growth is not much advanced as only a single green leaf is developed with a few additional divisions. The *Erigenia* germinates then with only one cotyledon.

The tuber as it appears during the seedling stage, as Holm has shown from anatomical considerations, is a swollen part of the primary root.

The structure in fully matured specimens is very different, and here is what the writer says concerning this:

"The mature tuberous root possesses a number of cork-layers, a secondary bark of very considerable width, filled with starch, and inside the bark is a band of collateral mestome-bundles with cambium between the leptome and hadrome and besides well defined strata of interfascicular cambium, while a broad pith

occupies the central portion of the root, of which, however, the innermost part is broken down into a cavity; thus the principal features of the primary root are almost totally obliterated. Oil-ducts are quite numerous in the mature root; they are located in the same radii as the mestome bundles and occur in four or five concentric bands. The innermost oil-ducts are to be seen in the leptome itself, the others some distance apart, the outermost being very near the periphery, though not in contact with the cork. It appears as if the ducts of the outermost two bands are mostly pentagonal in transverse sections; while those of the inner are rhombic and somewhat narrower in circumference."

There are thirty-eight oil-ducts in each mericarp in each fruit, twelve on the commissural side, one outside each of the five mestome bundles, and from five to six in the intervals between these. The mericarps are not glabrous, but hairy, consisting of short unicellular pointed hairs which cover the entire dorsal face.

Agri. College, Ames, Ia.

L. H. PAMMEL.

CYTOLOGY, EMBRYOLOGY, AND MICROSCOPICAL METHODS.

AGNES M. CLAYPOLE.

Separates of papers and books on animal biology should be sent for review to
Agnes M. Claypole, Sage College,
Ithaca, N. Y.

CURRENT LITERATURE.

- Prenant, A.** Cellules Trachéales des Oestres. Material used for this investigation was taken, living, from the stomach of the horse, and consisted in larvæ of the bot-fly (*Gastrophilus equi*). Examining these larvæ an area of red coloration is always seen at the posterior extremity of the animal. On dissection two bodies are found, one on each side of the digestive tube, which are white and opaque in their anterior three-quarters, and lobulated in structure. In the posterior part they are more granular, and of a reddish color, varying to a purple-red. This part of the organ is provisionally called the "organe rouge." This organ is found to be composed of a number of large oval cells, surrounded thickly by tracheæ, which branch and finally enter into the interior of the cell. Such cells are called "tracheal cells" to distinguish them from the fat cells of the anterior part of the organ. Besides using fresh material, organs were fixed in Flemming's stronger solution; Mann's fluid (picric acid, sat. sol., 10 pts.; sublimate sat. sol., 10 pts.; formol, 5 pts.); formo-picric sol. of Bouin (sat. sol. picric acid, 75 vols.; formol 25; glacial acetic acid, 5 pts.); platinum mixture of Bouin (platinic chloride of 1 per cent. sol., 10 pts.; sat. sol. picric acid, 20 pts.; formol, 10 pts.; or platinic chloride of 1 per cent. sol., 20 pts.; sat. sol. of sublimate, 20 pts.; formol, 10 pts.; acetic or formic acid, 2 to 5 pts.); Weigert's neuroglia fluid, consisting of 5 per cent. sol. of acetate of copper, 5 per cent. acetic acid, chrome alum 5 per cent., and 10 per cent. formol; saline saturated sublimate solution; Golgi's fluid.

Of these the formo-picric of Weigert, and Flemming's, gave the best results. The stains used were Benda's safranin and light green, Flemming's triple safranin-gentian-orange, Mann's blue of toluidin-eosin; especially good results were given by Heidenhain's iron hæmatoxylin after the picric-formol fixative. All sections were cut in paraffin. The author summarizes his results as follows: As before stated, there is present in the larvæ of *Gastrophilus equi*, Fabr. or *pecorum*, Fabr. but not in those of *Hypoderma bovis* L. and *Cephalomyia ovis* L., an organ occupying the posterior fourth of the animal, having a characteristic red color. This organ has anatomical continuity with the fat body. It is composed of large cells, between which the tracheæ branch and subdivide. The smallest branches penetrate to the interior of these "tracheal cells." Nothing further could be observed as to the ends of the branches beyond fine subdivision. The cytoplasm of the cells is distinguished from the tracheal branches by the different form and stain affinity of its filaments, which come into close relation with the walls of the tracheæ, but do not represent the fine continuations of these tubes. These tracheal cells pass gradually over into adipose cells in the transition region of the organ. This transition is effected by filling the tracheal cell with fat globules and the reduction of the intracellular trachea. Independent of this tracheal organ, certain irregular subcutaneous tracheal cells are found in certain regions of the body. The reason for this specialization is considered to lie in the peculiar habitat of the larvæ, since closely related forms living under different conditions show no such structures. It is an example of limited adaptation. Physiologically, the function of these cells is respiratory, and hence the cells are really "œnocytes," differing however from the latter in a red instead of a yellow coloration. The transformation of these tracheal cells into fat cells argues for their "œnocytic" nature, and they represent the first step in respiratory differentiation. They are abundantly supplied with oxygen, and in consequence easily elaborate fatty granules; hence the functions of the two parts of this organ are not distinct, but successive.

A. M. C.

Zollikofer, R. Kammerfärbung der Leucocyten. Zeit. f. wiss. Mikros. u. f. Mik. Techn. 17: 313-321, 1900.

In the study of leucocytes two objects are in view, the fixation of the whole mass of them and the differentiation of

this mass into its different kinds. In order that the study may be done in a counting chamber, it is necessary to mix the blood and the staining fluid, and to have this mixture take place in one pipette. To determine the numerical relations of the different kinds of leucocytes on a cover-glass preparation is impossible, since there is an unequal distribution of the kinds. Lymphocytes are found in thick places of the film, and are rare or crushed in thin places. No such objection can be made to a film of blood in a counting cell. The thing needed was a diluting fluid for this "staining-chamber" which would render the red corpuscles invisible and stain the white differentially. Thin aqueous formalin solution answers the first requirement, and for a stain a mixture of eosin and methylin blue (eosin W. G. and methylin blue B. x. of Grübler, Leipzig) was most satisfactory in the following composition: Eosin W. G. 0.05, concentrated formalin 1.0, distilled water 100.00; methylin blue 0.05, concentrated formalin 1.0, distilled water 100.00. These solutions must be filtered; the

formalin mixture needs to be kept in the dark, and a dark glass dropper was used. About equal parts of the two liquids were taken. A Thoma-Zeiss pipette was filled with blood to 0.5 mark, and filled to 1.20 with the mixture; 1.10 does not completely destroy the red cells. After five minutes, the chamber is filled from the pipette, and the white cells are allowed to settle. Then the blood plates are found to be arranged in characteristic masses, and stain a light gray-blue; the erythrocytes are destroyed; nucleated red cells are sometimes recognizable by their greenish "discoplasm." Malaria plasmodia stain blue, but their recognition is uncertain. Leucocytes are stained as to both nuclei and granules. Eosinophil granules are clearly outlined, and the nuclei remain bright. Neutrophil granules are gray-violet. Most cell granules are unstained. The mononuclear or ungranulated, leucocytes of normal blood are homogenous, with faintly blue cytoplasm and varying nuclei. Nuclei of the larger lymphocytes are clearer, and light violet, the others bright blue and oval. The nuclei of granulated leucocytes stain lightly. The granulated mononuclear, or "Mark" cells, are conspicuous by their size and varying form of nuclei. These are principally recognized by their granules and the size of the nucleus. For a counting chamber, Elzholtz's (Reichert) was used. This has a capacity of 0.9 cubic millimeter. The blood is diluted twenty times, and the whole field is counted. The contained number is multiplied by $\frac{200}{9}$ or 22.222. Many cover-glass stained preparations were also studied. Preparations were stained for a few minutes in eosin, and for half a minute in methylen blue diluted five times with water. Careful fixation is necessary for good results in staining; heating in a hot chamber at 115° for an hour, or for a few minutes at 120—125°, gives good results for both red and white cells. The triacid stain was used when it was desired to stain the neutrophil granules. The mixtures given above afford excellent results not only on blood but also on sputum, pus, and other secretions.

A. M. C.

Lewinson, J. Zur Methode der Fettfärbung
Zeitschr. f. wiss. Mikros. u. f. Mikr. Tech.
17: 321-326, 1900.

Osmic acid is the usual fixation and staining fluid for fats, but it has several disadvantages. It is expensive, it fixes

but a small part of the tissue put into it or any of the liquids in which it is an active agent. Any fat near the middle of the tissue remains unfixed and unstained. The stain of osmic acid is very often of short duration, and it is almost impossible to use other stains after this fixative. Experimenting on myelinic fibers, a hæmatoxylin method of Wolters' was used. By modifications it was found that other tissues than myelinic fibers took this stain. The author tried concentrated nuclear stain, warmed, after definite fixation methods, to see if any result in staining fat could be obtained. A concentrated solution of methylen blue in 2 to 5 per cent. salt solution, and hæmatoxylin in acetic acid, were first tried on objects fixed in different fluids. Celloidin sections of the ovary of a rabbit fixed in picric acid were stained in such a warmed solution of methylen blue as described above for 10 to 15 minutes. After decolorizing with weak aqueous hydrochloric acid and counterstaining with alcoholic picric acid, the following results: Nuclei of the cells are blue, protoplasm yellow-green, and the connective tissue is violet. The fat in the follicles takes the form of small, dark, almost black fat-corpuscles. For a modification of Wolters' method the

tissues are fixed in Müller's fluid; the object can have a large surface, but should not be thick. From the fixation fluid the tissue is put into 70 per cent. alcohol, as treatment with weak alcohol and water renders the fat unstainable. The celloidin sections are put in the stain for twelve hours at a temperature of 40°C. A 2 per cent. solution of Kultschitzki's hæmatoxylin (hæmatoxylin 2 gms., dissolved in a little absolute alcohol added to 100 c. c. of 2 per cent. acetic acid). When the mixture, which is at first yellow, becomes red, it is ready for use. The principal point is good decolorization, only well bleached preparations show the fat clearly. The whole process is as follows: (1) Fix in Müller's fluid 2 to 6 weeks, depending on the size of the object; wash out in 70 to 85 per cent. alcohol, etc., imbed in celloidin. (2) Cut sections 10 to 15 mikrons thick, and put them directly from alcohol into the stain for twelve hours at a temperature of 40°C. (3) Wash out with water. (4) Wash in a 1 per cent. solution of potassium permanganate 10 to 15 minutes. (5) Wash in water. (6) Treat with a 2 per cent. solution of oxalic acid, or a mixture of two parts of 2 per cent. oxalic acid to one of 2 per cent. solution of potassium sulphate, for five minutes. Should the preparation show a yellow or gray-black color, return it to the potassium permanganate, then pass to the oxalic acid. If no fat is present the sections lose their color entirely; if fat is there the sections are light ash-gray to an intense gray-violet, depending on the amount present. In this way fat is shown on a colorless background in gray-violet fat globules. If it is desired to stain the nuclei and protoplasm of the cells, a counterstain of concentrated carmin solution may be used as follows: (1) The sections decolorized in oxalic acid are washed in water and left in an ammoniacal solution of borax carmin for twenty-four hours. (2) Treated in acid alcohol (1 per cent. in 70 per cent. alcohol) for two minutes. (3) Sat. alcoholic sol. of picric acid for one minute. (4) 85 per cent. alcohol, absolute, xylol or origanum oil, balsam. The fat is now dark blue, almost black; nuclei, red; protoplasm, yellow. This method is valuable for four reasons: (1) Fat is clearly differentiated to the smallest particle. (2) This fat-stain is very lasting; preparations remain good for several months. (3) Müller's fluid is an easily available fixation fluid. (4) The method is both inexpensive and simple, requiring no complicated technique.

A. M. C.

RECENT LITERATURE.

- Lavdowsky, M.** Ueber eine Chromsublimat-
verbindung und ihre histologische Anwendung, unter anderem auch zur Restauration älterer Objecte. *Zeit. f. wiss. Mikros. u. f. Mikros. Technik.* **17**: 301-311, 1900.
- Weber, A.** Contribution à l'étude de la métamérie du cerveau antérieur chez quelques Oiseaux. *Archiv. D'Anat. Micros.* **3**: 369-424, 2 pls., 1900.
- Nicolas, A.** Recherches sur l'embryologie des Reptiles. Contribution à l'étude de la Fécondation chez l'Orvet. *Archiv. D'Anat. Micros.* **3**: 456-489, 1 pl., 1900.
- Goodrich, E. S.** Nephridia of Polychæta. *Quart. Jour. Micr. Sci.* **43**: 699-748, 6 pls., 1900.
- Yasuda, A.** Adaptation of Infusorians to Concentrated Solutions. *Jour. Coll. Sci. Tokyo.* **13**: 101-140, 3 pls., 1900.

NORMAL AND PATHOLOGICAL HISTOLOGY.

JOSEPH H. PRATT.

Harvard University Medical School, Boston, Mass.; to whom all books and papers on these subjects should be sent for review.

Bielschowsky and Plien. Zur Technik der Nervenzellenfärbung. *Neurologisches Centralblatt*, 19: 1441, 1900. Ehrlich and Lazarus introduced the use of cresyl-violet for staining the basophilic granules of mast-cells. Litten has used the same anilin dye for coloring the basophilic granules which are found in the red blood corpuscles in cases of anæmia. The writers of this article have found cresyl-violet a good stain for the chromophilic substance of the nerve-cells. They used chiefly the preparation which bears the trade name "cresyl-violet R. R."

In composition this new stain is probably related to methylen blue; in staining properties it resembles thionin or toluidin blue, but is superior to them, chiefly because the preparations are more permanent, and as dilute solutions are employed it is more economical. Another advantage, which the writers claim, is that the sections are never lost in the dilute transparent solution of cresyl-violet.

The best results were obtained with the following method :

1. Harden in alcohol or formalin.

2. Imbed in celloidin.

3. Stain in a thin aqueous solution of cresyl-violet for 24 hours. It is sufficient to add six to ten drops of a concentrated aqueous solution to 50 c. c. of water.

4. Wash quickly in water.

5. Dehydrate in a series of alcohols of increasing strength. The alcohol, by removing excess of color from the diffusely stained sections, differentiates the gray and white matter of the central nervous system.

6. Clear in oil of cajeput.

7. Xylol.

8. Mount in Canada balsam.

Equally good results are obtained after imbedding in paraffin. When a quick method is desirable, a concentrated solution of the stain may be used.

Cresyl-violet gives a metachromatic effect with amyloid, coloring amyloid substance bright blue, the remainder of the section violet. J. H. P.

Krompecher. Glandlike Carcinoma of Epidermic Origin. *Ziegler's Beiträge*, 28: 1, 1900. Krompecher describes a peculiar type of tumor of the skin, to which he gives the name "carcinoma epithelialeadenoides." He believes that the gross and histological appearances are sufficiently characteristic to establish it as a distinct group.

Braun, in 1892, studied this class of tumors, and regarded them as endotheliomata. Krompecher asserts that the diagnosis of endothelioma can be made only when the origin of the tumor-masses from the endothelium of the larger

lymph-spaces can be directly traced, or when the tumor is found in places, such as bones and lymph-nodes, where epithelium is lacking, and the structure of the tumor corresponds to that of undoubted endotheliomata. Braun did not fulfill these requirements of Krompecher. He based his diagnosis on the difference of structure as compared with ordinary epidermoid carcinomata; on the absence of epithelial pearls; and especially on the lack of any connection between the tumor and the skin.

Krompecher studied thirty-three cases. The tumors occurred on various parts of the body. By means of serial sections, he demonstrated the connection of these tumors with the surface epithelium, thus proving their epithelial origin. The striking feature of these tumors is their microscopic structure. While the epidermoid cancer is composed of the cylindrical cells of the stratum Malpighii, and of polygonal prickle cells, which by cornification give rise to epithelial pearls, the group of tumors under consideration is distinguished by the fact that only the cylindrical layer of the stratum Malpighii proliferates. The cells retain their embryonic character. The tumor consists of nests of high cylindrical cells, which stain intensely. There is no formation of epithelial pearls.

J. H. P.

Wright, J. H. A Case of Multiple Myeloma.
Trans. Assoc. Am. Phys. 15: 137, 1900.

Wright defines multiple myeloma as a primary neoplasm of the bone marrow, affecting chiefly the sternum, the ribs, the vertebræ, and the skull; the substance of the bone being more or less extensively replaced by the tumor tissue. The affection was first recognized by von Rustizky in 1873. It is a rare condition. Less than twenty cases have been reported. The association of albumosuria with multiple myeloma is an interesting feature, and an aid in diagnosis. In the case studied by the writer, the tissues were hardened in Zenker's fluid and in Flemming's solution. The sections were stained in various ways, but eosin and Unna's alkaline methylen blue solution, and fuchsin, either alone or in combination with aurantia, were found most satisfactory.

The tumor is chiefly made up of small cells closely crowded together. Most of the cells have all the appearances of plasma cells, except that the cytoplasm does not in all cases show a marked affinity for methylen blue, as does the typical plasma cell. Wright holds that these cells are plasma cells, and their deviations from the type of the parent cell are quite analagous to those seen in the cells of other neoplasms.

The author found that plasma cells are a normal constituent of the red marrow, and he concludes that the tumor arose from an abnormal proliferation of these cells. Hence his case of multiple myeloma is to be regarded as a neoplasm originating not in the red marrow cells collectively, but in only one of the varieties of the cells of the red marrow, namely, the plasma cells.

J. H. P.

GENERAL PHYSIOLOGY.

RAYMOND PEARL.

Books and papers for review should be sent to Raymond Pearl, Zoölogical Laboratory, University of Michigan, Ann Arbor, Mich.

Gamble, F. W., and Keeble, F. W. Hippolyte varians: a Study in Colour Change. Q. J. Mic. Sci. N. S. 43: 589-698, pl. 32-36, 1900.

This paper deals with the color changes shown by the prawn Hippolyte varians, which lives in shallow water clinging to

seaweeds and zoöphytes, in relation to different environmental conditions and to stimulation by light. It has been often noted that Hippolyte shows a very remarkable similarity in its coloration to its surroundings, and it was the purpose of the authors to determine under exact experimental conditions what the nature of these adaptive color changes was, and how they were brought about. As an introduction a description is given of the different natural varieties of this prawn and of the condition of the chromatophores associated with these varieties. Uniform brown, pink, red, and green adult specimens were collected, while among immature individuals "red liners," "black liners," "green liners" and yellow barred specimens were common. The "liners" are animals which are transversely striped with the color indicated. The pigments are contained in chromatophores which lie under the epidermis in the connective tissue and muscles and about the alimentary canal and blood vessels. The chromatophore itself consists of a central body from which diverge a number of fine, ramifying, hollow tubes. In these tubes and the central body are contained the pigments which give the color to the animal. There are three pigments, red, yellow and blue, and color changes are caused by the movement of these pigments in the tubes. There is a layer of chromatophores in the connective tissue just beneath the epidermis, the processes of which form a close meshwork about the clear transparent cells of the epidermis itself. To the combination of the three pigments in this epidermal meshwork is due the color of the animal as a whole. For example, in a green prawn the tubes of the meshwork are found to contain both yellow and blue pigment side by side.

The animal exhibits three sorts of color changes: (a) slow, sympathetic changes of color accompanying changes in the color of the weed to which the individual is attached; (b) rapid color changes caused by changes in light intensity; (c) periodic nocturnal color changes. (a) In regard to adaptive color changes in response to changes of the weeds, it was found that the animals were capable of only very slow sympathetic changes. The adaptations observed in nature are the result of the selection by the animal of those weeds whose color most closely matches their own. (b) The intensity of illumination has a pronounced effect on the color of the animals and this effect is produced in a very short time. In high light, or in low light scattered evenly from the surface of the containing dish, there is a retraction of the red pigment and an evolution of the blue and the yellow, producing a green coloration of the animal; while in low light absorbed by the walls of the vessel the red remains expanded. The color quality of the light has no effect on the color of the animal provided the

intensity remains the same. (c.) It was found that at evening the prawns change regularly and uniformly from their diurnal color to a deep, transparent blue. This blue color passes away in the morning and the diurnal color of the previous day reappears. This nocturnal change with its associated diurnal recovery is a periodic phenomenon. The nocturnal blue appears at certain intervals even if the illumination is kept constant for several days at a time, and on the other hand the recovery of the diurnal color occurs regularly in specimens kept in the dark during similar long periods. Blinded prawns exhibit the same periodicity. The general physiological condition of the animals is very different during the night and the day.

Other experiments showed that the condition of the chromatophores at any time is the result of impulses passing to them from the central nervous system. Color changes can be induced by a variety of stimuli such as temperature, chemicals, electricity, etc., which affect the nervous system. Removal of the eyes causes a change in the impulses going to the central nervous system and hence a change in the color. The nocturnal condition is a result of a periodicity in the action of the nervous system. The relation of the nocturnal color of these prawns to the color of deep sea animals is discussed.

This paper is an important contribution to the physiology of coloration. Unfortunately in the space of a brief review it has been impossible to do more than mention some of the most significant points in the great amount of interesting detail presented in the work. The admirably executed plates are a feature of the paper. The experimental methods described are numerous and valuable.

R. P.

Verkes, R. M. Reactions of Entomostraca to Stimulation by Light. II. Reactions of Daphnia and Cypris. *Amer. Jour. Physiol.* 4: 405-422, 1900.

The purposes of the investigation were to determine the relation between the rate of movement and the intensity of

light; to determine whether there is a reversal of the phototactic reaction of Daphnia and Cypris under certain conditions; and finally to study the effect of other stimuli on the light reactions. In regard to the first point it was found that Daphnia moved only slightly faster as the intensity of the light increased, while Cypris showed a still less definite relation between rate and intensity than Daphnia. No very conclusive results came from the experiments devised to test the question of reversal of phototaxis from positive to negative and vice versa. Daphnia usually gives a positive response which could be maintained indefinitely by changing the direction of the light. In some cases it was possible to change this positive reaction into a weak negative one by taking the animals up in a pipette as described by Towle (*Amer. Jour. Physiol.* 3: 345-365), but this result was not constant. The reverse change from negative to positive was not obtained, owing apparently to lack of negatively phototactic animals on which to experiment. In the case of Cypris, negative animals were made positive by contact with the sides of the pipette. Raising the temperature does not affect the phototaxis of these crustaceans. Sudden illumination of the animals from above in such a way that the directive influence of the light is excluded does not cause any change in the direction of swimming. In one set of experiments some strong HCl was put into the trough at the end nearest the source of light. The

animals swam towards the light until they encountered the acid solution, and then instead of turning back stayed there till they were killed. In conclusion the author gives a rather unconvincing answer to certain criticisms of his earlier work.

In the paper several useful pieces of apparatus for phototaxis work are described. The method of changing the direction of the light rays impinging on the animal without disturbing any of the other conditions seems especially valuable and will be described in detail. "A tin trough $8 \times \frac{1}{2} \times \frac{1}{4}$ inches (T) mounted on a wooden base was painted dead black; at either end of this trough a glass box, A, A', containing alum solution was placed. Screens, S, S', were arranged so that side rays and reflected light were cut off, and the trough was illuminated exclusively by rays parallel with its long axis coming through holes six inches high and two inches wide cut in the screens, S, S'. At either

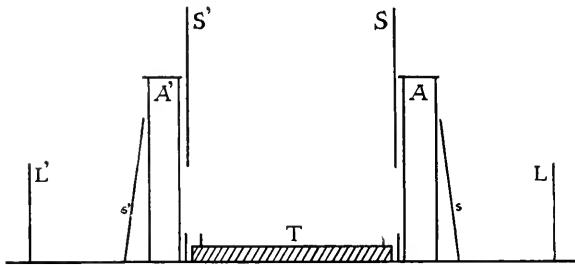

end, ten inches from S and S' respectively, was a Welsbach burner, L, L'. For observations this apparatus was set up in a dark room. After the trough had been filled with water and the screens s, s', which shut off all light, had been

placed in position, an animal was carefully dropped into the middle of T. One of the screens (s) was then removed and the animal responded usually with a + reaction,—it moved toward the end from which the screen had been removed, that is, toward the light. As soon as the animal came within two centimeters of the + end of the trough, s was quickly replaced and s' removed, thus giving light from the opposite direction without the inconvenience of moving the burner. By this means it could easily be observed whether the response was continued as before or reversed."

R. P.

Pütter, A. Studien über Thigmotaxis bei Protisten. Arch. Anat. u. Physiol. Physiol. Abth. Suppl. Bd. 1900: pp. 243-302.

The author deals in a thorough and exhaustive way with the effect of contact with solid bodies on the reactions of the Protozoa. After a brief historical introduction and description of methods employed, the reactions of a large number of Protozoa, including nearly all the main groups from the rhizopods to the hypotrichous ciliates, are described in detail. Positive and negative forms of thigmotaxis are distinguished according as the animal remains in contact with a solid body which it encounters, or moves away from it. The positive reaction displays two forms or factors. The first factor is the one which affects the locomotor organs (pseudopodia, flagella or cilia) and results in a lessening or inhibition of their movement. The second factor in the thigmotaxis is the secretion of a sticky slime which helps to fasten the animal to solid bodies. This secretion factor is very evident among the rhizopods, less apparent among the flagellates and ciliates where the first factor is most important, and finally it is the most essential phenomenon in the thigmo-

taxis of *Oscillaria*, diatoms and desmids, and the Gregarinidæ. It is evident that these phenomena of thigmotaxis are very important in the life of the Protozoa.

This importance is well shown by the effect of the thigmotaxis on the reactions to other stimuli. The other reactions studied were the electrotactic and the thermotactic. In regard to the electrotaxis it was found that among some of the ciliates, individuals which were kathodically electrotactic when swimming freely through the water, when in contact with a solid body (i. e., thigmotactic) oriented themselves more or less transversely to the direction of the current with the oral side of the body towards the kathode. This transverse orientation was investigated in a number of forms. It is evidently the same reaction as that which has been described by the reviewer (*Amer. Jour. Physiol.* 3: 96-123) and explained as due to the conflict between two sets of ciliary activities. It is now shown to be also in part the result of the thigmotaxis of the animal. The author confirms previous investigators as to the reversal of the cilia on the kathode side of the body during the action of the current. The permanent transverse electrotaxis of *Spirostomum* is thought to be a result of the thigmotaxis of the posterior end of the body. Professor Lœb's theory of the action of the external electrolytes in electrotaxis is thoroughly examined and strong evidence against it is presented. The effect of heat or cold is different according as the animal is, or is not, in contact with a solid body. Many forms (*Euglena*, *Chilodon*, *Stylonychia*, *Spirostomum* and others) cannot be made to leave the bottom by heating. They die while still thigmotactic.

The reactions of *Stylonychia mytilus* are described in more detail than those of any other form and some interesting curves are given showing the relative activities of the different groups of cilia at different temperatures. All the cilia show maximal activity at two widely separated temperatures (5-10° and 25-35°C.) while the minimal activity of all is between 15° and 20°C.

This excellent piece of work puts our knowledge of another of the reactions of the Protozoa on a firm basis.

R. P.

Delage, Y., and Delage, M. Sur les relations entre le constitution chimique des produits sexuels et celle des solutions capables de déterminer la parthénogénèse. *C. R. Ac. Sci. Paris*, 131: 1227-1229, 1900.

In this note are presented the results of some chemical analyses of the sexual products of the male and female in the sea urchin, *Strongylocentrotus lividus*. The

starting point of the work is the idea that if, as has been stated, it is the Mg-ion which causes the artificial parthenogenetic development of the egg, and if normal development is the result of the same sort of a process, analysis ought to show a greater proportionate amount of this salt in the sperms than in the eggs. This was not found to be the case. The magnesium content of the products of both sexes is essentially the same, so that normal fertilization cannot depend merely on the bringing of more of this salt into the egg by the sperm. This result in no way affects Professor Lœb's later views, which point to osmotic pressure as the essential factor in the production of artificial parthenogenesis.

R. P.

CURRENT BACTERIOLOGICAL LITERATURE.

H. W. CONN.

Separates of papers and books on bacteriology should be sent for review to
H. W. Conn, Wesleyan University, Middletown, Conn.

Jensen. Studien über die Enzyme im Kase.
Cent. f. Bac. II. 6: 734, 1900.

Babcock and Russell. Relation of the Enzymes of Rennet to Ripening of Cheddar Cheese.
Cent. f. Bac. II. 6: 817, 1900. (See also seventeenth annual report of Agri. Expt. Sta. of Wis.)

Babcock and Russell. Causes Operative in the Formation of Silage. Seventeenth An. Rep. of Agri. Expt. Sta. of Wis., 1900.

Behrens. Ueber die oxydierenden Bestandtheile und die Fermentation des Deutschen Tabaks. Cent. f. Bac. II. 7: 1, 1901.

The question whether various fermentative processes in nature are to be ascribed properly to the action of micro-organisms or to the action of enzymes, has, in late years, become a somewhat burning one with our bacteriologists and chemists. In large degree the question reduces itself simply to determining whether the enzymes, which are the direct cause of the action, are produced by bacteria or from some other source. The four papers here referred to discuss different aspects of this problem. It has been shown by Babcock and Russell that fresh milk contains an enzyme which they have named *galactase*. They believe that this enzyme, rather than micro-organisms, plays the important part in the ripening of cheese. The first of the articles here referred to contains an especially careful series of experiments to test this conclusion. As the result of a long series of most careful experiments, Jensen concludes, in brief, that in the ripening of soft cheeses the effect is produced. (1) by enzymes which are produced by yeasts and bacteria growing on the surface of the cheese; and (2) by enzymes in the center of the cheese which are not derived from bacteria growth, but rather from the rennet which was added to curdle the casein, the enzyme in this case being pepsin. The ripening of hard cheeses depends partly upon the action of an enzyme produced throughout the mass as the result of bacteria, and partly, especially in the early part of the ripening, upon the galactase, which, as Babcock and Russell have shown, is present in the fresh milk.

In the second article Babcock and Russell test, by an entirely different line of experiments, the question whether the pepsin present in the rennet has an important agency in the ripening of cheese. The conclusion they reached is essentially identical with that of Jensen, namely, that the ripening of cheese is dependent in considerable degree upon the pepsin present in the rennet. The agency of bacteria in the ripening of cheeses is not especially studied by these authors.

The third paper records a series of experiments to determine whether the production of silage is, as has previously been believed, the result of the growth of micro-organisms. The authors reached the conclusion that micro-organisms have nothing whatsoever to do with the production of normal silage. Both the initial heating and the subsequent ripening of silage are due to entirely different agents. The production of silage, the authors believe, is due, (1) to the

respiratory processes of plant tissues which continue for some time in the silage after the silo is packed, thus producing the initial heating; (2) to the presence of enzymes which are liberated from the plant cells after the death of the plant tissue.

Micro-organisms, the authors believe, only injure the silage and are of no significance in a properly constructed silo.

The paper by Behrens deals with the question of the fermentation of tobacco, which has been regarded as due to micro-organisms, but which Loew has somewhat recently insisted is the result of enzymes formed in the tobacco leaves. Behrens has tested Loew's conclusion and was able to isolate from the leaves of German tobacco the same chemical products referred to by Loew. After making a somewhat careful study of them and their action, he reaches, however, quite different conclusions from those of Loew. His conclusions are, briefly, that these bodies (oxydase, peroxydase) are formed in tobacco leaves. He is doubtful as to whether they are properly to be called enzymes, and is convinced from his experiments that they cannot be the cause of the tobacco fermentation, inasmuch as they disappear from the leaves before the important fermentation takes place. His experiments further show that these oxydases will not produce ammonia from nicotine, a phenomenon of tobacco fermentation which he attributes to bacteria. He finds, also, that micro-organisms will grow in tobacco when the amount of water is not over 25 per cent., contrary to Loew's claims, and is, therefore, convinced that the chief factor in the proper tobacco fermentation is due to bacteria growth rather than to these chemical bodies produced in the tobacco leaves.

H. W. C.

Harrison. Die Lebensdauer des Tuberkel-Bacillus im Käse. Landw. Jahrb. der Schweiz., 1900.

Harrison has experimented upon the length of time in which tubercle bacilli remain alive in cheese. His method of

experiment has been to inoculate milk with a considerable quantity of tubercle culture and then to make the milk into cheese in the ordinary fashion. At varying intervals the cheese was tested by inoculation into guinea pigs. These animals were studied both clinically and microscopically. He found that, in Emmenthaler cheese, the tubercle bacilli were dead at the end of 33-40 days, while in Cheddar cheese they might remain alive for 104 days. The conclusion is that neither of these cheeses is a source of danger to man, since they are seldom eaten until they are four months old, or even older.

H. W. C.

Lameris and Harrevelt. Bakterienbefund in Kuhnmilch nach algeheiliter Mastitis. Zeit. f. Fl. u. Milch Hyg. II: 114, 1901.

The authors made a study of the bacteria content of some cows' milk which had produced cases of diarrhœa.

Inspection of the source of the milk showed that some of the cows had formerly suffered from mastitis, but had apparently recovered. In the milk, however, there was present a species of streptococcus which is uniformly found and which is really the cause of the intestinal disturbance produced by the use of the milk. Inasmuch, however, as the milk produced these disturbances, even after boiling, and the streptococci were shown to be killed by this temperature, the authors conclude that the trouble arose from the toxins developed in the milk by the streptococcus rather than by the direct action of the organisms.

H. W. C.

Medical Notes.

THE EPILEPSY PARASITE.—The short paper published in the December number of the JOURNAL does not represent the present status of this parasite, and in justice to myself and the cause of science a little more should be said about it. That a parasite, represented in the cut accompanying the December article, is the cause of some forms of reflex epilepsy, is an undisputed fact. In the first case at Chester, Illinois, the boy was cured by the permanent removal of the parasite, and has remained cured. Three other cases are known to the writer where the parasite was found. Only one of these three was known to the writer in detail, and the removal of the parasites cured this case as in the first.

The parasite was found to be new to science, and a description of it was published in the September number, 1900, of the *Canadian Entomologist*, under the name of *Gastrophilus epilepsalis*. In the September number of the *Alkaloidal Clinic* of Chicago was published a more extended account of what was known of the three cases that had been found then. This article treated the subject more from a pathological standpoint than the article in the *Canadian Entomologist*. Since that, one other case has been found in Kentucky, where the parasite was connected with epilepsy.

The parasite, instead of being a Nematoid worm, is the larva of a fly, related to the horse bot-fly, *Gastrophilus equi*. The adult fly has not yet been recognized, nor has it been ascertained definitely how it first gains entrance to the system. In the investigation of this parasite, two other fly parasites infesting the human intestines have been found by the writer that the books do not tell us about, one a species of *Eristalis*, of the family Syrphidæ, and the other a species of *Sarcophaga*, of the family Sarcophagidæ.

I should like to get specimens of intestinal parasites, and have correspondence relative to the effect of such parasites on the system of the host.

Carbondale, Ill.

G. H. FRENCH.

Dr. Klett of Würtemberg has recently made important researches upon the phenomena of anaërobic life. In his investigations on the production of sporeless anthrax outside the living body, Dr. Klett found that if nitrogen is substituted for air in the anaërobic conditions, the growth of the organism is not impaired, and spores develop as freely as under ordinary conditions. If, however, hydrogen is substituted in place of air, no spores develop providing the medium is such as to permit intimate contact of gas with the culture. These results would indicate that absence of oxygen is responsible for non-production of spores in anaërobic cultivation of anthrax.

At a meeting of Pathologists and Bacteriologists in New York on January 26th, an American association was organized. The officers elected were: Dr. W. T. Councilman, president; Dr. H. C. Ernst, secretary; Dr. Eugene Hodenpyl, treasurer. The first regular meeting will be held in Boston on April 5th.

Journal of Applied Microscopy and Laboratory Methods.

VOLUME IV.

MARCH, 1901.

NUMBER 3

MICRO-CHEMICAL ANALYSIS.

XI.

AMMONIUM.

The salts of the radical NH_4 resemble so closely, in their behavior, those of the alkalis that it is more convenient to discuss ammonium in connection with the elements of Group I than under the head of Nitrogen.

As has already been seen from the preceding work, ammonium reacts with most of the reagents used for the detection of potassium, rubidium, and cesium. Hence it is usually not practical to test for ammonium directly in the substance. It follows, therefore, that it is generally necessary to first volatilize the ammonia and test for this substance after its separation.

Although the salts of ammonium are easily driven off by heat, any attempt to sublime them and then to test the sublimate will be found unsatisfactory. A far better plan is to expel the NH_3 by the action of an alkali and heat and to absorb the evolved gas in dilute acid. The method of procedure is as follows:

Place in a deep 25 mm. watch glass a tiny bunch of fibrous asbestos which has just been ignited to redness by being held, with the forceps, in the flame of the Bunsen burner. In the absence of asbestos, a tiny piece of thick filter paper can be employed, but in this case the paper must be tested for ammonia.

On the absorbent place a small amount of the substance to be tested and sufficient water to just thoroughly moisten the mass, but no more. Now add a fragment or two of sodium hydroxide so as to obtain an alkaline reaction. Invert over the watch glass thus prepared, a glass slide bearing at its center a minute drop of water acidified with hydrochloric acid.

Hold the watch glass thus covered (by grasping its edges between the thumb and fore-finger) over a small flame (see diagram, Fig. 39) so as to expel the ammonia. The heating is kept up until the slide becomes bedewed with moisture. Heating to boiling should be avoided, since in such cases there is danger of some of the contents of the watch glass spirting upon the slide.



FIG. 39.

Remove the slide from the watch glass and turn it over. Cause the condensed moisture to unite in one drop by stirring with a glass rod. This drop will contain the ammonia which has been expelled from the substance. The danger of a possible loss has been guarded against by the drop of dilute hydrochloric acid employed.

In order to test for ammonium in the drop thus obtained, it is only necessary to add a suitable reagent. Since it is extremely unlikely that any compound other than ammonium chloride is present, a number of methods are available. There are two, however, which will be found more satisfactory than the others.

I. Chlorplatinic Acid (Platinum Chloride).

II. Magnesium Acetate and Sodium Phosphate in alkaline solution.

In practice Method I is the most convenient, simple, and satisfactory.

It is essential that a blank experiment be always performed to ascertain whether the reagents employed are free from ammonium salts.

I. Chlorplatinic acid added to solutions of Ammonium salts precipitates Ammonium Chlorplatinite.

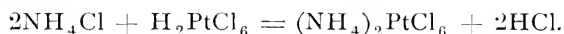

Method. Cause a drop of platinum chloride to flow into the drop obtained after the manner described above. In a few moments yellow octahedral crystals of $(\text{NH}_4)_2\text{PtCl}_6$ are obtained. These crystals resemble those of the corresponding potassium compound in size, form, and color. The reader is therefore referred to Potassium Method I, for a discussion of the appearance of the crystals and to Fig. 29 for a representation of their form.

Remarks. When much ammonium is present there is apt to be an immediate precipitation of the chlorplatinite in the form of very minute or skeleton crystals. It is then advisable to add a drop of water and recrystallize by heating. If, on the other hand, the amount of ammonium is small, no crystals will appear until the liquid has been concentrated by gentle heat.

II. The addition of Magnesium Acetate and Sodium Phosphate to alkaline solutions of Ammonium salts gives rise to the formation of Magnesium Ammonium Phosphate.

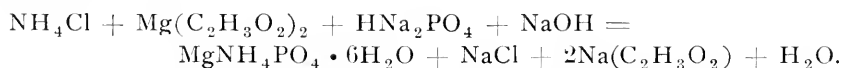

Method. To the test drop add a fragment of sodium phosphate and a very little magnesium acetate; stir thoroughly. Beside the drop, place a drop of a moderately concentrated solution of primary sodium carbonate (HNaCO_3) or of sodium hydroxide. Cause the drops to flow together. There is generally an amorphous precipitate immediately produced, which soon partly changes into star- and X-like crystallites, see Fig. 40. A little farther away, roof- and envelope-like crystals are obtained.

Remarks. In dilute solutions the Xs and stars are generally absent, being replaced by prismatic forms.

The crystals of magnesium ammonium phosphate belong to the orthorhombic system and have a great tendency to assume hemihedral and hemimorphic and skeleton forms.

Only very little magnesium acetate should be used since either a dense amorphous precipitate of magnesium phosphate will result, or if the conditions are favorable this salt will itself crystallize in star-like prism aggregates.

This method can be applied directly to the solution of the substance without the necessity of having recourse to the separation of the ammonia. When applied directly it is advisable to substitute sodium hydroxide for the carbonate. The objection to this procedure is that many elements are precipitated as phosphates in alkaline solution, and that magnesium hydroxide almost invariably separates as a flocculent mass.

Exercises for Practice.

Expel the ammonia from an ammonium salt by the method above described, and test by Method I.

Repeat, and test the drop by Method II. First employing primary sodium carbonate, then using sodium hydroxide.

Make a mixture of various compounds introducing a salt of ammonium. Test directly by II. Expel the ammonia and test by either I or II.

LITHIUM.

The element lithium can be considered as marking the transition between the alkalis on the one hand and the alkaline earths on the other, and is therefore a link between Groups I and II. Because of this—its peculiar behavior—lithium is worthy of a brief consideration, although it is so seldom that the chemist is required to test for its presence that it should properly not be considered in these articles.

The solubility of its sulphate and oxalate excludes its appearance in testing for calcium, strontium and barium; while its precipitation with ammonium (or potassium) carbonate and sodium phosphate brings it into close relationship with these elements.

With almost all the reagents used for Group I, as for example, chlorplatinic acid, potassium antimonate, tartaric acid, ammonium silicomolybdate, bismuth thiosulphate, etc., lithium resembles sodium in its behavior; yet on the other hand the fact that in rare cases phosphomolybdic acid may cause a precipitate and that hexagons are obtained with bismuth sulphate brings this element in close analogy to potassium.

Lastly, like magnesium, lithium forms a double ammonium phosphate of low solubility. Moreover, this salt is isomorphous with the magnesium ammonium phosphate. In this respect lithium resembles the magnesium group.

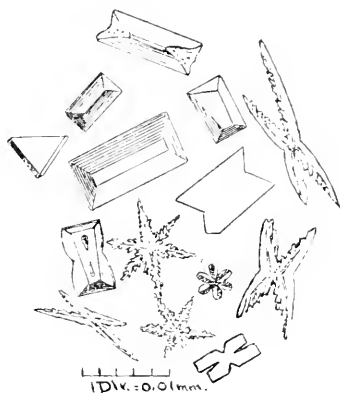

FIG. 40.

The microchemical detection of lithium is satisfactory only when this element is present in considerable amount and in quite simple mixtures.

At their best the methods are apt to prove unsatisfactory and require not a little care and experience.

Practically only three reagents are available; these are:

- I. Sodium Phosphate.
- II. Ammonium Carbonate.
- III. Ammonium Fluoride.

Only I and II will be described, since it is not advisable for the beginner to make use of fluorides, because of the great danger of corrosion of the objectives of the microscope.

I. Sodium Phosphate added to solutions of Lithium salts precipitates Lithium Phosphate.



Method. Allow a drop of a solution of sodium phosphate to flow into a drop of a moderately concentrated solution of the substance to be tested. Heat the preparation almost to boiling. An exceedingly fine crystalline precipitate is at once formed. Examined with a high power, this precipitate is seen to consist of strongly refractive lenticular and fusiform bodies either singly or arranged in cross-, star-, or dagger-like groups which are very characteristic of lithium (see Fig. 41). These crystals extinguish when their length lies parallel to the cross-hairs of the polarizing microscope. Globulites are also formed in abundance, which when examined between crossed nicols show the black cross of "sphero-crystals."



FIG. 41.

Remarks. The reaction should be performed in neutral (or slightly alkaline) solution. If acid, neutralize with sodium carbonate or sodium hydroxide. Since in the reaction an uncombined acid probably results, it is advisable to have a small amount of free alkali present, and in practice it is found that faintly alkaline solutions yield the best results. An excess of alkali is to be avoided.

If much sulphuric acid is present it is advisable to heat the material on platinum until most of the acid has been driven off, after which the residue is dissolved in water and the solution neutralized.

Elements of the calcium group can be advantageously removed by treatment with sulphuric acid or ammonium oxalate.

If much magnesium is present, globulites seem to predominate.

In the presence of ammonium there arises the possibility of the formation of a double phosphate $\text{LiNH}_4\text{PO}_4 \cdot 6\text{H}_2\text{O}$: hence if any ammonium salts have been employed in preceding operations, they should be removed by ignition before testing for lithium.

In testing mixtures, if in doubt as to the nature of the phosphate obtained, draw off the supernatant liquor, wash the precipitate, dissolve in dilute acid and

add ammonium hydroxide. If the precipitate was lithium phosphate no turbidity should result, while the alkaline earths are again precipitated.

II. Addition of Ammonium Carbonate to neutral solutions of salts of Lithium causes the separation of Lithium Carbonate.



Method. To the drop of the neutral solution, which should not be too dilute with respect to lithium, add a fragment of solid ammonium carbonate. After a short time there will appear near the circumference of the drop, globulites, bunches of needles and thin, more or less irregular plates and bristly masses (Fig. 42). The general appearance of these aggregates will vary somewhat with the concentration of the test drop.

Remarks. All substances forming difficultly soluble carbonates interfere.

The reaction requires care and experience in order that it can be made to always yield acceptable results.

Since the lithium carbonate separates only after some little time, there are apt to appear, almost simultaneously, crystals of other salts, particularly if the test drop contains sulphates.

In such an event add to the drop a little *dilute* alcohol; lithium carbonate will remain undissolved for some time, while the sulphates or chlorides of the other members of the first group will pass into solution.

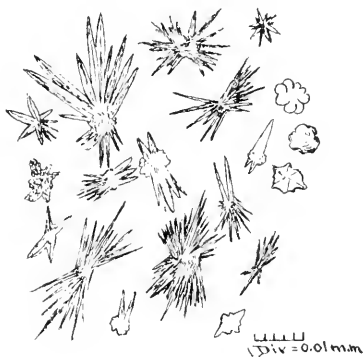

FIG. 42.

Exercises for Practice.

Try the above methods for lithium first on a simple salt of this element, then on mixtures of lithium and other members of its group, and lastly try mixture containing ammonium and others containing calcium, magnesium, etc.

EXAMINATION OF SUBSTANCES CONTAINING THE ELEMENTS OF GROUP I.

Ammonium is tested for in a portion of the material by expelling it in the manner previously given.

The material to be tested is brought into solution by any suitable means, not introducing alkalis.

If soluble in HCl, the solution of the chlorides is evaporated to dryness, and, if ammonium salts are present, the residue is ignited until all these salts have been driven off. The residue is extracted with absolute alcohol or with carefully purified amyl alcohol. The alcoholic extract is evaporated to dryness and the residue tested for the members of Group I.

When sulphuric acid has been employed, or if the substance contains sulphates, it is first necessary to convert the material into chlorides; this is accomplished by treating with barium chloride in sufficient amount to precipitate all the sulphuric acid and removing any excess of barium by means of ammonium

carbonate, carefully added. The turbid liquid is then either filtered, or, what is better, whirled in the centrifuge. The clear liquor is evaporated to dryness, the ammonium salts driven off and the residue extracted with alcohol or amyl alcohol.

Or, in the absence of sulphates, another method is open which avoids the use of alcohol. Treat the aqueous solution with ammonium hydroxide and ammonium oxalate, then add sufficient ammonium carbonate to precipitate the magnesium; separate the precipitate by filtration or by means of the centrifuge. Evaporate the clear liquid and ignite the residue. Treat with HCl, evaporate to dryness, and test the residue as given below. This method is open to a number of objections and is somewhat limited in its application.

Test a portion of the material with potassium chlorplatinate or ammonium silicomolybdate for Rb and Cs.

Another portion is treated with platinum chloride for K.

Sodium is tested for with uranyl acetate or, if thought to be in only small amount, with uranyl acetate and magnesium acetate. If much K has previously been found, either separate this element by the perchloric acid method, or test for Na at once with potassium antimonate or bismuth sulphate.

There now remains Li to be searched for. This can be done by any one of the three methods mentioned under the head of this element.

Cornell University, Chemical Laboratory.

E. M. CHAMOT.

Staining Sections for Class Work.

Being under the necessity of staining large numbers of sections of tissues sectioned in both paraffin and in celloidin, for class work, we have adopted the following methods for shortening the time and facilitating the technique.

The paraffin sections being mounted on cover-slips, and the paraffin removed by the usual method, they are placed in rows on a corrugated glass disc of a staining dish, the disc being provided with handles of wire, and resting in a dish of xylol deep enough to cover the sections. Upon this disc or tray the sections can be quickly transferred from one reagent to another, if necessary, allowing the disc to drain upon pieces of filter paper between the different reagents. In this way thirty or thirty-five sections can be stained in a very few minutes on one staining disc.

For celloidin sections, the reagents being in small, deep dishes, the sections are placed on a piece of copper or brass wire gauze, folded into the form of a cup, and resting in a dish of alcohol or water. By means of this porous cup the sections can be quickly transferred from one dish of reagent to another and easily drained; the number of sections that can be stained at once being indefinitely large.

NEWTON EVANS, M. D.

American Medical Missionary College.

Home Made Wall Charts.

I can vouch for the value of Professor Heald's method of making wall charts, described in the November JOURNAL, as many years ago, when connected with the State College of Iowa, I made some very serviceable charts in this way. I soon found that I could use a camel's hair brush for inking the pencil lines. After a little practice one learns just how rapidly the brush must be drawn over the surface to produce the right kind of a line, and to avoid spreading and blotting. I still have a few of these old muslin charts, which are as good as ever, after at least twenty years of service. One great advantage which such charts have over all others is that they may be folded into small, flat parcels, and tucked away in one's traveling bag, and not be any the worse for it, after an extended lecture trip.

Another method of making charts is one which grew out of the foregoing, and which I prefer for charts for hanging on the walls of the lecture room or laboratory, although less convenient for carrying about the country. I buy a roll of "opaque" curtain cloth, white or of a light shade, and about 100 cm. in width. This is cut into sections of the desired length, say $1\frac{1}{2}$ to 2 meters, and on these the desired figures are drawn. I buy one pound boxes of paints, ground and mixed, ready for use. In order to hasten the drying of the oily paint, I take out a little from the box, allowing the surplus oil to drain off, and then mix it with the proper amount of spirits of turpentine to make it flow readily from the brush. The figures having been traced in lead pencil, a good camel's hair brush is used in applying the paint. Since the curtain stuff is a kind of "filled" canvas, its surface takes the paint very easily, and there is no danger of its spreading. When the material is white, colored paints may be used to good advantage. I have been able to get good effects from the use of green, yellow, and brown paints of the quality found in the pound boxes mentioned above. Other colors, especially the reds, and the delicate shades of pink, lavender, gray, etc., are not as satisfactory with these coarser paints as with the "tube" paints, which I have used for finer work, as in cytological charts. For the charts made in black throughout, any good lampblack paint will prove satisfactory.

In mounting the charts, I have found that the best way is to use pairs of pine or whitewood "half round" strips of the proper length, clapping the end of the chart between the two, and fastening them together with small wire nails. They thus form a cylindrical roller at each end, and the cloth is fastened much more securely than when a solid roller is used.

I have a hundred or more charts in the Botanical department of the University of Nebraska, made in this way, and they have been found very satisfactory, while the cost for material has been little.

University of Nebraska.

CHARLES E. BESSEY.

Flattening and Fixing Paraffin Sections on Slide.

One of the difficulties in mounting paraffin sections in series is the loss due to imperfect fixing on the slide.

The following methods are generally recommended: *Water* (Lee's *Vade-Mecum*, sec. 182, 5th ed.); *alcohol* (70 per cent. alcohol is used instead of water. Method described in above reference); *Mayer's albumin* (Lee's *Vade-Mecum*, sec. 183, 5th ed.). Each of these methods is open to some objections, either on account of extreme care necessary for good results or clouding of sections in staining.

Of these, the alcohol method seems to be the most satisfactory, as it does not require that the slides be absolutely clean, nor are the sections clouded in staining as sometimes occurs in the albumin method. The improvement on the alcohol method suggested by Eisen (*Zeit. f. wiss. Micros. Bd. xvi*) makes it as certain as the albumin method, without its objectionable features.

The essential steps in the process are as follows:

- a. Flood the slide with 70 per cent. to 85 per cent. alcohol. Arrange sections in order. Hold slide a few inches above small flame until sections are flattened.
- b. Drain off surplus alcohol (use filter-paper or cloth). Rearrange sections in desired positions.
- c. Cut out two pieces of smooth blotting paper same size as slide. Wet one in same strength alcohol as used in (a), and place over sections. Over this put the other piece dry. Pass small rubber roller (such as used by photographers), firmly over the dry blotting paper two or three times. Instead of using the roller, any weight with smooth surface may be pressed against the blotting paper. The object of this step is to flatten the sections completely, so that every part of the section will come in contact with the slide.
- d. Remove any lint which adheres to the slide and dry in a place protected from dust. At the ordinary temperature of the room, two or three hours are necessary for complete drying. The process may be hastened by keeping the sections at a temperature a few degrees below the melting point of the paraffin (below 40° C).

If this method has been carried out carefully, the sections may be taken through as many stains or reagents as desired, or left indefinitely in any solution which will not act chemically on them.

B. M. DAVIS.

Biological Laboratory, State Normal, Los Angeles, Cal.

A new building is being erected, at a cost of \$125,000, for the Medical Department of Cornell University. It will be the finest building on the Cornell campus, and will offer facilities for scientific and practical study which are not excelled by any institution in the world.

A Ventilated Dish for Bacteria Cultures.

When Koch's original form of plate for bacteria culture was abandoned for the more convenient Petri dish, a step was undoubtedly taken in the right direction; yet in one respect it was a step backward. Koch's plates were placed for incubation in a large air-tight receptacle, as a bell-jar, which contained wet filter paper. The object of this jar was to prevent the gelatin from drying up as it would do if exposed to the atmosphere of the ordinary incubator. In the Petri dish drying was prevented by making the cover fit the bottom plate tightly—at least such was the intention. As a matter of fact, however, the dishes are seldom air-tight because the bottom plates and covers become mismated in the laboratory. Consequently when Petri dishes are used there is almost always a slight drying of the gelatin. The loss of water by evaporation in the ordinary Petri dish may be as great as 15 per cent. in 72 hours at 20°, but it is ordinarily about 5 per cent. Although this evaporation is comparatively small, it is sufficient to cause a thickening of the gelatin at the surface, and this thin film tends to exclude oxygen from the medium and thus retard or prevent the growth of aerobic bacteria. In a former publication* the writer has shown how the amount of moisture in the atmosphere of the incubator affects the number of bacteria that will develop from a sample of water. The results there set forth were summarized in the following table:

| Relative Humidity of the Atmosphere of the Incubator in per cent. of Saturation. | Per Cent. which the Number of Bacteria that Developed in the Incubator was of the Number that Developed in a Moist Chamber. |
|--|---|
| 60 | 75 |
| 75 | 82 |
| 95 | 98 |
| 98 | 97 |
| 100 | 100 |

It was also shown that air-tight Petri dishes are unfavorable for the growth of aerobic bacteria, because of the partial exhaustion of the oxygen from the somewhat limited air space and the collection there of gaseous products of growth. For example, the air in five sealed Petri dishes was collected and analyzed after bacteria had been allowed to develop in them for 72 hours, and was found to contain only 5 per cent. of oxygen and 5 per cent. of CO₂; whereas in ordinary Petri dishes with ill-fitting covers the percentage of oxygen was 15 per cent. and of carbonic acid 2 per cent.

From these two facts, that an air-tight Petri dish gave too low results on account of exhaustion of oxygen and that an ordinary Petri dish gave too low results on account of evaporation of moisture, it was argued that the best conditions would be obtained by cultivating bacteria in a ventilated dish placed in an

*On the Necessity of Cultivating Water Bacteria in an Atmosphere Saturated with Moisture. *Technology Quarterly*, Dec. 1899.

incubator of which the atmosphere was saturated with moisture. Thus drying of the gelatin was prevented and a sufficient amount of oxygen was provided. Experiments showed that the results obtained from these conditions warranted the trouble necessary to provide them. The atmosphere of the incubator may be easily kept nearly saturated by shallow pans of water placed beneath the shelves, and ventilation of the dishes may be accomplished in a number of ways.

I have recently had made a very convenient form of ventilated dish, which is shown in the accompanying diagram. The cover is supported about 2 mm. above the lower plate by means of three projections of glass, which are merely

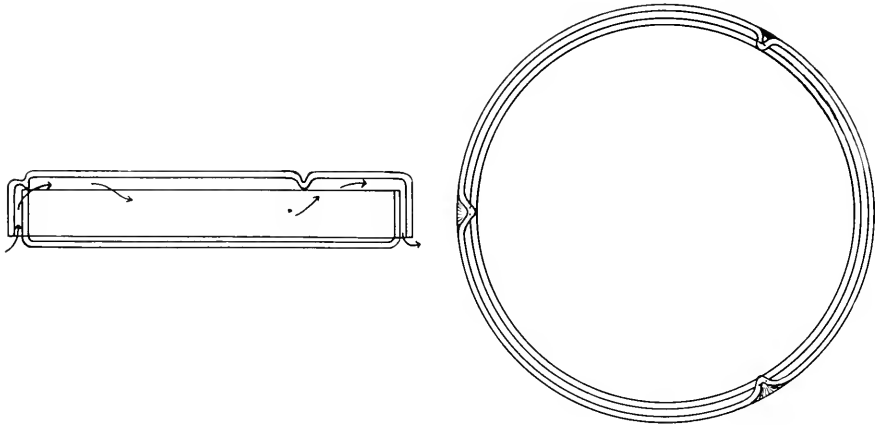

indentations in the cover, obtained by heating the edge and pressing in the softened glass with a sharp point. The sides of the cover are made deeper than in the Petri dish by an amount about equal to that which the cover is raised above the dish. With the cover thus elevated there is abundant opportunity for a free circulation of air, as indicated by the arrows. Ordinary Petri dishes may be thus ventilated, but unless the work is done by a skilled glass-blower the breakage is liable to be great. Furthermore, the cover of the ordinary Petri dish is too shallow.

If the ventilated dish is desirable for the cultivation of aerobic bacteria, it is even more necessary for the cultivation of anaerobic forms. When these ventilated dishes are placed in a jar, like the Novy jar, for example, the air in them may be easily replaced with hydrogen, while with the ordinary Petri dishes this is sometimes a difficult matter.

GEORGE C. WHIPPLE.

Mt. Prospect Laboratory, Brooklyn, N. Y.

As a result of the investigations on malaria carried on in Italy by Professors Celli and Grassi, the Italian government will soon consider the appropriation of a sum of money to continue the work already begun. Employers of labor in malarial districts will be compelled to provide the proper precautions against infection, and also supply medical aid to laborers who contract the disease, at the same time providing a fixed amount for the support of their families when the employer fails to comply with the requirements of the bill.

LABORATORY PHOTOGRAPHY.

Devoted to methods and apparatus for converting an object into an illustration.

THE PROCESSES OF PHOTO-MICROGRAPHY.

In a previous paper, I described the apparatus employed in high-power photo-micrography and outlined the method used for the projection of the luminous image upon the focusing screen. To complete this description and to reduce the whole matter to a concrete example, I will here explain the further steps involved in the production of a negative, giving actual details of exposure time, speed of plate, etc.

Before proceeding to a discussion of processes, however, it will be well to consider the materials which are to be employed. Chief among these is the sensitive plate designed to receive the light impressions and to make permanent record of them. Formerly the old collodion wet plate was used for this purpose, and many of the best photo-micrographs ever made are the productions of the earlier workers who employed this process. Workers now-a-days, though, do not resort to the tedious methods the use of the wet plate involves, but choose the more convenient and rapid gelatin dry plate.

Of dry plates, there are any number on the market, and most of them are good for ordinary photography; but in photo-micrographic work the conditions are different from those which prevail where the image is smaller than the object and the light is plentiful. The strong diffusion of light involved in the production of an image 1000 diameters larger than the object itself renders it expedient to use plates that will record strongly all differences of lighting and thereby produce negatives with good "contrast." In this respect the slower plates, those of lower sensitometer numbers, are the best; and if the operator has any one with which he is familiar, he will do well to make use of it when undertaking the unfamiliar work of photo-micrography.

To such as are not adept in the manipulation of any particular plate, I would strongly recommend the orthochromatic "Carbutt Process Plate." After an extended trial of many plates, I find this one in a large degree satisfactory. It produces negatives with clear, sharp details and abundant contrast. The film is hard and firm, washes readily, and dries quickly. Beginners will make no mistake, I am sure, in starting with this plate. Since so many sections are stained by some one or other of the blue dyes, it is best to make use of the orthochromatic plates, as they give better balanced negatives. The "Process" plate may be obtained in this form and I prefer it to the plain form.

Next in importance to the plate is the developer with which the latent image upon it is made manifest. Here, as in the former case, I have nothing to recommend to those who are well acquainted with the action of any good developing fluid. The agent itself is really not of so much importance as is the knowledge of how to use it. By this, I do not mean that there is no choice, but it is better to manipulate a poor developer well than a good one poorly.

It is recognized that certain reducing agents, e. g., eikonogen, produce "thin "

negatives with much detail; while others, such as hydrochinone, afford density. Contrast being desirable, it is well to choose a developer containing a reducing agent that will best produce it. In doing this, however, it is often advantageous to combine reducing agents with opposing characters in order to secure a negative well balanced in detail and density.

If asked to recommend developers of this character I should suggest three that do the work well and, at the same time, differ otherwise so as to make them applicable under different conditions.

The simplest of these is known by the trade name "Rodinal." To prepare it for use, it is only necessary to dilute it with twenty parts of water. This, with its good keeping qualities, makes it convenient for those who have only an occasional negative to develop. Persons unfamiliar with its use will perhaps be startled at the suddenness with which the image flashes into view under its action, and will consider a normally exposed negative overtimed. It is, further, somewhat deceptive in the relative amount of density apparent before and after fixing, since the negatives produced by its use lose more under the action of the hypo than do almost any others. As it does not produce chemical fog, even after long action, it is well to let it operate until an apparent excessive density is produced.

Among the class of one-solution developers that may be prepared by the operator and kept for some time, I like the metol-hydrochinone mixture prepared after the following formula:

| | |
|----------------------------|-----------|
| Water, distilled | 500 c. c. |
| Metol | 3 gm. |
| Hydrochinone | .5 " |
| Sodium Sulphite | 18 " |
| Sodium Carbonate | 14 " |

Mix in the order given, and when wanted for use dilute with an equal quantity of water.

As a type of the two-solution developers, I would recommend the one given by Carbutt for use with his plates. This is prepared as follows:

Solution 1:

| | |
|-----------------------------|-----------|
| Water, distilled | 600 c. c. |
| Sulphite of soda | 120 gm. |
| Eikonogen | 22 " |
| Hydrochinone | 10 " |
| Add water to make | 960 c. c. |

Solution 2:

| | |
|-------------------------------|-----------|
| Water, distilled | 600 c. c. |
| Carbonate of potash | 60 gm. |
| Carbonate of soda | 60 " |
| Add water to make | 960 c. c. |

To use, mix one part each of 1 and 2 with four parts of water.

Greater contrast can be obtained from any developer by decreasing the amount of alkaline solution or by the addition of a few drops of 10 per cent. potassium bromide solution.

The fixing bath, while by no means as important as the developing solution, may have its value underestimated. It is not uncommon to find operators who mix up water and hypo in almost any proportion and, without filtering the solution, use it until it becomes so discolored as to affect the film of the plate injuriously. A little care will greatly economise the use of the hypo and at the same time produce much better negatives. I find the following bath entirely satisfactory, cheap and convenient: Prepare and filter saturated aqueous solutions of hypo and boric acid. Mix one part of the hypo with three of the boric acid solution. This bath will keep until the hypo is exhausted without discoloring and, being acid, hardens the film.

Plate and developer are important agents in the production of a good negative, but, without the proper adjustment of light effect to the speed of the plate, they are worthless. The exposure must be judiciously regulated so that the darkest parts of the object will not be allowed to produce any effect upon the sensitive film, while, at the same time, the light must be allowed to act long enough to be effective, in various degrees, over the lighter portions of the object. General instructions regarding this part of the work are of little value, so I will outline the actual conditions under which negatives have been produced.

Source of illumination—the crater of an arc light placed at a distance of two feet from the object and having interposed between it and the condenser a ground glass disc. This disc stands about six inches from the crater and its matt surface is made somewhat transparent by rubbing with glycerin.

Condenser—a parachromatic of 1.30 N. A. in homogeneous contact with the lower portion of the slide. The diaphragm registers a numerical aperture of .5.

Object—a section of embryonic tissue $6\frac{2}{3}$ micra thick, stained with iron-hæmatoxylin and mounted in balsam.

Objective—a 2 mm. homogeneous immersion apochromatic of 1.30 N. A.

Ocular—a No. 2 projection.

Magnification—1000 diameters.

Plate—a “Carbutt Ortho. Process.”

Under these circumstances, an exposure of 20–30 seconds is sufficient.

Two things are to be guarded against during the time of exposure; viz., flickering of the light and vibration of the microscope or camera. Either of these untoward circumstances will ruin what might otherwise prove to be a good negative.

With the proper exposure and by the use of the metol-hydrochinone developer, the image will begin to appear upon the plate in about 30 seconds, and development will be complete in about five minutes. In the “Process” plate, very little of the image will show upon the reverse, or glass, side of the plate. The progress of the development is best observed by examining the image under transmitted light. Somewhat greater density than is finally desired should appear, since some of it is lost in the hypo.

Fix until all the unreduced silver salts are removed, and the shadows are clear. To be sure of this, allow the hypo to act some minutes after the last trace of milkiness has disappeared from the film.

Wash for an hour in running water and dry. With this plate, heat may be used to hasten the evaporation of the water from the gelatin.

The time limits here set are, of course, operative only under the conditions given. Increased light, either from greater transparency of the ground glass, enlarged aperture of substage diaphragm, or decreased magnification will materially shorten the time of exposure. It is possible, also to decrease considerably the exposure by employing a rapid plate instead of the slow one recommended. Some circumstances may justify this use, but ordinarily, the slow emulsion will give the better results.

Finally, one other suggestion may prove of advantage. Excessive contrasts may exist in the object itself, and it is desirable to reduce these. This may be accomplished by an over exposure producing a flat negative which may be made printable by subsequent intensification. This will give general detail even when the object is dark. Variations in density and detail, within more or less narrow limits, may also be secured by choosing printing papers of different kinds: this choice is particularly important when prints are made for micro-mechanical reproduction, since the balance of light and shade is not equally preserved by the various papers under these circumstances.

C. E. McCUNG.

University of Kansas.

A LABORATORY CAMERA STAND.

Photographic reproductions of material for illustrating Experiment Station and other literature have become important aids in technical work and have been used with more or less success—frequently the latter. The difficulty does not lie in the photographic processes, but rather in carrying them out. There are certain lines of work in which the photographic processes are not easily employed, such as illustrating microscopic insects and fungi. Even this field may be occupied in time. As long as botanists and entomologists depended upon the portrait photographer to prepare the negatives, the work was usually most disappointing; but with the advent of plant and insect photographers, some most excellent and pleasing results have been obtained.

In his little booklet on photographing trees and flowers, Mr. J. Horace McFarland has shown some things that may be done with simple apparatus. Before seeing this pamphlet an order was let for a laboratory stand that differs greatly from the one illustrated by Mr. McFarland, and also from the one used in the botanical laboratory of the Florida Agricultural College. The one at Clemson College is used for photographing diseased plants, individual plants, and similar material, with no idea of using it for illustrating bouquets or pot plants.

The source of light is from a high window to the north, making the illumination like a skylight.

THE STAND.—The frame is made of one-inch angle-iron and holds the camera post and a 30x30-inch glass plate. At the lower end of the post is a mirror, attached by mechanical contrivances in such manner as to allow it to be raised or lowered; tilted forward, backward, or sidewise; brought nearer to the object or drawn back from it; or so adjusted as to throw the reflection off

entirely. With this arrangement any portion of the field may be illuminated, or the illumination may be dispensed with entirely.

Above the mirror attachment is the camera attachment, which allows the camera to be raised and lowered to any point on the post and securely clamped. The front board having been brought into position and the ground glass adjusted, the whole camera may be lowered or raised, or racked entirely out of the way until wanted.

ACCESSORIES. Besides the camera and stand proper there are several accessories that are excellent time savers.

(1) A Four-Foot Rule, seen in the figure leaning against the camera frame. This rule has marked upon it the exact distance from the glass plate to the front board and to the ground glass for all combinations needed. Thus, by using a Zeiss 8x10 series V lens, to enlarge the object two diameters the front

board should be $10\frac{1}{2}$ inches from the glass plate and the ground glass $30\frac{1}{2}$ inches: for making a $\frac{5}{8}$ natural size negative the front board should be 18 inches and the

ground glass 29 inches, and so on, for other enlargements and reductions. The advantage of this rule is that the camera is adjusted quickly and accurately without experimenting. When the specimen is in place the camera may be racked to such position as to bring the highest part of the object (that nearest the lens) into sharpest focus. Those who do not use a rule of this kind will find it a surprising convenience. If the stand is of a different design it is sometimes practicable to mark these distances upon the post to serve the same purpose.

(2) A Ruled Card is prepared from a piece of heavy cardboard 30x30 inches, the size of the glass plate, and ruled so as to have areas corresponding to multiples of different sized plates. Where a large number of plates are used, the cost becomes an item worth considering, and there is no occasion for using an 8x10 plate if $6\frac{1}{2} \times 8\frac{1}{2}$ or 5×7 will answer. The areas for the 4×5 and 8×10 plates are 30×24 , 25×20 , 20×16 , 15×12 , 10×8 , 5×4 , and $2\frac{1}{2} \times 2$. The reverse side of the card is ruled for the 5×7 and $6\frac{1}{2} \times 8\frac{1}{2}$ plates. These two sizes do not coincide as is the case with the 4×5 and 8×10 , so a dotted line is used for the $6\frac{1}{2} \times 8\frac{1}{2}$ fields and a line for the 5×7 .

This ruled card serves two purposes: (1) The object is placed upon it to ascer-

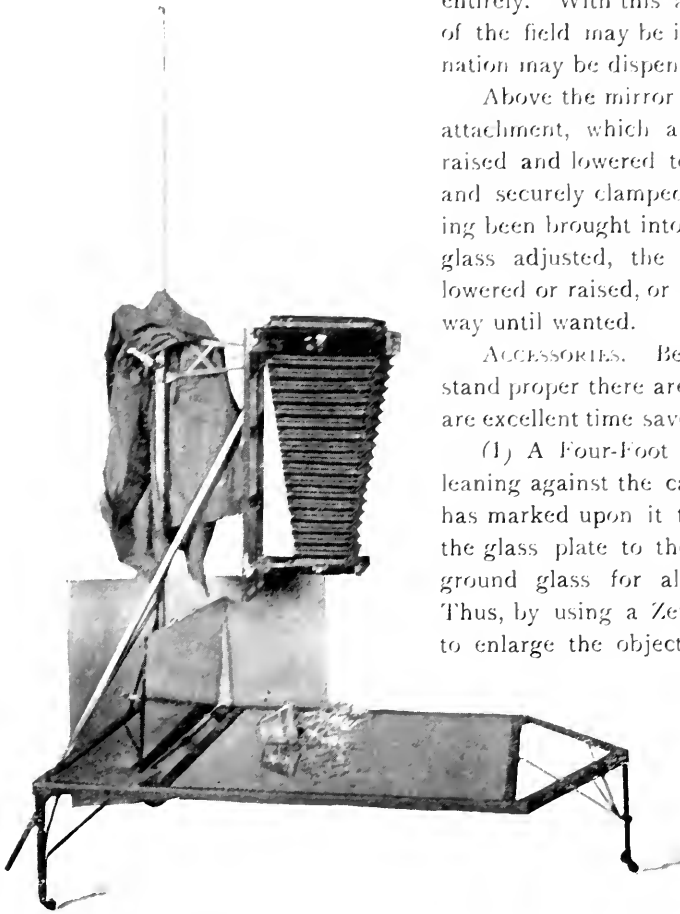

tain what sized plate will cover it with the least waste. It also shows at a glance how much the object will be reduced or enlarged for that particular plate, and by reading the rule the camera may be adjusted at once. (2) The card being placed *under* the glass plate shows the exact field that the object should occupy to be included on the ground glass.

(3) A Glass Plate. A method for posing insects, and one equally serviceable for arranging flowers, is to secure a clean glass plate, such as the glass from a photographic plate or other equally good sheet of glass of the desired size. The object is arranged upon this glass and when properly posed is slipped into position under the lens. The glass being clean, the plate of the stand likewise, and both free from defects, no image of either will be formed on the sensitive plate. This method was developed by Prof. A. L. Quaintance while associated with the writer.

(4) A Paper Rule such as is sold by the Cambridge Botanical Supply Company, with sharp lines upon clear white paper, a little heavier than heavy herbarium paper, makes a convenient object to focus upon. Such a rule is so light that it may be placed upon the object to be photographed for the purpose of verifying the focus before inserting the plate-holder. In many cases the rule may be left in an appropriate portion of the field to serve as an index of the enlargement or reduction. In the absence of a light paper rule, a visiting card, as Mr. McFarland suggests, makes a convenient object to prove the focus. A wooden rule is anything but a desirable substitute.

In conclusion I would recommend heavier angle-iron for the frame, say about $2\frac{1}{2}$ or 3 inches. The one-inch makes a frame appear light and the post not so firm as might be desired. In practice it has given no trouble.

A suitable background is supplied in the same way as suggested in the booklet referred to before.

P. H. ROLFS, Botanist.

Clemson Agricultural College, Clemson College, S. C.

Received for Notice.

Modern Photography in Theory and Practice.
H. S. Abbott, Chicago; Geo. K. Hazlett &
Co. Cloth, 230 pp.

This book is, as its title page states, "A Hand Book for Amateurs," containing chapters on the principal forms

of cameras and apparatus likely to be used by the amateur, methods of loading plate-holders, recording exposures, focusing, exposing, development, and the various processes in the manipulation of the negative, paper, etc., to produce a satisfactory print. Standard formulæ for the various solutions are freely quoted, and numerous illustrations show the principal kinds of paper for making prints.

The book is intended for the studious amateur, and as a repository of useful formulæ and hints for the beginner it serves its purpose admirably.

L. B. E.

Journal of
Applied Microscopy
 and
Laboratory Methods.

Edited by L. B. ELLIOTT.

Issued Monthly from the Publication Department
 of the Bausch & Lomb Optical Co.,
 Rochester, N. Y.

SUBSCRIPTIONS:

One Dollar per Year. To Foreign Countries, \$1.25
 per Year, in Advance.

The majority of our subscribers dislike to have their files broken in case they fail to remit at the expiration of their paid subscription. We therefore assume that no interruption in the series is desired, unless notice to discontinue is sent.

OWING to extreme pressure of work in connection with his new courses, at the University of Pennsylvania, Dr. R. M. Pierce will not be able to review the literature of "Normal and Pathological Histology" as heretofore. The work which Dr. Pierce has done for the JOURNAL in this department has been greatly appreciated by our readers. We are fortunate in securing the cooperation of Dr. J. H. Pratt, Harvard University Medical School, to continue the work. Dr. Pratt will conduct the department along the lines heretofore followed.

* * *

The interest expressed by our readers in Zoölogical methods, both in the laboratory and in the field, has made it necessary to add to our reviews a department of "Current Zoölogical Literature." In this department will be included reviews of important zoölogical investigations, especially those which deal with types most frequently used in laboratory work; methods in use in zoölogical laboratories and by zoölogical investigators in the preservation and preparation of animal forms for microscopical examination, for dissection and for exhibition purposes; methods in field work in zoölogy, apparatus for collecting aquatic and marine life, and suggestions for maintaining aquaria and vivaria in the laboratory; notes on methods in vogue at fresh water and marine biological stations. The fact that Mr. C. A. Kofoid, University of California, will conduct this department, is in itself a guarantee of the practical nature of the matter, which will be selected from the mass of American and foreign literature on the subject, and of the faithful rendering of the author's meaning. Separates of papers or books for review should be sent addressed to C. A. Kofoid, University of California, Berkeley, Cal. Authors will confer a favor by sending separates as soon as issued, in order that our reviews may be as little delayed as possible.

* * *

Now that we are on time in publication once more, notes and news items from the various laboratories will be welcomed, and we ask those in need of assistance to make use of the question-box. Inquiries will be answered through the JOURNAL, or, if in pressing need of information, at once by letter.

* * *

Numerous requests for an exchange department for the exchange or sale of books, material, and apparatus, have reached the editor from time to time. We do not consider the conduct of such a department advisable, as we are not in position to know the responsibility of every sender of an exchange notice, or of the merits of the article offered.

CURRENT BOTANICAL LITERATURE.

CHARLES J. CHAMBERLAIN.

Books for review and separates of papers on botanical subjects should be sent to
Charles J. Chamberlain, University of Chicago,
Chicago, Ill.

REVIEWS.

Dixon, H. H. On the first mitosis of the spore-mother-cells of *Lilium*. Notes from the Botanical School of Trinity College, Dublin, No. 4, pp. 129-139, pls. 7-8, Jan., 1901.

In reviewing the literature of this subject Prof. Dixon finds that, while there is a wide divergence of opinion in regard to the phenomena involved in this mitosis, there are, nevertheless, certain stages which are admitted and which have been constantly observed. How these stages are derived from one another is the most debated question. The writer figures and describes six well ascertained stages and then proceeds into the debated territory. Nearly all observers describe a longitudinal splitting of the entire thread just previous to the segmentation into chromosomes, but Prof. Dixon believes that the stage so constantly observed arises from the looping on each other and approximation of two portions of the thread. Several very suggestive objections are urged against the commonly accepted interpretation. While believing that each of the two twisted portions undergoes a longitudinal splitting while still in the spirem stage or immediately after differentiation into chromosomes, regarded as a *second* longitudinal splitting by Guignard and others, the author believes that this is the first and only longitudinal splitting.

A series of very clear diagrams illustrates the writer's interpretation of the composition of the chromosomes and their behavior during the later phases of mitosis. According to this interpretation there is no differential or "reducing" division during the first mitosis of the spore-mother-cell. C. J. C.

Britton, Elizabeth G., and Taylor, Alexandria. Life History of *Schizaea pusilla* Bull. Torrey Bot. Club, 28: 1-19, pls. 1-6, 1901.

This is the first fairly complete account of the life history of this interesting fern. The material was collected at Forked River, New Jersey, in July, 1900. Sections do not seem to have been made except in the study of the root, stem and leaf. While the peculiar gametophyte and general aspect of the young sporophyte is shown more clearly without sections, we cannot help feeling that the development of antheridia and archegonia and also the very young sporophyte would have been more satisfactory if the study had been made from microtome sections.

A part of the description, which could hardly be abbreviated, reads as follows: "The gametophyte is composed of numerous, erect, branching, dark green protonemal filaments; monoecious, bearing 5-12 archegonia, usually on a slightly thickened and expanded series of cells in the nature of an archegoniophore (?) or directly on the filaments; antheridia more numerous, often on separate branches and nearer the extremities of the filaments; radicles seldom borne on the filament, but produced from specially modified, large spherical cells, appar-

ently in symbiotic relation with a fungus." The filamentous prothallium persists until the young sporophytes have attained considerable size.

In the development of the antheridium, one figure shows a filament of three cells. The outermost cell "becomes large and globular and cuts off a cap cell at the summit, with the wall oblique; the large cell divides into the mother cells of the antherozoids and one ring cell."

The archegonia are not at all imbedded, but are entirely free, and, at first glance, bear a striking resemblance to the archegonia of certain liverworts. Each archegonium is derived from a single superficial cell which divides into three cells. The basal cell forms the venter and from the middle cell arises the central cell and the canal cell. The other cell forms the neck.

The anatomy of the root, stem and leaf is described in considerable detail. The six plates of careful drawings form no small part of the contribution.

C. J. C.

Macallum, A. B. On the Cytology of Non-nucleated organisms. University of Toronto Studies. Physiological Series, No. 2, 1900. This work was undertaken with the hope of throwing some light on the origin of the cell nucleus and to obtain data to determine the morphological character of the primal life organism. The work is divided into three parts, each dealing with a separate group of low organisms, namely, the Cyanophyceæ, Beggiatoa, and the yeast cell.

His results on the Cyanophyceæ are briefly as follows: The cell consists of two portions, the central body and the peripheral zone holding the pigment. There is no evidence of the presence of a special chromatophore. There are two types of granules present in the cell. The one stains with hæmatoxylin, contains "marked" iron and organic phosphorus, and therefore resembles chromatin. The other type is found in the peripheral layer, and chiefly adjacent to the cell membrane. It stains with picro-carmin, and is free from organic phosphorus and "marked" iron. It is probably a proteid. There is no nucleus, nor any structure which resembles a nucleus in the Cyanophyceæ.

In Beggiatoa there is no differentiation of the cytoplasm into a central body and a peripheral layer such as Bütschli describes. The compound of "marked" iron and organic phosphorus are uniformly diffused throughout the cytoplasm in the threads. In the "spirilla," "comma" and "cocci" forms the cytoplasm shows characters like those of the threads, but there are also granules present which give slight reaction for "marked" iron and organic phosphorus and therefore is considered analogous to chromatin. No specialized chromatin-holding structure in the shape of a nucleus was found in any of the forms of Beggiatoa studied.

In his studies on the yeast cell Macallum finds the cytoplasm takes a diffuse stain with hæmatoxylin and gives a diffuse reaction for "marked" iron and organic phosphorus. In addition to the chromatin-like substance diffused throughout the cell, there is usually present a homogeneous corpuscle. This is not considered to be a nucleus although held as such by other investigators. The chromatin-like substance in *Saccharomyces* is soluble in artificial gastric juice, thus differing from the chromatin of the higher animal and plant cells.

In his investigations Macallum used the ordinary cytological methods and

also micro-chemical reactions. Many fixing fluids were employed, but the best results were obtained with picric acid and corrosive sublimate. The staining reagents employed were Ehrlich's and Delafield's hæmatoxylin, Czokor's alum, cochineal, safranin, eosin, picro-carmin and methylen blue. Picro-carmin was employed to stain the cyanophycin granules. A strong solution of hydrogen peroxide containing traces of sulphuric acid was used to liberate the "marked" iron.

The paper is a most valuable addition to the literature of this important problem.

A. A. LAWSON.

Chicago.

Pierce, G. J. The nature of the association of Alga and Fungus in Lichens. Proc. Calif. Acad. Sci. Ser. III, 1: 207-240, pl. 41, 1899.

Both cultures and microtome sections were used in this work. Various fixing agents were used, but a saturated solution of corrosive sublimate in 35 per cent. alcohol just below the boiling point proved most satisfactory. Dehydration must be thorough, but, on account of the gelatinous coating of the lichen, must not be too rapid.

The results show that the hyphæ and gonidia are in the most intimate connection, the hyphæ developing branches which clasp the algal cell or even enter it as haustoria. This relation stimulates the algal cell to internal cell divisions. The haustoria drain the living contents of the algal cells, leaving only the empty cell walls. The fungus is fed by the alga and it is doubtful whether the alga receives any benefit, since it is known that in their resting forms free algæ withstand extremes of heat, dryness, etc., as successfully as do the algæ which are associated with fungi in lichens.

The results show that the hyphæ and gonidia are in the most intimate connection, the hyphæ developing branches which clasp the algal cell or even enter it as haustoria. This relation stimulates the algal cell to internal cell divisions. The haustoria drain the living contents of the algal cells, leaving only the empty cell walls. The fungus is fed by the alga and it is doubtful whether the alga receives any benefit, since it is known that in their resting forms free algæ withstand extremes of heat, dryness, etc., as successfully as do the algæ which are associated with fungi in lichens.

C. J. C.

CYTOLOGY, EMBRYOLOGY, AND MICROSCOPICAL METHODS.

AGNES M. CLAYPOLE.

Separates of papers and books on animal biology should be sent for review to
Agnes M. Claypole, Sage College,
Ithaca, N. Y.

CURRENT LITERATURE.

Beard, J. The Source of Leucocytes and the True Function of the Thymus. Anat. Anz. 18: 550-573, 1900.

The function of this obscure gland has been hitherto but little known. Its origin from the epithelium of the gill

pouch by Koelliker for mammals, and his subsequent statement that the original epithelial cells gave rise to leucocytes, has been followed by two views: one that these leucocytes have migrated into the gland from outside, the other that they originated within the gland. A complete developmental study of *Scyllium canicula* made by the author disclosed the fact that for a relatively long period the blood contains only nucleated red corpuscles, no leucocytes of any kind being present, as had been noted by Koelliker some years before. In these studies investigation was carried on in two lines. First, a careful search was

made for the stages in which leucocytes first appeared in the blood and mesoblast. Second, the development of the thymus was followed from its earliest stages till the permanent characters appeared. The best material was found to be that fixed in Rabl's picro-platino-chloride, or in corrosive sublimate. The most satisfactory stain is picro-carmin. In this stain the red blood corpuscles are yellow and the nuclei often unstained (in picric acid preparations); the leucocytes are differentially stained, nuclei a brilliant red and their scanty protoplasm a yellowish-brown. All the sections were of embryos less than 30 mm. in length and have been studied with the Zeiss 2 mm. apochromatic and a Leitz $\frac{1}{2}$ oil immersion.

The origin of the thymus element is from a small area of modified epithelium. The term "placode" will be used for this thymus element, a name introduced by von Kupper for such a small piece of modified epithelium. The thymus elements arise in the skate as specialized portions of the epithelium of the gill pouches before these open to the outside, and hence the thymus is of hypoblastic origin. These placodes are five in number on each side. In most cases the histogenesis of the thymus does not take place until the embryo is 17-18 mm. long, leucocytes appearing at the same time. It is evident that the first of these originate in the thymus epithelium, and until some are found there none are present elsewhere in the mesoderm or blood. The first changes seen in the transition of the epithelial cell into a leucocyte is an increase in the refractive power of the cytoplasm and under favorable conditions it assumes a somewhat brownish color. Gradually the nucleus changes from its oval shape and becomes rounder, a form later assumed by the whole cell. Finally the nucleus comes to its eccentric position. Many of these newly formed leucocytes wander out immediately into the tissue, while others remain in the gland and increase by division, as is shown by their being in groups of 2 and 4. Emigration of leucocytes begins at first singly, but later the even contour of the gland is broken, one break occupies nearly the whole lower surface, and here the leucocytes are wandering out en masse. Many are here in the blood itself. These breaks in the placode walls are very characteristic, all the thymus elements of all the embryos from this stage up to those 42 mm. in length.

The thymus of an embryo of 71 mm. has practically reached its adult condition. The corpuscles of Hassall have never been seen, in the embryo, young skate or adult. Their presence in fishes is uncertain, only one author mentions finding them. The transition from the epithelial structure is as follows: In an embryo of 33 mm. the epithelial cells are restricted to the basal portion of each placode; the emigration of leucocytes is in active progress; no blood vessels are as yet within the thymus and it is without a connective tissue capsule. No spleen has yet been formed. In an embryo of 43 mm. a capsule is in process of formation, but no blood vessels have formed. Connective tissue strands are forcing their way in and lobulating the organ. In an embryo of 71 mm. the thymus elements are free from the epithelium of the clefts, separated by the capsule growth; this latter still permits the emigration of leucocytes, and there are many such within the organ. Blood capillaries are now within the organ, brought there by the connective tissue, and afford easy transport for the leucocytes.

The author considers that there is no other source of leucocytes in the vertebrate body for several reasons. 1. The first leucocytes clearly rise from the thymus, as there are no others present in the body when this organ first forms such structures. These first or parent leucocytes quickly infiltrate the blood, and other lymphoid tissues rise in all probability from such migrating cells. 2. No other lymph organ is known which resembles the thymus in origin and developmental history. 3. The thymus alone is sufficient to account for all the leucocytes of the body and it is an organ characteristic of all true vertebrates. 4. Except in the case of paired or metameric organs it is not usual to find the same function in any two organs of the body. The thymus is a paired metameric structure of the branchial region only. That the thymus should be the parent source of leucocytes explains its functional activity in young animals and its later atrophy.

A. M. C.

Folsom, J. W. The Development of the Mouth Parts of *Anurida maritima*, Guér. Bull. of the Museum of Comparat. Zool., Harvard College, 36: 87-157, 8 pls., 1900.

The object of the paper was twofold, to supplement a previous account of the anatomy and functions of the mouth-

parts of a representative collembolan and to discuss the morphology of mandibulate mouth-parts of insects and their nearest allies upon anatomical and embryological evidence derived from the most primitive insects, the Apterygota. Material was killed in hot water and carried through successive stages of alcohol to be preserved in absolute alcohol. Material was imbedded in hard paraffin and sections cut from 5-10 μ in thickness. Delafield's or Kleinenburg's hæmatoxylin followed by safranin. Grenacher's alcoholic borax-carmin, and Heidenhain's iron-hæmatoxylin were used for staining.

Nine consecutive stages were taken for representing the development stages, and the following parts are considered: The procephalic lobes, labrum and clypeus, antennæ, premandibular appendages (intercalary), mandibles, lingua and superlinguæ, maxillæ, labium, skull, tentorium, segmentation of the head.

The proto cerebrum of the Apterygota agrees with that of other insects in development and structure. The ocular segments of the Hexapoda and decapod Crustacea, as well as the compound eyes of the two groups, are homologous. The labrum and clypeus of insects develop from a single median evagination between the procephalic lobes, and do not represent a pair of appendages. The labrum of Apterygota is homologous with that of other insects, and of the Symphyla, Diplopoda, Chilopoda, and higher Crustacea. The antennæ of the Apterygota evaginate from the posterior boundaries of the procephalic lobes, and agree with those of the Pterygota. In both groups the antennæ are first post- and later pre-oral in position. The denticerebrum of insects is homologous with that of Crustacea, and the antennæ of Hexapoda are equivalent to the antennules of Crustacea, and the embryonic pre-antennæ of Chilopoda. Pre-mandibular or intercellary appendages exist in the embryo of Anurida, and appear to be represented in the adults of several Apterygota genera. The tritocerebrum of Apterygota is homologous with that of Orthoptera and decapod Crustacea, and the rudimentary premandibular appendages of Collembola and Thysanura represent the second antennæ of decapod Crustacea, and probably the antennæ of Diplopoda and Chilopoda. A distinct ganglion for the intercalary

segment shows it to be a primary head segment. The mandibles develop from simple papillæ, and are only lobed in Campodea; they are homologous with the mandibles of Pterygota, Scolopendrella, Crustacea, and probably Diplopoda and Chilopoda. The hypopharynx consists of two dorsal "superlinguæ," developing from a pair of papillæ between the mandibular and first maxillary segments, also a ventral lingua. First maxillæ develop as in Orthoptera. A palpus appears in the embryo, which disappears before hatching. The labrum of Anurida develops from a pair of papillæ from which the entire gular region is derived. A palpus appears, but is resolved. It is homologous with the Pterygota structure, agrees in detail with the first maxillipeds of decapod Crustacea. The sides of the face develop from a lateral evagination near the mandibular segment, which eventually involve the labral and labial fundaments. These folds are of Collembola, Campodea, and Japyx, are homologous with the genæ of Pterygota. The dorsal region of the skull in Anurida does not differentiate into sclerites comparable with those of the Pterygota. The evidence is for seven segments in the head, as is probably true for all Hexapods. Ocular, antennal, intercalary, mandibular, superlingual, maxillary, labial, with ganglia, and a pair of appendages for each. The Collembola resemble Campodea and Japyx in structure, their entognathous characteristics separating these groups from the rest of these insects. The Collembola are somewhat more specialized than the Thysanura in general structure. The Aphoruridæ, including Anurida, are the more generalized and probably degenerate forms. The resemblance in most parts indicates that the primitive collembolan descended from the stem form of Campodea, the affinities of Campodea, and in two directions, towards Machilis and Lepisma, and towards Scolopendrella.

A. M. C.

Kizer, E. J. Formalin as a Reagent in Blood Studies. *Proceed. Indiana Acad. of Sci.*, p. 222-2, 1898.

This has been found a useful reagent in bringing out blood structures. It produces no visible distortion, does not

interfere with staining, and is an excellent preservative. One volume of fresh blood is mixed with three volumes of two per cent. formalin, and after standing for an hour a drop is pipetted from the sediment to a cover slip, and allowed to dry by evaporation after being spread evenly. Slips are fixed in a flame, and dipped once or twice in a five per cent. solution of acetic acid. The acid is removed by water, and two per cent. gentian-violet is used, or methyl-blue and gentian-violet, or hæmatoxylin and eosin, methyl-green and safranin, or Ehrlich's triple stain. Excess of stain is removed by water or alcohol, as the fluid requires. Mounted in balsam.

A. M. C.

Baum, J. Beiträge zur Kenntniss der Muskelspindel. *Anat. Hefte*. H. 42, 43, 249-306, 4 Tafeln, 1900.

The author used the muscles of man and other mammals (especially the hedgehog, guinea pig, dog, cat, rabbit

sheep, pig, mole) also of *Pristiurus melanostomus*, *Syngnathus phlegon*, *Petromyzon*, and the frog. The muscle was studied fresh; it was isolated in concentrated caustic potash, which does not affect the nuclei and fibres, but loosens the connective tissue, so that in fifteen minutes separation is easy, but great pressure on the cover-glass must be avoided. Acetic acid is used for isolation

since the nerve fibres are rendered very easily distinguishable. For nerve endings the gold stain of Löwit was used. Müller's fluid, and occasionally sublimate, were the best fixatives. Embryonic and small animals were decalcified with picric or hydrochloric acid. Imbedding was sometimes in collodion and sometimes in paraffin. Staining was mostly in hæmatoxylin and eosin. Both bulk and section staining were used.

A. M. C.

Smith, S. Note on Staining of Sections while Imbedded in Paraffin. *Jour. of Anat. & Physiol.* **31**: 151-152, 1900.

The author leaves the sections stretched on warm water to which the staining solution has been added. Subsequent washing in clear water was followed by treatment in the usual manner.

A. M. C.

CURRENT ZOÖLOGICAL LITERATURE.

CHARLES A. KOFOID.

Books and separates of papers on zoölogical subjects should be sent for review to Charles A. Kofoid, University of California, Berkeley, California.

Schönichen, W., und Kalberlah, A. B. Eyferth's Einfachste Lebensformen des Tier- und Pflanzenreiches. *Naturgeschichte der Mikroskopischen Süßwasserbewohner.* 516 pp., 16 Taf., Braunschweig, 1900. Verlag von Benno Goeritz.

A third fully revised and enlarged edition of Eyferth's treatise on the fresh water micro-fauna and flora has been prepared by Drs. Schönichen and Kalberlah, assistants in the Royal Botanical Gardens at Halle, Germany. The present work is a very decided advance upon previous editions, the revision having been most thorough and painstaking. The authors have endeavored to include only those forms which are most common and most widely distributed. Many genera and species described in recent years have been added in this edition. The cosmopolitan character of the organisms found in fresh water makes a treatise of this nature useful everywhere, quite as much in America as in Europe. The scope of the book is indicated in the title. The groups included are the bacteria, algæ, desmids and diatoms, the protozoa and the rotifers. The main body of the text is made up of brief diagnostic descriptions with synoptic keys to the various divisions down to species, over 600 of which are figured on the plates. The specific descriptions are necessarily very brief. The book is thus not for the use of the specialist, but is intended for the general student, and the amateur microscopist. It is a very convenient manual for the biological laboratory.

C. A. K.

Keibel, F., und Abraham, K. Normentafel zur Entwicklungsgeschichte des Huhnes (*Gallus domesticus*). 132 pp., 3 pls., 4to. Jena, 1900. Verlag von Gustav Fischer.

The second number of Keibel's "Normentafeln" of the development of the vertebrates has been written by the editor-in-chief of the series, with the assistance of one of his students. The growth of the chick embryo has been systematically traced from the earliest stages, through the first ten days of incubation. Carefully drawn figures are given of a series of embryos viewed, how-

The author leaves the sections stretched on warm water to which the staining solution has been added. Subsequent washing in clear water was followed by treatment in the usual manner.

ever, only as opaque objects. A tabular view is given of the stage of development of the various organs of the body in 132 embryos of successive ages up to ten days. The authors call attention to those features of the development which are subject to individual variation in the chick. The care with which this work has been done makes this book a valuable work of reference in establishing the age of embryos as well as in the selection of embryos for the study of organology. The book is an indispensable aid in every embryological laboratory. A very full bibliography of the subject occupies fifty quarto pages of the book.

The fixing agents used were sublimate-acetic and chrom-acetic, and the stains borax-carmin (followed in some cases by bleu de Lyon), para-carmin, and hæmatein.

C. A. K.

Linko, Alex. Ueber den Bau der Augen bei den Hydromedusen. Mem. de l'Acad. imp. des Sci. St. Petersburg. Cl. Phys. Math. 10: No. 3, 1-23, pls. 1-2, 1900.

Material was prepared with aceto-sublimate, Perenyi's fluid, etc., and stained with Delafield's hæmatoxylin or alum or borax-carmin. All attempts

to use methylen-blue or the Golgi method in any of their modifications were futile. The depigmentation of the eyes was effected neither by Grenacher's method, by chlorin, nor by eau de Javelle. In some species the pigment was partially removed by exposure to Perenyi's fluid for 3-4 hours, though this induced some maceration of the tissues. Eight genera were examined, exhibiting a wide range in structure. In *Catablemma* the eye is a simple pigment fleck, composed of pigmented and of visual cells. In *Oceania* a pigmented area of similar structure is found in a shallow pit. In *Staurostoma* the eyes are numerous (400) and vary from a simple pigment spot to the beaker-form eye with vitreous body. In *Codonium* the sensory cells are somewhat retracted and their outer ends exhibit thickenings which terminate in sensory "hairs." In *Sarsia* a vitreous body occurs and the sensory cells terminate in conical end organs. *Sarsia* is quite sensitive to the stimulus of light. The eyes of *Tiaropsis* are of the inverted type with pigment cells of entodermal origin.

C. A. K.

Bergh, R. S. Beiträge zur Vergleichende Histologie II. Ueber den Bau der Gefässe bei den Anneliden. Anat. Hefte 15: 599-623, pls. 48-51, 1900.

Various writers have stated that the blood vessels of Annelids are provided with a layer of longitudinal, and one of circular muscle-fibers, with a lining of

connective tissue intima, folds of which form the valves. Others have reported that the blood vessels have an endothelial lining. Bergh has found a number of errors in these statements. *Lumbricus* was cut open and pinned out with porcupine spines in silver nitrate. The silver was reduced by exposure to sunlight or in alcohol slightly acidulated with formic acid. The mixture of formic acid with the silver solution directly produced too excessive blackening and precipitation. Silver preparations were stained in hæmatoxylin. Blood vessels for sectioning were freed of their blood by slight pressure before fixing in aceto-sublimate. Sections were stained in hæmatoxylin or by van Gieson-Hansen's hæmatoxylin-acid fuchsin-picric method, which leaves the muscle fibers yellow, and the connective tissue ground substance a bright red. Bergh was not able to find an endothelial lining in any of the blood vessels, neither could he detect any longi-

tudinal muscle fibers. The valves are not folds of the intima, but are composed of masses of cells. The blood vessels, contractile and non-contractile alike, are lined throughout by a homogeneous non-cellular connective tissue membrane (Leydig's intima), which is sharply limited internally and externally. Outside of the intima is a layer of connective tissue cells which, in the non-contractile vessels contains fibrous or band-like elements in circular arrangement. In contractile vessels this connective tissue layer contains strong circular muscle fibers with characteristic nuclei. Free blood vessels are covered by the peritoneal cells, which have various forms. The formed elements of the connective tissue layer in silver preparations exhibit endothelial-like boundaries, and adherent blood cells in the vessels resemble endothelial nuclei, hence the endothelium reported by previous authors.

C. A. K.

Ritter, W. E., and Crocker, G. R. Multiplication of the Rays and Bilateral Symmetry in the 20-Rayed Starfish, *Pycnopodia helianthoides* (Stimpson). Proc. Wash. Acad. Sci. 2: 247-274, pls. 13, 14, 1900.

Young stars of this species were found having from six to sixteen arms in all stages of growth. The six arms are arranged in a group of five and a single

one, the budding zones being placed between the two and the younger arms coming in simultaneously on each side of the group of five. The stars are thus bilateral, but the madreporite is not a median organ. The arms arise as inter-radial outgrowths of the water-vascular ring-canal and the perihæmal canals, forming ambulacra and receiving radial nerves, which at first project into an ectodermal pocket from the outer edge of the nerve ring. A comparison is made of the position of the sixth arm and that of the larval organ (preoral lobe) of *Asterina*.

C. A. K.

NORMAL AND PATHOLOGICAL HISTOLOGY.

JOSEPH H. PRATT.

Harvard University Medical School, Boston, Mass., to whom all books and papers on these subjects should be sent for review.

Melnikow-Raswedenkow. Pachymeningitis Hæmorrhagica Interna. Ziegler's Beiträge, 28: 217, 1900.

In his study of the normal structure of the dura, the author found Weigert's elastic tissue stain of great value. In

the inner portion of the dura the following layers can be distinguished: (1) A single layer of epithelium which covers the inner surface; (2) a hyaloid, fenestrated, elastic membrane, which varies with age and with the individual; (3) the inner capillary network; (4) a layer of connective tissue, mixed with elastic fibers. The dura mater is a peculiar formation and has nothing in common with the plural and peritoneal serosæ.

Internal pachymeningitis is regarded as an inflammation. A fibrinous exudation occurs upon the surface of the internal elastic membrane. Organization of the exudate follows; thin-walled capillaries grow out from the capillary layer and pass through spaces in the internal elastic membrane. Rupture of the newly formed blood vessels is common and hæmorrhage into the delicate connective tissue results.

J. H. P.

Hauck, L. Untersuchungen zur Normalen und Pathologischen Histologie der Quergestreiften Musculatur. Deutsche Zeitschr. f. Nervenheilk., 17: 57, 1900.

Hauck found, in agreement with other observers, that in infants the individual fibers of different striated muscles have practically the same diameter, while in adults fibers from different muscles vary greatly in diameter. The thickness of the fiber is dependent upon the general nutrition of the individual. Rigor mortis causes a decrease in the diameter.

In a series of experiments upon young dogs the author studied the influence of rest, work and enervation upon the size of the muscular fibers. Cutting the sciatic nerve produces simple atrophy of the muscle supplied by it. The width of the muscular fibers is diminished about one-half. Simple muscular inactivity due to ankylosis gives the same result.

J. H. P.

Moser, A. Tuberculosis of the Heart. Med. and Surgical Reports of the Boston City Hospital, II: 194, 1900.

Moser reports a case of tuberculosis of the myocardium, and presents an analysis of forty-five other cases collected from the literature. In the case studied by the author, a firm yellow thrombus, two cm. in size, was found attached to the wall of the left ventricle. The heart muscle was yellow and fibrous. Histological examination showed that the muscle underlying the thrombus was tuberculous, and that tuberculous tissue was growing into the thrombus. The process apparently began with the formation of subendocardial tubercles, which later fused together. Tubercle bacilli were found in over half of the sections examined.

Moser states that the following method of staining tubercle bacilli in sections, devised by Mallory and Wright, is superior to the common method known as the Ziehl-Neelsen: Stain lightly in alum hæmatoxylin; then in steaming carbol-fuchsin two to three minutes; decolorize in one per cent. acid alcohol one-half minute; wash thoroughly in water; dehydrate in alcohol; clear in xylol and mount.

Birch-Hirschfeld, in reporting a similar case of tuberculous mural thrombus of the heart, gave two possible modes of origin: (1) Bacilli wandered into a mural thrombus, or (2) bacilli clung to the heart wall, grew, and formed a thrombus. The latter view was regarded as the more probable, as Ribbert produced endocarditis by injecting into the circulation particles of potato laden with micrococci.

J. H. P.

Fujinami. Ueber das Histologische Verhalten des Quergestreiften Muskels an der Grenze bösartiger Geschwülste. Virchow's Archiv., 161: 115, 1900.

Fujinami studied a large number of cases and found that both cancers and sarcomas invade muscle in much the same way. They may infiltrate between the separate muscle fibers; they may press against the muscle fibers as a mass; or they may be separated from the muscle fibers by bands of connective tissue, thus only affecting them indirectly.

The infiltration by the tumor takes place through the sarcolemma sacs, as well as through the tissue spaces, and through the lymph and blood vessels. The invasion of the sarcolemma sac is especially marked when the infiltration of the muscle is parallel to the muscle fibers, and is much more common in cancers

than in sarcomas. In fact, the round-celled type is the only form of sarcoma in which the invasion of the sarcolemma sac has been observed.

A variety of changes occurs in the muscle fibers as a result of the presence of the neoplasm. Simple atrophy is the most frequent. Usually the muscle nuclei disappear as the muscle fibers atrophy. Sometimes, however, the nuclei increase greatly in number. Multiplication occurs chiefly, if not entirely, by direct division. The nuclei may be found in masses, which may be mistaken for giant cells.

The tumor cells may compress muscle fibers, giving rise to an irregular atrophy, which causes the fibers to assume a beaded appearance.

All the changes which occur in regenerating muscle and which have been regarded as regenerative processes are found in the degenerating muscle. Hence, it is impossible to tell by histological examination alone whether regeneration or degeneration is in progress.

J. H. P.

Benedict, Dr. A. L., Buffalo. Clinical Quantitative Analysis of Proteids in Stomach Contents.

In the examination of stomach contents, thus far, the real function of the stomach, and how well or how poorly

that function is performed, has not been ascertained. It has been learned how much hydrochloric acid remained in excess of that taken up by food; whether a similar excess of ferments was present; how much the stomach had interfered with starch digestion, and when the stomach passed its contents into the small intestine; but the direct issue of the amount of albumin transformed into albumoses and true peptones has been ignored.

The method consists in the successive precipitation of the proteids in solution in the stomach contents and their approximate measurement by centrifugalizing the three precipitates, acid albumin; albumoses and peptones. At first thought, this would seem to be a very simple matter, but I assure you that to place it on a practical clinical basis required a large amount of research and laboratory experiment, as well as interviews and correspondence with chemists. Strangely enough, no analytic chemist seems to have undertaken the problem before. Any physiological chemistry contains directions regarding the reactions of the various forms of nitrogenous matter, but, in practically every case, it was assumed that an unlimited supply, usually prepared artificially, was available. In all instances, the tests were given with the understanding that the investigator would perform them as a matter of scientific curiosity and not with the practical, analytic object of separating and quantitating the ingredients of a mixed mass of proteids. For several years, it has been my custom to take up some special problem, either in physical diagnosis, applied chemistry of digestion, microscopical technic, or some other theoretic topic that seemed likely to yield practical results if properly applied, and to make a winter's study of it. But the problem of proteid digestion in the stomach has occupied two winters, simply because my ignorance of certain scientific details of chemistry compelled me to grope in the dark; while, on the other hand, lack of familiarity with the conditions of medical practice prevented chemists from giving me exactly the information which would have been of the greatest use. I mention this point

only to urge a more general co-operation between the medical scientist and the medical practitioner, in attacking the many problems that lie before us, the solution of which will make medicine more and more an applied science, as well as an art.

One of the difficulties in the way of careful analysis of chyme is the small amount obtainable—not usually over eighty and often less than thirty cubic centimeters, after the ordinary test meals. Free HCl and total acidity can be estimated at one titration, if we are careful and meet with no mishap. Combined acidity requires another titration, proteids another, and at least a small quantity must be reserved for various qualitative tests. While the tests for acidity are best applied to unfiltered chyme, proteolysis requires a clear filtrate, and a considerable loss occurs on account of the mass left on the filter. As a matter of practical experience, I have found that the tests for proteids must be made with ten or sometimes only five cubic centimeters. Filtration, especially if much mucus is present in the stomach contents, is a tedious process. I have tried all sorts of expedients, such as the use of absorbent cotton, separation by a colander, etc., but have not succeeded as yet in obtaining rapid filtration. By centrifugalizing the stomach contents, they can readily be separated into three layers, the lower one consisting of undigested food, the upper one of butter and mucus, the middle one of comparatively clear liquid. By removing the upper layer, the middle one can be decanted and filtered in the usual way, without the delay required if the stomach contents are simply poured into the filter.

There is no natural separation of the various steps of the peptonizing process, but, by common consent, chemists consider that every proteid not precipitated by ammonium sulphate in saturated solution is a peptone, and that everything between albumin and peptone may be called albumose. Of course, the process of peptonization could be further subdivided by using different reagents. To precipitate albumose—or rather albumoses—I add one gram of ammonium sulphate to ten cubic centimeters of decantate, dissolve the salt by heat, and cool. As the mixture cools, a turbidity forms, due to albumose. This is very light and is precipitated only with the greatest difficulty; in fact, I do not usually try to clear it absolutely by the centrifuge, but simply estimate what is thrown down by 10,000 revolutions; 1 per cent. may be taken as the normal maximum.

To precipitate peptones, I employ phospho-molybdic acid, which makes a very bulky precipitate. I should prefer tannic acid, the precipitate from which is only about a sixth as bulky, and tannic acid is the reagent usually recommended by chemists, even in experimenting with stomach contents; but they forget that tannic acid also precipitates starch, which is almost invariably present in chyme. This little oversight alone cost me several months' time, as it necessitated throwing out quite a series of observations. Normally, the precipitate with phospho-molybdic acid is from ten to nearly thirty per cent. of the filtrated chyme. This relatively enormous bulk suggests that something else than peptones is precipitated, and it was only after careful search of chemic literature and consultation with chemists that I became convinced that we could rely on this reagent. Phospho-molybdic acid precipitates alkaloids and certain biliary constituents, but it is impossible that there should be anything of a non-proteid

nature in the filtered chyme, in sufficient quantity to interfere with the result desired. For instance, to show that ordinary saline matters and waste that might be present in the stomach could not cause a precipitate, we need only add phospho-molybdic acid to urine, when we find a reassuring absence of any precipitation.

You will ask what practical result we can derive from such an examination. The method is comparatively simple, and by it we can tell exactly how much digestive work the stomach is accomplishing. In general, we shall find an excess of lower forms of proteids in cases of subacidity and deficient formation of ferments. For instance, in cancer, we should expect at least 2 per cent. of acid albumin, probably as much albumose, and only 5 or 10 per cent. of peptone, by bulk. We must also bear in mind that an excess of an end-product may mean either unusually good digestion or poor absorption.

A. L. B.

GENERAL PHYSIOLOGY.

RAYMOND PEARL.

Books and papers for review should be sent to Raymond Pearl, Zoölogical Laboratory, University of Michigan, Ann Arbor, Mich.

Driesch, H. Studien über das Regulationsvermögen der Organismen. 5. Ergänzende Beobachtungen an Tubularia. Arch. Entw.-Mech. II: 185-206, 1901.

In this paper are collected the results of several sets of experiments on the hydroid *Tubularia mesembryanthemum*, all having as a general problem the

regulatory processes of the organism. The first point considered is the number of tentacles formed in successive oral reparations. In the experiments the polyps were cut off and formed again five times in succession. In each successive reparation the average number of tentacles is less than in the preceding one. The difference in the number of tentacles between the original polyp and the individual resulting from the first reparation is greater than that between the individuals of any of the succeeding reparations. It is believed that this difference between the original hydranth and the subsequent formations is due to differences in nutritive conditions in the two cases. The second point determined was that fewer tentacles are formed on the polyp at the oral end of an aboral piece of stem than on the oral polyp of an oral piece, and that the number of tentacles of a polyp formed at the aboral end of an oral piece was less than in the case of oral polyps of either piece. From experiments with different lengths of stems it appears that, the longer the piece of stem is, the more tentacles the polyp formed on it has. The author repeats his former conclusion that the "red substance" is the "means" by which the regulatory processes are effected in Tubularia. All the facts of tentacle formation are explained as due to the greater aggregation of this formative "red substance" at the oral end of any piece of the hydroid, whether original or secondary (resulting from operation). The next main topic of the paper is the healing of wounds in the perisarc. If the perisarc is removed over a certain area of the coenosarc the wound heals very quickly.

This quick closing of the wound is thought to be due, in the first instance, to the elasticity of the healing tissue. It was found that small pieces of stem without perisarc were capable of regeneration. In some cases pieces about 1 mm. in diameter developed into complete polyps bearing tentacles. The last general subject considered was the reparation of pieces of the stem split longitudinally. The method of carrying out the experiments was to divide the aboral two-thirds of the animal into two cross pieces, and then to split longitudinally the more aboral of these two. The polyps produced by each of the split pieces are symmetrical. The number of the tentacles formed by each of the three pieces was determined, and it was found that the sum of the tentacles produced on the split pieces was always greater than the number produced by the intact, oral pieces of the same animal. The reason for this appears to be found in the relations of the surfaces of the pieces. The sum of the volumes of the split pieces is evidently equal to the volume of the unsplit piece, but the sum of their surfaces stand to the surface of the uncut piece in the relation of $\frac{1}{7}$, as they are approximately cylindrical and of equal length. On the other hand, the relation of the number of tentacles in split and unsplit pieces is $\frac{25.08}{19.36}$. Reducing these two fractions to a common denominator, we have $\frac{19.0}{133}$ and $\frac{17.5}{133}$. The close similarity of these fractions indicates the validity of the conclusion that the number of tentacles formed is directly related to the extent of surface of the formative basis. The paper is one of great interest and importance.

R. P.

Holmes, S. J. Observations on the Habits and Natural History of *Amphithœ longimana* Smith. Biol. Bull. 2: 165-193, 1901.

This paper describes quite fully the behavior and general "natural history" of the amphipod crustacean, *Amphithœ*.

The scope of the work is well indicated by the titles of the sections, which are as follows: "Specific Description, Habitat, Enemies, Food, Movements, Nests and Nest-Building, Moulting, The Seat of Smell, Color and Color Changes, Sexual Habits, The Disposal of Excrement, Timidity and Pugnacity, Phototaxis, Thigmotaxis, The Instincts of the Young, Regeneration, The Effect of Cutting the Animal in Two." Some points of particular interest are: 1. Amount of food eaten. It was found that the animals eat in twenty-four hours an amount of food, as estimated from the excrement voided, equal to approximately one-tenth of their own bulk. 2. Method of keeping a straight course while swimming. The constant state of partial flexion of the abdomen, together with the beating of the pleopods, tends to make the animal move in a curved path while swimming. This tendency is counteracted by the rotation of the body on the long axis through 180° , at frequent intervals. The result of the frequent repetition of this rotation on the long axis is a fairly straight path, having for component parts arcs of circles. This method of keeping a straight course resembles that shown by some of the Protozoa. 3. Nest-building. The nests, which are tubular structures open at both ends and attached to water plants, etc., are constructed from a secretion which is poured out from glands in the first two pereopods. This secretion hardens as it comes out, and is fastened at different points by the pereopods touching their ends to the object on which the nest is being constructed. New nests are built in a very short time, "often

in less than a half hour." 4. Sense of smell. The most important olfactory organs are the first antennæ, but from the fact that there is some reaction to olfactory stimulation after the removal of the antennæ, it is thought that there is a second organ for this sense. The author, however, did not succeed in precisely localising this second seat of "chemo-reception." 5. Color. Descriptions are given of several color varieties of *Amphithæ* which exist in nature and of the relation of the pigments in these varieties. The color changes adapting the animal to its surroundings are less perfect than those shown by the prawn, *Hippolyte varians*, as described by Gamble and Ashworth (*Q. J. Mic. Sci. N. S.* 43: 589-698, and this *Jour.* 4: 1182-1183). 6. Thigmotaxis. *Amphithæ* is very strongly thigmotactic over all parts of the body. The author believes that this thigmotaxis forms the basis of many of the animal's instincts. 7. The young animals soon after hatching show most, if not all, of the instincts and peculiarities of behavior exhibited by the adults.

The paper is a good example of the tendency, which is becoming strongly manifest, to return to the old "Natural History" view point, and, by the application of modern methods of thought and investigation, to attempt to solve the same sort of problems as those at which the "naturalists" of the early part of the century worked.

R. P.

Yasuda, A. Studien über die Anpassungsfähigkeit einiger Infusorien an concentrirte Lösungen. *Jour. Coll. Sci. Imp. Univ., Tokyo.* 13: 101-140, 1900.

This paper deals with the results of a study of the power of acclimatisation of some infusoria to chemical media.

A considerable amount of chemical acclimatisation work has been done on the lower Algæ and Fungi, but hitherto there have been no extensive results from correspondingly low animal forms available for comparison. Some of these needed results this paper presents. As objects of experimentation the following species of infusoria were employed: *Euglena viridis*, *Chilomonas paramecium*, *Mallomonas Plosslii*, *Colpidium colpoda*, and *Paramecium caudatum*. Cultures of these infusoria were put into solutions of milk sugar, cane sugar, grape sugar, glycerin, magnesium sulphate, potassium nitrate, sodium nitrate, potassium chloride, sodium chloride, and ammonium chloride. The solutions of these substances were of different strengths, beginning with very low concentrations and going up to those in which death occurred immediately. In all cases observations were made on the length of time the animal lived in the solution, the changes in structure, the effect on multiplication and movement, etc. Detailed accounts are given of all experiments, but only the most important results will be mentioned here. It was found that in isotonic solutions all the different substances have nearly the same effect on the same organism, but this relation is only an approximate one. The maximal limit of concentration to which infusoria can become acclimatised is considerably lower than in the cases of the Algæ and Fungi. It is noteworthy in this connection that *Euglena* showed the highest resistance capacity of any of the forms studied, while it is of course, structurally, more closely related to the Algæ than any of the others. Increase in concentration is accompanied by a checking of the multiplication of the organisms; by a retardation of the movement; by an increase in the size of the vacuoles, and chromatophores. In strong solutions the body

of the infusorian becomes rounded and uneven in contour, and there is a tendency, as the concentration approaches the maximal point, for the chromatophores or amylum bodies to join together and form large masses.

A method is described for making pure cultures of infusoria. A culture fluid is prepared according to the following formula:

| | |
|---|------------|
| Meat extract | 1 gram. |
| Cane sugar | 20 grams. |
| “ Concentrated, cooked infusion of <i>Porphyra vulgaris</i> ” . | 250 c. cm. |
| Distilled water | 729 c. cm. |

This culture fluid is sterilized and the desired infusoria are introduced into it by means of a capillary tube. The capillary tube can be examined under the microscope, and only that part of it which contains the species wanted is emptied into the culture fluid. The medium is thus inoculated with a single species and by multiplication a pure culture results. This method is stated to be very successful in practice.

R. P.

Moore, A. Further Evidence of the Poisonous Effects of a Pure NaCl Solution. *Amer. Jour. Physiol.* 4: 386-396, 1900.

The purpose of this work is to determine whether pure solutions of various electrolytes have the same poisonous

effects on fresh water animals as they have been shown to have on those living in sea water. The organisms used were young trout, and frog tadpoles. The trout were taken just after hatching and immersed in solutions of known concentrations. The time of death as indicated by the cessation of respiration was noted and the results from different combinations of salts were tabulated. The results are entirely confirmatory of Loeb's work on other forms. It was found that pure solutions of the chlorides of Na, Ca, K, Mg and Li were poisonous. The poisonous effects of NaCl were antagonized by Ca, but the latter was not found, however, to be in itself necessary, since it made a sugar solution more harmful. K did not counteract the effects of Na, but was antagonistic to Ca used in small quantities. Sugar in weak solutions was as poisonous as NaCl in solutions of equal osmotic pressure, while in stronger solutions it was less poisonous. The solutions in which the animals lived longest were combinations of NaCl and CaCl₂, or of these two salts with the addition of KCl. The young trout lived indefinitely in distilled water, showing that no salts are directly necessary for the preservation of life. A point of interest was that in case of the trout the heart beat continued for some time after respiration had ceased. Many of the solutions caused a remarkable shrinkage in the volume of the frog tadpoles kept in them.

R. P.

Galloway, T. W. Studies on the Cause of the Accelerating Effect of Heat upon Growth. *Amer. Nat.* 34: 949-957, 1900.

It is known that an increase of temperature causes an increased rate of growth in many organisms. The purpose of

this paper is to determine whether in accelerated growth due to increase of temperature, the imbibition of water and the anabolic metabolism are equally accelerated, and, if not, which of the two processes is more accelerated. Larvæ of *Rana sylvestris*, *Amblystoma punctatum* and *Bufo americana* were used in the experiments. Fertilized eggs were subjected to three different temperature con-

ditions: (1) 6°–8° C., (2) 12°–18° C. (12°–15° C. in *Rana*), and 22°–25° C. (20°–24° C. in *Amblystoma*). Measurements were made of the length, of the total weight when freed of superficial water, and of the dry weight, and the results were tabulated. It was found that the dry weight is practically unaffected by temperature, and that, therefore, the acceleration of growth accompanying a rise of temperature is almost entirely due to “the changed rate of imbibition of water.” The maximum percentage of water in tadpoles reared in high temperatures is slightly greater than in those which have lived in lower temperatures. The maximum total weight of the animals reared in low temperatures is greater than that of those in higher temperature conditions. Animals kept for seven days in a temperature of 12°–15° and then placed in a warm chamber show a greater rate of increase of imbibition than those which have been in the high temperature from the beginning.

R. P.

Jennings, H. S. Demonstrations of the Reactions of Unicellular Organisms. *Science*, N. S. 12: 74–75, 1901.

In a report of a recent meeting of the Zoölogical Journal Club of the University of Michigan, the author gives an

account of a series of demonstrations by means of the projection apparatus, of some of the more striking facts in the reactions of the unicellular organisms. Among many matters demonstrated, the most important were: (1) The collecting (“positive chemotaxis”) of *Paramœcia* about a bubble of CO₂ and in mineral acids. (2) The spontaneous collections of the organisms, due to CO₂ excreted by themselves. (3) Negative chemotaxis to salt solutions. (4) The absence of orientation in chemotaxis. (5) The “motor reaction” of *Oxytricha*. (6) The essential identity of “positive chemotaxis” and “negative chemotaxis.” In view of certain recent criticisms of the author’s brilliant and fundamentally important results, this record of *demonstrations* of the facts in the case is especially welcome.

R. P.

CURRENT BACTERIOLOGICAL LITERATURE.

H. W. CONN.

Separates of papers and books on bacteriology should be sent for review to H. W. Conn, Wesleyan University, Middletown, Conn.

Eckles. An Abnormal Fermentation of Bread. *Proceedings of the Iowa Acad. of Sc.* 7: 165.

Juckenack, A. Beitrag zur Kenntnis des fadenziehenden Brotes. *Zeit. f. Analyt. Chemie.* Pp. 73–81, 1900.

Several instances of a slimy fermentation of bread appearing a day or two after the baking have been recorded and studied in recent years. Eckles has found the trouble quite common in

a number of localities. The sliminess appears only in bread that is kept warm for some hours after baking, and makes its appearance on the third or fourth day. The bread is disagreeable in odor, becoming quite musty and stale, and extremely slimy. Eckles finds a number of bacteria present in such bread, but concludes that the trouble is due to two species: *B. mesentericus vulgatus* and *B. liodermos*, both of which organisms are found capable of producing such a

sliminess under proper conditions. The last organism produces a greater sliminess, but the first one a yellow color, which commonly accompanies this fermentation. They frequently act together. After studying the various sources which may serve as the cause of this infection, the author concludes that the trouble is probably due to impure yeasts. As a remedy he suggests either the use of purer yeasts, or the simple practice of cooling the bread directly after baking.

The second article here referred to describes a similar fermentation of bread, developing a very unpleasant odor and producing sickness among children when used as food. The cause of this slimy fermentation the author found to be neither of the bacilli mentioned by Eckles, but the well known species *B. mesentericus fuscus*. The author traced the trouble to the flour and attributed the infection to the fact that this flour had been allowed to stand after the milling in a damp, mouldy cellar, where it became impregnated with the bacilli. H. W. C.

Newfeld. Beitrag zur Kenntnis der Smegma bacillus. Arch. f. Hyg. 39: 184, 1900.

Fraenkel. Zur Kenntnis der Smegma bacillus. Cent. f. Bak. u. Par. I, 29: 1, 1901.

Russell and Hastings. The Thermal Death Point of Tubercle Bacilli. 27 An. Rep. of the Agr. Exp. Sta. of Wis.

Rabinowitsch, L. Befund von säurefesten Tuberkelbacillen ähnlichen Bakterien bei Lungengangrän. Deutsche med. Wochenschr. P. 257, 1900.

Korn, Otto. Weitere Beiträge zur Kenntnis der säurefesten Bakterien. Cent. f. Bak. u. Par. 27, p. 481, 1900.

The very great interest which has developed in recent years in regard to the tubercle bacillus and all other bacilli which have the same staining qualities, led the author to institute a careful study of the well known smegma bacillus, which has many points of resemblance to the tubercle bacillus. The smegma bacillus has shown considerable variation as studied by different

observers, and Newfeld attempts to determine whether this indicates a number of species, or simply variations under different conditions. He concludes that among the smegma bacilli that there are at least two types, one resembling the tubercle bacillus, which holds its color in spite of the action of acids, and the other having a similarity to the diphtheria bacillus, whose power of holding the stain is less. In addition, there are numerous varieties which are probably simply polymorphic forms of these two types. These two types remain distinct in spite of changes in the medium in which they grow, but, nevertheless, a change in the sub-stratum produces very noticeable differences in the character of the different bacilli, affecting their power of holding stains in a considerable degree. The smegma bacillus, in short, represents two distinct types, capable of wide variations under different conditions.

Fraenkel has made a study of the same problem. His methods of study have differed from those of Newfeld, but he has reached practically the same conclusion. He finds that there are two types of the so-called smegma bacillus, one resembling the diphtheria bacillus, and the other adhering more closely to the characteristics of the tubercle bacillus. The latter only he regards as the smegma bacillus. He is inclined to believe that the former represents the pseudo-diphtheria bacillus, which has acquired the power of resisting discoloration by acids.

The question of pasteurization of milk for the purpose of destroying pathogenic bacteria is one of great practical interest to the dairy industry. Pasteurization at a temperature of 75° to 85° C, temperatures which have been commonly

employed, unquestionably produce certain changes in the milk and cream which detract somewhat from their value. The question whether pasteurization at a lower temperature of 60° C (140° F) is not sufficient to kill the tubercle bacilli has been investigated by several observers. The authors of this paper have tested this subject more carefully than others up to the present time, and they reach the extremely important conclusion that an exposure of tuberculous milk in a tightly closed pasteurizer for ten minutes to a temperature of 60° C destroys the pathogenic character of the tubercle bacilli that are present. When, however, the milk is exposed under conditions that enable a scum to form on the surface, the organism resists this temperature for a longer time. The authors, however, regard a pasteurization of milk at 60° C, for not less than 20 minutes, under conditions that prevent formation of a scum, entirely sufficient to destroy the pathogenic character of the tubercle bacilli present.

The author finds in a case of chronic pulmonary gangrene a species of bacillus which, in its microscopic appearance and in its staining properties, agrees with the tubercle bacillus. Its culture relations on various media are, however, different from those of the tubercle bacillus. For example, in glycerin agar it produces an intense orange yellow pigment. It is not pathogenic for guinea pigs and seems to be identical with one previously isolated by the author from butter.

This last article describes the characters of a tubercle-like bacillus, found in butter. The chief characteristic of this organism is that it will not grow in gelatin stab cultures at an ordinary room temperature. In this respect, as well as in the fact that it cannot be adapted to room temperatures, it agrees with the tubercle bacillus. For mice and birds the organism is not pathogenic, but for guinea pigs and rats it produces an infection which cannot be distinguished from true tuberculosis. The author believes that this organism, though not the typical tubercle bacillus, is a closely related variety.

H. W. C.

NOTES ON RECENT MINERALOGICAL LITERATURE.

ALFRED J. MOSES AND LEA MCI. LUQUER.

Books and reprints for review should be sent to Alfred J. Moses, Columbia University, New York, N. Y.

Ternier, P. Nouvelle contribution à l'étude cristallographique du cadmium et du zinc métalliques. Bull. Soc. Min. **23**: 18, 1900.

The crystals were obtained by distillation of their metals in a vacuum at low temperatures.

Zinc crystals were very small (less than 1 mm. diam.), quite clear and in hexagonal tablets, with periphery formed of rhombohedral facettes. $c = 1.356$. Nine forms noted.

Cadmium crystals showed a marked similarity to those of zinc, with $\bar{c} = 1.335$; the zinc crystals, however, sometimes showed two prisms. Seven forms noted.

Both metals also yielded spherulitic aggregates with polyhedral facettes; and when the cooling was rapid showed confused, interlaced aggregates, with the free surfaces of the globules remaining spheroidal.

The "slipping figures" obtained with a needle point upon these facettes, were also discussed, their hexagonal nature being undoubtedly proved.

L. MCI. L.

Goldschmidt, V. Ueber Erkennung eines Zwillingings. Zeit. f. Kryst. **30**: 346-351, 1898.

In previous numbers* reference has been made to the two circle method of

measuring crystals and the gnomonic projection used in conjunction therewith. It may therefore be of interest to see how these can be applied to the recognition of twinned crystals.

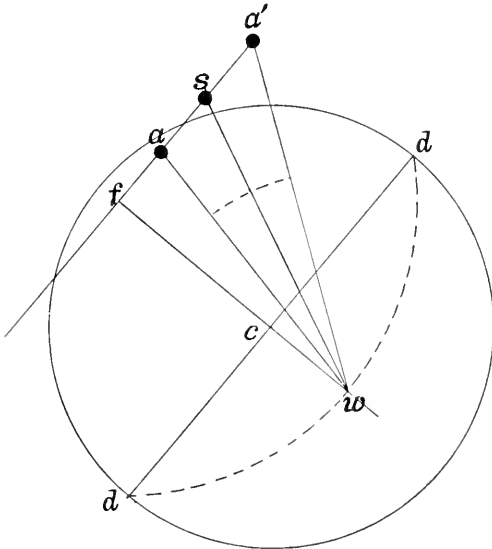

The crystal is measured with one individual in normal position, with its prism zone normal to the vertical circle. Symbols are obtained for this individual in the usual manner, and then for the other either by comparison with the first or by separate setting up and measurement. The gnomonic projection is then made and the corresponding faces distinguished for instance by *a a*, *b b*, *c c*, etc. If the grouping is a twinning there will be found a symmetry point *s* at the intersection of the zones connecting corresponding faces of the two individuals, and this point *s* will bisect the angle between any

two corresponding faces. Furthermore it will be the pole of an important face or zone or, rarely, at 90° to such a face or zone.

If the poles of two corresponding faces are superposed, then *s* is either coincident with these or at 90° thereto.

If the two poles, *a b*, of one individual coincide with two, *a' b'*, of the other, then *s* is the pole of the zone *a b*.

When it is not known which points are equivalent several poles of the one are connected by straight lines with one pole of the other, then all of the first to a second point of second, then to a third point, and so on. If several lines go through a common point, especially if it is the pole of an important face or zone, then the test is made whether this point bisects the angle between the two poles on any line.

The graphic determination of this equality in angle, and indeed the graphic measurement of the angle between any two faces in gnomonic projection, consists in finding the stereographic projection of the pole of the zone of the two faces

* Vol. 3, Nos. 2 and 7.

(this Goldschmidt calls the angle point) as follows, see Fig.: Let $a a'$ be the zone. Draw the diameters $d d'$ parallel to $a a'$ and $f c$ perpendicular to $a a'$. From f with radius $f d$ describe an arc. The intersection w with $f c$ is the desired pole of the zone $a a'$ and the angle $a w a'$ is the true angle between a and a' , and if s is a point of symmetry, then $a w s$ must equal $a' w s$.

In most cases the opposite faces are equivalent faces: sometimes, however, as in case of positive and negative tetrahedra, they are not equivalent. If the poles equidistant from the point s are non-equivalent, s is the pole of a plane of symmetry, but if the equidistant poles are equivalent s is the rotation point.

If no point of symmetry is found the group is not a twinning.

If s is known it may be made the pole face and the measurements so obtained will give corresponding points equidistant from s in the projection. A. J. M.

Stöber, F. Sur un procédé pour tailler des grains minéraux en lames minces. Bull. Soc. Min. **22**: 61, 1899. On account of the objections to the opaque cements of Thoulet and Mann, the author uses Canada balsam for cement and describes a quick, convenient way of mounting and grinding the grains, so as to obtain thin sections. L. MCI. L.

Wallerant, F. Perfectionnement au réfractomètre pour les cristaux microscopiques. Bull. Soc. Min. **22**: 67, 1899. Author describes apparatus as modified by Czapski.

Mallet, F. R. On Langbeinite from the Punjab Salt Range. Min. Mag. **12**: 159, 1899. Author concludes that the potassio-magnesian deposit, at the Mayo mines, consists of langbeinite ($2 \text{ Mg. So}_4 \cdot \text{K}_2 \text{ So}_4$), intimately mixed with kieserite, picromerite and epsomite. L. MCI. L.

Fletcher, L. On a Mass of Meteoric Iron from the neighbourhood of Caperr, Rio Senguerr, Patagonia. Min. Mag. **12**: 167, 1899. This is the first meteorite recorded found in Patagonia, and its latitude is the furthest south recorded for meteoric iron. L. MCI. L.

Hillebrand, M. F. Mineralogical Notes. Melonite (?), Coloradoite, Petzite, Hessite. Am. Jour. Sci. iv. **8**: 295, 1899. The *Melonite* (?) gives formula Ni Te_2 , but has same physical characters and is supposed to be identical with Genth's melonite ($\text{Ni}_2 \text{Te}_3$) from the same source in California. L. MCI. L.

Medical Notes.

A POINT IN THE TECHNIQUE OF BLOOD COUNTING.—I noticed an article in the December number of the JOURNAL, in which the complaint is made that the cross lines in the Thoma-Zeiss Blood Count Apparatus are indistinct under the microscope. Will you allow me to make a suggestion, which is very simple, but which I have found to obviate this difficulty entirely? It is to lower the Abbe Condenser far below the usual position for using it, until the lines stand out distinctly. Possibly every one has discovered this for himself, but as I have not seen it mentioned, and it took me some time to formulate it into a rule for myself, I hope some one may be helped by the hint.

Willebrand, E. H. Stain for Simultaneous Staining of Blood Smears with Eosin and Methylene Blue. *Deut. Med. Wochens.* Jan. 24 and 31, 1901.

| | |
|---------------------------------|-------------|
| Eosin, 0.5 per cent. alcoholic, | 25 c.c. |
| Methylene Blue, con. aq. sol., | 25 c.c. |
| Acetic acid, 1 per cent., | 10-15 drops |

The erythrocytes are stained red, nuclei blue, neutrophile granules violet, the eosinophile granules red, and those of the mast cells an intense blue.

C. W. J.

Lewinson. Method of Staining Fat. *Vratch,* 21, No. 39.

1. Fix in Müller's fluid for two to three weeks.
2. Dehydrate in successive changes of alcohol, commencing with 70 per cent.
3. Imbed in celloidin.
4. Stain sections of 10 to 15 μ for twelve hours in following solution :

| | | | | | |
|-----------------------------------|---|------------------------------------|---|---|-----------|
| Hæmatoxylin | - | - | - | - | 2 grams |
| Alcohol, absolute | - | sufficient to dissolve hæmatoxylin | | | |
| Acetic acid, 2 per cent. solution | - | | | | 100 c. c. |
5. Wash in water.
6. Transfer to 1 per cent. solution permanganate of potash and leave 10 to 15 minutes.
7. Wash in water.
8. Oxalic acid, 2 per cent. solution for five minutes.

If sections remain yellow or brownish black, carry through the permanganate of potash and oxalic acid solutions again. If no fat is present the sections are colorless. If sections contain fat they are slightly ashy or gray-violet in color. Under the microscope the fat appears gray-violet, while all other structures are unstained.

The following counterstain may be used :

1. After removal from oxalic acid solution, wash in water and stain for 24 hours in an ammonical solution of borax-carmin.
2. Acid alcohol 1 per cent. for 2 minutes.
3. Saturated alcoholic solution of picric acid, 1 minute.
4. Clear in alcohol, xylol, or oil of organum.
5. Mount in Canada balsam.

Nuclei are stained red, protoplasm yellow, and the fat dark, almost black.

C. W. J.

Kockel. New Stain for Fibrin. *Verhandl. d. Deutsch. Path. Gesell.* 11 : 320.

1. Stain with Weigert's hæmatoxylin.
2. Counterstain in Weigert's borax-potassium-ferricyanide solution, diluted with three times its volume of water.

Fibrin stains dark blue, background light gray or bluish.

It is recommended that tissues be hardened in alcohol, sublimate or formalin before being stained by this method.

C. W. J.

NEWS AND NOTES.

At the January session of the New Jersey State Microscopical Society, Dr. Byron D. Halsted read a very interesting and instructive paper on "The Movement of the Sap in Plants." The paper was followed by a fine series of lantern slides. During the past year it occurred to Dr. Halsted to prepare a list of questions concerning sap, any one of which might naturally occur to the "average layman" if he chanced to give the subject a little consideration. "What causes sap to rise in plants?" "Is there more than one kind of sap?" "Where is the sap in winter?" and a number of other questions of a like nature. Answers were received from representatives of a considerable number of professions and made rather interesting reading. Suffice it to say that the botanist was led to believe that a paper on the subject would not be amiss.

J. A. KELSEY, Secretary.

Recent experiments for obtaining pure cultures of algæ have shown that Cyanophyceæ grow rapidly and luxuriantly in a decoction of *Zamia*, with the addition of peptone and sugar.

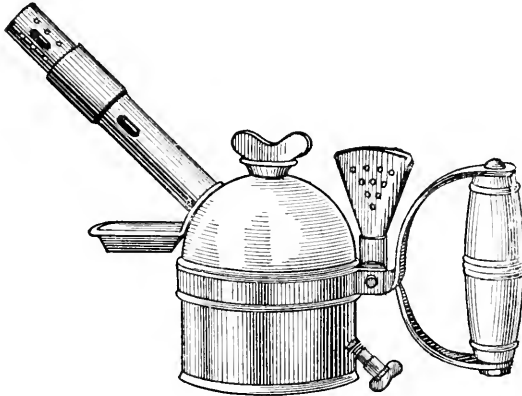

THE "QUEEN" TORCH.

The accompanying figure represents a device which may be used as a suitable lamp for field work, and also as a substitute for the blast lamp in laboratories where gas is not available. A torch designed to meet the same purpose was figured and described by W. J. Morse in Vol. III, p. 986, of the JOURNAL. The "Queen" torch, manufactured by the Bridgport Brass Co., has two burner tips; one for a round and one for a "fish-tail" flame. There is an attachment for regulating the flow of gas, allowing the flame to be turned down while not in use. This improved torch is recommended by Prof Morse as one which satisfactorially serves all purposes for which it was designed.

In Vol. IV, No. 1, p. 1129, the name of Prof. J. G. Adami was erroneously given as Prof. Adann. In the same reference the first sentence of the third paragraph should state that the pamphlet "How to Collect Mosquitoes" was issued by the British Museum and sent to the Montreal Nat. Hist. Soc.

Journal of Applied Microscopy and Laboratory Methods.

VOLUME IV.

APRIL, 1901.

NUMBER 4

The Laboratory Equipment of the "Bahama Expedition" from the University of Iowa.

The problem which confronted the originators of this expedition was the very common one of getting the greatest possible educational results for a very small expenditure of money. The plan was to furnish a floating laboratory and home for a class of university students which should lack no really necessary thing for comfort and reap the best results from a scientific standpoint. It was determined, moreover, to work in the best possible field and to extend our operations

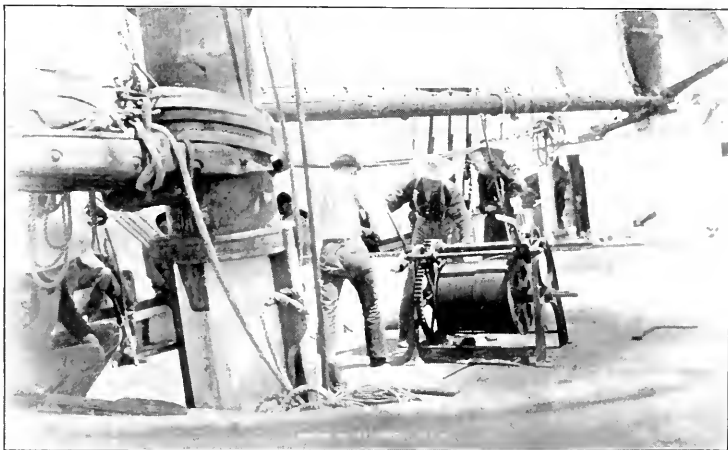

HAULING UP THE DREDGE.

down to a sufficient depth to reach the deep water fauna. That such a plan should originate in a university that is almost in the geographical center of the United States is not so strange as might at first appear, for the reason that we of the interior feel more deeply, perhaps, than our brothers of the coast, the immense advantage of study of marine life to those who would grasp fundamental biological facts, and if it was necessary to take a class over a thousand miles to reach salt water at all, we argued that we might as well go a thousand miles

farther while we were about it and reach one of the richest marine faunæ on earth, that found in the West Indian region.

In the choice of a vessel our poverty did us a real service in compelling the selection of a sailing vessel instead of a steamer. For such a service the sailing craft has several important advantages over the more modern type, and, so far as our experience went, very few disadvantages. In the first place our party would have required a much larger vessel if it had been necessary to provide room for engines and fuel for such a cruise, and with a larger vessel we could not have gone to some of the most delightful places that we visited. Again, the smoke, dirt and heat of a steamer would have been most uncomfortable in the heat of the tropics. On the other hand, it is remarkable how efficient wind

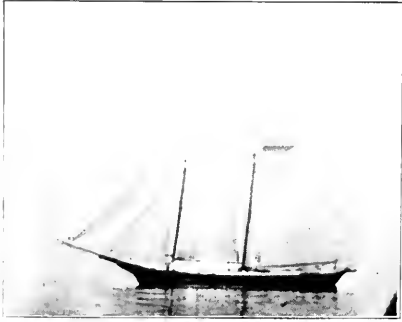

THE "EMILY JOHNSTON,"
CHARTERED FOR THE "BAHAMA EXPEDITION."

propulsion is when the skipper knows his business, and ours did. A biological party is never at a loss for work in case the vessel becomes becalmed in the West Indian region. In such a case there is always enough animal life at hand to be secured with the dip-net or the tow-net worked from a row-boat if at sea, or by a landing party if at anchor. As for dredging, any sort of a wind will answer for that, and our work was fully as successful as it could have been with steam.

Our vessel was an ordinary fruiting schooner from the Chesapeake, of the type known as a two-masted, double-topsail, centerboard schooner, with a net tonnage of 116 tons. She was 95 feet long, with 26 foot beam and a depth of hold of 7 feet. Although not notable for speed she was not slow, and was remarkably staunch and "dry" in rough weather. She had four state-rooms and a toilet room opening into a small cabin aft. The rest of the hold was ballasted with pebbles and a flooring was laid over the ballast. Along the sides of the hold were arranged the bunks for the men in two tiers with curtains in front like those in a sleeping car.

The stores, and these were gradually replaced by the collections, were stowed forward, leaving a large space between the stores and the after bulkhead for the laboratory, library, and dining-room. A door leading from the cabin to the hold divided the after bulkhead into two nearly equal parts. On one side of this door were the shelves for the microscopes, and on the other was the "library" containing the "Challenger" and "Blake" Reports, a number of text-books, and all the works concerning the sea that were contained in the university library. The



VISITORS ABOARD.

larger volumes were covered with black oil cloth and lettered with white paint, a most valuable precaution.

Two deal tables 20 by 4 feet, with ledges around them, accommodated the whole party either as dining or laboratory tables, the light from the sky-light being ample by day and four large swinging lamps serving at night, although but little laboratory work was done after dark.

A small dark-room for photographic work was enclosed on the starboard side next to the library shelving, and this room was as near purgatory in the heat of the tropics as one would be willing to endure, even in the cause of science.

The main, and altogether the most comfortable, laboratory was on deck. The cabin top was just high enough to serve as an excellent table to work at in a standing position, was almost flat, and large enough to accommodate the entire party at once when necessary. After we got into the warm region of the West Indies, this cabin top served as a bed for most of the party, and the bunks below were permanently deserted except in rainy weather, of which there was very little.

When at anchor the vessel was covered with an awning reaching from the foremast to the stern, and a cooler or more convenient laboratory would be hard to devise. Of course it was not provided with running water, but the very purest of sea water was easy to secure in any quantity by simply dipping it up in buckets. An abundance of tubs, buckets, tin pans and glass dishes was provided, as well as suitable instruments for dissection. We had a dozen laboratory microscopes of convenient type for dissection, and the same number of compound

instruments, although it seldom happened that all of these latter were used at any one time. For any special investigation demanding a better instrument we had a high-grade microscope with a 1-12th oil immersion lens. Histological work, beyond the examination of fresh tissues, was out of the question, under the circumstances, and would have been less profitable than the study of living organisms even had it been practicable.

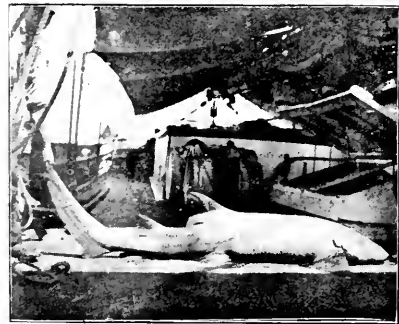

A CATCH.



SPOILS FROM LAND AND SEA.

As to our plan of work, it was, as is always the case where wisely directed, determined by the varying and unforeseeable conditions that daily confronted us. In other words, we studied that which was at hand in greatest abundance, or that which seemed most instructive. When under sail we depended largely upon the dip-nets for material.

One day, for instance, was devoted to a study of the Sargosso weed and its

inhabitants. A better object lesson in the matter of protective coloration it would be impossible to find anywhere, the "weed" at first seeming to be uninhabited, but afterwards disclosing no less than twenty-six species to which it gave shelter and protection. On another day we were sailing through countless millions of the little medusa *Linerges mercurius*, carefully described and figured by Dr. Fewkes. Here was an excellent chance to become acquainted with the medusa structure. Again, we made a careful dissection of a species of shark which was wonderfully abundant near the Dry Tortugas; and one day our pilot ran the vessel aground on a sandy bottom thickly strewn with an immense starfish, *Pentaceros reticulatus*, which gave us the best possible chance to study the anatomy of the Asteroidea. Still again, we had the unique pleasure of studying fully expanded *Millepora*.

The more serious work of the expedition was in the line of dredging in comparatively deep water. Those who were informed in the science of deep water dredging were, for the most part, inclined to smile quietly, but still significantly,

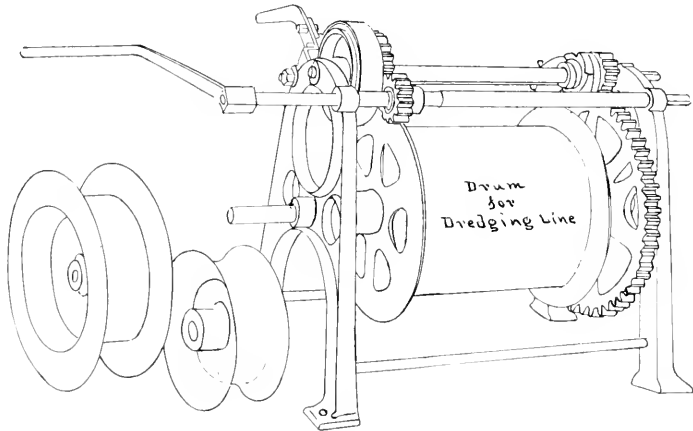

REELS FOR SOUNDING LINE. HAND "CRAB" USED IN DREDGING.

at our audacity in undertaking such work without steam either for propelling the vessel or hoisting the dredge. Perhaps it was a case where "fools rush in," etc., but we were nevertheless entirely successful, and probably secured as many interesting things from the deep water fauna as any expedition has obtained in the same length of time.

Our equipment for dredging was, briefly, as follows:

The power necessary to handle the dredges, trawls, tangles, etc., was furnished by a hoisting machine technically known as a "crab," which was a sort of windlass worked by hand, constructed after plans devised by Professor Weld of the University of Iowa.

It consisted essentially of a horizontal drum fifteen inches in diameter and thirty inches long, resting on a heavy iron frame bolted to the deck. This drum was provided with a single and double purchase for cranks, by which a sufficient power could be applied to meet every demand likely to be made upon the machine. The lowering of the dredge was regulated by a powerful friction brake. Upon

the drum was reeled something over three hundred fathoms of cast steel rope, not a foot of which was lost during the entire trip.

Of course the reeling in of this rope with a heavy dredge at its end under the direct heat of the tropical sun was no child's play, and taxed the endurance of even the most enthusiastic. But it was done, and to good purpose. Incidentally, it may be remarked that in my opinion this work had a good deal to do with the excellent physical condition of the men during the cruise.

Dredges of the regular "Blake" pattern were used. These and the trawls, also practically like those used on the Blake, were made in the engineering department of the university at surprisingly small expense. Trawls, however, are of little use where the bottom is rocky, as was the case almost everywhere in that

region at a depth of from fifty to two hundred and fifty fathoms. By far the most effective instrument, and the one upon which we eventually depended almost exclusively, was the tangles, made after a pattern suggested by Dr. James E. Benedict of the National Museum. This proved such a decided success that I may be excused for giving its construction in detail. A four-foot length of 1 x 2-inch iron bar is bent in the middle at nearly a right angle. Five iron rings are bolted at regular intervals to the inner side of this bar, and to each ring is fastened a two-foot length of fairly heavy chain. Through each link of these chains is passed a six-foot strand of $2\frac{3}{4}$ -inch Italian hemp rope, each strand being tied in the middle and thoroughly unraveled throughout its length.

The dredging cable is attached to a hook bolted to the outer side of the angle of the bar. The amount of material secured by this device was astonishing, and included all sorts of things from corals to fishes, quite a number of the latter being secured in this way.

Being provided with several of these tangles, we were able to economize time by detaching one from the cable as soon as it came up, and sending another down to be at work while we were picking over the first one. Many hands made this



DREDGING ON "POURTALES PLATEAU."

usually irksome labor light. Each student had a particular group of marine animals to look after, and he was responsible for the care of all of the material in his group, and had prepared himself to do just that work. The result was that the collections as a whole came through in very good shape.

We were astonished to find the amount of knowledge of the various groups



LETTING DOWN THE DREDGE.

that was acquired from the mere handling of quantities of material, and sorting it out. Indeed, this seemed to me to be the most thoroughly educative factor involved in the expedition. Again, one must have the actual experience to realize the difference in the instruction derived from museum specimens and those taken fresh from their proper habitat. For instance, we were all astonished at the bright colors of the deep-sea forms, and impressed with the manifestly adaptive nature of these colors, because not only a given species but also the associated forms were brought up together, making manifest the fact that these colors were very often protective.

Such facts would never have been suggested by the study of museum specimens, no matter how abundant and well preserved they might be.

Of course we had to depend almost exclusively upon alcohol as a preservative, formalin not having yet come into use. An excellent device for saving alcohol and weight was carried into effect at the suggestion of Dr. Benedict. This was simply to take specimens after they had been for a few days in alcohol and solder them up in large tin pans, two of which were soldered together by their broad flat rims. These pans were both square and round, and could be conveniently crated when sealed. Specimens preserved in this way often came through in better shape than when left in alcohol.

It may be of interest to some of your readers to be informed that the entire cost of this expedition to each member was almost exactly two hundred dollars, including fare from Iowa City to Baltimore and return, and every necessary expense during a three months cruise. There was no accident or misfortune of any kind, and no sickness except the inevitable sea-sickness.

C. C. NUTTING.

State University of Iowa.

A Description of the New Wing of the Laboratory of Hygiene at the University of Pennsylvania.

As an immediate result of the increasing interest in the science of bacteriology, the construction of suitable laboratories for its pursuit has come to be a subject of no little importance. At present there is of necessity more or less experimenting in this line, and the results obtained by one institution are of value to other institutions contemplating the erection and equipment of laboratories and lecture-rooms for the work.

Dr. A. C. Abbott, Professor of Hygiene and Bacteriology at the University of Pennsylvania, has recently contributed a detailed description of the new addition opened a year ago for the instruction of bacteriology in that institution. In planning the building, the primary object was to provide a lecture-room with seating capacity for not less than three hundred students, and a laboratory sufficiently large to accommodate not less than seventy-five students working at one time. Externally, the structure as completed is of red brick trimmed with brown stone and terra cotta, and two stories high; conforming in lines and finish to the original building. Internally there were three features of construction

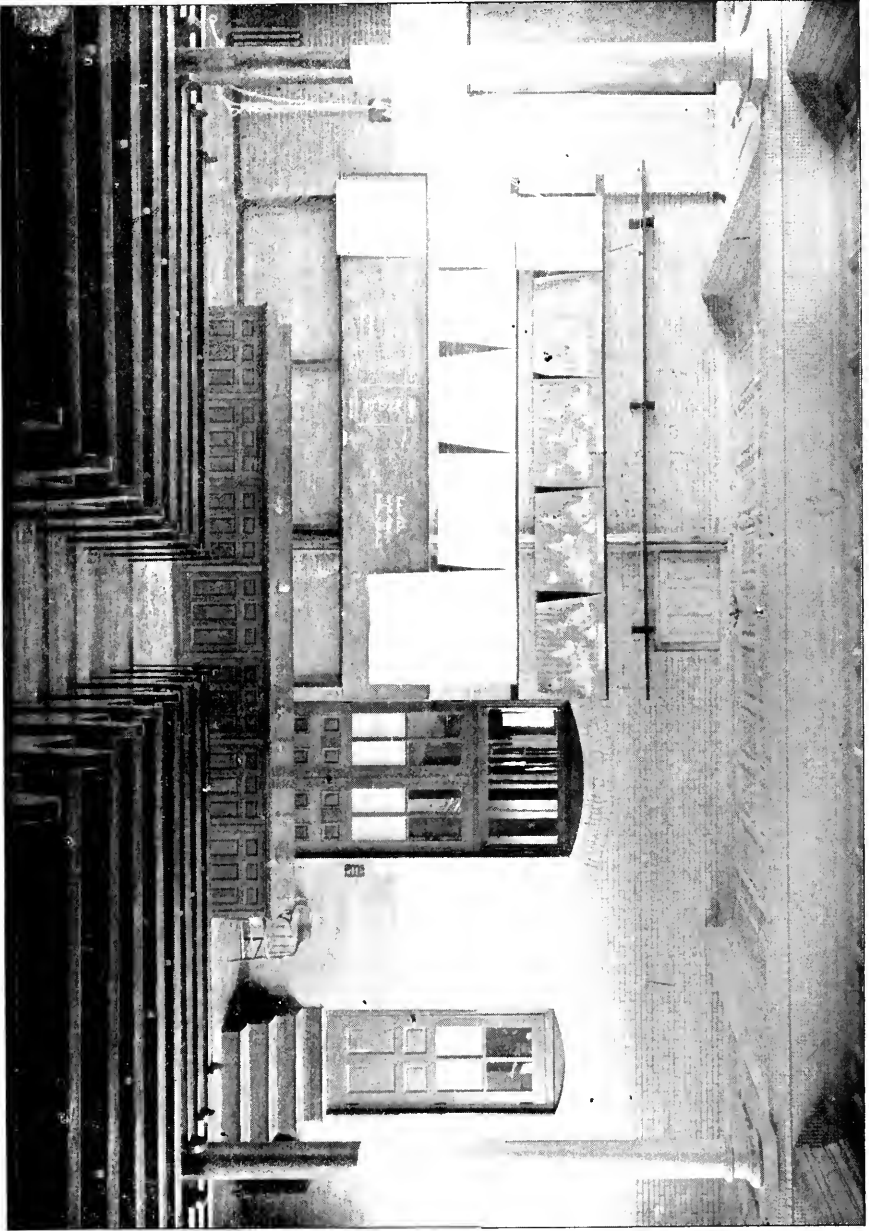

Fig. 1.—Lecture room, looking toward the instructor's table.

which were insisted on, and which there have been thus far no reasons to regret. They are: hardwood floors, steel ceiling for the lower room, and walls devoid of plaster. Hardwood floors were adopted more for economy than elegance, maple being preferred to yellow pine as it is less apt to splinter with hard usage, even though it is given much less care. The floors are well laid, stained, oiled and varnished.

Experience has shown that plaster ceiling is liable to fall at any time should, through accident, which is not rare, the floor of the room above become flooded with water. Plastered walls, unless painted, become soiled very quickly, and are difficult to clean; and if painted, this must be repeated from time to time, thus incurring constant expense. The objections that bare brick walls reflect less light, and favor the condensation of moisture upon them, are readily met by the use of light colored, smooth brick, and laying them with an air space between external and internal walls.

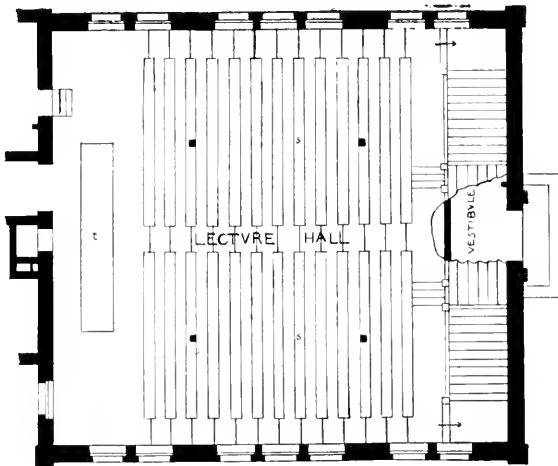

Fig. 2.—Lecture room. (s) seats; (t) instructor's table.

The first floor is occupied by a lecture-room 52 x 56 feet, to which students gain access directly from without through a vestibule doorway, while the instructor may enter behind the lecture-table directly from the laboratory hallway, or, by a door to the left of this, from the adjoining preparation room. (See Figs. 1 and 2 for general arrangement.)

The seats, with a capacity of 310, extend straight across the room, rising on 8- to 9-inch steps from the lecture-table to within 9 feet of the opposite wall. They are comfortable church pews of oak, with antique finish, 2' 8" from back to back, and each one subdivided by cast-iron arm rests 19" apart; the object of this being to ensure sufficient room for comfort to each individual, and also to discourage any tendency on the part of the occupants to lounge. There is a center aisle of 2' 8", and an aisle 3' 6" in width along each lateral wall. The ceiling, 17' 6" high at the point occupied by the instructor's table, is of paneled steel, painted with zinc paint to match the lighter parts of the walls, which are

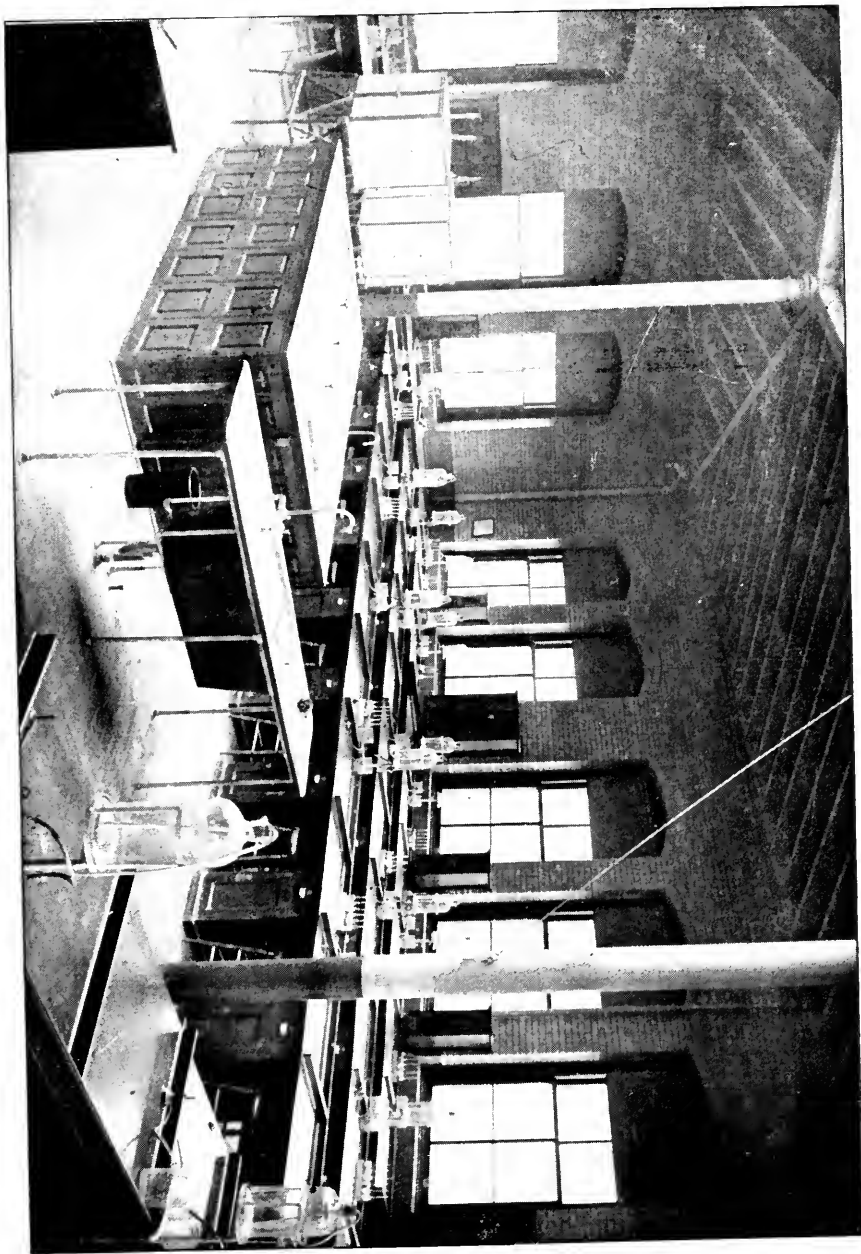

Fig. 3.—Laboratory, showing arrangement of desks, tables, etc.

of light buff pressed brick, laid in mortar of corresponding color, and smoothly finished. For a distance of five feet above the floor the color of the brick is a chocolate.

Illumination is supplied by rows of windows extending up to the ceiling on the east and west walls; in addition to which electricity is provided for use on dark days and at night.

Ventilation is through a large stack heated by steam coils. Heating is in part by direct radiation from steam radiators, and in part indirectly from large steam coils placed beneath the perforated stairways entering the room. Besides a large lecture-table provided with gas, water, and sinks, the instructor has at hand movable racks for the exhibition of diagrams used in the lectures.

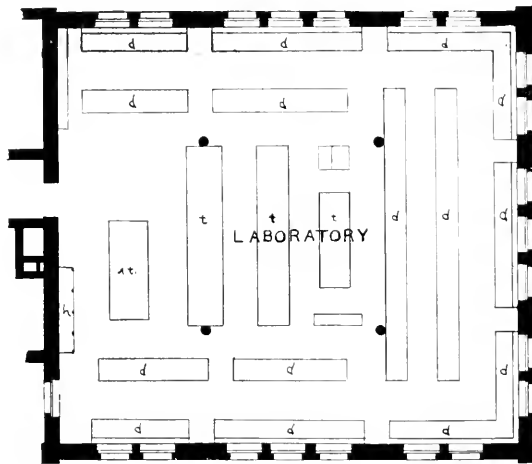

Fig. 4.—Laboratory. (d) desks for microscopical work; (t) tables; (i. t.) instructor's table; (h) hood.

A laboratory for practical work in bacteriology occupies the second floor, immediately above the lecture-room. The walls and floor are similar to those of the room below. The ceiling increases in height from the walls, where it is 14 feet, to the center of the sky-light, where it is about 24 feet. With a large sky-light, and with windows in the three walls, the illumination of this room is all that could be desired. The room is heated by steam, is well ventilated, and has a capacity of 83 students working at one time. The arrangement of the desks may be seen in Figs. 3, 4, and 5. Parallel with the east and west walls are two rows of desks with an aisle of 5 feet between them, while across the southern end there are three such rows separated by aisles of 3' 6". These desks, each one 3' wide, 2' 3" deep, and 2' 8" high, are made of poplar, and are joined together in sets of from four to six, as convenience required. On the low partition (about 2" high) dividing one desk from another, are gas and water, the latter being syphoned from large bottles, held in suitable iron racks. This plan is regarded as preferable to water-taps from the regular house supply, as the latter, even though filtered, is often objectionable, while the bottles can always be kept filled with distilled water. It also eliminates the frequent annoyance of

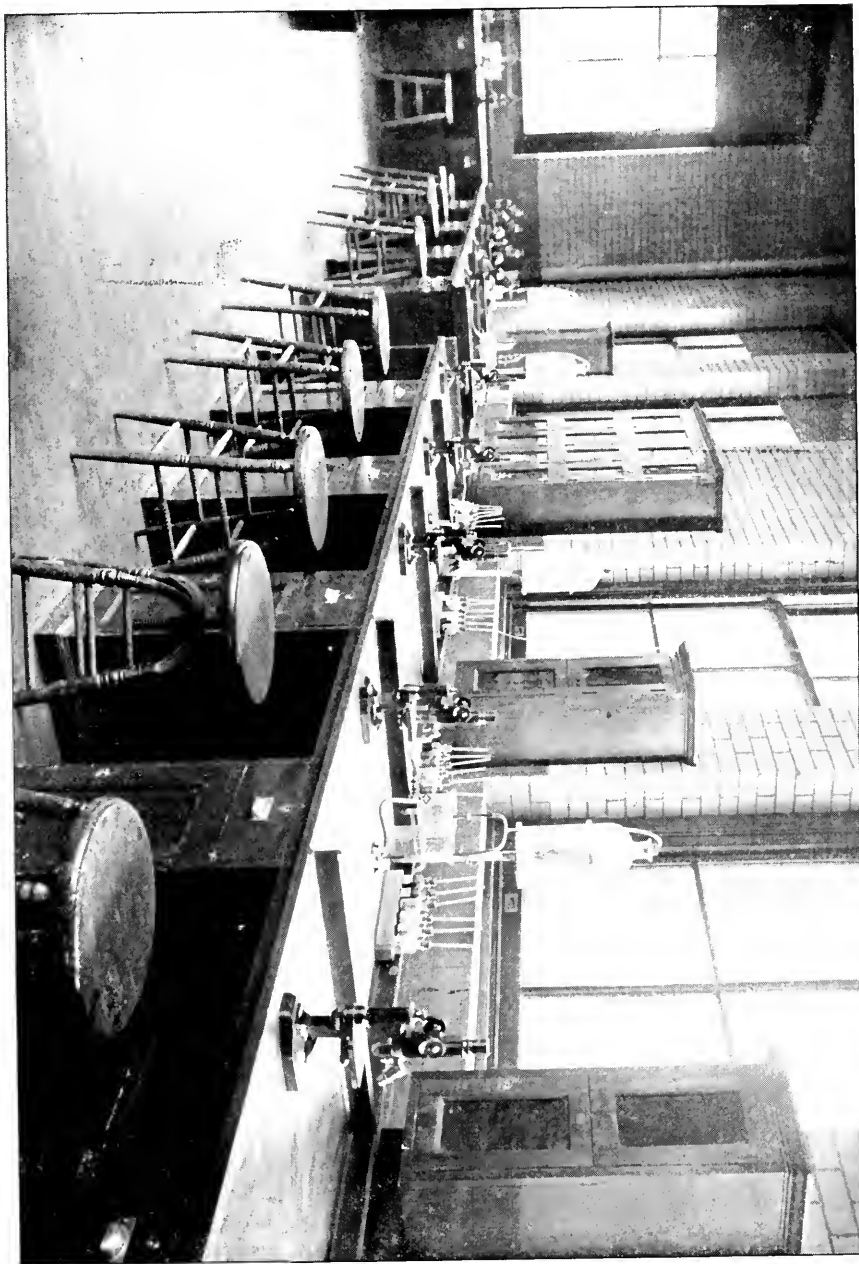

Fig. 5.—Desks for microscopical work.

obstructed drain pipes. Each desk is supplied on the right hand side with a drawer and locker one foot wide, extending through the entire depth of the desk; while beneath the top of the desk and well out of the way is a shelf, inclined toward the back, and large enough to accommodate an overcoat and a hat, thus obviating the necessity of special coat lockers.

The bodies of these desks are, like all other wood fittings of the room, finished in the natural color of the wood, oiled and varnished. The tops of all desks and of the tables in the room are finished in black, with lamp-black and paraffin. This finish has been found superior for laboratory purposes to any other, and is obtained by rubbing into the freshly dressed desk top a mixture of lamp-black and turpentine until the wood is thoroughly soaked with it. All excess of the black is then carefully removed by thorough rubbing with cotton waste, or with old rags. After this, paraffin of a high melting point is ironed into the wood with a hot iron. The excess of paraffin also is finally removed by thorough rubbing. The result is a comparatively dull black finish, very restful to the eyes, an excellent background, and a finish that is not injured by the ordinary chemicals, staining solutions, or warm objects that may get upon it. Under no circumstances should a laboratory table or desk be varnished. The tops of the desks are not screwed or nailed to the bodies in the ordinary manner, but are held in place by screws passing through slots in such a way as to allow the wood to shrink without cracking. There are no angles to tops of desks, all corners being rounded to facilitate cleaning.

On three walls of the room are glazed lockers for microscopes, each one bearing a number to correspond with a desk. The glazing of the lockers admits of ready inspection of contents by the instructor, without his being obliged to open the lockers. Each student on entering the laboratory for work is supplied with a desk, a locker and the keys for the same, for all of which he is held responsible. The equipment of each desk consists of a microscope of approved pattern, including an oil immersion lens, staining reagents, test-tubes, dishes, funnels, flasks, a gas stove, a Bunsen burner, and in short all the apparatus, except slides, coverslips, towels, notebooks, etc., that are necessary to pursue the course. No charge is made for any apparatus unless injured or destroyed.

In addition to the desks there are four large tables in the laboratory that are used for such work as the preparation of culture media and the demonstration of autopsies, dissections, etc. These are supplied with sinks, hot and cold water, and gas. Beneath these tables are lockers for the use of students, each locker being numbered to correspond with a particular desk.

On the north wall of the room are the necessary shelves and closets for apparatus and materials, and to the right of the door leading into the room is a commodious glass hood, the framework of which is of iron, the base of soapstone, and the back of brick. This hood is provided with gas, water, and aspirating flues. The glass inclosing such a hood should never be cemented firmly in the frames, as it is sure to crack by the expansion and contraction of the surrounding metal. It should be either loosely set, or set in some elastic material, that will relieve the strain upon it. The total cost of the addition to the original building was a trifle over fifteen thousand dollars (\$15,001.25). C. W. J.

LABORATORY PHOTOGRAPHY.

Devoted to methods and apparatus for converting an object into an illustration.

THE VALUE OF THE TELEPHOTO LENS.

The value of the telephoto lens to the naturalist has been shown in many ways. Photography has reached such a stage that it is impossible for a naturalist to do without it. In order to do the best work it is necessary to carry several lenses, or combinations which will produce both long and short focus, depending on the object to be taken.



PHOTOGRAPH MADE WITH ORDINARY PHOTOGRAPHIC LENS.



PHOTOGRAPH MADE WITH SAME LENS AND THE TELEPHOTO.

The accompanying pictures show how a telephoto lens was necessary to secure a picture of an osprey's nest which was in the top of an old pine tree, around the base of which there was a dense jungle of underbrush. The view

shown across the river is the only view to be had of the nest from this near distance without having the foreground so full of limbs as to obscure the nest.

The location is on the north end of Flathead lake, in western Montana. The nest is in front of the University of Montana Biological Laboratory, which is immediately behind the illustration. That is, it is at the photographer's back. The river in the foreground is Swan river, or Big Fork. It is swift and turbulent. There is no place on the opposite shore where the camera may be placed so as to take in the nest. The nest is about a hundred feet from the ground.

The picture with the nest small was taken on a Seed orthochromatic plate, on a cloudy day when rain was falling. Without changing the camera the telephoto lenses was added, and the camera was pointed so as to put the nest in the middle of a five by eight plate, and the magnification raised to five. Naturally the exposure was porportionally longer. The sky was overcast, and rain was falling. Indeed, it was necessary to notice that water did not get on the lens. Only the small opening seen between the trees was taken by the telephoto, and the background was clouds. While a longer exposure would have produced a better result for definition, the two pictures show how inaccessible objects become accessible by the use of this lens.

The pictures were taken in August, 1900. Many of these nests are found in this vicinity, and it is said this nest has been used by wild geese in times past. The nest has been used by ospreys for two years past, the birds being the objects of study by the students at the summer laboratory.

University of Montana.

MORTON J. ELROD.

MICRO-CHEMICAL ANALYSIS.

XII.

THE ANALYTICAL REACTIONS OF GROUP II.

Ca, Sr, Ba, — Gl, — Mg, Zn, Cd, Hg.

CALCIUM.

The following reagents will be found to be the most useful of those which have been proposed for the detection of this element :

- I. Sulphuric acid.
- II. Oxalic acid.
- III. Sodium tartrate.
- IV. Potassium ferrocyanide.
- V. Arsenic acid.
- VI. Primary sodium carbonate (HNaCO_3).

I. Dilute Sulphuric Acid added to solutions containing salts of Calcium, leads to the separation of hydrated Calcium Sulphate.



Method.—To a drop of the solution to be tested, add a tiny drop of sulphuric acid. In a few moments monoclinic crystals of calcium sulphate begin to form.

near the circumference of the test drop as exceedingly slender, colorless, transparent needles, either singly, in sheaves, or in star-like clusters (Fig. 43). When in tiny sheaves near the edge of the drop the crystals have often a more or less brownish tint when seen by transmitted light. Shortly after the appearance of the bunches of needles at the periphery, long, thin, slender and plate-like prisms with obliquely truncated ends are formed throughout the drop. These prisms are frequently twinned, yielding so-called arrow-head or swallow-tailed and X-like twins. These twin crystals are the most characteristic of the forms assumed by calcium sulphate of the formula $\text{CaSO}_4 \cdot 2\text{H}_2\text{O}$.

Remarks.—The sulphuric acid employed should be dilute and should not be added in excess. Sulphate of sodium or of ammonium may also be employed, but less advantageously.

The best results seem to be obtained when the reagent is added to a dilute neutral solution. If no crystals are visible after waiting a short time, the preparation may be cautiously concentrated. This procedure (evaporation) may, however, lead to the separation of such an amount of other salts as to render difficult the detection of the crystals of calcium sulphate. A better plan is to hasten the separation of the calcium salt by exposing the test drop to the vapor of alcohol. This is conveniently performed as follows: place a small bit of filter paper on the slide, a few millimeters from the test drop, invert a 25 mm. watch glass over the

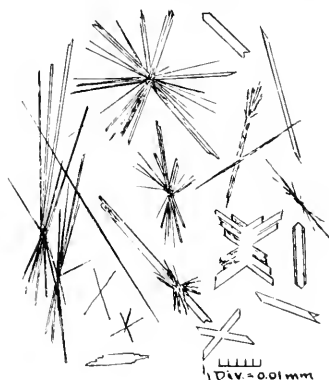

Fig. 43.



Fig. 44.

drop in such a way that part of the filter paper is included under the glass (see diagram, Fig. 44), add sufficient alcohol to the part of the filter paper outside the glass to completely saturate it, no more. If the test drop is situated at the corner of the slide, as is usually the case, place another slip alongside to support the watch glass, as is shown in the diagram. Allow the preparation to stand a few seconds, remove the glass and paper, and examine.

Strong acids should be absent. In the event of their being present add ammonium acetate, or, better, carefully evaporate the solution to dryness, if possible, and take up the residue with water.

It must be ever borne in mind that in the presence of an excess of salts of Group I, the solubility of calcium sulphate is usually so greatly increased that the detection of calcium by this test is sometimes difficult.

A more serious interference is that of the chlorides of the trivalent metals. In the presence of these salts it is generally advisable to proceed as follows: Add to the somewhat dilute solution, ammonium acetate, heat to boiling, but avoid long or violent ebullition, since in the latter case the precipitate formed often refuses to settle. The clear liquid is then separated from the precipitate by drawing off on the slide, filtration, or by means of the centrifuge, is concentrated if necessary, and tested for calcium with sulphuric acid.

Sulphuric acid added to salts of strontium may, under exceptional conditions (if the preparation be examined at once), yield a precipitate which closely resembles that given by calcium. These crystals of strontium sulphate rapidly disintegrate, however, and there results a fine granular deposit. This granular or sandy precipitate is the form assumed by strontium sulphate under the conditions which ordinarily obtain in this test. Barium is immediately precipitated in an exceedingly finely divided condition, amorphous in appearance. Any lead which may be present will also be precipitated as a dense white amorphous powder.

If calcium sulphate be heated with a drop or two of sulphuric acid until white fumes (SO_3) are given off, and the preparation allowed to cool, the calcium will separate either as the salt CaSO_4 or as $\text{CaSO}_4 \cdot \text{H}_2\text{SO}_4$. The crystal forms most frequently met with are shown in Fig. 45. This modification of the test is not satisfactory for calcium, but is characteristic for barium and strontium (q. v.).

It is not always wise to conclude that calcium is present when crystals separate on the addition of sulphuric acid, which apparently resemble the star and sheaf-like aggregates of calcium sulphate, even if the crystals exhibit oblique extinction. For it sometimes happens that other compounds, not calcium sulphate, separate in forms not to be distinguished, at first sight, from the crystals of the calcium salt. Such instances are fortunately very rare.

It has been proposed to check this test as follows:

After allowing sufficient time for the separation of almost all the calcium as $\text{CaSO}_4 \cdot 2\text{H}_2\text{O}$, draw off the supernatant liquor; add to the residue a solution of ammonium carbonate; the crystals of calcium sulphate are dissolved and highly refractive rhombs and grains of calcium carbonate appear, which are easily found by examining the preparation between crossed nicols. A high power is generally required.

In the presence of borates, calcium cannot be satisfactorily detected by means of sulphuric acid. In such an event Method II can be employed.

Exercises for Practice.

(See methods and exercises given under Strontium and Barium.)

Try reaction, after the manner given above, on salts of calcium in neutral solution.

Try the effect of precipitating in the presence of free hydrochloric acid; then in the presence of free nitric acid.

Precipitate with dilute sulphuric acid, then heat, adding more acid if necessary, until white fumes are given off, cool, breathe on the preparation and examine.

Try testing for a trace of calcium in the presence of a large quantity of salts of the elements of Group I.

Try effect of a solution of ammonium carbonate on crystals of calcium sulphate.



Fig. 45.

II. Salts of Calcium give with Oxalic Acid a difficultly soluble Calcium Oxalate.

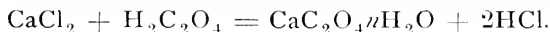

Method.—A drop of a solution of oxalic acid is caused to flow into a drop of the solution to be tested. The solution of the substance should be neutral or may contain a trace of free nitric acid. Calcium oxalate is almost instantly precipitated in the form of tiny highly refractive octahedra or rhombs. Often crosses and more or less irregular bundles of minute needles are obtained (Fig. 46).

Remarks.—The composition of the salt, with respect to the amount of water of crystallization, varies according to conditions. It seems to be quite generally accepted that when precipitated from neutral or alkaline solutions at room temperature the salt formed has the formula $\text{CaC}_2\text{O}_4 \cdot 3\text{H}_2\text{O}$ and is to be referred to the tetragonal system; while if precipitated from hot neutral or acid solutions or from acid solutions at room temperature there is obtained an oxalate of the formula $\text{CaC}_2\text{O}_4 \cdot \text{H}_2\text{O}$, a monoclinic salt. This latter form of calcium oxalate seems also to result in the presence of an excess of oxalic acid. It follows, therefore, that with the conditions which usually obtain, there may be precipitated either the salt with three molecules of water of crystallization or the salt with only one molecule.



Fig. 46.

Free nitric acid greatly retards the reaction, but the presence of a very little of this acid gives rise to the formation of larger crystals (because of their being more slowly formed), which are therefore more easily recognized.

Calcium oxalate is insoluble in acetic acid and in sodium, potassium and ammonium hydroxides, but is readily dissolved by the mineral acids.

Strontium gives with oxalic acid an identical reaction, save that the crystals of strontium oxalate are generally somewhat larger.

Barium oxalate takes the form of fibrous bundles of needles and is not likely to be mistaken for either calcium or strontium.

Zinc under certain conditions may yield a zinc oxalate difficult to distinguish from the oxalates of calcium and strontium.

Magnesium oxalate will separate in forms not to be distinguished from calcium oxalate if the test drop contains much acetic acid.

Lead oxalate may also assume forms somewhat resembling those of calcium oxalate, but after a short time these crystals grow into large, well developed prisms.

Many other elements are also precipitated by oxalic acid. If such elements are present in large amount they are apt to interfere.

Owing to the minute size of the crystals, testing for calcium with oxalic acid is not always satisfactory. As an offset to this disadvantage, chlorides of the trivalent metals and boric acid have no effect other than a retardation of the reaction.

In the event of a precipitate of doubtful composition being obtained, draw off the supernatant liquid, or separate by means of the centrifuge, add to the residue a tiny drop of dilute sulphuric acid. Calcium oxalate is dissolved and in a few seconds the characteristic crystals of $\text{CaSO}_4 \cdot 2\text{H}_2\text{O}$ make their appearance.

Exercises for Practice.

Try reaction after the manner given above, on a salt of calcium in neutral solution. Try again in the presence of free HCl; then in the presence of free HNO₃.

Precipitate calcium oxalate, draw off the supernatant liquor, and treat the residue with dilute H₂SO₄. After examining the preparation, add more acid, and heat until white fumes appear, cool and examine again.

(See also suggestions under Barium.)

III. Sodium Tartrate added to neutral or acetic acid solutions of salts of Calcium causes the precipitation of Calcium Tartrate.

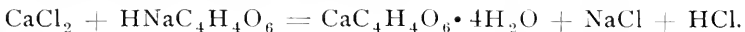

Method.—To a drop of the solution to be tested add a little sodium acetate and a little acetic acid, then add a fragment of sodium tartrate. In a few moments crystals of calcium tartrate separate near the spot where the reagent was added. These crystals are large, colorless, transparent, and well developed prisms belonging to the orthorhombic system (Fig. 47).



Fig. 47.

Remarks.—The reaction is apt to fail in the presence of free mineral acids owing to the solubility of the calcium tartrate; hence the reason for the addition of the sodium acetate. The calcium salt is also soluble in sodium and potassium hydroxides.

A little free acetic acid favors the formation of well developed crystals.

If the solution is too dilute no crystals will appear for some little time. On the other hand, too concentrated solutions give rise to the immediate precipitation of crystallites and imperfectly developed prisms.

Strontium gives a tartrate isomorphous with that of calcium and hence not to be distinguished from the latter, although there is a decided tendency on the part of the strontium salt to form shorter and therefore proportionally stouter prisms.

Barium is precipitated in the form of a fine powder.

Lead is at first thrown down as a fine sandy precipitate soon crystallizing in the form of irregular crystallites not to be confused with either calcium or strontium.

In the presence of magnesium the formation of the crystals of calcium tartrate is greatly retarded, and according to Behrens the crystals then formed are more slender and rod-like; in the experience of the writer, however, the formation of slender mixed crystals is seldom observed.

The tartrates of potassium and ammonium may sometimes be precipitated in forms which at first sight are difficult to distinguish from those of the calcium salt.

The testing for calcium with sodium tartrate is of little value when dealing with unknown mixtures, for in addition to the fact that the crystals of calcium tartrate cannot be distinguished from those of strontium tartrate, salts of barium,

lead, and potassium interfere. The salts of the trivalent metals and of boric acid prevent the formation of characteristic crystals.

With simple salts of calcium the reaction is a beautiful one, leaving little to be desired.

Exercises for Practice.

(See under Strontium.)

IV. Potassium Ferrocyanide added to solutions of Calcium salts in the presence of ammonium chloride, gives rise to the formation of a Double Ferrocyanide of Potassium and Calcium.

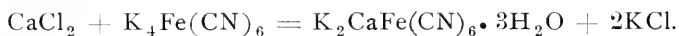

Method.—To the drop of the solution of the substance to be tested add a trace of acetic acid, then a moderate amount of ammonium chloride, stir thoroughly and cause a drop of a solution of potassium ferrocyanide to flow into the test drop. Near the zone of union tiny rectangular and square plates are immediately precipitated (Fig. 48).

Remarks.—In the presence of free mineral acids, first add ammonium acetate or sodium acetate in order to mitigate their action.

Concentrated solutions, with respect to calcium, lead to the precipitation of an amorphous product. Too much ammonium chloride produces a like result; but the reagent alone, in the absence of the ammonium salt, unless added in considerable excess, fails to yield a deposit of crystals. Barium gives large yellow rhombs with the reagent without the addition of NH_4Cl , while strontium fails to yield a precipitate in either case. Potassium ferrocyanide is, therefore, sometimes useful in dealing with mixtures of the calcium group, but as a characteristic test for calcium in simple salts it is of but little value.

All elements forming insoluble or difficultly soluble ferrocyanides interfere, and in most cases prevent the detection of calcium by the above method.

Exercises for Practice.

(See suggestions given under Barium.)

V. The addition of Arsenic Acid to ammoniacal solutions containing Calcium, precipitates Ammonium Calcium Arsenate.

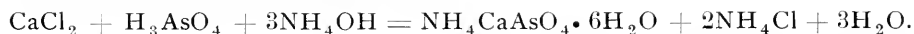

Method.—To the drop of the solution of the substance to be tested add ammonium hydroxide in slight excess, and cause to flow into the test drop a drop of an ammoniacal solution of arsenic acid. There is immediately produced a heavy precipitate rapidly growing into large crystals belonging to the orthorhombic system. These crystals of the double arsenate of calcium and ammonium generally take the form of envelope-like crystallites, or if separating from dilute solutions appear in hemimorphic forms like those of ammonium magnesium phosphate, but of a greater size (Fig. 49).

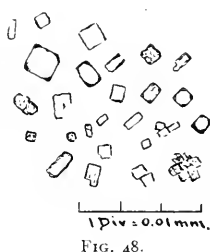
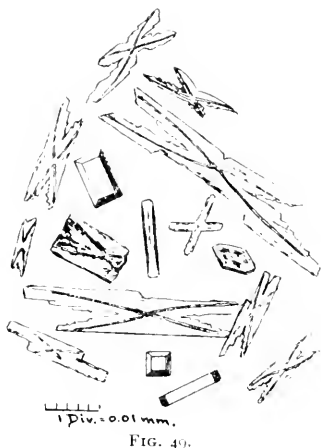

FIG. 48.



Remarks.—If much ammonium chloride is present, the crystals at first formed will rapidly disappear, or there may be no separation of the calcium salt owing to its marked solubility in solutions of ammonium chloride.

The double ammonium arsenates are isomorphous with the double ammonium phosphates, a fact which is liable to give rise to errors in the interpretation of results. Moreover it happens that the usefulness of this elegant reaction is unfortunately restricted, since the elements of the magnesium group, which are often present in mixtures to be tested for calcium, unite to form double ammonium arsenates of like crystalline appearance.

Strontium forms minute stars and tiny crystalline grains, while barium yields a dense precipitate amorphous in appearance.

Exercises for Practice.

Try the above reaction on salts of calcium, strontium and barium, first alone, then in mixtures.

Try on salts of magnesium, zinc and calcium.

Try a salt of calcium in the presence of much ammonium chloride.

VI. Primary Sodium Carbonate added to solutions containing Calcium causes the separation of crystalline Calcium Carbonate.

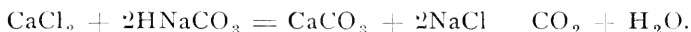

Method.—Cause a concentrated solution of the reagent to flow into a drop of a dilute neutral, or ammoniacal, solution of the calcium salt. In a short time very small disks and rhombs of the compound CaCO_3 appear.

Remarks.—The addition of the reagent in solid form gives nearly as good results.

Warming the preparation increases the rapidity of the reaction and leads to the formation of better crystals.

Unless the test drop is quite dilute an amorphous precipitate results.

Ammonium carbonate can be substituted for the sodium salt, the crystals then differ but little if any from those obtained as above. Normal sodium carbonate produces an amorphous precipitate.

Strontium is precipitated in the form of dumb-bell shaped aggregates and in the form of "sphero-crystals." Barium gives forms somewhat similar in appearance.

Elements of the magnesium group interfere. Lithium likewise interferes. But the chlorides of iron and aluminum and the salts of boric acid have no appreciable effect on the reaction.

When in doubt as to the nature of a precipitate formed by the treatment with

HNaCO_3 , draw off the supernatant solution, which is easily done since the crystals of calcium carbonate adhere closely to the glass slide, wash the residue, and then add dilute sulphuric acid. If the precipitate is due to calcium, characteristic crystals of $\text{CaSO}_4 \cdot 2\text{H}_2\text{O}$ appear.

In the presence of a great excess of the reagent a double carbonate of calcium and sodium separates, having the formula $\text{CaCO}_3 \cdot \text{Na}_2\text{CO}_3 \cdot 5\text{H}_2\text{O}$, which crystallizes in stout monoclinic prisms somewhat resembling the short, thin prisms of calcium sulphate. Strontium and barium prevent the formation of the double salt.

Exercises for Practice.

(See suggestions given under Zinc.)

E. M. CHAMOT.

Chemical Laboratory, Cornell University.

Course in Biology in the Horace Mann High School.*

Although the question of the arrangement of courses in natural sciences in their relation to other courses in the high school curriculum, is as yet open to various opinions from different educators, it is, however, quite generally accepted that the courses of botany and zoölogy should come early in any plan. In the Horace Mann High School, the courses in botany and zoölogy are given in the first year, and are followed by the courses in physics and chemistry. It is believed that the work in natural history appeals more strongly to pupils in their earlier years of the high school, than to those who pursue the same work later. An objection to the reverse arrangement lies in the fact that the application of the principles of physics and chemistry to botany and zoölogy must be repeated in the biological laboratory.

The course in zoölogy occupies the first half-year, followed by the botany in the second half-year. This arrangement seems most satisfactory, both because of the greater interest manifest by pupils of that age, in the study of animals than plants, and because the materials for botanical work are more available in spring than in fall. Four forty-five minute periods each week are devoted to the work.

The courses as outlined are complementary to each other; for instance, the "cell" is studied in the zoölogical part of the work and is not repeated formally in the botany course.

Throughout the course in biology it is the aim to develop the scientific method of thought and at the same time impart to the student as much as possible of the subject matter of biology, and the economic importance of animals and plants. To this end, attention is given to the form and structure of living organisms and to their development, relationships, physiology and ecology.

The method of presentation of the subjects of zoölogy and botany is a departure from the so-called logical method—that of beginning with simple forms and proceeding to the complex—for the reason that this is not believed to be the best method to pursue with young students.

* Lloyd, F. E., and Bigelow, M. A. Teachers College Record, Vol. 2, No. 1.

Zoölogy (Bigelow). What should be included in an elementary course in zoölogy for secondary schools, is a problem upon which no two persons will exactly agree. Certainly one point should be borne constantly in mind, viz., that the great majority of pupils will be unable to pursue the subject further than the one course, for which reason the subject matter should be selected from the standpoint of a liberal education, as distinguished from special and technical education.

The tendency has been to present courses embracing the detailed comparative study of the anatomy of animals to the exclusion of other phases of the subject, as the natural history, physiology, etc. It is now generally recognised, that this imparts an extremely narrow view of the animal kingdom in its varied aspects. That anatomy should form a part of any course, is beyond question, but to enter into anatomical details of half a dozen types at the expense of all other points of view must be regarded as of little value in a liberal education, and furthermore as using time which should be devoted to undoubtedly more important phases of zoölogical study. The physiological side of animals has in the past received but little attention comparatively, but has been found, in the experience of the present writer, a most profitable study for secondary pupils. He believes that no other phase of zoölogical study arouses a deeper interest and appreciation, or is more spontaneously applied by the pupils in connection with study of their own life activities.

It has been, therefore, the endeavor of those who outlined the course in zoölogy for the Horace Mann High School to combine the fundamentals of morphology, physiology and natural history, and thus give the pupils the most valuable ideas of animals and the widest view of animal life. Structure and function are studied in their natural relations. The principles of physiology are introduced as the different animals are studied morphologically, each principle being exemplified by concrete application. Such specific and comparative studies are made to lead to the direct application of the principles of comparative physiology to the activities of the human body.

As stated above, the method of study is analytical, that is, the pupils begin with multicellular animals with which they are more or less acquainted, and proceed down the scale of structural and functional complexity to the simplest forms. By this method pupils are introduced gradually to the compound microscope and are therefore able to use it with a degree of intelligence when they undertake the study of microscopic organisms. Furthermore, the pupil is better able to understand the principles of physiology when concretely applied to organs of an animal in which there is considerable physiological division of labor, than were he to begin with the study of a form in which the various functions are performed by the single cell. From the standpoint of the secondary school, the simple animal appears to be, after all, the most complex for the young beginner.

The course therefore, as outlined for the Horace Mann High School, begins with the complex animal, which is examined from the several view-points of zoölogy, as anatomy, histology, embryology, classification in connection with the near allies of the introductory type, distribution and ecology, general fundamental princi-

ples of physiology, habits of life and life history. To be sure, none of these phases go far into details, but it is the aim to lay a foundation which will make later study of animals, from whatever standpoint, more interesting and more intelligible, because there is included in the foundation work those great principles of animal structure and function which are of wide interest and application. With a foundation thus gained from the careful study of a suitable representative type, the pupil is usually eager to study each animal as it is brought before him as thoroughly as the introductory type, that is, from the various aspects of zoölogy.

As an introductory type, the crayfish has some decided advantages over other forms frequently used for beginners. In the Horace Mann High School the crayfish is viewed from the view-points indicated above. The study embraces lectures, readings, recitations and laboratory work. The author gives a complete outline of the subject matter as presented to his classes, which must, unfortunately, in this review, be reduced to only the general heads, which are as follows: "General External Structure of the Crayfish," "General Internal Structure," "Introductory Microscopic Work and Elementary Histology," "Elementary Embryological Study," "General Principles of Animal Physiology as Illustrated by the Crayfish," "Summary of the Introduction."

This work is followed by a more limited survey of forms, both invertebrate and vertebrate, which are studied chiefly from the standpoint of external structure, although other phases are considered as time permits. These forms are presented in the following order:

1. *Crustaceans.*
2. *Arachnids.*
3. *Insects.*
(*a*) grasshopper; (*b*) butterfly; (*c*) life history of cricket, beetle, bee, ant, fly, may-fly, cicada.
4. *Worms.*
(*a*) earth worms; (*b*) flat worms; (*c*) round worms.
5. *Celenterates.*
(*a*) hydra; (*b*) hydroid colony (*Pennaria*, *Obelia*, *Parypha* or *Campanularia*); (*c*) corals.
6. *Sponges.*
7. *Protozoa.*
8. *Echinoderms.*
(*a*) starfish; (*b*) sea-urchin.
9. *Mollusks.*
(*a*) gasteropods; (*b*) lamellibranchs; (*c*) cephalopods.
10. *Vertebrates (five weeks.)*
(*a*) amphibians; (*b*) fishes; (*c*) reptiles; (*d*) birds; (*e*) mammals.

The above outline may be made the basis for a full year course with much more satisfactory results, perhaps, than for a half year course, as a year's time is none to long in which to cover the field indicated.

Botany (Lloyd).—In general the methods and aims pursued in the course in botany are similar to those indicated above for the course in zoölogy. It is the

endeavor to view plants, in all their phases, giving the student the opportunity to acquaint himself with the essentials of plant structure, physiology and ecology. The work is begun with familiar plants and is carried on through all of the groups of spermatophytes, and thallophytes. A significant feature of the course lies in the fact that those subjects, which may be found sufficiently treated in the numerous text-books and laboratory guides in prevalent use, are treated of only briefly; the time being spent on those subjects which are not so satisfactorily presented to the student through the literature within his reach.

Another point, in which the course is especially advantageous for young pupils, is that emphasis is placed upon the study, first of all, of the fruit rather than the seed, thus obviating the difficulties which present themselves in the study of some seeds. The fruit is studied in different stages in order to impart to the student the idea of development rather than a statical conception of the matter in hand.

Attention is paid to foods in plants, to digestion and to absorption, the method being physiological rather than microscopical.

Especial attention is devoted to the problem of digestion, in which the essential similarity of plants and animals is brought into prominence. In this connection the writer recommends the cocoanut and the date, as most valuable material for demonstrating the morphological facts involved.

The subject of sexual reproduction, although not neglected, is deemed less profitable for young students than the study of the vegetative body and the more readily observable phenomena of adaptation. However, it is found that the essentials of the subject may be clearly brought out in a study of such forms as *Spirogyra* and *Vaucheria*. In the study of seed plants in this connection, somewhat more attention is paid to details, and the important morphological facts involved are demonstrated by means of charts and preparations. At this time also is demonstrated the phanerogamic embryo in earlier and later stages of development, and so the study of the life cycle, which was commenced in the study of the fruit, is rounded out to completion.

Like the outline for the work in zoölogy, the course in botany is outlined in detail. Of this outline only the headings can be given here:

I. THE STRUCTURE AND PHYSIOLOGY OF PLANTS.

1. *The Lima Bean.*
(*a*) fruit; (*b*) seed.
2. *The Indian Corn.*
(*a*) fruit; (*b*) embryo.
3. *The Castor Oil Plant.*
(*a*) fruit; (*b*) seed.
4. *The Pine.*
5. *Studies in Germination.*
(*a*) absorption of water; (*b*) rupture of seed coats; (*c*) manner in which seedlings break through the ground: epicotyl (pea), hypocotyl (castor oil), cotyledon (onion); (*d*) development of organs in embryo; (*e*) behavior of cotyledons during germination; (*f*) earlier leaves com-

pared with adult form ; (*g*) production of other shoots (pea) after destruction of plumule ; (*h*) etiolation.

6. *Respiration.*
7. *Nutrition (Foods).*
(*a*) proteids ; (*b*) starch ; (*c*) sugar ; (*d*) cellulose ; (*e*) oils ; (*f*) mineral substances.
8. *The Digestion and Absorption of Foods.*
9. *The Structure and Functions of Roots.*
(*a*) root system of ordinary type ; (*b*) absorption by roots ; (*c*) mechanical fixation of the plant by means of roots ; (*d*) storage of food in roots ; (*e*) modification of roots correlated with parasitic habit ; (*f*) mycorrhizal roots. root tubercles ; (*g*) air roots ; (*h*) modification of roots correlated with respiration ; (*i*) contractile roots.
10. *The Structure and Functions of the Shoot.*
(*a*) the stem ; (*b*) functions of the stem ; (*c*) the leaf : (*a*) functions of a typical foliage leaf : (*e*) the bud.

II. A STUDY OF TYPES OF THE GROUPS OF PLANTS.

1. *Spermatophyta : Angiosperms.*
(*a*) Willow ; (*b*) Hazel and Alder, Elm and Maple ; (*c*) Calla Lily ; (*d*) Hyacinth ; (*e*) Cyripedium ; (*f*) Strelitzia ; (*g*) Buttercup ; (*h*) Geranium ; (*i*) Abutilon or Malvavistrum ; (*j*) some leguminous flower ; (*k*) Azalea ; (*l*) a cactus flower ; (*m*) Begonia ; (*n*) Dandelion or field daisy.
2. *Gymnosperms.*
Fir, spruce or pine.
3. *Pteridophyta.*
(*a*) Aspidium ; (*b*) Equisetum ; (*c*) Isoetes ; (*d*) Marsilia ; (*e*) Pillularia ; (*f*) Salvinia ; (*g*) Azolla ; (*h*) Lycopodium ; (*i*) Selaginella.
4. *Bryophyta.*
(*a*) Polytrichum ; (*b*) Pogonatum ; (*c*) Georgia pellucida ; (*d*) Funaria.
5. *Hepaticæ.*
(*a*) Radula ; (*b*) Frullania ; (*c*) Scapania ; (*d*) Marchantia ; (*e*) Lunularia.
6. *Fungi.*
(*a*) Agaricus ; (*b*) Puccinia or Uromyces ; (*c*) Morcella ; (*d*) Sclerotinia ; (*e*) Lichens ; (*f*) Claviceps ; (*g*) Cordyceps ; (*h*) Penicillium ; (*i*) Microsphæra alni ; (*j*) Mucor ; (*k*) Saprolegnia ; (*l*) Yeast ; (*m*) Algæ ; (*n*) Schizophyta.

C. W. J.

The second summer session of the Laboratory of Biology of Tufts College will open at South Harpswell, Maine, on June fifteenth and continue until about September first. Courses in Invertebrate Zoölogy, Vertebrate Zoölogy, Botany, and Embryology will be given, as well as opportunity for special research work. The laboratory is well equipped with apparatus for ordinary investigations and has a library of several hundred volumes and pamphlets selected with reference to the work to be done. These advantages are placed at the disposal of students for the consideration of a very reasonable fee. Communications should be addressed to the director, J. S. Kingsley, Tufts College, Mass.

Journal of
Applied Microscopy
 and
Laboratory Methods.

Edited by L. B. ELLIOTT.

Issued Monthly from the Publication Department
 of the Bausch & Lomb Optical Co.,
 Rochester, N. Y.

SUBSCRIPTIONS:

One Dollar per Year. To Foreign Countries, \$1.25
 per Year, in Advance.

The majority of our subscribers dislike to have their files broken in case they fail to remit at the expiration of their paid subscription. We therefore assume that no interruption in the series is desired, unless notice to discontinue is sent.

It is very evident that bacteriological methods in the diagnosis of germ diseases cannot reach their highest degree of usefulness in the prevention of epidemics, as well as isolated cases, until the general public, and even many medical men, are better informed as to the "hows" and "whys" of these methods, and are thus enabled to understand the necessity of conforming strictly to their requirements. No more convincing proof of the benefit derived by a community from culture methods and strict adherence to bacteriological precautions ought to be needed than is shown in a recently published report* of some instances, where the evidence of the bacteriologist in the diagnosis of diphtheria was taken, in spite of more or less opposition from practicing physicians not thoroughly acquainted with the value of the methods, as a basis for treatment and preventive measures. As a result in these instances, the positive cases were promptly identified and isolated, and proper treatment applied in time to check the progress of the disease; while negative cases, however suspicious their appearance in ordinary clinical diagnosis, were safely dismissed. The bacteriological methods recommended for the control of diphtheria may be summarized with great clearness in early diagnosis, early use of antitoxin, strict quarantine, release on negative cultures only, and thorough disinfection. This procedure is based on the natural history of the disease, and is the most logical, well defined and satisfactory course to pursue with a suspected case. The culture methods are simple but most reliable, and their more rapid introduction and universal application are retarded by neglect and ignorance on the part of physicians, boards of health, and men holding positions pertaining to the public health, and prejudice, due to ignorance, on the part of the laity. These difficulties must be overcome by the thorough instruction of medical men in the use of the methods and the instruction of the people through the public schools. The latter subject is just now receiving much attention from men in charge of courses of study for pupils in high schools.

A subject of so much importance to society as the prevention of the spread of germ diseases should receive sufficient attention in all public and private schools, to inform the students of the paramount necessity not only of taking every precaution against contracting infectious diseases, but when once infected of submitting to the methods prescribed by the physician; the result of which would ultimately produce a public opinion heartily in favor of better sanitation, improved methods, and strict precautions in the preservation of the public health.

* The Control of Diphtheria in small cities and country districts from the Bacteriological Standpoint. Veranus A. Moore, M. D., Cornell University.

CURRENT BOTANICAL LITERATURE.

CHARLES J. CHAMBERLAIN.

Books for review and separates of papers on botanical subjects should be sent to
Charles J. Chamberlain, University of Chicago,
Chicago, Ill.

REVIEWS.

Juel, H. O. Vergleichende Untersuchungen über typische und parthenogenetische Fortpflanzung bei der Gattung *Antennaria*. Kongl. Svenska Vetenskaps-Akademiens Handlingar. **33**: 3-56, pls. 1-6, 1900.

A preliminary note announcing the discovery of parthenogenesis in *Antennaria alpina* appeared in the *Botanisches Centralblatt* about two years ago. It

was also noted at that time that *Antennaria dioica* presented a very different developmental history. The author's subsequent work upon these two species is described in great detail in the present paper.

In the nucellus of *Antennaria dioica* the sequence presents nothing exceptional, the mother cell of the megaspore producing four potential megaspores, one of which continues to develop at the expense of the other three and becomes the embryo-sac, just as in other *Compositæ*. The antipodal cells continue to divide and form a tissue, nineteen cells appearing in one section in one of the author's figures. Fertilization of the egg takes place in the usual manner, but no double fertilization could be detected. At the first division of the nucleus of the megaspore mother cell, a reduction in the number of chromosomes takes place. The production of a row of four potential megaspores is regarded as a true tetrad formation.

In *Antennaria alpina* the mother cell of the megaspore becomes the embryo-sac directly, just as in *Lilium*, without giving rise to a row of four potential megaspores, but, unlike *Lilium* and other plants, it shows no reduction in the number of chromosomes. Prof. Juel's previous statement that the embryos develop without fertilization and that there is no fusion of polar nuclei, is repeated with more detailed evidence.

Only one plate is from camera lucida drawings, the other five being taken from photographs and photo-micrographs. The latter were made with a 2 mm. oil immersion objective. The exposures were about two minutes long and no ray filters were used. While the figures show the stages fairly well, they also show the limitations of photo-micrography in its present stage of development.

C. J. C.

Smith, R. Wilson. The Achromatic Spindle in the Spore Mother Cells of *Osmunda regalis*. Bot. Gaz. **30**: 361-376, pl. 22, 1900.

The object of this work was to extend our meagre knowledge of the cytology of the vascular cryptogams. In the

spore mother cell of *Osmunda regalis*, Smith finds that the spindle originates out of a granular zone of cytoplasmic material which accumulates about the nucleus. The granules of this material arrange themselves into short rows concentric with the nuclear membrane. These rows of granules become massed at opposite sides of the nucleus and eventually become the cones of a bipolar spindle. The spin-

dle appears to be bipolar from the beginning, but no bodies that could be interpreted as centrospheres were found. Although tripolar spindles were occasionally met with, Smith is certain that they are not normal stages in the development of the spindle, and comes to the interesting conclusion that the spindle in *Osmunda* does not pass through a multipolar stage. To the reviewer the evidence for such a conclusion would have been more convincing had the appearance of tripolar spindles been accounted for or had more stages in the formation of the cones of the bipolar spindle been figured.

For fixing the material chrom-acetic acid and Flemming's weaker solution were employed. Chloroform was used to precede the infiltration of paraffin. The stains that gave the most satisfactory differentiation were iodine-green and acid-fuchsin, and safranin and gentian-violet. A. A. LAWSON.

Brown, H. T., and Escombe, F. Static Diffusion of Gases and Liquids in Relation to the Assimilation of Carbon and Translocation in Plants. Phil. Trans. Roy. Soc. of London, 193: 223-292, 1900.

The authors investigated the laws governing diffusion through very small apertures. They find that:

(1) The amount varies directly as the diameter of the orifice. This holds for openings 5 or 6 mm. or less in diameter. It follows that diffusion through holes 1 mm. or less is very rapid per unit of area.

(2) When the distance between the holes is ten times the diameter of the holes themselves, the amount of diffusion is the same as when a septum is wanting.

(3) These laws hold for both solutes and gases.

By analogy with the lines of force about an electrified disc, the investigators have reached the same conclusions mathematically.

Applying these results to plant structures the authors conclude that: (a) The open stomata of a normal mesophyte (*Helianthus annuus*) are sufficient for the diffusion of several times as much CO₂ as the plant actually uses. There is no need then for more stomata. (b) The limitation of the amount of CO₂ absorbed is to be looked for in the resistance to diffusion offered by the cell wall. (c) The stomata are sufficient to account for transpiration. (d) The translocation of foods is probably more largely a phenomenon of diffusion than was supposed, since .7 per cent. of opening in cell walls would permit 30 per cent. of free diffusion. The paper confirms Blackman's results (1895), and discusses the physical laws underlying them. T. C. FRVE.

Chicago.

The Martha's Vineyard Summer Institute, Hyde Park, Mass., announces the summer session of the School of Nature Study to be held during July and August, 1901. Besides the School of Natural Study the Institute embraces Schools of Methods, Oratory, Languages, Mathematics, Science, and Art; information concerning which may be obtained from the President of the Institute, Dr. Wm. A. Mowry, Hyde Park, Mass.

CYTOLOGY, EMBRYOLOGY, AND MICROSCOPICAL METHODS.

AGNES M. CLAYPOLE.

Separates of papers and books on animal biology should be sent for review to
Agnes M. Claypole, Sage College,
Ithaca, N. Y.

CURRENT LITERATURE.

Sjöbring, N. Ueber das Formol als Fixierungsflüssigkeit. Allgemeines ueber den Bau der lebenden Zellen. *Anat. Anz.* **17**: 273-304, 3 Abb., 1900. Abstract in *Zeis. f. wiss. Mikr. u. f. Mikr. Techn.* **17**: 337-340, 1900.

The author says that the opinions of formol as a fixing fluid are not, in general, favorable. Many writers say it is decidedly unfitted for the finer preserva-

tion of cell tissue. According to the writer formol does not merit this condemnation, caused by the fact that these writers have failed to discover the small point upon which the successful use of formol depends. A distinction is made between the "Formol" of the firm, Meister, Lucius, u. Brüning, Höchst a Main, and the "Formalin" of Actien (Schering) of Berlin. Formalin is not so suitable for histological work as formol. It must be understood that formol is only a fixing agent, not a hardener. Material fixed in formol should be hardened in 95 per cent. alcohol for 48 hours or longer, at least mammalian tissue should be so treated. For tissue containing much water, different strengths of alcohol are desirable. For Anodonta, 50 per cent. alcohol is most favorable. It is probably this point that causes the various results obtained by authors in the use of formol. The action of formol on tissue is probably an oxidation similar to that of osmic acid. The first requisite for a successful fixing fluid is that it should be approximately isotonic with the protoplasm. Formol, in comparison with the tissues of mammals, should have the isotonism of 8 to 10 per cent. formaldehyde (1 pt. formol to 4 of water), but not all tissues have the same tension. For mammals, the following process gives the best results: Fixation in formol, 1:4 water for 48 hours or longer; direct into 95 per cent. alcohol for at least two days. In this way the resting nuclei, red blood cells, intracellular cement between epithelial cells, fibrin, fibrinoid degeneration of connective tissue, gelatinous and other albuminous exudates, are especially well preserved. The metakinetic stages of mitosis are not successfully obtained. Formol is not especially good for nerve-tissue—preservation is good, but the staining capacity is lessened—stronger and warmed stains are necessary. Some methods of staining are especially applicable after formol fixation. Heidenhain's iron-alum-hæmatoxylin is especially good when used in a modified way. Strong solutions were found most effective. Hæmatoxylin of a concentrated aqueous solution and iron-alum for the mordant, in a 5 per cent. solution, allowed to act for three hours. For differentiation, the same strength or a one-half dilution was used. The stain was allowed to act for one hour, with some warming. Anilin blue was used for a preparatory stain; concentrated alcoholic solution in 50 per cent. alcohol was diluted one-half with water. Crystal-violet in a 1 per

cent. solution in 50 per cent. alcohol; counterstaining in orange or eosin is very satisfactory. This brings out very clearly and beautifully almost all kinds of granules. Bordeaux red is not so good as with sublimate and alcoholic fixation. Another method which gave good results in many cases where iron-hæmatoxylin failed, is anilin-water, fuchsin-anilin blue, according to Lugol's mixture. Ehrlich's triacid is very good in tissues where cell infiltration has occurred, but is uncertain in action. The stain must be made very concentrated in the original solution by warming it during the process. Taking up the stain with blotting paper, and decolorizing with 95 per cent. alcohol is the best method. The results after treatment with alcohol, acid, neutral or alkaline, differentiate connective tissue cell granules, neutrophil and eosinophil granules, plasma-cell granules, and clasmatocyte granules. Formol is as good for purposes of studying the cell body as is Flemming's solution for the study of the nucleus. It is especially necessary for the pathologist to make himself familiar with cell morphology under all normal and post mortem conditions before the method is applied to pathology. The method gives very fine differentiations, but must be used with great care. As a point of warning, the author speaks of the necessity of killing the animals used for cellular physiology by other means than chloroform, since the action of this substance is to decrease the staining capacity of red blood-cells in iron-hæmatoxylin, and to make noticeable changes in the cell granules, especially those of the liver and marrow cells. Guinea-pigs are killed by a blow on the back of the neck, and mice by cutting off the head with shears, etc. There is great difference in the staining capacity of different elements of the cell; liver, kidney, and bone-marrow are the easiest to stain, while those of the intestine or stomach epithelium are difficult, and the larger granules of the salivary glands always remain unstained. Those elements that do not stain in iron-hæmatoxylin can often be brought out by anilin-fuchsin, Ehrlich's triacid, etc. If large and small granules are present in the cells, they often stain differentially.

A. M. C.

Jolly, M. J. Recherches sur la division indirecte des cellules lymphatique granuleuses de la mole des os. Arch. d'Anat. Microsc. 3: 168-228, 2 plche., 1900. (Reviewed in Zeit. f. wiss. Mikros. u. f. Mikros. Tech. 17: 360-363, 1900).

The author gives first an extended historical review of the subject. His studies were chiefly on adult mammals. In the laboratory, the Cobaya rabbit, rat, mouse, dog, and cat; from the

market, calf, sheep, hare. Some rarer mammals, the bat and mole; finally, man in several stages, were studied. Besides these, the pigeon, hen, duck, and lizard were also examined. Red marrow from the long bones was always used, in addition to that from the sternum and the body of the vertebræ. In the lower mammals there is a distinct separation between the red and yellow marrow, which is less easily found in man. This is partly due to the uncertainty as to whether the marrow was perfectly normal in the material in use. The bone marrow of thirteen infants was examined, varying in age from eight days to two years, which died of various diseases. The structure of the femur was always the same; in the middle of the diaphysis is a short canal filled with red marrow; farther towards the epiphysis is a spongy bone-tissue filled with red marrow. This was very rich in cells, excepting in the case of two individuals who died of hereditary

syphilis. In these the marrow was comparatively deficient in lymph cells. With the adult man red marrow was always found in the spongy tissue of the sternum and the bodies of the vertebræ; and being more easy of access, this was usually the source of material for this investigation. To obtain the marrow fresh, the bones, after being freed from all other tissue, are split lengthwise by a sharp stroke on a strong knife. The lymph-cells of the marrow were examined fresh in blood serum, and also after fixation in 70 per cent. alcohol, and staining in picrocarmin, and mounting in glycerin. For nuclear studies, Malassez's method of 1882 was used. A slide is laid gently upon the fresh marrow, and the smear is fixed in osmic acid fumes. The results of this method are an improvement on the old smear method, since it avoids tearing and distorting. Such a spot shows three zones; a central, the largest of considerable thickness not available for study, a peripheral, very thin, of a single layer of cells. This is generally changed by drying slightly. Also, there is a middle zone, thin enough for observation and thick enough to show no effects of drying. Fixation fluids are poured directly upon the slide; later washing loosens the thick central piece, but the rest remains in place. Besides osmic acid, the author has used Flemming's solution, sublimate with platinum-chloride, and Zenker's fluid. Osmic acid, 1 per cent. solution, for 30 to 60 seconds, gave good preparations, but Flemming was still more satisfactory in a strong solution. For staining, the following combinations were used: hæmatein and eosin, hæmatein and aurantia, hæmatein and acid fuchsin, methylen blue and eosin, methylen green and acid fuchsin. The Ehrlich-Biondi-Heidenhain triacid mixture and safranin, with potassium permanganate (1 to 100), as a mordant. According to Henneguy's method, gentian-violet, thionin, and polychromic methylen blue of Unna, were all used. The general method of preparation was as follows: a small spot of marrow is fixed in Flemming's fluid (strong) 10 to 15 minutes, washed out in running water for 15 minutes, bleached in iodine solution (1 to 100.95 per cent. alcohol) for one second, washed in 95 per cent. alcohol to remove the iodine; wash out in water, stain with a solution of eosin containing glycerin (dry eosin 1 part, 95 per cent. alcohol 20 parts, glycerin 50 parts, and water 50 parts) for a long time, so as to over stain. Decolorize in alcohol, and stain the nucleus with the following hæmatein (hæmatein 1 part, 95 per cent. alcohol 25 parts, 5 per cent. solution of ammonia alum 200 parts); wash in water, alcohol, clear in clove oil, and mount in Damar balsam. In such preparations the middle of the spot, as already mentioned, is thick and badly fixed. This is removed with a needle, if it has not already fallen out in the various washings. The cells of the peripheral zone, which have been changed already through drying, show a weakly stained and diffuse nucleus. In the middle zone the cells are well fixed and stained; red corpuscles are orange, nuclei of lymph-cells violet, protoplasm of these is grey, eosinophil granules are red. Dry preparations, fixed by heat, are useful with reference to histo-chemical reaction, but are useless for nuclear study. By drying its structure is altered; it stained uniformly and slightly. The changes are similar to those in peripheral zone of spot. The appearance of these altered nuclei explains the definite appearance of normal blood. The diffuse nuclei of certain leucocytes, the large mono-nuclear forms, are brought out by drying. The author has verified his results by sections. The marrow was imbedded in gum or paraffin.

CURRENT ZOÖLOGICAL LITERATURE.

CHARLES A. KOFOID.

Books and separates of papers on zoölogical subjects should be sent for review to Charles A. Kofoid, University of California, Berkeley, California.

Wilson, H. V. Notes on a Species of *Pelomyxa*. Amer. Nat. 34: 535-550, 1900. The species here described, *P. carolinensis*, is especially favorable for laboratory use on account of its large size and freedom from foreign inclusions. In sections it affords fine material for the study of the structure of protoplasm. Strong acetic carmin (45 per cent.) was used in killing and staining for whole mounts in glycerin. The external form and the internal structure were better preserved by this method than by others. The author regards the "refractive bodies" as globules of an albuminous nature. The culture methods employed in rearing this rhizopod are of especial interest since they are applicable to other *Rhizopoda*, such as the various species of *Amoeba*. A wooden tub is filled with ordinary creek sand to the depth of four inches and flushed until the water remains clear. A handful of *Nitella*, two or three opened mussels, and fragments of a crayfish are partially buried in the sand and the tub is placed in a moderate north light. As decomposition progresses a stream of soft water is turned on for a short time every few days. After an interval of two to eight weeks *Amoeba proteus* appears in numbers on the surface of the sand and sides of the tub, the smaller forms, *A. radiosa* and *A. limax*, appearing earlier. The cycle of life in such a culture is somewhat constant. Bacteria appear first and are followed by the flagellate, and then the ciliate infusoria, especially *Stentor ceruleus*. Later still the rotifers and *Entomostraca* appear. *Cyclops* becomes abundant apparently at the expense of the rhizopods. Care should be taken not to introduce the oligochæte worm *Tubifex*, which also multiplies rapidly and quickly destroys most of the bottom forms. The brown film adhering to the sides and bottom of the aquarium harbors the rhizopods and *Stentors* in large numbers. C. A. K.

Stolc, A. Beobachtungen und Versuche über die Verdauung und Bildung der Kohlenhydrate bei einem amöbenartigen Organismus, *Pelomyxa palustris* Greef. Zeitschr. f. wiss. Zool. 68: 625-668, 2 pls. *Pelomyxa* was collected and placed in a large glass dish filled with swamp water, and containing the other swamp organisms collected at the same time.

The evaporation was made good with tap water, and at intervals little pieces of gelatin and clean filter-paper or cotton placed in the jar. Under these conditions *Pelomyxa* flourished, the individuals being usually found collected about the filter paper and cotton. The oligochæte *Dero* and the sensitive infusorian *Spirostomum* also did well.

To isolate the animals for feeding experiments they were placed in small dishes immersed in the water of the culture jar and sometimes covered with a cover-glass. If the small dishes were removed from the culture water *Pelomyxa* developed abnormally and soon died. The food was always solid; starch, glucosides, cellulose, and dried and powdered proteids being injected without

difficulty. With glycogen and the fats, however, special methods were necessary. Glycogen was mechanically united to albumin by dissolving large quantities in egg-albumin and coagulating with heat. The mixture was then dried, powdered and fed, the results showing that glycogen had been injected with the albumin. In the case of the fats an emulsion of fish oil in albumin was treated in the same way, and, after feeding the dried albumin, oil globules could be seen within the cytoplasm.

The results obtained concern almost entirely the refractive bodies which are present in great abundance within the cytoplasm, and are easily and constantly affected by certain kinds of foods. The principal results are:

1. The refractive bodies are, in the main, composed of glycogen, surrounded by a membrane of less soluble carbohydrate.

2. During starvation the refractive bodies decrease in size, the glycogen disappearing, until finally nothing but the membrane remains.

3. If now the animal be fed with carbohydrate food (starch, glucoside, glycogen, cellulose) glycogen is stored in the refractive bodies and they increase in size.

4. Proteids, gelatin, and fats cause no change in the refractive bodies, although the injected food particles are gradually dissolved.

FRANK W. BANCROFT.

University of California.

Senn, G. *Flagellata* in Engler and Prantl "Die Natürlichen Pflanzenfamilien." I Theil, 1 Abth. Lief. 202, 203, pp. 93-192, 1900. Leipzig. W. Englemann.

Both botanists and zoölogists will be interested in Dr. Senn's able monograph of this borderland group of organisms. The following orders are included: *Pantostomatineæ*, *Protomastigineæ*, *Distomatineæ*, *Chrysomonadineæ*, *Cryptomonadineæ*, *Chloromonadineæ*, and *Euglenineæ*. The work includes a comprehensive biological discussion of the group and keys to the genera, with very full descriptions. Abundant illustrations serve to characterize many of the species. Bibliographies are also very complete. Investigations since the publication of the monographs of Bütschli and of Klebs have greatly increased the number of known flagellates so that this revision of the group was much needed and will be welcomed by all who have to deal with these widely distributed and biologically important organisms.

C. A. K.

Johnston, J. B. A Sealing Stone Jar for Zoölogical Laboratories. *Amer. Nat.* 34: 969-971, 1900.

Stone jars eight to twenty-four inches in height and ten or twelve in diameter are made by the Zanesville Stoneware Co., Zanesville, O. The rim of the jar bears a groove to be filled with the sealing fluid. A dependent flange on the lower surface of the lid fits into the groove, thus sealing the jar. The edge of the lid projects so as to protect the rim of the jar from dust. For daily class use water may be used as a sealing fluid, while for permanent storage a very heavy paraffin oil is necessary. Lighter oils or glycerin do not make good sealing fluids. The moderate cost, large storage capacity, slight risk of breakage, the large mouth, and above all the ease of opening and resealing make this an ideal storage jar for laboratories and museums.

C. A. K.

NORMAL AND PATHOLOGICAL HISTOLOGY.

JOSEPH H. PRATT.

Harvard University Medical School, Boston, Mass., to whom all books and papers on these subjects should be sent for review.

Vogel, K. Zur Histologie der Pneumonia fibrosa chronica. Ziegler's Beiträge, 28: 170. 1000. The author studied light cases in which the fibrinous exudate of an acute lobar pneumonia was being replaced by connective tissue. The origin and development of the new connective tissue was investigated.

Several staining methods were employed. Unna-Tanzer's orcein solution followed by Loeffler's alkaline methylen blue yielded the best results. Orcein colors elastic tissue brown.

(1) Stain 6 to 24 hours in the following fluid:

| | |
|------------------------------|------|
| Orcein, | 0,5 |
| Absolute alcohol, | 40,0 |
| Distilled water, | 20,0 |
| Hydrochloric acid, | 0,5 |

(2) Wash in water.

(3) Decolorize about 30 minutes in—

| | |
|------------------------------|-------|
| Hydrochloric acid, | 5,0 |
| Alcohol, | 100,0 |
| Distilled water, | 20,0 |

(4) Wash in water.

(5) Stain 5 to 15 minutes in Loeffler's alkaline methylen blue solution.

(6) Decolorize for a few minutes in 70 per cent. alcohol.

(7) Absolute alcohol.

(8) Oil of origanum.

(9) Canada balsam.

In acute pneumonia fibrinous strands pass from the masses of fibrin in the alveoli to the alveolar walls. Some strands enter Cohn's pores and unite with fibrin plugs in other alveoli, others are attached to the wall. When resolution of the exudate fails to occur the plugs of fibrin become retracted and clear spaces are formed in the periphery of the alveoli. In early cases of organizing pneumonia, spindle shaped connective tissue cells are found on the surface and pushing their way into the interior of the fibrin plugs, and spindle cells are also seen advancing along the threads of fibrin which pass through Cohn's pores. The connective-tissue fibrillæ form at first a loose network which contains in its meshes many plasma cells. In one case new-formed elastic fibers were demonstrable.

Cohn thought that the connective-tissue arose from the inter-lobular and sub-pleural tissues. Ribbert asserted that the formation began in the smallest bronchi and the bronchioles. Vogel opposes both these views. In the first stage of organization he found young connective-tissue outgrowths springing from the

alveolar wall and extending along the fibrinous strands. He concludes that organization proceeds (1) from the alveolar wall into the fibrin plugs; (2) from one fibrin plug to another by the growth of connective-tissue through Cohn's pores.

J. H. P.

Flexner, S. Nature and Distribution of the New Tissue in Cirrhosis of the Liver. (Preliminary Communication.) *Trans. Asso. Am. Phys.*, 15: 523, 1900.

In this study account was taken of the normal and pathological distribution of the reticulum, the white fibrous tissue and the elastic tissue.

Two methods were employed for the demonstration of the elastica. The first was Unna's orcein stain, the other that of Weigert, which employs a resorcin and fuchsin combination. Unna's method was unsatisfactory, because the staining was irregular and inconstant. Weigert's method gave uniformly good results.

For the purpose of demonstrating the reticulum, the digestive method, as first introduced by Wall, as well as the modification of Spalteholz, were utilized. By these methods both fresh and preserved tissues in sections are digested in alkaline solutions by means of pancreatin, when the parenchymatous cells and elastic tissue are completely removed. There remains behind a framework consisting of white fibrous tissue and reticulum.

In the study of the white fibrous tissue stained sections, both before and after digestion, were employed. Mallory's specific stain was found of especial value in demonstrating the fine fibrils of white fibrous tissue contained within the liver lobules; but inasmuch as this stain also colors the reticulum its use is somewhat more limited than could be wished; on the other hand, it apparently leaves the elastic fibers unaffected.

From his study he drew the following conclusions:

1. In all forms of cirrhosis the white fibrous tissue is increased.
2. Along with the increase of white fibrous tissue there is a new formation of elastic tissue. This new elastic tissue is derived from pre-existing tissue in the adventitia of blood vessels and the hepatic capsules.
3. Both white fibrous and elastic tissue, in all forms of cirrhosis, may penetrate into the lobules. This penetration takes place along the capillary walls or follows the architecture of the reticulum. The chief distinctions between the histology of atrophic and hypertrophic cirrhosis depend upon the degree of extra lobular growth and the freedom with which the lobules are invaded. In hypertrophic cirrhosis there would appear to be less interlobular growth, and an earlier and finer intralobular growth.
4. The alterations in the reticulum, *per se*, consist, as far as can be made out at present, of hypertrophy rather than hyperplasia of the fibers. It is still uncertain whether any of the differential methods now in use suffice to distinguish between the reticulum and certain fibers derived from the white fibrous tissue of the periphery of the lobules.

J. H. P.

GENERAL PHYSIOLOGY.

RAYMOND PEARL.

Books and papers for review should be sent to Raymond Pearl, Zoological Laboratory, University of Michigan, Ann Arbor, Mich.

Holt, E. B., and Lee, F. S. The Theory of Phototactic Response. Amer. Jour. Physiol. 4: 460-481, 1901.

In the literature dealing with the effect of light on the movements of organisms two modes of action of the stimulus

have frequently been distinguished; one through the direction of the rays, and the other through the intensity of the light. It is the purpose of Holt and Lee to determine to what extent the direction of ray *per se* is effective in producing the orientation of an organism to light. The two leading theories of light response, those of Loeb and Verworn, are carefully outlined, and that of Verworn is "provisionally adopted," because it seems to the authors to be more explicit and capable of being applied to all the facts than the other. Four typical cases of light reaction are examined. The first and simplest reaction considered is that described by Strasburger for swarm-spores. These organisms move away from the light in strong illumination and towards it in weak. This is explained according to the Verworn theory as due, on the one hand to contraction phenomena induced by supra-optimal stimulation of one side in strong light, and, on the other hand, to expansion phenomena induced by sub-optimal stimulation of one side in weak light. This results in movement towards the optimum intensity in any case. The second point considered is the reaction of an animal exposed to light from two sources. The crustacean *Lynceus* was experimented on and found to move away from two lights of equal intensity along a path which equally divided the angle formed by the light rays striking the animal from the two sources. This again is evidently what would be expected from Verworn's hypothesis, since the path taken is such as would cause the two sides to be illuminated by light of equal intensity. The third case of phototactic phenomena treated is the response of an animal exposed to light rays coming vertically through a prismatic screen. By such an arrangement one end of the vessel is made darker than the other, independently of the direction of the rays. *Lynceus* and *Stentor* were used for experimentation. Both went to the dark end of the vessel along a more or less diagonal course. The explanation is that the animal shows contraction phenomena on the supra-optimally stimulated side until the body is in such a position that both sides are stimulated with equal light intensities. The simple diagonal path is in most cases modified by the fact that the animals strike the back wall of the containing vessel and are veered off by it, but necessarily in the general direction of their previous course. The fourth type of reaction considered is that shown by animals under the same experimental conditions as in the last case except that the light comes obliquely instead of vertically through the prism. Under these conditions a negatively phototactic animal will go into regions of brighter illumination, along a path more or less parallel to the direction of the rays. The authors show that it is possible to

explain this reaction as a result of the attainment of a position of equal bilateral stimulation by the same sort of contraction processes on the supra-optimally stimulated side as in the other cases.

The principal conclusion is that: "Light acts in one way, that is, by its intensity. The light operates, naturally, on the part of the animal which it reaches. The intensity of the light determines the sense of the response, whether contractile or expansive; and the place of the response, the part of the body stimulated, determines the ultimate orientation of the animal." Under ordinary circumstances the part of the body stimulated is, of course, a direct function of the direction of ray. The paper shows clearly that the *orienting* "photopathic" reaction is very probably the same thing as the response ordinarily known as "phototactic."

R. P.

Bardeen, C. R. On the Physiology of the *Planaria Maculata* with especial reference to the Phenomena of Regeneration. Amer. Jour. Physiol. 5: 1-55, 1901.

The aim of this work is to determine some of the internal conditions of regeneration in the common flatworm, *Planaria maculata*. The account of

the regeneration work is prefaced by sections devoted to the general anatomy and physiology of the animal. In the account of the physiology "sensation" is discussed in a very general way. The work of Loeb on the light reactions of the worm is mentioned and a very brief description is given of the reactions to contact stimuli. In this section the author makes the surprising statement that he has not found that "the worm is sensitive to anything but light and contact." Under "Movement" two sorts of progression, "swimming" and "crawling," are described. The "swimming," by which term the author evidently intends to designate the motion of the worm ordinarily spoken of as "gliding," is almost entirely due to the action of the cilia covering the ventral surface of the body. The crawling is an entirely muscular movement brought about by waves of contraction passing from the anterior to the posterior end. Experiments on the central nervous system showed that, at any level, it is capable of governing the activities of all parts of the body posterior to that level. Under "Internal Activities" are discussed the processes of deglutition, food-dispersion, defecation and respiration. Food is taken in by peristaltic contractions of the pharynx and then distributed evenly through the branches of the intestine by contractions of the body wall. Digestion is mainly intracellular. Defecation is brought about by a series of sharp contractions of the whole body while the pharynx is held open. There are a few brief and rather loose statements in regard to respiration and excretion. The part of the work devoted to the general physiology of the animal is, on the whole, weak and unsatisfactory. The remainder and larger part of the paper is devoted to a detailed study of the cellular processes taking place during regeneration. Most of the gross forms of regenerated animals which have been obtained by other workers on the same subject are carefully described with reference to the details of their development. The processes occurring after the removal of a part of the animal are briefly as follows: (1) The wound becomes smaller in surface area on account of the contraction of the surrounding musculature. (2) The cut surface remaining is protected by the transformation of the cells directly exposed to the water into mucoid tissue. Later the surface epithe-

lium grows out over the wound. (3) Along the cut surface and in the region just posterior to the point of least intestinal pressure, "embryonic tissue" is formed. This embryonic tissue comes from the transformation of adult parenchyma cells. (4) The next stage in the process is the differentiation of the embryonic tissue. This differentiation depends on the relation of the tissue to the intestinal apparatus in general, and to the axial gut in particular. Tissue at the anterior end of the axial gut forms a head, at the posterior end a pharynx, and behind the pharyngeal region a tail. The reason for this relation of the differentiation of tissue to the digestive system the author believes is to be found in the action of "nutritional currents of a specific direction, intensity, and force." The idea is a suggestive one and the experimental results give it considerable probability.

R. P.

CURRENT BACTERIOLOGICAL LITERATURE.

H. W. CONN.

Separates of papers and books on bacteriology should be sent for review to
H. W. Conn, Wesleyan University, Middletown, Conn.

Jordan. Some observations upon the Bacterial Self-purification of Streams. *Jour. Exp. Med.* **5**: 271, 1900.

Dr. Jordan has contributed an interesting and timely article on the problem of the disappearance of bacteria in

flowing streams by an exhaustive study of the bacteria in the Illinois river, which has, in the last year, been converted into a drainage system for Chicago, emptying into the Mississippi river, after flowing 318 miles. The pollution of this stream with the sewage of Chicago has alarmed the people along its banks, particularly in St. Louis, which city takes its supply of water from the Mississippi river, some four miles below the outlet of this system of sewage. A study of the bacteria of this river has been made with extreme care, and the bacterial contents of the river, at different distances between Chicago and the Mississippi outlet, have been determined. The result shows that the number of bacteria in the river falls rapidly, and at its outlet apparently all of the bacteria which came from the sewage of Chicago have disappeared, since there are no more bacteria in the river at that point than are contained in the ordinary tributaries of the river. The river, therefore, purifies itself and Chicago sewage does not materially pollute the Mississippi river. The author also considers the causes of this disappearance of bacteria without, however, reaching very positive conclusions. He is inclined to believe that the exhaustion of the food supply is one of the most important factors.

H. W. C.

Ford. The Bacteriology of Healthy Organs. *Transactions of the Association of American Physicians.* **15**: 389, 1900.

Bacteriologists, in the past, have been of the opinion that the organs of healthy individuals are sterile, and that

it is only under conditions of disease that bacteria invade the tissues. This opinion has been questioned occasionally, but no very definite conclusion has been reached. Ford, desirous of settling this question, performs a long series of very careful experiments. His method of work appears to be beyond criti-

cism. He has experimented with several species of animals, and has studied, in all, thirty-five different individuals. His conclusion is emphatic and decided. In eighty per cent. of the organs studied, positive evidence has been found of the presence of micro-organisms in the normal tissue of the healthy individual. Seventy-seven per cent. were demonstrated by growth in culture media, and the other cases only by the microscopic presence of bacteria in the organ. He found that each species of animal showed its own peculiar bacteriology; that each animal showed a distinct bacteriology; that the different organs showed the same bacteria on different media, although different culture media furnished a variety of species. The bacteria found were ordinary species, including staphylococci, bacilli, and proteus forms.

H. W. C.

Wakker. Wakker's Hyacinth Germ *Pseudomonas hyacinthi* (Wakker). Bull. Div. of Plant Phys. and Path. U. S. Dept. of Agri. 26: 45, pl. 1.

Dr. Erwin F. Smith's paper on Wakker's Hyacinth Germ is a noteworthy contribution towards a better knowledge

of the parasitic bacterial diseases of plants. The paper, though ready for publication in 1897, has been withheld till now to learn why such meager growth was obtained on the host plant. The *Pseudomonas hyacinthi* (Wakker) (E. F. Smith) is a yellow rod-shaped organism, non-sporiferous, color distinctly yellow but somewhat variable; old cultures on some media darken from the production of a soluble pale-brown pigment. This color was not observed in acid or alkaline beef broth, on cocoanut flesh, on sugar beets, in nutrient starch jelly, in agar, or in gelatin with or without sugar. The organism is pathogenic to hyacinths. The host plant is not rapidly destroyed, the cells first separate by solution of the middle lamella. The cavities contain large numbers of bacteria. It is closely related to *Ps. campestris*, parasitic on cruciferous plants, *B. phaseoli* on beans, *Ps. stewartii* parasitic on corn, especially sweet corn. The daughter bulbs contract the disease from mother bulbs. The bulbs may sometime contract the disease from germs lodged in the flowers. A more extended contribution has been promised. The paper is one well worthy of copying as a model for this kind of work.

L. H. PAMMEL.

Jones. Soft Rot on Carrot and Other Vegetables. *Bacillus carotovorus* (Jones). Rep. Vt. Agri. Exp. Sta 13: 299-332, fig. 11.

This paper deals with a soft rot of carrot found in Vermont. The organism *Bacillus carotovorus* (Jones) causes

a rapid soft rot of carrots which resembles Heinz's white rot of hyacinths and Potter's white rot of turnip. It causes the rapid disorganization of the tissues apparently due to an enzyme cytase, excreted by the bacteria, which softens the middle lamellæ of the cell walls and causes a breaking down of the intercellular substance. Wound infections led to decay in a large number of plants such as the carrot, parsnip, salsify, cabbage head, etc. The organism producing this disease is a bacillus having vibratory motion, oscillating or darting in young liquid cultures. The rod is provided with two to five peripheral flagella. The author suggests that we have a considerable number of groups of closely related organisms whose differentiation will tax the skill and patience of the bacteriologist as much as the *B. coli* group. The organism was grown in a large number of different media. Of interest is the fact that its action reduces nitrates. This paper is likewise a model of its kind, especially in regard to the thoroughness of testing the organism in different media while studying its biological and pathological characters.

L. H. PAMMEL.

Medical Notes.

Robin, A. Preservation of Sputum for Microscopic Examination. Jour. Bost. Soc. Med. Sci. 5: 7.

and hydrochloric acid 10 per cent. to determine their preservative power on sputum containing tubercle bacilli. The sputum treated was examined at the end of 24 to 48 hours, after which time, weekly and then monthly examinations were made for a period of four months. Except with HCl the preservation was good and the bacilli stained deeply; HCl seemed to disorganize the bacilli. The author recommends the addition of an equal volume of a 5 per cent. solution of carbolic acid to the sputum, which should be vigorously shaken in the bottle, so as to break up the lumpy coagulation.

The author experimented with carbolic acid 5 per cent. solution, trikresol 2 per cent., formaldehyde 5 per cent.,

c. w. j.

Conn, H. W. How can Bacteria be Satisfactorily Preserved for Museum Specimens? Jour. Bost. Soc. Med. Sci. 5: 7.

in large test-tubes which are tilted so as to make agar slants. The tubes are left undisturbed for six to eight weeks to allow the surplus moisture to evaporate. They are then inoculated in long streaks and immediately sealed with plaster of Paris and paraffin. The cultures grow for a few days, then cease growing and remain unaltered indefinitely. Only one unsatisfactory feature presents itself; viz., moisture within the tube condenses on the inside of the tube with changes of temperature, thus rendering the tube cloudy and for the time injuring the value of the display specimen.

In answer to this question the author offers the following method: A two per cent. agar culture medium is placed

c. w. j.

Eastes, G. L. Note on the Phenyl-Hydrazin Test for Sugar. Brit. Med. Jour., Feb. 23, 1901.

phenyl-hydrazin hydrochlorate. Stir with glass rod, which is left in the mixture throughout the operation. Place beaker on water bath and allow the mixture to evaporate gradually down to 10 or 15 c. c., occasionally scraping the sediment from the sides of the beaker if such tends to collect. When reduced to the bulk indicated, remove flame and allow the liquid to cool. When quite cool examine under microscope. Ozazone crystals will have formed if there is one part per thousand or more of sugar in the urine. If no crystals are formed it may be safe to conclude that no sugar (glucose) is present.

Place 60 c. c. of filtered urine in a beaker of 100 c. c. capacity, add 1 gm. of sodium acetate, and a little less of

c. w. j.

Uhlenhuth. Method for the Differentiation of the Blood of Various Animals with especial Reference to the Demonstration of Human Blood. Deutsche Med. Wochenschr., Feb. 7, 1901.

blood which cause it to give a reaction with the blood of that other animal alone and with no other. If a few drops of the serum of a rabbit that has been treated with ox blood, for example, are dropped into each of a row of test-tubes containing dilute solutions of the blood of various animals, absolutely no reaction is produced in any tube except that containing ox blood, which at once shows a slight turbidity, which increases on standing and finally develops into a flocculent precipitate.

If, at intervals of six to eight days, small amounts of the defibrinated blood of any animal is injected into the rabbit, changes are produced in the rabbit's

The blood of a rabbit which has been injected with human blood, furnishes an infallible reagent for detecting human blood even in very small amounts, and after having been allowed to dry for four weeks.

c. w. j.

Journal of Applied Microscopy and Laboratory Methods.

VOLUME IV.

MAY, 1901.

NUMBER 5

The University of Montana Biological Station.

Most of our Eastern friends who have not been through this Western country and have not seen its vastness in extent, its difficulties owing to the absence of roads and means for transportation, can scarcely comprehend the work necessary to carry on any amount of collecting or study in the field. The idea to be conveyed through this paper is to state what has been attempted in this line, the success that has been achieved, and the suggestions to be offered from the experiences of the past two years.

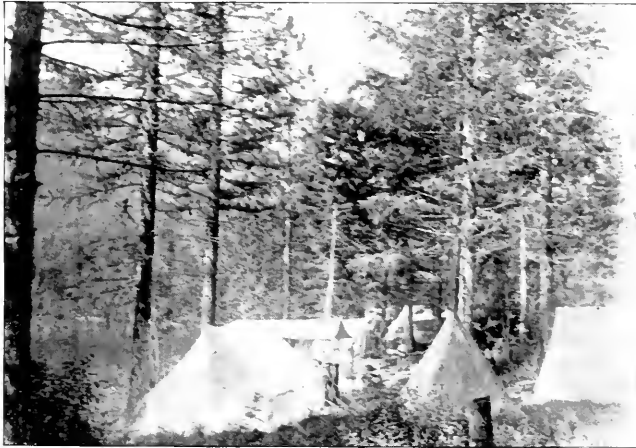

FIG. 1. CAMP AT SIN-YALE-A-MIN LAKE.

In the spring of 1899 plans were completed for the establishment of out-door work on a moderate scale, the location to be selected. A week was spent in the region of Flathead lake, Mont., and all available sites examined. A location was secured on the northern end of the lake, on the bank of Swan river, close to the outlet. The location was chosen as possessing the following advantages: The mouth of Swan river offers a harbor for boats, very few harbors being found on the lake. Swan river affords excellent fishing, and the region round about is a dense forest, practically untouched. This is one of the most convenient places to

reach from the Great Northern railroad on the north, and the Northern Pacific on the south, is on the regular wagon road, is easily reached by steamboat, and is but a short distance from the mouth of the Flathead river, which has abundance of marshes and swamps. This is one of the few places on the lake where suitable accommodations are to be had for board and lodging.

During the past season a month was spent in the Mission mountains, which extend north and south along the lake and Mission valley for a distance of nearly a hundred miles. The southern end of the range has a number of high peaks, the highest above ten thousand. The range slopes down toward the northern end. This northern end has been ground off by a glacier, which has left undisputable proof of its work on the tops of the high hills. The range ends at the Swan river, about where the laboratory is situated.

One of the highest peaks at the southern end is Sin-yale-a-min mountain, the Indian word meaning "surrounded." A ten days camp was made at the small



FIG. 2. CANVAS BOAT "DAPHNIA" WITH COLLECTING OUTFIT.

lake at the base of this mountain, and called also Sin-yale-a-min lake. The lake lies in the heart of the mountains, with high peaks on all sides except the west, which is dammed up by an old moraine, though it is of recent geological origin.

A general view of the camp at Sin-yale-a-min lake is given in Fig. 1. The party at this place, all told, numbered twenty-one, and with one or two exceptions all were engaged in some work. This lake is about fifteen miles from the nearest point on the Northern Pacific railroad, and is in the Flathead Indian reservation. It is therefore primitively wild and romantic.

The work on the lake was accomplished through the use of a fourteen-foot canvas boat, which was taken with some misgivings, but which proved all that was predicted for it by the makers. The boat, ready for use, is shown in Fig. 2, the photograph being taken later at Swan lake when fixed ready for use. The canvas boat carried heavy loads, having at one time four grown people and one child, guns, ammunition, nets, and other material. In the illustration it is shown

loaded as it was when used for actual work, with two occupants in addition to the material. At the front is seen the pump after plans by Ward, for taking entomostraca and other fresh water species. Hanging over the side of the boat is the net after plans by Kofoid, for straining the pumpings. To the right of the net is to be seen the apparatus for measuring depth, which is an instrument used in electric light plants and other establishments for measuring wire. The rubber hose for attachment to the pump is also seen. Of this hose one hundred and forty feet were carried.

The canvas boat was used continuously, and is about the only available means for work in these mountain lakes, so remote from civilization, where transportation is a grave problem. It was necessary to use common garden hose, owing to the fact that no other kind was kept in stock, and owing to the further fact that large hose and a large pump would be too difficult to handle.



FIG. 3. FIELD TABLE AT SIN-YALE-A-MIN LAKE, FOR MICROSCOPICAL WORK.

In Fig. 3 is shown the laboratory table of the microscopist in his study of the entomostraca and other forms. This consists of two sticks nailed to a fir tree at the desired height, and a couple of rough boards nailed to the top of these sticks. The location is selected in the shade, so that it is always comfortable. The lake is at an altitude of 3800 feet, and the cold water makes the surrounding air cool, so that when one is in the shade one is always comfortable. Unfortunately the microscopist was not aware the picture was being taken, and while the lower part of the body shows, the upper part is lacking. As this happens to be the only negative worth saving, the picture is shown to illustrate the ingenuity in making a table. The eye of the naturalist will readily take in the situation, working at the fresh material from a lake never before visited, with the beautiful sheet of water but a few feet away.

In this work a small microscope was carried, with a battery of objectives, and a few necessary stains, dishes, slips, covers, and the like. The material could be taken from the water and studied immediately. It may be well to say at this time of the year, July, rain seldom falls, so there is little difficulty from that source. When there was danger, or when the sun was too hot, a tarpaulin was made into a roof with ropes, which answered as protection. In case of emergency it required but a few minutes to put all the material under cover of the tents.

A similar camp was made at McDonald lake, about fifteen miles further north, in the same range, and in the same reservation. The camp at this lake was for the purpose of collecting additional material in shells, of which a new species had



FIG. 4. McDONALD PEAK AND LAKE.

some longer, considerably wider, and in the deepest 250 feet. McDonald lake is surrounded on all sides by high and rugged mountains, save at the west, where a moraine has made a dam as in the case of the lake before mentioned.

Work at this lake was conducted much as in the first case. The microscop-

been found the year previously, and to determine the microscopical life of the waters in comparison with those of Sin-yale-a-min lake. The view shown in Fig. 4 will give to the mountain lovers an idea of the beautiful peak that was always before us. This peak, McDonald, rises to a height of over ten thousand feet. The view here given was taken from the mountain side near camp. Photographers may be interested in knowing that the picture was taken on a Seed orthochromatic plate, the exposure being a fiftieth of a second. The plate was somewhat under exposed, but for the purpose desired, which was to bring out the peaks with the clouds above, the effect was successful.

McDonald lake is much similar to Sin-yale-a-min lake. The length is about a mile and a quarter, the width less than a quarter, the depth 68 feet. Sin-yale-a-min lake was



FIG. 5. ORNITHOLOGISTS AT WORK AT McDONALD LAKE.

pist rigged up a table similar to the one described, having saved the lumber and nails, both being a necessary feature in the unsettled region. The ornithologists are shown at work in Fig. 5. This table and roof is similar to that made use of in all camps. The lake lies in the middle foreground, just out of sight, being lower down. Under the table are to be seen various sizes of zincs, cylindrical in form, and almost closed. These are used for placing and holding the made skins while they dry. It is often necessary to pack the skins before they are dry, and even afterward the jolting the mountain roads give them is something very difficult to understand except by those who have been over the ground. By placing each skin in a zinc cylinder, the cylinders being of different sizes and lengths to accommodate different sized birds, it is then an easy matter to pack the skins, and at any time get them out to dry without danger of injuring the feathers and spoiling the shape. It is true the zincs are heavy, but they seem to be a necessity in this kind of work. They work as well with mammal skins, and are also employed in preserving small mammal skins.



FIG. 6. VIEW OF UPPER END OF FLATHEAD LAKE, SWAN RIVER OUTLET.

For the ornithologists long excursions were unnecessary, as the region all about is dense woods up to the mountain sides, and it was necessary but to take a handful of shells and go a few steps from camp in order to secure enough specimens for a half day's work. The picture was taken on a Seed orthochromatic plate with ray filter.

It is needless to relate instances of camp life, or to describe further methods of work. It is in order to say, however, that to change camp and get to the station, a distance of only about fifty miles, one must descend a thousand feet over bad road with all the paraphernalia of camp, and, with all material, cross the reservation, a distance to the lake of twenty or twenty-five miles, taking a day, dump the material off at the lake shore and again pile it on the small launch or the large steamer, whichever is taken, cross the lake, a distance of about thirty miles, again unload, and establish camp or take quarters at the farm house near. But the

ride is one never to be forgotten, especially if the sun is shining and the atmosphere is clear so as to bring out the beauties of the mountains and the waters of the lake bathing the base of the range.

Figure 6 gives a better idea of the country adjacent to the University of Montana Biological Station than could be given in any description. The view is toward Flathead lake, which is in the middle of the illustration. The water in the foreground to the left is Swan river, whose outlet into the lake is just beyond the bend. The location of the station is on the bank of the river a few feet to the left of the river at the left in the illustration. The narrow point of land behind the trees by the house is the bar made by the sediment from Flathead river, which enters the lake at this point, and which is some two and a half miles distant. The mountains in the background are the Cabinet range.

The field laboratory and camping ground are shown in Fig. 7, seen from the



FIG. 7. EXTERIOR UNIVERSITY OF MONTANA BIOLOGICAL LABORATORY AND CAMPING GROUND.

rear, the only place from which a picture can be taken. Immediately in front of the building is the Swan river, which has a bank here of some forty or fifty feet. Directly in front of the building, and at the water's edge, is a large spring, which furnishes an abundance of pure water, though the river water is clear and pure. There is abundance of room for tents. It has been the custom to live in tents and take meals at the hotel shown in Fig. 7, though since the picture was taken a large house has been erected, offering excellent accommodations to those attending.

The field laboratory is not large. It was planned as a convenient outdoor laboratory for work. It will be understood that when erected the building was about twenty miles from Kalispell, the nearest town. Carpenters, lumber, and material were difficult to secure, and the attendance upon the work was very problematical. The plan was to make a building suited to the needs of a few men who might devote a month or more annually to investigation in the immediate region, and at the same time offer the privileges to any who might wish to take advantage of the offer.

The state of Montana has 146,000 square miles of territory. There is a population in round numbers of 250,000 people. Of this number there is not a large number who wish to engage in such study, and the expense of getting around is no small item. The station was therefore primarily to offer a haven for a few enthusiasts who have planned to do something toward the working up of the material of the state, with the hope that the enthusiasm and interest would be more or less contagious, and that in time there would be work of considerable importance and by considerable numbers at the laboratory.

The two seasons the laboratory has been opened the work has progressed well, and was all that could be expected. During the summer of 1900 the laboratory was taxed to its utmost. Figure 8 shows a portion of the interior, with the students at work. The tables are rude, and the chairs have been constructed from raw lumber by unskilled hands, but the material with which they



FIG. 8. INTERIOR OF LABORATORY.

work is from the university laboratory, and is the best the country affords. Above the door may be seen rows of bird skins. To the left is the working library of a couple of hundred volumes. In the rear, not shown, is the photographic dark room and store room. With this small building, accommodating no more than a dozen or fifteen at a time, there has been made a start which it is hoped will later develop into something of importance.

Figure 9 is an illustration that will interest, if not please, many readers of the JOURNAL. Red-Horn, an Indian who had been on a visit to the Blackfeet in the northern part of the state, and was returning to his home on the Flathead reserve, made us a visit. He was much interested in our work, and seemed to want to know what was being done. He was shown various things through the microscope, which pleased him greatly. I persuaded him to let me take his picture, and the pleasure he is having is shown by the smile on his countenance. He was then taken into the dark room, where he watched the picture develop. Later

he received a print, and some months afterward I showed him his picture in the daily paper, which he at once recognized and readily understood.

The number of visitors at the station while work has been under progress has



FIG. 9. A NEW STUDENT ARRIVES AT THE LABORATORY.

been considerable, including the governor of the state, many school men of prominence, a number of government men, and many citizens and others from the region.

The equipment of the station as regards boats is shown in Fig. 10. A gasoline launch and a row-boat, besides the canvas boat, offer abundant facilities so far for all who have attended, and for those having charge of the work. In addition to these, the launch shown in the illustration to the rear may be chartered at any time, and will carry several tons, being 32 feet beam. The pump, net, hose,

sounding apparatus, and life preservers have been put out to dry. These boats are in the harbor shown in Fig. 7, being just below the windmill in that picture.

By means of these boats considerable work has been done on the lake. Soundings have been taken in many places, and pumpings made from various depths. The row-boat is also taken in wagon to the smaller ponds adjacent to the station, and thus renders the work there effective.



FIG. 10. STATION BOATS AND EQUIPMENT.

The location of the station is ideal in many respects. No one may hope for much interest to be taken in such work by the younger element, to whom we must look for future work, without making ample provision for recreation, so as

to combine work with recreation. This is especially true of teachers who wish a change, and are seeking a place where they may have a chance to work, and when work is over have a little enjoyment. During the first summer the number of plates exposed within a couple of miles of the station amounted to several hundred. There were more than a half dozen cameras, and they were in almost constant use. The dark room was in use most of the time both day and night. During the second season the number of exposures was still greater. The rapids above the station are a delight to the eye, a pleasant place to roam when there is nothing to do, and a great resort for the fishermen. The lake beach is beautiful, and many romantic bits of it have been taken. The number of illustrations accompanying this paper is already too large, or more would be shown. It is sufficient to say that the writer brought home from the summer's trip, including the work at the station, more than a hundred and twenty-five good negatives, each illustrating something in geology, physical geography, or biology.

Bathing in the lake is excellent. The bottom is smooth and sandy, and any depth desired may be obtained. The water is usually comfortable, the cold water from the rivers not reaching this portion of the lake.

Figure 11 is given as an illustration of an attempt to take a flashlight of a group around the camp fire at night. The magnesium was placed in a tin pan with a paper between the powder and the pan, the paper trailing outside so as to give a chance for lighting. The pan was placed on a bench with a tent as background.



FIG. 11. A FLASH LIGHT AROUND THE CAMP FIRE.



FIG. 12. AN EXPERIMENT IN REARING DRAGON FLIES.

Nearly an ounce of magnesium was found necessary to produce a satisfactory picture. The camera was placed, and the person in the middle of the group was given a candle, which was used to determine when a sharp focus was obtained. By giving the candle to the party at one end, then transferring it to the other end, a suitable arrangement was had. The shutter was opened about the time the trail of paper was lighted, after which the operator walked around and took a place in the group. After the flash he returned to the camera, closed the shutter, and later made development. On this occasion there was enough smoke to make part of the picture a trifle hazy.

Figure 12 is a device suggested by Calvert for rearing dragon-flies, suitable environment having been obtained. The cylinders of wire netting are placed in the water, and the insects placed therein. When they transform it is possible to identify the adults, and consequently distinguish between young. The picture given is from an experiment performed at the laboratory.

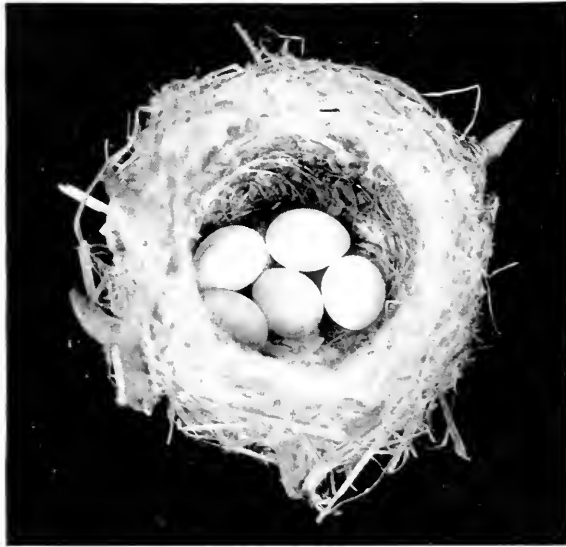

FIG. 13. INTERIOR OF NEST OF WRIGHT'S FLYCATCHER.

Figure 13 illustrates to photographers the possibilities of taking bird nests in-doors. The nest is that of Wright's flycatcher, *Empidonax wrightii*, Baird. A position was taken in front of the window, though out of the direct sun. A black felt cloth was used as a background, the nest being set on the cloth in the angle made by the table and a pile of books. A mirror was adjusted so as to throw light into the nest, as the side next the window was naturally darker than the other. The nest

was several inches long, but was inclined so as to be parallel to the lens, hence the observer is looking into the nest. The plate is a Seed orthochromatic, with ray filter, small stop. The fluffy appearance of the surface is due to the cottony material with which the nest is lined. By this same arrangement a series of pictures of nests was taken, without moving the apparatus.

The biological station will be open for the summer of 1901 from July 22 to August 17. The six weeks preceding will be spent in the adjacent region collecting. Five days of the week during the time the station is open will be spent in work, the sixth will be taken for excursions. As is usual, there are no fees in connection with this work, all of the material being provided free, and the teaching force giving their time gratuitously. Those attending will be asked to pay for what is broken or consumed, and to pay their living expenses.

Accommodations are better than heretofore. The post-office, Big Fork, has during the past year been established at the store close by the station. The Kalispell electric light plant is across the river, and several houses have sprung up during the summer. Daily mail, electric light, a railroad just built a short distance away, a new hotel, and other conveniences, make living less wild and more natural, and will give greater opportunity to those who wish to attend.

As the result of the two years' work thus far accomplished, several bulletins are ready for publication, and several others are under way. There is a fine opportunity for work, and plenty of material, in a new country, with practically no opposition; but the workers are too few and life too short.

MORTON J. ELROD.

The Marine Biological Laboratory at Cold Spring Harbor, L. I.

The twelfth annual session of this laboratory will be held during the months of July and August, of the present year, under the directorship of Professor C. B. Davenport. The regular class-work will begin Wednesday, July 3, and will continue for six weeks; the laboratory will be open from July 1 until August 24, but investigators may make arrangements for using it from the middle of June until the middle of September.

Cold Spring Harbor is about thirty miles from Brooklyn, on the north shore of Long Island. It is a deep, funnel-shaped inlet of Long Island Sound, with steep, wooded shores, about five miles long, and one and a quarter miles wide at its broad end, where it joins the sound. It is divided by a long sand-spit near its



COLD SPRING HARBOR, WITH A VIEW OF THE EAST END OF THE LABORATORY.

inner end into two distinct divisions, an inner basin about half a mile long, upon which the laboratory is situated, and the outer harbor; near the middle of the western shore of the latter, Oyster Bay, a body of water as large as Cold Spring Harbor, opens into it.

The depth of the water in the harbor varies considerably. The mean range of the tide is 7.3 feet. The inner basin is gradually silting up, and exposes about half of its bottom at every low tide for an hour or so. The depth of the outer harbor, at low tide, is from 15 to 18 feet above the entrance of Oyster Bay, immediately below the entrance a long bar extends from the western shore, upon which the water is from 6 to 10 feet deep at low tide. Beyond the eastern end of this bar, which is marked by a small light-house, is a channel 72 feet deep. Outside the bar the water deepens towards the sound.

The country surrounding the harbor is hilly and well wooded. The soil is moist and vegetation in the woods is rank. At its inner end a small, clear stream, Cold Spring creek, enters the harbor. This stream, within a mile of its mouth, runs through three small, deep ponds, all of which are surrounded by heavy woods; a portion of its course, also, is swampy.

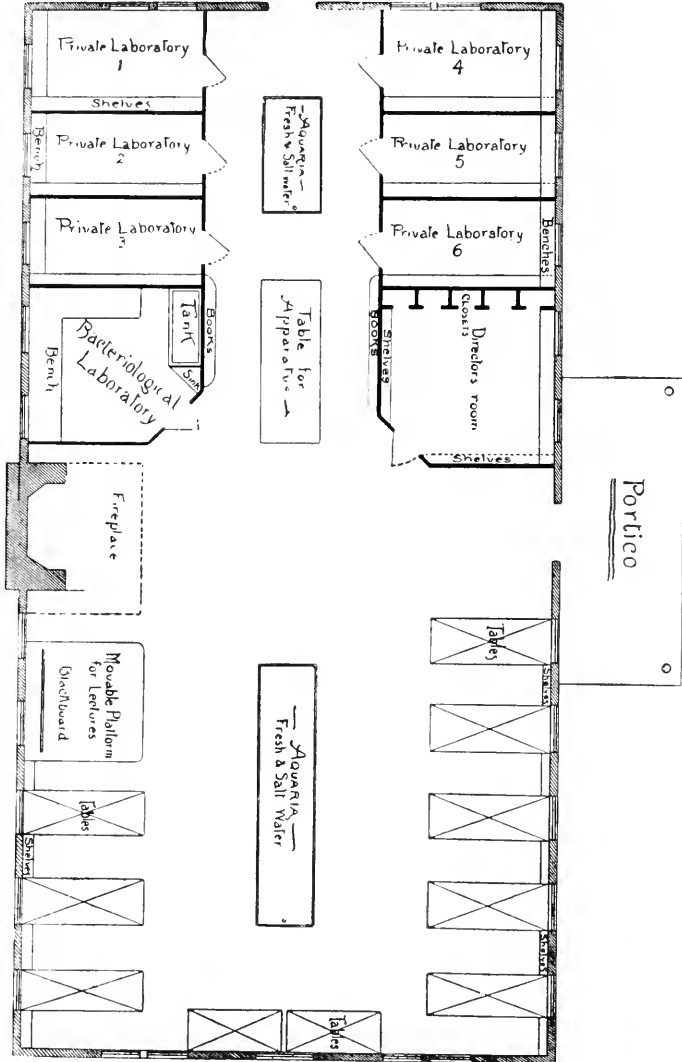

GROUND PLAN OF THE JOHN D. JONES LABORATORY BUILDING.

The situation of the laboratory is an especially favorable one, inasmuch as in addition to the marine fauna and flora at hand, a rich fresh-water and woodland fauna and flora are also easily accessible. The harbor and the adjoining sound contains a variety of environments—marsh, mud, and sand flats, hard and soft bottom, each with its peculiar forms of life; its waters are very rich in plankton.

The same is also true of the fresh-water ponds; deep and shallow water and marsh are present with abundant life, the plankton being very rich.

The most characteristic feature of the marine fauna is its stability. The animals found in the harbor all belong there, and have not been brought in by currents or tides from the open sea; their characteristics, consequently, have been determined by their relation to the local environment. An excellent opportunity is thus given of studying the conditions which have accompanied the development of a fauna.

The work of the laboratory is divided into several departments, which, with the instructors who have them in charge, are the following: I. Zoölogy. In this department, the following courses are given: high-school zoölogy, by Professors Davenport and S. R. Williams; comparative anatomy, by Professor H. S. Pratt; invertebrate embryology, by Dr. L. E. Griffin; entomology, by Dr. A. G. Mayer; variation and inheritance, by Professor Davenport. II. Botany. In this department the following courses are given: cryptogamic botany, by Dr. D. S. Johnson; ecology, by Mr. H. N. Whitford; bacteriology, by Professor N. F. Davis. III. Microscopical Methods, by Mrs C. B. Davenport and Professor W. L. Tower. IV. Nature Study, by Dr. H. A. Kelly. In addition to these courses, evening lectures, both of a technical and of a popular nature, occur several times a week.

The importance of excursions and collecting trips to give opportunities of studying the fauna and flora in their natural environment is fully appreciated. The laboratory has a launch and small boats with dredging and other collecting apparatus; a large oyster boat is also occasionally used; and trips to various parts of the neighboring waters are of daily occurrence. A trip is also made to Fire Island on the south shore of Long Island. Every facility is given for the collection of material for personal use and for the use of the institutions with which the members of the laboratory are connected.

A valuable feature of the laboratory at Cold Spring Harbor is the quiet and seclusion of the place. Situated a mile from the village of the same name and two miles from the railroad, it is an ideal place for work and rest. The beautiful harbor, the fine bathing beach, the excellent roads, the woods and fields, the freshwater ponds, all furnish numerous attractions to the summer visitor outside the work he accomplishes.

The laboratory building is a modern structure, 72 x 36 feet, lined inside with Georgia pine, and with excellent ventilation, due to the height of the roof; it is provided with running water, both fresh and salt, and a complete equipment. A special laboratory for investigators is also now being completed. The lecture hall is a large building lined inside with Georgia pine. The students and other members of the laboratory are housed in three dormitories, one for men, one for women, and one for married couples. The dining hall is run by the laboratory, and board is furnished at cost.

For information, application should be made to Prof. C. B. Davenport, University of Chicago, Chicago, Ill.

H. S. PRATT.

A Method for Injecting Small Vessels.

When injecting vessels too small to use the ordinary removable cannula usually provided with injection syringes, it is customary to employ a small glass cannula with rubber-tube connections. This has the great objection that in order to avoid forcing air into the vessel it is necessary to fill the apparatus before it is inserted and tied. When one then attempts to insert the cannula it is very difficult to prevent the injecting mass from coming out at the tip, getting into the surrounding tissues, and so obscuring things that it is next to impossible to see what one is about; and so much time is usually consumed in the process that the mass is apt to harden and clog the opening of the cannula. To prevent this a clamp is usually placed upon the rubber tube, but even then it is far from satisfactory.

A modification of this, using the principle of the removable cannula, has been found to give very satisfactory results. A piece of glass tubing of a little larger



diameter than would ordinarily be used is taken and drawn out to the desired fineness, depending upon the size of the vessel for which it is to be used. It is then cut off short so that it is much like a small funnel (*a*). The tip is flared slightly in the ordinary way to prevent the ligature from slipping. Another piece of tubing is now taken whose outside diameter is about the same as the inside diameter of the other—one that will just slip within the other nicely—and is drawn out slightly at one end and cut off so as to leave that end somewhat tapering. A short piece of rubber tubing is drawn over this tapering end (*b*), so that when it is inserted into the upper end of the cannula (*a*) it makes a perfectly tight joint. A rubber tube from the nozzle of the syringe leads to the other end (*c*) of the glass tube.

The cannula can now be inserted and ligatured. It should then be filled with some of the injection mass, either with a pipette, or by allowing it to drop in from the syringe. By using a small wire carefully it is possible to get practically all of the air out of the cannula and to get it well filled with the mass. The rubber-covered end of the tube can then be placed in the cannula and the pressure applied to the syringe, care being taken to hold the joint together tightly.

This device has all the advantages of the regular injection syringe over the glass cannula ordinarily employed, and is very simply and easily constructed.

LEON J. COLE.

Zoological Laboratory, University of Michigan.

The thirty-second anniversary meeting of the New Jersey State Microscopical Society occurred on March 25th. Mr. F. E. Ives of Philadelphia delivered an illustrated lecture on that occasion, his subject being "The Kromskop and Color Photography."

J. A. KELSEY, Secretary.

The Photo-Micrography of Tissues with Simple Apparatus.

The growing importance of photo-micrography has been greatly enhanced within a few years by improvements in the half-tone processes of reproducing prints; improvements which have now reached such a degree of perfection as to make the reproductions in many cases excel the originals, and this work being done at a very trifling cost, places in the hands of every microscopist ideal facilities for illustrating the result of his labors to an extended audience, provided of course he is familiar with photo-micrography, and can make micrographs of his subjects.

The appliances for doing this have kept pace with the general progress in all

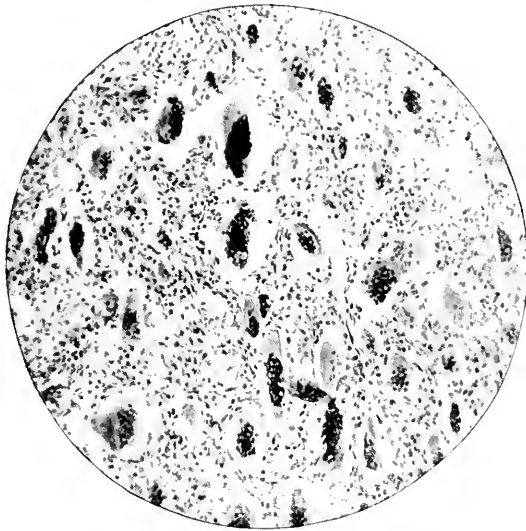

FIG. 1. GIANT CELL SARCOMA. X 100.

microscopical manipulations and technique. With homogeneous apochromatics, projection oculars, substage condensers of high numerical apertures, and stands of marvellously perfect workmanship constructed especially for the purpose, and having every conceivable convenience, it would seem that the limit of optical possibilities had been reached. If to these we add the specially designed cameras, combining in one the suggestions of many workers; orthochromatic or "color correct" plates and the many new, clearly and very perfectly developing reagents, it would likewise seem that the photographic branch of the subject has kept pace with the optical. In artificial illuminants we are equally fortunate. The electric current is almost universally available and arc lamps of great simplicity and steadiness are to be had at comparatively moderate cost. The new acetylene light, one of the most perfect of radiants for photo-micrography, is also available everywhere at no more expense than the old coal oil flame. In short, to the man with a desire for photo-micrography and a full purse, the world's

workshops are open for the supply of an unlimited amount of perfect apparatus for his purpose.

But to most students and the great mass of workers, these doors are closed. They simply have not the money to spare for such necessarily costly appliances and doubtless many turn aside in despair at the impossibility of commanding their use. But they need not. It is quite possible to do most of the work they would need with appliances already in their possession or quite within their means. The so-called student's microscope, generally in use in our colleges and high schools, usually has an inclinable stand with two eyepieces, two objectives of about 1 or $2/3$ inch and $1/4$ or $1/6$ inch focus and an Abbe condenser. With such an instrument it is quite possible to do most excellent photographing with amplifications ranging from about 50 to 600 diameters. Very little tissue work requires over 500, while most of it may be acceptably done at 100 to 200.

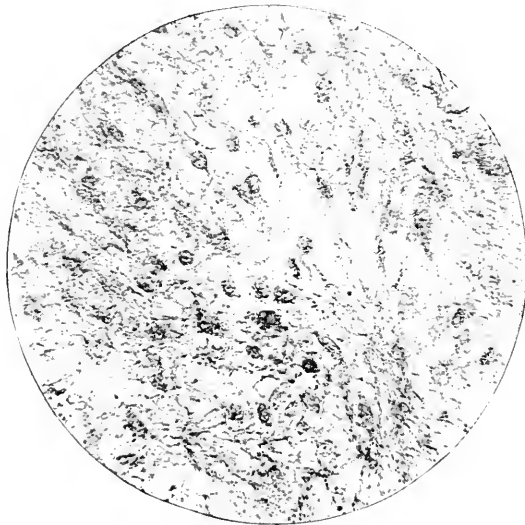

FIG. 2. MYXOMATOUS TISSUE. X 250.

All objectives of reputable makers are now so well corrected chromatically that there is little need to give the old bugaboo of focus difference consideration. Every student has such a microscope at his disposal, so we find the optical part of the question needs no further outlay.

You will probably ask, "What about the camera, this must make an extra cost?" Not at all. While very convenient and highly to be desired, good work can be done without a camera specially designed for the purpose. In fact, *any* camera provided with a focusing screen and from which the lens may be removed can be utilized in photo-micrography. A hand camera with these features is just as good for the purpose as any other form, though probably not so convenient. It merely requires to be firmly fastened to some support at such a height as to permit the tube of the microscope (when inclined to the horizontal position) to enter the lens opening and project the image of the object on the stage upon the focusing screen. The latter will be found too coarse for fine focusing, but the old

device of attaching a disk of cover glass to the ground slide with Canada balsam will offer a perfect surface for delicate focusing. A sheet of plain glass may be substituted for the focusing screen, or the aerial image may be found by means of a hand lens. The illumination may be obtained by means of a coal oil lamp standing at such a height as to bring the center of its flame up to the optical axis of the microscope.

For many years I have been profoundly impressed with the importance of photo-micrography as an educational agent which the successful introduction of the half-tone process of reproduction greatly intensified. At first the great cost of everything *necessary* for the work was no doubt a bar to its more general introduction, but happily this no longer exists. Quite recently one of a type of student's microscopes generally adopted by our best institutions of learning fell into my hands. It was a revelation to me of the wonderful progress made in the mechanism and optics of the microscope, and made my own apparatus, only some two decades old, seem quite ancient in comparison. Yet some of the objectives of my outfit represented an outlay of much more than the cost of this entire apparatus.

The microscope in question was fitted with two eyepieces, $\frac{2}{3}$ and $\frac{1}{6}$ -inch objectives, Abbe condenser and iris diaphragm; a plain working stand, as will be seen, costing very little money but of admirable workmanship throughout.

My test of a microscope and objectives being their adaptability to photography, I proceeded to apply it to this outfit, but came a shade further than usual in discarding the use of my special camera, and making up, instead, an improvised affair, that anyone can do for himself in a very few moments. A small quarter-plate camera was pressed into the service, secured to a block at just the proper height to bring its axis in line with that of the microscope. An old focusing cloth wound around the tube of the microscope at its junction with the camera, made this light tight. A coal oil lamp with an inch flame adjustable to any height afforded the necessary illumination for most of the tests, though the far more actinic light of an acetylene flame was also used at times.

With this very simple apparatus, I made a number of negatives, mostly of tissues normal and diseased and varying in amplification from 100 to 500 diameters, the range of most useful enlargements in that class of work. While these might perhaps be exceeded in absolute perfection by the employment of the very highest attainable excellence in optical appliances, my conclusion is that they are good enough for all practical purposes, and quite within the means and ability of every student to make for himself in illustrating his own microscopical work. For this reason it is urged upon everyone to make the attempt.

Among these negatives are two which may serve to illustrate the excellence of the optical work of this microscope. Both were made by the aid of the usual Huyghenian eyepieces furnished with the instrument, a form that we are told in the books is totally unsuited to the purpose. One was made with the Abbe condenser, a form which we are likewise told is useless in photography. But negatives and prints tell a different story. It is obviously impossible to give a detailed account of their working, within the limits of space at my disposal; but a synopsis may prove useful to many seeking information on the subject.

No. 1.

Giant cell sarcoma x 100.
 Object, thin section, carmin stained.
 Objective, $\frac{2}{3}$ inch, achromatic.
 Ocular, ordinary Huyghenian 1 $\frac{1}{2}$ inch.
 Condenser, none, flat side of flame used.
 Light, Acetylene gas flame. 1 foot burner.
 Plate, Seed's Non-halation.
 Screen, green glass.
 Exposure, six minutes (at least three times too short).
 Developer, metol—quinol.

No. 2.

Myxomatous tissue x 250.
 Object, very thick section, deeply stained.
 Objective, $\frac{1}{6}$ -inch achromatic.
 Ocular, ordinary Huyghenian 2-inch.
 Condenser, Abbe, iris diaphragm.
 Light, Acetylene gas flame, 1 foot burner.
 Plate, Wuestner's, "Jersey Beauty."
 Screen, cobalt blue (Rainig's Moderator).
 Exposure, 90 seconds.
 Developer, eikonogen-hydroquinone.

Prints on Velox Glossy Paper.

W. H. WALMSLEY.

COMBINED UREOMETER AND SACCHAROMETER

(IMPROVED.)

FERMENTATION TUBES FOR BACTERIOLOGIC INVESTIGATIONS OF FERMENTATION.

Further experiments with the Ureometer devised by the writer and described in the *Medical Record*, 59: 12, 477, have shown that the evolution of gas from the decomposition of the urine by the hypobromite can be greatly facilitated by using the following modification: Instead of the test-tube for the hypobromite solution a small 50 c. c. flask is used. Twenty c. c. of the hypobromite solution are put into the flask, the urine drawn up into the pipette, which is inserted into the rubber stopper so that the end is well above the level of the hypobromite solution. One c. c. of urine is then discharged into the latter. The evolution of gas takes place at once, and the test is completed in a few minutes. The volume of air in the flask displaced by the 1 c. c. of urine is deducted from the total volume generated, and in order to avoid calculations 1 c. c. of air space should be allowed at the closed end of the graduated limb of the *U* tube and the graduations begin at zero. The accompanying illustration shows the improved ureometer.

DIRECTIONS FOR USE.—Fill the *U* tube with water to the mark *A*. In doing this, put the index finger on the end of the side-tube *d* and fill the limb *B*. By inclining the *U* tube, the water is forced into limb *C*, and any air bubbles are removed in a similar manner. As soon as the tube is filled to the mark close the free end of *B* with a cork or a rubber stopper. This prevents the water from running out through the side-tube. Put 20 c. c. of the hypobromite solution into the flask *E*, replace the double-perforated rubber stopper *g*, insert the side-tube *d* into one perforation and the pipette *f* filled with urine into the other. Remove any air bubbles from the limb *C* by inclining the apparatus, taking care that none of the hypobromite solution comes in contact with the urine. Remove the cork from the free end of limb *B*. Open the stop-cock on the pipette, allowing 1 c. c. of urine to flow into the flask. The *N* accumulates at the closed graduated limb *C*. Gentle shaking of the apparatus will greatly hasten the reaction.

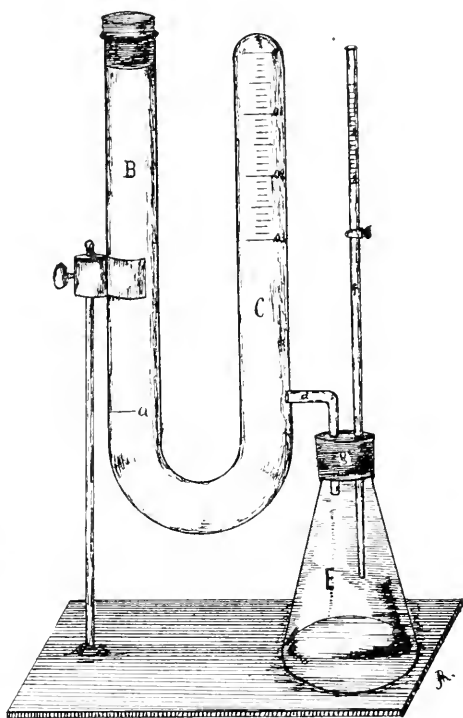

Fig. 1. Combined Ureometer and Saccharometer set up as Ureometer.

The hypobromite solution is best made up extemporaneously. The following method will be found most serviceable: Have on hand a saturated solution of sodium hydrate. Place 10 c. c. of the latter into the flask and add 1 c. c. of bromin. Shake gently until reaction is complete and add 10 c. c. of water. The writer's way of taking up the bromin will no doubt be appreciated by those who have had their Shneiderian membrane frequently exposed to the irritating vapors of this dangerous substance. We use the ordinary 1 c. c. pipette, to which a long piece of rubber tubing is attached. On the latter, somewhere near the end, is placed a small Hoffman clamp. The bromin is sucked up to the mark and the clamp at once closed tightly by means of the screw. The end of the pipette is then carried at once into the sodium hydrate solution, and the bromin discharged slowly by opening the clamp. As a safe precaution we keep open a bottle of ammonia during the operation.

To use this apparatus as a saccharometer the double-perforated stopper is replaced by one with a single perforation. The *U* tube is filled with water as described above, 10 c. c. of diabetic urine put in the flask, 1 gm. of Fleischman's yeast added, together with a small crystal of tartaric acid, and the apparatus set aside for 24 hours. The CO_2 generated will collect at the closed end of limb *C*.

FERMENTATION TUBES.—On the same principle the writer devised a ferment-

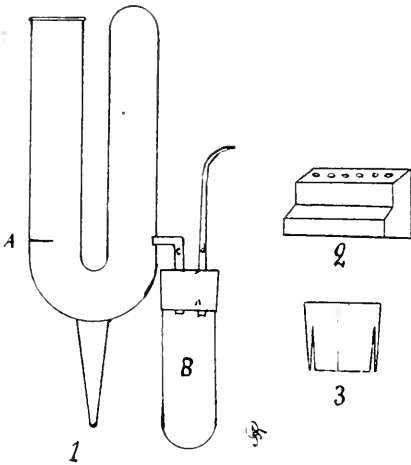

Fig. 2. (1.) Fermentation Tube.

placed in the incubator. The CO_2 collects in the closed end of the U tube under mercury, thus assuring the complete collection of the gas, which in the ordinary fermentation tubes escapes in considerable quantities from the open end. For convenience as well as for comparative study of different fermenting organisms a bench is made to hold 6 tubes (see Fig. 2-2.) Only the tubes intended for the culture need be sterilized. The rubber stoppers are sterilized (in steam) in a wide-mouthed bottle and kept there until used. The rubber stopper devised by the writer is especially useful for this purpose inasmuch as its handling does not carry with it contamination. The stopper is so made that an outer jacket is formed which fits over the neck of the container, while the stopper proper is within. The illustration in Fig. 2 (3) explains itself. The writer believes that this form of stopper will be found useful wherever an ordinary stopper is used, as it offers the additional advantage of keeping out dust and preventing the escape of gas. Where the neck of the bottle is unusually thick the outer jacket is reflected while the stopper is inserted.

A. ROBIN, M. D.

Delaware State Board of Health Laboratory, Newark, Del.

THE NEW JERSEY STATE MICROSCOPICAL SOCIETY.—At the February session of the N. J. S. M. S., a paper on "Pebbles" was presented by Dr. A. H. Chester, professor of mineralogy in Rutgers College.

The term "pebble" was defined as a more or less rounded piece of rock varying in size from that of a particle of sand to a boulder.

The three chief agents in the formation of pebbles are the small streams and rivers, the ocean and glaciers; the last named being by far the most important of the three.

The shape of a pebble depends upon the shape of the original fragment, and upon which of the three above named agents has produced it.

A number of lantern slides were presented illustrating glaciers chiefly, and their effects upon rocks. A large and exceedingly interesting collection of different sorts of pebbles was also placed on exhibition, the specimens ranging from the most common forms about us to gold nuggets and diamonds, sapphires and rubies in the rough—in their pebble state.

J. A. KELSEY, Secretary.

MICRO-CHEMICAL ANALYSIS.

XIII.

STRONTIUM.

We can employ, for the detection of this element :

- I. Sulphuric Acid.
- II. Oxalic Acid.
- III. Sodium Tartrate.
- IV. Ammonium Dichromate.
- V. Primary Sodium Carbonate.

None of these reagents can be considered as giving, at once, a characteristic and reliable test for strontium in the presence of calcium and barium or members of the magnesium group. It follows, therefore, that the detection of strontium is often a matter of not a little difficulty. When dealing with mixtures of the alkaline earths it is necessary to proceed as directed under—*Separation of the Calcium Group*—methods which will be found immediately following the reactions for Barium.

I. Sulphuric Acid added to solutions containing salts of Strontium leads to the separation of Strontium Sulphate.



Method.—To the drop to be tested add a drop of dilute sulphuric acid. A granular precipitate results. Add another large drop of the reagent, heat, and if insufficient liquid remains add more acid. The heating is continued until dense white fumes of SO_2 are given off in abundance. Allow the preparation to cool and examine at once. At first globular forms and rhombic plates appear, later, these develop into more or less irregular fusiform crystals which generally grow to crosses with two of the arms very short. Fig. 50.

Instead of recrystallizing from sulphuric acid we can employ hydrochloric acid. If the latter method is believed to be preferable, proceed as follows: after adding the reagent in sufficient amount to insure complete precipitation, carefully draw off the supernatant solution (or filter or whirl in the centrifuge). Wash the precipitate with hot water to remove any free acid and soluble salts, then add several drops of strong hydrochloric acid. Heat the preparation to boiling, draw off, allow to cool, and examine. If after a short time no crystals separate, concentrate the solution by heating. Strontium sulphate crystallizes from hydrochloric acid in the form of square and rectangular plates, long, thin prisms, and sheaves of acicular prisms. Fig. 51.



Fig. 50.

Remarks.—As already stated under Calcium, the addition of sulphuric acid to

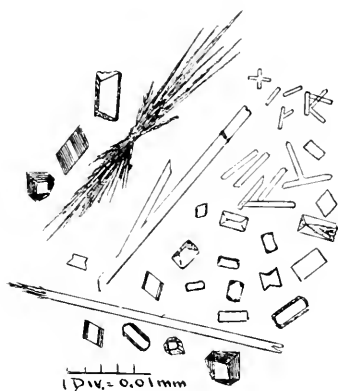

Fig. 51.

solutions containing strontium, yields bundles of needles rapidly disintegrating to merely a very fine granular precipitate. Unless the preparation is examined immediately after the addition of the reagent no acicular crystals will be seen.

If calcium is also present the grains of strontium sulphate are generally larger and often exhibit a tendency toward a spindle shape.

In all cases recourse must be had to recrystallization.

It is probable that the crystals of strontium sulphate separating from hot concentrated sulphuric acid have a composition analogous to

calcium sulphate recrystallized under the same conditions.

If after a short time no crystals appear in the drop of acid, breathe on the preparation.

It is imperative that the drop to be heated be placed at the very corner of the slide, that the latter be inclined so as to keep the drop at the corner, and that the "micro" flame be applied a little to one side, and nearer the center of the slip. This procedure is necessary in order to avoid (1) the breaking of the glass slide, and (2) the spreading of the sulphuric acid. This tendency of the hot liquid to flow over the slip when it is placed in a horizontal position is so great that it is generally advisable to transfer a part of the acid to a clean slip. The transfer is accomplished by gradually raising the slip, which has been heated, until it assumes an almost vertical position and the drop has flowed to the extreme corner. The corner is then brought in contact with a clean glass slide and the drop of solution caused to flow onto the latter by means of a glass rod. In this way a clear, well rounded, deep drop is obtained in which good crystals of strontium sulphate will form.

When dealing with very minute quantities of material it is better to heat with sulphuric acid on platinum foil, since the hot acid may extract sufficient material from the glass to interfere with the reaction.

The solubility of strontium sulphate in strong hydrochloric acid is quite low, hence it is necessary to employ a considerable quantity of the solvent in order to get satisfactory results. The resulting crystals are quite small and of varied form. The results are less satisfactory than with sulphuric acid, but there is, on the other hand, the advantage that barium sulphate is insoluble in HCl. It is of course essential in recrystallizing from HCl that only traces of free H_2SO_4 be present. Free nitric acid should also be absent.

Before any attempt is made to recrystallize the precipitate of strontium sulphate, it is advisable, and usually necessary, to remove any calcium which may be present. This is accomplished by extracting the precipitate with hot water. Unless this is done, peculiar crystal forms are obtained which are difficult to interpret.

If only a small amount of barium is present, characteristic crystals of stron-

tium sulphate are obtained from hot H_2SO_4 ; more barium is apt to alter the usual crystal form, although the appearance of the crystals separating, still suggests the strontium sulphate type. An excess of barium seems to cause the majority of the crystals to assume forms somewhat resembling barium sulphate. In general, crystals of both strontium and barium sulphate can be distinguished in mixtures of these two elements.

Any lead which may be present will be precipitated in an amorphous condition by the dilute acid. Recrystallized from hot sulphuric acid, the lead sulphate will separate in forms which at first closely resemble those of strontium sulphate and which, later, grow to forms which may be mistaken for barium sulphate.

Recrystallized from hydrochloric acid there is less danger of confusion. If in doubt, extract the precipitated sulphates with a solution of potassium or sodium hydroxide in which lead sulphate is soluble.

As in the case of calcium, chlorides of the trivalent metals and salts of boric acid may sometimes interfere with the formation of typical crystals of strontium sulphate.

Exercises for Practice.

To a drop of a moderately dilute solution of SrCl_2 add dilute H_2SO_4 and examine at once.

Recrystallize SrSO_4 from H_2SO_4 ; and from HCl .

Try to recrystallize from HCl in the presence of H_2SO_4 .

Make a mixture of calcium and strontium and add H_2SO_4 . Recrystallize the product from H_2SO_4 without having removed the calcium. In another portion remove the calcium by extracting with boiling water and then recrystallize the residue.

See also exercises suggested under Barium.

II. Strontium Oxalate is precipitated from solutions of salts of Strontium by Oxalic Acid.



Method.—Proceed as directed under Calcium, Method II. Strontium oxalate is precipitated at once. The crystals of this salt are similar to those obtained with calcium, but are somewhat larger and crosses are more pronounced; yet when dealing with mixtures of unknown composition, the difference is scarcely sufficient to permit of strontium being distinguished from calcium.

The crystal forms of strontium oxalate which are most frequently met with are shown in Fig. 52.

Remarks.—Either tetragonal or monoclinic crystals are obtained as in the case of calcium.

The remarks under Calcium (q. v.) apply equally well to strontium.

It is always advisable to draw off the supernatant solution and add dilute sulphuric acid to



Fig. 52.

the precipitate. If no crystals of calcium sulphate appear, add more acid, heat until white fumes appear, cool and examine the preparation for crystals of strontium sulphate (see Method I).

Exercises for Practice.

See exercises suggested under Barium.

III. With Sodium Tartrate solutions of salts of Strontium yield difficultly soluble Strontium Tartrate.

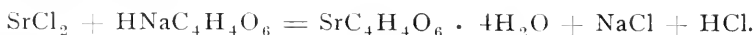

Method.—Proceed as directed under Calcium, Method III. Strontium tartrate is isomorphous with calcium tartrate and is not to be distinguished from the latter (see Fig. 47). There is, perhaps, a tendency on the part of the strontium compound to form shorter and stouter prisms and thin plate-like crystals in greater abundance than is the case with the calcium salt.

Remarks.—See remarks under Calcium. It is not possible to distinguish between calcium and strontium by this test.

Behrens suggests the addition of magnesium acetate and acetic acid to the mixture thought to contain both elements, before introducing the reagent. This, he states, retards the reaction and prevents the normal development of the calcium salt while the strontium tartrate grows to its usual size. Such a modification of the test requires considerable experience in order that just the proper conditions shall be obtained; for this reason the modification is seldom successful in the hands of a beginner.

The test is useless in the presence of barium and many other elements; the most important of these being lead, iron and aluminum as chlorides, and boron as borates.

IV. Ammonium Dichromate in alkaline solution precipitates Strontium Chromate.



Fig. 53.

Method.—To a dilute neutral or very slightly acid solution of the substance to be tested add a fragment of ammonium dichromate (or potassium dichromate). No precipitate should result if only strontium is present. Should a precipitate result, draw off the clear liquid after all the reagent has dissolved; then add to it a small drop of ammonium hydroxide. Strontium chromate immediately separates in tiny yellow globulites or dumb-bell-like forms. Near the circumference of the drop short rods appear later (Fig. 53). Warming gently, hastens the separation.

Remarks.—Unless care is taken to employ a sufficiently dilute solution, the precipitate obtained will consist of such minute granular masses as to appear to be amorphous.

The addition of sodium acetate in excess will also cause the precipitation of strontium chromate.

Normal potassium chromate (K_2CrO_4) on the other hand, will precipitate strontium at once from neutral or slightly acid solutions, as $SrCrO_4$, in the form of slender rod-like prisms of the orthorhombic system. The crystals obtained with K_2CrO_4 are usually better than those produced by $K_2Cr_2O_7$ or $(NH_4)_2Cr_2O_7$; unfortunately barium is precipitated by both these reagents in either acid or alkaline solution. It thus becomes a decided advantage to use a dichromate in a solution acidified with acetic acid; under these conditions only barium will be precipitated, the supernatant liquid can then be drawn off, and to it ammonium hydroxide added, when strontium will be precipitated.

Salts of calcium yield no precipitate with ammonium dichromate, whether the solution be acid or alkaline.

Testing for strontium with dichromate is impossible in the presence of zinc, cadmium or the rare earths.

Lead and other elements forming insoluble chromates will be precipitated before the ammonium hydroxide is added, but may escape complete precipitation and interfere with the subsequent test for strontium.

Exercises for Practice.

See exercises and suggestions given under Barium.

V. Primary Sodium Carbonate.

This reagent precipitates, from very dilute solutions, strontium carbonate in the form of spherulites, often of considerable size.

When simple salts of the elements Ca, Sr, Ba are employed it is not at all difficult to distinguish between them by testing with primary sodium carbonate (or ammonium carbonate). A drop of the almost saturated solution of the reagent being caused to flow into the dilute neutral test drop, calcium will give well defined, highly refractive grains and rhombohedra, strontium spherulites exhibiting the usual black cross between crossed nicols, and barium, spindle shaped crystallites and fibrous masses. But if two or more of these elements are present the reaction fails, characteristic crystals being the exception.

Elements of the magnesium group must be absent.

Primary sodium carbonate is of more value as a group reagent than as an identification test.

BARIUM.

The most important reagents available for the microchemical detection of barium are as follows:

- I. Sulphuric Acid.
- II. Oxalic Acid.
- III. Potassium Ferrocyanide.
- IV. Ammonium Fluosilicate.
- V. Ammonium Dichromate.
- VI. Potassium Antimonyl Tartrate.
- VII. Primary Sodium Carbonate or Ammonium Carbonate.

1. Sulphuric Acid added to solutions containing Barium precipitates Barium Sulphate.



Method.—Add to the test drop dilute sulphuric acid as long as any precipitate is formed; draw off, treat the residue with a large drop of the reagent, and heat until copious white fumes are given off. Cool, breathe on the preparation, and examine. Barium sulphate separates, first as tiny rectangular plates and X-shaped skeletons; then, in a short time, much larger crystallites appear with more or less feathery arms which still retain the X-form. See Fig. 54. These crystals apparently belong to the orthorhombic system.



Fig. 54.

Remarks.—Owing to the low solubility of barium sulphate, a considerable amount of sulphuric acid is necessary and the preparation must be strongly heated in order to obtain a solution of the precipitate. In this operation, the precautions mentioned under Strontium must be observed.

In the event of a heavy precipitate being obtained with the reagent, it is wise to remove a small portion to another slide for recrystallization, rather than attempt to dissolve the whole mass.

Recrystallization in the presence of much calcium is to be avoided. First extract the calcium sulphate with hot water.

In the presence of moderate amounts of strontium the crystallites of barium sulphate are generally not well formed. If strontium is in excess, the crystals separating from the hot sulphuric acid have the general type of strontium sulphate, but are not well developed and exhibit an inclination to approach X-forms of barium sulphate. For this reason it is advisable to remove any strontium which may be present by repeatedly heating with hydrochloric acid, in which strontium sulphate is soluble while the barium compound remains undissolved and can then be recrystallized by heating with sulphuric acid.

Any lead sulphate which may be present will appear, first, in crystals very suggestive of strontium sulphate, then, in a short time, in larger crystallites which may at times be mistaken for barium sulphate. Treatment with hydrochloric acid or, better, with sodium hydroxide will remove the lead, leaving the barium salt unacted upon.

It is sometimes desirable to apply other tests to the precipitated sulphate in order to confirm the presence of barium. In such an event, transfer the washed precipitate to platinum foil or to a platinum cup and fuse with potassium carbonate. The fused mass is then extracted with water and the residue of barium carbonate dissolved in hydrochloric acid. This solution can then be tested for barium by any of the tests given below.

Since chlorides of the trivalent metals sometimes interfere with the formation

of characteristic crystals of barium sulphate, it is advisable to draw off the supernatant liquor after the addition of the reagent and before heating with an excess of the acid. When dealing with mixtures it is always best to proceed in this manner.

Exercises for Practice.

Try above method on a simple salt of Ba.

Make a mixture of Ca and Ba, recrystallize at once without removing the Ca. From another portion remove the Ca with hot water and recrystallize the residue.

Try a mixture of Sr and Ba. Remove the Sr by treating with HCl and recrystallize the residue.

Try a mixture of Ca, Sr, and Ba; first recrystallizing at once, then removing in turn the Ca with hot water and the Sr with HCl.

After having tried the other reactions for barium, described below, fuse some BaSO_4 with K_2CO_3 and proceed as directed above.

II. Oxalic Acid precipitates Barium Oxalate from solutions of salts of Barium.

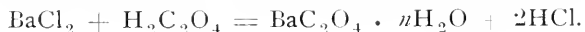

Method.—To a drop of a very dilute solution of the barium salt add sodium acetate and then oxalic acid in the same manner as in testing for calcium and strontium. In a few seconds large branching aggregates in the form of radiating bundles and sheaves of fibrous needles are seen. These radiating masses occasionally assume forms resembling snow crystals. Rarely well developed monoclinic prisms are obtained.

The usual forms of barium oxalate are shown in Fig. 55.

Remarks.—The solution to be tested should be neutral. A slight trace of acid is apt to prevent the separation of the characteristic crystals.

If no crystals appear after a short time, add a fragment of sodium or ammonium acetate.

When calcium or strontium are present the characteristic crystal forms of barium oxalate will not be obtained. Recourse may then be had to testing in dilute nitric acid. From nitric acid solutions the barium salt will not separate, while the oxalates of calcium and strontium will slowly crystallize in their usual form. After allowing sufficient time for the complete separation of calcium and strontium, draw off, concentrate the solution, and add sodium acetate. Barium oxalate now appears, usually in the form of rosettes of thin prisms.

Barium oxalate, like the oxalates of calcium and strontium, assumes different crystal forms according as the test drop is hot or cold. Hot solutions give rise to the production of strongly polarizing orthorhombic plates.

Since, in order to facilitate the separation of barium oxalate, sodium acetate

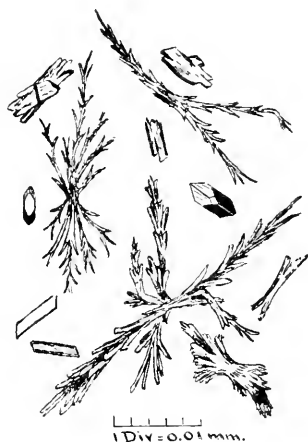

Fig. 55.

has been added, it is well to bear in mind that there is danger of interference from members of the magnesium group.

Boric acid present in the test drop may prevent the formation of characteristic crystals of barium oxalate.

Although chlorides of iron and aluminum have, as has been stated, no deleterious influence on the precipitation of the oxalates of calcium and strontium, we meet in the case of barium with a most interesting and remarkable reaction. Owing to the formation of a double oxalate, instead of the forms shown in Fig. 55, there are now obtained tufts and bunches of very long, fine, curving, hair-like crystals of exceedingly characteristic appearance. The chemical composition and formula of this compound is not yet clear. In order to obtain this interesting compound, proceed as follows: To the test drop containing barium, add ferric chloride in sufficient amount to impart a faint but distinct yellow color; then add a fragment or two of sodium or ammonium acetate; stir. The yellow should now have changed to a reddish tint. Into the drop thus prepared cause a drop of oxalic acid to flow. Tufts and sheaves of very fine needles soon

appear. The needles rapidly grow longer and longer and soon begin to curve in a most peculiar manner. See Fig. 56. The presence of calcium or strontium, or both, in even large amount does not appear to have any serious influence on the formation of this double oxalate of barium and iron, save that its separation is often somewhat retarded. In such mixtures the oxalates of calcium and strontium first appear in their usual form, then after a time the hair-like tufts of the double oxalate appear. If the quantity of barium is quite small, little rosettes of radiating needles are obtained, separating near the edges of the drop.

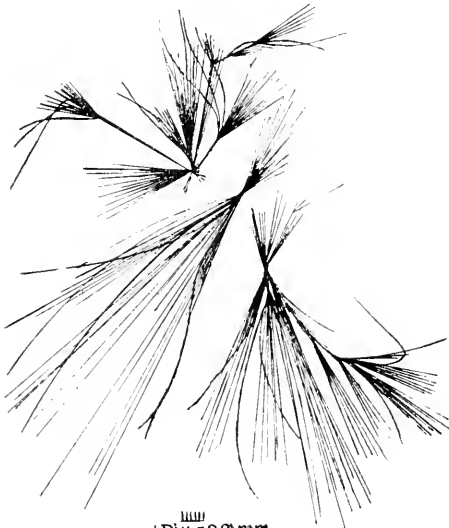

Fig. 56.

Aluminum gives rise to the formation of a similar product, but the crystal masses are colorless, while those of the iron salt are light brown.

Chlorplatinic acid interferes with the formation of barium oxalate in a manner similar to iron and aluminum. Hence it is inadvisable to test a preparation with oxalic acid for borium, which has already been tested for potassium.

For a list of the elements with which oxalic acid may give a crystalline precipitate, see the list of reagents*.

Exercises for Practice.

Try the reaction of oxalic acid on salts of Ca, Sr, Ba, in neutral solution, first

**Jour. App. Micros.* III, 818.

cold then hot. Draw off the mother liquor and test the precipitate with H_2SO_4 .

Try the three elements in test drops acidulated with nitric acid. To the drop from which barium oxalate does not separate add sodium acetate.

Try oxalic acid on a salt of magnesium, then add an excess of acetic acid to the test drop and examine again.

Test salts of Zn, Cd, and Pb.

Make a mixture of Ca, Sr, Ba. Add $\text{H}_2\text{C}_2\text{O}_4$. Repeat the experiment in HNO_3 solution; after a few moments, draw off the clear solution, concentrate slightly and add sodium acetate.

Try the effect of the presence of ferric chloride on the precipitation of the oxalates of Ca, Sr, Ba; first each element separately, then in mixtures of Ca and Ba; Sr and Ba; Ca, Sr, Ba.

If barium borate is at hand, try testing it for Ba.
Cornell University.

E. M. CHAMOT.

Simple Washing Device.

A copper tube twenty-four inches long and two inches in diameter, placed horizontally, is connected with the faucet through a half-inch tube let in midway above. The ends are closed. Below are let in twenty quarter-inch pipes one inch long. Over these are slipped rubber tubes, each carrying a nozzle of glass brought nearly to a point. The nozzle is pushed through the cheese-cloth fastened by rubber bands over the mouth of the bottle containing material to be washed. The bottle is made to stand in a hole in the plank forming the base of the support for the main pipe. The water then turned on descends through the

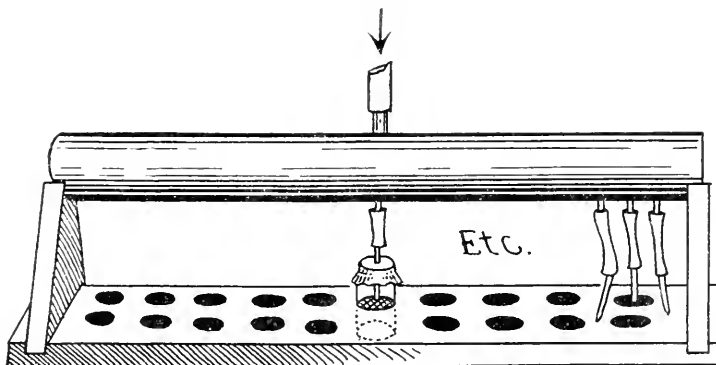

twenty feed-pipes, washing through any bottles which may be set into the apparatus. The whole arrangement stands in the sink. No pinch-cocks are needed for feed-pipes not in use.

The apparatus was designed by Mr. Ames, is not expensive, and proves very handy.

The bottles used and to be highly recommended are "sample-tubes" of rather thick glass, straight all the way up, two and three-fourths by one and one-fourth inches. Material is carried in the same bottle without removal, from collection up to the paraffin bath.

ROBERT G. LEAVITT.

Ames Laboratory, North Easton, Mass.

Journal of
Applied Microscopy
 and
Laboratory Methods.

Edited by L. B. ELLIOTT.

Issued Monthly from the Publication Department
 of the Bausch & Lomb Optical Co.,
 Rochester, N. Y.

SUBSCRIPTIONS:

One Dollar per Year. To Foreign Countries, \$1.25
 per Year, in Advance.

The majority of our subscribers dislike to have their files broken in case they fail to remit at the expiration of their paid subscription. We therefore assume that no interruption in the series is desired, unless notice to discontinue is sent.

SEASIDE, lakeside, and field laboratories will soon open, and, judging from the preparations being made, the attendance this year will be larger and more representative than ever. It is interesting to note in this connection the progress which has recently been made in the establishment and expansion of summer laboratories. It is but a few years since Agassiz and his pupils began their investigations in the extremely unpretentious laboratory at Penikese. The coming season will find well equipped laboratories, easily accessible from all parts of the country, with hundreds of teachers and students,

many of them entering for the first time into the real spirit of research work and gaining a clearer view of the possibilities for development in their own laboratories, where of necessity the most time is to be spent.

The opportunity to come in personal contact with the various forms of life in their native places, to study them under these most favorable conditions with the assistance of experienced and enthusiastic instructors, and to meet as co-laborers a similarly interested company, is one which ought to be taken advantage of by every teacher of biological science, especially since the cost is made so very moderate. Specially prepared short courses are now offered at most of the laboratories which are suitable for those beginning this work, and the information gained is of such a nature as to be of practical assistance for class use.

The life at a summer laboratory is conducive to physical recuperation, and the new ideas and impulses gained will be an antidote for the fossilizing tendency of sticking too closely to the native heath.

Some have helped defray expenses by collecting at the seaside laboratory sufficient material for class use during the ensuing year—star fish, sea urchins, crustaceas, worms, sea anemones—which can be easily preserved and sent inland by freight.

There are in every state many science teachers and others preparing for teaching who could spend two or three months at a summer laboratory at scarcely greater expense than any ordinary vacation costs, and reap benefits which could be had in no other way. No doubt many who would spend the summer vacation at some laboratory, do not do so from a lack of confidence in the practical value *to them* of the work and an exaggerated idea of the expense involved. We would suggest in such instances correspondence with the directors of the various laboratories.

CURRENT BOTANICAL LITERATURE.

CHARLES J. CHAMBERLAIN.

Books for review and separates of papers on botanical subjects should be sent to
Charles J. Chamberlain, University of Chicago,
Chicago, Ill.

REVIEWS.

Grout, A. J. Mosses with a Hand-lens. Svo, pp. xi + 74, 1900. Published by the author, 360 Lenox Road, Flatbush, New York City.

This convenient little book certainly supplies a long felt need. It is a non-technical handbook of the more com-

mon and more easily recognized mosses of the Northeastern United States. Two general keys are given, one based mainly upon structural characters and the other based mainly upon habitat. With the aid of these keys, the descriptions and Miss Thayer's numerous excellent illustrations, the student is enabled to recognize about one hundred mosses. An illustrated glossary of bryological terms is an important feature. It is a matter of common observation that experienced bryologists make a liberal use of the hand-lens, while beginners are much more dependent upon the compound microscope. All who would become familiar with the mosses are indebted to the author for the clear presentation of those characters which will enable one to recognize so many forms in the field without the necessity of bringing them to the laboratory and making mounts for the compound microscope. However, it is very probable that a student who uses this little book will soon find his interest increasing and will be led to use the more extended and technical works which would never have attracted him at the beginning.

C. J. C.

Campbell, D. H. The Embryo-sac of *Peperomia*. *Annals of Botany*. 15: 103-118, pl. 6, 1901.

In this, his third paper on *Peperomia*, the writer acknowledges that some of

his previous interpretations must be abandoned and that Johnson's results are substantially correct. It will be remembered, however, that Johnson confirmed the most important point in Dr. Campbell's preliminary paper, namely, that there are sixteen nuclei in the embryo-sac instead of eight, the usual number in angiosperms. The principal results of the present work are as follows: All species of *Peperomia* seem to agree in having sixteen nuclei in the embryo-sac, and there is no polarity as in other angiosperms. The egg cell is somewhat differentiated by an accumulation of cytoplasm about it, but there are no well marked synergids. Several (usually eight) nuclei fuse to form the endosperm nucleus. These are regarded as homologues of the polar nuclei of typical angiosperms. One of the male nuclei from the pollen tube fuses with the egg nucleus, but the fate of the other male nucleus could not be determined. The embryo is small and shows no differentiation into organs when the seed is ripe. The divisions of the endosperm nuclei are always accompanied by the formation of cell walls.

The writer still believes that the embryo-sac of *Peperomia* represents a primitive condition and that the presence of sixteen nuclei is not a derived feature.

He agrees with Johnson and Strasburger in not regarding the fusion of polar nuclei as a sexual process, but merely a physiological phenomenon. The whole endosperm as well as the antipodal cells are regarded as gametophytic structures. *Gnetum*, as described by Lotsy, furnishes the nearest approach to the embryo-sac structures of *Peperomia*.

The author had several species of *Peperomia* germinated at Kew and they proved to be genuine Dicotyledons. Attention is called to significant resemblances to the lower Monocotyledons, especially the Araceæ. The conclusion is reached that *Peperomia* is the most primitive type of the Dicotyledons and that the resemblances between the Piperaceæ and lower Monocotyledons suggests that the divergence of the two groups may have occurred very early.

C. J. C.

Timberlake, H. G. Swarm Spore Formation in *Hydrodictyon utriculatum* Roth. Bot. Gaz. 31: 203, 1901.

In this short preliminary note Prof. Timberlake announces some interesting results of his work on *Hydrodictyon*.

Material was fixed in a fluid recommended by Eisen.

- | | | |
|---|-----------|-----------|
| (1) Iridium chloride (0.5 per cent. aqueous solution) | - | 100 c. c. |
| Glacial acetic acid. | - - - - - | 1 c. c. |
| (2) Iridium chloride (1 per cent. aqueous solution) | - - | 100 c. c. |
| Glacial acetic acid, | - - - - - | 3 c. c. |

The second solution gave better results. There are no differentiated chromatophores, but the chlorophyll is distributed throughout the cytoplasm. The nuclei have the structure of those of higher plants. When the segments of older nets are to give rise to swarm spores, cleavage furrows are run in, at first cutting out large multinucleated portions of cytoplasm, which are then divided and subdivided until each mass contains only a single nucleus. Each mass then gives rise to a single uninucleated, biciliated spore.

C. J. C.

Palisa, J. Die Entwicklungsgeschichte der Regenerationsknospen, welche an den Grundstücken isolirter Wedel von *Cystopteris*-Arten entstehen. Ber. d. deutsch. bot. Gesell, 18: 398-410, pl. 14, 1900.

Among many ferns the power of regeneration has long been known. Heine- reicher, in studying the resistance of adventitious buds of *Cystopteris bulbifera*

to draught, found that after the central apical part of the bud had decayed, small plantlets often arose from the outer parts, and he ascertained by experiments that they arose from the bud-scales. He also found that similar buds arose from the basal part of the fronds of other ferns. The developmental history of the adventitious buds of *Cystopteris* and other ferns has been determined by Heine- reicher, and in the present article Palisa gives an account of the development of these regeneration buds. He worked mainly on two forms, *Cystopteris bulbifera* and *C. montana*. On the former, the buds arise from the outer scales of the adventitious buds, and on the latter from the basal portion of the fronds. The scales of the former were removed and placed in moist sand under glass tubes, while in the latter case the formation of buds was invoked by cutting off from the underground rhizome the still unrolled frond blade.

Palisa endeavored to answer two questions; first, are there any predetermined

cells from which the buds arise? Of four hundred scale leaves tried, over half regenerated. The location of the regeneration buds was mostly on the flanks at the leaf base. On older scales there is a greater tendency for the buds to appear on the median line of the scale. If the scale be divided in two by a cross section, regeneration only occurs from the basal half. The power of regeneration diminishes with the distance from the leaf base. Many bud *primordia* may start together and only one survive. If a *primordial* outgrowth be removed by cutting, then numerous primordia arise about the margin of the cut surface. No anatomical difference could be noticed between the epidermal cells from which the buds arise, and the adjoining ones, and Palisa concludes that they may arise from any of the epidermal cells.

The second question concerns the development of the buds. They always arise from a group of epidermal cells. Sections through the scales show the hypodermal cells to take no part whatever in the development. The first appearance is a dome-shaped elevation on the surface, which soon becomes prominent above the surrounding tissue. The outline of the original epidermal cells remains quite distinct after many divisions have occurred. When the outgrowth reaches a considerable size, an apical cell is organized and further growth proceeds from it. From its segment the frond is formed and from the lower part of the frond the roots spring. In the case of outgrowths which arise later and are more scattered and thus have more space, the growth from each epidermal cell may organize an apical cell and originate a bud. Between these methods there is every stage of gradation. A number of apical cells may start, close to one another, but one usually develops more rapidly than the rest, draws the nourishment from them, and they cease to function.

Palisa compares the developmental history of these buds with that of the normal adventitious buds which always arise from a single epidermal cell.

Chicago.

W. B. MACCALLUM.

CYTOLOGY, EMBRYOLOGY, AND MICROSCOPICAL METHODS.

AGNES M. CLAYPOLE.

Separates of papers and books on animal biology should be sent for review to
Agnes M. Claypole, Sage College,
Ithaca, N. Y.

CURRENT LITERATURE.

Nussbaum, J., u. Prymak, T. Zur Entwicklungsgeschichte der eymphoiden Elemente der Thymus bei den Knochenfischen. *Anat. Anz.* 19: 6-19, 1901.

This work demonstrates that the leucocytes of the thymus in bony fishes arise largely if not entirely from the epithelium; this is a point of very

general significance in regard to the germ layer origin of the lymphoid elements. The special point of interest and importance is the entire harmony of this work with that of J. Beard reviewed in March, 1901, of the *JOURNAL OF APPLIED MICROSCOPY AND LABORATORY METHODS*.

A. M. C.

Eismond, J. Ueber die Natur der Sogenannten Kinetischen Centren der Zellen. *Anat. Anz. Centralblt. für die Gesamte Wiss. Anat. Ergänz.* **18**: 125-141, 1900.

The question of the significance of the centrosome is one of the most prominent among the cytological problems of the present day; recently it is especially considered in reference to cell mechanism as it shows itself to be of importance in this connection. The view generally held is that the centrosomes are a distinct, granular, primary element of the cell, a permanent part of the cell, and like the nucleus multiplying by self-division. Opposed to this is the view of possible spontaneous origin of centrosomes. At the same time it is possible the centrosome may be a cell-organ, having to do primarily with the processes of division. Many authors say that the centrosome collects around itself a specially active kind of protoplasm—kinoplasm—and permeates this in the form of the different achromatic threads of the nuclear division figures. Further work has developed the resemblances between this "cell organ" and basal bodies in ciliated cells and the blepharoplasts in the plant antherozoid. The question is still whether the centrosome, the middle-piece of the spermatozoan, the blepharoplasts and the basal bodies are truly kinetic centers of the cell; whether they originate the power for such kinetic process.

Previous work by the author has developed the view that the centrosome is not a pre-formed organ in the cell, multiplying by division, but, at least in embryonic cells, more likely arises *de novo* and persists until changes enter into the cell-mechanism to destroy the mechanical reasons for its existence. Comparing the "kinoplasmic fibers" of the mitotic figures, in so far as they actually show distinctly differentiated parts of the plasmatic network, with the radiating fibers of pigment cell and the "muscle-threads" of the protozoan, compels the opinion that these structures are somewhat similar. The special character of the muscle-threads as a peculiar elastic structure acts to make them not cause contraction, but keep the body-form of the animal by their elastic property. Proof of elasticity, not contractility, lies in the effect of reagents on these fibers. The axial fibers coil spirally. The comparable nature of the elastic supporting apparatus of Heliozoa and tissue cells can be stated as follows: In embryonal cells there is, as in some tissue cells (pigment) and protozoa (Heliozoa), a permanent structure which forms a support for the cell-mechanism and can be considered an elastic cyto-skeleton. Considering the centrosome of embryonic cells in this connection, the cause for division is apparent. The centrosome is the inert central knot of this elastic skeleton and must be divided by the division of the cell body. It is a passive division. The evidence from Schaudinn's work on *Acanthocystis aculeata* shows clearly the origin of the centrosome in the new cells, no division of the original centrosome takes place. The great variations in the form of the centrosome, from small central granules to large, irregular axes as long as the cell, or as vacuolated vesicles, support the *de novo* view, and show that the kinoplasmic apparatus near the centrosome is in general a supportive structure, whose center has different space relations according to the mechanical conditions involved.

The basal bodies of ciliated cells are next considered. Cilia in most cases have no power of independent motion, but are passive, often stiff cell appendages.

Hence the motive force lies outside these structures. The structures are compared with the supporting bones of a fish's fin, and a comparison is made to bring out the resemblances caused, of course, by the similar mechanical conditions. Finally, the author states his belief, that the ciliated cell apparatus, the supportive structures of the mouth cirri of amphioxus and the blepharoplasts of antherozoids are all similar structures.

A. M. C.

Regaud, Cl. Quelques détails sur la division amitotique des Noyaux de Sertoli chez le rat. Sort du nucléole Deux variétés d'amitose: Équivalence ou non-équivalence des noyaux fils.

Anat. Anz. Centralblatt f. d. Gesamte Wissen. Anatomie. Ergänzungsheft zum xvii Bd., 1900, p. 110-124, 15 fig. in text.

In 1899 several articles were published by the same author to show that the cells of Sertoli do not play simply a nutritive role for sperm cells, but are cells capable of amitotic division, and hence of producing spermatogonia. The evidence for this is based not only on the nuclear figures clearly amitotic, but also on observations on the stages of development of the spermatogonia and on transition forms of nuclei between those of the Sertoli cell and the spermatogonia; finally on the impossibility of explaining the renewal of spermatogonia by the karyokinesis of the other cells present. The method used for the study of chromatic parts of the seminal epithelium, is a double stain of hæmatoxylin and safranin. This process gives very good results after fixation in Baum's picro aceto-formol mixture, and Lenshossék's of sublimate alcohol and acetic acid. The most exact results follow the use of Tellyesniczky's bichromate of potash and acetic acid. The sections are stained rather deeply with alum hæmatoxylin, then washed in water. If the sections appear too deeply colored under an immersion lens in water without a cover glass, decolorization follows with an aqueous solution of formic acid (1-100). Washing in ordinary water restores the blue color. After this the sections are stained for twenty-four hours or more in Zwaardemaker's solution of safranin. A rapid washing in water is followed by decolorizing in ninety per cent. weakly acidulated alcohol (1 HCl-1000 Alc.). The safranin is removed, but the hæmatoxylin is unaffected: neutral ninety per cent. alcohol is followed by absolute and then xylol and Canada balsam. If the two stains have acted with just equal intensity, a condition easily obtained by practice, the cytoplasm is stained a pale rose-violet and the chromatic parts are very intensely colored, sometimes a purple-violet, sometimes a red-purple, sometimes intermediate between these colors. The chromatic granules in the accessory nucleolus of the nucleus of the Sertoli cells, the surface chromatin of the spermatogonia and young spermatocytes, the chromatin of the nuclear mass of the spermatocyte during the first part of their development, the nucleus of the spermatids during first period of their transformation into spermatozoa, are all colored a violet-purple. The extra nuclear chromatic bodies of the spermatocyte and spermatid, the nucleolus of the nucleus of Sertoli cells, certain parts of the nuclear chromatin of the spermatocyte (body of Lenshossék at certain stages), the nucleolus of the spermatocyte, the nucleus of the spermatid during the last period of transformation, etc., are colored a red-purple. Intermediate between these are certain chromatic bodies of the young spermatogonia and the chromatin of the nuclear filament of the spermatocyte in certain stages. During the karyokinesis of spermatogonia their

chromatin is a violet-purple: during the karyokinesis of the spermatocytes their chromatin is always a red-purple. The author sums up his results as follows:

1. The amitotic division of the nucleus, which in most cases indicates a degeneration of the cells, does not always show the approach of final degeneration. The nuclei of the Sertoli cells divide a considerable number of times, perhaps indefinitely, by amitosis. The spermatogonia resulting from amitosis are the founders of a line of cells which show ultimately more karyokinesis and finally develop into spermatozoa.

2. Amitosis in the case noted is the same as that in many others: a phenomenon of the nucleus only, without an immediate division of the protoplasm. Much later the protoplasm divides.

3. The nucleolus of the Sertoli cell appears to be a cellular organ of primary importance, it is possibly the carrier of a reserve of hereditary substance.

4. It is remarkable that the nuclei of the Sertoli cells, the stem nuclei which carry the determinants (Weissmann) of the species, are really the poorest in chromatin of all the nuclei of the germinal epithelium. The quantity of chromatin which passes into the nucleus of the spermatogonia is infinitesimal in comparison with that contained by the spermatocyte at the moment of karyokinesis. The chromatin of the spermatocyte is then acquired, at least in its mass, and is not hereditary.

A. M. C.

NORMAL AND PATHOLOGICAL HISTOLOGY.

JOSEPH H. PRATT.

Harvard University Medical School, Boston, Mass., to whom all books and papers on these subjects should be sent for review.

Ewing, J. Malarial Parasitology. *Journal of Experimental Medicine*, 5: 429-491, 1901. Recent advances in our knowledge of the morphology of the malarial parasites have been largely due to improved staining methods. Ewing restricts the use of fresh blood to the study of various vital phenomena in the parasite, such as amoeboid movement, vibratory motion of pigment, and ex-flagellation. The discovery of parasites is so much more certain and rapid in stained dry specimens that a negative result with fresh blood invariably requires verification by search through a dry specimen, stained preferably by Nocht's method.

For all ordinary purposes staining by eosin and methylen blue is recommended. The solutions used are: (a) a saturated alcoholic solution of alcoholic eosin diluted with an equal quantity of 95 per cent. alcohol, and (b) a saturated watery solution of Ehrlich's rectified methylen blue at least one week old.

Methylen blue does not stain the young ring forms well. For this purpose Nocht's method is especially useful. The method of Benario and Marchoux as modified by Fatcher and Lazear is also of value, as the rings are densely stained and the preparations are permanent. It is employed as follows: Fix the specimens five minutes in 95 per cent. alcohol, 100 c. c., to which has been added

1 c. c. of formalin. Stain one to three minutes in the following mixture: saturated alcoholic solution thionin, 20 c. c., 20 per cent. carbolic acid, 100 c. c. The fixing solution must be fresh, and the staining fluid at least one week old.

Nocht's modification of Romanowsky's method consists in the addition of a few drops of neutralized Unna's polychrome methylen blue (Grübler) to the 1 per cent. solution of ordinary methylen blue. The author obtained uniformly good results by the following procedure: (1) To 1 oz. of polychrome methylen blue (Grübler) add 5 drops of 3 per cent. solution of acetic acid (U. S. P. 33 per cent). (2) Make a saturated (1 per cent.) watery solution of methylen blue, preferably Ehrlich's rect. (Grübler), or Koch's, dissolving the dye by gentle heat. This solution improves by age, and should be at least one week old. (3) Make a 1 per cent. solution in water of Grübler's aqueous eosin. The mixture is prepared as follows: To 10 c. c. of water add 4 drops of the eosin solution, 6 drops of the neutralized polychrome methylen blue, and 2 drops of 1 per cent. methylen blue, mixing well. The specimens, fixed in alcohol or by heat, are immersed for two hours, specimen side down, and will not overstain in 24 hours. The red corpuscles are stained light pink, the body of the parasite blue, while the chromatin particles of the nucleus appear deep red.

Nocht's procedure is also of value in studying the nuclear structures in other micro-organisms.

Goldhorn (N. Y. Path. Soc., Feb. 13, 1901) has succeeded in increasing the amount of the red staining principle by digesting polychrome methylen blue with lithium carbonate. He stains the specimen for a few seconds in 0.1 per cent. watery solution of eosin, then in digested polychrome blue 30 to 60 seconds.

Ewing found no evidence for the view that there is more than one species of the æstivo-autumnal parasite. The nucleus of the malarial parasite belongs to the "distributed type" of protozoan nuclei, consisting of granules of chromatin. While not a true nucleus in the metazoan sense, it possesses all the nuclear structures required in some protozoa. He believes that conjugation of malarial parasites occurs. His observations seem to him to admit of no other explanation; but he does not regard conjugation as an essential feature of the growth of the parasite. He regards the existence of several species of malarial parasites as not yet proven, and adheres to the theory that there is a single polymorphous species.

J. H. P.

Rosenberger, R. C. A New Blood Stain. Philadelphia Medical Journal, 7: 448, 1901.

Rosenberger discovered that phloxin stains the granules of the leucocytes remarkably well. He recommends the following solution as a differential stain for the cells in the blood:

| | | | |
|--|---|---|---------|
| Saturated aqueous solution of methylen blue, | - | - | 5 parts |
| Saturated aqueous solution of phloxin, | - | - | 2 parts |
| Alcohol (95 per cent.), | - | - | 3 parts |
| Distilled water, | - | - | 6 parts |

These are mixed together. A precipitate generally forms. The stain should be well shaken before using. It works well after fixation by heat, alcohol and ether, or absolute alcohol. Stain one to four minutes, wash freely, dry, mount in balsam.

J. H. P.

Baum, E. Ueber die punktförmigen Kalkkörperchen (sogen verkalkte Glomerule) der Nierenrinde. Virchow's Archiv, **162**: 85-93, 1900.

The yellowish-white points sometimes seen on the surface of the kidney have been regarded as calcified glomeruli. In the great majority of cases they are not glomeruli, but cysts containing lime-salts. These cysts are of two kinds. They are present in kidneys in which there is no evidence of chronic interstitial changes. The larger, irregularly shaped cysts arise from the uriniferous tubules. Their walls are lined in places with high epithelium. The cysts of the other variety are round, about the size of a glomerulus and confined to the cortex. They represent capsular spores of malpighian corpuscles, in which glomeruli have not developed. The lining epithelium when present is of a low type. The lime is deposited in the colloid material which fills the cysts. The lime occurs as small granules and as concentric masses. Only rarely does a sclerosed glomerulus become calcified.

J. H. P.

Whitney, W. F. A Quick and Simple Method for Fixing the Blood Corpuscles for Differential Staining. Jour. Boston Soc. Med. Sci. **5**: 341, 1901.

The writer states that the various methods for the rapid fixation of blood smears that have been devised are all uncertain. The method has given uniformly good results. It consists simply in the use of a modified Zenker's fluid. This solution consists of a mixture of potassium bichromate two parts, sodium sulphate one part, water 100 parts, saturated with corrosive sublimate, plus 5 per cent. of glacial acetic acid. In Whitney's modification 5 per cent. of strong nitric acid is substituted for the 5 per cent. of acetic acid.

The blood is drawn and spread in the usual way and dried thoroughly in the air or, if preferred, by a gentle heat. The cover-glass is taken with the forceps, the prepared surface covered with a few drops of the fluid and held while twenty are counted slowly. It is washed off with running water and blotted. The action depends upon the combination of corrosive sublimate with potassium nitrate and chromic acid which are formed in the solution.

Ehrlich's triacid stain, Unna's polychrome methylen blue and Chenzinski's eosin work well after the fixation.

J. H. P.

Goldhorn, L. B. A Rapid Method of Staining the Chromatin of the Malaria Parasite. Med. Rec. **59**: 11.

1. Fix fresh preparation by immersion in pure methyl alcohol for 15 seconds.
2. Wash in running water.
3. Stain for 7 to 30 seconds in 0.1 per cent. aq. sol. of eosin.
4. Wash in running water.
5. Stain for 30 to 60 seconds in polychrome solution.
6. Wash again and dry in air; no filter paper or heat being used.

If, on exposure to air, the dye becomes too alkaline, a few drops of a 4-5 per cent. solution of acetic acid may be added. If this amount of acid proves too much, add a few drops of a saturated aqueous solution of lithium carbonate. The stain improves on keeping.

C. W. J.

GENERAL PHYSIOLOGY.

RAYMOND PEARL.

Books and papers for review should be sent to Raymond Pearl, Zoölogical Laboratory, University of Michigan, Ann Arbor, Mich.

Schenck, F. Physiologische Charakteristik der Zelle. Würzburg, A. Stuber's Verlag (C. Kabitzsch). 8vo, pp. viii and 123, 1899.

This work aims to determine in how far the cell may be considered a "physiological unit" or "elemental organism."

and, having settled this point, to examine the real physiological significance of the cell and its parts. The method taken is a critical examination and analysis of a considerable part of the important literature bearing on the subject. The author is strongly opposed to the view that the cell presents the simplest condition of life phenomena, and that a physiological study of the cell ought to precede, and form a basis for the "organ physiology" of higher animals. Nearly a third of the book is occupied with a criticism of this view, the criticism being mainly directed towards Verworn. The principal points made in this portion of the work are: 1. That all cells are not capable of independent existence and hence are not physiological individuals. 2. That since some multicellular forms *are* physiological individuals, this sort of individuality must be independent of the formation of the organism out of cells. 3. That in a multicellular organism the cells are in organic connection with one another by means of protoplasmic strands and that, therefore, the whole must be considered as the individual. 4. That the study of the contraction phenomena in unicellular animals does not lead to any better understanding of the contractility of muscle, and furthermore that, in all probability, the phenomena are simpler and lend themselves more readily to analysis in the latter than in the former case.

The more distinctly constructive contributions have as their purpose to find whether the whole cell or only parts of it are necessary in the carrying on of the fundamental life processes. These processes are discussed under four heads. The first to be considered is the relation of the cell to "physiological combustion" or oxidation, and to the phenomena which primarily depend upon the oxidation of the living substance. The author makes citations from the literature which show, according to his belief, that movement, processes of dissimilation, electrical phenomena, irritability, etc., may take place in enucleated cell fragments. He concludes that "physiological combustion" does not depend upon the combined action of all the parts of the cell, and, therefore, that so far as this process is concerned the cellular structure of the organism is without significance. The next processes to be considered are those of assimilation, growth and morphogenesis. The point brought out here is that, while enucleated protoplasm is capable to some slight extent of carrying on the processes of assimilation, growth and regeneration, yet these processes can only go on continuously when both the characteristic cell parts, nucleus and cytoplasm, act together. It is maintained, however, that the cell is dependent in its formative activity on the whole organism of which it is a part. The division of labor between nucleus and cytoplasm

is the next topic discussed. It is believed that the cytoplasm has to do primarily with the relation of the organism to the external environment, i. e., with the reactions to stimuli; while, on the other hand, the nucleus, as a result of its assimilatory activity which conditions growth and reparation, enables the organism to continue living. In this section the author offers some very interesting and suggestive theories as to the physiological significance of the division of organism into cells, and the phylogenetic origin of the nucleus. In a short section on cell and nuclear division it is maintained that the centrosome is the part of the cell essentially concerned with these processes.

In concluding, Schenck condemns the view that "cell physiology" is synonymous with "general physiology," and even considers that the attention which has been paid to the former has tended to hinder the progress of the latter. The work is throughout one of interest, and in many respects, of value. The style is uncommonly clear and straightforward. The thing which most mars the work is the polemic character which pervades the whole and at times descends to absurd personalities.

R. P.

Cole, L. J. Notes on the Habits of Pycnogonids. Biol. Bull. 2: 195-207, 1901.

This paper, although brief, furnishes an important contribution to our knowledge of the general physiology of the somewhat neglected group, the Pycnogonida. The principal points treated are the movements and the reactions to light, both of which are described in detail. Two curious facts brought to light in connection with the movements are: (a) the action of the legs is precisely the same in both the swimming and crawling movements; and (b) the stroke of the anterior legs is found to be stronger than that of the posterior, and, since the action of both is qualitatively the same, it results from the structural relations of the body that the posterior legs act as hindrance to forward movement when the animal is crawling. The pycnogonids studied are shown to be positively phototactic, but the precise form of the orientation differs according as the animal swims or crawls. When *crawling* towards the light the anterior end of the body precedes, while when *swimming* towards the light the posterior end is in advance. The reaction is the same in the two cases, but the result is conditioned by the mechanical relations of the animal to a solid object, i. e., the bottom. This point is of considerable theoretical interest as indicating that the essential thing in an orientation is not the getting of one end of the organism towards or away from the source of the stimulus, but is, on the contrary, the placing of the axes of the body in definite relations to the lines of action of the directive stimulus. The transfer of the eggs from the female to the male was observed and found to be a comparatively simple process, apparently involving no psychic activity on the part of the animals.

R. P.

Ritter, W. E., and Congdon, Edna M. On the Inhibition by Artificial Section of the Normal Fission Plane in *Stenostoma*. Proc. California Acad. Sci. (Third Series). Zool. 2: 365-376, pl. xvii, 1900.

The question as to the effect of an artificial section of an animal just about to divide by fission was suggested to the senior author of this paper, in the course of his work on monogenesis in ascidians. A partial answer is gained from this study of the common rhabdocoel turbellarian *Stenostoma leucops* O. Schm. The

method taken was to cut across with a small scalpel an individual in which the normal fission plane had become well formed, at some other point of the body than that at which the fission plane was appearing. It was found that when the cut was anterior to the normal fission plane, the formation of this was inhibited and the ganglionic masses which mark its position moved forward till they came to the cut anterior end, where a head was formed. In other words, the tissue which was to form a head migrated as a result of the operation to a position where head tissue would normally never occur. When the cut was posterior to the normal fission plane the latter was not inhibited, but the operation had a distinct retarding influence on its formation. The rule in this case appears to be that the normal fission plane is not completely formed until the posterior piece which has been cut away is wholly regenerated.

In the theoretical discussion a comparison is made between the regulation shown in this case and that of the blastomeres of the segmenting egg. It is thought that the fundamental cause of the migration of the ganglionic cell mass is to be found in the "*specific form of the animal*," or, to quote the exact words of the authors: "We may conceive all the tissues of the individual animal to be in a state, not of *equi-librium*, but of *Stenostoma-librium*; and that when this is disturbed in any way the whole system *together* tends to re-establish it; and this may be done *through* physico-chemical means."

The paper is one of great interest and suggests many possibilities. R. P.

Gaule, J. Ueber den Einfluss der Jahreszeit auf das Gewicht der Muskeln bei Fröschen. Arch. f. d. ges. Physiol. Bd. 83, p. 81, 82. Taf. V, 1900.
Ueber die geschlechtliche Differenz der Muskeln bei Fröschen. Ibid. p. 83-88. Taf. V, 1900.

In these papers are given the results of a series of weighings of certain muscles of frogs of both sexes, at different seasons of the year. It is found that during the summer while the frogs are feeding the muscles take on

weight, while in the winter months, when there is no feeding and the sexual products are being formed, the muscles lose weight. The muscle weight of the males is at all times greater, per unit of body weight, than that of the females. Physiological measurements were also made of the relative amounts of work done by the isolated gastrocnemius muscles from the two sexes, when they were put under the same experimental conditions and stimulated in the same way. The results here show that the muscle of the male shortens more in contracting than that of the female, but, on the other hand, the muscle from the female raises a slightly greater weight than that of the male. The product gained by multiplying the height through which the weight is raised by the amount of the weight, gives a measure of the work done, and from determinations made in this way it appears that the muscle of the male frog is capable of doing more work than that of the female. The author believes that the material for the formation of the sexual products is taken directly from the muscles where it has been stored during the summer feeding season. These differences in the condition of the muscles between the females and the males are thus thought to be due to the greater amount of energy required in the forming of the sexual products in one case, over that required in the other.

CURRENT BACTERIOLOGICAL LITERATURE.

H. W. CONN.

Separates of papers and books on bacteriology should be sent for review to
H. W. Conn, Wesleyan University, Middletown, Conn.

1. **Moore, V. A.** Directions for Beginners in Bacteriology. Ginn & Co., Boston, Mass.
2. **Frost, W. D.** A Laboratory Guide in Elementary Bacteriology. Madison, Wis.
3. **Curtis, H. J.** Essentials of Practical Bacteriology. Longmans, Green & Co., New York.

The very rapid development of courses in bacteriology has led to the appearance of quite a number of outlines for practical bacteriological courses. The three books here referred to are all designed as laboratory guides. The first, by Dr. Moore, gives a series of sixty-four lessons in bacteriological technique, covering the general topics which students study in practical bacteriology. The Laboratory Guide, by Frost, is more specially designed as a laboratory note-book in the study of bacteriology. About half of it is taken up with blanks to be used by students in describing species of bacteria, while the other half is devoted to various exercises in general bacteriology. The Practical Bacteriology, by Curtis, is a somewhat more extended work, and contains a great deal more information than the other two books. It is full of illustrations of apparatus and laboratory devices, as well as of the chief species of bacteria. In addition to laboratory technique it gives a large amount of information in regard to various bacteria, and their relations to disease. This work is especially useful as giving the student not only a knowledge of laboratory technique, but also a great amount of information in regard to the significance of the organisms which he is studying. The work is especially full in its descriptions of some of the more unusual forms of bacteria. Ringworms and cancer are considered in very considerable detail, with the purpose of indicating lines of research for advanced students. A more detailed study of the Actinomyces and its allies is given than can be found in most works of bacteriology. For these reasons the student will obtain from the work much more than would be indicated by a common course in laboratory bacteriology.

H. W. C.

- Dinwiddie.** The Relative Susceptibility of Domestic Animals to the Contagion of Human and Bovine Tuberculosis. Bul. No. 63 Ark. Agri. Exp. Sta.

The author has conducted some very suggestive experiments to test the conclusion as to whether the bovine and human tubercle bacillus are, as has been claimed by Smith, different in their pathological properties. For this purpose he experiments not only with cattle, but with other animals. The result of the experiment is not only to verify Smith's conclusions, but to extend them. He finds that the bovine bacillus is always more virulent than the human bacillus, and that this is true whether the tests are made on cattle, sheep or pigs. So far as his experiments go, they appear to indicate that the bovine bacillus is more virulent for all susceptible animals. It certainly appeared to be for all animals experimented with, and the author infers that it is also more virulent for men. This inference, which is of extreme importance, the author recognizes, however, as not yet proved.

H. W. C.

Obermuller. Ueber neuere Untersuchung des Vorkommen echter Tuberkuloseerger in der Milch und den Molkeerprodukten betreffend. Hyg. Rund., 10: 845, 1900.

Having been for many years engaged in the study of tubercle bacilli in dairy products, the author in this article summarizes his general conclusions in regard to the proper relation which should be taken towards this highly important problem. These conclusions are hardly capable of brief summary. The most important are as follows: Milk cows should be subjected to obligatory inoculation by tuberculin under state law. Bovine tuberculosis can be reduced and, perhaps, largely gotten rid of by the gradual destruction of tuberculous animals which show signs of the disease, especially those with udder tuberculosis. For infants and invalids especial care should be taken to use milk from sound cows only. Cream freed from tubercle bacilli should alone be used for butter making. General mixed milk from the market is a source of danger, unless such milk is pasteurized. The author advocates the establishment of governmental bacteriological stations, whose duty it shall be to test market milk for the tubercle bacillus and other pathological bacteria.

H. W. C.

Tobler, Maria. Beitrag zur Frage des Vorkommens von Tuberkel bacillen und anderen Saurefesten Bacillen in der Marktbutter. Zeit. f. Hyg. u. Infec., 36: 120, 1901.

The author takes up the investigation of the tubercle bacillus and its allies in the market butter of Zurich. The conclusions reached are, in general, in accordance with those obtained by others, inasmuch as true tubercle bacilli are found in a certain number of the samples of market butter. The special point of interest in the investigation is the discovery of five new species of bacilli in the butter, which microscopically resemble the tubercle bacillus and have the same power of holding stains against the action of acids. These five "sauerfest" bacteria are pathogenic for various animals, but they are wholly different from the tubercle bacillus and different, also, from the similar organisms described by Rabinowitsch and others.

H. W. C.

Rabinowitsch, Lydia. Ueber die Gefahr der Uebertragung der Tuberkulose durch Milch und Milchprodukte. Cent. f. Bak. u. Par. 1, 29, p. 309, 1901.

Befund von Sauerfest tuberkelbacillenähnlichen Bakierium bei Lungen gangran. Deutsch Med. Woch., 1900.

The author has continued the investigations upon tubercle bacilli in dairy products, in which she has for some years been engaged. Her general conclusions are expressed as follows: Three dairy supply companies which regularly test their cows with tuberculin, and whose milk she has carefully studied, furnish a product entirely free from tubercle bacilli. Other dairies, that depend entirely upon clinical examinations by veterinarians, furnish milk which frequently contains living, virulent bacilli. The conclusion is, of course, that a clinical examination of cows is insufficient to guarantee the freedom of the milk from tubercle bacilli. The author recommends the sale of milk from herds tested with tuberculin at a price higher than that of ordinary milk.

In the second article the author discovers in the sputum of persons suffering from gangrene of the lungs, a bacillus which is microscopically identical with the tubercle bacillus. The organism in question, upon careful study, proves not to be the tubercle bacillus, but one of the "sauerfest" bacilli which are coming now to be recognized as so abundant in dairy products.

The author makes no attempt to draw any casual connections between the disease and the bacillus.

H. W. C.

NOTES ON RECENT MINERALOGICAL LITERATURE.

ALFRED J. MOSES AND LEA MCL. LUQUER.

Books and reprints for review should be sent to Alfred J. Moses, Columbia University,
New York, N. Y.

Clarke, F. W. The Constitution of Tourmaline. *Am. Jour. Sci.* iv, 8: 111, 1899.

Recent investigations of Penfield and Foote have led the author to modify in

some particulars his formula proposed in 1895.

Clarke regards all tourmalines as derived from the alumino-boro-silicate acid $H_{14}Al_3B_3Si_6O_3$, with all the H atoms replaceable by bases. Using the formula:

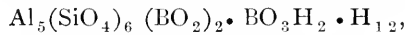

which is applicable to the discussion of the analyses, the author shows that the results of analyses can be expressed by the combination of different molecules, which are all derived from the general formula by the substitution of different bases for H. For example, the composition of the brown Gouverneur, N. Y. tourmaline corresponds to the following molecular mixture:

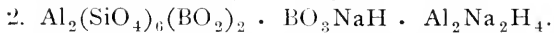
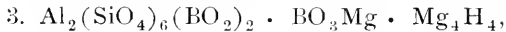
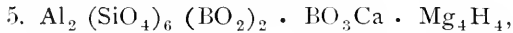

An elaborate chemical discussion is given and many examples cited.

Future investigations may prove tourmaline to be derived from a complex boro-silicic acid; hence the constitution must still be regarded as unsettled.

L. McL. L.

Foote, W. M. Note on a New Meteoric Iron, found near the Tombigbee River, in Choctaw and Sumter Counties, Alabama. *Am. Jour. Sci.* iv, 8: 153, 1899.

The occurrences are of the usual type, the disintegration of the iron being rather marked. Schreibersite was found to be present. The plessite in one

specimen exhibited, under etching test, a beautiful phenomenon suggestive of a metallic sun-stone.

The course of the meteorite must have been from N to S; as after breaking up the fragments were found in this direction, the smaller having fallen first.

L. McL. L.

Foote, W. M. Note on a New Meteoric Iron found near Iredell, Bosque Co., Texas. *Am. Jour.* iv, 8: 415, 1899.

Resembles most siderites, but Widmannstätten figures did not appear on etching, hence probably a distinct fall

from the other meteorites of that region.

L. McL. L.

Termier, P. Sur la composition chimique et les propriétés optiques de la leverrière. *Bull. Soc. Min.* 22, 27, 1899.

The general description is given in a previous article.

Analysis gives:

| | | | | | | |
|------------------|--------------------------------|--------------------------------|----------|------|------------------|---|
| SiO ₂ | Al ₂ O ₃ | Fe ₂ O ₃ | MgO | CaO | K ₂ O | loss by calcination (nearly all H ₂ O) |
| 49.90 | 37.02 | 3.65 | 0.30 tr. | 1.13 | 8.65 | = 100.65, |

yielding formula $(H_2, K_2)O \cdot Al_2O_3 \cdot 2SiO_2$, somewhat similar to that of Muscovite. $G. = 2.6$. Axial angle varies from 0°–50°, but is generally small.

Optical character negative. γ (pract. equal β) = 1.582, α = 1.554, $\gamma - \alpha$ = 0.28 (by Wallerant on Quarter-Gaillard material. Author finds double refraction variable from 0.02 to .0.03.

The mineral occurs in an argillaceous band in a bed of coal at the Fontannes pits.

L. McL. L.

Farrington, O. C. Publications Field Columbian Museum. Geol. Series, 1: 221-241, Feb. 1900.

Inesite. Crystals of the rare mineral, inesite, from San Cayetano mine near Villa Corona, Durango, Mexico, exhibit the

following forms (100), (010), (001), (201), (011), (11.0.12), and (946), of which the two latter are new. An analysis recalculated to 100 per cent. gave the following:

| | Analysis Calc. to 100. | Theory. |
|------------------|------------------------|---------|
| SiO ₂ | 44.76 | 42.91 |
| MnO | 38.86 | 40.51 |
| CaO | 8.21 | 8.00 |
| H ₂ O | 8.17 | 8.58 |
| | 100. | 100. |

from which the formula H₂(Mn · Ca)₆Si₆O₁₉ + 3H₂O is deduced.

Caledonite. Crystallographic examination of the rare mineral, caledonite, from the Stevenson-Bennett mine, Organ Mts., near Las Cruces, New Mexico. Eight forms were identified and from measurements in the zone of the basal and macro-pinacoids, the author concludes that the crystals are orthorhombic.

Gay-lussite. Examination of microscopic crystals of gay-lussite from Sweet-water Valley near Independence Rock, Wyoming.

Epsomite. Crystals of epsomite from Wilcox Station, Wyoming, described.

Golden Calcite. Calcite crystals from concretions of the Fort Pierre shale of the Bad Lands, South Dakota, described. Distorted crystals with the rhombohedron, -2 as the dominant form.

Dolomite used as Indian Money. Perforated cylinders of dolomite from near Lakeport, Lake county, California. A partial analysis gave CaO 28.27; MgO 22.46, Fe 1.18, which percentages are near those of normal dolomite.

Crystal Forms of Calcite, from Joplin, Mo. A crystallographic study of the calcites of this interesting mineral locality. The author distinguishes five types of crystals with the following forms. R, 4, - $\frac{1}{2}$, - $\frac{1}{3}$, - $\frac{7}{5}$, -2, -4, -11, -20, $1\frac{5}{3}$, 1³, $\frac{2}{5}$ 2, $\frac{1}{4}$ 3 of which O, -20, is new for calcite. Twin crystals are described with O, and - $\frac{1}{2}$ as twinning planes, those with the latter twinning planes resembling some from Guanajuato, Mexico, described by Pirsson.

A. F. R.

Palache, Charles. The Crystallization of Calcite, from the Copper Mines of Lake Superior. Geol. Surv. Mich. 6: 161-184, 1900.

An exhaustive study of the calcite crystals of Lake Superior, which perhaps in symmetry and beauty rival those of any other locality. Eighty-seven forms with eight doubtful ones are described in detail. Of these thirty-two are described as new, but ψ $\{ 11.1.\overline{10}.0 \}$ was previously given by Schnorr. (Abstr. Zeit. f. Kryst. 30.660) and \mathfrak{C} $\{ 4.20.\overline{34}.17 \}$ minus $1\frac{6}{7}$ to $\frac{3}{2}$ power by Sansoni (Giorn. Min. 1.136).

Crystals twinned according to the two laws O, and - $\frac{1}{2}$ are described.

A gnomonic projection of all the forms adds to the value of the paper. Details of the measurements, which were for the most part made on the two-circle goniometer, are to be given in a forthcoming number of the Zeitschrift für Kristallographie.

A. F. R.

MEDICAL NOTES.

EHRlich's TRIACID MIXTURE FOR STAINING BLOOD.

| | |
|------------------------------------|-----|
| Orange G, sat. aq. sol., | 30. |
| Säurefuchsin, " " | 20. |
| Methyl Green, " " | 33. |
| Alcohol, absolute, | 25. |
| Glycerin, | 50. |
| Water, dist., | 75. |

Unless the solutions are absolutely saturated before mixing, results will be unsatisfactory. In making up the mixture, the orange G and acid fuchsin are first thoroughly mixed; then, drop by drop, the methyl green is added, the solution being well shaken after each addition. The other three elements are then added, and the whole shaken thoroughly.

When the stock solution is once prepared it should never be shaken, but the desired amount drawn from the top by means of a pipette. The specimen to be stained is prepared in the usual manner by heat, and over the cover-glass spread is placed a drop of the stain, which is allowed to remain for two or three minutes or longer, if desired, after which the specimen is washed in water. Care must be taken in the application of heat during the staining process, for if too much heat is applied the specimen becomes pale yellow and is indistinct under the microscope; while if not enough heat is applied the specimen is too dark.

After being thoroughly washed in water, the specimens are dried with filter paper and mounted in Canada balsam. If the mixture is properly made it will keep for years.

C. W. J.

METHOD FOR CULTIVATING AND STAINING THE DIPHTHERIA BACILLUS (*Weiner Medical Wochenschrift*, No. 10, 1900).—Twist a small piece of absorbent cotton, impregnated with glucose glycerinized agar-agar, around the end of a sterilized glass rod. A supply of these rods thus prepared may be kept on hand, each in a sterilized test tube. To make a culture the cotton is swabbed over the affected material, and the rod returned immediately to the test tube. After being kept in the incubator at a temperature of 36° to 37° for four or five hours, enough bacilli will have developed to make a smear. This is stained with the following methylen blue solution:

| | |
|--------------------------|----------|
| Methylen blue, | 1 gm. |
| Alcohol, | 20 c.c. |
| Water, dist., | 420 gms. |
| Acetic acid, | 50 gms. |

This solution must not remain on the specimen more than two or three seconds, after which time the slide should be thoroughly washed with water. For a counterstain the following is used:

| | |
|---------------------|-----------|
| Vesuvium, | 2 gms. |
| Water, | 1000 gms. |

which is heated, and filtered while still warm.

The vesuvium should act on the specimen for fifteen to twenty seconds, being then washed off with water.

In absence of true bacilli, the smear appears brown. If both true and pseudo bacilli are present, a blue and brown color is visible. The true bacilli stain brown with their polar ends blue, while the pseudo bacilli stain wholly brown.

C. W. J.

NEWS AND NOTES.

THE ACADEMY OF SCIENCE OF ST. LOUIS.—At the meeting of the Academy of Science of St. Louis, on April 1, 1901, thirty-three persons present, a memorial notice of the late Judge Nathaniel Holmes, a charter member of the Academy, was presented by a committee composed of Professor Nipher, Dr. Sander and Dr. Baumgarten.

Dr. John S. Thurman delivered an address on the many industrial uses now made of compressed air, illustrating his remarks by apparatus in operation, including electric motor air compressor, compressed air auger, drill, disinfecting atomizer, sculptors' and stone-cutters' tools, carpet renovators, etc., and a set of lantern slides showing the practical uses made of these and other implements and machines operated by means of compressed air.

Dr. Theodore Kodis exhibited, under the microscope, slides illustrating a new method of staining brain tissue, whereby, in four or five days, it has proved possible to prepare single or double stained preparations containing nerve cells with the dendrites of the latter brought out by a direct stain, instead of being differentiated merely as amorphous silhouettes, as is the case with the much slower Golgi process commonly employed. It was stated that the material is treated before sectioning, for about twenty-four hours, with cyanide of mercury, followed for approximately the same length of time by a formaldehyde solution, after which sections are cut, stained with phosphomolybdate hæmatoxylin and, if desired, a contrasting stain, such as one of the anilin greens, and mounted in the usual way.

WILLIAM TRELEASE,

Recording Secretary.

We have received an announcement of the Summer School for Apprentices and Artisans, which will be held at the University of Wisconsin, from July 1st to August 9th of this year. The school has been established for the benefit of machinists, carpenters, or sheet metal workers; stationary, marine, or locomotive engineers; shop foremen and superintendents; superintendents of waterworks, electric light plants, power stations, factories, large offices and store buildings in cities; and for young men who wish to qualify themselves for such positions. The purpose is to give to apprentices a certain amount of theoretical and practical instruction in the line of their trade, which they would not get in the shops.

No detailed educational requirements are specified for entrance, the fitness of the applicant being determined by a series of questions to ascertain whether or not he seems likely to be benefited by the work, and not be a hindrance to others.

It is believed that employers can well afford to give intelligent, ambitious young men leave of absence from actual employment in order that they may increase their efficiency by availing themselves of the advantages offered in such sessions as the one outlined for this summer at the University of Wisconsin. Persons desiring to attend this school during the coming summer are asked to make application on or before June 1, 1901, to J. B. Johnson, Dean College of Engineering, University of Wisconsin.

THE COLD SPRING HARBOR BIOLOGICAL LABORATORY.—The twelfth session of the biological laboratory of the Brooklyn Institute of Arts and Sciences will be held at Cold Spring Harbor, L. I., from Wednesday, July 3d, until August 13th. The following courses are offered: Professor C. B. Davenport, University of Chicago, high school zoölogy; variation and inheritance. Professor H. S. Pratt, Haverford College, comparative anatomy. Dr. L. E. Griffin, Western Reserve University, invertebrate embryology. Dr. A. G. Mayer, Brooklyn Institute Museum, entomology. Professor E. B. Copeland, West Virginia University, cryptogamic and physiologic botany. Mr. H. H. Whitford, University of Chicago, plant ecology. Professor N. F. Davis, Bucknell University, bacteriology. Mrs. C. B. Davenport, microscopic methods. Dr. H. A. Kelly, Ethical Culture Schools, nature study. Professor S. R. Williams, Miami University, will give instructions in animal bionomics; Professor W. L. Tower, Antioch College, assists in entomology, and Mr. A. F. Blakeslee, Harvard University, in botany. Louise B. Dunn, Barnard College, assists in ecology. A new laboratory, exclusively for investigators, is announced. The dining and rooming accommodations are under the immediate control of the laboratory. There is a uniform fee of twenty-five dollars for study at the laboratory; private rooms are fifty dollars for the entire season. Board and room costs six dollars per week. Correspondence should be addressed to the director, Professor C. B. Davenport, University of Chicago, Chicago, Ill.

QUESTION BOX.

Inquiries will be printed in this department from any inquirer.
The replies will appear as received.

What is meant by the "growing tip" in *Allium*—when used for mitosis as figured in Wilson's book on the Cell?—v. A. L.

Can synthol be used in place of carbolic acid?—v. A. L.

What are the three formulæ of Kaiserling's solution, so often quoted?—v. A. L.

Can a Welsbach light be used in photo-micrography with $\frac{1}{12}$ H. I. objective and an achromatic ocular, and give light enough to focus on ground glass screen?—v. A. L.

Can H. I. lenses $\frac{1}{18}$, $\frac{1}{12}$, $\frac{1}{10}$, etc., be used in photo-micrography with a Welsbach gas light only, using Abbe condenser and bulls-eye with an *ocular in place*? The light on the focusing screen is so dim as to render the object indiscernible. Is an aplanatic ocular prone to give more light for this purpose?—C. L. P.

Journal of Applied Microscopy and Laboratory Methods.

VOLUME IV.

JUNE, 1901.

NUMBER 6

Improved Automatic Microtomes.

The two microtomes, to which I wish to call attention, are modifications of the two forms of automatic microtomes described by me in 1897.¹ In neither instrument have the essential features of the construction been changed, but the alterations made were introduced partly to increase the accuracy of the cutting, partly to facilitate the manipulation of the apparatus. Messrs. Bausch & Lomb undertook the series of improvements at my request, and I am indebted especially to Mr. Edward Bausch for the time and thought he has given both to planning and executing the work involved. Every detail has been the subject of extended consultation, but I wish the pleasure of acknowledging that several valuable innovations were first suggested by Mr. Bausch. The new feed for the precision microtome was devised and worked out by Messrs. Bausch & Lomb.

I. THE AUTOMATIC WHEEL-MICROTOME.

Perhaps the most important improvement in this instrument is its increased accuracy, which has been secured by the use of the finest machine tools for planing the sliding surfaces, cutting the micrometer screw and cutting the teeth of the feed wheel. The accuracy is now so great that one can cut easily a uniform series of sections of two microns in thickness, and presumably of one micron, but the one micron sections I have not sufficiently tested. In the former instruments, both American and German, the sections would skip occasionally, and then the following section would be of nearly double thickness and the uniformity of a series ruined. With the present instruments, three of which I have tested, this vexatious irregularity does not occur, at least with ordinary objects. I have not yet tried the microtome with objects specially difficult to cut.

Other improvements have rendered the microtome more convenient to use. The following five changes are most important: *First*—The toothed wheel which supplies the automatic feed has been enlarged and cut to have five-hundred teeth, so that, as the micrometer screw has a half-millimeter pitch, each tooth equals a feed of one micron. *Second*—The automatic feed has been so contrived that it will give any desired thickness, from one to twenty-five microns, and can be changed in a moment. This is accomplished by having the pawl-

¹SCIENCE, Vol. V, No. 127, pages 857-866, June 4, 1897.

bearing lever strike against an eccentric cam, which has twenty-five stops in it. To diminish the wear and friction, the lever where it strikes the cam is furnished with a steel wheel. To prevent the dislocation of the pawl it is made in the form of a fork, the prongs of which fit over the edges of the toothed wheel, so that the pawl cannot slip to either side. *Third*—To prevent the overthrow of the wheel, which, in rapid section cutting, is apt to cause a greater feed and therefore sections of greater thickness than intended, a simple and effective brake has been added, the tension of which is easily regulated. The brake consists of two steel springs, each with a leather pad, which press against the rim of the wheel by a set-screw; these pads may be pressed together more or less, thus regulating their pressure upon the wheel between them. *Fourth*—A split nut has been provided for the micrometer screw, the two pieces of the nut are attached to levers, which work like pincers, so that by pressing the levers the nut is opened and object carrier may be run forward or back rapidly without

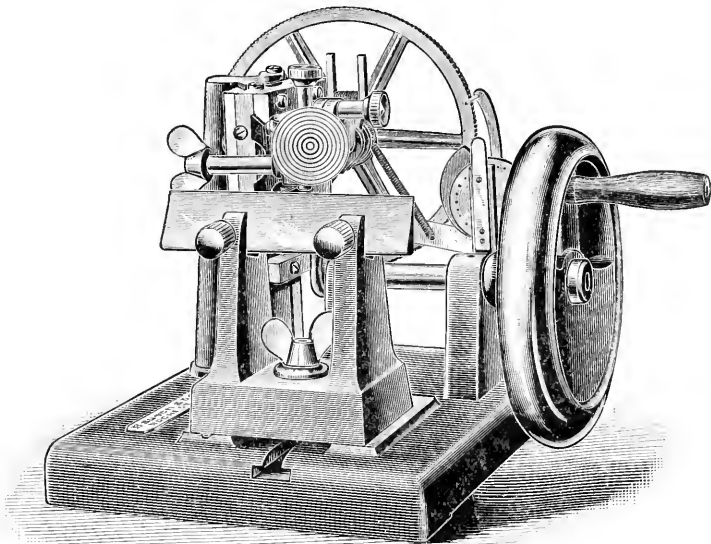

disturbing the screw; by releasing the levers the nut closes, and as it closes snaps into place automatically. The device is such that when the carriage is run way back to the beginning of its excursion, the nut snaps into place of itself, and the machine is ready to work. *Fifth*—The main wheel by which the machine is worked, has been so carefully balanced that the microtome may be stopped at any point, and will remain in the same position without change.

There are other minor alterations, which do not call for special description. The resulting apparatus produced by Messrs. Bausch & Lomb is a fine instrument of precision, very convenient and satisfactory in use, and attractive in appearance.

II. THE PRECISION MICROTOME.

The original form of this instrument was found by long continued use to have certain minor defects, three of which caused inconvenience. Perhaps the

most serious of them was the liability of the automatic feed to get out of order unless great and constant care was taken in the use of the machine. The second defect was the wear on the ways, which took place chiefly in the middle, and very little or not at all at the ends, so that the carriage was liable to bind at the end of a longer excursion than usual. A third defect was that the object holder could be lowered only by the slow process of turning the micrometer screw backwards. Messrs. Bausch & Lomb have sought to remedy the first defect by a new feeding device, which cannot be clearly described without special illustrations. The general principle is to have a lever bearing a pawl, which moves the toothed wheel; the backward motion is so arranged that the pawl is lifted free from the wheel altogether, but at the end of the backward motion the

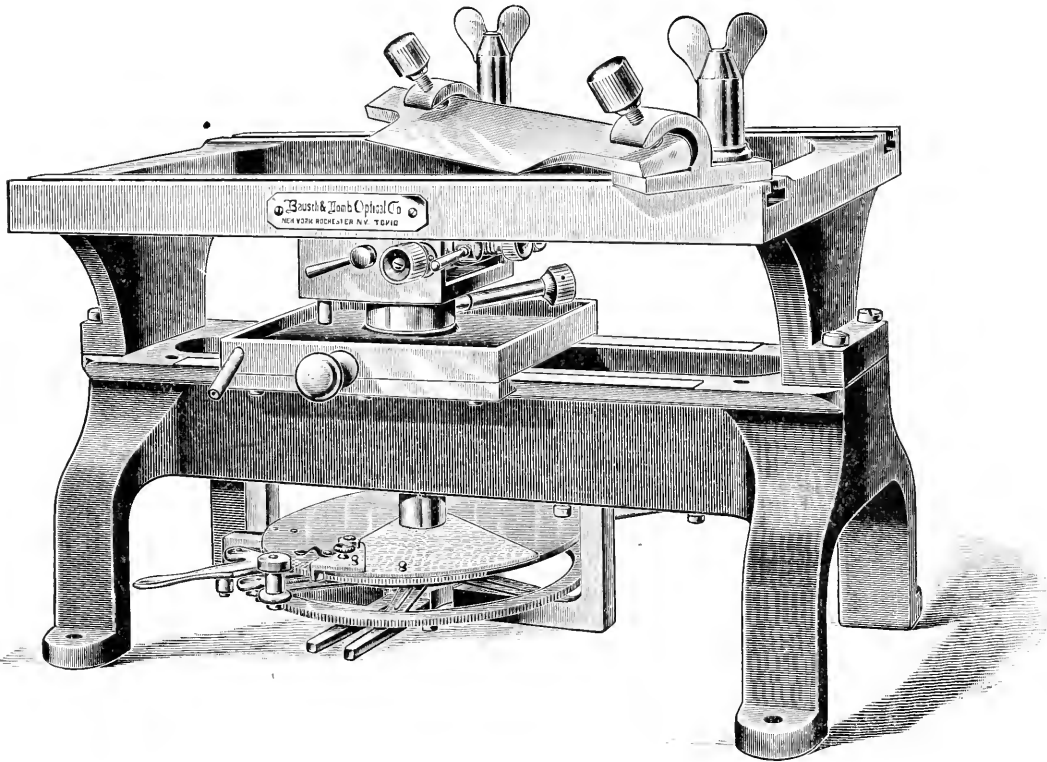

pawl is brought into place against the wheel again, by an action of the lever. For this purpose the lever is hinged in its middle, so that its outer arm can bend independently in one direction without displacing the whole lever. The motion of the outer arm is utilized to bring the pawl into place against the toothed wheel. This wheel is provided with five hundred teeth, each tooth equalling a feed of one micron. It is also, to prevent overthrowing, supplied with a brake similar to that on the wheel microtome. Of the new automatic feed it is proposed to publish a separate account, with figures, on another occasion. The second defect, that of the ways, has been obviated very simply by shortening the ways themselves so that the whole of the ways will be worn

during each ordinary excursion of the carriage. The third defect has been met by the addition of the split-nut; it is only necessary to press upon the levers which open the nut, in order to allow the object holder to sink gently to a lower level. Other minor improvements have been made, of which I will mention only the spring-buffers, which prevent the carriage, if it be moved a little too far or fast, from hitting too violently against the frame of the microtome. The other improvements have been intended chiefly to increase the rigidity of the apparatus.

The two instruments, above described, seem to me better suited to meet the severer requirements of microtomic work, than any others which I have hitherto tested. The "*Wheel*" microtome will probably be more used than the "*Precision*," partly because it works more rapidly. It is, however, adapted only to paraffin cutting. When, on the other hand, the finest grade of section work and a larger variety of imbedding substances are demanded, the precision microtome is preferable, since it can furnish not only the finest but also the thickest sections, and will give perfect sections of objects which cannot be cut satisfactorily with any other microtome, and, finally, it can be used for either dry paraffin or wet celloidin sectioning. We consider the precision microtome so much more accurate than any other, that we use it almost exclusively for cutting the series for the permanent collection of the Harvard Embryological Laboratory.

CHARLES S. MINOT, LL. D.

New Freezing Microtome for Use with Carbon-Dioxide Tanks.

A freezing microtome offers two great advantages to the student of microscopic anatomy. By its use thin sections of animal tissues can be prepared more quickly and in many respects in a less altered condition than is possible by other methods. Freezing was one of the earliest methods discovered of rendering animal tissues hard enough to be cut readily into thin slices. Thus, Stilling, in 1843, was enabled to prepare thin sections of the central nervous system. Since that date freezing, as a method of hardening, has always, to a greater or less extent, been utilized by histologists.

In the earlier days, freezing mixtures were made use of. The stand on which the object to be cut was placed was surrounded by ice, salt, and water until the tissue became frozen. Freehand sections were made with a razor. This method of freezing tissues for microscopic work was superceded by methods which involve the use of volatile fluids like ether. Instruments for the utilization of these fluids were devised as attachments to the precision microtomes which were invented after the use of celloidin and paraffin as embedding agents was discovered. These instruments are still in use among histologists. In the hands of careful workers they give satisfaction. They are, however, slow in action, expensive to use, and easily put out of order. For these reasons, although almost all biologists have freezing attachments to their sliding microtomes, few make much use of them. Of late, carbon-dioxide has been much utilized, especially by pathologists, as a means of freezing tissues for sectioning. The convenience with which

fluid carbon-dioxide may be obtained in tanks, and its power of rapid freezing, have caused it to be preferred to ether and similar fluids. In every active pathological laboratory the freezing microtome is in daily use. Perhaps its greatest value lies in the fact that thin sections may be made within a few minutes after the removal of tissue from the body, and in a few minutes more these sections may be hardened, stained, cleared, and mounted. The surgeon may thus be given a positive diagnosis of the microscopic condition of diseased tissues while he proceeds with an operation.

The carbon-dioxide microtomes commonly used have, however, several drawbacks which have served to render them far less useful than they should be. From the practical standpoint their most serious drawbacks are a tendency to

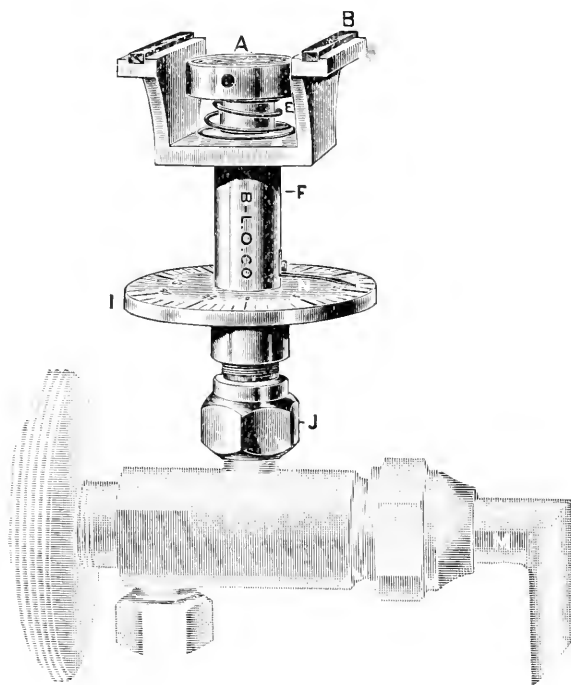

FIG. 1.

A. Cover of freezing stage ; B. Glass track for carrying knife ; E. Spiral spring ; F. Tubal base of knife-stage ; I. Wheel ; J. Nut for attaching axial tube to tank ; M. Handle of tank-valve ; N. Pointer.

become clogged and a great wastefulness of gas. From the scientific standpoint, lack of control over the temperature of the freezing stage serves to give rise to an "over-freezing," which produces marked alterations in the tissues. In order to remedy these defects the machine described below was devised. In designing a practical machine I had the able assistance of Mr. E. F. Northrup. The Bausch & Lomb Company, who have undertaken its manufacture, have also offered suggestions that have proved of much value.

Figure 1 shows the machine as it stands ready for use. It is supported directly by the nozzle of the carbon-dioxide tank. This offers a firm and convenient means of attachment, but, if desired, a heavy tubing may be utilized to

connect tank and machine. When the microtome is screwed directly upon the carbon-dioxide tank it is necessary that the latter lie in a horizontal position. On the other hand, if an L-shaped piece of tubing be utilized to connect freezing microtome and tank, the tank may be placed at any desired angle.

The valve of the tank is used to control the escape of gas into the machine.

The axis and main support of the instrument consists of a stout tube with a narrow lumen (K-D, Fig. 2). This axial tube is united by a nut (J, Figs. 1 and 2), either directly to the nozzle of the tank, or, in case a connecting tube is used, to the latter.

On the top of the axial tube the freezing stage (A, Fig. 1, A-C, Fig. 2), is screwed. This stage piece consists of two parts, a base and a cover. The base is the part screwed into the upper end of the axial tube (C, Fig. 2). To this base the cover piece is screwed (A, Fig. 2). Between the base of the stage and the axial tube is placed a thin brass plate (D, Fig. 2), with a very narrow aperture at its center. Through this narrow aperture the carbon-dioxide escapes into the lumen of the stage piece (C, Fig. 2). The difference in pressure on the two sides of the brass plate causes a very rapid expansion of gas between the cover and base of the freezing stage. The passage open for the escape of gas from the lumen of the base (C, Fig. 2) to the external world is in the form of a spiral passage which finally opens out through the side of the cover, as shown in Fig. 1, A. Between the cover and base of the freezing stage an asbestos washer is placed.

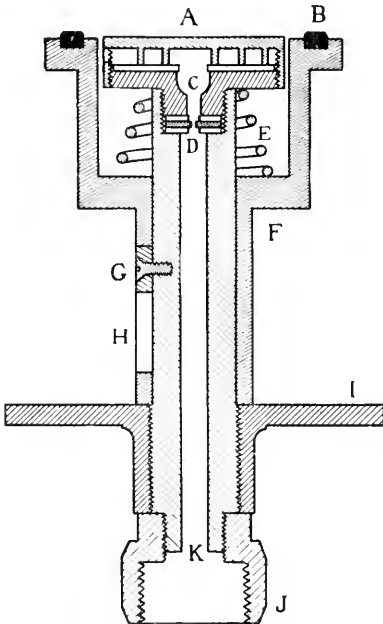

FIG. 2.

A. Cover of freezing stage; B. Glass track for carrying knife; C. Aperture in base of freezing stage; D. Aperture in thin brass plate; E. Spiral spring; F. Tubal base of knife stage; G. Check for limiting movements of knife-stage; H. Groove for G; I. Wheel; J. Nut for attaching axial tube to tank; K. Opening into lumen of axial tube.

The expanding gas, therefore, can absorb little heat from the base of the stage. Almost all heat absorption must take place from the cover. This heat absorption is greatly facilitated by the metallic spiral, which projects down from the cover so as to give rise to the spiral passage through which the gas escapes.

Through the mechanism here described far the greater part of the heat absorbing power of the expanding gas is utilized to lower the temperature of the surface of the cover of the freezing stage. The temperature of the rest of the machine is but little altered. Good control of the temperature of the freezing stage can be thus maintained. This control is further rendered possible by the valve of the tank. If this valve be turned on full the temperature of the cover of the freezing stage will be quickly reduced to a very low point. Tissue placed on it is quickly frozen. On the other hand, if the gas is not permitted to escape from the tank with full force, the difference in pressure on the two sides of the brass plate is less and heat absorption from the cover is less marked.

In this way tissues placed on the cover may be slowly frozen without subjecting them to severe cold. Thus, too, a constant low temperature may be maintained by opening the tank valve to the required point.

The mechanism for controlling the thickness of the sections is equally simple. On the lower end of the axial tube a movable wheel (I, Fig. 1 and Fig. 2) is placed. This wheel moves up and down the axial tube on a screw thread, cut twenty-five threads to the inch. A complete revolution of the wheel, therefore, raises or lowers it a millimeter. The margin of the wheel is divided into fifty spaces, each of which therefore represents twenty microns. A pointer (N, Fig. 1) serves to indicate the number of spaces passed in a partial revolution of the wheel, and thus to show the thickness of the sections cut.

The knife-stage (F-B, Fig. 1 and Fig. 2), consists of a tubal base (F), which surrounds an axial tube and rests on the movable wheel; and of two flanges (B), which extend above the freezing stage on each side for the support of the cutting blade. The base of the knife stage is moved up the axial tube by screwing the wheel upwards. It is forced down the axial tube by the spring (E, Fig. 1 and Fig. 2) whenever the wheel is turned so as to be carried downwards. The flanges of the knife-stage support parallel glass tracks upon which the cutting blade is carried to and fro.

For cutting sections a razor or a plane, or almost any good steel blade with a straight edge, may be used.

The advantages of the machine are as follows:

1. But little carbon-dioxide is wasted.
2. The temperature of the freezing stage can be controlled.
3. The machine, including the tank, may be readily carried about. This should render it of especial value to surgeons.
4. Above all, it is simple in design, strong, and exceedingly unlikely to get out of order.*

CHARLES RUSSELL BARDEEN.

Anatomical Laboratory, Johns Hopkins University, Baltimore.

MICRO-CHEMICAL ANALYSIS.

XIV.

BARIUM—Continued.

III. Barium unites with Potassium Ferrocyanide to form a Ferrocyanide of Barium and Potassium.

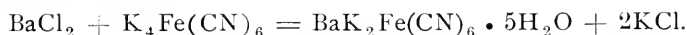

Method.—To the test drop, which should contain no free mineral acid, add a little acetic acid, then a little potassium ferrocyanide, and warm the preparation very gently. In a few seconds rhombs of the double ferrocyanide will appear

*The description of the microtome here given is essentially similar to one that will appear in the May-June number of the Johns Hopkins Bulletin, 1901.

near the edge of the test drop (Fig. 57). These crystals are clear and transparent. By transmitted light they appear to be colorless, but if examined by reflected light they will be seen to have a very faint, almost imperceptible yellow tint.

Remarks.—The reagent crystallizes in prisms belonging to the monoclinic system, while the barium salt is to be ascribed to the orthorhombic system. The danger of confusing the two salts is, therefore, slight. The crystals of the ferrocyanide of barium and potassium extinguish parallel to the diagonal bisecting the acute angles of the rhombs. Many of the crystals of the barium salt appear to be rectangular plates or even cubes, according to the position in which they are seen. An examination with crossed nicols will dispel the illusion. When the test drop is concentrated with respect to barium, the crystals of the double ferrocyanide separate at the point where the reagent was introduced.



1 Div = 0.01 mm.

Fig. 57.

Potassium ferrocyanide, though giving a neat reaction with pure salts of barium, is of little value when dealing with mixtures. It is then often difficult to avoid the precipitation of calcium with the barium, particularly if much ammonium chloride is present, or if much sodium acetate has been added to mitigate the action of mineral acids.

From mixtures, strontium may sometimes be precipitated if the solution is quite concentrated, and may thus interfere with the test. Pure salts of strontium give, in very concentrated solutions, only a granular deposit consisting of globular masses, exhibiting no distinguishable crystal form.

Magnesium is precipitated from ammoniacal solutions, but neither from acid nor from neutral solutions; hence the presence of this element will not mask the test for barium.

In addition to calcium and strontium, there are a number of other elements, which, if present, will either be precipitated in insoluble form or will interfere with the formation of the barium crystals. In this list the most frequently met with will be lead, iron, zinc, rare earths, and less often copper, mercury, uranium, titanium.

Exercises for Practice.

Crystallize a little of the reagent alone, and determine its optical properties.

Try reagent on pure salts of Ca; Sr; Ba; using both dilute and concentrated solutions. Try again, this time proceeding as directed under Calcium.

Try the reagent on mixtures, say of Ca and Sr; Ca and Ba; Sr and Ba.

Try effect of the reagent on salts of Pb, Zn and Fe. Then make mixtures of Ba and these elements, and test.

Make a preparation of $\text{BaK}_2\text{Fe}(\text{CN})_6 \cdot 5\text{H}_2\text{O}$, measure the angles of the crystals, and determine the optical properties of the compound.

IV. Ammonium Fluosilicate precipitates Barium Fluosilicate.

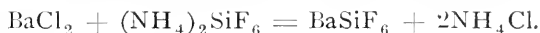

Method.—Place, on a celluloid slip, a drop of the moderately dilute solution to be tested. Acidify with acetic acid; spread out the drop a trifle; add a fragment of ammonium fluosilicate and warm gently. There will immediately form, throughout the test drop, fusiform crystals, either singly, in crosses, or in more or less irregular masses (Fig. 58).

If the solution is quite dilute, instead of the usual fusiform crystals, well-defined rhombohedra and prismatic crystals are obtained.

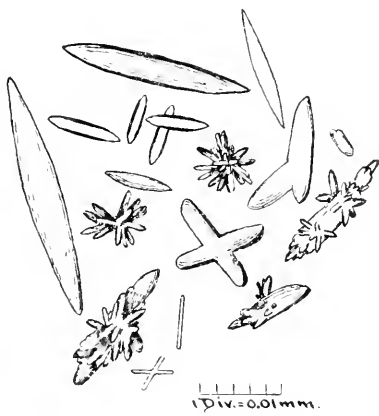

Fig. 58.

Remarks.—See Sodium, Method III. It is important to avoid testing concentrated solutions, since fluosilicates of calcium or strontium may possibly separate, although neither of these elements will be precipitated under the conditions which usually obtain in testing. This caution as to concentration is necessary, because when crystals of calcium fluosilicate $\text{CaSiF}_6 \cdot 2\text{H}_2\text{O}$ do appear, the forms obtained may resemble the barium salt quite closely. Calcium fluosilicate is to be referred, however, to the monoclinic system. The corresponding strontium salt, $\text{SrSiF}_6 \cdot 2\text{H}_2\text{O}$, is isomorphous with the calcium compound, and is slightly less soluble than the latter.

The form of barium fluosilicate varies quite a little according to the concentration of the test drop, and to its state of acidity.

Much free mineral acid is apt to interfere slightly with the precipitation.

When employing celluloid slips, it is of course essential to use great care in warming the preparation, owing to the inflammability of the material. Under proper precautions there is very little danger of losing the test. The warming should be slight.

If barium alone is to be searched for, a glass slip may be employed, as the formation of any sodium fluosilicate will not materially affect the test for barium.

In the absence of ammonium fluosilicate, ammonium fluoride and a little silica may be added to the test drop, or the silica may be suppressed and the test performed on a glass slip.

Exercises for Practice.

Test pure salts of Ba; Sr; Ca; first in dilute, then in concentrated, in neutral, and in acid solutions.

Make a mixture of Ca, Sr, Ba, and test as above.

Try reaction on mixtures of Na and Ba; then on Na, Ca, Ba; Na, Sr, Ba; varying the concentration of the test drops.

Test a mixture of Ba and Mg; then one of Ba and Fe.

Try the reagent on a salt of Pb.

V. Ammonium Dichromate added to solutions containing Barium precipitates Barium Chromate.

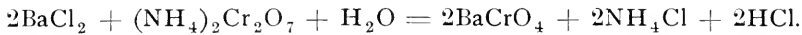

Method.—Employ a very dilute solution of the barium salt. Add a little acetic acid, and then a small fragment of the reagent. Do not stir. In adding the reagent avoid scratching the glass slide with the glass rod or platinum wire.

Barium chromate separates in the form of very minute, light yellow, globular masses, and tiny rods with rounded ends. These rods are often arranged in crosses and Xs (Fig. 59).

Occasionally rectangular plates are obtained.

Remarks.—The complete precipitation of all the barium present is slow.

Strontium will not separate in acid solutions, and calcium not even in the presence of ammonium hydroxide.



Fig. 59.

When strontium is to be tested for as well as barium, the test drop, after the addition of the reagent and examination for barium, is gently heated, then allowed to stand for some time. The supernatant solution is drawn off, and to it a tiny fragment of the reagent is again added, and the preparation warmed; if no precipitate results, showing that all the barium has been removed, strontium can be tested for by adding ammonium hydroxide.

In warming the preparation to accelerate the separation of the barium salt, great care must be exercised in order to avoid concentrating the drop to a point where strontium might be precipitated.

It is often better to allow a drop of ammonium hydroxide to flow slowly into the side of the test drop, rather than add it at once to the center of the preparation.

Normal potassium chromate produces, with barium salts, a precipitate similar to that obtained with dichromate, but is not to be recommended as a reagent because of its property of also precipitating strontium compounds in acid solution.

Ordinarily the precipitate of barium chromate is largely amorphous in appearance. Here and there, however, will be found spots where there are recognizable crystals. A high power is always required for the recognition of the form of the crystals, hence the drop to be studied must be spread out quite thin.

Free mineral acids interfere with the test.

Exercises for Practice.

Try reaction on salts of Ba; Sr; Ca; in acid, neutral and ammoniacal solutions, both in concentrated and in dilute solutions.

Try mixtures of Ca and Ba; Sr and Ba; use solutions acidified with acetic acid, draw off the clear solution, and to it add ammonium hydroxide.

VI. Potassium Antimonyl Tartrate precipitates, from solutions containing Barium, a Double Tartrate of Barium and Antimonyl.

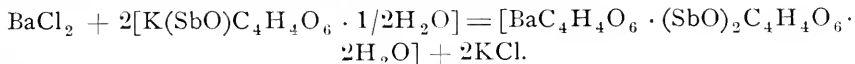

Method.—To the neutral and moderately concentrated drop to be tested add a small drop of acetic acid. Place close to the test drop a drop of distilled water containing the reagent. Warm the reagent drop, and stir until all the tartar emetic has dissolved. Warm the test drop, and while both drops are warm cause the reagent to flow into the solution being examined. On cooling, crystals of the double tartrate will separate in masses near the edges of the drop. As soon as crystals appear draw a platinum wire through one of the crystal masses, and thence across the drop. This will induce crystallization along the path of the wire and will lead to the formation of well formed single crystals. When this procedure is followed, beautiful, clear cut, thin, transparent, colorless crystals of the orthorhombic system are obtained. The usual forms are rhombs and hexagons (Fig. 60); the latter result from the cutting off of the acute angles of the rhombs. Multiple twins are frequent. There is a great tendency toward the formation of aggregates.

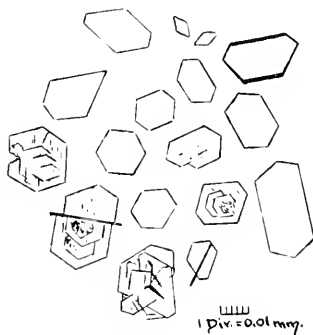

Fig. 60.

Remarks.—Free mineral acids must be absent.

It is unfortunate that this neat reaction is of quite limited application.

Strontium may be precipitated in like forms if the conditions are favorable.

Calcium interferes, as do also members of Group I, and of the magnesium group.

When dealing with small amounts of barium in a mixture, it is necessary, owing to the solubility of the barium double salt, to concentrate the solution to such a point as to render it practically impossible to obtain satisfactory results, because of the crystallization of other compounds.

Lead forms a double antimonyl tartrate isomorphous with that of barium and strontium. *

Of the other heavy metals, silver is the only one which will yield a crystalline precipitate with the reagent, but under the conditions of the test as described, the precipitate with silver is usually amorphous.

Exercises for Practice.

Dissolve a little of the reagent, and allow it to crystallize. Study the crystal forms, and determine their optical properties.

Try the reaction on BaCl_2 ; CaCl_2 ; SrCl_2 .

Test mixtures of Na and Ba; Mg and Ba; Ca and Ba.

Try action of the reagent on salts of Pb.

* Traube, Zeit. Kryst. 26: 188.

VII. With Primary Sodium Carbonate or Ammonium Carbonate.

The latter reagent gives much better results, but even at its best the reaction yields unsatisfactory crystals.

Neutral, very dilute solutions are necessary in order that recognizable crystals shall be obtained. The sodium salt tends to produce minute, spider-like aggregates and spherulites.

Ammonium carbonate yields tiny spindle-shaped crystallites, dumb-bells, and irregular masses.

The test is not applicable in the presence of Ca, Sr, Mg, Li, etc.

SEPARATION OF THE CALCIUM GROUP.

Brief outlines of the methods for the separation and identification of calcium, strontium, and barium have already been given in the discussion of the various tests for these elements. There remains, therefore, only the necessity of summarizing the various processes.

To separate this group from other elements, three reagents can be employed: *I, Ammonium Carbonate; II, Oxalic Acid; III, Sulphuric Acid.* For convenience each of these reagents will be discussed separately and in turn.

I. Ammonium Carbonate in Ammoniacal Solution.

In addition to *Ca*, *Sr*, and *Ba*; there can also be precipitated a number of other elements and compounds. Chief among these should be mentioned, *rare earths, Mn, Cr, Al, Fe, Pb, Magnesium group, phosphates, borates, arsenates, molybdates, oxalates, tartrates*, etc.

Inasmuch as the tests for the elements other than those of Group I and the Calcium group have not yet been described, it is not deemed expedient at this point to enter into a discussion of the methods for dealing with complicated mixtures.

The clear liquid is drawn off, or otherwise separated from the precipitate produced by the reagent. The precipitate is washed, and dissolved in hydrochloric acid.

Test one portion of the hydrochloric acid solution with sulphuric acid for *Ca*, if an amorphous or granular precipitate results, *Sr* or *Ba* (or *Pb*) is present, or the substance may contain both.

Test a second portion with ammonium fluosilicate for *Ba*.

If no *Ba* is found, test for *Sr* with ammonium dichromate and ammonium hydroxide.

If *Ba* is present, precipitate this element with dichromate in acid solution, Draw off and test for *Sr* with ammonium hydroxide.

II. Oxalic Acid.

Three modifications can be satisfactorily employed, the choice being governed by the nature of the material.

- a.* Precipitation with oxalic acid in nitric acid solution.
- b.* Precipitation with oxalic acid in the presence of ferric chloride.
- c.* Precipitation with oxalic acid in the presence of stannic chloride.

a. To the test drop add a little nitric acid, then the reagent. *Ba* is not precipitated. *Ca* and *Sr* separate slowly in the usual form of their oxalates. After allowing sufficient time for the complete separation of *Ca* and *Sr*, separate the clear solution and to it add sodium or ammonium acetate. *Ba* is now precipitated, and can be identified from the crystal form of its oxalate. The precipitated oxalates of *Ca* and *Sr* can be tested at once by adding sulphuric acid, or they can be dried, heated, and thus converted into carbonates. The carbonates can be dissolved in acid, and the solution thus obtained tested.

b. To the test drop add ferric chloride sodium acetate, and then the reagent. *Ca* and *Sr* appear in their normal form, and hence cannot be distinguished one from the other; but *Ba* separates as a double oxalate in the form of long filiform crystals of characteristic appearance.

c. Oxalates of *Ca*, *Sr*, *Ba* undergo a marvelous change when precipitated in the presence of stannic chloride. This beautiful method of distinguishing between these elements is due to Behrens.

To a drop of the moderately concentrated solution to be tested, which should be neutral, or at the most only very faintly acid, add a little stannic chloride; stir, then add a fragment of oxalic acid.

Instead of the usual crystal forms, the oxalates separating in the presence of stannic chloride undergo a remarkable change. *Ca* yields rounded and oval grains and thin disks, with here and there crystals showing unmistakable evidence of trying to develop into octahedra. The crystals are never of large size, though larger than those of the normally formed oxalate, and apparently never grow into clear cut octahedra (Fig. 61).

Sr under the same conditions yields large octahedra (Tetragonal), clear cut and beautifully developed (Fig. 62). These crystals soon become corroded, and may eventually disappear; hence it is necessary to examine the preparation immediately after the addition of the oxalic acid. Too much free mineral acid, or an excessive amount of the stannic salt, interferes with the reaction.

Ba is precipitated by oxalic acid under the above conditions as neat, well developed prisms, singly, in crosses, and in radiating masses (Fig. 63). If much *Ba* is present, long, very pointed, fusiform crystals result, and bundles of slender, pointed needles.

Mixtures of the alkaline earths do not yield, as a rule, the characteristic forms above figured. The form of the oxalates separating from such solutions is then dependent upon the dominating element.

Since it is difficult to properly describe the peculiar changes to be observed, the student is advised to try the reaction on mixtures containing the elements of the calcium group, taking care to have first one, then another of these elements in slight excess.



Fig. 61.

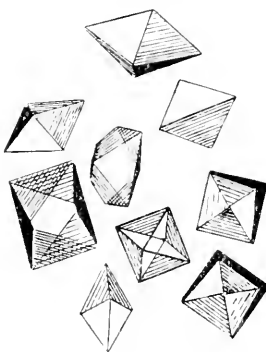

Fig. 62.



1 Div. = 0.01 mm
Fig. 63.

When dealing with mixtures of *Ca*, *Sr*, and *Ba*, Behrens suggests the addition of a little acetic acid prior to that of the oxalic acid, then by cautiously neutralizing with magnesium carbonate, one element after another can be caused to separate. This method of procedure requires great care and considerable experience. For this reason it generally fails in the hands of the beginner.

III. Sulphuric Acid.

The method of procedure has already been thoroughly discussed. Attention has been called to the fact that from mixtures of the sulphates, *Ca* can be extracted with hot water; *Sr* (and *Pb*) with hot hydrochloric acid; *Ba* remaining unacted upon.

Concentration of the water extract will give crystals of calcium sulphate.

Evaporation of the hydrochloric acid solution yields crystals of strontium sulphate.

The residual barium sulphate can be recrystallized from sulphuric acid, or can be converted into barium carbonate, dissolved, and tested.

With simple mixtures it is often unnecessary to proceed according to the above methods. Combinations of the different tests can be resorted to. For example, *Ba* can be precipitated in acetic acid solution by means of ammonium dichromate. The clear liquid is decanted, ammonium chloride and potassium ferrocyanide added, and the *Ca* precipitated and identified. The clear liquid is again separated and tested for *Sr* with sulphuric acid or potassium sulphate. The precipitated strontium sulphate can then be washed and recrystallized.

In addition to the above methods, it is possible to effect a fair separation by converting into nitrates, evaporating, and drying carefully. The perfectly dry nitrates can then be extracted with a mixture of absolute alcohol and ether. *Ca* nitrate is quite soluble, *Sr* nitrate much less so, while *Ba* nitrate is practically insoluble.

The alcohol-ether extract is evaporated to dryness, the residue dissolved in water, and tested for *Ca* with sulphuric acid, arsenic acid, or potassium ferrocyanide. The residual nitrates, insoluble in the alcohol, can then be tested for *Sr* and *Ba* by the dichromate method, or with stannic chloride and oxalic acid, or ferric chloride, sodium acetate, and oxalic acid; or oxalic acid in nitric acid solution.

In all cases the choice of method must be governed by the nature of the substance being examined. The ability to select, at once, the proper method of procedure which will yield the requisite information in the shortest possible time, and without error, is to be acquired only by experience and much practice.

E. M. CHAMOT.

Journal of
Applied Microscopy
 and
Laboratory Methods.

Edited by L. B. ELLIOTT.

Issued Monthly from the Publication Department
 of the Bausch & Lomb Optical Co.,
 Rochester, N. Y.

SUBSCRIPTIONS:

One Dollar per Year. To Foreign Countries, \$1.25
 per Year, in Advance.

The majority of our subscribers dislike to have their files broken in case they fail to remit at the expiration of their paid subscription. We therefore assume that no interruption in the series is desired, unless notice to discontinue is sent.

ALTHOUGH the list of scientific journals and periodicals is already so long that it is quite impossible for one to gain even a casual review of the subjects they contain, the growing importance of investigation in which the principal feature is the collection of large series of statistical information has opened a new field, and it is proposed to establish a journal to be devoted to the publication of biological data and known as the *Journal of Biological Statistics*. Such a publication could certainly be made a valuable aid in the distribution of the results of research work.

There are at present no journals of biological science that wish to fill their pages, beyond a very limited degree, with long series of tabulated observations, which often form the basis of most important theories and conclusions. It is rather the rule to accept only the conclusions drawn by the investigator, and rely upon his judgment to interpret correctly the significance of the mass of facts he has collected. To be sure, this is necessary in most publications, as the great majority of readers cannot devote the time necessary to review carefully the ground covered. However, those studying the same or similar questions desire the most detailed reports of other workers in the same field.

It often occurs that men most capable of handling large series of statistics are not in position to collect them; and, on the other hand, men who collect data often fail to see the full significance of the facts before them. There are few men who, like Darwin, can collect facts and at the same time are able to give them the most accurate interpretation. It is therefore most desirable that data upon which theories and conclusions of general interest are based should have a medium through which they may have unlimited circulation.

* * *

The setting aside of the week in which January 1st falls, as a time for the session of scientific societies, will certainly receive general approval. It will undoubtedly be the means of increasing the attendance at the meetings. It will also certainly add to the good derived by those who go, for the heat of summer and the relapse that usually comes after the year's work naturally tend to lessen the enthusiasm of the members.

It is to be hoped that the universities and colleges throughout the country will coöperate in establishing the convocation week, thus making it possible for scientific men to assemble at a time favorable to the most profitable sessions.

* * *

Owing to the necessary insertion of other matter, the department of Laboratory Photography has been omitted from this issue.

CURRENT BOTANICAL LITERATURE.

CHARLES J. CHAMBERLAIN.

Books for review and separates of papers on botanical subjects should be sent to
Charles J. Chamberlain, University of Chicago,
Chicago, Ill.

REVIEWS.

Ikeno, S. Contribution a l'étude de la fécondation chez le *Ginkgo biloba*. Ann. Sci. Nat. Bot. Ser. VIII, 13: 305-318, pl. 2-3, 1901.

This paper contains a detailed description of fertilization and related phenomena in *Ginkgo*, from the formation of the ventral canal cell up to the first division of the oöspore nucleus. The nucleus of the ventral canal cell rapidly disorganizes, while its sister nucleus increases in size and moves toward the center of the oöspore. In preparations stained with methyl blue and acid fuchsin, the metaplasmic ground substance of the nucleus stains red, and the chromatin, which forms a small, irregular, granular mass, also takes the red, while the nucleoli stain blue.

The nucleus now undergoes a great change in its structure, so that the metaplasm and chromatin can no longer be distinguished from each other. The further development of the nucleus of the oöspore agrees with the description of the corresponding phenomena in *Pinus laricio* as described by the reviewer some time ago. In one instance Professor Ikeno noted an abnormal development of the nucleus of the ventral canal cell, resembling the cases described for *Pinus laricio*.

The tube nucleus and the nucleus of the stalk cell disorganize within the pollen tube and do not enter the oöspore, and it is very probable that only one of the antherozoids is discharged, the other disorganizing without being able to enter. The nucleus of the antherozoid slips out from the cytoplasmic mantle before conjugating with the nucleus of the oöspore. The mode of fusion is like that already described for *Cycas revoluta*, i. e. the male nucleus gradually penetrates into the nucleus of the oöspore and lies within this nucleus before losing its own membranes. At the time of fusion the sex nuclei are very unequal in size, the female being about ten times as large as the male. The behavior of the chromatin during the fusion is not described.

The spindle in the first division of the fusion nucleus is very broad and multipolar and is never parallel with the longitudinal axis of the oöspore. In the case figured the spindle is transverse. Fertilization takes place before the ovules fall from the tree.

C. J. C.

Gruber, Eduard. Ueber das Verhalten der Zellkerne in den Zygosporen von *Sporodinia grandis* Link. Ber. d. deutsch. bot. Gesell. 19: 51-55, pl. 2, 1901.

The zygosporangium of *Sporodinia* is surrounded by three coats, the outer of which is dark brown, warty, and cutinized, and is formed from the membrane of the conjugating gametes, while the two inner coats belong to the zygosporangium itself. The middle coat is somewhat thickened and has a lamellate appearance, while the innermost is a mere Hautschicht.

Léger, who worked on *Sporodinia* six years ago, found that both gametes contain hundreds of small nuclei which become scattered in the mingling cytoplasm after the membrane separating the gametes has broken down. Double staining showed two kinds of nuclei, smaller ones near the periphery and much larger ones nearer the center. At a later stage, all the nuclei disappear and at each pole of the zygospore a spherical mass, the "embryonic sphere," is seen, each sphere containing a large number of granular bodies. These spherical masses increase in size and fuse with each other, and soon afterward numerous nuclei again appear, which pass into the germ tube as the zygospore germinates.

The present writer also finds a large number of nuclei in the zygospore, and finds that the nuclei are more numerous at the periphery, but there are also many nuclei in the center and all of the nuclei are approximately alike in size. This condition persists for a long time, and subsequent stages were hard to follow. No fusion division or disorganization of nuclei could be established with any certainty. On germination the nuclei appear in greater numbers in the germ tube. The presence of "embryonic spheres" is regarded as doubtful. Although the writer was not able to observe any fusion of nuclei, he believes that a fusion of the nuclei at the center of the zygospore is very probable.

C. J. C.

Davis, Bradley Moore. Nuclear Studies on Pella. *Annals of Botany*, 15: 147-180, pls. 10-11, 1901.

This work was undertaken with the object of extending our knowledge of the cytology of the Hepaticæ, and with the hope of throwing some light on the morphological relationships between the various manifestations of kinoplasm. Three phases in the life history of the plant were examined, namely, sporogenesis, the germination of the spore, and the vegetative activities in the seta. In the spore-mother-cell the spindles are developed in the same fashion as that which prevails in the spore-mother-cell of the Pteridophytes and pollen-mother-cells of Spermatophytes. In the stages of spore germination, asters with centrospheres were observed in the prophase. These, however, appear to be transitory structures as they disappear before the daughter nuclei are formed. In the vegetative cells the type of spindle formation is essentially similar to that described by Hof and Némec for the vegetative cells of the flowering plants. Davis also states that "it is probable, of course, that there is likewise a blepharoplast at the time of spermatogenesis." He concludes, however, that the kinoplasmic fibrillæ, the centrospheres and kinoplasmic caps are all secondary developments from the primal granular protoplasm, which is the only form of kinoplasm in any sense permanent in the cell.

Chicago.

A. A. LAWSON.

Noll, F. Ueber die Umkehrungsversuche mit Bryopsis, nebst Bemerkungen über ihren zelligen Aufbau (Energiden). *Ber. d. deutsch bot Gesell.* 18: 444-451, 1900.

In this paper Noll takes up again the much discussed subject of polarity among marine algæ. Beginning with the statement that in *Bryopsis muscosa*, on which he worked, the polarity was as pronounced as in *Pinus*, he gives us some interesting results of his experiments; namely, that very few indeed of his plants reversed their root and shoot pole when inverted. Measurements and

dates show that the young and actively growing plants were so strongly polarized as to resume the original manner of growth; that only older, more slowly growing forms succumbed to the external conditions, and turned root into shoot and shoot into root. These results agree with those of Winkler of an earlier date.

Noli takes exception to the definition of "Energid" as given by Sachs, and calls the Siphonæ "single but multinucleate energids," laying stress upon the "Hautschicht" rather than upon the nucleus and its dominated mass of protoplasm. He therefore defines the energid as a "one or many nucleate plasmatic body enclosed in a definite wall."

PHILIP G. WRIGHTSON.

Chicago.

Life, A. C. The tuber-like rootlets of *Cycas revoluta*. Bot. Gaz. 31: 265-271, 10 figures in text, 1901.

The coral-like outgrowths on the upward rising roots of *Cycas revoluta* have long been known, and the endophytic alga and fungus have also been described. Life has made a careful study of the subject from thin microtome sections and has been able to give a more precise account. In regard to the reputed dichotomy, he finds that not all of the meristem passes over into the two branches, but that a small portion is left as a bridge between them. This small portion, however, does not continue the main axis, and very soon disappears so that sections of roots in which the branching can be seen at the surface show no trace of meristem between the two branches.

The development of the algal zone is clearly figured and described. Three forms of fungi were observed. They make their appearance in advance of the algal zone and seem to prepare the way for the algæ, which are referred to the genus *Nostoc*. The presence of the fungi affects the intercellular spaces so that they become the rather large chambers occupied by the algæ. The *Nostoc* probably enters through the numerous lenticular areas. It is suggested that the tubercles serve for ærating and also assist in nitrogen assimilation.

C. J. C.

CYTOLOGY, EMBRYOLOGY, AND MICROSCOPICAL METHODS.

AGNES M. CLAYPOLE.

Separates of papers and books on animal biology should be sent for review to
Agnes M. Claypole, Sage College,
Ithaca, N. Y.

CURRENT LITERATURE.

Overton, E. Studien ueber die Aufnahme der Anilinfarben durch die lebende Zelle. Pringsheim's Jahrb. f. wiss. Bot. Bd. 34: 669-701, 1899.

The work gives the results of studies upon the action of anilin stains on animal and plant cells. Basic anilin stains are readily taken up by both kinds of cells. Four classes of these stains were studied in detail. (1) *Triphenylenethane* stains: rosanilin (chlorhydrate, nitrate, sulfate), gentian violet, methyl violet, dahlia, anilin blue soluble in alcohol, toluidin blue, victoria blue, malachite green, methyl green, iodine green, auramin, rhodamin; (2) *Chinonimid*

stains: thionin, methyl blue, methylen green, safranin, toluylene red (neutral red), nigrosin soluble in alcohol, indulin; (3) *Azo* stains: chrysoidin, vesuvin, bis-marck brown, the last two being probably the same; and (4) *Acridin* stains: chrysanilin. All these stains penetrate the living cell most rapidly, only rhodamin is somewhat slower. Quite different is the effect of the sulphuric acid stains. (1) Acid fuchsin, acid green, acid violet, anilin blue soluble in water; (2) Nigrosin soluble in water, and indulin; (3) Congo red, ponceau red, bordeaux red, biebricher scarlet; and (4) Indigo carmin, all penetrate neither animal nor plant cells. Only the acid stains belonging to group three (*Azo* stains), methyl orange and tropäolin 00 and 000 are an exception, since these act in some cases after long immersion. Eosin and acid carmin are in general not taken up, curcuma acts quickly, carthamin more slowly. Since all the studies agreed that all the substances easily soluble in fatty oils and similar substances were taken up quickly by living cells, while those insoluble or soluble with difficulty did not penetrate living cells, the conclusion was obvious that the osmotic condition of living cells rests on the phenomena of selective solution. Especially was the author drawn to this conclusion since the plasma-skin of cells is impregnated with cholesterin or a mixture of cholesterin and lecithin. It especially concerns these anilin colors, since all the commercial salts are basic anilin stains mixed with cholesterin, or else are easily soluble in a strong solution of cholesterin or lecithin in organic fluids. Also these liquids in a pure condition have no solubility for these dyes. Tannic acid-methylen blue, which does not penetrate the living cell, is also wholly insoluble in cholesterin and lecithin solutions. With a few exceptions all the sulphuric acid stains and acid carmines are completely insoluble in these liquids. Methyl orange and tropäolin are exceptions and penetrate very slowly and slightly into the living cell. A. M. C.

Retterer, E. Transformation de la cellule cartilagineuse en tissu conjunctiv réticulé. Comp. Rend. Soc. de Biol. 51: 904-907, 1899.

For this work sublimate solution, Zenker's and Flemming's fluids and also an aqueous solution of platinic chloride, 1 pt. to 1000, were used. Without previous decalcification, objects such as the ribs of rabbits and guinea pigs, are embedded in paraffin. The following combination of stains gave the best results: after leaving the sections for a few hours in a solution of safranin in anilin water, they are washed out in water, stained for a few minutes in Boehmer's hæmatoxylin, and decolorized in alcohol to which a very little picric acid is added. A. M. C.

Petroff, N. Neue Färbungsmethod zür rothe Blutkörperchen in Schnittpreparaten. Bolnicznaja Gazeta Botkina, 1899. (Russian.)

Up to now the contrast-staining of blood corpuscles has been done by the use of stains from the malachite-green group, which differentiate by virtue of the special characters of red blood cells. This process is as follows: material previously fixed in Müller's fluid or formalin, or Orth's mixture, is embedded in paraffin, not collodion, cut into the thinnest sections possible of regular thickness, and fastened to the slide. The paraffin is then taken out with xylol and the sections washed in alcohol and water. (2) Nuclear staining is done by putting the sections for 10-15 minutes in a concen-

trated solution of bismarck brown in one per cent. acetic acid, or in lithium or borax carmin for 20–30 minutes; in case of using borax carmin it should be washed out in hydrochloric acid alcohol. Washing with water follows. (3) Stain next for 10–15 minutes with 20 per cent. aqueous solution of malachite green, also brilliant green or victoria green. The solution is made by diluting the alcoholic solution five times. Wash out in water. (4) Stain for $\frac{1}{2}$ –1 minute long according to Van Gieson's tincture method or with concentrated aqueous picric acid solution, which is diluted 4–5 times with water. Wash in water. (5) The quickest possible dehydration and decolorization in absolute alcohol, mounting in xylol and balsam. Turpentine or bergamot oil may be used in the place of xylol. All the decolorizing necessary is easily managed, and can be allowed to continue for a long time. In preparations made in this way the beryl-green corpuscles are distinguished from all other structures, which are a gold-brown from bismarck brown or red-gold from carmin.

A. M. C.

Godlewski, E. O. rozmnazaniu jader w niesniach prazkowanych zwierzat kregowych (Ueber Kernvermehrung in den quergestreiften Muskelfasern der Wirbelthiere.) Bull. de l'Acad. des Sci. de Cracovie, Avril, 1900.

In order to learn to recognize the multiplication of nuclei in striated muscle of vertebrates during embryonic and postembryonic development, the author studied the striated muscle of newly born guinea pigs and mice, also those of salamander larvæ. The extremities of embryos taken from the mother or of narcotized newly born young were put in toto into the fixation fluid. Perenyi's fluid or concentrated sublimate solution with the addition of two per cent. acetic acid was used, followed by increasing strengths of alcohol. After hardening, small pieces of muscle were separated from the bone. During these fixing and hardening processes a great deal of contraction takes place in the muscle fibers. Muscles were cut in paraffin in longitudinal, transverse, and oblique sections five μ in thickness. These were stained in thionin, also in Heidenhain's hæmatoxylin, double stained with bordeaux red or eosin. In preparations so made the nucleoli are sharply tinted with red, so that a clear contrast is obtained between these and the blue chromatin bodies.

A. M. C.

His, W. Ueber Sogenannte Amitosis. Anat. Anz. Centralblt. f. d. Gesam. Wiss. Anat. 18: 52–60, 1900.

Since the discovery and demonstration of bipolar mitosis it has been known that nuclear figures exist which do not agree with the newly discovered principles. Flemming gives a second type of division, direct or amitotic. The characters of this kind are negative, absence of the spindle and splitting of the chromosomes. This form was considered degenerate or pathological, but recent work shows that by changing the conditions of growth the cells of *Spirogyra* may be made to pass from mitotic division to amitotic and back again, without disturbing the normal conditions of growth. This places the difference in the two types of division in the province of physiology and the problem is to determine in how far the two processes follow a common law, and in what way they are related to each other. It has already been suggested (His) that amitosis may be pleniolar mitosis and be related to the growth of multinuclear giant cells and syncytial formation. For these processes His suggests the name "syncaryosis."

In the division of the periplast cells of Selachians two types are recognizable, one in which the nuclei have central, regularly arranged chromatin, and another in which the chromatin is rod-shaped in separate pieces. Those of the first type are found earlier in development. The nuclei contain several small granules to which small furrows run radially. These granules grow to large masses without losing their relations to the radial grooves. Later a giant cell contains six, eight or more large nucleoli. The nuclei of the second type with separate chromatin rods are distinguished by their transparency and even staining. Transition forms are found forming two lines, one in the direction of dissociation and one towards synthesis. The former process is a simple breaking up of the chromatin rods into fine granules. Many stages of these are found. Reconstructive processes follow definite steps: (1) Breaking up of the plasma bodies, carrying the chromatin into several small balls; (2) separation of these balls, still remaining connected by a thread; (3) re-appearance of chromatin rods; (4) radial structure appears in connection with chromatin; (5) formation of enclosed nuclei, thickening of nuclear wall. The process continued still farther and showed itself that of a syncytial formation; it is a kind of nuclear division. Comparing this process with regular bipolar mitosis, we find in common the phases of dissociation of chromatin—prophases; the formation of the chromatin rods and their radial arrangement are the anaphases. The metaphase would correspond to the dissociated mass of granules. As long as the plasma of the nucleus retains a connection with the dissociated chromatin a “spirem” is present. The equivalent of spindle fibers are the plasma threads stretched between the nuclear balls. The origin and relations of polycentric giant cells are understandable on general cellular laws. It is known that a central force acts in such phenomena as division. Its nature is unknown, but simple exhibitions of “pull” and “push” are to be seen.

The process of mitosis can be divided into five steps: (1) The division of the pre-existing centrosome; (2) the separation of these parts; (3) the changed influence of these centrosomes, due to their changed position, shown in the appearance of double radiations; (4) the grouping of the chromatin bodies and arrangement in the daughter nucleus; (5) the formation of cell walls. Each of these processes requires a separate time; but any change in the time requisite for these steps may change the appearances entirely. If the division of centrosomes is relatively too rapid, new ones arise without the correlated changes, and the subsequent steps are those of cells with many centrosomes. The distribution of the chromatin is, hence, difficult to follow. The relation of the nucleolus to these centrosomes and the plasma cells remains yet to be studied.

A. M. C.

Moll, A. Zur Histochemie der Korpels. From the results of the author, Tanzer's Centralbl. f. Physiol. 13: 225-226, 1899. orcein solution (orcein 0.5 gram, alcohol absolute 40.0 c. c., dist. water 20.0 c. c., hydrochloric acid 10 drops) is an instructive double stain for embryonic cartilage. The preparations (embryos or parts of them) must be hardened in alcohol (not in chromic acid), and then in thin celloidin sections be put into the above staining solution for 6-24 hours, then washed in 80 or 90 per cent. alcohol until the celloidin is nearly colorless,

dehydrated in ninety-eight per cent. alcohol, cleared in origanum oil, and mounted in balsam. All preformed hyaline cartilage shows itself distinct microscopically, through its blue violet color, from the rest of the brownish red tissue. Microscopic investigation shows that the blue color has its place in the ground substance of the cartilage. This blue cartilage network makes a strong contrast with the red nuclei of the merely light blue or non-colored cartilage cells. In the embryonic fibro-cartilage of the intervertebral discs, as yet undifferentiated, the central cartilage cells stain blue, the nuclei red. The cells always become paler toward the margin. With orcein, embryonic elastic cartilage gives no double stain. The change in the color from that of adult cartilage is worth mention. Here the ground substance is reddish, the cartilage cell with its surrounding area intense blue, so that the red nuclei can only be seen in the thinnest sections. Similarly changed is the adult fibro-cartilage; only a few fibro-bundles are blue. The elastic cartilage also shows no double stain in the adult condition. Developed bone, both decalcified and non-decalcified, likewise shows no double stain.

E. J. C.

Linsler, P. Ueber den Bau und die Entwicklung des Elastischen Gewebes in der Lung. Anat. Hefte. H. 42, 43: 307-336, m. 3 Tfln., 1900.

The Weigert method was used to demonstrate the elastic tissue in the lung. The stain acted usually in 2-3 hours, yet a longer time for staining, even to 24 hours did not do much harm. If a shorter time was used, 15-20 minutes, no usable results could be obtained. By the longer staining one had this advantage, with others, to stain the adjoining kinds of connective tissue in contrast. Usually a simple washing out in strong alcohol sufficed to make the bundles appear separate. After a longer continuance of the staining process it is necessary to differentiate in hydrochloric acid alcohol if one wishes to have the elastic fibers stained. For a nuclear stain, alcoholic borax carmin and lithium carmin were used; control-stains were carried on with hæmalum-eosin after Van Gieson's method. For investigation 12 embryos, 3.3 cm. long (Kopf Steiss), to the oldest foetal stages, were used. Further, fourteen children up to five years of age and eight older human lungs of different ages. Further, eight different stages of the rat, both before and after birth, lungs of young and old cattle, of new born and older guinea pigs, of hare, dog, horse, pig, roe, stag. Tissues were preserved in formalin or alcohol and imbedded in celloidin.

E. J. C.

Foote, K., and Strobell, E. C. Egg of *Alloboophora fœtida*. Journ. of Morph. 16: 607-618, 3 pls., 1900.

A series of micro-photographs of this egg is published to illustrate the following points: (1) The effect on the cytoplasm of the different fixation fluids now in common use. (2) The character of the fertilization cone. (3) The position of the middle piece of the male aster. (4) The origin of the sperm granules. (5) The early stages in the development of the pronuclei. (6) The presence of osmophile granules in the nucleoli of the germinal muscles. The photographs have been taken at two magnifications, 660 and 950, and it is believed that proof has been offered of some of Foote's earlier conclusions, in regard to the cytoplasmic origin of centrosome of the male aster.

A. M. C.

CURRENT ZOÖLOGICAL LITERATURE.

CHARLES A. KOFOID.

Books and separates of papers on zoölogical subjects should be sent for review to Charles A. Kofoid, University of California, Berkeley, California.

Fülleborn, Dr. Ueber Formalinconservierung. After several years' experience in collecting in temperate regions and the tropics, Dr. Fülleborn gives his unqualified approval of formalin as a preservative of zoölogical material. Its portability, cheapness, ease of application, and its qualities as a preservative for histological purposes, combine to commend it for use in preference to alcohol on collecting expeditions. Large objects for anatomical work should be hardened in 5-10 per cent. formalin for 8-14 days. For transportation, objects thus hardened may be packed in excelsior moistened in formalin, in zinc cases which are soldered up when filled. These zinc cases are made up in sizes which "nest" readily for transportation into the field. Large fish should be opened along the ventral side and along the vertebral column, or the skin should be freed from the musculature in places and a wadding saturated in formalin thrust beneath it. Small fish may be thrown into the formalin solution or injected in the digestive tract. Formalin is especially recommended for fish whose scales are easily rubbed off. Large fish kept for six years in formalin, in relatively weak solutions, are still in a state of excellent preservation.

As a preservative of natural colors, formalin has not fulfilled the high hopes which it first called forth. Dr. Fülleborn reports that it preserved color well in some tropical Amphibia, and in many other instances specimens reached European museums from the tropics in unfaded condition. On the other hand, the iridescent colors of fishes fade as quickly in formalin as they do in alcohol. The brilliant pearly sheen found on certain beetles was preserved in specimens in formalin, though it faded at once in dried and in alcoholic material. The egg-masses of *Necturus* with their gelatinous coverings have kept well in formalin, the form, the eggs, and transparency of the membranes remaining unchanged. Tropical plankton was preserved in 2-5 per cent. formalin, the algæ retaining the green color of the chlorophyll and the smaller *Entomostraca* keeping their natural form as a rule. Some species, however, are distorted by the formalin.

Small birds were mummified by injecting a solution of 5-10 per cent. formalin saturated with sodium arsenate with a hypodermic syringe into the thoracic and abdominal regions, the musculature of the breast and shoulders, the eyes, and the brain (through the orbit). Injections should not be made between the musculature and skin. The small openings made by the syringe do not permit the fluid to escape and soil the feathers, if care is taken in handling the birds. This fluid is to be preferred to 15 per cent. carbolic acid, sometimes used in mummifying birds, since it does not destroy the color of the feathers wet by it. Large birds may be treated (in addition to the injection) by removing the viscera and packing the body cavity with wadding saturated with the injecting

fluid. After injection the feathers should be properly arranged and the birds hung by the bills, when they will dry rapidly. Specimens thus treated may be softened subsequently and mounted in the usual manner. This method is not only a rapid one, facilitating field work, but it also preserves the skeletons.

C. A. K.

Saint-Remy, G. Contributions a l'étude du développement des Cestodes. Arch. de la Parasit. 3: 292-315, pl. 7, 1900.

The small size and the very resistant membranes of the eggs of tapeworms render the technique of their study by modern methods a matter of considerable difficulty. These difficulties have been surmounted to some extent by Professor Saint-Remy, who has studied the development of two species of *Anoplocephala*, parasites of the horse. After removal from the host, the worms were kept in normal salt solution. Examination of the living eggs reveals but little, and the study of sections of the proglottids for the development of the eggs contained therein is even less satisfactory. The eggs are freed from the worm by compression or laceration, and are collected upon slides in sequence from the last proglottid, forward as far as they can be found, thus securing successive stages in development. The eggs are killed upon the slide, and the coagulated fluid in which they lie serves to fix them to the glass. A large number of reagents were tried, and good results were obtained with the aqueous solution of corrosive sublimate, and also with Carnoy's fluid (absolute alcohol 6 vol., chloroform 3 vol., glacial acetic acid 1 vol.). The eggs were not sectioned, but were mounted *in toto* in balsam. For this purpose it was found that alum-carmin and also *bleu de toluidin* eosin gave the finest results.

The development of *Anoplocephala* resembles that of *Tænia*. A small egg-cell and a large yolk mass are enclosed in the egg shell. The former gives rise to two minute polar cells. Two of the cleavage cells invade the yolk, grow at its expense into two giant cells which form the outer covering surrounding the embryo, which is ultimately cast off. Three or four other cells form a second envelope, a pyriform cap provided with branching filaments in the form of a grapnel, and the balance of the embryonic mass forms the onchosphere or embryo proper, within which the characteristic hooks are formed before the embryonic membranes are shed. No decisive evidence is contributed to the solution of the problem of the germ layers in Cestodes.

C. A. K.

Cope, E. D. The Crocodylians, Lizards, and Snakes of North America. Report U. S. Nat. Mus., 1898, 153-1270, 36 pls. with 347 figures in the text, 1900.

Students of our native reptiles will welcome this posthumous work of Professor Cope, for it is a very comprehensive manual, including all of the nearctic species of the orders of Loricata and Squamata. It is based upon the extensive collections of the author, of the Philadelphia Academy of Natural Sciences, and the U. S. Natural Museum. While it deals mainly with the taxonomy of the group, it also gives many facts pertaining to the external and internal anatomy, especially the osteology of the species described. Incidentally reference is made to many interesting points in the biology and natural history of the animals discussed. Ample synoptic keys are provided for the purposes

of identification of species, while abundant illustrations facilitate the recognition of diagnostic characters. The fact that this monograph is issued in the Report of the U. S. National Museum makes possible a much wider distribution to the public than was given Professor Cope's earlier bulletins upon the Batrachia. It is to be hoped that the monograph of the turtles, in preparation by the late Professor Baur, will soon be issued to complete the manual of the North American Reptilia.

C. A. K.

Sayce, O. A. A Method of Preserving Crustacea. *Victorian Nat.* 17: 73-78, 1900. Suppleness in dried specimens of such animals as the Crustacea is a great desideratum, especially in laboratory demonstrations. Mr. Sayce secures this and also preserves to a considerable degree the natural appearance of the animal, and at the same time obviates preservation in fluids, by the following treatment: The specimens, either fresh or from 70 per cent. alcohol, are immersed for some days, ten will suffice for crayfish, in a fluid which, in metric equivalents, has approximately this formula:

| | | |
|---------------------|-----------|-----------|
| Glycerin | - - - - - | 375 c. c. |
| Methylated spirit | - - - - - | 250 c. c. |
| Water | - - - - - | 250 c. c. |
| Corrosive sublimate | - - - - - | 0.5 gm. |

Slight punctures in inconspicuous parts of the carapace will facilitate penetration. After thorough soaking in this fluid, the specimens are removed and drained and allowed to dry. They can be stored in boxes or wrapped in water-proof paper. To avoid too much drying and also to prevent the accumulation of moisture due to hygroscopic action of the glycerin, specimens should be given a thin coat of gelatin and then immersed in 10 per cent. formalin for a few minutes. This hardens the gelatin, renders it impervious to water, but does not interfere with its transparency.

C. A. K.

NORMAL AND PATHOLOGICAL HISTOLOGY.

JOSEPH H. PRATT.

Harvard University Medical School, Boston, Mass., to whom all books and papers on these subjects should be sent for review.

Fujinami. Ueber die Beziehungen der Myocarditis zu den Erkrankungen der Arterienwandungen. *Virchow's Archiv.* 159: 447-490, 1900. The circumscribed areas of acute parenchymatous myocarditis are always associated with the narrowing or occlusion of the small arterial branches which supply them. This is the only form of myocarditis which bears a close and constant relation to sclerosis of the coronary arteries. In fibrous myocarditis sclerotic changes are found in the course of the coronary arteries, but not usually in immediate connection with the fibrous areas.

Arterio-sclerosis, without complete occlusion of the vessels, leads to disturbances of nutrition in quite large portions of the muscle-wall. Degeneration of the muscle-fibers results, followed by a reparative growth of connective tissue.

A destruction of the muscle does not always take place. The author describes a primary interstitial non-purulent form of myocarditis in which collections of cells pushed aside the intact muscle-fibers. He regards this variety as toxic in origin. The foci of cells are at length replaced by fibrous nodules.

The seat of the disease in the blood-vessels can be in the main branches of the coronary arteries, or outside the heart in the root of the aorta, or in the orifices of the coronary arteries.

Fujinami concludes that fibrous myocarditis originates in a variety of ways. It is simply the final outcome of a number of different pathological processes. The thickenings of the vessel-walls, demonstrable microscopically, are not always to be regarded as the cause of the formation of the fibrous areas. The vascular changes can occur as a result of the fibrous myocarditis just as the vessels in the scar tissue of healing ulcers become sclerosed.

Fragmentatio myocardii is frequently associated with sclerosis of the coronary arteries and fibrous myocarditis.

J. H. P.

Warthin. Accessory Adrenal Body in the Broad Ligament (Adrenal of Marchand). American Journal of Obstetrics, **42**: 797-805, 1900.

and spermatic veins, in 92 per cent. of all autopsy cases. Accessory adrenal tissue has been found in the kidney capsule and cortex. Along the spermatic vein, in the pampiniform plexus, between the testis and epididymis, in the corpus Highmori, pancreas, liver, and broad ligament.

According to Schmorl, accessory adrenals are found in the neighborhood of the adrenals, in the adrenal and solar plexuses, and along the adrenal

The author was able to collect from the literature only 23 cases of accessory adrenals in the broad ligament. Marchand in 1883 was the first to report this anomaly. The diagnosis is made by the characteristic epithelial-like cells, and the relation of these cells to the connective tissue and capillaries. Usually the structure of the body is uniform throughout, in some cases resembling the cortex and in others the medullary portion. As a rule the accessory adrenals of the broad ligament consist of cortical tissue only. The accessory adrenal found by Warthin was a pale yellow, fat-like body of the size of a pea. It was situated behind the ovary, near the plexus of veins.

J. H. P.

Abbott, M. E. Pigmentation Cirrhosis of the Liver in a Case of Hæmochromatosis. Journal of Pathology, **7**: 55-69, 1900.

an extensive deposit of iron-containing pigment in the tissues. There was a bluish gray slaty tinge of the skin, and a rusty brown discoloration of the internal organs. Sections of the liver and pancreas were loaded with golden-brown pigment, responding with a deep blue color to Perl's test for iron, which was present also, though in a lesser degree, in the spleen, suprarenals, and heart muscle. There was more or less fibrosis of all the organs except the kidney. In both liver and pancreas the heavy pigmentation of the connective tissue had its source, in part at least, in the broken-down pigmented cells of the parenchyma. A fairly advanced chronic interstitial pancreatitis existed without the clinical picture of diabetes so common in cases of advanced hæmochromatosis.

An advanced cirrhosis of the liver and a moderate degree of chronic interstitial pancreatitis were associated with

Sections of the organs were tested for iron with ammonium sulphide and with potassium ferrocyanide, with affirmative results. In the closer study of the case Perl's test only was used. The routine method at first employed was as follows: Potassium ferrocyanide, 2 per cent. solution, three minutes; hydrochloric acid 1 per cent. watery solution, two to five minutes; wash with distilled water. The bulk of the material was hardened in Müller's fluid to which 2 per cent. formalin had been added, and was preserved in methylated spirits. With the fresh tissue the reaction was prompt, but after two months no typical reaction occurred, the granules turning green or a greenish yellow; many did not react at all. That the iron was not liberated, but that the reaction was only delayed, was proved by the fact that sections left in the hydrochloric acid solution, two to twenty-four hours, gave a typical Prussian blue color, while when the test was performed with hot hydrochloric acid the reaction was almost instantaneous. Sections kept in 4 per cent. formalin gave a typical reaction in two minutes with cold hydrochloric acid. Bits of tissue hardened in alcohol reacted readily. Müller's fluid seems thus to have been the cause of the delayed iron reaction.

Four other cases of hæmosiderosis were studied by the author. She concludes that in general hæmachromatosis some primitive agency, as yet unknown, is at work leading to (a) an increased destruction of hæmoglobin taking place either in localized hæmorrhages, or within the blood stream, or perhaps sometimes within the parenchymatous cells themselves; (b) a degeneration of the cells of certain organs by which they become unable to throw off the granular pigment deposited in them, and, becoming loaded, finally disintegrate. The cirrhosis would seem to be the nature of a chronic interstitial inflammation, secondary upon the presence in the tissues of pigment set free after the destruction of the parenchymatous cell.

J. H. P.

GENERAL PHYSIOLOGY.

RAYMOND PEARL.

Books and papers for review should be sent to Raymond Pearl, Zoölogical Laboratory, University of Michigan, Ann Arbor, Mich.

Mühlmann, M. Über die Ursache des Alters. Grundzüge der Physiologie des Wachstums mit besonderer Berücksichtigung des Menschen. Wiesbaden (J. F. Bergmann), pp. xii und 195, mit 15 Abbildungen, 1900.

This discussion of the general physiology of growth begins with a comparison of the biological relations of unicellular and multicellular organisms. From the two premises that, on the one hand, the differences between unicellular and multicellular organisms are the results of the close proximity of the cells to one another in the latter as compared with the former, and, on the other hand, that one most important difference between the two is that the multicellular organism dies, the author arrives at the conclusion that *growth causes death*. This preliminary statement of the general standpoint opens the way for an analysis of the laws of growth. The subject is developed in the following way: Growth is primarily

related to nutrition. In the case of the Protozoa each cell is able to take nutriment and carry on respiration over its whole surface. When, however, the cells resulting from the division of a single one remain permanently in contact with one another, it necessarily follows that a smaller portion of each cell can come into contact with and absorb nutriment. Such developmental forms as the blastula and gastrula, and in fact all folds, furrows, invaginations and evaginations appearing during development, are explained as the result of the insufficient nourishment which is unable to keep pace with the growth. Since only the cells immediately in contact with nutritive substances are sufficiently nourished to support growth, while the cells within and away from nutriment are correspondingly insufficiently nourished, these latter very soon begin to degenerate and show necrobiotic phenomena.

The author considers that practically all processes of cell differentiation are, from the standpoint of the cell, regressive in nature. The primitive cells or "Blastzellen," from which are developed all other kinds of cells, are seen in the embryo before any beginning of differentiation, and are characterized by their large size, their richness in cytoplasm, and their large nuclei. Such cells are also found in the adult body in the Malpighian layer of the epidermis, the mucous lining of the alimentary canal, the endothelium of the blood vessels, the germinal epithelium, the osteoblasts, etc. All *changes* which occur in these "Blastzellen" are regressive in nature. The only progression is found in their *multiplication*, which is possible up to a very old age.

The theory is next applied in detail to the processes of ontogeny and histogenesis. It is believed that the development of the individual begins with the formation of the ovum within the ovary. The maturation of the ovum marks the beginning of the degenerative changes which ultimately lead to the death of the individual. The egg is left poorer in protoplasm and nuclear material after maturation. The development of the body form in all its details is explained as a result of the better nutritive conditions of cells on the periphery over those in the center of an embryo or an organ. The same principle is applied to the differentiation of the various tissues. Muscle cells or ganglion cells are degenerated because they have lost the cuboidal or polygonal form of the "Blastzellen" and are less rich in the sort of protoplasm that makes up the body of *Amœba*. The chemical as well as the morphological aspect of histogenesis is developed.

The relation of function to structure and the origin of the functional differentiations and adaptations are next discussed. The author is strongly opposed to a teleological consideration of life phenomena and in order to escape some of the difficulties along this line which his theory involves, he advances some astonishing physiological principles. An example will indicate the nature of these. It is stated that the saliva is a product of the regressive metamorphosis of the poorly nourished cells of the salivary gland, and is *useless* to the organism. The ptyalin is useless because the sugar into which it converts the starch of the food has to be reconverted into "animal starch."

The remainder of the book is devoted to a collection of data relating to the growth in size and weight of the human body and its organs, from birth to old age. These data support the author's view that there is during the course of

life a steady diminution in the relative amount of the additions to the size and weight of the body in successive years after birth. The same is true of the organs and tissues except in the case of those which are largely made of "Blastzellen." Such tissues, as for instance the epithelial lining of the alimentary canal, continue to grow by the multiplication of cells until nearly the time of death. The reason for the greater absolute weight of an adult man over that of an infant is found in the fact that the muscular and skeletal systems take on weight by processes of cell metamorphosis essentially regressive in character, there being in these cases no growth by cell multiplication after early life.

The work is one of value on account of the mass of data on the growth of the human body which it presents. While it is probable that few would agree with all the theories proposed, the discussion nevertheless brings out strongly the possible importance of cell nutrition as a factor in developmental processes.

R. P.

Bataillon, E. La pression osmotique et les grands problèmes de la Biologie. Arch. f. Entwick.-mech, II: 149-184, pl. 5, 1901. The general standpoint of the author is that osmotic pressure is a general and fundamental factor in biological phenomena, and should furnish the basis for the investigation of such important problems as the resistance of organisms to dehydration (latent life,) teratogeny, the production of multiple embryos, and artificial parthenogenesis. On all these points experimental results are offered. The first experiments discussed are on the extraordinary ability of *Ascaris* eggs to resist the action of fixing agents and other poisonous fluids. The reasons for this resistance capacity are found in the facts that the egg is surrounded by a membranous chorion which is semi-permeable, and that the fluid of the interior of the egg is of such a concentration as to furnish a very high osmotic pressure. On account of this high osmotic pressure ordinarily harmful substances cannot enter the egg. There is no plasmolysis of the egg in the fluids of less osmotic pressure than that of a 15 per cent. solution of NaCl. The eggs are unable to withstand the dehydration produced by a 30 per cent. solution of NaCl. The author thinks that cases of "latent life," of which desiccated rotifers form a good example, are to be explained as a result of the great osmotic pressure of their body substance which resists the extraction of water beyond a certain point.

Loss of water is found to have a retarding influence on development and may completely stop it. The eggs of *Petromyzon Planeri* show no segmentation in a 1 per cent. solution of NaCl, while in a .2 per cent. solution their development proceeds normally. In solutions of intermediate concentrations there are varying degrees of retardation. Solutions of CaCl_2 and sugar isotonic with the NaCl were tried and the same results were obtained, indicating that the osmotic pressure is the important factor rather than the chemical composition. Twin larvæ of *Petromyzon* were obtained by placing the fertilized eggs for a certain time (about eighteen hours) in solutions isotonic with 1 per cent. NaCl and then removing them to water, in which the development took place. Fertilized eggs of the teleost *Leuciscus rutilus* treated in the same way (except that they were kept in the solution only one hour) developed into multiple monstrosities.

By the use of the same method, with variations in the time of action of the solution, the author obtained segmentation of unfertilized eggs of some fish and

amphibians. *Leuciscus rutilus* and *Rana esculenta* gave the best results. The explanation offered for all of these phenomena has its basis in the osmotic effect of the different solutions.

R. P.

Kijanitzin, J. J. Weitere Untersuchungen über den Einfluss sterilisierter Luft auf Thiere. Virchow's Archiv, **162**: 515-533, Taf. 14, 1900.

In a series of papers which have appeared at intervals during several years past, Kijanitzin has given an account of his experiments on the physiological effects of sterilized air on animals. The paper here considered sums up the results which have thus far been gained and announces a conclusion which, if proven by future investigation to be true, will be of great significance with reference to the general subject of animal metabolism. The author maintains that in addition to the oxygen of the air there are necessary for the normal metabolism, and consequently the life of the animal, certain micro-organisms. These micro-organisms, entering into the blood in the process of respiration, are taken up by the leucocytes and digested. In the course of their digestion an oxydising enzyme is given off. By the action of this enzyme under normal conditions oxidation processes in the tissues are brought about. The experiments seem to show that in the absence of this enzyme the normal process of oxidation in the animal quickly declines, and soon ceases altogether. The animal then dies on account of the formation of large quantities of incomplete, intermediate products of metabolism (leucomaines).

R. P.

Weinland, E. Ueber den Glykogengehalt einiger parasitischer Würmer. Zeitschr. f. Biol. **41**: 69-74, 1901.

In an analysis of specimens of a tapeworm (*Tenia expansa*) and of the parasitic nematode *Ascaris*, Weinland found a very high glycogen content in both cases. In *Tenia* the glycogen amounted to 1.5-4.7 per cent. of the fresh animal, while in *Ascaris* the amount was 4.2-7.1 per cent. of the fresh animal. The amount of glycogen in the dry substance was found to be in the case of *Tenia* 15-47 per cent, while in *Ascaris* it was from 20-34 per cent. The highest previously known glycogen content was in the mussel *Cardium*, 14 per cent. of the dry substance of which is glycogen. In mammals the glycogen content is rarely more than 3 per cent. of the dry weight. The author discusses the chemical nature of the glycogen obtained from these worms.

R. P.

Macy, M. L., and Norris, H. W. A General Physiology for High Schools, Based upon the Nervous System. pp. 408. (No date.) American Book Company, New York.

In this text-book the authors have endeavored to bring all the conventional subject matter of the "high school physiology" under one point of view, and so treat its individual phases in their relation to a common basis. The idea is commendable, but the choice of a basis, or view point, is not altogether fortunate. The attempt is made to discuss *all* the structures and activities of man's body as things primarily related to the nervous system. It will readily be seen that such a method is a purely artificial one, and, from a physiological standpoint, unsatisfactory. The detailed treatment of most of the topics is very good. The most excellent features of the work are the sections devoted to laboratory and demonstration methods for the use of the teacher. Some of the methods of

demonstration with simple apparatus are ingenious and valuable. Especially worthy of mention in this connection are the methods given for illustrating the processes of circulation and respiration. The text figures are numerous and for the most part copied from standard works. As a whole the book makes a very good impression and, in the hands of a competent teacher, ought to prove an excellent high school text.

R. P.

CURRENT BACTERIOLOGICAL LITERATURE.

H. W. CONN.

Separates of papers and books on bacteriology should be sent for review to
H. W. Conn, Wesleyan University, Middletown, Conn.

Migula, W. System der Bakterien. Vol. II. A second volume of Migula's System der Bakterien has made its appearance. The author's original purpose was to collect all species of bacteria which had been described, and, by testing them in culture media in his own laboratory, to make comparative studies and descriptions. This task proved to be wholly impracticable. Many of the species he could not obtain, and many of those sent him were not in condition for study. The book is therefore simply a compilation of descriptions of species as given by the original authors. It is a large work of 1068 pages, with 35 figures, and indicates an immense amount of labor in compilation on the part of the author.

H. W. C.

Beijerinck. Anhäufungsversuche mit Ureumbakterien. Cent. f. Bak. u. Par. II, VII, p. 33, 1901. The very great importance of the fermentation of urea makes it somewhat strange that the bacteria producing this phenomenon have not been more carefully studied. Until the appearance of this work of Beijerinck very little has been known in regard to the micro-organisms concerned in urea fermentation, a few observations made some time ago comprising our sole information. The author, however, has investigated the subject, and has described, with excellent figures, five new species of micro-organisms associated with this universal and significant fermentation. These specimens include bacilli, some of which have flagella and others not, and it also includes a *Sarcina* species which is motile and abundantly provided with flagella; a somewhat unusual relation. The author also studied the subject from a physiological standpoint and concluded that the decomposition of urea is produced by an enzyme, *urase*. This enzyme is completely insoluble, and is so intimately bound to the body of the bacterium that it cannot be separated from it.

H. W. C.

Stutzer. Die Organismen der Nitrifikation. Cent. f. Bac. u. Par. II, VII, p. 168, 1901. For some years there has been a dispute between Stutzer and the Russian bacteriologist, Winogradsky, in regard to the nature and the physiological properties of the extremely important soil organisms known as *nitrifying bacteria*. Winogradsky, who originally discovered them, has described them as bacteria having a most extraordinary sensitiveness to the presence of organic substances,

being prevented from growth by the presence of the smallest amount of organic material or ammonia. In previous work Stutzer has taken grounds quite in opposition to many of the points which were held by Winogradsky. The present article is practically a withdrawal on the part of Stutzer of all of his previous claims. In an introduction he explains how, in the press of engagements, he was led into error by leaving the work to an assistant, and he now reports the results of more careful work. In practically all respects Stutzer now agrees with Winogradsky, so that the relation of the nitrifying bacteria to the various conditions of nature which had previously been so carefully described by Winogradsky, must be taken as confirmed by this latter work of his opponent Stutzer. Stutzer studies both the *nitrate* and the *nitrite* forming bacteria, and in most respects comes to identical conclusions with those of the Russian bacteriologist.

H. W. C.

Hiltner. Ueber die Ursachen, welche die Grösse, Zahl, Stellung und Wirkung der Wurzelknöllchen der Leguminosen bedingen. Cent. f. Bak. u. Par. II, VII, p. 202, 1900.

As is well known, all species of legumes growing in ordinary soil are likely to develop tubercles on their roots through the agency of bacteria. Out-

side of the family of legumes only three or four families of plants are known to produce similar tubercles, and these only in exceptional cases. The author raises the question as to the reason why the soil bacteria have this power of growing in the roots of legumes. Thinking that it was possible that the organisms produce some secretion which affects the roots of the legume, he instituted experiments, the result of which was to show him that: (1) the changes in the root hairs of the legumes accompanying the production of a tubercle are produced by some soluble substance secreted by bacteria; (2) this substance is present in great quantity in the tubercles; (3) the older root hairs are immune against the action of this substance.

The author finds that different cultures of the tubercle organisms have considerable difference in their power of producing tubercles. When a plant which already possesses tubercles is inoculated with culture of a bacteria of a higher virulence, it is noticed that there is a very considerable increase in the number and size of the tubercles. If, however, a plant possessing tubercles is inoculated by a culture of the same virulence there is no increase of number of tubercles. In other words, according to the author's conclusions, the presence of the tubercles renders the legume immune against the further action of cultures of the same grade of virulence, although they are not immune against a culture of a higher virulence.

H. W. C.

Piorkowski and Jess. Bacterium coli als Ursache eines seuchenartigen Pferdesterbens in Westpreussen. Cent. f. Bac. u. Par. I, XXIX, p. 285, 1901.

The authors investigate a somewhat unusual epidemic among horses occurring in West Prussia, and causing the death of quite a number. The disease

was accompanied by fever and intestinal troubles, and lasted from two hours to eight weeks in different cases. Post mortem examination showed the presence in the intestines, of ulcers which had a tendency to perforate the wall. Bacteriological study of the infected parts showed exceptionally large numbers of a

bacillus which the authors regard as the true *coli bacillus*. Finding this bacillus in such large numbers, the authors were led to experiment with it, and succeeded in demonstrating that cultures of the bacillus were pathogenic for the horse. By the use of these cultures, partly with food and partly by intravenous inoculation, they succeeded in reproducing the disease in experimental animals. They are of the conclusion, therefore, that the widespread *coli bacillus* is occasionally the cause of serious and fatal epidemics among horses.

H. W. C.

Bienstock. Du rôle des Bactéries de l'intestin. The author gives a very suggestive paper upon the functions of the ordinary intestinal bacteria. He has previously shown in the intestine of animals the presence of a *Bacillus putrificus*, which produces a putrefying action on proteids. He now finds that, under normal conditions, such putrefaction of the contents of the intestine does not occur. This fact seems surprising, inasmuch as *B. putrificus* is constantly present in the intestine, and the conditions are apparently proper for its growth. Bienstock is of the opinion that putrefactive action is checked by the presence, in the intestine, of certain aerobic bacteria, such as *lactic* and the *coli* bacilli. Experiments show that the putrefaction produced by *B. putrificus* does not take place when a quantity of these aerobic bacteria are present. The author concludes, therefore, that these aerobic bacteria, which are uniformly found in the normal intestine, are of direct value to the human body in preventing the putrefaction of the intestinal contents. He points out the fact that sterilized, and even pasteurized, milk is not so readily digested as raw milk, especially by persons with intestinal disturbances, and this he attributes to the fact that since the heat has destroyed the lactic organisms, these organisms are not present in the intestine to prevent the *putrificus* from producing putrefaction. In short, the author concludes that the reason why ordinary micro-organisms are needed in the intestine is to prevent the putrefaction which would otherwise occur in the intestinal contents, owing to the presence of certain putrefying micro-organisms which are always found.

H. W. C.

Reed, Carroll and Agramonte. The Etiology of Yellow Fever. Med. Rec., Feb. 16, 1901. These authors have presented a further report upon their conclusions in regard to the relation of yellow fever to mosquitoes. The results reached are of immense importance and are too numerous to be summarized. The most important are, that the disease is transmitted from yellow fever patients to healthy persons by the bites of mosquitoes, there being a period of incubation from 41 hours to 5 days. They have repeatedly succeeded in reproducing the disease by allowing mosquitoes (*Culex fasciatus*) to bite patients and, subsequently, healthy individuals. They find that an attack of yellow fever conveyed by a mosquito bite confers immunity against disease. A house is only infested with yellow fever when containing no mosquitoes. Yellow fever is not distributed by soiled articles of clothing or bedding, as has been supposed. The spread of yellow fever may be most effectually prevented by protecting the patient from mosquito bites. These conclusions, which represent only a few of

the important results of the work of these investigators, are clearly of the utmost importance in the future study of this serious disease. H. W. C.

Hilsum. Bakteriologische Untersuchung eines Schwimmbades in Bezug auf Selbstreinigung. Cent. f. Bak. u. Par 1, 2: 661, 1901.

The author studies the bacteria present in a swimming bath which was in constant use. He finds that the number of bacteria increased regularly during the first day, after being newly filled with water, and then constantly decreased. This decrease in the number of bacteria, he points out, could be due neither to the action of light nor to sedimentation, since the number of bacteria at night and morning was essentially the same, and since the water was in constant use, a condition which would prevent sedimentation. Nor does he believe that a want of food can be the cause, since the water filtered through a pasteur filter is an excellent culture medium for bacteria. The author believes that the matter is one of struggle among different bacteria with each other, resulting in a destruction of many individuals. H. W. C.

NOTES ON RECENT MINERALOGICAL LITERATURE.

ALFRED J. MOSES AND LEA MCI. LUQUER.

Books and reprints for review should be sent to Alfred J. Moses, Columbia University, New York, N. Y.

Viola, C. Ueber das "Glaukisiren" verschiedener Feldspäthe. Zeit. f. Kryst. 34: 171-195, 1901.

The writer proposes the term "Glaukisiren" for the variety of schillerization which takes place in moonstone—that is, when the inner reflection produces a silvery or bluish light. Whether or no a convenient English form of this term will be made remains to be seen, but Glaukisiren may be translated as the process which produces the silvery schiller or inner reflection. Hitherto the assumption has been that the process was one of internal reflection and interference. The tests made by Viola tend to prove that instead of interference it is a process of absorption. The method followed in examining the moonstone of Ceylon was as follows:

Ceylon moonstone consists of coarse feldspar crystals, enclosing and intergrown with quartz. The feldspar is not absolutely definite, but the analyses indicate orthoclase with slight admixture of lime and soda. It is usually milk white in color, and the cleavages are wave-like. The silvery schiller appears to be most marked parallel to the face $\bar{2}01$. Sections were therefore cut parallel to this face, and about 1 mm. thick. These were mounted in an ordinary Fuess goniometer with 201 vertical, and the plane of reflection of the schiller (found by experiment to be approximately (010)) horizontal. Parallel light from the collimator, reflected from $\bar{2}01$ as parallel light, gave a sharp signal for the plane; the section was then revolved until the sky-blue schiller signal was obtained; this was not sharp, but diffused through four to five degrees, but the

brighter center could be determined within one degree.

It was found that the signal was obtained for all angles of incidence precisely as if it was due to a reflection from some interior surface, and it might be assumed that the diffusion was due to this surface not being perfectly smooth. In order to find the angle between the supposed interior surface of reflection and the surface of the section,

Let O be center of revolution,

Let C be collimator,

Let T be telescope,

Let N be normal to plate when yielding ordinary signal,

Let N' be normal to plate when yielding schiller signal.

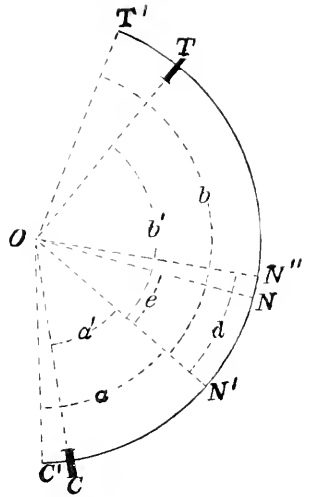

If $\text{COT} = 2\varphi$ then $\text{CON} = \text{TON} = \varphi$ and, see Fig., $a' = \varphi - e$ and $b' = \varphi + e$. But as the rays from C and to T must have been refracted, the true incident and reflected rays for the internal surface cannot have been these, but rather such rays as $C'O$ and $T'O$, making angles a and b with the surface normal ON' , in which $\sin a = \frac{\sin a'}{n}$ and $\sin b = \frac{\sin b'}{n}$, n being the mean index of refraction for the moonstone. The normal to the internal surface will therefore be ON'' , and the angle between the two surfaces will be equal to $N'O N''$, denoted by d , and, from the figure, $b - d = a + d$, or $d = \frac{b - a}{2}$.

For Ceylon moonstone cut parallel $d = 12^\circ 5'$ and $65^\circ 19'$, and is essentially independent of the angle of incidence. There is also a *transmitted* image the color of which is complementary, that is, yellowish to reddish orange. This would indicate that the violet and blue rays were diffused and reflected, while the red, yellow, etc., penetrate. If the phenomenon were one of interference, then if for a certain angle of incidence the reflected color is blue, it must pass into red for a larger incident angle, and this it does not do. The theory of internal reflection and absorption seems to best explain the phenomena. Similar results were obtained with the Amelia Co., Va., albite and the adular of Zillerthal.

A. J. M.

Melonite. From Worturpa, South Australia. Trans. Roy. Soc. S. Australia, **23**: 211, 1899.

Thin lamellæ with bright metallic lustre. Color on cleavage, silver white with

normal incidence, reddish brown with oblique incidence. G. 7.6 H. 1.5. Streak lead gray. $\text{Ni}_2 \text{Te}_3$ with traces Pb, Bi, and Au.

Minerals of Japan. Kotora Jumbo, in Jour. Coll. Sci. Tokio, **11**: 213-281, 1899. Nine page Abs. Zeit. f. Kryst. **34**: 215, 1901.

Fouqué, F. Contribution à l'étude des minéraux de group de la méllilite. Bull. Soc. Min. **23**: 10, 1900.

According to Vogt there should exist a series of minerals, belonging to this group, low in silica and containing variable amounts of calcium and aluminium, varying between the limits of

gehlenite and akemanite. Author's investigations on artificially prepared melilites do not prove the existence of this series. Different artificial melilites are described, all having positive optical character, and some showing spherulitic forms and zonal structure. They are also characterized by strong (for melilite) double refraction (ϵ .005 - .006).

L. M. C. I.

Rogers, A. E. Sphalerite crystals of a peculiar habit and with one new form, from Galena, Kansas. *Am. Jour. Sci.*, **9**: 144, 1909.

The crystals are reddish-brown in color, and shortened in the direction of one of the octahedral interaxes. They

have a hemimorphic aspect due to the presence of the faces of the new form, a positive hemitetragonal trisoctahedron σ (833), truncating half of the dodecahedral edges, the dodecahedron δ' (110) being the chief form. Twins are more common than simple crystals. Measurements were made only with contact goniometer.

L. M. C. I.

Preston, H. L. Illinois-Gulch Meteorite. *Am. Jour. Sci.*, **9**: 201, 1909.

Troilite present in very small quantity. Iron shows no etching figures. Rhabd. 2.35 grams. G = 7.7. Analysis given.

dite crystals probably present. Weight

L. M. C. I.

Subauite, a new mineral. G. A. Govder. *Ann. Chem. Soc.*, **77**: 1094, 1909.

A copper "sulpho-vanadite," $3\text{Cu}_2\text{S} \cdot \text{V}_2\text{S}_5$, from "near the Barra, in South

Australia," associated with malachite, azurite, quartz, vanadium ochre, gypsum, and calcite. First recorded instance of a sulphide mineral containing vanadium as one of its principal constituents. Two analyses gave the following:

| | Cu | V | S |
|---|-------|-------|-------|
| A. | 51.57 | 13.46 | 31.97 |
| B. | 52.96 | 13.72 | 31.62 |
| Theoretical for $3\text{Cu}_2\text{S} \cdot \text{V}_2\text{S}_5$. | 51.50 | 13.88 | 31.62 |

Some of the physical properties are: massive, luster metallic to sub-metallic, color bronze yellow, streak nearly black. H = 3.5 G = 4. No crystalline form detected.

A. F. R.

Richards, Joseph W., and Powell, Norman S. Substitutes for Hydrochloric Acid in Testing Carbonates. *Jour. Am. Chem. Soc.*, **22**: 117, March, 1909.

The experiments were undertaken to find a satisfactory substitute for hydrochloric acid for testing carbonates in

the field. The action of 20 per cent. solutions of potassium acid sulphate, citric acid, tartaric acid, and 10 per cent. solution of oxalic acid, on sixteen of the more common carbonate minerals, in lump and powder, are recorded in tabular form. Tartaric acid is regarded as the best reagent, with citric acid as a close second. Some sulphides give off hydrogen sulphide with the reagents. The authors seem to have been utterly unaware of Bolton's previous work along this line. *Annals N. Y. Acad. Sci.*, **1**: 1, 1879; *Chemical News*, **36**: 249; **37**: 14, 21, 65, 86, 98; **43**: 31, 39.

A. F. R.

Nichols, Henry W. A New Test for Chlorine for Use with the Blowpipe. *Amer. Chem. Jour.*, **25**: 318, April, 1901.

To test a substance for chlorine it is powdered with potassium acid sulphate and placed in a closed tube. A frag-

ment of filter paper, moistened with cobalt nitrate solution, is put into the mouth of the tube, and the mixture fused. If chlorides are present the paper will turn a bright blue, and if bromides or iodides are present the color will be green. In the case of minute quantities it may be necessary to dry the paper before the color appears. Other details of manipulation are given. Specimens of sodalite (Cl. 7.3 per cent.), zunyite (Cl. 2.9 per cent.), and apatite gave good reactions.

A. F. R.

MEDICAL NOTES.

METHODS FOR THE DETECTION OF SUGAR IN URINE—*Haine's Test*.—This is considered the best of the copper tests for sugar, and is made with the following solution :

Copper sulphate, - - - - - 6 grs.
Water, distilled, - - - - - 3 c. c.

Dissolve the CuSO_4 thoroughly in the water and add,

Glycerin, pure, - - - - - 3 c. c.

which should be thoroughly mixed, after which add,

Liquor potassæ, - - - - - 30 c. c.

To make a test for sugar in a sample of urine, boil 1 dram (3.7 c. c.) of the solution in a test tube, and add 2 or 3 drops of the urine; continue to boil and if, after a few seconds, no reaction occur, add 2 or 3 drops more, and so on until 8 drops are added, after which no more urine should be added. It is best to use the least possible amount of urine that will produce the reaction. The solution should not be allowed to boil more than one-half minute. If sugar is present in the urine, a yellow or yellowish-red precipitate forms.

This test is simple in application, and is sufficiently reliable to be depended upon in general practice. The solution is perfectly stable, and may be kept indefinitely without deteriorating.

Phenyl-Hydrazin Test.—This is an exceedingly delicate test, and is very desirable when the routine test, above, leaves any doubt as to the presence of sugar in the urine. The test is performed by adding to 50 c. c. of the suspected urine, 2 gms. of phenyl-hydrazin hydrochloride, 1.5 gm. of sodium acetate, and 20 c. c. of distilled water. This solution should be heated moderately in a water bath for an hour, after which, when cooled, if the smallest amount of sugar be present, a yellowish crystalline precipitate is deposited.

With the above methods the presence or absence of sugar in the urine may be readily and conclusively ascertained. When sugar is detected, it is very important to determine the amount present. This may be accomplished with accuracy by pursuing the following method :

Purdy's Method for the quantitative determination of sugar in urine.—Dissolve, with gentle heat, .5 gm. pure cupric sulphate, and 3.8 c. c. glycerol in 20 c. c. distilled water. With this mix a solution of 2.4 gms. potassium hydroxide in 20 c. c. distilled water, and add 35 c. c. strong ammonia. Make up to 100 c. c. with distilled water.

Place exactly 35 c. c. of this solution in a flask, dilute with an equal amount of distilled water, and bring to boil. To this add *slowly*, drop by drop, the urine to be tested until the solution loses its blue color and becomes perfectly colorless. The amount of urine required contains exactly .02 gm. of sugar. If it takes 1 c. c. of urine, there is 2 per cent. of sugar; if it takes $\frac{1}{4}$ c. c. of urine, there is 8 per cent. of sugar.

C. W. J.

NEWS AND NOTES.

The article "The University of Montana Biological Station," which appeared in the May number of the *JOURNAL*, elicited a number of questions, in answer to which the author, Prof. Morton J. Elrod, has added the following:

The microscopical equipment during the past summer consisted of four large compound microscopes, with two-thirds and one-sixth objectives each; one small microscope with three objectives, several additional objectives of higher and lower powers; a dozen or more hand lenses, doublets; an abundance of glass slips and covers; an assortment of common stains and chemicals; glassware necessary to carry on the work, such as watch glasses, small beakers, pipettes, staining dishes, etc. A centrifugal apparatus was used to determine the quantity of the plankton. The camera had a Zeiss anastigmat lens, Series IV, telephoto attachment, and ray filter. The vials for containing microscopic life, plankton, were of three different lengths, with the same diameter, making it necessary to carry corks of one size only. This was found to be a great convenience, especially as several gross of vials were carried. The vials were straight shells, without neck. As a preservative formaldehyde was used. The concentrated or forty per cent. solution was carried in small bottles, so that if one should be broken but a portion of the supply would be lost. The concentrated solution was diluted as used. No alcohol could be carried while collecting, the laws preventing alcohol from being taken into an Indian reservation.

During the past summer seventeen students took advantage of the facilities for work offered by the station. The microscopical work was largely elementary. Much use of the instrument was made in the study of Entomostraca from the lakes. Animal and plant structures were examined, several students using the microscope for the first time. Simple mounts were made, and the method of using stains was made known through practice. Four of those attending took regular courses in either botany or general zoölogy, with daily use of microscope and microscopic material. One microscope was in constant use for two months in study of Entomostraca. Four students devoted most of the summer to ornithology. One worked on fishes, one on butterflies.

In the light of past experience the following conclusions have been reached. Although the state is large and the population small, there is much more interest shown in the station work than was at first anticipated. The obstacles in the way are not so great as would naturally be expected. The chief difficulty is in getting over the country, but if one is not crowded for time this makes little difference. The lakes in the mountains, though containing cold water, have many very interesting forms of life. Very few of the lakes have been touched. Flat-head lake, with its inlets and outlet, has sufficient territory for a large working force, and sufficient material for wide range of study and experiment. Naturalists from the East who have a month to spare in the summer and who want to see the West, and at the same time wish to do some work, may find the station of advantage, and will be able to get into the field and into the hills without wasting most of the time in learning how and where to go. The field is rich enough to

warrant greater expenditure in apparatus and material. A house boat would be a great convenience and of great utility. The great needs of the station, in order to secure the best results, are more extensive working material and a longer working period. For many years the station will be a place for investigation rather than a summer school for students. Its best work will be done by making provision for both. There is excellent opportunity to establish a station on a larger scale, in a region offering great variety of life, from Alpine to that at 3000 feet altitude, and from swamp to barren hill. It is hoped the income of the university will warrant the increased expenditure at an early date. While there is no comparison between the life of the region and that of a favorable ocean locality, the problems offered are of a different nature, fully as interesting, and quite as important. Nowhere is there better opportunity to study variation and its effects than in mountain regions.

The work of the coming season will be better than in preceding years. In addition to the work of the director, Principal P. M. Silloway, of the Fergus county, Montana, Free High School, will have charge of work in ornithology, which he did so ably the past season. Maurice Ricker, principal of the Burlington, Iowa, High School, will give the instruction in nature study and physiography. The New York Botanical Garden will coöperate in the botanical work of the station. Dr. D. T. MacDougal, director of the laboratories in that institution, will join the party in the field for the purpose of making collections and pursuing some investigations upon the results of climate and vegetation, and will continue both lines of work at the station. The botanical work during the session will be under his guidance. Attention will be given to general botany, and to the special features of the flora of Montana. Mr. R. S. Williams, of the same institution, will spend the month of June making collections in the northwestern part of the state, and will be present during a part of the session, giving special attention to mosses and ferns.

During the five or six weeks previous to the opening of the station the instructors will devote their time to collecting in the immediate region. An outfit has been provided which will make the trip quite comfortable, and the entire time will be devoted to collecting in different fields, from snowy mountain summits to the marshes of the lakes and rivers. During this trip additional collections will be made in lakes not yet visited, and in regions where collectors have not yet been. After the collecting trip the party will proceed to the station, and will take care of the students attending, at the same time continuing the collecting and making additional observations.

The collecting trip is made possible through a contribution from Hon. Wm. A. Clark, who has contributed annually for this purpose, and to whom the station is greatly indebted. The purchase of the boats, erection of building, and expense of the instructors during the past two years has been met by contributions from friends, the principal contributors being E. L. Bonner, H. W. Hammond, A. B. Hammond, Dr. W. P. Mills, W. P. Murphy, and W. A. Clark. The expense for the coming summer, in addition to the contribution by Senator Clark, will be met by university appropriation.

DEMONSTRATION OF RETICULATE VESSELS.—The teacher of plant histology is usually seeking for the best possible materials to illustrate the several kinds of cells that are to be examined by his students. For well defined reticulate vessels, I have seen nothing to equal those found in the thickened roots of *Arenaria striata*, which grew in our botanic garden. They are somewhat different from those found in the stems of *Impatiens*.

W. J. BEAL.

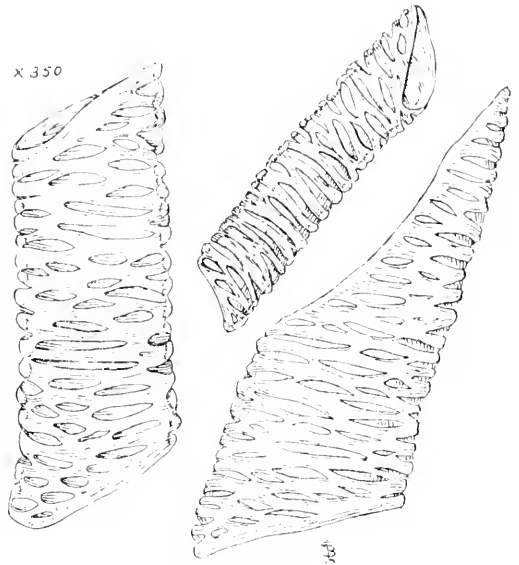

In the cuts of starchy granules of the pea, they are represented as having cracks, or checks in the middle. I wonder if it is generally known that the checks seldom appear if the peas are placed in alcohol or glycerin before drying?

W. J. BEAL.

QUESTION BOX.

Inquiries will be printed in this department from any inquirer.
The replies will appear as received.

5. Will you kindly refer me to a good method of how to make a biologic aquarium? In the JOURNAL OF APPLIED MICROSCOPY are a few notes on Cultivation of Algæ, but not sufficient for an amateur. What should be the soil—gravel, sand, or mud from a pond? How proceed to stock it and with what? Is the evaporation to be supplied from a pond or hydrant? If glass cover on, can there be enough air to pass between for living? I am desirous of having a number of jars for general elementary biology work; to supply *Amœba*, *Hydra*, *Chara*, *Vorticella*, *Spirogyra*, *Vaucheria*, *Nitella*, *Vallisneria*, etc.—V. A. L.

6. What is Scott's method for the examination of blood?—T. G. S.

7. Can tinted paper be used for the hæmoglobin test?—T. G. S.

REPLY TO QUESTIONS 3 AND 4 IN THE MAY NUMBER.

The Welsbach light is practically worthless for high-power microscopy, either visual or photographic, for with condenser focused, as it should be, an image of the fabric of the mantle is projected into field of view. Have found no difficulty in making photographs up to $\times 1200$, using H. I. objectives and Huyghenian oculars, with oil lamp, half-inch wick. Render rays approximately parallel with bulls-eye, or better, a large size, short focus photographic lens placed at its focal distance from lamp flame, and converge on object with substage condenser sharply focused, achromatic condenser decidedly preferable, but Abbe condenser will answer fairly if nothing better is available. No noticeable advantage derived from the use of achromatic, periscopic, orthoscopic, or compensation oculars over the Huyghenian, when used with achromatic objectives.—F. J. K.

Journal of Applied Microscopy and Laboratory Methods.

VOLUME IV.

JULY, 1901.

NUMBER 7

The Value of Methylene Blue as an Intravital Stain in the Tunicata.

While working for special results on the tunicate nervous system, with methylene blue, I found that this aniline could be made of much value as a general stain where living material was obtainable. Small species, such as *Amorecium*, *Botryllus*, and *Perophora*, as well as young *Molgulae*, left in sea water containing just enough methylene blue to color the water a lively blue (about 1 part to 5000) for half an hour, will give almost diagrammatically the branchial basket and its organs, as well as the free mesenchyme cells of the body cavity, leucocytes and phagocytes. This method is especially favorable for cilia; the demonstration of cilia in motion, the arrangement of cilia in rows on the surface of the cell, and the peculiar thickened basal portion of the tunicate cilium can all be well shown. Long, whip-like flagellæ, which are found in the endostyle and ciliated funnel, also take the blue and stand out with wonderful distinctness. The above named cells are usually the first to stain. The sensory or peripheral portion of the nervous system stains relatively early (from 1 to 1½ hours after immersion), while the deeper lying nerve cells and motor fibers stain later. Cells of the central nervous system are sometimes found colored blue as much as five hours after immersion. But all of this so-called staining of the different tissues is transitory, sometimes lasting only a few minutes—as in the case of the very delicate neurofibrils—or for several hours, or even days, in the case of the mesenchyme cells.

Special Methods.—The best results for the staining of the nervous system were obtained by the two following methods: *Molgulae* were placed in a weak solution (1–5000) of Meyer's BX methylene blue in sea water, and allowed to remain from one to five hours, according to the size of the animal and the tissue to be stained. For staining by immersion small specimens were used. It was found necessary to have the animals absolutely fresh, or satisfactory results could not be depended upon. *Molgulae* which had remained in aquaria for so short a period as two to three days, frequently refuse to take the stain; or give a diffuse staining. The exact intensity of the blue in solution does not seem to be as important a factor as the length of immersion. Just before taking out the animals

for examination they were removed to a dish of running sea water aerated by a pipette nozzle. Specimens thus treated gave uniformly good results, while those in which this process was omitted did not. Whether the former result was due to the revival of the animal or the oxygenation of the tissues, is hard to say. But the physical condition of the animal seems to play an important part.

The other method successfully used was to inject a fairly strong solution (1 to 4 per cent.) of methylen blue into the ovarian vein of *Molgula*. From thence the fluid reached the heart and was pumped to all parts of the body. A small amount of fluid should be used and great care taken not to allow too much of the body fluid to escape through the hole made by the needle. The percentage of successful staining by this method is small; but the results are valuable, because of the use of large specimens. The peripheral system seems to come out especially well by this method. Animals which die as a result of the injecting process give a diffuse staining of tissues that is of no neurological value. This diffuse staining can be recognized at once, by the fact that the whole animal stains a pale greenish blue color; while in a perfectly successful stain the color is deep blue.

The use of ammonia is advocated by Apathy in bringing out the stain. He believes that in exposure to the air just before examination, the specimen takes up some ammonia from the atmosphere. *Molgula* exposed to the fumes of ammonia gave negative results. The same may be said regarding the exposure of stained tissue to the air. It could not be proven that oxygen was a factor in the bringing out of the stain.

The fixation of the stain for permanent preservation.—Most of the methods used by investigators (*vide* Arnstein, Apathy, Bethe, Dogeil, Huber, Meyer, Peabody, Retzius, and others) agree in the use of picrate ammonia as a fixing agent. Aqueous solutions are usually employed, and the material is allowed to remain in a saturated solution of ammonium picrate from a few minutes to several hours, or even days, according to the size and permeability of the material. The macerating effect of the fluid is avoided in some cases by the addition of one part to 100 of a 1 per cent. osmic acid solution. Such material may then be either mounted permanently in a solution of saturated ammonium picrate and glycerin in equal parts (*vide* Meyer, Retzius); or in chemically pure glycerin without washing out (*vide* Dogeil); or by the somewhat complicated method of Apathy, when, after fixation in ammonium picrate plus a little (5 drops to 100 c. c.) concentrated ammonia, the material is passed through glycerin; glycerin and gum arabic; and finally mounted in a solution of gum arabic, cane sugar, and water, in equal quantities. I may say, in passing, that with tunicates I found the last named method the least useful.

By far the best of my results were obtained by the following modification of the methods of Bethe and Apathy :

Cut out the part to be used, and after examination under a fairly high power of the microscope, remove the successfully stained material to a saturated solution of ammonium picrate in sea water. The pieces of tissue are then immediately removed to a slide, or small dish, where they are left for a few minutes (10 to 20, according to the size of piece), in the following solution :

| | | | | | |
|-----------------------------|---|---|---|---|----------|
| Sea water (or normal salt), | - | - | . | - | 50 c. c. |
| Conc. c. p. glycerin, | - | - | - | - | 50 c. c. |
| Conc. ammonia, | - | - | - | - | 1 drop. |

Add more glycerin, and finally mount in glycerin containing just enough of the ammonium picrate to color it slightly. Specimens put up in this way have kept their color now for over three years, no noticeable change having taken place during that time.

The above method was frequently modified. I did not find, as some later writers have done, that better results were obtained by a bath of longer duration in ammonium picrate. A short bath of from $\frac{1}{2}$ to 1 minute suffices for sensory nerves and peripheral sense organs, and somewhat longer for deeper lying nerves.

I am inclined to take Apathy's view regarding the successful staining of the nerve fibers. He believes that he gets a true stain and not an impregnation. In a few very successful cases I have succeeded in following to the nerve cell a bundle of fibers, which I believe to correspond to primitive neurofibrils.

More frequently, however, an impregnation probably takes place, the whole interfibrillar space taking the blue. This can best be shown by following the successive changes which take place in the tunicate nerve fiber after death, or during the diffuse staining which takes place in the later stages of every successful nerve staining with methylen blue. The successful stain of a fiber shows an almost unbroken wavy blue line, or series of interlacing fibrils, around which can be seen very faintly the sheath. This fiber has almost no knobs or granulations in its course except at the true ending. At a point of branching a triangular blue area, probably caused by the stretching of the sheath, can be seen. As the

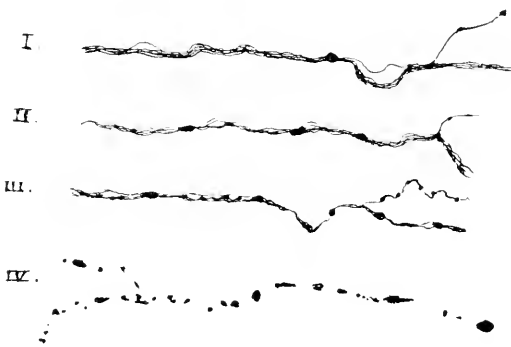

Four stages in the degeneration of a nerve fibre:

- I. A successful impregnation.
- II. Ten minutes later; beading commencing.
- III. Twenty minutes later; much beading.
- IV. Two hours later.

tissue dies, however, a change takes place. The nerve fiber begins to bead, at first hardly noticeably, but later these beadings become so large as to distort the whole fiber and completely change its appearance. Ultimately all trace of the fiber disappears except a line of irregularly placed blue globules. (See figure.)

This same beading of the fiber is frequently induced by fixation with ammonium picrate, and it is only in rare cases

when we have the fiber fixed so that it shows the individual fibrils. Frequently there appears to be a vacuolization of the nerve. Large vacuoles appear, at one side of which there is a heavier deposit of blue. This is, perhaps, a pathological condition induced by the injection of the methylen blue.

Fixation for imbedding and sectioning.—Parker's sublimate and alcohol method was tried with no success. Bethe's ammonium molybdate method (Arch. f. Mik. Anat. xlv. '94) yielded poor results. His later method (Anat. Anz. xii. '96)

proved of more value. After staining tissues in a concentrated solution of ammonium picrate (which I used in sea water) the material is brought into the following solution :

| | | | | |
|-----------------------|---|---|--------|---------------------------------|
| Ammonium molybdate, | - | - | 1 gr. | } or 20 c. c. H ₂ O. |
| H ₂ O, | - | - | 10 gr. | |
| 5 per cent. osmic, | - | - | 10 gr. | |
| Peroxide of hydrogen, | - | - | 1 gr. | |

or (with somewhat better results for tunicates), phosphomolybdate of soda may be substituted in the above formula for the ammonium molybdate.

After $\frac{3}{4}$ to 1 hour in above solution (or 4 to 12 hours in the osmic solution), we wash in water, rapidly pass through the alcohol, xylol, and imbed in paraffin. Results from this method have not been uniformly successful.

De Witt Clinton High School, N. Y. C.

GEORGE WILLIAM HUNTER, JR.

Spermatozoa of Man, Domestic Animals, and Rodents.

The male cell, or spermatozoön, is of minute size, and in its locomotor energy and vitality resembles a flagellate monad. Anatomically it is a true cell, consisting of the "head," composed mainly of nucleus, and the motile "tail," which may be fibrillated, and a small central portion between the head and tail, which is sometimes regarded as the "centrosome."

In studying the spermatozoön of the mastiff, I noticed the striking resemblance it bore to that of man; finding that if the spermatic fluids were allowed to stand for a time, even staining did not furnish sufficiently satisfactory evidence to enable one to distinguish, beyond question, the spermatozoön of man from that of the dog, except where careful measurements were employed; and a fact ever to be borne in mind is, that these measurements may vary slightly in different persons and animals, and even in the same specimen.

Through the courtesy of Dr. James Johnston I secured testicles, preserving as much as possible of the vasdeferens, from animals slaughtered at the Philadelphia abattoir, to which collection was added those from certain animals employed for experimental work in the laboratory. The spermatic fluids studied were taken from the vasdeferens, and from an incision of the testicle. In man, the fluid ejaculated at intercourse was also studied and the findings compared with those where the fluid was taken from the vasdeferens and from the parenchyma of the testicle.

Examinations were made immediately after the testes had been removed, and on the first, second, third, fourth, and fifth days after their removal. Spermatic fluids thus collected were placed in cold water, after which it was found that the tails became coiled, and were soon detached from the heads. In no case were the spermatozoa found to possess individual movement twenty-four hours after the testicle had been removed, or after the death of the animal; nor were they ever found motile in man even a few hours after death. These findings differ from the statements often made, that spermatozoa remain active for a long time after the death of the animal. To determine this point one testicle was kept in a cool room, and the other at a temperature of about 75° Fahr., when certain

other changes were also observed. After twenty-four hours it was common to find several free heads and tails, their number increasing daily, until by the fourth day it was often difficult to find a perfect spermatozoon; yet these, when present, showed evidence of marked degeneration, and their reaction to staining was not constant.

Staining was accomplished by the various anilin dyes, of which carbol-fuchsin was found to be of most value, therefore the accompanying illustrations were sketched from specimen slides stained by carbol-fuchsin. In examining specimens stained in 1899, I find that the tail is the first to give up its stain, and from one-fourth to one-seventh of the tails of the spermatozoa of the sheep and rats show no stain, and are seen with difficulty. Fading was noted to take place earlier where methylen blue was employed. In but one instance, that of the mouse, was it necessary to apply heat in order to stain the spermatozoa.

Measurements were made by the use of both the stage and eye-piece micrometers, always measuring the entire length, dimensions of head, and length of tail; the latter being markedly altered whenever the staining was imperfect. It was thought to be of possible service to have all measurements recorded both in millimeters and in inches. All measurements and sketches were made with a 1-6 objective and 2 eye-piece. In the sketching no attempt was made to preserve the original size of the cells. The total lengths given were obtained by the measuring of complete cells, recording the greatest and smallest measurements only; while the measurements of the heads and tails were often taken after these parts had separated. Therefore the total length is not always equivalent to the sum of the lengths of the head and tail.

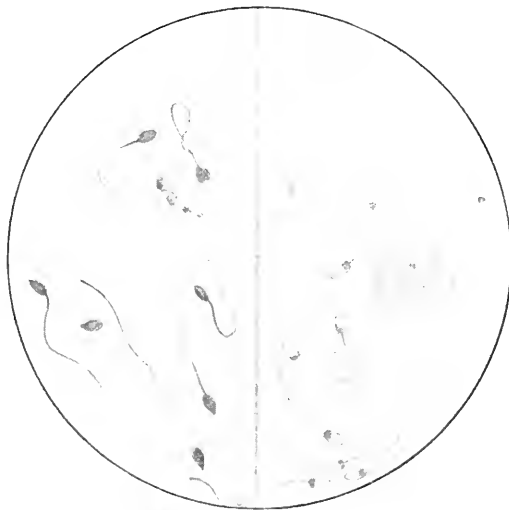

FIG. 1.—Man.

FIG. 2.—Dog (Mastiff).

The spermatozoa of man (Fig. 1) were found to stain deeply with carbol fuchsin; the heads and tails were equally stained, and appeared more distinct and uniform than did those from any other member of this series. The tail was seldom found to be coiled or twisted, except where water had been previously

added to the spermatic fluid. Measurements showed the spermatozoön of man to be the smallest member of this series.

| | |
|---------------------|---|
| Total length, . . | 0.051 to 0.058 mm., or 0.002 to 0.0022 in. |
| Length, head, . . | 0.004 to 0.006 mm., or 0.0001 to 0.0002 in. |
| Width, head, . . . | 0.003 to 0.004 mm., or 0.0001 to 0.0001 in. |
| Length, tail, . . . | 0.041 to 0.053 mm., or 0.0016 to 0.002 in. |

The spermatozoa of the dog (Fig. 2) presented many features which would readily distinguish them from those of man in the fresh and well prepared specimen; but if both were subjected to the action of certain secretions and fluids, or allowed to dry before properly smeared on the cover-glass, great question would doubtless arise as to the identity of either of these cells. A small portion of the head, located at the junction of the tail and head, stained deeply, while the remainder of the head appeared as a homogeneous structure bounded by a rather distinct margin. The tail, too, showed but moderate affinity for stains. The head and tail of an individual cell were occasionally seen to unite at right angles, and a few specimens were observed having two distinct, well formed heads projecting from a single tail. The dog furnishing the specimen for this series weighed 105 pounds, and it was the intention to compare the following measurements with those obtained by the study of spermatozoa taken from a terrier, but such opportunity did not offer itself.

| | |
|---------------------|---|
| Total length, . . | 0.067 to 0.074 mm., or 0.0026 to 0.0028 in. |
| Length, head, . . . | 0.004 to 0.008 mm., or 0.0002 to 0.0003 in. |
| Width, head, . . . | 0.003 to 0.002 mm., or 0.0001 to 0.0001 in. |
| Length, tail, . . . | 0.059 to 0.067 mm., or 0.0023 to 0.0026 in. |



FIG. 3.—Rabbit.

FIG. 4.—Horse.

The spermatozoa of the rabbit (Fig. 3) possess many features common to those of the dog; the head, in addition to being narrower, presents a deeply stained area at its junction with the tail, and a less marked deepening of the stain was seen at the other extremity, occupying nearly one-third of the whole head. Between these two stained portions a lighter zone was seen. It is

characteristic of the tail to form coils, which were often seen to surround the head, and if the smear be at all thick these coils render it impossible to outline the individual cells. An abrupt bend, at right angle, which extends for but a short distance and then forms another equally abrupt angle to assume the course previously taken, was a common finding. This irregularity in the course of the tail may be seen near the head, but more commonly at the junction of the first and second thirds.

Total length, . . . 0.051 to 0.066 mm., or 0.002 to 0.0025 in.
 Length, head, . . . 0.006 to 0.009 mm., or 0.0002 to 0.0003 in.
 Width, head, . . . 0.003 to 0.004 mm., or 0.0001 to 0.0001 in.
 Length, tail, . . . 0.045 to 0.058 mm., or 0.0017 to 0.0022 in.

In studying the spermatozoa of the horse (Fig. 4) it was observed that their general characteristics and reaction to stain were similar to those of man, except that after the fluid had been kept for a few days the tails of certain cells appeared to be fibrillated. The measurements of equine spermatozoa were found to be:

Total length, . . . 0.064 to 0.067 mm., or 0.0025 to 0.0026 in.
 Length, head, . . . 0.006 to 0.008 mm., or 0.0002 to 0.0003 in.
 Width, head, . . . 0.003 to 0.004 mm., or 0.0001 to 0.0001 in.
 Length, tail, . . . 0.054 to 0.060 mm., or 0.0021 to 0.0022 in.

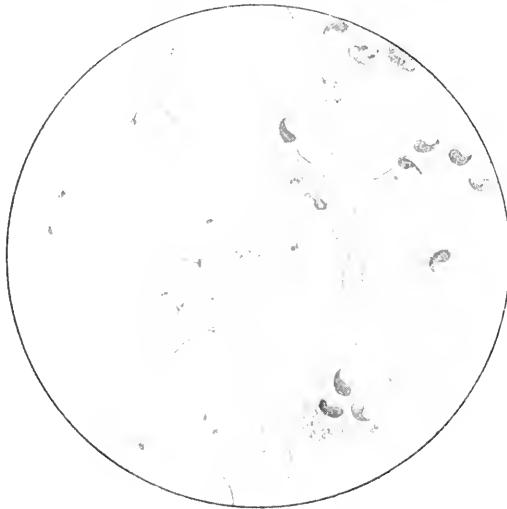

FIG. 5.—Bull.

FIG. 6.—Mouse.

The spermatozoa of the bull (Fig. 5) were always accompanied by many free heads, and comparatively few free tails. The head of each spermatozoon stained feebly except for a small portion at its junction with the tail (centrosome), which stained deeply. The tail was always found to be well stained; its course rather irregular; but never was it seen to change abruptly, as was commonly observed in the rabbit, nor did it ever extend in a direct course from the head, as is the rule in man and in the horse. The measurements of bovine spermatozoa were found to be:

Total length, . . . 0.087 to 0.093 mm., or 0.0033 to 0.0036 in.
 Length, head, . . . 0.009 to 0.009 mm., or 0.0003 to 0.0003 in.
 Width, head, . . . 0.006 to 0.006 mm., or 0.0002 to 0.0002 in.
 Length, tail, . . . 0.077 to 0.083 mm., or 0.003 to 0.0032 in.

The spermatozoa of the mouse (Fig. 6) presented many features in striking contrast with other members of this series. The head stained deeply and presented a slightly curved spine at one extremity, while surrounding the head was a clear zone (apparent capsule). From the portion of this capsule corresponding to the larger extremity of the head, a delicate, faintly stained tail was seen to emerge. This tail was rendered more distinct by the application of heat while staining. Measurements of these cells were found to be as follows:

| | |
|---------------------|---|
| Total length, . . . | 0.12 to 0.158 mm., or 0.0046 to 0.0061 in. |
| Length, head, . . . | 0.008 to 0.009 mm., or 0.0003 to 0.0003 in. |
| Width, head, . . . | 0.003 to 0.004 mm., or 0.0001 to 0.0001 in. |
| Length, tail, . . . | 0.112 to 0.138 mm., or 0.0043 to 0.0057 in. |

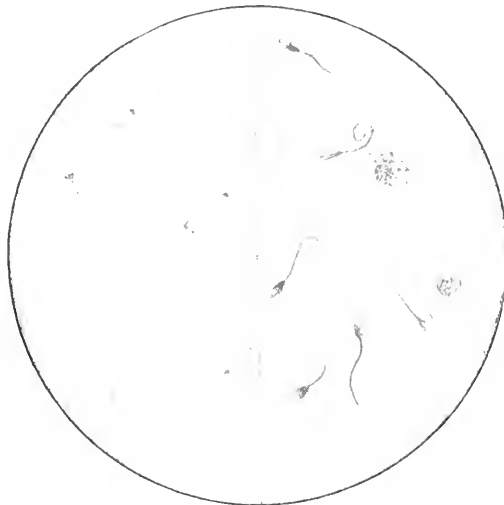

FIG. 7.—Sheep.

FIG. 8.—Cat.

The spermatozoa of the sheep (Fig. 7) stained evenly throughout except for a small central portion at the union of the head and tail. Its measurements were found to be:

| | |
|-------------------------|--------------------------|
| Total length, | 0.083 mm., or 0.0032 in. |
| Length, head, | 0.009 mm., or 0.0003 in. |
| Width, head, | 0.006 mm., or 0.0002 in. |
| Length, tail, | 0.074 mm., or 0.0028 in. |

Spermatic fluid from the cat (Fig. 8) was found difficult to study, as but few spermatozoa were present. Each spermatozoon presented a fibrillated tail, and at times this fibrillation was seen to surround the head. The head stained deeply, and at times a centrosome was distinct. Decided irregularity was noted in the size and form of the heads, which partially explains the variations found in the measurements of these cells.

| | |
|---------------------|---|
| Total length, . . . | 0.058 to 0.074 mm., or 0.0022 to 0.0028 in. |
| Length, head, . . . | 0.004 to 0.007 mm., or 0.001 to 0.0002 in. |
| Width, head, . . . | 0.003 to 0.003 mm., or 0.0001 to 0.0001 in. |
| Length, tail, . . . | 0.053 to 0.066 mm., or 0.002 to 0.0025 in. |

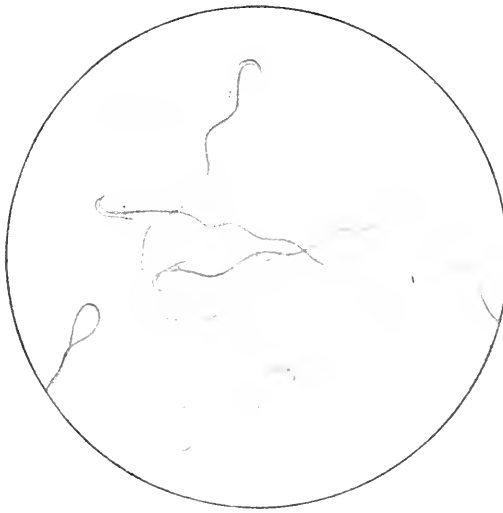

FIG. 9.—White Rats.

At first sight the spermatozoon of the rat (Fig. 9) reminds one of the immature male cell of the bird, and it is not impossible that these cells may undergo further development. The spermatic fluids of both white and gray rats were studied, and no marked difference was found to exist between these cells. The head and tail of this cell stains well, the concave border of the head staining slightly deeper than its body. Measurements were found to be :

| | | | |
|---------------|-------|---------------------|-------------------------|
| Total length, | . . . | 0.225 to 0.238 mm., | or 0.0087 to 0.0092 in. |
| Length, head, | . . . | 0.012 to 0.016 mm., | or 0.0004 to 0.0006 in. |
| Length, tail, | . . . | 0.209 to 0.222 mm., | or 0.0081 to 0.0086 in. |

The spermatozoon of the guinea pig (Fig. 10) differs widely from any other member of the series. Its head is nearly spherical, and a minute, deeply stained portion was noted at the junction of the tail. Each head was provided with a neatly fitting, semi-lunar cap, which was also well stained. At times these caps were seen detached, and at others deformed, giving that portion of the head either a concave or a pointed appearance. That portion of the tail nearest the head was always deeply stained, and the course of the tail was never found to be tortuous. The following measurements were obtained for these cells :



FIG. 10.—Guinea Pig.

| | | | |
|---------------|-------|---------------------|-------------------------|
| Total length, | . . . | 0.113 to 0.138 mm., | or 0.0053 to 0.0057 in. |
| Length, head, | . . . | 0.006 to 0.012 mm., | or 0.0006 to 0.0004 in. |
| Width, head, | . . . | 0.007 to 0.011 mm., | or 0.0004 to 0.0004 in. |
| Length, tail, | . . . | 0.125 to 0.132 mm., | or 0.0048 to 0.0051 in. |

L. NAPOLEON BOSTON, M. D.

LABORATORY PHOTOGRAPHY.

Devoted to methods and apparatus for converting an object into an illustration.

AN IMPROVED PHOTO-MICROGRAPHIC APPARATUS.

I have recently had constructed for Cornell Medical College a photo-micrographic apparatus by B. & L., a description of which may be of interest to the readers of the JOURNAL, since there are certain departures from the regular type of outfit. Some of these departures were suggested by me, but they were worked out in detail and put into practical shape by the makers. To begin with, I will point out the various alterations, all of which, I think, are improvements over the old style, and afterwards proceed to describe the apparatus as a whole.

In the first place, then, on the old plan the optical bench and camera stand being practically all in one piece, the only way of finding the desired field for photographing is to push the camera back in its bed and bend over to look through the eye-piece. In this uncomfortable and back-breaking position it is impossible to manipulate the slide except by means of one of those clumsy mechanical stages which, though all very well for special purposes such as blood cell counting, are not to be compared with one's fingers, which, after all, were made at a much earlier date, for rapid manipulation.

In a Zeiss camera stand which I had previously used, the steel rods on which the camera moved could themselves be pushed back so that one could sit on a stool between the optical bench and camera stand in order to find the field. The chief objections to this plan are that the rods are apt to sag, and that the bench and stand cannot be connected into one solid piece, making it difficult to preserve the exact optical axis, or arrange a satisfactory method for mechanical focusing.

Two years ago I saw at the Jenner Institute in London a photo-micrographic outfit with a revolving optical bench, but had no opportunity of examining the details or of finding out if the arrangement worked satisfactorily or not, since it was entirely new. On mentioning the idea to Bausch & Lomb, they suggested a modification of one of their revolving microscopical tables. The details will be described further on; sufficient to say here, that by this arrangement I can sit comfortably at one side of the apparatus and with my fingers manipulate the slide on the microscope stage as easily as if I were sitting at an ordinary table.

The camera stand has a connecting rod between its two cast iron supports, just above their feet, and I then suggested that the rod be continued on to the single upright of the revolving bench in order to give more rigidity, but was told that so low down it would be of no use. After much discussion, it was decided to have a rod connecting the upper parts of the uprights, and so made that it could be put up and clamped in at the time of setting up the apparatus. This seems a very satisfactory arrangement, undoubtedly adding to the rigidity and helping to keep the optical bench and camera stand in optical axis.

The next difficulty was how to manage for mechanical focusing. When the bench and stand are fixed there is, of course, no trouble, since the focusing rod can be prolonged under the fine adjustment of the microscope, but where the bench revolves this prolongation of the rod must be got out of the way tempora-

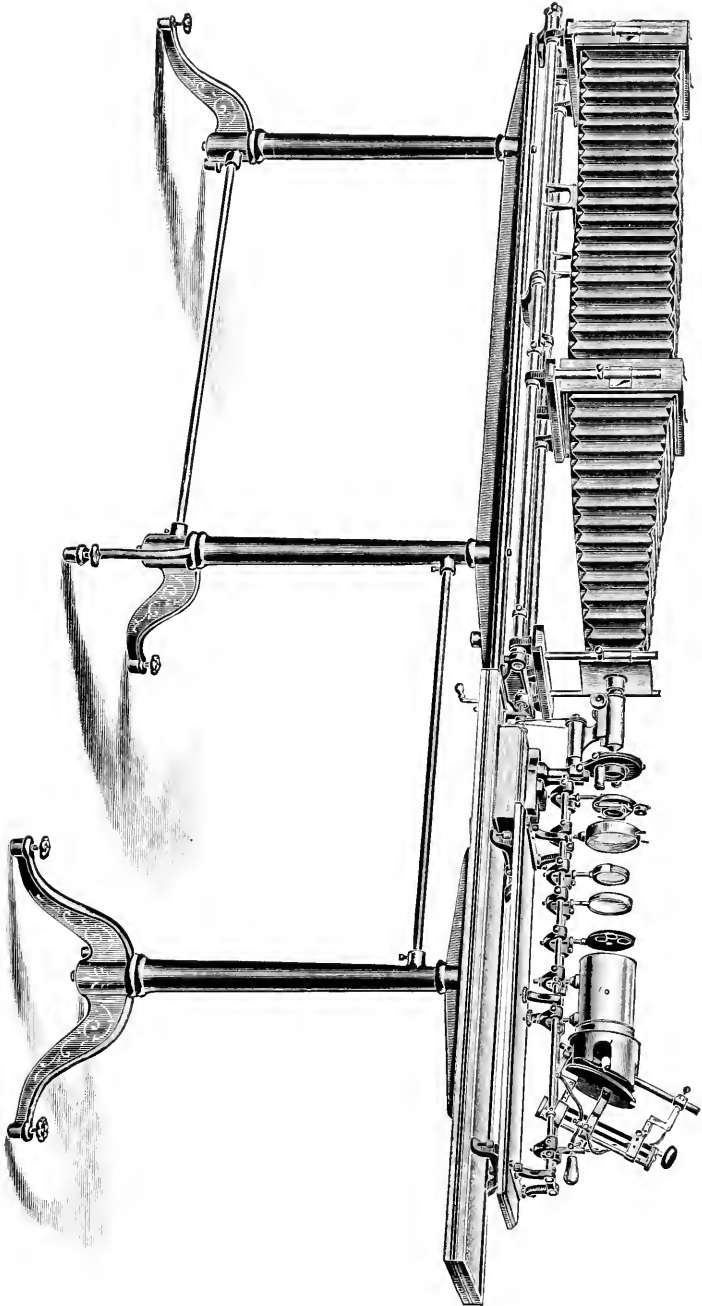

Fig. 1.—Complete Photo-micrographic Apparatus.

rily while the field is being found. Mr. Bausch asked me how I proposed to effect this, and I was forced to reply that I had not the least idea, but must leave it to him. Mr. Patterson, who had charge of the work, came to the rescue with a very ingenious device, which will be described further on.

It is, however, always best to avoid mechanical focusing, and be able to reach the fine adjustment with one's fingers, if possible, especially for the higher powers. In the B. & L. stands that I had hitherto seen, this appeared to be an impossibility, except within a very limited range, since the arrangement of the bellows was such that a shorter distance than fourteen inches could not be obtained between the eye-piece of the microscope and the ground glass of the camera.

Besides this, the front of the camera was always made the same size as the back, i. e., 11 inches square for a $6\frac{1}{2} \times 8\frac{1}{2}$ plate, so that the wrist had to be bent round over the front to reach the fine adjustment, thus losing three or four inches of distance for hand focusing.

Not only is the hand focusing superior in accuracy, but it is essential for another reason to be able to get the ground glass close up to the front, since the up-to-date apochromatic lenses will stand very high eye-piecing, with consequent shortening of focus. The higher the eye-piecing the shorter the focus for a given enlargement, as is illustrated by the accompanying photographs, all of which were made with this apparatus.

It will be noticed from the description and the accompanying cut that the disadvantages mentioned have been overcome. With the new apparatus I can bring the ground glass as near as seven inches from the eye-piece, and can focus by hand without any flexing of the wrist, the total range for hand focusing being about sixteen inches with a Zeiss projection ocular. The choice of a microscope stand was narrowed down to a Zeiss photographic and a Bausch & Lomb DD, the latter of which was finally decided upon since the former does not appear to offer any very special advantages, and the fine adjustment is situated so far forward that two inches in length would be lost for hand focusing.

Another improvement suggested was in making the camera stand entirely of metal. The wooden bed of the old style is liable to warp, and thus throw the rods out of true.

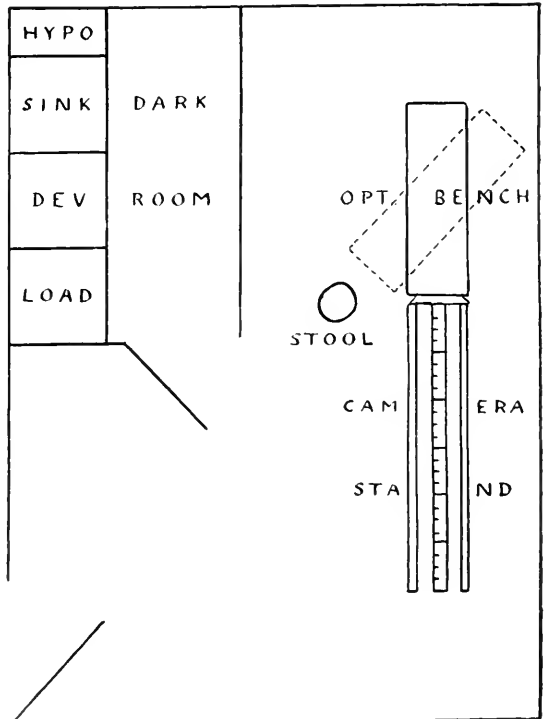

Fig. 2.—Plan of Room.

It would have been an advantage to have had one of the rods marked off in quarter inches, so that once the length of bellows for a certain enlargement had been accurately measured, the back of the camera could at any time be brought to the same position without any delay in measuring. This point was overlooked, but I have had quarter-inch spaces marked in white paint on the flat surface of the upper connecting iron casting, and this answers the purpose just as well. (See plan of room, Fig. 2.)

The optical bench carrying lamp, microscope, and accessories is 4 feet by 15 inches and is a turntable, revolving upon the supporting column, so that it can be turned partially round; the operator sitting on a low stool to find the field and rough focus.

Since the dark room is on the left of the apparatus, looking towards the source of illumination, the table has been constructed to turn to the left, and everything else is so arranged that it can be manipulated from the left, thus obviating any necessity for walking around the apparatus.

The accompanying diagram illustrates the plan of the room, 11 x 15 feet, the dotted lines showing the optical bench in position for finding the field. Of the camera stand only the steel rods on which the camera runs, and the central beam with some of the markings, are indicated. The lamp and accessories run on steel rods, which are supported on a wooden table, supported in its turn on leveling screws, which run in a metal groove on the surface of the optical bench, so that the table can be moved backward or forward as required.

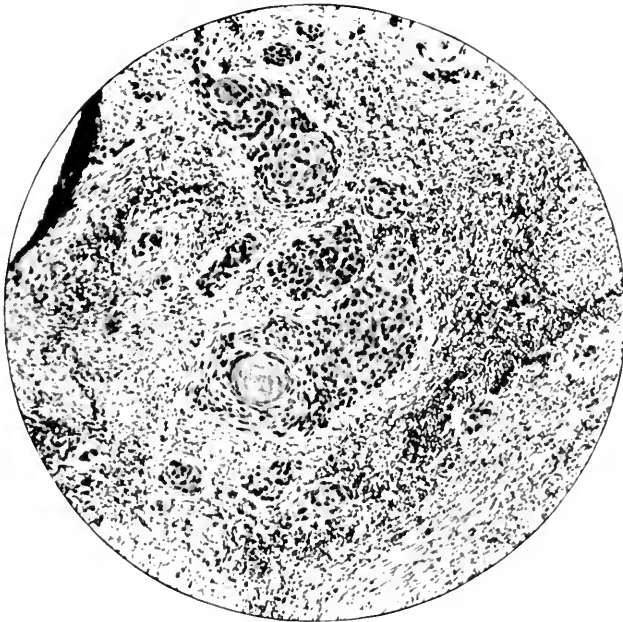

Fig. 3—Epithelioma invading lymph node. $\times 70$. Lens, Powell & Leland 1 in. apochromatic; ocular, none; exposure, $\frac{1}{2}$ sec.; distance of plate from hood, 70 inches.

The rheostat is a Colt adjustable, and stands on the floor just below the illuminating end of the optical bench. I had previously used an automatic arc

lamp, but finding that as a rule I had to be my own automaton, decided that a hand feed lamp would do better, since less liable to get out of order, and so far have no reason to regret the change.

The condenser and accessories are the regular Bausch & Lomb, so need no special description. In the figure the order from the lamp is: (1) condenser, (2) iris diaphragm, (3) paralleliser, (4) ray filter, (5) water tank, (6) iris diaphragm shutter. In practice so far, however, I have dispensed with the iris diaphragm, paralleliser, and ray filter, putting the water tank next to the condenser, and between tank and shutter using a flat tray on which ground or colored glasses, or a glass trough containing Zeltnow's solution, can be placed, so that the ray filter can be changed at a moment's notice. The lamp and condenser are then arranged so that the latter focuses directly on the substage condenser

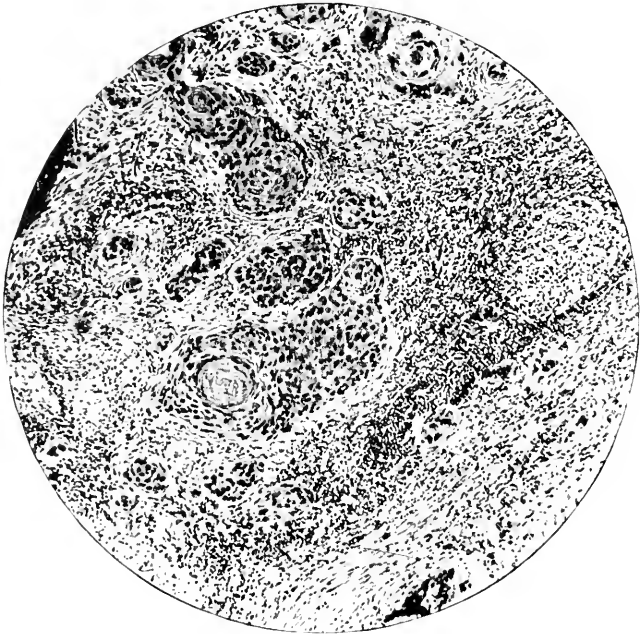

Fig. 4.—Same as Fig. 3. $\times 70$, Lens, B. & L. 1 in. apochromatic; ocular, B. & L. 1 in. compensation; exposure, 1 sec; distance of plate from hood, 12 inches.

or on the slide if no substage condenser is used. By this means a tremendous flood of light is thrown on the object, and exposures can be cut down to a fraction of a second without, so far as I can judge, affecting the results for the worse. On the day of writing this, with an exposure of one-half second, I photographed a small round cell sarcoma 250 diameters on a Cramer slow isochromatic.

The microscope stand rests on a fixed wooden block to which its horseshoe foot can be clamped.

The camera stand, as seen by the cut, consists of two cast iron uprights, connected above by a solid cast iron beam on the top of which are the already mentioned one-quarter inch spaces marked in white paint. This beam supports the steel rods upon which the camera runs.

The front of the camera is five inches square, and has vertical and horizontal movements. The bellows is divided into two, being so constructed that the back part can be taken off the central wooden frame when a short focus is required, and pushed back out of the way. The ground glass and plate-holder can then be fitted into the central frame. Both the back and central frames have vertical and horizontal movements, and are precisely alike in every particular, so that either can be used for focusing and exposing.

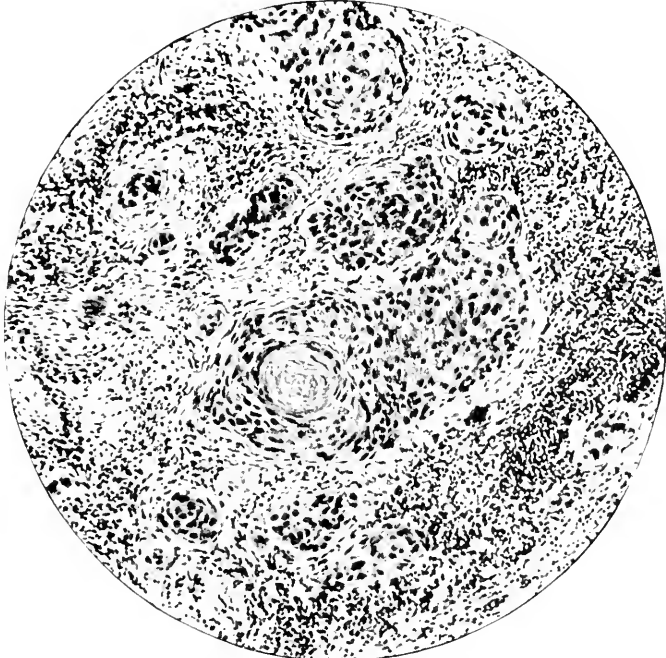

Fig. 5.—Same as Figs. 3 and 4. $\times 100$. Lens B. & L. 1 in. apochromatic; ocular, $\frac{1}{2}$ inch; exposure, 2 sec.; distance of plate from hood, 7 inches.

With regard to the arrangements for locking the optical bench, and mechanical focusing, I append a short description.

In making the mechanical attachment of a photo-micrographic camera for the purpose of operating the fine adjustment of the microscope, two points must be considered, viz. :

First. An arrangement whereby the attachment can be operated from any position, and

Second. The operation of the microscope fine adjustment without lost motion or back lash.

In the camera described above, a third problem is presented, in that the optical bench carrying the microscope and illuminating apparatus is arranged to rotate upon the supporting column, enabling the operator to adjust the specimen, illumination, and preliminary focus before connecting the microscope with the camera.

It will be seen that this arrangement necessitates the detaching of the focus-

ing rod of the camera from the microscope. To avoid the displacing and replacing of the belt connecting the mechanism, the following arrangement is adopted:

On the table of the optical bench, directly beneath the fine adjustment head of the microscope, is situated a milled wheel on suitable standard. A belt extends from this wheel to the fine adjustment head of the microscope. Through the axis of the wheel is located a rod carrying at the end toward the camera a clutch which can be quickly connected with the

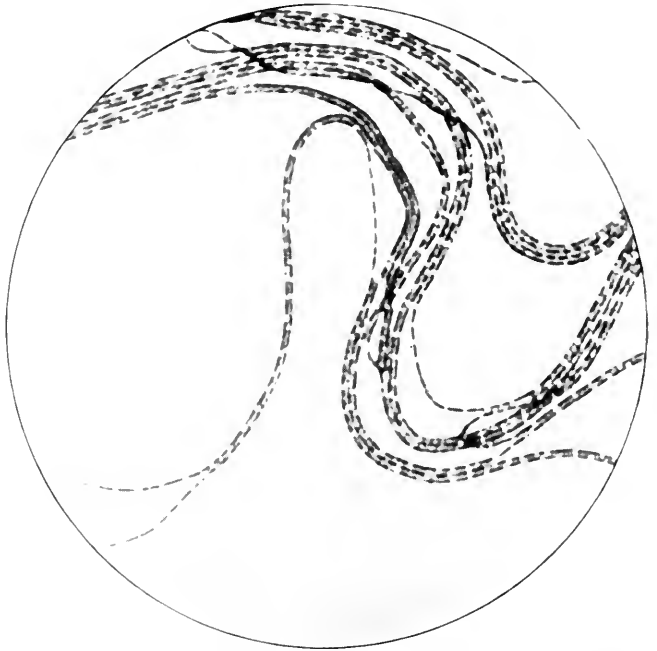
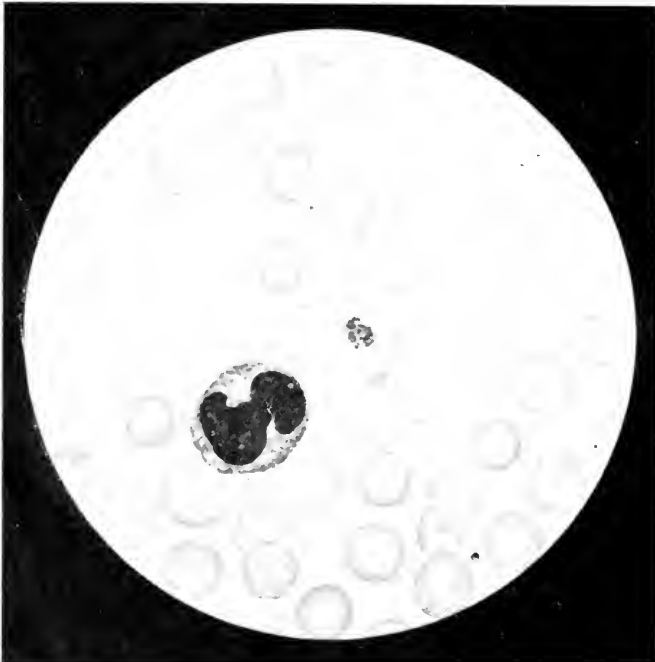

Fig. 6.—Anthrax, impression preparation from edge of colony on gelatin. $\times 700$. Lens, $\frac{1}{2}$ oil immersion; ocular 1 in. compensation; substage condenser, oil immersion N. A. 1.40.



Malarial Parasite in Human Blood. Crescentic form. $\times 1200$.

focusing rod of the camera by sliding adjustment, operated by a milled head. The optical bench must of course be brought to its proper position with relation to the camera in order to make this connection, and, that this position may be quickly and accurately located, an automatic catch is provided, which catch can be released by a lever, shown in the illustration.

B. H. BUXTON.
Cornell Medical College.

MICRO-CHEMICAL ANALYSIS.

XV.

Magnesium Group—Gl, Mg, Zn, Cd.

GLUCINUM.

This element, doubtless, should not be included in the present series of articles introductory to the methods of micro-chemical analysis, since it is rare that the analyst is called upon to search for it.

The element glucinum being, however, of much interest from the standpoint of pure chemistry, the writer has not been able to resist the temptation to include it among the few elements to be considered.

Glucinum resembles members of Group I in the crystallizing power of its chlorplatinate, this salt being analogous to that of sodium as regards its solubility and general appearance, but differs from the latter in that it crystallizes with more water of crystallization and in the tetragonal system.

Glucinum resembles aluminum and other trivalent metals in the gelatinous character of its hydroxide precipitated by ammonium hydroxide, but differs from them in that this hydroxide is soluble in solutions of ammonium carbonate.

Like magnesium, its salts unite to form double salts with ammonium; and its chloride, when evaporated to dryness from aqueous solution, is decomposed.

Like zinc, it is soluble in sodium or potassium hydroxide, the compound formed being a glucinate of the formula $\text{Gl}(\text{OM})_2$.

It has already been seen that glucinum can replace magnesium, zinc, or cadmium in the triple acetate of sodium, magnesium, and uranyl.

It is thus obvious that in the progress of a micro-chemical analysis, glucinum, if present, may appear when testing for Group I, Group II, and, perhaps, Group III.

There are only three reagents which can be considered as giving satisfactory crystals for the micro-chemical detection of glucinum. These are:

- I. Chlorplatinic Acid.
- II. Normal Potassium Oxalate.
- III. Uranyl Acetate and Sodium Acetate.

Of the three, the best undoubtedly is normal potassium oxalate. The other two are subject to too many disturbing conditions and sources of error.

1. Glucinum unites with Chlorplatinic Acid to form Glucinum Chlorplatinate.



Method.—Evaporate to dryness a drop or two of the solution to be tested, so as to obtain a thin, uniform film of residue. Place a drop of the reagent next to the dry residue, and carefully draw it across the latter. If the glucinum is present in considerable amount, there will appear neat, transparent, square, and rectangular plates and prisms of a faint yellow color (Fig. 64).

Remarks.—If it is desired to hasten the separation of the glucinum salt, tip up the slide and add a drop of alcohol to the test drop after the reagent has been drawn across. Generally the addition of the alcohol is essential in order that any crystals of the glucinum chlorplatinat be obtained.



1 Div. = 0.01mm

FIG. 64.

The test is satisfactory only when the air of the laboratory is quite dry. In a moist atmosphere the glucinum chlorplatinat is deliquescent, hence the test fails. In such an event it is necessary to add absolute alcohol, or place the preparation in a desiccator, or cover it with a watch-glass carrying a drop of concentrated sulphuric acid.

In case the quantity of glucinum present is small, and that of the members of Group I great, it is essential that sufficient reagent be added to unite with all. If, therefore, on examination of the preparation after the addition of the chlorplatinic acid, it is seen that members of the potassium group are present, it is wise to make a second addition of the reagent, and follow it with alcohol.

When sodium is present in considerable amount, it is often difficult to distinguish the glucinum salt from the sodium chlorplatinat; if, however, the preparation be examined between crossed nicols, the problem is simplified, since the chlorplatinat of sodium exhibits oblique extinction (triclinc) and a brilliant play of colors, while the glucinum compound gives parallel extinction (tetragonal) and but faint colors (usually none). The chlorplatinates of the potassium group are isometric.

If solutions containing glucinum in the form of sulphate are employed, care must be taken to avoid confusing this salt with the chlorplatinat, since the glucinum sulphate, $\text{GISO}_4 \cdot 4\text{H}_2\text{O}$, which is also to be referred to the tetragonal system, sometimes separates in thin, six-sided plates.

II. Normal Potassium Oxalate added to solutions of salts of Glucinum causes the separation of a difficultly soluble Double Oxalate of Potassium and Glucinum.

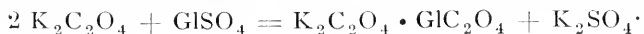

Method.—To the moderately concentrated solution add a little acetic acid, then a fragment of the reagent about twice as large as is usually the case in micro-chemical work. Almost immediately large, clear, colorless, highly refractive prisms of the monoclinic systems are obtained. These prisms unite to form twins and radiating masses (Fig. 65).

Remarks.—The appearance of the crystals varies greatly, according to the amount of the reagent present, as compared with that of glucinum. Too little potassium oxalate will yield only a precipitate of tiny crystals which probably consist of the normal oxalate of glucinum. Too much re-

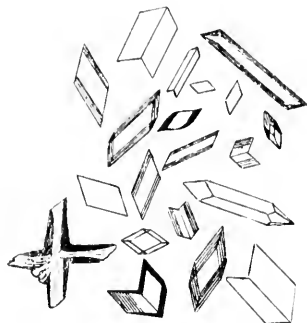

1 Div. = 0.01mm

FIG. 65.

agent, on the other hand, gives rise to skeleton crystals and to masses of thin lenticular plates.

During the disintegration of the fragment of potassium oxalate while passing into solution (particularly in concentrated solutions), crystals of the reagent appear *momentarily*, which bear a striking resemblance to some of the forms assumed by the double glucinum potassium oxalate. In testing unknown solutions the worker must be on his guard lest he fall into error by deciding too hastily.

The double oxalate of glucinum and potassium can be readily recrystallized from water by gently warming the preparation and allowing it to cool slowly. The salt is also soluble in solutions of ammonium carbonate, a property which can be utilized when there is doubt as to the nature of the precipitate obtained in the course of an analysis.

The addition of a little mercuric chloride will induce the production of long prisms and twins, and hence is useful when good crystals cannot otherwise be obtained.

Neither primary potassium oxalate, sodium, nor ammonium oxalates can be substituted for the normal oxalate of potassium.

With zinc, the reagent gives tiny double globulites and pseudo-octahedra of normal zinc oxalate, and later, as the test drop concentrates by evaporation, neat hexagonal plates appear, which are probably due to a double oxalate of potassium and zinc (?). Mercuric chloride seems to favor the formation of the hexagonal plates.

Cadmium treated in like manner yields, apparently, only crystals of normal cadmium oxalate (*g. v.*). No double salt seems to separate.

The reagent gives nothing with magnesium, providing the test drop is not too concentrated and does not contain an excessive amount of free acetic acid.

When zinc or cadmium is also present, the crystal form of the glucinum potassium oxalate is changed. It then becomes difficult to decide whether or not glucinum is present.

Magnesium, aluminum, and iron, on the other hand, have practically no influence, unless present in relatively large amount. But the double oxalate of glucinum and potassium crystallizing from such solutions will always occlude an appreciable quantity of the potassium double oxalate of these elements.

Calcium, strontium, and barium may mask the reaction.

Ammonium salts, if present, must first be removed by gentle ignition before testing with potassium oxalate.

Free mineral acids must be absent.

Stannous salts may at times give, with potassium oxalate, crystals of stannous oxalate which may be mistaken by an inexperienced worker for the glucinum double salt.* After the tin salt has been allowed to grow for a short time, there is little danger of confusing the two. If still in doubt, recrystallize from warm water, treat with ammonium carbonate, or apply tests for tin.

When the solution to be tested contains copper, cobalt, or nickel, it is gener-

* This error cannot arise in the course of a systematic analysis.

ally best to avoid testing it directly for glucinum, but to first practice a separation where the former are removed from the latter.

Exercises for Practice.

To a drop of a solution of a pure salt of Gl add $K_2C_2O_4$ in the manner directed above. Try the experiment several times, varying the amount of the reagent.

Try again under as nearly like conditions as possible, but this time having first introduced a little $HgCl_2$.

Try the action of HKC_2O_4 ; $(NH_4)_2C_2O_4$; $Na_2C_2O_4$.

Try reagent on salts of Mg; Zn; Cd; Cu; Co; Ni.

Then try mixtures, as for example, Gl and NH_4 ; Gl and Mg; Gl and Al; Gl and Fe; Gl and Zn; Gl and Ca, etc., and also more complicated mixtures.

III. With Uranyl Acetate and Sodium Acetate.

This reaction of glucinum salts has already been alluded to under Sodium, Method II.* The equation for the reaction is the same as that there indicated, save that glucinum replaces the magnesium.

To the material to be tested a little sodium acetate is added (unless it is known that sodium is present). The drop is then evaporated to dryness, and the solution of the reagent is drawn across the film of dry residue. Skeleton crystals, long, imperfect prisms, and almost colorless tetrahedra result.

There is, at times, some difficulty in clearly distinguishing between the triple acetate of glucinum, sodium, and uranyl, the double acetate of sodium and uranyl, and the crystals due to a separation of uranyl acetate. It has been the experience of the writer that students trying the method for the first time are invariably in doubt as to the nature of the crystals obtained.

The tetrahedra of the triple acetate differ only in size and color from those of the double acetate, the former attaining a greater size than the latter, and being only very faintly yellow instead of exhibiting a distinct yellow tint.

The amount of sodium present must be small, otherwise only the double acetate will appear.

Salts of ammonium, potassium, and of the calcium group will generally interfere, if present in excessive quantity.

Phosphates and other compounds precipitating uranium should be absent.

Free mineral acids must be removed by evaporation to dryness, as has been suggested.

It is obvious that this method cannot be employed for the detection of glucinum save in the absence of magnesium, zinc, cadmium, cobalt, nickel, iron, manganese.

MAGNESIUM.

The micro-chemical detection of magnesium in complex mixtures is usually a matter of not a little difficulty, since this element is commonly associated with others closely related, which are prone to interfere with or prevent the formation of typical crystals with the reagents employed for its recognition.

* Jour. App. Micros. III, 1900, 985.

Tests applied to pure salts and simple mixtures are quite satisfactory, and would scarcely lead the worker to anticipate the annoyances and difficulties which may beset him in other cases.

In ordinary practice three reagents will be found useful:

- I. Secondary Sodium Phosphate in Ammoniacal solution.
- II. Potassium Antimonate,
- III. Uranyl Acetate with Sodium Acetate.

I. The addition of Secondary Sodium Phosphate to Ammoniacal solutions containing Magnesium precipitates Ammonium Magnesium Phosphate.



Method.—Two methods are available; the choice of procedure depending upon the nature of the salts present in the drop to be tested. In all cases where there is a doubt as to the probable composition of the material to be examined, it is best to have recourse at once to the modification *B*.*

A. To the solution of the material to be tested, which must not be too concentrated, add several fragments of ammonium chloride; stir, then a very slight excess of ammonium hydroxide, and warm the preparation. (If a precipitate results it is best to draw off the clear solution.) To the warm solution add a small crystal of secondary sodium phosphate. Crystals of ammonium magnesium phosphate soon appear.

B. To the solution to be tested add a fragment or two of citric acid, then an excess of ammonium hydroxide. Evaporate to dryness. To the residue add dilute ammonium hydroxide. Warm, then add a very little solid secondary sodium phosphate. Crystals of ammonium magnesium phosphate separate.

The crystals of the ammonium magnesium phosphate separate as skeletons and hemimorphic forms of the orthorhombic system (see Figs. 40 and 66).

Remarks.—It should be remembered that a number of elements are precipitated by phosphates in alkaline solution; the most frequently met with in the course of micro-chemical analyses, either in the substance to be tested, or present as reagents from previous tests, are doubtless, lithium, members of the calcium and magnesium groups, trivalent metals, manganese, nickel, cobalt, tin, lead, silver, copper, uranium.† Of these elements, lithium, iron, manganese, cobalt, and nickel form, with ammonium and phosphoric acid, salts of similar composition to and isomorphous with the magnesium salt.



FIG. 66.

The ammonium glucinum phosphate, ammonium zinc phosphate, and ammonium cadmium phosphate

are not precipitated in crystal form.

* Romijn, Zeit. anal. Chem. 37, 300.

† Most of these elements will have been removed in the progress of the analysis before the addition of the sodium phosphate.

In *A* the reaction sometimes fails for lack of sufficient ammonium chloride, magnesium hydroxide being precipitated. A slight excess of this salt will do no harm.

Both modifications fail if there is an insufficiency of ammonium hydroxide, for it should be remembered that there must be not only enough ammonium present to unite to form the proper compound, but that this salt will not separate save in alkaline solution.

The advantage of employing modification *B* lies in the fact that owing to the presence of ammonium citrate, there is little danger of the interference of the elements listed above. If, in following this method, the residue after evaporation is not completely soluble in the ammonium hydroxide solution, it is best, though not essential, to draw off the clear liquid before adding to it the sodium phosphate.

Reactions *A* and *B* work equally well in the cold, but are then a trifle slower. Generally, an amorphous precipitate is at first produced, which begins to crystallize in a few seconds. The formation of merely an amorphous precipitate must never be taken as evidence of the presence of magnesium.

It must also be borne in mind that the use of too strong ammonium hydroxide in excess so reduces the solubility of many salts as to cause their separation, hence it is necessary to beware, in reactions of this character, of deciding too hastily as to the result of a test.

See remarks made under Ammonium, Method II (JOURNAL, p. 1190), and Calcium, Method V (JOURNAL, p. 1247).

In the presence of phosphates the detection of magnesium becomes quite difficult, particularly if other elements are present which form phosphates insoluble in ammonium hydroxide. If arsenates are also present, a still further complication arises, for, as we have already seen, double ammonium arsenates of calcium, zinc, etc., are formed, which are isomorphous with ammonium magnesium phosphate.

Of course it may happen that in some cases the mere addition of ammonium hydroxide will cause the separation of characteristic crystals of ammonium magnesium phosphate. Generally, however, it is first necessary to remove the phosphoric acid. This can be accomplished by tin and nitric acid, or by means of ammonium tungstate and nitric acid. Details will be given later.

Exercises for Practice.

Try method *IA* on a solution of MgSO_4 , then try it on salts of Fe, Mn, Co, Ni, Al, Zn, Cd. Repeat the experiments, this time adding the HNa_2PO_4 before the NH_4OH .

Try *IB* in like manner.

Make mixtures, trying various combinations of the above with members of Groups I and II.

Consult notebook on the results obtained with the experiments tried under Ammonium II and Calcium V.

II. Potassium Antimonate added to solutions containing Magnesium causes the separation of Magnesium Pyro-antimonate.

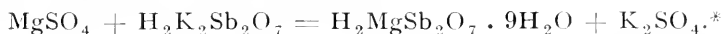

Method.—First prepare an almost saturated solution of the reagent by heating a fragment with water. A drop of this solution is placed next the test drop, and the two caused to unite. A dense amorphous precipitate is usually immediately produced. After a time, crystals of magnesium pyro-antimonate appear, generally near the circumference. The forms most frequently obtained are thin, colorless, transparent hexagonal plates, and spherical masses more or less crystalline in appearance (Fig. 67). Less often, short hexagonal prisms are seen.

Remarks.—The solution to be tested must be dilute and neutral. Free acid not only interferes with the formation of characteristic crystals, but also causes the reagent itself to yield an amorphous precipitate.

The development of the crystals of magnesium pyro-antimonate is quite slow, and eventually they may attain a size of double or even triple that of those shown in Fig. 67.

Alcohol can be employed to hasten crystallization, but it is better to allow the preparation to take all the time it needs.

Lithium sometimes yields crystals not to be distinguished from those of magnesium, more often circular disks and sperulites.

Sodium (q. v.) gives fusiform crystals.

Members of the calcium group are precipitated in an amorphous form, and interfere with the test for magnesium.

Ammonium salts should be absent.

Exercises for Practice.

Try reaction on salts of Mg.

Repeat the experiment in the presence of salts of NH_4 .

Make a mixture containing Na and Mg; test as above.

Test a salt of Li. Try the effect of the reagent on salts of Zn and of Cd.

Test a mixture of Mg and Zn.

III. With Uranyl Acetate and Sodium Acetate.

The method of applying the test has been described in Method III of Glucinum; there, and under Sodium, Method II, the properties of the triple acetates have been discussed in detail.

The formula and appearance of the triple acetate of sodium magnesium and uranyl will be found on page 985 of Vol. III, of this Journal. To this article, and to that on Glucinum, the reader is referred for details as to methods of procedure, sources of error, etc.

E. M. CHAMOT.

Cornell University.

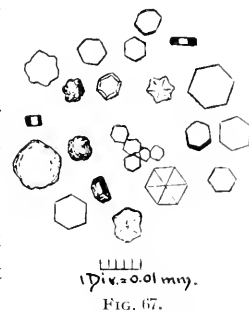

FIG. 67.

* See foot note, Sodium, Method V, Jour. App. Micros. III, 1900. p. 1048.

Journal of
Applied Microscopy
 and
Laboratory Methods.

Edited by L. B. ELLIOTT.

Issued Monthly from the Publication Department
 of the Bausch & Lomb Optical Co.,
 Rochester, N. Y.

SUBSCRIPTIONS:

One Dollar per Year. To Foreign Countries, \$1.25
 per Year, in Advance.

The majority of our subscribers dislike to have their files broken in case they fail to remit at the expiration of their paid subscription. We therefore assume that no interruption in the series is desired, unless notice to discontinue is sent.

AMONG the many questions clamoring for decision, that of the standard of equipment in the various classes of laboratories has received very little organized consideration, and yet it is one of as great practical value as any connected with science teaching, and one which would seem to admit of a very easy and practical settlement. It is not our purpose here to make any suggestions as to what might constitute a standard equipment, but to point out the value to educational institutions of adopting a standard.

The requirements for each class of laboratory, so far as the most important apparatus goes, are practically the same. The biological laboratory requires a microscope having powers ranging from a minimum to a maximum. The histological, bacteriological, chemical, high school, and each other class is likewise limited. There is, however, no unity of opinion as to the kind of stand these powers of lenses are to be used on, or the accessories, such as nosepiece, condensers, etc., which are to be used with them. The same is true in a general way in regard to microtomes, incubators, and the unit equipment, for each student, of glassware, stains, and reagents. Each laboratory director is a law unto himself, and an inspection of the purchases made for the various laboratories of the country for the year would seem to indicate that each had done his best to be original in the make-up of his equipment.

This is all well enough from the standpoint of the individual who is equipping the laboratory, but the practice costs the institutions of the country an immense sum of money, far greater than any one not fully conversant with the conditions can realize, and the cause is obvious.

The cost of any article is dependent very largely on the number consumed. Where the number is small the cost of production is high, because it does not pay the manufacturer to build expensive machinery and make up a large quantity to be held a long period, and in addition run the chance of his stock becoming antiquated through the development of more suitable models.

So with this laboratory apparatus; the ceaseless demand for variations from existing models, the selection of every grade of apparatus for the same kind of work, makes it necessary for the maker to build an endless variety of perfectly useless instruments, and to charge an average advance on all to compensate him for the extra cost to him of doing his work piecemeal.

If the subject of laboratory equipment could be taken up by a committee from each of the organizations of laboratory men interested in this work, and a joint recommendation made, there is no question but that the majority of laboratories would accept the findings, and that the uniform demand thus established would result not only in better apparatus, but at a decreased cost.

CURRENT BOTANICAL LITERATURE.

CHARLES J. CHAMBERLAIN.

Books for review and separates of papers on botanical subjects should be sent to
Charles J. Chamberlain, University of Chicago,
Chicago, Ill.

REVIEWS.

Murbeck, S. Ueber das Verhalten des Pollenschlauches bei *Alchemilla arvensis* und das Wesen der Chalazogamie. Lunds Universitets Arsskrift. **36**: 1-19, pls. 1-2, 1901.

Since other species of *Alchemilla* have been found by the same writer to be parthenogenetic, it is of interest to note that *A. arvensis* has a pollen tube at all. In the development of the ovule a micropyle is formed, but long before pollination occurs the continued growth of the integument entirely closes the micropyle. The pollen tube grows down through the style and enters the ovule at the chalazal end, then traverses the entire length of the integument, growing through the tissue, and enters the micropylar region of the sac. Although the act of fertilization was not observed, it may be reasonably assumed to take place in spite of the fact that other species of *Alchemilla* are parthenogenetic. In this case the pollen seems perfectly normal. The author does not regard this as a case of chalazogamy such as is found in *Casuarina*, *Corylus*, *Carpinus*, *Betula*, *Alnus*, and *Juglans*. but rather as a type intermediate between genuine chalazogamy and the condition found in *Ulmus*. Chalazogamy is regarded as a derived condition, and as a physiological phenomenon of no phylogenetic significance.

c. J. C.

Brand, F. Bemerkungen über Grenzzellen und über spontanrothe Inhaltkörper der Cyanophyceæ. Ber. d. deutsch. bot. Gesell. **19**: 152-159, 1901.

The heterocysts of the *Nostocaceæ* have been described as cells poor in contents, or with only watery contents, and they have been supposed to be concerned only in false branching and in breaking filaments up into hormogonia. The present writer, in investigating *Nostoc commune*, finds that in addition to the empty heterocysts there are also heterocysts with contents, which are not watery but elastic, and of considerable consistency. By pressure on the cover-glass, the walls of these heterocysts may be broken and dissociated from the contents which retain their spherical form. It was found that the contents divide like ordinary vegetative cells, and give rise to filaments. It was also found that in some cases the contents of the heterocyst pass over into the neighboring cells, and may induce in them a renewed activity. The writer believes that the red granules of the Wasserblüthe, forming members of the Cyanophyceæ, are not due to gases.

c. J. C.

Ernst, A. Beiträge zur Kenntniss der Entwicklung des Embryo-sackes und des Embryo (Polyembryonie) von *Tulipa Gesneriana* L. Flora. **88**: 37-77, pls. 4-8, 1901.

This paper treats in considerable detail the life history of *Tulipa Gesneriana*, from the appearance of the archesporial cell in the nucellus of the ovule up to the ripe seed. Besides the original work, there is a very convenient summary of the literature of polyembryony. A few of the points noted are the following:

The first division of the nucleus of the embryo-sac in which the reduction in the number of chromosomes is effected, takes place after the opening of the flower. The number of chromosomes in the gametophyte is twelve, but in one case six were counted. The antipodal nuclei become fragmented into a varying number of pieces. The generative cell of the pollen grain often occupies the greater portion of the space within the spore, and has an unusually thick membrane. The vegetative nucleus remains in the end of the tube after the two male nuclei have been discharged into the sac. One of the male nuclei conjugates with the nucleus of the egg, and the other becomes applied to the upper polar nucleus, so that the definitive nucleus results from the fusion of three nuclei, the two polar nuclei and one of the male nuclei.

After fertilization, the egg gives rise to an irregular mass of cells, in which the beginnings of several embryos may be distinguished. The polyembryony of *Tulipa* is very much like that described by Jeffrey for *Erythronium*.

C. J. C.

CYTOLOGY, EMBRYOLOGY, AND MICROSCOPICAL METHODS.

AGNES M. CLAYPOLE, Cornell University.

Separates of papers and books on animal biology should be sent for review to
Agnes M. Claypole, 125 N. Marengo avenue,
Pasadena, Cal.

CURRENT LITERATURE.

Doflein, F. Cell Division in Protozoa. Zool. Jahrb. 14: 1-16, 1900. Extracts from Royal Mic. Jour. April, 1900.

Dr. F. Doflein has studied *Noctiluca miliaris* with especial reference to the nuclear changes accompanying cell division. The life cycle is as follows: After dividing repeatedly the adult comes to rest, copulation of two individuals occurs, followed by rapid budding. The liberated buds are at first similar to Dinoflagellata, but ultimately become converted into adults. Division occurs, a sphere appears near the nucleus, and a process takes place believed by the author to have a superficial resemblance to metazoan karyokinesis. The division of the nucleus appears to be in some degree independent of the division of the sphere, the division of the latter being closely associated with plasmic division; the author believes that the former structure is but a concentration of the plasma itself, hence the close relation. The budding after copulation consists of a rapid cell division during which the division products remain united by a common stroma. It is uncertain whether this stroma indicates a reduction process or not. A discussion on the structure of protoplasm and the causation of its movement is also given in the paper.

A. M. C.

Stephens, J. W. W. and Christopher, R. S. R.
Technique for Malaria Blood. Roy. Soc. Report to Malaria Comm. 3d Series, 1900.
Ext. from Royal Mic. Jour., April, 1900.

The authors use the following simple method for preparing and staining films of malaria blood: The finger is pricked with a triangular surgical needle and a clean glass slide touched to the exuding blood. The drop thus obtained

on the slide is spread by the shaft of the needle in a broad, even streak, a little time being allowed for the drop to run along the needle by capillarity. The most perfect films are thus obtained. The slides are then placed in absolute alcohol for 5 minutes, after which the films are stained with saturated alcoholic solution of hæmatein. To every 10 c. c. of this solution is added 50 c. c. of alum solution (alum 50 grams, water 1000 c. c.). In this solution the slides are left 5 to 20 minutes or even hours. Oil is applied directly to the slide without a cover and the specimen examined. A permanent mount can be made by washing off the oil with xylol and mounting the preparation in balsam. If placed in a clean box and wrapped in paper, the slides will keep a year unmounted. A. M. C.

Gurwitsch, A. Die Vorstufen der Flimmerzellen und ihre Beziehungen zu Schleimzellen. *Anat. Anz.* 19: 44-48, 1901.

In the eighteenth number of this periodical a work on M. Heidenhain appeared which gives an opportunity

for a few remarks. Heidenhain's work came to the author so shortly before the appearance of his previous communication on this subject that it was impossible to discuss in the same issue Heidenhain's opinions of the author's statements. These are here set forth. The peculiarly shaped epithelial cells in the mouth and pharynx of salamander larvæ is the subject under special discussion.

The author has presented, beginning with the earliest stages, the development and its modifications of the peculiar superficial border of the cells; first appearing as an apparently homogeneous "crest" not sharply separated, the cell border is next clearly foam-like; in the course of the further development the foam-like structure is effaced to make a "felt work." (*Arch. f. Mikros. Anat.* 57: 209, Fig. 16-18.)

As an end product of development there comes a clearly formed, sharply isolated border of small rods, of which the separate little hairs correspond in their height exactly to the cilia of the mature ciliated cells and provisionally remain covered with a thin but very sharply apparent, net-like film. At this stage of development direct observation ceased, as the oldest of the remaining larvæ showed no more continuance of the process. Based on this observation the author felt drawn to the conclusion that these cells possessed of rods were the early stages of ciliated cells, and also to infer that in one kind of cells at least the cilia are formed before the basal bodies.

This interpretation of these questioned cells is now doubted by M. Heidenhain. He regrets that the "last step of development, the peculiar transformation into the true, mature, free cilia, was not observed." The reason for this deficiency was given thus: "I sought to remedy the lack somewhat by figuring in my detailed work (Fig. 21) a mature ciliated epithelial cell next to two intermediate ones from the transition of esophagus to pharynx." Heidenhain is much more disposed to consider the pharyngeal cells as forerunners of mucous cells. It seems that a misunderstanding arises each time. Although in both articles the authors speak only of pharyngeal, not of esophageal cells, and although Heidenhain mentions each time that the pharyngeal epithelium of the salamander was the object treated of, he suggests as a possible cause for confusion on

Gurwitsch's part the circumstance that "the epithelium of the esophagus and stomach in the transition region may not be sharply distinct from each other, so that ciliated regions could be found in the surface epithelium." This is impossible; since the part of the epithelium which was used for investigation lay above the esophagus, and since the whole region was covered with a similar unbroken coat of these questioned cells, just as in later life the ciliated coat is entirely unbroken, the author's conclusion is again justified and Heidenhain's assumption would only be right if there were ground for the belief that the whole pharyngeal epithelium was changed to a mucous condition and that later ciliated epithelium arose *de novo* from some unknown source. No evidence exists for this and such a process could not easily escape notice. Moreover, if Heidenhain's explanation were applied to all these questioned cells, then this rodDED border, which occurs in so many forms and kinds of cells, must be declared the forerunner of *mucoid* formation on the ground alone that it seems to be the case in this one kind of cell.

It cannot be doubted that identical tissues in two nearly related species of animals have in similar developmental stages an entirely different appearance. Therefore it is no objection to the writer's hypothesis that the methods of development of ciliated cells in salamanders may differ in various cases. The only apparent question existing is whether these steps are those of ciliary or mucoid formation in the cells.

The facts important for histogenesis in general must satisfy us that similar structures may owe their origin to different methods of development, and that the histogenetic processes which are found in one species may not be applied to a nearly related one. This is also true in other lines, as for example, the histogenesis of crystalline lens in different animals and the ectodermal origin of cartilage in *Petromyzon*.

The author adds a few words on the beaker cells in the same epithelium. This in the salamandar larva has always two layers, the one with the peculiar rod-cells is set on a layer of cubical or more or less sloping cells. In not a single case was the first or rodDED layer found in contact with the basilar membranes. On the other hand, all the mucous cells, independent of their condition of function, were placed directly on the basilar membrane. This immediately suggested the latter to be the mother cells of the beaker cells. While this could not be maintained by direct evidence, not sufficient transitional stages being examined, it is enough for this argument to state the facts that there is a good criterion for the differentiation of the immature mucous cell from the rod cell. "Thus the beaker or goblet mucous cells of the pharyngeal epithelium point clearly to a layer underlying the latter ciliated cells.) This relation holds true in all cases and all stages in development.

CURRENT ZOÖLOGICAL LITERATURE.

CHARLES A. KOFOID.

Books and separates of papers on zoölogical subjects should be sent for review to Charles A. Kofoid, University of California, Berkeley, California.

Bergh, R. S. Kleinere histologische Mitteilungen, Zeitsch. f. Wiss. Zool. **69**: 444-456. Taf. 32, 33, 1901.

The author commends the use of maceration methods in the study of the histology and organology of the larva of the leech *Aulastoma*. Very dilute acetic acid or a mixture of three or four parts of 30 per cent. alcohol with one part of 2 per cent. acetic acid was employed with good results, both for maceration and as a fluid for examination. For the demonstration of cell boundaries the silver method of Fischel was used, though the finest results were secured with a mixture of equal parts of 1 per cent. nitric acid and 1 per cent. silver nitrate allowed to act for a longer time than that usually employed in silver impregnation. Reduction was accomplished by sunlight or by a weak solution of formic acid in alcohol. By this method very fine demonstrations of the cell boundaries in the nephridia of the *Lumbricide* can be secured, the cell limits being defined even in the intracellular lumen. Bergh confirms his earlier thesis of the presence of a larval epidermis in *Aulastoma* consisting of about thirty large multinucleate cells, whose nuclei multiply by amitotic division. The structure of the nephridium of *Lumbricus herculeus* is considerably elucidated by the silver method. The cells in the margin of the funnel alone have the usual straight cell walls. Within the funnel and in the straight, ciliated, intracellular lumen of the adjacent section of the nephridium the cell walls are very tortuous. In the narrower regions when the lumen is intracellular they become even more irregular and in the ampulla almost labyrinthine, though everywhere transverse in general direction, each cell forming a short transverse section of the nephridial tube. Attempts to demonstrate cell boundaries in the nephridia of the aquatic oligochates by the silver method failed entirely.

C. A. K.

Coe, W. R. Papers from the Harriman Alaska Expedition, XX. The Nemerteans, Proc. Wash. Acad. Sci. **3**: 1-110, pl. 1-13, 1901.

Dr. Coe reports thirty-two species, of which all but two are new to the Pacific region and twenty-seven new to science. The methods employed with this refractory group are of general interest. The worms die well extended if a few drops of formalin are added to the sea water in which they are placed, and if handled with care they do not always break up into fragments. Material was hardened in 2 to 5 per cent. solution of formalin in sea water and eventually transferred to alcohol. Formalin gives good results for anatomical work or for the histology of epithelial structure, but it is disastrous to the connective and nervous tissues. For supplementary work, strong alcohol, sublimate-acetic, Gilson's fluid, and—for nervous system—Flemming's fluid were used. Iron hæmatoxylin followed by orange G was the most effective stain for sections.

C. A. K.

Burckhard, G. Die Implantation des Ei der Maus in die Uterusschleimhaut und die Umbildung derselben zur Decidua. Arch. f. Mik. Anat. u. Entwickl., **57**: 528-569, Taf. 26-28, 1901.

It was the purpose of this investigation to follow the changes in the uterus from the time the egg enters it from the oviduct until the embryo is fully

encapsuled in its walls in the so-called *decidua reflexa*. About the beginning of the fifth day after impregnation in the mouse, the ova are clustered at the lower end of the oviduct in an advanced stage of cleavage with a small cleavage cavity appearing. About this time they enter the uterus and are immediately distributed, probably by movements of the uterine walls, at somewhat regular intervals throughout the uterine lumen, lying in crypt-like depressions on the antimesometrial side of the lumen. The process of implantation is completed by the eighth day and, owing to the rapidity with which it takes place, has been overlooked in large part by all previous investigators of the subject. At the end of the eighth day the embryo is separated from the lumen and embedded in the decidua, composed entirely of mucosa cells from which all traces of the *uterine epithelium have disappeared*. Other investigators have suggested that the embryo sinks beneath the epithelium and develops in the mucosa, but Burckhard's results show conclusively that this position of the embryo is brought about by a *degeneration* of the uterine epithelium of the walls adjacent to the embryo. By the middle of the fifth day the epithelium near, but not as yet in contact with, the ovum, shows traces of flattening and the cells of the subjacent mucosa exhibit nuclear activity. Eosinophilous leucocytes invade this territory and the capillaries branch and spread toward the region of the ovum, while the uterine glands close and degenerate from the uterine lumen toward the musculature. By the middle of the sixth day the epithelium near the ovum (lining of the decidual cavity) is much flattened and the walls on the mesometrial side meet above the ovum uniting with its ectoplacental one (Träger), thus completely separating the decidual cavity from the uterine tract. By this time the epithelium near the ovum has disappeared entirely either by degeneration or retraction, while the remainder of the lining of the decidual cavity degenerates by evident desquamation and karyolysis.

The ovum now lies in the uterine mucosa beneath the epithelium on the antimesometrial side of the uterus. Multiplication of the decidual cells and their subsequent growth, combined with increased vascular supply, result in further closure of the uterine walls above the ovum until only a small lumen remains. The thickened vascular region above the ovum becomes the placenta, while the persistent lumen, now on the mesometrial side of the ovum, comes at a later stage to lie on the antimesometrial side. The manner in which the change is accomplished is not at present known. The probability of a method of implantation of the ovum in the human uterus similar to that found in the mouse is suggested and discussed at length. The material examined was secured entirely from white mice. The uteri were removed immediately after death to micro-sublimate, Zenker's, Flemming's or Hermann's fluids for twenty-four hours. Safranin iron-hæmatoxylin was used after the last two fluids, borax carmin or hæmatoxylin-eosin after the other fluids. These last preparations gave the best results; since the eosin differentiates the blood corpuscles and also gives the epithelium of the uterus and its glands a characteristic tint. The figures illustrating this paper are very fine, being based upon micro photographs prepared by Sobotta's method.

NORMAL AND PATHOLOGICAL HISTOLOGY.

JOSEPH H. PRATT.

Harvard University Medical School, Boston, Mass., to whom all books and papers on these subjects should be sent for review.

Lewy. Die Beziehungen der Charcot-Leyden'schen Krystalle zu den eosinophilen Zellen. *Zeitschr. f. klin. Med.* 40: 59, 1900.

Lewy shows that where eosinophilic cells abound, there Charcot-Leyden crystals appear. This association is

found in all the tissues in leukæmia, in the sputum in various diseases of the respiratory organs, in nasal polypi, in tumors, in the fæces in helminthiasis, and in the normal bone marrow. When the crystals are not present in the fresh preparations, they form quickly if the blood, pus, bits of tissue, or other material are preserved and kept from drying. The crystals can also be produced by the action of various metallic salts upon the eosinophilic cells.

The crystals can arise within the eosinophilic cells, and those that form outside the cells probably take their origin from eosinophilic granules, which lie free in the tissue-spaces. It is not to be assumed that the eosinophilic granules are directly transformed into crystals or simply supply the material by a chemical change. Lewy advances the hypothesis that the mother-substance of the crystals is formed physiologically in different tissues and is destroyed by the round cells attracted thither by chemotaxis. Under certain conditions the mother-substance is formed in such a large amount that a residue remains from which the crystals arise. The eosinophilic granules are formed from this mother-substance by the action of the round cells, which become transformed into eosinophiles. Lewy himself, however, brings forward objections to this hypothesis.

J. H. P.

Gliński, L. K. Zur Kenntniss des Nebenpankreas und verwandter Zustände. *Virchow's Archiv*, 164: 132-145, 1901.

A firm, oval, reddish gray, sharply circumscribed body, 4.5 cm. long, was discovered in the wall of the stomach

near the pyloric end. It produced a bulging of the overlying mucous membrane into the cavity of the stomach. On microscopical examination the structure was recognized as an accessory pancreas. It was embedded in the muscular coat. In all the other recorded cases the accessory pancreas has been situated in the submucosa or between the serosa and the muscular layer. The author collected from the literature thirteen cases in which an accessory pancreas has been found. Three times it was located in the stomach wall; ten times in the wall of the intestine. The pancreas in some of the lower vertebrates is situated in the wall of the stomach or intestine, hence the accessory pancreas in man is regarded as a reversion to the original type.

J. H. P.

Warthin, A. S. A Contribution to the Normal Histology and Pathology of the Hæmolymp Glands. *Journal of the Boston Society of Medical Sciences*, 5: 416-436, 1901.

Hæmolymp nodes differ from ordinary lymph nodes in that they contain blood-sinuses in place of the lymph-sinuses. These bodies were discovered

by Gibbes in 1889. Six years later they were described in more detail by Robert-

son, who gave them the name of hæmolymp glands. Clarkson and others have studied the occurrence and minute anatomy of these organs in the lower animals, but little attention has been paid to the hæmolymp nodes of man. The author bases his report on the investigation of these structures in autopsies on eighty subjects. Hæmolymp nodes occur in greatest number in the prevertebral retroperitoneal region near the great vessels, near the adrenal and renal vessels, along the brim of the pelvis, and in the root of the mesentery. They differ as to location, number, and size in different individuals. They undergo atrophy in old age. They usually lie embedded in fat, and as a rule very near to the wall of some large vessel. An interesting and suggestive feature is the richness of their blood supply. The hæmolymp nodes cannot be definitely distinguished from the ordinary lymph nodes by naked-eye examination. This is owing to the fact that the blood sinuses are usually empty and collapsed after death. When the sinuses are filled with blood the bodies are deep red or bluish, and the smaller ones are easily mistaken for blood clots.

Two types of hæmolymp nodes exist, to which Warthin has given the names splenolymp gland and marrowlymp gland, as indicating their structure and probable function. Between these types are transition forms, and also between these bodies and the spleen on the one hand and ordinary lymph nodes on the other.

The splenolymp node is the more frequent form. It possesses a relatively thick capsule. Trabeculæ pass from this into the organ dividing it into irregular lobules. Branches of a peripheral blood sinus accompany the trabeculæ, increasing in size as they approach the center. Between the sinuses lies the lymphoid tissue. Round collections of lymphoid cells, suggesting splenic follicles, are common. Next to the small lymphocyte the large mononuclear cell is the most common form in the lymphoid tissue. Red blood corpuscles lie free in the meshes of the reticulum, and there is a varying amount of blood pigment. Mononuclear phagocytes containing red blood corpuscles and blood pigment are found in the reticulum and in the central blood sinuses. Scattered areas of a hyaline substance which stains blue with Mallory's connective tissue stain occur in the lymphoid tissue. Fuchsinophile bodies, probably the product of the destruction of the red blood corpuscles, are seen in the reticular meshes and also in the mononuclear phagocytes. In the marrowlymp node there is a greater variety of cells than in the splenolymp node. Mononuclear eosinophiles are more numerous, and multinuclear cells and large mononuclear forms with deeply staining knobbed nuclei occur.

Warthin believes that under normal conditions the hæmolymp nodes are probably concerned chiefly in hæmolysis and leucocyte formation and play but little part, if any, in the production of red blood corpuscles. Under pathological conditions of the blood these bodies may assume a blood-forming function. The hæmolymp nodes take on the structure of either spleen or bone-marrow and compensate for these organs when their functional power is diminished by disease.

GENERAL PHYSIOLOGY.

RAYMOND PEARL.

Books and papers for review should be sent to Raymond Pearl, Zoological Laboratory, University of Michigan, Ann Arbor, Mich.

Schultze, L. S. Untersuchungen über den Herzschatlag der Salpen. Jenaische Zeitschr. f. Naturwiss. xxxv, N. F. xxviii, pp. 221-328. Taf. ix-xi, 1901.

The alternation in the direction of the heart beat in the tunicates is a phenomenon which has frequently been observed and described, but the present paper is by far the most comprehensive and detailed study of the subject which has ever appeared. The work was done on several different species of the transparent pelagic tunicate *Salpa*. A complete period in the activity of the normal heart of *Salpa* includes a succession of series of advisceral and abvisceral pulsations, with an intervening short pause after each series. The different phases of the activity of the heart vary so widely, both absolutely and relatively, that it is impossible to give a normal value for any one of them. As an example illustrative of this great variability may be taken the relative number of pulsations in the advisceral and abvisceral series in the case of a specimen of *Salpa democratica-mucronata*. The advisceral pulsations were to the abvisceral as 100 is to 115 in one individual of the colony, while in another individual of the same size in the same colony the two series were related as 100 is to 45. The rate of the abvisceral and advisceral pulsations is in general the same. The condition of the water has a very decided influence on the activity of the heart. Stale water produces an increase in the number of pulsations and an acceleration in their rate. The author gives a detailed account of the phenomena observed in an animal slowly dying in foul water. The most significant appearance under these conditions is the loss of coördination in the heart beat. For example, abvisceral and advisceral pulsations may start from opposite ends of the heart at the same time and meet in the middle, neutralizing each other and disappearing. An advisceral series may be extended to a great length; in some cases to as many as 241 single pulsations without any pause. A section on the effects of poisons is mainly devoted to an account of the action of two drugs, nicotine and hellebore. Nicotine decreases the number of advisceral pulsations, while hellebore increases it.

Experiments were performed to discover the source of the cardiac stimulus. It was found that a heart completely isolated from the body beats in the normal manner, thus showing that the cause of the pulsation is not peripheral. To test the effect of the central nervous system on the heart beat, stimulation and extirpation experiments were performed. Electrical stimulation of the ganglion had no effect either on the number or the rate of the pulsations. Extirpation of the ganglion causes a decrease in the number of pulsations in a series, but it is shown that this is not a specific effect of the removal of the nervous system, but, instead, is a result of the loss of a certain amount of body substance. Experiments in which the heart was cut transversely in pieces gave the result that these pieces will, after a time, begin to beat rhythmically whether they are from the ends or the middle region of the heart. Emptying the heart of all blood did not affect the

normal beat. The motor stimulus which causes the rhythmical pulsation must arise in the muscles of the heart itself, since a very careful search with a great variety of histological methods failed to reveal either ganglion cells or nerve fibers in this organ.

The next general subject considered, is the cause of the periodical change in the direction of the blood flow and the heart beat. After a critical review of the theories which have been advanced by previous workers, Schultze proceeds to an account of his own explanation. By isolating one end of the heart he found that its activity showed a marked periodicity. There were periods of maximal activity, in which the pulsations were strong and rapid, followed by periods of minimal activity during which the beats were weakened and nearly disappeared. Both ends of the heart, under normal circumstances, would, of course, show this periodicity. From the fact that any single muscle fiber of the heart cannot be made by extra stimulation to further react when already contracted or nearly contracted, together with the fact that the stimulus is conducted in the muscle fibers themselves, it is shown that the end of the heart which is beating more rapidly and strongly will determine the beat of the whole. Taking this in connection with the periodicity in the activity of either end of the heart, the result is that first one and then the other end will determine the beat of the whole heart. When, for example, the abvisceral end is in its period of maximal activity it will set the whole organ to beating synchronously with it, outweighing and obscuring the weaker pulsations of the advisceral end. After a time, however, its period of maximal activity ends and that of the opposite end begins and controls in turn the beat of the whole. The continuation of this process results in the observed alternation in the direction of the heart beat and blood flow.

R. P.

RádI, Em. Ueber den Phototropism einiger Arthropoden. Biol. Centralbl. 21: 75-86, 1901.

This paper gives an account of the effect of light on the movements of the eyes of various Cladocera, and the relation

of these eye movements to the phototaxis of the organisms. It was found that sudden shading of a *Daphnia* caused an immediate drawing in of the eye stalks. Careful study showed that under all conditions the eye was directed towards the source of greatest illumination. If, for example, a *Daphnia* on a slide on the microscope stage be shaded by the hand from above, the eye stalk will be rotated so as to point its tip towards the opening in the diaphragm; while, on the other hand, if the light be diminished from below, the eye will turn up towards the light now coming from above. When the organism (*Daphnia*) is oriented with its back towards the light the eye is in its normal position, with all the muscles of the stalk in a state of equal tension. If now the preparation is turned so as to bring the animal out of its position of orientation, it is found that the eyes maintain their orientation while the body turns about them as a fixed point until it is again in a position such that the eye muscles are in a state of equal tension. These reactions of the eyes do not usually appear in strong, direct sunlight, there being apparently an upper limit of intensity beyond which the normal phenomena do not appear.

Observations were made on the method of orientation to light of specimens

of *Simocephalus* swimming freely in the water. They always keep the back towards the source of light even though this necessitates an entire reversal of the usual position with reference to the force of gravity. Furthermore, to a sudden shading the animals react by a strong spring towards one side or the other. This results in getting all the individuals out of a shaded area in a short time.

The author considers the eyes of the Cladocera as physiologically comparable with the statocyst of the decapod crustacea. The eye orients itself along the "lines of force" of the light rays, and thus effects differences of muscle tonus. On the other hand, the statolith moves along lines of the force of gravity to the lowest point of the statocyst and, through the sense hairs, causes differences in the tonus of the body muscles. The general biological significance of the phototactic reaction is discussed, and the orientation of swarms of *Culicidae* to surrounding objects is explained as such a reaction.

R. P.

CURRENT BACTERIOLOGICAL LITERATURE.

H. W. CONN.

Separates of papers and books on bacteriology should be sent for review to
H. W. Conn, Wesleyan University, Middletown, Conn.

Karlinski. Zur Kenntnis der säurefesten Bakterien. Cent. f. Bak. u. Par. 1, 29: 521, 1901.

Murray. A preliminary report on acid resisting bacilli, with special reference to their occurrences in the lower animals. Jour. of Exp. Med., p. 205, 1900.

the course of this study he has discovered, in the nose in 19 cases out of 235, a very characteristic bacillus, which holds its stains against the action of acids in the same manner as the tuberculosis bacillus. This bacillus is larger than the tubercle bacillus or the lepra bacillus, and, indeed, when compared with the various other "säuerfest" bacilli, proved to be quite different from any of them. It appears to be the nearest to the organism discovered by Rabinovitsch, although, in some respects, it is different from that variety. The author thinks it is a new type of bacillus holding stains against the action of acids. The organism does not appear to be pathogenic for animals or for man when simply placed in the nasal cavities, although it is commonly found in individuals showing certain ulcers in the nose.

The second author studies the bacilli from the genital organs of dogs, horses, cows, cats, guinea pigs, rabbits, and white rats. He finds in all cases, except in those of cats and rabbits, acid resisting bacilli, resembling the smegma bacillus. They are not all alike, and the author thinks they form a group of closely allied but variable bacteria.

H. W. C.

Reichenbach. Ueber Verzweigung bei Spirillen. Cent. f. Bak. u. Par. 1, 29: 553 1901.

there are many who have a strong suspicion, amounting to a belief, that they are

Karlinski has made a study of the nasal cavities of quite a large number of individuals, originally for the purpose of determining whether the lepra bacillus could be found in these cavities in people not suffering from leprosy. In

During recent years many questions have been raised in regard to the relations of bacteria to other fungi, and

to be regarded as stages in the development of the higher fungi. This conclusion is no new one, inasmuch as it was advanced in the early days of bacteriological study; but it has been revived in recent years, because of evidence based upon quite new data. The most important fact pointing in this direction has been the discovery among some bacteria, for example the tubercle bacillus and the diphtheria bacillus, of undoubted branching forms. Branching is not supposed to be characteristic of typical bacilli, and wherever it occurs has suggested a relation to some of the higher fungi. Our author believes that the evidence for the branching of bacilli hitherto advanced is not quite conclusive, being of the opinion that many or most of the facts may possibly be explained upon the ground that the branching forms are degenerate types. He conceives that the spirilli are the most promising organisms for the proper solution of the question, and makes, therefore, a careful study of *Spirillum rubrum*. Under proper culture media he is able to obtain undoubted instances of branching forms of this spirillum, several excellent photographs of which are given. Whether these branching forms are to be regarded as normal or as degenerate types, he is unable positively to ascertain, inasmuch as the various branches do not all show the typical spiral coiling, and he concludes that if the branching is a normal feature, every branch should become spirally coiled and should, perhaps, subsequently show branching in turn. These characters he does not find, and while, therefore, he is confident that these spirilli have a true branching, he is unable to determine positively whether it can be regarded as a normal or abnormal character. The question of the relation of bacilli to the higher moulds is therefore left still uncertain.

H. W. C.

Bliesener. Beitrag zur Lehre von Sporenbildung. Zeit. f. Hyg. 32: 71, 1901.

Some investigators of cholera epidemics have reached the conclusion, from various facts connected with the distribution of the disease, such as the breaking out of the disease anew in the spring after a season of winter weather, or its sudden appearance in localities after having disappeared for a long time, that this bacillus must, under certain circumstances, produce spores or, at least, resisting forms capable of lying dormant for a long time. The author has obtained direct evidence that something of this kind occurs. A quantity of water contaminated with a large amount of organic material was filtered, and subsequently sterilized by discontinuous heat; into this a small amount of cholera bacillus was inoculated and, after some time, the author finds in the precipitate, which appears at the bottom, a number of oval, highly refractive bodies, which, in appearance and their relation to stains resemble spores. Experimental evidence which followed showed him that these were forms of the cholera bacillus, since they develop into the typical forms. He is inclined to believe, therefore, that they are spores of the cholera bacillus, but recognizes that the conclusion is not very satisfactory, inasmuch as a half hour heating at a temperature of 50° C is sufficient to destroy the vitality of these bodies, whereas true spores resist a much higher heat. In spite of this, the author is inclined to believe that he has discovered a spore formation in the cholera bacillus.

H. W. C.

NOTES ON RECENT MINERALOGICAL LITERATURE.

ALFRED J. MOSES AND LEA MCL. LUQUER.

Books and reprints for review should be sent to Alfred J. Moses, Columbia University,
New York, N. Y.

Clark, F. W., and Steiger, G. The Action of Ammonium Chloride upon Natrolite, Scolecite, Prehnite, and Pectolite. *Am. Jour. Sci.* iv, 9: 315, 1900.

The data given yield further proof of the *availability* of the method for investigation into the chemical constitution of silicates.

Natrolite and *Scolecite* proved to have no constitutional water, but similar chemical formulæ, which, however, are not those of ortho-silicates:

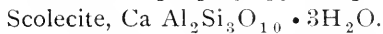
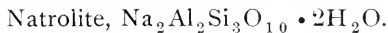

Prehnite may be regarded as having constitutional water and ortho-silicate formula.

Pectolite differs widely from these other minerals as regards the ammonium chloride reaction; but experiments suggest the probable existence of a hydrous ammonium pectolite.

L. McL. L.

Clark, F. W. and Steiger, G. The Action of Ammonium Chloride upon Analcite and Leucite. *Am. Jour. Sci.* iv, 9: 117, 1900.

Authors show that both analcite and leucite, when heated to 350° with this reagent in a sealed tube, yielded the same definite compound, ammonium leucite $\text{NH}_4\text{Al Si}_2\text{O}_6$. This reaction was fairly general in character, and analogous results were obtained with other species.

By substituting in many minerals a volatile base for fixed bases, silicates are obtained which split upon ignition in such a way as to shed light upon their molecular constitution.

The conclusion was reached that analcite and leucite were not true meta-silicates, but pseudo mixtures.

L. McL. L.

Parsons, Charles L. The Use of Metallic Sodium in Blowpipe Analysis. *Jour. Am. Chem. Soc.* 23: 159, Mar. 1901.

Contrary to the statement of Hempel, who first proposed the use of sodium in blowpipe analysis, the author finds that the reduction of metallic compounds by means of sodium takes place with the greatest ease on charcoal. The following procedure is recommended: A piece of metallic sodium 3 or 4 mm. in diameter is hammered flat. The powdered substance to be tested is spread upon and pressed into the metal, and the whole turned into a little ball. It is placed in a slight depression of a piece of charcoal, and ignited with a match or Bunsen flame. The residue is heated before the blowpipe, and fusible metallic particles readily collect into a globule; at the same time coatings of the volatile metals are obtained. Treated in this way, garnierite gives magnetic nickel, chrysocolla a copper button, and cassiterite a tin

button, as readily as a lead button is obtained from cerussite. Large quantities of sodium are to be avoided, and care must be taken not to touch the metal with the fingers, as the reaction sometimes begins spontaneously. A. F. R.

Morgan, Leonard P., and Smith, E. F. Experiments on Chalcopyrite. *Jour. Amer. Chem. Soc.* **22**: 107, Feb. 1901.

Weighed portions of chalcopyrite were exposed to the action of dry hydrochloric acid gas in a heated combustion tube. The liquid in the tube was titrated with potassium permanganate, and gave an iron content of from 30.56 to 30.72 per cent., theory requiring for chalcopyrite 30.5 per cent. Results indicate complete decomposition, and show that all the iron is in a ferrous state. The results obtained by heating the mineral in a closed tube with a solution of copper sulphate confirm this.

A. F. R.

Atkinson, Elizabeth Allen. Indium in Tungsten Minerals. *Jour. Amer. Chem. Soc.* **20**: 811, 1898.

From 150 to 300 grams of wolframite, hübnerite, and scheelite, from several localities, were carefully examined for indium, but only in the wolframite from Zinnwald was any found. Author comes to the conclusion that indium cannot be regarded as an associate of tungsten, and that Hoppe-Seyler's suspicion as to blende being its origin is probably correct, for only in the Zinnwald mineral was it found, zinc also being present only there.

A. F. R.

Vater, Heinrich. Ueber den Einfluss der Lösungsgenossen auf die Krystallisation des Calciumcarbonates. *Theil viii. Zeit. f. Kryst.*, **31**: 538-578, 1899.

This paper discusses the action of the solution upon gypsum and anhydrite, and concludes that at lower temperatures, below 30°C., calcite alone results, and that the only known cause by which pure calcium carbonate separates as aragonite is a temperature exceeding 30°C.

A. J. M.

Goldschmidt, V. Ueber Trägerit und künstlichen Uranospinit. *Zeit. f. Kryst.* **31**: 469-478, 1899.

Concludes Trägerite is tetragonal, not monoclinic, and ventures supposition that all other uranium micas: autunite, uranospinite, torbernite, zeunerite, and phosphuranlyite are also tetragonal.

A. J. M.

Viola, C. Zur Kenntniss des Anorthits vom Vesuv. *Zeit. f. Kryst.* **31**: 484-498, 1899.

Crystallographic study.

Ward, H. L. Notice of an Aerolite that recently fell at Allegan, Mich. *Am. Jour. Sci.* **iv.** **8**: 413, 1899.

The stone is light ash-gray in color, very friable, and covered with a black crust, which is 1-2 mm. thick, and has a smooth or wavy surface. The structure is chondritic, and the following minerals are present: enstatite, chrysolite, feldspar, troilite and iron, the two latter being granular and evidently scattered. G.=3.558.

L. McI. L.

Grimsley, G. P., and Bailey, E. H. S. Report on Gypsum and Gypsum Cement. Vol. v, *Univers. Geol. Sur. of Kansas.*

MEDICAL NOTES.

METHODS FOR STAINING TUBERCLE BACILLI.

EHRlich-WEIGERT ANILIN-METHYL-VIOLET METHOD.—Place a dried cover-glass preparation, film down, in the following solution, and heat gently until steam rises, then allow to stand for 2 to 5 minutes :

| | |
|--|------------|
| Methyl violet, sat. alc. sol., | 1.1 part. |
| Alcohol, absol., | 1. part. |
| Anilin water, | 10. parts. |

Anilin water is made by using 1 part anilin oil with 20 parts of distilled water, and after standing a short time and becoming thoroughly saturated, filtering the mixture. Decolorize for a few seconds in 1 part nitric acid and 3 parts water. Wash one or two seconds in 60 per cent. alcohol, then in water. If it is desired to counterstain the specimen, allow a few drops of saturated aqueous solution of vesuvin to cover the specimen for about five minutes. When the staining is complete the preparation is washed, dried, and mounted in balsam.

GABBETT'S METHOD.—This method is simple and rapid, and is considered by many to be a most excellent method for routine work. The cover-glass preparation is stained for 2 to 5 minutes in Ziehl's carbol fuchsin solution, after the formula :

| | |
|---|------------|
| Fuchsin, | 1 part. |
| Alcohol, | 10 parts. |
| Carbolic acid (5 per cent. sol.), | 100 parts. |

The fuchsin should be dissolved in the alcohol before the acid is added. After this solution is allowed to act for the desired length of time, the preparation is placed for 1 to 2 minutes in Babbett's methylen-blue sulphuric acid solution, consisting of :

| | |
|---|-----------|
| Methylen blue, | 1 part. |
| Sulphuric acid (25 per cent. sol.), | 50 parts. |

The specimen is then washed in water, dried, and mounted in balsam. Tubercle bacilli are stained red, while other elements of the mount are blue.

ZIEHL-NEELSON METHOD.—By this method tubercle bacilli are stained with the following solution :

Fuchsin, 1 part, dissolved in 10 parts alcohol, to which is added 100 parts 5 per cent. solution of carbolic acid. The cover-glass preparation is floated, film down, on the solution, to which gentle heat is applied until steam rises. The specimen is then washed in water, and decolorized in 25 per cent. nitric or sulphuric acid, then in 60 per cent. alcohol for a very short time, after which, with thorough washing in water, it is mounted in balsam.

C. W. J.

NEWS AND NOTES.

The New Haven Microscopical Society has just issued a very neat booklet containing the constitution and by-laws of the society, as well as a list of the members with the address of each. The officers of the society are : President, Robert Brown, Observatory place, New Haven ; Secretary and Treasurer, J. F. Malone, 25 Wooster place, New Haven.

The annual meeting of the American Microscopical Society will be held in Denver, Col., August 29 to 31. Efforts are being made to secure exceptionally low rates, and an enthusiastic and profitable meeting is assured.

The Hopkins Seaside Laboratory, of Leland Stanford Junior University, began its tenth session at Pacific Grove on Monterey Bay, Monday, June 10, 1901. The regular courses of instruction continue six weeks, closing July 20th. Provision is made at the laboratory to accommodate three classes of students: (1) teachers and students who wish to pursue laboratory courses in botany and zoölogy; (2) advanced students in zoölogy, physiology, and botany; and (3) investigators who are prepared to carry on researches in morphology and physiology. The regular courses, with the instructors in charge, are as follows:

1. General Zoölogy—Professor G. C. Price, Leland Stanford Jr. Univ.
2. Elementary Botany—Professor S. C. Price.
3. Advanced course on Structure and Physiology of Algae.—Professor G. J. Peirce, Leland Stanford Jr. Univ.
4. Embryology—Professor G. J. Peirce.
5. Comparative Morphology and Histology of the Nervous System and Sense Organs.—Professor F. M. MacFarland, Leland Stanford Junior University.
6. Advanced course in Zoölogy.—Professor F. M. MacFarland.
7. General Ornithology.

We have received the announcement of the third session of the Rhode Island Summer School for nature-study to be held at the Rhode Island College of Agriculture and Mechanic Arts, Kingston, R. I., July 5 to 20, 1901. The instruction is to be almost wholly in the nature of field work, the schedule being made up of excursions, led by competent men in every branch of natural science. The time given to class-room exercises will be just enough to indicate what is to be observed and done in the field. Special evening lectures will be given. Communications should be addressed to "Summer School," Kingston, R. I.

QUESTION BOX.

Inquiries will be printed in this department from any inquirer.
The replies will appear as received.

8. Where can "Stabilite" insulating material be bought? Is it used much in American laboratories? L. H.

9. What is the best method of drying and mounting microscopic fungi? Can you refer me to a good book dealing with the subject. M. R.

REPLIES TO QUESTIONS.

"What is meant by the *growing* tip in allium?" (Question No. 1.)

The growing part of a root (*a*), or the "growing tip," is a short space about one-sixth of an inch back from the extreme end. In this part of the root the cells divide rapidly, and its length is thereby increased. This is the only part of the root in which growth takes place. The end of the root is usually covered by a protecting coat of dead cells (*b*), derived from the living zone just back of it. These dead cells constitute what is known as the root cap.

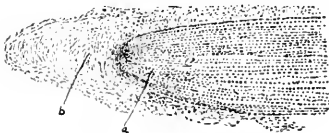

C. A. WHITING.

Journal of Applied Microscopy and Laboratory Methods.

VOLUME IV.

AUGUST, 1901.

NUMBER 8

Table of Specific Gravities of Saturated Solutions and Solubilities of Anilin Stains.

In the following tables will be found in the first two columns the specific gravity of saturated solutions of the various anilin stains, made in the cold and by boiling. Those made in the cold were allowed to stand with an excess of the stain, the bottle being vigorously shaken daily, for two weeks.

The solutions made with hot water were kept at the boiling point for twenty minutes and well stirred. Both solutions were carefully filtered and the s. g. ascertained by means of the specific gravity bottle. Correction was made for temperature and the average of five weighings was taken in each case.

The third column contains the increase in weight of 95 per cent. alcohol when various stains are dissolved in it to saturation. The s. g. in this case may be obtained by adding the weight of the alcohol in use to the figures given in the table. The s. g. of the solution is not given for the reason that the various samples of alcohol obtained commercially as 95 per cent. vary considerably in actual percentage and hence in weight. The solvent power varies practically not at all, so that by adding the weight of the sample at hand to the figures in the table the s. g. may be obtained sufficiently accurate for most working purposes.

The various formulæ which one encounters constantly call for saturated solutions of the various stains, and it is usually the custom to add three or four times as much of the dry stain as is really necessary. This can be obviated by a glance at the table. While it is true that all solutions will change slightly in volume when they have substances dissolved in them to the point of saturation, still the change is usually small, and we may also take the table as a guide to the solubilities of the stains in making them up, thereby avoiding waste.

In the first column the approximate solubilities in grams per hundred c.c. of water may be obtained by simply subtracting 100 from the s. g.

In the last column the increase in weight is given and may be taken directly as the approximate solubility.

A slight error will be found in several of the stains, which seems to be caused by a chemical change when the stains are boiled. This is notably the case with

gentian violet, which upon boiling yields a solution which is lighter than the water was at first (s. g. 99.928.)

All the stains used in this work were of the first quality for histologic purposes, not the ordinary commercial dyes.

I desire to acknowledge my indebtedness to R. H. Hough, for his assistance in this work.

| | | | |
|-------------------------|---------|---------|-------|
| Anilin Blue Black | 100.280 | 100.792 | 0.44 |
| “ Green | 100.530 | 100.740 | 1.71 |
| “ Red | 100.052 | 100.100 | 1.95 |
| “ Violet | 100.172 | 100.076 | 2.76 |
| “ Black | 100.478 | 100.264 | 0.54 |
| Benzoazurin | 100.504 | 101.120 | 0.99 |
| Benzo-Purpurin | 100.394 | 100.424 | 0.61 |
| Biebrich Scarlet | 101.972 | 101.054 | 0.27 |
| Bismark Brown | 100.440 | 100.752 | 0.55 |
| Blue Lumiere | Ins. | Ins. | 0.64 |
| Chrysoidin | 100.543 | 100.608 | 2.13 |
| Congo Red | 100.464 | 100.768 | 0.22 |
| Corralin | 100.926 | 101.012 | 2.74 |
| Dahlia | 100.294 | 100.180 | 2.12 |
| Delta Purpurin | 100.674 | 100.528 | 0.64 |
| Eosin (Bluish) | 102.496 | 101.872 | 2.43 |
| Erythrosin | 100.800 | 101.732 | 1.99 |
| Fuchsin | 100.018 | 100.072 | 1.54 |
| Fuchsin Acid | 101.200 | 101.452 | 0.72 |
| Gentian Violet | 100.068 | 99.928 | 3.65 |
| Gold Orange | 100.366 | 100.528 | 0.02 |
| Indulin | 100.606 | 101.024 | 0.79 |
| Magenta | 100.072 | 100.072 | 2.98 |
| Malachite Green | 100.232 | 100.372 | 3.56 |
| Metanyl Yellow | 100.420 | 100.580 | 1.12 |
| Methyl Blue | 100.446 | 100.672 | 0.28 |
| Methyl Green | 100.744 | 101.425 | 2.69 |
| Methyl Violet | 100.072 | 100.260 | 2.29 |
| *Methylene Blue | 100.060 | 100.580 | 0.28 |
| Orange B. Naphthol | 100.210 | 100.836 | 0.28 |
| Orange G. | 100.944 | 101.172 | trace |
| Orange II | 100.292 | 100.520 | 0.56 |
| Orseille G. | 100.456 | 100.812 | 0.40 |
| Rocellin | 100.372 | 100.312 | 0.33 |
| Rosanilin Hydrochlorate | 100.048 | 100.080 | 1.79 |
| Rosein | 100.053 | 100.076 | 1.48 |
| Rose Bengal | 101.416 | 101.856 | 2.12 |
| Rubin G. | 100.046 | 100.072 | 2.53 |
| Rubin S. | 102.464 | 102.364 | 0.15 |
| Saffranin | 101.526 | 100.596 | 2.36 |
| Solferino | 100.014 | 100.052 | 2.543 |
| Solid Green | 100.564 | 100.844 | 3.00 |
| Tropeolin 000 No. 2 | 100.448 | 100.660 | 0.58 |
| Vesuvium | 100.412 | 100.944 | 0.81 |
| Victoria Blue | 100.102 | 100.160 | 1.77 |
| Violet B. | 100.286 | 100.440 | 3.84 |

Vanderbilt University.

LOUIS LEROY.

*The sample of Methylene Blue here tested was but very slightly soluble, and stained very poorly.

LABORATORY PHOTOGRAPHY.

Devoted to methods and apparatus for converting an object into an illustration.

PHOTOMICROGRAPHY.

Introductory.

Photomicrography, as it may be practiced to-day, is of prime importance in several different kinds of work. Nothing can take its place as a means of illustration in popular lectures. In class lectures, for review, a term's work can be summarized more quickly and correctly by means of the lantern slides than in any other way. It has the advantage over microscopic observation, of directing everyone's attention, at the same time, to the same thing. In all our colleges and universities, students of history, sociology, psychology, etc., are calling for lectures on the laws of growth, on what is known about heredity, on the principles of kinship, etc.—students who have neither the time nor the skill to

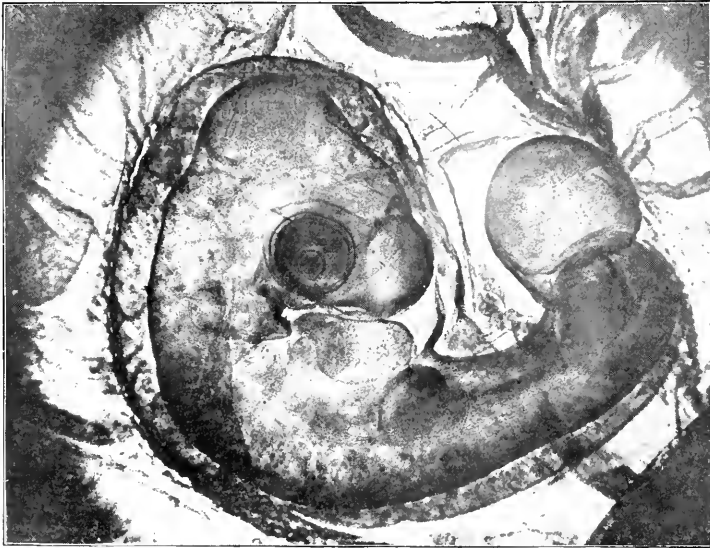

Fig. 1.—Four day chick. $\times 15$.

get the foundation facts in the laboratory. Wherever illustration in histology is desirable, photomicrography has advantages that will not longer permit it to be neglected.

There is no class work that must be seen through the microscope that the half-tone and the lantern slide cannot faithfully present. It is the purpose of the accompanying cuts to sustain this proposition. Five of the microscopic slides photographed were made by students in the regular work of the class-room. The negative for Fig. 1 was made with a 70 mm. apochromatic objective without eye-piece, and with a camera extension of three feet. The low-power objective gives penetration, and the extension gives the necessary amplification; by just

this means the depth of focus necessary in any case can be obtained. The lowest objective that will resolve the details wanted is selected, and then the requisite power is obtained by camera extension; this preserves at all times the relative depth of focus. It is true that a histological section can be so thick or prepared so poorly that the photography of it is difficult. A better section should be made (and this is one reason for the use of photomicrography—it will at once lead to the preparation of better microscopic slides). Any section can, however, be so photographed as to show all that can be seen at any one look, and by repeated exposures all can be shown. Fig. 2 was made with an 8 mm. objective and a No. 4 projection eye-piece, and a camera extension of four feet,

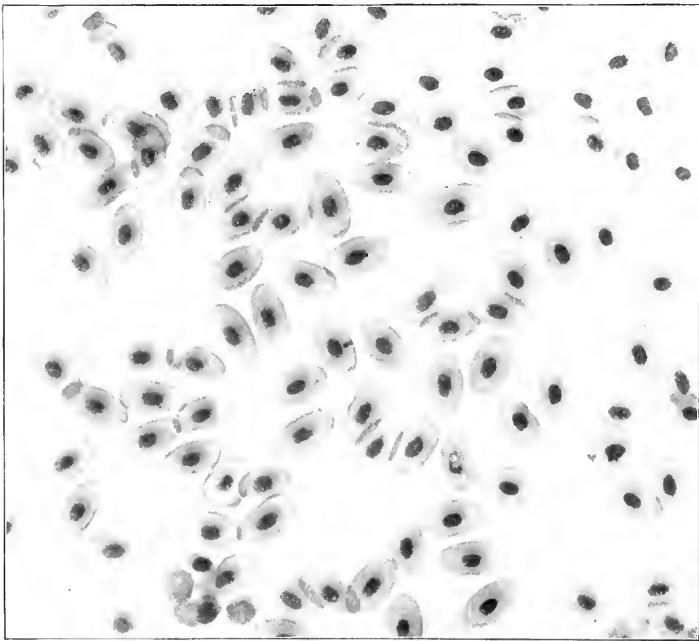

Fig. 2.—Frog's blood; hæmatoxylin-eosin stain. $\times 400$.

and shows the same things in flatness of field and depth of focus for its power, 400 diameters, that Fig. 1 does for its.

Fig. 3 is a section of onion root with chromosomes lying in several different planes, and shows the same for 1500 diameters. It was made with a 2 mm. oil immersion, apochromatic objective, and a No. 4 projection eye-piece, with a camera extension of thirty-seven inches. Fig. 4, Fig. 5, and Fig. 6, were made with the same combination.

Fig. 6 is a blastula of ascaris; it was photographed from an unsectioned blastula; the instrument was focused on the midsection of the ball of cells; the light had to pass through the lower cells before, and the upper cells after passing the points shown; this is a means of sectioning with the microscope. Fig. 1 represents low-power work, Fig. 2 medium-power work, and the remaining figures

high-power work, which for depth of focus, magnification, and extent of field, cannot be reproduced with cheap or improvised apparatus.

If, for instance, an ordinary microscope is used with an ordinary camera, none of the figures here shown can be duplicated, no matter how good the lenses may be, for to produce any power here given a higher objective, with a narrower field and less deep focus, would be indispensable, and this would sacrifice part of the field entirely, and the focus over the part retained.

One reason why photomicrography has not hitherto succeeded better, is that cheap apparatus, scraped together from a microscopic and a photographic outfit, has been recommended. This cheap apparatus was always the most expensive

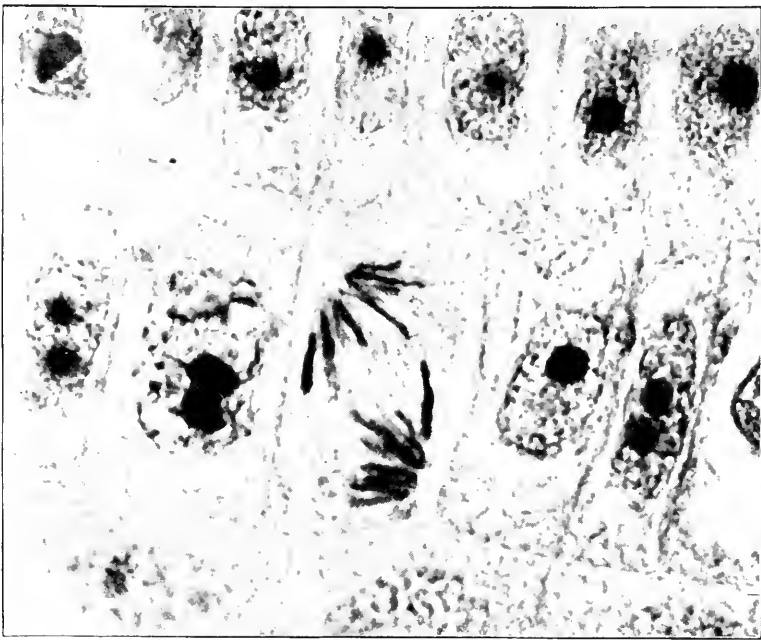

Fig. 3.—Cells from onion rootlet ; iron-haematoxylin stain. $\times 1500$.

to be had, for the reason that the time consumed in getting ready for and making a successful exposure costs, in the end, more than the investment for a correct outfit.

In the second place, the results, for reasons above given, were never valuable except in the case of slides so perfectly prepared that they had to be the best of an expert microscopist's work. I again and again concluded, while using these makeshifts, that histological slides could not be successfully photographed. I thought photomicrography was an art, the usefulness of which was confined to the resolving of lines on diatoms, and reproducing the silhouettes of bacteria so prepared that the contrast was sharp and the field flat.

The cheap way to make successful photomicrographs is to have a complete

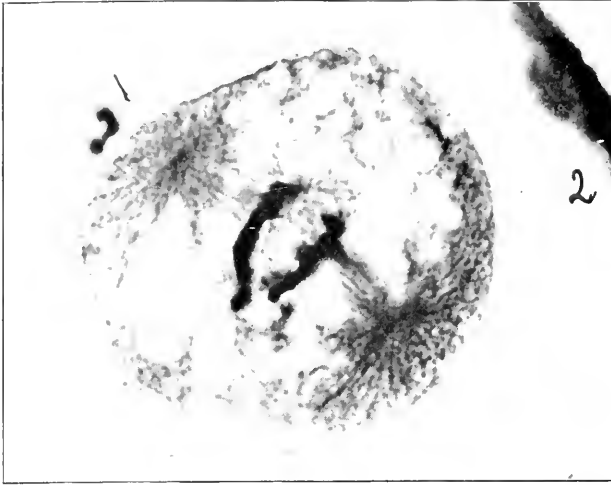

Fig. 4.—Early telophase of mitosis in *Ascaris megalocephala* var. *bivalens*; polar bodies at 1; egg-cell wall at 2. Centrosome divided just below polar bodies. $\times 1500$.

apparatus; microscope stand, lenses, camera, and illuminating appliances, dedicated to this one work; mounted to stay, on tables adapted to the purpose, resting on a floor that cannot be jarred, with a fully equipped dark room immediately at hand. The essentials of such an apparatus will be fully described in a succeeding paper.

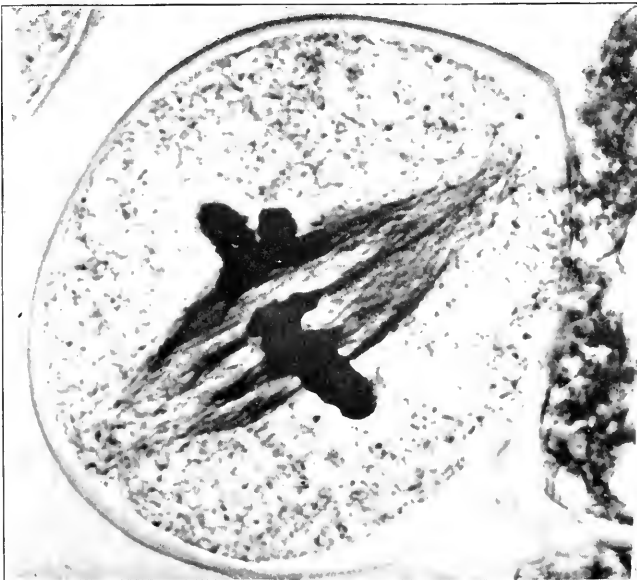

Fig. 5.—Mitotic figure from pollen mother-cell of *Lillium candidum*. Slide by Prof. David M. Mottier. $\times 1500$.

With such an apparatus, ten first quality negatives, of any diameters from 4000 down, can easily be made in a couple of hours. They can be more easily and certainly made than the same number of fair to middling negatives of from 40 to 100 diameters on any improvised outfit.

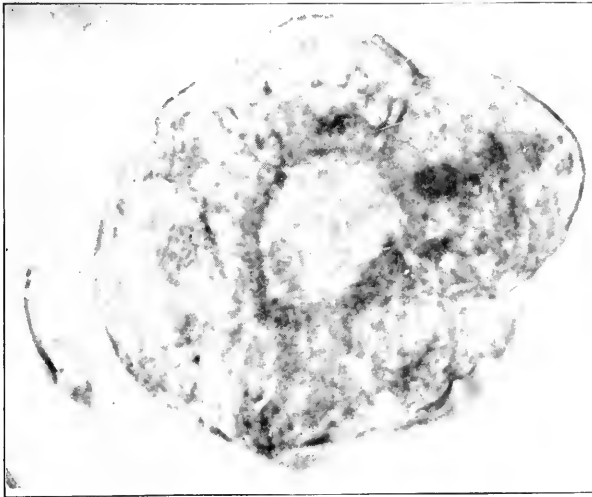

Fig. 6.—Unsectioned blastula of ascaris. x 1500.

This makes photomicrographs of all powers really usable. Previous to 1899, experts were happy with ten failures to one success; one correct negative had to pay for an entire evening's work. This made them expensive, too expensive for any use, however cheap the apparatus.

Earlham College.

D. W. DENNIS.

Notes on Testing for *B. Coli* in Water

TEST FOR *B. COLI* IN LARGE VOLUMES.

In 1898 we published a description of the methods employed at the Lawrence Experiment Station in the routine examination of water for *B. coli*. These tests were all made in one cubic centimeter.

The description of the preliminary test in large volumes, usually 100 cubic centimeters, was omitted at this time, as the test was then in the experimental stage. This test, as it is now made, has been in use in this laboratory for about two years, and has proved very satisfactory. The water to be tested is collected in clear, glass-stoppered bottles, of the tall Blake pattern, holding about eight ounces, with a graduation mark for 100 cubic-centimeters. To 100 c. c. of the water, in the bottle, we add 10 c. c. of a strong carbolated dextrose broth, which is prepared as follows: 100 grams of dextrose and 50 grams of peptone are dissolved in 1 liter of boiling water. After cooling, and filtering through paper till clear, 50 c. c. of a 5 per cent. aqueous solution of phenol is added, or approximately 0.25 per cent. of phenol. The solution is now ready for use, and requires no sterilizing. There is enough phenol present to prevent the spoiling of the solution, especially if kept on ice, as we always do.

The dilution in the test reduces the amount considerably below that necessary to retard the growth of *B. coli* and *B. typhosus*, but is still sufficient to prevent the growth of many species which would ferment the broth and interfere with the test. After inoculation, the bottles are placed in an incubator at 38°C. for twenty hours. At the end of this time, if *B. coli* be present, there should be a slight bead on the surface. Immediately on removing from the incubator, give the bottle one quick, hard shake, and set it up in front of a window. The gas, if *B. coli* be present, will now separate from the liquid and rise slowly to the top, giving the same appearance as when a bottle of highly carbonated water is opened. This appearance is quite characteristic. The pressure of the liberated gas is frequently sufficient to blow the stopper out of the bottle. We always plate out a sample showing positive indications and test to confirm the diagnosis, and in over 75 per cent. of such samples we have found *B. coli* to be the organism responsible for the fermentation. On the other hand, we have plated out many hundred negative tests, and have yet to find one in which *B. coli* was present.

A FERMENTATION TUBE ADAPTED TO RAPID HANDLING IN ROUTINE WORK.— In 1897, when we first began making routine tests for *B. coli*, we found that the usual type of fermentation tube, with a base, a large bulb, and a constriction at the bend, was not suited to rapid work, accordingly I had some tubes made omitting these features.

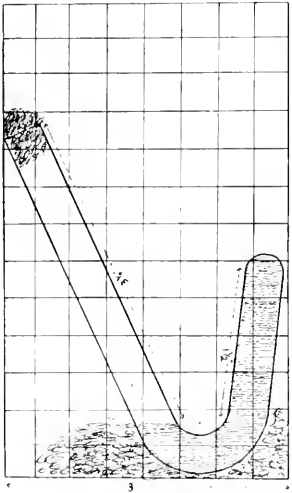

These tubes have given such general satisfaction in our laboratory, that I hope the following description and illustration will be of some value to others in the same line of work. The shape and dimensions of the tube are shown in the sketch. The tubes, when filled about as in the sketch, are set in a wire basket in rows, cotton wool being placed in the bottom for them to rest on. We use baskets 3 x 5 inches, and 5 inches deep; these will hold ten tubes in a row, and by putting in layers of cotton wool, three tiers can be placed in a basket. In this way, thirty tubes occupy about as much space as five or six of the ordinary style of tube would occupy, and can be handled as a unit in sterilization, etc. The open arm of the tube is sufficiently long to hold all of the liquid when it is forced out of the closed arm, without wetting the cotton plug.

Determinations of the volume and composition of the gas are made as easily and accurately as in the old style of tube. We have all of our tubes, test tubes included, made without lips, as we think it tends to decrease the breakage, and make the tubes pack better in baskets. The abolishment of the bulb and constriction at the neck also makes cleaning somewhat less of a grind.

The Cone Net.

This net was originally described in the Transactions of the Wisconsin Academy of Sciences, Arts, and Letters, Volume VIII, page 397, 1892. Since that time I have had numerous inquiries for directions for the construction of the net, and in response to these I give the following account of the net as I now use it. The apparatus is still very crude and improvements can easily be suggested. It has met my purposes, however, and therefore for some years I have given no attention to improving its details of construction. The metal parts of the apparatus are illustrated in the annexed figures. The diameter of the base of the cone top in the net which I now use is three inches. From this the scale of the drawings can easily be computed. The cone top is represented

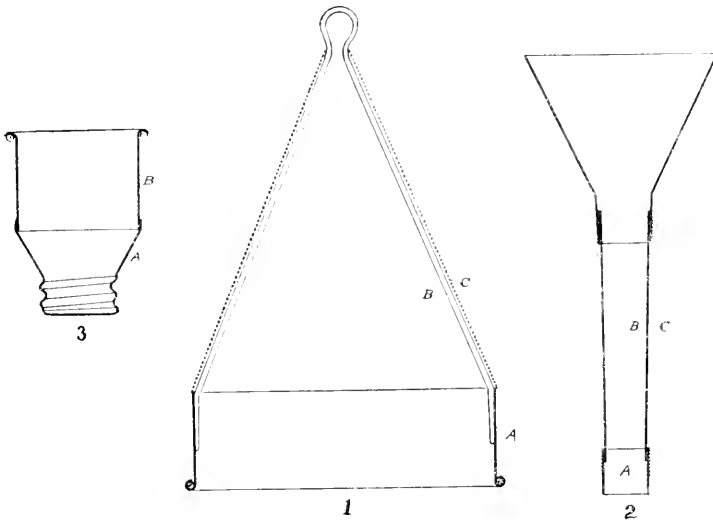

in Fig. 1. It consists of a rim of stout tin (A) three inches in diameter, one inch in height, with a stout wire turned into the lower edge. To the inside of this is soldered a wire loop (B), which lies under the cone and projects through its apex in a loop to which the line is attached. The top of the net is formed by a cone of brass wire netting (C), one-twentieth of an inch mesh, with a slant height of four inches soldered to the rim and to the wire loop at the top. The bottom of the net (Fig. 3) is formed by the screw top of a kerosene can, to which is soldered a cylinder of tin about one inch in height and one and one-fourth inch in inside diameter, into whose upper edge a stout wire is turned. The dredge net is fastened to these two metal parts, being firmly tied both at top and bottom. The tying must be firm, or if the net is thrown when containing water it may be pulled off from the cone top. I have found it a good method of tying to use a dry string drawn tightly, of a kind which will shrink when wet, and to tie the net twice, turning the edge down over the string of the first tying before fastening it the second time. For a net I use a fine cotton

cloth of the sort known to the trade as "India linen." This is faced with muslin at the top and bottom.

In my first nets I made the cone top removable, and this, of course, can easily be done. I discovered, however, that in working among weeds I practically always used the netting and that it was easier to carry a second net of the small size for work in open water than to have the more complicated and heavier arrangement necessitated by making the net removable.

The collecting funnel (Fig. 2) is the part of my apparatus which seems to have been least used, but which I regard as even more important than the cone dredge. The funnel is two inches in diameter at the top and has a cylindrical spout about three inches in length. The bottom of this is formed by a cylinder of tin (A) one-half inch in height, connected to the body of the funnel by two strips of folded tin (B). Outside of this is soldered a cylinder of fine brass wire netting (C). I have used a fine milk strainer, which is about one-fiftieth of an inch mesh, and also a finer netting, one-hundredth of an inch mesh, for this cylinder. For general use the coarser mesh is sufficiently fine and is decidedly more convenient. The diameter of the spout is about half an inch. It is made of such a size as to slip into the opening of an eight dram homeopathic vial, short form. This funnel is used in connection with a tin cup in collecting material, especially from among weeds. The material collected by the net is washed into the cup, which is then filled with water and allowed to stand for a short time. The vegetable debris settles to the bottom and most of the animals remain in the water above it, together with some of the lighter parts of the vegetation. The water is then poured through the funnel, the lower end of which may be stopped with a cork, or, as I find, more conveniently by the finger, and when the water is drained off, the spout of the funnel is thrust into a homeopathic vial filled with alcohol, and its contents washed out. In this way the greater part of the animals can be separated from most of the accompanying vegetable debris; thus greatly facilitating the subsequent study of the collection. Still further, the results of a large number of hauls of the net can be concentrated and preserved in a single bottle. In all cases, however, some of the material which settles to the bottom of the cup should be preserved, since it always happens that part of the animal life seeks refuge at once in this. The cup which I use is made of such a size as to contain the funnel, and the dredge net with the bottom part easily finds place in the interior of the cone.

The net can be used as a tow net, or can be thrown either from the shore or from a boat. In working among weeds, I prefer, if possible, to use it as a tow net, keeping it close to the boat and working it by the line in and out among the weeds. There is very little use in putting out a long line and allowing it to drag through the weeds, as the vegetation collects and very quickly entirely covers the top of the dredge. In hauling the net, it is better to use a violent jerking motion than to pull steadily, and the line and net should be so strong as not to suffer by this method. In throwing the net, it is often found difficult to make it sink after the cloth has once been wet. If the throw is not to a great distance the net can often be made to fall with bottom downward by a little manipulation of the line. The sinking can also be secured by

a weight at the apex of the cone, either formed by melted solder poured in, or by a lead weight which may be tied to the interior of the cone or to the screw-cap. In dragging the net along the bottom, I prefer to have the cone and net without weights and to attach a weight to a line so long that it will drag a little way behind the end of the dredge. In this way the net draws over the bottom instead of digging into it, as it is apt to do if weighted at the apex.

The materials and construction of the apparatus are such that it can be constructed by any tinman, and nets can be made of any size for various purposes. I have used them up to six inches in diameter and with a cone provided with a quarter-inch mesh. Such a net was used for collecting in salt water, to prevent the entrance of floating algæ. In nets so large it is well to make the cone top in two pieces so that the net can be easily removed from the cone.

In collecting on expeditions where it was not convenient to carry a large number of small bottles, I have furnished little bags of such a size as to slip over the spout of the funnel. The material collected is washed out into these bags, which are tied, numbered and labeled and placed in a large bottle or can of preserving fluid.

E. A. BIRGE.

University of Wisconsin.

A Modification of the Birge Collecting Net.

To collectors of the smaller aquatic organisms, especially of such as Crustacea, Hydrachnidæ, etc., the Birge collecting net, or some similar apparatus, is an indispensable part of their equipment. The writer has used it with general satisfaction for several years in the collecting of water-mites.

There are occasions, however, when its use in the ordinary form becomes awkward or impossible owing to the place or conditions about the place where it is desired to make collections. Frequently it is desirable to secure material from narrow, tortuous streams in which a straight haul for any distance is impossible, or from small springs or pools, or from the shore when, owing to the uncertain footing or to the interposition of branches or other objects, casting is extremely difficult, or in water so choked with vegetation that only small open spaces are left here and there amongst the weeds. To meet such conditions the author devised and has put to successful use the following modification, which he ventures to suggest to others who may have felt a similar want.

Briefly stated, it is as follows: A groove (Fig. 1) is passed about the tin cylinder,

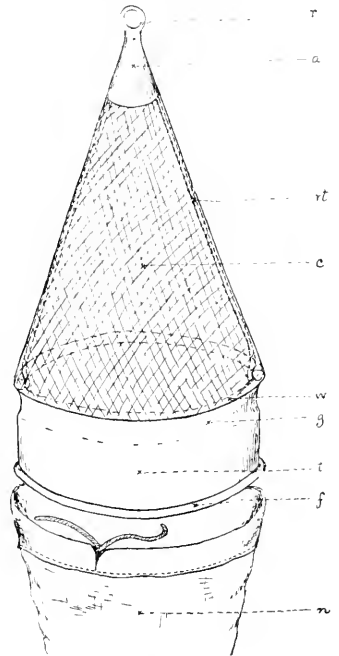
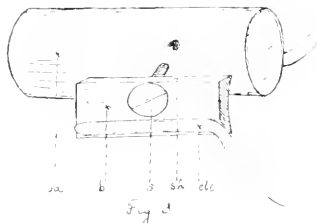
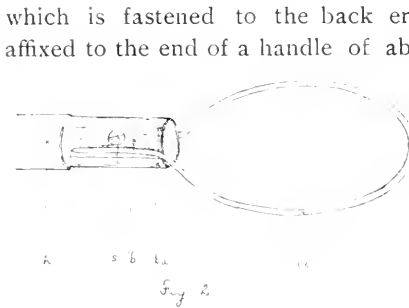
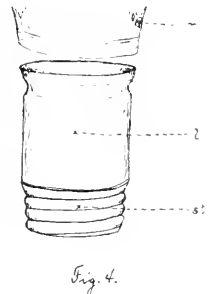

Fig. 1.



(Fig. 2), fits into this groove and is firmly clamped in this position. The collector then has perfect control of his net and can dip into a contracted space, scrape the margin of a pool, reach beneath a dock or other obstruction, or while wading sweep the bed of vegetation which carpets the bottom by passing the net back and forth from right to left and left to right before him as he walks. The figures given will illustrate the method of construction more clearly than can be done by means of a description, and to them the reader is referred for further particulars.

Reference may also be made to certain other details of construction which experience has shown to be of advantage. First, it is found that if the wire which forms the ring (r) to which the cord is attached be carried down inside the gauze cone to its base and there firmly soldered to another ring which forms the margin of the base of the cone, the stiffness thus gained is of great advantage. Second, if the tip of the cone be filled in with lead for a short distance the weight serves to hold the "nose" of the net down, and it draws through the weeds to better advantage. The attaching of a "sinker" to the cord attached to the net has been tried, but the "sinker" is liable to be caught and the "nose" of the net is, also, not carried down into a bed of Chara, as is desirable in the work of the writer. Third, it is suggested that the free margin of the tin cylinder (t) be made to project in the form of a flange, and that by "running" a cord through the overlapped border of the cloth net (n) this latter can be easily adjusted for use and as readily removed. Fourth, the writer has found that if the cup at the end of the cloth net which receives the collection be heavy by being made of a piece of lead pipe (Fig. 4) the net is less liable to "foul" itself in casting, and also sinks more quickly, as this end of the net is carried downward the more rapidly. For his own nets the writer uses a fine cheese-cloth, and lines this on the inside in the lower two-thirds with a fine quality of China silk, which costs about seventy-five cents a yard, and is thus much cheaper than bolting cloth while serving equally well.



The author is in the habit, during collecting trips taken to different portions of the state, of gathering material of all kinds, having in view the use of it in the interest of a complete faunal survey of the state, which it is hoped before many years may become possible. He has found it very useful to standardize his nets and thus to make them all capable of insertion into the same ferrule, whereby it becomes possible, by carrying one handle, to affix it as desired to any

particular form of net, whether it be one serving for the collecting of insects, minute or large aquatic animals, and either Birge net, dip-net, sieve or scoop.

EXPLANATION OF FIGURES.

Fig. 1.—The upper part of the net with the upper margin of the cloth “leg.”

Fig. 2.—The ring which clamps it to the handle.

Fig. 3.—Method of clamping suggested.

Fig. 4.—The collecting cup at the lower end of the cloth “leg.”

r, Ring of wire for attachment of cord if net is to be used in casting.

rt, Same wire carried down and soldered to the wire ring

w, which forms the rim at the base of the cone of gauze netting, c.

a, Mass of lead at the tip of the cone to add weight.

t, Short tin cylinder soldered to the base of the cone, with a groove at the upper end (g) and a flange at the lower (f), over which is fastened the end of the cloth “leg” of the net.

n, The cloth “leg,” which is about eighteen inches long, tapers toward the lower end, and is made, as before indicated, of cheese-cloth and China silk.

cl, The clamping ring, the end of which (cle) is soldered to a block (b), which in turn is capable of being fastened firmly to a base (ba) by a screw (s) fitting into a hole (sh). In the writer's nets these parts are all of brass.

l, Cup at lower end of the “leg” made of lead pipe flared at the upper rim and grooved near this rim for tying of the “leg.”

st, Screw top such as is used for kerosene cans. The material is accumulated in the cup and then by unscrewing of the cap allowed to run into a bottle, can, or vial as may be desired.

Zoölogical Laboratory, University of Nebraska.

ROBT. H. WOLCOTT.

A Method of Determining the Comparative Gravity of Alcohol when Dehydrating by Osmosis.

In dehydrating by osmosis it is not always easy to tell when the two fluids have reached an exact balance. The following simple method is very accurate, and practically no trouble at all. When it is thought that a balance has been reached, take a couple of drops of the dehydrated fluid in a dropping pipette, and carefully drop it into the dehydrating fluid. If there is any difference in the gravity of the two fluids the drops will descend to the bottom with the peculiar oily appearance always seen upon the mixture of two grades of alcohol. If the grades are equal, however, the drops will not be seen after touching the surface.

Chicago.

R. P. WOODFORD.

A simple plan of preparing permanent specimens to demonstrate any desired structures in the earth-worm, is to place the specimen, after careful dissection, into glass tubes of suitable size, one end of which has been sealed with a flame before the specimen is inserted, the other corked and sealed with sealing wax after the tube containing the specimen has been filled with 3 per cent. formalin.

Journal of
Applied Microscopy
 and
Laboratory Methods.

Edited by L. B. ELLIOTT.

Issued Monthly from the Publication Department
 of the Bausch & Lomb Optical Co.,
 Rochester, N. Y.

SUBSCRIPTIONS:

One Dollar per Year. To Foreign Countries, \$1.25
 per Year, in Advance.

The majority of our subscribers dislike to have their files broken in case they fail to remit at the expiration of their paid subscription. We therefore assume that no interruption in the series is desired, unless notice to discontinue is sent.

Perhaps there is no time throughout the year when laboratory apparatus, especially in high school laboratories, suffers so much through lack of attention as during the summer months. In the majority of school laboratories the apparatus lies untouched and forgotten throughout the entire summer vacation. This no doubt does very well where the necessary precautions are taken at the close of the school year to place the equipment in such condition as will preserve it unimpaired until it is desired for use again. However, the closing days of the school year bring so many things to take the attention, that the condition in which the working equipment of the laboratory is to be left is likely not thought of, or receives only unsatisfactory care. One has but to visit a few laboratories at this time of year to be convinced that the primary reason why many teachers have to work with scanty equipment is that either they or their predecessors have neglected to keep in perfect working order what has been provided for them. To accumulate a satisfactory equipment, the pieces as they are obtained must not be allowed to become worthless long before they have served their possible period of usefulness. School boards should not rely wholly on their teachers to care for the public property, for the care and preservation of which they are even more responsible than the teachers. If they have delegated those duties to the teacher, it is still for them to know that the work has been properly done.

The summer vacation affords, really, the only time when apparatus can be spared from the laboratory for repairs. It is the best time to go over the equipment carefully and make sure that every available piece is in the best possible shape for the coming year's work, and in case repairs are needed, such may be made with no inconvenience to teacher or pupils. Chemical apparatus should be cleaned, and thus saved from the action of destructive chemicals. Physical and optical instruments should be thoroughly cleaned, and protected from dust and moisture. A few hours' work now may save an endless amount of trouble, delay, and expense, when the apparatus is brought out for use at the beginning of another school year.

* * *

Owing to a short leave of absence of the author, for the purpose of securing much needed rest, the series of articles on Micro-chemical Analysis, by Prof. E. M. Chamot, Cornell University, is not continued in this number, but will appear again next month.

CURRENT BOTANICAL LITERATURE.

CHARLES J. CHAMBERLAIN.

Books for review and separates of papers on botanical subjects should be sent to
Charles J. Chamberlain, University of Chicago,
Chicago, Ill.

REVIEWS.

Guignard, L. La Double Fertilization dans le Maïs. Jour. du Bot. 15: 1-14, 1901. Double fertilization in *Zea mays*, which has been suspected for some time, and which is believed to be the cause of the phenomenon known as xenia, is described in a recent paper by Guignard.

The mature pollen grain contains, besides the vegetative nucleus, two very small elongated generative cells, each in the form of a slender rod, curved or straight. The ends are often pointed. The protoplasm of these cells is much reduced and difficult to distinguish. Their nuclei appear almost homogeneous.

The two synergids and the oosphere are large. The pyramidal synergids occupy the summit of the sac, and in many cases have a large vacuole in the base. They show near the tip a conspicuous longitudinal striation, especially in material fixed in absolute alcohol. Their nuclei do not stain readily at the time of fertilization.

The nucleus of the oosphere is very large and contains much chromatin. The protoplasm surrounding the nucleus is, ordinarily, highly granular and much massed together at the time of fertilization.

Near the oosphere, sometimes in the median line of the embryo-sac, sometimes at one side, are the two polar nuclei. These nuclei do not fuse before fertilization. They have each a relatively large nucleus and small amount of chromatin.

As many as a dozen multi-nucleate cells may be found in the much narrowed antipodal end of the embryo-sac.

The pollen tube, after penetrating the embryo-sac, usually seems to discharge its contents into one of the synergids. In one instance the two elongated male nuclei were observed resting against the base of a synergid; under high magnification their chromatin was distinct. One of the male cells unites with the oosphere, the other with the polar nuclei. These nuclei are bound together by the last male cell. Fertilization proceeds with such great rapidity that it could be observed in very few preparations. In general, the ovules at the base of the ear are first fertilized.

In hybrids many ovules are not fertilized.

After fertilization, one of the synergids usually persists for a time, with its contents finely granular and refractive. Division of the fertilized polar nuclei proceeds with such rapidity that the course of cell-division could not be followed. The first two nuclei of the endosperm are large, each one having an enormous nucleolus and many smaller nucleoli.

It is to be regretted no figures are given.
Chicago.

W. J. G. LAND.

Richards, H. M. *Ceramothamnion codii*, a new Rhodophyceous alga. Bull. Torrey, Bot. Club. 28: 257-265, pls. 21-22, 1901.

Rhodophyceæ. The form discovered is epiphytic on *Codium*, scarcely visible to the naked eye, appearing only as a slight reddening on the host plant. The new plant seems to combine in itself the characters of four other algæ. In habit it is like *Rhodochorton*, a prostrate filament sending up erect filaments and sending down rhizoids into the host. In structure it resembles *Callithamnion*, and *Ceramium*, having monosiphorous internodal cells and a node of three or four rows of closely packed smaller cells. Alternate nodal and internodal cells are cut off by the apical cell of each filament; the nodal cell divides longitudinally and transversely to form the rows; the internodal cell merely enlarges in all directions. Elongated hairs may arise from the nodal cells.

Reproduction is by tetraspores and polyspores. The tetrasporangium arises from an upper cell in a young node, often enclosed later by a bract-like growth of other adjoining nodal cells. After the maturity and discharge of the cruciate spores, proliferation of the basal cell of the sporangium occurs and another tetrasporangium is formed within the old wall. Mr. Richards reports finding sometimes four or five older walls surrounding a developing sporangium. The antheridia also arise from nodal cells, which by their activity, spreading up and down, completely envelop the internode. Usually the antheridial plants are separate. The polyspores resemble quite strongly the favellæ of *Callithamnion*, but entirely lack the functioning trichogyne. They occur in the axils of special branches near the tip. After careful investigation the author is emphatic in declaring that polysporic development is purely asexual and that where a hair is present, it in no way acts as a trichogyne.

For the reason that this alga resembles *Rodochorton* in habit, *Callithamnion* in cell and chromatophore structure, *Ceramium* in filamentous form, *Ptilota* in polyspores and has besides proliferation of the sporangium, the author makes it a new genus, *Ceramothamnion*. The paper is accompanied by two plates.

Chicago.

PHILIP G. WRIGHTSON.

Chamberlain, Charles J., A. M., Ph. D. Instructor in Botany in the University of Chicago. *Methods in Plant Histology*. Price, \$1.50.

The series of articles which appeared under the above title in THE JOURNAL OF APPLIED MICROSCOPY has been thoroughly revised and enlarged by about one-third and is now published in book form by the University of Chicago Press. Directions are given for collecting and preparing plant material of all groups for microscopic investigation. The various processes of fixing, embedding, sectioning, staining and mounting are treated in detail. In the later chapters specific directions are given for making those mounts which are needed by classes studying the development of the plant kingdom. It is intended to meet the requirements not only of the student who has the assistance of an instructor in a well equipped laboratory, but also of the student who must work by himself and with limited apparatus. Formulæ are given for stains and other reagents.

Lawson, A. A. Origin of the Cones of the Multipolar Spindle in *Gladiolus*. Bot. Gaz. 30: 145-153, pl. 12, 1900.

Investigations have shown that multipolar spindles are of very general occurrence in higher plants, at least in the mother cells of spores. Since this type of spindle formation does not require a centrosome, and since most investigators do not believe that centrosomes are present, some other explanation must be sought for the ultimate bipolarity of the spindle. Those who have investigated the multipolar spindle agree that it arises from a weft of kinoplasmic fibers, but they have not studied the earliest stages. In 1898, the present writer in studying the pollen mother cells of *Cobea scandens* found that the weft of kinoplasmic fibers arises from a granular zone which he designated as the perikaryoplasm. In *Gladiolus*, as in *Cobea*, there is a granular zone about the nucleus and it is probably from this that the felted zone of fibers arises. The felted network about the nucleus does not grow uniformly, but some portions grow more rapidly than others and appear as projections which become the poles of the multipolar spindle. The fibers of the spindle are formed by the elongating meshes of the network. The nuclear membrane, the nucleolus and the linin take no part in spindle formation. The cones fuse into two groups to form the bipolar spindle.

C. J. C.

Longo, B. La mesogamia nella commune Zucca (*Cucurbita Pepo* Lin.) Rendiconti della R. Accademia dei lincei. 10: 168-172, 1901.

When Treub, in 1891, found that in *Casuarina* the pollen tube enters the embryo-sac by way of the chalaza, he gave the name chalazogamy to this peculiar phenomenon and designated as porogams those plants in which the pollen tube reaches the embryo-sac by the usual route of the micropyle. Chalazogamy has since been observed in several other members of the *Amentifera* and in *Ulmus* a condition somewhat intermediate between chalazogamy and porogamy has been described. According to Dr. Longo the pollen tube in *Cucurbita* traverses the tissues of the funiculus and outer integument before entering the micropyle. He proposes the name *mesogamy* for this phenomenon.

C. J. C.

Bessey, Chas. E. The modern conception of the structure and classification of Diatoms, with a revision of the tribes and a rearrangement of the North American genera. Trans. of the American Mic. Soc. 21: 61-85, pl. 5, 1900.

Prof. Bessey accepts Müller's view that the filamentous condition is the primitive one, and that diatoms should be regarded as typically filamentous rather than as unicellular forms. They should then be classed between the Peridinalus on the one hand and the Desmidiaceæ and Zygnemaceæ on the other. The Zygnemaceæ are regarded as the most primitive of the Conjugatæ, while the Desmids and Diatoms are believed to represent two similar and somewhat parallel genetic lines in which the filaments tend to break up rather early into independent cells. The larger part of the paper is occupied by a key to the tribes and genera of the American forms.

C. J. C.

CYTOLOGY, EMBRYOLOGY, AND MICROSCOPICAL METHODS.

AGNES M. CLAYPOLE, Cornell University.

Separates of papers and books on animal biology should be sent for review to
Agnes M. Claypole, 125 N. Marengo avenue,
Pasadena, Cal.

CURRENT LITERATURE.

Rothig, P. "Ueber einen neuen Farbstoff Namens Kresofuchsin." Arch. f. Mikrosk. Anat. Bd. 56, 1900.

Kresofuchsin is an amorphous powder of grey blue color, it is easily soluble in acetic acid and acetone, less readily but quite soluble in alcohol, only very slightly so in water. It is insoluble in benzol. The alcoholic solution appears blue, the aqueous red. The former stains elastic tissue deep blue, mucous, cartilaginous and horny substances reddish; while the latter does not stain elastic tissue at all, but mucous, cartilage, keratin, as well as nuclei, are colored deep red. The author suggests that the stain contains two components of which one has an affinity for chromatin, mucin, chondrin, and keratin, while the other takes to elastin. To determine the staining of tissues by this new agent, the investigation was made on material fixed 24 hours in a weak alcoholic sublimate solution (9 parts of concentrated aqueous sublimate solution to 1 part 95 per cent. alcohol), then washed with alcohols of increasing strength through the iodized alcohol till free from sublimate and finally embedded in xylol-paraffin. The sections were fastened to slides by weak alcohol and placed successively in xylol, absolute alcohol, and then the stain. A simple alcoholic solution gives unsatisfactory results: the addition of hydrochloric acid gives better differentiation. Results are still better if a small quantity of picric acid is added as well as the hydrochloric acid. These substances are combined as follows: 0.5 gram of kresofuchsin in 100 c.c. of 95 per cent. alcohol, and 3 c.c. hydrochloric acid. With 40 c.c. of this solution, in which the particles of stain are not dissolved, are mixed 32 drops of a picric acid solution, consisting of 1 part concentrated picric acid solution and 2 parts water. The sections remain 2 hours or longer in the stain; 24 hours do no harm. Then into 95 per cent. alcohol, in which they must stay for a long time. From that into absolute alcohol until the remaining color is removed and the sections are dehydrated, thence into xylol and balsam. The best counterstain is orange G. For a final nuclear stain carmin is used: if hæmatoxylin is used it is necessary to overstain with it owing to the picric acid constituent of the kresofuchsin solution. After staining for an hour the sections are washed with water, treated with alcohol of increasing concentration and stained several hours with kresofuchsin. The violet color of the nuclei passes into a dark brown to brown red. The author has also sought to stain unfixed material with the new stain. He obtained the same results as in sublimate fixed tissues.

E. J. C.

Reuter, K. Zur Frage der Darmsresorption.
Anat. Anz. 19: 198-203, 1901.

The author has carried on investigations on *Alytes obstetricans*, in regard to the morphological changes in the

intestinal epithelium during its periods of secretion and absorption.

A previous paper on the intestinal spiral of *Alytes* led to a number of experiments on vertebrates—mouse, rat, guinea pig—accompanied by histological studies. Mingazzini worked on the absorption processes in the intestine of the fowl, and finds that there are distinct changes in the epithelium corresponding to the different stages of absorption. The absorption of albumen is especially worthy of mention, while fat absorption proved to be of much less value in the investigation. Mingazzini finds the first indication of absorption in the cells to be a granular clouding at the base; as the process continues the cell contents become watery. The whole process appears in some sort as an internal secretion.

The evidence of these researches goes to show that the so-called Gruenhagen's spaces are no artifact, but that they are truly the morphological expression of an internal secretion formed from absorbed nutritive material. By careless fixation and hardening on these absorption studies artifacts can easily be made. Careful work has made the following points fairly certain. The whole absorptive process, the passage from alimentary tract to blood and lymph, takes place in two chief stages: First, from the lumen of intestine through the epithelium into adenoid tissue; second, the passage from the adenoid tissue into the blood and lymph capillaries. In the first part of the course, albumens and fats pass readily. In this process two stages are visible: the taking up of material from the free ends of the epithelial cells, and, second, the passage into the basal part of the cell below the nucleus. This is doubtless due to the activity of the living cell. In all previous investigations absorption has been considered a purely physical process, due to osmosis, no account has been made of the individuality of different cells. Quite notable variations in absorption are due to this factor. Thanhoffer thought that the cells absorbed through pseudopodic processes, but the author, repeating his experiments most carefully, could distinguish no changes; the cell margins were uniform and at rest, the fat drops showing brownian movement, but no evidence existed of a mechanical taking up of these. Hardened material also showed no change in these margins that could be counted as any morphological change during absorption. In the author's opinion the border of the cylindrical epithelium acts as an osmotic membrane through which the soluble substances diffuse into the epithelial cells. The fat absorbed in small granules can be followed by the use of osmic acid, while the absorbed albuminous substances lying above the nucleus can only be traced by the protoplasmic conditions. The process of separation from the cylinder cells is in both substances entirely unlike. That of albuminous substances is intracellular; the whole process closely resembles mucous secretion with this difference, that the excretion product cannot be fixed and stained, this can be done only for the protoplasmic network that contains it. The fat on the contrary, is passed into the intercellular spaces between the separate cylinder cells. The contents of these spaces passes into the spaces of the adenoid tissue, where they probably undergo further changes by the agency of leucocytes,

followed by their final passage into the blood and chyle. The fat appears to pass into the adenoid meshes in comparatively large particles and here disappears as if in solution. It is frequently taken up by leucocytes, in the central chyle vessels which have been filled by absorption abundant fat occurs in the form of a very fine emulsion. The albuminous substances cannot be demonstrated by fixatives and stains, but the protoplasmic network surrounding these substances can be demonstrated. Till they reach the central chyle vessel each drop is undoubted albumin.

A. M. C.

Benda, C. Eine Makro- und Mikrochemische Reaction der Fettegewebnecrose. Virchow's Arch. Bd. 161, 1900.

The author applied Weigert's method for neuroglia demonstration to other histological subjects. The tissues are

hardened in a 10 per cent. formalin solution, then after one or several days put into Weigert's Neuroglia mordant, a mixture of copper acetate, chrom-alum and acetic acid. This impregnation is best accomplished in an incubator, with the exception of the bony substance, which is a deep blue from the copper salt, all the other organs after a week's treatment in this mordant take a pale green grey color, somewhat bleached by washing with water. The necrotic fat tissue (omentum with a little of the pancreas) appears after 24 hours' treatment in the incubator covered with green flakes or rust, both on the surface and deep in the tissue.

It was easily ascertained that it was the copper solution that caused this color and that it was the necrotic tissue exclusively that had taken it. This color was so sharp that it was possible to distinguish areas so small as to be otherwise indistinguishable macroscopically. Microscopically from preparations or from frozen sections (prepared from the pancreas treated with the copper solution) it was ascertained that the normal fat cells contained no trace of blue, while the necrotic areas were clearly blue green. The most intense color was in the needle-shaped fatty acid crystals. Before embedding a counterstain may be used, either alum or copper hæmatoxylin. The latter stain brings out some more points. A section of the copper treated tissue is stained with an aqueous solution of crystalized hæmatoxylin and there comes, as in the Weigert process, a blue black color, while the copper salt taken up goes over into a copper hæmatoxylin.

The fatty acid crystals, however, retain their blue green color. The author thinks in consequence that the copper salt in the crystals cannot be merely absorbed, but is present in some different chemical substance too firmly to be displaced by hæmatoxylin. This must be a copper salt of the fatty acid. The acids that are here concerned are stearic, palmitic, and oleic. The inner part of the necrotic fat cell contains stearic and palmitic acids, while the outer part of the cells contains a considerable amount of oleic acid. This new reaction has several advantages for histological investigation. The other fat staining methods, osmic acid and sudan-red, stain fats and fatty acids equally. The sudan-red stain is extraordinarily adapted to show the parenchymatous inflammation of the pancreas cells. But through the intensity of the staining of the fat, the difference between the normal and necrotic cells disappears, since the fatty acids, which are always surrounded by a fatty detritus, can scarcely be

recognized. On the contrary, the copper treatment brings out the blue green crystals from the amorphous stained material and the entirely unstained normal and abnormal neutral fat drops are very sharp. The smallest indication of disease can thus be detected microscopically. The author has found in a but slightly affected pancreas entirely isolated necrotic fat cells, which were not to be detected by any other method.

E. J. C.

Næoske, H. Eosinophile Zellen und Knochenmark, insbesondere bei chirurgischen Infektionskrankheiten und Geschwülsten. Deutsche Zeitsch. für Chir., Bd. 55, 1900.

The author considers the staining technique for eosinophile cells to be very important and uses the following method: The organ to be investigated

is fixed 12 to 24 hours in 4 per cent. formol solution at body temperature, hardened in alcohol and embedded in paraffin. Celloidin was not used. Fixation in Mueller's fluid was less satisfactory; better results came from 5 per cent. sublimate solution and Altmann's nitrous acid, fixing from a few minutes to 2 hours. The sections; from 3 to 6 μ thick, were stained with a 1 per cent. aqueous solution of Gruebler's eosin for 2 to 3 minutes, rinsed with water and counterstained with the following alkaline methylen blue: lithium carbonate, conc. aq. sol. 5 pts., distilled water 80 pts., alcohol 10 pts., methylen blue (conc. alc. sol.) 2 pts. This staining solution is poured abundantly over the eosin stained sections; it remains for a half minute or longer, according to the method of fixing or thickness of the section, washed off with absolute alcohol, cleared in xylol and mounted in balsam. In a section thus stained the radiating structures about the tubercle bacilli, the granules in their immediate neighborhood, the eosinophile cells, and in part the red blood cells, are all bright red, while the rest of the tissue is bluish. The alkaline condition of the methylen blue solution is necessary for this differentiation by the eosin. This seems important since weak *neutral* alcoholic or aqueous blue solutions remove the eosin entirely from the section, which is not bound firmly as a tissue element. Lyons blue has also been used, made as follows: 20 parts of a 1 per cent. aqueous solution of Lyons blue with one drop of officinal solution of caustic potash boiled about 5 minutes and diluted with 20 pts. of alcohol. In the same way 20 parts of a Bismark brown solution mixed with a drop of caustic potash solution boiled about 5 minutes and diluted with 20 pts. alcohol. Thirty parts of the first standard solution are mixed with 5 parts of No. 2, while shaking; to this mixture are added 25 pts. of alcohol and filled to 100 parts with distilled water. This brownish-violet stain is used on the section with cautious warming, allowing steam to form and then cooling slowly. The result of this is to give the sections a brownish yellow tone, then the stain is washed off with acid alcohol (HCl.) whereby the brownish color changes to a faint blue. This is followed by a careful short wash with a mixture of equal parts of pure anilin, alcohol and distilled water. The latter differentiating fluid should act only until the sections appear a light brown; this at most takes but a few seconds. Washing in alcohol follows; clearing in xylol and mounting in balsam complete the process. Excellent plates illustrate the granules of the eosinophile cells stained in this manner.

E. J. C.

CURRENT ZOÖLOGICAL LITERATURE.

CHARLES A. KOFOID.

Books and separates of papers on zoölogical subjects should be sent for review to Charles A. Kofoid, University of California, Berkeley, California.

Sand, René. Étude Monographique sur le Groupe des Infusoires tentaculifères. 441 pp. 24 pls., Bruxelles, 1901. Extrait des Ann. de la Soc. Belg. de Micros. T: 24, 25 et 26.

Since the publication of Bütschli's monograph of the *Protozoa* no more pretentious discussion of these interesting forms than this of Dr. Sand has

been attempted. The morphology, taxonomy, and especially the ecology of the group, are treated at length. Full synoptic keys for the determination of all known species are provided, and a synonymic bibliography is given for all recognized forms. The author rejects the idea that the *Suctorina* have been derived from the *Ciliata*, and seeks their ancestors among the *Heliozoa*. The ciliated embryos of the *Suctorina* are mere adaptive phenomena without phylogenetic significance, and still further, according to our author, the fundamental biogenetic law is not applicable to the *Protozoa*. The *Suctorina* are found in fresh, brackish, and salt waters, most abundant in the last, on *Bryozoa* and hydroids at depths of 10 to 20 meters. In fresh water they are most abundant in stagnant pools. In fresh water aquarium cultures they appear after the carnivorous *Ciliata*, which succeed the herbivorous forms. A very large number of killing fluids and stains were tried, but best results were obtained by the following simple method: Kill in 2 per cent. osmic acid, wash in water to which a trace of ammonia has been added, and mount under a cover-glass in a drop of acetic methyl green prepared in these proportions:

| | |
|----------------------------------|----------|
| Distilled water, | 80 c. c. |
| Alcohol, 9.4°, | 10 c. c. |
| Concentrated glycerin, | 10 c. c. |
| Methyl green, | 0.5 gm. |
| Glacial acetic acid, | 2 c. c. |

As the fluid evaporates about the preparation 10 per cent. glycerin is added. Bordeaux red, borax carmin, and a mixture of safranin, methyl violet, and eosin gave good results. The peduncle was stained by chrysoidin. Dehydration and mounting in balsam usually deforms the *Suctorina*.

C. A. K.

Chapman, F. M. Bird Life: a Guide to the Study of our Common Birds. With 75 colored plates after drawings by Ernest Seton Thompson. Popular colored edition, 8 vo. pp. xii and 195, with 25 illustrations and an appendix for use of teachers. Pp. 85, 1901. D. Appleton & Co., New York. \$2.00.

A new edition of this well known work adds colored figures of one hundred selected birds of Eastern North America. Mr. Thompson's lifelike and spirited drawings have been colored under the direction of Mr. Chapman,

and are here reproduced, thus greatly enhancing the value of the book to amateur students of birds and to teachers of nature-study and biology in the secondary schools. The teacher's appendix contains many suggestions for utilizing the book in the class-room, and especially in the field. Fortunately there is no hint of taxidermy or birds-nesting in its pages.

C. A. K.

Herrick, F. H. The Home Life of Wild Birds. A New Method of the Study and Photography of Birds. With 141 original illustrations from nature., pp. xix, 148, 4to, 1901. G. P. Putnam's Sons. \$2.50.

By means of a portable tent and camera, Professor Herrick has solved the problem of the successful study of the life of the nesting bird, especially during

the period between hatching and the first flight of the fledglings. The nest, usually with the nesting bough, is moved, if necessary, to a place of easy access near the original site, and the observation tent is set up close at hand. Concealed within it the observer can study at close quarters the behavior of both parents and young, and can record with the camera the various phases of the domestic life of birds. The author gives very full directions for the use of his method, and offers a number of suggestions for its wider application by others who would follow this fascinating sport. The apparatus used is in the main very simple, and can be easily managed by any one familiar with photography and possessed of the naturalist's patience and the ornithologist's enthusiasm. A brief review can give but little idea of the originality and freshness of these pages (for this is no ordinary "bird book"), which bring within sight and touch of the reader the secrets of the home life of our native birds. The abundant illustrations secured under these ideal conditions record what no naturalist has before seen, and "what no artist could hope to portray." Professor Herrick details in this book the results of his study by this method of fifteen of the land birds of New England, and his pages will prove to be a rich mine of suggestive information for teachers of nature-study and the "new" natural history. Though strictly scientific in method and treatment, the book is well adapted to the general library.

C. A. K.

Zoologisches Addressbuch. Namen und Adressen der lebenden Zoologen, Anatomen, Physiologen, und Zoopaläontologen sowie der Künstlerischen und technischen Hilfskräften. Teil. II, 8vo, pp. 517, 1901, Preis M. 6. Herausgegeben im Auftrage der deutschen zoologischen Gesellschaft von R. Friedländer & Sohn, Berlin.

Zoölogists everywhere will welcome this supplement to the admirable directory issued by this firm in 1895. The present issue is practically a new edition with the names, academic positions, addresses, and specialties of over seven

thousand zoölogists and collectors. There are full indices of places and names, and the latter are also conveniently grouped according to the specialties given. A list of deceased (since 1895) zoölogists, and an appendix or two, bring the directory up to date. This directory is indispensable to all publishing zoölogists. The American section needs revision sadly in places, and to this end it is to be hoped that our zoölogists will respond to the firm's request for corrections and additions for the next edition. These should be sent to the publishers at Berlin, N. W., Carlstrasse 11.

C. A. K.

Peter, K. Mittheilungen zur Entwicklungsgeschichte der Eidechse. II, Die Schlundspalten in ihrer Anlage, Ausbildung und Bedeutung. Arch. f. Mik. Anat. und Entwick. 57: 705-756. Taf. 38-40, 1901.

The author gives a very full account of the origin, growth, disappearance, and derivations of the gill-clefts in the lizard. The process was followed from

embryos of 4 somites (length of embryo 1.8 mm.) to those whose length was 6.3 mm. The greater part of this period is passed before the eggs are laid.

Reconstructions were made in wax from serial sections, and very instructive figures of these models are given in the plates. The author concludes that the entoderm only is active in the formation of the gill-clefts. It is marked by abundant mitoses, and by a thickening of the epithelium, and moves out to form a junction with the ectoderm. The outer gill pockets appear only on first, fourth, and fifth pairs, and are wholly of a secondary character, the ectoderm being passively drawn in by the withdrawing entoderm of the throat pocket. The closing membrane of clefts I to IV separates, but the openings are later closed and the entoderm retreats from the epidermis. The aortic arches appear *after* the formation of the gill pockets, arising as outgrowths from the dorsal, and later the ventral aortæ. The gill-clefts are thus in no way conditioned upon the appearance of aortic arches. Six aortic arches appear, though in one case a seventh vessel was found and in another instance the pulmonary (VI) was missing in the sixth gill-arch, and was found posterior to the sixth cleft. The derivatives of the clefts are as follows: The first cleft, as usual, gives rise to the middle ear and the eustachian tube. Epithelial buds from the dorsal ends of clefts I-III form the thymus, while the fourth disappears entirely save for some ephemeral epithelial corpuscles. The third cleft also gives rise to some similar elements. The fifth cleft leaves no trace, but the sixth (on the left side only) gives rise to the supra-pericardial body. All of these organs are of purely *entodermal* origin, thus our author regards this last pair of throat pockets as belonging to the branchial category, and concludes that the *Laertilia* have six gill-clefts. The utility of these ephemeral embryonic organs is found (1) in their relation to permanent organs (ear, thymus, supra-pericardial body); (2) in their relation to the formation of the ganglia of the seventh, ninth, and tenth cranial nerves. The fact that open clefts are found only in those amnota with yolk-laden eggs (reptilia, aves, echidna) leads to the further suggestion that these open clefts facilitate the passage of nutrient fluids from the yolk. C. A. K.

Richardson, Harriet. Key to the Isopods of the Atlantic Coast of North America, with descriptions of new and little known species. Proc. U. S. Nat. Mus. **23**: 493-579, 1901.

Richardson, Harriet. Synopses of North American Invertebrates, VIII, The Isopoda. Pt. I, Am. Naturalist, **34**: 207-230; Pt. II, *ibid*, 295-309, 1900.

These papers of Miss Richardson's dealing with the taxonomy of this widely distributed group of animals, are welcome aids for all who wish to study Isopods. The first paper is concerned only with species of the Atlantic Ocean and of our contiguous coasts. Synonymy, bibliography, geographical and bathymetrical distribution of all the known species in this habitat are given, and fourteen new forms described. The second paper includes keys to the fresh-water forms and the marine species of all North America, with only the most general statements as to their geographical distribution. C. A. K.

Reighard, J., and Jennings, H. S. Anatomy of the Cat. pp. xx, 498. With 173 original figures drawn by Louise Burridge Jennings. Henry Holt & Co., 1901.

A laboratory manual of mammalian anatomy, complete, of convenient size, approximating the general usage in terminology, and containing both description text systematically arranged and brief directions for preparations of

material and for dissection, has long been a desideratum. This need is most adequately met by Reighard and Jennings' work. The book is based upon a decade of practical experience in anatomical instruction in the University of Michigan and elsewhere, and is thus well adapted to the demands of university courses, while at the same time affording a valuable guide to the private student of anatomy and a desirable adjunct to the high school library. In symmetry of treatment, in freedom from extraneous matter, in clearness, comprehensiveness, and at the same time brevity of statement, and in technical execution, the book may well serve as a model. Mrs. Jennings' accurate figures supplement the text in all important subjects.

The book contains adequate directions for the preparation of the various systems of organs and advocates the use of formalin as a preservative. A 5 per cent. solution of commercial formalin is injected into the femoral artery to the amount of 300 to 400 cubic centimeters. Specimens thus injected may be preserved thereafter by immersion in 1 per cent. formalin. Color and pliability are better preserved by the following method: Inject 5 per cent formalin to which has been added one-sixth of its volume of glycerin and keep the specimen in a tight box, wrapping all exposed parts in cloths wet in the injecting fluid. The suggestion is made that the addition of fungicides to the injecting fluid might prevent the growth of molds which soon attack exposed surfaces.

C. A. K.

NORMAL AND PATHOLOGICAL HISTOLOGY.

JOSEPH H. PRATT.

Harvard University Medical School, Boston, Mass., to whom all books and papers on these subjects should be sent for review.

Pappenheim, A. Ueber das Vorkommen ein-kerniger Zellen: ein gonorrhöischen Urethralsecret. *Virchow's Archiv für path. Anat.*, 164: 72-119, 1901.

This is a consideration of the general histology of inflammation, and it presents an admirable survey of recent work in this field. The author dissents

from the view of the Cohnheim school and adopts in modified form the original view of Virchow that the fixed cells of the part, as well as the extravasated cells from the blood, participate in the formation of pus. The polynuclear leucocytes are hæmatogenous in origin, but the lymphocytes and mononuclear leucocytes he regards as formed locally from the cells of the connective tissue group.

Mononuclear cells occur in the gonorrhœal discharge in all stages of the disease and they are always present in larger proportion, in relation to the polynuclears, in the exudate than in the blood. The lymphocytes are not simply the small typical lymphocytes of the blood; many are of larger size, and forms as large as the great lymphocytes of acute lymphæmia are not uncommon. The mononuclear cells are found in the pus in clumps. As the process becomes more chronic there is a considerable increase of mononuclear leucocytes and particularly of lymphocytes. These facts favor the histogenetic origin of the

cells. If this theory be true we have a measure of the degree of productive cell activity in the appearance and still more in the number of the mononuclear leucocytes and lymphocytes in the pus, and hence a point of diagnostic value in determining the stage of the inflammation. Especially in gonorrhœa the finding of many gonococci, eosinophiles and few lymphocytes would speak for an acute infection, while the finding of few cocci and abundant mononuclear cells would indicate an exacerbation of a chronic process.

J. H. P.

Harris, H. F. A New Method of Staining Elastic Tissue. Proceedings of the Pathological Society of Philadelphia, 4: 167-168, 1901.

This method is based on the fact that hæmatin solutions have a remarkable affinity for elastin. Harris directs that the stain shall be prepared as follows:

Hæmatoxylin, 0.2 gm.; aluminum chloride, 0.1 gm.; 50 per cent. alcohol, 100 c.c. Dissolve the hæmatoxylin and aluminum chloride, and then carefully heat the solution to the boiling point; 0.6 gm. of mercuric acid is now slowly added, and as soon as the mixture assumes a dark purple color it is removed from the flame and cooled rapidly. The stain is filtered and one drop of hydrochloric acid is added. The stain requires several weeks to ripen. It appears to keep indefinitely.

Sections are stained from five to ten minutes and are then washed for about a minute in a 1 per cent. solution of nitric acid in alcohol; the acid alcohol is then thoroughly removed with pure alcohol, and the sections are cleared and mounted.

J. H. P.

Howard, W. T. Observations on the Character of the Cells in the Exudation in Acute Interstitial Nephritis, with Special Reference to the Presence of Cells with Eosinophilic granulations. American Journal of the Medical Sciences, 121: 151-163, 1901.

In 1898, Councilman published his study of acute interstitial nephritis. He showed that the disease is characterized by general and local infiltration of the interstitial tissue of the kidney

with Unna's plasma cells. He agreed with Marschalkó that these cells are derived from lymphocytes, and stated that they are carried to the kidney in the blood current. In addition to the plasma cells Councilman found a variable number of lymphocytes and polynuclear leucocytes in the exudation.

Howard has confirmed Councilman's observations, and in addition found large numbers of typical eosinophilic leucocytes in the interstitial exudation and in the blood vessels in the three cases of the disease which he has studied. The eosinophilic leucocytes are for the most part brought to the kidney by the blood-vessels and reach the interstitial tissue by emigration, but they may be formed locally from plasma cells.

J. H. P.

Fuchs, E. Beiträge zur Kenntniss der Entstehung, des Vorkommens und der Bedeutung "eosinophiler" Zellen, mit besonderer Berücksichtigung des Sputums. Deutsches Archiv für klinische Medicin, 63: 427-443, 1899.

Fuchs holds that the eosinophilic cells have no single mode of origin. Eosinophilic granules can be formed out of neutrophilic granules, or from fragments of broken down red blood corpuscles, which when ingested by cells transform the cells into eosinophiles.

This probably explains the increase of eosinophiles in various hæmorrhagic processes. Eosinophiles can be formed in all the tissues. They are especially

numerous in those organs and tissues that are exposed to bacterial invasion. The eosinophilic cells of the sputum probably arise in the respiratory tract. They occur in varying number in all diseases of the respiratory tract which are not associated with fever. In febrile conditions they ordinarily do not appear until the temperature has returned to the normal.

For the study of the sputum Fuchs highly recommends a modification of Teichmüller's method. A thin layer of sputum is spread upon cover slips, and the preparations are fixed by drawing them three times through the flame. They are stained for two minutes in a 0.5 per cent. alcoholic solution of eosin, and then decolorized in 50 per cent. alcohol. Everything is decolorized except the red blood corpuscles, which retain the stain partially, and the eosinophilic granulations. Counterstain with methylen blue. J. H. P.

Meek, E. R. Method of Staining the Elastic Fibers of the Skin. *Boston Medical and Surgical Journal*, **143**: 23-24, 1900.

The writer has devised a stain for elastic tissue which she considers superior to Weigert's method, as it is

less complicated and requires less time. The sections are taken out of strong alcohol and immersed in the following solution:

| | |
|------------------------------|-------|
| Orcein, | 3.0 |
| Absolute alcohol, | 100.0 |
| Hydrogen peroxide, | 40.0 |

If the sections are thin, three minutes suffice for staining. For differentiation the same solution in which the orcein was dissolved is used:

| | |
|------------------------------|-------|
| Absolute alcohol, | 100.0 |
| Hydrogen peroxide, | 40.0 |

For thin sections one minute suffices; the elastic fibers are then shown very clearly, while the rest of the tissue is lightly stained. J. H. P.

GENERAL PHYSIOLOGY.

RAYMOND PEARL.

Books and papers for review should be sent to Raymond Pearl, Zoölogical Laboratory, University of Michigan, Ann Arbor, Mich.

Oker-Blom, M. *Tierische Säfte und Gewebe in physikalisch-chemischer Beziehung.*

I. Die elektrische Leitfähigkeit des Blutes. *Arch. f. d. ges. Physiol.* **79**: 111-145, 1900.

II. Die Abhängigkeit der elektrischen Leitfähigkeit des Blutes von den Blutkörperchen. Beitrag zur Lehre von der Leitfähigkeit der Suspensionen. *Ibid.* **79**: 510-533, 1900.

III. Die Durchlässigkeit der rothen Blutkörperchen für verschiedene Stoffe, beurtheilt nach der elektrischen Leitfähigkeit. *Ibid.* **81**: 167-221, 1900.

IV. Die elektromotorischen Erscheinungen am ruhenden Froschmuskel. *Ibid.* **84**: 191-259, 1901.

During recent years there has been manifest a growing tendency to apply the methods and laws of physical chemistry to the study of physiological problems. This series of papers by Oker-Blom forms the most extensive and detailed contribution along this line which has yet appeared. The first paper of the series dealing with the electrical conductivity of the blood is introduced by an excellent brief summary of the present knowl-

edge of solutions, from the physico-chemical standpoint. In this study the resist-

ance of a certain quantity of blood in a standard cell was compared by the "telephone method" with a known resistance on a rheostat. The results are for convenience expressed 10,000 times greater than their absolute value in Kohlrausch units. It was found that the conductivity of defibrinated ox blood was from 52.50 to 70.89, while an equal amount of serum alone showed a conductivity of from 114.40 to 131.08. Furthermore the conductivity of a .7 per cent. solution of NaCl under similar conditions was 124.10, very nearly the mean value for the serum determinations: thus indicating in another way that such a solution of NaCl is a "physiological normal" solution. The degree of dissociation of the serum electrolytes was determined to be about .65 to .76. It was found that between 20° and 40° C. the conductivity rises with the temperature. There is no difference in the conductivity between arterial and venous blood. The electrolytes of the blood corpuscles contribute very little to the carrying of the current while they are in the corpuscles, but as soon as they diffuse out into the serum they become active. From this it follows that by measuring the conductivity of both serum and corpuscles a method is given whereby it may be determined what quantity of an electrolyte added to the blood has entered into the corpuscles and how much has remained in the serum. The conductivity of the blood is not simply proportional to the serum content, but is considerably influenced in some way by the resistance of the corpuscles present.

To determine precisely this effect of the suspended corpuscles on the conductivity of the whole blood is the purpose of the second paper in the series. A large number of experiments were performed to test the effect on the conductivity of solutions of different electrolytes of the presence of suspended particles of some non-conductor, as for example sand grains. The solutions of the electrolytes were made in gelatin, which was allowed to harden and thus hold the sand grains in any desired arrangement. Essentially the same methods of measuring the resistance were used in these experiments as in the preceding investigation. The results show that the electrical conductivity of a solution is mechanically influenced by the presence of non-conducting, suspended particles, and that this influence is, within certain limits, independent of the size of the particles and the conductivity of the solution, but is markedly affected by the amount and arrangement of the non-conducting bodies. Formulas are given by means of which an absolute value for this effect can be determined. From parallel experiments it appears that the blood, in so far as its conductivity is concerned, behaves as an electrolyte in which the corpuscles play the part of suspended non-conducting bodies.

The third paper in the series discusses the permeability of the red blood corpuscles for different substances. The method used was that which has been indicated above, namely the measurement of the electrical conductivity of the blood after the addition of the substance to be tested. Solutions were made in both water and serum. When potassium chloride, potassium sulphate, or magnesium sulphate are dissolved in serum and mixed with defibrinated ox blood, by which process the osmotic pressure of the serum is of course raised, they only enter the corpuscles to a very slight degree. On the other hand, under similar conditions ammonium sulphate and ammonium chloride are taken up by

the corpuscles to a much greater extent. When these same substances in the form of water solutions are mixed with the blood it is found that potassium chloride and potassium sulphate are only taken up by the corpuscles when the osmotic pressure of their solutions is higher than that of the serum. Magnesium sulphate when in solution of lower osmotic pressure than the serum does not enter the corpuscles. Ammonium chloride and sulphate in water solutions are taken up by the corpuscles whether the solutions are hypertonic or hypotonic. This method of the electrical conductivity gives excellent results in the measurement of the permeability of the corpuscles for electrolytes, but is not so well adapted for the treatment of the resorption of non-conductors, as for example, urea.

The last paper deals with the so called "demarcation current" of a resting muscle which has been injured in some way. The sartorius muscle of the frog was used and this was injured, either by wounding with a knife or by the application of chemicals to its surface, or by both methods in combination. The arrangement of the experiments was as follows: on the ends of two "normal," unpolarisable electrodes filled with .1N KCl were placed secondary electrodes, one of which was filled with an indifferent fluid - .1N NaCl - and the other with the substance whose effect on the muscle was to be tested. On the ends of these secondary electrodes the muscle from a curarised frog was laid. Before beginning each experiment the muscle was tested and found to give no current. From the primary electrodes wires were led to a suitable apparatus for measuring the current. With such an arrangement it was found that distilled water in contact with the surface of the muscle produces a negative electrical condition at that point. After a short time (fifteen to thirty minutes), however, this affected area becomes positive with reference to the rest of the muscle, and later again changes to negative. If very dilute solutions of KCl are brought in contact with the muscle, analogous phenomena appear, the only difference being that in this case the negative and positive phases of the current are of shorter duration than when water is used. The sheath of the muscle fibril has an important influence on the electromotive force of the muscle, the current becoming weaker as this surface layer becomes more and more injured. The author believes that all these phenomena can be brought into agreement with the laws of physical chemistry. It appears that the contractile substance and the sheath are affected separately by the irritating agent. In case of each there arise decomposition products, whose positive ions move faster than their associated negative ions. The diffusion of these ions is the primary cause of the electrical phenomena, and the changes in the direction of the current are the results of changes in the permeability of the sheath. This paper forms an important step towards the bringing of animal electricity, one of the most peculiar of physiological phenomena, under physical and chemical laws.

R. P.

Courtade, D. L'Irritabilité dans la Serie animale. Paris (Carre & Naud). Pp. 86, 1900.

Bonnier, P. L'Orientation. Paris (Carre & Naud). Pp. 90, 1900.

These two numbers in the "Scientia" series are useful little hand-books on their respective subjects. Their purpose is not the publication of new facts

or theories, but rather to give a clear, concise, and more or less elementary

discussion of the different phases of the subjects treated. Considering the space at the authors' disposal, this end is very well attained.

The first of the two books is a discussion of all the so-called irritable phenomena displayed by the living organism. After a brief but excellent introductory historical chapter, the morphology and chemical composition of living matter are treated in a very general way. A chapter is then given to the discussion of the external conditions, such as oxygen supply, heat, nutriment, etc., necessary for the performance of vital functions. Under the caption "Nutritive Irritability" the process of digestion is described, particular attention being given to the action of the different ferments. Under "Functional Irritability" are treated the subjects of animal heat, the phenomena of movement, including the various "taxes" and "tropisms," animal electricity and phosphorescence. Considerable space is devoted to the functions and activities of the nervous system, the subject being introduced by a somewhat doubtful comparison of the nucleus of the cell to the central nervous system. A section is given to the phylogenetic development of the nervous system. The final chapter takes up briefly the nature of irritability in general, from the standpoint of the chemical relations of protoplasm.

The other book, "L'Orientation," is psychological, both in point of view and treatment. Its purpose is to show how an organism's notions of its relations in space are developed. The term "orientation" is used throughout in this general sense of "space relation," rather than in the more ordinary restricted physiological sense of a particular sort of a reaction to certain stimuli. Such subjects as the muscle sense, the senses of active and passive movement, equilibrium, and tactile, visual and auditory space localization are discussed, among others. A chapter is devoted to the migratory and homing instincts of birds. These the author explains (?) as due to heredity and a well developed sense of direction.

R. P.

Levene, P. A.

I. On the Nucleoproteids of the Brain. *Arch. Neurol. and Psychopathol.* V. II, p. 1-14, 1899.

II. Iodine Compounds in the Tissues after Administration of Potassium Iodide. *Ibid.*, p. 15-20, 1899.

III. On the Absorption of Proteids (with I. Levin). *Ibid.*, p. 551-556, 1899.

IV. Embryochemical Studies. *Ibid.*, p. 557-565, 1899.

V. The Chemical Relationship of Colloid, Mucoid and Amyloid Substances. *Ibid.*, p. 571-573, 1899.

(Reprints dated 1900.)

This series of papers, while dealing with technical matters in the subject of physiological chemistry, are, on account of their breadth of view and clear method of presentation, of considerable interest to the biological reader. The first paper of the series discusses the chemical nature of the nucleoproteid or chromatin of the brain. Extracts of the brains from freshly killed calves were used. The nucleocompound obtained by this extraction was found to be a true nucleoproteid, differing from other nucleoproteids by its low percentage of phosphorous, by the nature of its xanthin bases, and by the large amount of proteids bound to its nuclein. There does not seem to be any evidence of more than one nucleoproteid in the brain, but on the contrary it seems probable that the chromatin of the cytoplasm (in the Nissl's granules of the ganglion cells) does not differ chemically from that of the nucleus.

The second paper deals with the question of how a drug acts on the cell, that is, whether by merely changing the physical condition of cell or tissue, or by forming new chemical compounds with the cell constituents. The method of attacking the problem was to examine the eggs, and finally the tissues of hens that had been given regularly certain doses of potassium iodide, in order to determine whether any actual combination of iodine with the cell substance had taken place. In the analysis of the eggs only iodides were found; that is, no iodoproteids had been formed. Analysis of all the principal tissues of the body gave the same result, so that it appears that the drug does not act by forming new chemical compounds.

The third paper in the series deals with the question of whether the proteid material is taken up from the digestive tract by the blood or by the lymph. The method employed was to inject into a ligated portion of the alimentary tract a certain amount of an artificially prepared iodoproteid. After some time the lymph of the animal was collected and tests for iodoproteid were made. In the eight experiments no iodoproteid compounds were found in the lymph, the work thus tending to confirm the old view that the proteids are absorbed by the blood.

The fourth paper describes some of the chemical changes which take place in the developing egg, the point of view being that, since in the process of development assimilation is greatly in excess of dissimilation, a chemical study of the egg at different stages ought to furnish a good opportunity for the working out of the synthetic processes in the metabolism of the organism. As material, cod-fish eggs were used. The results of analyses of eggs at different stages of development seem to indicate that the process of synthesis is preceded by decomposition, since immediately after fertilization the proteids decrease in quantity and basic nitrogenous substances are formed. Later the proteids grow in quantity and complexity. The amount of mineral salts in the egg increases with development.

The last paper in the series is a preliminary communication in regard to a technical point with reference to the relation or possible identity of colloid, mucoid and amyloid substances.

R. P.

CURRENT BACTERIOLOGICAL LITERATURE.

H. W. CONN.

Separates of papers and books on bacteriology should be sent for review to
H. W. Conn, Wesleyan University, Middletown, Conn.

Buchner. *Immunitat. Hyg. Rund.* II: 301, 1901. The dispute between the chemical and biological theory of immunity has been, in the last few years, carried on largely by the two leaders, Buchner and Metschnikoff, the former holding to the chemical theory of immunity, and the latter being the leading exponent of the biological theory. It has been evident that the two schools have, in recent years, been rapidly coming together, each of them admitting certain conclusions of the opposing school. In an address recently given by Buchner this harmony of the views is distinctly stated, and

Buchner admits that, though in earlier years he was inclined to place no weight upon the phagocytosis theory, he has in recent years come to believe that this theory of Metschnikoff represents a truth. The phagocytes are active agents in immunity, and produce their effect from the fact that they eliminate certain poisonous products which are the direct cause of the repressing action upon the invading bacteria. With this admission, the French and German schools are very close together. Buchner makes a further classification of these poisonous products produced in the animal body, showing that they are to be divided into two different types. One class is destroyed by a heat of 60° C, and the other is not destroyed by this temperature. He thinks that these two should be separated from each other and would call the first group, which can resist the temperature of 60°, by the name of alexines, while the latter group, which cannot resist this temperature, he calls "anti-bodies," (antikörper), for example anti-toxin, anti-hæmatin, etc.

H. W. C.

Sternberg, Carl. Zur Kenntniss des Aktinomycespilzes. Hyg. Rund. II: 297, 1901.

The author makes a study of three cases of actinomycosis in man, from which he succeeds in isolating three different cultures of Actinomyses. These cultures, when inoculated into guinea pigs and rabbits, produced typical abscesses in which great quantities of the fungus were found in form of rods. The author concludes that the species which he has described are identical with the Wolf-Israel Actinomyses although the results of animal inoculations are somewhat different. He believes that the Actinomyses species, liable to attack the human body, are two in number. One of these he has described, while the other is that described by Bostroem.

H. W. C.

Miscellaneous Studies of Cancer.

The whole of number 52 of the *Journal of the Boston Society of Medical Science* issued October, 23, 1900, is taken up with a report of the series of studies on cancer made at the Harvard Medical School. There are several distinct papers devoted to various aspects of the problem. The problems considered include, statistics of cancer; the etiology of cancer; a report on the presence of "Plimmer's Bodies" in cancer; the study of tumors and sporozoa in fishes; a paper, with a figure, on a reconstruction of a cancer nodule, and a series of reports on culture experiments made with carcinomatous tissue. The papers are useful as giving an outline of various facts known, but they reach no positive conclusion as to the cause of this mysterious disease.

H. W. C.

G. d'Arrigo. Ueber die Gegenwart und über die Phasen des Kochschen Bacillus in den sogenannten skrophulösen Lymphdrüsen. Hyg. Rund. II: 292, 1901.

By improving his method of technique the author has made a careful study of scrofulous glands for the purpose of determining to what extent they are tuberculous in origin. His general conclusion is that all so-called scrofulous glands are tubercle lesions. He further finds that in ages from four to twelve years the cervical and sub-axillary glands are most liable to be affected, while in later life the axillary glands are more commonly attacked. The author further finds that the bacilli in scrofulous glands have certain morphological peculiarities.

H. W. C.

Busquet. Transmission de la tuberculose par les timbrespost. Hyg. Rund. II: 289, 1901.

The author has described a new source of distribution of tuberculosis by postage stamps which the collector of postage stamps moistens with his tongue for the purpose of sticking them into stamp albums. A case of tuberculosis having such a source was brought to the author's attention, the patient being a soldier, who was a stamp collector. The author, thinking that the stamps were possibly the source of the trouble, made careful studies of these stamps, inoculating guinea pigs with a watery solution made from them, and in every case the animals showed tuberculosis. The author thinks that this is a new source of distribution which should be guarded against.

H. W. C.

Leclainche and Vallée. Etude comparee du vibriion septique et de la bacteries du charbon symptomatique. Ann. de l'Inst. Past. 14: 590, 1900.

After alluding to the close biological relations of the bacterium of symptomatic anthrax and the septic vibrio, the authors state that it is possible to distinguish the two microbes for, while the septic vibrio produces long forms both in the serum of the specific oedema and in the peritoneal sac of guinea pigs, these are constantly absent in the case of symptomatic anthrax. The same methods for immunising against anthrax are applicable to the vibrio, and the immunising serums are in both cases rigorously specific. The same holds good for agglutination by these serums. Animals vaccinated against anthrax are not immunised against the vibrio; and, reciprocally, vaccination against the septicæmia does not protect against anthrax.

H. W. C.

Funck. A Preliminary Note on the Etiological Agent in Vaccinia and Variola. Brit. Med. Jour., p. 448, 1900.

The author claims to have finally solved the problem of the specific agent in vaccine virus and variola. According to his views this is not a bacterium, but a protozoon, belonging to the group of Sporozoa, which the author has named Sporidium vaccinale. This protozoon he finds uniformly present in the vaccine pustules, as well as those of variola. He finds that vaccine material, treated in such a way as to render it impossible for bacteria to live, still contains these protozoa. The most significant part of his work consisted in separating the organisms in question, in what seems to be a pure culture. His method is as follows: In the pustules he finds that the protozoon produces sporocysts which are of tolerably good size. These sporocysts are large enough for him to fish out successfully with a platinum needle. He then places them in a small amount of sterilized agar and makes an emulsion with a sterilized liquid. Such an emulsion he found capable of reproducing the disease, and he is convinced, consequently, that this protozoon is the long sought cause of variola and, probably therefore, of small pox. If these conclusions are correct, they will doubtless inaugurate an new era in the study of small pox.

H. W. C.

Fisher, Alfred. Die Empfindlichkeit der Bakterienzelle und das baktericide Serum. Zeit. f. Hyg., 35: 1, 1900.

Fisher has, in this paper, published a very pregnant series of experiments bearing upon the problem of the alexines in the blood. Fisher is clearly of the opinion that the destruction of bacteria

in fresh blood is to be explained upon some other ground than the presence of poisonous substances, which Buchner has called alexines. Fisher's experiments have been in the line of transferring bacteria from one culture medium to another containing a larger amount of salt, and in all cases he finds that the change from one medium to another is followed by a granulation of the protoplasm in the bacteria body, and a greater or less destruction of the bacteria, quite similar to that which has been described under the influence of the so-called alexines. Fisher experiments with a large number of micro-organisms, stationary and motile, including all types. He finds that this granulation, which he calls "plasmotyse," is a very common occurrence, as the result of a change in culture media. He believes that it is due to purely physical phenomena affecting the protoplasm and is, therefore, not inclined to place much weight upon the action of alexines.

H. W. C.

Gromakowsky. Varieties of Pseudodiphtheria Bacilli. Cent. f. Bac. u. Par. 1, 28: 136, 1900.

The author states that there are three kinds of pseudodiphtheria bacilli, which are distinguishable by their cultural characters and by their growth in bouillon: (1) A relatively thick rodlet of variable length, which does not render bouillon turbid. It resembles Loeffler's bacillus in staining by Neisser's method, and in the acid reaction which it develops in bouillon. Its distinguishing characters are its large size and its cultural appearances. (2) A rodlet, of medium thickness and length, which after 25 hours at 36° C, renders bouillon markedly turbid and causes a copious deposit. Morphologically and culturally, it closely resembles Loeffler's bacillus. Its distinguishing feature is the absence of acid reaction in bouillon and a negative Neisser staining. (3) A short, thin rodlet which causes only slight cloudiness in the medium and a scanty deposit. It has some resemblance in appearance to Loeffler's bacillus.

H. W. C.

Clowes and Houston. The Bacterial Treatment of London Sewage. Brit. Med. Jour. p. 287, 1901.

In a report on the general subject of London sewage, bacteriological examination is made to determine whether the bacterial method of treating sewage, which is now coming to be so widely adopted, is efficient in removing bacteria as well as chemical products. The conclusion reached is that, although the water may be chemically purified, it is hardly improved, so far as concerns bacteria. Crude sewage, which contains seven million bacteria before treatment, contains about five millions afterward, a reduction of only thirty per cent. The reduction in number of coli bacillus is about the same per cent., a fact which indicates, of course, that if the sewage contains typhoid bacilli, the treated sewage will also contain them, only in somewhat less numbers. In other words, the bacteria treatment of sewage has practically no influence in rendering sewage less likely to distribute sewage borne diseases.

H. W. C.

NOTES ON RECENT MINERALOGICAL LITERATURE.

ALFRED J. MOSES AND LEA McI. LUQUER.

Books and reprints for review should be sent to Alfred J. Moses, Columbia University, New York, N. Y.

tenSiethoff, E. G. A. Eine einfache Construction der sogenannte Interferenzkreuzes der zweiaxigen-Krystalle. *Centralblatt für Mineral. Geol. und Palaent.* 267, 1900.

The accompanying rough tracing from ten Siethoff's diagram will illustrate the simple method taken to make clear the interference cross in

biaxial crystals. As is well known, this dark cross or curve obtained between crossed nicols is not due to interference, but to the total extinction of all rays the vibration directions of which are parallel to the vibration direction of either nicol. In the diagram the little crosses represent the vibration directions (with

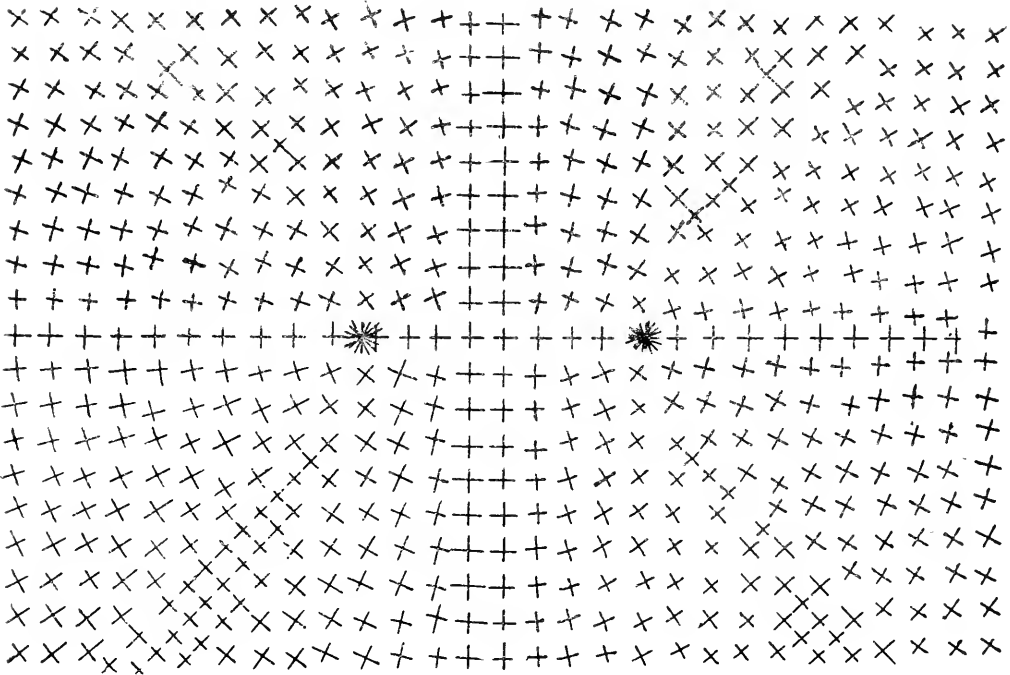

convergent light) of the different rays emerging from a section cut normal to a bisectrix; the ★ points are the optic axes. As the plate is turned, the vibration directions of different rays, that is, different series of little crosses, move into parallelism with the vibration direction of the nicols, and together make up the hyperbola or the cross. By turning the diagram, while resting on a pad the edges of which may represent the vibration directions of the nicols, the series of little crosses parallel to the edges of the pad at any moment is easily observed. The fact that with an optic axis in the field the rotation of the plate in one direction

about this axis is accompanied by a rotation of the dark brush in the opposite directions, is shown in the same manner. Minor facts, such that one arm of the cross is broader than the other, and that the hyperbola branches broaden the further we go from optic axis, may also be shown.

A. J. M.

Schenck, R. Ueber die Dynamik der Krystalle.
Centralblatt Min. Geol. Palaen. 313, 1900.

Starting with the proposition that, "with crystallized material the free physical and chemical energy is dependent on the direction," the writer assumes that all equations involving vapor pressures are valid for solution pressures since there is perfect analogy between these pressures. If, then, any crystal is considered to be a volatile chemical substance with different crystal faces, and if all but two of these faces are coated with a layer which hinders vaporization, then on these two free faces there will be different pressures. If A possesses the higher pressure and B the lower, then A yields vapor, or crystal molecules, until the surrounding medium is saturated therewith but the medium being supersaturated for B T, the vapor, or crystal molecules, condense on B T. If the vapor pressure at both faces is known, the work done in transporting one gram-molecule from one crystal face to another can be calculated. A system of formulæ are given which practically apply the principles of thermodynamics to crystallographic problems. As a practical example, crystals of potash alum were coated with shellac, but on some the octahedral faces were not covered, on some the cube faces, and on some the dodecahedral faces. The velocity of weathering at constant temperature and per square centimeter surface of each of three crystal faces was determined. The *relative* water yield per square c. m. for octahedral, cubic and dodecahedral faces at 35°C was 1 : 1.27 : 1.60; at 50°C about four times as much water was yielded, but the relation for octahedral and cubic faces remained nearly the same, viz., 1 to 1.25.

A. J. M.

Grünling, Fr. Ueber die Mineralvorkommen
von Ceylon. Zeit. f. Kryst. 33: 209-239,
1900.

Dr. Grünling was sent by the Tamnau-Stiftung of Berlin on a collecting tour to Ceylon in 1896. He describes the mineral localities, the history of the occurring species, and the native method of cutting, and gives a bibliography and map and statistics of production of pearls, rubies, etc. The species obtained included apatite, phlogopite, hydrophlogopite, serpentine, pyrite, spinel, graphite, ruby, sapphire, chrysoberyl, zircon, tourmaline, sillimanite, moonstone, garnet, and rutile.

A. J. M.

Melzer, G. Ueber einige Mineralien vorwie-
gend von Ceylon. Zeit. f. Kryst. 33: 240-
262, 1900.

Determines forms and axial relations of Ceylon chrysoberyl, as well as twinning law and optical characters, and compares with Brazilian and Siberian chrysoberyls. One crystal of sillimanite from Ceylon was exceptionally fine. It was a *transparent*, grayish blue prism, with excellent cleavage in one direction. $H=6\frac{3}{4}$ $G=3.249$. A plate was cut from the center perpendicular to the length, and about $2\frac{1}{2}$ m.m. thick, which gave a beautiful axial figure with $\rho > v$. In the Abbe Refractometer this yielded :

| | γ | β | α | $2V$ from $\alpha \beta \gamma$ |
|----|----------|---------|----------|---------------------------------|
| Li | 1.6730 | 1.6542 | 1.6527 | $31^{\circ}48\frac{3}{4}$ |
| Na | 1.6766 | 1.6576 | 1.6562 | $31\ 11\frac{1}{2}$ |
| Tl | 1.6801 | 1.6611 | 1.6597 | $30\ 38\frac{1}{2}$ |

By measurement in the Fuess apparatus.

| | $2V$ |
|----|---------------------|
| Li | $31^{\circ} 19$ |
| Na | $30\ 57$ |
| Tl | $30\ 35\frac{1}{2}$ |

The pleochroism was :

For vibration parallel $c(=\bar{c})$ deep blue with feebly violet tone.

“ “ “ $a(=\bar{b})$ pale yellow to brownish yellow.

“ “ “ $b(=\bar{a})$ feeble green to gray green.

The transparent blue spinel of Ceylon was also examined optically and as to form.

A. J. M.

vonWorobieff, V. Krystallographische Studien über Turmalin von Ceylon und einigen anderen Vorkommen. *Zeit. f. Kryst.* **33**: 263-454, 1900.

After a historical review with bibliography the author proceeds to a careful examination of some hundreds of fine

crystals obtained by Dr. Grünling in Ceylon, and now in the Berlin museum, and also others from other museums. The entire recorded series of forms are compared and tabulated by zones, and with respect to antilogous and analagous poles. *One hundred and thirty-one* new forms are recorded, and a discussion of the relation between crystal form and pyro-electrical behavior of tourmaline in general is given, and finally the conclusion is reached that the mineral belongs to the ditrigonal-pyramidal class of symmetry.

A. J. M.

Goldschmidt, V., and Preiswerk, H. Chrysoberyllzwilling von Ceylon. *Zeit. f. Kryst.* **33**: 455-467, 1900.

Good illustrations of two-circle measurement and calculation.

Goldschmidt, V. Zur Theorie der Zwilling- und Viellingsbildungen. *Zeit. f. Kryst.* **33**: 468-476, 1900.

Smith, G. F. H. A Three-Circle Goniometer. *Min. Mag.* **12**: 175, 1899.

The object of goniometrical measurement is to determine in the simplest and quickest manner the geometrical constants of crystals, and the indices of their faces. The relative advantages and disadvantages of the *one-* and *two-*circle goniometers are pointed out, and the author states that the advantages of both instruments may be combined by the addition of a third circle. A detailed description of the instrument is given (with plate) and the method of use described, some actual readings being recorded.

L. McI. L.

Smith, G. F. H. Note on the Identity of Paralaurionite and Rafaelite. *Min. Mag.* **12**: 183, 1899.

The oxychloride of lead rafaelite (described by Arzruni) proved to be identical with paralaurionite by comparison of angles, made by twinning and optical characters, the only difference being in the color, P. being white while R. is violet-red, and shows strong pleochroism. Axial ratio of P. $= a : b : c = 2.7036 : 1 : 1.8019$.

L. McI. L.

MEDICAL NOTES.

Robin, A. A Contribution to the Technic of the Widal Test. Phila. Med. Jour. 7: 11.

Four problems present themselves to the bacteriologist who attempts to perform the Widal test in the diagnosis of typhoid fever, viz.: 1. The dilution. 2. The best way of obtaining a motile culture free from "natural" clumps. 3. The differentiation between a true and a pseudo-reaction. 4. The time limit.

To these problems Dr. Robin offers solutions which in his experience have proved most practical and satisfactory.

1. Accurate dilutions are obtained by means of the simple medicine dropper device (Fig. 1) described in Vol. III, No. 8, p. 962 of the JOURNAL.

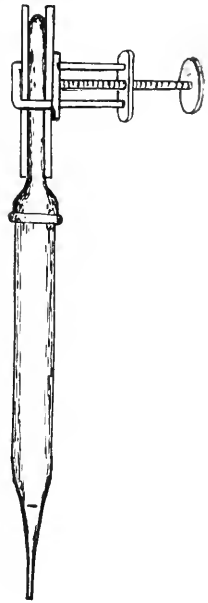

2. Motile organisms may be readily obtained for the test by keeping at hand pure cultures of typhoid bacilli in hermetically sealed tubes. When a test is to be made a fresh agar or bouillon culture is made from the stock culture and kept in the incubator for eighteen to twenty-four hours. It was found that the temperature of a fairly warmed room produced just as good if not better results than the incubator. The author deems the bouillon culture unsatisfactory and has adopted the following medium: An agar culture is kept in the incubator or at room temperature for twelve to eighteen hours, when two or three loopfuls are transferred into bouillon until a marked turbidity results, or a small quantity of bouillon is added to the agar culture and enough of the growth scraped off to produce a uniform cloudiness. The latter course is preferable and if carefully followed the "natural" clumps so frequently observed in bouillon cultures (Fig. 2 B) are entirely avoided.

3. The third problem is met by using a slide with two concavities (Fig. 3), around the edges of each of which is a ring of vaseline. On each of two clean cover-glasses is deposited a loopful of the culture; to one a loopful of the blood, diluted 1:20 to 1:40, is added, while the other serves as a control. The behavior of the bacilli on each cover may be readily observed. If the reaction is positive the bacilli on the test cover will gather in clumps of two, three or a dozen and will soon lose their motility (Fig. 2 D), while in the pseudo-reaction only a few clumps will form, the rest of the bacilli remaining separated (Fig. 2 C).

4. The time given to determine whether a reaction is positive or negative varies greatly with different bacteriologists. Dr. Robin proposes the adoption of a uniform limit and offers the following: Dilution 1:10, time limit 5 to 15 minutes; 1:20, 15 to 20 minutes; 1:40 to 1:100, 30 to 60 minutes; 1:100 to 1:200, 1 to 2 hours. That is, if within the specified time a considerable number of bacilli are found actively motile or, if dead, fail to arrange themselves in clumps, the reaction is negative, irrespective of the clumps which have already formed.

c. w. J.

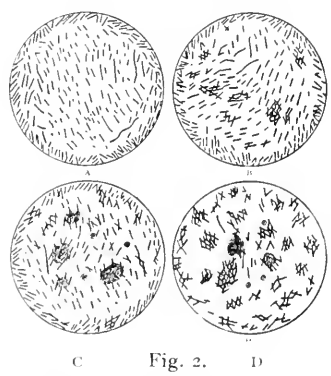

Fig. 2.

Fig. 1.

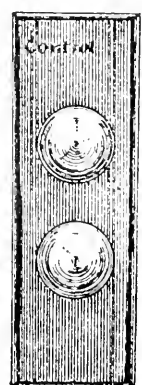

Fig. 3.

NEWS AND NOTES.

It is recommended in the study of infusoria to use, in place of powdered carmin, water-color carmin. The infusoria are added to a drop of water in which a very small quantity of the stain has been dissolved.

In the study of the mouth parts of the crayfish very satisfactory results have been obtained by sewing the parts, in their proper order, to a piece of stiff linen paper. Thus mounted the parts may be preserved in vials in 3 per cent. formalin, and be ready at any time for study in connection with the whole specimen.

A CONVENIENT TABLE FOR FORMALIN SOLUTIONS.

100 % formalin = 40% formaldehyde, usual strength of commercial solutions.

| | | | | | | | | | | | | | | |
|-----|---|---|-------|---|---|-----|---|---|-------|---|---|---|-------|---|
| 50 | " | " | = 20 | " | " | = 1 | " | " | + 3 | " | " | " | = 4 | " |
| 25 | " | " | = 10 | " | " | = 1 | " | " | + 7 | " | " | " | = 8 | " |
| 12½ | " | " | = 5 | " | " | = 1 | " | " | + 9 | " | " | " | = 10 | " |
| 10 | " | " | = 4 | " | " | = 1 | " | " | + 12½ | " | " | " | = 13½ | " |
| 7½ | " | " | = 3 | " | " | = 1 | " | " | + 19 | " | " | " | = 20 | " |
| 5 | " | " | = 2 | " | " | = 1 | " | " | + 39 | " | " | " | = 40 | " |
| 2½ | " | " | = 1 | " | " | = 1 | " | " | + 99 | " | " | " | = 100 | " |
| 1 | " | " | = 0.4 | " | " | = 1 | " | " | | " | " | " | | " |

The Biological Department of Earlham College has recently issued Bulletin No. 1, containing fifty-five excellent photo-micrographs of fertilization, maturation, and segmentation stages of ascaris, and the development stages of the chick. The illustrations, together with the running description accompanying them, briefly and concisely summarize the steps in embryological development from the unfertilized egg to the union of the alantois with the alimentary canal.

Referring to Mr. H. A. Doty's article on "Conochilus and Vorticella as Commensals" (J. A. M. 3: 989), Mr. H. D. Thompson of Moline, Ill., notes the following observation :

"For some years I have been wont, when other methods failed me, to obtain Vorticellæ for class use by collecting quantities of cyclops, with a small muslin net, from a certain spring hole. The Vorticellæ, living in great abundance on these cyclops specimens, are invariably provided with a short stalk, which is only slightly contractile, and incapable of assuming the usual spiral posture."

PHELN'S METHOD OF STAINING THE MALARIA PARASITE.—Wash the fixed specimens for three or four minutes in absolute alcohol, after which they are stained for five or six minutes in the following solution :

| | |
|---|----------|
| Methylen blue, conc., aq. sol., | 15 |
| Eosin, ½ per cent. sol. in alcohol, 75 per cent., | 5 |
| Water, dist., | 10 |
| Sodium hydrate, 20 per cent., | 3 drops. |

After thorough washing in water, mount in Canada balsam.

A COMBINED SLIDE AND COVER-GLASS FORCEPS.

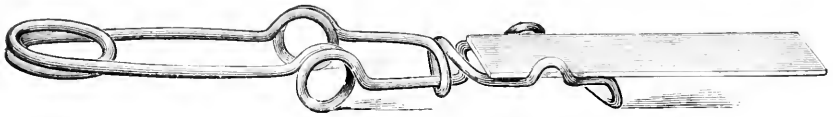

Fig. 1.—The forceps with the slide locked in position.

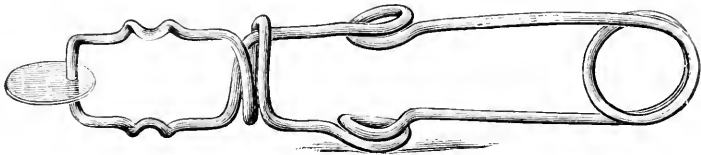

Fig. 2.—As a cover-glass forceps.

The forceps illustrated was devised by Mr. L. Napoleon Boston, Philadelphia, and combines in a single instrument both a slide and cover-glass holder. It is made of brass wire. A slide is easily picked up from a smooth surface and held as shown in Fig. 1.

We recently received a copy of the preliminary announcement of the fiftieth annual meeting of the American Association for the Advancement of Science, to be held at Denver, August 24 to 31, 1901. The announcement contains lists of officers and members of the association, and a general programme of the coming meeting. Care has been taken in the preparation of a guide to the city of Denver, embracing hotel accommodations, excursions to points near Denver, and points of interest within the city.

QUESTION BOX.

Inquiries will be printed in this department from any inquirer.
The replies will appear as received.

10. How should the solution of gutta percha in turpentine, recommended by V. A. L. for cementing liquid mounts, on page 712 of JOURNAL OF APPLIED MICROSCOPY, be made?—I. D.

11. For what kinds of vegetable tissues are Amann's media (pp. 711-2 of JOURNAL OF APPLIED MICROSCOPY) suitable? Are they useful for hydrous tissues, or must tissues be dehydrated prior to mounting in them?—I. D.

12. F. M. L. wishes to secure specimens of *Selaginella lepidophylla* alive and producing spores. Can any of our readers supply such specimens?

Journal of Applied Microscopy and Laboratory Methods.

VOLUME IV.

SEPTEMBER, 1901.

NUMBER 9

Laboratory Courses by Correspondence.

Not every one who desires an education finds it possible to spend three or four years at a university. Many teachers with only a high school education hold good positions which they would not feel justified in resigning for an extended course of study. Correspondence courses carefully planned by competent instructors enable such teachers, while still holding their positions, to devote some time to a systematic study of branches connected with their work, and thus to increase their own knowledge and at the same time be better prepared to instruct their pupils. Those who are working for university degrees, but are compelled to spend the shortest possible time in residence at the university, find in the correspondence system a solution of the problem. Others who are neither teachers nor university students are deeply interested in particular subjects: such people, even when relying entirely upon their own resources, will advance along the chosen line, but progress is more rapid and satisfactory when efforts are systematized and directed by those who have often traversed the ground before.

It has for some time been recognized that many university courses can be pursued successfully by correspondence. The favorable results secured in language, literature and history suggested that an attempt be made to conduct laboratory courses also.

Several years ago the writer was asked to conduct a course in botany by correspondence. With many misgivings as to the success of any laboratory study by this method, a course in the Morphology of Algæ and Fungi was planned and the work was begun with a single pupil. The result soon showed that a persistent student could do the work thoroughly in spite of the difficulties.

Several courses were then announced, each course being the full equivalent of the same course as conducted at the university. The following is the general plan for the Algæ and Fungi and the other two morphological courses are similar: Material, selected with extreme care, is sent to the student and all preparations for the microscope which require a knowledge of technique are also included. The directions for study are in the form of twelve lessons, each lesson covering three laboratory exercises as conducted at the university. In the laboratory work more than fifty types are studied, and these are arranged so as to

give a view of the structure, development and relationship of all the great groups of Algæ and Fungi. The lack of lectures is compensated for by assigned readings and the study of a larger number of types. As soon as a lesson is completed, it is sent to the instructor, who returns it with corrections and suggestions.

Three courses in botany. (1) General Morphology of the Algæ and Fungi, (2) General Morphology of the Bryophytes and Pteridophytes, and (3) General Morphology of the Gymnosperms and Angiosperms, have been thoroughly tested by the writer, nearly a hundred students having taken the work. The results are surprising. Many students after taking one or more of these courses by correspondence have come to the university for further work, and have not only been able to hold their own in classes with students who had done the previous work in residence, but, on the whole, have shown a more thorough preparation.

However, it must not be inferred that correspondence work is preferable to residence work, for such is not the case. The explanation is to be sought in the fact that those who have sufficient interest and determination to carry on a course by correspondence are willing to devote more time and effort than can be required of the average university student. It is particularly noticeable that correspondence students, when they come for resident work, are more independent and ask fewer thoughtless questions than those who have always had an instructor at the elbow. Several who have laid the foundation for morphological work by correspondence have subsequently come to the university for research work, and have published excellent papers, and two have even taken the doctor's degree, with botany as the major subject.

After the success of these courses became evident, a course in histological technique, preëminently a laboratory course, was offered and has proved a success. Work in the newer, but very popular field of Ecology, is also being conducted satisfactorily by correspondence.

In looking over the list of those who have studied botany by correspondence, it is interesting to note that, aside from the teachers and students who form the great majority, there are also lawyers, business men, clerks and artisans, who have found time to improve themselves in their chosen subject.

The success which has attended the correspondence work in botany suggests that in other sciences also those laboratory courses which do not require very expensive apparatus may be conducted by this method.

University of Chicago.

CHARLES J. CHAMBERLAIN.

DR. W. BURCK, of the Royal Academy of Sciences of Amsterdam, has recently published some observations bearing upon the subject of the prevention of hybridisation in plants. His experiments showed that certain chemical substances act very differently on the pollen of different plants. Levulose in small quantities greatly accelerates the growth of pollen tubes in some plants, while in others the pollen grains are caused to burst. Saccharose and dextrose produce different effects than levulose. According to the author's interpretation these results would indicate the possibility that the stigmatic secretion of a given species contains substances which promote the emission of pollen tubes in that species, but prevent the growth of pollen from other species.—*Nature* 64: 1656.

LABORATORY PHOTOGRAPHY.

Devoted to methods and apparatus for converting an object into an illustration.

PHOTOGRAPHING DIATOMS.

In photographing diatoms at the University of Iowa the apparatus used is of the simplest character. It consists primarily of a "Practical" photomicrographic camera, a microscope furnished with a mechanical stage, apochromatic lenses, and with compensating and projection eyepieces. The remainder of the apparatus is mostly home made and consists of a table, condensing lenses suitably disposed, an acetylene generator, and simple lamp or burner.

The camera is hinged so that it may be used in either a vertical or horizontal position. I find this very convenient, as the bellows may be quickly raised to allow the operator to make a direct examination of the object. The working lens is a dry apochromatic, 3mm. of .95 N. A. A compensating eyepiece No. 8 and a projection eyepiece No. 4 are the oculars used. The table, which serves the purpose at once of camera table and optical bench, is about three feet six inches long. The width is about sixteen inches and the height so adjusted that when the operator sits in a chair the ocular is in a convenient position for observation.

When making an exposure the bellows is turned down and rests on the leaf of the table, which for this purpose is raised to a horizontal position.

The condenser is composed of two plano-convex lenses two and one-half inches in diameter, an achromatic pair two and one-fourth inches in diameter, and a one-inch negative to effect the parallelism of the rays. The spherical and chromatic aberration of the first system of condensers is in a large measure corrected by this simple device; and, although it is conceded that every additional lens is in a sense an added obstacle, nevertheless the advantage to be derived from the introduction of the negative in the series at this point will quickly become apparent to anyone who chooses to try the experiment.

No heat filter is necessary with acetylene gas as the illuminant. As is well known, this light is remarkably cool. The substage condenser is a plain, uncorrected Abbe.

A small acetylene generator and a *round flame* burner complete the outfit. I have adopted the round flame burner after a series of experiments involving every other form of burner offered by the trade. I certainly consider it the most desirable and efficient.

In the present discussion I shall assume that the material to be photographed is properly mounted in well cleaned styrax on cover-glasses of known thickness. For mounting the larger species a mechanical finger will be found convenient, as such species should be mounted singly. In photographing from spreads I pro-

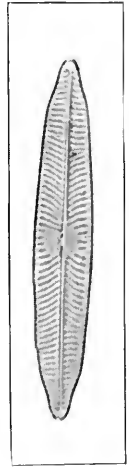

Fig. 1.

ceed as follows: By the aid of the mechanical stage I carefully review the entire slide, noting the location of every suitable specimen of the species desired, of all species not yet photographed, and their degree of perfection. Such specimens should lie in optical contact with the lower side of the cover-glass, be clearly marked and free from foreign matter. These observations are

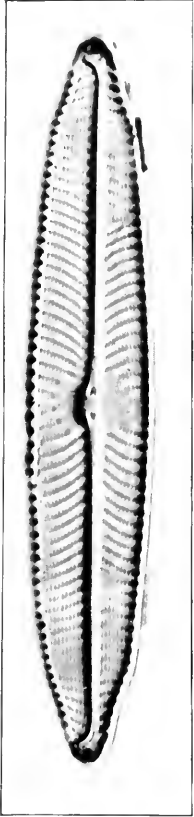

Fig. 2.

recorded with the readings of the mechanical stage, and by use of the record at any subsequent time the desirable specimens may be turned to readily and photographed without loss of time. This search work may be done by daylight or, what I consider an exceedingly good substitute, by means of the acetylene lamp with a rather dense ray filter interposed. The filter, which has given me excellent results, is simply a flat eight-ounce bottle filled with a fluid composed of 175 grams of copper sulphate, 17 grams potassium bichromate, 2 c. c. sulphuric acid and 500 c. c. of water. The color is restful and agreeable to the eyes, and the density is not sufficient to interfere in any serious way with accurate vision or inspection.

Focusing and adjusting for cover-glass thickness can be learned by experience only. As is well known, however, both arts are of the most vital importance. In this paper I shall not endeavor to give any advice on these two points except merely to mention a little matter that I have never seen elsewhere stated and which has been of great service to me. In my experience the microscope is always horizontal; this is the convenient position.

One day when working at the instrument I discovered that when I placed my fingers on the milled head of the fine adjustment screw, there ensued an alteration of the focus although the head had not been turned. Further investigation brought out the fact that the alteration was due to a springing of the arm induced by a downward pressure on the milled head, and that when the finger was removed the object came again into perfect focus. I also found that a slight pressure upward caused the object to pass out of focus in the opposite direction.

This proved to be an exceedingly delicate test of the correctness of the focus. If perfectly focused the error produced by this slight pressure is equal in both directions; but if not perfectly focused the error will be more evident in one direction than in the other. This apparently commonplace and trifling matter is well worth the attention of anyone who attempts the photography of these very delicate and difficult forms.

The time of exposure will, of course, vary according to conditions. I use two different amplifications, 660 diameters and 1320 diameters. All my photographs are made at 660 diameters unless the objects are very small or are adorned with very fine striae. When the forms are large and marked with fine striae two photographs are taken; one to show simply the outline, and the other at the

higher magnification and with oblique illumination to show details, as in Figs. 1, 2 and 3.

The exposure is made as short as possible without sacrificing detail; then, if the plate be strongly developed the requisite contrast will be secured. I find, too, that it is best to make two exposures of each specimen.

On removing the plate from the holder a number is placed on one corner with a soft lead pencil, say Dixon's "Ultimatum" or one similar to it. This number is also placed in a book kept for the purpose with the name of the species, date, magnification, light, number of slide, and location. With these data it is an easy matter to re-photograph any particular specimen if at any time the negative be lost or broken, or if for any reason it prove unsatisfactory.

I have experimented with every developer to be had here, and have tested many formulas, but none of them is equal to the one known as Bromo-hydroquinon. It gives the requisite amount of contrast, a thing to be kept constantly in mind in photographing objects so very hyaline as are diatoms.

For a fixing bath plain hypo seems to give better results than the acid alum bath.

Any good plate will answer the purpose providing it is *heavily coated*: my preference, however, is "Cramer's Instantaneous Isochromatic." Let me say again, a thin plate will not answer. In order to economize, I get the 4 x 5 plates and then cut them once or twice as the size of the diatom demands; i. e., the plates are then $2\frac{1}{2} \times 2$, or $2\frac{1}{2} \times 4$. When dry they are put in appropriate envelopes, filed away in alphabetical order, and a full record of each one is kept in a card index.

Most diatoms lend themselves readily to photography, the side of the valve which is most important usually being nearly plane. Some, however, are more or less convex or concave. Figure 5 represents a species that has a ridge just inside the margin and a depressed center. This of course necessitates a compromise, with some loss of detail. Only a very few species of the fresh-water forms, however, are impossible of photography as here described.

As is well known, *Navicula* is the typical genus of the Bacillariaceæ, with hundreds of species; these come out beautifully, as is attested by Fig. 4.

Previous to printing, the negative is placed in a retouching frame and the background is all cut out by the application on the back of a heavy coat of "Copelin's Opaque." This cuts out everything but the image desired. For printing, all sorts of paper have been tried. Among those that I have used, of the developing sort, Velox, and of the printing sort, Solio, seem to give the best results. I have discarded Solio, however, on account of its slowness. In print-

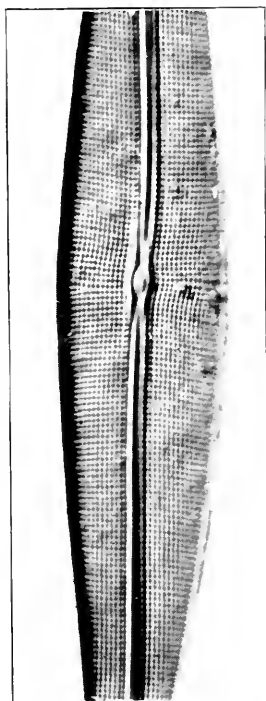

Fig. 3.

ing on Velox I proceed as follows: Six frames are prepared and arranged on the six sides of a hexagonal wire frame on which are stretched two thicknesses of white tissue paper.

This screen is about six inches in diameter, six inches deep, and open at the top. The printing frames are placed at irregular distances from the screen, according to the density of the plate in each case.

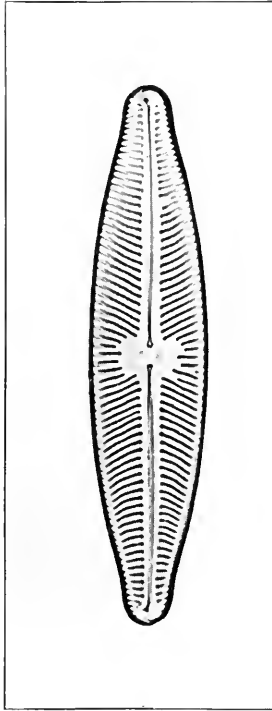

Fig. 4.

A bit of magnesium ribbon about one and one-half inches long is then ignited in an alcohol flame and instantly placed within the screen near the center. This prints all six pictures at once and they are ready to be developed. The screen prevents the edge of the opaque from printing up as a sharp line. The use of the magnesium light greatly increases the rapidity with which the prints may be produced and also contributes not a little to the sharpness of the image.

Of course, with the simple appliances here described, the highest degree of critical photography may hardly be attempted. Nevertheless, it may be readily seen, from the samples herewith submitted, that illustrations may easily be secured, sufficiently accurate for practical purposes. No doubt a better apparatus is a thing to

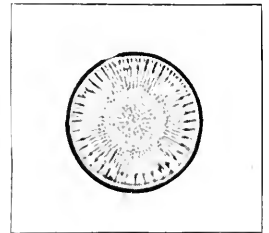

Fig. 5.

be desired. But, if the matter of expense must be taken into account at all, the apparatus which we have here described and successfully used will commend itself to many who might be prevented by the consideration of cost from attempting experiment in this most fascinating field of work. The results of our labors in this direction will form the subject of a descriptive paper presently to appear in the Bulletin of the Laboratories of Natural History of the State University of Iowa.

P. C. MYERS.

University of Iowa.

THE 5 mm. APOCHROMAT, AFTER PROF. CHARLES S. HASTINGS, IN THE PHOTOGRAPHY OF DIATOMS.

We are in receipt of a very interesting series of photo-micrographs of diatoms from Honorable A. A. Adee, Washington, D. C., made while testing a 5 mm. apochromatic objective after the formula recently computed by Prof. Charles S. Hastings, Sheffield Scientific School, Yale University.

The following brief notations, in connection with data which show subject,

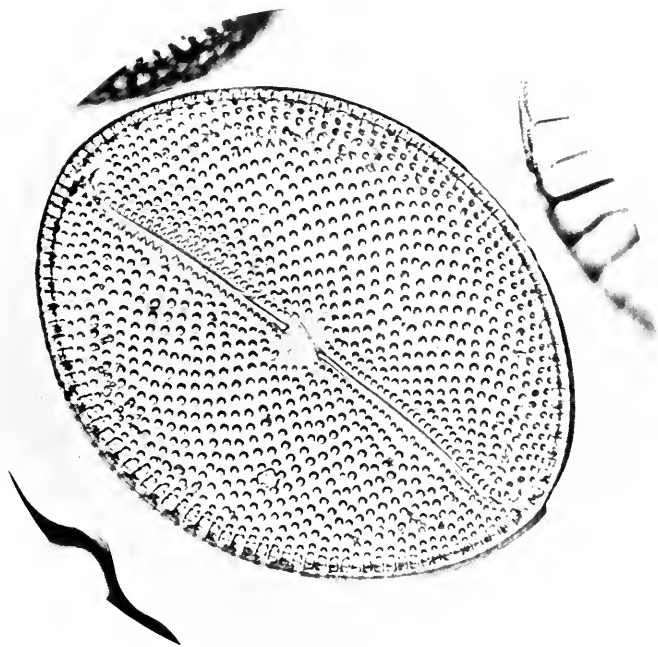

Orthoncis splendida, Grunow.

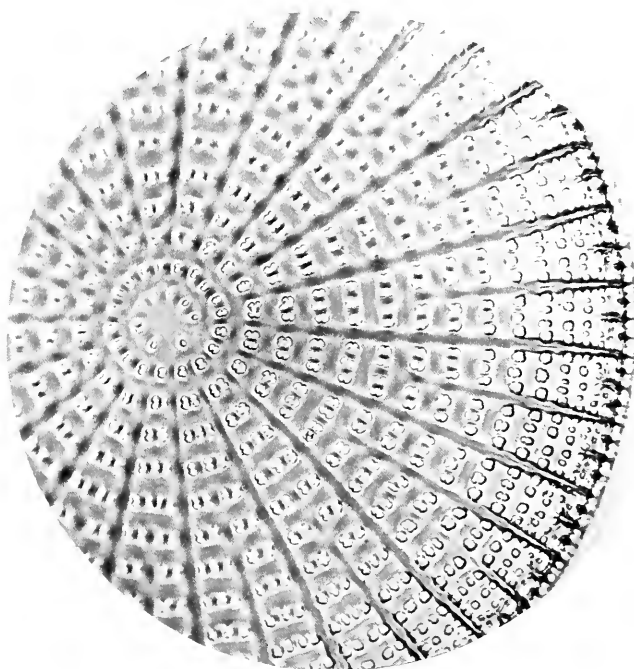

Arachnoidiscus indicus, Ehrh.

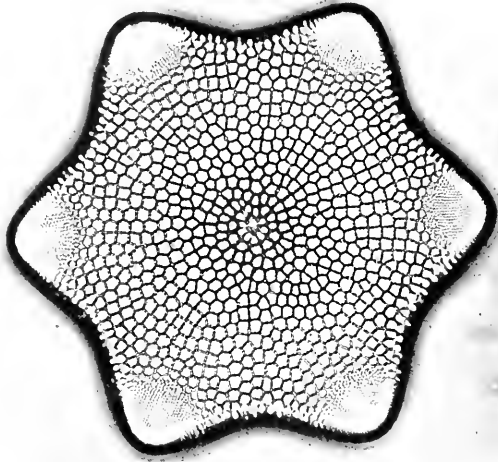

Triceratium tripolare, Temp Br.

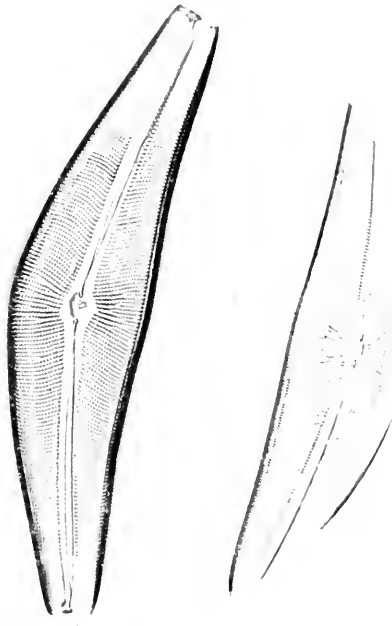

Cymbola mexicana, Ehr.

accessory apparatus, illuminant, etc., used, are interesting as showing advance made by American opticians in constructive optical mathematics and the possibilities of the application of theoretical conclusions in the production of an apochromatic objective system, without the use of other materials than the glasses ordinarily employed :

“ Although I cannot claim any expert knowledge of optical science, my experience during the past six years in difficult photo-micrography may make my test of this glass in the camera of some worth to you. I find it superior in working quality to any lens of apochromatic focus I have yet tried except the Zeiss apochromatic of 4 mm., and as to that it holds its own for photographing. The correction for actinic rays is surprisingly good, so that exquisite definition is obtainable, even with a projection ocular No. 4, and it does not bring it down under a compensation ocular No. 8. Notwithstanding the extremely wide aperture, the field is perfectly flat, so that perfect photographic definition is obtained to the edges of a large circle on the focusing screen. It bears more light than any others I have tried, and I can open the condenser and diaphragm at least 40 per cent. more than with the other glasses, and still get excellent photographic contrast.

“ The focus of this lens appears to be a trifle less than 5 mm., about 4.65 mm., as nearly as I can estimate it by comparison of the negatives with it, and the Zeiss 4 mm.”

L. B. E.

The New Medical Laboratories of the University of Pennsylvania.

The University of Pennsylvania is about to erect, at a cost of more than \$500,000, exclusive of grounds and equipment, a Medical Laboratory building which will be unexcelled in every respect. The trustees are also contemplating the erection in the near future of a new Medical Hall, Anatomical Building, and auxiliary buildings, which will adjoin the new laboratory about to be erected, and which will form one of the most extensive systems of buildings devoted exclusively to the teaching of medicine in Europe or America.

The new Medical Laboratory building, which will be erected at once, will be quadrangular in shape, and will be located on the south side of Hamilton walk, between Thirty-sixth and Thirty-seventh streets. The building will be two stories in height above a high basement, and measure 340 feet front by nearly 200 feet in depth. The long front faces north, securing a maximum amount of the best light for laboratory purposes. All along the front are arranged small rooms for research, rooms for professors and their assistants, a library, etc.; these open into a private corridor, so that men employed in these rooms may pursue their work without interruption from students passing through the main halls.

Perfect lighting of all the laboratories has been obtained, the courts being large enough, with the low front building, to furnish good north light to the

laboratory of pharmacodynamics on the first floor, and to the large laboratories on the second floor devoted to pathology, where microscopical work is done, the north front of these rooms facing on the courtyard being made almost wholly of glass, and extending higher than the front, so that steady north light will be thrown to the back of the room.

The first floor of the new laboratories will be devoted to physiology and pharmacodynamics.

The second floor will be devoted exclusively to pathology. An examination of the commodious plans will disclose the purpose of the pathological laboratory. After providing for lectures upon general topics in pathology, the chief provision is for laboratory instruction. The entire north front of the building is devoted to laboratories for advanced students in pathology and pathological bacteriology, and to the special research and assistants' rooms. Each of the advanced laboratories measures 31 x 44 feet. The east wing accommodates the laboratory of experimental and chemical pathology, while the west wing is occupied by the museum of pathological specimens. This latter, which measures 44 x 65 feet, adjoins the demonstration hall of morbid anatomy, which hall communicates with the general pathological-histological laboratory. The last laboratory, the front of which is to consist almost entirely of glass, is located in a section of the building looking north into a spacious court. This room, 37 x 100 feet, will seat one hundred students, and will be devoted entirely to microscopical work, for which, on account of the excellent lighting, it will be admirably adapted. In order to combine in one harmonious whole the study of the microscopical features of diseased organs and the gross alterations in them, the pathological-histological laboratory, the laboratory of morbid or gross pathological anatomy, and the museum of pathology are made closely communicating and freely accessible one from the other. Another section of the building, of equal size with the first, and also looking north into the court, is subdivided into three smaller laboratories for the instruction in comparative (pathology of animal diseases), neurological (pathology of nervous diseases), and surgical pathology. The same method of lighting, with enormous glass windows, is to be carried out in this group of laboratories. Finally, the west wing of the building will also provide for photographic and micro-photographic outfits.

Besides the numerous laboratories, research rooms, etc., there are four lecture rooms in the building. The two marked "Demonstration Rooms" on the plan each seats 184 students. These lecture rooms communicate with two preparation rooms each. At the rear of the building there are two large lecture rooms, each seating 400 students. To avoid confusion between lectures, the corridors and stairways are so arranged that one class enters the large lecture room from one side as the other class leaves it from the opposite side. Students enter these rooms from a landing at the main stair, midway between the first and second floors. The floor of the lecture room is on a level with the basement, and the lecturer will enter directly from the basement level, and all specimens needed to illustrate the lectures will be brought through the entrance, thus saving the crossing of the halls through which classes move.

The equipment of the laboratory will be adequate and in keeping with the

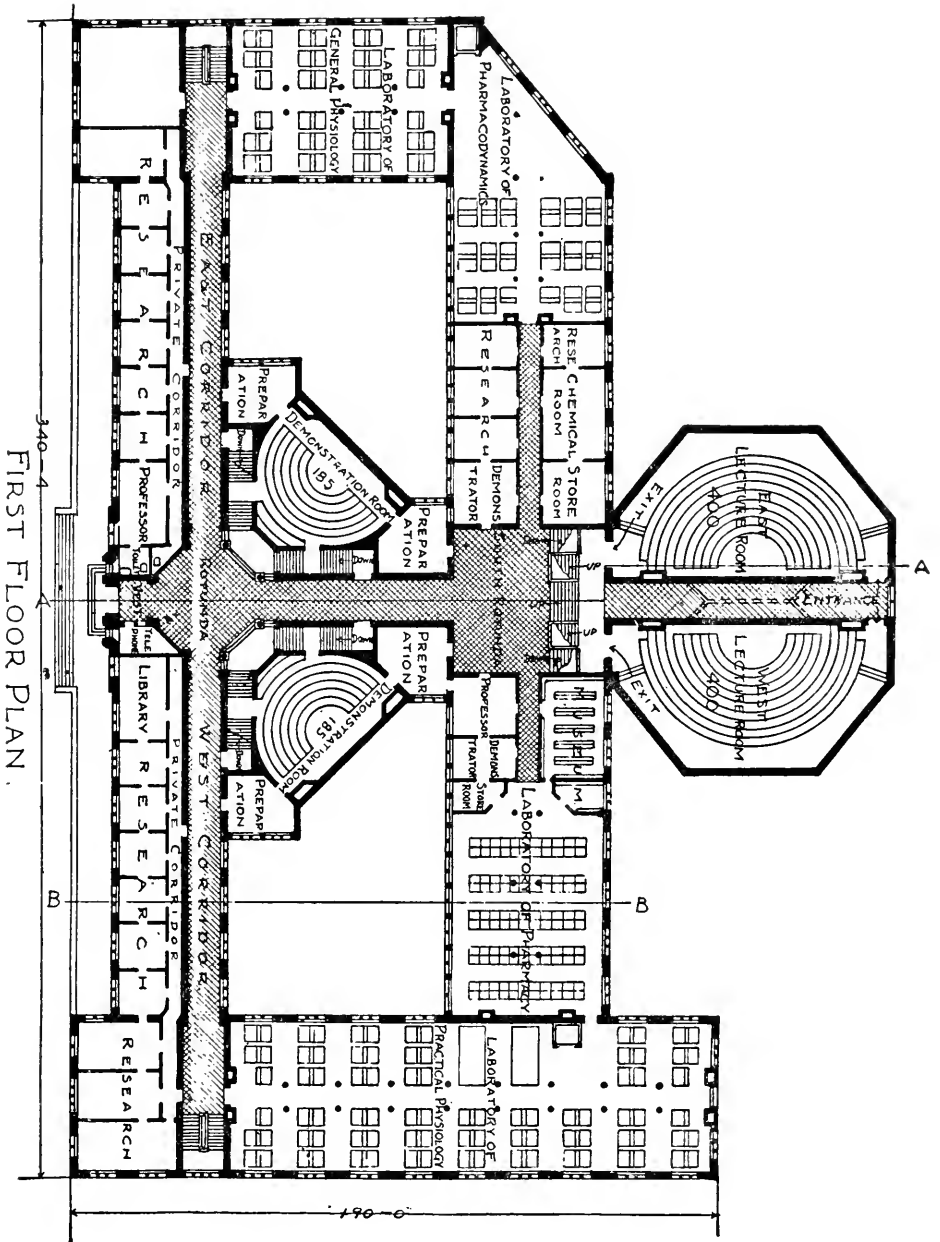

FIRST FLOOR PLAN.

advanced ideas of the times regarding laboratory instruction. That of the physiological department will be described at another time. The outfits for the laboratories of pathology will include modern microscopes, furnished with suitable optical parts for the study of animal tissues and bacteria, complete bacteriological outfits, for the study of the relation of bacteria and other parasites to pathological formations, new and complete photographic, micro-photographic, and projection apparatus, and a special outfit consisting of kymographs, respiratory apparatus, etc., for the study of subjects in general and experimental pathology.

The assistants' and research rooms will contain individual outfits for histological and bacteriological study. This will be in addition to those provided for the use of undergraduates and advanced (or post-graduate) students in the general laboratories.

It is intended to cultivate and promote a spirit of independent and research work, both in respect to students taking the course in medicine and graduates who have such preliminary training as to adapt them to this work.

A feature of the undergraduate instruction that may be well to indicate especially, is the close union between the laboratories of pathological-histology and morbid anatomy, and the museum of pathology. In order that the gross changes in and appearances of organs may be correlated with the histological alterations as shown by the microscope, the gross specimens will be exhibited in the laboratory of morbid anatomy during the exercises on pathological-histology. The arrangement of rooms and seating is such that the student may enter one room from the other without creating disturbance, or interfering with the illumination of the microscopes in his rear.

It is believed that the use of enormous glass fronts for the histological laboratories will provide such abundance of north light as to make all the seats of equal value for microscopical work.

SIMON FLENNER.

University of Pennsylvania.

Magnifiers.

After some years' experience as teacher and examiner of classes requiring in their work the use of magnifying lenses, I have come to the conclusion that fewer persons know how to make good use of simple microscope than of the compound one.

The majority of students whom I have met have used either the folding lens or the tripod. The former is convenient for carrying in the pocket, but has the disadvantage of requiring the exclusive use of a hand, leaving only one free to manipulate or dissect the object under examination. Such single-handed manipulation is tedious and frequently gives very imperfect and unsatisfactory results. With wire and cork, one can improvise a holder for the folding magnifier, but so mounted it is less satisfactory than the tripod.

Within two years I have tried, with three classes of nearly one hundred students in each, the magnifier known as the watchmaker's glass with two

lenses. The lens on the tip may be removed, thereby rendering the remaining lens lighter to hold in the eye, while at the same time giving sufficient amplification for most work. The great advantage of this magnifier is that both hands are free, and the object can be placed or held up in the most favorable light. The objection to its use is that a considerable portion of the students, despite the most careful directions and praiseworthy perseverance on their part, are unable to retain the magnifier on the eye. This year I have had a detachable spring added to the mounting. This is a heavy watch spring which goes round the head and when properly adjusted holds the lens comfortably in a suitable position. Even those who can hold the lens on without the spring find that when the protracted use of the instrument is necessary fatigue is reduced to a minimum or eliminated by using the spring. The latter's being detachable permits the glass to be carried in the pocket and used in the hand for simple magnification as conveniently as a folding lens. The spring is kept with the kit of dissecting tools and attached when desirable. Its use so far is proving highly satisfactory.

London Normal School, London, Canada.

J. DEARNESS.

A New Thermo-Regulator.

The following is a simple and extremely efficacious form of thermo-regulator which was shown to me some while ago by one of my ingenious friends, and who kindly undertook to provide me with one. I have been trying it on an air sterilizer (one of Jung's) with the most satisfactory results. I have also got one for low temperatures, as per modifications suggested by myself: i e, india rubber cork through which passes the tube t, at the inner end of which is a conical entrance, c. B is a glass float which is counterpoised, and which either rises so as to obstruct the gas entry (the black end closing the tube t), or it descends into the cup A. This cup is provided with a tube which dips into the mercury. The apparatus being put into its place, the heat causes the mercury to rise into the cup A, and lifts B, which will finally, i e., at a given temperature, obstruct the gas passage so as to limit the supply of gas, and thereby govern the temperature.

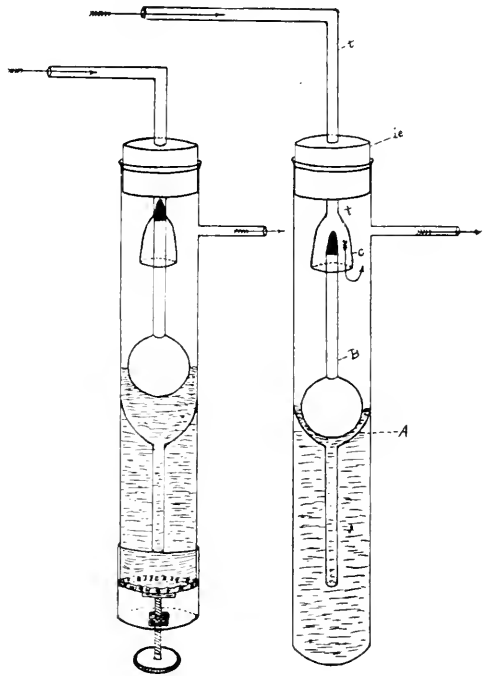

The form shown is, of course, serviceable for only one temperature, but by interposing a metallic cap and screw, as shown in the left figure, acting on a leather diaphragm, the apparatus may be regulated to any temperature.

THOS. PALMER.

A Rapid Method of Making Slides of Amoeba.

If a small film of detritus which contains abundant amœbæ be placed in a solid watch glass with plenty of water and examined with a magnification of 10 to 20 diameters, amœbæ can, after a little practice, be readily seen and can be picked out with a thin-walled dipping tube such as any one can readily make for himself. The medicine droppers which one buys have walls too thick to be available.

The drop of water containing the amœba may be placed on a coverslip and with a little care any fragments of dirt taken up with it can be removed to a distance by needles and then taken away altogether by a cloth or a bit of filter paper. With a little experience also it will be easy so to manipulate the currents as to bring the amœba to the center of the slide. As much water should be drawn off as is possible without incurring the risk of allowing the animal to dry. After he has been quiet for a few moments and has begun to put forth his pseudopodia, he adheres slightly to the glass and it is now possible by a sudden move to drain off the rest of the water and to replace it by a small drop of picric alcohol (saturated solution of picric acid in 50 per cent. alcohol). If the alcohol is placed directly upon him and is not allowed to fall from any considerable height, the attachment to the glass will not be loosened. The cover may now be inclined somewhat and a gentle current of 50 per cent. alcohol allowed to flow over it until the amœba appears quite colorless. Dehydration may be accomplished by allowing two or three c.c. of each of the higher grades of alcohol to flow over it in the same way. This done, the animal may be permanently fixed to the cover, as Overton suggests, by adding a small drop of a very dilute solution of collodion, which, by tilting the slip in various directions, may be spread out into the thinnest possible film. As soon as the collodion ceases to flow it may be completely hardened by dropping the cover, amœba-side up of course, into 80 per cent. alcohol.

In this alcohol the preparation may be left as long as convenient, or it may at once be stained with any suitable stain, such as borax carmin or hæmatoxylin. I am accustomed to use Syracuse watch-glasses for manipulation of such covers, and the only precaution necessary is to incline the cover somewhat as it is put into a fluid, since if attention is not given to this point the entire film with the specimen may float away.

The collodion, like the amœba, will of course be colored, but if the film was not too thick it may be entirely decolorized before the color is withdrawn from the specimen. In dehydrating, anhydric alcohol, which does not dissolve collodion, should be substituted for the ordinary absolute ethyl alcohol. If the specimen is so large that supports are needed for the cover, two slips of paper previously soaked in xylol may be used instead of wax feet. The final step is of course to place a drop of balsam upon a slide and invert the cover upon it.

Although the process may sound somewhat tedious, it is really a rapid one. I have repeatedly put away a completed specimen in my cabinet less than half an hour from the time when the amœba was crawling about in his home. I should add that I have not made any cytological study of specimens prepared in this way. For purposes of demonstration, however, they are exceedingly satisfactory.

MICRO-CHEMICAL ANALYSIS.

XVI.

ZINC.

Although zinc, from its position in the periodic system, closely resembles magnesium in general, in its chemical behavior, the majority of the micro-chemical reactions of the two elements are quite different. We have already seen, however, that with uranyl acetate and sodium acetate, and with arsenic acid, magnesium, zinc and cadmium give identical reactions.

A number of reagents have been proposed for the detection of zinc, but of these only the following need to receive our attention :

- I. Double Sulphocyanate of Mercury and Ammonium.
- II. Oxalic Acid.
- III. Primary Sodium Carbonate.

Of these, the third is the most sensitive and most characteristic, but is not so simple, convenient nor so easily applied as is the first. The second reagent—oxalic acid—is unsatisfactory and of comparatively little value.

I. Ammonium Mercuric Sulphocyanate added to neutral or slightly acid solutions containing Zinc, precipitates a Double Sulphocyanate of Zinc and Mercury.

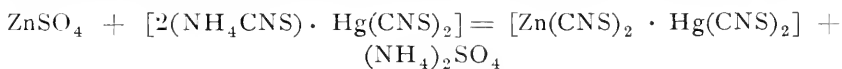

Method.—The reagent is prepared by adding to an almost saturated solution of mercuric chloride a saturated solution of ammonium sulphocyanate in slight excess of the amount required by theory to form the double salt of the formula given above. The solution thus prepared is employed as the reagent. It suffers no deterioration on keeping.

Next to a small drop of the solution to be tested, place a tiny drop of the reagent and cause the latter to flow into the test drop by means of a glass rod, at the same time inclining the slide. Almost immediately, pure white feathery crosses and branching feathery aggregates separate (Fig. 68). These skeleton crystals, when thick, appear black by transmitted light, snow white by reflected light. The normal crystal of the double sulphocyanate of zinc and mercury is said to be a right-angled prism of the orthorhombic system, but under the conditions which obtain in ordinary practice, only skeleton and dendritic forms will be seen.

Remarks.—Employ dilute solutions only. Mitigate the action of free mineral acids by the addition of ammonium or sodium acetate.



Fig. 68.

Avoid adding too much reagent. This, however, is a matter of little importance when zinc alone is present, but it is quite necessary when dealing with mixtures.

Neither magnesium nor aluminum interfere with this test, save that when magnesium is present in large amount the separation of the zinc salt is retarded, and that aluminum under similar conditions renders the skeleton crystals of the zinc salt somewhat less feathery.

The reagent gives reactions with zinc, cadmium, copper, cobalt and indium. These reactions are among the most interesting and elegant of micro-chemistry and leave little to be desired.

When zinc alone is present the crystals, as has been stated above, are snow white and of the form shown in Fig. 68; but if copper is present in minute amount, the crystals of the zinc salt are colored chocolate brown without undergoing any change of form. These brown crystals begin to appear after the white ones have separated. More copper than sufficient to yield the brown tint produces black crystals of modified form; still a greater proportion of copper completely changes the appearance of the crystals, and jet black spheres and botryoidal masses result. Finally a point is reached where crystals of copper mercuric sulphocyanate predominate, accompanied by the black crystals just mentioned.

This change in color of the zinc salt brought about by the presence of copper is a most interesting one. The zinc compound — $\text{Zn}(\text{CNS})_2 \cdot \text{Hg}(\text{CNS})_2$ — contains no water of crystallization, while the copper salt normally separates as — $\text{Cu}(\text{CNS})_2 \cdot \text{Hg}(\text{CNS})_2 \cdot \text{H}_2\text{O}$ — and being hydrated is greenish in color. The presence of water of crystallization in salts of copper seems to determine their color. The removal of the water leads to the production of a brown or almost colorless body. The nature of this change is not yet thoroughly understood. It seems probable that in the case of the brown and black copper-zinc-mercury sulphocyanates we have to deal with a case of solid solution, although it is also conceivable that an anhydrous copper-mercury double salt may exist in the presence of the zinc compound, isomorphous with the latter, yet incapable of existing alone.

In the presence of cobalt, the zinc salt is colored blue, the intensity of the coloration depending upon the amount of cobalt present. With very small amounts the color is exceedingly faint and the crystal form unchanged, but as the proportion of cobalt increases, the skeleton crystals of the zinc salt become deeper and deeper blue, simpler, less feathery, and gradually assume the color and appearance of the normal cobalt mercuric sulphocyanate. As in the case of the copper-zinc compound, these blue crystals are doubtless cases of solid solution, but the theory of isomorphous mixture is more tenable in this case than in that where copper is present.

Small amounts of zinc in the presence of much cobalt cannot be detected by this reagent.

Cadmium gives long prismatic crystals (Fig. 71), which are more soluble than the zinc salt. Even a small amount of cadmium destroys the feathery and branched character of the skeletons of the zinc-mercury sulphocyanate, owing

to the formation of mixed crystals, and there generally result crystallites of the shape of an arrowhead. Small amounts of zinc in the presence of much cadmium will usually escape detection.

The presence of both copper and cobalt in a solution containing zinc gives rise to the formation of mixed crystals of very peculiar color and form. These peculiarities are accentuated when cadmium is also present. The experienced worker thus will have little difficulty in detecting a number of elements in one single operation.

Indium forms with the reagent a double sulphocyanate, crystallizing in forms resembling those of the corresponding cadmium double salt. The reaction is quite slow in the case of indium.

When iron is present in sufficient amount to give a blood-red color to the preparation on the addition of the reagent, the crystals of the double sulphocyanate of zinc and mercury, separating from such solutions, are colored a deep reddish brown, appear jet black by transmitted light, and have at first the usual form of the zinc double salt. The appearance of these crystals usually changes rapidly, and in a few seconds bunches and masses of curving, branching, filiform crystals are seen. The change is a very remarkable one and takes place rapidly.

Lead, unless present in large amount, seems to have little or no effect on the zinc reaction. Under some conditions it seems to interfere, however, and it is, therefore, always best to first remove the lead by means of dilute sulphuric acid. Add the acid, draw off or filter; evaporate the clear solution to dryness; fume off the free sulphuric acid; dissolve in water; add ammonium acetate, and test as above.

Silver gives with the reagent a white amorphous precipitate, soon crystallizing in the form of small, thin, slender prisms with square or oblique ends, somewhat resembling those of the cadmium-mercury salt, but very much smaller than the latter. In the presence of silver the test for zinc is sometimes masked. In such an event, first remove the silver with hydrochloric acid and test, after evaporation, in the usual manner.

Exercises for Practice.

Apply the reagent, in the manner indicated, to solutions of a pure Zn salt of different degrees of concentration.

To a Zn solution add a very little Cd and test. Repeat the experiment, using more Cd.

In like manner try mixtures of Zn and Cu; Zn and Co; Zn and Ni; Zn and Fe; Zn and Mg; Zn and Al; Zn and Pb; Zn and Ag.

Then try more complex mixtures, as for example: Zn, Cd and Cu; Zn, Cd and Co; Zn, Cu and Co; etc.

In each case prepare several slides under different conditions and note well the changes in the appearance of the crystals which separate.

See also remarks and suggestion of experiments given under Cadmium, Copper and Cobalt.

II. Oxalic Acid added to solution containing Zinc causes the separation of Zinc Oxalate.

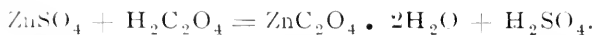

Method.—The reagent is applied to the test drop, as in previous tests, with oxalic acid, i. e., employ a concentrated solution and cause it to flow into the test drop.

Small double spherulites, pseudo-octahedra, either singly or united in twos, and thin rhombs result. (Fig. 69.)

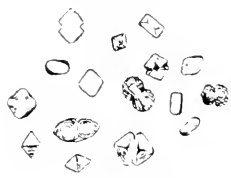

Fig. 69.

The great majority of the crystals separating have their angles rounded. It is rare that a preparation is obtained yielding clear-cut crystals.

Remarks.—The solution to be tested should be neutral or only slightly acid.

Crystals of zinc oxalate, when examined with a low power, often bear a striking resemblance to the oxalates of calcium and strontium; for this reason the alkaline earths should be first removed.

Magnesium interferes. Under certain conditions a double oxalate of zinc and magnesium separates in the form of hexagonal plates.

Ammonium salts should be removed before adding the oxalic acid.

In the presence of cadmium this test for zinc is unreliable.

Recrystallization of the zinc oxalate from a solution of ammonium hydroxide sometimes yields good results, and will aid in reaching a decision as to what element has been precipitated by the oxalic acid. In recrystallizing proceed as follows after adding the oxalic acid: Carefully separate the solution from the precipitate; add to the latter a large drop of ammonium hydroxide; warm gently; cool and examine. Zinc oxalate separates from such solutions in the form of tufts and aggregates of very fine needles. Occasionally masses of radiating, curving needles are seen. In most preparations the crystals separating resemble the tufts formed by calcium sulphate. These crystals are not obtained if cadmium or magnesium is present.

If lead, copper, cobalt or nickel should be present, it is necessary to first effect a separation before testing for zinc with oxalic acid.

Unless present in very small amount, iron interferes.

Oxalates of Group I also yield precipitates consisting of normal and double oxalates, but these are of little value as tests for zinc.

Exercises for Practice.

See suggestions under Cadmium.

III. Zinc forms, with Primary Sodium Carbonate, a Double Carbonate of Zinc and Sodium of low solubility.

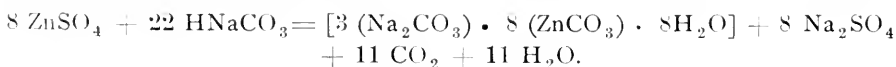

Method.—Prepare a saturated solution of the reagent. Place a large drop

of this solution next to the drop to be tested. Tip the slide a very little and cause the reagent to flow into the test drop. An amorphous precipitate of basic zinc carbonate is generally at once produced. After a short time, if the reagent is in excess, the double carbonate will appear at the edges of the test drop nearest the reagent as small, colorless, triangular and tetrahedral crystals. (Fig. 70.) These crystals adhere strongly to the glass and are very characteristic of zinc.

Remarks.—It is essential that an excess of the reagent be employed. Failure not infrequently results from a neglect of this precaution. This is particularly true if the test drop is acid. Because of the necessity of adding large amounts of primary sodium carbonate, the test drop must be of greater volume than is usual in micro-chemical testing and must be correspondingly dilute.

The formation and separation of the double salt is rather slow.

Other carbonates, as for example, those of potassium and lithium, can be substituted for primary sodium carbonate, but the reactions are not so satisfactory.

Salts of ammonium must be absent.

It is unfortunate that this, which is one of the most characteristic as well as delicate of the micro-chemical tests for zinc, should be open to many difficulties. The chief of these lies in the fact that many elements are precipitated as carbonates, and that these often bulky precipitates interfere with or mask the zinc reaction. Among the interfering elements, those most frequently met with are doubtless calcium, strontium, barium, magnesium, cadmium, lead, iron, manganese, cobalt, nickel. Of this list, calcium, strontium, barium and lead will probably have been removed by previous treatment with sulphuric acid. For method for dealing with mixtures containing the remaining elements of the list, see Separation of the Magnesium Group.

If only a very small amount of cadmium is present, it is precipitated before the zinc, and by avoiding the addition of an excess of the reagent, drawing off the clear liquid and adding to the decanted liquid a fresh portion of the reagent in sufficient quantity, the zinc can be precipitated as the double carbonate. When considerable cadmium is present this method is not feasible. In such an event recourse may be had to ammoniacal solutions, as suggested by Behrens.* The test drop is made strongly ammoniacal and to it primary sodium carbonate is added. Cadmium is immediately precipitated, while the zinc remains in solution. The clear solution is separated at once from the precipitate and allowed to stand for a short time. Zinc separates from the decanted solution as the double carbonate in the forms shown in Fig. 70. Some little skill and experience is generally necessary in order to obtain good results.

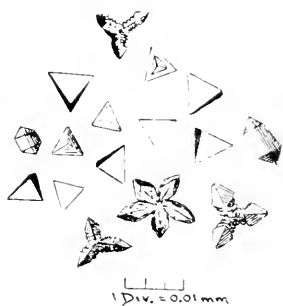

Fig. 70.

* Anleitung, 2 Auf. p. 52.

Exercises for Practice.

Try precipitating Zn in acid, neutral and ammoniacal solutions.
 Test mixtures of Zn and Cd. first in neutral, then in ammoniacal solutions.
 Experiment with Zn in the presence of the interfering elements noted above.

CADMIUM.

Cadmium, in the absence of zinc, can be very easily and satisfactorily detected by either :

- I. Ammonium Mercuric Sulphocyanate, or
- II. Oxalic Acid.

But if zinc is also present, great care must be exercised to avoid being led into error, for these two elements are very much alike in their chemical behavior.

Several other reagents have been suggested for the detection of cadmium, but it can be said of all of them that the results are not satisfactory, even when working with pure salts of cadmium, and that they fail completely when dealing with complex mixtures.

I Cadmium forms, with Ammonium Mercuric Sulphocyanate, a Double Sulphocyanate of Cadmium and Mercury.

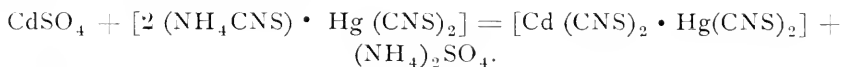

Method.—Proceed exactly as directed under Zinc, Method I, avoiding an excess of the reagent. Long, highly refractive prisms separate. (Fig. 71.)



Fig. 71.

The appearance of these prisms varies with the conditions which obtain at the time of their formation, as, for example, the concentration, depth of the test drop, amount of reagent added, acidity, etc. These variations are, however, not of a kind to render the test doubtful; long prisms, either singly or in groups, being the rule.

Remarks.—The remarks made under zinc are applicable to cadmium in every case.

The double sulphocyanate of cadmium and mercury is more soluble than that of zinc, hence the reaction is slower and more concentrated solutions should be employed.

If a small amount of zinc is also present, mixed crystals containing zinc and cadmium first separate whose crystal form can be described as non-feathery skeletons; soon after this the cadmium double salt separates in its usual form. In order that this sequence shall be brought about, it is best to employ a solution somewhat more dilute than when zinc is absent. Much zinc usually prevents the formation of any of the prismatic crystals of the cadmium salt, only mixed crystals resulting.

Traces of copper color the cadmium crystals a faint chocolate brown; this brown color intensifies with an increase in the amount of copper. When considerable copper is present, the copper double salt first separates, since it is slightly less soluble than the cadmium compound; then mixed crystals form, in which the copper apparently predominates over the cadmium. These mixed crystals are of a deep bluish-green color. By this time most of the copper and but little of the cadmium has been precipitated, and the concentration has also reached such a point that the cadmium double salt begins to separate in the crystal forms shown in Fig. 71. These are, however, still mixed crystals, for they are colored brown by the small amount of copper yet in solution.

It is improbable that these brown copper-cadmium-mercury sulphocyanates are isomorphous mixtures.

As in the case of the zinc reaction, iron may sometimes color the cadmium salt a reddish brown.

Cobalt colors the cadmium salt blue. Much cobalt gives an intense blue color and alters the crystal form.

Magnesium and aluminum have even less effect than in the case of zinc.

Before testing for cadmium with the sulphocyanate reagent, it is best to first remove any lead or silver which may be present.

See also remarks under Zinc, Method I.

Exercises for Practice.

Experiment with salts of cadmium in the manner suggested under "Zinc," trying all the exercises mentioned, but having cadmium as the element in excess instead of zinc.

II. Oxalic Acid added to solutions of salts of Cadmium precipitates Cadmium Oxalate.

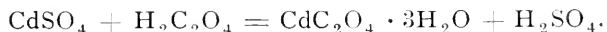

Method.—To the test drop add a solution of the reagent by the flowing in method. Clear, colorless monoclinic prisms and tabular crystals separate, either singly, in Xs, or in clusters. (Fig. 72.) The tabular crystals have the appearance of rhombs and rectangles.

Frequently very concentrated solutions yield crystals having an octahedral aspect.

Remarks.—The solution to be tested should be neutral or only slightly acid, and rather concentrated with respect to cadmium.

Dilute solutions fail to give good results.

The typical crystals of cadmium oxalate are seen only when working with almost pure salts of this element.

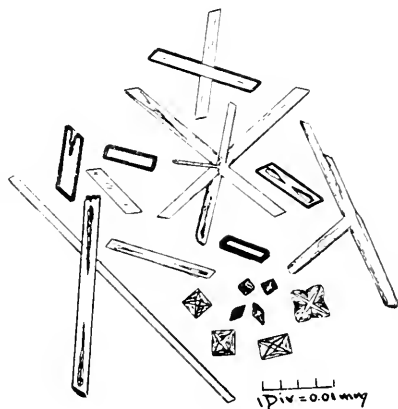

Fig. 72.

In the presence of zinc, only the forms of zinc oxalate are usually obtained.

Members of the calcium group and lead are first removed with sulphuric acid and a trace of alcohol. Silver with hydrochloric acid.

In the presence of copper, aluminum, iron, manganese, chromium, nickel and cobalt, the reaction with oxalic acid is not reliable and in most cases worthless.

Treated with ammonium hydroxide in the manner described under Zinc, cadmium oxalate recrystallizes in the form of rods and tables. This method of procedure is often of value in arriving at a decision as to the nature of a precipitate obtained with oxalic acid. Unfortunately, zinc prevents the formation of these rod-like crystals.

Exercises for Practice.

Test a pure salt of Zn in dilute and in concentrated solution. Repeat the experiments, substituting Cd for the Zn.

Make a preparation of $\text{ZnC}_2\text{O}_4 \cdot 2\text{H}_2\text{O}$; draw off the supernatant liquid; add NH_4OH ; warm gently and study the preparation. Prepare slides of different degrees of concentration.

Recrystallize $\text{CdC}_2\text{O}_4 \cdot 3\text{H}_2\text{O}$ in the same manner as the Zn salt.

Test mixtures of Zn and Cd.

Recrystallize the mixed oxalates from NH_4OH .

Make mixtures of Zn and the interfering elements listed above. Treat the precipitated oxalates with NH_4OH . Then try Cd in the same manner.

Try precipitating Zn with HKC_2O_4 , $\text{K}_2\text{C}_2\text{O}_4$, $(\text{NH}_4)_2\text{C}_2\text{O}_4$, etc. Then try Cd in like manner.

E. M. CHAMOT.

Cornell University.

Device for Leveling the Microscope.

In examining objects in liquids on the stage of a microscope, the want of true level annoys by keeping up currents and displacing, often disastrously, the object sought.

By this simple and inexpensive device all this trouble could be overcome.

One need not even add the expense of a small "spirit" level; for a glass slip on which are placed a few drops of water containing particles of opaque material which would render any tendency to current motion visible, will answer the purpose.

Place this trial slip on the stage, and level by means of the three screws until no currents are perceptible.

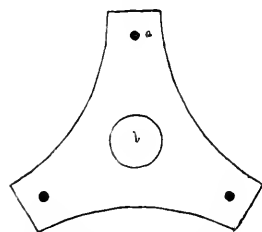

MICROSCOPE FOOT.
a. Threaded hole for leveling screw.
b. Microscope pillar.

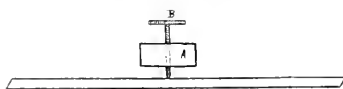

A. End view of microscope foot.
B. Milled head of leveling screw.

T. O. REYNOLDS.

Journal of
Applied Microscopy
 and
Laboratory Methods.

Edited by L. B. ELLIOTT.

Issued Monthly from the Publication Department
 of the Bausch & Lomb Optical Co.,
 Rochester, N. Y.

SUBSCRIPTIONS:

One Dollar per Year. To Foreign Countries, \$1.25
 per Year, in Advance.

The majority of our subscribers dislike to have their files broken in case they fail to remit at the expiration of their paid subscription. We therefore assume that no interruption in the series is desired, unless notice to discontinue is sent.

THE JOURNAL has been called the *Clearing House for Methods*, and we hope that it fills a place among scientific publications such that the term may be truly applicable. A clearing house for methods, just as a clearing house for accounts, is, however, dependent upon outside sources for its maintenance, and without the coöperation and support of its adherents must certainly fall short of its purpose.

The summer months have closed and the beginning of another year of school work is at hand. There is, however, sufficient time to look back over the work of the summer and balance up our accounts before opening those of the coming year. By many the vacation is taken as an opportunity to do original work in some summer laboratory; others leave their own laboratories for the purpose of securing recreation and pleasure; but teachers, wherever they go, seldom forget the work that is before them, and are constantly alert for methods and improvements in the study or presentation of their subject. Visits to strange laboratories and contact with new minds give new and valuable suggestions for work. These should be allowed to pass the clearing house, and their helpfulness made as general as possible.

The suggestions you have received from some other worker in your field, the improvement you have made in your method of work at the summer or field laboratory, may seem of little importance to you, but may, if allowed to circulate, come to the hands of some who need just what you have to give.

If, on the other hand, in your work you have met a difficulty which you have been unable to solve, through the clearing house you may expect to receive an answer to your question.

No doubt there are few of our readers who would admit that they had spent the entire summer without having learned something that will be of benefit to them during the coming year. Would it not be well to give others an opportunity to profit by the advancement you have made?

* * *

THE article on Photo-micrography, by Dr. D. W. Dennis, which appeared in the Department of Laboratory Photography last month, was the introduction to a series of articles which the author will contribute on that subject during the coming year. The series will include "Apparatus," "Illuminating the Object," "Focusing for very high and very low powers with long bellows," "The Negative and Positive," etc., and the author will endeavor to put into them the most valuable things now known on the subject.

CURRENT BOTANICAL LITERATURE.

CHARLES J. CHAMBERLAIN.

Books for review and separates of papers on botanical subjects should be sent to Charles J. Chamberlain, University of Chicago, Chicago, Ill.

REVIEWS.

Wettstein, Dr. R. von. Handbuch der Systematischen Botanik. I: v. + 201. Figs. 762, in 128 plates. Franz Deuticke, Leipzig, Germany. 1901. 7 marks. This volume deals with those plants which are usually termed Thallophytes. A second volume, which will be ready some time within the next year, will treat the Bryophytes, Pteridophytes and Spermatophytes, which the author will describe under the term, Cormophytes. It is the purpose of the book to give a comprehensive view of plant forms with particular reference to development and phylogeny. This purpose is accomplished by a full presentation of the larger divisions and by giving the developmental history of a large number of the more important types.

The book is intended for those who would know systematic botany from the phylogenetic standpoint, but it will also be very helpful to those who need such a taxonomic background for morphological and citological work. While the author is indebted to other taxonomic works, and especially to Engler and Prantl's *Die Natürlichen Pflanzenfamilien*, the work is by no means a compilation. A chapter on the history of taxonomy gives a brief summary of the systems of Jusieu, A. P. DeCandolle, Endlicher, Brogniart, A. Braun, Eichler, and Engler.

In a phylogenetic classification many things must be considered and it is not always easy to decide whether a plant is high or low in any particular respect. In general, the lines of advance are the same as those given in *Die Natürlichen Pflanzenfamilien*. The possibility of a polyphyletic origin must be admitted because it is known that similar life conditions tend to produce similar morphological structures. The fossil record shows that Angiosperms are more recent than Gymnosperms and Pteridophytes, and that Pteridophytes are older than Gymnosperms, but the record is too fragmentary to be of much importance in determining the relative positions of smaller divisions. Comparative morphology must be the principal basis for classification. The evidence of geographical distribution, of rudimentary organs, monstrous forms, juvenile forms and anatomical details must be weighed, and it must be remembered the ontogeny of a form may give useful hints as to its phylogeny.

The first forty-five pages are occupied by a discussion of the principles of classification; the rest of the book is devoted to plants which are usually designated as Thallophytes. These comprise six genetic lines (Stämmen) between which it is not possible at present to demonstrate relationships, although such may exist. The lines are *Myxophyta*, *Schizophyta*, *Zygophyta*, *Euthallophyta*, *Phaeophyta* and *Rhodophyta*. The term "Algæ" is usually applied to the independent members of these groups, and "Fungi" to the parasitic and saprophytic forms. Each group with its orders and families is clearly characterized and the

life histories of typical forms are thoroughly illustrated. The most important genera and the commonest species are often mentioned, so that while the book does not pretend to be a manual for the identification of genera or species, it nevertheless serves this purpose in many cases. The large number of excellent illustrations, together with the clear style in which the book is written, afford the English speaking student a good opportunity for improving his German while increasing his knowledge of Algæ and Fungi.

C. J. C.

Bernard, Ch. Recherches sur les sphères attractives chez *Lilium candidum*, *Helosis guayanensis*, etc. Jour. de Botanique 14: 118-124, 177-188, 205-212, pls. 4-5, 1900.

For the past five or six years many investigators have denied the existence of centrosomes in the higher plants, while other investigators, working with

practically the same material and employing the same methods, have insisted that the centrosomes are present. Prof. Bernard has examined *Lilium candidum*, *L. Martagon* and *Helosis guayanensis* and has convinced himself of the presence of these much discussed structures. Material was fixed in alcohol and in Flemming's solution and was stained in a mixture of fuchsin and iodine green (1 per cent. aqueous solution of fuchsin, 2 parts; 1 per cent. aqueous solution of iodine green, 2 parts, and water 40 parts). The safranin-gentian-violet orange combination did not give as good results. In *L. candidum* the centrosomes were found quite regularly during various phases in the germination of the megaspore. They resemble the structures described by Guignard, but are not so sharply defined. The centrosome was also identified in the gametophytes of *Helosis*. In *L. Martagon* centrosomes were found in the female gametophyte, in the vegetative cells of the ovule, but could not be positively identified in the endosperm. The centrosome is cytoplasmic in origin.

Incidentally, it is noted that there are sometimes two embryo sacs in *L. candidum*. In this species a very large vacuole develops between the two polar nuclei, preventing the nuclei from fusing. The writer suggests that this may account for the sterility of this species. It is also noted that the upper polar nucleus and the nuclei of the egg and synergids are erythrophilous, while the four nuclei at the antipodal end of the sac are cyanophilous. This difference in chromatophily is attributed to chemical differences due to sexuality, the nuclei at the antipodal end of the sac having lost all sexual character.

C. J. C.

Chodat, R., and Bernard, C. Sur le sac embryonnaire de *Helosis guayanensis*. Jour. de Botanique. 14: 72-79, pls. 1-2, 1900.

Comparatively little is known of the embryology of the Balanophoraceæ, but it is certain that they have puzzling

peculiarities. Writers agree that there is no ovule or placenta in *Balanophora*, but that the megaspore is situated in a tissue at the base of a prolongation incorrectly termed a "style." Van Tieghem (1896) found that in *B. indica* the polar nuclei do not fuse and that fertilization occurs at the antipodal end of the sac as often as at the upper end. According to Treub (1898), in *B. elongata* the megaspore germinates in the usual manner. The polar nuclei, however, do not fuse, but each divides independently. The egg apparatus breaks down and there is no fertilization, but an embryo develops from one of the cells of the endosperm. Lotsy (1899) investigated *B. globosa* and supported Treub in every particular, including the peculiar origin of the embryo.

In the present paper, Chodat and Bernard give the results of their work on *Helosis guayanensis*. The archesporial cell becomes the megaspore directly without cutting off a tapetal cell or giving rise to a row of potential megaspores. The jacket or "tapetum" surrounding the embryo-sac is sporogenous tissue. The two daughter nuclei resulting from the first division of the nucleus of the megaspore are quite different in appearance, the one at the upper end of the sac staining much more deeply. This nucleus gives rise to the egg, two synergids and a polar nucleus in the usual manner. The other nucleus stains faintly and rarely divides at all, but soon degenerates, so that no antipodals or polar nucleus are formed. According to Van Tieghem the egg is fertilized in *Helosis* and *Balanophora*. The present writers find that in *Helosis* the egg becomes large, but also becomes weak and feeble in appearance, so that, while they were not able to prove or disprove the occurrence of fertilization, they believe that the feeble condition of the egg, together with the position of the embryo in the endosperm, favor Treub's view that the embryo arises apogamously from the endosperm.

C. J. C.

CYTOLOGY, EMBRYOLOGY, AND MICROSCOPICAL METHODS.

AGNES M. CLAYPOLE, Cornell University.

Separates of papers and books on animal biology should be sent for review to
Agnes M. Claypole, 125 N. Marengo avenue,
Pasadena, Cal.

CURRENT LITERATURE.

Hoffman. Die Rolle des Eisen bei der Blutbildung. Zugleich ein Beitrag zur Kenntniss des Wesens der Chlorose. Virchow's Arch., **100**: 235-306, 1900.

The efforts of the author were directed to the investigation of the so-called blood forming organs, and were laid in

the following lines: Enumeration of the blood corpuscles; determination of the hemoglobin; tracing the manner in which the metal is taken into the organism; the effect of different preparations; the effect in healthy and anæmic animals, etc. Ninety-eight rabbits in all were used in the investigation. To determine whether the entrance of the metal into the so-called blood forming organs could be proved, the bone marrow, spleen, and the mesenteric lymph glands were examined for their contained iron. The liver and kidneys were usually similarly tested. The bone marrow was taken out as entire columns of $\frac{1}{2}$ -1 cm., depending on the size of the animal, from the humerus, radius, femur, and tibia, and put, as were the other tissues, into 70 per cent. alcohol to which 5 per cent. solution of ammonium sulphide was added, then after 24 hours into absolute alcohol plus a few drops of sulphide. In all animals containing iron the marrow became after one-half or more hours, of a gray black, then of a distinct green color. This was especially clear to the eye if the tissues were compared with some from an animal not containing iron. Since, for the most part, parallel investigations were made on both iron and non-iron fed animals, it was easy to determine macro-

scopically, in a few hours, with certainty from which rabbit the piece of marrow was taken. Moreover, the marrow of the non-iron fed animal lost much of its reddish color, passing into a dirty red, yet never acquiring the looks of the sulphide of iron preparation. The spleen always, after a term of feeding with iron, was the quickest to color, becoming dark green in a few minutes. This was sometimes true in animals which had received no iron, but the difference in the intensity of the reaction was a ready means of distinction between the animals with and without iron. The mesenteric glands also showed the same difference, taking in iron-fed animals a clear green tone, which became much lessened, or entirely absent, in iron free cases. The pieces of tissue were hardened 24 hours in absolute alcohol, embedded in paraffin, sectioned in different regions, and fastened with albumenized glycerin on the slides; paraffin dissolved out with xylol, and the sections placed for an hour or so in ammonium sulphide, washed rapidly in distilled water, and mounted in glycerin. In every iron-fed case, in the bone marrow the iron is readily distinguished, especially in thin sections. The iron laden transporting cells, diffusely green, have two to five black green granules. Usually these cells are most abundant in the red marrow, at the ends of the bone, apparently less abundant in the yellow fatty marrow, though absolutely more. To study the exact position of these iron cells, the author made preparations after Stieda's method, that is, Berlin blue with alum carmin. The bone marrow of the animals not fed with iron was practically iron free. The spleen of the ordinary plant fed rabbit contained a fair amount of iron, contained exclusively in the pulp. The amount after feeding with iron rose to such a degree that the sections became stained deep green in a second, only the follicles appearing as light, unstained spots. In the mesenteric lymph glands, on ordinary food, solitary green leucocytes can be found; after an iron diet their number increases in a marked degree. The liver in young animals gives no iron reaction without feeding the substance, but in older animals a small amount is usually indicated. On feeding iron these assume, more slowly and to a less degree than the spleen, the characteristic color showing the presence of iron. This is especially true in the portal regions. The kidneys, only here and there, even with large doses of iron, show single green epithelial cells in the convoluted portions. On the contrary, pieces of the small intestine and colon washed in and left in ammonium sulphide for a short time become green to deep blackish green. The large intestine always gives the strongest reaction.

The enumeration of the red corpuscles and determination of the hemaglobin were also made. Cover-glass preparations were stained with Ehrlich's hæmatoxylin and eosin solution. Sections of bone marrow were hardened in alcohol of increasing strength, embedded in paraffin, and stained with eosin-hæmatoxylin and alum carmin. The spleen and mesenteric glands were similarly treated. For investigation of the special kinds of cells in the bone marrow, Neumann's process was discarded. It was to crush a piece of bone and receive the exuded marrow pulp into a capillary tube, and bringing very small drops from this on to the cover-glass. The author did not employ this method because it seemed to him that marrow cells, as well as the contents of the larger and smaller blood vessels, were obtained. The author arrived at the quantitative relation of the

mature non-nucleated erythrocytes to the nucleated red corpuscles and the remaining marrow cells by taking, with a fine pair of scissors, as nearly as possible equal amounts of marrow about the size of a pin head, and very carefully pressing them evenly between two clean cover-glasses. With the very cellular lymphoid marrow of the anemic animal this was always successful, giving a thin smear, a little thicker in places where fibrin lay about heaps of cells, which did not interfere in a general view over the preparation. The air-dried cover smears were fixed in an alcohol and ether mixture, and stained with Ehrlich's eosin-hamatoxylin solution or the triacid stain. In the same manner preparations were made of spleen and in a few cases of the lymph glands also. E. J. C.

Danjeard, P. A. Nuclear division in Protozoa.
Le Botaniste 7, 1900. Extract from Royal
Mic. Jour. April, 1901.

Figures and descriptions of ordinary division as shown in *Amoeba polypodia* are given: that of *Amoeba crystalligera*, in which the dividing nucleus is drawn to a thread at the division plane: in *Sappinia pedata* in which the nucleus divides twice without cytoplasmic division: finally a full account of the process of division in *Amoeba hyalina*, sp. n., in which no karyokinesis occurs. In this form the nucleus contains a large nucleolus which breaks up at the onset of division and appears to give rise to chromosomes. Some parts of the nucleolus also mingle with the nucleoplasm and give it chromatic properties. This nucleoplasm forms a spindle in which very fine chromosomes arrange themselves in an equatorial plate. Later they separate and approach the poles of the spindle. The spindle is pulled out as they do this, which process is continued as the chromosomes migrate to the poles of the elongating amoeba, until but elongated threads remain to represent the spindle. The author holds this as proof that the chromosomes migrate by their own activity here as elsewhere; since in the present case no spheres exist and the movement of the chromosomes continues after the poles of the spindle have been reached, the threads of the latter cannot be active agents. As the new cells separate, the chromosomes round themselves off and form the nucleolus, the spindle remains, constituting the surrounding nucleoplasm. This is clearly a karyokinetic process, but in the author's opinion its simplicity shows that the evident process is merely a modification of the simpler direct division, special emphasis being laid on the conditions occurring in *Amoeba crystalligera*. A. M. C.

Penard, E. Dr. Experiments in Dittlugia,
Rev. Suisse Zool, 8, 1900. Ext. from Jour.
Roy. Mic. Soc., April, 1901.

Dr. Eugene Penard has succeeded in separating the nucleus intact from the cytoplasm in several cases, three of which were accomplished without any other material injury to the organism. Such separate nuclei appear healthy for 9 to 24 hours after removal, but they ultimately die apparently of inanition. The non-nucleated portions, however, lived and moved about for several days apparently none the worse for the operation. In three cases the specimens were killed for examination and consisted to all appearances of normal protoplasm. Non-nucleated animals were not seen to take food, but since intact forms can remain without food for weeks uninjured there seems no doubt that the mutilated specimens could digest food. A. M. C.

CURRENT ZOÖLOGICAL LITERATURE.

CHARLES A. KOFFID.

Books and separates of papers on zoological subjects should be sent for review to
Charles A. Koffid, University of California, Berkeley, California.

Howard, L. O. Mosquitoes. 121 pp., with 38
figs in the text. New York, 1906. McClure,
Phillips & Co. \$1.50.

The popular interest in mosquitoes growing out of the discovery of their agency in causing malaria and yellow fever, makes this book of Dr. Howard's very timely. The author describes the life history, the feeding, breeding, and living habits, and the transformations of mosquitoes. The method by which malaria, yellow fever, and filariasis are transmitted to man, and the species concerned in this process, are carefully described. American mosquitoes are also discussed, and a key to all of the known species is given. Suggestions are giving for breeding and rearing the larvæ, and directions for collecting and preserving specimens for examination and for museum purposes are detailed. Means of extermination of these pests, and the precautions necessary to prevent the spread of disease by them, are given in the light of recent experiments. This book should find its way into every high-school library, and will be of value to physicians and travellers. Chapter IX, "How to Collect and Preserve Mosquitoes," is reprinted herewith by courtesy of the publishers.

C. A. K.

"Adult mosquitoes are very fragile creatures. The scales upon their bodies and legs are easily rubbed off, and the antennæ, and especially the legs, break with the least handling. Even in their ordinary course of life the scales rub off, and with certain species an adult which is two or three weeks old is quite different in appearance from one which has just emerged from the pupa. Practically, they cannot be handled with the fingers, or their value as cabinet specimens or as specimens for study is lost. With some forms there are important characters in the arrangement of the scales on the thorax. With others the scales on the wing are of importance, and if the front legs are accidentally broken off, an important character to which I have referred in the systematic portion of this book as existing in the claws of the fore feet, is naturally unavailable. In capturing them, therefore, they must not be handled, and I have found the most satisfactory method of capture to consist in simply placing a small, open-mouthed vial over the mosquito while at rest. On the wing, it cannot be caught, even with a delicate net, without rubbing or leg-breaking. If a mosquito lights upon your hand, or upon a twig, or a leaf, or upon a wall of a room, it is quite easy, especially if it be engaged in sucking blood, to cover it adroitly with the vial. It rises almost instantly, and the mouth of the vial is plugged with a plug of absorbent cotton. A drop of chloroform on the cotton will stupify the specimen almost immediately, and another drop will kill it.

The specimen may be kept permanently in the vial, and when studied, if the study goes no further than an examination of the coarser characters. In an attempt to determine the species, it will often suffice gently to slide it out upon a sheet of white paper and examine it with a powerful hand-lens. With the one-quarter inch achromatic triplet lens, made by different firms, I have found it possible to distinguish all of the generic and specific characters, even down to the teeth of the tarsal claws. This, however, is difficult to persons not accustomed

to the use of high-power hand lenses, and in such instances one must break off a tarsus and mount it upon a slide in glycerin or Canada balsam for examination under a compound microscope.

It is not advisable to mount adult mosquitoes bodily on slides in any medium whatever. They should not be preserved in alcohol or formalin, but should be kept dry in vials. Of course they will rattle around somewhat, and there is danger that the legs and the antennæ will be lost; therefore, if they are moved from the vial after the collecting and killing, into pill boxes with cotton, they can be carried safely, or can be sent in the mails. Several of the pill boxes may be placed inside a tight tin or wooden box and mailed with perfect security.

A collection of mosquitoes should, however, not be kept in this way, provided that it is intended as a study collection. The method which I have adopted, and which is the one customarily used for small insects that are not too small for hand-lens work, is the triangular-tag method. Take a sheet of stiff paper or very thin cardboard, and cut a strip say five-sixteenths or three-eighths of an inch wide. Then from this strip, by slightly oblique cuts, cut a series of triangles that will be pointed at the tip and a little less than an eighth of an inch wide at the base. Through the base of the tag may be run an insect pin, and to the tip the mosquito should be glued, white or yellow shellac being the best medium for the gluing. The mosquito should be glued on its side, just behind one wing, so that its back is away from the pin. This enables one readily, by holding the point of the pin in one's hand, to examine with a lens, all legs, antennæ, palpi, one side, and the back. The tag should be pushed up on the pin until it is from two-thirds to three-quarters of the length of the pin away from the point. To the lower part of the pin should be attached a small label giving date, exact locality, and name of the collector, and below this may be pinned another small label bearing the name of the insect.

Those who for some reason do not like the paper triangle method of mounting, use very minute pins, made by Mueller in Vienna, and known as "minuten insekten naedeln," which are sold by Queen & Co., Philadelphia, and other large dealers in such things. These pins are so small and delicate that they must be thrust through the thorax of the mosquito and into a little strip of cork; the cork strip itself being pinned upon one of the larger and longer insect pins.

Some collectors, instead of using the chloroform method of killing, prefer the cyanide bottle. The cyanide bottle is made by taking a wide-mouthed flask, putting a small lump of cyanide of potassium at the bottom, and covering it with a layer of liquid plaster of Paris, which, when allowed to set, makes a complete layer over and around the cyanide, and prevents the water that comes from the deliquescence of the cyanide from injuring specimens that are placed in the vial, but which at the same time is sufficiently porous to permit the escape of the deadly cyanide fumes. Even with the layer of plaster of Paris, however, the cyanide bottle will sometimes become wet, so that a bit of blotting-paper may with advantage be inserted to cover the plaster of Paris, and to absorb the superfluous moisture. A mosquito captured in one of these cyanide flasks dies very quickly, and is in good condition for dry mounting or for transfer to pill boxes. The cyanide bottle is, preferably, stoppered with a cork stopper, but rubber stoppers are also used.

In collecting early stages of mosquitoes, it is only necessary to have a supply of bottles, a little coffee-strainer with a handle, and a large reading glass. Other apparatus is cumbersome and unnecessary. I have a large reading-glass four inches in diameter, with a strong handle, which I find very useful in examining the surface of water-pools, especially for *Anopheles* larvæ. The dip-strainer used is an ordinary cheap coffee-strainer, which has been mounted upon a long handle, so that one can reach out two or three feet from the shore and capture larvæ and pupæ. Other large strainers with a fine mesh are sold at the hard-

ware stores, and may be purchased cheaply. In bringing larvæ and pupæ in from the field, too much jarring about in a bottle may result in their death by drowning. It is desirable, therefore, to put moss or water-weed in the bottle with a minimum of water, provided the insects are transferred to an aquarium or a still jar within a few hours.

Nuttall, Cobbett, and Strangeways-Pigg, who have done a great deal of collecting of mosquito larvæ in England, as shown in one of their important papers, entitled "Studies in Relation to Malaria," published in the *Journal of Hygiene*, Vol. 1, No. 1, January, 1901, used as their collecting apparatus some wide-mouthed bottles of medium size with cork stoppers; a white enamelled dipper which, when required, can be tied with a piece of twine to a long bamboo rod; a small pipette with a rubber bulb, and small vials containing dilute alcohol for the preservation of larvæ which they did not wish to keep alive. They travelled over England on their collecting trip on bicycles. When the larvæ or eggs were captured in the porcelain dippers they were removed with a pipette and put in bottles, which were half filled with water, wrapped in cloths, and attached to the bicycle frame. They found that they could be transported for several hours without injury. They noted also that the large larvæ did not withstand the shaking as well as the small ones, but that a sufficient number could always be brought back for studying purposes. On expeditions lasting a couple of days, they took precaution to remove the corks occasionally to give the insects fresh air. White dippers were used, since they could more easily detect the eggs or larvæ on the white background, and they found that only rarely could they detect the insects by direct inspection of the surface of the water.

Larvæ and pupæ, when it is desirable to preserve them in these stages, and it is always desirable to keep a small set of each species, may be kept in vials of alcohol or dilute formalin (5 to 10 per cent.). When preserved in alcohol they should be passed through different strengths, beginning with a weak mixture, in order that they may not shrivel; or, what is still better, kill the larvæ or pupæ suddenly in a cyanide bottle, then bring the water nearly to the boiling point in a little porcelain dish over an alcohol lamp, and drop the insects in, leave them until the boiling point is just reached, and then remove them. An immersion of only a few moments will suffice. Ordinarily the larvæ will sink at once to the bottom of the water, and very soon thereafter rise to the top. This rising is an indication that the specimen should be removed at once. The specimen may then be preserved in ordinary commercial alcohol, and will retain perfectly its color and shape. This method is used successfully with the larvæ of many insects. It is not necessary to mount either larvæ or pupæ whole on slides. One of these preserved specimens can be put in a cell with alcohol or glycerin and studied under a low power with perfect ease, and the examination of minute details of its anatomy, external and internal, may readily be accomplished by dissection, and the parts dissected out mounted permanently on slides in any of the ordinary media.

In rearing different species of mosquitoes I have had perfect success in the use of large, cylindrical glass jars, known as battery jars. They can be bought in almost any city, and of various sizes. The size which I find most convenient will hold about a gallon of water. A layer of sand an inch or two deep is placed in the bottom of the jar and a quart or more of water poured over it. After the sand has settled and the water has cleared, a bit of almost any small water-plant may be inserted to advantage, provided mosquitoes of the genus *Culex* are being reared. If the experiment is with *Anopheles*, however, some fresh-water alga is introduced, such as *Spirogyra*, *Mougeotia*, *Ceodogodium*, *Cladophora*, or *Oscillaria*—almost any green scum from stagnant water, in fact. Over the top of the jar is placed a piece of swiss, or other fine, translucent cloth, held down by a large rubber band.

The eggs of *Culex* may be had with ease by exposing a bucket of water out of doors in a mosquito locality on almost any summer night. If the egg masses be transferred from the bucket to the prepared breeding-jar, the growth of the larvæ can be watched, and their transformations can be observed with perfect ease. Occasional specimens can be taken out and preserved, to illustrate variations of different stages of growth. Accurate notes can be kept as to temperature, periods of transformation, and so on. A series of dates, provided several jars are under observation, can be written from time to time upon a slip of paper, which may be pinned to the edges of the cloth covering of each jar.

Where the eggs of *Anopheles*, for example, have not been found, females collected at large may be liberated in such a prepared breeding-jar. They will rest on the under side of the cloth covering during the day, and at night will lay their eggs on the surface of the water. It is desirable to have a stick in the water, or a leaf, or a bit of cork floating on the surface. I have had no difficulty in obtaining the eggs of *Anopheles* in large numbers in this way, and the eggs of *Culex* as well, but although as many as fifty females of *Psorophora* have been liberated in breeding-jars prepared in this way, I have not been able to get the eggs of this genus, which, as a matter of fact, are yet unknown. It is possible that *Psorophora* does not deposit its eggs upon the surface of water. This, however, is unlikely, and it is rather to be supposed that the females used in my experiments were not old enough for oviposition, and died from the confinement of the jar before the egg-laying period arrived.

When one wishes to study closely the movements and intimate habits of the early stages of mosquitoes, a great deal may be observed through the glass sides of the jar, by using a coarse lens and studying those near the side, but when a closer study is desired, individual larvæ or pupæ may be lifted out with a strainer and put in a shallow porcelain vessel, where they can be watched with ease under a dissecting microscope. *Anopheles* larvæ may be studied in this way very easily, and no nature study could be of more fascinating interest than the observation of these creatures, lying as they do with the body practically in a single plane, so that they may be easily watched, with the mouth parts in constant action, and the head occasionally turning upside down, and the reverse, with lightning-like rapidity."

C. A. K.

NORMAL AND PATHOLOGICAL HISTOLOGY.

JOSEPH H. PRATT.

Harvard University Medical School, Boston, Mass., to whom all books and papers on these subjects should be sent for review.

Sailer, J. Primary Endothelioma of the Left Superior Pulmonary Vein. Contributions from the William Pepper Laboratory of Clinical Medicine. Philadelphia, pp. 416-444, 1900.

At the orifice of the left superior pulmonary vein there was a dense mass of fibrous tissue, almost occluding the lumen, and extending on the auricular wall to the upper end of the left inferior pulmonary vein. The wall of the superior pulmonary vein was nearly uniformly thickened throughout its whole course in the upper lobe, forming a round cord fifteen mm. in diameter. Upon section it was seen to be made up of grayish and yellowish tissue. The upper lobe was contracted, pigmented and airless.

There was found, on microscopical examination of the thickened vein, hyperplasia of the connective tissue stroma and enlargement of the lymphatic spaces

and of the vasa vasorum. The peculiar feature was the proliferation of the endothelial cells in these spaces. The writer regards the process as a primary endothelioma, although he admits that it may be simply the result of chronic inflammation. There is an excellent résumé of the literature of endothelioma.

J. H. P.

MacCallum, W. G. On the Intravascular Growth of Certain Endotheliomata. Contributions to the Science of Medicine, dedicated by his pupils to Dr. W. H. Welch. Baltimore, pp. 497-509, 1900.

MacCallum studied a malignant tumor, originating in the left testicle, which he designates lymphendothelioma testis.

The primary tumor formed a nodulated mass about 6x5 cm. in size. It was succulent, myxomatous in places and variegated in color by opaque yellow areas of necrotic tissue. Death occurred four months after the removal of the testicle. The growth had extended from the scrotum in a remarkable manner. The spermatic vein was packed with a somewhat cylindrical tumor mass which extended upward through the left renal vein into the vena cava, in which it spread out into a bunch of translucent villus-like processes which extended throughout the whole length of the vena cava and projected into the right auricle. These curious formations resembled the villi of hydatidiform moles. Similar bundles were also found in the pulmonary arteries and in the pulmonary, jugular and subclavian veins. The lungs, liver, intestine and brain contained tumor nodules and there were local recurrences in the scrotum and groin which formed a chain leading up to a large tumor mass in the lumbar region. The tumor nodules in the lungs and liver were rounded and rather sharply outlined; many were semi-translucent and appeared to be made up of small cysts, others were more opaque and consisted of very soft, succulent, whitish tissue.

Histologically the neoplasm consisted of a framework of soft myxomatous tissue which contained cysts and tubules of various sizes and shapes. These spaces were lined with cells which varied in height from a flat, scale-like form, exactly resembling the endothelium of the lymphatics, through all gradations to high columnar epithelium-like cells. In places the cells were piled up two or three rows deep and arranged in folds and papillary masses which had invaded the surrounding tissue and finally had broken their way into the veins. The intravascular growths were covered by the endothelium of the veins, just as an organizing thrombus would be covered, and continuing in their development they formed papillary masses which projected along the lumen of the vein and occasionally formed secondary attachments to the walls. Passing through the heart into the pulmonary arteries, these masses became attached to the walls of the finest arterioles, and breaking through these gave rise to the secondary tumor nodules in the lung. The nodules in the liver, brain, and intestine were probably tertiary in origin.

The cyst-like spaces found in the metastases and intravascular masses, as well as in the primary tumor, were lined by cells which do resemble epithelial cells and have been regarded as epithelial in nature by the few other investigators who have studied this type of tumor. MacCallum, however, in view of the facts—(a) that no connection with the well defined epithelium of the seminal

tubules nor with any other epithelial structure can be traced: (b) that the morphology of such cells, as shown by Volkmann, Krompecher, and others, is of very slight importance in their identification with epithelial or endothelial structures; (c) that direct transitions between the obviously connective tissue elements of the stroma and these cells occur: (d) that intercellular fibrils can be demonstrated between the cells of such masses by the use of Van Gieson's stain; and (e) that the spaces in which such cell masses occasionally lie have not, like the alveoli in carcinomata, any further lining endothelium—concludes that it is justifiable to consider these cells of endothelial rather than of epithelial nature. Hence he classes the tumor as an endothelioma, rather than a carcinoma.

J. H. P.

GENERAL PHYSIOLOGY.

RAYMOND PEARL.

Books and papers for review should be sent to Raymond Pearl, Zoölogical Laboratory, University of Michigan, Ann Arbor, Mich.

Weinland, E. Zur Magenverdauung der Hai-fische. Zeitschr. f. Biol. 41: 35-68, Taf. I. 1901. This paper treats in considerable detail of the digestive processes and functions of the anterior part of the alimentary tract in the selachians. As living material individuals of the following species were used: *Scyllium catulus* and *canicula*; *Torpedo ocellata* and *marmorata*; and *Raja asterias*, *clavata* and *glauca*. The chemical reactions of the stomach contents were also studied in dead specimens of a number of other species. The method used for obtaining the secretion of the gastric glands in a pure condition from the living animal is ingenious and seems to have given excellent results. Briefly, the procedure was as follows: one end of a glass siphon of from 10 to 15 mm. diameter was thrust down through the mouth well into the cavity of the stomach, and allowed to remain there until a sufficient amount of the fluid contents of the stomach had passed out. Meanwhile artificial respiration was maintained by passing a current of water over the gills. The œsophagus closed tightly over the siphon so that there was no risk of any mixture of sea water with the stomach contents. The treatment apparently has no ill effect on the animal, as the author states that he has in some cases daily emptied the stomach of the same animal by this method for considerable periods of time (fourteen days and over), without causing any injury. This method should be widely applicable, both for purposes of investigation and class demonstration.

The principal points discussed are: (1) the length of time the food remains in the stomach, and (2) the chemical reaction of the stomach contents. It was found that the food remains in the stomach for a considerable time; from two to three days in the majority of cases, up to eighteen days in one instance observed. The food is generally completely disintegrated in the stomach, forming a fluid or semi-fluid mass. The animals studied were able to live for several months at a time without taking food.

It appears clearly from the experiments that in the living skate (*Raja*) the

reaction of the stomach may be either acid or alkaline, both during digestion and when empty. The reaction is influenced by the nature of the food. For example, when the animals are fed crabs the reaction of the stomach contents is alkaline, while with fish as food the reaction is almost invariably acid. In the species of *Scyllium* and *Torpedo* studied the reaction was found to be always acid. That the reaction of the stomach contents is not due to the specific reaction of the food itself, but that instead there are both acid and alkaline gastric secretions, is proven by the fact that the alkaline secretion may be induced by the action of ergot subcutaneously injected. This drug causes certain sphincter muscles in the walls of the blood vessels of the stomach to contract strongly, and at the same time the secretion becomes alkaline. After a time recovery occurs and the secretion becomes again acid. In the case of *Scyllium* and *Torpedo* there are no sphincter muscles in the walls of the vessels, and injection of ergot gave only negative results; the reaction remained acid. Microscopical examination of the walls of the stomach of *Raja clavata*, in which the reaction was alkaline, showed the sphincters of the vessels so strongly contracted that there was only a very minute opening in the center. The hindrance of the blood flow caused by this contraction of the walls of the vessels seems to be the immediate cause of the pouring out of the alkaline secretion. R. P.

Oker-Blom, M. Eine Normal Elektrode für physiologische Zwecke. Arch. f. d. ges. Physiol. 79: 534-536, 1900.

The necessity for frequent change and renewal of its contents is a defect which has long been felt in the ordi-

nary physiological, "unpolarisable," zinc-sulphate electrode. These electrodes dry up quickly, and if it becomes necessary to use them in contact with different fluids, they must be cleaned and refilled after each change of condition. Oker-Blom has devised an electrode which in large measure gets rid of these difficulties, and is constant in its working.

A glass tube, A (Fig. 1), of about 1.2 cms. diameter and 6 cms. in length, is closed at one end and has fastened to the side near the closed end a smaller tube, B, of the form shown in the figure. Over the top of this smaller tube is fitted a small cap, bearing at its outer end a camel's hair brush. The upper end of the main tube is closed by a rubber tube and a spring clamp. Into the bottom of the tube A is melted a platinum wire, through which external electrical connection is made. This platinum wire is covered with about 1 c. c. of quicksilver, over which is placed some calomel. The apparatus is then filled with "physiological salt solution" (.7 per cent. NaCl). This can be done most easily by removing the cap bear-

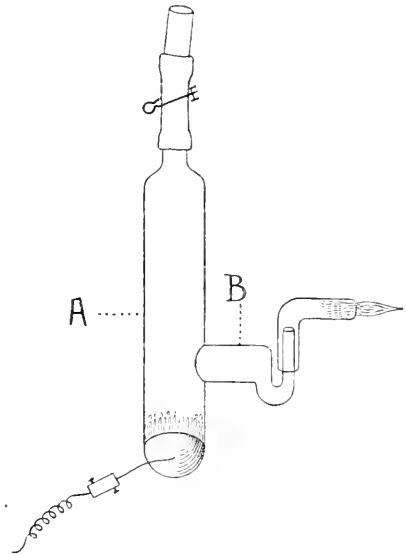

Fig. 1.

ing the brush and attaching in its place a rubber tube, which is allowed to dip into some salt solution. Then by applying suction at the upper end of the main tube A, the whole electrode may be filled. When desired for use, the cap bearing the brush may be filled with the salt solution and slipped over the end of the tube B, care being taken not to allow the entrance of any air bubbles. When not in use the end of the tube B is corked, thus preventing any evaporation of the solution. The author says: "Once in order, the electrodes are always ready for use and are very constant."

R. P.

CURRENT BACTERIOLOGICAL LITERATURE.

H. W. CONN.

Separates of papers and books on bacteriology should be sent for review to
H. W. Conn, Wesleyan University, Middletown, Conn.

Schultz. Ueber die Lebensdauer von *Bacillus pestis hominis* in Reinkulturen. *Cent. f. Bac. u. Par.* II, **27**: 12, 1901.

Schultz has had an opportunity of investigating cultures of pest bacillus, which are four years of age. He finds

that these cultures are still filled with active bacteria, and are virulent. The question as to the condition assumed by the bacteria in these cultures has been carefully studied, with the following conclusions: The pest bacillus does not produce endogenous spores. Its resisting power, lasting for four years, appeared to be due to a condensation of the protoplasm of the bacteria rods, which serve the same purpose as spores. These shriveled bacilli are capable of resisting adverse conditions.

H. W. C.

Hinterberger. Eine Modifikation des Geiselfärbungsverfahrens nach Ermengen. *Cent. f. Bak. und Par.* II, **27**: 597, 1901.

This article gives a convenient and useful modification of the method of staining flagella. The method is too

detailed to be given here, and the original article must be referred to by those wishing to adopt it.

H. W. C.

Müller. Über Tuberkelbacillen, und Sporenfärbung unter Anwendung von Kaliumpercarbonat und Wasserstoffsperoxyd. *Cent. f. Bac. u. Par.* I, **29**: 791, 1901.

The author gives an improvement of the method of staining tubercle bacilli, which he thinks is far more sure to detect the presence of these organisms

than the one commonly in use. It consists in the use of calcium percarbonate, or hydrogen peroxyde, as a decolorizing medium, in the place of acid. The method of use is simple. The material containing the bacilli is fixed upon a cover-glass in the ordinary way, and stained as usual in carbol-fuchsin. The surplus stain is washed off with 60 to 70 per cent. alcohol, and then with water. Afterward, the preparation is placed in a 5 to 10 per cent. solution of calcium percarbonate. This decolorizes the preparation, a quarter of an hour being required for the purpose. After this a counterstain with methyl blue follows. In the use of hydrogen peroxyde, essentially the same method is followed, hydrogen peroxyde being used for decolorizing instead of calcium percarbonate. The

hydrogen peroxyde acts quickly, only a few moments being required for decolorization. The result is far more sure than by decolorization with acid. The tubercle bacilli are never decolorized, and will be found, in the end, fully stained with the carbol-fuchsin, whereas the decolorization of other organisms is perfect. The author thinks the method vastly superior to the methods commonly used for this purpose.

H. W. C.

Dains. A Pseudo Tetanus Bacillus. Journ. Boston Soc. Med. Science. 5: 506, 1901. The author studies the case of a boy, wounded by a blank cartridge, in regard to whom there were some fears of tetanus. For the purpose of study the wound was examined microscopically, and there was found in it a bacillus having a great resemblance to tetanus. The patient, however, made a rapid recovery and never showed any symptoms of the disease. This led to a special study of this tetanus-like bacillus, which is given in the article referred to. The resemblance to the tetanus bacillus was very great, the organism having the same general appearance, and producing spores on the end in the typical manner. It differed, however, from the tetanus bacillus chiefly in the following points: It is decolorized by Gram's method, while the tetanus bacillus is not. The flagella are less numerous than those of tetanus bacilli. It is not pathogenic for guinea pigs, while the tetanus bacillus is markedly pathogenic for these animals. Its growth in glucose and stab culture is wholly unlike the growth of the tetanus bacillus, and it does not liquefy gelatin, while the tetanus bacillus does. The organism is quite different, evidently, from the tetanus organism which it so closely resembles.

H. W. C.

Poynton and Paine. The Etiology of Rheumatic Fever. Lancet, 1900. These authors endeavor to confirm, if possible, the claim that rheumatic fever is a disease due to micro-organisms. By proper culture methods they succeeded in isolating from several cases of rheumatic fever a bacterium in the form of a coccus, with a diameter of $.5 \mu$, which does not color with the Gram method, and does not grow in ordinary culture media. The organism does grow readily in a culture medium of bouillon and milk, with the addition of a little lactic acid. This organism they found in a variety of exudates in the bodies studied, in that of the pericardium, in the heart's blood, etc. They do not usually find it in the tissues themselves. Experiments of inoculating animals with the pericardial fluid from individuals suffering from this disease resulted in the development in the animals of an infection which has many of the distinctive characteristics of rheumatic fever, and which the authors naturally infer is the same disease. Essentially the same results were obtained by inoculating bacteria cultures. The coccus grown on agar tubes was inoculated into the veins of rabbits, and this was followed by manifest disturbances which were of a nature to indicate to the authors that they were dealing with an infection similar to rheumatic fever, and produced by the coccus in question. The authors think their organism identical with that previously found by Achalmé and others, and regard their observations, therefore, as a confirmation of the view that this disease is a bacterial disease, produced by the micro-organism which they have studied.

H. W. C.

NOTES ON RECENT MINERALOGICAL LITERATURE.

ALFRED J. MOSES AND LEA MCL. LUQUER.

Books and reprints for review should be sent to Alfred J. Moses, Columbia University,
New York, N. Y.

Viola, C. Ueber optische Erscheinung am Quarz und am Turmalin von Elba. *Zeit. f. Kryst.* **32**: 551-560, 1899.

Wülfing, E. A. Ueber die Lichtbewegung im Turmalin *Centralblatt. f. Min. Geol. u. Palaen.* Pp. 299-302, 1901.

Viola claims that the indices of refraction for quartz can be determined from a cut plate by the Abbe refractometer with exactitude to the *fifth* decimal place. From *two* sections cut from

the same crystal of quartz, one parallel, the other perpendicular to the optic axis, he obtained for the ordinary ray with sodium light:

ω (transmission parallel axis) 1.54426.

ω (transmission perpendicular to axis) 1.54442.

That is, a difference of 0.00016.

From which he concludes that the wave surface consists of two rotation ellipsoids, and that the Fresnel theory is not here available.

In tourmaline, using, however, the prism method, but using two different prisms from the same crystal, he obtains for the ordinary index in Elba tourmalines with sodium light:

| | | Transmission Parallel axis. | Transmission Perpendicular axis | Difference. |
|---------------------|-------|-----------------------------------|---------------------------------------|-------------|
| Yellow crystals, | - - - | 1.6494 | 1.6482 | 0.0012 |
| Colorless crystals, | - - - | 1.6425 | 1.6402 | 0.0023 |
| Green crystals, | - - - | 1.6479 | 1.6503 | 0.0024 |

Wülfing objects to the conclusions of Viola, pointing out that in the case of quartz, in spite of great care in observation and in construction of the apparatus,

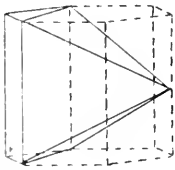

it is not possible to claim absolute freedom from error to the fourth decimal. In case of tourmaline, he points out the well known variation in composition in different portions of same crystal. To avoid this he prepared a single four-sided pyramid, so that both directions of transmission were through the same material, as in the figure, the dotted lines representing the portion of the tourmaline that was ground away.

With such pyramids he obtained for ω :

| | | Transmission Parallel axis. | Transmission Perpendicular axis. | Difference. |
|---------------------|-------|--------------------------------|-------------------------------------|-------------|
| Elba Colorless I, | - - - | 1.6419 | 1.6419 | 0.0000 |
| Elba Colorless II, | - - - | 1.6418 | 1.6418 | 0.0000 |
| Elba Colorless III, | - - - | 1.6424 | 1.6423 | 0.0001 |
| Haddam Green, | - - - | 1.6401 | 1.6400 | 0.0001 |

That is, the greatest difference was $\frac{1}{12}$ to $\frac{1}{24}$ that obtained by Viola, and indicate that, at least for tourmaline, the Fresnel law holds.

A. J. M.

Gareiss, A. Ueber Pseudomorphosen nach Cordierit & Tschermak's. Min. u. petrog. Mitth. 20: 1-39, 1900. Entirely aside from synonyms, some twenty names have been given to pseudomorphs after cordierite (iolite)

which are simply stages and phases of decomposition, the usual final product of which is muscovite or biotite. The author examines most of these, and concludes that the decomposition starts from a network of clefts in the cordierite, sometimes arranged irregularly, at other times parallel, both to base (001) and the cleavage (010). In several instances clefts were also observed parallel to the prism (110).

These alteration clefts in some instances serve only as central canals for the transportation of material, and enclose a fine grained zone. At other times this zone is surrounded by another, in which extinction takes place in perfect unity with the cordierite, but differs in the color and the lowered double refraction, which may reach isotropy. Frequently this material fills the entire space between the canals, and the entire crystal becomes thus "intermediate" substance composed of undeterminable fibers and little scales.

A third type of cleft shows little fibers or scales perpendicular to the central canal, and frequently with brilliant interference colors.

The final products of the decomposition are mica and chlorite, and some quartz. The MgO of the iolite gradually diminishes, and water, alkalies, and iron enter. The mica is usually muscovite, rarely biotite, and in one case paragonite. The tendency to form muscovite is shown by the fact that this exclusively is formed from cordierite in granites and gneisses (which are rich in potassium), whereas in cases such as the cordierite in quartz lenses in mica schist, where little potassium is obtainable, the pseudomorphs consist principally of chlorite.

Upon the basis of alteration product the author proposes the following nomenclature, which is practically in conformity with the *original* use of each name:

Pinite.—Preponderating final product mica, and without lamellar parting parallel (001). Here are included the occurrences of Schneeberg, Auvergne, Silberberg, Schönfeld, and Fichtelgebirge.

Gigantolite.—Preponderating final product mica, and with lamellar parting parallel (001). Here are included the pseudomorphs from Heidelberg and Wasserhäusel.

Prasiolite (Praseolite, wrong orthog.).—Preponderating final product chlorite, and without lamellar parting parallel (001). Here are included the occurrences from Bamle, Krageröe, and the Alpine pseudomorphs, which show no lamellar parting.

Chlorophyllite.—The preponderating end product chlorite, and with lamellar parting parallel (001). Here belong the occurrences of Haddam, Unity, and the gigantolite of Tammela, the lamellar fahlunite of the Talkschiefer, and the Alpine pinites with lamellar parting.

As to the many other names the author points out the essential identity of several, as shown by descriptions. These may be summed up as follows:

Esmarkite = Chlorophyllite.

Raumite = Prasiolite.

Weissite, Triclasite and Huronite = Fahlunite, but fahlunite not in every instance a cordierite pseudomorph.

Iberite = Gigantolite.

Bonsdorffite = Prasiolite.

Micarrell *Friesleben* = Kataspilite *Igelström*, which is not a cordierite pseudomorph according to author.

MEDICAL NOTES.

GRAM'S METHOD FOR STAINING DIPHTHERIA BACILLI.—Allow the fixed specimens to remain for 20 to 30 minutes in an anilin-water solution of gentian violet, prepared in the following manner:

To 100 c. c. of distilled water add, drop by drop, anilin oil until the mixture is opaque. Shake well after each addition of anilin oil. Filter through moistened filter paper until perfectly clear. To 100 c. c. of the filtrate add 10 c. c. of absolute alcohol and 11 c. c. of concentrated alcoholic solution of gentian violet.

After remaining the required time in this mixture the specimens are placed for about five minutes in the following iodine solution:

| | |
|-----------------------------|-----------|
| Iodin, | 1 gm. |
| Potassium iodide, | 2 gms. |
| Distilled water, | 300 c. c. |

This solution should be allowed to act until the specimens are black, after which they are thoroughly washed in alcohol, which removes the black color, causing the specimens to appear pale grey.

Dry and mount in balsam, or contrast stain with carmin or Bismark brown.
C. W. J.

Piorhowska. The Staining of Diphtheria Organisms. *Berliner klin. Wochens.*, Mar. 4, 1901. A method is given by which the author believes it possible to demonstrate positively the existence of these organisms by staining. Make dry cover-glass preparations from a culture of bacilli grown on either glycerin-agar, or Loeffler's blood serum, at a temperature of 37.7°C. for 15 to 20 hours. Stain for 20 to 30 seconds with methyl-blue. Decolorize in 3 per cent. solution of HCl-alcohol for 5 seconds. Counterstain in 1 per cent. aqueous solution of eosin for 5 seconds. Polar nuclei stain deeply, and the central portion takes a marked red color.
C. W. J.

Boston, L. Napoleon. How to preserve as permanent specimens casts found in urine. *Rep. N. Y. Med. Jour.*, Nov. 4, 1899. Partially fill a bottle with urine, cork tightly, and allow to stand in a cool place until a precipitate collects at the bottom of the liquid. Decant the supernatant urine, add an equal quantity of distilled water to the precipitate, and allow it to stand until it collects again at the bottom of the liquid. With a pipette place a small drop of the thickest of the sediment on the center of a slide and examine under low power. If casts are present, evaporate the mount nearly to dryness and add by means of a glass rod to the center of the drop of urine a drop of the following mixture:

Liquor acidi arseniosi (U. S. P.), one fluid ounce.
Salicylic acid, half a grain.
Glycerin, two fluid drachms.

Dissolve by heat and add acacia (whole tears), and again warm until the solution is saturated; after subsidence, decant clear supernatant liquid, and add a drop of 40 per cent. formalin if desired.

In order to get an equal distribution of casts throughout the field, it is necessary to draw a fine needle from the outer margin of the urine to the center of the medium until the two substances show no tendency to separate. A cover-glass is moistened by the breath and then allowed to fall gently on the specimen. Cool the slide for a few hours in order to harden the mount completely. Specimens thus prepared may be kept indefinitely without deterioration.
C. W. J.

Journal of Applied Microscopy and Laboratory Methods.

VOLUME IV.

OCTOBER, 1901.

NUMBER 10

The Botanical Laboratory and the Botanical Garden of the Tokyo Imperial University, Japan.

The Botanical Laboratory of the Tokyo Imperial University is located in the Botanical Garden, about three-quarters of a mile from the other university buildings. It was removed from the university campus to its present site three years ago. The building is one story high, and consists of two parts which are connected by a covered alley-way.



FIG. 1.—Botanical Laboratory of the Tokyo Imperial University. Front view.

The front part of the double building contains the herbarium, the library, laboratories, and rooms for a professor and three assistants. The second building contains the museum and the lecture room. Here also are more laboratories and a professor's room. In addition, here are found the dark room, the room for the physiological apparatus and chemical balance, the store room, and the room for the incubators, sterilizers, etc. Gas and water are conducted to all working rooms.

The herbarium is well represented with Japanese flowering plants and ferns,

including tropical plants from the islands of Liu-Kiu and Formosa, besides some exotic species. The lower cryptogams, though constantly added to the collection, are yet far from complete.

The library contains the leading English, German, French, and Italian botanical journals. The museum contains both dried and alcoholic specimens of plants for morphological, ecological, and pathological purposes. Some tropical fruits and seeds from Java and Formosa are also found here.

The laboratory is quite well equipped with apparatus and literature for research work in plant physiology. Various important contributions have been made here along this line during the last few years.

A good microtome, Zeiss' microscopes with oil-immersion objectives, afford facility in the study of cytology and embryology. Some good work has also been done along these lines. Among them Mr. Hirase's well known studies on *Ginkgo* should especially be mentioned.

The specimens and literature give facility for the study of systematic botany also. The systematic studies of tropical and subtropical plants from the islands



FIG. 2.—Botanical Laboratory of the Tokyo Imperial University.
End view.

of Liu-Kiu and Formosa, and monographic investigations on some difficult phanerogamic group, e. g., *Bambusacea*, are the present features along this line in the laboratory.

The apparatus for the study of bacteriology and fermentation is also well provided.

The following lectures and laboratory work are given in this laboratory for undergraduates:

a. Lectures.

1. General botany (morphology and physiology). Three hours a week throughout the year.
2. Systematic botany. Three hours a week throughout the year.
3. Advanced plant physiology. One hour a week during the first term.

b. Laboratory work.

1. Classification, morphology, histology, and embryology. Twelve hours weekly throughout the year.

2. Morphology and histology. Six hours weekly, especially for geology students.
3. Plant physiology. Twelve hours weekly throughout the year.
4. Research work.

There are now six graduates and about fifteen undergraduates studying in this laboratory. It should be noticed here in this connection, that nearly all of the studies in the university are required, and students who specialize in botany are required to study zoölogy, including histology and embryology, geology,

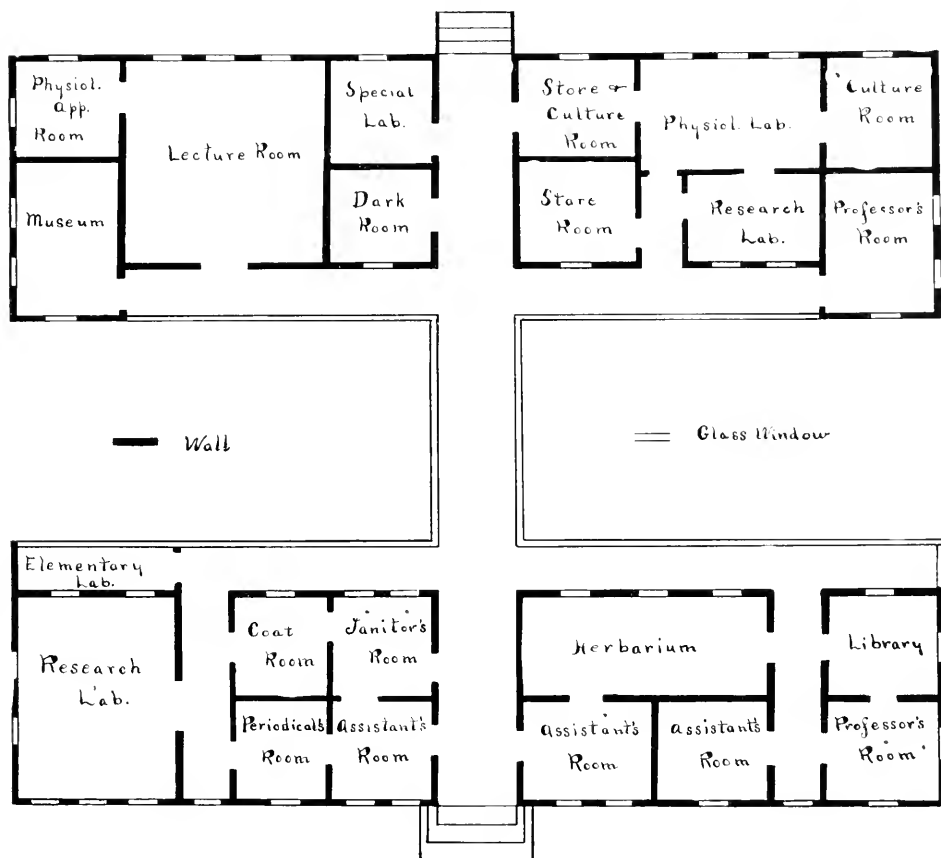

FIG. 3.—Plan of the building of the Botanical Laboratory of the Tokyo Imperial University.

paleontology, mineralogy, physiology, physiological chemistry and bacteriology, besides the above mentioned courses in botany. Only students of botany, zoölogy, and geology come to this laboratory to study. Students of forestry and agriculture pursue their botanical studies at the botanical laboratory in the agricultural college of the university.

The following is the present instructing staff of the botanical laboratory:

Prof. J. Matsumura, professor of botany and the director of the botanical garden. (Systematic botany.)

Prof. M. Miyoshi, professor of botany. (Plant physiology.)

Mr. K. Fujii, assistant. (In charge of morphology and embryology.)

Mr. T. Makino, assistant. (Systematic botany.)

Mr. S. Matsuda, assistant. (Systematic botany.)

Mr. Y. Yabe, assistant, and secretary of the botanical garden.

The Botanical Garden is the great source of living materials for study. It was established in 1681, and was long renowned as the "*O Yaku En*" (garden



FIG. 4.—Greenhouse in the Botanical Garden.

of medicinal plants). The area occupied by the garden is more than five acres. The plants are placed in rows according to the natural order, each with labels having Latin and common names. In one quarter of the garden medicinal plants are planted in groups. In the greenhouse the tropical plants from various parts of the world are quite well represented.



FIG. 5.—Cherry trees (*Prunus pseudo-cerasus*) in blossom in the Botanical Garden.

A row of large cherry trees (*Prunus pseudo-cerasus*) with large pink blossoms is a very beautiful sight at the flowering time in April. A few large Ginkgo trees (*Ginkgo biloba*) and several hundred tall bamboos would be a new sight to the Western traveler.

In a part of the Botanical Garden we have a genuine Japanese garden with a pond. In the pond, lotus (*Nelumbo nucifera*), water-lilies (*Nymphaea odorata*, etc.), and several other water plants are growing. It is also a good collecting place for fresh water algæ and planktons. The climbing wistaria (*Wistaria*

chinensis), from which hang purple branches of flowers in May, and plumb trees (*Prunus mume*), renowned for their sweet fragrance of flowers, are found in other corners of the garden.

A large cycas tree (*Cycas revoluta*), several yuccas (*Yucca filamentosa*, *Y. gloriosa*, *Y. aloifolia*), Japanese palms (*Trachycarpus excelsa*, *T. fortunei*), planted in front of the Botanical Laboratory, give quite a tropical aspect to that corner.



FIG. 6.—The lotus (*Nelumbo nucifera*) in the pond of the Botanical Garden.

Of these only cycas is protected from the cold in winter. Japanese banana trees (*Musa basjoo*), which bear no fruit, are planted in groups in one corner of the garden. The plant dies in winter, with the exception of the lower parts of the stem and the root, from which new shoots come out in the spring.

Cornell University.

KIICHI MIYAKE.

The Course of Study in Invertebrate Zoölogy in the Marine Biological Laboratory at Wood's Holl.



FIG. 1.—Marine Biological Laboratory at Wood's Holl.

The laboratory in which the course of study in invertebrate zoölogy is given at Wood's Holl is a large room, twenty-eight by fifty-six feet, on the first floor of the south wing of the main building of the Marine Biological Laboratory. The room receives light from the north, west and south sides through eighteen large windows. Directly in front of each window is placed a laboratory table which is arranged to accommodate two students. On the middle of each table is a two shelved rack on which the student finds, in easy reach, a set of the reagents and apparatus he will need for the work of the course. A good arrangement of the reagents and apparatus on the shelves is that given below in the table:

| | |
|---------------------------|----------------------------------|
| Canada balsam, | Wash bottle, |
| Clove oil, | Alcohol lamp, |
| Nylol, | Tincture Iodine, |
| Cedar Oil, | Acidulated 70 per cent. alcohol, |
| Absolute alcohol, | Borax carmine, |
| 95 per cent. alcohol, | Aceto-carmine, |
| 80 per cent. alcohol, | Alum-carmine, |
| 70 per cent. alcohol, | Delafield's haematoxylin, |
| 50 per cent. alcohol, | Picro-acetic, |
| 35 per cent. alcohol, | Sublimate acetic, |
| 1 concave watch glass, | 10 per cent. nitric acid, |
| 4 Syracuse watch glasses, | Dilute glycerine, |
| 1 black watch glass, | |
| 12 glass slides, | |
| 1 box cover slips, | |

One finger bowl, 2 large white dishes, 1 paraffin bottomed tray, 2 pipettes, and a lamp.

The east end of the room has no windows, but is furnished with a blackboard and a chart rack. In addition to blackboard sketches, a set of Leuckart charts were used in illustrating the lectures of the course. In front of the blackboard, a lecture table and several benches are placed. The laboratory is provided with running water, both salt and fresh, and in the middle of the room there are a number of large aquaria. When practical, these aquaria were supplied with the animals being studied, thus giving the student the opportunity of seeing the living animal under more or less normal conditions. Considerable stress was laid on this part of the work and twice each week excursions were made to various localities for the purpose of seeing the animals at home. On

some of these excursions digging and shallow water collecting was the object. In others, dredges were used in deeper water. On one afternoon the class accepted the invitation from Dr. H. M. Smith of the U. S. Fish Commission, to go on a dredging trip on the Steamer "Fish Hawk" and had the privilege of seeing how dredging is done by means of the most efficient and up-to-date apparatus.

The course of study covered six weeks, beginning July 3d, and ending August 13th. It consisted in both lectures and laboratory work. The lectures, which were given daily, from 9 to 10 a. m., by the instructors, had for their subject matter the natural history, classification, anatomy and development of the animals or groups of animals to be studied in the laboratory during the day. The instructor who gave the morning lecture had charge of the laboratory work which followed. In this he was assisted by two other instructors. He had



FIG. 2.—General Laboratory.

selected the forms for study and was responsible for their collection and preparation for the students. He had, with a few exceptions, prepared the laboratory outlines which were used by the students in their studies and dissections. For a few forms Bumpus' "Invertebrate Zoölogy" was used.

In addition to these elementary lectures by the instructors it was intended that each day's work should close with a lecture by an investigator of the group being studied on some subject in which he is interested relating to the group. This plan was given up for two reasons, the investigators were either not at Wood's Holl or were unwilling to lecture, and at 4 o'clock the greater part of the students wanted to go bathing. Those lectures which had been promised, before the course began, were given—the three by Professor C. O. Whitman

on "Metameric Segmentation," at the originally planned hour, 4 p. m., but the three lectures by Dr. G. N. Calkins on the "Protozoa" and three by Prof. G. H. Parker on the "Sense Organs of the Crustacea" were given in the evening at the general lecture hall.

The laboratory work of the day was divided into two periods of two hours each, the first from 10 a. m. to 12 m., the second from 2 to 4 p. m. During these periods it was the duty of three instructors to be in the laboratory for the purpose of distributing material to the students and to answer such questions as they might be asked concerning the work of the day. Besides these regular working hours the laboratory was open at all times to the students and many of them took the opportunity to carry further the work begun in the course or to work along lines in which they were especially interested. The work in the laboratory consisted chiefly in gross dissections and microscopical studies but some



FIG. 3.—Private Laboratory.

work was given in killing, staining and mounting small animals and in mounting and interpreting serial sections. Each student furnished his own dissecting instruments, drawing materials and microscope. In many cases the microscopes were owned by the students, but in others they were rented for the course from the Bausch & Lomb agency. For a rental of five dollars a student was provided with a B.B. stand furnished with an Abbe Condenser, two eyepieces and two objectives.

Students were advised to make accurate drawings of what they saw, and in case the work was to be substituted in their college course such drawings were required.

The table which follows will give a better idea of the actual work done in the course and the manner of conducting it, than could be gotten from a lengthy description.

| DATE | DAY | GROUP | LECTURER | LABORATORY ASSISTANTS | FIRST PERIOD WORK | SECOND PERIOD WORK |
|--------|-------|-----------------|---------------|-----------------------|---|-----------------------------|
| July 3 | Wed. | Protozoa | Dr. Hall | Entire Staff | Amoeba, Paramoecium, Spirostomum | Spirostomum |
| " 4 | Thur. | " | " | " " | Vorticella, Euglena, (Tomium), Pandorina, Gregarina | Excursion to Ram Island |
| " 5 | Fri. | Porifera | Dr. Grave | McGregor | Granita | Pandorina, Gregarina |
| " 6 | Sat. | " | " | " | " | Granita |
| " 7 | Sun. | Coelenterata | Mr. Badington | " | Hydra | Obelia |
| " 8 | Mon. | " | " | " | Gonionemias | Metridium |
| " 9 | Tues. | " | " | " | Metridium | Excursion to Vineyard Haven |
| " 10 | Wed. | " | " | " | Aurelia | Eudendrium |
| " 11 | Thur. | " | " | " | Planocera, Panaria | Rholloura |
| " 12 | Fri. | Platyhelminthes | Dr. Grave | " | EXCURSION TO KETTLE COVE | |
| " 13 | Sat. | " | " | " | " | |
| " 14 | Sun. | " | " | " | " | |
| " 15 | Mon. | " | " | " | Distomum | Crossobothrium |
| " 16 | Tues. | Annelida | Dr. McGregor | Badington | Nereis | Nereis |
| " 17 | Wed. | " | " | Badington | Nereis | Excursion to Hadley Harbor |
| " 18 | Thur. | " | " | " | Sipunculus | Brachionus |
| " 19 | Fri. | Polyzoa | Dr. Drew | McGregor | Bagula | Plumatella |
| " 20 | Sat. | " | " | " | EXCURSION TO NORTH FALMOUTH | |
| " 21 | Sun. | " | " | " | " | |
| " 22 | Mon. | Echinodermata | Dr. Grave | Hall | Asterias | Asterias |
| " 23 | Tues. | " | " | Badington | Arbacia | Arbacia |
| " 24 | Wed. | " | " | McGregor | Thyone | Took towsings |
| " 25 | Thur. | Mollusca | Dr. Drew | Badington | Chiton, Venus | Venus |
| " 26 | Fri. | " | " | " | Venus | Venus |
| " 27 | Sat. | " | " | " | EXCURSION TO PENNAKESSE ISLAND | |
| " 28 | Sun. | " | " | " | " | |
| " 29 | Mon. | " | " | " | Sycotypus | Sycotypus |
| " 30 | Tues. | " | " | " | Sycotypus | Sycotypus |
| " 31 | Wed. | " | " | McGregor | Loligo | Dredged off Nobsque |
| Aug. 1 | Thur. | " | " | " | Loligo | Loligo |
| " 2 | Fri. | Arthropoda | Dr. Hall | " | Lobster | Lobster |
| " 3 | Sat. | " | " | " | VISITED PROFESSOR WHITTMANS' PIGEONS | |
| " 4 | Sun. | " | " | " | Lobster | Lobster |
| " 5 | Mon. | " | " | Badington | Crab | Hippa |
| " 6 | Tues. | " | " | " | Talorchestia, Cyclops. | Rain, no Excursion |
| " 7 | Wed. | " | " | Grave | Molgula | Molgula |
| " 8 | Thur. | Tunicata | Dr. McGregor | " | Perophora, Botryllus | Dredged on "Fish Hawk" |
| " 9 | Fri. | " | " | " | Appendicularia, Salpa | |
| " 10 | Sat. | " | " | " | " | |
| " 11 | Sun. | Vertebrata | " | Hall | Skate | Skate |
| " 12 | Mon. | " | " | " | Skate | |
| " 13 | Tues. | " | " | " | Skate | |

Outline of work for the summer session of the Marine Biological Laboratory at Wood's Hall.

Of the thirty-one students who attended the course, this year about one-half were teachers. The other half was made up of students who were either making credits in their regular college work or who were preparing for a course in medicine. One practicing physician took the course. A few who took the work had come to Wood's Holl for the Nature course which was not given this year.

After the work of the day the instructors met for a short time in the director's room and went over the work next to be given. Difficult points were demonstrated by the instructor who would be in charge of the work and methods of presenting the subject were discussed.

Formerly, at the time each group was being taken up, an investigator, especially interested in the group but not otherwise interested in the course, has been invited to lecture on his specialty before the class. The duty of the instructors was only to assist in the laboratory work, while the director in charge of the course was responsible for the selection of the types to be studied and for the manner in which each group was presented to the students. While this method may be the theoretically ideal way of introducing students to the study of zoölogy it is lacking in practice in some important respects; it is not always possible to get investigators of certain groups of animals to lecture at the time the lectures are needed, and often the work goes on without lectures. Investigators, not knowing the students to whom they are lecturing, nor the work they have done, often fail to present their subjects in the best manner possible. It was to ensure a coördination between lectures and laboratory work, and lectures adapted to beginning students, that the director this year, Dr. G. A. Drew, not only asked each instructor to give the lectures on certain groups but to take charge of the laboratory work on the same.

The success of the plan was to be seen in the active interest of the students in their work which continued throughout the course. Very little *cutting* was done and on the last day twenty-eight of the thirty-one students who began the course reported for work.

CASWELL GRAVE.

Johns Hopkins University.

Botany at the Biological Laboratory at Wood's Holl.

BOTANICAL STAFF.

| | |
|-----------------------|--|
| BRADLEY MOORE DAVIS, | Instructor in Botany, University of Chicago. |
| GEORGE T. MOORE, | Instructor in Botany, Dartmouth College. |
| RODNEY H. TRUE, | Lecturer at Harvard University. |
| CHARLES H. SHAW, | Professor of Botany, The Temple College. |
| ANSTRUTHER A. LAWSON, | Fellow in Botany, University of Chicago. |
| LILLIAN G. MACRAE, | Curator and Collector in Botany. |

Developments, such as have in recent years taken place at Wood's Holl in physiology and in botany, afford illustrations of the all-embracing love of knowledge so characteristic of this unique station by the sea, the Mecca of American biology. More than ever, during the past season, botany has made itself felt as a live and considerable part of the laboratory. The building was full to the last table. On the upper floor were assembled the workers in cryptogamic botany under Dr. Davis and Dr. Moore. These were divided into three groups, those

devoting the whole session to the algæ, those working throughout on the fungi, and those who divided the time between the two classes.

The wetness of the season brought on an abundant supply of fungi; twenty-six species of myxomycetes alone were found. Expeditions near and far brought to the laboratory tanks, also, the usual rich assortment of algæ.

The lower floor was occupied by two classes—in physiology and in ecology, respectively. The former reached a circle much larger than the class, many zoölogists and other workers attending the lectures. The ecology people spent much of their time in the field, and made the beginning of an ecological survey of the vicinity. At the close of the term many members joined in a botanizing party to the White Mountains.

Year by year the work in botany will take new steps forward, and seeking ever to turn the students in the direction of research, it may well do its share in upholding the Marine Laboratory ideal of productive scholarship.

Temple College, Philadelphia, Pa.

C. H. SHAW.

LABORATORY PHOTOGRAPHY.

Devoted to methods and apparatus for converting an object into an illustration.

THE ORTOL DEVELOPER.

It may be of some interest to the readers of the JOURNAL who are interested in laboratory photography to be put in touch with one of the best all around developers.



FIG. 1.—Viscera of Frog.

After using the various developers put on the market, with various degrees of success, I have at last struck upon one which fulfills all of my requirements. This salt goes by the name of Ortol, and is purchased in sealed tubes with an accompanying cartridge of the required amount of soda. The contents of each are dissolved in 20 oz. of water and kept in separate bottles.

Various grades of intensity may be gotten by regulating the strength of the solution and by the use of more or less soda as occasion requires. In Fig. 1 the development was carried slightly too far, but shows great contrast and clearness. In the second illustration we have a transverse section of the human sciatic nerve developed for detail rather than contrast.

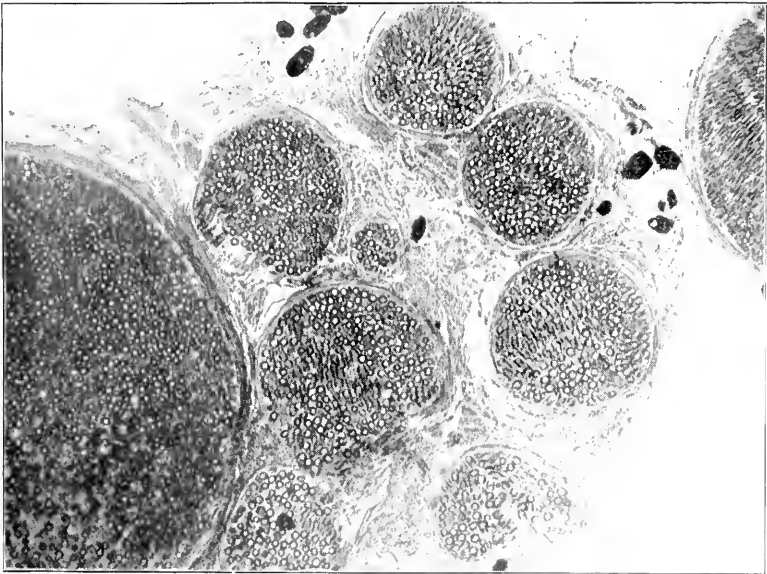

FIG. 2.—Transverse section of human sciatic nerve.

The following proportions may be varied somewhat according to exposure, but I have found them to answer for all purposes by using more or less bromide:

For negatives:

| | | | | | |
|--------|---|---|---|---|-------------------------|
| Ortol, | - | - | - | - | 2 parts stock solution, |
| Soda, | - | - | - | - | 2 " " " |
| Water, | - | - | - | - | 4 " |

For lantern slides:

| | | | | | |
|--------|---|---|---|---|-------------------------|
| Ortol, | - | - | - | - | 2 parts stock solution, |
| Soda, | - | - | - | - | 1 part " " |
| Water, | - | - | - | - | 3 parts. |

For bromide papers:

| | | | | | |
|--------|---|---|---|---|------------------------|
| Ortol, | - | - | - | - | 1 part stock solution, |
| Soda, | - | - | - | - | 1 " " " |
| Water, | - | - | - | - | 8 parts. |

I do not believe any definite rule can be set down as to just how much

bromide shall be used, this being regulated by the judgment and experience of the operator. I have found it very convenient to use none at all in some cases, and again in others to stop the developer back so that an image will not appear in less than six or eight minutes.

When working for extreme contrast, as in reproducing book illustrations, mechanical diagrams, etc., a plate sensitized specially for this purpose is absolutely necessary. Such a plate is manufactured by the G. Cramer Dry Plate Co. of St. Louis, and may be obtained of any dealer in photo supplies. They are rather slow in their action and must be given a longer exposure than ordinary.

For development, the solution must be as strong as possible and well stopped back. I usually make up the developing solution in 200 c. c. quantities, "enough to conveniently fill a 5x7 tray," after the following formula :

| | | | | | | | |
|----------|----|-----|-------|-------|-------|-------|-----------|
| Ortol, | - | - | - | 75 | c. c. | stock | solution, |
| Soda, | - | - | - | 100 | c. c. | " | " |
| Bromide, | 10 | per | cent, | sol., | 25 | c. c. | |

After exposure, the plates should be brushed off and immersed in the developer, when the image will flash up rather quickly, and stand out in very strong contrast with the black background ; but do not remove until the entire plate is perfectly black, even when held up to the red light, then pass it into acid fixing bath. The black background will be found to be perfectly opaque, even if held up to the sun, while the lines will stand out perfectly transparent.

Should any of my readers start using Ortol, I feel fully satisfied that it will be some time before they change again.

R. P. WOODFORD.

Contributions to Our Knowledge of Color in Photo-micrography.*

One of the most perplexing and as yet unsolved problems of Photo-micrography is that of color values, i. e., how to reproduce natural colors by means of the sensitive plate. Of the plates now in use, the orthochromatic approaches most nearly the ideal color plate ; yet this is not perfectly satisfactory, as it does not give sufficient contrast.

The investigations which form the basis of this article were undertaken to determine the relative merit of various photographic plates. The apparatus, as illustrated in Fig. 1, consists of a direct vision spectroscopie so mounted in the front board of an ordinary camera (with lenses removed) that the spectrum, when projected on the plate, will come in the center horizontally and at the top of the plate. The back of the camera is constructed in such manner as to allow of its being moved in the vertical plane, thus making it possible for one to make four exposures on the same plate, and by so doing to make an accurate comparison between them.

The plates examined may be grouped according to their degree of perfection as follows :

Group I—Characterized by a very high degree of sensitiveness a little above

* F. L. Richardson. *Journal of the Boston Society of Medical Sciences*, 5: 460-464.

line D, falling off abruptly on either end, and only slightly sensitive to the greens and blues.

Group II—Characterized by two distinct maxima—one a little above the

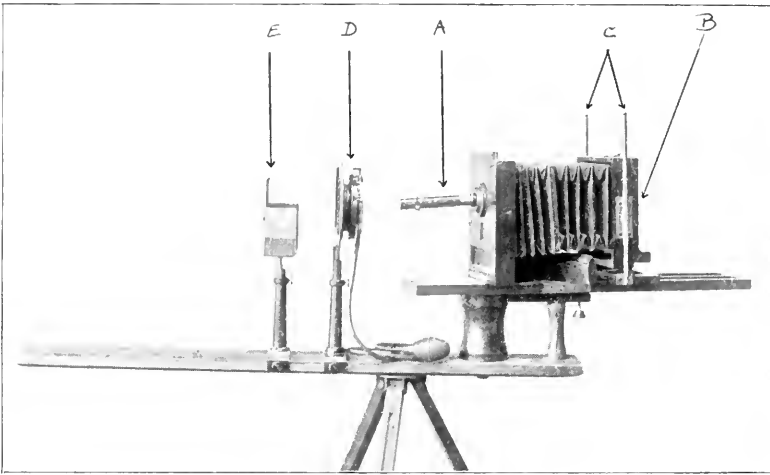

Fig. 1.

Apparatus for making spectrographs. A. Spectroscope. B. Back of camera, carrying screen and plate-holder. C. Supports upon which the back (B) may be moved. D. Shutter. E. Color screen in color screen holder.

D line, and the other in the blue-green. Between these two maxima the sensitiveness falls very considerably.

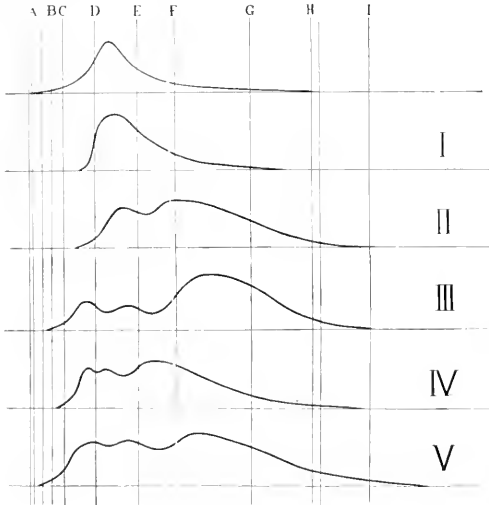

Fig. 2.

Explanation to Figure.—The upper curve shows the visual intensity of the spectrum (from Fraunhofer). Curves I-V represent the photographic intensity of the spectrum taken on plates from group of corresponding number. GROUP I—Cramer isochromatic (slow). GROUP II—Standard orthochromatic (slow); Forbes orthochromatic (slow); Carbutt orthochromatic (slow); Otto Perutz. GROUP III—Lovell color-differentiating; American spectrum plate. GROUP IV—Cadett & Neal spectrum plate (slow). GROUP V—International "Erethro."

Group III—Characterized by having its maximum sensitiveness in the blue (as with ordinary plates), with lesser bands of sensitiveness extending below the D line.

Group IV—Characterized by bands of sensitiveness extending below line D, with greatest intensity in the yellow-green, and falling off at the violet end before H₂.

Group V—This group most nearly approaches perfection. It is characterized by a sensitive band well below line D, and somewhat below the red end of Groups III and IV. This plate gives an almost uniform degree of sensitiveness with a maximum intensity in the green.

If sensitiveness to the spec-

trum were the only feature to be considered in the selection of a plate for photomicrographic work, a plate from Group V would be chosen, but the general working of the plate as well as the keeping qualities are factors that must be considered. For practical work and keeping qualities the author found the Cadett & Neal Special Slow Spectrum Plate of Group IV most satisfactory, and used it in the preparation of the spectrographs illustrated in Fig. 3.

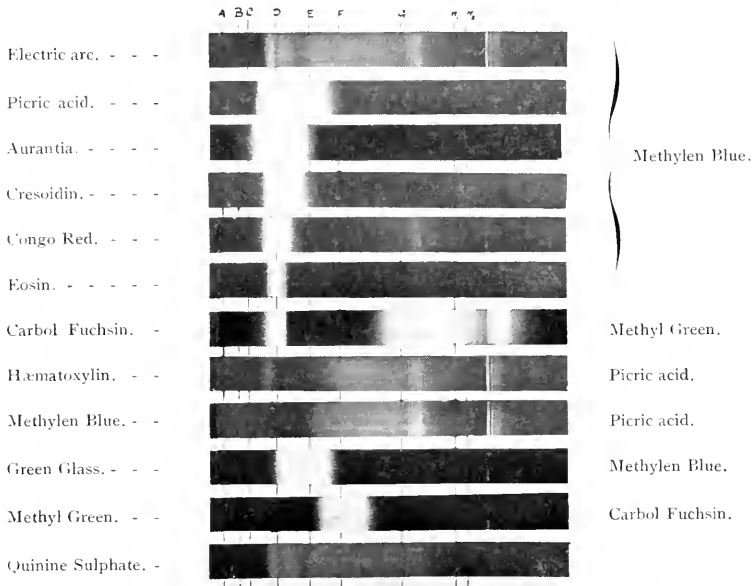

Fig. 3.

Explanation to Plate.—This plate is a reproduction of spectrographic analyses of some of the common stains. The red end of the spectrum is on the left. The principal Fraunhofer's lines are marked. The name of the stain is on the left, while on the right is the name of the proper screen to use to increase the photographic intensity. To decrease the contrast use a screen of the same color as the stain.

The perfect photo-micrographic plate would give equal photographic intensity to all the colors of the visual spectrum, but since this degree of excellence has not been attained, the value of a given plate may be enhanced by the use of color screens, or ray filters, which serve to increase or decrease the photographic intensity of a color. The following are the laws upon which the use of color screens is based:

First. To increase the photographic intensity of a color, a screen of complementary color should be used.

Second. To decrease the photographic intensity of a color, a screen of the same color should be used.

These laws hold good for all branches of photography, whether by transmitted or reflected light, and are not dependent upon the position of the screen, i. e., whether the screen is placed between the source of illumination and the object, between the object and the objective lens, or between the lens and the plate.

In determining the photographic complement of a color it is more accurate to make photographic analyses of stains and color screens than to make simple visual analyses.

The same plate and source of light must be used as in taking the photo-micrograph, because, as shown above, plates of different makes may differ greatly in their degree of sensitiveness to different parts of the spectrum, and it is a well recognized fact that different illuminating agents give different spectra. The object for which one should strive in the analyses of stains and color screens is to imitate as exactly as possible the conditions that will exist in the process of photo-micrography. The spectrographs illustrated in Fig. 3 were made with color screens in preference to cells of fluid, as the screens are much more convenient than cells, and are quite as satisfactory. The color screens are made by soaking a cleared lantern slide in a solution of the desired stain until the gelatin is saturated, then rinsing and removing the surface liquid with a cotton pad. The screen is then dried and covered with a cover-glass as in mounting a lantern slide. The depth of color in these screens is dependent upon the degree of concentration of the staining solution rather than upon the length of time the plate is soaked.

C. W. J.

Kresylechtviolett.

In the *Centralblatt für Bakteriologie*, Vol. 27, Homberger describes a new method of staining the *Gonococcus* by which it may be distinguished from all other micro-organisms. The stain used for this purpose was Kresylechtviolett, a fluorescing color prepared by Leonhard. In dilutions of 1-10,000 the water solution of this stain colors the *Gonococcus* a reddish violet while other micro-organisms are either not stained at all or take a faint blue tinge. Homberger mentions further that mast-cells, amyloid, mucin and colloid are stained well with this dye and that it can also be used in Gram's method.

It was found on working with the stain in this laboratory that the water solutions precipitate on standing and lose their staining power. The alcoholic solutions did not precipitate, but satisfactory results could not be obtained with them. Since the reactions obtained with the stain were found by repeated experiment to be very characteristic, and as it promised to be a very valuable addition to diagnostic methods the present work was undertaken at the request of Dr. Warthin to find, if possible, a satisfactory method of using the stain, and to extend its application in pathological work.

The stain used was prepared by Grüber. It is soluble in water and alcohol. After much experimental work the following method of preparation was found to be satisfactory in all respects, and to meet all requirements, and is the one used throughout this work :

Preparation (Morse):

| | | |
|--|-----------|----------|
| Five per cent. aqueous solution of Phenol, | - | 80 c. c. |
| Ninety-five per cent. Ethyl Alcohol, | - - - | 20 c. c. |
| Stain, | - - - - - | 1 gm. |

Mix the two solutions, then add the stain, stirring thoroughly. As soon as the stain is all dissolved, filter. This solution keeps well, gives all the staining reactions, and may be diluted to any degree with distilled water without causing precipitation. The above method of preparation must, however, be rigidly followed.

Tissue may be fixed in any way, but formalin, mercuric chloride, and Zenker's give the best results in the order named. Paraffin or celloidin embedding may be used. Excellent results may be obtained by the combination plate-method.

Staining method (Morse) :

1. Stain 1-5 minutes.
2. Wash thoroughly in distilled water.
3. Blot with filter paper.
4. Anilin-Xylol (2:1).
5. Pure Xylol.
6. Balsam.

This method is the best one for the reactions with the majority of pathological substances. The variations of this method for certain specific reactions will be mentioned below. Nearly all the tissues of the body and the important pathological conditions have been worked over with this stain. Its most important applications are as follows :

For use as a simple nuclear stain it is best to stain only two minutes, then wash and differentiate in alcohol. A contrast stain is not necessary, as the deep violet color of the nuclei is easily distinguished from the pale blue tint given to other structures. Eosin may, however, be used after the sections have been stained and differentiated in alcohol.

Blood smears give the best results when fixed as for tri-acid staining. Heat fixation gives the best result. When stained for two minutes the red cells are a light yellowish green, the protoplasm of the leucocytes colorless, and the nuclei rose-pink. Blood-plates and basophile granules stain like the nuclei. The malarial plasmodium stains a dull pink, not as deep as the leucocyte nucleus, and is easily distinguished. In well fixed tissue sections blood stains similarly, but the basophile granules do not show.

The nuclei of young connective tissue stain a light purple, while the intercellular substance takes a dull rose pink; in old connective tissue the nuclei stain a deep violet or purple, while the intercellular substance does not stain at all or takes a very light violet.

Yellow elastic tissue stains a sky blue. It is best brought out by longer staining.

Voluntary muscle stains a pale green with violet nuclei, the protoplasm of involuntary muscle a light purple to a light blue with nuclei of a darker shade.

Nerve cells and axis cylinders stain purple, the nuclei violet, the granules of the cell body are very distinctly shown. Neuroglia stains a very light purple, or not at all.

Fibrin stains a bluish purple, but this reaction is not distinctive.

Hyalin in corpora fibrosa does not stain at all or takes faint blue tint.

Colloid takes a deep indigo blue, which is very characteristic.

Calcification takes a dirty, cold blue, which can be readily distinguished from colloid.

Cartilage takes a reddish violet, which is very characteristic.

Corpora amylacea also stain a reddish violet.

The most valuable reactions with this stain are those with mucin, amyloid, mast-cells, and the so-called cancer parasite. In staining for these the sections should be dehydrated in alcohol and cleared in turpentine. The excess of turpentine must be thoroughly blotted off before mounting in balsam, else the stain will run and the specimens become blotchy.

The reaction with amyloid as brought out by the method given above is very striking and characteristic, and is particularly valuable in teaching work. The amyloid stains a ruby red, which is sharply contrasted with the clear blue nuclei and faint blue protoplasm of the living tissues. No other method brings out so well the presence and location of small quantities of amyloid. The stain appears also to give a permanent reaction; in the ten months in which this stain has been used in this laboratory no fading of properly prepared specimens has been observed, and trial specimens exposed daily to sunlight have retained their color for months. The apparent permanency and clearness of this reaction, as well as the fact that the sections so treated can be preserved in balsam, gives this stain a high place over the anilin dyes usually employed for amyloid reactions.

Mucin stains a bright rose pink, which is very characteristic and brings out the presence of mucin when the amounts are too small to be demonstrated by other methods. It also distinguishes mucin from pseudomucin, the latter either not staining at all or taking a very light blue tint.

The method is also a most excellent one for the staining of mast-cells. The best results are obtained by staining only ten seconds, washing thoroughly and differentiating in alcohol. The nucleus stains a light violet, the granules a fuchsin red.

The so-called cancer parasite stains a rose pink, and may be seen as a point in the protoplasm of the cell or as a slightly larger mass surrounded by a clear zone containing radiating lines. A more advanced stage is seen as a reticular mass replacing more or less of the cell protoplasm, and, in some instances, continuous with the mucin surrounding the cell nests. The resemblance to the reaction with mucin may be noticed in passing.

The specific reaction with the *Gonococcus* has already been mentioned. This stain has, however, the further advantage in that the material may be stained in the hanging drop and the life of the cell not destroyed, so that the movements of the leucocyte containing the micro-organisms may be studied.

From these investigations it seems that for ease of manipulation, wide application and specific staining reactions Kresylechtviolett holds a very high place among differential stains for diagnostic purposes, and that it is a most valuable addition to the resources of the teaching laboratory.

Pathological Laboratory, University of Michigan.

RALPH L. MORSE.

MICRO-CHEMICAL ANALYSIS.

XVII.

MAGNESIUM GROUP—SEPARATIONS.

When engaged upon the examination of a complex mixture of unknown composition, the chemical behavior of all the elements and salts liable to be present must ever be borne in mind. It is seldom indeed that the analyst is called upon to make an analysis of a substance or mixture of absolutely unknown composition. The chief constituents are almost always known, or at least suspected; and there are also always good reasons why certain other substances cannot be present. He who would become a rapid worker must learn to reason by exclusion, but the beginner must realize that there is a vast difference between using one's judgment and common sense, and hazarding a mere guess. Thus the choice of methods in micro-chemical work will depend as largely upon what substances are *absent* as upon what are present.

In all analytical work rapidity is to be striven for, but such rapidity must never be gained at the expense of accuracy.

In order to better understand the chemistry of the separation methods of this group, it may be well to recall the most important of the chemical properties of the elements composing it, upon which our procedures will depend.

The hydroxides of all the members of the group are insoluble in pure water.

Glucinum hydroxide is insoluble in excess of ammonium hydroxide, but is soluble in ammonium carbonate, potassium hydroxide, and sodium hydroxide.

Magnesium hydroxide is soluble in the presence of ammonium salts, especially ammonium chloride, but is insoluble in excess of the fixed alkalis.

Zinc hydroxide behaves like that of glucinum toward fixed alkalis, but unlike glucinum, it is also soluble in ammonium hydroxide.

Cadmium hydroxide is insoluble in excess of sodium or potassium hydroxides, but is soluble in ammonium hydroxide.

Magnesium is the only one of the group normally yielding a crystalline precipitate with secondary sodium phosphate in ammoniacal solution.

Zinc and cadmium are readily precipitated by oxalic acid, glucinum with difficulty, and magnesium only when much acetic acid is present or the solution is excessively concentrated. In the case of glucinum, the double potassium oxalate is less soluble than the normal oxalate.

All four elements are precipitated by alkaline carbonates.

The chlorides and oxides of zinc and cadmium can be easily volatilized.

Zinc and Cadmium from Magnesium, etc., by sublimation.

A. Place a small portion of the material on a nickel or platinum spatula,* moisten with nitric acid, evaporate gently, then ignite to convert into oxides, but

* This Journal, III, p. 794, Fig. 6.

avoid their volatilization. Convert into chlorides by evaporating repeatedly with hydrochloric acid. When perfectly dry, the flame is moved nearer and nearer the substance and a glass slide bearing on its upper side a drop of water** is held directly over the substance being tested. If a sublimate results it may consist of $ZnCl_2$, $CdCl_2$, $BiCl_3$, $PbCl_2$, $FeCl_3$, $CuCl_2$, and perhaps $HgCl_2$. Any arsenic, antimony and probably all the mercury which might have been present will have been driven off in the ignition of the nitrates to oxides.

Dissolve the sublimate in a drop of water and test with ammonium mercuric sulphocyanate. In the event of the sublimate being complex, add water to remove the bismuth. Decant. Remove the lead by sulphuric acid. Add sodium hydroxide, cadmium and iron are precipitated and zinc passes into solution. Dissolve the precipitate in dilute acid and test for cadmium. To the sodium hydroxide solution add ammonium carbonate and examine the preparation for the double carbonate of zinc and sodium.

When much copper is present it is always best to first remove it by placing a drop of a solution of the substance on metallic iron, thus causing it to separate.

B. The oxides of zinc and cadmium can be sublimed on charcoal before the blowpipe. Make a slight depression in the carbon, place in it a moderate quantity of the material, moisten with water and heat gently till dry, then strongly with the *oxidizing* flame, holding the coal at an angle. Zinc oxide forms a coating on the charcoal, yellow while hot, pure white when cold. Cadmium oxide yields a brown variegated coating. The film on the charcoal is removed by carefully scraping with the spatula, transferred to a slide, heated with dilute acid and the clear liquid drawn off from the residue of carbon. The solution is then tested for zinc and cadmium.

In addition to zinc and cadmium, films on charcoal are given by antimony, tin, bismuth, lead, and rarely by arsenic and mercury.

Removal of Phosphates.

If phosphates are present in the substance to be tested, it is often necessary to first remove them before any reliable tests can be obtained for magnesium and glucinum. One of the simplest methods of procedure is as follows:

Add strong nitric acid, then a few small strips of thin, pure tin foil or a little powdered tin. Boil until all the tin has been converted into the oxide and phosphate; draw off or filter, and repeat the process until no test for phosphoric acid is obtained with ammonium molybdate. The solution is now evaporated to dryness, and if arsenates are also present, the residue is ignited to drive off any arsenous acid which may have resulted from any reducing action of the metallic tin. The residue is extracted with water acidified with nitric acid and tested as given below.

The removal of phosphoric acid by metallic tin is simple, expeditious and satisfactory. Only a few cautions are necessary. The nitric acid must be strong acid, the size of the drop, and the amount of tin added must correspond

** This Journal, III, pp. 857-858.

to the amount of phosphoric acid present ; that is, when there is a large amount the drop must be large, so as to permit of sufficient heating. It is better under such conditions to employ two operations to remove the phosphates rather than attempt it in a single one. A small test tube will generally prove more satisfactory than a slide or watch glass.

GLUCINUM.

A. Glucinum in Simple Substances.

Add ammonium hydroxide and ammonium carbonate (see page 1328) in excess, glucinum hydroxide is dissolved (also U, Zn, Cd, and perhaps Mg). Decant or filter, and to the solution add ammonium chloride in moderate amount, evaporate, and ignite gently until all ammonium salts are removed. The residue is dissolved in dilute sulphuric acid, a little sodium acetate and a trace of mercuric chloride added. The preparation is then tested for glucinum with potassium oxalate. Or, treat the residue with uranyl acetate and sodium acetate. In the latter case Mg, Zn, Cd must be absent.

B. Glucinum from Magnesium.

Add to the solution sodium hydroxide, warm, evaporate and take up with water. Magnesium hydroxide is precipitated, the glucinum passes into solution (also Zn and Al).

Wash the precipitate and treat it with ammonium chloride, the magnesium passes into solution and is tested with sodium phosphate and ammonium hydroxide.

The solution containing the glucinum is evaporated, extracted with hydrochloric acid and tested with potassium oxalate.

C. Glucinum in Complex Mixtures.

Remove any copper, etc., by iron foil.

Add ammonium hydroxide and hydrogen peroxide. Warm for a time, then evaporate. Repeat the treatment. Extract the residue with a solution of ammonium carbonate. Fe, Mn, Co, Al and part of the Mg should remain insoluble, while Gl, Zn, U, Mg will be dissolved. The solution is evaporated, ignited, dissolved in dilute acid and tested with potassium oxalate ; or if much magnesium is present, separate with sodium hydroxide as in *B*.

MAGNESIUM.

A. Magnesium from Glucinum, Zinc, Cadmium, Aluminium.

Precipitate with sodium hydroxide, warm, evaporate, and extract repeatedly with water. Mg and Cd remain behind. Dissolve the residue in hydrochloric acid and divide into two portions. Test one part for magnesium with sodium phosphate, and the other for cadmium with sulphocyanate or oxalic acid.

B. Magnesium in Complex Mixtures.

Add ammonium chloride and ammonium hydroxide in slight excess, then hydrogen peroxide, and warm. Evaporate and treat again. Extract the residue

with a dilute solution of ammonium hydroxide; Mg, Zn, Cd, Ni, Cu are dissolved. To the solution add oxalic acid and acetic acid and from the precipitated oxalates of Zn, Cd, Ni, and Cu, the clear solution is separated by decantation, filtration, or the centrifuge. This solution is evaporated with sulphuric acid and heated to destroy the oxalic acid. The residue is dissolved in acidulated water, treated with sodium hydroxide, the precipitate carefully washed, dissolved in hydrochloric acid and tested for magnesium with sodium phosphate.

C. Magnesium from Glucinum.

To the solution to be tested add ammonium chloride, then carefully, a little at a time, ammonium hydroxide as long as a precipitate results, draw off at once and test the decanted solution with sodium phosphate for magnesium.

ZINC.

A. Zinc from Glucinum, Magnesium, and Cadmium.

Ignite, warm gently with sodium hydroxide solution. Zinc and glucinum are dissolved, magnesium and cadmium remain in the residue. Separate the solution, add to it acetic acid and precipitate the glucinum with potassium oxalate (a little zinc is always precipitated with the glucinum). Separate the clear solution, evaporate and destroy the oxalic acid by means of sulphuric acid and heat. Take up the residue with water, acidified if necessary, add ammonium acetate, and test for zinc with sulphocyanate; the addition of a trace of copper will increase the delicacy of the reaction. Or, instead of testing with sulphocyanate, to the sodium hydroxide solution after the removal of the magnesium and cadmium, add ammonium carbonate, zinc will separate as the double carbonate of zinc and sodium.

B. Zinc from Cadmium.

Precipitate with primary sodium carbonate in ammoniacal solution, cadmium separates at once, draw off the supernatant solution and allow to stand for a short time, zinc separates as the double carbonate. Or, acidify the solution to be tested, and to it add powdered metallic magnesium. Zinc and cadmium are precipitated. Wash carefully the finely divided metallic mass; add acetic acid, heat the preparation; zinc passes into solution with but very little cadmium, decant and test for zinc. The residual metallic cadmium is dissolved in hydrochloric acid and tested.

C. Zinc in Complex Mixtures.

Treat with ammonium hydroxide and hydrogen peroxide. Then with ammonium carbonate. To the decanted solution add oxalic acid and acetic acid. Separate the precipitated oxalates, ignite and extract the zinc with sodium hydroxide. The clear solution containing the zinc is heated with ammonium chloride and tested for zinc with primary sodium carbonate or acidified and tested with sulphocyanate.

CADMIUM.

A. Cadmium from Magnesium.

The bulk of the magnesium can be precipitated as magnesium ammonium phosphate by adding ammonium hydroxide and sodium phosphate, the latter very carefully and only a very little at a time so as to avoid precipitating any cadmium. The clear supernatant solution is then drawn off and tested for cadmium.

B. Cadmium from Glucinum, Zinc, or Aluminum.

Precipitate with excess of sodium or potassium hydroxide. Glucinum, zinc, and aluminum are dissolved. Cadmium remains insoluble. Dissolve the precipitate in hydrochloric acid and test with oxalic acid or with sulphocyanate.

C. Cadmium in Complex Mixtures.

Proceed as in the above described methods in which ammonium hydroxide and ammonium carbonate, etc.; e. g., *Zinc C.* After precipitation and ignition of the oxalates, the residue is extracted with sodium hydroxide, cadmium remains insoluble. This residue insoluble in sodium hydroxide is washed, dissolved in hydrochloric acid, and tested for cadmium.

D. Cadmium from Zinc.

See *Zinc B.*

E. M. CHAMOT.

Cornell University.

A Damp Chamber for Use on the Klinostat.

Students of Plant Physiology have often found need for a damp chamber for use on the klinostat which will furnish a firm support for seedlings in rapid rotation and will retain a supply of moisture for several hours. The original method used by Knight has been variously modified so as to provide moisture for the plants. In cases where the desired plane of rotation is horizontal the experiment may be successfully performed by covering with a bell-jar a rotating disk whose axis projects below the table and to which the motive power is applied. In work where the desired plane of rotation is vertical, some experimenters have arranged a reservoir of water so that the supply of moisture falls upon the rotating seedlings in drops; but here is a chance that the thigmotropic or traumotropic stimulus given by the falling drops may affect the results of the experiment.

The apparatus described below has been successfully used for different kinds of work in the Botanical Laboratory of the University of Michigan.

A narrow board, containing about eight pegs 5 or 6 cm. long, is fitted into the bottom of a thin glass basin of about 22 cm. diameter and 6 cm. depth. The pegs serve for the attachment of the small bars holding the seedlings. The glass dish is lined with moist filter paper and closed with a circular glass plate 24 cm. in diameter; the inner side of the cover is completely lined with a piece of moist blotting paper, which forms an almost perfectly tight fitting cover.

In case the plate of the klinostat is too small for the attachment of the basin, it must be fastened to a circular wooden plate, which is screwed to the plate of the klinostat and also serves for securing the cover clamp. The cut shows the

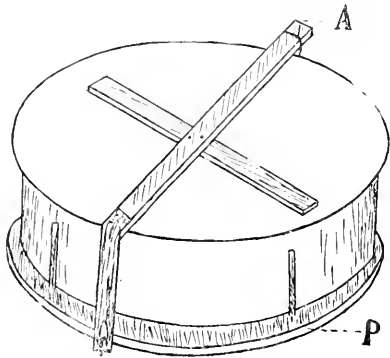

manner of securing the cover and the dish. The clamp A is made of strong, elastic wood with disks of rubber under the extremities of the arms; one end of it slips into a loop of wire, a strip of brass at the other end hooks to the wooden plate P. The dish is held from slipping sideways by four pegs in the wooden plate, which may be covered with short pieces of rubber tubing. The seedlings for use should be attached to short wooden bars, which are fastened to the pegs inside of the dark chamber by means of

two rubber bands. The strength of the centrifugal force, in terms of the attraction of gravity, may be calculated for the pegs from the following formula :

$$\frac{4 \pi R \text{ (in meters)}}{gt^2}, \frac{4 \pi^2}{g} = 4.024, \text{ a constant.}$$

$$4.024 \times \frac{R}{t^2} = \text{no. of } g \text{ (gravity).}$$

R = radius expressed in meters.

t = time in seconds of one revolution of the chamber.

If the centrifugal force is small, i. e., less than three times the force of gravity, the seedlings may be attached to the wooden bars in the ordinary method by the use of rubber bands and strips of blotting paper; but if the centrifugal force is considerable, I have found it better to pack the seedlings in short pieces of glass tubing, allowing about 5 millimeters of the root-tip to protrude, then to fasten the pieces of glass tubing to the wooden bars. The pieces of tubing should be arranged so that they lie in a tangential plane.

For short periods of time the supply of moisture will not need to be replenished if the chamber is well saturated before beginning; in long continued experiments it is best to introduce more water by means of an atomizer every six or eight hours.

The advantages of such a chamber for use on the klinostat are that in the moist air the roots are freer to respond than in moist sawdust, where the higher rates of rotation invariably cause the sawdust to become packed at the circumference of the cylinder; the seedlings can be easily observed during the progress of the experiment; it retains its supply of moisture well,—I have seen corn seedlings grow for four days with only the initial supply of moisture; it can be rotated in any desired plane and at any speed.

HOWARD S. REED.

University of Michigan.

Journal of
Applied Microscopy
 and
Laboratory Methods.

Edited by L. B. ELLIOTT.

Issued Monthly from the Publication Department
 of the Bausch & Lomb Optical Co.,
 Rochester, N. Y.

SUBSCRIPTIONS:

One Dollar per Year. To Foreign Countries, \$1.25
 per Year, in Advance.

The majority of our subscribers dislike to have their files broken in case they fail to remit at the expiration of their paid subscription. We therefore assume that no interruption in the series is desired, unless notice to discontinue is sent.

SEPARATES.

One hundred separates of each original paper accepted are furnished the author, gratis.

Separates are bound in special cover with title. A greater number can be had at cost of printing the extra copies desired.

cent eastern meetings, the registration reaching 311. That the Association is rallying after a period of gradual decrease in membership is assured by the fact that since the 1900 meeting, 1500 new members have been added. More than 200 papers were presented. The report of the financial condition of the Association was very encouraging, the permanent endowment fund having been increased during the year by over one thousand dollars, bringing the present amount of that fund to something over eleven thousand dollars.

Several changes of policy were either adopted or recommended for future consideration. Of these the most important is that of a change in the time of meeting, to conform with the recent action taken by the universities to establish a Convocation Week during the winter. It was recommended that the Association, with its affiliated societies, meet at Washington during the week in which New Year's day of 1903 falls, without, however, abandoning the summer meetings. Thus the plan for winter meetings will be given fair trial, and its permanent establishment will depend largely upon the success of the first winter meeting.

An amendment for the mutual advantage of the Association and its affiliated societies provides that each affiliated society be entitled to elect one member (two if the society has more than twenty-five members) as its representative in the council of the Association; thus forming a closer organization between all the societies concerned.

Another step, intended to add strength to the council, is the provision for the election each year of three councillors-at-large, who shall serve for a term of three years, thus giving greater permanency and efficiency to that body. It is proposed to lengthen the term of office of the secretaries of sections to five years, in order to give the sections the benefit of experienced service. The present term gives the secretary little more than time enough to become familiar with his duties.

Although we have noted only a very small part of the proceedings of the Denver meeting, it is sufficient to show that the American Association for the Advancement of Science is growing in size and efficiency, and is an organization to which all who are interested in scientific work can well afford to belong.

THE results of the Denver meeting of the American Association for the Advancement of Science undoubtedly came as an agreeable surprise to any who may have had fears for the success of a meeting so far from the center of American scientific activity. The reports of the meeting are most gratifying. The results accomplished during the past year, and the steps taken for the betterment of the organization in coming years, are of such interest as to bear repetition. We would also take this opportunity to congratulate those who assumed the responsibility of the arrangement of the recent meeting at Denver for the success with which their efforts have been rewarded. One more step in advance has been taken, and a closer and more efficient organization has been attained. The meeting was a success from every standpoint. The attendance approached that of recent

CURRENT BOTANICAL LITERATURE.

CHARLES J. CHAMBERLAIN.

Books for review and separates of papers on botanical subjects should be sent to
Charles J. Chamberlain, University of Chicago,
Chicago, Ill.

REVIEWS.

Hill, A. W. The distribution and character of connecting threads in the tissues of *Pinus strobus* and other allied species. Phil. Trans. of the Roy. Soc. of London, Ser. B., 194: 83-125; pls. 31-35, 1921.

This paper, by Mr. Hill, constitutes Part I of an extensive study by Gardiner and Hill of "The Histology of the Cell Wall, with special reference to the

mode of connection of cells." The purpose was to discover the extent and distribution of the connecting threads in any particular plant. The embryo and seedlings of *Pinus pinaster* and the mature tissues of *Pinus sylvestris* were chosen as particularly favorable material. The endosperm was also studied in *P. pinaster*. The endosperm consists chiefly of rather large, rounded cells, but a close examination shows that in many cases an internal division has occurred. The threads are evenly distributed in the young walls, but are grouped in the older walls. Near the cotyledons the cells are smaller, the threads thicker, and there are traces of ferment action. Ferments from the cotyledons pass into the endosperm through the threads, and by the same route, food materials pass from the endosperm to the embryo.

In the seedling the absorptive side of the cotyledon is more abundantly supplied with threads than the side not exposed to the endosperm. There are no threads in the external walls of the epidermis, and but very few connecting the guard cells with their neighbors. All parenchyma cells show a general resemblance in the character of their threads, the threads on the end walls being irregularly scattered, while on the side walls they are grouped. In the phloem, all the sieve tube threads show a characteristic median dot. The albuminous cells at the edge of the phloem of the leaf have their threads grouped in localized thickenings on the walls, and serve to pass materials from the mesophyll to the phloem. The very numerous threads of the root cap form a connection with the free surface of the root and with the periblem.

In the mature tissue of *P. sylvestris* the threads in the cortical tissue are similar to those of the seedling. In the phloem there is no connection between the sieve tubes and the bast parenchyma, or the starch medullary ray cells. The sieve tube threads on the radial walls have a median dot. The torus of the bordered pit is probably traversed by threads which soon disappear. In the leaf, the distribution is about the same as in the cotyledon. The endodermis, with very numerous threads, is in close connection with the cortex and the stele. In the pericycle, living cells are connected by threads, but there is no connection between the pericycle and the lignified transfusion tissue.

In general, the main direction of threads in the cortex and phloem is tangential. The transitory nature of certain threads explains the absence of threads between the sieve tubes and medullary ray cells. Except in the medullary rays,

and in the cork cambium, the threads are chiefly on the radial walls. This suggests that in conifers food supplies and stimuli are conducted mostly in a tangential and vertical direction.

C. J. C.

Arnoldi, W. Beiträge zur Morphologie einiger Gymnospermen. I. Die Entwicklung des Endosperms bei *Sequoia sempervirens*. Bull. des Natur. de Moscou, Pp. 1-13, pls. 7-8, 1899.

In Gymnosperms, as a rule, only one embryo sac attains any considerable development. Very rarely two embryo sacs develop in *Taxus*, and in one

instance, two embryo sacs have been seen in *Pinus sylvestris*. In *Sequoia*, however, several embryo sacs begin to develop, and in *Gnetum* it is the rule for several sacs to develop almost to maturity before one of them secures any decided advantage. Prof. Arnoldi has taken up the somewhat incomplete work of Shaw, and has made a careful study of the development of the endosperm of *Sequoia sempervirens*. Free nuclear division takes place in the usual manner in an evenly distributed peripheral layer of protoplasm, but very soon there is a denser accumulation of protoplasm at the lower end of the sac. When the formation of walls begins, three regions of the endosperm may be distinguished: the upper, the lower, and the middle. The upper, and particularly the lower, develop faster than the middle, so that the ends of the sac become filled with a solid tissue, while the nuclei are still almost free in the middle portion. Each nucleus of the middle portion now becomes surrounded by a wall which is open on the inner side; the walls grow inward, and when the center is reached walls are formed at the inner ends of the cells. The nucleus now begins to divide, and each of these cells ("alveoli") becomes divided into several cells. Archegonia are formed only from these alveolar cells of the middle region. At the time of fertilization, the upper and lower portions of the endosperm consist of small-celled tissue, while the middle portion is alveolar. *Sequoia* is regarded as a connecting link between *Gnetum* and the Angiosperms on the one hand, and between Gymnosperms and the Archegoniates on the other.

C. J. C.

Arnoldi, W. Beiträge zur Morphologie und Entwicklungsgeschichte einiger Gymnospermen. II. Ueber die Corpuscula und Pollenschläuche bei *Sequoia sempervirens*. Bull. des Natur. de Moscou, Pp. 1-8, pls. 10-11, 1899.

The number of archegonia in *Sequoia* is very large, some of the writer's drawings showing as many as sixty. They sometimes occur singly, but are often grouped. In development they resemble

the archegonia of the Cupressineæ, since they are often in direct contact with each other, and do not form any ventral canal cell. There are no proteid vacuoles. The neck consists of two cells, in this respect resembling the older Gymnosperms. The pollen tube grows through the nucellus, not between the nucellus and integument, as described by Shaw. At the time of fertilization the pollen tube contains the two male cells of equal size, and two small nuclei, one of which is the tube nucleus and the other "the nucleus of the cell which united the generative cell with the microspore wall." The general structure of the pollen tube and its contents agrees with the Cupressineæ. The morphological considerations, together with the geographical distribution, lead to the conclusion that *Sequoia* is nearly related to the ancient type from which the modern Araucarias and Cupressineæ have descended.

C. J. C.

CYTOLOGY, EMBRYOLOGY, AND MICROSCOPICAL METHODS.

AGNES M. CLAYPOLE, Cornell University.

Separates of papers and books on animal biology should be sent for review to
Agnes M. Claypole, 125 N. Marengo avenue,
Pasadena, Cal.

CURRENT LITERATURE.

Cade, A. Les Éléments Secrétateurs des glandes
gastriques du fond chez les mammifères.
Arch. d'Anatomie Microscopique, 4: 1-86,
1901.

This article contains a description of the histological structure of the glands of the stomach in different stages of

their normal activity, the changes in the glands during hibernation, the effects produced by pilocarpin, section of the vagus nerve, isolation of a part of the stomach, and the formation of an artificial pylorus in the region of the fundus. The cells of the fundus are grouped under three heads—cells of the neck of the gland, the central or chief cells, and the parietal cells. The material studied was obtained from the dog, cat, rat, mouse, hedge-hog, marmot, and, in a few cases, from man. Methods of fixation and staining are given, and the structure of the cells described in detail. The central or chief cells frequently contain two or more nuclei, and divide amitotically; careful research failed to discover a single case of karyokinesis. Amitosis is apparently the chief mode of division in the border cells also. The neck, or muciparous, cells exhibit transitions into the central cells, and the author inclines to the view that the one type may be transformed into the other, although it is admitted that this is not proven. A close connection exists between the neck cells and the epithelial cells of the surface of the mucosa, and there is a relationship between the neck cells of the fundus glands and the cells of the body of the pyloric glands. (“Il y a entre les cellules des grandes pyloriques et les cellules principales du col une certaine parenté.”) There is no evidence of a transition either way between the chief cells and the border cells of the fundus; they apparently always remain specifically distinct elements. Contrary to the opinion held by Opper and others that the cells of the body of the gland in the lower vertebrates represent only the parietal cells of the mammals, the author holds that they correspond to both parietal and chief cells of the higher forms. The theory that the parietal cells are especially concerned in the production of hydrochloric acid is considered devoid of adequate foundation.

Section of the vagus nerve gives rise to marked structural changes in the secreting cells. The border cells become less granular. The cytoplasm of the chief cells stains less deeply, and the cells lose the differentiated region at the base; the nucleus becomes shrunken and wrinkled in outline. Isolation of a part of the stomach gives rise to changes similar to those produced by section of the vagus. The author concludes that the vagus plays an important role in the secretion of the gastric juice.

The experiment of forming an artificial pylorus in the fundus of the

stomach gave very interesting results. The stomach of a cat was cut completely across in the middle, and a junction was made between the fundus and the jejunum, so that the pyloric region was entirely excluded from the route along which the food passed. A similar operation was performed on a dog, and both animals were killed about seven months afterward. A careful study was made of the histological changes that occurred in the region of the fundus near the line of juncture. Near the junction with the intestine the fundus glands became more sinuous, the lumen increased in size, and the interglandular tissue became infiltrated with leucocytes. The character of the gland cells was markedly altered. The parietal cells disappeared entirely; the chief cells lost their characteristic granulation, their basal differentiation disappeared, and they assumed the principal features of the cells of the neck. Both in general structure and in the character of the cells the fundus glands near the new pylorus became strikingly similar to the ordinary pyloric glands. This working over of the fundus glands into glands resembling those of the pyloric region in response to the new enviroing conditions imposed is a feature of considerable theoretical interest. There is a closing section on deductions concerning the process of secretion in general.

S. J. H.

Conklin, E. G. Centrosome and Sphere in the Maturation, Fertilization, and Cleavage of *Crepidula*. *Anat. Anz.* 19: 280-287, 1901.

This paper is a summary of a more extended publication which will soon appear in the *Journal of Morphology*.

In fertilization there is no "quadrille" of the centers. The egg sphere and sperm sphere, however, fuse into a granular mass. Within this mass the centrosomes of the first cleavage spindle arise apparently independently of each other. The author holds that "there is good evidence that the cleavage centrosomes are not derived exclusively either from a sperm centrosome or from an egg centrosome, but that one of these comes from the egg sphere, the other from the sperm sphere."

S. J. H.

Hoffmann, R. W. Ueber das Orientiren und Schneiden mikroskopisch kleiner, undurchsichtiger und dotterreicher Objecte. *Zeit. wiss. Mik.* 4: 443-448, 1901.

While the consistency of yolk depends to a certain extent upon the fixing fluid employed, the length of time the object

remains in alcohol and the duration of the process of embedding in paraffin were not found to have any influence on the ease with which yolk can be cut. No reliable method of treating yolk so as to be cut easily in paraffin was hit upon, so resource was had to embedding in celloidin. In orienting small opaque objects in celloidin, 90 per cent. alcohol is a serviceable medium in which to operate, as it enables one to see easily the configuration of the object, and only hardens the celloidin very slowly; 100 per cent. alcohol, which the author at first employed, dissolves the celloidin too much, and 85 per cent. alcohol hardens it too rapidly. After the object is oriented under a small amount of the alcohol it is placed in xylol to harden. The turbidity that appears after treatment with xylol soon disappears, and the mass becomes clear. One convenient method of orienting is as follows: A number of objects are impregnated with thick celloidin solution in a shallow glass dish, enough celloidin being used to form, after it is hardened, a mass but little thicker than the objects embedded. After the mass is hardened under 80 per cent. alcohol it is cut up into small, square pieces, one for each object. After being placed for some time in 90 per cent. alcohol, the objects are stuck to a block, oriented under a small amount of 90 per cent. alcohol, and then placed in xylol until hardened and cleared.

S. J. H.

CURRENT ZOÖLOGICAL LITERATURE.

CHARLES A. KOFOID.

Books and separates of papers on zoölogical subjects should be sent for review to Charles A. Kofoid, University of California, Berkeley, California.

Siedlecki, M. Contribution à l'étude des changements cellulaires provoqués par les Gregarines. Arch. d' Anat. Micros. 4: 87-100. Avec 9 figs., dans le texte. 1901.

Monocystis ascidiæ develops within a cell of the intestinal epithelium of *Ciona intestinalis* from the sporozoöte issuing from the sporocyst of the Gregarine in

the intestine. The presence of the parasite in the cell provokes at first an hypertrophy of the nucleus and the cytoplasm. The chromatin is disorganized, and the nucleolus increases in size. These changes are due to the chemical action of the parasite. In material fixed in Flemming, or sublimate, the parasitized cells are but feebly stained by safranin, thionin, the various hæmatoxylin, or the Biondi mixture. The infected and greatly hypertrophied cell is pushed beneath the epithelial layer into a sac of connective tissue formed by the basement membrane. From this sac the *Monocystis* escapes by passing through the epithelial layer between the cells into the lumen of the digestive tract. Here it attaches itself by means of its small amœboid projection upon the epithelial cells, in which, however, it produces no pathological condition. *Pterocephalus*, parasitic in *Scolopendra*, lies, in its adult stage, between the cells of the intestinal epithelium attached to them by protoplasmic prolongations of the protomerite. The changes in the epithelium due to its presence are purely mechanical. C. A. K.

Miall, L. C., and Hammond, A. R. Structure and Life-history of the Harlequin Fly. Pp. vi, 196. With 127 figs., and 1 pl. The Clarendon Press, Oxford, 1900.

The revival of interest in the *Diptera* which has resulted from the discovery of the agency of mosquitoes and house-flies in the spreading of disease makes

the publication of this book very opportune. Though *Chironomus* is not itself an obnoxious form, its structure and life-history are in many points so similar to those of the *Culicidæ*, that this work may well serve as a guide to students of that group. The anatomy and histology of both the larvæ and the adult are treated in detail with abundant original illustrations, and comparisons with other *Diptera* are frequently made. The habits, parasites, enemies, and the life-history are fully described.

Chironomus is widely distributed, and its larvæ abound in every body of fresh water, and also in some places in salt water in the littoral region. Slow, muddy streams rich in decaying organic matter constitute the best collecting grounds, and a long-handled ladle forms a good collecting instrument. Larvæ are easily reared in the laboratory in shallow aquaria with decaying vegetation. High temperatures favor their rapid transformation.

The study of the living larva is best made upon half-grown specimens entangled in a nest of cotton-wool. The external structure is best seen in specimens killed in Flemming's fluid, and the detail of the exoskeleton in specimens treated for three days in a ten per cent. solution of caustic potash, and then

mounted in glycerin or balsam. For histological study the larvæ may be killed in Flemming's fluid; after one hour's exposure they should be halved and again placed in the fluid for another hour, and then thoroughly washed in running water in a washing bottle for twenty-four hours. Perenyi's fluid for six hours also fixes the tissues very well; after three hours in the fluid the larvæ should be halved. Larvæ for entire mounts should be prepared as follows: Select transparent specimens and keep them in clear water for a day or two, until the alimentary canal is emptied. Then place the larva in a mixture of absolute alcohol (9 parts) and ether (1 part), holding it in the desired position with small sable brushes until it is set (three to ten minutes). After several hours' exposure to this fluid transfer to absolute alcohol so as to remove all the ether. Pass through oil of cloves to *new* benzine balsam. Many points in the anatomy may be elucidated by fresh specimens teased out in two per cent. caustic potash, or by those killed in the fluids above mentioned, and stained in carmin or hæmatoxylin before teasing out. In staining *in toto* with carmin or Delafield's hæmatoxylin it is necessary to permit the stains to act for at least a week. Material prepared by the methods above described may be successfully sectioned in either paraffin or celloidin. Serial sections in the paraffin are facilitated by coating the block with soft paraffin.

The peculiar nuclear structures of the salivary glands may be studied in material fixed in a fluid composed of equal parts of one per cent. osmic and acetic acids allowed to act for several minutes. The glands are then stained in acetized methyl green followed by carmin, and are mounted in glycerin. The glands are easily secured from decapitated larvæ, passing out with the blood, or being readily released by gentle pressure.

The eggs of *Chironomus* are very favorable objects for the study of insect development; they are abundant, quite transparent, and the larval stage is reached in the brief period of six days. The authors recommend hot, thirty per cent. alcohol half saturated with corrosive sublimate for killing the egg-chain for subsequent sectioning and staining by the Heidenhain method. C. A. K.

Guiart, J. Les Mollusques Tectibranches. *Causeries Scientifiques de la Soc. Zool. de France*, 1900: 77-132, 4 pl. Avec 35 figs. dans le texte. 1900.

This is a *résumé* of the author's monograph of these mollusks, and is devoted principally to the *Bullidæ* and the *Aplysidae*. A very complete outline is

given of the gross anatomy of several types, and a modified classification is proposed for the group. The *Pleurobranchidæ* are included with the Nudi-branches, and the group, as a whole, are derived through some such form as *Acteon* from the Prosobranchs by a process of detorsion as shown in the comparative study of the nervous system. The author recommends the subcutaneous injection of one cubic centimeter of five or ten per cent. hydrochlorate of cocaine to overcome the extreme contractility of *Aplysia*. Muscular relaxation is thus secured in several minutes. Tissues may be fixed by injection of sublimate-acetic by way of the gill. This paper is one of an excellent series of lectures by specialists before the Zoölogical Society of France. C. A. K.

NORMAL AND PATHOLOGICAL HISTOLOGY.

JOSEPH H. PRATT.

Harvard University Medical School, Boston, Mass., to whom all books and papers on these subjects should be sent for review.

Michaelis, L. Ueber Fett-Farbstoffe. Virchow's Archiv für path. Anat. **164**: 263-270, 1901.

Much that relates to our histological staining methods is purely empirical.

Hence Dr. Michaelis' attempt to determine chemically what part of the sudan III molecules gives the fat-staining property, and from this knowledge to synthetically prepare a more satisfactory stain, is very welcome. But why do we require a new stain or any stain for fat, a substance so easily recognizable both morphologically and by its high index of refraction? Unfortunately other substances, as the zymogen granules of the pancreas, eosinophilic granules, etc., are in these ways indistinguishable from fat. Osmic acid is not specific and does not color all fat, for Altmann has shown that osmic acid colors only the oleic acid fats. Sudan III has not proven perfectly satisfactory.

Sudan III is azobenzol-azo β naphthol. Michaelis first assumes that the double azo group lends the fat-coloring property to the molecule. However, he finds that a stain with a simpler azo group (benzol-azo β naphthol) will color fat. Another stain, differing from last only in being α instead of β naphthol, stains tissues diffusely. This latter is soluble in alkalis, while the former is soluble neither in alkalis nor acids, but only in organic solvents, thus resembling sudan III. In experimenting he finds that the staining reaction of the β compound does not depend on the orthoposition of the azo group to the OH group, but in the lack of a free OH group—in other words the lack of a salt-forming group. So he concludes that fat-stains are those azo bodies which possess no salt-forming group—indifferent coloring stuffs in opposition to acid and basic.

Knowing this, he prepares synthetically azoorthotulolazo β naphthol (scharlach R or fettponceau), which gives better results than sudan III, coloring very small droplets of fat bright red. This stain is insoluble in water, acids and alkalis, soluble with difficulty in alcohol, and easily soluble in chloroform, fatty oils and melted paraffin.

The technique for its employment is—

1. Tissues preserved in formol.
2. Freezing microtome sections.
3. Saturated solution of scharlach R in 60-70% alcohol for fifteen to thirty minutes.
4. Counterstain with hæmatoxylin.
5. Mount in glycerine or levulose syrup.

H. A. CHRISTIAN.

Feldbausch, F. Ueber das Vorkommen von eosinophilen Leukocyten in Tumoren. Virchow's Archiv. f. path. Anat. **161**: 1-18, 1900.

Goldmann, Müller, Rieder, and Reinbach have previously called attention to the presence of large numbers of

eosinophilic leucocytes in certain tumors.

Feldbausch has found in epidermoid carcinomas almost constantly a marked increase of the eosinophiles, while in adeno-carcinomas and sarcomas this does not occur. The eosinophiles lie chiefly in the connective tissue surrounding the masses of tumor cells. They form part of the cellular infiltration which owes its origin to inflammatory irritants of chemical, bacterial, or mechanical nature. They are present in greater number in the earlier stages of the development of the tumor, and also in the beginning of inflammations, than later when degeneration has occurred.

This investigation throws little if any light on the origin of eosinophiles. The author does not believe they arise *in loco*. Although he admits that Ehrlich's view that the cells develop in the bone-marrow may be correct, he thinks they may also be formed in the blood. The eosinophilic granules, he holds, are not formed by the ingestion of broken-down red blood corpuscles. The researches of Arnold have shown that the granules belong to the structural elements of the cell, and hence cannot arise through phagocytosis. Eosinophiles are often found in great number in places where no hemorrhage has occurred, and are often not found where destruction of red blood corpuscles regularly takes place, as in the liver and spleen, or where hemorrhage has occurred.

J. H. P.

Edmunds, W. The Pathology and Diseases of the Thyroid Gland. *Lancet*, 1: p. 1317, 1901.

Recent researches have shown that the parathyroid glands are of great importance to the organism. Removal of these bodies usually causes the death of the animal. The parathyroid glands differ in structure from the thyroid gland in that they consist wholly of cells and contain no vesicles and no colloid, or at most a minute droplet.

It is not easy to identify the parathyroid glands in the human subject, because some of the minute outlying nodules are found to consist of ordinary thyroid tissue, and to be therefore accessory glands. The anatomy of the parathyroid gland in man has been worked out by Welsh of Edinburgh. He finds that there are four of these glands—one anterior and inferior to, one posterior and superior to, each thyroid lobe.

Although no symptoms occur as a consequence of the removal of one lobe of the thyroid gland, the other lobe, as pointed out by Wagner, hypertrophies. The vesicles enlarge and become branched, their lining membrane becomes folded, the cubical secreting cells become columnar, and the colloid disappears and is replaced by a mucous secretion which takes the staining reagents badly.

In dogs, if one parathyroid gland be dissected free from the thyroid lobe, taking care not to interfere with its blood supply, and the entire thyroid gland with the other parathyroid glands be excised, so that only one parathyroid be left in the animal, the dog will live and no obvious effects will ensue. The parathyroid that is left in these experiments shows signs of more active growth than the normal, but it does not develop into thyroid tissue proper. No vesicles form. This disposes of the view once held that the parathyroid glands are undeveloped thyroid tissue.

Edmunds excised the parathyroids in a number of dogs, leaving the thyroid intact. Interesting changes occurred in the thyroid. The colloid diminished, or completely disappeared, and its place was taken by a watery fluid; the

vesicles, instead of remaining round became branched, and the secreting cells became columnar, or multiplying, filled the cavity of the vesicles with round cells. These changes are identical with those described as "compensatory hypertrophy," but the thyroid lobes did not enlarge, on the contrary, sometimes they seemed to become smaller. This would coincide with the view that the parathyroids manufacture the secretion, and the thyroid stores it; when the parathyroid had been removed there would be no secretion for the thyroid to store.

In a number of dogs important histological changes followed excision of a portion of the superior laryngeal and vaso-sympathetic nerves on one side, and the lateral thyroid lobe on the other side. The colloid disappeared from the remainder of the thyroid. Usually the secreting cells multiplied into the cavity of the vesicle. In one case, the dog having survived the experiment, the lobe was excised 49 days later. It was greatly enlarged and weighed 35 grams, which is three or four times the normal weight. The proliferated secreting cells did not fill the cavities, which contained instead a watery secretion. The great size of the lobe was due to a growth of young thyroid tissue between the vesicles. This shows the possibility of defective innervation being the cause of serious symptoms and pathological changes.

J. H. P.

GENERAL PHYSIOLOGY.

RAYMOND PEARL.

Books and papers for review should be sent to Raymond Pearl, Zoölogical Laboratory, University of Michigan, Ann Arbor, Mich.

Dale, H. H. Galvanotaxis and Chemotaxis of Ciliate Infusoria. Part I. Jour. Physiol. 26: 291-361, 1901. In this work detailed comparisons were made between the chemotactic and electrotactic reactions of certain organisms, for the purpose of determining to what extent the electric current stimulates through its chemical action. The experimental work was done mainly on the infusoria parasitic in the intestine of the frog. The species used were: *Balantidium duodeni*, *B. elongatum*, *B. entozoon*, *Nyctotherus cordiformis*, and *Opalina ranarum*. On account of the high osmotic pressure of the medium in which these organisms normally live it was necessary to examine them in a solution of approximately equal concentration. A .6 per cent. solution of NaCl was used for this purpose, the organisms being shaken directly into it from the intestine. It was found that the chemical reaction of the solution in which the infusoria were placed had a very marked influence on their responses, so that it was necessary to conduct parallel experiments with solutions carefully made acid, neutral or alkaline. The chemotaxis was tested by introducing into the solution containing the organisms, either on a slide or in a watch-glass, capillary tubes filled with the test solutions. The principal solutions employed for testing the chemotaxis were an organic acid (acetic or butyric), a mineral acid (H_2SO_4), and an alkali (NaOH or Na_2CO_3). The electrotactic experiments were performed in the usual way with a stimulation trough, to which the current

was led through unpolarisable, brush electrodes. The current was obtained from a battery of small bichromate cells.

The reactions of *Opalina* are first discussed. It was found that this form, when in an alkalinated or neutralised medium, showed an "attraction" to (i. e., formed a collection in) an acid test solution and a "repulsion" from an alkaline, and, in response to the electrical stimulus, collected at the anode. If the salt solution containing the organisms was acidified the reactions were reversed, collections being formed in the alkaline test solution and at the kathode pole. The reactions of *Nyctotherus* showed a still closer dependence on the chemical reaction of the medium than did those of *Opalina*. In a strongly alkalinated medium *Nyctotherus* collected in acids and at the anode pole. In a weakly alkalinated medium these organisms collected in weakly acid test solutions and were "repulsed" from strong acids and from alkalis of all strengths. In response to the electric current collections were formed at the anode except in very strong currents, when there was a transverse orientation. In a neutral medium there was "repulsion" from both acids and alkaline test solutions and the electrotactic reaction was transverse to the direction of the current. Passing to the reactions in acid media, it was found that when in a weakly acid salt solution, the organisms formed collections in weakly alkaline test solutions and at the kathode pole. "Repulsion" occurred from strong alkalis and from acids of any strength. With strong electric currents there occurred again the transverse orientation. In a strongly acid medium collections were formed in alkaline test solutions and at the kathode. Under all conditions except when in strongly alkalinated media *Balantidium elongatum* collected in alkaline test solutions and at the kathode pole. In strongly alkalinated saline, however, this form collected in weakly acid test solutions and exhibited a diphasic reaction to strong solutions, being first "attracted" to the acid and then in a short time passing over to the alkali. In this strongly alkaline medium there was also a diphasic reaction to the current. An immediate movement to the anode was replaced—after a time dependent on the strength of the current—by motion towards and collection at the kathode. Without going into the details of the individual cases it may be stated that in the two other species studied, *Balantidium entozoon* and *B. duodeni*, essentially similar reactions were found. In all cases there was a distinct parallelism between the chemotaxis and the electrotaxis.

The ciliary action in these responses was studied principally in *Opalina* and *Nyctotherus*. *Opalina* reacts to repellent stimuli by a response like the "motor reflex" of the free living infusoria as described by Jennings. This reaction brings about its "repulsion" from alkalis. Its collections in acid solutions are, however, the result of a different sort of a response. When the anterior end of the organism comes in contact with a weak acid the ciliary waves change their direction in such a way as to directly orient the body along the lines of diffusion. The organism then swims toward the center of diffusion. This is probably the first clear case recorded in the literature where an infusorian becomes directly oriented along the path of diffusion of ions, and forms collections in solutions as a result of such a response. The orientation to the electric current is brought about by a rotation as in the ordinary "motor reflex" until the anterior end is towards

the anode or the kathode as the case may be. There is no ciliary reversal on the kathode half of the body, as has been described by several observers in the case of the free living infusoria. The author lays stress on the parallelism in the forms he has studied between the effect of chemical and electrical stimuli on the ciliary action.

Experiments were made with media of different electrical conductivities. It was found that in both hyper- and hypotonic solutions *Opalina* and *Nyctotherus* show a tendency to pass to the kathode pole, although the reaction varies somewhat. Experiments with *Paramecium* and *Colpidium* in salt solutions showed that, under these conditions, both of these ordinarily kathodic forms went to the anode when the current was passed. It is maintained that probably nearly all the ordinarily described electrotactic reactions are conditioned by the conductivity of the solution in which they are tested, and that they may disappear or be replaced by very different responses under different conditions.

The author considers the general phenomenon of electrotaxis to be the result of two factors; one, a rheotactic reaction to the current of fluid produced by the kataphoric action of the electric current, and the other a chemotactic reaction to the acid continually set free at the anodic, and the alkali at the kathodic end of the body. Whatever may be one's opinion as to the adequacy of this theory, the work as a whole is an extremely important and well developed contribution to the discussion of the phenomenon of electrotaxis.

R. P.

Jennings, H. S. On the Significance of the Spiral Swimming of Organisms. Amer. Nat. 35: 369-378, 1901.

It has long been known that a great many lower organisms (e. g., swarm-spores, flagellate and ciliate infusoria,

rotifers, and others) swim in a spiral path. It is the purpose of the present paper to explain the biological significance of this form of progression. It is very clearly shown by Dr. Jennings that the purpose and result of this movement in a spiral is to keep the animal on a straight course. Most of the infusoria are unsymmetrical, and as they start to move forward they are swerved from a straight course as a result of this asymmetry. This swerving is always towards the same, structurally defined, side of the body. If, however, as is in fact the case, the organism rotates on its long axis as it advances, it is at once apparent that any tendency to swerve to one side from the straight course will compensate itself, thus leaving the forward component of the motion the only effective one, and making the path a spiral with a straight axis. This method of swimming is closely related to the method of reaction to stimuli of these organisms, since the side of the body towards which the infusorian turns in the "motor reflex" is always directed away from the axis of the spiral. Not only asymmetrical organisms use this method of keeping on a straight course, but many bilaterally symmetrical rotifers also swim in a spiral path. These rotifers have a marked tendency, when moving freely in the water, to swerve towards the dorsal side. This tendency is the one compensated for by the spiral swimming in this case. Correlations between the method of movement and the form of the body in other cases are discussed.

R. P.

NOTES ON RECENT MINERALOGICAL LITERATURE.

ALFRED J. MOSES AND LEA MCL. LUQUER.

Books and reprints for review should be sent to Alfred J. Moses, Columbia University,
New York, N. Y.

Clarke, F. W., and Steiger, George. Experiments Relative to the Constitution of Pectolite, Pyrophyllite, Calamine, and Analcite. *Ann. Jour. Sci.* iv, 8: 245, 1899. The article treats of the fractional analysis of silicates by means of various reagents, in order to gain evidence bearing upon their chemical structure.

Pectolite proved to be a true metasilicate by ignition and solution in sodium carbonate, the mineral being decomposed and losing practically $\frac{1}{6}$ of its SiO_2 , as required by theory.

Pyrophyllite not proved to be a metasilicate by same test. May be regarded as having formula, $\text{Si}_2\text{O}_5 = \text{Al} - \text{OH}$.

Calamine tests as a rule yielded negative results, but supported the usual formula.

Analcite appeared not to be a metasilicate, but may be a mixture of ortho- and tri-silicate, represented by formula, $\text{Al}_4\text{Na}_4(\text{SiO}_4)_2(\text{Si}_3\text{O}_8)_2 \cdot 4\text{H}_2\text{O}$.

Analcite and leucite determined by authors to belong to garnet-sodalite group.

L. McL. L.

Prior, G. T. and Spencer, L. J. The Identity of Binnite with Tennantite, and the Chemical Composition of Fahlerz. *Min. Mag.* 12: 184, 1899. *Binnite* possesses the same degree of symmetry as the Cornish *tennantite*, being simply better developed and having more and brighter faces.

Tetrahedrite (Fahlerz) appears to have the formula $3\text{Cu}_2\text{S} \cdot (\text{Sb} \cdot \text{As})_2\text{S}_3$ in the case of the simple sulphantimonite or sulpharsenite of copper. The Fe and Zn appear to be the disturbing elements, producing the 4 : 1 original formula of Rose.

As a result of many analyses the author proposes the new formula $3\text{R}'_2\text{S} \cdot \text{R}''_2\text{S}_3 + x[6\text{R}'''\text{S} \cdot \text{R}''''_2\text{S}_3]$, in which $\text{R}' = \text{Cu}, \text{Ag}$; $\text{R}'' = \text{Fe}, \text{Zn}$; $\text{R}''' = \text{Sb}, \text{As}, \text{Bi}$; and $x =$ a small fraction, often $\frac{1}{10}$ or $\frac{1}{5}$, but rising to $\frac{1}{2}$ in the case of the highly ferriferous tetrahedrite "coppite."

Many tests of the new formula are given by reference to to analyses.

L. McL. L.

Hartley, E. G. G. Communications from the Oxford Mineralogical Laboratory on the Constitution of the Natural Arsenates and Phosphates. *Min. Mag.* 12: 152, 1899. *Pharmacosiderite*.—As a result of careful analysis, in green Cornish crystals, the following formula was proposed:

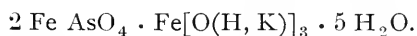

The undoubted presence of K (new to pharmacosiderite) is of interest.

During the course of the investigation, the apparent permeability of the mineral to certain liquids was shown. A green transparent crystal immersed in ammonia turned red, and became green again in hydrochloric acid.

L. McL. L.

- Neuwirth, V.** Titanit von der Hüttellehne bei Wernsdorf un Mähren. Tschermak's Min. u. petrog. Mitth. **20**: 178-180, 1901. Asparagus green crystals 4×3 mm. Crystallographic description.
A. J. M.
- Martin, Fr.** Ueber Scheinbar spaltbaren Quarz von Karlsbad. Tschermak's Min. u. petrog. Mitth. **20**: 80-82, 1900. Quartz kernels from an old wall are imperfect crystals. Under action of frost certain liquid inclusions which are arranged parallel R, ∞ P and sometimes o P, have produced apparent cleavages.
A. J. M.
- Erben, F., and Ceipek, L.** Analyse des Albits von Amelia. Tschermak's Min. u. petrog. Mitth. **20**: 85, 1900. Leading to formula $Ab_{9.5}An_5$.
A. J. M.
- Judd, Hidden, and Pratt.** On a New Mode of Occurrence of Ruby in North Carolina. Min. Mag. **12**: 139, 1899. The specimens are almost similar in beauty and color to those from the Mogok district of Burma, and certain garnet (rhodolite)-bearing basic rocks at Cowee-Creek, the ruby having probably crystallized out from the basic fluid magma. The "non-gem" corundum occurs in ordinary crystalline schists, or in peridotites.
The rubies frequently contain inclusions of various kinds, and the clearest crystals almost always show the tabular habit, regarded by Lagoria as characteristic of those separating from an igneous magma.
A pseudomorphous change by hydration is very common, as in the case of the Burma rubies, and it is hoped that more investigation will bring to light the similarity in rock magma producing the Burma and North Carolina rubies.
L. McL. L.
- Pratt, J. H.** On the Crystallography of the Rubies from Macon Co., N. C. Min. Mag. **12**: 150, 1899. The Cowee Valley crystals have two general habits:
(1) Flat tabular, a combination of base and unit rhombohedron.
(2) Prism a (1120), prominently developed with base, the prism being either short or long. Pyramidal faces n (2243) sometimes show.
Basal planes are striated, or show repeated growth of unit R and base.
Similarity in development is noted between these rubies and the corundums from Yogo Gulch, Mont., and the Burma district.
L. McL. L.

MEDICAL NOTES.

BLOOD EXAMINATION.—The following method for the preparation of specimens for the examination of blood is given by Dr. W. L. Braddon, of the Malay Peninsula: The mounts may be made either between two square cover-glasses, or a square cover-glass and a regular size slide. The covers and slides are first sterilized by a method recommended by Parker and Howard; viz., drop, *one by one*, into a 10 per cent. solution of chromic acid, contained in an enamelled iron dish, and boil for twenty minutes. They are then poured, altogether, into a

shallow basin, and washed with ordinary tap water until no trace of the yellow color of chromic acid remains. The water is next poured off, and the slips are covered with rectified spirit. After this they are washed in absolute alcohol, and handled with clean forceps.

If two cover-glasses are used for the mount, they are accurately superposed and firmly pressed together. An edging of vaseline, if for temporary purposes, or cement if for permanent purposes, is laid over all the edges, except one, and a very small portion of that edge which is opposite the uncemented one. A drop of blood is touched with the free edge of the paired cover-glasses, whereupon the blood enters between the glasses in an exceedingly thin film, the corpuscles being spread out with beautiful uniformity, and having suffered a minimum amount of change from exposure to air and none at all from handling or pressure. When the blood film has entered, the free edges may be completely closed, and the examination made.

If slide and cover-glass are used the latter is placed on the slide in such a position that one of its edges exactly coincides with that of the slide. It is then firmly pressed, and sealed with vaseline or cement, as when two cover-glasses are used, and the subsequent course pursued as with covers. By this method a number of mounts may be made and stored in a suitable air-tight bottle, and thus be always ready for use. Fresh blood keeps well under these circumstances. No special skill is required for the making of first-class blood film.

This method has been carefully tested, and it was found necessary to put the smallest possible amount of cement between the covers before edging them outside, otherwise the cement had a tendency to run in.—*Knowledge*, 24: 183.

C. W. J.

METHODS OF STAINING THE GONOCOCCUS.

Schütz method :

1. Stain for five to ten minutes in sat. sol. methylen blue in 5 per cent. carbolic acid water.
2. Differentiate for three seconds in :

| | | | |
|---------------|-----------|---|--------|
| Acetic acid, | | 1 | part. |
| Water, dist., | | 4 | parts. |
3. Wash in distilled water.
4. Counterstain in dilute solution of safranin.

Neisser's method :

1. Stain in conc. alc. sol. of eosin, slightly warmed, for two or three minutes.
2. Remove excess of stain with filter paper, and counterstain with conc. alc. sol. methylen blue for fifteen to thirty seconds.

Chenzinski's methylen blue and eosin :

- | | | | |
|---|-----------|---|--------|
| Methylen blue, sat. aq. sol., | | 2 | parts. |
| Eosin, 0.5 per cent. in 70 per cent. alcohol, | | 1 | part. |
| Distilled water or glycerin, | | 2 | parts. |

With this solution cocci stain blue, pus cells pink.

NEWS AND NOTES.

The University of Zurich has enlarged its anatomical building. A dissecting room, with overhead light, to accommodate two hundred students, has been added, and on the floor below a microscopical room of the same size. There is also a demonstration room with overhead light, a laboratory for anthropology, and a laboratory for advanced embryological study, together with rooms for the director. The old part of the building will be rearranged for a large lecture room, a reading and study room for the students, a museum, and the laboratories for assistants.—*Science*, **14**: 347.

The Bureau of Plant Industry of the U. S. Dept. of Agri. has recently been reorganized, and, with Beverly T. Galloway as chief, now embraces the following groups: Vegetable pathological and physiological investigations, Alferd J. Wood in charge; Botanical investigations and experiments, Frederick V. Coville; Pomological investigations, Gustavus B. Brachett; Grass and Forage Plant investigations, F. Lamson Scribner; Experimental Gardens and Grounds, L. C. Corbett; Congressional Seed Distribution, Robert J. Whittleton; Seed and Plant introduction, Ernst A. Bessey; Tea Culture experiments, Charles U. Shepard; and the Arlington Experimental Farm, L. C. Corbett.—*Bot. Gaz.* **32**: 2.

QUESTION BOX.

Inquiries will be printed in this department from any inquirer.
The replies will appear as received.

13. Is there a simple, satisfactory method of determining whether or not a given sample of milk contains bacteria, that can be performed with the aid of a microscope the highest power of which is a one-fourth inch objective?

I. G. B.

14. What is Tallquist's method of blood examination and estimation of hemoglobin?

R. C. W.

15. Can specimens (animal) preserved in alcohol for a long time be safely transferred to formalin?

J. D.

16. I am working on the various methods of fixing or producing death in the animal organism and cell. My work ranges from micro-organisms to vertebrates, and requires specimens for dissection killed in such a manner as not to show the distortion due to contraction of the muscular tissues, such as occurs when death is produced by chloroform, ether, or other anæsthetic. The reagents I employ in the preparation of dissections for demonstrating will probably react unfavorably with any metallic poisonous compound that might be employed. The substance used should produce death as immediately as possible, in order to avoid maceration or pathological changes, and should be practically tasteless, with no irritating odor, and capable of being used in minute or minimum quantities with delicate water animals, etc. If you can suggest such a substance, or anything which would lead to similar results, it would be greatly appreciated.

G. W. E.

Journal of Applied Microscopy and Laboratory Methods.

VOLUME IV.

NOVEMBER, 1901.

NUMBER 11

Studying and Photographing the Wild Bird.

The problem in Bird Photography* is how to see and not be seen. If a bird is actually caught and kept in a cage, or in any way restrained, its behavior is no longer perfectly natural and free, at least not until all fear has been subdued, and it is no longer wild but tame. What is most needed in the photography of wild birds is an invisible chain to hold the animals to some fixed spot which can be approached in disguise.

Fortunately for the student of bird habit and instinct, all these conditions are fulfilled for a most important and interesting period, that of life at the nest. The nest is the given fixed point, and parental instinct is the invisible chain. The wild bird, however, is bound not merely to the nest, but to its young. Wherever the young go the old follow. By using the nearly fledged young as a lure, some species could, I believe, be led across the country for a mile or more. I have taken them two hundred feet without special effort.

Hitherto the bird photographer has had to rely mainly

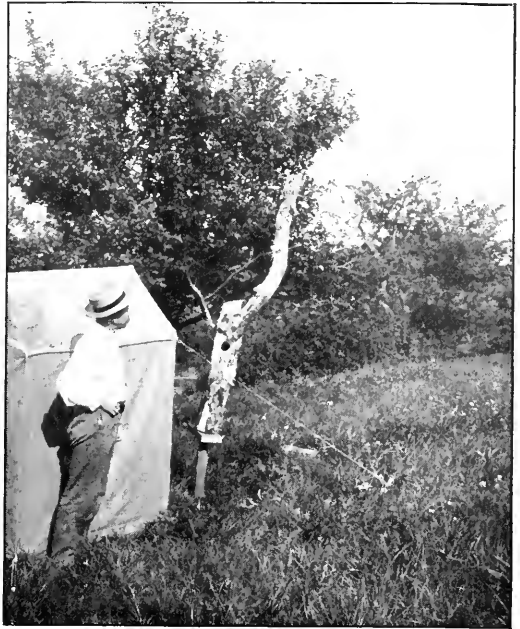

FIG. 1.—Nest-hole of Flicker used by Bluebirds. This dead stump was sawn from an apple tree and mounted on a pivot so that it could be easily turned at any angle with the sun.

* The following paper is partly taken from "The Home Life of Wild Birds: A New Method of the Study and Photography of Birds," by Francis H. Herrick, with 141 original illustrations from nature by the author, and published by Messrs. G. P. Putnam's Sons, New York and London, to which the reader is referred for further details. It also contains some results of the author's latest experience in the field.

upon chance in getting a picture of the nesting scenes. Most land birds depend upon concealment for protection from their enemies during the season of young. Their nests are apt to be shrouded in grass or foliage, and, if easily approached, are usually inaccessible to the camera. If the nest is in a high bush or tree, the difficulties of the position and light are usually an effectual bar to obtaining good pictures, to say nothing of seeing what takes place. When the nest is near the ground, or upon it, and in a well lighted spot, conditions which are rarely fulfilled, it has been customary to set up the camera, and attaching a long rubber tube or thread to the shutter, to retire to a distance and wait for the birds to appear. When one of them is seen

to go to the nest, the plate is exposed by pulling the thread or pressing the pneumatic bulb, and, if in luck, a picture may thus be obtained. Many plates, however, are sure to be spoiled; little can be seen, and the observer has no control over the course of events. In the following outline a method is described by which nesting birds can, in most cases, be successfully approached and studied with ease whatever the position of the nest. The usual mode of procedure is reversed, and instead of attempting to carry the sensitive plate up to the bird, the camera is fixed and the bird is brought directly before it.



Fig. 2.—Tent pitched beside Cedar-bird's nest. In this case the nesting branch was sawn from a neighboring apple tree and mounted upon two stakes driven into the ground, on a hillside close to a dwelling house.

It is a comparatively easy matter to examine and photograph the nest, the eggs, or the young of such species whose dwellings are accessible to all; but, to portray the free

behavior of the adult bird in the shy land species is quite another question.

The method, though limited in its application from the necessities of the case, is based on the solid ground of animal instinct, and may confidently be expected to have a wide application.

The method in use depends mainly upon two conditions: (1) The control of the nesting site, and (2) the concealment of the observer.

By nesting site is meant the nest and its immediate surroundings, such as a twig, branch, hollow trunk, stem, or whatever part of a tree the nest may occupy, a bush, stub, strip of sod, or tussock of sedge, that is—the nest with its immediate settings. If the nest, like that of an oriole, is fastened to the leafy branch of a tree, the nesting bough is cut off, and the whole is then carefully lowered to the ground and set up in a good light, so that the branch with the nest shall occupy the same relative positions which they did before. The nest, however, is

now but four instead of forty or more feet from the ground. The nesting bough is carried to a convenient distance from the tree, and firmly fastened to two stakes, driven into the ground and placed in a good light. If the nest is in a tussock in a shaded swamp, the whole is cut out and taken to the nearest well lighted place: if in the woods, it is carried to a clearing where the light is favorable for study. Again, when a nest like that of the brown thrush occupies the center of a dense thorn bush which no human eye can penetrate and much less that of the camera, its main supports are cut off, and the essential parts are removed to the outside of the clump or to any favorable point close at hand. If the nest is but five or ten feet up, the main stem is severed, and the nesting branch lowered to the four-foot mark, a convenient working height.

This sudden displacement of the nesting bough is of no special importance to either old or young, provided certain precautions are taken. The most important conditions for success are as follows: the change of nesting site at the proper time, or when parental instinct is approaching its culmination; the protection of the young from excessive heat and violent storms, and the protection of the nesting bough from predacious enemies.

When the nesting branch is vertical and not too large, it can be easily kept fresh for days by placing it in a can or jug of water, which should be set in the ground.

Young birds have many relentless enemies, among the worst of which are cats, jays, squirrels, and small boys. On page 15 of "The Home Life of Wild Birds" this subject is thus referred to: "I feared lest prowling cats should discover the young whose nest and branch had been brought down from the tree top, and set up again in plain sight within easy reach from the ground, but I was happily mistaken. Predacious animals of all kinds seem to avoid such nests as if they were new devices to entrap and slay them." It is best not to stake too much upon this assurance, for no nest of young birds is ever safe, however perfectly concealed. We must also be aware that cats and wild depredators, like the birds themselves, soon become accustomed to new objects and surroundings. The nest and nesting branch, whether moved or not, should be protected whenever possible by a wire net of ample height, secured to the ground



FIG. 3.—Female Cedar-bird astride nest, shielding her young, which were then six day old, from excessive heat.

by wire staples. It is impossible to overestimate the importance of this screen, especially in a country overrun with cats.

The nest might be taken from the bough or from the sward, but this would be inadvisable, chiefly because it would destroy the natural site or the exact conditions selected and in some measure determined by the birds themselves.

For an observatory, I have adopted a green tent which effectually conceals the student, together with his camera and entire outfit. The tent is pitched beside the nest, and when in operation is open only at one point, marked by a small square window, in line with the photographic lens and nest.

When the birds approach the nest in its new position, any strange objects, like the stakes which support the bough, or the tent which is pitched beside it,



FIG. 4.—Female Robin brooding on a hot July day.

arouse their sense of fear or suspicion; they may keep away for a time, or advance with caution. If very shy, like many catbirds, they will sometimes skirmish about the tent two hours or more before touching the nest. Their fears, however, are usually overcome in from twenty minutes to an hour, and when the nest has once been visited in its new site the victory is won. I have known a chipping sparrow and red-eyed vireo to feed their young in three minutes after the tent was in place.

The tent which I have used for three seasons is made of stout grass-green denim, and, with the frame, weighs only six and one-half pounds. It can be pitched in ten minutes almost

anywhere, and may be compactly rolled, and carried for miles without serious inconvenience. One may spend any number of hours in it by day or night, and with a fair degree of comfort, excepting in very hot or sultry weather, when exposed to the sun on all sides. It is also a welcome shield from the rain. The green color of the material renders the tent an inconspicuous object in a field or open pasture, but from the standpoint of the bird the color is really a matter of complete indifference. It is of some importance, however, when we consider the attraction which a tent seems to possess for human spectators, whether young or old.

The front of the tent should be parallel with the nesting bough, when there is one, and the long axis of the latter should be parallel with the sun's course. The tent is so placed that the nest is in direct line, not with the middle of the

tent, but with the window to one side. If the focal length of the lens be $6\frac{1}{2}$ inches, the nest mounted at the height of four feet, and the lens be 28 inches from the rim of the nest, we shall get a picture with adequate setting on a 4×5 plate.

When the nest is excavated out of wood, as in the chickadees and woodpeckers, or occupies similar cavities, as in the house wrens and bluebirds, the vertical branch or stump should be mounted on a pivot, so that it can be readily turned at any angle with the sun. Wherever a sky background is not available, it is of great advantage to use a large screen of white cloth, which should be mounted at a distance of five or six feet immediately behind the nesting bough. By such devices one can obtain serial pictures of birds performing their various acts in and about their nests, in front, back, or profile views, against a clear white ground.

After birds have once adopted the changed site, the addition of the white or dark screen or the protecting wire net is not likely to cause the least annoyance. I have seen a Baltimore oriole perch on the top of a tall screen in one minute after it was set up, and the house wren come to her nest almost immediately after the screen had been torn up by the wind and carried with a crash against a neighboring fence.

Any good long-focus camera with reversible back will answer, the size and weight being the considerations of greatest moment. Most naturalists and sportsmen, who travel long distances and carry their own traps, find a camera which takes a 4×5 plate the most convenient and economical. I have used this, but for work with the tent prefer a 5×7 size, because it gives a larger and better picture of the object sought. For work outside the tent, a reflecting camera may be used. The principal requirement in either form is a long bellows.

In photographing a moving animal at the close range of from twenty to thirty-six inches, the difficulties are by no means slight, and are not lessened by the use of long-focus lenses. A lens of a focal length of ten inches or more, when used so close to the object, must be stopped down in order to give the necessary depth, and bring every part of the object into focus. But by thus cutting off the light we reduce the speed, so that the negative with an exposure of $1/25$ sec-

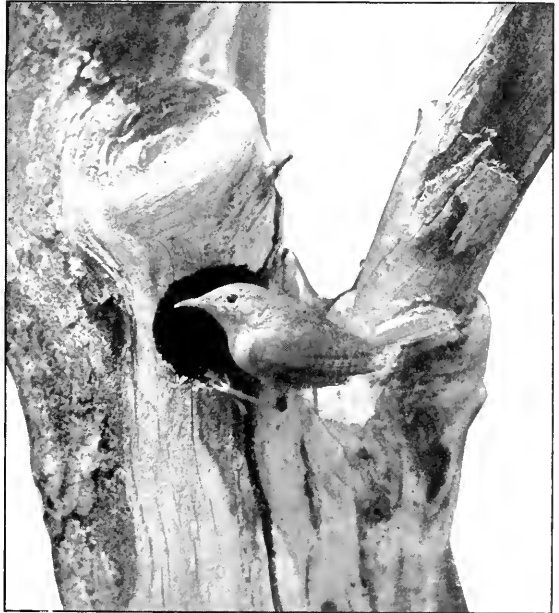

FIG. 5.—Old nest-hole of Downy Woodpecker occupied by a family of House Wrens. The female, which has just fed her brood, is about to re-enter the nest for a more careful inspection.



FIG. 6.—Nest-hole of Chickadees appropriated by House Wrens. Front view of circular entrance, showing the female approaching it with moth miller. No screen was used here, but the foliage background was cut out of the picture.

ond," the maximum time usually allowable, is too weak for successful printing even after the intensifying process has been used.

The most satisfactory small lens with which I have worked is the Zeiss

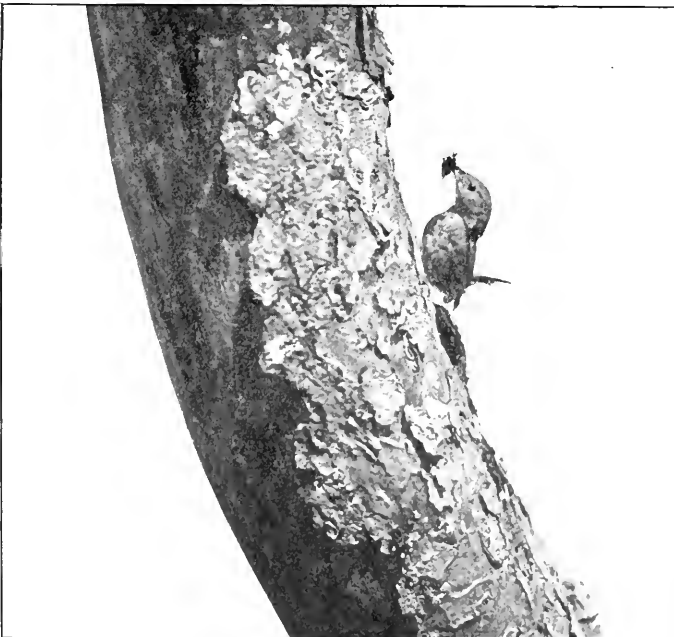

FIG. 7.—The same nest turned through an angle of 90° , with white cloth screen at back. Stump removed from tree, mounted on pivot, and protected by a fence of wire netting.

Anastigmat. Ser. 11-a. 6 1/2 inch focus, speed $f/8$, when used with a 4 x 5 plate. Pictures of nearly one-half life size can be made with this lens without stopping, in full sunlight, with an exposure of $1/25$ second of the iris diaphragm shutter, and at a distance of eighteen inches.

Lenses of long focus are not available for work at very close range unless we are able to allow a time exposure of $1/5$ second or more, but at distances of eight feet and upward a lens of 9 or 10-inch focus, stopped to 32 , with a speed of $f/6$, will yield satisfactory results with an exposure of $1/50$ second.

When a clear, perfect image of the object is once obtained, it is easy to make pictures of one-half or even life size by the well known process of enlargement.

We thus see that in selecting a lens for photographing moving objects at close range, its registered speed is apt to be very misleading. We should know how much the lens should be stopped (or how much the speed must be reduced) in order to render sufficient depth or detail.

For animal photography the most rapid plates are none too fast, and any of the best brands can be recommended. Orthochromatic plates require careful treatment, but in skilled hands offer advantages which should not be neglected. When used out of doors in full sunlight and with rapid exposure, these plates do not seem to yield their best results.

We have thus far considered the wild bird during the period of young. For photographing inaccessible nests, and for approaching birds in free life when the sway of parental instinct is over, one must resort to other methods. For fuller details the reader is referred to the volume from which the preceding paragraphs have been largely drawn. The method of the study and photography of birds which is here illustrated has been used, as the case of each required, with over forty nests of the common land birds of New England, and its value has been fully demonstrated.

Western Reserve University, Cleveland, Ohio.

FRANCIS H. HERRICK.



FIG. 8.—Kingbirds rending a troublesome dragon-fly preparatory to serving it to their young. The female, which stands at the front, was brooding when the prey was brought in by the male.

A Few Remarks on the Technic of Blood Preparations.

It is for those who have had the same difficulty as myself in mastering the technic of dried and heated preparations of blood for clinical examination that these remarks are intended. While I will not say that I have not sometimes succeeded in getting beautiful preparations by the ordinary method of drying and heating the cover-glass smears and staining with the Biondi-Ehrlich triacid stain, I may say that to make a perfect slide in this way has been the exception, and I have often had to try over and over again before accomplishing creditable results. This I will not say is the fault of the method, but I imagine from patient work that all are not able to acquire the requisite skill to make infallibly a good mounting. My own results have been far from uniform.

The method which I am now using is in no wise new, but it is the application of well known principles that I would call attention to. With a little care and at the expense of less time than the usual heat method employed, I have been able to invariably get a good mounting. Instead of the cover-glass preparation, the method of spreading the blood directly on the slide, as pointed out by Ewing in his new work, is used. This consists of laying the slide to be smeared flat on the table, and picking up the drop of blood from the finger or ear on the end of another glass slip and distributing it with a little movement along the edge of the end of the slip and then bringing the end of this slide in contact with the flat surface of the other at an angle of about thirty degrees and drawing it the length of the slide with proper pressure to produce the required thickness of film. The slide is then hastily placed in a Naples staining jar into which has previously been put two or three drops of one per cent. osmic acid in one per cent. chromic acid solution. It is allowed to stay in this vapor, the cover having been placed on the jar, for from forty seconds to one minute. If allowed to remain in the vapor too long, it will not take the stain. The object is to allow it to remain just long enough that when removed the film will not wash off when put under the tap of water. During the time the slide remains in the jar the film will not dry, and when removed it should be dried carefully over the lamp, and may be held as long as the hand will bear the heat. Without any washing now, the film is flooded with an aqueous solution of eosin (quite strong) and allowed to remain thus for from three to ten minutes. The time will depend on the strength of the eosin solution and the fixation. It is then washed under the tap for a considerable length of time, flooded with distilled water and stained with a full strength solution of Mayer's hæmalum for about ten or fifteen minutes. It is then washed off in the hydrant and the tap water allowed to run over it as long as desired. With this method all cells are characteristically stained, and everything is distinct and in good contrast. Hæmatoxylin may of course be used for the nuclear stain instead of hæmalum, but it appears that the latter makes by far the most beautiful stain.

As when one has once learned to distinguish the various elements of the blood the oil-immersion lens is no longer necessary, there is no advantage in using balsam as a mounting medium, the slide may be allowed to drain and be covered with a cover-glass and examined at once.

While the above method does not fill all the requirements of the triacid stain in pathological specimens, perhaps, it makes the differential count easier and shows the different elements of the normal histology of the blood perfectly.

LABORATORY PHOTOGRAPHY.

Devoted to methods and apparatus for converting an object into an illustration.

PHOTOMICROGRAPHY.

II. An Apparatus Adapted to All Kinds of Work.

The apparatus with which my work in photomicrography is at present done is in one of the private offices of Dr. C. S. Bond of Richmond, Ind. ; he has not only by his material help made it possible for me to have such an apparatus with which to work, but he has also worked with me from the first ; everything that has been done with this apparatus has been our joint work.

The essential parts of the apparatus are shown in Fig. 1. It rests on an unshakable stone floor, and consists of two tables supported on adjustable metal

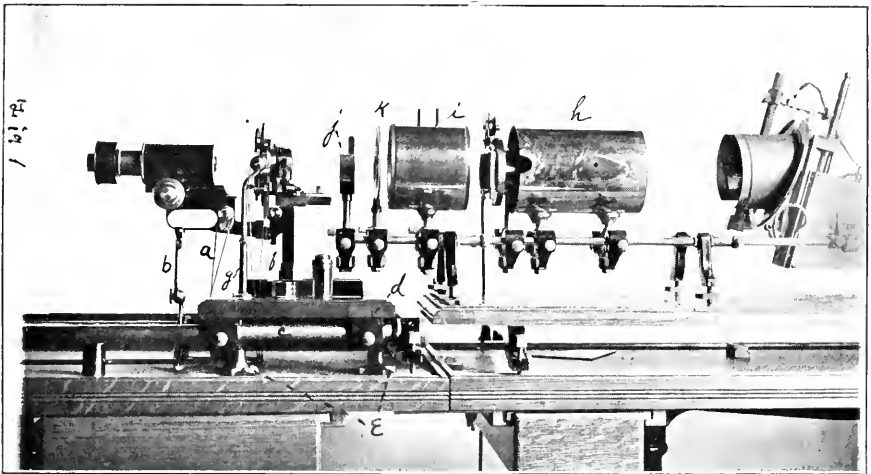

FIG. 1.—Photomicrographic apparatus.

legs. Their combined length is ten and a half feet. One, four feet long, carries the arc light and illuminating accessories; the other carries the microscope and camera. The microscope stand is the 1899 Zeiss model, expressly made for photomicrography. It is fitted with apochromatic objectives of from 70 mm. to 2 mm. and compensating and projecting eyepieces. The fine adjustment screw is controlled by a brass rod, which lies on the bench under the camera and has a pulley and cord attachment (*a*) with the milled head of the micrometer screw. The microscope is so supported by an adjustable brass pillar (*b*) that this pulley cannot in the least affect it.

The camera is carried on two nicked steel tubes (*c*) which rest on adjustable metal supports. The board (*d*) on which the microscope rests is bound also by clamps to these same tubes. Four strong, adjustable brass pillars (*e*) hold the board firmly at one distance from the table. These arrangements may be summed in the statement that the microscope and its supports are immovable.

The movable stage is also controlled from the ground glass six feet away by brass rods with milled heads and cord and pulley attachment (*f*), and the stage is supported against the strain of these by an adjustable brass pillar (*g*). The stage can thus easily and quickly be searched over a space three-eighths of an inch square. The coarse adjustment of the microscope is similarly controlled.

Some may think that these arrangements are mere conveniences; they are, however, indispensable, for the reason that without them photomicrography ranging in powers from 5 to 5000 diameters consumes so much time that the game is not worth the ammunition.

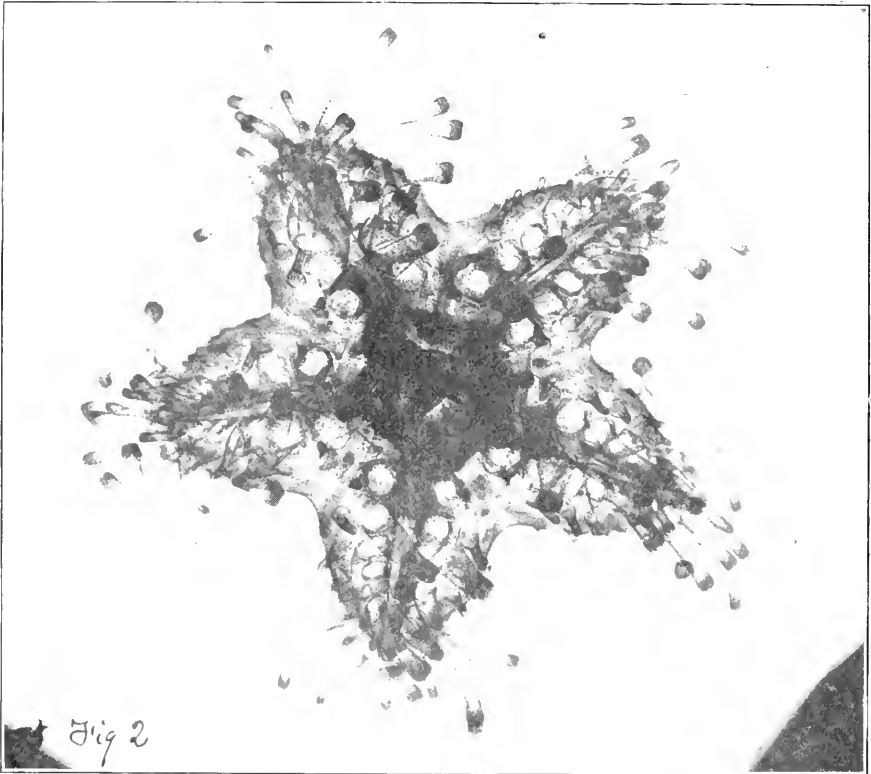

FIG. 2.—Photomicrograph of a starfish, fixed and decalcified in picro-sulphuric acid, and, after washing, stained in acid carmine. A 35 mm. apochromatic gave the necessary resolution and depth of focus, and a camera extension of four feet gave a magnification of forty diameters determined by measuring the object and the image.

The arrangement for controlling, from the ground glass, the coarse adjustment—necessary in low power work; that for controlling the stage—so convenient as to be necessary in all classes of work; the adjustable pillars under the microscope bench; the adjustable pillar under the microscope to offset the pull of the cord on the fine adjustment screw; the adjustable pillar under the stage, and such a scale on both the camera table and the optical bench that all parts of the apparatus can quickly be brought into any desired relationship, are additions which we have made to the apparatus since setting it up.

When work of all powers is to be done on the same instrument, two features

of our microscope stand are necessary, namely, the large tube, two inches in diameter into which the objectives screw without collars, and the improved fine adjustment which lowers or raises the objective only .04 of a millimeter for an entire round. As it can easily be turned less than a degree, the distance from the object to the objective can easily be varied .0001 mm.

The camera is large enough to carry a six and one-half by eight and one-half plate and can be extended six feet.

The optical bench carries the arc light and all the illuminating accessories somewhat as the camera is carried; all these are adjustable up and down, to and from the light, and from side to side.

The necessary accessories are a pair of condensers (*h*), a cooling cell (*i*), two ray filters (*j*), a field diaphragm (*k*), and a double convex lens not shown in the cut, as the instrument was arranged for low power work at the time the photograph was made; these are necessary, in the sense that one pays more in time and failures for not having them than they cost.

These tables, benches, condensers, and cells should all be carefully levelled; this is done by means of a spirit level and adjustable feet and clamps, one or the other of which they all have. Our cooling cell is three and a half inches long and four and a half inches in diameter; we keep it filled with water and have never had either a slide or an objective perceptibly warm, though we have kept them exposed for hours together. The tradition that calls for alum in the cell is not valuable. In a future article on "Illuminating the Object," the use of the other accessories will be explained. It follows from what I have said, that a laboratory costing some thousands of dollars is necessary for the best results in photomicrography. Experience convinces me that it is equally necessary for an expert microscopist and photographer to be in charge of it; he then could do all work of this sort in conjunction with all departments of a university, or possibly of more than one university. A joint laboratory used by a dozen different men, all mainly interested in something else, will yield in the future results similar to what it has in the past. The discouragement one hears on every hand is not well founded; it is traceable to the notion that photomicrography is a simple art that any one can practice. If courses of instruction were given in our leading universities in connection with such laboratories, it would soon come to pass that we should be as well off in photomicrographic manipulators as we are now in microscopists.

Recently, at the seaside laboratory of the Misses Foot and Strobell, I saw some excellent work done with very simple apparatus; their work follows entirely new lines; in a future article on "Focusing the Instrument," I shall describe their arrangement.

Earlham College.

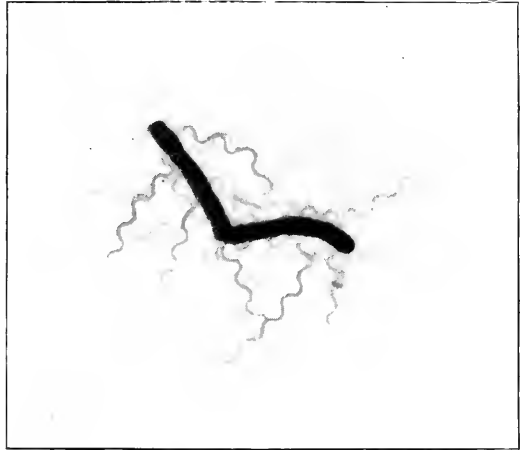

FIG. 3.—Malignant Edema, 2 mm. oil immersion, apochromatic objective, and a No. 4 projection eyepiece with camera extension of 60 inches. The magnification is 3000 diameters.

Staining Bacteria in the Root-tubercles of Leguminous Plants.

In a paper presently to be published in the Proceedings of the California Academy of Sciences, Third Series, Botany, I have discussed some of the relations of the bacteria which cause the formation of the root-tubercles of leguminous plants to the cells in which they occur. One or two matters of technique developed in the course of the study, and reported in the paper above referred to, may be of some interest to the readers of the JOURNAL.

When I once casually made some hand-sections of the root-tubercles of Bur Clover (*Medicago denticulata Willd.*), the plant which I have especially studied, these objects seemed to me unusually favorable for treatment with paraffin and the microtome. I tried fixing them in a concentrated 35 per cent. alcoholic solution of corrosive sublimate, and found that they were easily penetrated by paraffin from xylol solution, embedded, and sectioned. They stain readily by the usual anilin stains. I was particularly interested in demonstrating the manner of infection of the cells of the root, and of the tubercle subsequently formed, and in order to produce the best conditions for cytological study, I fixed a fresh lot of young and growing tubercles in dilute Flemming's chrom-osmic-acetic mixture. This visibly browns the tubercles of any considerable size, blackens the oldest, and darkens all. Of this change in color I took no active notice until just before staining the sections on the slide. Then I bleached by immersing the slide for half an hour in a solution of one part Marchand's hydrogen peroxide in twenty parts 80 per cent. alcohol.

Since the tubercles are composed almost exclusively of soft tissues, paraffin melting at 54°C. is hard enough for embedding and sectioning, provided of course that the room temperature is suitable. I cut very thin sections, 1 μ in some cases, with perfect success.

The staining method was fundamentally that described by Hof¹. For making up the stains I used the proportions given in Humphrey's translation of Zimmermann's Botanical Microtechnique, anilin safranin, anilin gentian-violet, orange G. The sections were attached to the slide by albumen fixative. Hof's directions for staining, followed without modification, give excellent preparations, showing the degeneration of the nucleus and cytoplasm as the bacteria multiply in the cells. This method, however, does not show the infection threads by means of which the root-hairs, root, and new tubercle cells are infected, for it does not clearly differentiate the bacteria from the cytoplasm. This can be readily done by treating the slide, washed with water as it comes from the anilino-gentian-violet solution, with Gramm's iodine solution, for a half hour or longer, before staining with orange G.

This method consists simply in applying to bacteria in tissues the well known bacteriological method used in differentiating cover-glass preparations stained by Ehrlich's anilin-gentian-violet. By this means the infection threads running from older infected cells toward and into the daughter cells of the tubercle

¹ Hof, A. C. Histologische Studien an Vegetationspunkten. Botan. Centralb., Bd. 76, No. 3, 1898.

meristem can be shown in all growing tubercles. In sufficiently young and recently infected roots, the course of the infection threads from the root-hairs to the pericycle can be clearly demonstrated.

The success in embedding, sectioning, and staining root-tubercles which follows the application of the methods just described, makes it difficult to understand the difficulties which prompted Miss Dawson² to declare "the tubercle tissues very difficult objects to stain upon the slide," and that "ordinarily thin hand-sections serve better for the examination of the filaments within the cells." Miss Dawson used with success the following method, but it lacks some of the advantages possessed by the one I have used. She placed "sections hardened in alcohol (best without previous treatment with chromic or osmic acid)" "for about two hours in alcoholic potash (one part 5 per cent. potash to three parts absolute alcohol) and then passed into Eau de Javelle for ten minutes. From this solution they are transferred to the dye, which is prepared by mixing an alcoholic solution of anilin blue with orseillin, drop by drop, until a violet solution is obtained. This mixture is acidulated with a few drops of glacial acetic acid. The sections remain in the stain for two hours, and are then transferred directly to dilute glycerine, and finally mounted in glycerine." This method of Miss Dawson's is merely an improvement in definiteness of statement of the one described by Strasburger in his "Praktikum." One of the stains which she used, Orseillin, is not obtainable under that name in this country, and I do not know whether she means Orcèin or Orseille, two stains made by Grüber and carried in stock here.

However, it is not my intention to criticise Miss Dawson's method or her description of it, but rather merely to describe my own, which anyone sufficiently interested to try it will find practicable.

Leland Stanford Jr. University.

GEORGE J. PEIRCE.

MICRO-CHEMICAL ANALYSIS.

XVIII.

In order to be consistent with a former statement we should properly consider in this article the analytical reactions of the element mercury; this element falling in the same group in the periodic system as the elements last considered. Unfortunately there is still a missing element between cadmium and mercury, thus causing a serious break in the series. The change in chemical behavior which we find, in passing from cadmium to mercury, is such that so far as our micro-chemical tests are concerned, there are practically no analogous reactions existing between mercury and the other members of the group.

On the other hand, so many of the properties of aluminum, the horizontal analogue of magnesium, are closely related to those of the group last discussed, that it has been thought best to take up aluminum at this point. Moreover, we

² Dawson, Maria. Nitrogen and the Nodules of Leguminous Plants. Philos. Trans. Royal Soc., London, 1899.

are now reaching a part of the periodic system containing so many rare elements that a strict adherence to the order of the periodic system is no longer practicable if the plan outlined in VII of this series of papers is followed—namely, to merely discuss the tests employed for the detection of the elements most frequently met with in ordinary analytical work.

The remaining articles of the series will, therefore, be devoted to the common metals—mercury, lead, silver, arsenic, antimony, bismuth, tin, copper, cobalt, nickel, iron, manganese, chromium. Then will follow the tests for the common acids, and finally tests for several of the less common acid forming elements.

ALUMINUM.

Reference has already been made a number of times to this element in previous articles, as seriously interfering with many tests; thus, it frequently happens that an indication of its presence will be obtained while engaged in testing for other elements.

The separation of aluminum from most of the other elements has been hinted at in the last article (XVII). Like glucinum and zinc, its hydroxide is precipitated by alkalis and is soluble in excess of sodium or potassium hydroxides, an aluminate of the general formula $\text{Al}(\text{OM})_3$ being formed. In this connection it should be borne in mind that aluminum phosphate may often separate in the course of micro-chemical analyses when the material containing phosphates is made alkaline, or when sodium phosphate is being used as a reagent. Aluminum phosphate ($\text{AlPO}_4 \cdot 4\text{H}_2\text{O}$) is soluble in potassium and sodium hydroxides, difficultly soluble in ammonium hydroxide, and insoluble in these hydroxides in the presence of ammonium salts. Unlike the hydroxide, aluminum phosphate is insoluble in acetic acid.

The following reagents have been suggested for the micro-chemical detection of aluminum:

- I. Cesium Sulphate.
- II. Ammonium Fluoride.
- III. Primary Potassium Sulphate.
- IV. Staining Aluminum Hydroxide with Dyes.

I. Cesium Sulphate added to solutions containing Aluminum Sulphate leads to the formation of Cesium Alum.

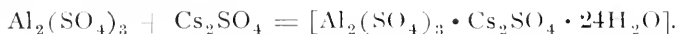

Method.—To a drop of the solution to be tested, add a drop of ammonium hydroxide. Draw off or filter off the supernatant solution. Wash the precipitate once with water. Then add a single drop of water and a trace of dilute sulphuric acid, only just enough to dissolve the aluminum hydroxide. Warm gently; cool, and to the drop add a fragment of the reagent. After a few seconds, beautiful large crystals of cesium alum separate (Fig. 73). The crystals are regular octahedra, and the usual combinations of octahedron and cube, etc.

Remarks.—Cesium chloride can be employed as reagent, providing that the solution to be tested contains a little free sulphuric acid. The chloride is, how-

ever, not as satisfactory as the sulphate, particularly in the hands of beginners, for cesium chloride crystallizes in the isometric system, thus sometimes leading to confusion. Cesium sulphate, on the contrary, crystallizes in the orthorhombic system. An examination of a preparation with the latter salt, between crossed nicols, will therefore permit of an easy differentiation between crystals of cesium sulphate and those of cesium alum.

Cesium sulphate is not found in the list of reagents heretofore given. It is made from the chloride as follows: Place a drop of sulphuric acid at the corner of a slide or on platinum foil. Add a small crystal of cesium chloride, and evaporate to dryness. If no fumes of sulphur trioxide escape, add another drop of acid and heat again. It is evident that by this method of treatment, in the majority of cases, it is primary cesium sulphate that is formed, and not the normal sulphate as indicated in the reaction given above.

Test drops containing cesium alum have a great tendency to remain in a state of supersaturation. Often a single large crystal only will appear. In such an event, crushing the crystal and drawing its fragments through the drop will almost invariably yield a large crop of well formed crystals.

Testing for aluminum with cesium sulphate leaves little to be desired as to accuracy and elegance, but requires a little practice to learn just the proper concentration. Too dilute a test drop requires very long waiting. Spontaneous evaporation leads almost invariably to supersaturation. Evaporation over the "micro" flame is very unsatisfactory. On the other hand, the addition of the reagent to too concentrated a test drop gives rise to the immediate formation of dendritic masses and skeleton crystals. It is true that the experienced worker will usually at once recognize these dendrites as due to the presence of aluminum, but in view of the fact that beautiful and far more characteristic crystals can be obtained, the worker should not be satisfied with an unsightly preparation.

It is because of the difficulties just mentioned that the method of first precipitating the aluminum as hydroxide has been suggested. By this method the operator always knows the concentration of the test drop and the probable amount of free sulphuric acid. Moreover, all other free acids have been removed as well as many objectionable salts, a matter of not a little importance.

In the presence of magnesium sulphate there is formed a double sulphate of magnesium and cesium, hence in dealing with such cases it is necessary to add a sufficient amount of cesium sulphate to permit of the formation of both the cesium magnesium sulphate and the cesium alum. It is very seldom that the cesium magnesium double sulphate separates; when it does its crystals are to be referred to the monoclinic system.

It is of course obvious that in the case of simple substances it is merely necessary to acidify with sulphuric acid and add the reagent. Excellent results can be thus obtained. But this method of procedure requires (1) just the proper concentration, (2) the absence of much free sulphuric acid, (3) the absence of free acids other than sulphuric.

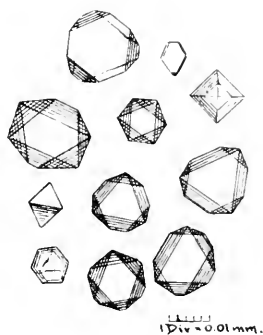

Fig. 73.

Cesium alum is one of a group of double sulphates known as "alums," having the general formula $M_2(\text{SO}_4)_3 \cdot N_2\text{SO}_4 \cdot 24\text{H}_2\text{O}$, where $-M-$ can be Al, Cr, Mn, Fe, In, Ga, Tl; and $-N-$ Na, K, Rb, Cs, NH_4 , Ag, or Tl. All alums are isomorphous, and are to be referred to the isometric system. Theoretically, therefore, one would be led to expect that the presence of elements capable of taking the place of aluminum in alums would be liable to interfere with the test for aluminum. But in addition to their property of being able to replace aluminum in these double sulphates, we must consider the crystallizing power of the compounds formed. It is herein that lies the explanation of the value of cesium sulphate over and above that of any other of the sulphates we might be inclined to select. Of the above listed alum forming elements, aluminum is the only one which unites with cesium or rubidium sulphates to form easily crystallizable alums. The other elements unite with these two sulphates only with difficulty, and the alums formed can be regarded, from a micro-chemical standpoint, as practically uncrystallizable. Sodium, potassium, and ammonium sulphates readily unite to form more or less crystallizable alums with the other alum forming elements as well as with aluminum.

Exercises for Practice.

To a test drop consisting of a solution of aluminum sulphate add a fragment of the reagent.

Precipitate another drop with ammonium hydroxide, draw off, wash the precipitate, dissolve in the least possible amount of sulphuric acid, and test.

Try rubidium sulphate as reagent: then potassium sulphate; sodium sulphate; ammonium sulphate. Try cesium chloride.

Test for Al in the presence of free hydrochloric acid; free nitric acid.

Test preparations containing Al and Fe; Al and Cr; Al and Mn; Al, Fe, Cr; Al and Mg; Al and Gl; Al in the presence of phosphates.

Prepare slides of chrome alum, iron alum, etc., then mixtures of these various alums; note isomorphism.

II. Ammonium Fluoride in excess leads to the separation of a Double Fluoride of Aluminum and Ammonium.



Method.—Place on a celluloid slip a drop of a moderately dilute neutral solution of the substance to be tested, and to it add several small fragments of ammonium fluoride. Very minute crystals immediately separate. The preparation is set aside for a few seconds, and is then examined near the circumference of the drop. Small but clear cut octahedral crystals of the double fluoride of ammonium and aluminum will be seen (Fig. 74).

Remarks.—The solution must contain no appreciable amount of free mineral acid. The best results seem to be obtained when the test drop is neutral.

Unless the reagent is present in excess, a compound of different composition,



Fig. 74.

containing a higher percentage of aluminum, separates in the form of tiny rods.

Double fluorides of aluminum and sodium, potassium, rubidium and cesium, having the general formula $AlF_3 \cdot 3RF$, are also known. Or we can indicate the composition by the formula R_3AlF_6 , calling the compounds fluoaluminates, a term preferred by some chemists.

With lithium fluoride the double fluoride formed is less soluble than in the case of the alkali metals; its crystallizing power is also considerably less.

Crystalline double fluorides of aluminum with copper, nickel, and zinc have been described, but these are too soluble to appear under the conditions which usually obtain in an analysis.

In testing for aluminum with ammonium fluoride, salts of lithium, sodium, and iron must be absent.

The presence of silicon and analogous elements will generally seriously complicate matters, and may ruin the test, owing to the formation of fluosilicates. (See ammonium fluosilicate tests, under Sodium and Barium.) Aluminum fluosilicate is gelatinous, and does not crystallize.

Testing for aluminum with ammonium fluoride generally yields results a trifle quicker than Method I, but the delicacy of the reaction is but very little greater. Moreover, Method II is subject to many complications and interferences, and there is always danger, in spite of great care, of damaging objectives by the corrosive vapors arising from the test drop. For these reasons, testing with ammonium fluoride will never be considered as being as satisfactory as the cesium method. One of the chief reasons for inserting the test in this series is the fact that crystals of ammonium fluoaluminate may occasionally appear when this reagent is being employed for other purposes, and the presence of aluminum is not yet suspected.

III. With Primary Potassium Sulphate, $HKSO_4$.

This salt, added to sulphate solutions of aluminum, leads to the formation and separation of beautiful, large crystals of potassium alum. This reaction is an elegant and satisfactory one, but is not nearly so good as that with cesium sulphate, for the reasons which have already been stated above, still with due observance of the precautions, etc., there given, testing for aluminum with primary potassium sulphate, in the absence of the cesium salt, can be depended upon to give neat and satisfactory tests.

IV. Staining the Precipitated Hydroxide.

Owing to the fact that aluminum hydroxide has the property of uniting with various pigments to form colored compounds, it is possible to detect this element by staining methods.

Of the various dyes proposed, Congo red and cochineal (Carmine) have been most favorably received, the former being the better.

An aqueous solution of the dye, added to freshly precipitated aluminum hydroxide, stains the latter a more or less deep red.

The reaction is subject to many errors, is of very limited application, and is unsatisfactory in the routine work of chemical analysis.

Journal of
Applied Microscopy
 and
Laboratory Methods.

Edited by L. B. ELLIOTT.

Issued Monthly from the Publication Department
 of the Bausch & Lomb Optical Co.,
 Rochester, N. Y.

SUBSCRIPTIONS:

One Dollar per Year. To Foreign Countries, \$1.25
 per Year, in Advance.

The majority of our subscribers dislike to have their files broken in case they fail to remit at the expiration of their paid subscription. We therefore assume that no interruption in the series is desired, unless notice to discontinue is sent.

SEPARATES.

One hundred separates of each original paper accepted are furnished the author, gratis.

Separates are bound in special cover with title. A greater number can be had at cost of printing the extra copies desired.

The society enjoyed several fine musical numbers furnished by friends of the Colorado Microscopical Society, and at the close of the program a very pleasant informal reception with refreshments was tendered by the latter organization.

On Friday the general sessions of the society were occupied by the reading of papers, a noteworthy feature of which was an address by Ex-President Dr. W. C. Krauss of Buffalo, on "The Debt of American Microscopy to Spencer and Tolles." The committee appointed at the New York meeting announced the completion of the Spencer-Tolles Fund to the limit of \$1200, as set a year ago, and other members spoke in a congratulatory tone on the completion of the fund. The report of the committee which provided that a specific sum should be set aside yearly from the interest of this fund for the encouragement of microscopical research was adopted, and the conditions of the grant ordered printed in the annual volume.

Resolutions of regret at the death of Ex-President E. W. Claypole were read and ordered spread upon the minutes of the society.

The following officers were elected for the year 1901-2:

President, Charles E. Bessey, University of Nebraska, Lincoln, Nebr.

First Vice-President, E. A. Birge, University of Wisconsin, Madison, Wis.

Second Vice-President, John Aspinwall, New York City.

Elective members of the Executive Committee: Dr. A. M. Holmes, Denver, Colorado; Dr. V. A. Latham, Chicago, Ill.; Mr. G. C. Whipple, New York City.

Secretary, Henry B. Ward, University of Nebraska, Lincoln, Nebr.

Treasurer, J. C. Smith, New Orleans, Louisiana.

Custodian, Magnus Pflaum, Pittsburg, Pa.

The session of Saturday morning was held while en route to Colorado Springs on an excursion tendered the society, in the course of which a banquet at the Antlers Hotel, a visit to Colorado College, a carriage ride through the Garden of the Gods, and Manitou were enjoyed. The society is indebted to the Commercial Clubs of Denver and Colorado Springs and to the Colorado Microscopical Society for the many hospitalities extended to it.

The next meeting will probably be held in Pittsburg. We would urge the desirability of every one interested in microscopical work becoming a member of this society.

The twenty-fourth annual meeting of the American Microscopical Society was held in Denver, Colorado, on Thursday, Friday and Saturday, August 29 to 31. While in attendance the meeting was the smallest but one which the organization has held; Prof. H. B. Ward, the secretary of the society, informs us that the papers presented were not inferior in number or quality to those of any previous meeting.

The Thursday evening meeting took the form of a reception by the Colorado Microscopical Society, on whose invitation the American Microscopical Society met in Denver. After address of welcome by Dr. A. M. Holmes, president of the Colorado Society, and a response by Dr. A. M. Bleile, the retiring president of the American Microscopical Society, the incoming president, Dr. C. H. Eigenmann, gave the annual address on the solution of the eel problem.

CURRENT BOTANICAL LITERATURE.

CHARLES J. CHAMBERLAIN.

Books for review and separates of papers on botanical subjects should be sent to
Charles J. Chamberlain, University of Chicago,
Chicago, Ill.

REVIEWS.

Dangeard, P. A. La reproduction sexuelle des Champignons. Étude critique *Le Botaniste*, 7: 89-130, 1900. The most interesting portion of this paper is that which deals with the question of sexuality in *Sphaerotheca*.

Several botanists believe that in *Sphaerotheca* there is a fusion of the nucleus of the antheridium with that of the oosphere, and that this fusion is followed by a fusion of the two nuclei of the ascogonium cell. Prof. Dangeard claims that no nucleus passes from the antheridium into the oosphere, but that the antheridium cell with its nucleus soon disorganizes. He points out that in the stage of development in which the ascogonium contains two nuclei, the antheridium should not have any nucleus, if the theory of a fusion of egg nucleus and antheridium nucleus is correct. According to his observations the antheridium, at this stage, still retains its nucleus. The author attempts, on other grounds, to disprove a repeated nuclear fusion in *Sphaerotheca*. C. J. C.

Stephani, F. Species Hepaticarum. Bull. de l'Herbier Boissier, pp. 275-353. Dec. 1899 and Apr. 1900. This portion of the writer's work on Hepaticæ contains a very full account of the genus *Metzgeria*, sixty-four

species being described. Of these, two species are cosmopolitan, one belongs to northern forests, nine are native in tropical and sub-tropical Africa, eight in tropical Asia and Oceanica, twenty-nine in tropical America, and fifteen in antarctic regions. Another paper (Extrait des Mémoires de l'Herbier Boissier, pp. 1-46, 1900) contains a full account of *Fossombronina*, with descriptions of forty species. Several other genera are described in this paper. The writer believes that *Fossombronina* is the connecting link between the thallose and leafy liverworts. This paper, which completes Vol. I, Acrogyneæ der "Species Hepaticarum," has an index of thirteen pages. C. J. C.

Butters, F. K. A Preliminary List of Minnesota Xylariaceæ. Minn. Bot. Studies, Second Ser. 3: 563-567, 1901. Material from which this list is made has been accumulating for fifteen years. Specimens of all the forms listed have

been deposited in the herbarium of the University of Minnesota. The list contains nineteen species distributed among five genera, as follows: *Nummularia*, 3; *Ustilina*, 1; *Hypoxylon*, 12; *Daldinia*, 2; *Xylaria*, 1. The list is accompanied by notes. C. J. C.

Hirn, Karl E. Monographie und Iconographie der Oedogoniaceen. Acta Societatis scientiarum Fennicæ, 27: 1-394, pls. 1-64, 1900. This is the most important work on the morphology and taxonomy of the Oedogoniaceæ which has yet appeared.

The first forty-seven pages are devoted to structure and development. Special

attention is given to the development of the ring. The analytical key of twenty-two pages is in Latin, supplemented by notes in German. Descriptions are given of 244 species, of which about 46 species, with 35 varieties, are new. The illustrations form a valuable feature of the work, 239 of the 244 species being figured. About two-thirds of the illustrations are original. C. J. C.

Buller, A. H. R. Contributions to our Knowledge of the Physiology of the Spermatozoa of Ferns. *Ann. of Botany*, 14: 543-582, 1900.

Besides malic acid and its salts, many organic and inorganic salts in the cell sap have a positive chemotactic stimulus for the spermatozoa of ferns, but malic acid exerts a stronger influence than any other substance tested. Sugar, alcohols, asparagin, and urea do not attract. The cell sap attracts spermatozoids, but this does not prove that the sap contains malic acid compounds, because the attraction takes place in their absence. Withdrawal of water brings the spermatozoids to rest, but they may recover upon the reabsorption of water. The swarm period for spermatozoa of *Gymnogramme Martensi* is about two hours, much longer than was previously supposed. The starch in the vesicles of spermatozoa disappears during the swarm period. C. J. C.

Golden, Katherine E. *Aspergillus oryzae* (Ahlburg) Cohn. *Proc. Indiana Acad. of Science*. pp. 1-15, 12 figs. 1898.

Aspergillus oryzae is a mold of considerable practical interest because it is claimed that under certain conditions it can be converted into a yeast and that it can give rise to alcoholic fermentation. In Japan it is used in the manufacture of saké, and Takamine, a Japanese chemist, introduced the mold into the United States hoping to do away with the malting of grain in breweries. He took out a patent and introduced it into a brewery, but while fermentation took place, the mold has not superseded yeast.

The present paper traces the life history in some detail. Good figures are given of the conidia and mycelium, but an ascosporic stage could not be found. Pure cultures made from material obtained from Takamine and a series of experiments have led the writer to conclude that this mold is never, under any circumstances, converted into a yeast and that it does not have the power of inducing alcoholic fermentation. It has been admitted by previous investigators that their cultures were not quite pure. C. J. C.

Du Sablon, Leclerc. Recherches sur les fleurs cléistogames. *Revue Générale de Botanique*. 12: 305-318, figs. 11, 1900.

Violets, and especially *Viola odorata*, have typical cleistogamous flowers.

The normal flower, which appears early in the spring, has a handsome corolla, but it seldom produces good seed. The inconspicuous cleistogamous flowers which come later, usually after the normal flowers have disappeared, produce an abundance of good seed. The stamens are larger in the normal flowers than in the cleistogamous, but the size of the pollen grains is about the same in both. The structure of the anther wall is quite different, the normal anther having the usual endothecium with lignified thickenings, while in the cleistogamous flowers the endothecial layer retains its nucleus and cytoplasm. After the pollen is mature there is a resting period of various duration. Pollen tubes are then put out which penetrate the wall of the anther at its upper part where there is a region of small cells rich in protoplasm, a tissue comparable to the conductive tissue of the style. *Ovalis actosella*, *Linaria spuria* and *Leersia oryzoides* were also studied. In typical cleistogamous flowers the pollen germinates within the pollen sac and the structure of the anther wall is modified to meet the new mode of pollination. In *Linaria* and *Leersia*, where the pollen was not observed to germinate within the pollen sac, the anther wall has the same structure as in the normal flower. C. J. C.

CYTOLOGY, EMBRYOLOGY, AND MICROSCOPICAL METHODS.

AGNES M. CLAYPOLE, Cornell University.

Separates of papers and books on animal biology should be sent for review to
Agnes M. Claypole, 125 N. Marengo avenue,
Pasadena, Cal.

CURRENT LITERATURE.

Cloetta, M. Kann das Medicamentöse Eisen nur im Duodenum resorbiert werden? Arch. f. Exp. Path. u. Pharm. **64**: 363-367. 1900. The white mouse was used for the investigation. The form of iron used was a specially prepared iron nuclein.

The animals were fed for two weeks on a food poor in iron; then the alimentary canal is to be considered free from iron. For several days succeeding, the food was mixed with iron nuclein. The animals were killed with ether, the intestine hardened at once in absolute alcohol, and subsequently treated by Quincke's method (see Arch. f. Exp. Path. and Pharm. **37**: 183).

After staining with ammonium sulphide it was found necessary to let the tissue lie in glycerin before examination, since the granules became more distinct. An aqueous solution of safranin, which is not changed by alkalies, was used for a double stain. The dark green granules stood out markedly from the yellow red protoplasm. In applying the Berlin blue reaction it is necessary to put the section first into weak alcohol containing hydrogen dioxide, for 24 hours. The intestine hardened in absolute alcohol was cut into 1 cm. pieces. These were embedded in paraffin, and the whole canal thus cut serially. All preparations proved that the iron reaction extended far beyond the limits of the duodenum.

E. J. C.

Wilson, J. T. A New System of Obtaining Directing Marks in Microscopical Sections for the Purpose of Reconstruction by Wax-plate Modeling. Zeit. f. wiss. Micros. u. f. Mikros. Techn. **17**: 169-177, 1900.

The method was suggested while using the Born-Peter process, and is a modification of this in the following way:

Instead of depending entirely upon the filling of ruled lines in a glass plate with pigment, darkly colored, perfectly straight organic filaments are placed in the paraffin together with the tissue to be embedded. The materials used were some of the long, slender root bundles of the human cauda equina; the intraspinal roots of the fifth sacral and coccygeal nerves are very long and fine, but if more delicate strands are required they may easily be separated from other nerve roots. The absence of branching and uniform caliber, together with their delicacy, make these very favorable for the purpose. Portions of such bundles of 10-12 centimeters in length are suspended by a thread, and carry on a thread at the other end weight enough to keep the strand perfectly straight after immersion in fluid, but not enough to stretch it. These pieces are now hung in a vessel of 1 per cent. osmic acid to blacken the myelin of the nerve fibers. Then they are carried in a like manner through the alcohols and xylol, and infiltrated with paraffin in a test tube. These strands

are lifted carefully out and allowed to harden, and can be kept till required for use.

For embedding, a glass base plate and the usual Naples L-shaped embedding bars are required. The glass plate may be constructed in the laboratory from plane-surfaced glass. It is convenient to have it of such a shape as to replace easily the stage of a dissecting microscope, but it should not be more than 2-3 mm. thick. The surfaces should be plane, and it is advantageous to have a central, rectangular outline on the upper surface with the sides measuring 2 cm. each. This outline should be blackened. On the under side of this area a series of deep lines should be engraved and blackened; they must be accurately parallel to two of the sides of the quadrilateral figure on the upper side and to each other, and placed at intervals of 1-2 mm. The embedding bars should be exactly rectangular throughout, and have their arms 2 cm. in length.

Before proceeding to embed the object, the glass plate must be so placed that it can be heated from below, and it and the bars are slightly rubbed with glycerin to facilitate the removal of the paraffin block. Two or more of the blackened strands of nerve tissue are laid very carefully on the glass coincident with two of the parallel blackened lines. The base plate is now heated to fix the paraffin-covered strands in place, and to arrange them perfectly coincident with the engraved lines. One of the embedding bars is then so placed that the cross-arm will limit the basal plane of the future paraffin block, corresponding to or parallel to the plane of sectioning. Both bars slightly cover the ends of the nerve strands. A moderate weight of a kilo, in the shape of an iron bar, is laid on the upper surface of the embedding bars, and the plate is again heated till the paraffin is melted, and either allowed to cool or the process of embedding completed. The weighting of the bars allows complete flattening of the ends of the strands of tissue, which are held in place by the bases of the bars, and hence their very slight thickness does not interfere with the angle of the surface of the bars. If there is objection to this process, the filaments may be held down by two pieces of lead placed inside the bars. If the plate has been allowed to cool it must be again warmed to the melting point of paraffin; after filling the chamber with melted paraffin the object must be carefully oriented, with reference to the lines and strands, under a dissecting microscope, if necessary, but the plate must be kept warm till everything is completed. Rapid cooling in iced water follows, with care to prevent cupping of the block by the addition of drops of melted paraffin, and manipulation with a hot needle.

The advantages of this method are: 1. No special apparatus is required beyond what is found in any laboratory, even the glass plate may be prepared by an ordinary engraving diamond if necessary. 2. None of the operations require any special dexterity, and all may be accomplished by anyone with certainty. 3. Very little expenditure of time is required beyond that of ordinary embedding after the stock of prepared nerve is laid in. 4. The actual directing marks in each section are brought as close as desired to the object. 5. Whenever the embedding has taken place the importance of the directing plane disappears, the only plane of importance being the future base of the object block. 6. The necessity for scratching the paraffin block by a "Ritzer" or for the alternative

Born-Peter ridges. 7. There is no necessity for filling up the scratches, or for coating the ridges with amorphous color, nor for the addition of color, lacquer, or any foreign substance. 8. Each section bears its directing marks in the shape of circumscribed black spots. 9. The detecting strands cause no inconvenience at any time in the processes, and their axes are for all practical purposes as accurately perpendicular to the plane of section as are the colored ridges of the Born-Peter block. 10. It is possible, but not yet fully tested, to apply the process to celloidin.

A. M. C.

Stepanow, E. M. Eine neue Einbettungsmethode in Celloidin. Zeit. f. wiss. Mikros. u. f. Mikros. Techn. 17: 185-191, 1900.

The author uses a solution of celloidin in clove oil with ether and absolute alcohol in the following proportions:

Celloidin (shavings very fine and well dried), 1.5 gr.; clove oil, 5.0 c. c.; ether, 20.0 (of 0.720 sp. gr.); alcohol absolute, added by drops, 1.0 c. c. One c. c. of this mixture contains more than 6 per cent. celloidin, corresponding to the weakest used solution. By the addition of ether and alcohol much thinner liquid can be obtained, and by concentration thicker up to 35 per cent. The process with the "normal" solution (6 per cent.) is as follows: Tissue well hardened in alcohol, dehydrated, and freed from superfluous alcohol by touching it lightly with filter paper, is put in a glass-stoppered bottle containing 4-5 c. c. of clove-oil-ether-celloidin. According to the size of the pieces, it is kept here from one to six hours or more, then the bottle is uncorked and put under an inverted glass, leaving the solution to evaporate for four to six or more hours. This thickened mixture is poured into a small, freely hanging filter of fine silk paper; the mass is then either left open or loosely closed to reduce it to embedding consistency. The process may be hastened by keeping the filter in a warm place. The clearness and dryness of the substances are the best assurances for a good embedding matrix. This thickening takes place in from four to six hours; the object is then cut out from the surrounding mass. Further preparations may follow one of several lines: 1. If the sections are to be cut in alcohol the material is mounted on a cork which has been well coated with celloidin and then put for twenty-four hours in 70-85 per cent. alcohol. Treatment for two to three hours in chloroform, is equally sure and much quicker. 2. The object, fastened on a piece of wood, is made firm, by means of a needle, to the cork of a bottle containing chloroform, for two to six hours, then the sections are cut with a dry knife and transferred with oil to a slide. Sections 10, 7.5, and 5 μ can be cut this way, and the block is always transparent. 3. The best method is to put the freshly embedded object into benzol, and there it hardens. Such an object may be put directly into anethol (later into anethol-paraffin); into a solution of paraffin in benzol, and then into liquid paraffin; into cedar oil for dry sections, or into 85 per cent. alcohol for wet sections.

The chief advantages of the method are: 1. The manipulations are as simple as in the ordinary methods, and fewer. 2. The imbibition is more quickly completed (twenty-four hours or fewer). 3. The embedding is so thorough that sections can be cut 3 μ in thickness. 4. The control of the embedding processes is easily indicated by transparency. 5. After these preliminaries the tissues may

be finished by many various methods. 6. The possibility of embedding by anilin oil without higher grades of alcohol than 70-80 per cent. 7. The short time needed in each embedding solution.

A. M. C.

Eisen, G. The Spermatogenesis of *Batrachoseps*. Jour. Morph. Vol. 17, 1900. Earlier investigations were made on material hardened in Flemming's and Hermann's fluids; later Heidenhain's sublimate-acetic mixture with and without formol was tested. Others also, as Hermann's and Flemming's fluids mixed with sublimate or palladium chloride, vanadium chloride, uranium chloride and osmium chloride. Except the latter the author discarded them all. He believes to have proved that every mixture containing platinum chloride or osmic acid completely destroyed the outer cells. As the testis of *Batrachoseps* is very small and possesses but few cell layers, all such fixatives must be rejected. Platinum chloride is more injurious than osmic acid, since it destroys the chromatin, while the latter injures the fine structure of the cytoplasm. Osmium chloride is a very valuable fixative, especially in 1/2 to 1/10 per cent. solutions, although it also possesses the property of blackening the tissues to a less degree than osmic acid. Three to twelve hours are necessary for proper fixation, no shrinking and no blackening occurs, and the outer layers of cells are in good condition as well as the inner ones. An hour's washing in water follows the treatment with alcohol and bergamot oil and xylol, again into bergamot oil and embedded in paraffin. Sections 4 to 6 μ thick are cut that every cell may be sectioned. This the author holds to be an essential for good staining.

Benda's iron hæmatoxylin combined with congo-red was largely used. The sections left for 24 hours in the following solution: ferric sulphate according to the German pharmacopeia diluted with six times its volume of water, then in concentrated hæmatoxylin solution containing 10 per cent. alcohol for 48 to 72 hours. The best results came from the longer action of the stain. The differentiation is effected by 10 per cent. acetic acid containing a very small quantity of liquor ferri, in 10 to 20 minutes, washed as rapidly as possible, cleared in bergamot oil and mounted in xylol balsam. A triple stain with congo-red, thionin and ruthenium red can be used also. The sections remain a few seconds in a weak aqueous solution of congo-red, then about 10 minutes in thionin in water, and finally differentiated by a very weak aqueous solution of ruthenium red.

A. M. C.

RádI, Em. Arthropod Vision. Zeitschr. wiss. Zool. 67: 557-598, 1 pl., 1900 (review in Journ. Roy. Micr. Soc. pt. 1, pl. 36, 1901).

The author considers that not enough importance has been laid on the study of the nerve centers of the eye as well as of its dioptric apparatus. He believes the key to the problem of arthropod vision to lie in the central rather than peripheral organs. He has exhaustively studied the eye and optic tract in *Squilla mantis*. After a brief description of the external appearances of the eye, the phenomenon of "double eyes" in arthropods is fully considered. The eye itself is described briefly. Each ommatidium gives off seven nerve fibrils, which unite in a bundle; as these pass across the space between the basal membrane of the eye and the first ganglion, those from neighboring ommatidia unite to form larger bundles. In

the first ganglion these bundles break up into constitutional bundles. This ganglion, like the eye, is made up of two halves connected by a thick bunch of vertical nerve fibers. The ganglia are complex. An especially important element is the granular layer, containing darkly staining bodies, "nerve nodes" (Nervennoden), corresponding to the ommatidia in number. These consist of neuroglia fibrils, which come from several ommatidia; the fibrils do not end, but pass on to other ganglia. As the fibers leave the first ganglion to pass on to the second, they cross so that the right becomes left and vice versa. The importance of this crossing lies, according to the author, in the varying lengths of the fibers, which have a physiological significance, explained as follows: Suppose the eye to be stimulated in such a way that a certain set of retinulæ receive an equal impulse. These impulses pass down the fibrils to the second ganglion, but owing to variation in the length of these fibers will arrive at different times. If it is supposed that a stimulus affects one ommatidium only, a successive series of changes in the nerve centers would follow, since each ommatidium has seven nerve fibrils and each has a different length from the others. This theory of arthropod vision was reached by the author by a process of induction, but he believes he is supported by the theories of other authors who have based their conclusions on theoretical grounds.

A. M. C.

CURRENT ZOÖLOGICAL LITERATURE.

CHARLES A. KOFOID.

Books and separates of papers on zoölogical subjects should be sent for review to Charles A. Kofoid, University of California, Berkeley, California.

Seeliger, O. Tierleben der Tiefsee. 49 pp., 1 Taf., Verlag von W. Engelmann, Leipzig, 1901. Preis Mk. 2.

This brief treatise on the abyssal life of the ocean covers the subject in succinct fashion in the light of the latest

investigations in this field of zoölogical exploration. A short historical sketch is followed by an explanation of the factors of the environment, such as the chemical condition, pressure, temperature, and light. The problems that center about the coloration, phosphorescence, and vision of deep-sea animals are also discussed.

C. A. K.

Nutting, C. C. The Hydroids of the Wood's Holl Region. Bull. U. S. Fish Commission for 1899, pp. 325-386. 1901.

Students at marine laboratories will welcome Professor Nutting's paper on these favorite forms of seaside study.

The descriptions are brief, but illustrations, mainly original, are abundant, and very full keys are provided for both hydroid and medusa stages. In all, 112 different forms are described from Wood's Holl and Newport indicating the richness of the hydroid fauna in that region. In providing for the preparation and publication of a series of papers, of which this is one, upon the local fauna at the Wood's Holl Station, the United States Fish Commission is rendering valuable aid to all American students of marine life.

C. A. K.

Petersen, C. G. J. An Otter-Seine for the Exploration of the Deeper Seas. Rep. Danish Biol. Sta., 8: 24 pp., 4to, 10 figs., 1899.

The problem of capturing the larger and more active inhabitants of the sea bottom has been attacked in the past by large beam trawls. These are limited in size, the largest being 10 to 15 feet beam, and are difficult to manoeuvre, even with large vessels. The beamless trawling gear used of late by North Sea trawlers has been adapted by Dr. Petersen to biological work. With a 32-foot steam launch he operated, in depths

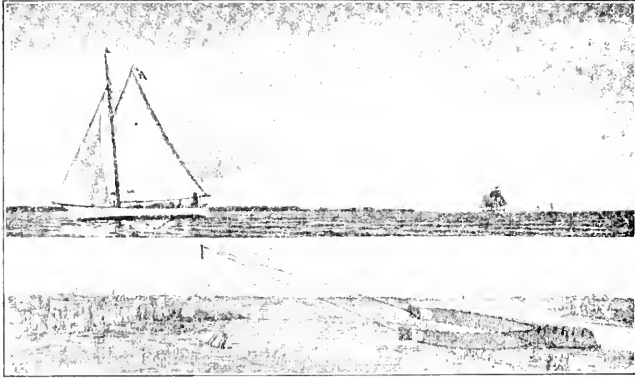

Sailing Vessel with Otter Drag-Seine.

of 1 to 300 fathoms, a trawling gear of this pattern whose spread at ordinary speed was 12 to 16 feet. With a more powerful craft and larger trawl a much greater speed can be secured. Two boards, 29 x 32 inches, with iron runners, are attached to the ends of the wings of the bag, which is provided with a light, collapsible funnel. The mouth of the bag is kept in shape by suitable weights and Norwegian glass floats. From the boards pass bridles, eight fathoms long, to the vertex of the crow-foot, where a shackle, float, and lead keep the bridles from twisting. From the vertex a *single* line passes aboard ship. A proper adjustment of speed is necessary to secure the most successful operation of the trawl. The figure gives some idea of the trawl in action. Full directions for knitting the bag are given in the original article. The catches of this apparatus are said to be phenomenal.

C. A. K.

Bock, M. de. Observations Anatomiques et Histologiques sur les Oligochètes Spécialement sur leur Système Musculaire. Rev. Suisse de Zool. 9: 1-41, pl. 1, 2, 1901.

The author seeks to clear up some controverted points concerning the musculature of the *Oligocheta*, employing as objects of study a number of different terricolous and limicolous species. The study of sections was supplemented by the examination of material prepared by maceration for several months in a $\frac{1}{2}$ to 1 per cent. solution of bichromate of potash and then disassociated, after several weeks, in glycerin. The silver nitrate method of Dekhuyzen was employed to demonstrate the membrane of the so-called sarcolemma. The muscle columns (*colonnes musculaires* of Cerfontaine) which constitute the musculature of the body wall of the *Oligocheta* are composed of bundles, each containing a small number of fibers, and are enclosed

in a delicate membrane. The fibers in turn are made up of muscle elements which cannot be further divided. The muscle elements arise in myogenous cells, each cell producing several of the elements, though neither the fiber nor the muscle column represents a single cell. In the *Lumbricidae* the muscle columns unite in well defined compartments, most pronounced in the longitudinal series, each with distinct connective tissue membrane in which nuclei but no cell boundaries are found. This connective tissue serves to reduce the pressure and friction in muscular movement, and in limicolous species it forms a compact layer beneath the peritoneum. The nuclei of the muscular tissue are distinguished from those of the connective tissue by their larger size, and in limicolous forms are often pedunculate and grouped along the lateral line. No nerve runs along this line, though a fine canal, probably a lymphatic vessel, lies among the nuclei cells.

C. A. K.

Sabin, Dr. Florence R. An Atlas of the Medulla and Mid-brain. A Laboratory Manual. Pp. 123; 52 figs.; 8 pl., 1901. The Friedenwald Co., Baltimore. \$1.75.

This atlas was prepared for the study of the human brain, and it will prove to be a valuable aid in the laboratory

for the study of the brain of lower types. The abundant drawings of typical sections, and above all the elegant colored plates of the medulla and mid-brain regions, with their several parts shown in relief, will serve to elucidate these difficult and complicated parts of the brain. It is stated that reproductions in wax from the studio of Zeigler, in Freiburg, will be available within the year. The material studied was preserved in Müller's fluid and stained by the Wright-Pal method. Sections of 70 μ thickness were made in a horizontal plane and every other one used as the basis for reconstruction in wax by the Born method. Wax plates two millimeters in thickness were used, thus giving a magnification of 14.5. The wax was composed of 19 parts ordinary beeswax and 1 part resin. To facilitate the counting of the sections in the model, every fifth plate was made black by an admixture of lampblack. Melted wax of a weight sufficient to cast a plate of the desired size is poured through a strainer into a tarred receptacle, and then emptied upon a pan of hot water, bubbles being removed by a strong gas flame. When firm, the plate is removed to a level surface to harden. The drawings from the sections were made by the aid of a projection apparatus and an electric lamp, the image being received upon a rigid but movable screen, and care being taken to preserve a uniform magnification and orientation of the sections. Drawings are then transferred to the wax plates by carbon paper, and finished in oil paints. The sections thus outlined are cut from the plates, which are slightly warmed, and placed upon a sheet of glass, a thin, narrow-bladed knife being used for the cutting. The sections, and the shells also, are then piled up in proper relation and their edges fused, thus giving a model of the external form of the organ and a mould for a plaster cast of the same. The different structures of the organs were then modeled separately, and the whole so united as to display the true spatial relations of the various nuclei and fiber tracts. The result, even as shown in the figures, will serve to elucidate and simplify greatly the study and the demonstration of the structure of these important but very complex organs.

C. A. K.

NORMAL AND PATHOLOGICAL HISTOLOGY.

JOSEPH H. PRATT.

Harvard University Medical School, Boston, Mass., to whom all books and papers on these subjects should be sent for review.

Hirschmann, A. Pathologisch-anatomische Studien über acute u. chronische laryngitis nicht-spezifischen Ursprungs nebst Bemerkungen über Vorkommen von Plasma- und Mastzellen. *Virchow's Archiv für path. Anat.* **164**: 541-569, 1901.

This paper is based upon a histological study of twenty-four larynges which were the seat either of acute or chronic inflammation. Cases of tuberculous or syphilitic laryngitis were excluded.

Formalin was the fixing agent employed. It was found that mast-cells are as well preserved by formalin as by alcohol. Earlier writers have claimed that alcohol yields the best results in the study of mast-cells. The tissues were embedded in paraffin. Sections were stained with haematoxylin and eosin, orcein, thionin, and polychrome methylen blue.

Plasma cells were not found either in the normal or inflamed larynx. Laryngitis is usually due to an irritant which is too weak to cause an extensive destruction of cells. There is generally a marked emigration of leucocytes and proliferation of cells. The author found mast-cells in every case of laryngitis examined. This agrees with the view that these cells are found especially in those organs which are the seat of a mild, chronic inflammation. He holds that mast-cells are due to the long continued action of a mild irritant, while plasma cells are due to the long continued action of a strong irritant.

Hirschmann claims that mast-cells are derived from leucocytes. Large mononuclear leucocytes wander from the blood vessels into an inflammatory area and are there converted into mast-cells by ingesting the products of inflammation. It is these products of inflammation which give the cell its characteristic color. The different forms of mast-cells which have been described are simply different stages in the development of the cell. For the demonstration of mast-cells either thionin or aqueous methylen blue gives as good results as polychrome methylen blue.

J. H. P.

Melnikow-Raswedenkow. Studien über den *Echinococcus alveolaris sive multilocularis*. Ziegler's Beiträge zur path. Anat., Supplementheft 4: 1-295. 1901.

The black jaundice of Tyrol is herein pretty clearly established as a separate type of echinococcus disease, endemic

in Tyrol. The multilocular type is found also in various parts of Germany and Russia in such degree, as to play some part in the differential diagnosis of liver affections, such as cancer and cirrhosis. In all, 235 cases are reported. Melnikow-Raswedenkow presents the protocols of 101 cases, besides 8 cases in animals, and seeks to establish the parasitology, general pathology, and pathological anatomy of the affection which he prefers to call alveolar echinococcus disease.

As early as 1856, Virchow had made clear the parasitic nature of what was before confused with colloid, or even with colloid cancer. It is interesting to find that at least the alveolar type of echinococcus disease is hardly surpassed

in malignancy by either cancer or tuberculosis. This is the more surprising in that the cestodes are as a rule, though dangerous, still far from malignant. But for many years the differences between the many small chambers of the alveolar type and the great hydatids were set down as the effects of individual variation, and the *Tænia echinococcus* v. Siebold was held responsible for both species of reaction.

It is of course somewhat out of fashion in these days to work upon parasites without recourse to experiment. Fresh material was, however, not accessible to Malnikow-Raswedenkow. And by histological study alone, several capital points have been brought out. No intermediate host appears to be required (a character resembling the trematode rather than the usual cestode type of attack). The embryo, doubtless of intestinal origin, makes its way by the blood stream to its favorite site in some small vein just beneath Glisson's capsule. Here a multilocular chitinous structure is formed, wholly analagous with the mature segment (proglottis) of the tape-worm. The chitinous walls are lined not only within, as in the great single hydatids, but also externally with a layer of granular protoplasm in which are produced not only scoleces, as in the hydatid, but also young parasite forms, without capsule, and ovoid embryos, with capsule.

By release from the outer wall of the cyst, metastasis in this form is rendered much easier than in the unilocular type. The discharged embryos, in case they do not forthwith succumb to phagocytosis within the tissue spaces, gain entrance to some blood vessel, or perhaps a bronchiole, and there form more chitinous cysts. As a consequence of their more intimate contact with the body fluids, the new cysts lose in virulence and usually remain sterile. It is probable, moreover, that feeding experiments may fail for similar reasons if the material is metastatic.

The affection works by no means simply through pressure or mere mechanical destruction, but toxically as well. Proliferation, phagocytosis, and local tissue-necrosis occur, and in places true granulomata are formed, characterized by the presence of lymphoid cells, epithelioid cells, and giant cells, with caseous degeneration.

The technique employed is in brief as follows :

1. Fix in 4 per cent. formaldehyde, 24 hours.
2. Harden in alcohols of increasing strength, cut from celloidin.
3. Place from water into Weigert's elastic tissue stain, 30 minutes.
4. Wash, decolorize in 90 per cent. alcohol 2 minutes, dip in weak lithium carbonate solution, and wash.
5. Stain with alum-hæmatoxylin and either eosin or Van Gieson's mixture.

The histological appearances are adequately shown in colored plates, of which a good example is Taf. iii, Fig. 25, showing penetration of the elastica by young forms of the parasite in the act of invading an hepatic vessel.

E. E. SOUTHARD.

GENERAL PHYSIOLOGY.

RAYMOND PEARL.

Books and papers for review should be sent to Raymond Pearl, Zoölogical Laboratory, University of Michigan, Ann Arbor, Mich.

Dewitz, J. Verhinderung der Verpuppung bei Insektenlarven. Arch. f. Entwicklungsmech. II: 690-699, 1901.

In a brief but interesting paper, Dewitz gives an account of the results of experiments on the effect of a limited amount of air on the time of pupation of the larvæ of flies and other insects. The method of experimentation was to place active larvæ in small medicine vials which were filled to different heights with sand. These vials were corked and sealed with wax, and the number of cubic centimeters of contained air recorded. After some days they were opened and the results noted. In case of the larvæ of *Lucilia cæsar*, which normally pupates in two days, it was found that after a stay of five days in the corked vials only three larvæ out of ninety-five had pupated; eighteen were dead, and the remaining seventy-four were alive but had not pupated. Left with free access to air these all transformed in two days. *Musca* larvæ were not influenced in their time of pupation by the amount of air, those in the closed tubes transforming as soon as the controls. The author correlates this difference in behavior with the fact that *Lucilia* larvæ do not pupate under natural conditions later in the year than the end of October, while *Musca* larvæ pupate up to the end of November, and indoors throughout the winter. The caterpillars of *Pieris brassicæ* were prevented from pupating by limiting the supply of air. The transformation of the larvæ of the ichneumonid *Microgaster glomeratus* was prevented by placing them in a very moist atmosphere.

R. P.

Bickel, A. Beiträge zur Gehirnphysiologie der Schildkröte. Arch. f. Anat. u. Physiol. Physiol. Abth., 1901, Pp. 52-80.

In continuation of his earlier work on the physiology of the spinal cord of the turtle, the author presents this contribution on the functions of the brain of the same animal. The results were gained from operation experiments, in which different parts of the brain were isolated or extirpated, and from stimulating the surface of the brain by electrical or chemical means. The wounds from the operations were covered with gelatine mixed with tannin, the latter preventing the gelatine from dissolving in the water. Most of the work was done on *Emys europæa*, although in a few experiments the terrestrial form, *Testudo graeca*, was used. The operations consisted of complete extirpation by transection of each of the five principal divisions of the brain (forebrain, 'tweenbrain, midbrain, cerebellum, and medulla), and of transverse cuts extending to the middle line at the posterior boundaries of each of these divisions.

Loss of the forebrain causes a decrease in the frequency with which spontaneous movements are executed, although there is no difference in the character of the movements themselves under these circumstances. An animal in which the 'tweenbrain has been extirpated, shows a tendency to hold the legs in

abnormal, cramped positions for long periods of time. Movements are normal in character, but spontaneous movements are again less frequent than in the normal animal. The primary function of both the forebrain and the 'tweenbrain is to stimulate the animal to spontaneous movement, *i. e.*, furnishes motor impulses. The olfactory lobes alone have this power to some extent. The forebrain is lacking in any appreciable regulatory effect on the movements, but the 'tweenbrain has, in a small degree, such an effect. Removal of the mid-brain causes a pronounced increase in the activity of the animal. All directive influence over the movement is lost, the animal proceeding in a straight line until it is stopped by some obstacle. The co-ordination between the different extremities is preserved, but the movements of the individual appendages are wild and exaggerated. The chief function of the midbrain, in its relation to the movement of the animal, is evidently an inhibitory and regulatory one. Removal of the cerebellum has no observable effect on the animal. Turtles in which the nervous system has been transected at the point of junction of the medulla with the cord show only very slight spontaneous movements of single appendages. There is no spontaneous locomotion. The reflex irritability of the posterior part of the body is greatly increased, and various forced movements appear. Locomotion in a straight line forward can only be induced by very strong stimulation at the posterior end of the body. In this movement the different appendages are fairly well co-ordinated. The most important function of the medulla is the inhibition of spinal reflexes.

Electrical or chemical stimulation of the surface of the cerebral hemispheres causes no muscular movement, or tonic cramps, or convulsions, such as result from similar stimulations of the mammalian brain.

R. P.

Holmes, S. J. Phototaxis in the Amphipoda.
 Amer. Jour. Physiol. 5: 211-234, 1901.

The author investigated the phototactic response in about twenty species of aquatic and terrestrial amphipods. The aquatic Gammaridea were found to be uniformly negatively phototactic. This reaction may be modified and obscured by the thigmotactic reaction, but positive phototaxis does not appear under any conditions. The terrestrial forms most studied were *Talorchestia longicornis*, *Orchestia agilis*, and *Orchestia palustris*. All three species are positively phototactic under ordinary conditions, the intensity and precision of the reaction in each case being correlated with the general habits of the organism. The positive reaction is less decided in those species which are habitually exposed to the most light. *Talorchestia longicornis* always reacts positively both in weak and in strong light. Nevertheless this animal generally comes to rest in shaded areas, presumably because it is less stimulated in the shade. The normal positive reaction of *Orchestia agilis* is temporarily changed to negative by keeping the animals for a time in the dark. When returned to the light they again react positively. A rather remarkable fact was brought out by the experiments on this form, it being found that if specimens that are exhibiting a well marked positive reaction in strong light, are suddenly brought into weak light, their reaction becomes immediately strongly negative. This reversal is independent of changes of temperature. The phototaxis of *Orchestia palustris*

is positive in sense, though much less pronounced than the reaction of the other two terrestrial species studied.

The positive phototaxis of *Talorchestia longicornis* and *Orchestia agilis* is changed to negative if these animals are placed in water, the permanence of the change apparently depending to some extent on the degree of salinity of the water. In sea water the change persists until death, while in fresh water *Orchestias* become again positive some time before they die. Experiments in which one eye was blackened over with asphalt varnish, or extirpated, were performed on several species of amphipods and insects. These operations caused the animals to perform circus movements, which differed in direction according as the specimen was positively or negatively phototactic. Positively phototactic forms turn continually in this movement towards the side bearing the blackened eye, while negative forms turn in the opposite direction. Hemisection of the brain caused a complete loss of the power of orientation to light in all cases where the experiment was tried, although the animals are still affected by light, as is shown by their general behavior.

The closing section of the paper is devoted to a discussion of the relations of phototaxis and photopathy. The author sharply criticises the position recently taken by Holt and Lee (*Amer. Jour. Physiol.* iv, p. 479. Review in this JOURNAL, p. 1264) that there is no proper basis for the separation of reactions to intensity of light from reactions to direction of ray. Dr. Holmes maintains that there are different forms of behavior towards light, which may be conveniently designated by the terms "phototaxis" and "photopathy."

Throughout the paper there appear numerous interesting references to the general habits and behavior of the organisms discussed.

R. P.

CURRENT BACTERIOLOGICAL LITERATURE.

H. W. CONN.

Separates of papers and books on bacteriology should be sent for review to
H. W. Conn, Wesleyan University, Middletown, Conn.

The Reception of Prof. Koch's New Views concerning Bovine and Human Tuberculosis.

The paper of Prof. Koch, delivered at the Tuberculosis Congress in London, was a veritable bombshell in the camp of the bacteriologists. This paper has been widely read and much discussed. The address of Prof. Koch can be found in the *British Medical Journal*, July 27, 1901. The reputation of Prof. Koch as the discoverer of the tuberculosis bacillus lends, of course, to his conclusions a weight greater than would be given those of any other bacteriologist. The general conclusions of this remarkable address are already well known. They are essentially two: 1. *Bovine tuberculosis and human tuberculosis are produced by quite different bacteria.* This he concludes from the fact that the inoculation of cattle with human tuberculosis does not produce the typical bovine disease. 2. *Human tuberculosis is to be attributed to infection from other human*

beings and very rarely from cattle. This belief he bases upon his first conclusion, and also upon the fact that in mankind primary tuberculosis in the intestinal tract is quite rare, while, if the disease were commonly due to the consumption of flesh or milk, primary intestinal tuberculosis should be frequent.

It was inevitable that these bold conclusions should be received by the members of the congress with consternation and disapproval. Many of the members of the congress had appeared especially prepared to discuss the dangers to mankind of the distribution of tuberculosis by milk or flesh of cattle, and the sweeping conclusions of Prof. Koch inevitably destroyed, in a large degree, the significance of many of the papers read before the congress. The members of the congress did not accept the conclusions of Prof. Koch, and nearly all of the remarks which referred to the paper took a position quite opposite to that occupied by the discoverer of the tubercle bacillus. The opinion was expressed that Prof. Koch had done the cause of public health a great injury by advancing unproved conclusions which would tend to decrease the care given to the methods of preventing the use of tuberculous material as food, and thus making the work of sanitary boards more difficult. Indeed, a resolution was passed in the State and Municipal Section to the effect that the conclusions of Prof. Koch were not demonstrated, and that the same amount of care should be exercised in preventing the use of tuberculous material as before the publication of the address of Prof. Koch.

Since the closing of the congress bacteriologists of repute have expressed in public opinions as to the conclusions taken by Prof. Koch. These are too numerous to be mentioned in this place, but the attitude taken by some of the more prominent bacteriologists may be properly mentioned.

It must be noticed at the outset that the first conclusion is not new with Prof. Koch, for Theobald Smith of Harvard University had already some years ago demonstrated conclusively that the human bacillus is only slightly, if at all, pathogenic for cattle. This conclusion was, therefore, well known, and the only novelty in Prof. Koch's address is in the claim that bovine tuberculosis is not a source of human tuberculosis. In regard to Prof. Koch's claims, wide divergence of opinion may be found among bacteriologists who have commented on the matter. Prof. Virchow (*Ber. Klin. Woch.*, p. 818, 1901) expresses himself as of the opinion that there is a difference between the bovine and human bacillus, though not so great a one as Prof. Koch is inclined to think. He believes that many of the tubercles which have been described as due to tuberculosis are not properly described, and that histological study of the tubercles alone can be depended upon to determine the presence of this disease, and not the simple presence of a tubercle which stains properly. He insists that the second conclusion of Prof. Koch is not justified, and that there are cases on record which show that the disease may pass from cattle to men, although the danger is slight. He thinks that more attention must be paid to the *number of bacteria* inoculated than has been paid hitherto. Prof. Klebs (*Milchztg.*, p. 501, 1901) very violently attacks Koch's position, claiming that both of Koch's conclusions are erroneous; that the bacillus is the same in cattle and men, and the milk and flesh of tuberculosis animals are a prominent source of danger to man.

Prof. Heuppe (*Ber. Klin. Woch.*, Aug. 2) is also positive in his opposition to Prof. Koch's views, insisting that the evidence in our possession is quite sufficient to demonstrate that the disease may pass from animals to men, and insisting that the differences between the bacilli in the two animals are far less than the differences between the avian and bovine bacillus, which experiment has shown to be only cultural conditions of the same organism. Among others who hold a similar position may be mentioned McFadyen, Ravenel, Nocard, Brouardel, Bang, Boullanger. Without giving further references of this sort, it may be stated that the majority of bacteriologists who have expressed any opinion at the present time hold a view somewhat as follows: The bacillus from man is very slightly, if at all, pathogenic for cattle. This, however, does not indicate that they are different species of bacteria, but simply that they are different cultural varieties of the same organism due to growth in different environment. The second conclusion of Prof. Koch, that human tuberculosis is not derived from cattle, is quite generally discredited. It is insisted that Prof. Koch drew this conclusion without sufficient evidence; that primary intestinal tuberculosis is common among children; and that there are sufficient instances of direct transference from cattle to man to show that such a source of the disease is possible. There is thus a general tendency to discredit the second position of Prof. Koch.

On the other hand, some have expressed themselves as agreeing in general with Prof. Koch's views. Prof. Baumgarten (*Ber. Klin. Woch.*, Sept. 2) is inclined to accept the position of Koch. He had in 1893 found it impossible to produce the bovine disease with human bacilli. He instances a long series of attempts made to inoculate a certain patient suffering from cancer with tuberculosis by the use of a culture from cattle. These all proved futile because, as he believes, the bovine bacillus was used rather than the human bacillus. He, however, is inclined to regard the organisms as of the same species, though different cultural varieties, but he believes that the danger of transference of the disease from cattle to man is very small. Heubner is inclined to side with Prof. Koch, thinking with him that the danger to man from bovine tuberculosis is slight although perhaps it is too early to make generalizations.

Dr. Ostertag (*Zeit. f. Fl. u. Milch Hyg.*, XI, 353) has given one of the most complete discussions of the present aspect of the question. While very careful to make no positive statements, he points out an unfortunate result that Prof. Koch's lecture has had in tending to allay the care taken by farmers in regard to the treatment of tuberculous animals. He emphasizes the fact that we have as yet no proof, indeed, *no good reason*, for believing that Prof. Koch's position is a correct one, and until this question can be positively settled we should proceed exactly as we have done in the last few years, upon the assumption that the disease can be transmitted from cattle to men, and that bovine tuberculosis is therefore a serious danger for mankind.

All who have discussed the question recognize that the conclusions which Prof. Koch advanced can only be settled by further experiment and discussion. Already a number of persons have offered themselves for experiment and have expressed their willingness to be inoculated with bovine bacilli in order to dem-

onstrate, if possible, the truth or falsity of Prof. Koch's position. A committee has been appointed recently in England, consisting of the most prominent experts among English scientists, to investigate the questions concerned. The great importance of these conclusions rests upon the fact that the belief in the possibility of transference of the disease from animals to man has been the basis of widely adopted public laws and sanitary rules, connected with the care of cattle and the distribution of milk in all civilized communities, and if Prof. Koch's views should be accepted as correct it would result in almost a revolution in conducting sanitary inspection. The extreme importance of the subject makes it certain that in the next few years many contributions will be given on the question, and we may in a short time expect a satisfactory demonstration or refutation of the two positions advanced by Prof. Koch.

H. W. C.

Nikolsky. Charbon chez des animaux nourris avec leur aliments habituel, mêlés de spores charbonneuses. *Ann. d. l. Inst. Past.* **14**: 794, 1900.

The question as to the distribution of the anthrax bacillus has, ever since the days of Pasteur, been subject to a considerable degree of uncertainty. The author endeavors to determine whether the anthrax spores, mixed with ordinary food, are capable of giving rise to the disease. His conclusion is positive. The spores, mixed with the ordinary food, were not only able to resist the action of the ordinary intestinal bacteria, but made their way through the intestinal walls, and in a short time produced typical cases of anthrax. This, of course, is a factor which explains in a measure the appearance of anthrax in old pastures where the bodies of animals that have suffered from this disease have been buried.

H. W. C.

Smith. The Nodule Organism of the Leguminosæ. *Proc. Linn. Soc. of New South Wales.* P. 653, 1899.

The author has made a more careful study of the organism that produces the tubercle in legumes than has hitherto been made. Previous observers have dwelt almost wholly upon the action of the nodule in producing the tubercles, without making a sufficiently careful study of the organism itself. Smith studies and gives a thorough description of the tubercle organism. His conclusions are, essentially, as follows: 1. The nodule organism is a yeast, possessing a vacuole, and not a bacterium. 2. It multiplies by budding, and this, together with a persistent mucilaginous capsule, indicates its relations to yeasts, although the organism has a variety of forms. 3. Vigorous motor forms are found and the motile organ in each consists of a single terminal or tufted flagellum. 4. The organism grows best in a slightly acid glucose medium. 5. It does not fix nitrogen in an artificial medium, at least, so far as the author's experiments show. 6. It is always accompanied in the nodule by other bacteria, but whether they have anything to do with the formation of the nodule, the author is not sure.

H. W. C.

The Exclusion and Elimination of Pathogenic Bacteria from Sewage. *Brit. Med. Jour.* p. 902, 1901.

An editorial article discusses the hygienic value of the modern accepted method of the treatment of sewage as adopted chiefly in England. The bacterial treatment of sewage produces a very

great chemical purification of the material, but the results of such careful experiments have seemed to indicate that ordinarily this treatment does not materially reduce the bacteria, and it is very questionable whether it lessens the danger of the sewage material distributing diseases. The author of the present article points out that no satisfactory means has yet been employed for destroying the bacteria in sewage sufficiently to reduce in any great measure its pathogenic nature. It should be noted that the results obtained in the bacterial purification of sewage are not always in harmony, and certainly in many of the sewage plants, particularly in this country, there is a very remarkable reduction in bacteria, which surely renders the sewage far less liable to distribute disease. In the filter beds used in the vicinity of London, however, such a reduction is not very great, and the author is of the opinion that entirely new methods must be adopted in the treatment of sewage before we can be satisfied that the problem has been mastered. His general conclusions are five, as follows:

1. The lines of defense which protect us from invasion by sewage borne disease germs are defective and uncertain. Consequently, it is ever necessary to strengthen these deficiencies by all means in our power.

2. The presence of disease germs in sewage and the possibility of their surviving the various processes for sewage purification cannot be ignored.

3. We are ignorant with regard to the fate of these germs before, during, and after the processes of purification, and can only say that, so far as the evidence hitherto acquired shows anything, it tends to prove that the disease germs are not necessarily destroyed by the purification processes.

4. It is imperative that investigations (similar to those described above) should be continued, developed, and applied to the various systems of purification by precipitation, by "bacteria beds," etc., and by land filtration and irrigation.

5. Any effluent which has been so far purified that it is free from putrescible matter and incapable of giving rise to offensive nuisance must still be regarded as capable of giving rise to disease until it has been shown that the disease germs have been eliminated from it.

H. W. C.

Weissenfeld. Der Befund des Bakterium coli in Wasser und das Thierexperiment sind keine brauchbaren Hilfsmittel für die hygienische Beurteilung des Wassers. Zeit.f. Hyg. 34: 78, 1900.

The author investigates the question as to whether the presence of the common *B. coli* in water is an indication of the unhealthfulness of the water. It

has generally been assumed that the presence of this organism in quantity is an indication of sewage contamination, and consequently an indication that the water in question is unwholesome. The author uses modifications of Pariettii's fluid, and having isolated his organisms injects them into guinea pigs. The conclusions that he reaches in regard the *B. coli* from the waters which he studied were, that the organisms isolated from the best waters were commonly pathogenic for guinea pigs, whereas those isolated from the suspicious waters, and waters of a clearly undesirable character, were less pathogenic, or indifferent in their action upon guinea pigs. He therefore is of the conclusion that the discovery of *B. coli* in water is not necessarily an indication of sewage contamination.

H. W. C.

Whipple, Geo. C. Changes that Take Place in the Bacterial Contents of Waters during Transportation. *Tech. Quart.* **14**: 21, 1900.

The author has undertaken a study of the conditions under which the number of bacteria in samples of water for analysis increase or decrease during transportation from the point of collection to the laboratory, a subject of considerable interest to those engaged in bacteriological analysis of drinking waters. He reaches two conclusions: 1. After a sample of water is collected, either in large or small bottles, there is, first, a slight reduction in the number of bacteria, due to the change in environment. The reduction is greater when small volumes of water are collected. Subsequently, there is an increase in the number of bacteria, which is greater in a small bottle than in a large one, and is more rapid when the bottle is but partially filled. With bottles of the same size the growth is more rapid in small volumes of water than in large volumes. 2. An agitation of the water exercises a slight retarding influence upon the multiplication of bacteria, but the shaking to which the water samples are liable during transportation is so slight, that it is of practically no importance in affecting the number of bacteria in the water.

H. W. C.

NOTES ON RECENT MINERALOGICAL LITERATURE.

ALFRED J. MOSES AND LEA McI. LUQUER.

Books and reprints for review should be sent to Alfred J. Moses, Columbia University, New York, N. Y.

Vernadsky, W. Zur Theorie der Silicate. *Zeit. f. Kryst.* **34**: 37-66, 1901.

A theoretical discussion limited to the simpler and better known compounds.

All historical and bibliographic data are omitted, though included in a previous article in a Russian journal.

Natural silicates are usually isomorphic mixtures, that is, are analagous to solid solutions, some predominating substance (the "solvent") containing dissolved in it other substances, *necessarily crystallizing in the same one of the thirty-two classes, but possibly of very different type of formula.*

If the "solvent" contain no R_2O_3 we may call the silicate a simple (einfache) silicate.

If the "solvent" contain R_2O_3 the silicate may be called an alumosilicate, ferrisilicate, borosilicate, etc. Only the alumosilicates are directly discussed, the others may be considered by analogy.

There is a sharp line between simple and alumosilicates:

(a) There is no known reaction by which the metals of RO can be replaced by Al, or conversely.

(b) There is no known reaction by which the alumosilicates can be directly changed into silica hydrate, (opal) or conversely.

(c) The alteration products of simple silicates often include opal and quartz; the alumosilicates can only with very uncommon proportions yield opal (and aluminum hydrate), but usually yield only clay and minerals of the chlorite group.

(d) Simple and aluminosilicates, under action of heat, either unite to a complicated substance or there is an interchange of metals of the RO group.

(e) With complicated aluminosilicates containing RO there are many known reactions which produce aluminates of RO.

The simple silicates are salts of known acids, but, while a few aluminosilicates, such as leucite $K_2Al_2Si_4O_{12}$, could be considered double salts of known acids, most are classed as salts of complicated hypothetical acids, and for some no satisfactory acid has been found.

Alumina may be regarded either as an anhydrous acid or as a weak base. In the latter case the salts show many characters of so-called complex acids, and as indicated by the following experimental data, it is much more probable the aluminosilicates are anhydrides, hydrates, and salts of complex aluminosilicic acids :

(a) Aluminates form under the same conditions as aluminosilicates.

(b) By splitting up of aluminosilicates at high temperature aluminates are formed.

(c) The action of water or carbonate solution often results in destruction of aluminosilicates, and formation of aluminates or alumina hydrates.

The complex structure of the aluminosilica nucleus is shown by the properties of the compounds ; for instance :

(a) Compounds of only Al_2O_3 and SiO_2 correspond in properties to acid anhydrides ; e. g., heated with carbonates they swell and evolve CO_2 rapidly, and form an aluminosilicate. Similar results are obtained by heating with sulphates, haloids, etc.

(b) Kaolin and other clays act like acids, destroying haloid salts at comparatively low temperatures.

In nature and the laboratory many substitution reactions occur in which the aluminosilica kernel is not destroyed. The general scheme is :

$Mx + M_1Als = M_1x + MAls$, in which x is the acid anhydride, M and M_1 different metals, and Als the aluminosilica kernel.

Clay (aluminosilicic acid) and minerals of sillimanite group (aluminosilica anhydride) form by destruction of aluminosilicates under the same conditions as hydrates and anhydrides, by the destruction of their salts. This is best seen by a comparison with silicates.

(1) By heating opal we obtain silica ; by heating clay we obtain minerals of sillimanite group.

(2) By destruction of simple silicates under the action of water and CO_2 in nature we obtain opal ; by similar destruction of aluminosilicates we obtain clay.

(3) At high temperatures in fusions rich in alumina, corundum or sillimanite separates, just as from fusions rich in silica, tridymite or quartz separates.

THE SIMPLE SILICATES.

These are salts of known acids, and their derivatives. the two great groups,

being the *orthosilicates*, with a structure formula $\begin{matrix} RO & & OR \\ & \diagdown & / \\ & Si & \\ & / & \diagdown \\ RO & & OR \end{matrix}$ and the *meta-*

silicates, with a structure formula of $\begin{matrix} RO & & \\ & \diagdown & / \\ & Si=O & \\ & / & \\ RO & & \end{matrix}$.

It is given as a general rule that with strong mineral acids orthosilicates gelatinize, metasilicates yield pulverulent silica, and slimy silica indicates the presence of both.

THE ORTHOSILICATES.—*Salts*.—The only great family of normal salts is the chrysolite group. Sepiolite is probably an acid salt.

Derivatives.—The general formula is $m R_4SiO_4 \cdot nA$, in which A is an added group of atoms. That these derivatives may fairly be said to consist of an orthosilicate nucleus and added groups, is evidenced by:

- (a) The groups A may be added by influence of water or of heat.
- (b) Heat will split the derivative into nucleus and A if latter is volatile.
- (c) One derivative passes into another by simple exchange of elements in A, without affecting the nucleus.
- (d) If A involves a metasilicate the jelly of SiO_2 becomes slimy.

These derivatives cannot be regarded as ordinary double compounds of A and orthosilicate, for the properties of A are very variable; e. g., humite, $3 Mg_2SiO_4 \cdot MgF_2$ does not simply split, but on heating yields SiF_4 . Serpentine yields its water only at red heat.

Only a few proportions between m and n are possible. For instance, the orthosilicate Mg_2SiO_4 and $A=MgF_2$, if $m=1$ then $n=1$ or 2 only.

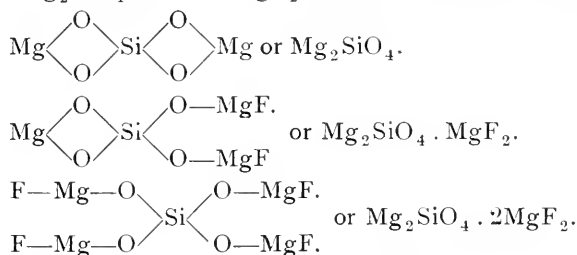

Isomeres may be expected, for the unsymmetrical character of the structure formula of $Mg_2SiO_4 \cdot MgF_2$ becomes symmetrical if doubled.

There are known the following five series of derivatives of orthosilicates:

- | | |
|--------------------------|--|
| 1. $n Mg_2SiO_4 \cdot A$ | $\left\{ \begin{array}{l} A = \text{metasilicate. Serpentine group.} \\ A = MgF_2Mg(OH)_2. \text{ Chondrodite group.} \end{array} \right.$ |
| 2. $n Ni_2SiO_4 \cdot A$ | |
| 3. $n Cu_2SiO_4 \cdot A$ | $A = H_2O$. Chrysocolla group. |
| 4. $n Zn_2SiO_4 \cdot A$ | $A = H_2O$. Calamine group. |
| 5. $n Mn_2SiO_4 \cdot A$ | $A = MnS, MnCl_2$, etc. Helvite group. |

THE METASILICATES.—*Neutral Salts*.—The very stable group of pyroxenes and amphiboles not only are neutral salts but form derivatives, for it is an excellent solvent for different alumosilicates and ferrisilicates, the best known being $R''Al_2SiO_6$ and $R'_2Al_2Si_4O_{12}$ (or $R'_2Fe_2Si_4O_{12}$).

Acid Salts.—The metasilicates differ from orthosilicates in the formation of chain-like compounds. For instance, the structure formula of talc $H_2Mg_3Si_4O_{12}$ may be written

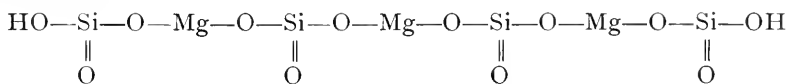

whereas reusselaerite, with two more atoms of water than talc, is intermediate between talc and serpentine, and with still two more atoms would pass into the orthosilicates.

(Continued in December.)

Publications Received for Journal Library.

- The Neocene Lake Beds of Western Montana and Descriptions of Some New Vertebrates from the Loup Fork. Earl Douglass, University of Montana.
- Proceedings of the Indiana Academy of Science, Vols. 1898 and 1899.
- Annual Report of the Board of Regents of the Smithsonian Institution, 1898.
- Library Expedients in Microscopy. R. H. Ward, M. D. Reprint from Transactions of the American Microscopical Society. Twenty-second annual meeting, Aug. 17, 18, and 19, 1899.
- Peach Leaf Curl, its Nature and Treatment. Newton B. Pierce. Bull. No. 20, U. S. Dept. of Agri.
- Key to Land Mammals of Northeastern North America. Bull. of the New York State Museum, Vol. VIII, No. 38.
- Agriculture Year Book, University of Tennessee Record. Vol. IV, No. 1.
- Report of Committee on the Protection of North American Birds. Witmer Stone.
- Concerning the New Formation of Elastic Fibers, Especially in the Stroma of Carcinomata. Herbert W. Williams, M. D.
- Report of Laboratory of Pathology of the University of Buffalo. No. 1.
- Course in Biology in the Horace Mann High School. Teachers College Record, Vol. II, No. 1.
- Columbia University Quarterly. Vol. II, No. 3.
- A Fresh Water Sponge from Sable Island. A. H. Mackay, LL. D., Halifax.
- Transactions of the Texas Academy of Science. Vol. III.
- A Catalogue of Publications of the University of Chicago Press.
- Sixteenth Report of the State Board of Health of the State of New Hampshire.
- Proceedings of the American Association for the Advancement of Science. Forty-ninth meeting.
- Bulletin of the Illinois State Laboratory of Natural History, Vol. V.
- Art. XI. Notes on species of North American Oligochaeta. IV. On a new Lumbriculid genus from Florida, with additional notes on the nephridial and circulatory systems of Mesoprorodrilus asymmetricus Smith.
- Art. XII. The Hirudinea of Illinois.
- High School Department, University of the State of New York. Bull. 2, Feb. 1901.
- Wakker's Hyacinth Germ. Erwin F. Smith. Bull. No. 26, U. S. Dept. of Agri., Division of Veg. Phys. and Path.
- Report of the Connecticut Agri. Expt. Sta. for year ending Oct. 31, 1900. Part II, Food Products.
- Thirty-first Annual Report of the Entomological Society of Ontario.
- Maryland Agricultural Experiment Station. Bulls. Nos. 68, 69, 70, 71, 72, 73, 74, 75, 77.
- Tennessee Agricultural Experiment Station. Bulls. Nos. 1 (Vol. XIV), 4 (Vol. XIII).
- Second Preliminary Report of the Behring Sea Fur Seal Investigations. David Starr Jordan, 1897.
- New York Agricultural Experiment Station. Bulls. Nos. 177, 178, 179, 180, 181, 182, 183, 184, 185, 186, 187, 188, 189, 190, 191.
- Fourth Annual Report of the Forest Preserve Board, 1900.
- New Jersey Agricultural Experiment Station. Bulls. Nos. 148, 149.
- Florida Lichens. P. H. Rolfs. Transactions of the Academy of Science of St. Louis, Vol. XI, No. 2.
- Pineapple Fertilizers. P. H. Rolfs. Reprint from Proc. 12th annual meeting Florida State Horticultural Society, 1899.
- The Wilson Bulletin, Nos. 34, 35, 36.
- Vanderbilt University Quarterly, Vol. I, No. 1.
- Bericht über die Pestepidemie in Kobe und Ōsaka von Nov. 1899 bis Januar 1900. Prof. Dr. S. Kitasato.
- Bulletino del Laboratorio ed orto Botanico. Vol. terzo, Fasc. III-IV. Fl. Tassi.
- Annual Report of the Smithsonian Institution, 1897. The U. S. National Museum, II.
- Publications of the University of Pennsylvania. Proceedings of "University Day." Bull. No. 9, new series.
- Commercial Fertilizers. J. H. Stewart and B. H. Hite. West Virginia University Agri. Expt. Sta. Bull. 72.
- Spraying. L. C. Corbett. West Virginia University Agri. Expt. Sta. Bull. 70.
- University of the State of New York. Bulls. 15, 16, 35, 52.
- Mosses with a Hand Lens. A. J. Grout.
- The Use of the Röntgen Ray by the Medical Department of the U. S. Army in the War with Spain. This is a volume of 98 pages, prepared by W. C. Borden, under the direction of Surgeon General Geo. M. Sternberg, U. S. Army. The first 30 pages are descriptive of apparatus, following which is a series of specific cases in which the Röntgen Ray was used in the study of wounds, fractures, and other effects produced by missiles. These cases are illustrated by 38 full-page heliotype plates which represent accurately the positions of Mauser bullets or other missiles in every part of the body, and the effects they produce. The great distinctness with which these plates reveal the location of bullets deeply embedded in the chest, pelvis, and even within the skull, is ample proof of the extraordinary character of the radiographs from which they were taken.
- The concluding chapter is devoted to radiographic technic, embracing the manipulation of machines, photographic plates, and methods in development of negatives, and in printing.

Journal of Applied Microscopy and Laboratory Methods.

VOLUME IV.

DECEMBER, 1901.

NUMBER 12

General Methods for the Study of the Nervous System.

Biologists were accused, not so very long ago, with a tendency to neglect the nervous system in their laboratory courses. Whatever may have been the reasons for the existence of such a condition, it is certain that there now are means whereby adequate corrective measures can be applied. The literature of neurological methods has grown into bulk of indeed formidable proportions. In fact, the beginner in the field of neurology is very apt to find himself bewildered by the opportunities for choice between the many and widely divergent schemes recommended by their enthusiastic advocates.

This paper has been written for the purpose of describing those methods which may properly claim a place in the general laboratory study of the vertebrate nervous system. Since this field necessarily involves certain technical difficulties, the outlines have been given some degree of detail wherever it has seemed desirable to do so. The attempt has not been made to anticipate the special needs of the investigator, but, rather, to serve the purposes of those who desire to demonstrate, for the class room, the microscopical structure of the nervous system of some vertebrate.

1. *Staining with Iron Hæmatoxylin and Orange-G.*

While originally intended for an altogether different purpose, iron hæmatoxylin may now be claimed as a neurological reagent of distinct value. It may be applied advantageously wherever it is desired to obtain a comprehensive picture of structural elements, such, *e. g.*, as would appear in a longitudinal section of the entire brain of the frog; in transverse sections through typical regions of a small mammalian brain; or in sections at different levels of the spinal cord. This stain exhibits the structural elements without confusing the eye with too much detail, outlining groups of nerve-cells, and bringing tracts of nerve-fibres into sharp relief. Its value, therefore, lies in the basis which it gives for a conception of the relations between important parts of the nervous system.

For this general purpose, the whole brain of a rat or mouse, or segments of

the spinal cord of a cat or dog, should be hardened for several days in an excess of a solution of formaldehyde:

| | | | | | |
|-------------------------|---|---|---|---|-----------|
| Commercial formaldehyde | - | - | - | - | 10 vols. |
| Water | - | - | - | - | 100 vols. |

After the nervous tissue has been well hardened, take pieces of suitable size and character. wash them in water to extract the formaldehyde, dehydrate, and finally imbed them in celloidin in the usual manner. The sections should be cut as thick as 20 to 30 μ , since a considerable thickness is necessary to define general relations.

The sections are to be brought from distilled water into the mordant of iron alum:

| | | | | | |
|---------------------|---|---|---|---|-----------|
| Ammonia-ferric alum | - | - | - | - | 4 grams. |
| Distilled water | - | - | - | - | 100 c. c. |

The duration of the mordanting is not of especial consequence, but may be some two to four hours in length. The free mordant must now be rinsed away with distilled water, a moment only. Then bring the sections into the stain:

| | | | | | |
|----------------------|---|---|---|---|-------------|
| Hæmatoxylin crystals | - | - | - | - | 0.5 gram. |
| Distilled water | - | - | - | - | 100.0 c. c. |

Staining will require at least four hours for entirely satisfactory definition.

The uncombined stain is to be washed away with water. Clean tap-water is best, since this appears to fix the lake more firmly.

The stain now requires differentiation. Dilute some of the iron alum solution used as a mordant with an equal volume of distilled water, and pour this over the sections. The full strength, four per cent., may be used later if necessary. Only a few sections should be decolorized at a time, and these should be moved about in the fluid to secure even results. Observe the process of decolorizing with the microscope from time to time, and when the desired effect has been obtained, transfer the sections to tap-water. Nerve-cells and nerve-fibres should appear blue on a light field.

Thorough washing of the sections after staining is necessary to prevent subsequent fading. The slight alkalinity of ordinary tap-water appears to be a factor aiding in the preservation of the stain.

Light counter-staining with orange-G is almost always desirable. After washing, bring the sections for one to two minutes into a nearly saturated aqueous solution of orange-G (Grübler's). Dehydrate rapidly with ninety-five per cent. alcohol, clear, and mount in balsam.

Iron hæmatoxylin may also be employed in the study of the minute structure of the nerve-cell. Small pieces of the brain or cord should be fixed with the fluid of Flemming, or with the chrome-oxalic mixture given below (2). Imbed in paraffin, and cut the sections quite thin. For such cytological study, it has been found preferable to omit the counter-staining with orange-G.

2. *The Staining Method of Nissl.*

The staining method of Nissl is invaluable for demonstrating the organization of the nerve-cell in general, as well as for the comparative study of different types of nerve-cells. The cervical cord of the rabbit is a particularly favorable

object for the former purpose ; while for the latter, material should be chosen from sensory ganglia, from the spinal cord, and from the several regions of the brain.

For the fixation of the tissues, the writer has found nothing so admirable as the chrome-oxalic mixture of Graf :

| | | | |
|------------------------------------|---|---|-----------|
| Oxalic acid, 8 per cent. aq. sol. | - | - | 200 c. c. |
| Alcohol, 95 per cent. | - | - | 150 c. c. |
| Chromic acid, 1 per cent. aq. sol. | - | - | 150 c. c. |

Mix in the order as named.

This fluid has been given a thorough trial with nervous tissue from many vertebrates, and it has proven uniformly satisfactory. Quite small pieces of perfectly fresh tissue should be fixed for some six hours. It is preferable to wash out the fixing agent with seventy per cent. alcohol, changed repeatedly.

Thin sections should be made by the paraffin method. It is quite desirable that the sections be mounted in serial order, so that the organization of any given nerve-cell can be traced completely. Mayer's albumen is the safest thing to use for sticking the sections to the slide, since some of the subsequent steps make strong demands on the tenacity of the medium. If the sections are at all wrinkled, a film of water should be interposed in the usual manner.

Dissolve the paraffin from the sections with xylol, and carry the slide through descending grades of alcohol to distilled water. The sections are now ready for staining.

The stain of Nissl has the following composition :

| | | | |
|------------------------------|---|---|---------------|
| Methylen-blue (Grübler's BX) | - | - | 3.75 grams. |
| Olive-oil soap | - | - | 1.75 " |
| Distilled water | - | - | 1000.00 c. c. |

Use any pure soap from one of the southern countries of Europe where olive-oil is employed in soap-making. The soap should be cut into thin shavings ; gentle heat may be employed for hastening its solution. The stain should be filtered just before using.

Rest the slide to be stained on a watch-glass so that its surface will be level. Heat five c. c. of the Nissl stain in a test-tube until it almost boils. Pour the hot stain over the slide, and allow it to act for five minutes. Have at hand a quantity of bibulous paper. Flood the slide with distilled water for the briefest practicable time, just enough to rinse away the free stain. Absorb as much of the water clinging to the slide as possible with the porous paper. and immediately pour on the decolorizer :

| | | | | | |
|-----------------------|---|---|---|---|----------|
| Alcohol, 95 per cent. | - | - | - | - | 90 c. c. |
| Aniline oil | - | - | - | - | 10 c. c. |

The process of decolorizing is the only part of this method involving especial difficulty, as it lasts only 20 to 30 seconds and must be stopped at just the right point. Hold the slide between the thumb and finger, and rock it back and forth so as to move the decolorizer over the entire field. This reagent should be applied liberally. Watch the process closely. Just as soon as the sections begin to look nearly colorless and take on a delicate rose tint, stop the decolorizing by flooding the slide with oil of cajeput.

The oil of cajeput will clear the sections within a few seconds in perfectly dry air; but under the usual conditions of the laboratory, it is desirable to hasten the action by warming the slide gently. Mount in a thick solution of colophonium dissolved in xylol.

A word concerning colophonium may not be out of place here. Colophonium is the ordinary "rosin" of commerce. It is best to secure the privilege from the dealer of selecting those lumps which have the least possible color. When held up to the light, a suitable lump should not show crystals on the inside. The powdered rosin of dealers should be avoided, since its character cannot be determined.

When the several steps of the method as outlined are followed faithfully, the staining will be so precise that the nerve-cells will appear bright blue on a perfectly colorless field. Moreover, the tigroid bodies should not appear blurred in any part of the nerve-cell. As to the permanence of the stain, slides stained by me several years ago have shown no tendency to fade.

3. *Methylen-Blue and Erythrosin.*

Staining with methylen-blue alone, as just noted, simply outlines the bodies of nerve-cells. As an accessory demonstration, it is often quite desirable that the remaining structures present be given a light stain. This may be accomplished through the use of the following double-staining method.

The tissues should be treated, and the sections should be cut and affixed to the slide as in the procedure given for the method of Nissl. But, instead of staining with methylen-blue at once, this is preceded by the erythrosin mixture of Held:

| | | | | | |
|----------------------|---|---|---|---|-----------|
| Erythrosin (Grübler) | - | - | - | - | 1 gram. |
| Distilled water | - | - | - | - | 150 c. c. |
| Glacial acetic acid | - | - | - | - | 2 drops. |

The acetic acid tends to precipitate the erythrosin, and so the stain should be made shortly before using. Warm the mixture, pour it over the slide, and allow it to act for some ten seconds, only. Rinse with distilled water for about thirty seconds: the red color should be made distinctly lighter.

Now dilute some of the regular stain of Nissl with an equal volume of a five per cent. aqueous solution of acetone. Heat the mixture rather strongly, flood the slide with it, and allow staining to proceed for five minutes. Then differentiate the stain with:

| | | | | | |
|-----------------|---|---|---|---|-------------|
| Distilled water | - | - | - | - | 100.0 c. c. |
| Common alum | - | - | - | - | .1 gram. |

The solution of alum extracts the blue color gradually, so that the effect is readily controlled. From one to two minutes will usually suffice to bring the red of the erythrosin distinctly into view. Follow with a brief rinsing in water. Dehydrate rapidly with absolute alcohol, clear in xylol, and mount in xylol-colophonium.

A successful preparation should have the nerve-cells outlined in bright blue on a pale red field. Too deep a stain with erythrosin must be avoided.

4. *Chrome-Silver Impregnation.*

The principle of this remarkable method involves the formation of a deposit of chrome-silver in the elements of the nervous system. This is accomplished

by hardening in potassium bichromate, followed by impregnation with silver nitrate. The production of the metallic deposit is not in the nature of a staining process; it is the outcome, rather, of an interaction between the potassium bichromate and the silver nitrate employed, in conjunction with the substances present in the nervous elements themselves. Since the chemistry of nervous tissue is continually changing during life, it follows that the results of this method will be far from uniform. In one animal, certain elements may be brought out with all the crisp sharpness of a silhouette, while in another individual the corresponding structures may not appear at all. The reactions of the tissues in the two instances have differed sufficiently to thus affect the result. Hence the apparent capriciousness of the method is due to the presence of physiological factors often quite unknown. The character of some of these physiological conditions has been discussed by me elsewhere.*

Freshness of tissue and active metabolism are factors indispensable to success. A young animal will yield better results than an old one; and one direct from the field is preferable to one which has been kept for a time in confinement. In any case, the parts of the nervous system to be studied should be placed in the hardening mixture as soon as possible after the death of the animal.

a. The Rapid Method of Golgi.—Of the many schemes for securing the formation of the chrome-silver deposit, the one which has given me the largest returns is the so-called “rapid” method of Golgi. For this purpose, the pieces should be taken small, not over two or three millimeters in thickness for a slice of the brain. Place these fresh slices directly in the hardening mixture:

Potassium bichromate, 3.5 per cent. sol. - 4 vols.
 Osmic acid, 1 per cent. sol. - - - 1 vol.

This reagent, while somewhat expensive, must be used liberally. There should always be a large volume in proportion to the mass of the nervous matter present, and the solution should be renewed before it shows the least signs of becoming turbid. Hardening must take place in the dark.

The duration of the hardening is the all-important factor which we have under control. If the tissues be hardened for too short a time, the impregnation will be diffuse; while an overhardened specimen may permit of no impregnation at all. The proper length of hardening must be determined by experiment for each animal; it will most often be found to lie between the limits of two to three days where supporting elements are to be shown, three to five days for neurones, and five to seven days for nerve-fibres.

Impregnation is secured by bringing the hardened slices into a solution of silver nitrate:

Silver nitrate crystals - - - - 0.75 gram.
 Distilled water - - - - 100.00 c. c.

A solution which has been used once will answer for washing the specimens until the copious precipitate ceases to form. Then pour on a liberal quantity of the fresh solution, and change it frequently. It should not be allowed to take

* Houser, 1901. *The Neurones and Supporting Elements of the Brain of a Selachian: Journal of Comparative Neurology*, Vol. XI.

on a yellowish tinge. Keep the specimens in the dark. The duration of the silver-bath is not of importance; it may be one to three days in length, or even longer if the solution be renewed.

When the steps which follow can be carried through without a pause, replace the silver solution with ninety-five per cent. alcohol. Change the alcohol repeatedly during the course of half an hour, in order that all free silver nitrate may be washed away. Follow with absolute alcohol, also renewed, thirty minutes; alcohol and ether, fifteen minutes; thin celloidin, thirty minutes; and thick celloidin, five minutes. Then mount the specimen on a wooden block, and harden the celloidin with chloroform. The imbedding has been too hastily done, of course, to permit true infiltration with celloidin, but this cannot be secured without destroying the impregnation.

Clearing of the entire mass, as imbedded, is advantageous. For this purpose, place the block in a mixture of oil bergamot, oil cedar-wood, and melted carbolic acid crystals, equal parts. This mixture clears rapidly, it may be used over and over again, and it has the additional advantage of allowing the preparations to be kept in it for a little while without impairing the impregnation.

Sections should be cut as thick as 75μ . In cutting, keep the knife flooded with the clearing mixture. Place the sections on slides, as desired. The surplus oil may be removed neatly by pressing on the sections with tissue paper backed with a blotter. Mount in either colophonium, dammar, or balsam, *without* a cover-slip. The mounting medium should cover the section with a thin and even coating. Hasten the drying of the preparation with gentle heat for a few hours.

Successful preparations should have the neurones, to their finest ramifications, a perfectly opaque black on a nearly transparent field. If the field becomes clouded with fine specks later on, the silver nitrate was not all removed in the washing.

Under certain conditions, pure formaldehyde may be substituted for the osmic acid in the hardening mixture given above, a good proportion being three parts of commercial formaldehyde to one hundred parts of the bichromate solution. The formaldehyde tends to reduce the potassium bichromate quite rapidly, and so the two should be mixed just before using. The application of formaldehyde in this way often yields beautiful results with the mammalian nervous system, but I have not been so successful with it in the field of the lower vertebrates.

b. Previous Hardening with Formaldehyde.—It is often quite desirable to be able to harden a brain some time in advance of its final use for impregnation, as in planning for classwork, or in the transportation of specimens from the field to the laboratory. This may be accomplished through preliminary hardening with formaldehyde.

The whole brain is hardened in ten per cent. formaldehyde, and should be kept in this strength of solution until it is wanted. Slices cut from the desired regions are washed with water for half an hour to extract the formaldehyde, and are then to be saturated with potassium bichromate.

Place the pieces in a three and five-tenths per cent. solution of potassium

bichromate in an oven kept at 60°C. for twelve hours. Change the fluid frequently. Continue the saturation with potassium bichromate in the dark box for five to seven days; the proper duration must be determined by tests made from time to time. Then transfer to the solution of silver nitrate.

From this point, the procedure is the same as for the "rapid" method of Golgi previously described. This plan is especially successful for the forebrain and spinal cord. In any case where there is good impregnation, the beauty of the preparation is enhanced by the perfect clearness of the field.

It may be worth noting here that this same method is particularly desirable for demonstrating the bile-capillaries of the mammalian liver. A shortening of the bichromate-bath is, of course, necessary in this case.

5. *Weigert's Myelin Stain.*

The study of the central nervous system cannot be complete without preparations to illustrate the course of medullated nerve-fibres. The many schemes extant for staining the myelin sheath depend upon the formation in the nervous elements of either a chrome- or copper-lake of hæmatoxylin. This lake combines so firmly with myelin that the decolorizing process does not remove it. Doubtless the chrome-lake yields the more delicate results, and hence some plan for securing it is to be recommended for purposes of special investigation. But for general classwork, the writer has found a copper method preferable because of its entire certainty under all conditions.

Harden the brain and spinal cord of the animal chosen for study in a bichromate solution. This will, of course, require several months if the well-known fluid of Müller, or a simple solution of a bichromate salt be used. The time may be shortened to a more convenient length by preliminary hardening with formaldehyde; or, formaldehyde may be added directly to the bichromate solution. In any case, the hardening should take place in the dark.

When the hardening has been completed, cut slices from the regions desired, and, without washing in water, transfer them to graded alcohols for dehydration, still in the dark.

After the pieces have been dehydrated, imbed them in celloidin, allowing plenty of time for thorough penetration. Harden the celloidin in eighty per cent. alcohol.

The celloidin blocks are now to be mordanted for two days in a half-saturated solution of neutral acetate of copper. At the end of this time, place the blocks back in eighty per cent. alcohol for a day, and then cut sections at once.

Sections should have a thickness of 25 μ . Rinse the sections rapidly with distilled water, and bring them directly into the stain:

| | | | | | | | |
|---|---|----------------------------------|---|---|---|----------|-----------|
| A | { | Distilled water | - | - | - | 93 c. c. | } 9 vols. |
| | | Lithium carbonate, sat. aq. sol. | - | - | - | 7 c. c. | |
| B | { | Absolute alcohol | - | - | - | 10 c. c. | } 1 vol. |
| | | Hæmatoxylin crystals | - | - | - | 1 gram. | |

Mix A and B just before using.

The duration of the staining will depend upon the region involved. For sections of the spinal cord, two hours will be sufficient; but for sections of the brain, twenty-four hours will be required.

Rinse away the excess stain for a few minutes with distilled water. Then transfer the sections to the decolorizer:

| | | | | | | | |
|------------------------|---|---|---|---|---|--------|--------|
| Distilled water | - | - | - | - | - | 1000.0 | c. c. |
| Potassium ferricyanide | - | - | - | - | - | 12.5 | grams. |
| Borax | - | - | - | - | - | 10.0 | " |

The decolorizing must be watched carefully so that it may be stopped at just the right moment. The gray matter should be bleached to a yellow tint, while the medullated nerve-fibres should remain a bright blue-black. When the action has gone far enough, transfer the sections to clean tap-water, running, if possible, in which they must be washed for some time. If the washing be thorough, the stain will not fade.

Dehydrate, clear, and mount the sections in the usual manner.

6. *Staining Isolated Nerve-Cells.*

Some plan for making preparations of entire nerve-cells is altogether desirable for class demonstrations. For this purpose, the writer is about to risk his reputation as a modern microscopist by advocating the use of a stain which the older workers are supposed to have forgotten, and of which the younger ones have never even heard. This stain is Beale's Carmine. No other method known to the writer is capable of yielding preparations of nerve-cells rivaling in clearness and beauty the results of the procedure here indicated.

Secure the coöperation of a butcher, and have him furnish the lumbar cord of the ox in a perfectly fresh condition. Slit the cord lengthwise so as to expose the gray matter. Scoop out quite small pieces from the anterior cornua. Place these fragments directly in the following stain:

| | | | | | | | |
|-----------|---|---|---|---|---|-----|--------|
| Carmine | - | - | - | - | - | 3 | grams. |
| Ammonia | - | - | - | - | - | 10 | c. c. |
| Glycerine | - | - | - | - | - | 300 | c. c. |
| Water | - | - | - | - | - | 300 | c. c. |
| Alcohol | - | - | - | - | - | 75 | c. c. |

(Dissolve the carmine in the ammonia with the aid of gentle heat; allow the solution to stand in an open dish for an hour; then add to the other ingredients. Filter.)

The pieces of nervous matter are to lie in this stain for several weeks. Then transfer them to dilute glycerine acidulated with a trace of acetic acid. After a few days, replace this medium with pure glycerine.

Place a bit of the stained tissue on a slide, in a drop of glycerine. Press a cover-slip straight downward on the mass so as to spread the nervous matter in an even film. Avoid rotating the cover-slip. Some of the preparations will necessarily show so few cells as to be practically valueless, but others will be crowded with brilliantly stained nerve-cells in all their completeness. Aside from the value of such a preparation for purposes of demonstration, it is worth noting that the fibrillar elements of the neurone are made particularly evident.

7. *Peripheral Nerve-Fibres.*

Place short lengths of the sciatic nerve of the frog in five-tenths per cent. osmic acid for about twenty-four hours. Keep in the dark. The osmic acid

blackens the myelin sheath of the nerve-fibre. When the degree of blackening desired has been obtained, wash the nerve thoroughly with distilled water.

A piece of the nerve may now be transferred to a drop of glycerine on a slide, teased apart, and used at once for a demonstration. Other pieces should be imbedded in paraffin for sectioning. It is convenient to arrange the pieces so that, in the same block, some will be cut lengthwise and others transversely. The sections should be counter-stained with a saturated aqueous solution of fuchsin-S for twenty-four hours.

GILBERT L. HOUSER,

Laboratory of Animal Morphology, The State University of Iowa.

A Short Method for the Widal Test.

One of the inconveniences of this test is the length of time required to get a broth culture in which the typhoid bacilli are sufficiently numerous and active to permit of use for the test. If the bacilli are too few in number the "clumps" are not only small, but are also slow in forming; and if they are not active agglutination does not take place readily. Eighteen hours is the time usually specified as being necessary to get a broth culture in proper condition for use, but this length of time makes it impossible to apply the test during the day on which the culture was started, so the tube must be inoculated late in the afternoon of the day before it is to be used in order that it may be ready for the test at a seasonable hour the next morning. If the culture is not then used rather promptly at the specified time, agglutination is likely to be found to have taken place spontaneously in the tube. The culture is thus rendered useless and a delay of eighteen hours more is required to get another one ready. The writer has found that the time can easily be shortened to six or eight hours and that cultures started in the morning can be used in the afternoon of the same day. The essential point of the method is to start the culture in *warm* broth. The details are so simple as scarcely to require explanation. By means of the platinum loop a small mass of the growth is removed from the stock culture on agar and is well mixed with eight or ten cubic centimeters of broth by rubbing the mass against the inside of the tube below the surface of the liquid. The tube is then gently tapped for a minute or so in order to insure the thorough and even dissemination of the bacilli throughout the broth, and is heated until it feels comfortably warm to the hand by holding well above the gas flame. A tumbler is then heated still warmer by holding it inverted over the flame and the culture placed in it resting on a wad of cotton and the whole put into the incubator for six or more hours. It is sometimes well to remove the tube once from the incubator and tap it gently for a few seconds in order to mix the denser growth in the bottom with the upper portion of the broth. The opacity and opalescence of the liquid will show when sufficient growth has taken place. On several occasions cultures only six hours old have been used with perfect satisfaction, but, of course, the bacilli are neither so active nor so numerous as in cultures which have stood in the incubator for two or three hours longer.

University of Rochester.

CHARLES WRIGHT DODGE.

Method for Rearing Amoeba.

It is frequently very difficult to secure a large number of *Amoebæ* satisfactory for class work when wanted. The usual method of visiting the pools of stagnant water is very uncertain and laboratory cultures made from decaying *Algæ* are equally unsatisfactory. For some time the writer has been experimenting with protozoan cultures and has been successful in securing *Amoebæ* in the following simple manner: A nutrient medium is made by boiling a lot of dead leaves. As soon as cool, both liquid and leaves are placed in an ordinary battery jar and a lot of unboiled leaves and enough water to stand about one inch above the leaves added. In two or three days a scum will form and in from five to ten days, depending upon the temperature of the room, *Amoebæ* will be found in the scum in large numbers. They will be small, but very satisfactory for class work. The writer has tried this method a great many times, and in different localities and at different seasons of the year, and always been successful.

De Pauw University, Greencastle, Indiana.

MEL T. COOK.

The Arrangement of Cilia on Paramecium.

The cilia of many of the Infusoria are so fine and so closely set, notably on *Paramecium*, that it is very difficult for the student to determine their exact arrangement. Careful focusing will sometimes reveal their order on favorable specimens, but the use of Loeffler's alkaline methylen blue as a stain has been found to be a very reliable method of demonstrating their arrangement on almost every specimen. A drop of the stain is mixed with the drop of water in which the animalcules are swimming on the slide and the cover glass placed in position. *Intra vitam* staining takes place in many of the individuals, but they soon die and the cuticle separates more or less completely from the cytoplasm and forms a halo around the deeply stained body. The perforations in the cuticle are thus brought very distinctly into view and the plan of arrangement of the cilia revealed. The stain is prepared as follows: Add 30 c.c. of a concentrated alcoholic (95 per cent.) solution of methylen blue to 100 c.c. of a .0001 solution of caustic potash. The caustic potash solution may be prepared by adding 1 c.c. of a one per cent. solution of potash to 100 c.c. of distilled water.

University of Rochester.

CHARLES WRIGHT DODGE.

LABELING MOUNTED SPECIMENS.—The following method is given as useful where specimens mounted on cover-glasses or slides are to be passed through various solutions: Mix with equal parts of egg albumen and glycerin, sufficient lampblack to make a good black fluid. This may be used with a steel pen for writing on the glass, after which the glass should be held over a flame until the characters are dry. The markings are not removed when the specimens are passed through solutions.—*Knowledge*, 24: 191.

Immersion Oil in Collapsible Tubes.

The immersion oil bottle shares with the Canada balsam bottle the distinction of being the stickiest and dirtiest piece of apparatus on the work table. A portion of the first drop of oil to be removed is almost invariably left on the mouth of the bottle and thereafter the stopper never fits tightly; the oil runs over the neck of the bottle and smears the fingers in spite of almost all precautions; in the course of time the oil thickens, turns yellow, becomes turbid as the result of exposure to the light and air, and its refractive index is thus changed. A container which excludes both light and air, holds the oil in such a manner as to reduce the inconvenience of handling to a minimum, delivers the exact amount needed each time, and is made of a material which causes no change in the optical properties of the oil, is the ordinary collapsible tube which has long been used for holding moist water color and oil paints. During the past few years certain dealers in microscope supplies have used this form of tube as a container for Canada balsam with most satisfactory results. After several annoying experiences with bottles, the writer determined to have immersion oil put up in tubes although warned that the metal of which the tubes are made might have some deleterious effect upon the optical properties of the oil. During the past year the tubes have been used daily in the routine bacteriological examinations attending health department work and have proved to be so free from the faults which characterize the bottles that on no account will the latter be again employed. Immersion oil which has been stored in these tubes for more than a year is now being used and no signs of deterioration have been detected. The oil is as clear, colorless and thin as when first made, and there is no indication of change in its refractive index.

CHARLES WRIGHT DODGE.

University of Rochester.

The minute adopted by the council of Columbia University on the resignation of President Low gave a few very interesting facts concerning the development of that institution in the twelve years during which Mr. Low has been at the head of its administration. In the academic year 1889-90 the institution consisted of four faculties, in charge respectively of the schools of arts, laws, mines, and political science. These faculties numbered 122 officers of instruction, and the schools were attended by 1134 students. The library of the college contained 91,000 volumes, and the wealth of the corporation was estimated at \$10,500,000. The faculties, schools, library, and entire equipment were crowded into narrow and noisy quarters, bordering upon the tracks of the New York Central Railway.

To-day the university consists of nine faculties, in charge respectively of Columbia College, Barnard College, Teachers' College, and the university schools of law, medicine, applied science, pure science, philosophy, and political science. The faculties now number 385 officers of instruction, and the colleges and schools are now attended by 4500 students. The library of the university now contains 311,000 volumes, and the wealth of the corporation is now estimated at \$18,000,000, of which \$1,500,000, in round numbers, were given by Mr. Low himself. And finally, the university is now located upon a site, and possesses a physical equipment, unsurpassed in beauty, comfort, and completeness, by those of any institution of learning in the world.—*Science*, 14: 356.

LABORATORY PHOTOGRAPHY.

Devoted to methods and apparatus for converting an object into an illustration.

FURTHER NOTES ON THE USE OF THE TELEPHOTO LENS.

In Volume IV, No. 4, of the JOURNAL OF APPLIED MICROSCOPY, I gave an illustration of the use of the telephoto lens in taking a nest from the top of a dead pine tree. During the past summer I made further efforts to test the value of a long focus lens, and give some of the results.

My telephoto lens is fitted to a wide angle Zeiss Anastigmat, series IV. The illustrations presented in this paper are from experiments on mountain ranges and peaks, to be used geologically and physiographically.

The Mission range is in western Montana, extending north and south for a distance of about a hundred miles; its western slopes are abrupt and craggy. Many peaks in the range are unexplored, and few are named. The difficulties one encounters in making a study of the range are many, and a complete study has not yet been made.



FIG. 1.—View of a Portion of the Mission Range of Mountains in Western Montana.

Fig. 1 is a portion of the southern end of the range, taken from a high hill to the southwest of the range proper.

The mountain indicated by A is McDonald peak, distance from the place where the picture was taken about fifteen miles. The height is about ten thousand feet, or about seven thousand above the village of St. Ignatius on the plain. The negative was made early in June, with an orthochromatic plate and ray filter. The atmosphere was clear, and the mountains are shown with much more than ordinary distinctness.

The mountain indicated by B is Sin-yale-a-min mountain, distance about ten to twelve miles on an air line, with an elevation of 9200 feet. This mountain is nearer than McDonald, owing to the position of the photographer with regard to

the range. The direction toward Sin-yale-a-min is almost due east, toward McDonald northeast. The photographs were taken at about eleven o'clock in the morning, and hence the sun is in the rear, or behind the operator. A slight wind was blowing, requiring considerable time to secure the negatives. When the wind blew so as to shake the instrument the cap was placed over the lens, and was removed when the instrument again became quiet.

Fig. 2 shows distinctly many features not made out in Fig. 1, and not discernible to the naked eye. McDonald peak is the double peak in the left of the illustration, the peak to the right being much lower, nearer, and not connected with McDonald. The ridge extending to the left immediately in front of McDonald is a separate peak, and between it and McDonald is a deep canyon through which flows a good sized stream.

McDonald peak is plainly seen to be double. The distant peak, the right hand snow-capped peak, is about a thousand feet higher than the nearer one.



FIG. 2.—A Portion of the Range shown in Fig. 1, indicated by A.

So far as known it has not been ascended from the side seen, and is apparently inaccessible, although experience may prove it to be reached from this side.

The strata are clearly shown. In a photograph printed lighter the details of the mountain side are shown more clearly, but the snow summit is less distinct. I do not know that the two peaks shown in the foreground and to the right of McDonald have ever been ascended, and I have heard of no names for them. In this connection I may say that land snails are living on the shoulder of McDonald shown in the left. The plate used in making Fig. 2 was an orthochromatic, with ray filter. The magnification is about eight diameters.

The camera was next turned toward Sin-yale-a-min mountain, shown in Fig. 3. The conditions were precisely the same, and the position unchanged. By an examination of Fig. 4, Sin-yale-a-min mountain, the snow-capped peak to the left, is seen to be double. The nearer peak is the lower, by some few hundred feet. At a point half way up the peak along the ridge, snails similar to those mentioned on McDonald were found.

By printing for detail in any one place in the negative various features may be brought out with much distinctness.

By following up the creek along the canyon to the right, as shown in Fig. 2, the position from which Fig. 4 was taken is found. The peak is the same as shown in Fig. 3, the direction of the peak being east of north. It was several days after taking the negatives from which the first three figures were taken. The peak is distant from the camera from five to seven miles. To reach the summit from the position given in the illustration would require five or six hours of stiff climbing. The wooded peak in the foreground, immediately behind the small tree in the center, is a mile or more nearer than the main peak, and is the end of the slope shown in Fig. 3. The day was bright and almost cloudless, following a light rain. The sun was in the rear. The plate used was an orthochromatic, with ray filter as usual.

In Fig. 5 the telephoto was turned on the wooded ridge to the right of the middle of Fig. 4, with the peak on the left. By one of those peculiar accidents which often occur while exchanging plates under a blanket in the field, the

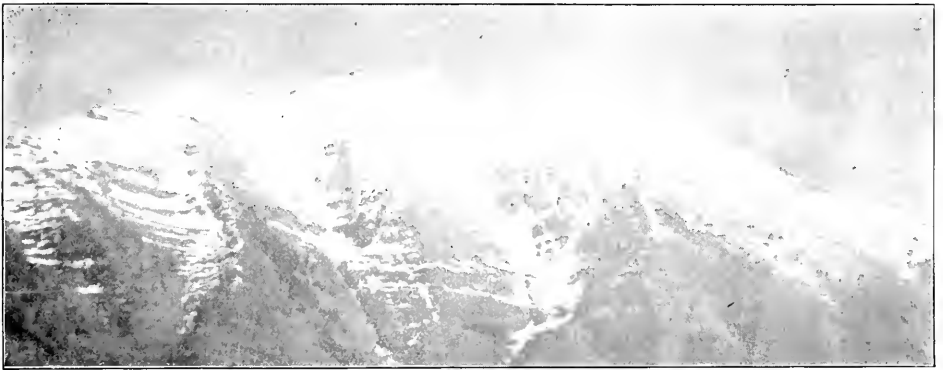

FIG. 3.—A Portion of the Range shown in Fig. 1, indicated by B.

plate was reversed in the camera, but the result is sufficient to show all that was desired. The ridge to the right should be to the left. By a close examination of Fig. 5, and comparison with Fig. 4, many details will appear in the former not seen in the latter.

The advantages of such photographs will be at once apparent to the reader. It is possible to make out details of structure in mountain ranges without necessarily making laborious climbs, and it is possible to make out details where ascent is impossible.

The difficulties in taking such photographs are not few. In mountainous regions, where weight is a great consideration, it becomes necessary to carry a small and light tripod. This is not sufficient for work with the telephoto, where there must be great strength and rigidity in the tripod to prevent motion. The days when wind is not blowing from some direction are not numerous while the traveller is among mountain peaks. Long exposures are necessary, and a very small vibration makes the result a failure. Another difficulty is that of getting a satisfactory focus. The light coming through the lens from so small a portion of the horizon is not great. The landscape on the ground glass is indistinct,

and it becomes a difficult task sometimes to determine when the instrument is in focus. Often the developed plate shows the unexpected, and failure is the result.

A long focus lens will, of course, produce results similar to those here given,



FIG. 4.—Sin-yale-a-min Mountain, Mission Range, Montana.

but on a smaller scale. The advantage of a telephoto attachment is that the magnification may be made such as will bring out the features desired. With a telephoto attachment, with magnification up to eight diameters, an ordinary lens is increased in value many fold. With a long focus or short focus lens but one



FIG. 5.—View of Portion of Fig. 4, magnified eight diameters. Plate accidentally reversed.

size of photograph may be taken, that of the long or short focus. With telephoto attachment the focus may be lengthened, and the size of the image correspondingly increased, at pleasure, resulting in a very great increase in the usefulness of the lens.

MORTON J. ELROD.

University of Montana.

Journal of
Applied Microscopy
 and
Laboratory Methods.

Edited by L. B. ELLIOTT.

Issued Monthly from the Publication Department
 of the Bausch & Lomb Optical Co.,
 Rochester, N. Y.

SUBSCRIPTIONS :

One Dollar per Year, Strictly in Advance. To Foreign
 Countries, \$1.25 per Year, in Advance.

NOTICE Subscribers will be notified on expiration
 of subscription and, unless remittance for
 ensuing year is received promptly, the JOURNAL will be
 discontinued.

SEPARATES.

One hundred separates of each original paper accepted
 are furnished the author, gratis.

Separates are bound in special cover with title. A
 greater number can be had at cost of printing the extra
 copies desired.

microscope is used, they might many times have been discouraged, and the thanks of the users of the microscope are certainly due them for their efforts in this direction.

From this time forward, however, the JOURNAL will have to stand or fall on its own intrinsic value to the public. It will therefore be necessary to cancel all subscriptions which are not renewed upon expiration. The subscription price will not, however, be advanced for the year, and we trust that sufficient new subscribers will be added to our list during that time to make it unnecessary for us to do so later.

A number of interesting series of articles will be published during the coming year, among which may be mentioned the conclusion of Professor Dennis's series on photomicrography, illustrated with some of the best examples of his work. A series which, when concluded, will be a monograph on medical micro-technique for the use of practicing physicians, will be begun in the January number, and we hope to add a number of features of special interest to physicians. We have also received a valuable addition to our review department in the coöperation of M. Girault, of the Laboratoire de Bacteriologie de la Ville de Paris, who will contribute each month reviews of current French literature. It is our desire to improve the JOURNAL just as rapidly as circumstances will warrant, and to this end we welcome suggestions, and respectfully solicit your contributions for publication, in order that the JOURNAL may become, as intended, a repository of American microscopical literature, accessible not only to the specialist and the richly endowed library, but to all who may desire it.

Our observation shows that a large number of the methods published during the year have been put into practical use in many institutions, and our contributors have the satisfaction of knowing that every article contributed, whether the result of original investigation or an improved reworking of an old process, assists many of our readers who are so situated as not to be able to pursue these researches for themselves.

The JOURNAL has also met with a kindly reception in foreign countries, as is shown by the large number of citations and reprinted articles in such leading publications as *Zeitschrift für Wissenschaftliche Mikroskopie*, *Journal of the Royal*

THE present number closes the fourth volume, and fourth year of our publication. Beginning with a few closely set pages and limited corps of regular assistants, the scope and volume of the JOURNAL has been gradually increased to the present time, the demand for more, and more varied information resulting in the addition of the various departments which have succeeded each other. Although the JOURNAL has received from the beginning the loyal support of those most interested in the advancement of scientific work, the expense of introducing it to the public, and of keeping up the publication until its merits became sufficiently well known to give it the favorable position which it has now attained, has been so great that, had its publishers been less in earnest in their desire to establish in America a representative journal for the sciences in which the

Microscopical Society, London, and many others. It now numbers its subscribers in England, Canada, Japan, Mexico, Germany, Cuba, New Zealand, Brazil, Cape Colony, France, Portugal, Hawaii, Belgium, New South Wales, Bermuda, Sweden, Queensland, Victoria, Costa Rica, Alaska, St. Lucia, Hayti, San Marino, Equador, Jamaica, India, Argentine Republic, Venezuela, Formosa, Chili, Greece, Austria, Servia, Russia, Italy, and Natal, in the order given.

CURRENT BOTANICAL LITERATURE.

CHARLES J. CHAMBERLAIN.

Books for review and separates of papers on botanical subjects should be sent to Charles J. Chamberlain, University of Chicago, Chicago, Ill.

REVIEWS.

Arnoldi, W. Beiträge zur Morphologie einiger Gymnospermen. V. Weitere Untersuchungen der Embryogenie in der Familie der Sequoiaceen. Bull. des Nat. de Moscow. Pp. 1-28, pls. 7-8, 1901.

The previous papers of this series have already been reviewed in the JOURNAL. The present paper deals with *Sequoia* and other members of the Sequoiaceæ,

viz.: *Taxodium*, *Cryptomeria*, *Cunninghamia*, *Arthrotaxis*, *Glyptostrobus*, and *Sciadopitys*. As might be expected in a paper dealing with so many and such inaccessible genera, the series are often incomplete, but the results are nevertheless interesting and important. In *Cunninghamia sinensis* there are numerous archesporial cells, and several embryo-sacs attain a considerable degree of development. In *Sequoia gigantea* the endosperm develops uniformly, thus differing decidedly from *S. sempervirens*, in which the development at the middle of the endosperm differs from that at both ends. The archegonia occur singly or in groups, but are not so numerous as in *S. sempervirens*. There are two neck cells and no ventral canal cell. In *Taxodium*, *Cryptomeria* and *Cunninghamia* the archegonia are grouped as in Cupressineæ and have a common jacket, but sometimes there is a layer of endosperm between the archegonia. In *Sciadopitys* the neck is very peculiar, consisting of from four to eight vertically elongated cells. Proteid vacuoles are present in the archegonium and they probably arise from the jacket cells. These vacuoles are not found in any other members of the Sequoiaceæ. No ventral canal cell was identified, but it may yet be found. In *Cryptomeria* the upper end of the egg becomes mucilaginous and sometimes separates from the rest of the egg, but no ventral canal is formed.

In *Sequoia sempervirens* at the time of fertilization the pollen tube contains two male cells and two free nuclei, one, the nucleus of the pollen tube, and the other the nucleus of a disorganized cell which Belajeff called the sterile cell of the generative complex. No vegetative cell of the male prothallium is formed. The body cell contains starch. In *S. gigantea* the pollen tube presses between the endosperm and the nucellus. The pollen tubes of *Taxodium* and *Cryptomeria* behave as in the Cupressineæ. The upper part of the egg becomes mucilaginous and presses upon the neck cells from beneath, while an outgrowth from the pollen tube presses from above and forces its way into the egg. In *Sequoia sempervirens*

the round male cell becomes elongated, one figure showing it spirally wound, but this may not be the normal form. In *Taxodium*, however, the spiral form is the usual one, and this is probably the case in the Cupressineæ also. The form is probably due to the narrow entrance, the male cell having a greater diameter than the neck of the archegonium. The behavior of the chromatin during fertilization is not described.

In *Sequoia sempervirens* the sex nuclei fuse at the middle of the archegonium, then sink to the bottom and divide. Two cells are organized about the nuclei and the lower nucleus divides again, thus giving rise to a row of three cells, the lowest of which becomes the embryo and the middle the suspensor. The upper soon disorganizes and at this stage the embryo appears to consist of two cells. The first division of the embryo is longitudinal. In *Cryptomeria* and *Taxodium* the fertilized egg nucleus passes to the base of the archegonium, where two or three divisions occur. Cells are formed about the lower nuclei, but the upper ones remain free. Two or three tiers are organized, the lower one or two tiers forming the embryo, and the tier next above, the suspensor. This agrees with Strasburger's account of *Juniperus*, except that the free cells were not described. *Cunninghamia* agrees with *Taxodium*, *Cryptomeria* and the Cupressineæ. In *Sciadopitys*, the series was very incomplete, but enough was obtained to show that the embryology is very peculiar. The earliest stage found shows four free nuclei at the base of the archegonium, as in all the Abietineæ. A later stage shows a "rosette," suspensors, and a loose tissue of embryonic cells. The lowest of these cells form the embryo, those next above develop into a second set of suspensors, still leaving some of the embryonic cells between the two suspensor systems. The figures bear some resemblance to Strasburger's figures of *Araucaria*, but in Strasburger's account the second set of suspensors, as described by Arnoldi, form a cap which is cast off while the part between the two suspensor systems—or between the suspensor and cap—develops into the embryo.

Arnoldi believes that the two species of *Sequoia* should constitute a family, the Sequoiaceæ; that *Taxodium*, *Cryptomeria* and, perhaps, *Cunninghamia* should be included in the Cupressineæ; and that *Sciadopitys* is best regarded as constituting a special family, the Sciadopiteæ.

C. J. C.

Livingston, B. E. On the Nature of the Stimulus which Causes the Change of Form in Polymorphic Green Algæ. Bot. Gaz. 30: 289-317, pls. 17-18, 1901.

The effect of external osmotic pressure upon green algæ has recently been made the subject of an investigation by B. E. Livingston. A polymorphic form

of *Stigeoclonium* was chosen. Knop's solution was used as a nutrient medium. In a weak solution (up to 0.1 per cent.) swarm spores are produced in great numbers which germinate to form branching filaments. In a solution whose concentration is 0.5 per cent. to 2 per cent. no swarm spores are produced, but the cells grow and multiply by divisions in all directions, the daughter cells separating almost as soon as formed. This process results in a mass of rounded cells like those of *Palmella*. If filaments are placed in the stronger solution their cells change from the cylindrical to the spherical form and break apart. In solutions of intermediate strengths, swarm spores may be

produced, but fail to germinate as filaments, growing directly into the round celled form. By varying the proportions of the four salts contained in the nutrient fluid and yet keeping its osmotic pressure the same, an attempt was made to determine whether these changes in the form of the alga were due to a physical or chemical cause. Many cultures were made in this way with a uniform result; the form of the plant is always determined by the osmotic pressure of the surrounding medium and is never influenced by the varying proportions of the constituent compounds. Some considerations follow concerning the probable way in which variations in the osmotic pressure of the medium may affect the organism. The author believes that the effect is produced by a change in the water content in the cell. Whether or not the rounding up of the cells in the strong solution has any connection with the process of plasmolysis is a question which he discusses at some length. The results of the different experiments are shown by full tables and by two excellent plates of half-tone reproductions of photomicrographs. This work opens up an entirely new field in plant physiology, and it is to be hoped that further research on the influence of osmotic pressure in nutrient media may be forthcoming.

J. B. OVERTON.

Chicago.

Guignard, L. La double fécondation dans le *Najas Major*. Jour de Bot. 15: 1-9, 1901. The details of fertilization in *Naias major* do not differ essentially from those in other forms. The chromosomes are very long and the gametophyte number is six, being the smallest number yet observed in any plant. The male nuclei are elongated, but do not assume the vermiform appearance so conspicuous in those of the Compositæ. One synergid disintegrates soon after the entrance of the pollen tube, the other, in general, remains intact until after several divisions of the embryo. The fertilized egg does not rest for a time, as is usual in other forms, but divides immediately after fusion is effected. One figure shows the fertilized endosperm nucleus in the spirem stage, and the embryo two celled. In all previously described cases of double fertilization, the endosperm nucleus invariably divides first. Many times two embryos were observed lying side by side, the unfertilized endosperm nucleus lying between them. One of the synergids had evidently functioned as an egg, and endosperm was not produced. Two of the antipodals soon show signs of disintegration. The upper one continues to enlarge long after fertilization. The article is illustrated with fourteen text figures.

W. J. G. LAND.

Chicago.

Lyon, H. L. Observations on the Embryogeny of *Nelumbo*. Minnesota Bot. Studies, 2: 643-655, 1901. *Nelumbo* is certainly a perplexing form. The closed bundles, irregularly scattered, present a distinctly monocotyl feature; the leaves with reticulate venation suggest dicotyls, while the flowers might be either monocotyl or dicotyl. The earlier observers, dealing with mature seeds, have described the embryos of *Nelumbo* and of other members of the Nymphæaceæ as monocotyl. Material for the present work was collected in August, 1899, and August, 1900, in southeastern Minnesota, where acres of *Nelumbo lutea* grow in the bayous of the Mississippi river. A study of

the development of the embryo shows that it retains a spherical shape until it consists of several hundred cells. The single cotyledon then appears as a crescent shaped organ partly surrounding the plumule. The single cotyledon now becomes bilobed by a localization of growth. The first foliage leaf arises on the side opposite the cotyledon. The radicle is transitory and does not develop into a primary root, but the work is done by secondary roots arising from the hypocotyl. The only character which has kept the Nymphaeaceæ among the Dicotyls is the apparently dicotyl embryo. Since a study of the development shows that the embryo is truly monocotyl and since the anatomy conforms more closely to the Monocotyls, the Nymphaeaceæ should be classified as a sub-series coördinate with the Potamogetonaceæ, Alismaceæ, and Butomaceæ in the series Helobia.

A future paper will deal with the development of the embryo-sac and fertilization.

C. J. C.

CYTOLOGY, EMBRYOLOGY, AND MICROSCOPICAL METHODS.

AGNES M. CLAYPOLE, Cornell University.

Separates of papers and books on animal biology should be sent for review to
Agnes M. Claypole, 125 N. Marengo avenue,
Pasadena, Cal.

CURRENT LITERATURE.

Boveri, Th. Die Polarität von Ovocyte, Ei und Larve des *Strongylocentrotus lividus*. Zoologische Jahrbücher, Abth. f. Anat., July, 1901.

Boveri has made the interesting discovery that the principal axis of the *Strongylocentrotus* is marked out in the egg before fertilization, and that it probably corresponds to the axis of the ovocyte of the germinal epithelium. The unripe egg is surrounded by a gelatinous envelope which is so transparent that it is invisible under ordinary circumstances. At one point this envelope is perforated by a micropyle. Into this micropyle the polar bodies are usually extruded. After the maturation divisions, the pigment which previously was scattered uniformly over the egg collects into a broad band, surrounding the side of the egg opposite the micropyle. The principal axis of the egg is thus determined. The female pronucleus is eccentric, but stands in no constant relation to this chief axis. Fertilization is usually effected through the micropyle, and the first cleavage spindle lies at right angles to the entrance path of the spermatozoön. This was observed when the sperm entered near the equator of the egg, so the first cleavage plane is apparently determined by the entrance path of the sperm. No trace of a bilateral organization of the egg could be detected, and as the first cleavage plane is not known to stand in any relation to the bilateral symmetry of the larva, the entrance path of the sperm is not known to mark out the plane of bilaterality, as it has been said to do in the frog. The unpigmented animal pole of the egg forms the ectoderm, the pigmented belt, which lies in the vegetal half of the egg, forms the entoderm,

while the unpigmented area at the vegetal pole gives rise to the primary mesenchym and larval skeleton. Boveri holds that the micropyle represents the point of attachment of the ovocyte, and that the chief axis of the embryo is therefore traceable back to the germinal epithelium of the ovary.

S. J. H.

Holmgren, N. Ueber den Bau der Hoden und die Spermatogenese von *Staphylinus*. Anat. Anz., June, 1901.

The seminal tubules of the testis in *Staphylinus* differ much in different seasons of the year. In summer the

outer zone of the tubules contains spermatocytes and spermatids, and the inner zone is filled with spermatozoa. No spermatogonia are present. In animals killed in the winter the capsules of tubules are thickened except over a portion on one side where the tubule is swollen out. This swollen part contains, besides a Verson's cell, only spermatogonia; the latter differ from the spermatogonia of the rest of the tubule in size and structure, and become arranged radially around the Verson's cell. No spermatocytes of the second order, nor spermatids, are found at this season, but there are a few spermatozoa which represent remnants left over from the previous summer. The thick outer capsule of the testis is a syncytial membrane from which the spermatogonia arise. The spermatogonia become enclosed in packets, surrounded by a capsule derived from the main capsule of the tubule. The spermatozoa that are not discharged are finally ingested by the capsule and resorbed. This is apparently a normal process of utilizing the unused spermatozoa. The spermatogonia of both parts of the tubule, although they differ much in structure and history, give rise to spermatozoa, which, so far as could be determined, are all alike. It is a fact of interest that the same kind of specialized cell is developed by two different routes.

S. J. H.

Conklin, E. G. The Individuality of the Germ Nuclei during the Cleavage of the Egg of *Crepidula*. Biol. Bull. II, June, 1901.

In *Crepidula plana* it is very probable that the germ nuclei do not completely fuse, as is indicated by the double

character of the nuclei, which can be traced to quite an advanced period of cleavage. The double nature of the nuclei appears most clearly during the telophase of each division, but may sometimes be observed throughout the entire resting period. The chromosomal vesicles, when the daughter nuclei are being formed, fuse into two separate groups, which, for a time, are separated by a partition wall. In the early cleavage stages two nucleoli are present. These may represent the descendents of the nucleoli of the male and female pronuclei, as each pronucleus possesses a nucleolus. It is probable that the half of the nucleus lying nearest the animal pole of the egg is derived from the female pronucleus, and the other half from the sperm.

S. J. H.

Petrunkewitsch, A. Die Richtungskörper und ihr Schicksal im befruchteten und unbefruchteten Bienenei. Zoologische Jahrbücher, Abth. f. Anat., July, 1901.

The theory that the unfertilized eggs of bees give rise to drones is supported by the observations of the author, who

finds that the eggs laid by the queen in the drone cells are always unfertilized. In both the fertilized and unfertilized eggs the first maturation division is an "equation division." The first polar body divides, the outer portion being

extruded from the egg, while the inner copulates with the second polar body, forming a large nucleus. This nucleus soon disintegrates in the fertilized eggs, but in the parthenogenetic eggs divides repeatedly, taking part in the formation of eight cells, which wander into the central portion of the egg, where their ultimate fate could not with certainty be determined. No copulation occurs between the female pronucleus and either of the polar bodies. How the normal number of chromosomes is regained in the parthenogenetic eggs, repeated efforts failed to discover.

S. J. H.

Montgomery, T. H. A Study of the Chromosomes of the Germ Cells of Metazoa. Trans. Am. Philos. Soc., 1901.

This paper is divided into two portions. The first is devoted to detailed observations on the spermatogenesis of forty-two species of Hemiptera. The subjects that received especial attention are the changes that occur during the synopsis stage, the reduction in the number of chromosomes, and the chromatin nuclei. The interesting discovery is recorded that in four species of Hemiptera the normal number of chromosomes is odd. In the second portion of the paper there is a discussion of subjects of a general nature, chief of which are the following: The individuality of the chromosomes, the significance of the chromatin nucleoli, the relation of number of chromosomes to genetic affinity, the factors which determine the number of chromosomes, significance of the uneven number of chromosomes, and the problem of reduction.

S. J. H.

Noack, W. Beiträge zur Entwicklungsgeschichte der Musciden. Zeit.wiss. Zool., 1901.

Investigation was carried on mainly upon *Calliphora erythrocephala*. The following subjects are treated: The first developmental changes in the fertilized egg, formation of polar bodies, origin of the yolk cells, formation of the blastoderm and germinal layers, development of the alimentary canal, and the fate of the pole cells. In regard to the last subject the author finds that the pole cells wander into the archenteron, becoming embedded finally in the entoderm, where their further fate could not be followed.

S. J. H.

Hennip, C. Dr. Depigmenting the Eyes of Arthropoda. Zeit. Wiss. Mick., 17, 1900.

The author uses a mixture of 2 pts. 80 p. c. alcohol and 1 pt. glycerin to which 2 vols. of strong sulphuric acid are added. The solution acts best at a temperature of about 35° C., the time required varying from 10 minutes to about 12 hours according to the kind of pigment. The prolonged action of the fluid is not injurious to the eye tissues.

A. M. C.

CURRENT ZOÖLOGICAL LITERATURE.

CHARLES A. KOFOID.

Books and separates of papers on zoölogical subjects should be sent for review to Charles A. Kofoid, University of California, Berkeley, California.

Harvey, N. A. Introduction to the Study of Zoölogy for the use of High Schools and Academies. 208 pp. 1901. The Western Publishing House, Chicago.

An elementary laboratory manual, the outgrowth of the normal school method, put forth as a guide for work in the

first grade of the high school. The objects studied are almost exclusively arthropods and vertebrates, and the work is planned for laboratories not equipped with microscopes. The comparative method is well sustained throughout the book, and the manner of presentation is one well adapted to cultivate independence in the pupil, and to develop the scientific method. The effort to combine both text-book and laboratory guide in two hundred pages has been less successful, and the reputed micro-photographs which are offered as substitutes for the compound microscope will be of little value even to schools with meager equipment.

C. A. K.

Peters, A. W. Some Methods for Use in the Study of Infusoria. *Am. Naturalist*, 35: 553-559, 1901.

THE YARN SIPHON is used for separating Infusoria in large numbers from both the culture water and the solid debris

which it contains. Transfer the liquid containing the Infusoria from the culture jar to a Stender dish, and mix thoroughly to obtain a uniform distribution of the organisms. Next, several pieces of woolen yarn are laid side by side without twisting, moistened, and placed with one end in the Stender dish and the other hanging down the side of the dish, and siphoning into a collecting vessel. The yarn filters the water so that only active organisms pass over into the lower vessel.

THE TUBE FILTER is an apparatus for concentrating the *Ciliata* contained in a large amount of water, and changing the culture medium. The ordinary methods of filtration fail in this case because so many organisms stick to the filter paper. The tube filter is a piece of large glass tubing, over one end of which filter paper is fastened with a rubber band. This tube is lowered into the culture vessel, and the filtration takes place upward. More culture fluid, or any desired solution, may be added to the outer vessel from time to time, and the filtered water removed from the tube by means of a siphon with its lower end bent up to prevent it running empty.

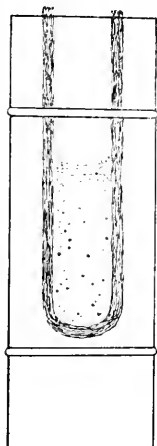

Fig. 1.

THE U-CELL (Fig. 1) is also a device for filtration, but on a smaller scale. It admits of microscopical observation. It consists of a long U of large, close fibered darning cotton, which has been previously moistened and placed between two thin slides. The cotton is so placed that the U is two-thirds the length of the slide, and that its ends barely project beyond the parallel ends of the slides, which are held together with rubber bands. If it is desired to examine with a higher power of the microscope, a cover-glass may be substituted for one of the slides, but in this case narrow strips of slides should be laid over the cover-glass where the rubbers go around it. The cotton yarn should be of such a thickness that the slides will be 0.5 mm. apart when the cell is complete. To fill the cell it should be held nearly vertical, and the culture fluid and Infusoria inserted through the open end of the U with a small

pipette. Part of the water will flow out through the cotton, but part will be retained by capillary attraction. By repeated use of the pipette any desirable

number of organisms may be concentrated in the same cell. The cell may also be filled by means of the yarn siphon, a single strand being sufficient for the passage of many Infusoria. Such preparations may be kept for a long time by placing the cells in a larger vessel containing water, so that the upper open end of the U is above the level of the water, while a part of the U is immersed in it.

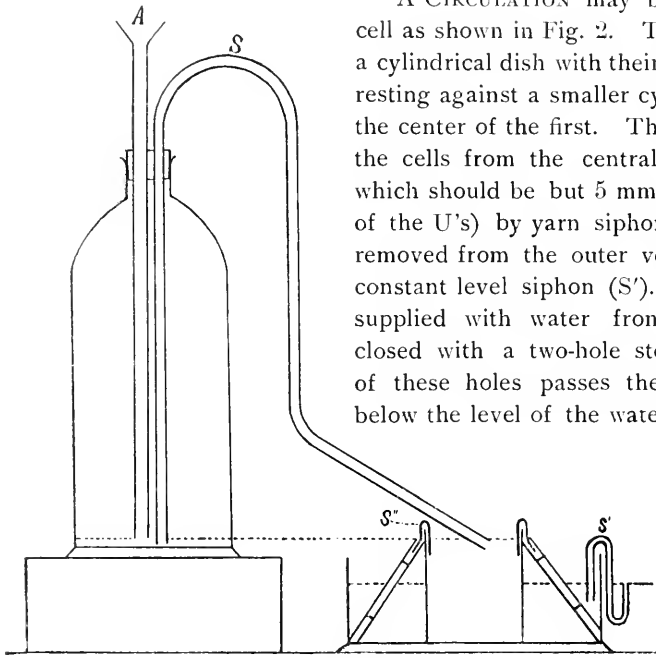

Fig. 2.

A CIRCULATION may be kept up in the U cell as shown in Fig. 2. The cells are placed in a cylindrical dish with their inner and upper ends resting against a smaller cylindrical vessel set in the center of the first. The water is supplied to the cells from the central vessel (the edge of which should be but 5 mm. above the open end of the U's) by yarn siphons (S''). The fluid is removed from the outer vessel by means of a constant level siphon (S'). The inner vessel is supplied with water from an elevated bottle closed with a two-hole stopper. Through one of these holes passes the siphon, which dips below the level of the water in the inner vessel.

Through the other the air-tube is inserted. This passes nearly to the bottom of the bottle, and by means of raising and lowering it the water in the inner cylindrical

vessel may be kept at any desired height. In siphoning, woolen yarn produces a more rapid flow than cotton.

ABSORBENT COTTON may be conveniently used for making temporary or permanent microscopical preparations. A very small amount of dry absorbent cotton is spread upon the slide, a few drops of fluid with the Infusoria are added, and the cover-glass lowered horizontally so that the animals shall be caught in the meshes of the cotton, and not above or below the fibers. The cover-glass is then secured with rubber bands, and the preparation treated in any desired way, subjected to the action of killing, dehydrating agents, etc., without any fear of the Infusoria being washed away or misplaced.

F. W. BANCROFT.

Looss, A. Zur Sammel- und Conservierungstechnik von Helminthen. Zool. Anz. 24: 302-304, 309-318, 1901.

Directions are given by this eminent helminthologist for the collection and preservation of parasitic worms by

methods which prevent undue contraction and distortion, and which are at the same time available for field work or in the absence of laboratory facilities.

Trematodes.—The strongly contractile forms are not readily killed in extended state except by the old method of washing in normal salt solution, stretching

them out on glass plates with soft brushes, and fixing them in sublimate solution while held in this position. Other trematodes, large and small alike, are very well prepared as follows: One or two cubic centimeters of the intestinal contents are put in a test-tube one-third full of normal salt solution and shaken vigorously for one-half to one minute. Concentrated sublimate solution is then added to the amount of one-half the quantity of salt solution in the test-tube, and the shaking continued for one-half minute longer. The parasites die in an extended condition, and, if need be, may remain four to six weeks in the sublimate solution without injury.

The worms may be freed from extraneous material by repeated shakings and decantations, and put through alcohol grades and iodine-alcohol. When numerous small trematodes are amid the intestinal villi they may be secured by cutting the intestine in small pieces and shaking these vigorously in normal salt solution till the worms are freed, when the intestinal fragments can be removed and the worms treated with sublimate. In many cases the duration of the shaking must be adjusted to the contractility of the parasites present. Large species should be placed in flat-bottomed dishes till hardened. If possible, a few specimens of each species should be killed in 70 per cent. alcohol on a slide beneath a cover-glass, supported by wax feet. The alcohol should be changed from time to time, and when the killing is completed the whole should be transferred to 90 per cent. alcohol, and freed from the slide and cover-glass.

Cestodes.—Small species with chains of proglottids, such as *Taenia echinococcus*, are preserved by the above described shaking method. It is advisable in all cases to test the tenacity of the proglottid chains before submitting them to the shaking process, for some forms readily break up when shaken. In such cases a moderate movement of the preserving fluid suffices to preserve the worms in an extended condition. Larger forms, including many fish and reptile tapeworms, become tangled if shaken. These should be stretched out on glass plates to harden after the first few minutes exposure to the killing fluid. Tapeworms exceeding 5 cm. in length should not be subjected to the shaking process, but may be gathered in shallow dishes in normal salt solution. From this they are taken singly, by grasping the posterior proglottid with forceps, and are shaken to and fro in a one to two per cent. solution of sublimate in normal salt solution until contraction ceases. When the posterior proglottids are too readily detached, the worm should be held near the middle of the chain. Very large worms, such as *Taenia saginata* and *Moniezia expansa*, etc., are not easily shaken out in the ordinary dish of killing fluid. Fine specimens may be secured, however, by pouring the concentrated sublimate solution over the worms, suspended across the palm of the left hand so that the head and the end of the strobila hang free.

Nematodes.—Small species, such as *Strongylus subtilis*, when present in considerable numbers, may be collected and cleaned by the shaking and decantation method above described, treating, however, but a small amount of the material at one time in the salt solution. Species with thin cuticula (*Strongylus* from the lungs, *Filaria* from the body-cavity) should be placed in 1–1.2 per cent. salt solution to avoid the swelling which attends the use of weaker solutions. The

best killing fluid for nematodes intended for collections and systematic work was determined after much experiment to be 70 per cent. alcohol heated to 80–90°C. With few exceptions the worms thus killed are well extended, free from wrinkling, and give excellent histological detail, tissues being much less brittle than when killed in acids or metallic salts. For subsequent examination the worms are transferred to a mixture of glycerin and alcohol, from which the latter is evaporated over a warming oven at 50–60°C. until the pure glycerin alone remains. For some worms, such as *Sclerostoma*, the mixture may contain as much as 20 per cent. glycerin, for more delicate species it must not exceed 2–3 per cent. before evaporation. The evaporation of the alcohol must be very slow in the case of those forms with thick cuticula. Permanent mounts of small species may be made in glycerin jelly. Specimens from the concentrated glycerin may be transferred to 96 per cent. alcohol directly, without shrinkage, for subsequent sectioning. All attempts to bring nematodes from formalin into alcohol without collapse failed utterly.

Acanthocephali.—Shaking in normal salt solution, followed by similar treatment in sublimate, leaves the specimen fully extended with proboscis protruded.

C. A. K.

Marpmann, G. Eine neue Vorschrift zum Konservieren von Zoologischen und Anatomischen Präparaten. *Zeitsch. f. angew. Mik.* 7: 14, 1901. The author recommends the following fluids for use in fixing and preserving zoölogical specimens and anatomical material where it is necessary or desirable that alcohol should be avoided. The following formula is given for the fixing fluid :

| | | | | |
|------------------------------|---|---|---|------------|
| Sodium fluoride, | - | - | - | 50 gm. |
| Formaldehyde (40 per cent.), | - | - | - | 20 c. c. |
| Water, | - | - | - | 1000 c. c. |

From this fluid the preparations are passed into the following mixture for preservation :

| | | | | |
|---------------------|---|---|---|------------|
| Glycerin (28°B) | - | - | - | 500 c. c. |
| Water, | - | - | - | 1000 c. c. |
| Magnesium chloride, | - | - | - | 100 gm. |
| Sodium fluoride, | - | - | - | 20 gm. |

This fluid is said to have preserved the natural colors of anatomical material and of reptiles. Objects for sections should be washed three or four times in water, and then treated to the usual grades of alcohol. Glycerin material may, however, be passed directly to the embedding soap.

C. A. K.

NORMAL AND PATHOLOGICAL HISTOLOGY.

JOSEPH H. PRATT.

Harvard University Medical School, Boston, Mass., to whom all books and papers on these subjects should be sent for review.

Wells, H. G. Multiple Primary Malignant Tumors; Primary Sarco-carcinoma in the Thyroid of a Dog, with Mixed Sarcomatous and Carcinomatous Metastases. *Journal of Pathology and Bacteriology*, 7: 357-366, 1901.

Wells has collected from the literature only seventeen cases of primary multiple malignant growths. The great rarity of the co-existence of different kinds of malignant tumors seems to

show that the presence of one variety does not predispose to the development of another type. Their occurrence is probably fortuitous. He also has found two cases and only two of tumors of a mixed epithelial and mesoblastic type, and to these adds a case of his own. These two cases are not complete, but are probably authentic. In his case there was a primary growth showing a true sarcomatous and carcinomatous type, and metastatic nodules were found in the lymph-nodes, heart, lungs, and kidneys, showing not only secondary growths of both types, but in several nodules there were both sarcomatous and carcinomatous growths in the same nodule. The primary tumor was in the thyroid of a dog, but in his plates the alveolar carcinoma and the sarcomatous growths are not very clearly shown.

He discusses further the bearing of these cases on the theories of the etiology of tumors and in conclusion states that the very great rarity of these sarco-carcinomatous growths offers positive proof that the organism, if such there is, which causes malignant tumors is not the same for sarcoma and carcinoma, otherwise the frequency of these mixed growths would be greater. He thinks it is not surprising that multiple malignant growths should occur in the body, and further calls attention to the remarkable fact that these three cases of mixed tumor were in the thyroid.

We do not think the author is fully justified in claiming such a great rarity of primary multiple malignant growths. His list does not include all the published ones, for, looking through five years' records of 1000 tumors, microscopically examined, we find a number of multiple primary malignant growths.

H. C. Low.

Sultan, C. Beitrag zur Kenntniss der Schilddrüsen-Functio. *Archiv für klinische Chirurgie*, 63: 620-626, 1901.

Katzenstein stated in 1899, as a result of his experiments, that the thyroid gland is not an organ essential to the

animal economy, and that it can be removed without necessarily destroying the health of the animal. Sultan has followed the same method of investigation, but has arrived at a different conclusion. Total extirpation of the thyroid gland in dogs and cats was followed by severe, characteristic disease-phenomena ending in death if accessory gland-tissue was not present in sufficient amount to take up the functions of the thyroid. Sultan thinks that Katzenstein, who worked with dogs, overlooked accessory thyroids and was thereby led into drawing false conclusions.

Piana found accessory thyroid glands in sixty-six per cent. of all the dogs he examined. These are to be sought for in the neighborhood of the aorta. One of Sultan's cases shows how readily they may be overlooked. He examined, microscopically, the lymph nodes from the arch of the aorta, and not until he had looked over many sections did he find an island of typical thyroid tissue. It partially surrounded a lymph-node and he likened it to a skull-cap.

In cats, accessory thyroids are rarely found.

J. H. P.

Neumann, E. Das Pigment der braunen Lungeninduration. Virchow's Archiv für path. Anat., **161**: 422-435, 1900.

In his studies of the pigment of brown induration of the lung, Neumann never observed the formation of melanotic pigment from hæmosiderin. Granules with a black center and a periphery more or less the color of hæmosiderin were seen. He regards these bodies as particles of carbon-dust which have been incrustated with hæmosiderin. He also observed bits of carbon with colorless peripheries. Both the colored and the colorless borders gave the iron reaction equally well. The author is inclined to regard this colorless modification as the last stage in the transformation of the blood pigment which terminates in its complete disappearance through resorption.

Neumann found these peculiar pigment bodies in the bronchial lymph nodes as well as in the lungs.

The hæmosiderin is formed from the red blood corpuscles. There is first a diffusion of the hæmoglobin, and later the pigment separates itself out of the solution.

J. H. P.

GENERAL PHYSIOLOGY.

RAYMOND PEARL.

Books and papers for review should be sent to Raymond Pearl, Zoölogical Laboratory, University of Michigan, Ann Arbor, Mich.

Loeb, J. On an apparently New Form of Muscular Irritability (Contact Irritability?) produced by Solutions of Salts (preferably Sodium Salts) whose Anions are Liable to form Insoluble Calcium Compounds. Amer. Jour. Physiol. **5**: 362-373, 1901.

The author found that when the gastrocnemius muscle of a frog is put in certain salt solutions in a strength of 1 gram molecule of the salt in 8 to 10 liters of water, and, after being subjected for a time to the action of this solution, is brought back into air or certain other substances, it goes into a tetanus or performs a series of strong contractions. This apparently new irritable phenomenon is provisionally considered as "contact irritability." The substances other than air which produce the contraction when the muscle is passed from the salt solution into them are CO_2 , oil, 2n sugar solution, glycerine, chloroform, toluol and probably mercury. The salts whose solutions bring about the contact irritability are, with a single exception, sodium salts; viz., sodium fluoride, sodium carbonate, Na_2HPO_4 , sodium oxalate, sodium citrate and sodium tartrate. In addition to these $(\text{NH}_4)_2\text{SO}_4$ has the same effect. The anions of these sodium salts produce insoluble calcium compounds and it is to the presence of these in the surface layers of the muscle

that the author believes the effect to be due. This view is supported by the fact that the presence of solutions of calcium salts hinders or entirely prevents the contact reaction. This contact reaction does not appear in curarised muscle, indicating that the action of the solution is on the nerve elements in the muscle. If the nerve of one of these nerve-muscle preparations be put into the solutions which bring about the contact irritability, the muscle will begin to twitch in a few minutes and tetanus finally ensues. Removal of the nerve from the solution stops the contractions, which will, however, begin again if the nerve is brought into contact with any solid or liquid body. Thus apparently the ions do not stimulate directly, but merely increase the sensitivity of the nerve to contact stimuli.

R. P.

Murbach, L. Physiology in the High School. Physician and Surgeon. December Number, 1900.

In this brief note the author gives a skeleton outline of the course in physiology taught in the Detroit Central

High School. In the space of a review, mention can only be made of a few of the more particularly noteworthy features of a wholly excellent course. The standpoint of the entire course is experimentation by the student, and independence ("forced, if necessary") in the drawing of conclusions from experiments. The experiments and laboratory work on the gross anatomy of bodily organs are planned so as to bring *forcibly* to the student's mind nearly all the fundamental principles of the functional activities of living things. Along with this groundwork of the course interesting and valuable special features are introduced. Food-stuffs are studied experimentally in the laboratory, according to the following plan: "Simple tests are made for starch, sugar, fat and proteid in *known* foods, such as corn starch, glucose, mutton tallow (extracted with chloroform), and white of egg. Then students are given yolk of egg, milk, beans, castor beans, peas, flaxseed, wheat and wheat flour, barley, and then sprouted barley—for sugar—to determine the principal food constituents. The uses and abuses of alcohol and narcotics are discussed from a scientific and moral point of view, rather than from a dogmatic, prejudiced, emotional one." Simple experiments on digestion are performed by the students, illustrating the principles of solution, emulsification, osmosis, ferment action, etc. In connection with the study of the special senses, experiments on skin sensations are introduced.

These examples will suffice to indicate something of the originality displayed in the whole plan. Such a course as this of Dr. Murbach's is in agreeable contrast with those mixtures of poor anatomy, poorer physiology, and a smattering of hygiene which are still too frequently served up to the secondary school student as "physiology."

R. P.

Stiles, P. G. On the Rhythmic Activity of the Oesophagus and the Influence upon it of Various Media. Amer. Jour. Physiol. 5: 338-357, 1901.

This paper presents the results of experiments on the effects of solutions of various salts on the rhythmic contractions of strips of the œsophagus of the

frog, with the purpose of obtaining light on the general question of the activity of plain muscle tissue. The œsophagus was chosen for the work because its spontaneous rhythm was found to be more regular and rapid (4 to 6 beats per

minute) than that of any other portion of the alimentary tract. It was found that only in the presence of Ca and K, as for example in Ringer's mixture, would the contractions continue regular and forcible for any considerable length of time. No substance was found which could be substituted for the Na in the Ringer mixture. The author inclines to the view that both Ca and K have specific effects, the former acting as a stimulant and the latter having an inhibitory action, instead of merely serving to neutralize the toxic effect of the NaCl. The Cl-ion is not necessary for the rhythmic activity, as in place of sodium chloride, NaBr, NaI or several other sodium compounds may be used. Special attention is called to the correspondence between the œsophagus and the venous end of the heart, which manifests itself in the activity and relation to solutions of the two organs.

R. P.

Levin, I. Physiological Studies on the Blood of Animals deprived of the Adrenals. *Amer. Jour. Physiol.* **5**: 358-361, 1901.

The purpose of this investigation was to determine whether the secretion of the adrenal bodies serves to neutralize toxic substances formed in the body and thus prevent, under normal conditions, auto-intoxication; or, on the other hand, merely acts on the nervous system to maintain the tonus of the vasomotor and respiratory centers and the general muscle tonus. Both of these views as to the function of these organs have been held by physiologists. It was found that when the blood from an animal (dog or cat) from which the adrenals had been removed some hours previously was injected into the vascular system of a normal animal an immediate and marked rise in the blood pressure occurred. This result was uniformly obtained and indicates that the blood of the animals without adrenals contains some active substance which is under normal circumstances neutralized. The author concludes that the death of animals deprived of the adrenals is not due merely to nervous depression, but to some unfavorable change in the metabolism, or, as was held by the earliest investigators of the subject, to an auto-intoxication of some sort.

R. P.

Godlewski, E. (jun.) O wpywie tlenu na rozwój organizmow i o wymianie gazow w pierwszych stadyach rozwoju zarodka u Rana temporaria. (Ueber die Einwirkung des Sauerstoffs auf Entwicklung und über den Gaswechsel in den ersten Entwicklungsstadien von Rana temporaria.) *Bull. Internat. Acad. Sci. de Cracovie.* Pp. 1-24. July, 1900.

The author finds that segmentation may occur in the absence of external oxygen supply, but that development under these conditions only proceeds to a certain point. CO₂ has a specific toxic action on development. The amount of gaseous metabolism is shown experimentally to increase as development proceeds.

R. P.

Beer, Th. Ueber primitive Sehorgane. *Wiener klin. Wochenschr.*, Jahrg. 1901. Nr. 11, 12 and 13.

A very complete summary and critical discussion of the literature on the histology and physiology of the eyes of lower invertebrates. The "objective nomenclature" advocated for physiological work by Beer, Bethe and von Uexküll is developed for the physiology of light perception.

R. P.

- Wasmann, E.** Nervenphysiologie und Tierpsychologie. Biol. Centralbl. 21: 23-31, 1901. A criticism of the method of investigation of animal behavior which centers itself in the study of the physiology of the nervous system. The author favors the method of comparative psychology.

R. P.

CURRENT BACTERIOLOGICAL LITERATURE.

H. W. CONN.

Separates of papers and books on bacteriology should be sent for review to
H. W. Conn, Wesleyan University, Middletown, Conn.

- Pierce, Newton B.** Walnut Bacteriosis. Bot. Gaz. 31: 272. Newton B. Pierce, of the U. S. Department of Agriculture, has recently described a new organism as the cause of the walnut bacteriosis, giving to it the name of *Pseudomonas juglandis*. The organism is a short rod with rounded ends, actively motile, bearing a single, long, polar, unusually wavy flagellum, occurring singly or in pairs, and sometimes in short or long chains. This organism is very strikingly pathogenic to the nuts, leaves, and tender branches of the English walnut. In the young walnut, the epicarp and forming shell and kernel are destroyed. The author has produced a large number of infections by spraying the young buds with a pure water culture of the organism. L. H. PAMMEL.

- Eijkmann.** Ueber Enzyme der Bakterien und Schimmelpilzen. Cent. f. Bak. u. Par. 1, 29: 841, 1901. The author has experimented upon the formation of enzymes by bacteria in a somewhat ingenious and extremely interesting method. The method consists, in brief, in using agar which has been mixed with a certain amount of material upon which the enzyme to be tested will have a solvent or other noticeable action. For example, he first tested the formation of an enzyme which digested casein. To do this, he mixed a certain amount of fresh skimmed milk with agar, making a white, cloudy liquid, and then inoculated this agar, upon an ordinary plate, with the bacteria to be tested. If the enzyme is produced, it diffuses from each colony and, as it diffuses, it digests the casein so that it dissolves in the liquid present. The result is that the colonies become, in a few days, surrounded by clear fields, which indicate the digestion of the casein. On the other hand, bacteria which do not produce this enzyme do not develop such clear fields. By this means can be determined at a glance whether certain bacteria develop the enzyme in question. The author tested a large number of bacteria, finding that those which liquefy gelatin produce also the enzyme which digests the casein. From this he concludes that the casein digesting enzyme and the liquefying enzyme are identical.

The author tested the hæmolytic power of bacteria by adding to the agar a few drops of blood, thoroughly shaking the mixture, and afterwards inoculated it with the bacteria to be tested, pouring it out upon plates as usual. The bacteria

producing this hæmolytic enzyme develop colonies which become surrounded by a clear area, due to the disappearance of the hæmoglobin. This enzyme does not appear to be the same as the casein digesting enzyme, since some bacteria produce the one and not the other. In a similar way he tested the production of an amyolytic enzyme, by bacteria. For this purpose he mixed agar with a small amount of boiled starch, and inoculated and made plates as usual. After the colonies have grown there can be detected around the colonies producing a starch digesting ferment, clear fields where the starch has disappeared, or the presence of the enzyme can be tested by throwing a weak solution of iodine over the plate, when the plate will turn blue in all regions where the starch has remained undigested: the clear fields around the areas are not rendered blue, indicating that the starch has been converted into sugar. This production of amyolytic ferment is tested for many bacteria. Lastly, he tested the power of micro-organisms for saponifying fat. The method in this case was to mix certain amounts of fat, mutton tallow being used, with the agar under certain conditions, and then inoculating as usual. The bacteria which produce the saponifying enzyme become surrounded by areas in which the appearance of the fat has been greatly changed, due to its saponification.

The method is quite ingenious, and the experiment interesting and suggestive of further data for determining physiological properties of bacteria, and of thus assisting in separating different species from each other.

H. W. C.

Kreibich. Ueber bakterienfrei Eiterung beim Menschen. Wien.klin. Woch. 14: 583, 1901.

It has been generally assumed in recent years that the formation of pus was always the result of the action of bacteria, so much so that it has been more or less a dictum of bacteriologists that there is no pus formation without micro-organisms. It has, however, been recently recognized that there are certain chemical agents which are certainly capable of producing pus, totally independent of micro-organisms. For example, Croton oil, turpentine, or nitrate of silver, injected subcutaneously in animals, produce pus without a suspicion of bacterial action. The author studies the question whether pus is ever naturally formed in man in any other way than by the agency of bacteria. That pus may be formed in man by the action of oil of turpentine and other chemicals, is evident: but the author is quite convinced, from his observations, that there are certain instances when pus is formed naturally in the human body, and yet independent of the action of bacteria. He mentions, for example, some cases of pus formation in bubonic pest, in which the most careful examination has failed to show any trace of micro-organisms. He himself studies some cases of eczema in which pus is formed. The most careful study with the microscope failed to show any organisms in the pus, and the most careful investigation by culture methods has failed to reveal their presence. A long series of studies in this direction convinced him that such pus is sterile, and can not therefore be regarded as due to the action of bacteria. Hence, he concludes that the dictum, no pus without micro-organisms, is totally erroneous, and that sometimes pus is formed naturally in man by chemical action.

H. W. C.

Neisser and Wechsberg. Ueber das Staphylo-
toxin. Zeit. f. Hyg. 36: 299, 1901.

The authors have undertaken the study of the question whether the bacteria going under the name of *Staphylococcus* produce toxic products. The production of toxins by the well known pathogenic forms of *Streptococcus* has previously been subject to much experimentation, but the *Staphylococci* have been generally neglected. The author studies both of the common species of this genus, the *Staph. aureus* and *Staph. albus*. His method is to cultivate the organisms in proper media and then, after filtration, to test the filtrate for the presence of toxic products. His conclusion is that both of these species produce toxins, and the toxins produced are identical in both cases. There are two such toxins, one of which produces a dissolution of red corpuscles, called *hæmolysin*, and the other producing a dissolution of white corpuscles, and called *leukocidin*. All tests indicate that the toxic products produced by the two species are identical, inasmuch as they always answer to the same tests.

The author is further of the opinion that, so far as concerns the production of these toxic products, all of the numerous varieties of *Staphylococcus* are essentially the same.

H. W. C.

NOTES ON RECENT MINERALOGICAL LITERATURE.

ALFRED J. MOSES AND LEA MCL. LUQUER.

Books and reprints for review should be sent to Alfred J. Moses, Columbia University, New York, N. Y.

Vernadsky, W. Zur Theorie der Silicate.
Zeit. f. Kryst., 34: 37-66, 1901.

(Concluded from November.)

ALUMOSILICATES.

Again we have the salts and "derivatives," the most important part being that of the salts of the alumosilicic acids, for which the general formula is $m MO \cdot n Al_2O_3 \cdot p SiO_2$, but as experience shows, $m=n$, and when $m=n=1$, then $p=1, 2, 4, 6$, and rarely 8, 10, or 12; that is, only the following alumosilicates have been observed: $M_2Al_2Si_6O_{16}$, $M_2Al_2Si_8O_{20}$, $M_2Al_2Si_{10}O_{24}$, $M_2Al_2Si_{12}O_{28}$.

The first of these may be called the group with the chlorite nucleus, and all the others the group with the mica nucleus, for the following reasons:

(a) There is no known reaction by which alumosilicates with chlorite nucleus can pass *directly* into alumosilicates with mica nucleus, or the converse. It can only be accomplished by the introduction of "derivatives."

(b) Alumosilicates, with mica nucleus readily pass from one division to another.

(c) By weathering, the alumosilicates, with mica nucleus, yield clay; those with chlorite nucleus do not.

(d) Chrome silicates, with chlorite nucleus, are red or rose colored, but with mica nucleus are green, indicating different structure.

It is probable that in the structure formulæ the hydroxyl belongs rather with the Al than the Si, because the relation between the hydroxyl group and alumina group is constant, but is not with the silica group. Also because in reactions this constancy mentioned remains, while the silica molecule may be split, and finally because on destruction of the aluminosilicate there result aluminates and not silicates.

The following may be, therefore, taken as the structure formulæ of the chlorite nucleus $H_2Al_2SiO_6$, and the mica nucleus $H_2Al_2Si_2O_8$.

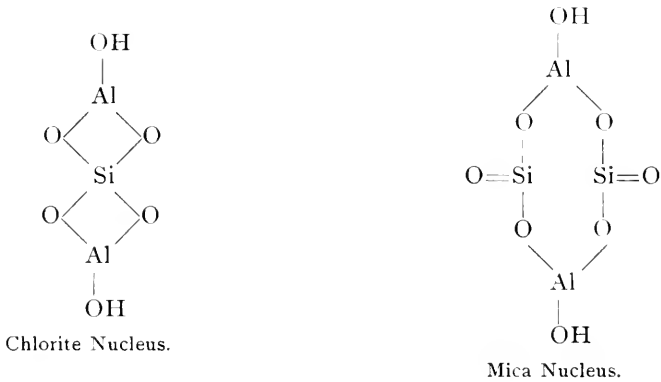

The remaining aluminosilicates readily pass into the second type, and differ from it only in additional *pairs* of SiO_2 groups; these additional pairs differ from the first pair in that they readily separate or recombine. From the two groups represented, however, the SiO_2 can only be separated by the strongest methods, involving the destruction of the aluminosilicate.

GROUPS WITH THE CHLORITE NUCLEUS.—The minerals belonging to these groups have been little studied. Very few simple salts are known, e. g., margarite $CaAl_2SiO_6$ and some chlorites. They form very complex isomorphous mixtures with each other, and also isomorphous mixtures with metasilicates. In the group may be included all minerals with the formulæ $R_2Al_2SiO_6$ or $m R_2Al_2SiO_6 \cdot A$, and include:

1. The staurolite and clintonite groups—usually very complicated formulæ.
2. The chlorite group.
3. The mellilite group.

As yet no simple formulæ will express their composition, and there is therefore no substantial basis for structure formulæ.

GROUPS WITH MICA NUCLEUS.—These groups are much more important, and have been more thoroughly studied. As before stated, characteristics are: Easy transformation into one another; production, on earth's surface, of clays by weathering; constant nucleus in structure formula little affected by most reactions; of SiO_2 atoms, two can only be removed by destruction of the compound, but the rest can be easily removed or added.

The different salts of mica variety readily form isomorphous mixtures with each other, and also with metasilicates, etc.

All "derivatives" can be synthetically obtained at definite temperatures by bringing together the mica nucleus silicate and the material to be added, and may be represented by the general formula $mR_2Al_2Si_{2+n}O_{2n+4} \cdot A$. The substance A may be replaced by another A_1 etc., without alteration of the nucleus.

The physical characters of "derivatives" are peculiar. For instance, the derivatives of many colorless aluminosilicates are strongly colored; for instance: ρ . $Na_2Al_2Si_2O_8 \cdot A$, rose and red cancrinite, yellow cancrinite, blue lapis lazuli, haüynite, sodalite.

The important groups are: mica group, leucite group, feldspar group, nephelite group, epidote group, garnet group, under each of which structure formulæ are given.

THE CLAYS.—The Clays, under this theory of the silicates, are free acids. No clay corresponding to the chlorite nucleus has been found in nature, nor is any known corresponding to the mica nucleus, though by heating rectorite $H_2Al_2Si_2O_8$ is left. The clays may be considered as natural mechanical mixtures of the following acids and their derivatives, and possibly others:

- | | | | |
|----------------------|---|---|-----------------------------------|
| (1) Kaolin, | . | . | $H_2Al_2Si_2O_8 \cdot H_2O$. |
| (2) Halloysite, | . | . | $H_2Al_2Si_2O_8 \cdot 2H_2O$. |
| (3) Pyrophyllite, | . | . | $H_2Al_2Si_4O_{12}$. |
| (4) Montmorillonite, | . | . | $H_2Al_2Si_4O_{12} \cdot 2H_2O$. |
| (5) Nontronite, | . | . | $H_2Fe_2Si_2O_8 \cdot H_2O$. |

A classification of the silicates under this theory is given.

A. J. M.

MEDICAL NOTES.

Year by year the importance of more liberal education for students entering the medical college is more clearly recognized, and the requirements made more rigid. Prof. Stanley Coulter, of Purdue University, Lafayette, Ind., recently read a paper before the Indiana State Medical Society on the subject of Pre-medical Education, at the close of which he outlined briefly the pre-medical course as given at Purdue University:

Purpose of the Pre-medical Course.—The pre-medical course of Purdue University is arranged to meet a three-fold demand:

1. To furnish a broad and liberal education.
2. To give special and extended training in those subjects which underlie the strictly professional studies of the medical school.
3. By this co-relation of work to shorten the time required to obtain the university and professional degrees.

Graduates of Purdue who have completed this course are admitted to the second year of all first-class medical schools, thus saving a full year.

The preliminary work required of students entering this course is that of the freshman and sophomore years of the general course, including mathematics,

English literature, history, three years of either German or French, and one year each in general chemistry, biology, and physics. Additional general subjects taken are those required of the junior and senior years of the general course, including psychology, literature and history, geology, and German or French.

Special Pre-medical Studies.—The special work of this course may be summarized as follows:

Quantitative chemical analysis, lectures (37 hrs.); laboratory (222 hrs.).
Organic chemistry, lectures (52 hrs.); organic preparations (108 hrs.).
Physiological chemistry, lectures (18 hrs.); physiological chemistry and urine analysis (102 hrs.).

Microscopical technique, lectures (15 hrs.); laboratory (105 hrs.).

Normal and pathological histology, lectures (46 hrs.); laboratory (140 hrs.).

Vertebrate anatomy and dissection, recitation (74 hrs.); laboratory (222 hrs.).

Embryology, lectures and laboratory (88 hrs.).

Bacteriology, lectures (37 hrs.); laboratory (222 hrs.).

Animal physiology, lectures (37 hrs.); laboratory (150 hrs.).

Elective.—Technical chemical analysis, eight hours weekly through the year.

The most cursory inspection shows that in such a course none of the professional studies of the medical course are undertaken. There is no attempt to anticipate them, but there is insistence placed upon certain subjects, knowledge of which and skill in which are evidently of the highest value in the work of the medical college. Such a course has two main objects: First, to give to the pre-medical student the broad vision and strong mental grasp that can result only from a broad and liberal culture. Second, to give such special training in those subjects which underlie the science of medicine that he may, when he enters the professional school, be prepared for its real problems, and in a much greater degree than at present understand the magnitude of the work he has undertaken when he has chosen to enter the ranks of the medical profession. Incidentally, this method saves one of the preparatory years—no small matter in these strenuous times.”—*Medical Record*, 10: 14.

C. W. J.

KAISERLING METHOD FOR THE PRESERVATION OF PATHOLOGICAL SPECIMENS.—It is held that by employing this method the natural colors of specimens will be preserved almost exactly, and apparently for an indefinite period when kept in a dark place. The specimens are placed as soon as possible in the following solution, in which they remain for 3 to 5 days:

| | |
|------------------------------|------------|
| No. 1. Formalin, | 40 parts. |
| Water, | 200 parts. |
| Potassium nitrate, | 3 parts. |
| Potassium acetate, | 6 parts. |

Specimens must *not* be carefully washed out in running water, as it removes the blood on which the color depends. Any excess of blood, etc., should be simply wiped off before placing specimens in solution No. 1. Specimens lose

their color after remaining in solution No. 1 for a few days, but the color returns after the specimens are transferred to the next solution, which consists of,

No. 2. Alcohol, 4 parts.
Water, 1 part.

and in which they remain for 3 to 5 hours, after which they are placed in,

No. 3. Alcohol, 95 per cent,

for 1 to 2 hours, and finally are permanently preserved in,

No. 4. Potassium acetate, 1 part.
Glycerin, 2 parts.
Water distilled, 10 parts.

which, before use, should be allowed to stand for 48 hours, and then filtered.

Specimens thus prepared and preserved should be kept in a dark place, as light produces bleaching in the course of time.—*Texas Med. News*, 10: 10.

C. W. J.

EXAMINATION OF BLOOD.—Six things are essential in order to make satisfactory examination of the blood: (1) The apparatus must be absolutely clean. (2) The various stages in the process must be performed rapidly, because the cell coagulation of the blood will interfere with any of the tests. (3) The work must be done accurately. (4) Making large quantities of stain and keeping same in a glass-stoppered bottle will standardize the solution, giving minimum variations in intensity of stain. (5) Fixing of specimens, by continuous heat, with as slight a degree of variation in distribution of heat as possible. (6) Taking of blood specimens with reference to time of day.

In order to more accurately fix the blood count, it has been found that specimens taken in the morning, before any undue excitement is indulged in, and previous to taking of liquids or solids, will give a more uniform blood count than those taken at any other period of the day.—*Jour. Am. Med. Ass.* 37: 8.

C. W. J.

The corner-stone of the new medical building of the University of Michigan was laid on October 15th by Dr. Leartus Connor, president of the State Medical Society. The building will contain the laboratories and class-rooms of the departments of hygiene, bacteriology, anatomy, histology, and pathology. The contracts for its erection call for an expenditure of \$88,000, exclusive of what may be required for heating, plumbing, and general equipment.—*Science*, 14: 356.

NEWS AND NOTES.

AN APPARATUS AND METHOD FOR RAPIDLY STAINING LARGE NUMBERS OF SPUTUM SPECIMENS.—This apparatus, as illustrated, consists of a long, narrow copper bath, mounted on legs, weighted to ensure stability, and of sufficient height to permit the use of a Bunsen burner under the bath. At one end near the top are two inlets; the upper one (*A*) to admit the stain, the lower one (*B*) to admit water. In the bottom of the bath, at the same end, is a small outlet (*C*) for the

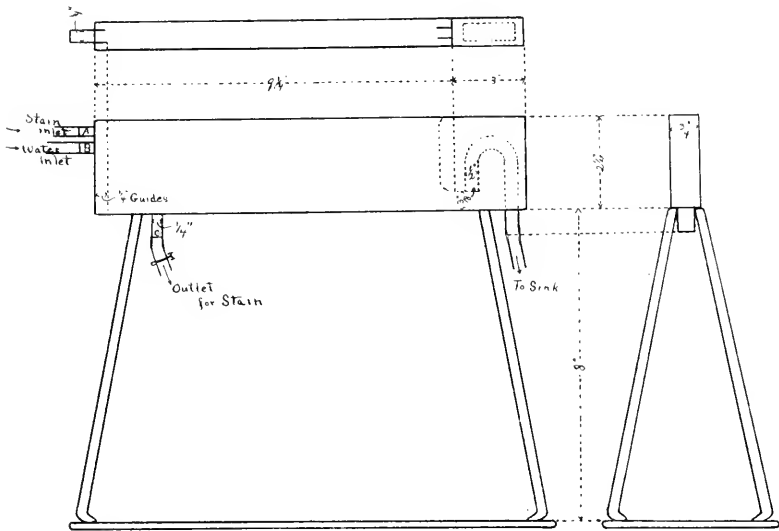

FIG. 1.—Staining Bath for Sputum Specimens.

stain, closed by a rubber tube and pinchcock. At the other end of the bath, partitioned off by a false wall, is a one-half inch siphon, the inner end of which is about three-eighths inch from the bottom, and the top about on a level with the upper inlet.

Instead of ordinary microscopical slides, a thin plate of glass, etched as shown in Fig. 2, is used. The etched area above the spacings furnishes a surface on which desired data may be written. This large slide is made of a size to fit the bath and is held upright by guides in the ends of the bath.

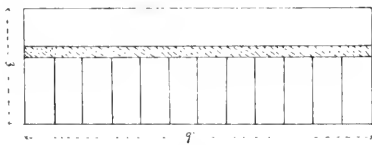

FIG. 2.—Slide for Sputum Specimens.

To use this apparatus, proceed as follows:

Stain is admitted through *A* until the bath is about two-thirds full, or to a depth sufficient to cover the preparations without starting the siphon. The specimens are then stained, after which the stain is drawn off through the outlet *C*. Water is then turned into the bath through *B*. The bath fills until the top of the siphon is reached, then drains rapidly until the

siphon breaks, when the bath fills again and empties as before, and so on until washing is completed. A glass candy tray, a trifle over nine inches long and wide enough to hold two slides side by side, is recommended for decolorizing the specimens. Small strips of glass are cemented in the ends of the tray so that when the slides are placed in it specimen side down, just sufficient space remains for the required amount of decolorizer. After decolorizing, the specimens may again be washed in the bath, after which they are ready for examination.—*Jour. Bost. Soc. Med. Sci.*, 5: 8.

A DEVICE FOR PARAFFIN EMBEDDING.—This device consists of a printer's composing stick, six inches long and two and one-fourth inches wide. It has an adjustable slide, fastened by a thumb set-screw, and set at a distance of four inches from one end, giving a space

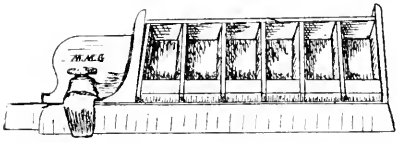

four inches long and two and one-half inches wide. This space may be divided by nonpareil slugs and quads into compartments of any desired size, to hold the blocks of material. When the tissue is ready for embedding, a small amount of melted paraffin is poured into the compartment, the tissue properly arranged therein, and the compartment filled with paraffin. The stick is then cooled on ice or in cold water, so that it requires only a few minutes to accomplish the work.—*Am. Med.* 1: 1.

RINGING SLIDES.—Many amateurs are unable to finish well made mounts with neatly made rings of cement. This is often caused through using the cement too thick. Professional mounters have two bottles, one containing the cement, the other the solvent—generally turpentine or methylated spirits. The brush is first dipped in the solvent, then in the cement, and a thin coat is deposited on the slide as it is rotated on the turn-table. Some build up the ring at once, others allow the first layer to dry and then complete the process. Each time a fresh brushful of cement is taken, it should be preceded by a dip in the solvent. The cement can then be deposited with cleanness and regularity.—*Knowledge*, 24: 186.

The annual meeting of the American Society of Naturalists and Affiliated Societies will be held at Chicago on Tuesday and Wednesday of Convocation Week, that is, December 31st and January 1st. The discussion before the naturalists will be on Wednesday afternoon, and the annual dinner, at which the president, Prof. Wm. T. Sedgewick, will give the address, will take place in the evening. The subject selected for the discussion is "The Relations of the American Society of Naturalists to Other Scientific Societies."—*Science*, 14: 356.

A new science building, to cost \$300,000, is being constructed at Colorado College.

A catalogue of the Marine Invertebrata of Eastern Canada, by Dr. J. F. Whiteaves, has been published by the Geological Survey of Canada (1901). It consists of a systematic list of all the species described from the Bay of Fundy, the Atlantic coast of Nova Scotia, the Gulf and Mouth of the St. Lawrence river as far north as the straits of Belle Isle. The localities at which some of the species are found fossil in the Pleistocene deposits are also briefly indicated.—*Nature*, 64: 1666.

Numerous inquiries have been received asking where and at what cost the bulletin of photo-micrographs issued from the Biological Laboratory of Earlham College, and noticed in our August number, may be secured. The bulletin is published by Nicholson & Bro. of Richmond, and may be had at twenty-five cents per copy.

QUESTION BOX.

Inquiries will be printed in this department from any inquirer.
The replies will appear as received.

REPLY TO QUESTION No. 13.

A quantitative test for the bacteria in milk can be made with very low magnifying power. To do this a known quantity of milk is diluted with a known quantity of sterilized water. This is evenly spread over a gelatine culture in a Petri dish. Place this in a warm (not above 100°F) and dark place for thirty-six hours, and it will then be ready for examination. The bacterial colonies, many of which can be seen with the unaided eye, will show the approximate number of bacteria present in the milk used. The Petri dish may be placed, without uncovering, upon the stage of the microscope, and the colonies examined with the low power. Objectives ranging from the 2-inch to the $\frac{3}{8}$ -inch may be used. Directions for making the gelatine culture may be found in almost any work on bacteriology, and Petri dishes can be purchased for twenty-five cents apiece.

C. A. WHITING.

REPLY TO QUESTION No. 14.

In response to the inquiry of your correspondent this month, allow me to say that Tallqvist's method of hæmoglobin estimation consists of specially prepared paper upon which a drop of blood is allowed to fall, and a color scale for comparison. It is accurate to about ten per cent. It costs \$1.25, and may be obtained of the Harvard Coöperative Society, Boylston street, Boston.

F. W. HIGGINS, M. D.

REPLY TO QUESTION No. 15.

I have frequently transferred alcoholic specimens of animal tissue to formalin without bad results. In fact, tissues originally placed in dilute alcohol are frequently improved for histological purposes by being changed to formalin.

C. A. WHITING.

Journal of Applied Microscopy and Laboratory Methods

Vol. IV

January, 1901

No. 1

LEADING SUBJECTS

| | |
|--|------|
| Moses C. White. | |
| S. H. GAGE, Cornell University, | 1109 |
| Fire in the Veterinary College at Cornell. | |
| S. H. GAGE, | 1111 |
| Laboratory Photography. | |
| Stereo Photo-Micrography, | 1113 |
| The New York Botanical Garden. | |
| D. T. MAC DOUGAL, | 1115 |
| Preliminary Study of Mycetozoa. | |
| CLARA LANGENBECK, Wells College, | 1119 |
| Micro-Chemical Analysis, X. Potassium. | |
| E. M. CHAMOT, Cornell University, | 1121 |
| Easy Method of Mounting and Preserving Mosquitos. | |
| V. A. LATHAM, M. D., | 1129 |
| Current Botanical Literature. | |
| CHAS. J. CHAMBERLAIN, University of Chicago, | 1131 |
| Cytology, Embryology and Microscopical Methods. | |
| AGNES M. CLAYPOLE, Cornell University, | 1133 |
| Normal and Pathological Histology. | |
| RICHARD M. PEARCE, M. D., Harvard College, | 1136 |
| General Physiology. | |
| RAYMOND PEARL, University of Michigan, | 1138 |
| Current Bacteriological Literature. | |
| H. W. CONN, Wesleyan University, | 1141 |
| Notes on Recent Mineralogical Literature. | |
| ALFRED J. MOSES, LEA McI. LUQUER, | 1144 |
| Medical Notes, | 1145 |
| News and Notes, | 1147 |

Publication Department BAUSCH & LOMB OPTICAL CO., Rochester, N. Y.

Entered at the Post Office at Rochester, N. Y., as Second Class Matter.

For Hawaiian Islands: Hollister Drug Company, Honolulu.

For New South Wales: Turner & Henderson, 16 and 18 Hunter Street, Sydney.

JUST ISSUED

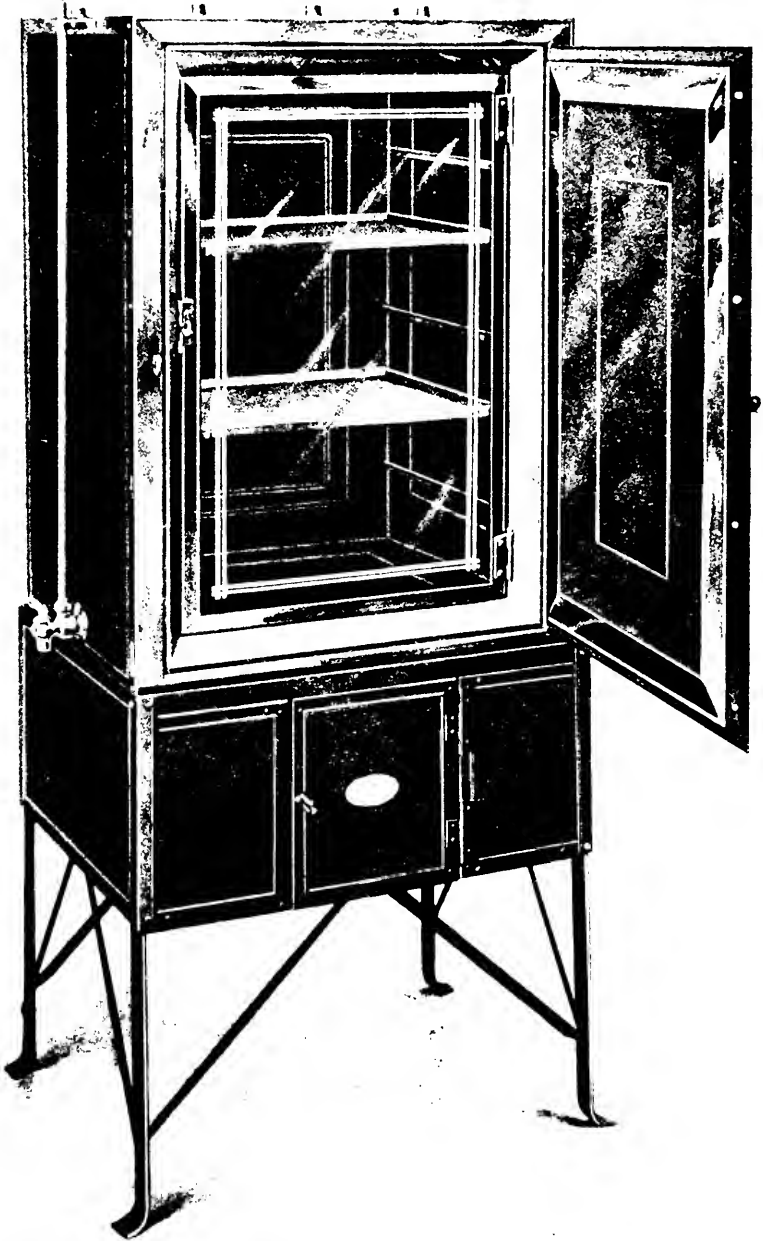

BACTERIOLOGICAL CATALOG

Send for one to
BAUSCH & LOMB OPT. CO.
Rochester, N. Y.



THERE ARE NOW IN USE OVER

234,000 LENSES

Manufactured by the Bausch & Lomb Optical Co.

This enormous number represents only Bausch & Lomb-Zeiss Anastigmat, Rapid Universal, Alvan G. Clark, Rapid Rectilinear, Portrait, and Wide Angle Lenses, and does not include the millions of simpler photographic lenses produced.

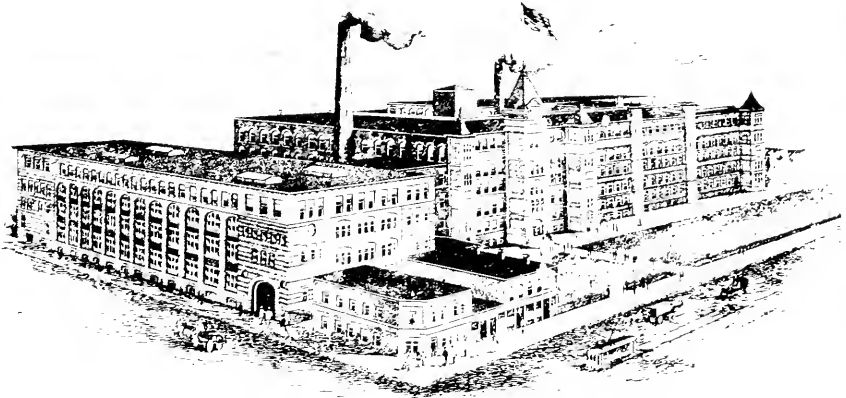

MANUFACTORY OF THE BAUSCH & LOMB OPTICAL CO.

THE POPULAR VERDICT as expressed by actual purchase and use is that our Lenses are practically WITHOUT A RIVAL.

OUR PRODUCTS ARE OBTAINABLE FROM ALL DEALERS.

CATALOGUE FREE.

Bausch & Lomb Optical Co.

ROCHESTER, N. Y.

NEW YORK CITY,
Broadway and 25th Street.

CHICAGO,
State and Washington, Sts.



SYNTHOL

(ABSOLUTE)

A chemically pure synthetic substitute for absolute ALCOHOL.

PURER, STRONGER, MORE STABLE, CHEAPER.

SYNTHOL may be used for every purpose for which alcohol is used, except for internal consumption. Being chemically pure it does not have as much odor as absolute alcohol from grain or wood. It is perfectly free from color, is non-irritant to eyes or skin and has from ten to fifteen per cent. more solvent power than ordinary alcohol.

PRICES :

| | |
|---------------------------------------|--------|
| 1 pint, net | \$.40 |
| 1 gallon, net | 2.50 |
| 1 bbl. of 50 gallons per gallon, net, | 2.25 |

As a killing, fixing, or hardening agent it is in every respect equal to the best absolute alcohol and can be used as a substitute for it in the preparation of stains, reagents, etc. We offer a special low price on Synthol in barrel lots FOR MUSEUM PURPOSES. As a preservative it is superior to any alcohol. Alcohol becomes tinged with color on exposure to light. Synthol retains its absolute colorlessness under all conditions. Sample supplied free to laboratories.

MANUFACTURED EXCLUSIVELY FOR

BAUSCH & LOMB OPTICAL CO.,

CHICAGO.

ROCHESTER, N. Y.

NEW YORK.

Journal of Applied Microscopy and Laboratory Methods

Vol. IV

February, 1901

No. 2

LEADING SUBJECTS

| | |
|--|------|
| The New Biological Laboratories of Ripon College. C. DWIGHT MARSH, Ripon College, | 1149 |
| A Combined Condenser and Polarizer for Petrographical Microscopes. W. L. PATTERSON, | 1155 |
| A Plan for a Ureometer. J. B. NICHOLS, M. D., Washington, D. C., | 1156 |
| A Device for Supporting Pasteur Flasks. KATHERINE E. GOLDEN, | 1157 |
| Laboratory Photography. High-Power Photo-micrography. C. E. McCLUNG, University of Kansas, | 1158 |
| An Improvised Microtome. IRWIN LAVERNE POWERS, | 1162 |
| The Study of Bacteria in the Public Schools JAMES E. PEABODY, | 1164 |
| Biology Wall Charts. ORSON HOWARD, | 1172 |
| Staining in Toto with Delafield's Haematoxylin. NEWTON EVANS, M. D., Am. Med. Missionary College, | 1172 |
| Current Botanical Literature. CHAS. J. CHAMBERLAIN, University of Chicago, | 1174 |
| Cytology, Embryology, and Microscopical Methods. AGNES M. CLAYPOLE, Cornell University, | 1176 |
| Normal and Pathological Histology. JOSEPH H. PRATT, Harvard University Medical School, | 1180 |
| General Physiology. RAYMOND PEARL, University of Michigan, | 1182 |
| Current Bacteriological Literature. H. W. CONN, Wesleyan University, | 1186 |
| Medical Notes, | 1188 |

Publication Department BAUSCH & LOMB OPTICAL CO., Rochester, N. Y.

Entered at the Post Office at Rochester, N. Y., as Second-Class Matter.

For Hawaiian Islands: Hollister Drug Company, Honolulu.

For New South Wales: Turner & Henderson, 16 and 18 Hunter Street, Sydney.

For SPRING BOTANY

Our line of Botanical Supplies is not the regular stock which is usually found on the market.

Our

Botanical Mounting Paper

is a fine quality of linen ledger paper manufactured especially for us after our own specifications with a view to producing a pure white sheet which will retain its whiteness and strength with age, and have that much desired stiffness which makes the sheet stand out firmly when held by one end for inspection of the specimen. Our

Genus Covers

are likewise made especially for us, and in addition to being made of the finest fiber, have a superior writing finish. We likewise have our

Driers

made to order to secure that bibulousness and weight which add to their effectiveness. Having these papers made in quantity enables us to quote a very satisfactory rate on large orders for the herbaria of universities, colleges, and other institutions. Our prices on small lots for private use will be found as low as any, and you get an extra quality of paper besides. In the matter of the

Vasculum and Plant Press

We have advantages to offer in the convenient construction, neat workmanship, durability, and moderate price. Place orders early and do not fail to get estimates from us before ordering elsewhere.

- No. 1244 Mounting Paper—standard size used in the Asa Gray Herbarium at Harvard; per ream—500 sheets \$4.50
- No. 1242 Genus Covers for above, per 100 2.00
- No. 1210 Drying Paper, 33x16 cm., ex. heavy, pr. 100 1.00
- No. 1248 Vasculum, with strap—size 13x20x10 cm. 1.50
- No. 1216 Portable Plant Press, very light, with bands to prevent disarrangement of specimens when new plants are added in the field 2.00

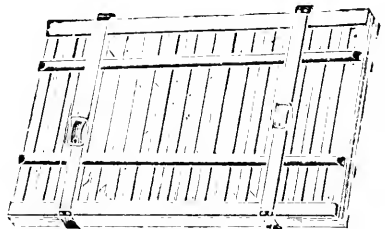
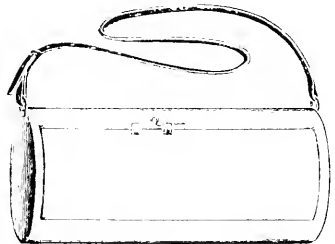

Bausch & Lomb Optical Co.

ROCHESTER, N. Y.

Chicago, Ill. New York
 80 Central Washington St. 35th St. and Broadway.
 Gowanus, Brooklyn, at Branch Office.

The Thornton-Pickard Focal Plane Shutter

is the only Shutter that will do
full justice to very fast Lenses

A complete catalogue of Thornton-Pickard Shutters will
be sent postpaid to any address upon application to

ANDREW J. LLOYD & CO.

323-325 Washington Street, - - BOSTON, MASS.

“A Finger Touch Finds the Reference”

IN THE

“Y & E” Card Index

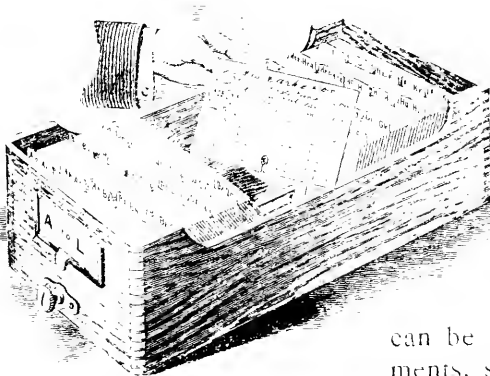

Adapted for use in any con-
nection for any subject. If
you want to know how it
can be applied to your special require-
ments, send for our new catalogue No.

27-B. It illustrates and explains 35 different forms of records and
gives complete information on the subject of card indexing.

Principal Branches :

Yawman & Erbe Mfg. Co.,

NEW YORK, 360 Broadway.

CHICAGO, 138 Wabash Ave.

SAN FRANCISCO, 29 New Montgomery St.

Factories and Main Offices, Rochester, N. Y.

THE
PREMO

The Best Camera Made

Fitted with all the latest improvements and supplied with the Victor Lens and Shutter. Our absolute guarantee goes with every Premo sold.

The Premo Uses Both Glass Plates and Film

1900 Catalogue sent on application.

Rochester Optical Co., South Street,
Rochester, N.Y.

THE PONY
PREMO

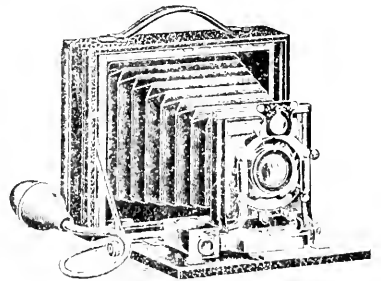

is a special camera for wheelmen. So compact and portable that it can be attached to a bicycle the same as a tool bag. Price, \$10.00 and upward.

Journal of Applied Microscopy and Laboratory Methods

Vol. IV

March, 1901

No. 3

LEADING SUBJECTS

| | |
|--|------|
| Micro-Chemical Analysis, XI. Ammonium. E. M. CHAMOT, Cornell University, | 1189 |
| Staining Sections for Class Work. NEWTON EVANS, M. D., Am. Med. Missionary College, | 1194 |
| Home Made Wall Charts. CHARLES E. BESSEY, University of Nebraska, | 1195 |
| Flattening and Fixing Paraffin Sections on Slide. B. M. DAVIS, State Normal, Los Angeles, Cal., | 1196 |
| A Ventilated Dish for Bacteria Cultures. GEORGE C. WHIPPLE, Mt. Prospect Lab., Brooklyn, N. Y., | 1197 |
| Laboratory Photography: The Processes of Photo-Micrography. C. E. McCLUNG, University of Kansas, | 1199 |
| A Laboratory Camera Stand. P. H. ROLFS, Clemson Agri. Coll., S. C., | 1202 |
| Current Botanical Literature. CHAS. J. CHAMBERLAIN, University of Chicago, | 1206 |
| Cytology, Embryology, and Microscopical Methods. AGNES M. CLAYPOLE, Cornell University, | 1208 |
| Current Zoölogical Literature. CHARLES A. KOFOID, University of California, | 1212 |
| Normal and Pathological Histology. JOSEPH H. PRATT, Harvard University Medical School, | 1214 |
| General Physiology. RAYMOND PEARL, University of Michigan, | 1218 |
| Current Bacteriological Literature. H. W. CONN, Wesleyan University, | 1222 |
| Notes on Recent Mineralogical Literature. ALFRED J. MOSES, LEA Mc I. LUQUER, | 1224 |

Publication Department BAUSCH & LOMB OPTICAL CO., Rochester, N. Y.

Entered at the Post Office at Rochester, N. Y., as Second Class Matter

SYNTHOL

(ABSOLUTE)

A chemically pure synthetic substitute for absolute ALCOHOL.

PURER, STRONGER, MORE STABLE, CHEAPER.

SYNTHOL may be used for every purpose for which alcohol is used, except for internal consumption. Being chemically pure it does not have as much odor as absolute alcohol from grain or wood. It is perfectly free from color, is non-irritant to eyes or skin and has from ten to fifteen per cent. more solvent power than ordinary alcohol.

PRICES :

| | |
|---------------------------------------|--------|
| 1 pint, net | \$.40 |
| 1 gallon, net | 2.50 |
| 1 bbl. of 50 gallons per gallon, net, | 2.25 |

As a killing, fixing, or hardening agent it is in every respect equal to the best absolute alcohol and can be used as a substitute for it in the preparation of stains, reagents, etc. We offer a special low price on Synthol in barrel lots FOR MUSEUM PURPOSES. As a preservative it is superior to any alcohol. Alcohol becomes tinged with color on exposure to light. Synthol retains its absolute colorlessness under all conditions. Sample supplied free to laboratories.

MANUFACTURED EXCLUSIVELY FOR

BAUSCH & LOMB OPTICAL CO.,

CHICAGO.

ROCHESTER, N. Y.

NEW YORK.

The Thornton-Pickard Focal Plane Shutter

is the only Shutter that will do
full justice to very fast Lenses

A complete catalogue of Thornton-Pickard Shutters will
be sent postpaid to any address upon application to

ANDREW J. LLOYD & CO.

323-325 Washington Street, - - BOSTON, MASS.

“A Finger Touch Finds the Reference”

IN THE

“Y & E” Card Index

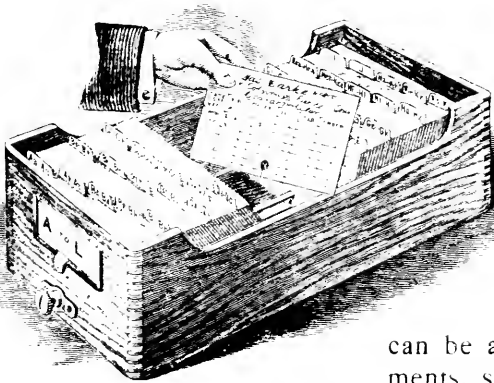

Adapted for use in any con-
nection for any subject. If
you want to know how it
can be applied to your special require-
ments, send for our new catalogue No.

27-B. It illustrates and explains 35 different forms of records and
gives complete information on the subject of card indexing.

Principal Branches :

NEW YORK, 360 Broadway.

CHICAGO, 138 Wabash Ave.

SAN FRANCISCO, 29 New Montgomery St.

Yawman & Erbe Mfg. Co.,

Factories and Main Offices : Rochester, N. Y.

THE
PREMO
The Best Camera Made

Fitted with all the latest improvements and supplied with the Victor Lens and Shutter. Our absolute guarantee goes with every Premo sold.

The Premo Uses Both Glass Plates and Film

1900 Catalogue sent on application.

Rochester Optical Co., South Street,
Rochester, N.Y.

THE PONY
PREMO

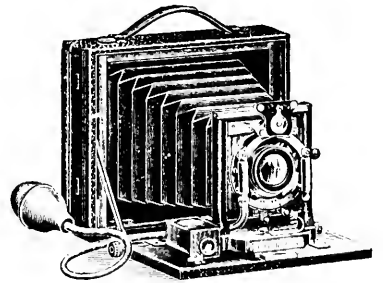

is a special camera for wheelmen. So compact and portable that it can be attached to a bicycle the same as a tool bag. Price, \$10.00 and upward.

Journal of Applied Microscopy and Laboratory Methods

Vol. IV

April, 1901

No. 4

LEADING SUBJECTS

| | | |
|---|---|------|
| The Laboratory Equipment of the "Bahama Expedition" from the University of Iowa. | C. C. NUTTING, University of Iowa, | 1229 |
| Laboratory Photography. | | |
| The Value of the Telephoto-Lens. | MORTON J. ELROD, University of Montana, | 1241 |
| Micro-Chemical Analysis XII. The Analytical Reactions of Group II. | E. M. CHAMOT, Cornell University, | 1242 |
| A Description of the New Wing of the Laboratory of Hygiene at the University of Pennsylvania, | | 1234 |
| Course in Biology in the Horace Mann High School, | | 1249 |
| Current Botanical Literature. | CHARLES J. CHAMBERLAIN, University of Chicago, | 1255 |
| Cytology, Embryology and Microscopical Methods. | AGNES M. CLAYPOLE, Cornell University, | 1257 |
| Current Zoological Literature. | CHARLES A. KOFOID, University of California, | 1260 |
| Normal and Pathological Histology. | JOSEPH H. PRATT, Harvard University Medical School, | 1262 |
| General Physiology. | RAYMOND PEARL, University of Michigan, | 1264 |
| Current Bacteriological Literature. | H. W. CONN, Wesleyan University, | 1266 |
| Medical Notes, | | 1268 |

Publication Department BAUSCH & LOMB OPTICAL CO., Rochester, N. Y.

Entered at the Post Office at Rochester, N. Y., as Second Class Matter.

For Hawaiian Islands: Hollister Drug Company, Honolulu.

For New South Wales: Turner & Henderson, 16 and 18 Hunter Street, Sydney.

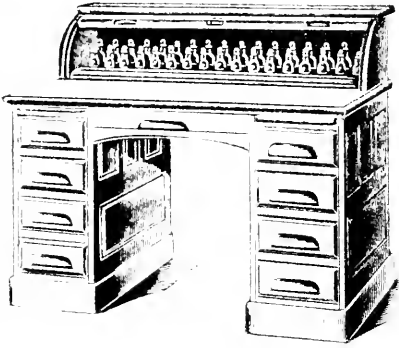

LABORATORY TABLE DESK

FINE QUARTERED OAK. FULL OFFICE SIZE.

THE problem of the Laboratory Table is still far from settled to the satisfaction of all, but all who have had an opportunity to work at one of these desks will be loth to try any other. The general construction is the same as of the Roll Top Office Desk, but modified to suit the requirements of the laboratory. There are thirty-four glass-stoppered reagent bottles in the top case, covered by a roller curtain with lock and key. The top of desk is plate glass. There are seven large side drawers for apparatus, the lower right deep for microscope; the upper left with receptacles for microscopic preparations.

PRICE, \$50.00.

BAUSCH & LOMB OPTICAL CO.

ROCHESTER, NEW YORK.

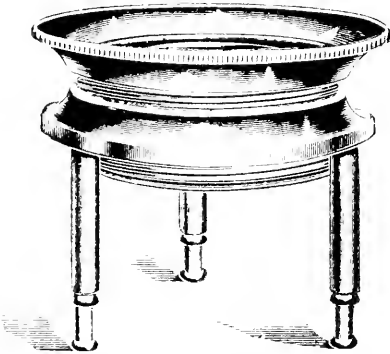

Q. R. M. A. S. H. E. R.

B O T A N Y C L A S S E S

puzzle the instructor as to what to recommend for an all-round

**MAGNIFYING GLASS AND
DISSECTING MICROSCOPE.**

THE Q. R. Magnifier has stood the test of time and offers many advantages where a low priced lens is required. It costs so little every student can afford one, and being adjustable for focus and having a large, clear field, with good magnifying power, serves the purpose of a pocket lens (with legs removed) and dissecting microscope.

Q. R., 50 CENTS. SPECIAL PRICES IN QUANTITY.

BAUSCH & LOMB OPTICAL CO.

ROCHESTER, NEW YORK.

Thornton-Pickard Shutters

THE GREAT THING ABOUT THESE SHUTTERS IS THAT THEY ADMIT MORE LIGHT, EXPOSE THE EDGES OF THE PLATE AS EVENLY AS THE CENTER, AND DO THE LENS NO INJURY BY JARRING. THEY ARE ROLLER CURTAIN SHUTTERS, SIMPLE IN CONSTRUCTION, RELIABLE IN ACTION, AND NOT LIKELY TO GET OUT OF REPAIR.

For general purposes, the **Time and Instantaneous**, either before the lens or behind the lens, is the best shutter made.

For very rapid work, **The Thornton-Pickard Focal Plane Shutter** is unapproached, works directly in front of the plate, passes an enormous quantity of light, and is the only shutter to do justice to the full powers of the fastest lenses. Very simple, reliable, and not easily put out of order.

Thornton-Pickard Catalogue free on application.

Andrew J. Lloyd & Co.,

324 Washington Street,
BOSTON.

The New Edition of our Encyclopædia will be ready about May 10th.
Send 20 Cents and it will be sent promptly when issued.

“A Finger Touch Finds the Reference”

IN THE

“Y & E” Card Index

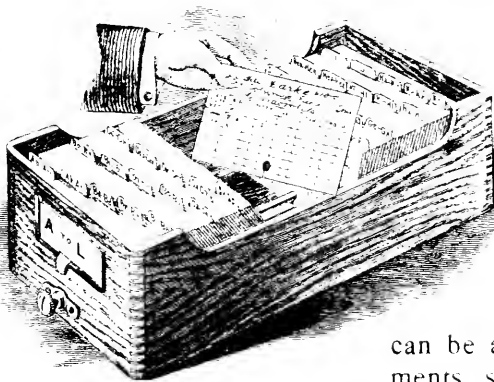

Adapted for use in any connection for any subject. If you want to know how it can be applied to your special requirements, send for our new catalogue No.

27-B. It illustrates and explains 35 different forms of records and gives complete information on the subject of card indexing.

Principal Branches :

Yawman & Erbe Mfg. Co.,

NEW YORK, 360 Broadway.

CHICAGO, 138 Wabash Ave.

SAN FRANCISCO, 29 New Montgomery St.

Factories and Main Offices: Rochester, N. Y.

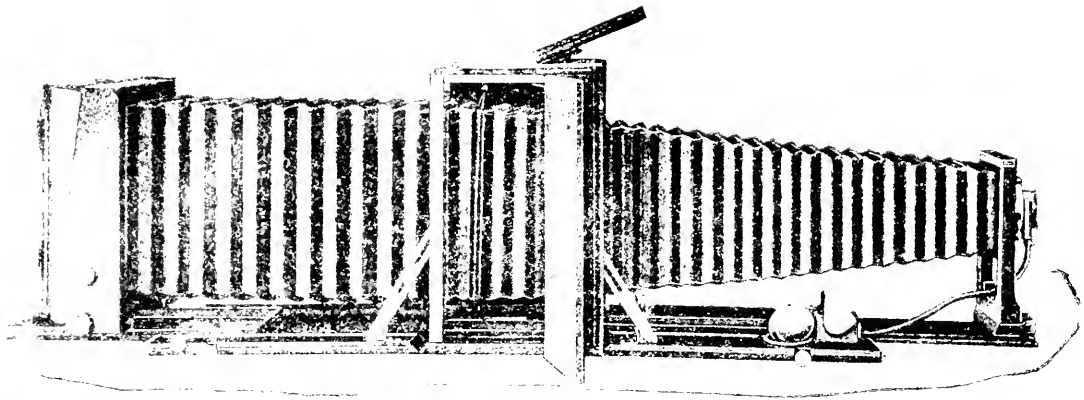

PREMO AND POCO CAMERAS

The recognized standard high-grade Cameras of the world, have been reduced in price 25 to 50 per cent. Our increased facilities have made this reduction possible.

New Ideas and New Features

Especially adapted for scientific photography have been introduced, making both the PREMO and POCO Cameras the best and most practical instruments ever constructed.

Write for complete Art Catalogue, describing this entire line.

ROCHESTER OPTICAL & CAMERA CO.,

SCIENTIFIC DEPARTMENT.

ROCHESTER, N. Y., U. S. A.

Journal of Applied Microscopy and Laboratory Methods

Vol. IV

May, 1901

No. 5

LEADING SUBJECTS

| | |
|--|------|
| The University of Montana Biological Station. MORTON J. ELROD, University of Montana. | 1269 |
| The Marine Biological Laboratory at Cold Spring Harbor, L. I. H. S. PRATT, Haverford College. | 1279 |
| A Method for Injecting Small Vessels. LEON J. COLE, University of Michigan. | 1282 |
| Laboratory Photography. The Photo-Micrography of Tissues with Simple Apparatus. W. H. WALMSLEY. | 1283 |
| Combined Ureometer and Saccharometer. A. ROBIN, M. D. | 1286 |
| Micro-Chemical Analysis XIII. Strontium, Barium. E. M. CHAMOT, Cornell University. | 1289 |
| A Simple Washing Device. ROBERT G. LEAVITT. | 1297 |
| Current Botanical Literature. CHARLES J. CHAMBERLAIN, University of Chicago. | 1299 |
| Cytology, Embryology and Microscopical Methods. AGNES M. CLAYPOLE, Cornell University. | 1301 |
| Normal and Pathological Histology. JOSEPH H. PRATT, Harvard University Medical School. | 1304 |
| General Physiology. RAYMOND PEARL, University of Michigan. | 1307 |
| Current Bacteriological Literature. H. W. CONN, Wesleyan University. | 1310 |
| Notes on Recent Mineralogical Literature. ALFRED J. MOSES, LEA McI. LUQUER. | 1312 |
| Medical Notes. | 1314 |
| News and Notes. | 1315 |
| Question Box. | 1316 |

Publication Department BAUSCH & LOMB OPTICAL CO., Rochester, N. Y.

Entered at the Post Office at Rochester, N. Y., as Second-Class Matter.

For Hawaiian Islands: Hoffstetter Drug Company, Honolulu.

For New South Wales: Turner & Henderson, 16 and 18 Hunter Street, Sydney.

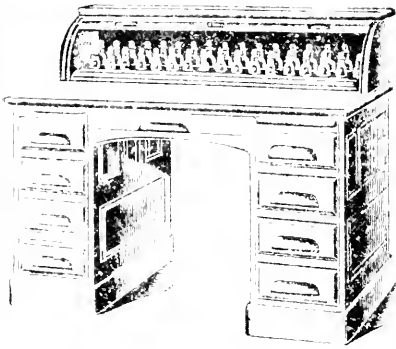

LABORATORY TABLE DESK

FINE QUARTERED OAK. FULL OFFICE SIZE.

THE problem of the Laboratory Table is still far from settled to the satisfaction of all, but all who have had an opportunity to work at one of these desks will be loth to try any other. The general construction is the

same as of a fine Roll Top Office Desk, but modified to suit the requirements of the laboratory. There are thirty-four glass-stoppered reagent bottles in the top case, covered by a roller curtain with lock and key. The top of desk is plate glass. There are seven large side drawers for apparatus; the lower right deep for microscope; the upper left with compartments for microscopic preparations.

PRICE, \$50.00.

BAUSCH & LOMB OPTICAL CO.

ROCHESTER, NEW YORK.

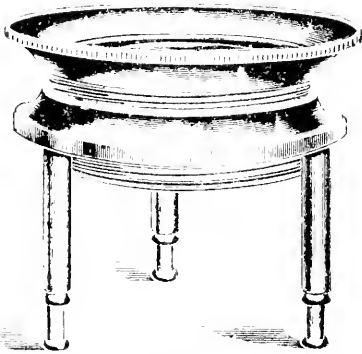

FIG. 154-10-11-12

B O T A N Y C L A S S E S

prized by instructor as to what to recommend for educational

**MAGNIFYING GLASS AND
DISSECTING MICROSCOPE.**

THE QR Magnifier has stood the test of time and offers many advantages where a low priced lens is required. It costs so little every student can afford one, and being adjust-

able for focus and having a large, clear field, with good magnifying power, serves the purpose of a pocket lens (with legs removed) and dissecting microscope.

QR, 50 CENTS. SPECIAL PRICES IN QUANTITY.

BAUSCH & LOMB OPTICAL CO.

ROCHESTER, NEW YORK.

Thornton-Pickard Shutters

THE GREAT THING ABOUT THESE SHUTTERS IS THAT THEY ADMIT MORE LIGHT, EXPOSE THE EDGES OF THE PLATE AS EVENLY AS THE CENTER, AND DO THE LENS NO INJURY BY JARRING. THEY ARE ROLLER CURTAIN SHUTTERS, SIMPLE IN CONSTRUCTION, RELIABLE IN ACTION, AND NOT LIKELY TO GET OUT OF REPAIR.

For general purposes, the **Time and Instantaneous**, either before the lens or behind the lens, is the best shutter made.

For very rapid work, **The Thornton-Pickard Focal Plane Shutter** is unapproached; works directly in front of the plate, passes an enormous quantity of light, and is the only shutter to do justice to the full powers of the fastest lenses. Very simple, reliable, and not easily put out of order.

Thornton-Pickard Catalogue free on application.

Andrew J. Lloyd & Co.,

**323 Washington Street,
BOSTON.**

The New Edition of our Encyclopædia will be ready about May 10th.
Send 20 Cents and it will be sent promptly when issued.

“A Finger Touch Finds the Reference”

IN THE

“Y & E” Card Index

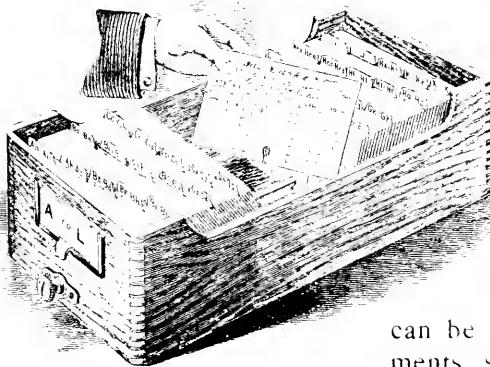

Adapted for use in any connection for any subject. If you want to know how it can be applied to your special requirements, send for our new catalogue No.

27-B. It illustrates and explains 35 different forms of records and gives complete information on the subject of card indexing.

Principal Branches :

NEW YORK, 360 Broadway.
CHICAGO, 138 Wabash Ave.
SAN FRANCISCO, 29 New Montgomery St.

Yawman & Erbe Mfg. Co.,

Factories and Main Offices : Rochester, N. Y.

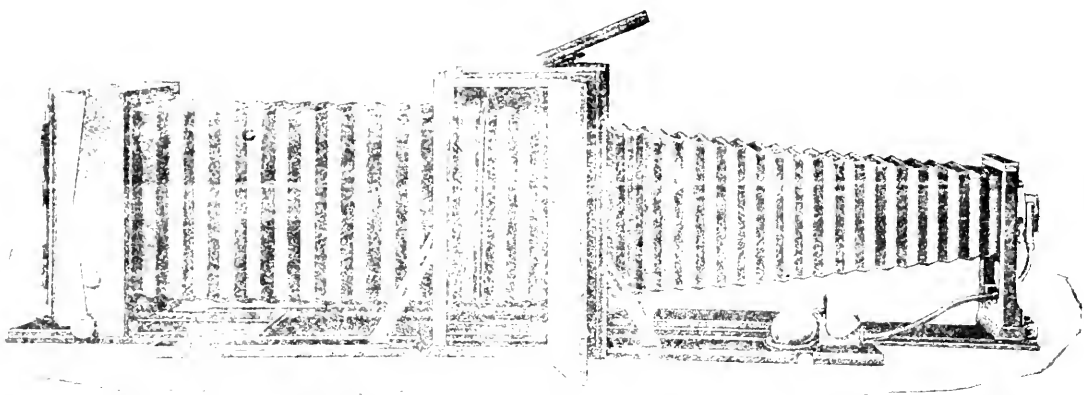

PREMO AND POCO CAMERAS

The recognized standard high-grade Cameras of the world, have been reduced in price 25 to 50 per cent. Our increased facilities have made this reduction possible.

New Ideas and New Features

Especially adapted for scientific photography have been introduced, making both the PREMO and POCO Cameras the best and most practical instruments ever constructed.

Write for complete Art Catalogue, describing this entire line.

ROCHESTER OPTICAL & CAMERA CO.,

SCIENTIFIC DEPARTMENT.

ROCHESTER, N. Y., U. S. A.

Journal of Applied Microscopy and Laboratory Methods

Vol. IV

June, 1901

No. 6

LEADING SUBJECTS

| | | |
|---|--|------|
| Improved Automatic Microtomes. | | |
| CHARLES S. MINOT, LL. D., Harvard University, | | 1317 |
| New Freezing Microtome for use with Carbon-Dioxide Tanks. | | |
| CHARLES R. BARDEEN, Johns Hopkins University, | | 1320 |
| Micro-Chemical Analysis, XIV. Barium. | | |
| E. M. CHAMOT, Cornell University, | | 1323 |
| Current Botanical Literature. | | |
| CHARLES J. CHAMBERLAIN, University of Chicago, | | 1332 |
| Cytology, Embryology and Microscopical Methods. | | |
| AGNES M. CLAYPOLE, Cornell University, | | 1334 |
| Current Zoölogical Literature. | | |
| CHARLES A. KOFOID, University of California, | | 1339 |
| Normal and Pathological Histology. | | |
| JOSEPH H. PRATT, Harvard University Medical School, | | 1341 |
| General Physiology. | | |
| RAYMOND PEARL, University of Michigan, | | 1343 |
| Current Bacteriological Literature. | | |
| H. W. CONN, Wesleyan University, | | 1347 |
| Notes on Recent Mineralogical Literature. | | |
| ALFRED J. MOSES, LEA McI. LUQUER, | | 1350 |
| Medical Notes, | | 1353 |
| News and Notes, | | 1354 |
| Question Box, | | 1356 |

Publication Department BAUSCH & LOMB OPTICAL CO., Rochester, N. Y.

Entered at the Post Office at Rochester, N. Y., as Second Class Matter.

For Hawaiian Islands: Hollister Drug Company, Honolulu.

For New South Wales: Turner & Henderson, 16 and 18 Hunter Street, Sydney.

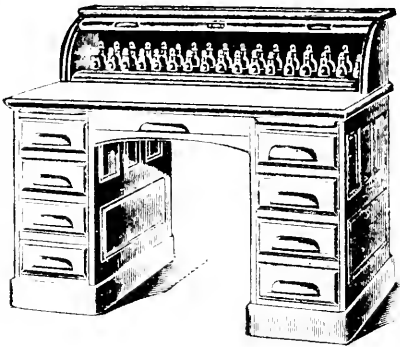

LABORATORY TABLE DESK

FINE QUARTERED OAK. FULL OFFICE SIZE.

THE problem of the Laboratory Table is still far from settled to the satisfaction of all, but all who have had an opportunity to work at one of these desks will be loth to try any other. The general construction is the same as of a fine Roll Top Office Desk, but modified to suit the requirements of the laboratory. There are thirty-four glass-stoppered reagent bottles in the top case, covered by a roller curtain with lock and key. The top of desk is plate glass. There are seven large side drawers for apparatus, the lower right deep for microscope; the upper left with receptacles for microscopic preparations.

PRICE, \$50.00.

BAUSCH & LOMB OPTICAL CO.
ROCHESTER, NEW YORK.

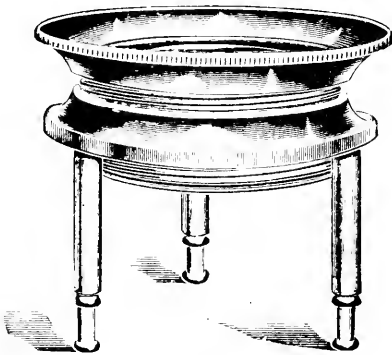

QR MAGNIFIER.

B O T A N Y C L A S S E S

puzzle the instructor as to what to recommend for an all-round

**MAGNIFYING GLASS AND
DISSECTING MICROSCOPE.**

THE QR Magnifier has stood the test of time and offers many advantages where a low priced lens is required. It costs so little every student can afford one, and being adjustable for focus and having a large, clear field, with good magnifying power, serves the purpose of a pocket lens (with legs removed) and dissecting microscope.

QR, 50 CENTS. SPECIAL PRICES IN QUANTITY.

BAUSCH & LOMB OPTICAL CO.
ROCHESTER, NEW YORK.

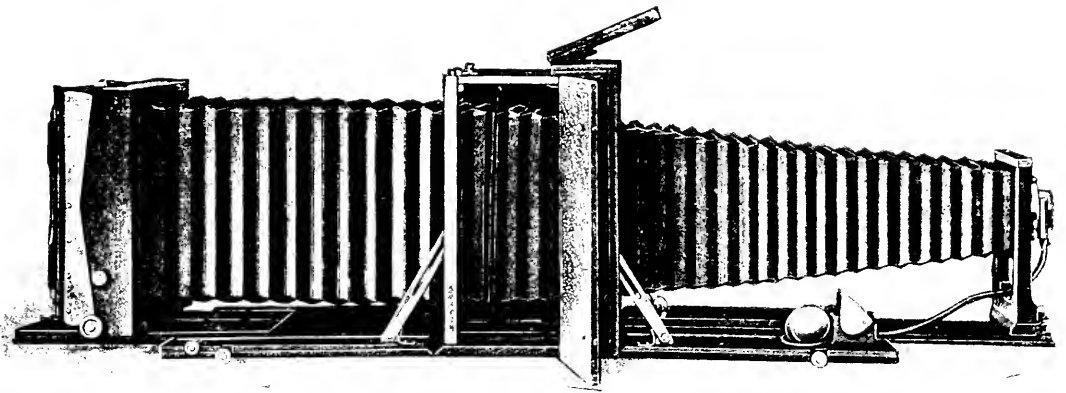

PREMO AND POCO CAMERAS

The recognized standard high-grade Cameras of the world, have been reduced in price 25 to 50 per cent. Our increased facilities have made this reduction possible.

New Ideas and New Features

Especially adapted for scientific photography have been introduced, making both the PREMO and POCO Cameras the best and most practical instruments ever constructed.

Write for complete Art Catalogue, describing this entire line.

ROCHESTER OPTICAL & CAMERA CO.,

SCIENTIFIC DEPARTMENT.

ROCHESTER, N. Y., U. S. A.

IN ALL THE WORLD NO TRIP LIKE THIS



TOUR OF THE GREAT LAKES ON THE FLOATING PALACES OF THE **NORTHERN STEAMSHIP COMPANY**

A new steamer and two sailings weekly service to Chicago, Milwaukee, and Harbor Springs, will be added to the regular Buffalo-Duluth service, which opens early in June.

For particulars regarding service and extended tours apply to

W. M. LOWRIE,
General Passenger Agent, Buffalo.

Journal of Applied Microscopy and Laboratory Methods

Vol. IV

July, 1901

No. 7

LEADING SUBJECTS

| | |
|--|------|
| The Value of Methylene Blue as an Intravital Stain in the Tunicata. GEORGE WILLIAM HUNTER, JR., DeWitt Clinton High School, | 1357 |
| Spermatozoa of Man, Domestic Animals and Rodents. L. NAPOLEON BOSTON, M. D., Philadelphia Hospital, | 1360 |
| An Improved Photo-Micrographic Apparatus. B. H. BUXTON, Cornell Medical College, | 1366 |
| Micro-Chemical Analysis, XV. Magnesium Group. E. M. CHAMOT, Cornell University, | 1373 |
| Current Botanical Literature. CHARLES J. CHAMBERLAIN, University of Chicago, | 1381 |
| Cytology, Embryology and Microscopical Methods. AGNES M. CLAYPOLE, Cornell University, | 1382 |
| Current Zoölogical Literature. CHARLES A. KOFOID, University of California, | 1385 |
| Normal and Pathological Histology. JOSEPH H. PRATT, Harvard University Medical School, | 1387 |
| Current Bacteriological Literature. H. W. CONN, Wesleyan University, | 1391 |
| Notes on Recent Mineralogical Literature. ALFRED J. MOSES, and LEA McI. LUQUER, Columbia University, | 1393 |
| Medical Notes, Methods for Staining Tubercle Bacilli, | 1395 |
| News and Notes, | 1395 |
| Question Box, | 1396 |

Publication Department BAUSCH & LOMB OPTICAL CO., Rochester, N. Y.

Entered at the Post Office at Rochester, N. Y., as Second Class Matter

For Hawaiian Islands: Hollister Drug Company, Honolulu.

For New South Wales: Turner & Henderson, 10 and 18 Hunter Street, Sydney.

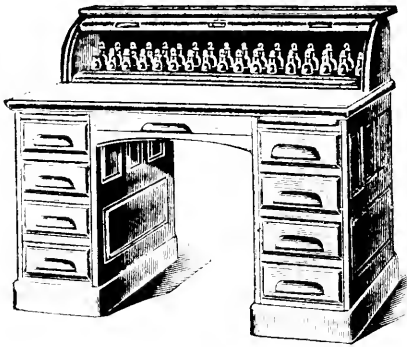

LABORATORY TABLE DESK

FINE QUARTERED OAK. FULL OFFICE SIZE.

THE problem of the Laboratory Table is still far from settled to the satisfaction of all, but all who have had an opportunity to work at one of these desks will be loth to try any other. The general construction is the same as of a fine Roll Top Office Desk, but modified to suit the requirements of the laboratory. There are thirty-four glass-stoppered reagent bottles in the top case, covered by a roller curtain with lock and key. The top of desk is plate glass. There are seven large side drawers for apparatus, the lower right deep for microscope; the upper left with receptacles for microscopic preparations.

PRICE, \$50.00.

BAUSCH & LOMB OPTICAL CO.
ROCHESTER, NEW YORK.

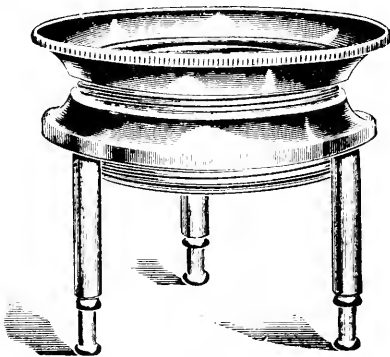

QR MAGNIFIER.

BOTANY CLASSES

puzzle the instructor as to what to recommend for an all-around

**MAGNIFYING GLASS AND
DISSECTING MICROSCOPE.**

THE QR Magnifier has stood the test of time and offers many advantages where a low priced lens is required. It costs so little every student can afford one, and being adjustable for focus and having a large, clear field, with good magnifying power, serves the purpose of a pocket lens (with legs removed) and dissecting microscope.

QR, 50 CENTS. SPECIAL PRICES IN QUANTITY.

BAUSCH & LOMB OPTICAL CO.
ROCHESTER, NEW YORK.

PREMO AND POCO CAMERAS

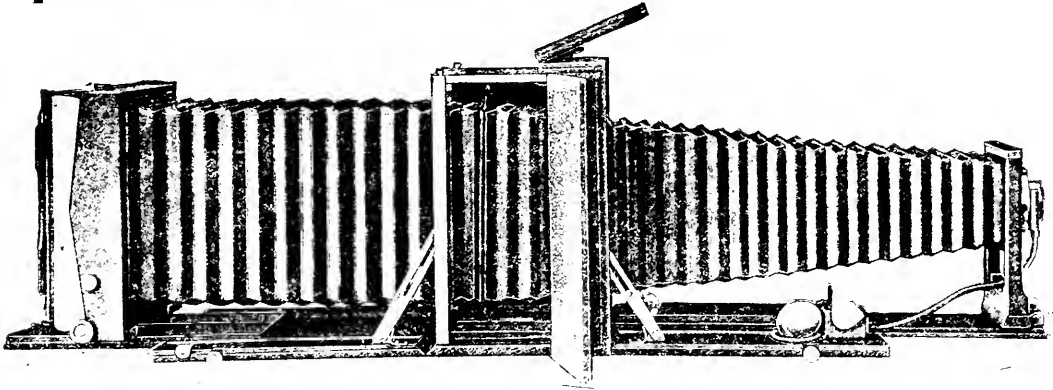

NEW IDEAS AND NEW FEATURES

The recognized standard high-grade Cameras of the world, and the world's greatest Cameras, especially adapted for scientific photography have been introduced, making both the PREMO and POCO CAMERAS the best and most practical instruments ever constructed. * * * *

WRITE FOR COMPLETE ART CATALOGUE,
DESCRIBING THIS ENTIRE LINE.

ROCHESTER OPTICAL & CAMERA CO.

SCIENTIFIC DEPT

ROCHESTER, N. Y., U. S. A.

IN ALL THE WORLD NO TRIP LIKE THIS

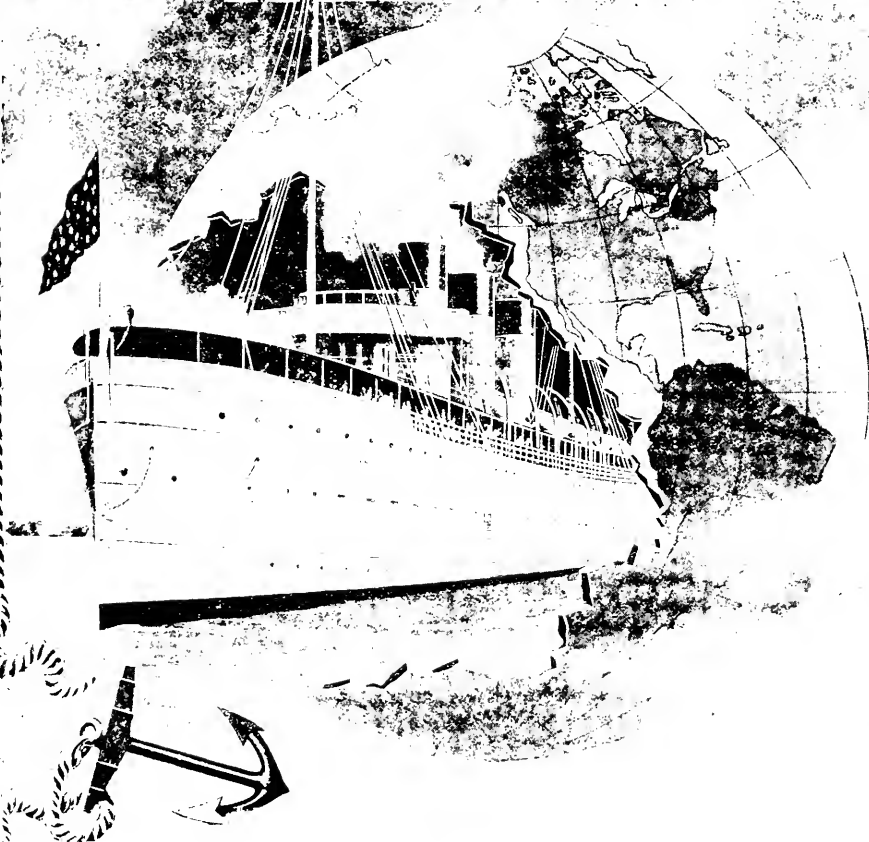

TOUR OF THE GREAT LAKES ON THE FLOATING PALACES OF THE **NORTHERN STEAMSHIP COMPANY**

A new steamer and two sailings weekly service to Chicago, Milwaukee, and Harbor Springs, will be added to the regular Buffalo-Duluth service, which opens early in June.

For particulars regarding service and extended tours apply to

W. M. LOWRIE,

General Passenger Agent, Buffalo.

Journal of Applied Microscopy and Laboratory Methods

Vol. IV

August, 1901

No. 8

LEADING SUBJECTS

| | |
|--|------|
| Table of Specific Gravities of Saturated Solutions and Solubilities of Anilin Stains. LOUIS LEROY, Vanderbilt University, | 1397 |
| Laboratory Photography. Photomicrography. D. W. DENNIS, Earlham College, | 1399 |
| Notes on Testing for B. Coli in Water. STEPHEN DeM. GAGE, Lawrence Experiment Station, | 1403 |
| The Cone Net. E. A. BIRGE, University of Wisconsin, | 1405 |
| A Modification of the Birge Collecting Net. ROBT. H. WOLCOTT, University of Nebraska, | 1407 |
| A Method of Determining the Comparative Gravity of Alcohol when Dehydrating by Osmosis. R. P. WOODFORD, | 1409 |
| Current Botanical Literature. CHARLES J. CHAMBERLAIN, University of Chicago, | 1411 |
| Cytology, Embryology and Microscopical Methods. AGNES M. CLAYPOLE, Cornell University, | 1414 |
| Current Zoological Literature. CHARLES A. KOFOID, University of California, | 1415 |
| Normal and Pathological Histology. JOSEPH H. PRATT, Harvard University Medical School, | 1421 |
| General Physiology. RAYMOND PEARL, University of Michigan, | 1423 |
| Current Bacteriological Literature. H. W. CONN, Wesleyan University, | 1427 |
| Notes on Recent Mineralogical Literature. ALFRED J. MOSES and LEA Mel. LUQUER, Columbia Uni- versity, | 1431 |
| Medical Notes, | 1434 |
| News and Notes, | 1435 |
| Question Box, | 1436 |

Publication Department BAUSCH & LOMB OPTICAL CO., Rochester, N. Y.

Published at the Post Office at Rochester, N. Y., as Second Class Matter.

For Hawaiian Islands: Hollister Drug Company, Honolulu.

For New South Wales: Turner & Henderson, 16 and 18 Hunter Street, Sydney.

MINOT AUTOMATIC PRECISION MICROTOME

Cuts Paraffin or
Celloidin Equally Well.

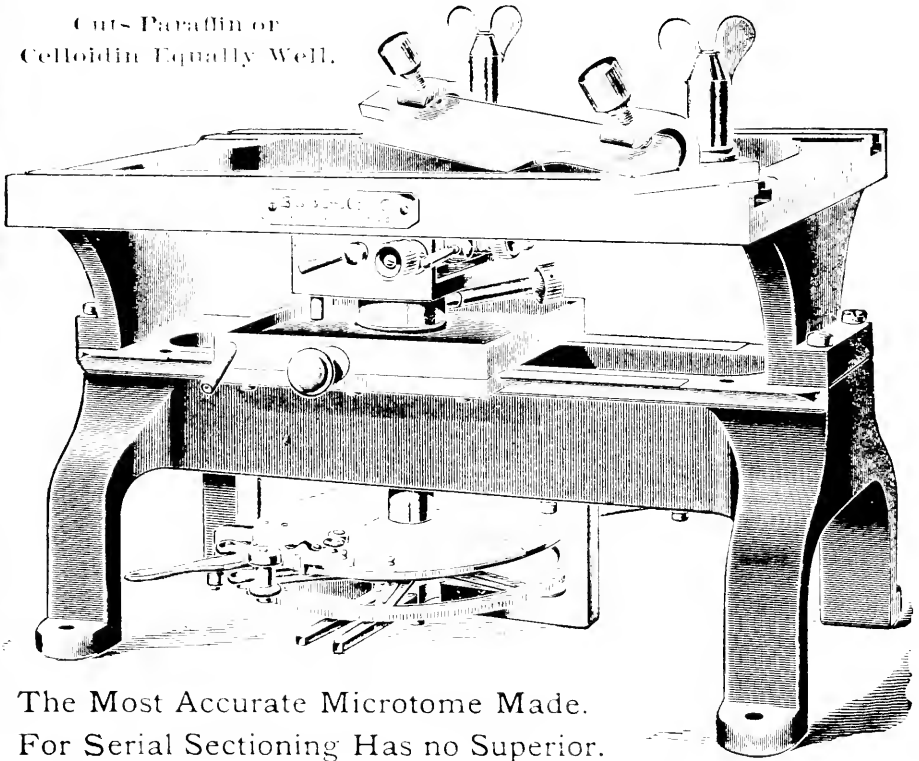

The Most Accurate Microtome Made.
For Serial Sectioning Has no Superior.

OUR NEW CATALOGUE OF MICROTOMES and accessories contains full descriptions of an entire new line of Microtomes and is illustrated with photographic reproductions of the instruments, showing all details. Mailed free.

Bausch & Lomb Optical Co., Rochester, N. Y.

NEW YORK.
CHICAGO.

PREMO AND POCO CAMERAS

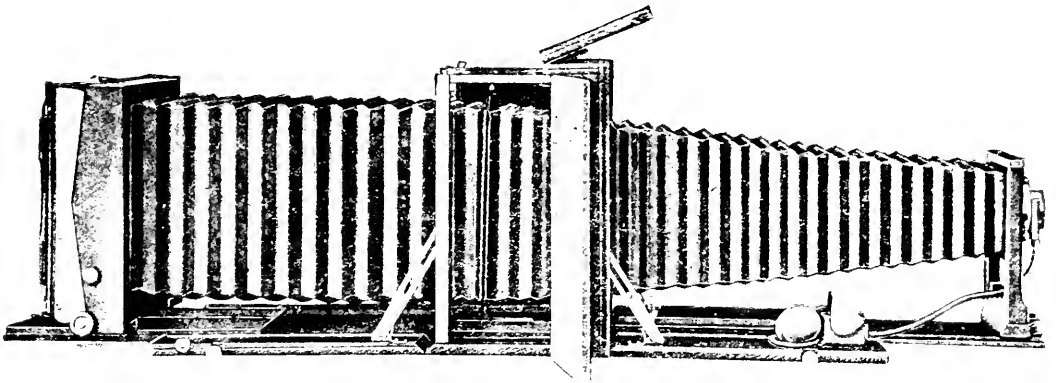

NEW IDEAS AND NEW FEATURES

The recognized standard high-grade Cameras of the world, and the world's greatest Cameras, especially adapted for scientific photography have been introduced, making both the PREMO and POCO CAMERAS the best and most practical instruments ever constructed. * * *

WRITE FOR COMPLETE ART CATALOGUE,
DESCRIBING THIS ENTIRE LINE.

ROCHESTER OPTICAL & CAMERA CO.

SCIENTIFIC DEPT.

ROCHESTER, N. Y., U. S. A.

IN ALL THE WORLD NO TRIP LIKE THIS

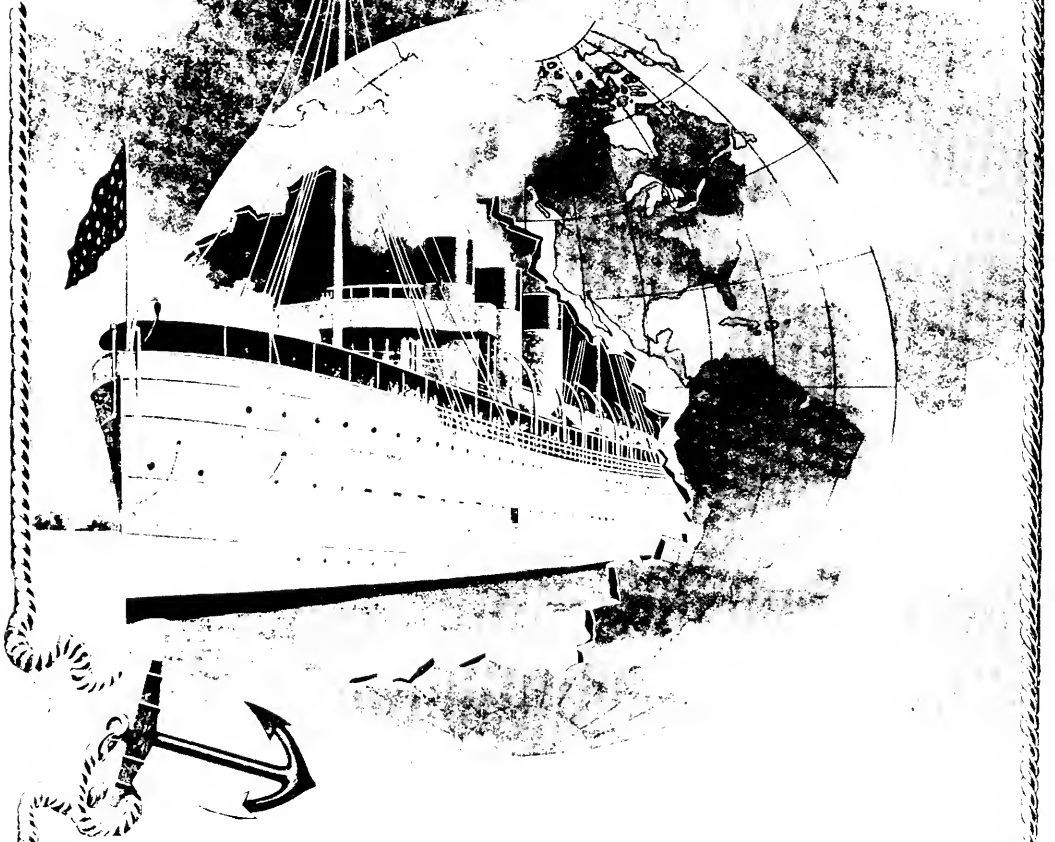

TOUR OF THE GREAT LAKES ON THE FLOATING PALACES OF THE
NORTHERN STEAMSHIP COMPANY

A new steamer and two sailings weekly service to Chicago, Milwaukee, and Harbor Springs, will be added to the regular Buffalo-Duluth service, which opens early in June.

For particulars regarding service and extended tours apply to

W. M. LOWRIE,
General Passenger Agent, Buffalo.

Journal of Applied Microscopy and Laboratory Methods

Vol. IV

September, 1901

No. 9

LEADING SUBJECTS

| | |
|---|------|
| Laboratory Courses by Correspondence. CHARLES J. CHAMBERLAIN, University of Chicago, | 1437 |
| Laboratory Photography: Photographing Diatoms. P. C. MYERS, University of Iowa, | 1439 |
| The 5 mm. Apochromat, after Prof. Charles S. Hastings in the Photog- raphy of Diatoms, | 1442 |
| The New Medical Laboratories of the University of Pennsylvania. SIMON FLEXNER, University of Pennsylvania, | 1445 |
| Magnifiers. J. DEARNESS, London Normal School, London, Canada, | 1448 |
| A New Thermo-Regulator. THOMAS PALMER, | 1449 |
| A Rapid Method of Making Slides of Amoeba. M. A. WILLCOX, Wellesley College, | 1450 |
| Micro-chemical Analysis, XVI, Zinc, Cadmium. E. M. CHAMOT, Cornell University, | 1451 |
| Device for Leveling the Microscope. T. O. REYNOLDS, | 1458 |
| Current Botanical Literature. CHARLES J. CHAMBERLAIN, University of Chicago, | 1460 |
| Cytology, Embryology and Microscopical Methods. AGNES M. CLAYPOLE, Cornell University, | 1462 |
| Current Zoological Literature. CHARLES A. KOFOID, University of California, | 1465 |
| Normal and Pathological Histology. JOSEPH H. PRATT, Harvard University Medical School, | 1468 |
| General Physiology. RAYMOND PEARL, University of Michigan, | 1470 |
| Current Bacteriological Literature. H. W. CONN, Wesleyan University, | 1472 |
| Notes on Recent Mineralogical Literature. ALFRED J. MOSES and LEA McI. LUQUER, Columbia Univ. | 1474 |
| Medical Notes, | 1476 |

Publication Department BAUSCH & LOMB OPTICAL CO., Rochester, N. Y.

Entered at the Post Office at Rochester, N. Y. as Second Class Matter

Automatic Laboratory Microtome

A PRACTICAL LABORATORY INSTRUMENT.

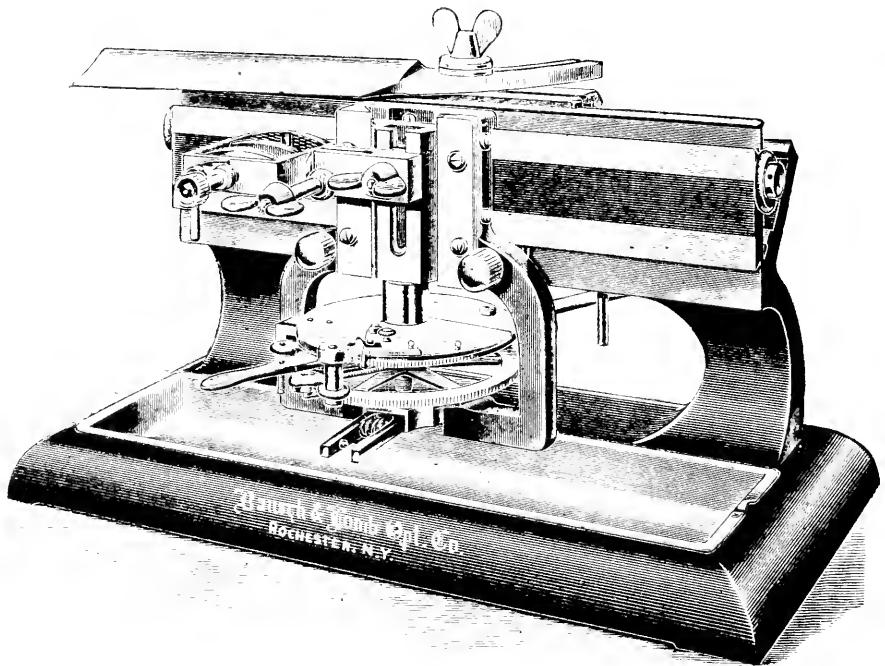

Cuts Paraffin or Celloidin Material
equally well.

Cuts any thickness from two to sixty
Microns.

Has all Adjustments for orienting
large and small objects required.

Moderate in price.

OUR NEW CATALOGUE

describes a complete new series of Microtomes of several different styles, all entirely remodeled and representing the highest mechanical attainments in construction. * Photographic illustrations show each in detail. Mailed free.

Bausch & Lomb Optical Co.,

ROCHESTER, N. Y.

NEW YORK.

CHICAGO.

MINOT AUTOMATIC PRECISION MICROTOME

Cuts Paraffin or
Celloidin Equally Well.

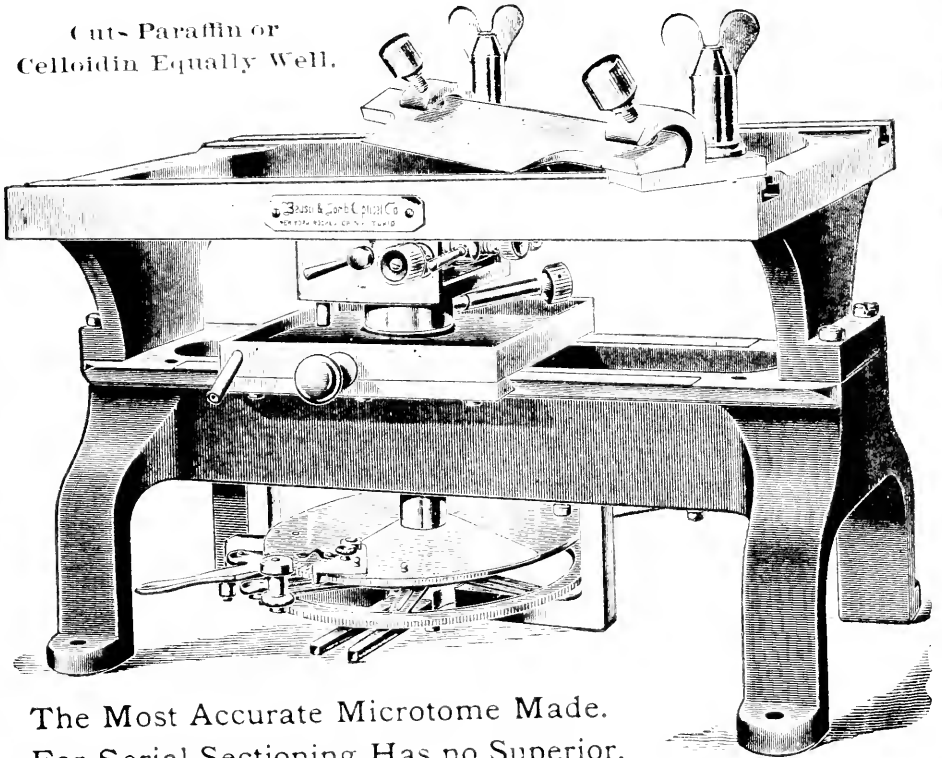

The Most Accurate Microtome Made.
For Serial Sectioning Has no Superior.

OUR NEW CATALOGUE OF MICROTOMES and accessories contains full descriptions of an entire new line of Microtomes and is illustrated with photographic reproductions of the instruments, showing all details. Mailed free.

Bausch & Lomb Optical Co., Rochester, N. Y.

NEW YORK.
CHICAGO.

PREMO AND POCO CAMERAS

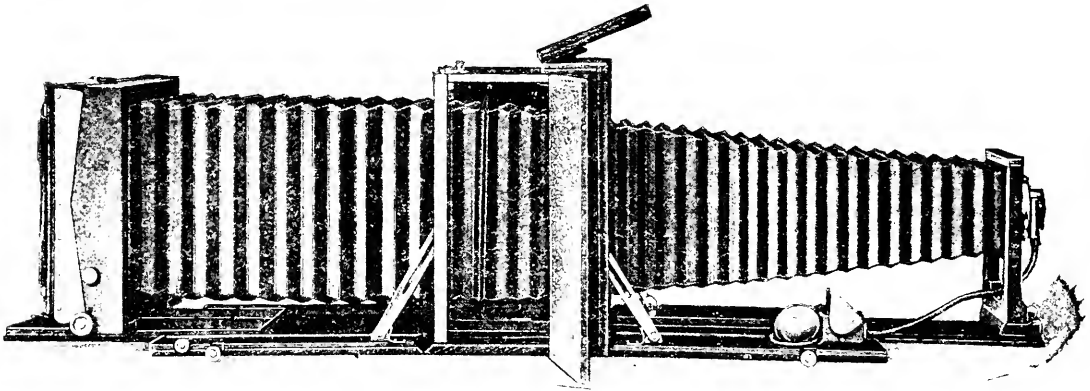

NEW IDEAS AND NEW FEATURES

The recognized standard high-grade Cameras of the world, and the world's greatest Cameras, especially adapted for scientific photography have been introduced, making both the PREMO and POCO CAMERAS the best and most practical instruments ever constructed. * * * *

WRITE FOR COMPLETE ART CATALOGUE,
DESCRIBING THIS ENTIRE LINE.

ROCHESTER OPTICAL & CAMERA CO.

SCIENTIFIC DEPT.

ROCHESTER, N. Y., U. S. A.

Journal of Applied Microscopy and Laboratory Methods

Vol. IV

October, 1911

No. 10

LEADING SUBJECTS

| | |
|---|------------|
| The Botanical Laboratory and the Botanical Garden of the Toyo University, Japan. KIICHI MIYAKE, Cornell University, Ithaca, N. Y. | 477 |
| The Course of Study in Invertebrate Zoology in the Marine Biology Laboratory at Wood's Hole. CASWELL GRAVE, Johns Hopkins University | 481 |
| Botany at the Biological Laboratory at Wood's Hole. C. H. SHAW, Temple College. | 486 |
| Laboratory Photography: The Ortol Developer. R. P. WOODFORD, University of Michigan | 487 |
| Contributions to Our Knowledge of Color in Photomicrography. Kresylechitiolet. | 489 |
| RALPH L. MORSE, University of Michigan | 492 |
| Micro-Chemical Analysis, XVII, Magnesium Group-Separations. E. M. CHAMOT, Cornell University | 495 |
| A Damp Chamber for Use on the Kibrostatt. HOWARD S. REED, University of Michigan | 499 |
| Current Botanical Literature. CHARLES J. CHAMBERLAIN, University of Chicago | 502 |
| Cytology, Embryology and Microscopical Methods. AGNES M. CLAYPOLE, Cornell University | 504 |
| Current Zoological Literature. CHARLES A. KOFOID, University of California | 506 |
| Normal and Pathological Histology. JOSEPH H. PRATT, Harvard University Medical School | 508 |
| General Physiology. RAYMOND PEARL, University of Michigan | 510 |
| Notes on Recent Mineralogical Literature. ALFRED J. MOSES and LEA M. LUQUER, Columbia Univ. | 513 |
| Medical Notes, News and Notes, | 514 516 |
| Question Box, | 516 |

Publication Department BAUSCH & LOMB OPTICAL CO., Rochester, N. Y.

Entered for the Post Office at Rochester, N. Y., as Second-Class Matter.

Your "Magazine-Money"

and how best to spend it

It is the purpose of this special plan to make it possible for you to enjoy the most valuable and interesting magazines at a price that is well within the reach of every pocket. The ten most popular magazines of the year have been selected, based on a year's subscription statistics. The result of this survey is now open to the public in the following special combination offers, by which you may obtain **FOUR MAGAZINES** at the price of **ONE**.

LAST YEAR more than 300,000 people took advantage of our remarkable clubbing offers.

GREAT FAMILY OFFER

For
Father,
Mother
and the
Boys
and
Girls

| | | |
|-----------------------------|---------------|--------|
| Success | Regular Price | \$1.00 |
| Review of Reviews (new) | | 2.50 |
| | | 3.00 |
| Frank Leslie's Pop. Monthly | | 1.00 |
| The Designer | | 1.00 |

Total Value
\$6
Our Price
\$3

ALL SUBSCRIPTIONS are for a FULL YEAR and may be sent to one or several addresses. Foreign postage extra. SUCCESS, REVIEW OF REVIEWS, CURRENT LITERATURE, THE COSMOPOLITAN, THE DESIGNER, THE HOUSEHOLD, THE NEW ENGLAND MAGAZINE, FRANK LESLIE'S POPULAR MONTHLY.

Review of Reviews - The Cosmopolitan
The Household - Leslie's Current Literature

OTHER ATTRACTIVE OFFERS...

| | | | | |
|--|---------------|--------|-----------|--------|
| SUCCESS and any one of our dollar magazines | Regular Price | \$2.00 | Our Price | \$1.50 |
| SUCCESS and any two of our dollar magazines | | 3.00 | | 2.00 |
| SUCCESS and any three of our dollar magazines | | 4.00 | | 2.50 |
| SUCCESS and LESLIE'S WEEKLY | | 5.00 | | 2.75 |
| SUCCESS Current Lit. (new) and any two of our dollar magazines | | 6.00 | | 3.00 |
| SUCCESS Review of Reviews (new) and Current Literature (new) | | 6.50 | | 3.00 |
| SUCCESS REVIEW OF REVIEWS (new) and LESLIE'S WEEKLY | | 7.50 | | 3.75 |
| SUCCESS Review of Reviews (new), Current Literature (new) and New England Magazine | | 9.50 | | 4.00 |

New subscriptions only will receive the above prices. Review of Reviews, Current Literature, North American Review.

Our Great Educational Offer:: \$12.00

| | |
|--------------------------|---------------|
| SUCCESS | \$1.00 |
| Review of Reviews (new) | 2.50 |
| Current Literature (new) | 3.00 |
| North Am. Review (new) | 5.00 |
| | \$5.00 |

North American Review
Magazine
Good Housekeeping
Weekly
The Designer
The New England Magazine
Leslie's

Substitutions:

Review of Reviews, Current Literature, New England Magazine, The Cosmopolitan, Leslie's Monthly, Good Housekeeping, The Designer, Household

Send in early in the season.

The Success Company

60 University Building - Washington Square, NEW YORK

*Remarkable Colored Plates
Photographed from the Insects themselves*

The Insect Book

By Dr. L. O. HOWARD

Chief of Division of Entomology, Dept. of Agriculture.

A POPULAR description by the foremost authority on this country of the Bees, Wasps, Ants, Grasshoppers, Flies, and other insects of North America. It contains full life histories, giving an intimate account of the most wonderful feats of the insect world around us, which is so important to our agriculture and so interesting. There is today almost nothing that excites so authoritatively, yet popularly, the vast field, so that the present volume is of special importance. Unfamiliar with our other "Nature Study" books.



CUT
THIS
OUT
AND
MAIL
TO US
WITH
\$3.00

DOUBLEDAY, PAGE & CO.,

34 Union Square, New York.

Please find enclosed three dollars (\$3.00)
for which send me postpaid one copy Howard's
"THE INSECT BOOK."

Name...

Address

City, State and Zip 1901.

16 Colored Plates; 32 Full-Page Half-Tones and
about 300 Text Cuts. Price, net, \$3.00.

DOUBLEDAY, PAGE & COMPANY

34 UNION SQUARE, NEW YORK.

HARPER & BROTHERS'

NEW EDITION OF SIR WALTER SCOTT'S

WAVERLEY NOVELS

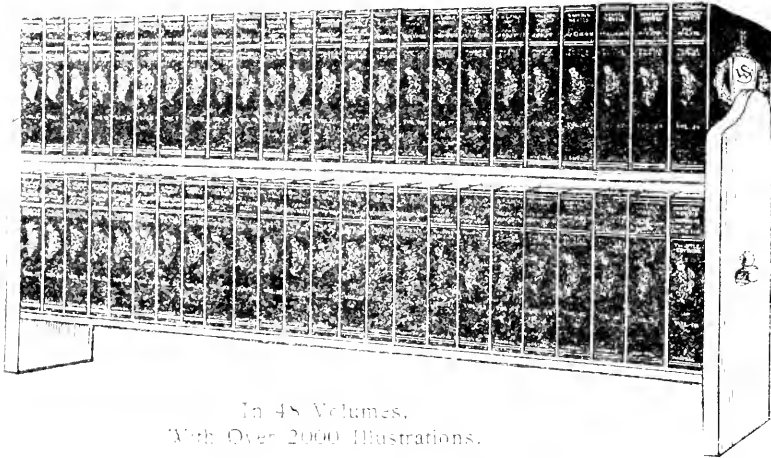

In 48 Volumes,
With Over 2000 Illustrations.

Forty-eight Volumes will be sent to you on receipt of **\$2**

Payment thereafter to be at the rate of \$2.00 per month for 11 months; cost to you per volume, 50 cents.

SCOTT'S classic books will be read as long as the English language endures, combining, as they do, the thrilling interest of romance with historical instruction. No library is a library without them. Here are some facts about this great offer:

1. There are forty-eight separate books in the set.
2. They occupy over four feet of space in a row. Size of cover, 5 X 7 1/2 inches.
3. Each volume contains many pictures—there are over 2000 illustrations in all.
4. The books are printed on fine paper from large, new type.
5. They are bound in excellent cloth in permanent style, and should last a century.

Our Offer: We will send you the entire set of forty-eight volumes, charges prepaid, on receipt of \$2.00. If you do not like the books when they reach you, send us back all in exchange, and we will return the \$2.00. If you do like them, send us \$2.00 a month for the next 11 months. In order to keep you in touch with us during these months, on receipt of your request for these books, we will enter you as a subscriber to either HARPER'S MAGAZINE, HARPER'S WEEKLY, or HARPER'S PULP, for one year, without any additional cost to you. In writing, state which periodical you want. If you select the Bazar, a 20-page cloth-bound book on beauty, "The Ugly Girl Papers," will be added free. A dress.

HARPER & BROTHERS, FRANKLIN SQUARE, NEW YORK CITY.

This same set is also bound in half-leather, with gold stamping on side and back. The price in this binding is \$48. It will be sent on the same terms for \$4 a month.

Journal of Applied Microscopy and Laboratory Methods

Vol. IV

November, 1901

No. 11

LEADING SUBJECTS

| | |
|---|------|
| Studying and Photographing the Wild Bird. FRANCIS H. HERRICK, Western Reserve University, | 1517 |
| A Few Remarks on the Technic of Blood Preparations. B. L. RAWLINS, | 1524 |
| Laboratory Photography: Photomicrography, II. An Apparatus Adapted to all Kinds of Work. D. W. DENNIS, Earlham College, | 1525 |
| Staining Bacteria in the Root Tubercles of Leguminous Plants. GEORGE J. PEIRCE, Leland Stanford Jr. University, | 1528 |
| Micro-Chemical Analysis, XVIII. E. M. CHAMOT, Cornell University, | 1529 |
| Current Botanical Literature. CHARLES J. CHAMBERLAIN, University of Chicago, | 1535 |
| Cytology, Embryology and Microscopical Methods. AGNES M. CLAYPOLE, Cornell University, | 1537 |
| Current Zoological Literature. CHARLES A. KOFOID, University of California, | 1541 |
| Normal and Pathological Histology. JOSEPH H. PRATT, Harvard University Medical School, | 1544 |
| General Physiology. RAYMOND PEARL, University of Michigan, | 1546 |
| Current Bacteriological Literature. H. W. CONN, Wesleyan University, | 1548 |
| Notes on Recent Mineralogical Literature. ALFRED J. MOSES and LEA McI. LUQUER, Columbia Univ. | 1553 |

Publication Department BAUSCH & LOMB OPTICAL CO., Rochester, N. Y.

Entered at the Post Office at Rochester, N. Y., as Second Class Matter

New Ideas and New Features

PREMO AND POCO CAMERAS

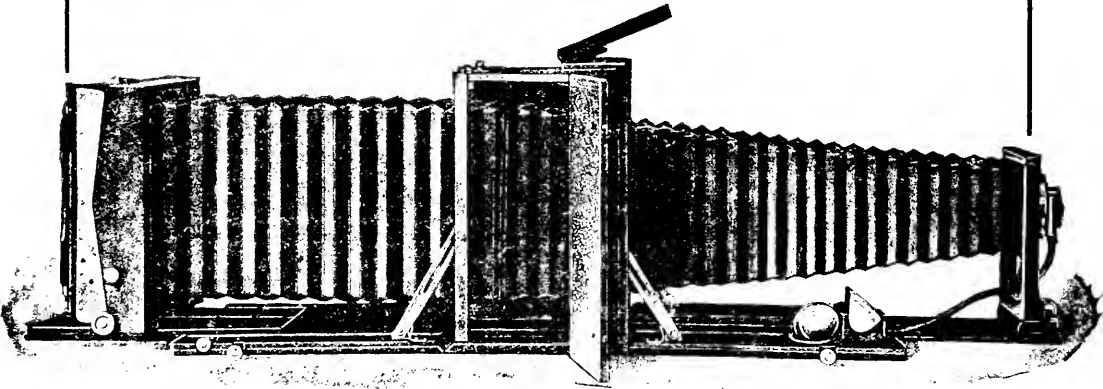

THE recognized high-grade Cameras of the world, and the world's greatest Cameras, especially adapted for scientific photography, making both the PREMO and POCO CAMERAS the best and most practical instruments ever constructed.

WRITE FOR COMPLETE ART CATALOGUE DESCRIBING THIS ENTIRE LINE.

ROCHESTER OPTICAL AND CAMERA CO.

Scientific Department.

ROCHESTER, N. Y., U. S. A.

The Ideal Enlarging Lanterns

THESE LANTERNS represent the latest and most improved invention in the Photographic Art. They are optically and mechanically perfect. By their use the operation of making Bromide Enlargements is simplified to the greatest degree. They can also be used as high grade

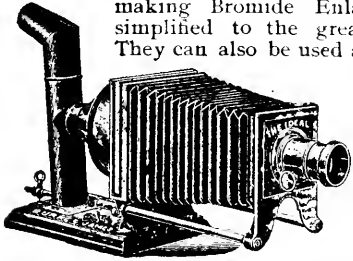

Lantern Slide projectors by the use of our Lantern Slide attachment.

The Ideal Enlarging Lanterns are

made in three sizes: No. 1, fitted with 6½-inch condensing lenses; No. 2, fitted with 8-inch condensing lenses; and No. 3, fitted with 10-inch condensing lenses.

We supply either size with incandescent gas light, incandescent electric light, electric arc light, or acetylene gas light.

Prices from \$25.00 up to \$84.00.

Send for our 1901 catalogue containing a complete list of everything pertaining to photography, including cameras, apparatus, lantern slide material, magic lanterns, stereopticons, etc.

BURKE & JAMES,

Manufacturers of Photographic Apparatus and Supplies, CHICAGO, ILL.

A CARD INDEX MAKES IT EASY

to catalogue any miscellaneous collection of material and keep it in shape for ready reference; to keep the bibliography of any subject or group of subjects up to date and in accessible form; to control the expenditure, stock and business transactions of the laboratory.

VETTER QUALITY

appeals especially to college men, as all our Cabinets, Filing Cases, Card Indexes, Desks, and Furniture for offices and libraries are built on honor and are built to last.

Write us your wants.

SEND
FOR
CATALOG
H

VETTER DESK WORKS

ROCHESTER, N. Y.

Laboratory Steam Sterilizers

FOR UNIVERSITIES AND COLLEGES.

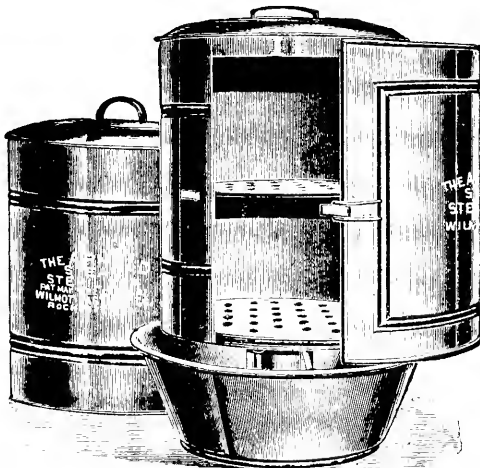

Improved Style with Side Door.

The Arnold Sterilizer,

illustrated on this page, is adapted for class work. It is inexpensive and a number of them can be purchased for a small outlay, thus permitting the use of one sterilizer for every two or three students.

COMPLETE CATALOGUE OF STERILIZERS

FOR ALL PURPOSES MAILED

ON APPLICATION.

WILMOT CASTLE & CO., 16 Elm St., Rochester, N. Y.

The Insect Book

By DR. L. O. HOWARD,

Chief of Division of Entomology, U. S. Department of Agriculture.

16 colored plates, 32 full-page half-tones and 300 text cuts illustrating hundreds of species.



A popular description by the foremost authority in this country of the Bees, Wasps, Ants, Grasshoppers, Flies, and other North American insects—exclusive of the Butterflies, Moths, and Beetles. It has full life histories, giving an intimate account of the most wonderful facts in that insect world all around us, which is so incompletely known, even by scientists. A man may go into a city park, and with patience and industry find insects never described by the entomologists. There is to-day almost nothing that covers authoritatively, yet popularly, this vast field, so that this volume has special importance.



The **INDEPENDENT** says: "It is refreshing to see an entomologist of such eminent standing ignore the most popular insects and devote his space to the less and little known orders. One noteworthy feature of 'The Insect Book' is its frequent direct indication of **fields wherein special study is likely to be well rewarded.**"

Other books in the "New Nature Library" are: The Butterfly Book, The Mushroom Book, Nature's Garden, Bird Homes, Birds That Hunt and are Hunted, and Bird Neighbors.

SIZE, 7 1/2 x 11 1/2 pages, about 400, binding, cloth, decorated, uniform with "Nature's Garden," and the other Nature Study books.

PRICE, NET.

\$3.00

*DOUBLEDAY, PAGE & CO.,
34 Union Square, New York.
Kindly send me **The Insect Book**, for which find enclosed \$3.00,
book to be returned if unsatisfactory.*

J. A. M.

Journal of Applied Microscopy and Laboratory Methods

Vol. IV

December, 1901

No. 12

LEADING SUBJECTS

| | |
|---|------|
| General Methods for the Study of the Nervous System. GILBERT L. HOUSER, University of Iowa, | 1557 |
| Method for Rearing Amoeba. MEL T. COOK, DePauw University, | 1566 |
| A Short Method for the Widal Test, | 1565 |
| The Arrangement of Cilia on Paramecium, | 1566 |
| Immersion Oil in Collapsible Tubes. CHARLES WRIGHT DODGE, University of Rochester. | 1567 |
| Laboratory Photography: Further Notes on the Use of the Telephoto Lens. MORTON J. ELROD, University of Montana, | 1568 |
| Current Botanical Literature. CHARLES J. CHAMBERLAIN, University of Chicago, | 1573 |
| Cytology, Embryology and Microscopical Methods. AGNES M. CLAYPOLE, Cornell University, | 1576 |
| Current Zoölogical Literature. CHARLES A. KOFOID, University of California, | 1578 |
| Normal and Pathological Histology. JOSEPH H. PRATT, Harvard University Medical School, | 1583 |
| General Physiology. RAYMOND PEARL, University of Michigan, | 1584 |
| Current Bacteriological Literature. H. W. CONN, Wesleyan University, | 1587 |
| Notes on Recent Mineralogical Literature. ALFRED J. MOSES and LEA McI. LUQUER, Columbia Univ. | 1589 |
| Medical Notes, | 1591 |
| News and Notes, | 1594 |
| Question Box, | 1596 |

Publication Department BAUSCH & LOMB OPTICAL CO., Rochester, N. Y.

Entered at the Post Office at Rochester, N. Y., as Second Class Matter.

For Hawaiian Islands: Hollister Drug Company, Honolulu.

For New South Wales: Turner & Henderson, 16 and 18 Hunter Street, Sydney.

New Ideas and New Features

PREMO AND POCO
CAMERAS

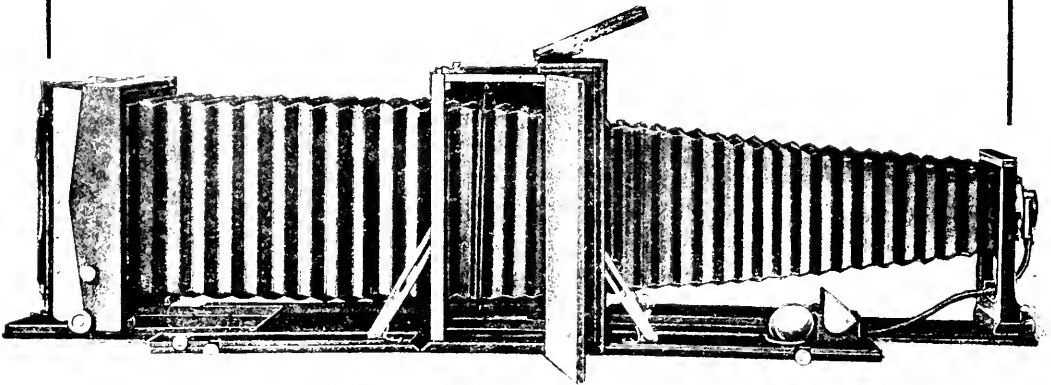

THE recognized standard high-grade Cameras of the world, and the world's greatest Cameras, especially adapted for scientific photography, making both the PREMO and POCO CAMERAS the best and most practical instruments ever constructed.

WRITE FOR COMPLETE ART CATALOGUE DESCRIBING THIS ENTIRE LINE.

**ROCHESTER OPTICAL
AND CAMERA CO.** 

Scientific Department.

ROCHESTER, N. Y., U. S. A.

VETTER

quality in office desks, files, cabinets, sectional filing cases, WILL PLEASE YOU.

The **Modern Laboratory**

is conducted on business principles, and its material, literature, and expenditures are classified and accessibly arranged. **THE CARD INDEX** is the modern way of classifying and making accessible.

Name of Article - Jars - Round Aquarium (1 Liter capacity).
From - Whitall Tatum Co. Barclay St. N.Y.
Address - 46, 48
Order No. - 113
Date of receipt of Articles - July 2, 1898
Remarks - used for waste jars and for water
DEPT. - Histology

Cost. \$ 6.00
No. of Pieces - 24
Inv. storied } 1898

NEW YORK STATE VETERINARY COLLEGE, CORNELL UNIVERSITY. Established 1879.

Send for Catalogue H.

We furnish cabinets and indexes adapted for every purpose, from the simplest to the most complex. We adapt them to YOUR SPECIAL CASE.

VETTER DESK WORKS, Rochester, N.Y.

Laboratory Steam Sterilizers

FOR UNIVERSITIES AND COLLEGES.

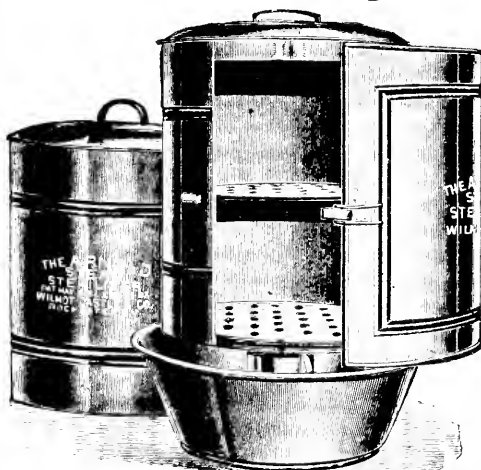

Improved Style with Side Door.

The Arnold Sterilizer, illustrated on this page, is adapted for class work. It is inexpensive and a number of them can be purchased for a small outlay, thus permitting the use of one sterilizer for every two or three students.

COMPLETE CATALOGUE OF STERILIZERS
FOR ALL PURPOSES MAILED
ON APPLICATION.

WILMOT CASTLE & CO., 16 Elm St., Rochester, N.Y.

ALASKA

ITS NATIVES,
BIRD AND ANIMAL LIFE,
TREES AND FLOWERS,
AND RESOURCES.

The Results of the Harriman Alaska Expedition. Published with the cooperation of the Washington Academy of Sciences.

By
John Burroughs, W. H. Brewer, William Healey Dall, Bernhard E. Fernow, Henry Gannett, Geo. Bird Grinnell, Charles Keeler, C. Hart Merriam, John Muir, M. L. Washburn.



An Epoch Making
Work of
Scientific Travel
with 40 Superb
Colored Plates,
85 Photogravures,
300 Text Drawings
and 5 Maps.
2 Vols.
\$15.00 NET.

WHAT THE
BOOK IS.

WHAT IS
SAID OF IT.

This work contains, in popular form, the results of the expedition sent in 1899, by Mr. Edward H. Harriman, to this land of fogs, glaciers, volcanoes, seals, and gold.

The twenty-five eminent scientists made extensive collections in their various branches of research; no less than twenty-six new species of mammals were discovered, and the results in other branches of zoology, in botany, ornithology, geology, etc., were almost as important. Many new glaciers, and a large fjord, hitherto unmapped, were also explored. It is not only the final authority on Alaska, but a book of fascinating interest.

"Sumptuous."

—New York Tribune.

"The finest example of the publisher's art that the present season has produced."

—New York Telegram.

"Nothing approaching the pictures, in range, variety, and beauty has ever been obtained before. The most beautifully illustrated work of travel ever issued on this side of the Atlantic."

—The Nation.

"Chaste and elegant in design and execution, artistic from every point of view, lavishly and exquisitely illustrated."

—The Dial, Chicago.

Size, 7 x 10; pages, about 500; binding, cloth, decorated; illustrations, 40 in color, 85 photogravures, and 300 drawings from photographs and paintings by Louis Agassiz Fierres, Charles Knight, R. Swain Gifford, F. S. Dellenbaugh, etc.; 2 vols.; price, net, \$15.00.

DOUBLEDAY, PAGE & COMPANY,
34 UNION SQUARE, EAST, NEW YORK.

New York Botanical Garden Library



3 5185 00264 0504

