

58
t.

The Journal of ARACHNOLOGY

OFFICIAL ORGAN OF THE AMERICAN ARACHNOLOGICAL SOCIETY

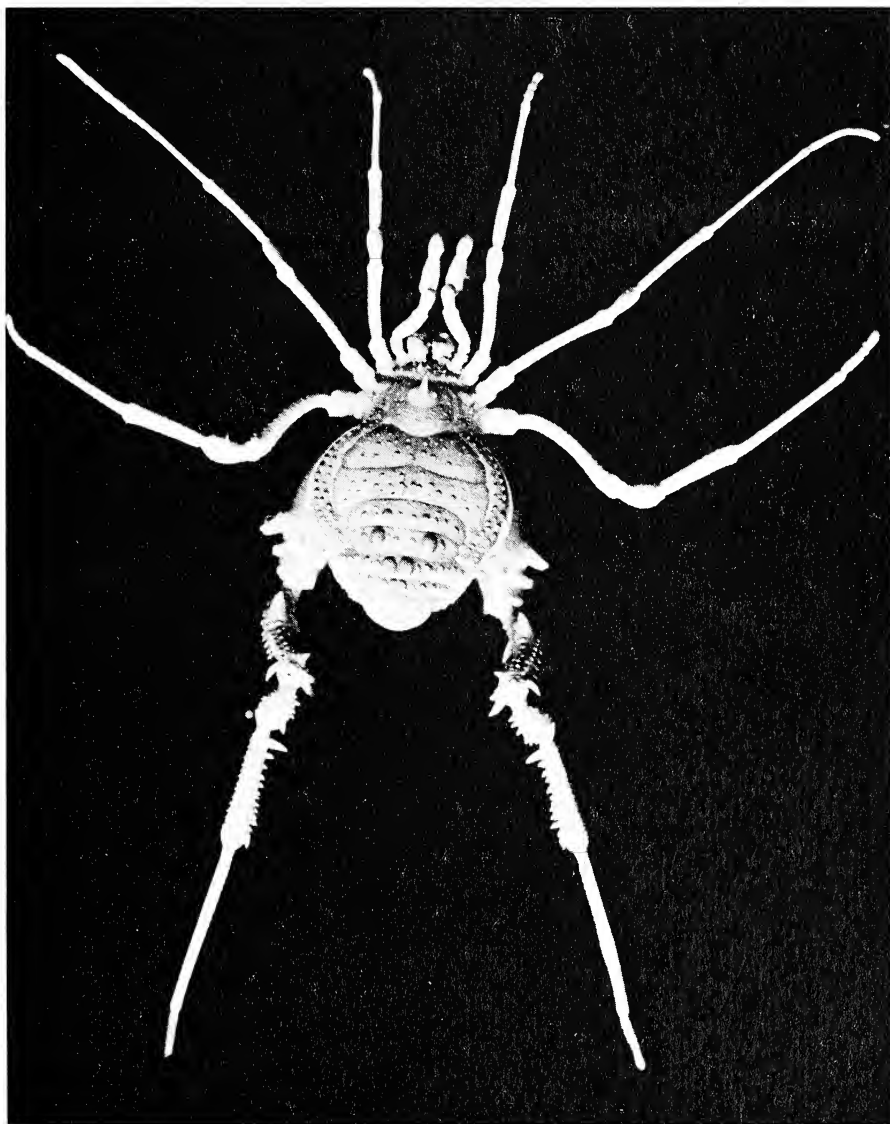

VOLUME 14

SPRING 1986

NUMBER 1

THE JOURNAL OF ARACHNOLOGY

EDITOR: Oscar F. Francke, Texas Tech University

ASSOCIATE EDITOR: William B. Peck, Central Missouri State University

ASSISTANT EDITOR: James C. Cokendolpher, Texas Tech University

EDITORIAL ASSISTANT: Scott A. Stockwell, Texas Tech University

EDITORIAL BOARD: C. D. Dondale, Agriculture Canada; W. G. Eberhard, Universidad de Costa Rica; M. E. Galiano, Museo Argentino de Ciencias Naturales; W. J. Gertsch, American Museum of Natural History; N. F. Hadley, Arizona State University; V. F. Lee, California Academy of Sciences; H. W. Levi, Harvard University; E. A. Maury, Museo Argentino de Ciencias Naturales; W. B. Muchmore, University of Rochester; M. H. Muma, Western New Mexico University; N. I. Platnick, American Museum of Natural History; G. A. Polis, Vanderbilt University; S. E. Riechert, University of Tennessee; M. E. Robinson, U.S. National Zoological Park; V. D. Roth, Southwestern Research Station; J. S. Rovner, Ohio University; W. A. Shear, Hampden-Sydney College; W. J. Tietjen, Lindenwood College; G. B. Uetz, University of Cincinnati; C. E. Valerio, Universidad de Costa Rica; S. C. Williams, San Francisco State University.

THE JOURNAL OF ARACHNOLOGY (ISSN 0161-8202) is published in Spring, Summer, and Fall by *The American Arachnological Society* at Texas Tech Press.

Individual subscriptions, which include membership in the Society, are \$25.00 for regular members, \$15.00 for student members. Institutional subscriptions to *The Journal* are \$35.00. Correspondence concerning subscriptions and memberships should be addressed to the Membership Secretary (see back inside cover). Back issues of *The Journal* are available from Dr. Susan E. Riechert, Department of Zoology, University of Tennessee, Knoxville, TN 37916 U.S.A., at \$10.00 for each number; the Index to Volumes 1-10 is available for \$10.00. Remittances should be made payable to *The American Arachnological Society*. Correspondence concerning undelivered issues should be addressed to the Texas Tech Press, Texas Tech University, Lubbock, Texas 79409, U.S.A.

Change of address notices must be sent to the Membership Secretary.

Manuscripts for *The Journal of Arachnology* are acceptable only from current members of the Society. Detailed instructions for the preparation of manuscripts appear in the Fall issue of each year, and can also be obtained from the Editor and the Associate Editor. Manuscripts that do not follow those instructions will be returned to the author(s) without benefit of review. Manuscripts and all related correspondence must be sent to Dr. William B. Peck, Associate Editor, Department of Biology, Central Missouri State University, Warrensburg, Missouri 64093, U.S.A.

PROOFS, REPRINTS, and CHARGES: Authors will receive a reprint order form along with their proofs. Reprints are billed at the printer's current schedule of costs. All authors will be billed by the American Arachnological Society for page charges. The charge per journal page will be assessed as follows: \$15.00-papers acknowledging grant, institutional, or other support; \$10.00-full members who do not have (and do not acknowledge) support; \$5.00-student members who do not coauthor with full members and who do not acknowledge support.

Haskins, M. F. and J. H. Shaddy. 1986. The ecological effects of burning, mowing, and plowing on ground-inhabiting spiders (Araneae) in an old-field ecosystem. *J. Arachnol.*, 14:1-13.

THE ECOLOGICAL EFFECTS OF BURNING, MOWING, AND PLOWING ON GROUND-INHABITING SPIDERS (ARANEAE) IN AN OLD-FIELD ECOSYSTEM

Mary F. Haskins¹ and James H. Shaddy

Science Division
Northeast Missouri State University
Kirksville, Missouri 63501

ABSTRACT

Cursorial spiders were studied in northeast Missouri from April-November 1980 in annually manipulated old-fields, in fields undergoing succession from manipulations, and a control field. Manipulations included burning, mowing, and plowing. Eleven cursorial families were collected in the study. Pitfall traps were used as the collecting device. Spider communities were compared using Bray-Curtis similarity indices. Seasonal and monthly spider and plant diversities were calculated using the Shannon Index. Spider diversity was correlated with plant diversity during May. The relative abundance of five spider species was correlated with the importance value of several plant species.

INTRODUCTION

Some of the current land management practices include burning, mowing, and plowing. These practices along with natural disturbances often result in changes in abundance, species composition, and diversity within both the plant and animal communities (Lowrie 1942). Ecosystem disturbances appear to be important factors in the evolution of plant and animal species (Denslow 1980, Connell and Slayter 1976, and Pickett 1976). Since plants are important to arthropods from the standpoint of food and other factors any natural or man-made disturbance (e.g. burning, mowing, and plowing) in the plant community may significantly alter the arthropod community (Lowrie 1942). Relatively small differences in habitat structure have been shown to affect significantly the abundance and type of spiders present (Duffey 1978). Many workers have reported associations between arthropod and plant diversity and succession (Almquist 1973, Muma 1973, Drew 1967, Duffey 1962, Chew 1961, Kajak 1960, and Elliot 1930 cited by Bultman et al., 1982; Murdoch et al., 1972; Riechert and Reeder 1972; Lowrie 1948, 1942). Spider diversity and abundance have been correlated with the physical structure of the litter (Hagstrum 1970, Berry 1967, and Lowrie 1948 cited by Bultman et al., 1982; Uetz 1979; Uetz 1975, Jocque 1973 cited by Uetz 1976).

Extensive reviews on prairie fire ecology may be found in Wright and Bailey (1980) and Hulbert (1969). Studies on the effects of cultivation and mowing have been reported by Duffey (1978), and Kajak et al. (1971). Diversity theories and indices have been reviewed and modified by many workers (Berry 1967 cited by Bultman et al., 1982, Pianka 1978, Uetz 1974, Huhta 1971, Goodall 1968, Lloyd

¹Present address: Division of Biological Sciences, University of Missouri, Columbia, Missouri 65211.

et al., 1968, Pielou 1966a, 1966b, and Lowrie 1948). Reviews concerning the use of pitfall traps may be found in Merrett (1976), Uetz and Unzicker (1976), Gist and Crossley (1973), Duffey (1972), Huhta (1971), Southwood (1966), and Greenslade (1964).

Specifically, the objectives of this study were to: 1) identify the cursorial spider fauna in fields which were manipulated (burned, plowed, and mowed) annually for the past four years, fields manipulated four years ago and undergoing succession, and a control field, 2) determine the active density, diversity, and similarity of cursorial spider populations in these fields, 3) determine the effects of vegetation on spider distribution, and 4) compare the capture efficiency of white and clear pittraps (reported elsewhere).

METHODS

Spiders were sampled in an 8.1 hectare area located approximately 2 kilometers south of Kirksville in northeast Missouri. The area lay fallow for approximately 20 years before the land management study originated. Seven fields employing three common agricultural land management techniques: burning, mowing, and plowing were used in the study. Fields were subdivided into four quadrats measuring approximately 30 m by 40 m each. To reduce edge effect a buffer zone at least 9 m in width surrounded each field. Experimental design involved the administration of one treatment per field: annually for one quadrat, every fifth year for a second quadrat, and every 10th and 20th year for the third and fourth quadrats respectively (Figure 1).

Field manipulations were started in 1976. At that time two fields (all eight quadrats) were burned, two fields were mowed, and two fields plowed. Manipulated fields were mowed and plowed in the fall, and burning treatments were conducted in the spring. Area II fields served as duplicates of Area I to increase the sample size. The seventh field was left untreated as a control. Samples for this study were taken from quadrats that were manipulated annually for the past four years, quadrats manipulated four years ago and undergoing succession, and a control field which had been fallow for 20 years.

Pitfall trapping for cursorial spiders was conducted from April to November 1980. Six traps, 3 clear and 3 white, were placed approximately 10 m apart in each quadrat. A total of 42 white and 42 clear traps were used in the study. The initial trap color arrangement within each quadrat was random. Thereafter the color arrangement and trap location were constant throughout the study. Traps were placed in the ground for 7-day intervals approximately every 3 weeks. A small amount of ethylene glycol was placed in each trap as a preservative. Clear and white trap data were combined for the spider analyses in this paper.

Vegetation data, including frequency, density, cover, grass mat depth, and species, were collected for area I quadrats. Three random one-square meter samples from each quadrat were taken during the months of May, July, and September. Grass mat depth was also recorded for each sample. Vegetation in Areas I and II appeared to be similar. Vegetation samples were not taken, however, from Area II because of time limitations.

Spider identifications were made to the species level for adults, and family level for juveniles. Several non-cursorial species were identified only to family.

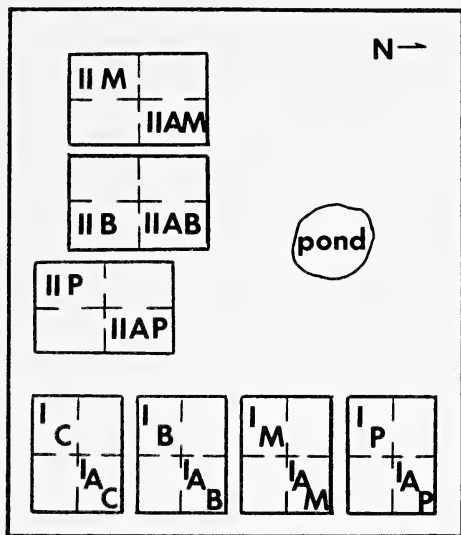

Fig. 1.—Map of study site using field and quadrat abbreviations. Abbreviations: I-area one fields, II-area two fields. Four year succession quadrats: burned-IB, IIB; mowed-IM, IIM; plowed-IP, IIP. Annually manipulated quadrats: burned-IAB, IIAB; mowed-IAM, IIAM; plowed-IAP, IIAP. Control quadrats-IAC, IC (AC used to distinguish between control fields). (1 cm = 30 m)

Comparisons of active densities were made for selected species between annually treated quadrats and their succession counterparts. The Bray-Curtis similarity index (Huhta 1979) was used in community comparisons between habitats which had received different physical treatments, and between communities undergoing succession from those physical treatments. The number of guilds and their percent composition was compared with the study habitats.

Spider diversity using the Shannon (1948) Index was calculated. Previous studies dealing with pitfall trapping of cursorial spiders have also used the Shannon Index (Jocque 1973, Uetz 1975, 1976, 1979a, 1979b, Pielou 1966 cited by Bultman et al., 1982). Diversity analyses were made for each quadrat using data for the trapping season. Diversity indices between quadrats were tested for significant differences with a t-test proposed by Hutcheson (1970 cited by Zar 1974). Trap dates were then separated into three groups which corresponded closely with the vegetation sampling dates. Diversity analyses were then made for each quadrat using the grouped data.

Importance values for each plant species were calculated by adding relative density, relative frequency, and relative dominance values for each species (Cox 1980). Linear correlation analyses were run using the importance values for plant species and the number of adult spiders captured in selected species. Monthly plant diversity was also calculated for the samples taken in area I using the Shannon Index. Hutcheson's test was used to determine significant differences in plant diversity.

RESULTS AND DISCUSSION

Representatives of thirteen spider families, eleven of which are considered cursorial or vagrant web builders, were captured. Forty-one genera with sixty-three

species represented the eleven families, with a total of 1,989 adults and 2,945 juveniles (Table 1).

Chi-square analyses indicated that significant differences existed in the numbers of adult cursorial spiders captured in many of the quadrats. The annually plowed quadrats (area I and II) exhibited significantly fewer spiders than all quadrats except the annually mowed (area I) quadrat. The differences were not significant for these two quadrats (Table 2). The number of adult spiders captured in other annually manipulated quadrats was usually significantly less than the numbers captured in their succession counterparts. However, two exceptions were observed: higher numbers captured in the annually mowed quadrat as compared to mowed quadrat in area II, and no difference in the numbers captured between annually burned and burned quadrats in area I. Three quadrats exhibited significantly higher numbers of spiders than did the control quadrats. These quadrats included: plowed (area I), annually mowed (area II), and burned (area II). Other succession quadrats also exhibited higher numbers, but they were not statistically different, as compared to the control quadrats.

Nine cursorial species representing three families accounted for approximately 65% of the adults captured. The species were: *Neoantistea agilis*, *Hahnia ononidum*, *Schizocosa saltatrix*, *Schizocosa retrorsa*, *Schizocosa bilineata*, *Schizocosa avida*, *Pardosa saxatilis*, *Callilepis pluto*, *Zelotes laccus*. The two species with the highest active densities for the trapping season were *S. avida* and *Z. laccus* respectively.

Guild composition analysis revealed wolf spiders as the major guild in all quadrats except the annually plowed area I quadrat where running spiders predominated, and in a control quadrat where vagrant spiders were most abundant. Crab and jumping spiders composed the highest percent guild composition in the annually mowed and annually burned, area I, quadrats respectively (Figure 2).

Bray-Curtis analyses resulted in similarity indices between annually plowed quadrats and plowed quadrats of 0.36 and 0.48. Similarity was higher (approximately 0.65) between annually mowed and annually burned quadrats and their succession counterparts (Table 3). As expected, annually manipulated quadrats showed less similarity to the controls than did the succession quadrats. Bray-Curtis similarity indices indicated the mowed and burned area II quadrats were the most similar in species composition with a value of 0.79. Both of the annually plowed quadrats exhibited low degrees of similarity with other quadrats. Similarity indices were calculated for quadrats between treatment types within area I and area II (i.e. areas I and II were not compared). Those quadrats having similarity indices greater than 0.60 are included in Table 3.

Similarity indices were also calculated for the major guilds. Quadrats exhibiting the highest similarity for the running spiders were mowed and annually burned quadrats in area II with an index of 0.80. Wolf spiders had the highest similarity in the mowed and burned quadrats (area II) with a value of 0.85. Their lowest similarity was between the annually plowed quadrats of areas I and II, with a value of 0.22. Wolf spiders in both annually plowed quadrats exhibited low degrees of similarity with other quadrats. Vagrant spider populations were found to be most similar in the annually mowed and burned area II quadrats with an index of 0.94. Jumping spiders were found to be most similar in the annually mowed and annually burned area II quadrats with a value of 0.72.

The number of species captured in each quadrat ranged from 13 to 31 with an average of 23 species. The highest spider diversity for the season was found

Table 1.—Spider species represented in the study. Asterisk denotes web-building spiders known to leave their webs when foraging for prey. (Ann = Annual, Suc = Succession, I and II = areas I and II)

	Adults Captured in Quadrats							
	Plowed		Mowed		Burned		Control	
	Ann I,II	Suc I,II	Ann I,II	Suc I,II	Ann I,II	Suc I,II	I,II	
Wolf spiders								
Lycosidae								
<i>Lycosa avara</i> (Keyser.)	0, 0	0, 0	0, 1	0, 0	0, 0	0, 0	6, 2	
<i>L. punctulata</i> (Hentz)	2, 0	1, 0	0, 0	1, 0	0, 0	2, 0	3, 3	
<i>L. rabida</i> Walck.	0, 0	3, 0	0, 0	1, 0	0, 0	1, 0	0, 1	
<i>Lycosa</i> sp.	0, 0	2, 0	2, 0	2, 2	2, 0	0, 3	1, 0	
<i>Pardosa saxatilis</i> (Hentz)	0,10	27,21	3, 1	3, 5	13,18	2, 5	0, 1	
<i>Pirata hiteorum</i> Wallace and Exline	0, 0	0, 0	0, 0	0, 1	2, 0	2, 0	4, 0	
<i>P. minutus</i> Emerton	0, 0	3, 6	0, 3	1, 4	2, 0	3, 3	3, 2	
<i>Schizocosa avida</i> (Walck.)	3,14	20,30	10,44	24,16	47,46	32,60	11,11	
<i>S. bilineata</i> (Emerton)	1, 0	2,17	8,21	21,15	1, 1	17,22	21,14	
<i>S. retrorsa</i> (Banks)	0, 5	6, 2	13,16	1, 6	14,14	3, 6	7, 7	
<i>S. saltatrix</i> (Hentz)	2, 0	24, 9	0, 3	5, 4	1, 4	2, 6	7, 3	
<i>Schizocosa</i> sp.	0, 0	0, 0	0, 0	0, 1	0, 0	0, 0	0, 0	
Lycosidae sp.	0, 3	0, 0	0, 0	3, 0	0, 3	0, 1	4, 1	
Running spiders								
Clubionidae								
<i>Castianeira descripta</i> (Hentz)	1, 0	3, 0	0, 0	0, 0	0, 0	1, 1	0, 0	
<i>C. gertschi</i> Kaston	0, 1	2, 0	0, 0	1, 0	0, 0	0, 0	0, 0	
<i>C. longipalpus</i> (Hentz)	0, 0	1, 1	0, 0	0, 0	0, 0	0, 0	0, 0	
<i>C. variata</i> Gertsch	1, 0	1, 0	0, 0	0, 0	0, 0	0, 1	1, 0	
<i>Clubiona johnsoni</i> Gertsch	0, 0	1, 0	0, 0	1, 0	0, 0	0, 0	1, 0	
<i>C. mixta</i> Emerton	0, 0	0, 0	0, 0	0, 1	0, 0	0, 0	0, 0	
<i>Scotinella similis</i> (Banks)	0, 0	0, 0	0, 1	0, 0	0, 0	0, 0	0, 0	
<i>Scotinella fratella</i> (Gertsch)	1, 0	1, 1	0, 0	0, 0	0, 0	0, 0	0, 0	
Clubionidae sp.	0, 0	1, 0	0, 0	0, 0	0, 1	0, 0	0, 0	
Gnaphosidae								
<i>Callilepis pluto</i> Banks	9,11	1, 2	2, 2	0, 9	4,11	1, 5	2, 0	
<i>Drassylus depressus</i> (Emerton)	2, 1	4, 3	4, 2	2, 0	6, 2	0, 1	2, 0	
<i>D. fallens</i> Cham.	0, 0	2, 1	0, 0	0, 0	0, 0	0, 0	0, 0	
<i>D. nannellus</i> (Chamber. and Gertsch)	0, 0	1, 0	0, 1	0, 0	0, 0	1, 0	4, 1	
<i>D. rufulus</i> (Banks)	1, 0	0, 0	0, 0	0, 0	0, 0	0, 0	0, 0	
<i>Drassylus</i> sp.	0, 0	0, 0	0, 1	0, 0	0, 0	1, 0	0, 1	
<i>Haplodrassus signifer</i> Koch	0, 0	0, 0	0, 0	1, 0	0, 0	0, 0	0, 1	
<i>Micaria elizabethae</i> (Gertsch)	0, 0	3, 5	0, 6	4, 3	0, 3	3, 9	2, 0	
<i>Sergiolus variegatus</i> (Hentz)	0, 0	0, 0	0, 0	0, 2	1, 0	1, 1	1, 2	
<i>Zelotes hentzi</i> Barrows	0, 0	0, 0	0, 2	0, 1	0, 1	2, 0	0, 0	
<i>Z. inheritus</i> Kaston	0, 0	0, 0	1, 1	0, 0	0, 0	1, 0	0, 0	
<i>Z. laccus</i> (Barrows)	0, 3	21,18	7,33	28,23	11,10	35,40	23,21	
Gnaphosidae sp.	1, 0	3, 0	0, 1	1, 2	3, 1	0, 2	2, 0	
Crab spiders								
Philodromidae								
<i>Thanatus</i> sp.	1, 0	4, 3	4, 1	6, 2	3, 5	9, 4	9, 6	
Thomisidae								
<i>Xysticus</i> sp.	2, 5	22,27	16,18	24, 6	17,15	11,10	12,16	
Thomisidae sp.	0, 2	0, 0	0, 0	0, 0	0, 0	0, 0	0, 0	
Jumping Spiders								
Salticidae								
<i>Agassa cyanea</i> (Hentz)	0, 0	0, 0	1, 0	0, 0	0, 0	1, 0	0, 0	
<i>Corythalia delicatula</i> (Gertsch & Mulaik)	0, 0	0, 0	2, 0	1, 0	0, 0	0, 0	1, 0	

Table 1.—Continued.

<i>Eris aurantia</i> (Lucas)	0, 0	1, 1	0, 2	0, 1	4, 2	2, 1	0, 1
<i>Evarchi hoyi</i> (Peckham)	0, 0	0, 2	0, 3	2, 1	0, 0	0, 1	3, 1
<i>Marpissa mucosa</i> (Clerck)	0, 0	1, 0	0, 0	0, 0	0, 0	0, 0	1, 0
<i>Metaphidippus canadensis</i> (Banks)	0, 1	0, 0	0, 0	2, 2	0, 0	1, 0	3, 0
<i>M. galathea</i> (Walck.)	0, 0	0, 0	0, 1	1, 0	1, 1	1, 0	0, 2
<i>Pellenes coecatus</i> (Hentz)	0, 2	0, 1	1, 0	0, 0	2, 1	0, 0	0, 0
<i>Pellenes</i> sp.	1, 0	0, 0	0, 0	0, 0	0, 0	0, 0	0, 0
<i>Phidippus clarus</i> (Keyser.)	0, 0	1, 0	1, 0	0, 0	2, 0	1, 0	0, 0
<i>P. mc cooki</i> (Peckham)	0, 0	1, 1	0, 0	0, 0	0, 0	0, 1	1, 0
<i>P. princeps</i> (Peckham)	0, 0	0, 0	0, 1	1, 0	0, 1	0, 0	1, 2
<i>Sarinda hentzi</i> Banks	0, 0	0, 1	0, 0	1, 2	0, 0	0, 0	0, 0
<i>Sitticus cursor</i> Barrows	0, 0	0, 2	1, 4	3, 3	6, 3	3, 6	2, 1
<i>S. striatus</i> Emerton	0, 0	0, 0	0, 0	0, 0	0, 0	1, 0	0, 1
<i>Talavera minuta</i> (Banks)	0, 0	0, 1	3, 0	2, 2	6, 1	5, 1	0, 2
Salticidae sp.	0, 0	0, 1	0, 0	1, 0	0, 0	0, 0	0, 0
Vagrant spiders							
Agelenidae							
<i>Cicurina cavealis</i> * (Bishop & Crosby)	5, 4	2, 3	2, 0	0, 0	1, 4	1, 0	0, 0
<i>C. ludoviciana</i> * (Simon)	0, 0	0, 1	0, 0	0, 0	0, 0	0, 0	0, 0
Hahnidae							
<i>H. onomidum</i> * (Simon)	0, 0	0, 2	2, 0	2, 0	0, 0	1, 0	25,35
<i>Neoantistea agilis</i> * (Keyser.)	0, 4	13,11	5, 8	6,13	3, 2	7, 6	0, 3
Other guilds							
Antrodiaetidae							
<i>Antrodiaetus stygius</i> (Coyle)	6, 0	2, 0	0, 2	0, 0	0, 1	0, 1	0, 0
Oxyopidae							
<i>Oxyopes salticus</i> (Hentz)	0, 1	3, 1	2, 0	4, 6	1, 4	0, 3	0, 0
Mimetidae							
<i>Mimetus epeiroides</i> Emerton	0, 0	0, 0	0, 0	1, 0	0, 0	0, 0	0, 0
<i>Ero</i> sp.	0, 0	0, 0	0, 0	0, 0	0, 0	0, 0	1, 0
Web-builders							
Araneidae	30,45	23,36	34,35	28,37	44,34	30,28	46,37
Agelenidae							
<i>Agelenopsis kastoni</i> Chamber. & Ivie	0, 0	0, 1	0, 0	0, 0	0, 0	0, 0	0, 0
<i>Agelenopsis</i> sp.	0, 0	0, 1	0, 0	0, 0	0, 0	0, 0	0, 0
Agelenidae sp.	0, 0	0, 0	0, 0	0, 0	1, 0	0, 0	0, 0
Dictynidae	15,37	8, 1	9, 4	4, 1	15, 0	7, 2	0, 1

in the plowed quadrat of area I with an index of 2.720. The lowest diversity calculated was 2.203 and was in the annually plowed quadrat of area II (Table 4). Differences in diversity values were tested between quadrats. The diversity in the plowed quadrat of area I was significantly higher than the diversities in the annually plowed, annually burned, burned, and control quadrats of area I. The area II plowed quadrat was significantly higher in diversity than the annually mowed, and burned quadrats of area II.

Community complexity and diversity usually increase during early and mid-succession seral stages. Arthropods generally increase in number as succession progresses toward a climax state (Bultman et al. 1982). The succession quadrats in this study should, therefore, be higher in diversity than the annually manipulated quadrats. This was observed for the annually plowed (area I and II) and the annually mowed (area II) quadrats when they were compared to their succession counterparts. The annual burn quadrats (areas I and II and the area I mowed quadrat exhibited low diversity values in the spring, but the diversities rapidly

Table 2.—Quadrats exhibiting significant differences between seasonal pitfall catches of spiders. Asterisks denote: * $p < 0.05$, ** $p < 0.01$, *** $p < 0.001$.

Quadrats	Adults captured		Chi-square value
IAP I P	39	183	92.112***
IIAP II P	67	172	42.255***
IAP IAM	39	90	19.379***
IIAP IIAM	67	178	49.388***
IAP I M	39	156	69.005***
IIAP II M	67	130	19.513***
IAP IAB	39	152	65.675***
IIAP IIAB	67	155	34.094***
IAP I B	39	153	66.505***
IIAP II B	67	197	63.034***
IAP IAC	39	162	74.049***
IIAP IAC	67	162	38.585***
IAP I C	39	139	55.061***
IIAP I C	67	139	24.471***
I P IAM	183	90	31.004***
II P II M	172	130	5.566*
I P I C	183	139	5.742*
IAM I M	90	156	17.174***
IIAM II M	178	130	7.172**
IAM IAB	90	152	15.376***
IAM I B	90	153	15.818***
IAM IAC	90	162	20.003***
IAM I C	90	139	10.061**
IIAM I C	178	139	4.555*
II M II B	130	197	13.321***
IIAB II B	155	197	4.775*
II B I C	197	139	9.670**

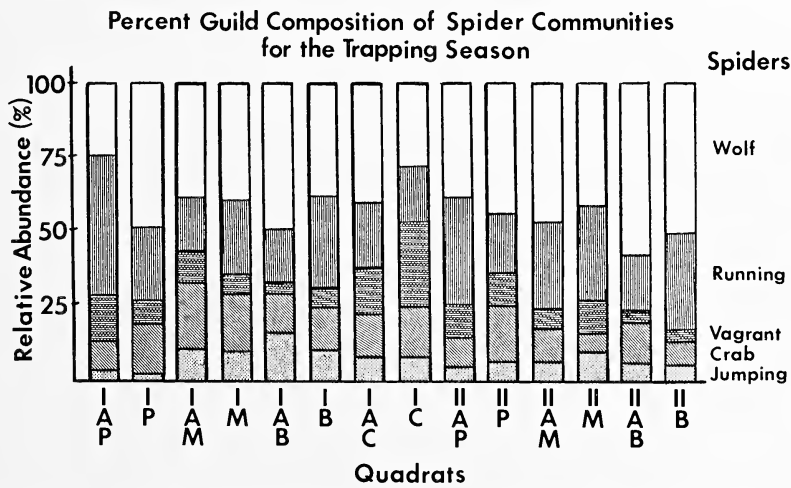

Fig. 2.—Percent guild composition of spider communities for the trapping season.

Table 3.—Bray-Curtis similarity values for the cursorial spider community for the trapping season (0.00 no similarity, 1.00 maximum similarity).

Quadrat comparisons	Bray-Curtis values		Quadrat comparisons	Bray-Curtis values >0.60
	<0.60	>0.60		
IAP I P	0.36		II M II B	0.79
IIAP II P	0.48		IIAM II B	0.74
IAP I C	0.23		II P II B	0.72
IIAP I C	0.36		IAM IAB	0.70
I P I C	0.50		II P II M	0.68
II P I C	0.56		IIAM IIAB	0.67
IAM I M		0.61	II P IIAM	0.66
IIAM II M		0.68	II P IIAB	0.66
IAM I C	0.57		I M I B	0.66
IIAM I C		0.66	II M IIAB	0.66
I M I C		0.67	IIAP IIAB	0.63
II M I C	0.57		I P IAB	0.63
IAB I B		0.64	I P I M	0.62
IIAB II B		0.69	IAM I B	0.61
IAB I C	0.53			
IIAB I C	0.54			
I B I C		0.70		
II B I C		0.60		

increased. By July these diversities were similar to the diversities observed for their succession counterparts, and also of the controls. Hence no significant differences in diversity were observed for these quadrats in the overall trapping season.

Shannon diversity indices were also calculated for vegetation data collected in area I (Table 5). Previous studies have shown increased diversity in disturbed grasslands and old-field habitats for the first one to four years (Hessing et al. 1981 and Bazzaz 1975). Diversity then decreases somewhat as grasses become the dominant species of the habitat. Increases in diversity are again observed after

Table 4.—Shannon diversity and J values for spiders in each quadrat for the trapping season.

Quadrat	Number of species captured	Number of adults captured	Diversity value	J component of evenness
IAP	14	36	2.305	0.873
I P	31	157	2.720	0.792
IAM	19	70	2.604	0.884
I M	29	126	2.601	0.773
IAB	21	132	2.349	0.771
I B	28	133	2.434	0.730
IAC	26	141	2.696	0.827
I C	23	117	2.351	0.750
IIAP	13	60	2.203	0.859
II P	26	144	2.577	0.791
IIAM	24	160	2.326	0.732
II M	23	123	2.663	0.849
IIAB	24	136	2.375	0.747
II B	23	185	2.240	0.714

Table 5.—Shannon diversity and J evenness values for vegetation sampled in area I.

Quadrat	Number of plant species	Diversity value	J component of evenness
<i>May</i>			
IAP	14	0.380	0.144
I P	29	2.649	0.787
IAM	24	1.390	0.437
I M	22	2.295	0.743
IAB	19	0.880	0.299
I B	20	2.207	0.737
IAC	10	1.419	0.616
I C	13	1.653	0.645
<i>July</i>			
IAP	25	0.992	0.308
I P	32	2.878	0.831
IAM	27	2.475	0.735
I M	31	2.612	0.761
IAB	19	0.715	0.243
I B	24	2.296	0.722
IAC	14	1.700	0.644
I C	19	2.105	0.715
<i>September</i>			
IAP	22	1.194	0.386
I P	34	2.965	0.841
IAM	31	2.812	0.819
I M	32	2.859	0.825
IAB	27	1.618	0.491
I B	30	2.753	0.809
IAC	16	2.034	0.734
I C	21	2.289	0.752

woody plants and shrubs become established in the community. This second increase in diversity is initially rapid and then continues at a slower rate as succession continues toward a climax state. In this study the most diverse vegetation was observed during May in the plowed quadrat with a value of 2.649. This quadrat also had the highest diversities in July and September. July and September diversity values increased for most of the other quadrats. The diversity of the vegetation in the succession quadrats was higher throughout the season than the diversity of the control. Two quadrats, annually plowed and annually burned exhibited lower vegetation diversities than the control did throughout the season. However the diversity in the annually mowed quadrat was lower than the control's diversity in May, then increased, and was higher than the control's diversities in July and September.

Uetz (1975) found no relationship between cursorial spider and vegetation diversity in a forest. However he observed significant positive correlations between spider diversity and litter depth. Linear correlation analysis showed a significant positive correlation ($r = 0.747$, $p < 0.05$, d.f. = 6) between the vegetation diversity and spider diversity observed in May. A negative correlation was observed between vegetation and spider diversities in all quadrats for the overall season. This correlation was significant in only three quadrats: mowed ($r = -0.864$), annually burned ($r = -0.713$), and one control ($r = -0.726$) ($p < 0.05$, d.f. = 6 in each case). This was a result of the summer peak in spider abundance and diversity

followed by a decline, whereas the plant abundance and diversity continued to increase throughout the season. No correlations were observed between spider diversity and grass mat depth.

Linear correlation analyses were made using importance values of plant species, and the number of spiders captured. These calculations were made using the eight quadrats from area I. Thirty-four significant correlations were observed between plant importance and the number of hahniid and lycosid spiders captured. Twenty-six correlations were observed in May, and eight in July (Table 6). Most of the correlations occurred in the annually plowed quadrat of area I. No correlations were observed in September. This was probably a result of the decline in spider abundance in the fall. Many of the correlations observed were significant because the plant species occurred in only one quadrat or its importance value was highest in that quadrat, and the number of spiders captured was highest in that particular quadrat. The vegetation in the quadrats exhibiting correlations may be characteristic of a particular habitat in which the spiders live. Whether or not the spiders were actually interacting with the plants cannot be determined from the data.

Hahnium ononidum was positively correlated with *Phleum pratense* and *Agrimonia gryposepala* and negatively correlated with *Prunella vulgaris*. *Neoantistea agilis* was positively correlated with nine plants. Five of these plants occurred only in the plowed quadrat (area I) where the active density of *N. agilis* was highest. The plants were: *Antennaria neglecta*, *Astor novae-angeliae*, *Potentilla simplex*, *Solidago graminifolia*, *Ulmus americana*. The four remaining plants: *Agrostis alba*, *Cerastium vulgatum*, *Chrysanthemum leucanthemum*, and *Erigeron strigosus*, exhibited high importance values in IP, and lower importance values in other quadrats.

Two wolf spiders were positively correlated with plants in May. *Pardosa saxatilis* was positively correlated in the annually plowed quadrat (area I) with seven plant species: *Agrostis alba*, *Antennaria neglecta*, *Astor novae-angeliae*, *Panicum lanuginosum*, *Potentilla simplex*, *Prunella vulgaris*, and *Ulmus americana*. *Schizocosa avida* was positively correlated with only one plant, *Astor* sp., during May. This correlation was observed in seven quadrats. *Schizocosa saltatrix* was correlated with six plant species during May. The species were: *Agrostis alba*, *Antennaria neglecta*, *Astor novae-angeliae*, *Potentilla simplex*, *Ulmus americana*, and *Solidago graminifolia*. The first four species were also correlated with *P. saxatilis* and *N. agilis*.

Significant correlations in July for spiders and plants were observed only in wolf spiders. *Pardosa saxatilis* continued to be correlated in the annually plowed area I quadrat with the importance values of *Panicum lanuginosum*, *Astor novae-angeliae*, and *Potentilla simplex*. It was also found to be correlated with *Solidago* sp. and *Composite* sp. The latter species was not observed in the May samples. However, *Solidago* sp. was present in both May and July. Whether or not the spider is truly correlated with this species is questionable. *Schizocosa avida* in July was positively correlated with *Phleum pratense* and *Veronia baldwinii*. *Astor* sp. was no longer significantly correlated with *S. avida* although it was still present in most of the quadrats. *Schizocosa bilineata* was also found to be correlated in several quadrats with *Phleum pratense* in July.

In this study the spider and flora communities found in fields which were plowed annually were quite different from those communities found in fields which were mowed and burned annually. Although some cursorial spiders appeared to be

Table 6.—Significant correlation coefficients from spider-plant linear correlation analyses. Asterisk denotes $p < 0.05$, d.f. = 6.

Month	Plant Species	Spider Species	Correlation Coefficient
May	<i>Phleum pratense</i> L.	<i>Hahnia ononidum</i>	0.802*
May	<i>Agrimonia gryposepala</i> Wallr.	<i>H. ononidum</i>	0.919*
May	<i>Prunella vulgaris</i> L.	<i>H. ononidum</i>	-0.822*
May	<i>Agrostis alba</i> L.	<i>Neoantistea agilis</i>	0.807*
May	<i>Antennaria neglecta</i> Greene	<i>N. agilis</i>	0.764*
May	<i>Aster novae-angeliae</i> L.	<i>N. agilis</i>	0.764*
May	<i>Cerastium vulgare</i> L.	<i>N. agilis</i>	0.846*
May	<i>Chrysanthemum leucanthemum</i> L.	<i>N. agilis</i>	0.773*
May	<i>Erigeron strigosus</i> Muhl.	<i>N. agilis</i>	0.769*
May	<i>Potentilla simplex</i> Michx.	<i>N. agilis</i>	0.764*
May	<i>Solidago graminifolia</i> (L.) Salisb.	<i>N. agilis</i>	0.764*
May	<i>Ulmus americana</i> L.	<i>N. agilis</i>	0.764*
May	<i>Agrostis alba</i> L.	<i>Paradosa saxatilis</i>	0.944*
May	<i>Panicum lanuginosum</i> Ell.	<i>P. saxatilis</i>	0.794*
May	<i>Antennaria neglecta</i> Greene	<i>P. saxatilis</i>	0.956*
May	<i>Aster novae-angeliae</i> L.	<i>P. saxatilis</i>	0.956*
May	<i>Potentilla simplex</i> Michx.	<i>P. saxatilis</i>	0.956*
May	<i>Prunella vulgaris</i> L.	<i>P. saxatilis</i>	0.709*
May	<i>Ulmus americana</i> L.	<i>P. saxatilis</i>	0.956*
May	<i>Aster</i> sp.	<i>Schizocosa avida</i>	0.794*
May	<i>Agrostis alba</i> L.	<i>S. saltatrix</i>	0.934*
May	<i>Antennaria neglecta</i> Greene	<i>S. saltatrix</i>	0.973*
May	<i>Aster novae-angeliae</i> L.	<i>S. saltatrix</i>	0.973*
May	<i>Potentilla simplex</i> Michx.	<i>S. saltatrix</i>	0.973*
May	<i>Solidago graminifolia</i> (L.) Salisb.	<i>S. saltatrix</i>	0.973*
May	<i>Ulmus americana</i> L.	<i>S. saltatrix</i>	0.973*
July	<i>Panicum lanuginosum</i> Ell.	<i>Pardosa saxatilis</i>	0.750*
July	<i>Aster novae-angeliae</i> L.	<i>S. saltatrix</i>	0.798*
July	<i>Potentilla simplex</i> Michx.	<i>P. saxatilis</i>	0.798*
July	<i>Solidago</i> sp.	<i>P. saxatilis</i>	0.798*
July	<i>Composite</i> sp.	<i>P. saxatilis</i>	0.798*
July	<i>Veronia baldwinii</i> Torr.	<i>Schizocosa avida</i>	0.811*
July	<i>Phleum pratense</i> L.	<i>S. avida</i>	0.708*
July	<i>Phleum pratense</i> L.	<i>S. bilineata</i>	0.708*

correlated with the presence of certain plants it should not be concluded that there is a causal relationship. More study is needed in the area of spider-plant relationships. Annual plowing results in reduced spider and vegetation diversity. Mowing and burning treatments that are annually or periodically administered and periodic plowing may increase spider and vegetation diversity above that of a fallow control field.

ACKNOWLEDGMENTS

Sincere appreciation is extended to Drs. William Peck and Charles Dondale for specimen verification. Sincere thanks are extended to Randa Meiser for her help in field and lab work.

LITERATURE CITED

- Bazzaz, F. A. 1975. Plant species diversity in old-field ecosystems in southern Illinois. *Ecology*, 56:485-488.
- Bultman, T., G. W. Uetz, and A. R. Brady. 1982. A comparison of cursorial spider communities along a successional gradient. *J. Arachnol.*, 10:23-33.
- Connell, J. H. and R. O. Slayter. 1976. Mechanisms of succession in natural communities and their role in community stability and organization. *Amer. Nat.*, 111(982):119-1144.
- Cox, G. W., 1980. Laboratory manual of general ecology. 4th edition. William C. Brown Company. Dubuque, Iowa, 237 pp.
- Denslow, J. S. 1980. Patterns of plant species diversity during succession under different disturbance regimes. *Oecologia*, 46:18-21.
- Duffey, E., 1972. Ecological survey and the arachnologist. *Bull. British Arachnol. Soc.*, 2(5):69-82.
- Duffey, E. 1978. Ecological strategies in spiders including some characteristics of species of pioneer and mature habitats. *Symp. Zool. Soc. London*, 42:109-123.
- Gist, C. S. and D. A. Crossley, Jr. 1973. A method for quantifying pitfall trapping. *Environ. Entomol.*, 2(5):951-952.
- Goodall, D. W. 1968. Sample similarity and species correlation. Ordination of plant communities. Dr. W. Junk B. V. Publishers, The Hague, pp. 99-149.
- Greenslade, P. J. M. 1964. Pitfall trapping as a method for studying populations of Carabidae (Coleoptera). *J. Anim. Ecol.*, 33:301-310.
- Hessing, M. B., C. D. Johnson, and R. P. Balder. 1981. Secondary succession of desert grassland in north-central Arizona, USA, powerline corridors. *J. Environ. Management*, 13(1):59-70.
- Huhta, V. 1971. Succession in the spider communities of the forest floor after clear-cutting and prescribed burning. *Ann. Zool. Fennici*, 8:483-542.
- Huhta, V. 1979. Evaluation of different similarity indices as measures of succession in arthropod communities of the forest floor after clear-cutting. *Oecologia*, 41:11-23.
- Hulbert, L. C. 1969. Fire and litter effects in undisturbed bluestem prairie in Kansas. *Ecology*, 50:874-877.
- Kajak, A., A. Breymer and J. Petal. 1971. Productivity investigation of two types of meadows in the Vistula Valley. *Ekol. Polska*, 19(17):223-233.
- Lloyd, M., J. H. Zar and J. R. Karr. 1968. On the calculation of information-theoretical measures of diversity. *Amer. Midl. Nat.*, 79(2):257-267.
- Lowrie, D. C. 1942. The ecology of spiders of the xeric dunelands in the Chicago area. *Bull. Chicago Acad. Sci.*, 6(9):161-189.
- Lowrie, D. C. 1948. The ecological succession of spiders of the Chicago area dunes. *Ecology*, 29(3):334-351.
- Merrett, P. 1976. Changes in the ground-living spider fauna after heathland fires in Dorset. *Bull. British Arachnol. Soc.*, 3(8):214-221.
- Murdoch, W., F. C. Evans and C. H. Peterson. 1972. Diversity and pattern in plant and insects. *Ecology*, 53:819-829.
- Pianka, E. R. 1978. *Evolutionary Ecology*. Second edition. Harper and Row, Publishers. New York, 397 pp.
- Pickett, S. T. A. 1976. Succession: an evolutionary interpretation. *Amer. Nat.*, 110(971):107-119.
- Pielou, E. C. 1966a. Shannon's formula as a measure of specific diversity—its use and misuse. *Amer. Nat.*, 100:463-465.
- Pielou, E. C. 1966b. The measurement of diversity in different types of biological collections. *J. Theor. Biol.*, 13:131-144.
- Riechert, S. E. and W. G. Reeder. 1972. Effects of fire on spider distribution in southwestern Wisconsin prairies. *Proc. Second Midwest Prairie Conf.*, 1970, 75-90.
- Shannon, C. E. 1948. A mathematical theory of communication. *Bell Inst. Technol. J.*, 27:379-423, 623-656.
- Southwood, T. R. E. 1966. *Ecological methods with particular reference to the study of insect populations*. London: Methuen, 524 pp.
- Uetz, G. W. 1974. Species diversity: a review. *Biologist*, 56:111-129.
- Uetz, G. W. 1976. Gradient analysis of spider communities in a stream-side forest. *Oecologia*, 22:373-385.
- Uetz, G. W. 1979. Influence of variation of litter habitats on spider communities. *Oecologia*, 40:29-42.

Uetz, G. W. and J. D. Unzicker. 1976. Pitfall trapping in ecological studies of wandering spiders. *J. Arachnol.*, 3:101-111.

Wright, H. and A. Bailey. 1980. Fire ecology and prescribed burning in the great plains. USDA Forest Service. General Technical Report INT-77.

Zar, J. H. 1974. *Biostatistical Analysis*. Prentice-Hall, Inc., Englewood Cliffs, N. J., 620 pp.

Manuscript received August 1983, revised December 1984.

CHACTIDAE (SCORPIONES) FROM TRINIDAD AND TOBAGO

Oscar F. Francke

Department of Biological Sciences
Texas Tech University
Lubbock, Texas 79409

and

Julius Boos

314 Northeast 26th Drive
Fort Lauderdale, Florida 33334

ABSTRACT

The scorpions belonging to the family Chactidae from Trinidad and Tobago are studied. A new species, *Chactas raymondhansi*, from bromeliads on the highest mountains of Trinidad is described. The type species of the genus *Broteochactas* Pocock, *Broteochactas nitidus* Pocock from Trinidad, is resurrected from its synonymy under *Broteochactas gollmeri* (Karsch) from Venezuela. The genus *Auyantepeuia* González-Sponga, from Venezuela, is synonymized under *Broteochactas*.

INTRODUCTION

Trinidad and Tobago are islands located on the continental shelf off the northeast coast of Venezuela. Their proximity to the mainland, and their location opposite the mouth of the Orinoco River have been used to hypothesize an Orinoco-Guianan origin for their biota via rafting. Their scorpion fauna, however, does not support this hypothesis at all. Kjellesvig-Waering (1966) noted that the affinities of the scorpion fauna of Trinidad and Tobago were with the Coastal Ranges of Venezuela to the east, rather than with the Orinoco River delta to the south. Only one of the seven scorpion species reported from Trinidad by Kjellesvig-Waering (1966) was regarded as an endemic; four were shared with Venezuela and two with the Guianas. Likewise, one of the three species reported from Tobago was considered an endemic; the other two were shared with both Trinidad and Venezuela.

Considerable work done on the Venezuelan fauna during the past 20 years by González-Sponga (summarized in his 1984 contribution) and additional collecting in Trinidad and Tobago have changed the picture considerably. The three chactids found in Trinidad and Tobago, including one new species described below, are endemic. Two of the buthids (*Microtityus rickyi* Kjellesvig-Waering,

and *Tityus trinitatis* Pocock) are now also considered endemic to the islands, and four others are shared with the mainland. The high percentage of scorpion endemism (55%) in Trinidad and Tobago reinforces the hypothesis put forth by Kjellesvig-Waering (1966) that the Venezuelan Coastal Ranges and the Trinidad Northern Range were continuous at one time; subsequently, faulting and erosion during Pliocene or Pleistocene times led to the isolation of the island fauna. The lack of shared species between the Orinoco River delta and Trinidad and Tobago indicates that rafting is an unlikely dispersal mechanism in scorpions in general.

The terminology used herein follows essentially that of Stahnke (1970), except for trichobothriotaxy (Vachon 1974), and metasomal carinae (Francke 1977). Acronyms for specimen depositories are given in the acknowledgments, except for those in the authors' collections which are followed by their initials.

FAMILY CHACTIDAE

The systematics of this worldwide scorpion family are chaotic and unreliable. The diagnostic characters given below will readily separate it from the Buthidae, the only other family found in Trinidad and Tobago. These characters are also useful for northeastern South America and the Caribbean region, as the families Bothriuridae, Iuridae and Vaejovidae do not occur there naturally.

Diagnosis.—Sternum pentagonal rather than subtriangular. Tibial spurs absent, prolateral and retrolateral pedal spurs present. Cheliceral fingers without ventral teeth, movable finger with distal ventral tine considerably longer than the dorsal tine. Pedipalps with trichobothrial pattern C of Vachon (1974); femur with three trichobothria, tibia with 5-7 ventral trichobothria. Telson without a ventral tooth under the sting.

Genus *Chactas* Gervais

This genus is known from Central America (Costa Rica and Panama) and South America (as far south as Peru and Brazil). It differs from *Broteochactas* Pocock, the only other genus in this family known from Trinidad and Tobago, by having 5-6 instead of 7 ventral trichobothria on the tibia.

Five subgenera are presently recognized within the genus *Chactas* (Francke 1985). The new species described below belongs to the subgenus *Andinochactas* González-Sponga, characterized by having the tarsi armed with a ventral median row of spines, and five ventral trichobothria on both the tibia and the chela of the pedipalps.

Chactas (Andinochactas) raymondhansi, new species

Figs. 1-10

Type data.—Holotype male found on a bromeliad along the eastern ridge near the summit of Mt. El Tucuche (1000 m), Northern Range, Trinidad, 26-VI-1982 (Betty Faber, Eddie Rooks and party). Deposited in the American Museum of Natural History, New York. Paratypes listed under specimens examined.

Distribution.—Known only from bromeliads on the highest mountains on the Northern Range of Trinidad.

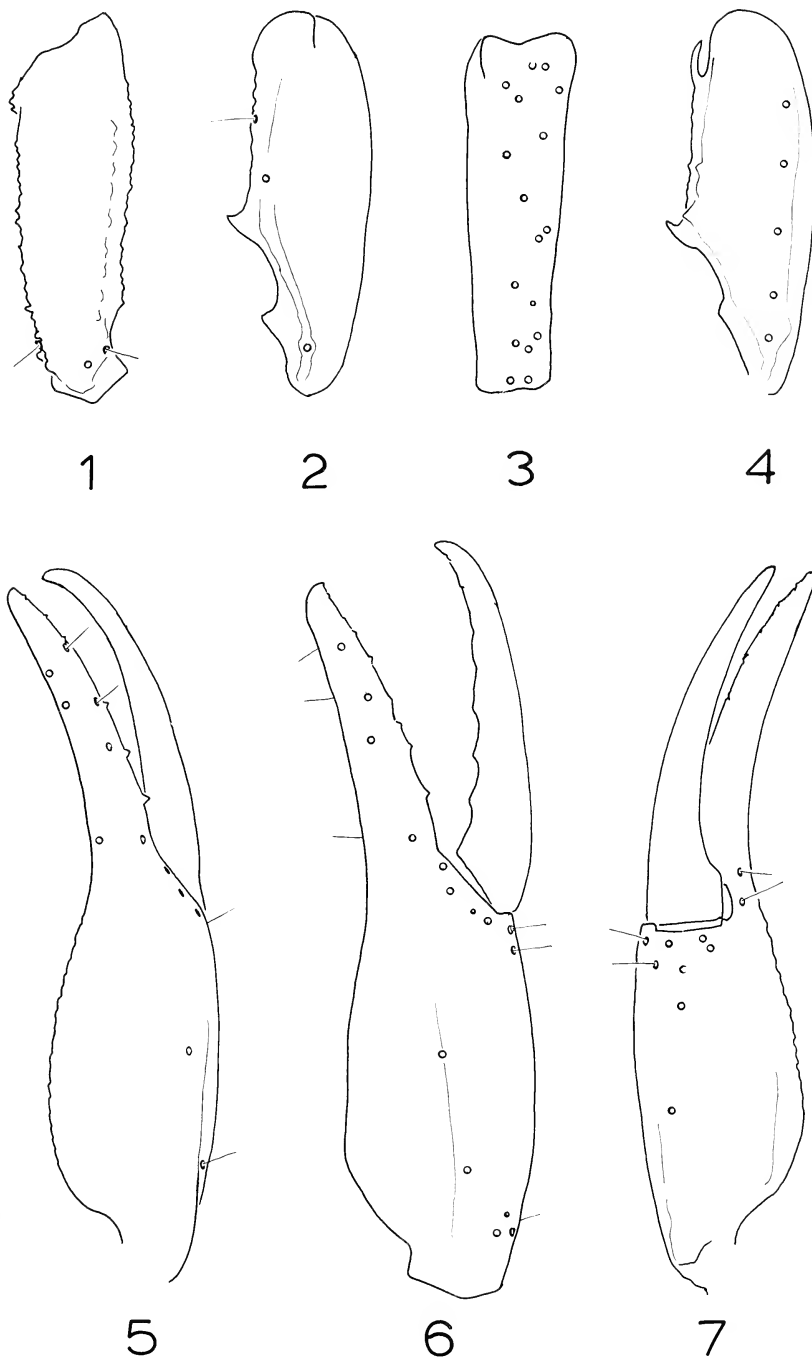

Figs. 1-7.—Right pedipalp of holotype male of *Chactas (Andinochactas) raymondhansi*, new species, showing trichobothrial patterns: 1, dorsal aspect of femur; 2, dorsal aspect of tibia; 3, external aspect of tibia; 4, ventral aspect of tibia; 5, dorsal aspect of chela; 6, external aspect of chela; 7, ventral aspect of chela.

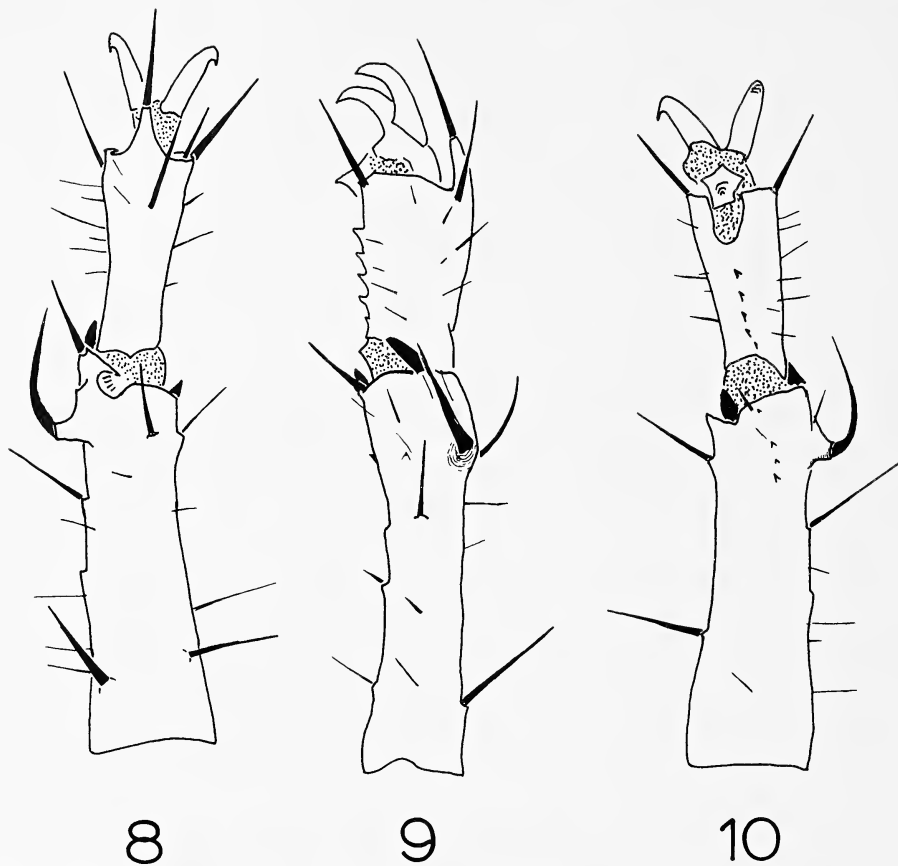

Figs. 8-10.—Tarsomeres on first right leg of holotype of *Chactas (Andinochactas) raymondhansi*, new species, showing diagnostic curved spiniform seta prolaterally: 8, dorsal aspect; 9, prolateral aspect; 10, ventral aspect.

Etymology.—This species is dedicated to Raymond A. Mendez and Hans E. A. Boos, joint collectors of the first specimen seen by the junior author. That specimen started the search that resulted in this publication.

Diagnosis.—Adult males 55-60 mm long, females 60-65 mm. Pedipalp tibia (Fig. 4) and chela (Fig. 7) with five ventral trichobothria each. Pectinal tooth counts 8-11. Tarsomere I of leg I with a strongly developed, curved spiniform seta prolaterally (Figs. 8-10). Tarsi on all legs with 5-8 ventral median spines.

Male.—Measurements (lengths in mm) of holotype: carapace 9.5, metasomal segment V 8.8; pedipalp femur 11.5, tibia 11.5, chela 20.5. Opisthosoma, metasoma, chelicera and pedipalps dark red brown; sternites, legs and telson yellow brown. Carapace and tergites acarinate. Pectinal tooth counts 9-11 (mode = 9). Stigmata large, suboval. Sternite VII acarinate. Metasomal segments I-IV: dorsolateral carinae weak, granulose; lateral supramedian carinae moderate, granulose; lateral inframedian carinae on I weak, granulose, on II-IV obsolete; ventrolateral keels weak, smooth; ventral submedian keels vestigial, smooth. Segment V: dorsolateral and lateral median carinae vestigial to obsolete; ventrolateral and ventromedian carinae weak, sparsely granulose. Pedipalps elongate, femur and tibia longer than carapace, chela slightly over twice as long as carapace. Trichobothrial pattern C (Vachon 1974): femur orthobothriotaxic

with 3 trichobothria (Fig. 1); tibia neobothriotaxic with 1 internal, 2 dorsal, 17 external, and 5 ventral trichobothria (Figs. 2-4); chela neobothriotaxic with 27 trichobothria, 5 ventrals (Figs. 5-7).

Female.—Measurements (lengths in mm) of largest female: carapace 10.3, metasomal segment V 8.8; pedipalp femur 9.0, tibia 9.0, chela 18.6. Sternites, legs and telson medium brown. Pectinal tooth counts 8-10 (mode = 9). Pedipalps not as elongate as on male: femur and tibia shorter than carapace, chela less than twice as long as carapace. Curved spiniform seta on tarsomere I of leg I not as strongly developed as on male, although still very conspicuous. Other characters as on male.

Variability.—Male sexual dimorphism in pedipalp length appears with the penultimate molt; immature males resemble females morphometrically. Pectinal tooth counts vary as follows: in males 14 combs with nine teeth, 1 comb with ten teeth, and 1 comb with eleven teeth; in females 2 combs with eight teeth, 11 combs with nine teeth, and 6 combs with ten teeth. Finally, the diagnostic, curved spiniform seta on tarsomere I is present in the smallest specimens examined (a male and a female with carapace lengths of 2.9 and 3.0 mm, respectively; probably represent second or third instars).

Comparisons.—The new species differs from *Chactas (Andinochactas) gestroi* Kraepelin, the only other member of the subgenus, (1) by having a strong, curved spiniform seta on tarsomere I of leg I, (2) by lacking dense punctations on the metasoma, and (3) by having higher pectinal tooth counts on both sexes (range 8-11 and mode is 9 in *C. raymondhansi*; range 6-8 and mode is 7 in *C. gestroi*).

Remarks.—This species has been collected only from water-filled spaces between leaf sheaths of the bromeliad *Glomeropitcairnia erectiflora* Mez. On live specimens a large chamber extending from the stigmata and surrounding the book lungs can be seen. This chamber may act as a reservoir for air if summersion becomes necessary or unavoidable.

The same species of bromeliad occurs on the Paria Peninsula and Margarita Island, Venezuela (Smith and Pittendrigh 1967). A search of this specific habitat in those locations might reveal the presence of *C. raymondhansi*, or a close relative, on the mainland.

Specimens examined.—TRINIDAD: Northern Range, on east ridge near summit of Mt. El Tucuche (1000 m), in bromeliad, 26-VI-1982 (Betty Faber, Eddie Rooks and party), holotype male (AMNH); same locality, in bromeliad 10 feet up small tree, 25-I-1981 (Raymond A. Mendez and Hans Boos), one adult male paratype (JB); same locality, in bromeliad, 16-V-1982 (R. W. Bruce, Jr. and L. Downie), one adult female paratype (JB); same locality, in bromeliad, 24-VI-82 (John Murphy and Ron Humbert), one adult male paratype (FSCA); same locality, in bromeliad, VIII-1982 (M. Read), one subadult female paratype (FSCA); same locality, in bromeliad, IX-1982 (M. Read), one subadult male paratype (MAGS); same locality, in bromeliad, 1980 (M. Koo), one juvenile male paratype (UWI); El Tucuche (3,000 ft.), 30 October 1937 (E. McC. Callan), one adult male paratype (USNM); Northern Range, top of Mt. Aripo, in bromeliads, 9-X-1982 (M. Read and J. Seyjagat), one adult male, one adult female, one subadult female, and one juvenile male paratypes (OFF); on ridge 1 mi W of Mt. Aripo, XI-1982 (M. Read), one juvenile female paratype (JB); El Aripo (2,800 ft.), 25 March 1942 (C. G. Pittendrigh), one adult female paratype (USNM); El Aripo (3,085 ft.), 24 February 1944 (A. M. Adamson), one adult female paratype (USNM); Northern Range, summit of Morne Bleu, in *Glomeropitcairnia* bromeliad, 4 March 1984 (M. Read), one juvenile female paratype (JB); St. Augustine, 1941 (E. McC. Callan), one subadult female paratype (USNM).

Genus *Broteochactas* Pocock

Broteochactas Pocock, 1893. Ann. Mag. Nat. Hist., ser. 6, 12:77 (Type species *Broteochactas nitidus* Pocock 1893 by original designation).

Auyantepuia González-Sponga, 1978. Escorpiofauna de la Region Oriental del Estado Bolivar, en Venezuela, p. 75. (Type species *Broteochactas scorzai* Dagert 1957, by monotypy). NEW SYNONYMY.

This genus is known from Panama, Colombia, Ecuador, Venezuela, the Guianas, Brasil, and Trinidad and Tobago. The type species, originally described from Trinidad, was synonymized under *Broteochactas gollmeri* (Karsch) from Caracas, Venezuela, by Kraepelin in 1894, and has remained in synonymy ever since. Comparison of material from Caracas, including the lectotype of *B. gollmeri* (hereby designated), with specimens from both Trinidad and Tobago revealed that these two taxa are not conspecific. Thus, *B. nitidus* is redescribed below.

The genus *Auyantepuia* was created by González-Sponga to accommodate *Broteochactas scorzai* Dagert, from Estado Bolivar, Venezuela. This small species differs from other *Broteochactas* spp. known from Estado Bolivar in three characters, which is why it was placed in a separate genus. First the dentition in the pedipalp fingers terminates in two distal teeth, rather than three to five. Second, the trichobothrium designated eb on the external series of the pedipalp chela finger (Vachon 1974, González-Sponga 1978) is found on the finger proper, rather than on the base of the finger basal to the commissure. Finally, among the supernumerary trichobothria on the external distal series on the tibia, et₄ is "petite" as opposed to et₅ and et₆ being "petite." When all species of *Broteochactas* are considered, rather than only those from Estado Bolivar, *B. scorzai* no longer stands out as a generically distinct entity.

The variation in the first character mentioned above appears to be size-related, with smaller species having fewer terminal teeth than larger species. *Broteochactas scorzai* and *Broteochactas laui* Kjellesvig-Waering, the two smallest species in the genus, have two terminal teeth on both the fixed and movable fingers of the pedipalp chela. *Broteochactas nitidus* and *B. gollmeri*, two medium sized species have two terminal teeth on the fixed finger and three on the movable finger. Finally, some of the larger *Broteochactas* spp. have three terminal teeth on the fixed finger, and three to five on the movable finger. Thus, this character is not taxonomically significant at the supraspecific level.

Regarding the second character used to diagnose *Auyantepuia*, *B. nitidus* and *B. gollmeri* have trichobothrium eb in the same position as *B. scorzai*, on the fixed finger proper, whereas *B. laui* and some of the larger Venezuelan *Broteochactas* spp. have eb on the basal portion near the fingers' commissure. Thus, this character does not have the taxonomic significance ascribed to it by González-Sponga.

The third "character" mentioned above actually involves two different, subjective problems, each of which is dealt with separately. First, a decision must be made as to what constitutes a normal versus a "petite" trichobothrium. Among the six trichobothria assigned to the external terminal (et) tibial series in *Broteochactas*, some species have one with a small pit and short hair, and another one with a normal pit but with a short hair (e.g., *B. laui*, Fig. 11); some

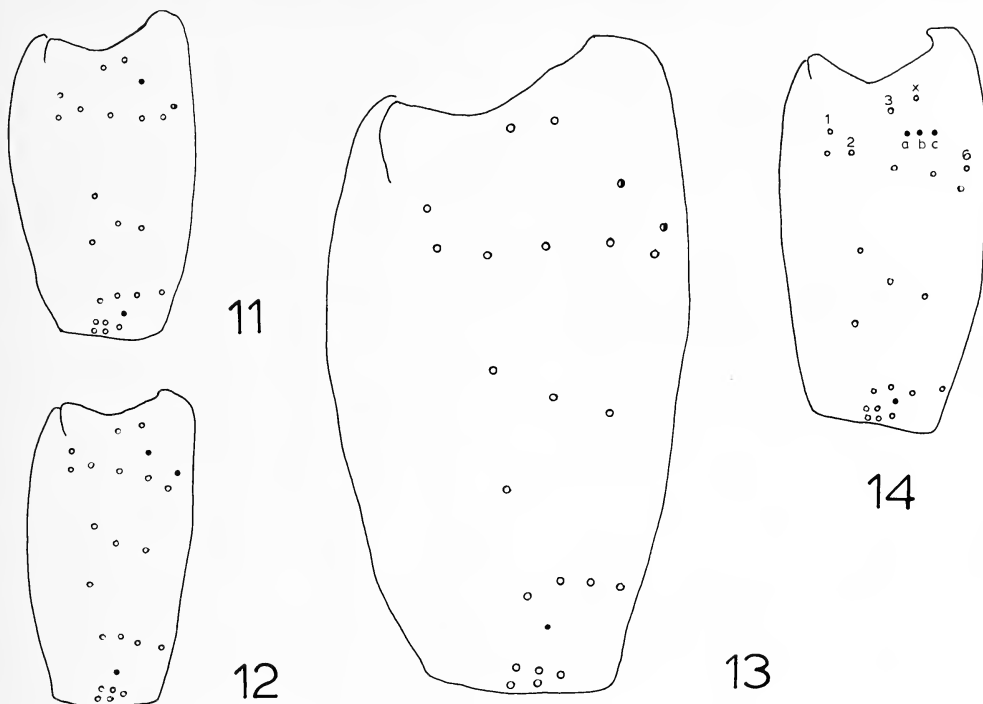

Figs. 11-13.—External aspect of pedipalp tibia (drawn on same scale) showing trichobothrial variability in *Broteochactas* spp. An open circle denotes a normal trichobothrium, a half-closed circle denotes a trichobothrium with a normal pit and a small seta, and a small dot denotes a trichobothrium with a small pit and a small seta. 11, *B. laui*, from Tobago; 12, *B. gollmeri*, from Venezuela; 13, *Broteochactas* sp. from Guyana.

Fig. 14.—Semi-diagrammatic illustration showing that positional variation in one small trichobothrium can lead to erroneous homologies in designations: a = et_4 and x = et_5 , however c = et_5 and x = et_4 (see text for further discussion).

species have two trichobothria with small pits and short hairs (e.g., *B. gollmeri*, Fig. 12), and some have two with normal pits but short hairs (e.g., *Broteochactas* sp., Fig. 13). The second problem is that created by the numbering convention of Vachon (1974), and used by González-Sponga (1978), and its implied homologies (see Francke 1982, and Francke and Soleglad 1981, for further discussion on this problem). In Fig. 14, a small trichobothrium appearing in position "a" becomes et_4 , and "x" becomes et_5 ; the same small trichobothrium in position "c" becomes et_5 , and "x" is considered as et_4 : and in position "b" it is a toss-up! The reputed difference between *Auyantepuia*, with trichobothria et_4 small and et_5 normal (position "a" in Fig. 14), and *Broteochactas*, with et_4 normal and et_5 small (positions "b" and "c" in Fig. 14) is based on a false homology and certainly does not justify the recognition of two separate genera.

Broteochactas nitidus Pocock

Figs. 15-20

Broteochactas nitidus Pocock 1893b:339-401, pl. 29, figs. 7-7a.

Broteochactas gollmeri (in part): Kraepelin 1894:176-177, 1899:173, 1912:53; Pocock 1897:365-366, 1900:68; Mello-Leitão 1932:32, 1945:100.

Broteochactas gollmeri (misidentification): Roewer 1943:237; Waterman 1950:169; Kjellesvig-Waering 1966:126.

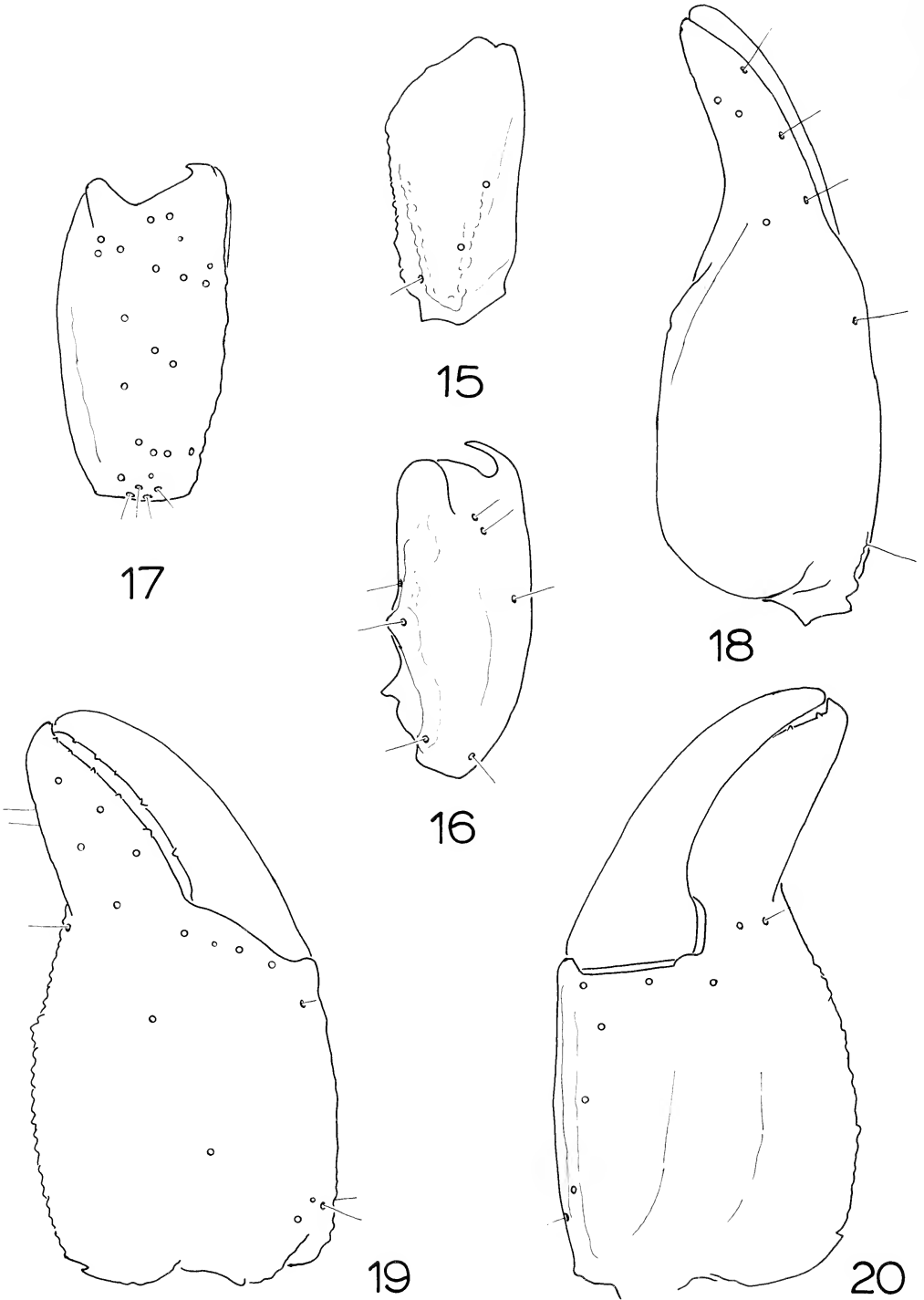

Fig. 15-20.—Right pedipalp of adult male *Broteochoctas nitidus* Pocock, from Trinidad, showing trichobothrial patterns: 15, dorsal aspect of femur; 16, dorsal aspect of tibia; 17, external aspect of tibia; 18, dorsal aspect of chela; 19, external aspect of chela; 20, ventrointernal aspect of chela.

Type data.—Lectotype male and seven paralectotypes (hereby designated) from Trinidad (L. E. Broadway). Permanently deposited in the British Museum (Natural History). Examined.

Distribution.—Known only from Trinidad and Tobago.

Diagnosis.—Adults 30-35 mm long; dark brown to black, legs medium to dark brown. Pectinal tooth count 8 in males, 7 in females. Metasomal segments III-IV with ventrolateral keels moderate, granulose. Pedipalp chela with three external trichobothria on finger (Fig. 18); dorsal margin of manus with dense, coarse granulation; external aspect of manus with fine granules in reticulated pattern. Chela length less than twice its width.

Male.—Measurements (lengths in mm) of lectotype male from Trinidad: carapace 4.1, metasomal segment V 4.7; pedipalp femur 2.8, tibia 3.3, chela 6.3, fixed finger 2.6. Opisthosoma, metasoma and pedipalps dark red brown; sternites, chelicera and legs light brown; all areas heavily infuscate. Carapace and tergites shagreened, acarinate except for tergite VII with few distal granules on submedian and lateral carinal regions. Pectinal tooth count 8. Stigmata small, round. Sternites smooth, acarinate. Metasomal segments I-IV: dorsolateral carinae strong, granulose; lateral suprmedian carinae moderate, granulose; lateral infrmedian carinae on I vestigial, subgranulose, on II-IV obsolete; ventrolateral carinae on I obsolete, on II vestigial and subgranulose, on III and IV weak to moderate and granulose; ventral submedian carinae on I and II obsolete, on III vestigial and subgranulose, on IV weak to moderate and granulose. Segment V: dorsolateral and lateromedian carinae weak, finely granulose; ventral keels moderate, granulose. Telson with moderately dense, small granulation. Pedipalps stout, chela considerably wider (1.3-1.5X) than fixed finger length. Bothriotaxia C (Vachon 1974): femur orthobothriotaxic with 3 trichobothria (Fig. 15); tibia neobothriotaxic with 1 internal, 2 dorsal, 24 external and 7 ventral trichobothria (Figs. 16 and 17); chela orthobothriotaxic with 26 trichobothria (Figs. 18-20). Tarsomere II on all legs armed ventrally with two submedian rows of long setae.

Female.—Measurements (length in mm) of adult from Chancellor Hill, Trinidad: carapace 5.0, metasomal segment V 5.0; pedipalp femur 3.5, tibia 4.0, chela 7.6, fixed finger 2.9. Pectinal tooth count 7.

Variability.—The populations from Trinidad and Tobago are remarkably uniform morphologically. However, specimens from mountainous areas tend to be darker (almost black) than lowland forms. Pectinal tooth counts display very low variability: in males 7 combs had seven teeth, 68 combs had eight teeth, and 1 comb had nine teeth; in females 2 combs had six teeth, 185 combs had seven teeth, and 9 combs had eight teeth.

Comparisons.—*Broteochoactas nitidus* differs from *B. gollmeri*, with which it had been confused, as indicated below. First, in size: carapace length in adult males is greater than 4.0 mm in *B. nitidus*, and less than 4.0 mm in *B. gollmeri*; in females greater than 4.5 mm in *B. nitidus*, and less than 4.1 mm in *B. gollmeri*. Second, in pectinal tooth counts: in *B. nitidus* 8 in males, and 7 in females; in *B. gollmeri* 7 in males, and 6 in females. Third, in ornamentation on the dorsal and external faces of the pedipalp chela: densely granulose in *B. nitidus*, smooth and shiny in *B. gollmeri*. Fourth, in pedipalp chela proportions: 1.9 times longer than wide in males of *B. nitidus*, 2.1 times longer than wide in males of *B. gollmeri*; 1.8 times longer than wide in females of *B. nitidus*, 2.15 times longer than wide in females of *B. gollmeri*. Finally, in development of the ventral

submedian carinae on metasomal segments III and IV: weak to moderate and granulose on *B. nitidus*, vestigial and subgranulose on *B. gollmeri*.

Broteochactas nitidus differs from *B. laui*, with which it coexists on Tobago, as follows. First, in size: carapace length in adults of *B. laui* is less than 4.0 mm. Second, in pectinal tooth counts: 7 on males and 6 on females of *B. laui*. Third, in the disposition of the external trichobothria along the fixed finger of the pedipalp chela: eb basal to the finger commissure in *B. laui* (Fig. 25), and distal to the commissure in *B. nitidus* (Fig. 19).

Specimens examined.—TRINIDAD: no date [29.IV.1890 ?] (L. E. Broadway), lectotype male, two paralectotype males, and five paralectotype females (BMNH); 3.4.1900 (W. Ince), one male, five females (BMNH); Maraval Valley, 1913 (Thaxter), two females (MCZ); Port-of-Spain, Jan. 1913 (R. Thaxter), two juveniles (MCZ); near Salibia, 28 April 1916 (H. L. Clark), one female (MCZ); La Seira Valley, April 1916 (H. L. Clark), two males, two females (MCZ); Mt. Tucuche (in bromeliads), 28 May 1917 (J. B. Rorer), one female (MCZ); Port-of-Spain, 28 Jan. 1926 (W. S. Brooks), one male (MCZ); Port-of-Spain, February 1942 (H. F. Loomis—A. V. Armour Exp.), two adult females (USNM); Port-of-Spain, Chancellor Hill (1000 ft.), 20 March 1964 (E. N. Kjellesvig-Waering), three adult males, one subadult female (FSCA); Simla, 18-25 April 1964 (no collector), four juveniles (MCZ); Port-of-Spain, 15-V-1965 (E. N. Kj. Waering), two adult, one juvenile females (FSCA); Port-of-Spain, Chancellor Hill (1000 ft.), 15-VII-1965 (E. N. Kj. Waering), four males, five females (FSCA); Port-of-Spain, 1 May 1966 (E. N. Kj. Waering), one juvenile (FSCA); Port-of-Spain, Chancellor Hill (1500 ft.), Aug. 1966 (E. N. Kjellesvig-Waering), one adult male, three adult females, two subadult females (OFF), three males, one female (FSCA); Port-of-Spain, Ft. George Hill (1200 ft.), 15-VIII-1967 (Ricky Kj. Waering), one juvenile male (FSCA); Port-of-Spain, Chancellor Hill (1500 ft.), March 1968 (E. N. Kj. Waering), four females (FSCA); Maraval, N of Port-of-Spain, 16 Dec. 1962 (E. N. Kj. Waering), one female (FSCA); Maraval, 4 Mar. 1963 (E. N. Kj. Waering), one female (FSCA); 5 Mar. 1964 (W. R. Jones), one male, three females (one with 46 first instars) (FSCA); Maraval, 6 March 1964 (W. R. Jones), one female (gave birth in captivity) (FSCA); Maraval, 13 Mar. 1964 (W. R. Jones), two females (FSCA); Maraval, 12 April 1964 (E. N. Kj. Waering), one male, one female (FSCA); Maraval, 15 April 1964 (E. N. Kj. Waering), one female (FSCA); Maraval, 23 April 1964 (E. N. Kj. Waering), one male (FSCA); Maraval, 12-I-1968 (E. N. Kj. Waering), one female (with 27 first instars born in captivity) (FSCA); Maraval, Fondes Amandes Road, 2 Dec. 1967 (H. and J. Boos), four females (one with 44 first instars born in the wild) (FSCA); Maraval, Fondes Amandes Rd., 24-V-1968 (J. Boos), one female (FSCA); Mayaro Beach, 2 mi N Plaisance (2 m), 15 Mar. 1964 (E. N. Kj. Waering), one female (FSCA); Mayaro Beach area, Ortoire, 12 June 1964 (E. N. Kj. Waering), one female (FSCA); Mayaro Beach area, Ortoire Village, 20 Nov. 1964 (E. N. Kj. Waering), one female (FSCA); Mayaro Beach, 15 Nov. 1965 (E. N. Kj. Waering), one male, one female (FSCA); Mayaro Beach, 1 May 1966 (E. N. Kj. Waering), one female (FSCA); Mayaro, Ortoire Village, III-1968 (E. N. Kj. Waering), one female (FSCA); Mayaro Beach, Ortoire Village, 15-IV-1968 (E. N. Kj. Waering), three females (FSCA); Mayaro Beach, 15-V-68 (E. N. Kj. Waering), one male (FSCA); Maracas, 1941 (E. McC. Callan), one adult female (USNM); Maracas Valley, 9-IV-1968 (Hans Boos), one male, one female (FSCA); milepost 6.4 Maracas Bay to Port-of-Spain Rd. (800 ft.), 15-VI-1968 (Ricky Waering), one female (FSCA); milepost 6-1/4 on Maracas Bay Road, 20-VIII-1976 (J. Boos), one adult male (JB); Mt. Cathrine, 13-II-1977 (J. Boos), one adult male, one juvenile female (JB); St. Joseph, Maracas Falls trail, 8-III-1977 (J. Boos), two adult females (OFF); Asa Wright Nature Center, Arima Valley, 16-VII-1978 (R. A. Mendez), one adult female (OFF); Blanchisseuse Valley, 1-II-1979 (R. Mendez and J. Boos), one adult male, one subadult female, one immature male (OFF); El Tucuche (2,000 ft.), June 1944 (A. H. Strickland), one adult female with 27 first-instar young (USNM); Tucuche (2,500 ft.), 12 November 1944 (A. M. Adamson), one adult and one juvenile males (USNM); Mt. Tucuche (3000 ft.), 1-VI-1969 (Julius Boos), one male (FSCA); trail to Mt. El Tucuche (under rock), 18-II-1979 (J. Boos), one adult male, one subadult female (JB); in leaf litter nr. summit of Mt. El Tucuche, N. Range, 16-V-1982 (R. W. Bruce, Jr. and L. Downie), two adult females (MAGS); Verdant Vale Road, off Blanchisseuse Rd., Arima, July 1982 (M. Read), one adult female (JB); Simla, Blanchisseuse Rd., Arima, Sept. 1982 (M. Read), one adult female (UWI); in bromeliad, summit of Mt. Aripo, Northern Range, IX-1982 (M. Read), one female (UWI); Haven Hill farm, Talparo, Nov. 1983 (V. Quesnel), one juvenile female (JB); in rotting log, summit of Mt. Aripo, Northern Range, 14 Dec. 1983 (M. Read), one adult female (JB); Northern Range (2,000 ft.), 8 February 1942 (A. M. Adamson), one adult female (USNM); same locality (2,000 ft.),

24 March 1943 (A. M. Adamson), one adult male (USNM); Diego Martin, Petit Valley, 5 May 1964 (E. N. Kj. Waering), one male (FSCA); St. Anns, 12-XI-1968 (J. Boos), two females (FSCA); 3 mi W Morne Bleu, 30-VI-1968 (J. Boos), one female (FSCA); 1 mi W Morne Bleu, 9-III-1969 (J. Boos), two females (FSCA). TOBAGO: Speyside, 1 Sept. 1964 (Edgar Lau), one male (FSCA); Speyside, 28 Nov. 1969 (Egbert Lau), one female (FSCA); Speyside, .7.1970 (E. N. Kj. Waering), one female (FSCA); road to Hillsborough Dam, May 1977 (Ray Mendez), one adult female (OFF); Mertichon Estate nr. Speyside, 3-IV-1979 (Dave Hardy), one subadult female (JB); Pigeon Hill, nr. Charlotteville, 4-V-1979 (Dave Hardy), one adult female (JB); Pigeon Peak, nr. Charlotteville, 26-27-X-1982 (M. Read), two adult females (JB); near summit of Pigeon Peak, under stone in gully, 26 Feb. 1984 (M. Read), two adult females (OFF).

Broteochactas laui Kjellesvig-Waering

Figs. 21-26

Broteochactas laui Kjellesvig-Waering 1966:126-128, figs. 1-2; González-Sponga 1974a:5, 1974b:300.

Type data.—Holotype female from Speyside (Paradise Inn Hotel), Tobago. Permanently deposited in the American Museum of Natural History, New York. Not examined.

Distribution.—Known only from Tobago.

Diagnosis.—Adults 22-25 mm long; medium brown and heavily infusate, with legs yellow brown and lightly infusate. Pectinal tooth counts 6-7 (mode = 7) in males, 5-7 (mode = 6) in females. Pedipalp chela with two external trichobothria on finger (Fig. 25); dorsal and external aspects of chela densely and coarsely granulose. Carinae on metasomal segments I-IV absent, except for lateral supramedians on I and II and dorsolaterals on III and IV which are weak and subgranulose.

Female.—Measurements (length in mm) of adult paratype from Speyside, Tobago: carapace 3.7; metasomal segment V 3.1; pedipalp femur 2.1, tibia 2.6, chela 5.0, fixed finger 1.9. Opisthosoma and metasoma medium brown, heavily infusate; pedipalps dark red brown, heavily infusate; sternites, chelicera and legs yellow brown, lightly infusate. Carapace and tergites acarinate, smooth and shiny. Sternites smooth and shiny; stigmata small, round. Metasomal carinae on I-IV: lateral supramedians on I and II, and dorsolaterals on III and IV weak, subgranulose; all others obsolete. Segment V with dorsolateral keels weak, finely granulose; ventral keels moderate, granulose. Telson shiny, with sparse small granules. Pedipalps stout; chela with broad, stubby fixed finger. Bothriotaxia C (Vachon 1974): femur orthobothriotaxic with 3 trichobothria (Fig. 21); tibia neobothriotaxic with 1 internal, 2 dorsal, 24 external, and 7 ventral trichobothria (Figs. 22 and 23); chela orthobothriotaxic with 26 trichobothria (Figs. 24-26). Tarsomere II on all legs armed ventrally with two submedian rows of setae.

Male.—Measurements (lengths in millimeters) of adult paratype from Speyside, Tobago: carapace 3.5; metasomal segment V 3.5; pedipalp femur 2.2, tibia 2.7, chela 4.7, fixed finger 1.7. Differ from females primarily in pedipalp chela proportions, having a wider manus and a shorter fixed finger; in pectinal morphology, with one more tooth, and each tooth is 2.5 to 3 times longer than on females.

Variability.—Pectinal tooth counts varied as follows: on males 1 comb with six teeth, 3 combs with seven teeth (one male reported upon by Kjellesvig-Waering 1966); on females 1 comb with five teeth, 22 combs with six teeth, and 7 combs with seven teeth.

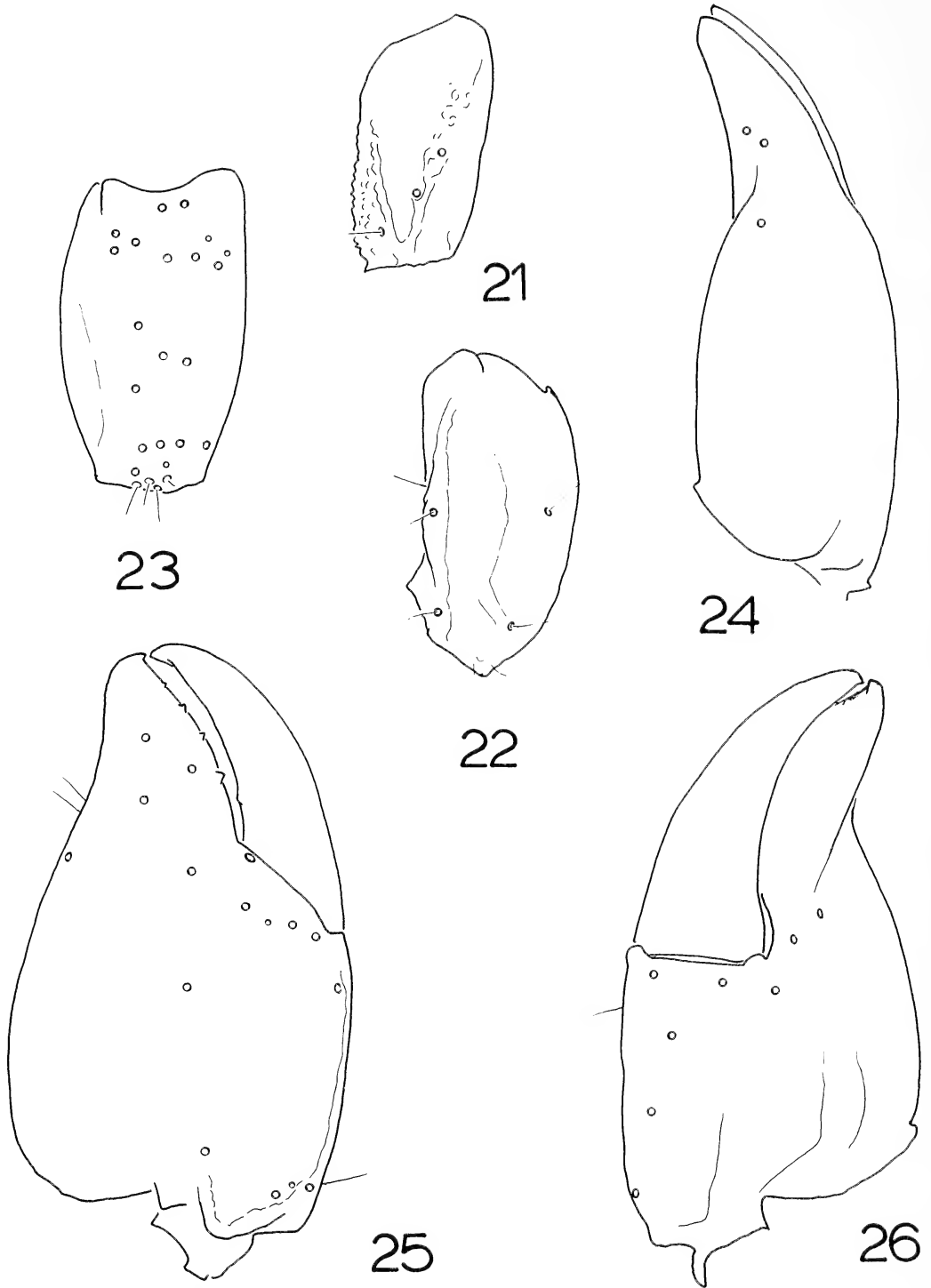

Figs. 21-26.—Right pedipalp of adult female *Broteochactas laui* Kjellevig-Waering, from Tobago, showing trichobothrial patterns: 21, dorsal aspect of femur; 22, dorsal aspect of tibia; 23, external aspect of tibia; 24, dorsal aspect of chela; 25, external aspect of chela; 26, ventrointernal aspect of chela.

Comparisons.—See the section under *B. nitidus* for differential characters with that species.

Specimens examined.—TOBAGO: Speyside (under rocks in burrows; forest), 15-II-1965 (Edgar Lau), one adult male, one adult female paratypes (FSCA); Speyside, 20 April 1965 (Edgar Lau), two adult female paratypes (FSCA); between Charlotteville and Speyside, 29 Oct. 1982 (M. Read), one adult female (JB); milepost 26 Windward road, among rocks and soil from walls of gully in cocoa plantation, 19-20 Feb. 1984 (M. Read), five adult, one subadult and three juvenile females (JB, OFF).

ACKNOWLEDGMENTS

We thank Dr. Mary Alkins, Department of Zoology, University of the West Indies, St. Augustine, Trinidad (UWI), Dr. J. Coddington, U. S. National Museum, Washington, D. C. (USNM), Dr. G. B. Edwards, Florida State Collection of Arthropods, Gainesville, Florida (FSCA), Mr. P. D. Hillyard, British Museum (Natural History), London (BMNH), Dr. H. W. Levi, Museum of Comparative Zoology, Harvard University, Cambridge (MCZ), and Dr. M. Moritz, Zoologisches Museum der Humboldt Universität, Berlin (ZMB) for the loan of specimens. Dr. M. A. González-Sponga (MAGS) kindly donated some Venezuelan scorpions to the senior author, and gave advice and loaned specimens to the junior author. Special thanks to the many collectors of specimens who are mentioned in the text, in particular Dr. Morley Read and Mr. John Seyjagat; and to Mr. J. Santiago-Blay for locating specimens in the collection of the U. S. National Museum. Finally, Dr. W. D. Sissom and Mr. S. A. Stockwell kindly commented on a draft of the manuscript.

LITERATURE CITED

- Francke, O. F. 1977. Scorpions of the genus *Diplocentrus* from Oaxaca, Mexico. *J. Arachnol.*, 4:145-200.
- Francke, O. F. 1982. Studies of the scorpion subfamilies Superstitioninae and Typhlochactinae, with description of a new genus (Scorpiones, Chactoidea). *Bull. Assn. Mexican Cave Studies*, 8:51-62.
- Francke, O. F. 1985. *Conspectus Genericus Scorpionorum* (Arachnida, Scorpiones). *Occas. Papers Mus., Texas Tech Univ.*, No. 98, 32 pp.
- Francke, O. F. and M. E. Soleglad. 1981. The family Iuridae Thorell (Arachnida, Scorpiones). *J. Arachnol.*, 9:233-258.
- González-Sponga, M. A. 1974a. *Broteochactas sanmartini*: nueva especie del Rio Caura, en la Guayana de Venezuela. *Monografías Científicas "Augusto Pi Suñer"*, Caracas, No. 7, 16 pp.
- González-Sponga, M. A. 1974b. Una nueva especie de escorpiones de la Amazonia Venezolana (Chactidae). *Acta Biol. Venezuela*, 8:299-313.
- González-Sponga, M. A. 1978. Escorpiofauna de la region oriental del Estado Bolivar, en Venezuela. *Consejo Nac. Inv. Cient. Tecnol. Caracas, Roto-Impresos C. A.*, 217 pp.
- González-Sponga, M. A. 1984. Escorpiones de Venezuela. *Cuadernos Lagoven, Cromotip, Caracas*, 126 pp.
- Kjellesvig-Waering, E. N. 1966 The scorpions of Trinidad and Tobago. *Caribbean J. Sci.*, 6:123-135.
- Kraepelin, K. 1894. Revision der Skorpione. II: Scorpionidae und Bothriuridae. *Jahrb. Hamburg. wiss. Anst.*, 11:1-248.
- Kraepelin, K. 1899. Skorpiones und Pedipalpi. *Das Tierreichs*, 8:1-265.
- Kraepelin, K. 1912. Neue Beiträge zur Systematics der Gliederspinnen. II. Chactinae. *Jahrb. Hamburg. wiss. Anst.*, 29:45-88.
- Mello-Leitão, C. de 1932. Notas sobre escorpiões Sul-Americanos. *Arq. Mus. Nac. Rio de Janeiro*, 34:9-46.
- Mello-Leitão, C. de 1945. Escorpiões Sul-Americanos. *Arq. Mus. Nac. Rio de Janeiro*, 40:7-468.
- Pocock, R. I. 1893a. A contribution to the study of Neotropical scorpions. *Ann. Mag. Nat. Hist.*, ser. VI, 12:77-103.

- Pocock, R. I. 1893b. Contributions to our knowledge of the arthropod fauna of the West Indies.— Part I. Scorpiones and Pedipalpi; with a supplementary note upon the freshwater Decapoda of St. Vincent. *J. Zool. Linn. Soc.*, London, 24:374-409.
- Pocock, R. I. 1897. Report upon the Scorpiones and Pedipalpi obtained on the Lower Amazon by Messrs. E. E. Austen and F. Pickard-Cambridge during the trip of Mr. Siemen's Steamship "Faraday." *Ann. Mag. Nat. Hist.*, ser. VI, 19:357-368.
- Pocock, R. I. 1900. Myriapoda and Arachnida, in Report on a collection made by Messrs. F. V. McConnell and J. J. Quelch at Mr. Roraima in British Guiana. *Trans. Linn. Soc. London*, ser. II, 8:64-71.
- Roewer, C. F. 1943. Ueber eine neuerworbene Sammlung von Skorpionen des Natur-Museums Senkenberg. *Senckenbergiana*, 26:205-244.
- Smith, L. B. and C. S. Pittendrigh. 1967. Bromeliaceae. Pp. 37-50, *In* Flora of Trinidad and Tobago. Ministry of Agriculture, Industry and Commerce, Trinidad and Tobago. Government Printery, Trinidad.
- Stahnke, H. L. 1970. Scorpion nomenclature and mensuration. *Entomol. News* 81:297-316.
- Waterman, J. A. 1950. Scorpions in the West Indies with special reference to *Tityus trinitatis*. *Caribbean Med. J.*, 12:167-177.
- Vachon, M. 1974. Etude des caractères utilisés pour classer les familles et les genres de Scorpions (Arachnides). *Bull. Mus. Nat. Hist. Nat. Paris (ser. Zool.)*, 104 (140):859-958.

Manuscript received August 1985, revised October 1985.

ECOLOGY AND BEHAVIOUR IN *PORTIA SCHULTZII*, WITH NOTES ON RELATED SPECIES (ARANEAE, SALTICIDAE)¹

Lyn M. Forster

Otago Museum
Gt. King St.
Dunedin, New Zealand

and

Frances M. Murphy

323 Hanworth Road
Hampton, Middlesex
TW12 3EJ, England

ABSTRACT

Field observations of *Portia schultzi*, a web-building jumping spider from Kenya, Africa, reveal that it commonly inhabits the dense webs of *Ischnothele karschi*, a diplurid spider. As a detritus mimic, this spider is inconspicuous whether in a web or on the move. Laboratory studies show that it readily catches a variety of prey-spiders and insects (mainly *Drosophila*) in its own webs, in *I. karschi* and other alien webs, as well as in non-web situations. Although the basic, visually-directed, predatory sequence conforms to that of the typical salticids, several derived features, such as the extremely slow and specialised locomotory movements, long periods of immobility in a cryptic posture, the web strategies of 'quivering' and 'dropping', and shorter visual discriminatory distances (not more than 10 cm) than most other salticids, enable this spider to exploit a web environment.

INTRODUCTION

Jumping spiders (Salticidae) have long been known for their proficiency and versatility as cursorial predators (see Forster 1982a) so it has come as rather a surprise to find that some species of the genus *Portia* Karsch specialise in the use of webs to catch their prey. Web-building was first observed by one of us (FMM) in the course of rearing *P. schultzi* Karsch collected from Kilifi, Kenya, in 1974 (see Wanless 1978b, Murphy and Murphy 1983) and it was soon evident that these salticids seized insects detained by the silk. Although 'web piracy' by members of this group had been recorded several times (e.g., Gravely 1921,

¹The preparation of this paper was supported by grants from the Scientific Distribution Committee, New Zealand Lottery Board.

Bristowe 1941) the fact that some of them also build their own three-dimensional structures in which to lurk was unknown until that time. These same studies confirmed that other spiders too were acceptable prey items and explained why *P. schultzi* were frequently found in the dense, extensive webs of *Ischnothele karschi* (Bosenberg and Lenz), a diplurid spider.

The discovery that *P. schultzi* construct and utilise their own webs as well as invading those of other spiders in the pursuit of prey raises a number of questions. How is prey detected, for instance, and do these salticids rely on vision to the same extent as cursorial species? Do they behave like other members of the family, or genus for that matter, and what are the advantages of this life style to them? To investigate these questions, live *P. schultzi* were sent to LMF in New Zealand and the present paper is the result of the collaborative studies thus undertaken.

At much the same time, another series of investigations (Jackson and Blest 1982a, b) was begun in Australia, the subjects being *Portia fimbriata* (Doleschall) which had been located in northern Queensland. Some of these studies paralleled ours thus enabling us to make comparisons between the two species. Other *Portia* spp. were observed and tested by FMM and these findings also provide useful comparisons.

MATERIAL AND METHODS

Portia schultzi is a medium-sized salticid with a body length of about 7-8 mm. Its long legs are quite slender but this is seen only in the two terminal segments where the long, variously colored hairs covering the rest of the body are lacking. Fringes and tufts on certain parts of the legs supplement this hairy covering, and the many hues create a mottled effect.

Portia schultzi range from the Forest of Gedi, near Malindi, Kenya, in the north, to Durban, South Africa, in the south, and westwards to the Rift Valley. This species has also been recorded from West Africa and Madagascar. For more detailed descriptions and distribution of *P. schultzi* and other *Portia* spp. see Wanless (1978b) and Murphy and Murphy (1983).

Portia schultzi used in these studies were observed in their natural habitats in Kilifi on the coast of Kenya from the Forest of Gedi to the Shimba Hills during the following periods: 11-16 Aug. 1974; 29 Aug. - 24 Sept. 1977; 8 Aug. - 11 Sept. 1980. Spiders were located in a number of sites, viz., in the webs of *Ischnothele karschi* (most commonly), on tree trunks and the walls of buildings, in leaf litter and a stick pile, under a water container, in an old Cyrtophora web, in a tangle of pholcid and uloborid webbery, and in their own webs.

Captive *P. schultzi* were housed in variously sized plastic containers (small, 4-5 cm in diam. x 2-5 cm high; medium, 5-10 cm in diam. x 5-10 cm high; large, 10-20 cm in diam. x 15.25 cm high), with one or more corked openings, usually supplied with moist cotton wool, and kept in room conditions (15-25°C).

Some of the tests with *P. schultzi* reported here were carried out in Kilifi but most of the longer-term observations and experiments were undertaken in England and New Zealand.

Investigations included: utilisation of silk and construction of webs, behaviour in various alien webs with or without other intruders, prey preferences, as well

as the sequence of predatory reactions in web and non-web situations. In these latter tests, attention was paid to the primary events and secondary subdivisions established for *Trite auricoma* (Urquhart) and other salticid species (Forster 1977a). Briefly, these are:

- Orientation: Alert (spider adopts a 'watchful' posture)
 - Swivel (spider turns to face source of movement)
 - Alignment (abdomen lines up with cephalothorax)
- Pursuit: Walk (slow movement towards target)
 - Run (rapid movement towards target)
 - Stalk (very slow movement with lowered profile towards target)
- Capture: Pre-crouch (low profile, 2 front pairs of legs forwards)
 - Crouch (low profile, 3 pairs of legs forwards, hind legs tensed)
 - Jump (leap towards target)

A variety of prey (see 'Prey preferences') was offered to *P. schultzii* in small, medium or large containers, in web and non-web situations.

Small (3-4 mm) lures (plasticene ball, tufts of cotton wool, bits of twig and leaf) attached to clear nylon thread were moved about in the vicinity of *P. schultzii* and their reactions observed. Other events were recorded and described. More details of methods are given in text where necessary.

RESULTS

The variegated coloration and patterning of *P. schultzii* together with its characteristic 'folded legs' resting posture (Fig. 1) combine to disguise the identity of this spider in the web where, as an effective detritus mimic, it is almost indistinguishable amongst the tiny bits of bark, seeds, dust and leaf fragments which readily accumulate there. On the move on tree trunks, *P. schultzii* is all but invisible and since, in the wild, it is most likely to commute between webs via trees and shrubs, its crypticity is obviously designed to cope with the two most likely situations in which it may find itself.

Distribution and Ecology.—The marked propensity of *P. schultzii* to inhabit the webs of *I. karschi* probably means that the distribution of these two species is closely linked. *Ischnothele karschi* have apparently benefited from the modification of tropical rain forests by man since their webs are very abundant in the partly cleared secondary bush which forms most of the gardens in Kilifi, whereas they are far less abundant in the tropical rain Forest of Gedi. Perhaps this has been advantageous for *P. schultzii*, too.

Ischnothele karschi is a medium-sized diplurid (about 15 mm in body length) which builds an extensive sheet web, occasionally on the ground, but more commonly in shrubs at a height of about one metre above the ground. The dense, central region of this web becomes greatly cluttered with plant debris thus providing an apparent refuge not only for immature *I. karschi*, but also for a great variety of spiders and insects, e.g. mysmenids (most common), scytodids, palpimanids, prodidomids, pisaurids, mimetids, *Ctenus* sp., *Orchestina* sp., *Argyrodes* sp., *Cylobellus* sp., *Cosmophasis* sp., *Myrmarachne* sp., in two instances *Thyeni inflata* females with eggsacs (constructed between leaves supported in the upper threads), and once an *Olios* exuviae, as well as insects such as thysanurids, crickets and ants. Unfortunately, it was rarely possible to see



Fig. 1.—Often observed hanging motionless in its web for long periods of time, *Portia schultzi* bears little resemblance to a spider. Its long legs are tucked against the body and are thereby concealed, a mimetic attitude of the kind described by Robinson (1969). But if it sights likely prey, the legs unfold and *Portia* begins a slow stealthy trek towards it.

what parts of the web *P. schultzi* usually occupied, or how they behaved therein, although they could sometimes be seen wandering about on the periphery of the web.

Fortuitously, an *I. karschi* web built in a fold of the trunk of a baobab tree (*Adansonia digitata*) had not accumulated any fallen leaves or other debris and it was possible to see further into the interior than usual. On three successive days, a small *P. schultzi* was seen in the web but on the fourth day, three were seen at much the same time. Two days later, a half-grown *Portia* as well as a smaller one (alongside what was presumed to be its exuviae) were present although they quickly vanished into the depths of the web. None was seen during occasional observations over the next two weeks but when the web was demolished only one half-grown *Portia* was revealed although there were several small mysmenids, some thysanurids, as well as the resident owner.

These observations suggest that *P. schultzi* is nomadic, wandering from one web to another, whereas *P. fimbriata* is relatively sedentary (Jackson and Blest 1982a) and in any case, can move readily from one host web to another because of their contiguity. Evidently *P. schultzi* prefer *I. karschi* webs, since they were never found in the quite prevalent *Stegodyphus* webs and only occasionally in pholcid or uloborid webs. Moreover, they were found in widely varying non-web situations which suggests they were merely seeking for webs to invade.

A diplurid web usually harboured a single *Portia* at a time although very small spiders were sometimes found together. Moreover, a survey of about 25 webs in the Kilifi area showed that the overall distribution of *P. schultzi* was about one

individual to every third diplurid web. In one instance, a rolled-up leaf, hung in the upper strands of an *I. karschi* web, yielded a cluster of newly hatched *Portia* spiderlings. Since the hair tufts did not appear until the third instar, spiderlings were not immediately recognisable as *P. schultzii* offspring. Interestingly, Jackson and Blest (1982a) report that *P. fimbriata* females construct special webs (Type 2) prior to the suspension of suitable leaves where the eggsacs are deposited.

Behaviour in 'captive' alien webs.—*Portia schultzii*. In captivity, a *P. schultzii*, introduced into a small cage where thick webbery had been constructed by an *I. karschi*, disappeared within the hour and was not seen again, apparently a victim of the owner. It was a similar story with *Stegodyphus* sp. although the *Portia* survived for several days before vanishing. However, in a large cage where *I. karschi* had built a thick webbery extending from a retreat of dead leaves bound with silk, the introduction of a half-grown *P. schultzii*, three mysmenids, and later a number of *I. karschi* spiderlings, led to rather different results.

Although one of the mysmenids lasted for about 4 months, two disappeared within a week, and not long after, *P. schultzii* was seen to catch a young *I. karschi* on the edge of the web. Two days later, fruitflies were put into the cage whereupon the adult *I. karschi* emerged and took two, ignoring both *Portia* and the spiderlings. Indeed, *I. karschi* was never seen to attack the spiderlings although they were sometimes seen eating each other. *Portia*, however, often seized wandering spiderlings.

Initially, *P. schultzii* remained near the floor of the cage at the opposite end to *I. karschi* and generally ignored fruitflies in favour of spiderlings. After about a month it moved up to the corked opening where the fruitflies were introduced and subsequently took fruitflies as prey although there were still several spiderlings available. Then, after 3 weeks, it moulted, moved back to the bottom of the cage, and shortly afterwards disappeared, evidently a victim itself.

***Portia labiata* (Thorell):** In 1979, three *P. labiata* were collected in Malaya. One female, taken back alive to England, made a small sheet web on the underside of its cage but did not respond to fruitflies dropped into the web as *P. schultzii* had done. After being introduced into a medium-sized cage where an immature *Tegenaria* had built a retreat and a web, *P. labiata* soon seized the *Tegenaria*. Returned to its home cage, *P. labiata* was later observed hanging from the web by its 3rd and 4th pairs of legs devouring its victim, a posture usually adopted by *P. schultzii* when eating prey. In a pholcid web, *P. labiata* showed its ability to move through the threads without alerting the pholcid but although it jumped into the web after fruitflies did not succeed in catching any.

When *P. labiata* was placed on a wooden frame supporting a *Meta* web and spider, it suddenly stirred after a long period of inaction and swivelled very slowly through 30° towards the motionless *Meta* about 3 cm away. Aligning its abdomen, *Portia* slowly stalked the *Meta* along the frame, finally crouching and leaping at it from about 1 cm. After jumping back to the frame *Portia* began feeding. *Phiale* is another salticid which attacks the spider *Argiope argentata* (Fabricius) from outside the web although both victim and quarry then drop to the ground (Robinson and Valerio 1977).

When a plasticene lure was jiggled briefly to one side of *P. labiata*, it swivelled very slowly through about 40°, aligned its abdomen, then began to creep slowly, almost imperceptibly towards the now stationary lure until the side of the clear

plastic arena was reached. It did not jump but other salticids often refuse to jump at lures or live prey when barriers of glass or plastic intervene (Forster 1979b).

***Portia durbanii* Peckham and Peckham:** Not all *Portia* species make webs. A juvenile *P. durbanii* from South Africa (see Wanless 1978b) was reared by FMM through several moults and showed no sign of web-spinning activity. Fed mostly on fruitflies, it caught prey in typical salticid fashion, albeit much more slowly. This species moults in the open.

Utilisation of silk by *Portia schultzi*.—When moving about in the open or leaping across gaps, *P. schultzi* laid down a dragline and attached it at various points, as all typical salticids do. But once a number of aerial threads had been established, this salticid showed a pronounced tendency to use these threads for passage and this, in turn, increased the aggregation of aerial lines which readily became attached to each other where they crossed. However, typical salticids seldom use draglines in this manner nor do their silk threads adhere to each other in such a way. Clearly, these modifications are fundamental to the life style exhibited by *P. schultzi*.

When caged, *P. schultzi* immediately constructed a few aerial threads from which it hung, upside-down. More silk was added to the preliminary structure from time to time, resulting in a three-dimensional network supporting a recognisable platform beneath which the spider usually rested. Mature males, however, seldom built such platforms; indeed, their webs were much flimsier than either female or juvenile structures.

In a web, whether its own or that of a host, *P. schultzi* almost always moved about in a languid manner interspersing stepping movements with flexing and stretching motions of the limbs, thus creating the impression of a 'lolloping' gait (Figs. 2-3). This gait is strongly reminiscent of the locomotory activity of gradungulid spiders (LMF. pers. obs.) which flex and stretch their long legs in like manner as they move about the substrate. Perhaps the flexing, stretching components of stepping actions in *P. schultzi* are necessary to manoeuvre the extra length of the limbs while keeping the body close to the ground given that 'long leggedness' is a useful adaptation in web environments.

Lolloping movements differed little regardless of whether the spider was approaching prey, exploring a new web, or walking along a substrate, although in the first situation, a directional element was present. However, lolloping seemed more pronounced during stalking than during walking or running but perhaps this was merely a function of the distance of the forward motion involved.

During the day, *Portia* remained quiescent for long periods, usually suspended upside-down from its platform, or alternatively it sought a 'vantage' point from which it apparently monitored activity in the web. For example, several captive spiders regularly sat on cork plugs all day, facing the web, never moving from there unless prey was introduced. If disturbed, their palps undulated rapidly. Another jumping spider, *Euophrys parvula* Bryant, which sits for long periods on the walls of houses keeping a 'watchful eye' on its visual territory, also undulates its palps rapidly in the presence of intruders (Forster and Forster 1973).

Without fail, *P. schultzi* returned to their platforms at night. In one instance, a spider devouring prey in a cage without a web, promptly constructed a web at dusk (holding the prey meanwhile) and then continued its meal. This nightly



Figs. 2-3.—The 'lolloping' gait of *Portia schultzii* is apparently achieved by the long legs which alternately (Fig. 2) flex and (Fig. 3) stretch as the spider makes its unhurried way towards the target.

behaviour is clearly analogous to that of many salticids which usually either make new retreats at dusk or return to an old one.

Moulting.—*Portia schultzii* exuviae were observed on some occasions either hanging in their own webs or in those of *I. karschi* thus leading to the assumption that these salticids moult in the open (also see Jackson and Blest 1982a). On one occasion, the final stage of the moult of a caged spider was observed. The moult skin was suspended in the web, attached to a thread by the claws of a fourth leg; the spider, free except for its spinnerets, was hanging from the moult skin, its pale, translucent legs still extended against the underside of the body. Some slight flexing of the limbs was noticed and then suddenly the spider began to 'twirl.' For at least 90 seconds both spider and skin 'twirled', a relatively slow motion in which both were clearly visible. When the action ceased, the spider was seen to be free of its exuviae and the legs in more normal positions. The spider darkened up quickly and some time later it had assumed its typical hanging posture in the web (see Fig. 1). Was this a freak happening or might twirling be an adaptive feature of moulting to aid the spider in casting off its skin in the open?

PREDATORY EVENTS

Predatory events were examined in four different situations (see Methods): in two cages *P. schultzii* were in their own webs and in two they were without webs.

Typical and modified salticid responses.—*Portia schultzii*'s primary responses (Orientation, Pursuit and Capture) to prey were identical in form and sequence in both the web and non-web situations to those of typical salticids but the secondary components were frequently modified. Orientation (Alert, Swivel and Alignment) always preceded approach although there was a marked tendency for small-angle ($<30^\circ$) swivels to be quite fast and for large-angle ($>30^\circ$) swivels to be abnormally slow. This suggests a distinction in the rate at which turning is mediated either between the two pairs of lateral eyes or between the principal and lateral eyes, a difference not recorded in other members of the family. However, within the visual range of the principal eyes, a series of 'tantalus-like' turns (see Land 1971) often occurred, such reactions being common to typical salticids. The rate of alignment was typical, a movement probably also mediated by the principal eyes.

During approach to the target, *P. schultzii* walked, very occasionally ran, and crept towards the target. Unlike typical salticids, however, walking along a

substrate or negotiating the web network was punctuated by leg stretching and flexing movements (lolloping) (Figs. 2-3) which tended to further reduce the already slow rate of stepping. Nor did stalking result in the low profile adopted by most other salticids (Forster 1977a) but no doubt *Portia*'s long legs precluded this posture on the ground and it would have had little value in the web. Moreover, the pursuit of a target, however prolonged, was always linear, *Portia* apparently being unable to diverge from a straight path unlike, e.g. *Phidippus* (Hill 1979). If, for instance, a fruitfly or prey spider walked consistently around the perimeter of a circular cage, *Portia* never walked around after it, although it would swivel from time to time. This behavioural limitation is also demonstrated by *Trite planiceps* Simon when its anterior-lateral eyes are occluded (Forster 1979a); under such conditions this salticid also creeps very slowly and only in a straight line towards the target, whereas normally it could give chase at speed in any direction regardless of the inconsistency of the quarry's movements (Forster 1979b). The consequences of this is demonstrated by the following test:

When *P. schultzei* and *Trite auricoma* were each presented simultaneously with a fruitfly in small identical containers, *T. auricoma* seized its quarry in 15 seconds whereas *Portia* did not succeed for 1½ hours. There were, in fact, only two circumstances whereby *Portia* could catch the fruitfly. Either the fruitfly had to remain motionless long enough for *Portia* to stalk it directly or it had to fly between *Portia*'s front legs. In brief, *Portia* cannot maintain visual contact with swift, erratically-moving prey nor can it run after it, whereas *T. auricoma* possesses both capabilities, functions most likely mediated by the anterior-lateral eyes (see Forster 1979a).

To complete the hunting sequence, *P. schultzei* halted at a critical distance from the target, usually 1.0 to 1.5 cm, placed the first two pairs of legs forward (pre-crouch) and then brought the third pair up (crouch), as typical salticids do (see Forster 1977a), before lunging forward and seizing its quarry. Generally, the 4th pair of legs did not leave the ground, or the web, so that, in effect, the spider simply reached forward to grasp its prey. Nonetheless, in escape situations, these spiders were able to move very fast and often jumped distances of several centimetres during which the 4th pair of legs clearly left the ground.

Atypical tactics.—One tactic by which prey was seized has not been recorded previously in salticids, as far as we know, although there are similarities to the behaviour of *Phiale* (q.v.). A prey spider that ran beneath *Portia*, alert in its web, could be captured when *Portia* dropped on it from distances of up to 8 cm above it. The "drop", always with *Portia* in a web, was extremely rapid so that details of the movement could not be recorded by eye. If *Portia* missed the target, it quickly hauled itself back to the original look-out site in the web and waited for another attempt. Moreover, it usually positioned itself as before which is exactly what Hill (1979) found in *Phidippus pulcherrimus* Keyserling when testing this spider's capacity for re-orientation on a substrate after jumping at prey in mid-air. Clearly, too, *Portia* was alert for a second chance, for it could be seen swivelling in the web as the object of its intentions moved about below it. Normally, a subsequent drop was successful. However, dropping was a more common occurrence from 2-4 cm above, regardless of whether the target was in the web or on the ground, because longer drops were generally inhibited by web structure. We never saw *Portia* attempt a drop if there was even the flimsiest of

silk structures between it and the target so we presume that the spider can determine the presence of silk by sight. If, in the wild, *P. schultzii* lurked in the lower portions of a web, it would be able to drop on insects and spiders moving about on the ground below but such behaviour has not been observed.

A second web stratagem, not seen in typical salticids, was recorded as a 'quiver.' *Portia schultzii* always crept very, very slowly towards motionless prey, especially if it was roughly equal in size to or larger than itself. When within about 2-3 cm of its quarry, *Portia* might pause for up to 10 minutes, but in one case for 25 minutes, during which time the body would quiver with very rapid motions at fairly regular intervals. This movement was transmitted to the web and hence to the target. It is difficult to say, unless one has seen both performances, whether quivering is comparable to web vibration and tweaking in *P. fimbriata* (Jackson and Blest 1982a) although it seems as if, in *P. fimbriata*, these agitations of the web were caused by movements of the limbs whereas in *P. schultzii* the entire body appeared to be involved. We never saw *P. schultzii* tweak the web as these authors described for *P. fimbriata*. In almost all instances, the quarry had remained completely motionless during the approach by *Portia* so it seems most likely that quivering was designed either to enhance some aspect of the spider's visual perception of the target or to induce its movement.

Distances at which prey is detected.—In large, domed terraria, *P. schultzii* constructed extensive but not dense networks of silk in the upper half of the dome and mostly placed their platforms near the centre. From here, and the side of the dome where they often sat, *Portia* had a range of vision extending some 10-15 cm across and above, with about 25 cm below.

Under illumination levels ranging from 1500 lux to bright sunlight, the distance at which prey was detected was 9 or 10 cm. No responses to prey were ever observed at distances greater than this, despite the fact that flies and spiders introduced into the cage provided ample opportunity for long distance perception and recognition to occur. Compare this behaviour to that of *Trite auricoma*, for instance, which swivels towards a movement up to 75 cm away and approaches suitable targets from about 20 cm (Forster 1977a, 1979a). Presumably, there is little advantage to *Portia* in being alerted to prey at any great distance since its slow rate of locomotion would seem to preclude it from ever reaching the target in time to capture it. Nor was there the slightest indication that detection and prey capture were mediated by other than vision; prey trapped out of sight in the web but within 10 cm elicited not the slightest response from *Portia*.

At luminance levels of less than 100 lux, *P. schultzii* did not respond to prey but between 100 and 500 lux they detected, approached and seized prey from distances up to 6 cm. Above 500 lux response distances increased but reached a maximum of about 10 cm at 1500 lux. More precise measurements obtained from courtship and agonistic interactions (Forster, in prep.) confirmed that reliable discriminations can only be made up to 10 cm away.

Reactions to lures.—Whether in or out of the web, *P. schultzii* treated all moving lures as potential prey. Reactions included all elements of the salticid prey-catching sequence: Alert (if target in front); Swivel (if target to side or rear); Walk, Run or Stalk (depending on mobility of target); Follow (if target receding); Pre-crouch, Crouch and Lunge (if target stationary but jiggled slightly).

These tests (n = 36) showed that target movement was a most important stimulus parameter, apparently over-riding details of target shape and pattern,

since *P. schultzi* did not discriminate between the items used as lures and actual prey.

Other observations were as follows:

1. No reactions occurred at distances greater than 10 cm.
2. If movement of the target was erratic, *Portia* did not pursue it.
3. If the target was stationary, *schultzi*'s approach was extremely slow (5 mm/min - 100 mm/min) and very long pauses (up to 25 mins) preceded pre-crouch, crouch and lunge. In 43% of cases, the sequence was not completed.
4. If the target was stationary, but jiggled slight (cf. 3) *Portia*'s approach was much faster and the sequence was always completed.
5. If lures were trailed directly away from *Portia*, *Portia* followed — the faster the lure receded, the faster *Portia* moved (up to a limit). *Trite planiceps* behaves in a similar fashion under such predatory conditions (Forster, 1985).

Prey preferences.—*Drosophila* were the most readily available insects hence were regularly offered to captive *P. schultzi*. The *P. schultzi* spiderlings, mentioned previously, fed readily on them and in the tests designed to identify predatory events they were seized almost as frequently as prey spiders. House flies were less likely to be caught, *Portia* invariably retreating before their sudden flights and buzzing onslaughts. If, however, a fly was left for several days in a small cage, gradually becoming less active or entangled in the web, *Portia* might eventually catch it. Although various insects were found in diplurid webs it was not possible, owing to the opacity of the webs, to say whether *Portia* ever ate any of them. But once, on a wall in Kilifi, *Portia* was seen eating a fly.

Offered one live and one dead *Drosophila*, *Portia* stalked and lunged at the dead one, although it took 5 minutes to cover the two-centimetre distance to the lunging point. Perhaps the live fly provided the initial stimulus but clearly the stimulus properties of the dead fly were able to elicit the remainder of the sequence. Moreover, there were other occasions on which *Portia* accepted dead flies although details of the seizures were not witnessed. Hence movement is not the only inducement needed for stalking and lunging.

Thomisids offered as prey when *P. schultzi* was off the web were rarely captured, largely because these prey-spiders had a tendency to wave their front pairs of legs at any 'menacing object', a ploy which certainly deterred *Portia*. However, on two occasions, when *Portia* was in a web and a thomisid was moving about on the ground several centimetres below, *Portia* dropped and scooped it up. Theridiids, too, were often caught by this tactic, generally when both prey and predator were in the web.

Small jumping spiders (unidentified) were only caught when both were on the ground but capture depended on these prey-spiders either (i) remaining stationary long enough for *Portia* to stalk them directly or (ii) walking away from *Portia* in a straight line. This type of departure apparently induced *Portia* to follow in much the same way as some male salticids follow a mate (Forster 1977c).

The ready availability of *Cambridgea* sp. meant that they were offered to *P. schultzi* more frequently than other prey spiders. All the tactics at *Portia*'s disposal were used against them but since *Cambridgea* tended to remain motionless for long periods of time, very slow approaches were customary and body quivers were commonly employed.

Araneids were more likely to be captured if they moved about. *Portia* regularly stalked the motionless spiders but if unable to induce movements by quivering,

or to obtain adequate stimulation by sidling around and scrutinising the araneid from different angles, *Portia* would abandon the hunt.

Given a choice off the web between active prey (fruitflies, small salticids, thomisids, *Neoramia* spp.) and relatively quiescent prey (*Cambridgea* spp., *Araneus* spp.), *Portia* invariably selected the laggards, stalking very slowly and lunging only when its quarry stirred slightly.

DISCUSSION

Our observations show that *Portia schultzii* is primarily a web-dweller and that the web it occupies may be of its own construction or that of an alien species. Within the geographical limits of the present study, the most preferred alien web appears to be that of a diplurid spider, *Ischnothele karschi*. We find, moreover, that *P. schultzii* readily catches prey when in a web and just as readily when away from a web. As a web-dweller, therefore, the question is, does this spider catch prey in the manner of a typical salticid or does it use methods more commonly associated with other web-builders?

The evidence from this study is that *P. schultzii* is a salticid-like hunter and that it has only secondarily adapted to a web-dwelling lifestyle. This conclusion is based, first, on the fact that *P. schultzii* hunts solely by vision (also see Forster 1982a) and since the structure of the eyes is very similar to that of the typical salticid (Forster, pers. obs.) the conclusion is that the peripheral detection of prey, as evidenced by swivelling, is mediated by the lateral eyes and that the ensuing pursuit and capture of prey are mediated by the principal eyes. Second, *P. schultzii* employs the same set of predatory events as typical jumping spiders and although two web tactics (quivering and dropping) have been added to the basic salticid repertoire, both are guided by vision and neither appear to be inherited from any other web-builders. Third, *P. durbanii* is shown to be a cursorial hunter despite its known morphological relationship to the web-building *Portia* species (Wanless 1978b). Moreover, all known *Portia* species possess two claws and a claw tufts (Wanless 1978b), an acknowledged salticid feature which links them to a cursorial predecessor (Gertsch 1979). Taken together, these findings suggest that a number of *Portia* species, including *P. schultzii* have secondarily adapted to a web-building and web-invading lifestyle.

The commonality of the visually specialised hunting strategy in salticids suggests that the division of labour, which probably evolved to meet the needs of a diurnal predator (Forster 1982b), was so successful that these spiders soon outstripped their closest relatives. This basic cursorial strategy gave rise to a variety of adaptations by which salticids were able to exploit a vast array of terrestrial habitats and situations. One of the most successful of these — mimicry — has taken many forms (see Reiskind 1977, Wanless 1978a, b, Platnick 1984, Edwards 1984). *Sarinda hentzi* Banks, for example, is a Central American ant-mimicking salticid which not only has the appearance of an ant, but also spends much of its time in ant-like behaviour, being diverted only spasmodically for bouts of salticid-like predation and reproductive activities (Forster 1982a and pers. obs.). *Portia schultzii*, too, is a mimic, spending much of its time posing as a piece of bark which has fallen into a web, reacting like a salticid only when it sights potential prey or mate.

In adapting to a web environment, *P. schultzi*'s precursor retained the primary visual elements of prey capture, i.e. orientation, pursuit and capture (Forster 1977a) because these visually mediated events characterise the predatory sequence in the present-day *P. schultzi*. It was in the secondary components that adjustments were required. In a web, it was clearly advantageous for large-angle swivels to be performed slowly because fast ones might produce vibratory stimuli or visual signals that would alert a neighbouring web-dweller or the host spider. Slow, spasmodic approaches to prey would obviate the same kind of disturbances and also be more appropriate when negotiating an alien web structure. 'Dropping' onto the prey from the relative safety of a vantage point does not carry the same risk, hence rapid movement would be acceptable under these conditions.

Portia's failure to chase fast-running and erratically-moving prey either on or off the web may mean that the anterior-lateral eyes are not involved in post-detection behaviour as shown for *Trite planiceps* (Forster 1979a, 1985). Moreover, because insects are usually immobilised by the silk, or prey spiders quiescent, 'quivering' by *P. schultzi* may be an adaptive ploy by which movement is induced in the quarry and visual cues enhanced, selection processes having apparently ensured that its nature and frequency do not imitate those of a trapped insect and so attract another predator to the scene.

Portia schultzi pierces prey after lunging at it, or scoops it up after 'dropping' whereas Jackson and Blest (1982a) observed that *P. fimbriata* swoops at, stabs or picks up prey. Nevertheless, behavioural variability in *P. schultzi* does not appear to be related to diversity in the type of prey encountered as shown by *P. fimbriata* (Jackson and Blest 1982b) but rather to differences in prey mobility as well as the conditions under which predation occurs (Forster 1985). Moreover, *P. schultzi* does not 'tweak' the web as Jackson and Blest (1982a) describe for *P. fimbriata* for 'quivering', which has some similar characteristics, does not appear to have the same functions.

In captivity, *P. schultzi* catches a wide range of spiders as prey and, unlike *P. fimbriata* (Jackson and Blest 1982a), catches insect prey just as readily. *Portia labiata* exhibits a similar ability to catch prey both in its own webs as well as alien webs and is also able to jump into and out of webs, a skill not demonstrated by *P. schultzi* nor, it seems, by *P. fimbriata*, because Jackson and Blest (1982a, b) make no mention of it. Moreover, the absence of web-building in *P. durbanii* highlights the need for caution in making assumptions about the evolutionary status of this genus until more species have been studied.

Many of the behaviours exhibited by known *Portia* species have been observed independently in cursorial salticids. For example, a New Zealand *Marpissa* sp. has been seen hunting on an araneid web (Forster, pers. obs.). An unidentified salticid has been observed devouring ants while suspended from a thread, and *Phiale* apparently makes a practice of leaping onto *Argiope* in its orb-web (Robinson and Valerio 1977) as does *Phidippus* (Tolbert 1975). In behaviour comparable to that of *P. fimbriata* taking insects from the chelicerae of the web spider host (Jackson and Blest 1982a), an Indian *Marpissa* sp. robs ants of their prey (Marson 1947). Similar prey robbery, described as kleptoparasitism, has been reported for four Japanese salticid species, one of which has been seen devouring the eggs of another spider (It 1977). Because the behaviour of relatively

few salticid species is known, it is likely that many more diverse strategies are yet to be discovered.

ACKNOWLEDGMENTS

We would like to thank Mr. Neville Chalke for acting as a courier and bringing *Portia schultzii* to Dunedin for study.

REFERENCES

- Bristowe, W. S. 1941. The Comity of Spiders. Vol. 2. Ray Society, London.
- Edwards, G. B. 1984. Mimicry of velvet ants (Hymenoptera: Mutillidae) by jumping spiders (Araneae: Salticidae). *Peckhamia*, 2(4):46-49.
- Forster, L. M. 1977a. A qualitative analysis of hunting behaviour in jumping spiders (Araneae: Salticidae). *New Zealand J. Zool.*, 4:51-62.
- Forster, L. M. 1977b. Mating behaviour in *Trite auricoma*, a New Zealand jumping spider. *Peckhamia*, 1:35-36.
- Forster, L. M. 1979a. Visual mechanisms of hunting behaviour in *Trite planiceps* — a jumping spider. *New Zealand J. Zool.*, 6:79-93.
- Forster, L. M. 1979b. Comparative aspects of the behavioural biology of New Zealand jumping spiders (Araneae: Salticidae). Ph.D. dissertation. University of Otago, New Zealand. 402 pp.
- Forster, L. M. 1982a. Vision and prey-catching strategies in jumping spiders. *Amer. Sci.*, 70(2):165-175.
- Forster, L. M. 1982b. Visual communication in jumping spiders (Salticidae). Chapter 5, *In Spider Communication: Mechanisms and Ecological Significance* (P. M. Witt and J. S. Rovner, eds.). Princeton Univ. Press, Princeton.
- Forster, L. M. 1985. Target discrimination in jumping spiders. Chapter 13, *In Neurobiology of Arachnids*. (F. Barth, ed.). Springer-Verlag, Frankfurt, Berlin.
- Forster, R. R. and L. M. Forster. 1973. *New Zealand Spiders, an introduction*. Collins, Auckland, London. 254 pp.
- Gertsch, W. J. 1979. *American Spiders* (2nd Edition). Van Nostrand Reinhold Coy, New York.
- Hill, D. E. 1979. Orientation by jumping spiders of the genus *Phidippus* (Araneae: Salticidae) during the pursuit of prey. *Behav. Ecol. Sociobiol.*, 5:301-322.
- It, N. 1977. Observations on a strange plundering behaviour in salticid spiders. *Acta Arachnol.*, 27:209-212.
- Jackson, R. R. and A. D. Blest. 1982a. The biology of *Portia fimbriata*, a web-building jumping spider (Araneae: Salticidae) from Queensland: utilisation of webs and predatory versatility. *J. Zool. London*, 196:255-293.
- Jackson, R. R. and A. D. Blest. 1982b. The distances at which a primitive jumping spider, *Portia fimbriata*, makes visual discriminations. *J. Exp. Biol.*, 97:441-445.
- Land, M. F. 1971. Orientation by jumping spiders in the absence of visual feedback. *J. Exp. Biol.*, 54:119-139.
- Marson, J. E. 1947. The ant mimic, *Myrmarachne plateleoides*. *J. E. Africa Nat. Hist. Soc.*, 19:62-63.
- Murphy, J. and F. Murphy. 1983. More about *Portia* (Araneae: Salticidae). *Bull. British Arachnol. Soc.*, 6(1):37-45.
- Platnick, N. I. 1984. On the pseudoscorpion-mimicking spider *Cheliferooides* (Araneae: Salticidae). *J. New York Entomol. Soc.*, 92(2):169-173.
- Reiskind, J. 1977. Ant-Mimicry in Panamanian clubionid and salticid spiders (Araneae: Clubionidae, Salticidae). *Biotropica*, 9(1):1-8.
- Robinson, M. H. 1969. Defenses against visually hunting predators. Pp. 225-259, *In Evolutionary Biology* (T. Dobzhansky, et al., eds.), vol. 3.
- Robinson, M. H. and C. E. Valerio. 1977. Attacks on large or heavily defended prey by tropical salticid spiders. *Psyche*, 84(1):1-10.

- Tolbert, W. W. 1975. Predator avoidance behaviours and web defensive structures in the orb weavers *Argiope aurantia* and *Argiope trifasciata* (Araneae, Araneidae). *Psyche*, 82(1):29-52.
- Wanless, F. R. 1978a. A revision of the spider genera *Belippo* and *Myrmarachne* (Araneae: Salticidae) in the Ethiopian region. *Bull. British Mus. Nat. Hist. (Zool.)*, 33(1):1-139.
- Wanless, F. R. 1978b. A revision of the spider genus *Portia* (Araneae: Salticidae). *Bull. British Mus. Nat. Hist. (Zool.)*, 34(3):83-124.

Manuscript received March, 1985, revised July 1985.

Ugolini, A., I. Carmignani and M. Vannini. 1986. Mother-young relationship in *Euscorpium*: Adaptive value of the larval permanence on the mother's back (Scorpiones, Chactidae). *J. Arachnol.*, 14: 43-46.

MOTHER-YOUNG RELATIONSHIP IN *EUSCORPIUS*: ADAPTIVE VALUE OF THE LARVAL PERMANENCE ON THE MOTHER'S BACK (SCORPIONES, CHACTIDAE)

A. Ugolini, I. Carmignani and M. Vannini

Dipartimento di Biologia Animale e Genetica
Università di Firenze
v. Romana 17, 50125 Firenze, Italy

ABSTRACT

Mortality rates were measured in *Euscorpium flavicaudis* larvae which had been made to stay on their mother's back (as actually occurs in nature) or had been separated from their mother, under three different relative humidity levels. Mortality was greatest among larvae exposed to low RH levels and in any cases, among larvae separated from their mother. The mother-offspring relationship likely serves several functions: it is an obvious defense against predators and provides an optimum microhabitat selection. These experiments suggest that the mother may also provide a greater resistance to dehydration, either by water-proofing the larvae or by refurbishing their water loss.

INTRODUCTION

The permanence of the larvae on the mother's back after birth is an universal feature among scorpions. In spite of investigations by Angermann (1957), Torres and Heatwole (1967), Le Pape (1974), Vannini et al. (1978), Vannini and Ugolini (1980) and Ugolini and Vannini (1983), evidence is still lacking as to the exact adaptive value of this behavior.

Defense against predators and maintenance of the larvae at more optimal microclimatic conditions seem plausible (Williams 1969, Maury 1969, Vannini et al. 1978, Vannini and Ugolini 1981) but some kind of trophic exchange has also been hypothesized (Alexander 1977).

The purpose of our work was to investigate whether larvae raised on their mother's back and larvae isolated from their mother exhibit the same survival rate under stressful environmental conditions of low relative humidity.

MATERIALS AND METHODS

Pregnant females *Euscorpium flavicaudis* (Geer) were captured near Florence (Italy) in August-September 1980-1982. In the laboratory the animals were reared individually in small containers under natural conditions of temperature, relative humidity and photoperiod. They were given *Tenebrio molitor* larvae and water once a week. No food or water was administered during experiments.

Within 24 hours of birth, each litter was divided into two or three groups: 1) larvae put back onto their mother (OM); 2) larvae separated from their mother

Table 1.—Mortality rates (total number of deaths/total number of larvae tested) with respect to relative humidity (RH) and treatment; OM, larvae on mother; WM, larvae without mother; n = number of broods.

	RH:	10%	60%	90%
treatments:	OM	47/132 (35.6%)	10/130 (7.7%)	5/112 (4.5%)
	WM	91/16 (71.2%)	32/139 (23.0%)	6/123 (4.9%)
	n=	9	13	11

but grouped together in a single container (WM); and, in certain cases, 3) larvae separated from their mother but also isolated one from another (IS). Each group was exposed to one of three levels of RH (10%, 60% and 90%), obtained by using CaCl_2 , environmental RH and distilled water, respectively.

The larval mortality rate was then measured for each type of treatment and defined as the ratio between the nymphs still alive after the first moult and the initial members of each group.

RESULTS

The comparison of the experiments on larvae kept at 10%, 60%, and 90% RH, on the mother and without the mother (Table 1), shows that the larval surviving probability increases at higher RH levels, and, in general, in presence of the mother.

The effect of the presence/absence of the mother can be tested by applying the Wilcoxon matched-pairs test (Table 2). The absence of the mother is shown to increase the larval mortality rate at 10% and 60% RH but not at 90%.

It is possible then to compare the mortality rates at different RH levels by applying the Mann-Whitney test (Table 3). The differences between 10% vs 60% and 10% vs 90% RH are always significant, whereas the difference between 60% and 90% RH is only evident among the larvae separated from the mother.

The presence of the mother is therefore reducing the larval water loss. The larvae, when on their mother's back, are usually highly aggregated. The larvae without the mother are usually found aggregated at low RH, whereas they appear largely scattered at high RH levels. The presence of the mother could then reduce the larval water loss, independently from any substances exchange, by simply inducing their aggregation.

The effect of the aggregation on the surviving rate was then measured comparing (only at the lowest RH level) the behaviour of larvae with the mother, without the mother but free of aggregating and without the mother and isolated from each other (Table 4). The analysis of the results show the aggregation effect is anyway quite negligible.

Table 2.—Comparison between mortality rates on and without mother. T = statistics of Wilcoxon matched-pairs test (two-tailed); N = number of matched pairs whose difference is not zero; in brackets, total number of pairs.

RH	10%	60%	90%
N=	12 (13)	10 (13)	6 (11)
T=	4	0	7
P	<0.05	<0.01	n.s.

Table 3.—Comparison between mortality rates on the mother (OM) and without the mother (WM), at different RH levels. U= statistics of Mann-Whitney test (two-tailed).

	RH:	10% vs 60%	10% vs 90%	60% vs 90%
(OM)	U=	5.5	5.0	67.0
	P	<0.002	<0.002	n.s.
(WM)	U=	15.5	7.5	22.5
	P	<0.002	<0.002	<0.02

When is dehydration mostly affecting the larval survival rate? The 91.5% (279/305) of the dead larvae were dead the moulting day or the day before.

DISCUSSION AND CONCLUSIONS

Larval aggregations are a universal and necessary feature of scorpion life history. Such aggregation is accomplished both by larval behaviour (fallen larvae climb back onto their mother's back; Vannini et al. 1978) and chemical cues favoring their permanence on the mother (Torres and Heatwole 1967, Vannini and Ugolini 1980, Ugolini and Vannini 1983).

It is possible that the mother provides protection for their young in a number of ways:

- i) when the larvae are on their mother's back they are probably safe from a wide range of potential predators (other scorpions, spiders, ants, centipedes; Polis et al., 1981) which are unlikely to harm larger scorpions;
- ii) movement by the mother allows selection of more suitable microhabitats while larvae are quite limited in their movements.

Our investigations show two additional advantages:

- iii) by aggregating together on the mothers there is a passive decrease because of boundary layer effects, of water loss and subsequent dehydration;
- iv) the larvae on their mother's back are more likely to survive the moult without mishap.

Could advantage iv) result from trophic exchange between mother and young? The larvae never participate in their mother's meal, nor do they tend to take up a position near her mouth-parts; this excludes any oral exchange of food and water between the mother and her larvae. It is possible that the mother secretes wax or water through her cuticle and this in turn is absorbed by the larvae. Preliminary research using radioactive isotopes (tritium) shows that the radioactive marker does pass from the mother to the larvae (Vannini et al. 1985).

Table 4.—Mortality rates at 10% RH of larvae on the mother (OM), without the mother and aggregated (WM), without mother and isolated from each other (IS). Number of broods = 13. T = statistics of Wilcoxon matched-pairs test (two-tailed). N = number of matched pairs whose difference is not zero.

treatments:	OM: 36/102 (35.3%)	WM: 55/104 (52.9%)	IS: 63/106 (59.4%)
	OM vs WM	OM vs IS	WM vs IS
N=	12	11	10
T=	14	7	23
P	<0.005	<0.002	n.s.

ACKNOWLEDGMENTS

We wish to thank Profs. L. Pardi and A. Ercolini for reading the manuscript. This study was supported by a grant of the Ministero della Pubblica Istruzione (fondi locali 60%).

LITERATURE CITED

- Alexander, A. J. 1977. Parental behaviour in scorpions. Abstr. 15th Int. Ethol. Conf., Bielefeld 1977.
- Angermann, H. von. 1977. Über Verhalten, Spermatophorenbildung und Sinnesphysiologie von *Euscorpis italicus* Hbst. und verwandten Arten (Scorpiones, Chactidae). Z. Tierpsychol., 14:276-302.
- Le Pape, G. 1974. Sur quelque aspects des relations mère-jeunes chez trois espèces de scorpions Buthidae. Rev. comportement Anim., 8:261-264.
- Maury, E. A. 1969. Observaciones sobre el ciclo reproductivo de *Urophonius brachycentrus* (Thorell 1877) (Scorpiones, Bothriuridae). Physis, 29:131-139.
- Polis, G. A., W. D. Sissom and S. J. McCormick. 1981. Predators of scorpions: field data and a review. J. Arid Environments, 4:309-326.
- Torres, F. and H. Heatwole. 1967. Factors influencing behavioral interaction of female parent and offspring in scorpions. Caribbean J. Sci., 7:19-22.
- Ugolini, A. and M. Vannini. 1983. Larval behavior and phylogenetic relationships among scorpions. J. Arachnol., 11:433-436.
- Vannini, M. and A. Ugolini. 1980. Permanence of *Euscorpis carpathicus* (L.) larvae on the mother's back. Behav. Ecol. Sociobiol., 7:45-47.
- Vannini, M. and A. Ugolini. 1981. Parental care in *Euscorpis* (Arachnida, Scorpiones). 17th Int. Ethol. Conf., Oxford, 1981.
- Vannini, M., A. Ugolini and C. Marucelli. 1978. Notes on the mother-young relationship in some *Euscorpis* (Scorpiones, Chactidae). Monitore zool. Ital., (N. S.) 12:143-154.
- Vannini, M., M. Balzi, A. Becciolini, I. Carmignani and A. Ugolini. 1985. Water exchange between mother and larvae in scorpions. Experientia, 41:1620-1621.
- Williams, S. C. 1969. Birth activities of some North American scorpions. Proc. California Acad. Sci., 37:1-24.

Manuscript received October 1984, revised July 1985.

Raven, R. 1986. A revision of the spider genus *Sason* Simon (Sasoninae, Barychelidae, Mygalomorphae) and its historical biogeography. *J. Arachnol.*, 14:47-70.

A REVISION OF THE SPIDER GENUS *SASON* SIMON (SASONINAE, BARYCHELIDAE, MYGALOMORPHAE) AND ITS HISTORICAL BIOGEOGRAPHY

Robert J. Raven

Queensland Museum
Gregory Terrace, Fortitude Valley
Queensland, Australia

ABSTRACT

The barychelid spider genus *Sason* is revised and includes six valid species: the type species, *S. robustum* (O. P.-Cambridge 1883), *S. andamanicum* (Simon 1888), *S. colemani* sp. nov., *S. maculatum* (Roewer 1963), *S. pectinatum* Kulczyński 1908, and *S. seychellanum* Simon 1898. *Sason cinctipes* (Pocock 1892) and *S. armatoris* Pocock 1900 are newly synonymized with *S. robustum* (O. P.-Cambridge 1883), and *Chrysopelma* Roewer 1963 with *Sason. Rhianus* (= *Rhianodes*) and *Monodontium* are transferred to the Barychelinae. *Sason* occurs in the Seychelles, India, Ceylon, the Andaman Islands, New Guinea, to the islands of the Northwestern Pacific, and in northern Australia. Its distribution is similar to that of other Indo-Pacific taxa; a vicariance hypothesis is proposed for its historical biogeography.

INTRODUCTION

Sason Simon 1887 is a very distinctive barychelid genus that has included six species distributed from the Seychelles in the western Indian Ocean, northwards in the Andaman Islands, in Ceylon, southern India, to New Guinea (Roewer 1942). In general appearance, these spiders resemble migids (Simon 1892). They are small, compact, and stout-legged, lack a strong rastellum and, unlike many barychelids, their eyes are usually not on a tubercle and the eye group is rectangular. The synonymy of *Sason* includes two generic names that allude to the regal appearance of the spider: *Sason*, an abbreviation of the biblical name Samson; and *Sarpedon*, (the first given name and a homonym) the legendary king at the siege of Troy (Bonnet 1954). Roewer (1963) described a new genus, *Chrysopelma*, from the Mariana Islands but judging by the number of genera mentioned in his discussion he was unable to determine the closest relative. *Sason* was not mentioned but is here considered its senior synonym.

The subfamily name Sasoninae derives from a tribe made by Simon (1892) solely for *Sason* but *Rhianodes* (= *Rhianus* Thorell but invalidly emended to *Rianus* by Simon), a putatively related genus of which Simon had seen no material, was listed as "genus *invisum et incertae sedis*" under the Sasoneae. Simon (1903) made no further comment about "*Rianus*." Roewer (1942) reflected Simon's initial decision by including *Rhianodes* in the Sasoninae and extended the group to include the New Guinea genus *Monodontium*. The description of

Monodontium Kulczyński followed that of *Sason pectinatum* but Kulczyński (1908) associated the former with *Barychelus* and therefore the Barychelinae. Since then, Benoit (1966, 1978) described further material of *Sason seychellanum*.

Most subsequent authors have followed Pocock (1903) who elevated Simon's Barychelinae to family rank and his tribes (including the Sasoneae) to subfamilies. According to Bristowe (1938), Kishida (1930) elevated the Sasoninae to a family without explanation. Benoit (1964) placed the Sasoninae in the synonymy of the Barychelinae but continued to recognize the other two barychelid subfamilies—Diplothelinae and Leptopelmatinae. Raven (1985) continued to maintain the Sasoninae as a subfamily of the Barychelidae.

MATERIALS AND METHODS

Except for eye data, given in ocular eyepiece units, all measurements are in millimeters. For brevity, several abbreviation techniques are used. Characters present in all species, e.g., scopulae on metatarsi and tarsi I and II, are stated only in the generic description. Only the presence of spines on legs is noted. Rather than repeat the measured interval or object, a numeral is used to denote the character. The numeral is followed by a comma and the value(s) of the interval(s) in that specimen. For eyes, numerals denote the following: 1, number of rows; 2, width of group at its midlength/head-width through the same point; 3, ratio of front width: back width: length; 4, ratio of AME: ALE: PME: PLE; 5, ratio of MOQ (median ocular quadrangle) front width: back width: length; 6, minimum eye interspaces of AME-AME, AME-ALE, ALE-PLE, ALE-ALE, PME-PLE, PME-PME, respectively.

Leg segments in spine descriptions are abbreviated to their first two letters: fe, femur; pa, patella; ti, tibia; me, metatarsus; ta, tarsus. Spine statements are standard for the Araneae; other techniques not mentioned above are given in Raven (1984).

Trichobothria: 1, approximate number per row and extent on tibiae; 2, approximate number and extent on metatarsi; 3, number of clavate (c) and filiform (f) on tarsi.

Spinnerets: 1-3, refer to posterior median spinnerets; 1, length; 2, mid-width; 3, separation of bases; 4-7 refer to lengths of segments of posterior lateral spinnerets; 4, basal; 5, middle; 6, apical; 7, total.

SYSTEMATICS

SASONINAE SIMON

Diagnosis.—The Sasoninae differ from most other barychelids by the combination of the conical apical segment of the posterior lateral spinnerets, very low or absent eye tubercle, and edentate paired claws of males, and from *Ammonius* by the presence of a row of cuspules on the labium in females and the short cymbium in males.

Apical segment of posterior lateral spinnerets short, conical. Four spinnerets. Eye group about twice as wide as long, not on distinct tubercle. Paired claws of males with few teeth in one row or bare.

Genera included.—*Sason* Simon 1887, *Cosmopelma* Simon 1889, and *Paracenobiopelma* Feio 1952.

Sason Simon

Sarpedon O. P.-Cambridge 1883:353. Type species by monotypy *Sarpedon robustum* O. P.-Cambridge 1883.

Sason Simon 1887:195. Replacement name for *Sarpedon* preoccupied in the Coleoptera by *Sarpedon* Bonvouloir 1870.

Satzicus Simon 1888:286. Type species by monotypy *Satzicus andamanicum* Simon 1888. First synonymized by Simon 1892.

Oecophloeus Pocock 1892:49. Type species by monotypy *Oecophloeus cincipes* Pocock 1892. First synonymized by Simon, 1892.

Chrysopelma Roewer 1963:113. Type species by original designation *Chrysopelma maculata* Roewer 1963. **NEW SYNONYMY.**

Diagnosis.—*Sason* differs from *Paracenobiopelma* by the absence of a distinct clypeus, and from *Cosmopelma* by the presence of a line of cuspules on the anterior edge of the labium in females.

Description.—Small, strongly patterned spiders. Carapace glabrous but with numerous short bristles, especially in males. Caput low but arched medially. Thoracic region slopes down from broad, shallow, slightly procurved or recurved fovea. Eyes in three rows or two rows with strongly procurved front row. Back row more or less straight. Eye group about twice as wide as long, rectangular. Eye tubercle absent or low, and if present, usually excludes ALE. Clypeus absent. Chelicerae short, sloping, with one row of teeth on furrow. Rastellum absent or with two to four short spines. Maxillae rectangular; anterior lobe not differentiated; heel acute, rounded; few cuspules in females. Lyra absent. Labium rectangular, anterior edge straight, lateral edges almost parallel; males of some species and all females armed with stout cuspules in line. Cuspules on maxillae present or absent in males, always present in females. Sternum cordate with two or three pairs of small, oval to round sigilla touching margin, and on sloping edge. Labiosternal suture narrow, distinct. Legs stout, sometimes with distinct annulations. Leg formula 4123. Scopulae entire but thin for full length of metatarsi and tarsi I, II; divided, distal if present on metatarsi III, IV; divided, thin if present on tarsi III, IV. Spines generally weak, few in number; often present on femora, ventral patellae, rarely on metatarsi, never on tarsi. Preening combs absent. Tarsi of females short, stout. Palpal claw and paired claws without teeth or with one row of teeth in males and females. Claw tufts small, moderately dense but never conceal claws entirely. Trichobothria in two short rows extending to one-half to two-thirds of tibiae; distal group on metatarsi; broad band on tarsi. Tarsi with both filiform and clavate trichobothria; bothria corrugiform. Tarsal organ low, domed. Relative lengths of posterior lateral spinneret segments: basal > middle > apical; apical segment with distal cluster of spigots. Spermathecae with two receptacula, sometimes apically divided. Tibia I of males with prolateral distal spur bearing megaspines. Males palp: tibia short; cymbium short, truncate, undivided; bulb pyriform with tapering embolus.

Distribution and Natural History.—*Sason* is known from the Seychelles, the Andaman and Mariana Islands, southern India, Ceylon, northern Australia, and

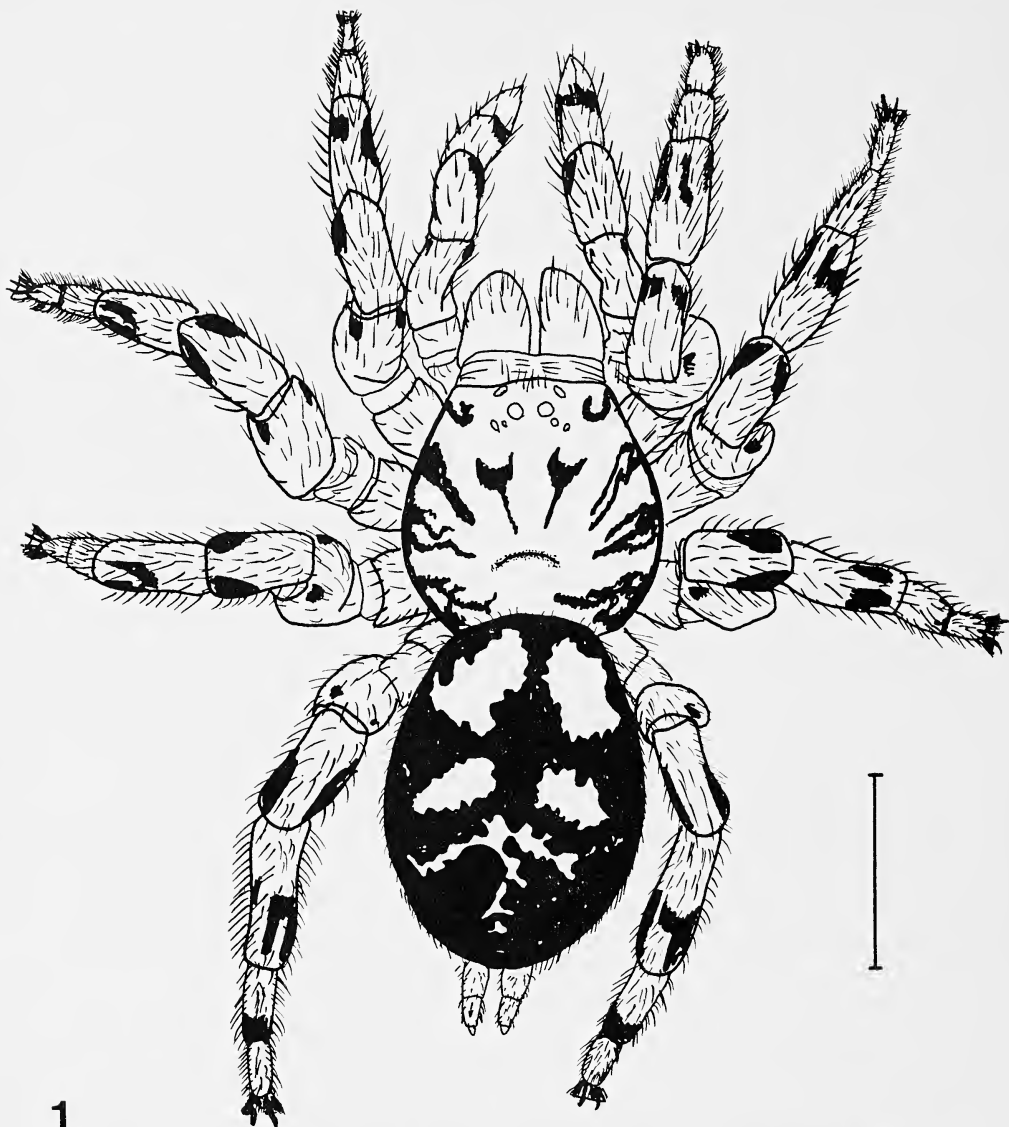

Fig. 1.—*Sason robustum* (O. P.-Cambridge), female, dorsal view. Scale line, 5 mm.

New Guinea. The retreat (fig. 19) consists of a very short tube with a door at each end (Pocock 1900, Coleman 1981). The outer surface of the retreat is usually impregnated with particles of soil and leaves.

Species included.—*Sason andamanicum* (Simon), *Sason colemani*, sp. nov., *Sason maculatum* (Roewer), *Sason pectinatum* Kulczyński, *Sason robustum* (O. P.-Cambridge), *Sason seychellanum* Simon.

Synonymy.—Roewer (1963) placed *Chrysopelma* in the Leptopelmatinae, considering it unique in the absence of a clypeus and teeth on the tarsal claws. However, Roewer's subfamilial placement appears to be based upon Petrunkevitch (1928) in which the key is erroneous through the "inversion" of one of the key couplets of Simon (1903). Simon (1903) separated the Sasoninae plus Leptopelmatinae by their "*area oculorum compactilis*;" whereas Petrunkevitch (1928) separated the Sasoninae from the Leptopelmatinae plus Barychelinae by

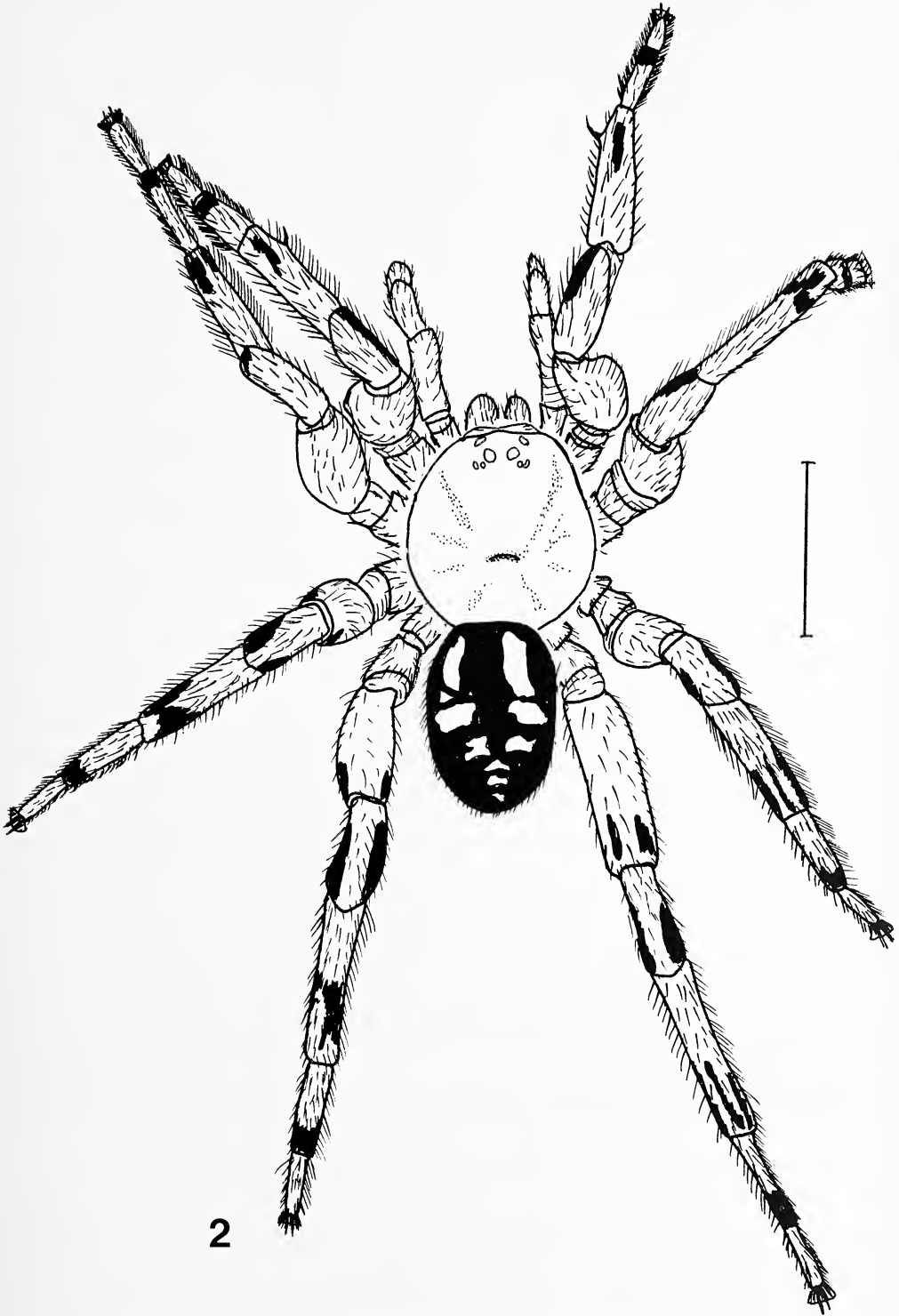

Fig. 2.—*Sason robustum* (O. P.-Cambridge), male, dorsal view. Scale line, 5 mm.

the non-compact eye group. Presumably, had Roewer (1963) used Simon (1903) *Chrysopelma maculata* would have been placed in or related to *Sason*.

Relationships.—*Sason* uniquely shares with *Paracenobiopelma* the line of cuspules on the anterior edge of the labium of females. (The maxillae have fewer cuspules than the labium.) Because that condition is unique in the Barychelidae, it is considered a synapomorphy and not a retention of the densely cusplated labium that is plesiomorphic in the Theraphosoidina (see Raven 1985). *Cosmopelma* shares with *Sason* and *Paracenobiopelma* the similarly patterned carapace, annulated legs, and broad chevrons on the abdomen—also unusual, if not unique, conditions in the barychelids. Associated with that character congruence, in both *Cosmopelma* and *Paracenobiopelma* the rectangular eye group is on a tubercle that is very low or absent and, unlike *Sason*, is separated from the edge of the carapace by a distinct clypeus. Males of *Paracenobiopelma* and *Sason* also share the absence of biserially dentate claws—a condition found widely in other barychelids and considered the family autapomorphy. Thus, one synapomorphy of *Sason* and *Paracenobiopelma* is presumed to be the reduced or edentate paired claws. Males of *Cosmopelma* are not known. The absence of a clypeus and abdominal pattern in *Cosmopelma dentata* Fischel 1927 (the type now lost) are sufficient to exclude it from the genus; the species may be correctly placed in *Trichopelma*. *Cosmopelma* lacks the linear cuspules of both *Sason* and *Paracenobiopelma*. Raven (1985) concluded that two hypotheses were equally parsimonious. First, either the linear cuspules were gained in the Sasoninae and lost only in *Cosmopelma*, and the clypeus was lost in the Sasoninae plus Barychelinae but regained in *Cosmopelma* and *Paracenobiopelma*. The second hypothesis is that the linear cuspules are synapomorphic for *Sason* plus *Paracenobiopelma* (one step) and that the clypeus was regained in each of *Paracenobiopelma* and *Cosmopelma* (two steps). Outgroup comparison supports the latter hypothesis that, internal to the Sasoninae, is unaffected by outgroup changes and uses two steps. The first, although also using two steps, is more parsimonious because one of the steps applies also to the Barychelinae. In either hypothesis the synapomorphies of the Sasoninae are the cephalic, leg, and abdominal patterns, plus the edentate claws of males, but the first hypothesis is correlated with the synapomorphy of the linear cuspules. If the presence of a clypeus is considered plesiomorphic, intrafamilial homoplasies of the shape and dentition of the labium and reduction of the posterior lateral spinnerets increase.

HISTORICAL BIOGEOGRAPHY OF *SASON*

The biogeography of *Sason* was little discussed when the genus was known only from areas within and around the Indian Ocean. Pocock (1903) believed that *Sason* arose near the Seychelles, India, and Ceylon prior to their separation “in very early times (p. 353)” but attributed their occurrence in the Andaman Islands to artificial introduction by man and suggested that the same may be true for their occurrence in the Seychelles. Legendre (1979) suggested that the arboreal nest of *Sason* allowed for its transport as flotsam in ocean currents. Raven (1980) admitted that possibility in mygalomorphs generally and suggested the most parsimonious mechanism would require that a gravid female made the voyage. Main (1981a) attributed the origin of much of Australia’s mygalomorph fauna to

northern or southern invasions. In contrast, Kikkawa et al. (1981) found little support among distributions of birds, beetles, and butterflies for large scale invasions (through the Cape York corridor, at least). Williams (1981) also found the invasive component of Crustacea in Australia was very small. Coyle (1983, 1985) observed that two other mygalomorph genera, *Sphodros* and *Ummidia*, can disperse aerially and presented evidence that water gaps may be traversed during such ballooning.

Main (1981b), although stating that mygalomorphs generally have "poor powers of dispersal", later made the contradictory claim that the occurrence of mygalomorphs in New Guinea indicates that the groups "show exceptional capacity for dispersal or are ecologically aggressive with an unusually high invasive potential" (p. 587). Later, the theraphosids (accounting for about two-thirds of the known species of mygalomorphs and to which *Sason* was erroneously attributed) are considered "an extraordinarily "mobile" group (p. 589)." Neither the mechanism for the dispersal nor evidence for it has ever been presented.

Alone, the dispersal ability of a group is insufficient to support a dispersal explanation of their biogeography; areas of endemism (sometimes quite small) of birds, butterflies, and fish falsify that notion repeatedly. As Platnick (1981) points out, arachnologists have long been forced to concede the potential, however small, of spiders to disperse. Thus, some mygalomorphs may disperse beyond normal established ranges but that potential is not often realized. Clearly, once an organism transcends one barrier it could be expected to transcend all similar ones and so attain a very wide distribution.

Platnick (1981) rejected the need to consult dispersal abilities in discussing biogeographies; the degree of endemism is the most informative component. *Sason* species are endemic to relatively small areas. The species are morphologically distinct. Intra-relationships of *Sason* species should therefore reflect vicariance events in the historical biogeography of the genus.

Intra-relationships.—At present, two species groups are evident in *Sason*. *S. pectinatum* and *S. maculatum* share the back eye row being wider than the front (figs. 21, 27); and *S. andamanicum* and *S. colemani* share the "retreated" edge of the distal first tibia (figs. 9, 11) and the absence of labial cuspules of the male (figs. 7, 15). The plesiomorphic eye condition of barychelids is rectangular, thus the rhomboidal condition is apomorphic. In *S. robustum*, the cuticle at the base of the male tibial spur is not invaginated but the spur arises on a separate process (fig. 35); the spur is the same shape as in *S. andamanicum* and *S. colemani*. No spur is present in *Paracenobiopelma*, thus it cannot be used as an outgroup for this character. It is not possible to establish whether the spur was plesiomorphically distal and moved proximally with the resultant invagination closing over in *S. robustum*. The correlation of the invaginated tibial cuticle with the absence of cuspules (present in *Paracenobiopelma* and *S. robustum*) on the labium of males of *S. andamanicum* and *S. colemani* indicates that it is apomorphic; that is accepted here. Thus, three groups are evident: *S. robustum* and *S. seychellanum*, which lack a synapomorphy, *S. andamanicum* plus *S. colemani*, and *S. pectinatum* and *S. maculatum*. Without males of all species no further grouping is possible. I predict that a synapomorphy will be found linking *S. robustum* and *S. seychellanum*, and another linking *S. andamanicum* plus *S. colemani* and *S. pectinatum* plus *S. maculatum*.

At present, two areas of endemism (plus one default area) are recognizable: eastern Indian Ocean plus Australia, northwestern Pacific Ocean, and western Indian Ocean, respectively. Given an original widely spread southern occurrence, the rafting of India would have produced two of those areas (eastern and western Indian oceanic areas) and the uplifting of New Guinea would have produced the third. Hence, the areas are consistent with geological events. Full resolution of the area cladogram will come with recognition of synapomorphies of *S. robustum* plus *S. seychellanum*, and of the other two groups.

KEY TO THE SPECIES

Females

- 1. No scopuliform hairs on tarsi III. 2
 Scopula present but may be only thin and divided by setae on tarsi III.
 *S. robustum*
- 2. Ocular area as wide in front as behind (Fig. 47). 3
 Ocular area clearly wider behind than in front (Fig. 21). 4
- 3. Rastellum completely absent, rastellar area without even thick short setae
 *S. seychellanum*
 At least two differentiated thick setae form weak rastellum (e.g., Fig. 29)
 *S. colemani*
- 4. Eye group about twice as wide in front as long or wider *S. pectinatum*
 Eye group clearly less than twice as wide in front as long (Fig. 21)
 *S. maculatum*

Males

- 1. Cuspules present on labium and maxillae. *S. robustum*
 Cuspules absent on labium and maxillae. 2
- 2. Teeth present on paired claws. *S. colemani*
 Teeth absent on paired claws. *S. andamanicum*

Sason andamanicum (Simon)

Figs. 3-9 Table 1

Satzicus andamanicum Simon 1888:287.
Sason andamanicum: Simon 1892:130.

Type.—Holotype male, Andaman Is., Port Blair (R. D. Oldham, MNHNP No. 9763, examined).

Diagnosis.—Differs from *S. colemani* by the absence of teeth on the paired claws of the male and a rastellum.

Fovea recurved. Rastellum absent. Cuspules absent on maxillae and labium of male. Scopulae thin, ventral, divided by scattered setae on tarsi III, rudimentary on tarsus IV; few distal scopuliform hairs on metatarsi III. Tibia I of male with

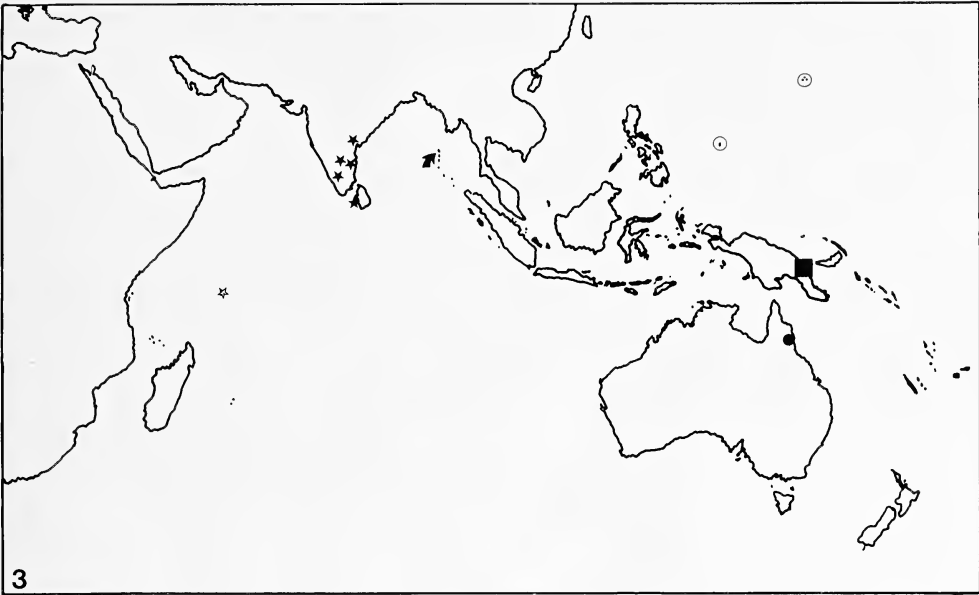

Fig. 3.—Map showing distribution of *Sason* species. Symbols (from left): *S. seychellanum* (star), *S. robustum* (black star); *S. andamanicum* (arrow); *S. maculatum* (hollow circle); *S. pectinatum* (solid square); *S. maculatum* (dot).

prolateral distal spinose process directed entally. Palpal bulb squat. Spines present on femur and tibia I. Paired claws without teeth. Females unknown.

Description.—Holotype male MNHNP No. 9763. Carapace 5.00 long, 4.75 wide. Abdomen 4.67 long, 3.42 wide.

Color in alcohol: carapace yellow brown with slight brown mottling on caput; legs with faded pattern, without brown annulations, probably faded; abdominal pattern faded. The leg annulations characteristic of *Sason* may be absent because the type was in poor condition when first described.

Carapace: fovea broad, recurved. Bristles: about 20, long, erect on clypeal edge; 5 anteromedian; numerous long, erect, and thick, forming uniform covering on caput and interstitial ridges. Eyes: all but ALE on low tubercle; 1, 3; 2, 0.49; 3, 73:77:39; 4, 24:17:9:12; 5, 52:56:31; 6, 7, 11, 23, 45, 2, 43. Chelicerae: long bristles in two narrow dorsal bands; rastellum absent; 7 spaced promarginal teeth, 1 small basomesal tooth on furrow.

Labium: 0.44 long, 0.88 wide; without cuspules. Maxillae: 1.20 long in front, 1.60 long behind, 0.72 wide; without cuspules. Sternum: 2.88 long, 2.28 wide; only posterior and middle sigilla evident.

Legs: (Table 1). 413. Scopulae: thin, ventral, divided by scattered setae on tarsus III; rudimentary on tarsus IV; metatarsus III with few distal scopuliform hairs; tibia I with predistal prolateral process bearing entally directed megaspine. Spines. Leg 1: fe, d2; ti, v4 + megaspine. Leg 2, missing. Leg 3, 0. Leg 4: fe, d4. Palp, 0. Claws: bare. Trichobothria: 1, 10 for half; 2, 10 in distal one-third; 3, 6 c. and 6 f. Palp: bulb squat, pyriform, with narrow tapering embolus.

Spinnerets: 1, 0.34; 2, 0.14; 3, 0.14; 4, 0.72; 5, 0.22; 6, 0.12; 7, 1.06.

Distribution.—*S. andamanicum* is known only from the Andaman Islands in the Bay of Bengal.

Material examined.—Only the type.

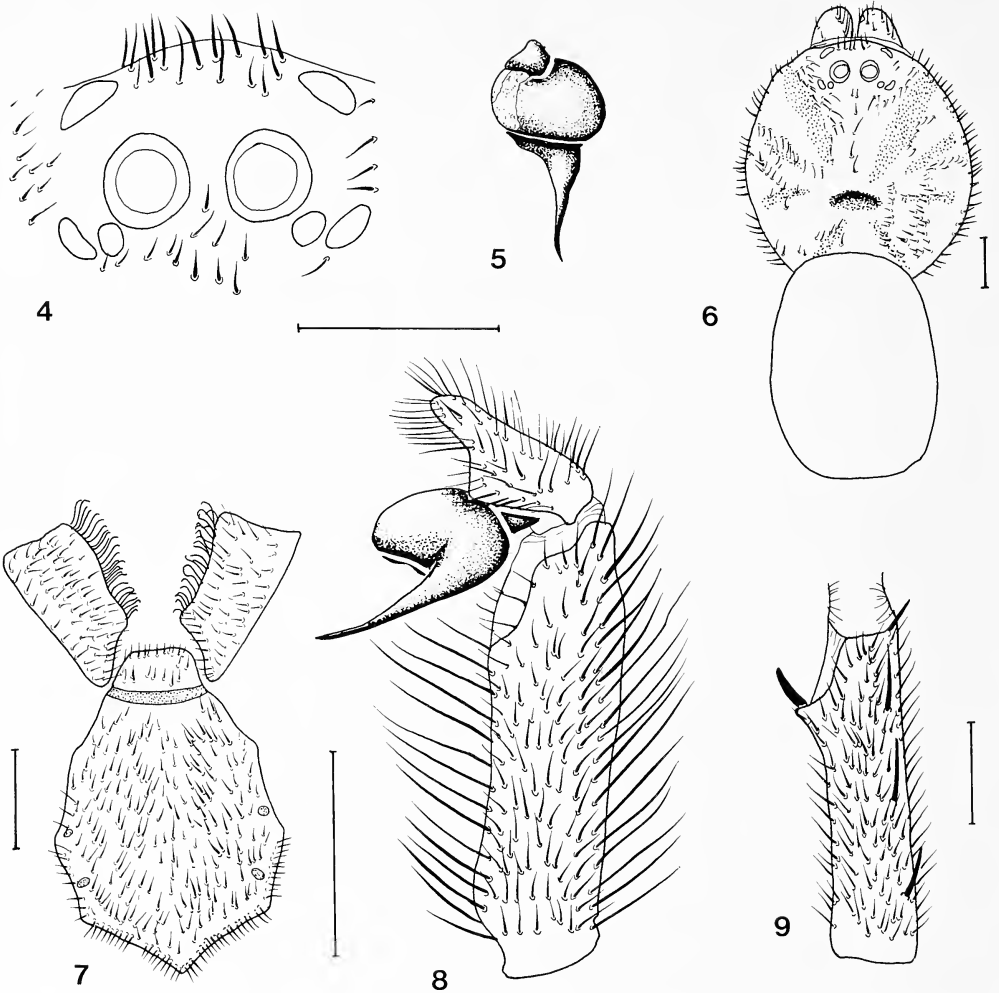

Fig. 4-9.—*Sason andamanicum* Simon, holotype male: 4, eyes, dorsal view; 5, palpal bulb, ventral view; 6, cephalothorax and abdomen, dorsal views; 7, sternum, maxillae, and labium; 8, palpal tibia, cymbium, and bulb, retrolateral view; 9, tibia I, ventral view. All scale lines, 1 mm.

Sason colemani, new species

Figs. 3, 10-20 Table 2

Types.—Holotype male, paratype female. Australia: Queensland: Cairns, in swamp on trees in short tubes covered by bark particles (17.xi.1980, N. C. Coleman, QM S 1311, 1312); female paratype, same data (QM S 1313).

Table 1.—Leg measurements of *Sason andamanicum*. Legs 2 are missing. Values are for holotype male.

	Leg 1	Leg 3	Leg 4	Palp
Femur	4.83	4.25	5.33	2.58
Patella	2.75	2.33	2.83	2.08
Tibia	3.50	3.50	5.00	2.08
Metatarsus	2.75	3.00	3.92	
Tarsus	1.50	1.33	1.50	0.67
Total	15.33	14.41	18.58	6.91

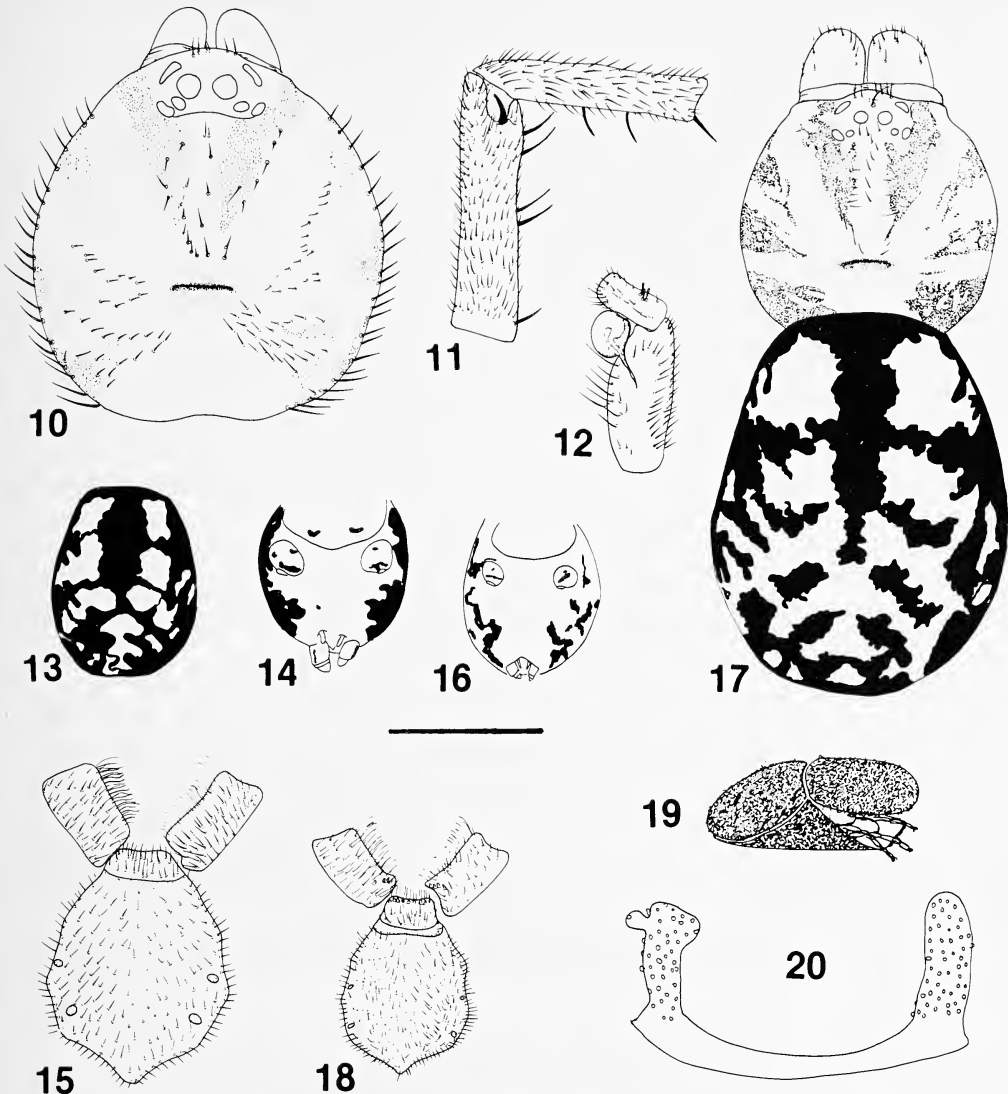

Figs. 10-20.—*Sason colemani*, new species, holotype male, paratype female: 10-15, male; 10, cephalothorax, dorsal view; 11, tibia and metatarsus I, prolateral view; 12, palpal tibia, cymbium, and bulb, retrolateral view; 13, 14, abdomen, dorsal view (13), ventral view (14); 15, sternum, maxillae, and labium; 16-20, female; 16, abdomen, ventral view; 17, cephalothorax and abdomen, dorsal view; 18, sternum, maxillae, and labium; 19, nest showing two doors; 20, spermathecae. Scale line: figs. 10-12, 15-18 = 1 mm; figs. 13, 14, 16 = 2 mm; fig. 19 = 5 mm; fig. 20 = 0.5 mm.

Diagnosis.—Differs from *S. andamanicum* by the presence of teeth on the claws of the male, two coniform rastellar spines, and more spines on the legs.

Fovea almost straight. Rastellum consists of 2-3 coniform spines. Scopulae in females divided on metatarsi and tarsi I, II; absent on metatarsi and tarsi III, IV of males and females. Tibia I of males with prolateral and distal megaspine on low ectally directed spur. Palpal bulb pyriform. Spines present on femora I-IV and tibiae I and II of males, and ventral patellae and metatarsi I, II of females.

Description.—Holotype male QM S 1311. Carapace 2.43 long, 2.28 wide. Abdomen 2.50 long, 1.95 wide.

Color in alcohol: carapace light brown with darker brown areas near eyes, on caput, and interstrial ridges; chelicerae cream with brown areas; abdomen dorsally brown with large white paired areas medially forming two large and small lateral pairs in median triangular area, with irregular white spots posteriorly; ventrally cream with small brown areas on booklung covers and laterally; sternum edge brown; legs cream coloured with brown annulations on distal and lateral femora, prolateral patellae, tibial joints, and distal metatarsi.

Carapace: fovea shallow, centrally placed, broad, transverse almost straight with slightly recurved ends. Bristles: short curved in fringe on lateral margins, posterior interstrial ridges, and few on anterior ridges; 5 thick anteromedian; 6 on clypeal edge; 1 long between AME; several between PME. Eyes: tubercle low; 1, 2; 2, 0.62; 3, 33:35:18; front row strongly procurved, back row recurved; 4, 7:9:4:5; 5, 19:25:12; 6, 3, 3, 6, 20, 1, 15. Chelicerae: short, almost glabrous; rastellum consists of two distinct coniform bristles distally; 6-7 teeth on promargin, no teeth or granules visible elsewhere.

Labium: 0.18 long, 0.50 wide; separated from sternum by shallow groove; cuspules absent. Maxillae: 0.53 long, 0.30 wide; cuspules absent. Sternum: 1.30 long, 1.18 wide; posterior sigilla round, marginal, 0.06 across; other sigilla not discernible.

Legs: (Table 2). 4123. Scopulae: present but very thin on short shiny tarsi and metatarsi I, II; entirely absent on metatarsi and tarsi III, IV. Tibia I with small megaspine on low mound prolaterodistally. Spines. Leg 1: fe, d2; pa, v2; ti, p2 v6 + megaspine; me, v4. Leg 2: ti, v6. Leg 3: fe, d3. Leg 4: fe, d5. Palp: pa, v1. Claws: three teeth on ental edge of both claws on legs I; long curved with two teeth on leg IV. Trichobothria: 1, 2-5 for half; 2,6; 3, 7-9 c. and f. Palp: bulb spheroidal; embolus tapers to point, grooves absent.

Spinnerets: 1, 0.13; 2, 0.08; 3, 0.03; 4, 0.28; 5, 0.13; 6, 0.08; 7, 0.49.

Paratype female QM S 1312. Carapace 1.90 long, 1.64 wide. Abdomen 4.88 long, 3.75 wide.

Color in alcohol: carapace, dorsal abdomen, and legs similar to male but with more distinct pattern; carapace pattern darker with paler areas behind eye group; abdomen ventrally pallid with brown areas laterally and medially between posterior booklungs; sternum entirely pallid.

Carapace: fovea broad, straight. Bristles: in three lines anterior to fovea; 3 very long thick anteromedian; 1 long between AME; 2 long between PME; 6 on clypeal edge. Eyes: not on tubercle; 1, 2; 2, 0.47; 3, 24:26:13; front row strongly procurved, back row slightly recurved; 4, 8:10:5:7; 5, 12:17:9; 6, 3, 3, 5, 14, 1, 12. Chelicerae: short, geniculate, pallid with fine brown hairs; rastellum consists of 2-3 coniform spines distally; 5 thick teeth, 5-7 granules basomesally on promargin.

Labium: 0.75 long, 0.40 wide; 9 thick pointed cuspules. Maxillae: 0.70 long, 0.55 wide; with 5-6 cuspules on inner edge, and thin spinules posteriorly. Sternum: 1.90 long, 1.63 wide; posterior and middle sigilla evident as small paired depressions.

Legs: (Table 2). 4123. Scopulae: distinct but thin, divided on metatarsi and tarsi I, II; entirely absent on metatarsi and tarsi III, IV. Spines. Femoral 'spines' are long, thick, curved bristles. Leg 1: fe, p1 d3; pa, v1; ti, v3; me, v1. Leg 2: fe, d3; pa, v1; ti, v3; me, v2. Leg 3: fe, d3. Leg 4: fe, d3. Palp: fe, d2 pa, v2; ti,

Table 2.—Leg measurements of *Sason colemani*. Values are for holotype male with allotype female in parentheses.

	Leg 1	Leg 2	Leg 3	Leg 4	Palp
Femur	2.28(1.72)	2.24(2.16)	2.08(2.04)	2.32(2.72)	1.05(1.48)
Patella	1.32(1.52)	1.16(1.20)	1.08(1.28)	1.02(1.72)	0.75(1.20)
Tibia	1.76(1.40)	1.72(1.40)	1.64(1.40)	2.32(2.36)	0.83(1.00)
Metatarsus	1.56(1.08)	1.48(1.00)	1.40(1.20)	1.84(1.60)	
Tarsus	0.76(0.64)	0.68(0.76)	0.68(0.60)	0.68(0.72)	0.48(1.04)
Total	7.68(6.36)	7.28(6.52)	6.88(6.52)	8.18(9.12)	3.11(4.72)

v6. Claws: long curved, without teeth. Trichobothria: 1, 5-8 for half; 2, 5-6; 3, 4-6 c. and 9 f.

Spinnerets: 1, 0.20; 2, 0.08; 3, 0.20; 4, 0.33; 5, 0.18; 6, 0.08; 7, 0.61. Spermathecae: each a short lobe with or without small, distal, ectal lobe.

Distribution, Habitat, and Remarks.—*S. colemani* is known only from a natural swamp in the Botanical Gardens in Cairns, north Queensland. The retreat consists of a very short tube with a door at each end (Fig. 19); as one door opens the other is pressed closed. Retreats were found on the bark of trees. Two other barychelid genera, *Cyphonisia* and *Paracenohipelma*, make similar but slightly longer retreats with more distance between the door hinges (Blandin and Célérier 1977, Feio 1952). The similar retreat is probably another synapomorphy of *Sason* and *Paracenohipelma*.

Material examined.—Only the types.

Sason maculatum (Roewer)

Figs. 3, 21-26 Table 3

Chrysopelma maculata Roewer 1963:113, figs. 3d-f. **NEW COMBINATION.**

Types.—Holotype female, Korori, Palau Island (26.xi.1947, H. Y. Dybas, USNM, examined). Paratypes: female, Palau Island (August 1945, H. Y. Dybas, SMF No. 12758); female, Ponape (March 1948, H. F. Dybas, deposition unknown).

Diagnosis.—Differs from *S. pectinatum* in the relatively longer eye group.

Fovea broad with recurved ends. Rastellum consists of two coniform spines. Scopulae in females absent on metatarsi and tarsi III, IV. Spines present on all femora, and tibiae and metatarsi III, IV. Eye group about 1.5 times wider in front than long, and clearly wider behind than in front.

Description.—Paratype female SMF No. 12758. Supplementary description to Roewer 1963. Carapace 3.78 long, 2.72 wide. Abdomen 5.42 long, 3.58 wide.

Color in alcohol: carapace yellow brown with small brown areas on caput and lateral margins; narrow brown areas radiating from fovea along interstitial ridges; chelicerae yellow brown; legs yellow brown with large brown spots on posterior femora I, II, prolateral and retrolateral on femora III, IV, prolaterally on patellae and tibiae I, II, and dorsally on metatarsi I-IV; lateral brown markings on patellae and tibiae III, IV; abdomen dorsally brown with large irregular brown spots, ventrally fawn with brown markings posteriorly.

Carapace: fovea broad, straight with recurved ends. Bristles: one foveal pair; 3 posteriorly directed pairs in front of fovea; several on lateral caput; 1 long

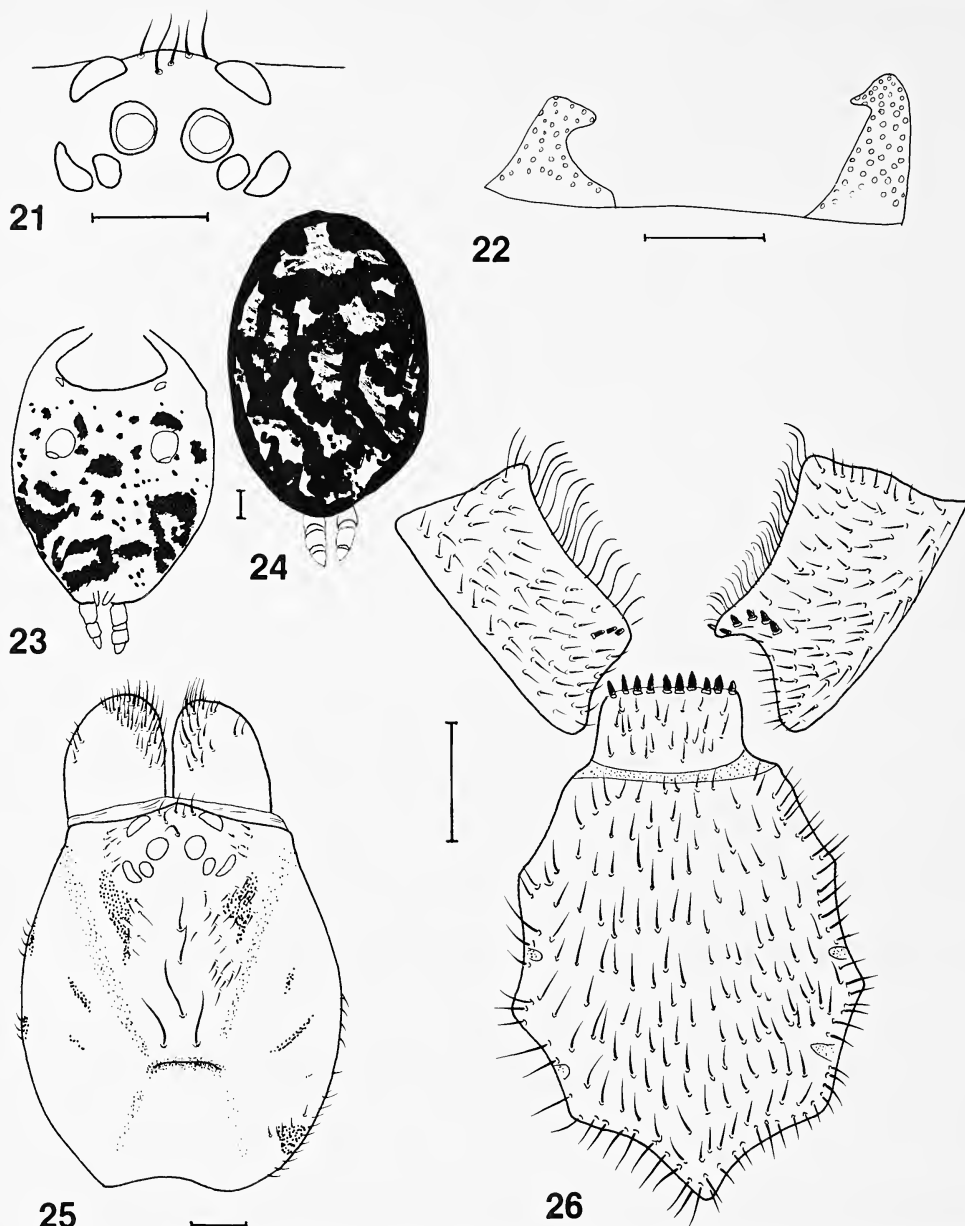

Figs. 21-26.—*Sason maculatum* (Roewer), paratype female: 21, eyes, dorsal view; 22, spermathecae; 23, 24, abdomen, ventral view (23), dorsal view (24); 25, cephalothorax, dorsal view; 26, sternum, maxillae, and labium. Scale lines, 0.5 mm, except Fig. 22, 0.1 mm.

between AME; 5 long, curved between ALE. Eyes: not on tubercle; 1, 2; 2, 0.51; 3, 42:50:28; front row strongly procurved, back row slightly recurved; 4, 12:12:7:10; 5, 25:34:18; 6, 5, 6, 11, 21, 1, 22. Chelicerae: sparse bristles on prodorsum; rastellum consists of 2 coniform spines medially on distal edge; 6 large and one small tooth, several small granules basomesally on promargin.

Labium: 0.66 long, 0.38 wide; with 10 blunt cuspules. Maxillae: 0.90 long in front, 1.20 long behind, 0.52 wide; with 4-6 cuspules. Sternum: 1.84 long, 1.48 wide; all sigilla oval, touching margin.

Table 3.—Leg measurements of *Sason maculatum*. Values are for paratype female.

	Leg 1	Leg 2	Leg 3	Leg 4	Palp
Femur	2.08	2.16	1.84	2.60	1.60
Patella	1.56	1.52	1.28	1.64	1.24
Tibia	1.36	1.32	1.32	2.00	1.00
Metatarsus	1.00	1.08	1.20	1.68	
Tarsus	0.72	0.64	0.64	0.84	1.08
Total	6.72	6.62	6.28	8.76	4.92

Legs: (Table 3). 4123. Scopulae: entirely absent on metatarsi and tarsi III, IV. Spines. Leg 1: fe, d5; ti, v5. Leg 2: fe, d5; pa, v1; ti, v5. Leg 3: fe, d5; ti, v7. Leg 4: fe, d5; ti, v4; me, v6. Palp: fe, d3; pa, v3; ti, v7. Claws: palpal claw short with two small teeth; others without teeth. Trichobothria: 1, 5-6 for half; 2, 6; 3, two divided bands of 4-6 c., 8 f.

Spinnerets: 1, 0.20; 2, 0.10; 3, 0.16; 4, 0.42; 5, 0.38; 6, 0.14; 7, 0.94. Spermathecae: each receptaculum with short lateral lobe.

Distribution.—*S. maculatum* is known only from Saipan in the Marianas, and Kusaie, Ponape, Truk, and Woleai in the Caroline atolls, north of New Guinea.

Material examined.—Only the types.

Sason pectinatum Kulczyński

Figs. 3, 27-29

Sason pectinatum Kulczyński 1908:450.

Type.—Holotype juvenile, northeastern New Guinea (1896, L. Biró. *Museum Nationalis Hungarici*, examined).

Diagnosis.—Differs from *S. pectinatum* in the comparatively wider eye group and stronger spines on legs I, II.

Fovea recurved. Rastellum consists of one or two spines. Scopulae of females absent on metatarsi and tarsi III, IV. Spines only on femora to metatarsi I, II, and femora and metatarsi III, IV. Eye group about twice as wide in front as long, slightly wider behind than in front. Palpal claw with one or two small teeth. Adults unknown.

Description.—Carapace 2.04 long, 1.80 wide. Abdomen 2.68 long, 1.84 wide.

Color in alcohol: carapace yellow brown with some faded areas on caput and lateral margins; chelicerae yellow brown; legs yellow brown with faded annulations on all patellae, tibiae, and metatarsi; abdominal pattern faded, only medial brown area evident; ventrally pallid, also with no pattern.

Carapace: bristles: 3 anteromedian; 2 long, curved between ALE. Fovea broad, straight. Eyes: not on tubercle; 1, 2; 2, 0.48; 3, 34:37:16; front row procurved, back row slightly recurved; 4, 8:8:5:4; 5, 21:26:12; 6, 3, 3, 8, 21, 2, 18. Chelicerae: bristles sparse on prodorsum; rastellum consists of 1 or 2 coniform spines medially on distal edge; promargin with 6 large and one small tooth, 6-8 small teeth basomesally.

Labium: 0.24 long, 0.48 wide; with one small, blunt and nine pointed cuspules. Maxillae: 0.56 long in front, 0.70 long behind, 0.38 wide; with 7-12 cuspules. Sternum: 1.24 long, 1.08 wide; sigilla not evident.

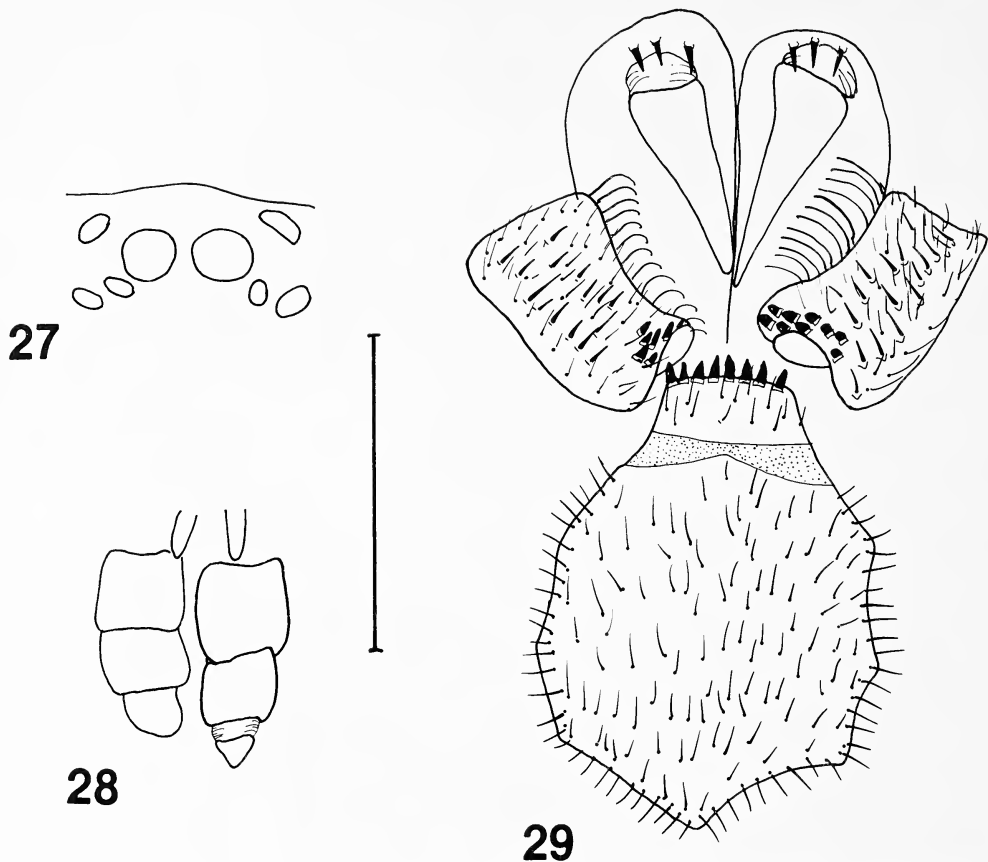

Figs. 27-29.—*Sason pectinatum* Kulczyński, holotype juvenile: 27, eyes, 28, spinnerets, ventral view; 29, chelicerae, sternum, maxillae, and labium, ventral view. Common scale, 1 mm.

Legs. 4123. Scopulae: entirely absent on metatarsi and tarsi III, IV. Spines: strong ventrally on legs I, II. Leg 1: pa, v1; ti, v5; me, v1. Leg 2: fe, d3; pa, v1; ti, v5; me, v1. Leg 3: fe, d5; me, v3 (weak). Leg 4: fe, d4; me, v2 (weak). Palp: fe, proventral 2; pa, p2, v1; ti, v6. Claws: palpal claw short with one or two small teeth; others without teeth. Trichobothria: similar to *S. maculatum*.

Spinnerets: 1, 0.16; 2, 0.06; 3, 0.08; 4, 0.24; 5, 0.20; 6, 0.10; 7, 0.50. Spermathecae: not evident.

Distribution and Remarks.—*S. pectinatum* is known only from north-eastern New Guinea. Because the type is a juvenile, the above description and figures are less informative than those of mature specimens, and no leg measurements are given.

Material examined.—Only the type.

Sason robustum (O. P.-Cambridge)

Figs. 1-3, 30-45 Table 4

Sarpedon robustum O. P.-Cambridge 1883:354, plate 36, fig. 1a-f.

Sason robustum Karsch 1891:273; Simon 1892:129, 130; Pocock 1900:173.

Oecophloeus cinctipes Pocock 1892c:49, pl. III, figs. 1, 2 (syntype female, Ceylon, Punduloya River, E. E. Green, BMNH No. 1890.10.22.70, examined; female syntype, Kanthalai, BMNH No.

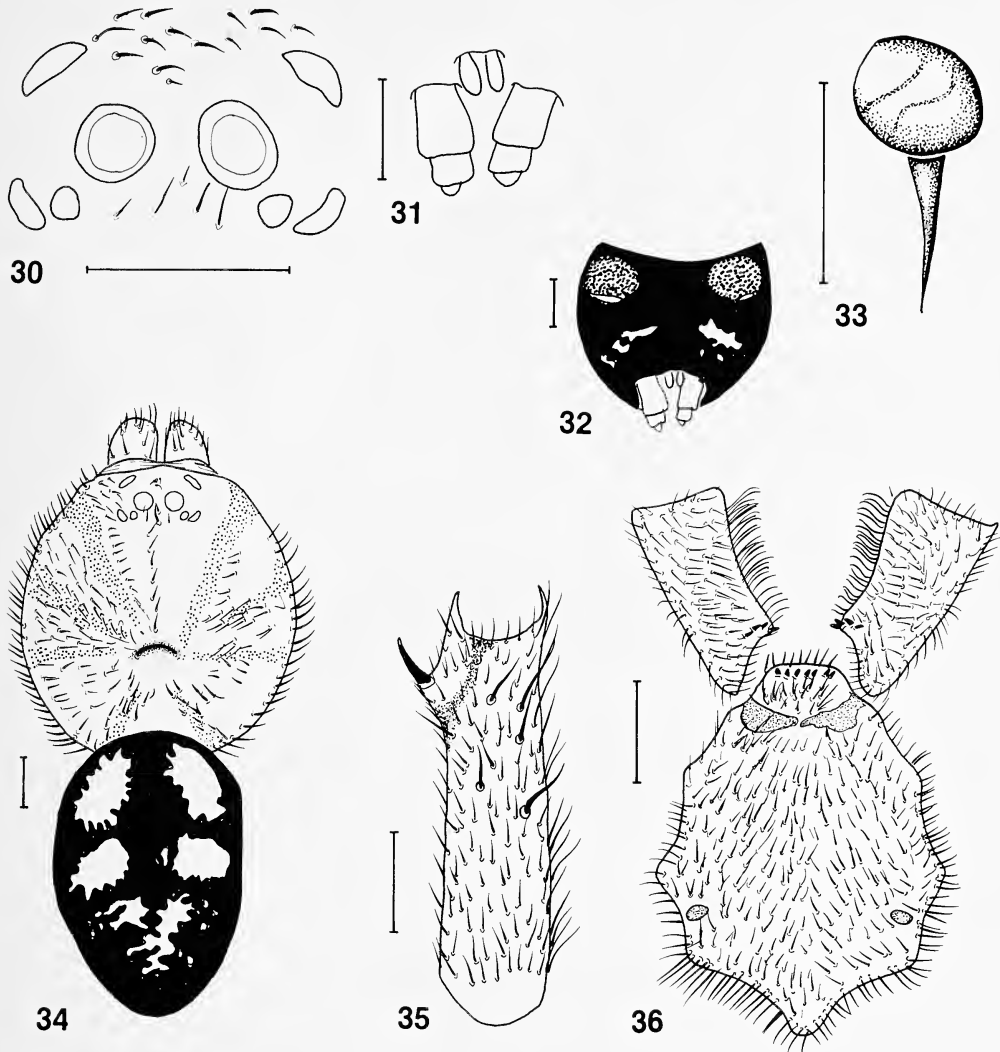

Figs. 30-36.—*Sason robustum* (O. P.-Cambridge), male: 30, eyes, dorsal view; 31, spinnerets, ventral view; 32, abdomen, ventral view; 33, palpal bulb, ventral view; 34, cephalothorax and abdomen, dorsal view; 35, tibia I, ventral view; 36, sternum, maxillae, and labium. All scale lines, 1 mm.

1898.3.21.3, examined; female and juvenile syntypes, Madras Jambunathan, BMNH No. 1923.xii.21.33-34, examined). **NEW SYNONYMY.**

Sason cinctipes: Simon 1892:130; Pocock 1904:799.

Sason armatoris Pocock 1900:173; fig. 56 (syntype male, south western India, Travancore, Ponmudi, coll. Ferguson, BMNH No. 1899.7.11.6, examined; male, Trevandrum, Feb. 1896, BMNH No. 1899.1.17.1). **NEW SYNONYMY.**

Type.—Lectotype female and paralectotype juvenile, Ceylon (G. H. K. Thwaites, Hope Museum, Oxford, examined and here designated).

Diagnosis.—*S. robustum* females differ from those of other *Sason* species by the absence of scopula on tarsus IV; males differ from those known of other species by the presence of cuspules on the maxillae and labium.

Fovea broad, recurved. Rastellum absent. Scopulae: in females, distal, thin on metatarsus III, sometimes absent on IV; thin but divided by broad setal band on

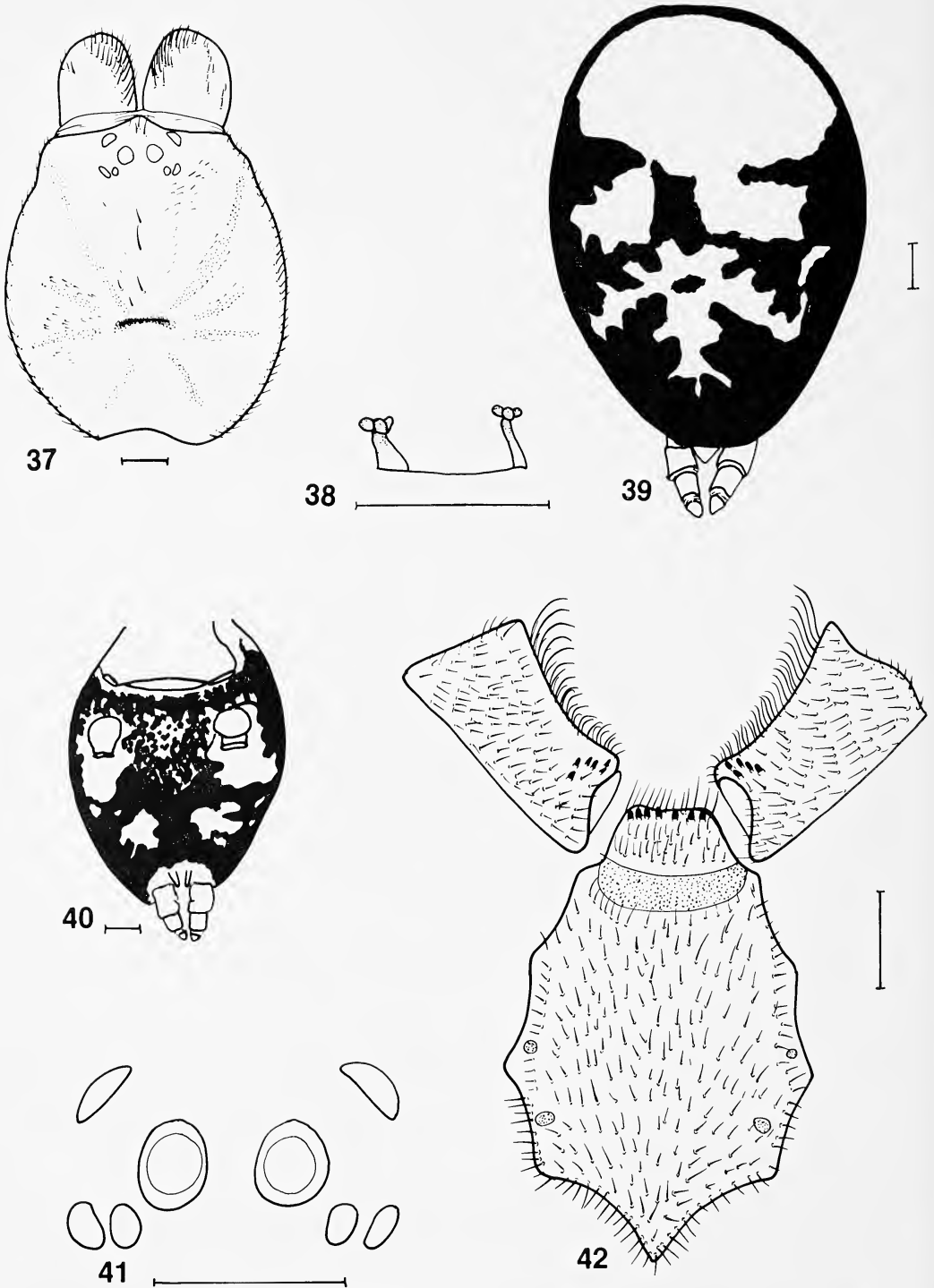

Figs. 37-42.—*Sason robustum* (O. P.-Cambridge), female: 37, cephalothorax, dorsal view; 38, spermathecae; 39, 40, abdomen, dorsal view (39), ventral view (40); 41, eyes, dorsal view; 42, sternum, maxillae, and labium. All scale lines, 1 mm.

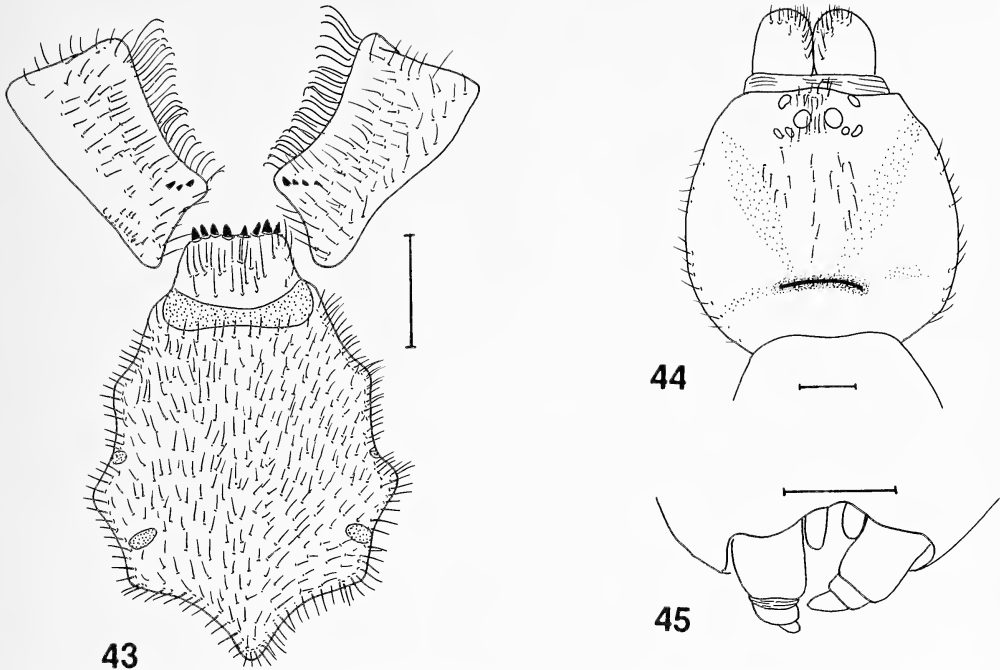

Figs. 43-45.—*Sason robustum* (O. P.-Cambridge), holotype female: 43, sternum, maxillae, and labium; 44, cephalothorax and anterior abdomen, dorsal view; 45, spinnerets, ventral view. All scale lines, 1 mm.

tarsus III, sometimes absent on IV; in males, divided by narrow band of setae on tarsi III, absent on tarsi IV and metatarsi III, IV. Tibia I of males with proventral process and spur. Palpal bulb spheroidal with distinctly demarcated embolus. Spines present or absent on all femora and tibiae of males and females.

Description.—Male BMNH No. 1899.7.11.6. Carapace 4.64 long, 4.56 wide. Abdomen 4.00 long, 3.75 wide.

Color in alcohol: carapace orange brown with brown radial marks; chelicerae similar with darker areas; abdomen, dorsally brown with 3 paired white areas and three brown inverted V's, ventrally mottled with yellow brown booklung covers; laterally brown. Legs with pattern faded, ?without brown annulations.

Carapace: fovea broad, recurved. Bristles: thinly distributed, short, brown; in one row on lateral margins; 4, thick anteromedian. Eyes: on low tubercle; 1, 3; 2, 0.48; 3, 64:70:39; 4, 19:14:8:11; 5, 45:49:29; 6, 7, 10, 21, 40, 2, 37. Chelicerae: short, geniculate; stiff, long bristles dorsally; rastellum absent; 1 small and 5 thick teeth on promargin.

Labium: 0.40 long, 0.96 wide; 6 pointed cuspules anteriorly. Maxillae: 1.20 long in front, 1.64 long behind, 0.76 wide; with 2 pointed cuspules. Sternum: 2.84 long, 2.08 wide; only posterior and middle sigilla evident—both pairs oval, marginal.

Legs: (Table 4). 4123. Scopulae: distal two-thirds of metatarsi I, II; divided by narrow setal band on tarsus III; absent on metatarsi III, IV and tarsus IV. Tibia I with low prolateral spur set back from cuticle edge. Spines: Leg 1: fe, pl d3; ti, v4 + megaspine. Leg 2: fe, pl d3; ti, v5. Leg 3: fe, pl d6 r1. Leg 4 missing. Palp: fe, pl d3; ti, v2. Claws: two small teeth on legs I, II; bare on leg III.

Table 4.—Leg measurements of *Sason robustum*. Values are for holotype female with MNHNP male in parentheses.

	Leg 1	Leg 2	Leg 3	Leg 4	Palp
Femur	3.04(4.83)	3.20(5.08)	3.04(4.67)	4.40(5.83)	2.48(2.83)
Patella	2.24(3.33)	2.48(3.08)	1.92(2.67)	2.80(3.33)	1.84(1.92)
Tibia	1.92(3.92)	2.08(4.17)	2.16(4.00)	3.28(5.17)	1.68(2.42)
Metatarsus	1.52(3.83)	1.28(3.83)	1.84(3.75)	2.56(4.67)	
Tarsus	1.20(2.00)	1.04(1.83)	0.88(1.67)	1.12(2.00)	1.76(1.00)
Total	8.92(17.91)	9.09(17.99)	9.84(16.76)	14.16(21.00)	7.76(8.17)

Trichobothria: 1, 10 for half; 2, 12; 15-20 c. and f. Palp: bulb squat, pyriform, with narrow tapering embolus.

Spinnerets: 1, 0.20; 2, 0.08; 3, 0.08; 4, 0.20; 5, 0.12; 6, 0.08; 7, 0.40.

Lectotype female Hope Entomological Collections, Oxford. Carapace 4.83 long, 4.17 wide. Abdomen 6.00 long, 4.58 wide.

Color in alcohol: carapace, chelicerae, and legs yellow brown; brown annulations on proximal tibiae I-IV, and distal metatarsi and tarsi. Abdominal pattern faded.

Carapace: Bristles: long, numerous on caput, fewer on thoracic region; 4 between AME; 4 long anteromedian; 2 long, several short on clypeal edge. Eyes: not on tubercle; 1, 3; 2, 0.43; 3, 76:79:39; 4, 16:15:9:11; 5, 46:61:25; 6, 13, 13, 19, 45, 3, 54. Chelicerae: small, geniculate; rastellum absent; 7 thick teeth on promargin, 4 granules basally.

Labium: 0.64 long, 1.16 wide; 8 thick pointed cuspules. Maxillae: 1.64 long in front, 2.12 long behind, 0.92 wide; 5 blunt cuspules on inner edge, thin spinules posteriorly. Sternum: 3.20 long, 2.76 wide; sigilloid depressions not evident.

Legs: (Table 4). 4123. Scopulae: lateral and strongly divided by setae on tarsi III; absent on metatarsi III, IV and tarsi IV. Spines. Leg 1: pa, v1; ti, v5. Leg 2: pa, v1; ti, p1 v5. Leg 3: ti, v4. Leg 4: 0. Palp: pa, v3; ti, v6. Claws: 2-3 small teeth on single keel; palpal claw (of female MNHNP No. 15063) with one distinct tooth. Trichobothria: 1, 9; 2, 14; 13 f. and c.

Spinnerets: 1, 0.36; 2, 0.16; 3, 0.16; 4, 0.52; 5, 0.44; 6, 0.20; 7, 1.16. Spermathecae: not examined.

Distribution and Remarks.—*S. robustum* is known only from Ceylon and southern India. Pocock (1900), citing Simon (1892), diagnosed male *Sason* by the cuspule-free labia and maxillae. However, Simon appears to have overlooked the cuspules on the males in his collection and instead based his diagnosis of the genus on the male of *S. andamanicum*.

Synonymy.—*S. cinctipes* and *S. armatoris* differ from *S. robustum* only in having less dense or less extensive scopulae on metatarsi and tarsi III and IV, and also in having spines on the femora—differences that would indicate that *S. cinctipes* is a valid species. However, the differences are not congruent. The extent and density of scopula hairs are not correlated on metatarsi and tarsi III and IV. Thus, in the absence of males that have similar characteristics to females of *S. cinctipes* (spines on the femora and scopulae on metatarsi and tarsi III and IV) I conclude that only one species is present.

Material examined.—The types and the following: INDIA. female, 2 juveniles, Haragam (Aug. 1903, BMNH); female, south India, Yercaud, 1200 m (6.iii.1962, E. S. Ross and D. Cavagnaro, CAS); juvenile, 2.5 km south of Toppur, 340 m (3.iv.1962, E. S. Ross and D. Cavagnaro, CAS); female ?, Madras (8.iv.1962, E. S. Ross and D. Cavagnaro, CAS). CEYLON. female, Pundul Oya R, (E.

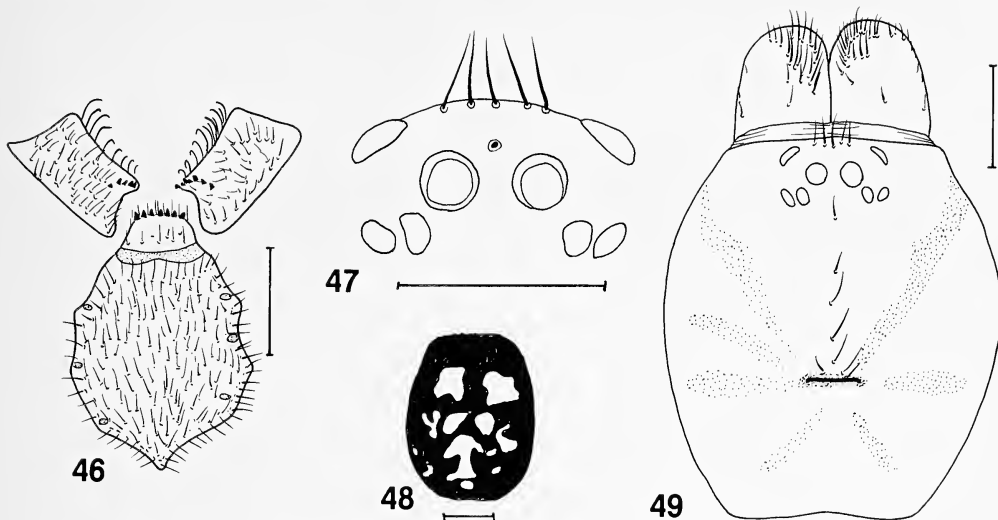

Figs. 46-49.—*Sason seychellanum* Simon, syntypes female: 46, 48, 49, ZMH specimen; 47, MNHNP specimen; 46, sternum, maxillae, and labium; 47, eyes, dorsal view; 48, abdomen, dorsal view; 49, cephalothorax, dorsal view. All scale lines, 1 mm.

E. Green, BMNH 1895.11.14.12.13); juvenile, (Dr. A. Willy, BMNH 1906. 11.14.4.6); female (Holdeworth collection, BMNH No. 1875.12); male, female (MNHNP No. 15963).

Sason seychellanum Simon
Figs. 3, 46-49 Table 5

Sason seychellanum Simon 1898:370; 1903:915; Hirst 1911:381; Benoit 1966:213; 1978:407, figs. 1a-d.

Types.—Lectotype female, Seychelle Islands (A. Brauer, 1895, ZMH, examined). Paralectotypes: juvenile male, juvenile female same data (in ZMH, examined); female, same data (MNHNP No. 15.220, examined). NEW DESIGNATIONS.

Diagnosis.—Differs from *S. andamanicum* by the complete absence of scopulae on legs III and IV, and more spinose legs.

Fovea more or less straight. Rastellum consisting of 3 coniform setae. Adult males unknown. Scopulae in females absent on metatarsi and tarsi III, IV. Paired claws of legs I, III with two teeth; palpal claw with 4 teeth.

Description.—Lectotype female ZMH. Carapace 3.92 long, 3.24 wide. Abdomen 3.42 long, 2.58 wide.

Color in alcohol [of MT 122.898]: carapace yellow with black margin and two roughly V-shaped areas on caput; femora with two brown areas distolaterally and I-IV also with pair at half length of femora; patellae with distolateral brown triangles; tibiae with three brown areas dorsally separated by two glabrous ovoid bands; metatarsi brown in distal one-third. Abdomen dorsally with three large white paired areas and posteriorly three irregular medial areas becoming smaller towards spinnerets; laterally mottled; ventrally pallid with incomplete transverse brown bands posteriorly.

Carapace: fovea broad, straight or very slightly procurved. Bristles: 5 on clypeal edge; 1 thick between AME; 1 foveal pair; 5 anteromedian; 3-4 groups

Table 5.—Leg measurements of *Sason seychellanum*. Values are for female MT.

	Leg 1	Leg 2	Leg 3	Leg 4	Palp
Femur	3.33	3.42	3.00	4.00	2.11
Patella	2.50	2.25	1.83	2.67	1.83
Tibia	2.33	2.25	2.33	3.17	1.83
Metatarsus	1.75	1.92	2.08	2.75	
Tarsus	1.25	1.42	1.25	1.42	1.75
Total	11.16	11.26	10.46	14.01	7.91

each of 4-5 on margins; few on cephalothorax. Eyes: not on tubercle; 1, 2; 2, 0.47; 3, 53:54:29; front row slightly procurved, back row straight; 4, 10:12:9:9; 5, 27:28:20; 6, 7, 10, 11, 33, 2, 26. Chelicerae: bristles sparse on prodorsum; rastellum not evident in ZMH but three distinct thorns in MT 122.898; 7 spaced teeth on promargin, 4-5 small teeth basomesally. Presumably the rastellar spines were damaged in the lectotype.

Labium: projects downward between maxillae; 0.36 long, 0.72 wide; 7 thick pointed cuspules. Maxillae: 1.00 long in front, 1.32 long behind, 0.64 wide; 7-8 cuspules in straight diagonal line. Sternum: 2.08 long, 1.80 wide; separated from labium by narrow shallow groove; all sigilla oval, about 0.08 long, and touching margin.

Legs: (Table 5). 4123. Scopulae: thin but entire on metatarsi and tarsi I, II; entirely absent on metatarsi and tarsi III, IV. Spines [from MT 122.898]: Leg 1: fe, d5; pa, v1; ti, v5. Leg 2: fe, p1 d5; pa, v1; ti, v6; me, v1. Leg 3: fe, d5; ti, v4; v3. Leg 4: fe, d5; ti, v3; me, v5. Palp: fe, p2 d3; pa, v4; ti, v7. Claws: 2 teeth on legs I, II; bare on leg IV; 4 long teeth on palpal claw. Trichobothria: 1, 7; 2, 5; 3, 13 c. and f.

Spinnerets: too inverted to measure. Spermathecae: two broad lobes narrowing and apically divided into two broad mounds (Benoit 1978, fig. 1d).

Distribution.—*S. seychellanum* is known only from the Seychelles.

Material examined.—The types and the following: Seychelles: female, Mahe, La Misère, 438m, mixed wet forest (P. L. G. Benoit and J. J. Van Mol, Mt 122.898); female, juvenile, Silhouette (Percy Sladen Trust expedition, BMNH 1910.5.1.2-3).

ACKNOWLEDGMENTS

I am grateful to Dr. V. E. Davies (QM, Queensland Museum, Brisbane) for making comments upon this manuscript. For locating and/or loaning material of *Sason*, *Cosmopelma*, and *Paracenobiopelma*, I am grateful to Drs. M. Grasshoff (SMF, Senckenberg Forschungsinstitut, Frankfurt-am-Main), S. Mahunka (Natural History Museum of Hungary, Budapest), W. Mathis, and J. Coddington (USNM, U. S. National Museum, Washington, D. C.), G. Rack (ZMH, Zoologisches Museum, Hamburg), W. Pulawski (CAS, California Academy of Sciences, San Francisco), R. Jocqué (MT, Musée Royal de L'Afrique Centrale, Tervuren), J. Tenorio (Bernice P. Bishop Museum, Honolulu), I. Lansbury (HMO, Hope Entomological Collections, Oxford), Ms. A. M. da Costa (MNRJ, Museu Nacional, Rio de Janeiro), and also for gracious aid provided during periods at their respective institutions, I am grateful to Mr. P. D. Hillyard (BMNH, British Museum of Natural History, London) and Dr. M. Hubert (MNHN, Muséum National d'Histoire Naturelle de Paris). Research involving

this manuscript was carried out while I was in receipt of a C.S.I.R.O. Post-doctoral Fellowship with the superb facilities of the Department of Entomology, American Museum of Natural History, New York, and was completed at the Division of Entomology, Canberra, C.S.I.R.O. Australia. For all of that I am very grateful.

LITERATURE CITED

- Benoit, P. L. G. 1964. Etudes sur les Barychelidae du centre africain (Araneae—Orthognatha). I. La séparation des sous-families. *Rev. Zool. Bot. Afrique*, 70:412-416.
- Benoit, P. L. G. 1966. Les Barychelidae-Barychelinae africains et malgaches (Aran., Orthogn.). *Rev. Zool. Bot. Afrique*, 74:209-241.
- Benoit, P. L. G. 1978. Contributions à l'étude de la faune terrestre des îles granitiques de l'archipel des Séchelles (Mission P. L. G. Benoit—J. J. Van Mol 1972) (Araneae, Orthognatha). *Rev. Zool. Africain*, 92:405-420.
- Bristowe, W. S. 1938. The classification of spiders. *Proc. Zool. Soc. London*, ser. B, 108:285-321.
- Blandin, P. and M. L. Célérier. 1977. Observations sur les mygales terricoles récoltées à la Station d'Ecologie Tropicale de Lamto (Côte d'Ivoire). *Rev. Arachnol.*, 1(2):75-83.
- Bonnet, P. 1954. Difficultés de nomenclature chez les Arañeides. VIII. Le nom de genre *Sason*. *Bull. Soc. Hist. Nat. Toulouse*, 88:295-6.
- Cambridge, O. P.- 1883. On some new genera and species of spiders. *Proc. Zool. Soc. London*, 1883:352-365.
- Coleman, N. C. 1981. A genus of spiders new to Australia. *J. North Queensland Nat.*, 45(178):14.
- Coyle, F. A. 1983. Aerial dispersal by mygalomorph spiderlings (Araneae, Mygalomorphae). *J. Arachnol.*, 11:283-286.
- Coyle, F. A. 1985. Ballooning behavior of *Ummidia* spiderlings (Araneae, Ctenizidae). *Ibid.*, 13:137-138.
- Feio, J. L. de A. 1952. Uma curiosa migalomorfa aboricola—"Paracnobiopelma gericormophila" g. n., sp. n. (Araneae, Barychelidae). *Bol. Mus. Nac. (n.s.) Rio de Janeiro*, 113:1-19.
- Fischel, W. 1927. Über Südamerikanische Aviculariiden. *Zool. Anz.*, 74:59-74.
- Hirst, A. S. 1911. No. XVIII. The Araneae, Opiliones and Pseudoscorpiones. *In*, "Percy Sladen Trust Expedition to the Indian Ocean in 1905 under the leadership of Mr. J. Stanley Gardiner." *Trans. Linnean Soc. London, Zool.*, ser. 2, 14:379-395.
- Karsch, F. 1891. Arachniden von Ceylon und von Minikoy gesammelt von den Herren Doctoren P. und F. Sarasin. *Berlin Entomol. Zeits.*, 36:267-310.
- Kikkawa, J., Monteith, G. B., and G. Ingram. 1981. Cape York Peninsula: major region of faunal interchange. Pp. 1695-1743, *In* Keast A. (ed.), *Ecological Biogeography of Australia*. Dr. W. Junk, The Hague.
- Kishida, K. 1930. [Cited in Bristowe, 1938]. *Lanzania*, Tokyo, ii, 1930.
- Kulczyński, W. 1908. Araneae musei nationalis Hungarici in regionibus Indica et Australica a Ludovico Biró collectae. *Ann. Hist. Nat. Mus. Natl. Hungary*, 6:428-494.
- Legendre, R. 1979. Les Arañeées et la dérive des continents. *Ann. Biol.*, 18:37-68.
- Main, B. Y. 1981a. Eco-evolutionary radiation of mygalomorph spiders in Australia. Pp. 853-872, *In* Keast A. (ed.), *Ecological Biogeography of Australia*. Dr. W. Junk, The Hague.
- Main, B. Y. 1981b. Some zoogeographic considerations of families of spiders occurring in New Guinea. Pp. 583-602, *In* Gressitt, J. L. (ed.), *Biogeography and Ecology in New Guinea*. Dr. W. Junk, The Hague.
- Petrunkevitch, A. 1928. *Systema araneorum*. *Trans. Connecticut Acad. Arts Sci.*, 29:1-270.
- Platnick, N. I. 1981. Spider biogeography: past, present and future. *Rev. Arachnol.*, 3:85-96.
- Pocock, R. I. 1892. Description of a new Trap-door spider from Ceylon. *Ann. Mag. Nat. Hist.*, ser. 6, 9:49-51.
- Pocock, R. I. 1900. The fauna of British India, including Ceylon and Burma. Arachnida. Taylor and Francis, London. 1900:i-xii, 1-279.
- Pocock, R. I. 1903. The geographical distribution of spiders of the order Mygalomorphae. *Proc. Zool. Soc. London*, 1:340-368.
- Pocock, R. I. 1904. Arachnida, Pp. 797-805, *In* J. Gardiner (ed.), *The fauna and geography of the Maldive and Laccadive Archipelagoes*, vol. 2, part 3. [Cambridge] University Press, Cambridge.

- Raven, R. J. 1980. The evolution and biogeography of the mygalomorph spider family Hexathelidae (Araneae, Chelicerata). *J. Arachnol.*, 8:251-266.
- Raven, R. J. 1984. A new diplurid genus from eastern Australia and a related *Aname* species (Diplurinae: Dipluridae: Araneae). *Australian J. Zool.*, Suppl. ser. no. 96:1-51.
- Raven, R. J. 1985. The spider Infraorder Mygalomorphae (Araneae): cladistics and systematics. *Bull. Amer. Mus. Nat. Hist.*, 182:1-180.
- Roewer, C. F. 1942. Katalog der Araneae. Band 1. Friedländer and Sohn, Bremen, pp. 1-1040.
- Roewer, C. F. 1963. Araneida: Orthognatha, Labiodognatha. *Insects Micronesia*, 3(4):1-132.
- Simon, E. 1887. [Observations sur divers arachnides: synonymies et descriptions.] *Ann. Soc. Ent. France*, 6:195.
- Simon, E. 1888. Etudes sur les Arachnides de l'Asie méridionale faisant partie des collections de l'Indian Museum (Calcutta). II. Arachnides recueillis aux îles Andaman par M. R. D. Oldham. *J. Asiatic Soc. Bengal*, 57:282-287.
- Simon, E. 1892. Histoire Naturelle des Araignées. Roret, Paris, vol. 1, pt. 1:1-256.
- Simon, E. 1898. Etudes arachnologiques. 29^e memoire. XLVI. Arachnides recueillis en 1895 par M. le Dr A. Brauer (de l'Université de Marburg) aux îles Séchelles. *Ann. Soc. Ent. France*, 66:370-388.
- Simon, E. 1903. Histoire Naturelle des Araignées. Roret, Paris, vol. 2, pt. 4:669-1080.
- Williams, W. D. 1981. The Crustacea of Australian inland waters. Pp. 1101-1138, *In* Keast A. (ed.), *Ecological Biogeography of Australia*. Dr. W. Junk, The Hague.

Manuscript received July 1985, revised October 1985.

SPECTRAL SENSITIVITIES OF THE EYES OF THE ORB WEB SPIDER *ARGIOPE ARGENTATA* (FABRICIUS)

Klaus B. Tiedemann, Dora Fix Ventura and Cesar Ades

Department of Experimental Psychology
Institute of Psychology
University of São Paulo
São Paulo, Brazil

ABSTRACT

Spectral sensitivity curves to light between 425 and 650 nm for the four eyes of the spider *Argiope argentata* were determined. Maximum sensitivity was observed at 530 nm for the secondary eyes and at 525 nm for the principal ones. Chromatic adaptation did not affect this maximum, which suggests that there is only one receptor and photopigment in this spectral region.

INTRODUCTION

Recordings from the anterior median eyes of jumping spiders demonstrated the existence of different photoreceptor types, thus confirming earlier behavioral data suggestive of color vision in these animals (Peckham and Peckham 1887, Crane 1949, Kästner 1950, Young and Wanless 1967). According to DeVoe's (1975) intracellular recordings, color vision in the principal eyes of the jumping spider *Phidippus regius* (C. L. Koch) is mediated by three photoreceptor types: UV cells with peak sensitivity at 370 nm; green cells with peak at 532 nm, and UV-green cells, peaking at 370 and 532 nm. In the secondary eyes of this spider DeVoe found only green cells. In the jumping spider *Menemerus confusus* (Bösenberg and Strand), Yamashita and Tateda (1976) found, in addition to UV and green receptors, a blue receptor at 490 nm and a long-wave-length receptor at 580 nm. Their data were based both on intracellular recordings and on chromatic adaptation effects on the electroretinogram (ERG).

Other families of spiders did not exhibit the same color vision abilities as found in jumping spiders. Young and Wanless (1967) conducted a T-maze preference study in seven spider families, and found that only Salticidae exhibited behaviors suggestive of color vision. In ERGs from Lycosidae, DeVoe, Small and Zvargulis (1969) found only one photopigment (green) in the secondary eyes. The principal eyes contained variable amounts of this pigment in addition to an UV absorbing one.

Color vision was only recently studied in spiders of the Araneidae family. The anterior median eyes of *Argiope brueningi* (Scopoli) and *Argiope amoena* (L. Koch) were found to have three photoreceptors, with maxima at about 360 nm, 480-500 nm and 540 nm (Yamashita and Tateda 1978, 1981). No recordings were reported for the secondary eyes.

The present study, which was started before the publication of Yamashita and Tateda's reports (Tiedemann 1975), brings information about the color vision system of *Argiope argentata* (Fabricius), an orb web spider whose behavior has been extensively studied (Robinson 1969, Robinson and Olazarri 1971, Ades 1973). *Argiope argentata* lives in sunny areas and is diurnal, but it is capable of hunting and of building its web in the dark. Its characteristic thermoregulatory posture (Robinson and Robinson 1978) was shown to be controlled by light rather than by heat (Ades and Kanner 1978). Its choice of the side of the web on which to stand is also light dependent (Ades and Kanner 1979). It can rely on visual stimuli when placing the first threads of the web, as do other orbweavers (Tilquin 1942). There is no doubt that visual cues are of great relevance to several aspects of behavior of this species. There is not, however, any information regarding its color vision abilities. In this report we describe the ERG measured spectral sensitivities of the dark-adapted eyes of *Argiope argentata*, and the results obtained under chromatic adaptation, showing that it has only one receptor type in the spectral range from 425 to 625 nm.

METHOD

Preparation.—The animal was lightly anesthetized with CO₂ and fixed to a black cardboard with adhesive tape over the legs. The cephalothorax was immobilized with acrylic (Simplex dental acrylic). The recording electrode was a cotton wick held in a glass tube pulled out at one end to a capillary tip and filled with insect physiological solution. Contact with the recording system was done through a nonpolarizable Ag-AgCl wire. The indifferent electrode was a Microtode 415 (Transidyne General Corporation) inserted in a leg of the first or second pair just below the surface. Such a preparation could last for at least 12 hours and longer than a week, if the spider received water by means of a capillary tube. The temperature was maintained at 22 to 24°C during the recordings. ERGs were measured with a Tektronix 122 AC amplifier with a 1 s time constant and 50 Hz filter, and a Tektronix 5103/D13 dual beam storage oscilloscope and photographed with a Grass C-4 camera.

The preparation was placed in a light tight box inside a recording chamber. The optical equipment consisted of a double Maxwellian view system with a tungsten halide quartz lamp (Osram 58.8105 100W) as the light source, which permitted focussing through a light pipe (Fiber Lite) of a 3 mm diameter light spot on the eyes. Intensity was controlled by means of glass-mounted Kodak Wratten 96 neutral density filters and duration of the stimulus flash through a photographic shutter (Wollensack). Monochromatic light was filtered out through an interference color wedge (Veril S-200-Leitz), corrected with neutral density filters Kodak-Wratten 96 for equal light energy for wavelengths between 425 nm and 675 nm in steps of 25 nm. The light passed through a 3 mm slit yielding a halfband width of ca. 8.75 nm. A second light source, for the adapting light was a Fiber Lite Illuminator Mod. 172 with a simple Maxwellian system, perpendicular to the first. In the experiments with ultraviolet light, an incandescent UV-lamp, which emitted light between 320 nm and 440 nm with a maximum output at 380 nm (GE Purple X - 250W) was used in connection with an UV filter with a maximum transmittance at 380 nm and an edge at 400 nm (Kodak 18 A), directly on the preparation.

The stimulating light produced at the end of the light pipe a light intensity of $(4.24) \cdot 10^{-6}$ W at 500 nm, so that a 20 ms flash corresponded to about $(2.76) \cdot 10^{11}$ photons. The adapting light yielded, with a red filter with transmittance from 570 nm to infrared (Kodak 23 A), an intensity of $(3.60) \cdot 10^{-5}$ W and with a narrow band blue filter with maximum output at 430 nm (Kodak 48 B), $(1.60) \cdot 10^{-5}$ W. Calibrations of ND filters at each of the wavelengths used were made with a Tektronix radiometer J 16 with J 6502 probe and a Zeiss DMR-21 spectrophotometer.

Procedure.—All recordings were done during the day, between 8 a.m. and 5 p.m. The preparation was dark adapted for at least 30 minutes prior to each experimental session.

For each eye (anterior median, posterior median, anterior lateral and posterior lateral eye) the energy-response functions were determined under conditions of dark adaptation and red-, blue- and white-light adaptations for each of the calibrated monochromatic lights between 425 and 675 nm. Data collected under light-adapted conditions were preceded by 10 min of exposure to the adapting light before measurements were begun. Energy-response functions were obtained at each of these adapting conditions by measurements of ERG amplitude for stimuli of the following mean attenuations: 0; 0.21; 0.53; 0.95; 1.26; 1.60; and 2.13 log. At each attenuation value the spectrum was scanned twice, at 25 nm steps, in opposite directions, with 20 ms long flashes presented at 30 s intervals.

A standard of 550 nm was used throughout the experiment for frequent checks of the stability of the preparation. All data reported are from preparations which remained quite stable, within 2% variation.

RESULTS AND DISCUSSION

Waveform of the ERGs.—The waveform of the ERGs recorded in *A. argentata* is similar for all four eyes and does not differ as a function of wavelength of the test flash, as can be observed in Figure 1. Changes in waveform were only noticed in connection with variation in light intensity. Recordings shown in Figure 2 exemplify such waveform changes. At high intensities the waveform was typically a single rapid negative wave followed by a slow uniform decay. The small positive wave is an artifact of capacity coupling of the AC recording amplifier. At low intensities the ERG consisted of a double negative wave in all eyes except the principal. In the latter, peak latency was intermediate between the two negative waves found for the other eyes.

The shape of the ERG was also examined under chromatic light adaptation, because it has been reported to change in species that have different photoreceptor types, such as the jumping spider, *M. confusus* (Yamashita and Tateda 1976). In the eyes of *Argiope argentata* no change in waveform was observed as a function of wavelength of chromatic adaptation. This was a first indication of the absence of additional photopigments in the tested part of the spectrum (400-600 nm) in the species.

Spectral Sensitivity.—To determine the spectral sensitivity curves of the four eyes, the ERG amplitudes in response to monochromatic lights presented to the dark-adapted eye at 25 nm steps were measured as a function of light intensity over a 2.0 log unit range. The energy-response functions thereby obtained are plotted in Figure 3. The functions are closely parallel for each of the eyes, but

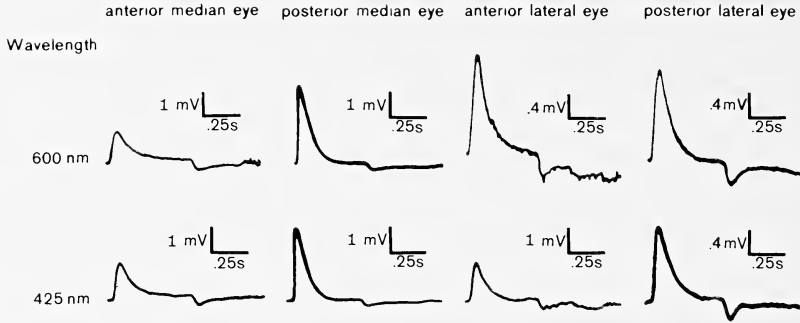

Fig. 1.—ERGs in response to stimuli of 425 nm and 600 nm obtained in the four eyes. Test flash duration was about 1s.

differ in slope from one eye to the other. The posterior median eyes exhibit the shallowest curves, whereas the posterior lateral eyes the steepest ones. The differences could be attributed either to different densities of photoreceptors, or, as suggested by Dahl (pers. comm.), who found similar differences in the eyes of *Aphonopelma*, to the presence of the tapetum in the eyes that exhibited the lesser slope.

To draw the spectral sensitivity curves, the amplitude data collected above were transformed according to the procedure described by Autrum and von Zwehl (1964). This consisted of plotting the mean energy function for each eye and finding the intensity that would have been necessary to elicit a given ERG amplitude. The relative sensitivity is the reciprocal of that intensity.

The entire procedure was repeated under chromatic adaptation to blue and red lights with the purpose of determining whether any of the eyes contained more than one type of visual cell or pigment in the visible part of the spectrum. If this were so, the spectral sensitivity curve obtained under selective chromatic adaptation would be displaced relative to that obtained in the dark adapted state (Wald 1968, Yamashita and Tateda 1976).

Figure 4 shows the spectral sensitivity curves for the four eyes, under dark adaptation and the three light adapting conditions. As can be seen, chromatic adaptation did not change the shape of the spectral sensitivity curves for any of the four eyes. The smooth lines are Dartnall nomogram curves (Dartnall 1953). For the lateral and posterior eyes, the best fitting was a 530 nm nomogram curve, whereas for the anterior median eye a 525 nm nomogram curve yielded the best fit. This discrepancy may be due not to a different photopigment but to differences in the optic media between principal and secondary eyes (Young and Wanless 1967). In the short-wave range of the spectrum the fit of the Dartnall

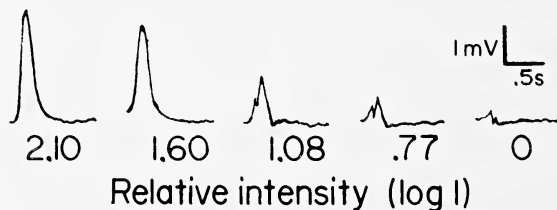

Fig. 2.—ERGs from light adapted posterior lateral eye for 550 nm, light stimuli of five different intensities. Test flash duration was 20 ms.

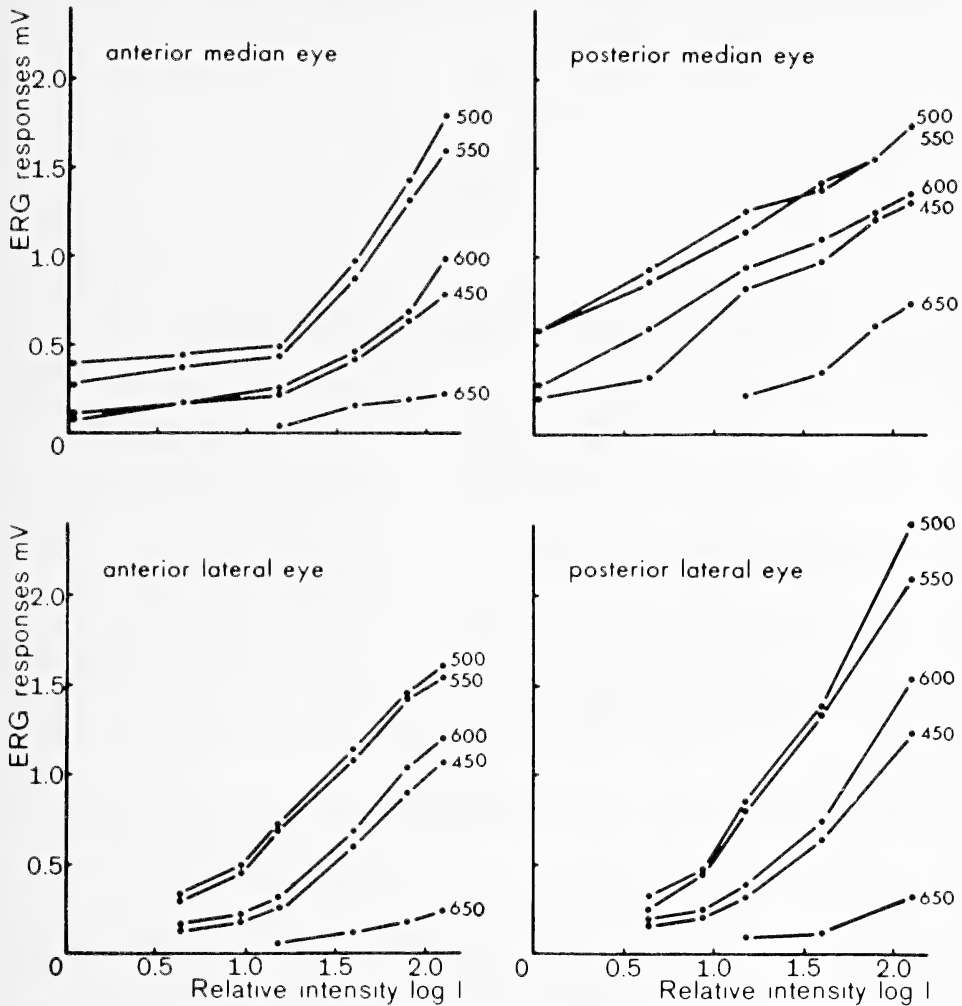

Fig. 3.—Energy-response functions for dark adapted eyes obtained for five different wavelengths (data from one preparation).

nomogram curves was not so good. The sensitivity was less than predicted by the nomogram for all four eyes. The same type of result was found by DeVoe, Small and Zvargulis (1969). This is not, however, the common finding in other arthropods, the rule being that sensitivity in the near UV is higher than predicted by the nomogram curves, as found in the bee (Autrum and von Zwehl 1964), dragonfly (Autrum and Kolb 1968), *Calliphora* and *Periplaneta* (Walther and Dodt 1959), *Musca domestica* (Eckert 1971), *Atta sexdens* (Martinoya, Bloch, Ventura, and Puglia 1975) and several species of crustacea (Scott and Mote 1974). UV sensitivity is nevertheless present in *A. argentata*, as revealed by tests made with UV stimulation (GE Purple X lamp plus Kodak 18 A filter). These tests showed that responses in the UV are present in all four eyes, but are higher in the anterior median eyes than in the other ones. This is in agreement with DeVoe's observations (DeVoe, Small and Zvargulis 1969, DeVoe 1972, 1975), who also found higher sensitivity in the anterior median eyes.

The reason why we did not find evidence for more than one visual pigment in the anterior median eyes of *Argiope argentata*, as found for the Japanese

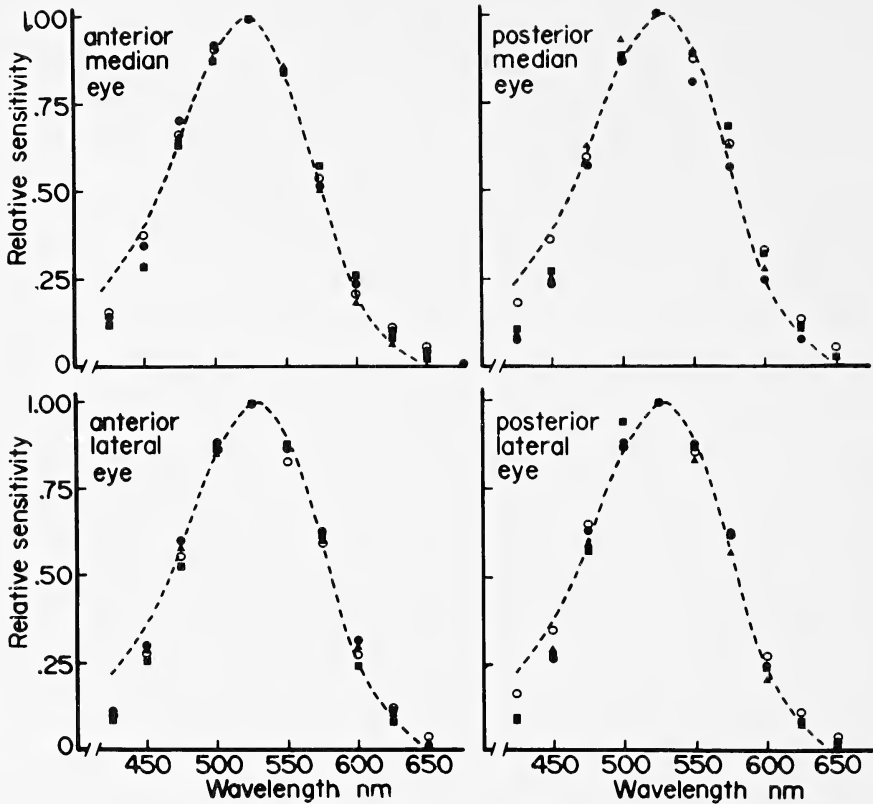

Fig. 4.—Spectral sensitivities of dark (open circle), white (solid circle), blue (square) and red (triangle) adapted eyes (sensitivity expressed as I/I_λ , where I is the intensity needed for a standard response at peak wavelength, and I_λ the intensity needed for the same response at wavelength λ). The line drawn in each graph is a Dartnall nomogram for a photopigment with λ_{\max} at 530 nm in secondary eyes, and 525 nm for the principal eyes.

species, is not clear. This failure to isolate a blue receptor (their “green” cell with peak at 540 nm closely overlaps our data, which peaks at 530 nm) could be attributed either to species differences, or to a lower sensitivity of our technique. It could have also been due to the time of day in which the data were collected. The blue cells found by Yamashita and Tateda were recorded at night. Our data were always collected during the day. Alternatively, Yamashita and Tateda’s claim for the existence of a “blue” receptor cannot be regarded as unquestionable. There are two reasons for this. First, the fact that their claim is based on recordings from only two cells. Second, the fact that the peak of the “blue” cell (480-500 nm) falls very close to that of the “green” one. In fact, out of the 24 cells studied by them, only nine had a single peak (three were “UV” cells, two were “blue” cells, and four, “green” ones). It is possible that the spectral sensitivities obtained for the cells classified as “blue” represent the result of electrical coupling between “UV” and “green” ones. A recent article by Horridge, Marcelja, Jahnke and Matic (1983) shows interactions caused by coupling which produced nine different types of spectral sensitivity curves in the butterfly retina. Because coupling appears “to be the rule rather than the exception in visual systems” (Shaw 1981), the identification of spectral sensitivity curves with single pigments or single photoreceptors cannot be made without the meeting of a

number of criteria, as was done by Horridge et al. (1983) for their primary cell types.

Alternatively, more recent work from our group (Souza, Menzel, and Ventura 1985) shows that the flash method of spectral sensitivity measurement yields unreliable data, due to both the lengthy recording sessions, with unavoidable baseline fluctuations, and to the changes in the state of adaptation of the cell with the use of different spectral filters. A much more reliable method called "voltage clamp" by Franceschini (1984) or "constant response" (Hertel and Ventura, in press) avoids both problems and produces reproducible pigment — like spectral sensitivity curves.

REFERENCES

- Ades, C. 1973. A teia e a caça da aranha *Argiope argentata*, Doctoral Thesis, University of São Paulo.
- Ades, C. and E. Kanner. 1978. Orientação postural na aranha *Argiope argentata*. Paper presented at the 30th Annual meeting of the Brazilian Society for the Advancement of Science, São Paulo, Brazil, 1978. *Ciência e Cultura*, 30:654 (Abstract).
- Ades, C. and E. Kanner. 1979. Luz e travessia da teia pela aranha *Argiope argentata*. Paper presented at the 31st Annual meeting of the Brazilian Society for the Advancement of Science, Fortaleza, Brazil, 1979. *Ciência e Cultura*, 31:754 (Abstract).
- Autrum, H. and V. von Zwehl. 1964. Die spektrale Empfindlichkeit einzelner Sehzellen der Bienenauges. *Z. vergleichende Physiol.*, 48:357-384.
- Autrum, H. and G. Kolb. 1968. Spektrale Empfindlichkeit einzelner Sehzellen der Aeschniden. *Z. vergleichende Physiol.*, 60:450-477.
- Crane, J. 1949. Comparative biology of salticid spiders of Rancho Grande, Venezuela. Part IV. An analysis of display. *Zoologica*, 34:159.
- Dartnall, H. J. A. 1953. The interpretation of spectral sensitivity curves. *British Med. Bull.*, 9:24-30.
- DeVoe, R. D., R. J. W. Small and J. E. Zvargulis. 1969. Spectral sensitivities of wolf spider eyes. *J. Gen. Physiol.*, 54:1-32.
- DeVoe, R. D. 1972. Dual sensitivities of cells in wolf spider eyes at ultraviolet and visible wavelengths of light. *J. Gen. Physiol.*, 59:247-260.
- DeVoe, R. D. 1975. Ultraviolet and green receptors in principal eyes of jumping spiders. *J. Gen. Physiol.*, 66:193-207.
- Eckert, H. 1971. Die spektrale Empfindlichkeit der Komplexaugen von *Musca* (Bestimmungen aus Messungen der optomotorischen Reaktion). *Kybernetik*, 9:145-156.
- Franceschini, N. 1984. Chromatic organization and sexual dimorphism of the fly retinal mosaic. *In* Photoreceptors (A. Borsellino and L. Cervetto, eds.), Plenum, New York.
- Hertel, H. and D. F. Ventura. (in press). Spectral sensitivity of photoreceptors in the compound eye of stingless tropical bees. *J. Insect Physiol.*
- Horridge, G. A., L. Marcelja, R. Jahnke and T. Matic. 1983. Single electrode studies on the retina of the butterfly *Papilio*. *J. Comp. Physiol.*, 150:271-294.
- Kästner, A., 1950. Reaktion der Hufspinnen (Salticidae) auf unbewegte farblose und farbige Gesichtsstreife. *Zool. Beitr.*, 1:13-50.
- Martinoya, C., S. Bloch, D. F. Ventura and N. M. Puglia. 1975. Spectral efficiency as measured by ERG in the ant (*Atta sexdens rubropilosa*). *J. Comp. Physiol.*, 104:205-210.
- Peckham, G. W. and E. G. Peckham. 1887. Some observations on the mental powers of spiders. *J. Morphol.*, 1:383.
- Robinson, M. H. 1969. Predatory behavior of *Argiope argentata* (Fabricius). *Amer. Zool.*, 9:161-173.
- Robinson, M. H. and J. Olazarri. 1971. Units of behavior and complex sequences in the predatory behavior of *Argiope argentata* (Fabricius). *Smithsonian Contrib. Zoology*, 65:1-36.
- Robinson, M. H. and B. C. Robinson. 1978. Thermoregulation in orb-web spiders: new descriptions of thermoregulatory postures and experiments on the effects of posture and coloration. *Zool. J. Linnean Soc.*, 64:87-102.
- Scott, S. and M. I. Mote. 1974. Spectral sensitivity in some marine crustacea. *Vision Research*, 14:659-663.

- Shaw, S. R. 1981. Anatomy and physiology of identified non-spiking cells in the photoreceptor-lamina complex of the compound eye of insects, especially Diptera. *In* Neurons without impulses (A. Roberts and B. M. H. Bush, eds.), Cambridge University Press, Cambridge.
- Souza, J. M. de, R. Menzel and D. F. Ventura. 1985. Improved spectral sensitivity measurements in bee photoreceptors. *Brazilian J. Med. Biol. Res.*, 18:5-6.
- Tiedemann, K. B. 1975. Sensibilidade espectral em *Argiope argentata*, Master dissertation, Univ. São Paulo.
- Tilquin, A. 1942. La toile géométrique des araignées. Presses Universitaires de France, Paris.
- Wald, G. 1968. Single and multiple visual systems in arthropods. *J. Gen. Physiol.*, 51:125-155.
- Walther, J. B. and E. Dodt. 1959. Die Spektralsensitivität von Insektenkomplexaugen im Ultraviolett bis 290nm. *Z. Naturforsch.*, 14b:273-278.
- Yamashita, S. and H. Tateda. 1976. Spectral sensitivities of jumping spider eyes. *J. Comp. Physiol.*, 105:29-41.
- Yamashita, S. and H. Tateda. 1978. Spectral sensitivities of the anterior median eyes of the web spiders *Argiope brueningi* and *A. amoena*. *J. Exper. Biol.*, 74:47-57.
- Yamashita, S. and H. Tateda. 1981. Efferent neural control in the eyes of orb weaving spiders. *J. Comp. Physiol.*, 143:477-483.
- Young, M. R. and F. Wanless. 1967. Observations on the fluorescence and function of spider's eyes. *J. Zool.*, 151:1-16.

Manuscript received January 1984, revised October 1985.

Herrero, M. V. and C. E. Valerio. 1986. Analisis de la actividad diaria de *Aphonopelma seemanni* (Araneae, Theraphosidae) en Costa Rica. J. Arachnol., 14:79-82.

**ANALISIS DE LA ACTIVIDAD DIARIA DE
APHONOPELMA SEEMANNI
(ARANEAE, THERAPHOSIDAE) EN COSTA RICA¹**

Marco V. Herrero

Centro Universitario del Atlántico, Universidad de Costa Rica
Facultad de Ciencias Exactas y Naturales, Universidad Nacional²

and

Carlos E. Valerio

Escuela de Biología, Universidad de Costa Rica

ABSTRACT

Variation in the daily activity patterns of *Aphonopelma seemanni* females was studied during the rainy season in Guanacaste, Costa Rica. Hourly variations were significant ($p < 0.05$), with a constant pattern throughout the season. The spiders are nocturnal predators that reach the activity peak between 20.30 and 0.30 hours.

RESUMEN

La variación en el patrón de actividad diaria de las hembras de *Aphonopelma seemanni* fue estudiada durante la época lluviosa en Guanacaste, Costa Rica, encontrándose que los cambios durante el día fueron significativos ($p < 0.05$) con un patrón constante durante toda la estación. Las arañas son eminentemente nocturnas y alcanzan su actividad máxima durante las 20:30 y las 0.30 horas.

INTRODUCTION

La ecología de las arañas terafósidas en los trópicos ha sido poco estudiada, siendo las especies costarricenses las mejor conocidas (Valerio 1979, 1980a, 1980b, 1982). En el caso de *Aphonopelma seemanni* (F. P. Cambridge) existe información sobre estructura de túneles (Herrero y Bolaños 1982) y sobre hábitos de vida, informándose que las hembras son básicamente nocturnas (Herrero et al. 1983). Se destaca también la información de Minch (1978) sobre la actividad diaria de *Aphonopelma chalcodes* del sur de Estados Unidos. En el presente

¹Este trabajo fue financiado por la Vicerrectoría de Investigación de la Universidad de Costa Rica.

²Dirección actual; Department of Entomology, Oklahoma State University, Stillwater, Oklahoma 74078.

Cuadro 1.—Prueba de la menor diferencia significativa, usada para comparar promedios de actividad horaria (diurna y nocturna) en *Aphonopelma seemanni*. Promedio subrayado con la misma línea no son significativamente diferentes ($P > 0.05$).

Actividad						
<i>A. Diurna:</i>						
Horas (rango)	16.30	6.30	8.30	14.30	10.30	12.30
Promedios	0.38	0.36	0.32	0.32	0.19	0.16
<i>B. Nocturna:</i>						
Horas (rango)	22.30	20.30	0.30	4.30	2.30	18.30
Promedios	0.97	0.96	0.93	0.88	0.86	0.76

trabajo se hace un análisis de la actividad diaria (diurna y nocturna) de esta especie durante la época lluviosa.

MATERIALES Y METODOS

El estudio se realizó en Pozo Azul de Abangares, Provincia de Guanacaste, Costa Rica, en una colina rocosa de 7400 m² de área, poblada por gramíneas y árboles aislados. La zona corresponde a una formación tropical húmeda (Tosi 1969), con una precipitación mensual típica de 235 mm (máxima de 417 en setiembre y mínima de 13 en diciembre) y una temperatura ambiente (promedio mensual) entre 24° y 27°C durante la época lluviosa. Se efectuaron cuatro visitas (junio, agosto, octubre y diciembre de 1981) y en cada visita fueron observados 42 túneles (cuya localización había sido previamente marcada con estacas de madera) cada dos horas durante un periodo de 24 horas.

Una araña se consideró activa cuando se encontró en el borde del orificio de entrada al túnel.

RESULTADOS

El análisis de varianza indica que las diferencias entre los datos de las cuatro visitas no son significativas ($F = 0.65$; $p > 0.5906$); siendo la diferencia horaria altamente significativa ($F = 26.94$; $p > 0.0001$). Para comparar los promedios una prueba de la "menor diferencia significativa" fue llevada a cabo (Cuadro 1).

En el cuadro 2 se presentan los resultados de la actividad diurna en términos de proporción de arañas activas por hora de observación notándose muy poca actividad ya que esta especie es predominantemente nocturna (Herrero et al. 1983). La actividad decreció a partir de las 6.30 cesando casi totalmente al medio día, para aumentar durante las horas de la tarde (Fig. 1).

Como aspecto de interés biológico se observó que algunos túneles estaban cubiertos de seda entre las 6.30 y las 8.30. Entre las 16.30 y las 18.30 se observaron en el área de estudio avispas pompilidas (posiblemente *Pepsis*) que son depredadoras de estas arañas.

La mayor actividad se observó durante la noche, iniciándose a las 18.30 y alcanzando su máximo a las 22.30 (Cuadro 2) para decrecer gradualmente en la madrugada (Fig. 1).

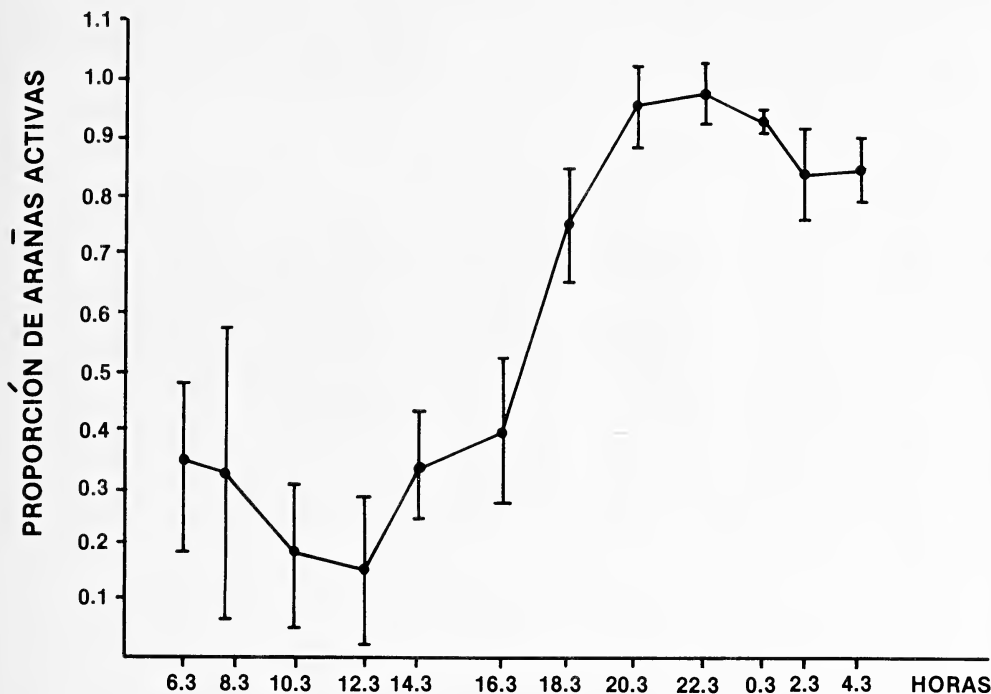

Fig. 1.—Actividad diaria de hembras de *Aphonopelma seemanni* (se indica la desviación estándar para cada hora).

Una curva de regresión negativa significativamente diferente de cero ($1.10 - 0.01(X)$, $r^2 = 0.78$, $p > 0.048$), elaborada con las observaciones entre las 20.30 y las 4.30 enfatizó el hecho de que la actividad decreció en horas de la madrugada.

CONCLUSIONES Y DISCUSION

Esta especie presenta un ciclo dial de actividad con un mínimo a medio día y un máximo cerca de la media noche, que parece mantenerse sin variación a través de toda la época lluviosa.

Algunas especies de arañas "pica-caballo" (como se conoce en Costa Rica a las terafósidas) son depredadores encontrados con frecuencia en terrenos de vegetación herbácea, como los pastisales cultivados para la cría de ganado. Su impacto sobre las poblaciones de insectos herbívoros no ha sido evaluada y un análisis sobre la actividad de las arañas puede aportar valiosa información para iniciar tales estudios. En particular *Aphonopelma seemanni* cuya distribución en Costa Rica corresponde al Pacífico Seco (Valerio 1980b), es comúnmente encontrada en la sabana guanacasteca, sitio importante en la producción de ganado de carne. Por años ha sido creencia popular que esta araña puede causar lesiones locales en el ganado conocidas como "orinadas de araña", en cuyo caso la asociación de estas arañas con el ganado sería inconveniente. Pero Herrero (1980) demostró que el único efecto asociado con sus secreciones externas es una leve destrucción del músculo esquelético en ratones blancos.

En lo referente a la actividad de los machos de esta especie, que es más difícil de estudiar por cuanto estos no viven en túneles fácilmente localizables, Valerio

Cuadro 2.—Actividad diaria de *Aphonopelma seemanni* durante la época lluviosa en Costa Rica. Resultados expresados en proporción de individuos activos.

HORAS DE OBSERVACION.	JUNIO	AGOSTO	OCTUBRE	DICIEMBRE	PROMEDIO
6:30	0.52	0.62	0.16	0.32	0.36
8:30	0.00	0.62	0.25	0.39	0.32
10:30	0.00	0.29	0.16	0.32	0.19
12:30	0.58	0.29	0.09	0.25	0.16
14:30	0.45	0.29	0.22	0.32	0.32
16:30	0.58	0.29	0.22	0.32	0.38
18:30	0.71	0.76	0.69	0.89	0.76
20:30	1.00	0.86	1.00	1.00	0.96
22:30	1.00	1.00	1.00	0.89	0.97
0:30	0.90	0.95	0.94	0.82	0.93
2:30	0.90	0.76	0.94	0.82	0.86
4:40	0.84	0.81	0.94	0.93	0.88

(1980) informó sobre actividad reproductiva en la época lluviosa durante julio y agosto. Aunque han sido también colectados deambulando durante la época seca (Herrero y Bolaños 1982).

AGRADECIMIENTOS

Agradecemos a los estudiantes Alvaro Morales y Ramón Vargas su asistencia en el trabajo de campo y al Dr. Róger Bolaños sus valiosas sugerencias. También agradecemos al Dr. David Weeks, Departamento de Estadística, Oklahoma State University, su asesoramiento durante el análisis de este trabajo.

Ejemplares de referencias depositadas en el Museo de Zoología, Universidad de Costa Rica (MZUCR).

LITERATURA CITADA

- Herrero, M. V. 1980. Características generales y efectos locales de las secreciones externas de dos especies de araña pica-caballo, *Aphonopelma seemanni* y *Sphaerobothria hoffmanni* (Araneae: Theraphosidae) Tesis M. Sc., Universidad de Costa Rica.
- Herrero, M. V. y R. Bolaños. 1982. Hábitos de vida y túneles de dos arañas pica-caballo de Costa Rica (Araneae: Theraphosidae). Observaciones preliminares. Brenesia, 19/20:19-22.
- Herrero, M. V. A. Morales Y R. Vargas. 1983. Patrones de actividad diaria de las hembras de *Aphonopelma seemanni* (Araneae: Theraphosidae) durante la época lluviosa en Guanacaste, Costa Rica. Rev. Biol. Trop., 31(1):161-162.
- Minch, E. W. 1978. Daily activity patterns in the tarantula *Aphonopelma chalcodes* Chamberlin. Novit. Arthrop., 1:1-34.
- Tosi, J. 1969. Mapa Ecológico (Costa Rica). Centro Científico Tropical, San José, Costa Rica.
- Valerio, C. E. 1979. Arañas terafósidas de Costa Rica (Araneae: Theraphosidae). II. *Psalmopoeus reduncus*, redescipción, distribución y el problema de dispersión en terafósidas. Rev. Biol. Trop., 27:301-308.
- Valerio, C. E. 1980b. Arañas terafósidas de Costa Rica (Araneae: Theraphosidae). III. *Sphaerobothria*, *Aphonopelma*, *Pterinopelma*, *Citharacanthus* y *Stylochoplastus*. Rev. Biol. Trop., 28:271-296.
- Valerio, C. E. 1982. Arañas terafósidas de Costa Rica (Araneae: Theraphosidae). IV. Géneros *Metriopelma* y *Cyclosternum*, incluyendo especies de Panamá. Brenesia, 19/20:407-423.

REDEFINITION OF THE GENUS *OLPIOLUM* AND DESCRIPTION OF A NEW GENUS *BANKSOLPIUM* (PSEUDOSCORPIONIDA, OLPIIDAE)

William B. Muchmore

Department of Biology
University of Rochester
Rochester, New York 14627

ABSTRACT

The genus *Olpiolum* Beier is redefined on the basis of a redescription of the type species, *Olpiolum medium* Beier. *O. elegans* (Balzan) is retained in the genus, but all other species previously assigned there are removed. *Olpiolum modestum* Banks, redescribed, serves as the type species of the new genus *Banksolpium*, and a new species, *B. magnum*, is added to the genus.

INTRODUCTION

In 1931 the genus *Olpiolum* was established by Beier, with the new species *Olpiolum medium* as the type species. Since then, a dozen other species have been placed in the genus. However, many of these have differed in significant ways from the original diagnosis and the genus has been (both implicitly and explicitly) emended several times (Beier 1954, 1959, Hoff 1964). As a result of these and other considerations, the distinction between *Olpiolum* and *Pachyolpium* Beier (1931) has been difficult to maintain (Hoff 1964, Mahnert and Schuster 1981, Heurtault and Rebière 1983).

In an attempt to fix the definitions of and distinguish clearly between the genera *Olpiolum* and *Pachyolpium*, I have examined and redescribed the types of the type species of the two. The present paper deals with *Olpiolum*; *Pachyolpium* will be treated in another place.

Species which have been assigned to *Olpiolum* are as follows:

- O. medium* Beier 1931; Paraguay
- O. elegans* (Balzan 1890), Beier 1932; Paraguay
- O. modestum* (Banks 1909)?, Beier 1932; Brazil
- O. peruanum* Beier 1959; Peru
- O. crassum* Beier 1959; Peru
- O. aureum* (Hoff 1945), Hoff 1964; Puerto Rico
- O. puertoricensis* (Hoff 1945), Hoff 1965; Puerto Rico
- O. confundens* (Hoff 1945), Hoff 1964; Puerto Rico
- O. monae* Hoff 1964; Mona Is., Puerto Rico
- O. amplum* Hoff 1964; Jamaica
- O. paucisetosum* Muchmore 1977; Yucatan, Mexico

O. fuscipalpus Muchmore 1977; Belize

O. machadoi Heurtault 1980; Venezuela

Of these, *O. medium* and *O. elegans* actually belong in the genus as redefined below, *O. modestum* forms the basis for the establishment of a new genus, and the others belong elsewhere.

Genus *Olpiolum* Beier

Olpiolum Beier, 1931:312, 1932:196; Hoff 1964:19.

Type species.—*Olpiolum medium* Beier, 1931.

Description.—Beier's original description of the genus is as follows (1931:312):

Cephalothorax länger als breit, glatt, mit 4 Augen. Tergite ungeteilt, mit je 4-6 kleinen Borsten. Palpen mässig kräftig. Femur dorsal nahe der Basis mit einem Tasthaar. Giftkanal der Palpenfinger kurz. Apodem des beweglichen Fingers klein. Das Tasthaar *est* etwas proximal der Mitte gelegen, *it* etwas vor *est*, *ist* proximal von *est*, jedoch nicht an der Fingerbasis. Patella des 1. Beinpaars kürzer als das Femur, gegen dieses frei beweglich. Arolien einfach.

In *Das Tierreich* (1932:196), Beier changed this slightly, to read:

Cephalothorax deutlich länger als breit, ohne Quereindrücke, mit vier grossen, nahe beisammen stehenden Augen. Tergite ungeteilt, die vorderen mit je 4, die mittleren mit je 6 Marginalborsten. Palpen mässig kräftig. Femur mit einem Tasthaar dorsal nahe der Basis. Giftkanal der Palpenfinger kurz, Apodem des beweglichen Fingers klein. Patella des 1. Beinpaars kürzer als das Femur, gegen dieses beweglich. Arolien einfach. Das Tasthaar *it* etwas vor *est*, letzteres etwas proximal der Mitte gelegen; *ist* zwischen *it* und der Fingerbasis.

These are essentially correct, but several features require better definition or amplification.

Namely, a genus with the basic characters of the family Olpiidae, subfamily Olpiinae, and tribe Olpiini (cf. Hoff 1964). The 4 eyes large, with bulging corneas, as is common in Olpiinae. Setae on tergites very small and inconspicuous, as are most other vestitural setae on animal. Palps moderately robust for an olpiin (cf. Beier 1932:Fig. 228; present paper: Figs. 2 and 3). Tactile seta on dorsum of palpal femur about $\frac{1}{4}$ length of femur from proximal end. Venom ducts in chelal fingers quite short; nodus ramosus in fixed finger distad of trichobothrium *et*, while that in movable finger less than half distance from finger tip to trichobothrium *t*. Trichobothrium *est* slightly proximad of middle of fixed finger; *it* only slight distance distad of *est*; *ist* about midway between *est* and *isb*, or a little closer to *isb*. On movable finger *sb* a little closer to *b* than to *st*. Basifemur (femur) of leg I about 1.5 times as long as telofemur (patella). Arolia of pedal tarsi simple, longer than claws. And in addition: Cheliceral flagellum of 3 setae. All surfaces of palpal segments entirely smooth. Chaetotaxy of metatarsus of leg IV, in terminology of Heurtault (1983:594), 2 dorsal, 2 ventral, 3 lateral external (including a long tactile seta proximally), 7 lateral internal (or T+2-2-7-2 in my abbreviated notation).

In brief, *Olpiolum* can be distinguished from all other genera of the Olpiini by the location of both trichobothria *est* and *it* near the middle of the fixed chelal finger, the very short venom ducts in the chelal fingers, the occurrence of only 6 setae on the middle tergites, and a single tactile seta on the palpal femur.

Remarks.—According to our present knowledge, *Olpiolum* must be considered a small genus with only two species restricted to Paraguay, though, certainly, future collections will extend its distribution. So, too, its systematic relationships

will become better understood when more is learned about the South American Olpiidae.

While I do not believe that the chaetotaxy of the metatarsus (basitarsus) of leg IV is important at the generic level (cf. Mahnert 1982:298), I have included the numbers here for comparison with Heurtault and Rebière's figures for *Olpiolum* and *Pachyolpium* (1983:594). A more fruitful discussion of this subject can occur later, in reference to *Pachyolpium*, for which very many specimens are available to demonstrate intra- and interspecific variations.

Olpiolum medium Beier

Figs. 1-5

Olpiolum medium Beier, 1931:312, Fig. 8 [erroneously labelled *Apolpium medium*]; 1932:197, Fig. 228.

Material.—Female lectotype (here designated) and 3 paralectotypes (1 male, 2 tritonymphs) from "Paraguay, unter Holz und Laub, 18.7, K. Fiebrig, Nr. 672"; all labelled syntypes, Nr. 27113, in the Museum für Naturkunde an der Universität zu Berlin. The lectotype has been cleared and mounted on a microscope slide and examined; the paralectotype male was examined in glycerine.

Description.—The description by Beier is sketchy, but generally accurate. However, I give here a complete description based mainly on the mounted lectotype female. The paralectotype male is a little larger than the lectotype. Carapace and palps light brown, other parts lighter. Carapace a little longer than broad, without transverse furrows; anterior margin slightly indented at center; with 4 large, corneate eyes; surface mostly smooth, but with few reticulations laterally and posteriorly; setae short and thin, difficult to count accurately, but apparently with 6 across anterior margin and 4 at posterior margin. Abdominal tergites and sternites undivided; tergites with 4-6 small, thin setae; setae of sternites impossible to count accurately. Cribriform plates not visible.

Chelicera 2/5 as long as carapace; hand with 5 long, acuminate setae; flagellum of 3 setae (1 long, 2 short), all finely denticulate; subapical lobe of movable finger prominent and bifurcate (Fig. 1); galea long, slender, with 3 small terminal rami (Fig. 1); lamina exterior present.

Palp rather heavy, with femur and tibia about equal in length (Fig. 2); all surfaces smooth. Femur 3.0, tibia 2.5, and chela (without pedicel) 2.9 times as long as broad; hand (without pedicel) 1.5 times as long as deep; movable finger 1.03 times as long as hand. Femur with a conspicuous tactile seta on dorsum about 1/4 length from proximal end. Trichobothria on chela as shown in Fig. 3: *est* and *it* at about same level near middle of fixed finger, *eb*, *esb*, *ib* and *isb* in a group at base of finger, *ist* midway between *est* and *isb*; on movable finger *sb* closer to *b* than to *st*. Venom apparatus well developed in both fingers, venom ducts short; nodus ramosus in fixed finger distad of trichobothrium *et*, in movable finger less than half distance from tip to *t*. Fixed finger with 30 marginal teeth, the distal ones cusped, the proximal ones low and flat; movable finger with 26 similar teeth.

Legs moderately robust. Leg I with basifemur about 1.5 times as long as telofemur (Fig. 4). Leg IV with entire femur 2.7 and tibia 3.5 times as long as

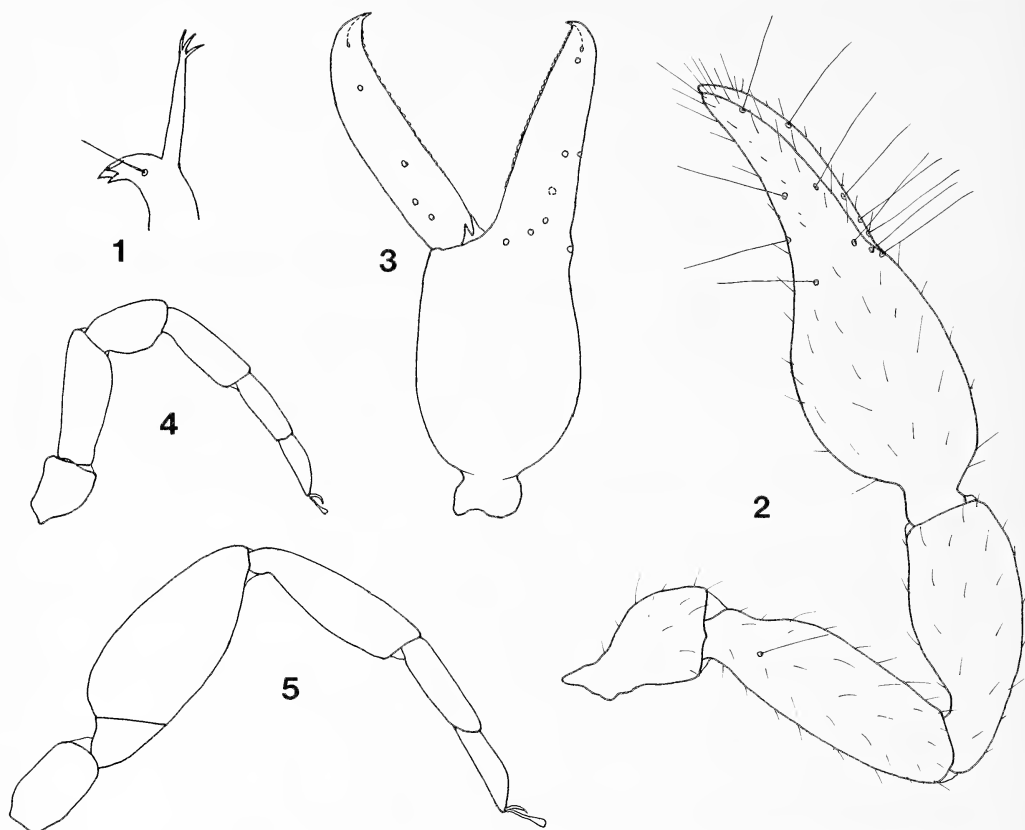

Figs. 1-5.—*Olpiolum medium* Beier, lectotype female: 1, end of movable finger of chelicera; 2, dorsal view of right palp, 3, lateral view of left chela; 4, lateral view of leg I; 5, lateral view of leg IV.

deep (Fig. 5). Chaetotaxy of metatarsus IV: T+2-2-7-2, tactile seta (T) very close to proximal end. Arolia longer than claws, not divided.

Measurements (mm).—Figures given first for lectotype female, followed in parentheses by those for paralectotype male. Body length 1.96 (1.52). Carapace length 0.48(0.49). Chelicera 0.20(0.21) by 0.11(0.105). Palpal trochanter 0.245(0.26) by 0.13(0.14); femur 0.40(0.43) by 0.13(0.15); tibia 0.40(0.445) by 0.16(0.185); chela (without pedicel) 0.665(0.76) by 0.23(0.26); hand (without pedicel) 0.34(0.36) by 0.23(0.26); pedicel 0.06 (0.065) long; movable finger 0.35(0.37) long. Leg I: basifemur 0.19(0.215) by 0.065(0.07); telofemur 0.125(0.14) by 0.065(0.075). Leg IV: entire femur 0.38(0.39) by 0.145(0.16); tibia 0.27 by 0.08; metatarsus 0.155 by 0.05; telotarsus 0.13 by 0.04.

Remarks.—The measurements given above are slightly different from those given by Beier (1931:313). This may be due to differences in our methods of measuring or may be the result of Beier's mistaken assumption that all 4 individuals were adults.

Olpiolum elegans (Balzan)

Olpiolum elegans Balzan, 1890:437, Pl.16, Figs. 19, 19a, 19b.; 1891:549; Ellingsen 1910:390; Beier 1930:207.

Olpiolum elegans (Balzan), Beier 1931:313; 1932:196, Fig. 227; Feio 1945:4; Hoff 1964:20.

O. elegans and *O. medium* seem very similar, with only slight differences in size and proportions (cf. Beier 1931:313). Indeed, the types of *O. medium* are apparently specimens which were identified as *Olpiolum elegans* by Ellingsen (1910) and Beier (1930). Study of additional material may well prove the two to be synonymous.

The type locality of this species is Rio Apa, Paraguay. Feio (1945) has also recorded collections in Brazil and Argentina, but his identifications may not be correct.

Olpiolum modestum Banks (1909) was referred tentatively to *Olpiolum* by Beier (1932:197). Reexamination of the types of this species reveals that it belongs in another genus, heretofore unrecognized.

Banksolpium, new genus

Type species.—*Olpiolum modestum* Banks, 1909.

Etymology.—The genus is named in honor of Nathan Banks, an early, great pioneer in the study of American pseudoscorpions and other arachnids.

Diagnosis.—A member of the family Olpiidae, subfamily Olpiinae, and tribe Olpiini (cf. Hoff 1964), with relatively heavy palps, venom duct in fixed finger of palpal chela reaching just to level of trichobothrium *et*, trichobothrium *ist* lying distad of *est*, one tactile seta on palpal femur proximally, and cheliceral flagellum of 3 setae.

Description.—Generally robust. Carapace and palps well sclerotized and darker than other parts. Carapace longer than broad; anterior margin slightly indented at middle; surface smooth, without transverse furrows; 4 large corneate eyes; 30-40 vestitural setae, with 4 at anterior and 4 at posterior margins. Abdominal tergites and sternites entire, smooth; pleural membranes longitudinally striate; setae short and slender; middle tergites with 6-12 setae; anterior genital operculum of male with 11-12 setae in 2 transverse rows, that of female with about 4 setae in a single row; internal genitalia not obviously distinctive. Chelicera about one-third as long as carapace; hand with 5 long setae; flagellum of 3 setae (1 large, 2 small); subapical lobe of movable finger distinct; galea with 3 terminal rami, smaller in male than in female. Palps moderately robust for an olpiin, femur and tibia about equal in length and hand (without pedicel) and movable finger about equal in length (Figs. 7 and 8). All surfaces smooth. Femur with conspicuous tactile seta in proximal third of dorsum. Chela with venom ducts short, the nodus ramosus lying at or just proximad of trichobothrium *et* in fixed finger and about midway between *t* and finger tip in movable finger. Trichobothria on fixed chelal finger generally as in olpiins, but with *ist* lying distad of *est*; on movable finger, *st* much closer to *b* than to *st*. Both fingers with contiguous marginal teeth, well developed and cusped distally, but becoming lower and rounded proximally. Legs rather robust, with entire femur 2.2-2.6 times as long as deep. Leg I with basifemur 1.6-1.8 times as long as telofemur. Arolia of pedal tarsi simple and longer than claws.

Remarks.—*Banksolpium* can easily be distinguished from other genera of the Olpiini by the placement of the trichobothria on the fixed finger of the chela, notably the location of *ist* distad of *est*. The genus is presently known to include only 2 species from eastern and southeastern Brazil.

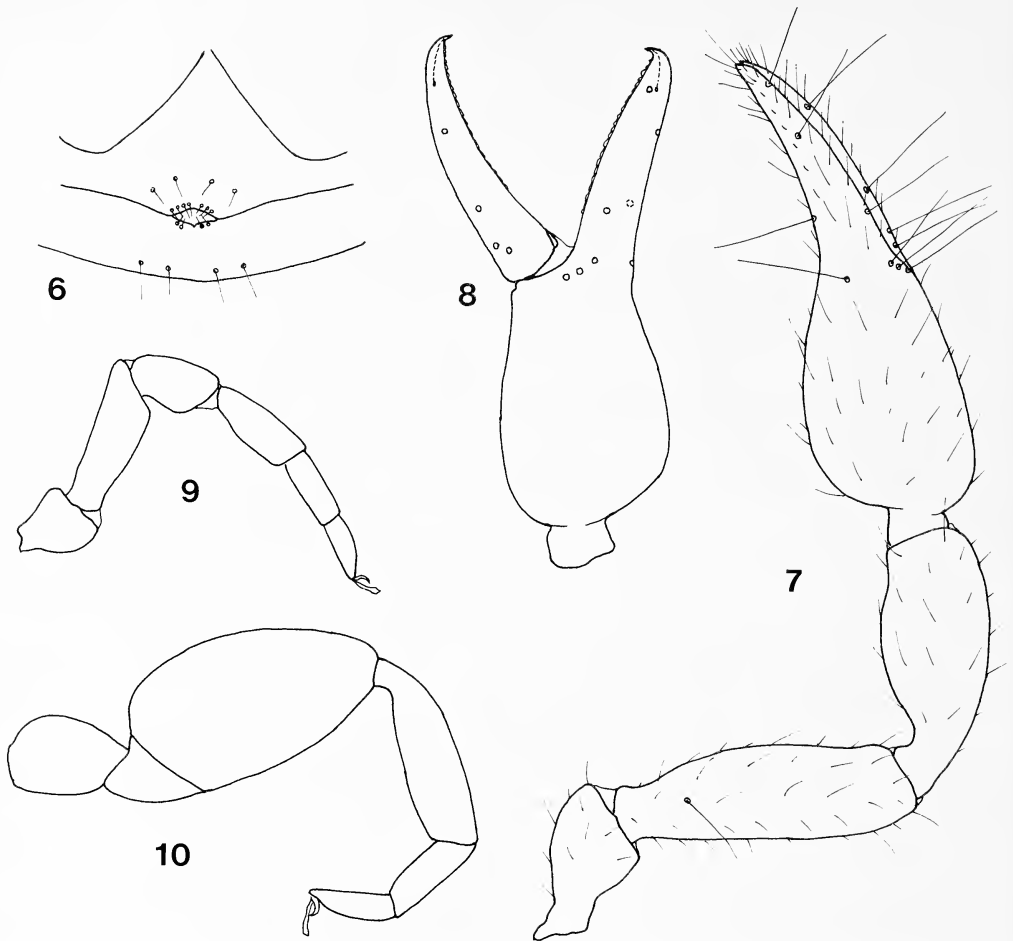

Figs. 6-10.—*Banksolpium modestum* (Banks), lectotype male: 6, genital opercula; 7, dorsal view of right palp; 8, lateral view of left chela; 9, lateral view of leg I; 10, lateral view of leg IV.

Banksolpium modestum (Banks), new combination

Figs. 6-10

Olpium modestum Banks, 1909:148, no fig.

Olpiolum(?) modestum (Banks), Beier 1932:197.

Olpiolum modestum (Banks), Hoff 1964:20; Heurtault 1980:71; *not* Beier 1954:134, Fig. 3.

Material.—Lectotype male (WM 4534.01003) (here designated) and 2 paralectotype females from Pernambuco, Brazil, in the Museum of Comparative Zoology, Harvard University; all specimens have been cleared, dissected, mounted on slides, and examined.

Description.—The original description by Banks is very short and general and not accompanied by illustrations. Therefore, a complete description is presented here. Male and female similar. Moderately robust for an olpiin. Carapace and palps well sclerotized and darker than other parts. Vestitural setae small and fine. Carapace longer than broad; smooth and without transverse furrows; anterior margin nearly straight or slightly indented at middle; 4 large, corneate eyes; about 30 setae, 4 at anterior and 4 at posterior margins. Abdominal tergites and sternites entire, surfaces smooth; pleural membranes longitudinally striate. Tergal

chaetotaxy of lectotype 2:4:4:4:6:6:6:10:10?:2; paralectotypes similar but with 6 setae on tergite 4. Sternal chaetotaxy of male 11:[2-2]:(0)4(0):(0)6(0):6:-, that of females 4:(0)4(0):(0)6(0):6:-; anterior genital operculum of male with setae in 2 transverse rows (Fig. 6), that of female with setae in 1 row. Internal genitalia not distinguishable.

Chelicera one-third as long as carapace; hand with 5 long setae; flagellum of 3 setae (1 long, 2 short), all finely denticulate; subapical lobe of movable finger distinct and finely incised at tip; galea long, with 3 terminal rami, smaller in male than in female; lamina exterior present.

Palp moderately heavy, with tibia slightly shorter than femur (Fig. 7); femur 3.3-3.35, tibia 2.3-2.4, and chela (without pedicel) 2.75-3.0 times as long as broad; hand (without pedicel) 1.45-1.64 times as long as deep; movable finger 1.0-1.05 times as long as hand. All surfaces smooth. Femur with conspicuous tactile seta on dorsum about $\frac{1}{4}$ length from proximal end. Trichobothria on chela as shown in Fig. 8: on fixed finger *it* nearer to *et* than to *est*, *ist* distad of *est*, and *eb*, *esb*, *ib* and *isb* in a group at base; on movable finger *sb* much closer to *b* than to *st*. In one paralectotype there is an extra trichobothrium on the external surface midway between *et* and *it*. Venom apparatus well developed in both fingers, ducts short; nodus ramosus in fixed finger at level of trichobothrium *et*, in movable finger about half distance from tip to *t*. Fixed finger with 29-33 marginal teeth, the distal ones cusped, the proximal ones very low and flat; movable finger with 20-22 similar teeth.

Legs robust; leg IV with entire femur 2.15-2.25 and tibia 3.5-3.7 times as long as deep (Fig. 10). Leg I with basifemur about 1.65 times as long as telofemur (Fig. 9). Chaetotaxy of metatarsus IV of lectotype T+1-2-8-2, tactile seta (T) close to proximal end; others T+1-2-7-2 and T+1-3-7-2. Arolia longer than claws, not divided.

Measurements (mm).—Figures given first for the lectotype male, followed in parentheses by those for the two paralectotype females. Body length 2.0(2.1,2.25). Carapace length 0.59(0.59,0.62). Chelicera 0.19(0.20,0.19) long. Palpal trochanter 0.26(0.27,0.27) by 0.14(0.14,0.16); femur 0.50 (0.51,0.51) by 0.15(0.155,0.155); tibia 0.42(0.45,0.45) by 0.175(0.19,0.195); chela (without pedicel) 0.755(0.81,0.82) by 0.25(0.28,0.30); hand (without pedicel) 0.39(0.42,0.44) by 0.265(0.25,0.30); pedicel 0.070(0.075) long; movable finger 0.41(0.44,0.43) long. Leg I: basifemur 0.235 (0.245,0.245) by 0.07(0.09,0.08); telofemur 0.14(0.155,0.15) by 0.08(0.08,0.09). Leg IV: entire femur 0.48(0.50,0.49) by 0.22(0.23,0.22); tibia 0.32(0.33,0.34) by 0.09(0.09,0.095); metatarsus 0.16(0.18,0.18) by 0.06 (0.06,0.06); telotarsus 0.13(0.13,0.13) by 0.04(0.04,0.04).

Remarks.—As pointed out by Heurtault (1980:71-72), the specimen from Venezuela described by Beier (1954) as *Olpiolum modestum* (Banks) is actually referable to *Olpiolum machadoi* Heurtault. Importantly, the trichobothriotaxy of the palpal chela and the numbers of setae on the abdominal tergites preclude its being *B. modestum*.

Banksolpium magnum, new species

Figs. 11 and 12

Material.—Holotype male (WM 612.03001) from Viçosa, Minas Gerais, Brazil, 6 July 1933, in Cornell University Insect Collection.

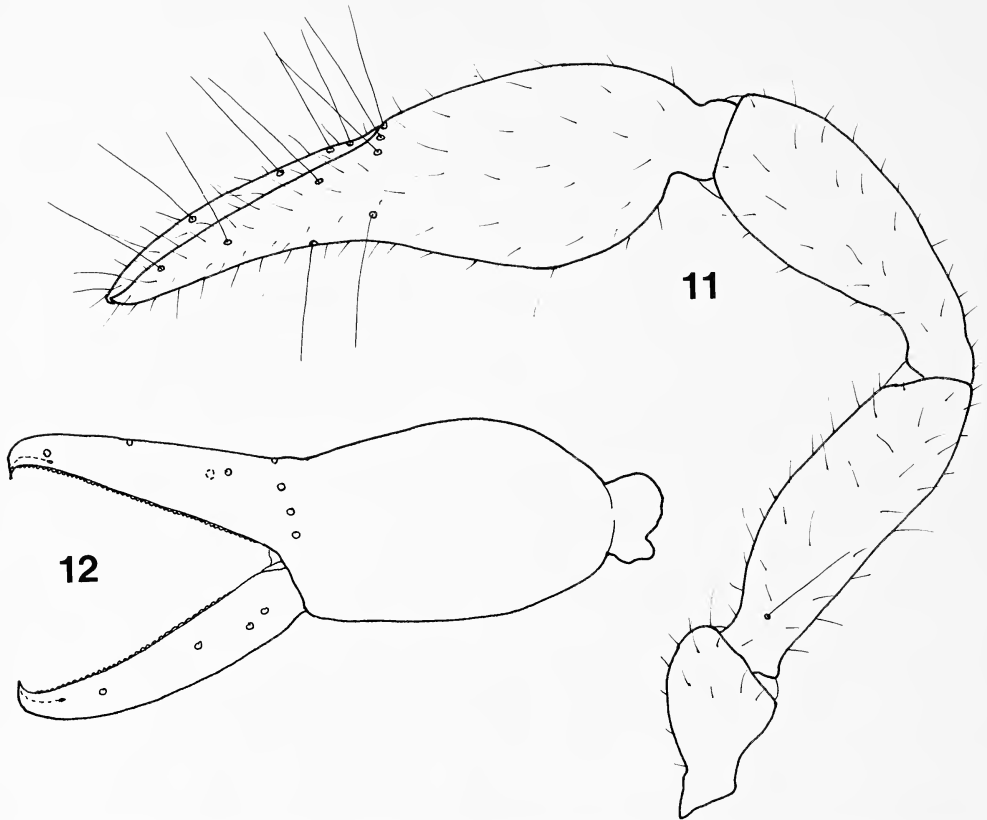

Figs. 11 and 12.—*Banksolpium magnum*, new species, holotype male: 11, dorsal view of right palp; 12, lateral view of left chela.

Diagnosis.—Much like *B. modestum* but larger (carapace length 0.835 vs. 0.59) and with more setae on carapace (40 vs. 30) and on abdominal tergites (5:6:9:11:- vs. 2:4:4:4:-).

Description of male (female unknown).—A large species of the genus *Banksolpium* as presently known. Carapace, palps, and posterior tergites well sclerotized and reddish brown in color, other parts lighter. Vestitural setae generally thin and short. Carapace a little longer than broad; smooth and without transverse furrows; anterior margin straight; 4 large, corneate eyes; about 40 setae, 4 at anterior and 4 at posterior margins. Abdominal tergites and sternites entire, smooth; pleural membranes finely, longitudinally striate. Tergal chaetotaxy 5:6:9:11:10:12:12:12:12:12:6:2. Sternal chaetotaxy 12:[2-2]:(0)6(0):(0)8(0):12:13:14:13:13:12:4:2; disposition of setae on genital opercula much as in *B. modestum*. Internal genitalia not obviously distinctive.

Chelicera 0.4 as long as carapace; hand with 5 long setae; flagellum of 3 setae, all denticulate; subapical lobe of movable finger distinct, entire; galea slender, with 3 small rami; lamina exterior present.

Palp moderately heavy, with tibia slightly longer than femur (Fig. 11); femur 3.1, tibia 2.75, and chela (without pedicel) 3.1 times as long as broad; hand (without pedicel) 1.7 times as long as deep; movable finger 0.92 as long as hand. All surfaces smooth. Femur with tactile seta about one-fifth length from proximal end. Trichobothria on chela as shown in Fig. 12: on fixed finger *est* closer to

isb than to *it*, and *ist* distad of *est*; on movable finger *sb* much closer to *b* than to *st*. Venom apparatus well developed in both chelal fingers, ducts short; nodus ramosus in fixed finger just proximad of trichobothrium *et*, in movable finger about midway between *t* and finger tip. Fixed finger with 46 contiguous teeth, nearly all cusped; movable finger with 39 teeth, cusped in distal half but becoming rounded and flattened proximally.

Legs more slender than in *B. modestum*; leg IV with entire femur 2.65 and tibia 4.15 times as long as deep. Leg I with basifemur about 1.85 times as long as telofemur. Chaetotaxy of metatarsus IV is T+2-3-8-3. Arolia longer than claws, not divided.

Measurements (mm).—Body length 2.57. Carapace length 0.835. Chelicera 0.33 by 0.17. Palpal trochanter 0.415 by 0.235; femur 0.77 by 0.25; tibia 0.82 by 0.30; chela (without pedicel) 1.33 by 0.43; hand (without pedicel) 0.725 by 0.43; pedicel 0.105 long; movable finger 0.665 long. Leg I: basifemur 0.40 by 0.125; telofemur 0.215 by 0.125. Leg IV: entire femur 0.72 by 0.27; tibia 0.54 by 0.13; metatarsus 0.325 by 0.09; telotarsus 0.265 by 0.065.

Etymology.—The species is named *magnum* in reference to its being larger than *B. modestum*.

Remarks.—The type locality in southeastern Brazil is some 1500 km from the type locality of *B. modestum* on the eastern bulge of the country, indicating a broad distribution of the genus. However, thus far no other congeneric species are known.

ACKNOWLEDGMENTS

I am much indebted to the following for the loan of material: H. W. Levi of the Museum of Comparative Zoology, M. Moritz of the Museum für Naturkunde in Berlin, and L. L. Pechuman of the Cornell University Insect Collection.

LITERATURE CITED

- Balzan, L. 1890. Revisione dei pseudoscorpioni del bacino dei fiumi Paranà e Paraguay nell'America meridionale. Ann. Mus. Civ. Stor. Nat. Genova, (2)9:401-454.
- Balzan, L. 1891. Voyage de M. E. Simon au Venezuela (Décembre 1887-Avril 1888). 16e mémoire. Arachnides. Chernetes (Pseudoscorpiones). Ann. Soc. Entomol. France, 60:497-552.
- Banks, N. 1909. New tropical pseudoscorpions. J. New York Entomol. Soc., 17:145-148.
- Beier, M. 1930. Die Pseudoskorpione des Wiener Naturhistorischen Museums. III. Ann. naturhistor. Mus. Wien, 44:199-222.
- Beier, M. 1931. Neue Pseudoscorpione der U. O. Neobisiinea. Mitt. Zool. Mus. Berlin, 17:299-318.
- Beier, M. 1932. Pseudoscorpionidea I. Subord. Chthoniinea et Neobisiinea. Tierreich, 57:1-258.
- Beier, M. 1954. Pseudoscorpionidea. Beitr. Fauna Perus, 4:1-12.
- Beier, M. 1959. Zur Kenntnis der Pseudoscorpioniden-Fauna des Andengebietes. Beitr. neotrop. Fauna, 1:185-228.
- Ellingsen, E. 1910. Die Pseudoskorpione des Berliner Museums, Mitt. Zool. Mus. Berlin, 4:355-423.
- Feio, J. L. A. 1945. Novos pseudoscorpões da região neotropical (com a descrição de uma subfamília, dois géneros e sete espécies). Bol. Mus. Nac., Rio de Janeiro, (N.S., Zool.), 44:1-47.
- Heurtault, J. 1980. Le développement postembryonnaire chez deux espèces nouvelles de pseudoscorpions Olpiinae du Venezuela. Rev. Nordest. Biol., 3:57-85.
- Heurtault, J. and J. Rebière. 1983. Pseudoscorpions des Petites Antilles I. Chernetidae, Olpiidae, Neobisiidae, Syarinidae. Bull. Mus. Natn. Hist. Nat., 5(A):591-609.
- Hoff, C. C. 1945. The pseudoscorpion subfamily Olpiinae. Amer. Mus. Novitates, 1291:1-30.

- Hoff, C. C. 1964. The pseudoscorpions of Jamaica. part 3. The suborder Diplosphyronida. Bull. Inst. Jamaica, Sci. Ser. 10(3):1-47.
- Mahnert, V. 1982. Die Pseudoskorpione (Arachnida) Kenyas. 3. Olpiidae. Monitore Zool. Ital. (N. S.) Suppl. 16:263-304.
- Mahnert, V. and R. Schuster. 1981. *Pachyolpium atlanticum* n. sp., ein Pseudoskorpion aus der Gezeitenzone der Bermudas — Morphologie und Ökologie (Pseudoscorpiones: Olpiidae). Rev. suisse Zool., 88:265-273.
- Muchmore, W. B. 1977. Preliminary list of the pseudoscorpions of the Yucatan Peninsula and adjacent regions, with descriptions of some new species (Arachnida: Pseudoscorpionida). Assoc. Mexican Cave Stud. Bull., 6:63-78.

Manuscript received September 1985, revised November 1985.

MYGALOMORPH SPIDERS IN THE BARYCHELIDAE (ARANEAE) FROM COSTA RICA¹

Carlos E. Valerio

Escuela de Biología
Universidad de Costa Rica
Ciudad Universitaria Rodrigo Facio
Costa Rica

ABSTRACT

Two species of Barychelidae, *Psalistops venadensis* and *Trichopelma laselva*, are described from Costa Rica. These are the first records of this mygalomorph family from this country. Both species were associated with tropical wet forests.

INTRODUCTION

Among the mygalomorph families, the Theraphosidae are particularly diverse in Costa Rica with more than 30 species, including arboreal, diggers, forest-dwellers, species associated with pastures, many lowland, and one-high-altitude species (Valerio 1979, 1980). The Dipluridae are represented by three species and the Ctenizidae by one (Zúñiga 1980). The remaining families have no published records, except for one paratropidid collected in 1930 and erroneously identified as *Anisaspis tuberculatus* (a Caribbean species) by Reimoser (1940). I examined the specimen and it is an immature *Paratropis* sp.

In this paper I record the presence of two species in the Barychelidae, a group previously known, in the New World, only from South America and some Caribbean islands. Additional specimens have been collected in Panama, Honduras, Guatemala, and Mexico (W. Gertsch and V. Roth personal communications).

Although some theraphosids are locally very abundant, long years of collecting have yielded only three specimens of these barychelids and I think they are relevant enough to merit taxonomic treatment.

FAMILY BARYCHELIDAE SIMON

The species from Costa Rica possess a conspicuous rastellum on the anterior face of the basal cheliceral segment, minute PME, eye tubercule low and scopulation of legs as follows: entire and thin pads on palpal tarsus and metatarsi I and II, thin pad divided by a band of short setae on tarsus III. Scopulae absent on tarsus IV and metatarsi III and IV. The labium bears some 25 cuspules on the anterior half of its length (Figs. 7-8).

¹Supported by a grant from Vicerrectoría de Investigación, Universidad de Costa Rica.



Map 1.—Map of Costa Rica indicating type localities for *Psalistops venadensis* (triangle) and *Trichopelma laselva* (circle). Shaded area indicates tropical wet formations.

Genus *Psalistops* Simon

Psalistops Simon 1889, Simon 1892, Waterhouse 1902, Mello-Leitão 1923, Petrunkevitch 1928.

Easily distinguished from *Trichopelma* by the absence of a clear annular band on tarsus IV. Lateral spinnerets with apical segment short and conical. Three species are known from Venezuela, three from the Caribbean islands and two from Brazil. (Bonnet 1949, Brignoli 1983).

Psalistops venadensis, new species

Figs. 1-3, 6, 7, 10, 11; Map 1

Type.—Female from El venado, San Carlos, Alajuela Province (10° 33' N, 84° 24' W) collected by C. E. Valerio, deposited in the Museo de Zoología (Universidad de Costa Rica). An additional specimen (immature female) from Tortuguero, Limón Province 10° 29' N, 83° 30' W) was examined and deposited in the MZUCR.

Diagnosis.—Closely related to the Venezuelan *P. zonatus* Simon, characterized by the presence of two strong spines ventrally on the base of tibia III in addition

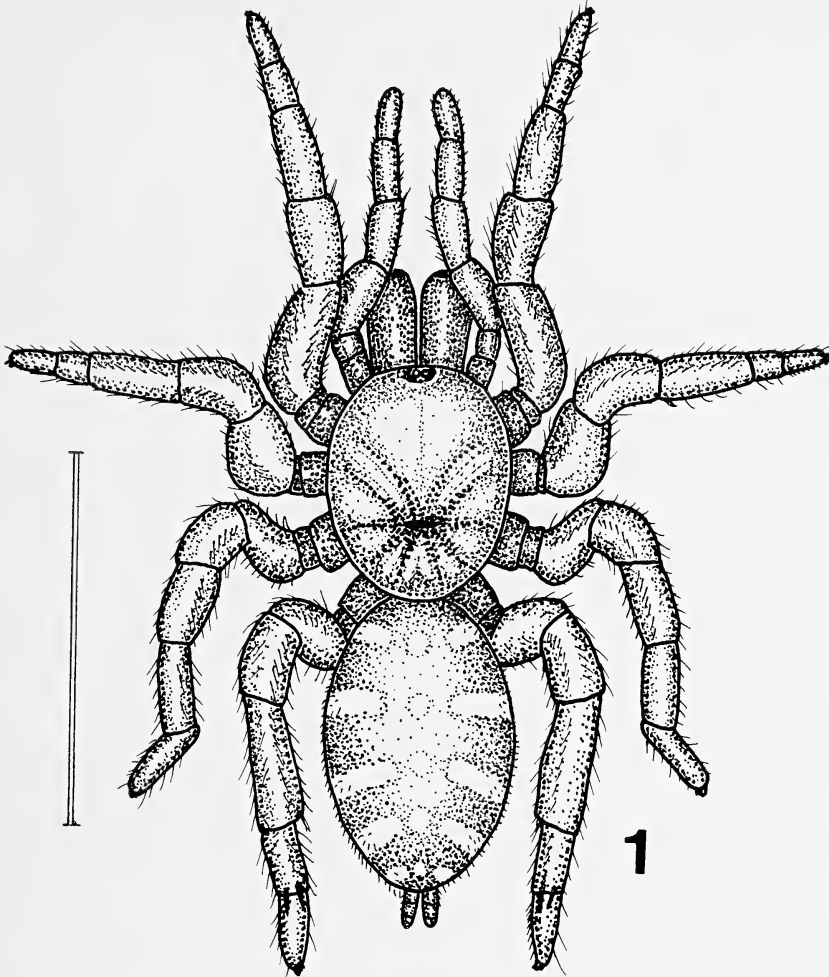
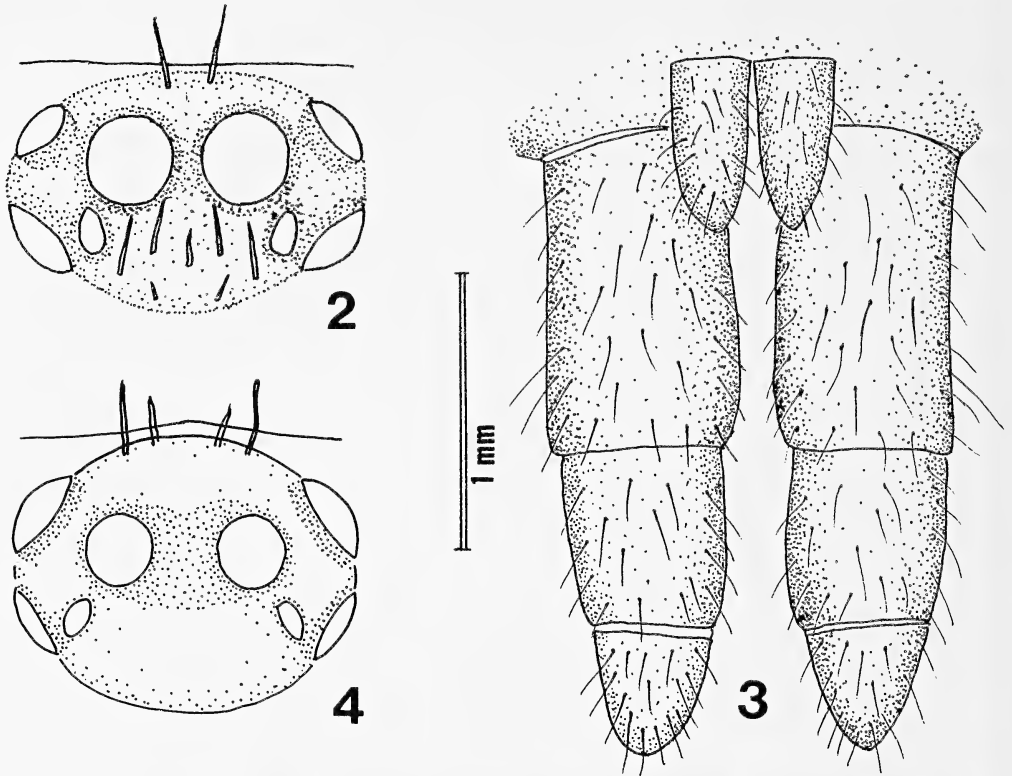

Fig. 1.—*Psalistops venadensis*, female, dorsal view. Scale line 10 mm.

to two apical ones (Figs. 5-6), larger size (21 mm total length), dark coloration and size of spermathecae (1.5 mm wide). Separated from the genotype *P. melanopygius* Simon by the shape of spermathecae (head divided into large protuberances vs. smooth, see Fig. 10). Note: the third Venezuelan species is *P. tigrinus* Simon, but the specimen labeled as type in the MNHN in Paris, number 10716 - 3.244, is a small prodidomid rather than a barychelid (the type must be lost or misplaced). It can be separated from *Trichopelma laselva* n. sp. (besides the generic characters) by its large AME (Fig. 2), the presence of three denticles on tarsal paired claws (Fig. 11), considerably less cuspules on maxillary segments and light body coloration.

Female.—Basal cheliceral segment with conspicuous rastellum. Sternum, labium, maxillae and ventral side of coxae covered with short spines. Maxillae with some 30 cuspules near medial border. Labium with some 25 cuspules covering anterior half. Carapace covered with fine pubescence. All legs covered dorsally with setae, all tarsi with few capitated hairs dorsally. Metatarsi I and II with one strong distal spine on ventral side, metatarsi III and IV with two on ventral side and metatarsi III alone with two such spines dorsally. Tibia III with



Figs. 2-4.—Ocular area (dorsal view) and spinnerets (ventral view): 2-3, *Psalistops venadensis*; 4, *Trichopelma laselva*. Scale line 1 mm.

only two strong spines on ventral side, located distally (Fig. 6). Tarsal claws with series of three denticles (Fig. 11). Ocular area dark, prominent, with conspicuous pair of setae anteriorly near clypeus, AME twice as large as ALE (Fig. 2). Thoracic furrow transverse. General coloration light tan with ocular area black, longitudinal series of five clear patches dorsally on abdomen and matching transversal clear bands on sides (Fig. 1). Posterior lateral spinnerets long with small triangular apical segment (Fig. 5). Measurements in mm: carapace 6.3, sternum 2.8, abdomen 8.0, palp 11.5, leg I 15.0, leg II 13.5, leg III 13.5, leg IV 20.0. Spermatheca 0.9 in width, divided in two capitated regions, covered by rounded spermathecal glands (Fig. 1).

Male.—Unknown.

Distribution.—Known from the Northern lowlands (Map 1).

Natural History.—Both specimens were collected under forest litter in disturbed areas, in tropical wet formations.

Genus *Trichopelma* Simon

Trichopelma Simon 1888, Simon 1889, Simon 1891, Mello-Leitão 1923.

This genus is characterized by the presence of an annular pale band (suture?) on tarsus IV (better seen from the sides and ventrally). One species is known from the Dominican Republic and two from Brazil.

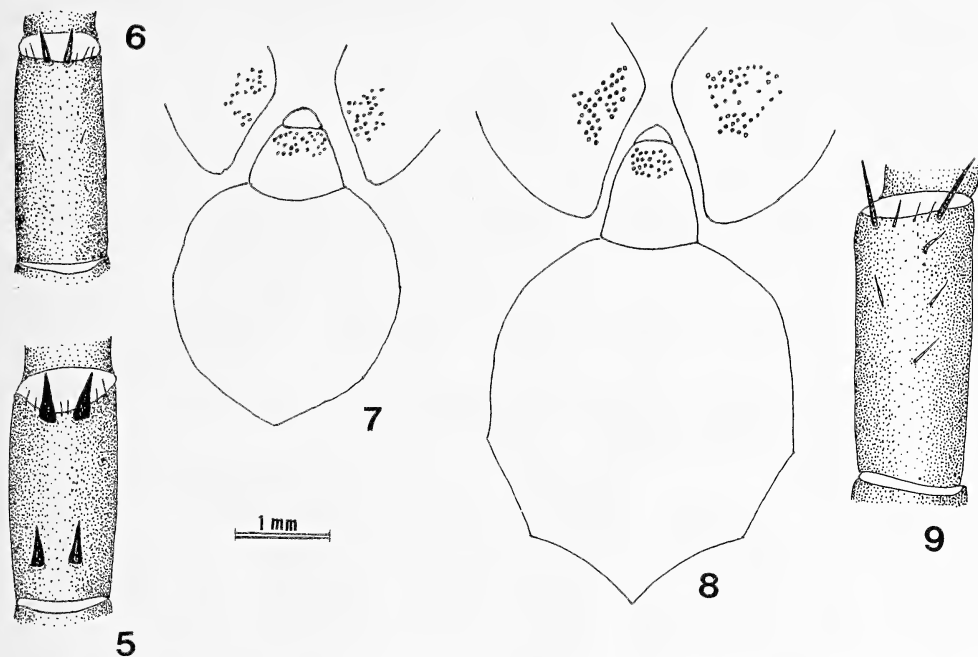

Figs. 5-9.—Right tibia III (ventral view) and prosoma (ventral view): 5, *Psalistops zonatus*; 6-7, *Psalistops venadensis*; 8-9, *Trichopelma laselva*. Scale line 1 mm.

Trichopelma laselva new species

Figs. 4, 8, 9, 12, 13; Map 1

Type.—Female from Finca La Selva Station, near Puerto Viejo de Sarapiquí, Heredia Province ($10^{\circ} 25' N$, $84^{\circ} 01' W$), collected by V. Roth, deposited in the American Museum of Natural History.

Etymology.—The name refers to the type locality.

Diagnosis.—This species shows the suture ring on tarsus IV characteristic of the genus. Valid comparisons cannot be made with its closest geographic neighbor, *T. nitida* Simon from the Caribbean, since it is known from a single male specimen and sizes and proportions vary considerably with sex. Taken into consideration that geographic ranges in mygalomorphs tend to be small (valerio 1979) and that *T. nitida* is isolated in a Caribbean island, I think it is safe to consider this Costa Rican female a separate species.

Female.—Basal cheliceral segment with conspicuous rastellum. Sternum, labium and maxillae covered with long black setae. Maxillae with some 40 cuspules anteriorly near medial border. Labium with some 25 cuspules on anterior half (Fig. 8). Tarsi and metatarsi on all legs covered with spines. Tibia III with two slender spines ventrally near distal end (Fig. 9). Paired tarsal claw with one denticle (Fig. 13). Ocular area prominent, anterior eyes in strongly procurved line, AME smaller than ALE (Fig. 4). Thoracic furrow transverse. General coloration dark brown, with pattern of light transverse bands on abdomen, similar to that of *P. venadensis* (Fig. 1). Measurements in mm; carapace 9.0, sternum 3.5, abdomen 12.0, palp 12.0, leg I 21.0, leg II 22.0, leg III 19.0, leg IV 28.0. Spermathecae 0.9 in width, similar in shape to that of *P. venadensis* n. sp. (Fig. 12).

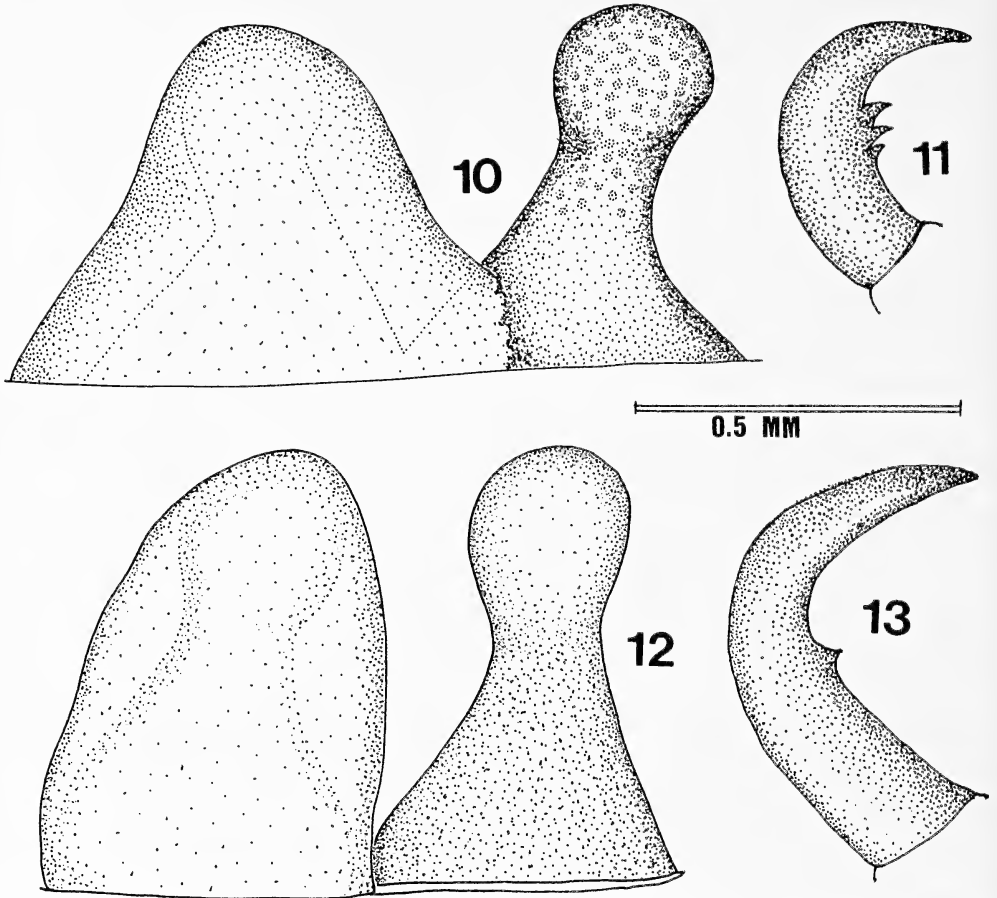

Figs. 10-13.—Spermathecae (dorsal view) and paired tarsal claw III: 10-11, *Psalidopsis venadensis*; 12-13, *Trichopelma laselva*. Scale line 0.5 mm.

Male.—Unknown.

Distribution.—Known only from the type locality (Map 1).

Natural History.—Collected in a densely forested area, in a tropical wet formation.

ACKNOWLEDGMENTS

I am indebted to R. Raven for a critical review of the manuscript and for sending me his unpublished keys for the mygalomorphs. I was able to study the collections of the Museum Natural d'Histoire Naturelle, the Zoologisches Museum Wien and the American Museum of Natural History, through the generosity of M. Vachon, J. Gruber and N. Platnick.

LITERATURE CITED

- Bonnet, P. 1949. *Bibliographia Araneorum*. Vol. II. Imprimerie Douladoure, Toulouse, pp. 3797, 4688-4680.
 Brignoli, P. M. 1983. *A catalogue of the Araneae*. Manchester University Press, Manchester, 755 pp.

- Mello-Leitão, C. F. 1923. Theraphosoideas do Brazil. Rev. Mus. Paulista, 13:1-438.
- Petrunkévitch, A. 1928. Systema Araneorum. Trans. Connecticut Acad. Arts Sci., 29:1-270.
- Reimoser, E. V. 1940. Wissenschaftliche der osterreichischen biologischen expedition nach Costa Rica. Ann. Naturhist. Mus. Wien, 50:328-386.
- Simon, E. 1888. Etudes arachnologiques 21. Descriptions d'espèces et de genres nouveaux de l'Amerique Centrale et des Antilles. Ann. Soc. Entomol. France, 8:203-216.
- Simon, E. 1889. Arachnides. In: Voyage de M. E. Simon au Venezuela. Ann. Soc. Entomol. France, 9:169-220.
- Simon, E. 1892. Histoire naturelle des Araignées. Librârsic Roret, Paris, 256 pp.
- Valerio, C. E. 1979. Arañas terafósidas de Costa Rica (Araneae, Theraphosidae): *Psalmopoeus reduncus*, redescrición, distribución y el problema de dispersión en terafósidos. Rev. Biol. Trop., 27:301-308.
- Valerio, C. E. 1980. Arañas terafósidas de Costa Rica (Araneae, Theraphosidae). *Sphaerobothria*, *Aphonopelma*, *Pterinopelma*, *Citharacanthus*, *Crypsidromus* y *Stichoplastus*. Rev. Biol. Trop., 28:271-296.
- Waterhouse, C. O. 1902. Index Zoologicus. London, 421 pp.
- Zúñiga-Vega, C. M. 1980. Lista anotada de especies de arañas de Costa Rica. Brenesia, 18:310-352.

Manuscript received August 1985, revised January 1986.

**ALBINISM AND EYE STRUCTURE IN AN AUSTRALIAN
SCORPION, *URODACUS YASCHENKOI*
(SCORPIONES, SCORPIONIDAE)**

N. A. Locket

Department of Anatomy and Histology
University of Adelaide
Box 498, G.P.O.
Adelaide
South Australia 5001

ABSTRACT

Two albino individuals of *Urodacus yaschenkoii* (Birula 1903) were caught among a normally pigmented population in South Australia. These are illustrated and discussed.

Microscopy of the eyes shows that the melanin granules normally present in the epidermis and in the retina are represented by non-pigmented premelanosomes. Though the components of the eye are all present, the rhabdoms are abnormal, consisting of reduced and disorganised microvilli. The phaospheres, present in retinula cells, are also abnormal. The nature of the defects and their possible consequence are discussed.

INTRODUCTION

Albinism, a specific lack of melanin pigment, is well known in a wide variety of animals, including crabs, isopods and insects, but does not appear to have been recorded in scorpions. The occurrence of depigmented arthropods, including scorpions, is well known, most of them recorded from caves which provide a totally dark environment in their depths. Commonly the pallor is associated with the loss of eyes: Mitchell (1968, 1972) described the troglobite genus *Typhlochactas*, eyeless pale scorpions from caves in Mexico, and Mitchell and Peck (1977) later described another species of this genus, also pale and without eyes, but from forest litter, not a cave. Francke (1977, 1978) has described troglobite, i.e. obligate cave-dwelling, scorpions belonging to the family Diplocentridae. One of these, *Diplocentrus anophthalmus*, is pale and has no eyes. The other two species appear less extreme; *D. mitchelli* has minimal pigmentation and markedly reduced eyes, but *D. cueva* has only slightly reduced pigment and small median eyes; the lateral eyes are described as equal to related epigeal examples of *Diplocentrus*.

The eye structure of scorpions has been the subject of a number of studies, from the early work of Lankester and Bourne (1883), Parker (1891), and Scheuring (1913) to the electron microscope studies of Bedini (1967), Belmonte and Stensaas (1975), Fleissner and Schliwa (1977), and Schliwa and Fleissner

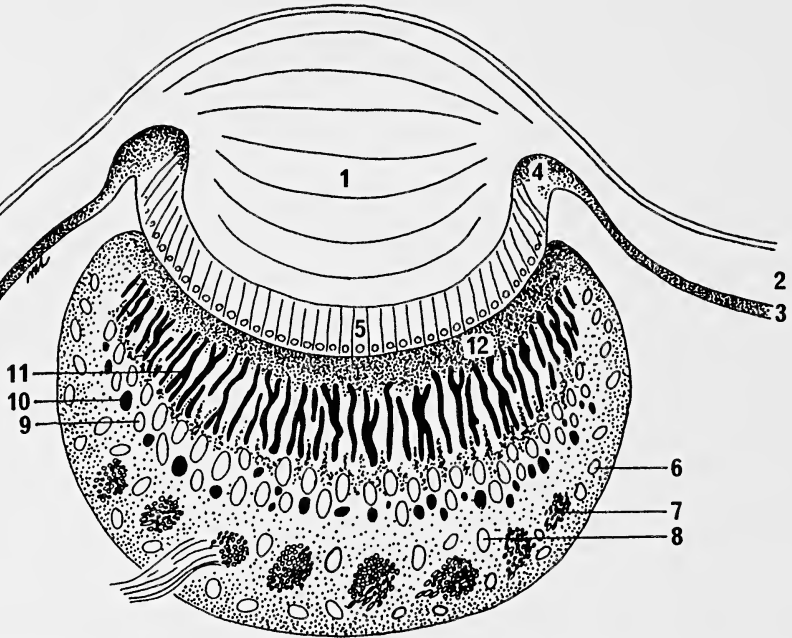

Fig. 1.—Diagram of scorpion median eye. Lens, 1, is a thickening of cuticle, 2. Epidermis, 3, contains pigment which extends to limbus 4. Modified epidermal cells form transparent vitreous, 5. Deep portion of retina contains pigment cells, 6, nerve fibre bundles, 7, and bodies of arhabdomeric cells, 8. Retinula cell nuclei, 9, and phaospheres, 10, are deep to rhabdoms, 11. In light-adapted condition rhabdoms are shielded by pigment, 12.

(1979, 1980). It was early recognised that the structure is different in the median and lateral eyes; only the former will be considered in the present paper.

The median eyes (diagram, Fig. 1) occur close to each other on either side of an ocular tubercle approximately in the middle of the carapace. They have a single lens, derived from and continuous with the cuticle. Between lens and retina, in the median but not the lateral eyes, is a layer of cells called the vitreous or lentigen by various authors. This layer, continuous with the epidermis at the edge of the eye, does not contain melanin granules, but the surrounding epidermis, and particularly the cells at what may be called, by analogy with vertebrate eyes, the limbus, are packed with these granules.

Separating the vitreous from the retina is a preretinal membrane, apparently of cuticular origin, and continuous with a postretinal membrane of similar structure.

The retina thus enclosed contains three classes of cells. The deep aspect of the retina is lined by pigment cells, with flattened nuclei disposed parallel to the postretinal membrane and packed with melanin granules. Interstitial pigment cells occur within the retina at the level of the retinula cell nuclei. Between the outer pigment cells and the bases of the retinula cells are the arhabdomeric cells described by Schliwa and Fleissner (1979). The retinula cells, which show regional specialisation, occupy most of the thickness of the retina. From their basal aspects arise the nerve fibres, which form bundles amongst the pigment cells before they penetrate the postretinal membrane and form the optic nerve. Further details of retinal structure are given under Results.

The chance finding of two scorpions lacking the normal pigmentation in and around the eye, and elsewhere in the body, and thus presumably albinos,

suggested that a comparison of their eyes with the normal might be of interest. This account is now presented.

MATERIALS AND METHODS

The two individuals now reported were caught in an area of scrub near Berri in the Riverland of South Australia. The burrow mouths, which have a characteristic appearance (Shorthouse 1971), were identified, and a plastic vending machine cup buried so that its lip was level with the floor of the mouth of the burrow. The trapped burrows were marked, and revisited about 1.5h after sunset, when many scorpions had emerged from their burrows and fallen into the cups. When the catch was inspected later indoors, it was noticed that two specimens lacked the normal pigmentation. No other albinos have been caught in previous or subsequent trapping in the same area. One albino was kept in the laboratory for several months, during which time it was fed mealworms and other insects. It showed no behavioural differences from normal examples. Measurements of hand length and carapace plus first five metasomal segments were made on this specimen following Shorthouse (1971), and it falls into Shorthouse's group C, i.e. fourth instar.

The second albino, of similar size, was killed and pieces of tissue, including the eyes, were fixed for electron microscopy in 2% paraformaldehyde and 2.5% glutaraldehyde in 0.1M phosphate buffer, pH 7.3. The tissue was fixed for 2h, postfixed in 1% osmium tetroxide in 0.1M phosphate, dehydrated through an ethanol series and taken through propylene oxide to Araldite, in which it was embedded.

Sections along and perpendicular to the optic axis were cut for light and electron microscopy on a Cambridge Huxley ultramicrotome, using glass knives. Sections for light microscopy were cut at 1 μ m, stained with methylene blue/azure II followed by basic fuchsin/borax, and mounted in immersion oil. Thin sections were stained with alcoholic uranyl acetate followed by Reynolds' (1963) lead citrate, and examined in a JEOL 100c electron microscope.

Sections of the eye of a normal scorpion, of the same size and from the same locality, were prepared as a control. Experiments showed that a primary fixative containing 0.5g sucrose/100 ml gave improved fixation, and this was used for the control tissue.

RESULTS

General appearance.—Normal specimens of *Urodacus yaschenkoi* (Birula, 1903) (Fig. 2), are predominantly buff to pale brown. The mesosoma appears darker and somewhat grey owing to the dark coloured viscera beneath the cuticle. The aculeus, leg joints and tarsal claws, and the fingers of the chelae and chelicerae are reddish to dark brown due to dense sclerotization. The fifth metasomal segment and vesicle, and the eyes and their surrounds, are dark brown to black due to pigmentation.

The albinos (Fig. 3) differed from the normal in the pallor of the metasoma and vesicle, and complete absence of pigment from the eyes and their surrounds. The mesosoma showed some of the normal darkness, but was noticeably paler

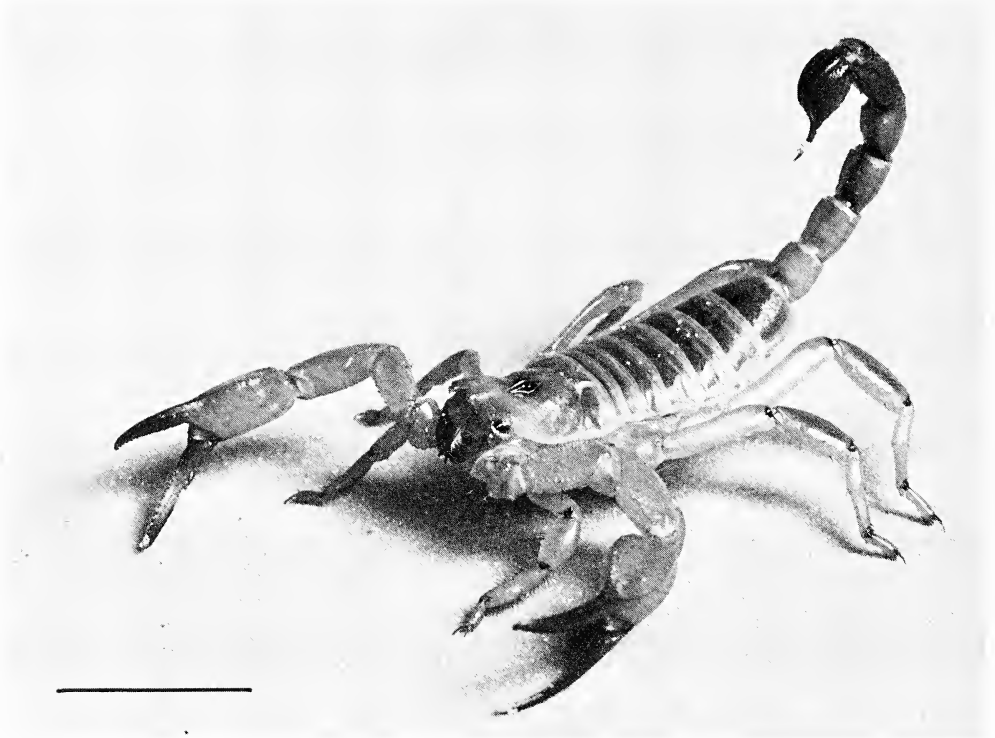

Fig. 2.—*Urodacus yaschenkoi*, normal. The darkness of chelae and fingers, aculeus, tarsal claws and leg joints is due to dark sclerotization whereas that of eyes and surrounds, vesicle and metasomal segments is caused by pigmentation. Scale = 10 mm.

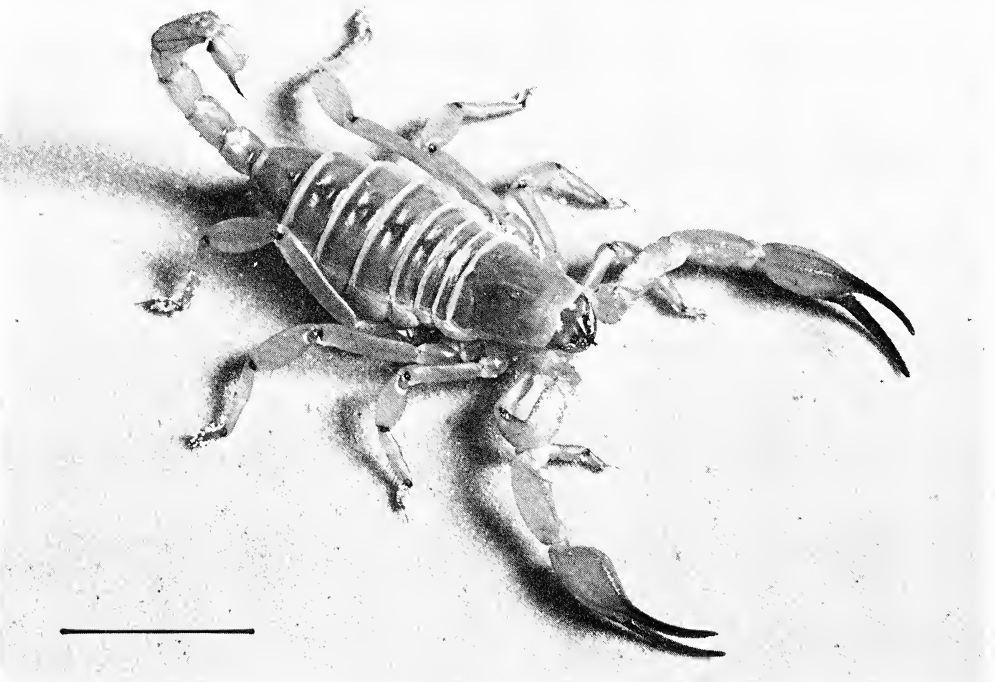

Fig. 3.—*Urodacus yaschenkoi*, albino. Sclerotized parts resemble normal, but eyes, vesicle and metasomal segments lack pigment. Scale = 10 mm.

than the normal. Those parts that are normally dark due to sclerotization were no less so than in the normal scorpion.

Eye structure.—The structure of the median eyes accords well with the descriptions given by Bedini (1967), Fleissner and Schliwa (1977), Fleissner and Siegler (1978) and Fleissner and Heinrichs (1982) and summarised in the Introduction. Sections show that the overall architecture is the same in the normal and albino, Figs. 4, 5. The cuticular lens has the same configuration, and stains similarly. The columnar vitreous cells, with basal nuclei, are of similar shape and size, and were transparent in both. The epidermis surrounding and up to the limbus in the normal contain numerous pigment granules. These granules are represented in the albino, but are not pigmented. They appear the same as those in the retina, described below. The preretinal membrane, situated at the junction of retina and vitreous, and the postretinal continuation of this membrane, called the sclera by Bedini (1967), are well developed in both.

The retina contains the populations of cells outlined in the Introduction. The normal retina (Fig. 4) has a layer of densely pigmented cells lining the eye cup beneath the postretinal membrane, and extending to the limbus, where they lie close to the pigmented epidermal cells. These cells have somewhat flattened densely staining nuclei and their cytoplasm is packed with pigment granules. Electron microscopy shows these as dense granules, in at least some cases clearly membrane-bound (Fig. 12).

The 'pigment' cells are also present in the albino (Fig. 5) in which the disposition of their nuclei is better seen than the normal, due to the absence of pigment. Where the normal has melanin granules, the albino has an equal or greater density of granules, but these are unpigmented. These granules are membrane bound and have a finely granular content; some contain bars or rings with a paracrystalline appearance. Similar granules occur among the melanin granules in the normal, and they are considered to be premelanosomes, (Fig. 13).

A second population of pigment cells is present in the normal, interspersed with the retinula cells in the substance of the retina. These cells have nuclei at the same level as those of the retinula cells, and their perinuclear cytoplasm is densely packed with melanin granules. They have processes that extend vitreally between the retinula cells, and which also contain pigment granules. Corresponding cells have not been identified with certainty in the albino.

Arhabdomeric cells with cell bodies located deeper in the retina than those of retinula cells, and processes which penetrated between the retinula cells to the level of the rhabdom bases were described by Schliwa and Fleissner (1979). Cells conforming to their description are present in both normal and albino eyes, and profiles corresponding to Schliwa and Fleissner's description are present in tangential sections of retina at the level of the rhabdom bases.

Axonal profiles containing dense vesicles, and identified by Fleissner and Schliwa (1977) as neurosecretory fibres, are also present in normal and albino retinas.

Most of the volume of the retina is made up by the retinula cells. These extend from close against the lining pigment cells to the preretinal membrane. They are interspersed near their bases by the arhabdomeric cells and intraretinal pigment cells, but are the sole cell type present in the vitread half of the retina. The size and extent of the retinula cells are similar in the normal and the albino. The location and staining properties of their nuclei are also similar, and in both cases

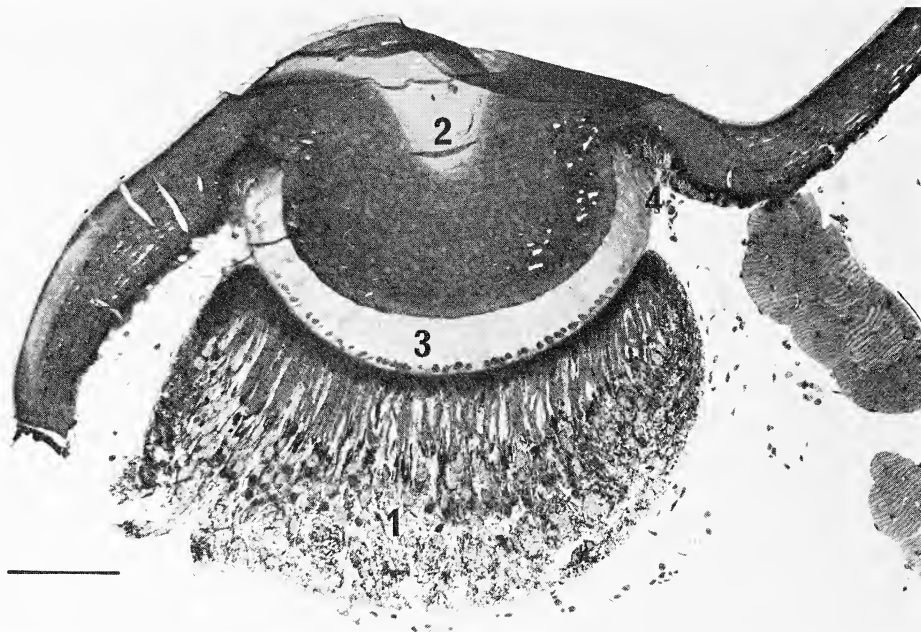

Fig. 4.—Normal median eye, coronal section. Retina, 1, is separated from lens, 2, by vitreous 3. Epidermis is heavily pigmented, particularly at limbus, 4. Retina contains abundant pigment. Scale = 100 μ m.



Fig. 5.—Albino median eye, coronal section. Retina, 1, epidermis, 2, and limbus, 3, are devoid of pigment. Scale = 100 μ m.

the cells give rise to nerve fibres that form bundles in the deep part of the eye before piercing the postretinal membrane to form the optic nerve.

The normal retinula cells each contain a rounded body called by Lankester and Bourne (1883) a phaosphere, presumably from their dark appearance in stained

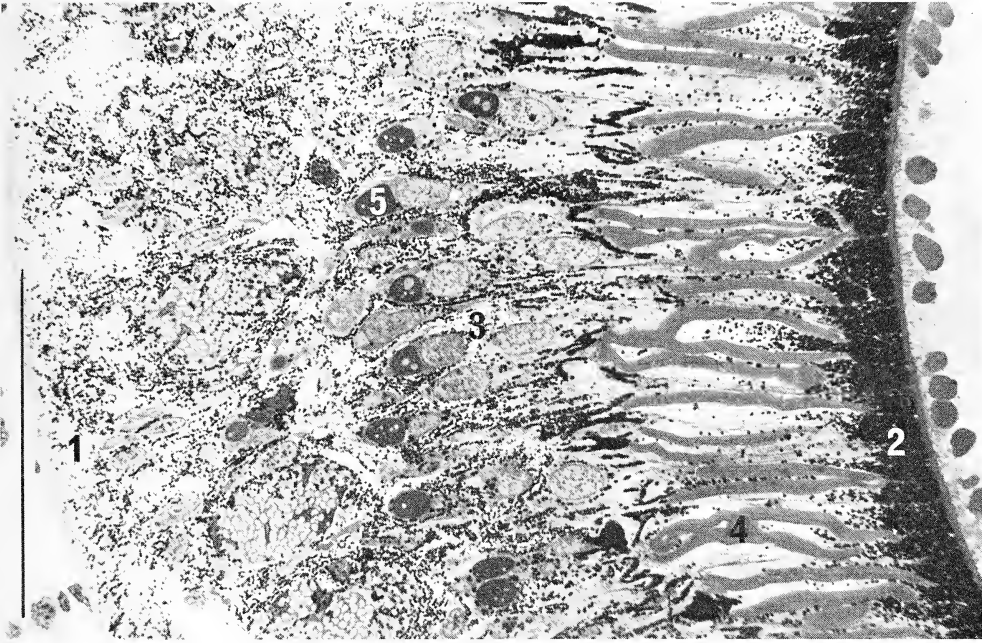

Fig. 6.—Retinal periphery, normal. Abundant pigment in peripheral pigment cells, 1, vitread end of retinula cells, 2, and in substance of retina, 3. Rhabdoms, 4, and phaospheres, 5, well formed. Scale = 100 μ m.

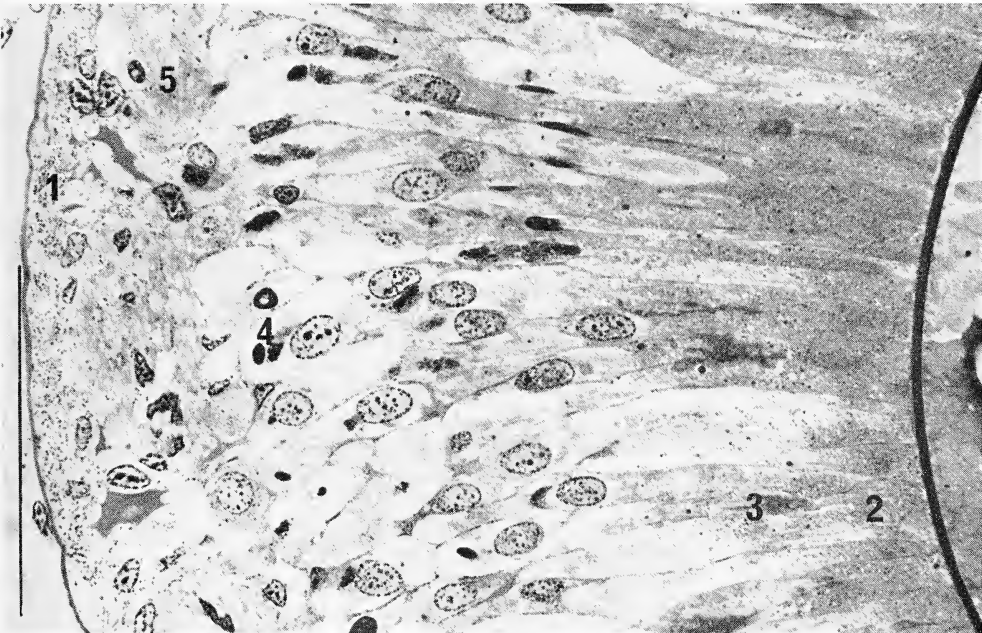

Fig. 7.—Retinal periphery, albino. Granules replace pigment in peripheral cells, 1, and retinula cells, 2, Rhabdoms, 3, and phaospheres, 4, are degenerate. Nuclei, and nerve fibres, 5, appear normal. Scale = 100 μ m.

sections. The phaospheres, of which at least one appears to be present in each retinula cell, are usually located deep to the nucleus and are of comparable size. Ultrastructurally they appear as an aggregation of dense granules approximately 40 nm in diameter (Fig. 10). The phaospheres contain vacuoles that stain with

basic fuchsin but not with the blue dyes, and that are described as refractile by other authors (Bedini, 1967). These vacuoles contain scattered granules, some similar to those aggregated and others smaller and frequently arranged in a paracrystalline array. Phaospheres have not been reported from other cell types, and their function remains unknown.

The phaospheres in the albino are abnormal (Fig. 11). In most cases they are represented by smaller and less regular clumps of dense amorphous material without the normal granular substructure, though some show the normal rounded profile and contain vacuoles.

The retinula cell processes vitread to the nuclei are in close mutual apposition, and from the abutting processes the rhabdomeres are formed over a distance of some 70 μm . Typically the cells are grouped in fives; the rhabdoms are consequently star shaped in cross sections in most cases, though other patterns are common, particularly in the periphery of the retina. Electron microscopy of the rhabdoms confirms the observations of Bedini (1967) and Fleissner and Schliwa (1977) that they consist of close arrays of uniform microvilli, approximately 80 nm diameter and up to 2 μm in length (Fig. 8).

An unexpected finding in the albino is that the rhabdoms are markedly degenerate. The length of the retinular cell along which rhabdomeres are formed is much reduced, and the normal star pattern is disorganised or absent. Electron microscopy shows that the normal grouping in fives is present, but that the rhabdomeres are represented only by small and disorganised arrays of microvillar material, lacking the density and regularity of the normal, (Fig. 9).

The normal retinular cells contain abundant melanin granules, some present in the base of the cell close to the nucleus, and even extending into the nerve fibres. Most granules are concentrated in the vitread ends of the cells where they effectively screen the rhabdoms from incoming light. These melanin granules appear identical to those in the pigment cells. Premelanosomes, membrane bound and with laminated bars or rings in them, are also found among the granules (Fig. 12).

The melanin granules are absent in the albino, their place being occupied by numerous premelanosomes that appear similar to those of the normal, except that they show a greater size range and are present in greater density (Fig. 13). These premelanosomes show the same distribution along the cell as the melanin granules of the normal, suggesting that they may have undergone circadian migration as do the normal melanin granules (Scheuring, 1913; Fleissner, 1974), or that they were permanently in the light regime position.

DISCUSSION

Before discussing the differences between the normal and albino examples we may review the factors affecting the colouration of scorpions. As Cutler and Richards (1972) point out, the dark colours commonly seen in arachnids are partly due to brown exocuticle and partly to pigment granules present in the epidermis, the features being present singly or alone.

Some scorpions are uniformly pale; *Centruroides sculpturatus* is a pale yellowish or clay colour, and the newborn young of *Urodacus manicatus*, and of other species illustrated in the literature, are white all over. This pallor is due to poorly sclerotized cuticle in the case of the young, but in *C. sculpturatus* the

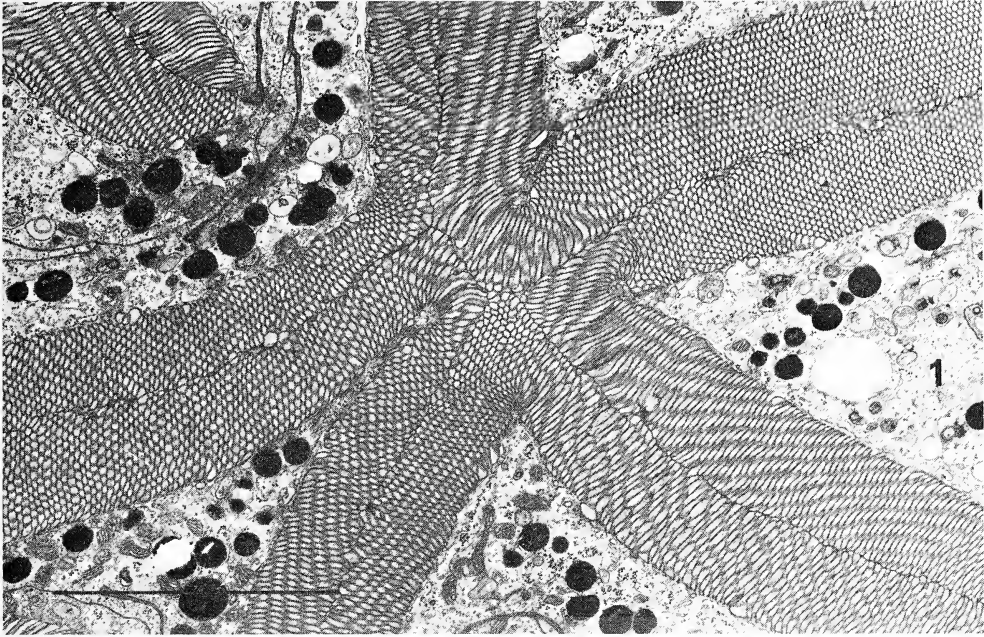

Fig. 8.—*T. S. rhabdom*, normal, E. M. Each retinula cell, 1, contributes microvilli to two arms of the star-shaped rhabdom. Cytoplasm contains mitochondria, ribosomes and abundant melanin granules. Scale = 5 μ m.

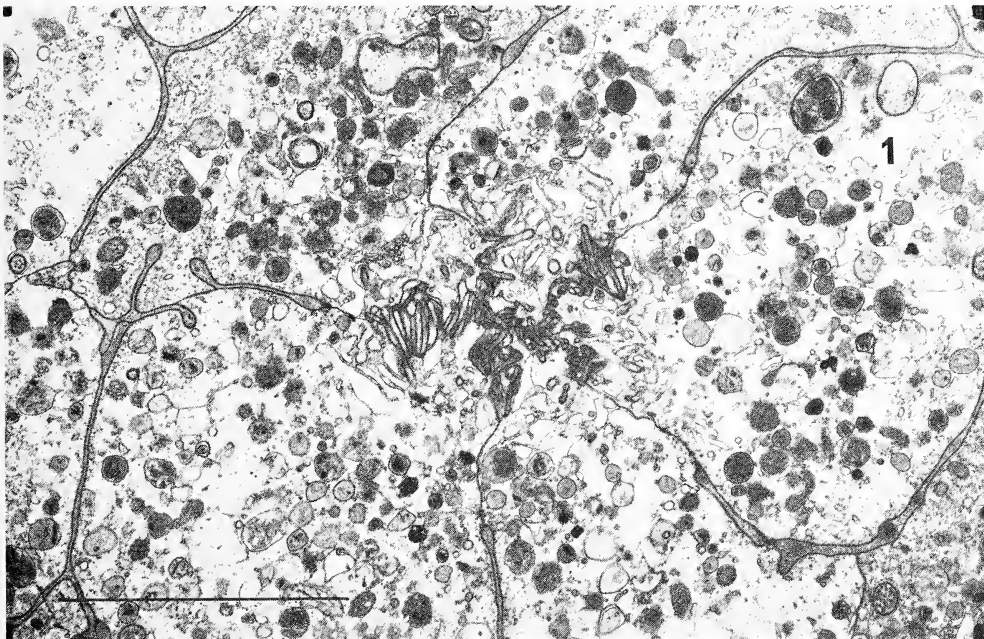

Fig. 9.—*T. S. rhabdom*, albino, E. M. Groups of five retinula cells, 1, bear reduced and disorganised microvilli. Mitochondria and ribosomes deficient. Pigment granules replaced by non-pigmented premelanosomes. Scale = 5 μ m.

cuticle is well sclerotized but pale, and there is little epidermal pigment. Other scorpions are very dark; *Heterometrus* species from Asia and *Urodacus manicatus* from Australia are cases in point. Of these *U. manicatus* certainly owes its colouration to both dark cuticle and epidermal pigmentation. The fingers and

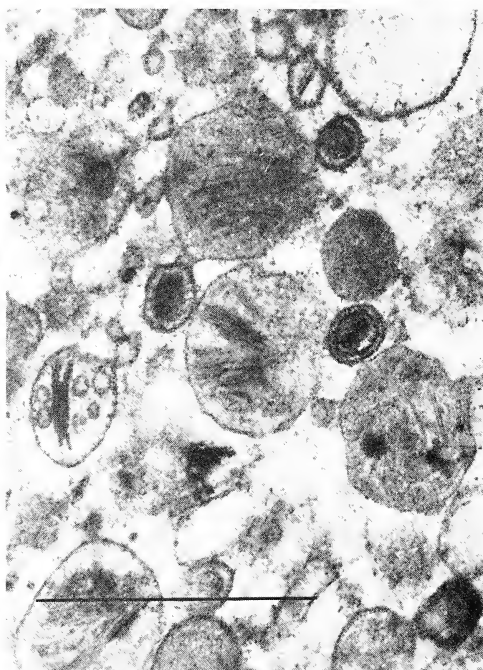
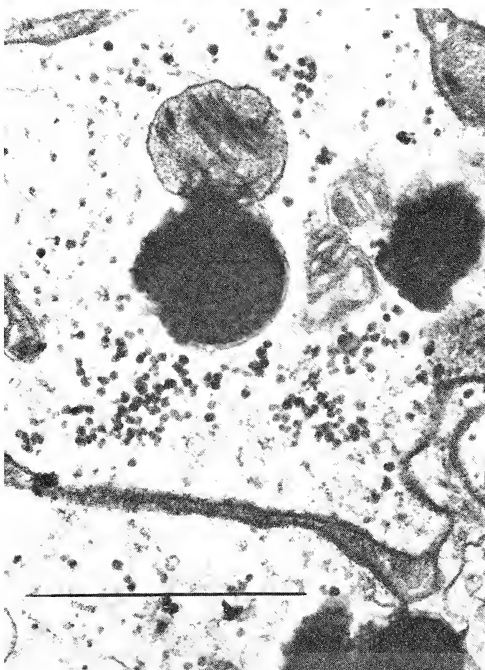
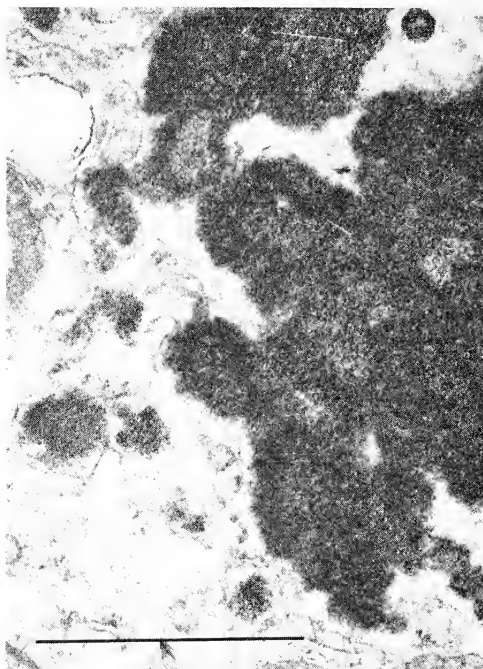
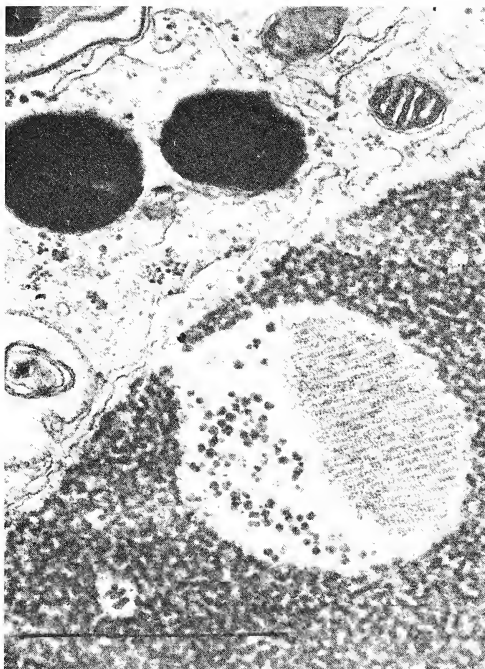

Fig. 10.—Phaosphere, normal, E. M. Phaosphere consists of aggregated granules. Similar granules present in cytoplasm and within vacuole. Paracrystalline array of smaller granules in some vacuoles. Scale = 1 μ m.

Fig. 11.—Phaosphere, albino, E. M. Dense amorphous mass replaces well-defined granules. Scale = 1 μ m.

Fig. 12.—Pigment granules, normal, E. M. Melanin granules are dense and membrane-bound. Adjacent premelanosome contains granular matrix and lamellae. Scale = 1 μ m.

Fig. 13.—'Pigment' granules, albino, E. M. Membrane-bound granules resemble normal premelanosomes, but occur in greater size range. No melanin present. Scale = 1 μ m.

aculeus are darkly sclerotized, but most of the darkness of the tergites is due to epidermal pigment. Other scorpions are patterned; *Lychas marmoreus* owes its pattern to epidermal pigment beneath a pale cuticle. Even the fingers are pale, though well sclerotized, recalling the pallor of *C. sculpturatus*.

Whatever the amount of pigment elsewhere in the epidermis, the eyes are almost always black. This is the case in *C. sculpturatus*, and the white newborn scorpions have densely pigmented eyes. The only cases in which eye pigment is usually lacking is in certain cavernicolous examples, e.g. *Typhlochactas* described by Mitchell and Peck (1977) which has lost its eyes altogether. Another troglobitic species, *Diplocentrus mitchelli* is described by Francke (1978) as retaining some eye pigment, even though the rest of the body is depigmented and the eyes are vestigial.

Comparing the albino and normal *U. yaschenkoi* we see that the darkness of the fifth metasomal segment and vesicle, and that in and around the eyes is due to pigment, but that the darkness of the chelae and chelicerae, the aculeus and tarsal claws, and the leg joints is due to darkly sclerotized cuticle.

Hackman (1974) notes that some insects may have melanin within the cuticle itself, besides the intracellular granules, but this does not appear to be the case in the scorpions examined here.

The process of melanin formation is summarized by Hogan, Alvarado and Weddell (1971) for the human retina: Rough endoplasmic reticulum within the melanin-forming cell elaborates the enzyme tyrosinase, which is thought to be transferred to the Golgi apparatus. Here it is packaged into the membrane-bound premelanosomes, which contain a finely striated protein framework with which the tyrosinase is associated. On this framework tyrosine is polymerised to form melanin; when polymerisation is complete and the granule mature, no further tyrosinase activity is demonstrable. In albinos the melanocytes contain vesicles and premelanosomes, containing a protein framework but no melanin; such individuals lack tyrosinase.

The present findings accord well with this scheme, despite the phylogenetic disparity between scorpions and humans and the smaller size of the invertebrate pigment granules. Melanin granules and premelanosomes are present in the normal, but the albino contains only premelanosomes, many containing laminated bodies but not melanin, and in a wider range of sizes than normal.

Accounts on vertebrate (Nyhan 1981) and insect (Hackman 1974) melanin formation agree on the biochemical pathway. An enzyme, tyrosinase or o-diphenyl oxidase, catalyses the conversion of tyrosine to dopa and then to dopa-quinone. The remaining steps, which can proceed non-enzymatically, at least in vertebrates, lead to moieties which undergo condensation to form a repeating polymeric structure of high molecular weight. This dark pigment, eumelanin, is bound to protein.

Hackman (1974) makes the point that the production of melanin, cuticular or intracellular, and the hardening or sclerotization of cuticular proteins both involve the conversion of tyrosine to dopa and dopa-quinone. The hardening of cuticle, in many cases accompanied by darkening (Andersen 1980), involves the tanning of a protein by quinones, which are derived from an o-diphenolic compound by an oxidase. In at least some cases the diphenol is tyrosine from the haemolymph (Pryor 1940, Fraenkel and Rudall 1940, 1947). The colour to which cuticle eventually tans will depend on the proportion of quinones to

residual diphenols; the quinoid, oxidised, state of the protein-bound material is dark (Hackman 1959).

Though the tyrosine-dopa-quinone pathway may be involved both in the hardening of cuticle and in melanin formation, the enzymes responsible for the two trains of reactions are probably different. Dennell (1958) found that injection of phenylthiourea into blowfly larvae completely suppressed the haemolymphal tyrosinase activity, preventing the formation of the normal black banding of the puparia, but not affecting their formation and sclerotization.

We may postulate a selective disability of tyrosinase in the present case, in which the formation of melanin is suppressed in an individual with normally sclerotized cuticle.

Fleissner (1974) confirmed Scheuring's (1913) observation that the retinal pigment granules normally undertake circadian migrations, being concentrated in the vitread part of the retina by day, and retreating to the basal part by night. Fleissner also showed that the sensitivity of the retina altered by 3 to 4 log units with the movement of the pigment. It is clear from examining sections of the retina in the light-adapted state that pigment is present vitread to the rhabdoms in such quantities as greatly to attenuate the amount of light that would penetrate to them.

Fleissner and Schliwa (1977) demonstrated neurosecretory fibres in the retina and suggested that these control the pigment migration, later shown by Fleissner and Fleissner (1978) to be mediated by the optic nerves. Section of the nerve did not merely abolish the pigment movement, which would be expected if the movement depended on visual impulses reaching the central nervous system, but the pigment assumed the daylight position, normally associated with an illuminated eye. They concluded that the pigment migration was controlled by efferents in the optic nerve. The cell bodies of these neurosecretory fibres were located in the supraoesophageal ganglion by Fleissner and Heinrichs (1982).

In view of the close association of the pigment with visual function it would not be surprising to find a functional deficit due to the lack of pigment in the albinos, but the structural disorganisation of the rhabdoms and of the phaospheres is unexpected. It may be that the integrity of the rhabdoms depends on protection from excess illumination, normally provided by the burrowing habit and by the screening pigment. That the observed degeneration was not caused by the laboratory regime is shown by the control, which was kept in the same conditions, and in which the rhabdoms appear large and well ordered. The nature and function of the phaospheres remain unknown, but it is interesting that they too show degeneration in the absence of pigment and of intact rhabdoms.

The presence of the much reduced and degenerate rhabdoms in the albino suggests that eye function was poor. Despite this, it had survived to the fourth instar, managing to catch prey while being surrounded by normal individuals, important potential predators. This survival of albino, and probably blind, individuals confirms the relative unimportance of vision in scorpions.

In diurnal animals albinism may be disadvantageous, since pale individuals may be more easily seen by predators. In dark environments this pallor will not matter, and many cave forms are depigmented. Some cave dwellers have degenerate eyes; others, including the *Typhlochactas* species described by Mitchell and Peck (1977) and certain opiliones (Briggs 1974), have lost their eyes altogether.

Though not a cave dweller, *U. yaschenkoi* does live in a burrow which spirals underground, and so is dark at the end (Shorthouse 1971, Koch 1978, Shorthouse and Marples 1980). The scorpion comes to the burrow mouth, and commonly beyond it, at nightfall. This habit was certainly present in the albinos, because the trapping method depends on it. This evening emergence suggests that the circadian behavioural rhythm of the species was present, in spite of the absence of pigment and disordered eye structure.

Consequences of albinism on scorpion metabolism other than those to the eyes are not obvious. Cloudsley-Thompson (1979) discusses the possibility that cuticular melanin may reduce water loss, and quotes Kalmus' (1941) finding that dark varieties of *Drosophila* withstand dehydration better than pale ones do. Kalmus' paper however does not distinguish unequivocally between darkness due to cuticular sclerotization or melanin production, cuticular or epidermal. Dark coloration is not associated with resistance to desiccation in scorpions. Edney (1977) points out that black scorpions from rain forests have high cuticular permeabilities while some pale desert scorpions have the lowest permeabilities recorded from any arthropod. Supposed waterproofing properties of melanin are probably unimportant in the present context, since *U. yaschenkoi* is a pale species, the only pigmented regions, one metasomal segment, the vesicle and the ocular area, representing a small fraction of the surface area.

Little can be said about the genetics of albinism in scorpions, since the phenomenon is only known from the two specimens now described. Albinism in man, which is due to a recessive gene, occurs with a frequency of about 1 in 20,000. If the rate is comparable in scorpions it would take a very large collecting effort to determine the rate in the wild. Shorthouse and Marples (1982) have shown that *U. yaschenkoi* takes at least 6y to reach maturity and that the gestation period is 18 months. In his extensive study of the species Shorthouse (1971) never observed mating, nor did he find females with first instar scorpions. These features of the life history, with the burrowing habit, mean that breeding experiments would be highly unlikely to succeed.

ACKNOWLEDGMENTS

I wish to thank my father, G. H. Locket, for introducing me to the study of arachnids, and for his invaluable example and discussions over the years. I thank my wife Deirdre for assistance in the field, Ms. Cathy Shanahan for advice on localities and collecting methods and discussion of scorpion genetics, Professor N. F. Hadley for valuable comments on the problems, Professor G. E. Rogers for discussions on biochemistry and Mrs. Barbara Sheldon for typing the manuscript.

LITERATURE CITED

- Andersen, S. O. 1980. Cuticular sclerotization. Pp. 185-215, in *Cuticle techniques in arthropods* (T. A. Miller, ed.). Berlin, Heidelberg, New York: Springer-Verlag.
- Bedini, C. 1967. The fine structure of the eyes of *Euscorpium carpathicus* L. (Arachnida, Scorpiones). *Arch. Italiennes Biol.*, 105:361-378.
- Belmonte, C, and L. J. Stensaas. 1975. Repetitive spikes in photoreceptor axons of the scorpion eye. *Invertebrate eye structure and tetrodotoxin*. *J. Gen. Physiol.*, 66:649-655.

- Briggs, T. S. 1974. Troglotic harvestmen recently discovered in North American lava tubes. (Travuniidae, Erebonastriidae, Triaenonychidae: Opiliones). *J. Arachnol.*, 1:205-214.
- Cloudsley-Thompson, J. L. 1979. Adaptive functions of the colours of desert animals. *J. Arid. Env.*, 2:95-104.
- Cutler, B. and A. G. Richards. 1972. Sclerotization and the localization of brown and black pigments in Chelicerates (Arthropoda). *Zool. Jb. Anat.*, 89:404-421.
- Dennell, R. 1958. The amino acid metabolism of a developing insect cuticle: The larval cuticle and puparium of *Calliphora vomitoria*. II. The non-specific hydroxylation of aromatic amino-acids and the production of polyphenols by the cuticle. *Proc. Roy. Soc. London. B.*, 148:280-284.
- Edney, E. B. 1977. Water balance in land arthropods. Berlin, Heidelberg, New York: Springer-Verlag, 282 pp.
- Fleissner, G. 1974. Circadiane Adaptation und Schirmpigment verlagerung in der Sehzellen der Medianaugen von *Androctonus australis* L. (Buthidae, Scorpiones). *J. Comp. Physiol.*, 91:399-416.
- Fleissner, G. and G. Fleissner. 1978. The optic nerve mediates the circadian pigment migrations in the median eyes of the scorpion. *Comp. Biochem. Physiol. A.*, 61:69-71.
- Fleissner, G. and S. Heinrichs. 1982. Neurosecretory cells in the circadian clock system of the scorpion *Androctonus australis*. *Cell Tiss. Res.* 224:233-238.
- Fleissner, G. and M. Schliwa. 1977. Neurosecretory fibres in the median eyes of *Androctonus australis* L. *Cell Tiss. Res.*, 178:189-198.
- Fleissner, G. and W. Siegler. 1978. Arhabdomeric cells in the retina of the median eyes of the scorpion. *Naturwiss.*, 65:210-211.
- Fraenkel, G. and K. M. Rudall. 1940. A study of the physical and chemical properties of the insect cuticle. *Proc. Roy. Soc. London. B.*, 129:1-35.
- Fraenkel, G. and K. M. Rudall. 1947. The structure of insect cuticles. *Proc. Roy. Soc. London. B.*, 134:111-143.
- Francke, O. F. 1977. The genus *Diplocentrus* in the Yucatan peninsula, with description of two new troglotites (Scorpionida, Diplocentridae). *Bull. Assn. Mexican Cave Stud.*, 6:49-61.
- Francke, O. F. 1978. New troglotite scorpion of genus *Diplocentrus*. *Scorpionida, Diplocentridae. Entomol. News*, 89:39-45.
- Hackman, R. H. 1959. Biochemistry of the insect cuticle. *Proc. Int. Congr. Biochem.* 4th. Vienna 1958, 12:48-62.
- Hackman, R. H. 1974. Chemistry of the insect cuticle. Pp. 215-270, *in*, The Physiology of Insects. Vol. VI. (M. Rockstein, ed.). New York, London, Academic Press.
- Hogan, M. J., J. A. Alvarado and J. E. Weddell. 1971. Histology of the human eye. Philadelphia, W. B. Saunders.
- Kalmus, H. 1941. The resistance to desiccation of *Drosophila* mutants affecting body colour. *Proc. Roy. Soc. London B.*, 130:185-201.
- Koch, L. E. 1978. A comparative study of the structure, function and adaptation to different habitats of burrows in the scorpion genus *Urodacus* (Scorpionida, Scorpionidae). *Rec. West. Australian Mus.* 6(2):119-146.
- Lankester, E. R. and A. G. Bourne. 1883. The minute structure of the lateral and central eyes of *Scorpio* and *Limulus*. *Quart. J. Micr. Sci.*, 23:177-212.
- Mitchell, R. W. 1968. *Typhlochactas*, a new genus of eyeless cave scorpion from Mexico (Scorpionida, Chactidae). *Ann. Speleol.*, 23:753-777.
- Mitchell, R. W. 1972. *Typhlochactas elliotti*, a new eyeless cave scorpion from Mexico (Scorpionida, Chactidae). *Ann. Speleol.*, 26:135-148.
- Mitchell, R. W. and S. B. Peck. 1977. *Typhlochactas sylvestris*, a new eyeless scorpion from montane forest litter in Mexico (Scorpionida, Chactidae, Typhlochactinae). *J. Arachnol.*, 5:159-168.
- Nyhan, W. L. 1981. Inheritable abnormalities of amino acid metabolism. Pp. 305-481, *in* Comprehensive biochemistry. Vol. 19A (A. Neuberger and L. L. M. van Deenen, eds.). Amsterdam, Elsevier.
- Parker, G. H. 1891. The eyes in scorpions. *Bull. Mus. Comp. Zool.*, 13:173-208.
- Pryor, M. G. M. 1940. On the hardening of the cuticle of insects. *Proc. Roy. Soc. London B.*, 128:393-407.
- Reynolds, E. S. 1963. The use of lead citrate at high pH as an electron-opaque stain in electron microscopy. *J. Cell Biol.*, 17:208-212.
- Scheuring, L. 1913. Die Augen der Arachniden. I. Die Augen der Skorpioniden. *Zool. Jb. Abt. Anat. Ontog.*, 33:553-588.

- Schliwa, M and G. Fleissner. 1979. Arhabdomeric cells of the median eye retina of scorpions Part 1. Fine structural analysis. *J. Comp. Physiol. A.*, 130:265-270.
- Schliwa, M. and G. Fleissner. 1980. The lateral eyes of the scorpion *Androctonus australis*. *Cell Tiss. Res.*, 206:95-114.
- Shorthouse, D. J. 1971. Studies on the biology and energetics of the scorpion *Urodacus yaschenkoi*. Ph.D. Thesis. Australian National University.
- Shorthouse, D. J. and T. G. Marples. 1980. Observations on the burrow and associated behaviour of the arid-zone scorpion *Urodacus yaschenkoi* (Birula). *Australian J. Zool.*, 28:581-590.
- Shorthouse, D. J. and T. G. Marples. 1982. The life stages and population dynamics of an arid zone scorpion *Urodacus yaschenkoi* (Birula 1903). *Australian J. Ecol.*, 7:109-118.

Manuscript received August 1985, revised December 1985.

RESEARCH NOTES

LAS CITAS DE *PACHYLUS CHILENSIS* PARA LA ARGENTINA
(OPILIONES, GONYLEPTIDAE, PACHYLINAE)

Si bien la presencia de *Pachylus chilensis* (Gray) en Argentina ha sido señalada en diversas ocasiones, las referencias son en su mayoría repeticiones de citas anteriores. Sólo cuatro de ellas corresponden a especímenes estudiados por el autor respectivo: Thorell (1877, 1878) consigna la especie para Córdoba; Sørensen para San Luis (1895) y Buenos Aires (1884), en tanto Roewer (1913) vuelve a indicar su presencia en esta última localidad. La mención de Roewer (1929) para "Argentinien (Aconcagua)" debe ser atribuida seguramente a la provincia chilena de ese nombre, como lo sugiere Ringuélet (1959); por otra parte, la referencia que este autor —siguiendo a Roewer (1929)— hace para "Santa Cruz: Estrecho de Magallanes" (Ringuélet, op. cit.) no es exacta, pues la cita original se limita a consignar: "Magelhaes-Strasse."

Aún excluyendo estas localidades cuestionables, *P. chilensis* parece ocupar en Argentina un área de distribución extensa; sin embargo, la especie no se halla representada en colecciones aracnológicas del país, ni fueron publicados nuevos hallazgos. Por este motivo, he procurado localizar el material estudiado por Thorell, Sørensen y Roewer, consultando para tal fin al Naturhistoriska Riksmuseet de Estocolmo (NRE), el Museo ed Istituto di Zoologia Sistemática della Università di Torino (MIZT), el Zoologisk Museum de Copenhage (ZMC) y el Muséum National d'Histoire Naturelle de Paris (MNHN), con los siguientes resultados:

Thorell (1877, 1878).—Menciona especímenes provenientes de Córdoba (hembra y juvenil) de *Pachylus granulatus* C. L. Koch; esta especie es colocada en sinonimia de *P. chilensis* por Sørensen (1884), involucrando con ello la cita de Thorell. Dichos ejemplares (NRE, Coll. Thorell, N° 76/119, "Córdoba, Weijenberg col.") corresponden en realidad a la especie *Sphaleropachylus butleri* (Thorell).

Sørensen (1895).—También aquí se trata de un error de identificación, pues los ejemplares examinados por Sørensen (MIZT, Op. 75, Provincia de San Luis, "*Pachylus chilensis*") son 2 machos adultos y uno juvenil de *S. butleri*.

Sørensen (1884).—Según el aracnólogo danés, en el Museum Hauniensis (Copenhage) existirían un macho y una hembra de *P. chilensis*, colectados por Kjellerup en Buenos Aires durante el viaje de la Galatea. Al parecer, Sørensen omitió rotular convenientemente el material, por lo que la localización de dichos especímenes no es segura. En el ZMC se encuentran varios goniléptidos conservados en seco, provistos de sendas etiquetas: "Buenos Ayres, Galatea"; uno de ellos es un macho de *P. chilensis*, en tantos los demás son *Acanthopachylus aculeatus* (Kirby), especie muy común en dicha localidad. Es posible que ese ejemplar sea uno de los referidos por Sørensen pero no tengo certeza de ello.

Roewer (1913).—Tal como lo consigna este autor, en el MNHN existe efectivamente un lote de *P. chilensis*, 2 machos y 2 hembras procedentes de

Buenos Aires (MNHN, nº 1601, 41-97); en el rótulo se especifica "det. Roewer, 1912", sin precisar fecha ni colector.

Lo expuesto plantea un amplio interrogante acerca de la inclusión de *P. chilensis* en el elenco opilológico argentino, toda vez que sólo el material del MNHN —y con margen para la duda, el del ZMC— coincide con lo indicado en su referencia original. Cabe agregar que existen dos citas de esta especie también para Montevideo, Uruguay (Sørensen 1902, Roewer 1913) ambas referidas al mismo lote conservado en el Zoologisches Museum de Hamburgo (ZMH); he tenido ocasión de consultar ese material (ZMH, Montevideo, Ehrhardt leg. 1870), comprobando que se trata de un par de hembras de *A. aculeatus* (aunque a juzgar por las etiquetas contenidas en el mismo tubo faltaría allí un macho de *P. chilensis*).

Agradezco a los Doctores T. Kronstedt (NRE), O. Elter (MIZT), H. Enghoff (ZMC), A. Muñoz-Cuevas (MNHN) y G. Rack (ZMH) el envío del material citado en este trabajo, y al Dr. E. A. Maury y el Sr. J. C. Cokendolpher la lectura del manuscrito.

LITERATURA CITADA

- Ringuelet, R. 1959. Los arácnidos argentinos del orden Opiliones. Rev. Mus. Arg. C. Nat., C. Zool., 5(2):127-439, lám. I-XX.
- Roewer, C. 1913. Die Familie der Gonyleptiden der Opiliones-Laniatores. Arch. Naturg., 79A(4):1-256, lám. I.
- Roewer, C. 1929. Weitere Weberknechte III. III Ergänzung der: "Weberknechte der Erde", 1923. Abh. Natur. ver. Bremen, 27(2):179-284, lám. I.
- Sørensen, W. 1884. Opiliones Laniatores (Gonyleptides W. S. olim) Musei Hauniensis Naturh. Tidskr. (ser. 3), 14:555-646.
- Sørensen, W. 1895. Viaggio del dottor Alfredo Borelli nella Repubblica Argentina e nel Paraguay. XVII. Opiliones Laniatores. Boll. Mus. Zool. Anat. Comp. Univ. Torino, 10(210):1-6.
- Sørensen, W. 1902. Gonyleptiden (Opiliones Laniatores). Ergeb. Hamb. Magalh. Sammlr., 2:1-36.
- Thorell, T. 1877. Sobre algunos arácnidos de la República Argentina. Period. Zoolog., 2(4):201-218.
- Thorell, T. 1878. Sobre algunos arácnidos de la República Argentina. Bol. Acad. Nac. Cienc. Córdoba, 2(3):255-272.

Luis Eduardo Acosta, Museo Argentino de Ciencias Naturales, Av. Angel Gallardo 470, 1405 Buenos Aires, Argentina.

Manuscript received June 1985, accepted September 1985.

A RANGE EXTENSION OF THE PURSEWEB SPIDER
***SPHODROS RUFIPES* IN EASTERN KANSAS**
(ARANEAE, ATYPIDAE)

Little is known about the behavior or ecology of atypid spiders, aside from descriptions of tube-web construction and prey capture (McCook 1888, Poteat 1890, Bristowe 1958) and partial descriptions of the natural history of a few species (Enock 1885, Muma and Muma 1945, Coyle and Shear 1981). Gertsch and Platnick's (1980) excellent paper provides a much needed taxonomic revision of the group as well as known distributions and notes on natural histories of the Nearctic species of atypids.

Atypids are patchily distributed, though locally abundant. The areas of abundance are often difficult to locate and associate with climatic and ecological variables, making their occurrence difficult to predict. They are more common in the southern U.S., where they are found in forested areas with sandy soil, or soil with a moderate to low clay content. In these areas, sites with southern exposures, often along a stream or in fairly mesic situations, seem to be the most prevalent purseweb habitats (Bristowe 1933, Muma and Muma 1945, pers. comm. Teeter).

This note extends the range of *Sphodros rufipes* (Latreille) to the northwest of previous records and is the first record of the species in Kansas. Previously published distribution is from eastern Texas to northern Florida and northward to southern Illinois and Rhode Island (Gertsch and Platnick 1980). *S. bicolor* and *S. milberti* have recently been synonymized with *S. rufipes* (Gertsch and Platnick 1980).

Wandering adult males of *S. rufipes* have been found in two separate areas in Douglas County in northeastern Kansas, syntopically with *S. niger* (Fitch 1963, Gertsch and Platnick 1980). Males of *S. niger* and *S. rufipes* were captured in a 2:1 ratio during the five week study period in May-July 1983 in baffle-type pitfall traps (in prep. Morrow). The traps were placed at approximately 20-30 m intervals in mixed hardwood forests at the University of Kansas Natural History Reservation (NHR) in Douglas County, near Lawrence, Kansas and the Breidenthal Tract, also in Douglas County, 3 km north of Baldwin, Kansas. Traps were checked every other day at each site during the study period.

S. rufipes is absent from the list of spider species found on the NHR (Fitch 1963), however, a preserved specimen from the NHR was recently uncovered from a private collection, an adult male *S. rufipes*, which had been misidentified as *S. fitchi*. Adult males of *S. rufipes* and *S. fitchi* are easily confused. Both have a black cephalothorax and abdomen and red legs. The two species can be discriminated by the extent of the red coloration present on the legs. In males of *S. rufipes* the femora and all distal leg segments are completely colored carmine red. In males of *S. fitchi* the red coloration is limited to the dorsal surface of the distal ends of the femora and all distal leg segments. Proximally, the femora of *S. fitchi* are a darkish brown to black, the same color as the cephalothorax. The shape of the sternum and the pattern of the sigilla on the sternum is also distinctive in the two species. For a more detailed description of characters, see Gertsch and Platnick (1980). Voucher specimens of male *S. rufipes*

were sent to the American Museum of Natural History, New York, and the Museum of Comparative Zoology, Cambridge.

Both the NHR site and the Breidenthal Tract have mixed populations of *S. niger* and *S. rufipes*. The possible occurrence of *S. fitchi* is currently being investigated. Both sites are mixed hardwood forest, predominantly oak-hickory, with moderate understory vegetation. In 1982 over 100 upright tube-webs located at the bases of trees and shrubs had been marked at NHR and over 150 at the Breidenthal Tract. Of these, approximately 20% contained spiders which had been tentatively identified as adult females of *S. niger* (c.f., Fitch 1963, Beatty 1983). A May 1984 census indicated only 20% of the originally marked population at both sites was still present. Only one individual believed to be an adult female of *S. rufipes* has been found. Unfortunately, this individual escaped before a positive identification could be made. One adult female, believed to be *S. fitchi*, has been found on a forested slope adjoining the Breidenthal site.

Adult females and immatures of both sexes are not known to leave their tube-webs, except under extreme conditions. Wandering adult males may be found seasonally. Over 40 males of *S. niger* and 20 of *S. rufipes* were captured during a five week emergence in May-July 1983 at both locations. During the following year, 35 males of *S. niger* and 4 of *S. rufipes* were captured. This seems to be a large percentage of the population, given the total number of tube-webs marked, probably contributing to the decline in population density over the past two years. If these samples represent a typical emergence size, perhaps the total population is larger than indicated, or males are capable of dispersing over large distances (200 m). A mark, release and recapture experiment using males of *S. niger* proved inconclusive. Alternatively, males may have a more rapid maturation rate than presently suspected. A large number of medium sized tube-webs were found empty or abandoned following the emergence. Current data suggest that the 1983 emergence represents a peak year, possibly a cyclic occurrence, in a population of fluctuating size. Demographic evidence indicates a high mortality rate during extremely cold winters and hot summer drought conditions. These temperature extremes may be the primary factors limiting the ranges of these spiders.

A third species, *S. fitchi*, which had previously, though rarely, been collected at the NHR in or near grasslands was not collected in pitfall traps at this site. Advanced succession at the NHR could be responsible for a decrease in abundance of this species. Large, uninhabited tube-webs have been found in prairie and grassland areas at the NHR (c.f., Muma and Muma 1945). *S. fitchi* and *S. rufipes* may prefer more open woodlands or ecotone situations to dense, forested areas where *S. niger* is more common. Males of both *S. fitchi* and *S. rufipes* share distinct carmine red legs, an unusual coloration among atypids. This coloration may be associated with some form of mimicry or aposematic display advantageous to wandering males (Coyle and Shear 1981).

LITERATURE CITED

- Beatty, J. A. 1983. Discovery of the webs of the atypid *Sphodros niger*. Amer. Arachnol., 28:11.
Bristowe, W. S. 1933. Notes on the biology of spiders. —IX. The British species of *Atypus*. Ann. Mag. Nat. Hist., ser. 10, 11:289-302.

- Bristowe, W. S. 1958. *The World of Spiders*. Collins, London, 304 pp.
- Coyle, F. A. and W. A. Shear. 1981. Observations on the natural history of *Sphodros abboti* and *Sphodros rufipes* (Araneae, Atypidae), with evidence for a contact sex pherome. *J. Arachnol.*, 9:317-26.
- Enock, F. 1885. The life history of *Atypus piceus* Suly. *Trans. Entomol. Soc. London*, pp. 389-420.
- Fitch, H. S. 1963. Spiders of the University of Kansas Natural History Reservation and Rockefeller Experimental Tract. University of Kansas Publs., Mus. Nat. Hist., Lawrence, 202 pp.
- Gertsch, W. J. and N. I. Platnick. 1980. A revision of the American spiders of the family Atypidae (Araneae, Mygalomorphae). *American Museum Novitates*, 2704:1-39.
- McCook, H. C. 1888. Nesting habits of the American purseweb spider. *Proc. Acad. Nat. Sci. Philadelphia*, pp. 203-20.
- Muma, M. H. and K. E. Muma. 1945. Biological notes on *Atypus bicolor* Lucas (Arachnida). *Entomol. News*, 56(5):122-26.
- Poteat, W. L. 1890. A tube-building spider. *J. Elisha Mitchell Sci. Soc.*, 6(2):134-47.

Willard Morrow, Department of Entomology, University of Kansas, Lawrence, Kansas 66045 (Present address: University of Pennsylvania School of Veterinary Medicine, 3800 Spruce Street, Philadelphia, Pennsylvania 19104).

Manuscript received October 1984, revised December 1984.

VERTICAL COPULATION CAN OCCUR IN *LYCOSA MALITIOSA* TULLGREN (ARANEAE, LYCOSIDAE)

During studies on the sexual behavior of *Lycosa malitiosa* Tullgren we observed several copulations occurring on the cage wall (Fig. 1). It has been assumed that lycosid copulation (position II, Gerhardt, U. 1924. *Arch. Naturgesch.*, 90:85-192) always occurs in the horizontal plane. This view may result from the general use of glass or plastic cages, which prevent lycosid spiders from climbing.

Lycosa malitiosa is a large, terrestrial species. It is often collected among stones in sandy areas with short grass (Capocasale, R. M. y F. G. Costa, 1975. *Vie et Milieu*, 25(1):1-15). They have also been found *in copula* under stones (Costa, F. G. and F. Pérez-Miles, *occas. obs.*). Copulation is lengthy: 288 palpal insertions during 99 min, at 21°C in laboratory conditions (Costa, F. G. 1979. *Rev. Brasil. Biol.*, 39(2):361-376).

Spiders were separately housed in cylindrical cages with metallic mesh walls (12 cm diameter x 12 cm height) that were closed above and below with plastic dishes. These cages are useful because they extend the locomotory freedom of lycosid spiders, and they also improve the control of environmental parameters by external equipment. Each male was stimulated with sexual pheromone (female silk threads) and then introduced to the female's cage. The male's courtship — foreleg jerking and palpal drumming, described elsewhere (Costa, F. G. 1975. *Rev. Brasil. Biol.*, 35(3):359-368) — was generally seen while the spiders were on the cage wall.

Twenty-four copulations of virgin spiders occurred: 13 on the floor (horizontal copulations), 10 on the wall (vertical copulations), and one that began vertically (first 15 min) and, after descending to the floor, was completed horizontally, all without any difficulties. Within vertical copulations, 6 occurred with the female

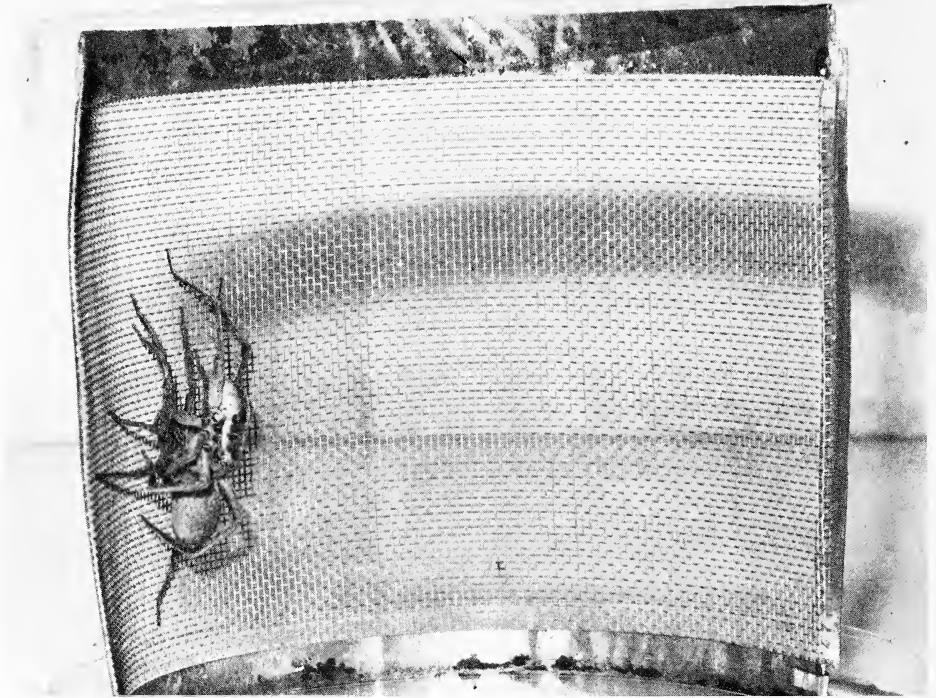

Fig. 1.—Side view of a vertical copulation of *Lycosa malitiosa* (male facing down and female facing up). To take this picture, the cylindrical cage wall was sectioned (Photography: R. M. Capocasale).

face down (and male face up), 3 with the female face up, and one with the longitudinal axis of the couple parallel to the floor. No qualitative or quantitative differences were found within vertical copulations, and none between vertical and horizontal copulations (mean durations: 76 min and 75 min, respectively, at 27°C).

The couple's orientation showed no influence of gravity on mating embrace or copulatory pattern in *L. malitiosa*. The couple's maintenance of a vertical orientation may be attributed mainly to the female's ability to hang on the wall, since only legs IV of the male grasped the cage wall (Fig. 1). These results do not agree with a view of a passive role ("cataleptic state") for lycosid females *in copula*.

We thank R. M. Capocasale and F. Pérez-Miles for the comments, and A. Postiglioni and J. S. Rovner for the English version of the manuscript. This work was supported by "Programa Regional de Desarrollo Científico y Tecnológico de O.E.A."

Fernando G. Costa and **J. Roberto Sotelo, Jr.**, Divisiones Zoología Experimental y Biofísica, Instituto de Investigaciones Biológicas Clemente Estable, Avenida Italia 3318, Montevideo, Uruguay.

Manuscript received October 1984, revised May 1985.

**CHROMOSOMES OF *LEIOBUNUM JAPONICUM JAPONICUM*
AND *LEIOBUNUM PAESSLERI* (ARACHNIDA, OPILIONES)**

The chromosomes of sixteen harvestmen of the genus *Leiobunum*, have been examined (Sokolow 1930, Parthasarathy and Goodnight 1958, Suzuki 1941, 1957, 1976a,b, Tsurusaki 1985). The early investigators used paraffin section and/or squash methods and usually were unable to make precise karyological analyses or to discriminate sex chromosomes. Recently air-drying techniques have become available and Tsurusaki (1982, 1985) has used them on several harvestmen with good results. In this note, we describe karyotypes of two species of *Leiobunum* that were successfully analyzed by the same method.

Leiobunum japonicum japonicum Müller: $2n$ (σ , ♀) = 20, NF = 40 (Fig. 1). Two juvenile specimens, one of each sex from Maruyama in Sapporo, Hokkaido, Japan were dissected on 16 July 1982. Six adult males from Mt. Kiyosumi, Chiba prefecture, Honshu were also prepared on 29 August 1984. The chromosome analysis was based on examination of 35 spermatogonial metaphase plates. There was one pair of heteromorphic chromosomes that consisted of a submetacentric similar in size to chromosomes 1-4 and a small metacentric similar in size to chromosome 8. We presume that this heteromorphic pair constitutes the sex

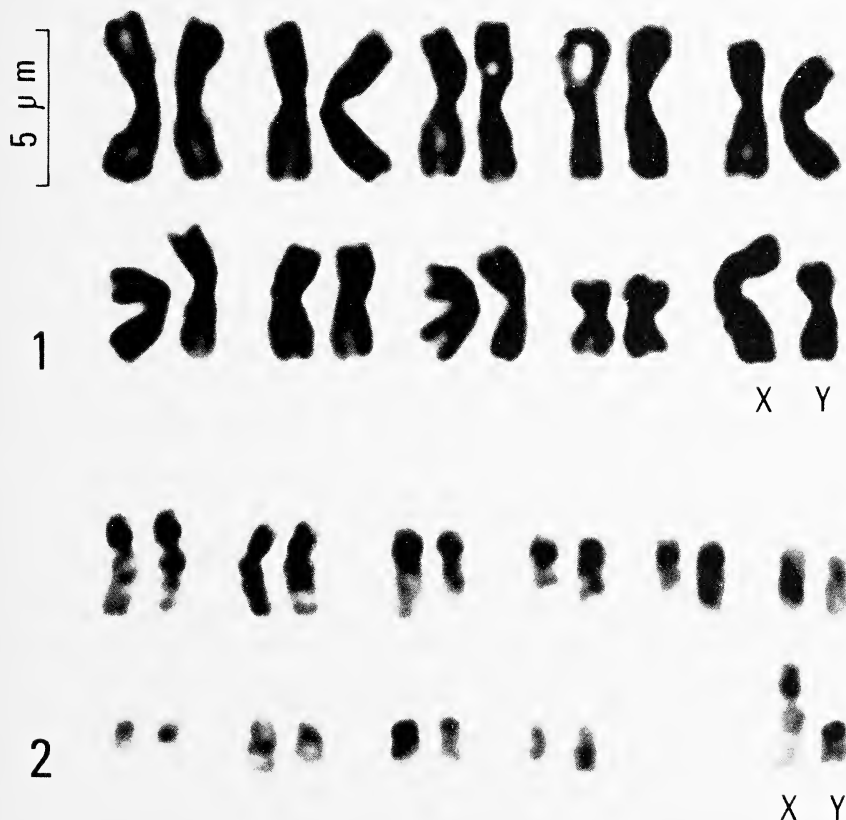

Figs. 1-2.—Male karyotypes of two species of *Leiobunum*: 1, *L. japonicum japonicum* ($2n = 20$); 2, *L. paessleri* ($2n = 22$).

chromosomes, and that the larger member of the pair is the X and the smaller the Y chromosome. The autosomes consisted of 9 pairs of metacentric chromosomes. Numerous first meiotic metaphases from adult males invariably showed 10 bivalents. No differences were detected between the males from the two locations. Unfortunately, no mitotic metaphase plates good enough for karyological analysis were obtained from the female. However, 20 chromosomes could be clearly counted from one ovarian follicle cell. The diploid chromosome number of $2n = 20$ was previously reported for the male of this species by Suzuki (1941).

Leiobunum paessleri Roewer: $2N$ (♂) = 22. $NF = 44$ (Fig. 2). Adult specimens were collected near Kuskonook, British Columbia, Canada on 19 October 1984 and stored at about 5°C until needed. One male was dissected on 22 February and three more on 14 May 1984. Based on an examination of 13 well spread spermatogonial metaphase plates, the diploid chromosome number was determined to be 22. The presumed X and Y chromosomes were, respectively, a large submetacentric, about the size of the largest autosomal chromosome, and the smallest metacentric. The autosomes consisted of 10 pairs of meta- or submetacentrics. Numerous first meiotic metaphases showed 11 bivalents without exception.

Sharma and Dutta (1959) first reported the existence of heteromorphic chromosomes in opilionids. Since then, Tsurusaki (1982, 1985, unpubl.) has distinguished X and Y chromosomes in *Paraumbogrella huzitai* as well as six species of the *Leiobunum curvipalpe*-group. Similarly, in males of the two species reported here, we distinguished a pair of heteromorphic chromosomes that probably correspond to the X and Y. These results further support the prediction of Tsurusaki (1982) that an XX-XY mechanism is the usual mode of sex-determination in opilionids.

All *Leiobunum* species thus far studied have diploid chromosome numbers between 16 and 26 (Sokolow 1930, Parthasarathy and Goodnight 1958, Suzuki 1941, 1957, 1976a, b, Tsurusaki 1985, unpubl.). In the two species considered here, where $2n = 20$ and 22, all the chromosomes were invariably found to be meta- or submetacentric, with no acrocentrics or telocentrics. This stability in chromosome structure has also been observed in almost all species of the *curvipalpe*-group (Tsurusaki 1985, unpubl.), in which the diploid number fluctuates widely from 18 to 26.

We thank Dr. Ramesh Bhambhani of the University of Alberta and Mr. James C. Cokendolpher of Texas Tech University for their valuable comments on the manuscript. N. T. also thanks Prof. Mayumi Yamada, Hokkaido University, for his constant encouragement.

LITERATURE CITED

- Parthasarathy, M. D. and C. J. Goodnight. 1958. The chromosomal patterns of some Opiliones (Arachnida). *Trans. Amer. Microsc. Soc.*, 77:353-364.
- Sharma, G. P. and G. P. Dutta. 1959. On the male heterogamety in *Melanopa unicolor* Roewer (Opiliones-Arachnida). *Res. Bull. (N.S.) Punjab Univ.*, 10:209-213.
- Sokolow, I. 1930. Untersuchungen über die Spermatogenese bei den Arachniden. IV. Über die Spermatogenese der Phalangiiden (Opiliones). *Z. Zellforsch. mikrosk. Anat.*, 10:164-194, T. 6-8.
- Suzuki, S. 1941. On the chromosomes of some opilionids. *Zool. Mag. (Tokyo)*, 53:101. (In Japanese).
- Suzuki, S. 1957. On the three closely related forms of the genus *Liobunum* (Phalangiidae, Opiliones). *J. Fac. Sci. Hokkaido Univ., Ser. VI, Zool.*, 13:109-117.

- Suzuki, S. 1976a. Cytotaxonomy in some species of the genus *Leiobunum* (Opiliones, Arachnida). Proc. Japan Acad., 52:134-136.
- Suzuki, S. 1976b. The genus *Leiobunum* C. L. Koch of Japan and adjacent countries (Leiobunidae, Opiliones, Arachnida). J. Sci. Hiroshima Univ., Ser. B, Div. 1, 26:187-260.
- Tsurusaki, N. 1982. Chromosomes of the Japanese gagrellid, *Paraumbogrella huzitai* Suzuki (Gagrellidae, Opiliones, Arachnida). Bull. British Arachnol. Soc., 5:397-398.
- Tsurusaki, N. 1985. Taxonomic revision of the *Leiobunum curvipalpe*-group (Arachnida, Opiliones, Phalangiidae). I. *hikocola*-, *hiasai*-, *kohyai*-, and *platypenis*-subgroups. J. Fac. Sci., Hokkaido Univ., Ser. VI, Zool., 24:1-42.

Nobuo Tsurusaki, Zoological Institute, Faculty of Science, Hokkaido University, Sapporo 060, Japan and **Robert G. Holmberg**, Sciences, Athabasca University, Athabasca, Alberta, T0G 2R0, Canada.

Manuscript received November 1984, revised June 1985.

ONTOGENETIC CHANGES IN THE WEB OF *EPEIROTYPUS* SP. (ARANEAE, THERIDIOSOMATIDAE)

A recent summary of information on changes in spider web design during ontogeny showed that when ancestral as opposed to derived designs can be distinguished, adult webs are usually more derived than those of juveniles (Eberhard, W. G. 1985. *Psyche* 92:105-117). This note on an undescribed species in the theridiosomatid spider genus *Epeirotypus* demonstrates another possible example of this pattern of change, and documents further differences between the webs of young and old spiders.

Adult spiders in the genus *Epeirotypus* construct orb webs with a spring line that is out of the plane of the orb, and the spider reels the line in as it sits at the hub, thus pulling the web into a cone (J. Coddington pers. comm., pers. obs.). In some species the web is built near a more or less vertical object such as a tree trunk or a rock, and the spider reels in the entire spring line so that its body is very close to or perhaps in some cases actually in contact with the substrate as it waits at the hub (Fig. 1). These webs may be derived with respect to those in which the spider is not next to a substrate as it holds the web tight (other *Epeirotypus*, *Theridiosoma*, and *Ogulnius*, *Wendilgarda galapagensis*—see McCook, H. C. 1889. *American Spiders and their Spinningwork*. I. Webs and Nests. published by the author, Philadelphia; Coddington, J. in press, *in Spider webs and Spider Behavior* [W. Shear, ed.], Stanford Univ. Press, Palo Alto; pers. obs.), though other relationships are also feasible (J. Coddington, pers. comm.). Sudden sounds nearby usually cause *Epeirotypus* spiders to release the reeled-up spring line, thus making the web (and themselves) “snap” backward as in *Theridiosoma* (McCook, H. C. 1889). This response presumably aids in prey capture and defense against predators.

Sites and methods.—*Epeirotypus* sp. was studied 10-14 Feb., 1985 on mossy tree trunks just inside a long narrow pasture (estimated 300 x 50 m) in the midst of forest about 0.5 km down the road from the Tropical Science Center research



Fig. 1.—Large *Epeirotypus* sp. (probably fifth instar) at hub of web. The spider (arrow) has reeled in the entire spring line, and is touching or nearly touching the moss to which the line is attached.

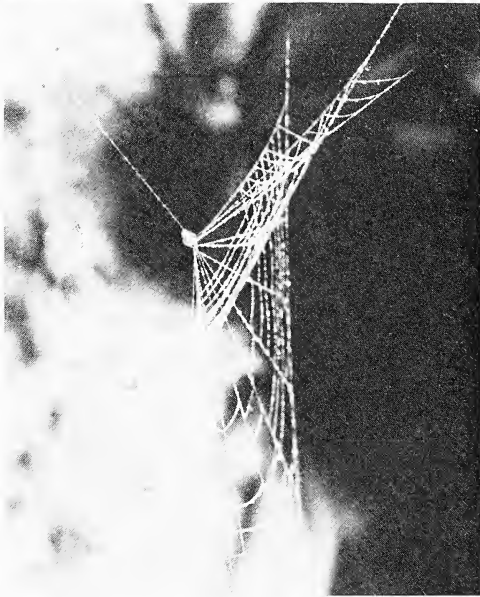

Fig. 2.—Small *Epeirotypus* sp. (probably first instar) at hub of web. Spider has reeled in only a small fraction of the spring line.

station in Monteverde, Costa Rica (elevation about 1200 m). The planes of most orbs were more or less vertical, but angles were not measured. Webs were gently coated with cornstarch before being measured with a ruler held near the web. The angle between the web plane and the spring line was estimated visually. The number of loops of sticky spiral was the average of the numbers of loops directly above and directly below the hub, and the average space between sticky spiral lines was calculated by dividing the number of loops by the distance from the innermost to the outermost loop of sticky spiral directly above the hub and directly below it. Spiders often replaced part or all of the spring line after the web was powdered, then reeled in the new line and tensed the web again; otherwise they did not usually alter their webs while I measured them. This

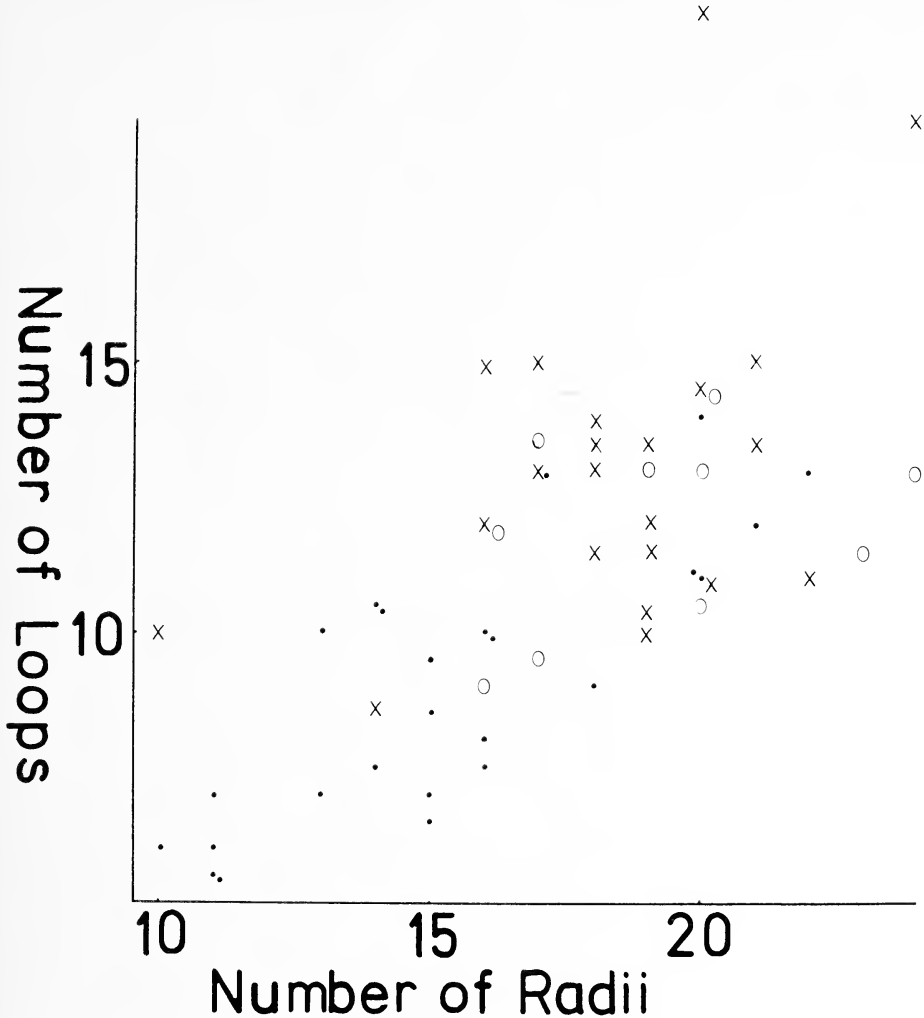

Fig. 3.—Number of radii versus average number of loops of sticky spiral in webs of small (dots), medium (circles), and large (x) *Epeirotypus* sp. spiders.

species apparently passes through four or five instars before reaching maturity (unpub. analysis of the distribution of sizes), but in this study spiders were classified as "small" (av. max. carapace width $0.45 \pm \text{s.d. } 0.05$ mm — probably corresponding to instars 1 and 2), "medium" (carapace width 0.67 ± 0.03 m — probably instar 3), and "large" (carapace length 0.77 ± 0.24 mm — probably instars 4 and 5). No other spiders with similar webs (orbs with spring lines and hub loops) were found on these trees, so the species identity of even the younger instars is relatively certain. Voucher specimens of adults are deposited in the Museum of Comparative Zoology, Cambridge, Massachusetts, and the U. S National Museum in Washington, D.C.

Results.—The distance (measured along the spring line) from the spider to the substrate while the spider held the web tensed varied with spider size. Averages were 0.2 cm for large ($N = 21$), 0.4 cm for medium ($N = 12$), and 1.6 cm for small spiders ($N = 21$); small spiders rested significantly farther from the substrate than did large spiders ($p < 0.01$ with Mann-Whitney U Test).

The angle between the web plane and the spring line apparently increased with spider size. Average estimated angles for small, medium and large spiders were 44, 49, and 65 respectively; the difference between small and large were significant ($p < 0.01$ with G Test when angles were grouped in categories of 20-39, 40-60, and 70-90, and with Mann Whitney U Test). One small spider had an orb without a spring line.

Webs of small spiders had fewer radii and sticky spiral loops, and their sticky spiral lines were closer together than those of larger spiders ($p < 0.01$ for all three with Mann-Whitney U Test; average distances between loops of sticky spirals were 0.16, 0.21, and 0.23 cm for small, medium and large spiders). As shown in Fig. 3, the relationship between numbers of radii and sticky spiral loops in small and large spiders' webs did not change (analysis of covariance showed that the relationship was not significantly different in the two groups).

There was no difference in the degree of above vertical asymmetry (above hub vs. below hub) in the webs of large and small spiders. In both groups the average space between sticky spiral loops was usually slightly larger below the hub than above (totals 26 larger vs 14 smaller, $p < 0.05$ with Chi Squared Test), and usually there were fewer loops below the hub (total 9 webs) than above (24 webs) ($p < 0.01$ with Chi Squared Test; 21 webs had equal numbers of loops above and below the hub).

Discussion.—One of the differences between the webs of small (younger) and large (older) spiders is that the distance between smaller spiders and the substrate measured along the spring line as the spider rests at the hub is larger—a character that is probably less derived (more nearly like that of the probable ancestor of this group) than is that of large spiders. Another difference, the angle the spring line makes with the web plane, may follow this same pattern if spring lines were derived from radial lines (spring lines and other lines running out of the orb plane from the hub are laid as part of radius construction by some theridiosomatids and anapids—Eberhard, W. G. 1982. *Evol.* 36:1067-1095; Coddington, J. in press; pers. obs.). The polarity (primitive vs derived) of the other web characters mentioned is not known. If further studies continue to follow the trend for juvenile characters to be less derived, ontogenetic changes in web design may be useful in deducing the direction of evolution in orb web design in this and other groups.

I thank Jonathan Coddington for identifying the spiders and reading a preliminary version of the manuscript, and the Vicerrectoría de Investigación of the Universidad de Costa Rica for financial support.

William G. Eberhard, Smithsonian Tropical Research Institute, and Escuela de Biología, Universidad de Costa Rica, Ciudad Universitaria, Costa Rica.

**POSSIBLE PARTHENOGENESIS IN THE HUNTSMAN SPIDER
ISOPODA INSIGNIS (ARANEAE, SPARASSIDAE)**

On the 7th of August at Lake Bonney on the River Murray an immature female *Isopoda insignis* (Thorell) huntsman spider (South Australian Museum voucher specimen N1985143) was found beneath a piece of bark on a dead *Eucalyptus* tree. It was caught, returned to Adelaide, and kept in a large plastic container, being fed occasionally with a large blowfly. In October the spider underwent its final moult to become a sexually mature female. During its captivity the spider was kept in complete isolation from all other spiders. During the early morning on the 26th of December a single eggsac was laid on the bottom of the container. It was white, lenticular, 35mm in diameter, 5 mm in height and attached by a few lateral non-viscid threads to the container bottom. During incubation the mother ceased feeding and guarded the eggsac with her body. The spiderlings hatched before dawn on the 21st of January. One hundred and twelve spiderlings emerged from a large rough hole in the dorsal surface of the eggsac. It was not possible to observe if the mother perforated the eggsac for the young, as occurs in *Delena cancerides* Walckenaer (Windsor L. 1972. Victorian Nat. 89:355-366, Coleman E. 1941. Victorian Nat. 58:88-90). Examination of the eggsac revealed eight light yellow eggs which had become crumpled through dehydration amongst the exuviae of the newly hatched young.

Sperm retention has been recorded by a female *Paraplectanoides crassipes* Keyserling for over five years (Hickman V. V. 1975. Bull. British Arachnol. Soc. 3:166-173) with a 91% fertility rate. All other recorded cases of sperm retention have been for eighty days or less, with fertility rates of less than 20% (Valerio C. E. 1970. Bull. British Arachnol. Soc. 1:28). It is unusual for spiders with short life spans to moult after mating, but huntsmen spiders may live several years (Hickman V. V. 1967. Tasmanian Museum and Art Gallery, Hobart). However, sperm retention requires a fully developed reproductive system, in particular epigynal openings, not present in this specimen prior to its penultimate moult. Females of this species have been observed only to become sexually receptive after their final moult (Clyne D. 1971. Victorian Nat. 88:244-248, McKeown K. 1952. pp. 85-86 Angus and Robertson). It is therefore unlikely that the young resulted from a mating by the mother, prior to capture.

The only other possible explanation is parthenogenesis. Parthenogenesis has been known to occur in spiders for many years (Savory T. H. 1928. Sidgwick and Jackson, London pp. 246-247) but is rare and usually results in a low fertility rate. In this instance the fertility rate was 93%.

David C. Lake, South Australia Museum, North Terrace Adelaide, South Australia 5000.

WEB STRUCTURE AND BURROW LOCATION OF *SPHODROS NIGER* (HENTZ) (ARANEAE, ATYPIDAE)

The purse-web spider *Sphodros niger* (Hentz) has long been regarded as one of the rarer North American mygalomorphs. In their recent revision, Gertsch and Platnick (1980 Amer. Museum Novitates, 2704:1-39) list only 47 specimens examined by them, though others doubtless are to be found scattered in various collections.

The spider's apparent rarity may be due principally to the fact that its habitat is unknown. Whereas other atypids, such as *Sphodros rufipes* (Latreille) and *Sphodros abbotii* Walckenaer build tubular webs attached to the bases of trees, *S. niger* is not known to do so, and its burrow has rarely been found. Of the 47 specimens listed by Gertsch and Platnick (op. cit.) only 6 were females. The males were captured mostly in pitfalls, or when they were seen wandering about on the ground. Of the six females, one was taken from the stomach of a frog, no information on web or burrow is given for four others, and one was taken from a "tube in leaf mould." The latter appears to be the only existing clue to the location of this species' burrows.

Recently it has been suspected (Gertsch and Platnick, op. cit.) that *S. niger* lays the above-ground portion of its tube flat on or near the ground as the European species of *Atypus* and the American *Atypus snetsingeri* Sarno are known or believed to do. This suspicion has been confirmed by my discovery in 1981 of the tubes and burrows of *S. niger* on Gibraltar Island, Lake Erie, Ottawa Co., Ohio.

The first web found, that of a tiny juvenile, was standing erect and attached to a grass blade in the lawn near the northeast end of the island, at the site shown in Figure 1. This tube was about 20mm high and 1.5mm in diameter. Further search of the area disclosed 15-20 more tubes, all but one or two of which lay flat on the ground, concealed by the grass. All of these tubes occurred in an area measuring about 5 by 20 feet.

As is usual with atypids, the tubes were partially covered externally with particles of soil and local debris, bits of grass blades in this case. There were few very small tubes, no more than 2-3 were found in any one summer. The size distribution of the tubes was otherwise made up of about equal numbers of tubes of each size class. Almost all were judged as being made by individuals ranging from about half-grown to adult.

During the next two summers (I have not visited the island more recently) additional specimens were found at the same spot, though few were collected. Searching in other parts of the island has revealed a few tubes in widely scattered areas, but no more concentrations such as occur at the original site. One of these other areas is shown in Figure 2, and a large, but somewhat worn (perhaps abandoned?) tube found there is illustrated in Figure 3. This web was left undisturbed. The next year no tube could be found in this spot.

Considering the habitats of *S. abbotii* and *S. rufipes*, the placement of the *S. niger* burrows is surprising. The soil on Gibraltar Island is, in most places, hard and rocky, and often quite dry. The subterranean portions of the *S. niger* tubes sometimes twist tortuously around and between buried rocks. In very dry weather the "aerial" portions of the tubes are often completely packed with soil,

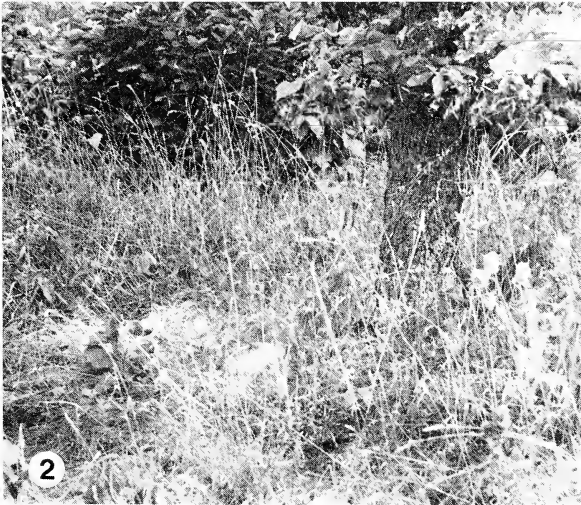

Figs. 1-3.—1. Location of original find and only dense colony of *S. niger* on Gibraltar Island, Lake Erie, Ottawa Co., Ohio. The limits of the colony lie between the edge of the rocks and arrow tips. (Photo by courtesy of Craig Holman, and the Columbus Dispatch.) 2. Another location where a few burrows were found. 3. A large tube found at the location shown in Fig. 2. Arrows indicate ends of the somewhat damaged tube.

presumably by the spider. One adult female was taken from the burrow beneath the only one of these filled tubes I have excavated.

The exposed sites of the burrows may not be the preferred habitat of these spiders. In the wooded sections of Gibraltar Island the soil is thin, more rocks are present, and the bedrock is sometimes quite close to the surface. The open

areas may be the only places where the spiders can burrow successfully to a sufficient depth.

Up to now the number of collected specimens of *S. niger* from Gibraltar Island is only five: a male taken on the ground surface in 1978 by the late Michael Glorioso, and an immature and three females all taken by me at the site of the initial discovery of the webs. The total number of webs observed from 1981-1983 has been about 40-50, however.

It is unclear from the discussion by Gertsch and Platnick just how many *Sphodros* species do extend their webs up tree trunks. Only two, *S. abbotii* and *S. rufipes*, are unequivocally indicated as doing so. Coyle (personal comm.) states that *Sphodros atlanticus* Gertsch and Platnick and *Sphodros coylei* Gertsch and Platnick build vertical tubes attached to tree stumps or grasses, and that *S. atlanticus* has also been found in semi-horizontal tubes. *Sphodros fitchi* Gertsch and Platnick has apparently been found in a burrow only once (Fitch H.S. 1963. Univ. Kansas Mus. Nat. Hist., Misc. Pub., 33:1-202). The description of the tube was brief, but implied that the tube was vertical. In southern Illinois, where *S. atlanticus*, *S. niger* and *S. rufipes* have all been collected (rarely), the only webs found on tree trunks have either been empty or have contained *S. rufipes*.

I wish to thank Craig Holman and the Columbus (Ohio) Dispatch for permission to use the photograph designated Figure 1. Mr. David Thrush kindly made the other photographs for me. Michael Glorioso found the male *S. niger*, recognized it, and presented it to me when I arrived on the island that summer. Dr. Fred Coyle provided information on *S. atlanticus* and *S. coylei* habits. I am grateful to all for their assistance.

Joseph A. Beatty, Department of Zoology, Southern Illinois University, Carbondale, Illinois 62901.

Manuscript received July 1985, revised September 1985.

**PRE-COURTSHIP COHABITATION OF MATURE MALE
AND PENULTIMATE FEMALE *GEOLYCOSA TURRICOLA*
(ARANEAE, LYCOSIDAE)**

Pre-courtship cohabitation of mature male(s) and immature female spiders is well known in some groups. The webs of subadult female araneids of several genera (e.g., *Nephila*, *Argiope*) may contain many "suitor" males (Robinson and Robinson 1980, Christenson and Goist 1979) and the immature females of some wandering spiders (e.g., Salticidae, Clubionidae) tolerate mature males (Pollard and Jackson 1982, Jackson 1977). However, no such phenomenon is known for the family Lycosidae. Here we report on pre-courtship cohabitation of subadult female and mature male *Geolycosa turricola* (Treat) and comment on the significance of this observation.

As part of a study of the male courtship behavior of *G. turricola*, we made evening observations of a number of burrows in a population near Starkville, Mississippi. Courtship activities of *Geolycosa* are known to occur near dusk (Wallace 1942). On the evening of 13 August 1984 we observed six burrows that contained mature male spiders, each positioned face down at the burrow entrance with the abdomen clearly visible from the surface. Each male was captured, and the burrow was excavated. A penultimate female was found in each burrow. The male-female pairs were held in the laboratory (females in artificially constructed burrows, males separately in wire cages) until the female molted to maturity between 5 and 6 days later (successfully in each case). Each pair was mated successfully.

Cohabitation in spiders may serve to habituate females to the presence of the male, thereby dampening her predatory instincts (Robinson 1982), or provide males with the advantage of proximity, thereby increasing the chances of a successful courtship (Christenson and Goist 1979). However, these advantages are available to the male only if the female is stationary. Thus the cohabitation phenomenon is thought to be associated primarily with web-building spiders or wandering spiders that construct "nests" for reproduction (Robinson 1982). Although the Lycosidae are generally considered vagabond spiders, the *Geolycosa* have adopted a sedentary life style as obligate burrowers. Immature males and females and mature females leave their burrows only for prey capture [e.g., we found that the average prey capture distance of *Geolycosa hubbellei* (Wallace) in Florida was less than 10 cm.]. Mature males abandon their burrows in search of females. The advantages of cohabitation for male *Geolycosa* are probably analogous to those of other spiders that exhibit the phenomenon.

Pre-courtship cohabitation has not been reported in the North American web-building lycosids (*Sosippus* spp.). Brady (pers. comm.) notes that, on the several occasions when he has observed mature males in the webs of females, the latter have also been mature.

The mechanism by which male *Geolycosa* locate immature females is unknown. Draglines deposited by receptive female wolf spiders are thought to aid the searching male by effectively increasing the area of detection around the female (Tietjen 1977). Contact sex pheromones in the silk and tactile stimulation provided to the male by the dragline are both apparently important in this

process (Dondale and Hegdekar 1973, Tietjen 1977). Our observations (laboratory and field) indicate that draglines probably are not as important in mate-finding in *Geolycosa*. Only males wander any great distance from the burrow, and although females deposit silk outside of the burrow, it is confined to a small area containing the material that forms the turret. This is not to say, however, that chemical cues associated with silk are not important in close range mate-finding or other courtship behavior among *Geolycosa*. We have observed mature male *G. turricola* perform preliminary courtship displays to the turrets (no burrow or female) of a conspecific mature female.

We have not investigated the role of aerial sex-attractants or substrate and airborne sounds in mate finding in *Geolycosa*. Airborne pheromones are known to be important in some lycosids (e.g. *Schizocosa saltatrix* (Hentz) and *S. ocreata* (Hentz), Tietjen and Rovner 1982). One is tempted to hypothesize that the turret could serve as a broadcasting location for airborne pheromones. With regard to sound production, we have observed a variety of palpal movements during courtship, some of which may result in vibrations of the substrate (Miller and Miller in prep.). Whether the immature female actively advertises her impending readiness by producing vibrations of some sort is, however, unknown. Whether the male produces a different signal prior to cohabitation than he does prior to copulation also must be determined.

We thank G. Stratton, A. Brady, J. Rovner, and M. Robinson for their comments on this manuscript. Voucher specimens are deposited in the Mississippi Entomological Museum.

LITERATURE CITED

- Christenson, T. E. and K. C. Goist. 1979. Costs and benefits of male-male competition in the orb weaving spider, *Nephila clavipes*. Behav. Ecol. Sciobiol., 5:87-92.
- Dondale, C. D. and B. M. Hegdekar. 1973. The contact sex pheromone of *Pardosa lapidicina* Emerton. Canadian J. Zool., 51:400-401.
- Jackson, R. R. 1977. Courtship versatility in the jumping spider, *Phidippus johnsoni* (Araneae: Salticidae). Anim. Behav., 25:953-957.
- Pollard, S. D. and R. R. Jackson. 1982. The biology of *Clubiona cambridgei* (Araneae, Clubionidae): Intraspecific interactions. New Zealand J. Ecol., 5:44-50.
- Robinson, M. H. 1982. Courtship and mating behavior in spiders. Annu. Rev. Entomol., 27:1-20.
- Robinson, M. H. and B. Robinson. 1980. Comparative studies of the courtship and mating behavior of tropical araneid spiders. Pac. Insects Monogr. No. 36. Bishop Museum, Honolulu.
- Tietjen, W. J. 1977. Dragline-following by male lycosid spiders. Psyche, 84:165-178.
- Tietjen, W. J. and J. S. Rovner. 1982. Chemical communication in lycosids and other species. Pp. 249-279, in Spider Communication: Mechanisms and Ecological Significance (P. N. Witt and J. S. Rovner, eds.). Princeton University Press, Princeton.
- Wallace, H. K. 1942. A revision of the burrowing of spiders of the genus *Geolycosa* (Araneae, Lycosidae). Amer. Midl. Nat., 27(1):1-61.

Gary L. Miller and **Patricia Ramey Miller**, Department of Entomology, Mississippi Entomological Museum, Drawer EM, Mississippi State University, Mississippi State, MS 39762 (Present address: Department of Zoology, School of Natural Sciences, Weber State College, Ogden, Utah 84408).

**A NEW SPIDER HOST ASSOCIATION FOR
MANTISPA VIRIDIS (NEUROPTERA, MANTISPIDAE)**

Mantisfly larvae of the subfamily Mantispinae are predators within the egg sacs of spiders (Redborg and MacLeod 1985). Laboratory studies by these workers demonstrate that larval mantispids enter spider egg sacs by two strategies: 1) direct penetration of existing egg sacs, or 2) boarding female spiders prior to egg sac formation and subsequently entering the sac during its construction. The larvae of some mantispid species are obligate egg sac penetrators, whereas other larval mantispids are facultative penetrators or boarders (Redborg and MacLeod 1985).

Laboratory experiments with first instar larvae indicate that *Mantispa viridis* Walker is an obligate egg sac penetrator (Redborg and MacLeod 1985, Richardson 1976). Only one of 420 *M. viridis* larvae boarded spiders during experimental trials by Redborg and MacLeod (1985), whereas 85% of the larvae placed in jars containing spider egg sacs were found on or in the sacs 24 h later. These authors suggested that the one record of a mantispid larva on a spider may have been fortuitous. Although several first instar larvae of *M. viridis* boarded spiders during initial experiments by Richardson (1976), she was unable to repeat these results during subsequent trials involving several hundred mantispid larvae and could not explain her initial results. She also reported that *M. viridis* larvae penetrated the egg sacs of eight species of spiders in the laboratory.

The purpose of this note is to report the rearing of an adult *M. viridis* from the egg sac of a *Lycosa pulchra* (Keyserling). The spider was carrying the egg sac in typical lycosid fashion (i.e., attached to its spinnerets) when it was captured on the ground on 12 March 1982 in Tyler State Park, Smith County, Texas. The spider and egg sac were transported to Lawrence, Kansas, where the spider died on 2 April. Upon opening the egg sac two weeks later, I found 95 surviving spiderlings and a mantispid cocoon. An adult *M. viridis* emerged on 20 April and lived until 25 May. These observations corroborate a report of high spiderling survival within a mantispid-infested egg sac of *Lycosa rabida* (Rice 1985).

The known range of natural spider egg sac hosts of *M. viridis* consists of six species in five families (Table 1). This is the first record of a lycosid spider serving as a host for *M. viridis*. Stein (1955) reported the emergence of two *M. viridis* adults from egg sacs that he misidentified as being those of a lycosid. Rather, these egg sacs apparently belonged to a clubionid or gnaphosid spider (Redborg and MacLeod 1985).

It is unlikely that the first instar larva of *M. viridis* boarded the *L. pulchra* female prior to egg sac construction. The egg sac probably was penetrated after it was constructed and being carried by the spider. *Cupiennius salei*, another known host of *M. viridis*, also carries its egg sac (Melchers 1963). Also, larvae of *Mantispa styriaca* and *Mantispa vittata*, which are known to feed on the eggs of lycosid spiders, can penetrate spider egg sacs (Brauer 1869, McKeown and Mincham 1948). Both of these species, like *M. viridis*, probably are obligate egg sac penetrators (Redborg and MacLeod 1985). In contrast, first instar larvae of *Mantispa uhleri* naturally board various spiders, including *L. pulchra* (Redborg and MacLeod 1985).

Table 1.—Documented spider hosts of *Mantispa viridis*.

Family	Species	Reference
Theridiidae	<i>Achaearanea tepidariorum</i>	Valerio 1971
Araneidae	<i>Argiope aurantia</i>	Tolbert 1976
	<i>Mecynogea lemniscata</i>	Hieber 1984
Agelenidae	<i>Agelenopsis</i> sp., probably <i>pennsylvanica</i>	Parfin 1958
Ctenidae	<i>Cupiennius salei</i>	Milliron 1940
Lycosidae	<i>Lycosa pulchra</i>	This report

I thank Kurt E. Redborg for bibliographic assistance. He and Marlin E. Rice provided useful comments on the manuscript. Allen R. Brady identified the *Lycosa pulchra*, which was collected during a field trip under the direction of Robert E. Beer of the Department of Entomology, University of Kansas.

LITERATURE CITED

- Brauer, F. 1869. Beschreibung der Verwandlungsgeschichte der *Mantispa styriaca* Poda und Betrachtungen über die sogenannte Hypermetamorphose Fabre's. Verh. Zool.-Bot. Ges. Wien, 19:831-840.
- Hieber, C. S. 1984. Egg predators of the cocoons of the spider *Mecynogea lemniscata* (Araneae: Araneidae): Rearing and population data. Florida Entomol., 67:176-178.
- McKeown, K. C. and V. H. Mincham. 1948. The biology of an Australian mantispid (*Mantispa vittata* Guerin). Australian Zool., 11:207-224.
- Melchers, M. 1963. Zur Biologie und zum Verhalten von *Cupiennius salei* (Keyserling), einer amerikanischen Ctenide. Zool. Jb. Syst., 91:1-90.
- Milliron, H. E. 1940. The emergence of a neotropical mantispid from a spider egg sac. Ann. Entomol. Soc. Amer., 33:357-360.
- Parfin, S. 1958. Notes on the bionomics of the Mantispidae (Neuroptera: Planipennia). Entomol. News, 69:203-207.
- Redborg, K. E. and E. G. MacLeod. 1985. The developmental ecology of *Mantispa uhleri* Banks (Neuroptera: Mantispidae). Illinois Biol. Monogr., 53. 130 pp.
- Rice, M. E. 1985. Spiderling survival in a *Mantispa* (Neuroptera, Mantispidae) infested egg sac. J. Arachnol., 13:139-140.
- Richardson, M. W. 1976. Micropredators of spiders. Unpubl. Ph. D. thesis, Southern Illinois University, Carbondale.
- Stein, R. J. 1955. An insect masquerader. Nat. Hist., 11:472-473.
- Tolbert, W. W. 1976. Population dynamics of the orb weaving spiders *Argiope trifasciata* and *Argiope aurantia* (Araneae: Araneidae): Density changes associated with mortality, natality and migrations. Unpubl. Ph. D. thesis, The University of Tennessee, Knoxville.
- Valerio, C. E. 1971. Parasitismo en huevos de araña *Achaearanea tepidariorum* (Koch)(Aranea: Theridiidae) en Costa Rica. Rev. Biol. Trop., 18:99-106.

Steven M. Roble, Museum of Natural History and Department of Systematics and Ecology, University of Kansas, Lawrence, Kansas 66045. Present address: Section of Amphibians and Reptiles, Carnegie Museum of Natural History, 4400 Forbes Avenue, Pittsburgh, Pennsylvania 15213.

**USE OF PHEROMONES BY MALES OF
PHIDIPPUS JOHNSONI (ARANEAE, SALTICIDAE)
TO DETECT SUBADULT FEMALES THAT ARE ABOUT TO MOLT**

Courtship versatility and a complex display repertoire have been described for *Phidippus johnsoni* Peckham and Peckham, a common salticid species from western North America (Jackson 1977). The nests of *P. johnsoni* are built under rocks, under the bark of trees, and in similar places with low-intensity ambient light. Males that encounter adult females away from nests use vision-dependent displays (Type 1 courtship) similar to those traditionally associated with salticids, but adult females inside nests elicit vibratory courtship (Type 2) that is independent of vision. With a subadult (penultimate instar) female inside her nest, the male first uses Type 2 courtship and then constructs an adjacent silken chamber, cohabits with the female until she molts and mates when she matures.

Cohabitation durations, which were measured in nature and the laboratory (Jackson 1978a), tend to be only a few days in duration (mean: 7 days; maximum: 14 days), although the penultimate instar generally lasts much longer (mean: 83 days; maximum: 145 days; Jackson 1978b). Both male and female behavior may influence whether or not cohabitation will occur.

Males of *P. johnsoni* are known to begin vibratory courtship upon contacting vacant nests of adult or subadult females (Jackson 1976, 1981), and silk-associated, chemotactically-detected pheromones are probably involved. Previous studies did not ascertain the stage (days before molting) at which nests of subadults become attractive to males. This information was obtained for the present paper, because male responses to vacant nests can provide an indication of male sexual interest in subadult females without the subadult's behavior being a confounding factor.

MATERIALS AND METHODS

Juvenile *P. johnsoni* were collected in Berkeley, California in the spring of 1985 and taken to the laboratory in Christchurch. Maintenance, testing procedures, and terminology were essentially the same as in earlier studies (Jackson 1981), and only a few remarks will be provided here.

Tests were carried out by introducing males to cages with vacant nests. Vacant nests were obtained by removing the resident subadult females 2-8 min before introducing the males. The male's response was recorded for 30 min after he first contacted the nest. Only dense nests (4 or 5 on the scale provided elsewhere: Jackson 1979) were used.

Males and subadult females were taken at random from the laboratory stock for testing. A strictly random testing procedure, however, would have resulted in a disproportionate number of tests being carried out on nests of subadults nearing maturity, although this group was of lesser interest in this study. To minimize this problem, subadults suspected to be nearly ready to molt (because of their large abdomens, sedentary behavior, etc.: Jackson 1978b) were removed from the stock of spiders used in testing.

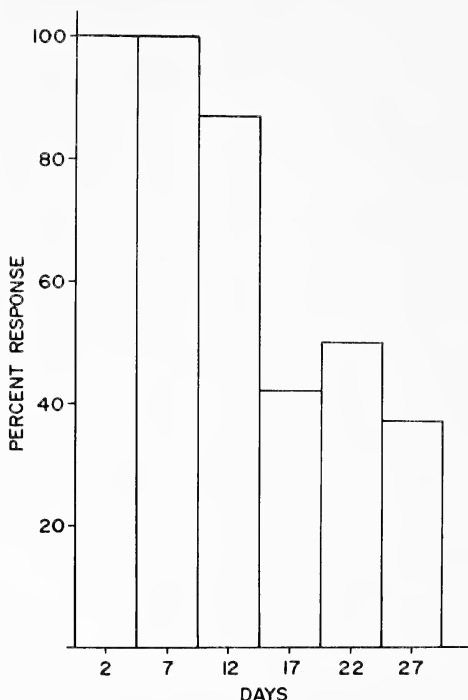

Fig. 1.—Sexual responses by males of *Phidippus johnsoni* tested with vacant nests of conspecific subadult females of differing proximity to molting. 2 days: midpoint for 0-4 days; etc. See text for numbers of tests. Response expressed as percentage of tests at each interval (0-4 days, etc.) in which nests elicited sexual responses.

Each nest was used in only one test. Each male was tested no more than once per day. After removal from their nests, subadults were given clean cages and the number of days elapsing before they molted to maturity was recorded. If they had not molted within 1 week of the last test, and if they had built a dense nest in the interval, subadults were used in additional tests.

The performance by the male of any of the following behaviors while on a nest was recorded as a sexual response: abdomen twitch (abdomen flicks up and down), probe (legs I move backward and forward on silk), vibrate (with legs on the nest, body flutters up and down). These behaviors normally occur only during intraspecific interactions, and they are described in detail elsewhere (Jackson 1977).

RESULTS AND DISCUSSION

The number of days elapsing between the end of tests and molting by females ranged from 0 to 47 days: 0-4 days, 10 tests; 5-9 days, 10, 10-14 days, 8; 15-19 days, 12; 20-24 days, 6; 25-29 days, 8; 30-34 days, 9; 35-39 days, 5; 40-44 days, 8; 45-49, 4. Nests of subadults more than 29 days from molting never elicited sexual responses (Fig. 1). Nests of subadults less than 10 days from molting always elicited sexual responses. The tendency for nests to elicit sexual responses seemed to gradually increase over the period between 29 and 10 days from molting.

These data suggest that females begin emitting a sex pheromone only late in their penultimate instar. Within 10 days of molting, all are emitting pheromones which make their nests highly attractive to males. For c. 3 weeks before this either there are fewer females emitting pheromones or pheromone emission by individual females is at a less effective level. Females apparently fail to make their nests attractive to males if they are a month or more away from molting.

Peak nest attractiveness and cohabitation initiation apparently coincide: most cohabitation durations observed in the laboratory and in nature were less than 10 days in duration, and none were more than 14 days. However, one-third to one-half of nests tested when females were 2-4 weeks away from molting elicited sexual responses from males. Whether these females would have cohabited is not known but seems unlikely given the failure to observe cohabitation durations of greater than 2 weeks in previous studies. Females probably begin to emit pheromones before they are ready to cohabit. Whether this has any adaptive significance for the female can not be inferred from existing data.

In conclusion, cohabitation durations are the results of the combined influence of male and female behavior as well as female pheromones. There is a limited period near the end of the female's penultimate instar during which males are interested in cohabitation, but this period may be longer than the female is willing to cohabit.

I thank Joan Buckley for preparing the histogram and Simon Pollard for comments on the manuscript. Financial assistance was provided by grants from the University Grants Committee of New Zealand and the Academic Staffing Committee of the University of Canterbury. The New Zealand Ministry of Agriculture provided an import permit.

LITERATURE CITED

- Jackson, R. R. 1976. Predation as a selection factor in the mating strategy of the jumping spider *Phidippus johnsoni* (Salticidae, Araneae). *Psyche*, 83:243-255.
- Jackson, R. R. 1977. An analysis of alternative mating tactics of the jumping spider *Phidippus johnsoni* (Araneae, Salticidae). *J. Arachnol.*, 5:185-230.
- Jackson, R. R. 1978a. The mating strategy of *Phidippus johnsoni* (Araneae, Salticidae): I. Pursuit time and persistence. *Behav. Ecol. Sociobiol.*, 4:123-132.
- Jackson, R. R. 1978b. Life history of *Phidippus johnsoni* (Araneae, Salticidae). *J. Arachnol.*, 6:1-29.
- Jackson, R. R. 1979. Nests of *Phidippus johnsoni* (Araneae, Salticidae): characteristics, pattern of occupation and function. *J. Arachnol.*, 7:47-58.
- Jackson, R. R. 1981. Nest mediated sexual discrimination by a jumping spider (*Phidippus johnsoni*). *J. Arachnol.*, 9:87-92.

Robert R. Jackson, Department of Zoology, University of Canterbury, Christchurch 1, New Zealand.

Manuscript received August 1985, revised November 1985.

**ON THE MALE OF *SPHODROS PAISANO*
(ARANEAE, ATYPIDAE)**

Eight species (one *Atypus* and seven *Sphodros*) of atypid spiders are known from North America (Gertsch, W. J., and N. I. Platnick. 1980. Amer. Mus. Novit., 2704:1-39). Of these, all save one are known from both sexes; *Sphodros paisano* Gertsch and Platnick was described from females only. Material recently acquired from Drs. J. and S. Peck of Carleton University included the first known males of that species, described here. The format of the description follows that used in the revision; the illustrations are by Dr. M. U. Shadab.

Sphodros paisano Gertsch and Platnick
Figs. 1, 2

Sphodros paisano Gertsch and Platnick, 1980:20, figs. 20, 30, 31 (female holotype from Rancho El Milagro, Cruillas, Tamaulipas, Mexico, in Museum of Comparative Zoology, examined).

Diagnosis.—This species differs from all other known *Sphodros* except *S. abboti* Walckenaer in having four-segmented posterior lateral spinnerets; as the character appears during postembryonic development by subdivision of one of the three normal segments, it seems to be a synapomorphy linking the two species (with parallelism in some *Atypus*). Males of *S. paisano* can be distinguished from those of *S. abboti* by the wider ventral ledge on the palpal conductor (Fig. 2).

Male (Brownsville, Texas).—Total length, including chelicerae, 11.80. Carapace dark chestnut brown with ocular area darkest. Chelicerae dark brown dorsally, reddish brown ventrally; sternum, labium, and palpal coxae orangeish brown. Legs light brown except for orange tarsi and anterior metatarsi. Abdomen iridescent green to blue dorsally, with long, dark brown scutum covering two-thirds of dorsum; venter brown except for orangeish brown lung covers and medially lightened spinnerets.

Carapace 3.74 long, 3.24 wide, irregularly pitted and roughened, with only a few small setae along anterolateral edges, longest at middle, widest just behind eyes, smoothly narrowed posteriorly, emarginated above pedicel. Pars cephalica strongly elevated, set off by two posterolateral depressions, smoothly sloping posteriorly. Pars thoracica level, thoracic groove deep, subquadrate depression placed back three-fifths of carapace length, occupying one-eighth of carapace width at that point.

Eyes on elevated tubercle occupying almost one-third of front width. Ratio of eyes, anterior lateral: anterior median: posterior lateral: posterior median, 7:7:6:5. Anterior row slightly wider than posterior, procurved from front, recurved from above; medians separated by 1.5 times their diameter, by slightly more than their diameter from anterior laterals. Posterior row recurved; medians separated by 4.5 times their diameter, by one-fifth their diameter from posterior laterals. Median ocular quadrangle wider than long (16/7), narrowed in front (16/11).

Sternum 2.27 long, 2.05 wide; labium 0.45 long, 0.75 wide; both clothed evenly with short, erect, black hairs. Sternum with eight sigilla, smallest pair at base of labium, other pairs progressively larger, situated at level of posterior edges of coxae I, II, and III, posterior pair separated by their length, farther from margins

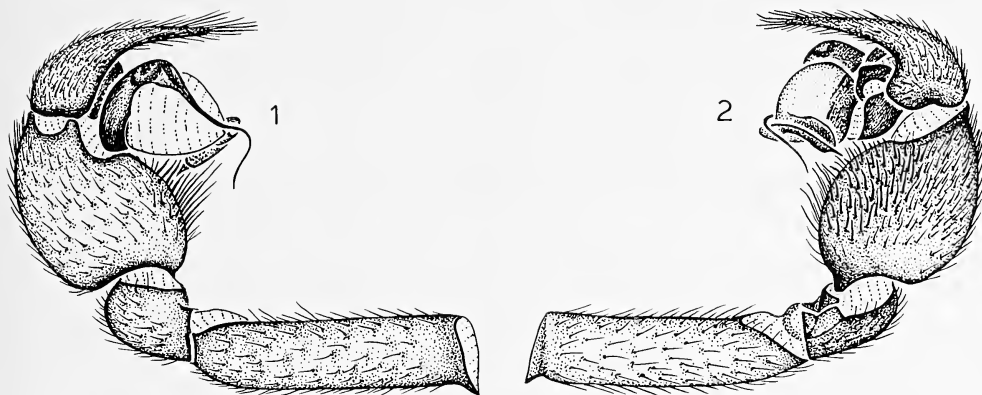

Figs. 1, 2.—Left male palp of *Sphodros paisano*: 1, prolateral view; 2, retrolateral view.

of sternum. Median edge of palpal coxae with two rows of long spinules followed laterally by few irregular rows of small spinules. Chelicerae twice as long as wide at middle, strongly elevated dorsally for most of length, flat prolaterally, set with thick, strong setae distally; promargin with nine strong teeth, most proximal greatly reduced in size; retromargin with thin band of black hairs.

Leg formula 4123. Legs slender, evenly clothed with short, black hairs, with spines restricted to venter except for few dorsal spines on metatarsi (most numerous on legs II and III). Tarsi long, flexible, distal three-quarters with numerous false articulations, ventral surfaces with short, curved spines at sides (most numerous on legs III and IV). Unpaired tarsal claws small, armed with single weak tooth (strongest on leg IV); paired claws small, usually with five teeth in single row. Leg measurements in mm:

	I	II	III	IV	Palp
Femur	3.26	2.65	2.27	3.01	2.21
Patella	1.26	1.26	1.17	1.33	0.83
Tibia	1.75	1.45	1.48	2.09	1.37
Metatarsus	2.59	2.23	2.61	3.31	—
Tarsus	2.09	2.12	2.09	2.59	1.52
Total	10.95	9.71	9.62	12.33	5.93

Palp (Figs. 1, 2) with long, curved conductor folded ventrally to produce wide ledge, bearing long, curved embolus; tibia incrassate, almost as high as long, with retrolateral clump of spines.

Abdomen 3.73 long, 2.77 wide, clothed with weak, black hairs. Six spinnerets: anterior laterals slender, 0.38 long; posterior medians separated by two-thirds their basal width, 0.47 long; four-segmented posterior laterals with lengths as follows: basal 0.47, median 0.61, subapical 0.48, apical 0.54, total 2.10.

New Record.—UNITED STATES: *Texas*: Cameron Co.: Sabal Palm Grove, Brownsville, May 31-Aug. 10, 1983 (S. and J. Peck), 2 males, deposited in the American Museum of Natural History.

Distribution.—Texas and Tamaulipas, Mexico.

Norman I. Platnick, Department of Entomology, American Museum of Natural History, New York, New York 10024.

UMMIDIA TRAPDOOR SPIDER CAUGHT IN A STEATODA WEB (ARANEAE: CTENZIDAE, THERIDIIDAE)

The following is an account of a large immature trapdoor spider, *Ummidia* (Ctenizidae), being preyed upon by a mature female comb-footed spider, *Steatoda triangulosa* (Walckenaer) (Theridiidae) in an underground water meter housing. This event was observed by the junior author while he was collecting spiders in Sunset, Montague Co., Texas on 15 March 1985.

The water meter housing was in sandy loam soil, the lid flush with the ground, in a residential area. Upon removing the lid of the meter housing a typical theridiid tangle web was observed. The *Ummidia* was swathed with a large amount of silk and suspended with the ventral side up in the lower one-third of the web. The silk was tightly wrapped around the abdomen and legs three and four. The spider was immobile and appeared dead; however, when grasped with forceps legs one and two moved slightly, suggesting that it had already been bitten, but the venom had insufficient time or was incapable of totally paralyzing a spider of this size. The female *Steatoda* scurried to shelter near the upper rim of the housing when the lid was opened and was collected after the *Ummidia* was removed.

General statements of theridiid's ability to capture prey much larger than themselves are mentioned by Gertsch (1979, *American Spiders*, Van Nostrand Reinhold Co., New York 274 pp.) and Bristowe (1971, *The World of Spiders*, Collins, London 304 pp.). No reference was found regarding *Steatoda* feeding on large prey. In this instance the trapdoor spider was approximately 19 times larger by weight than the *Steatoda*. This late instar trapdoor spider weighed 567 mg (alcohol weight) and was 19 mm long (total length) and 7 mm wide at the cephalothorax. The *Steatoda* weighed only 30 mg (alcohol weight), was 6 mm long (total length), and 2 mm wide at the cephalothorax.

Norman V. Horner, Department of Biology, Midwestern State University, Wichita Falls, Texas 76308; and **Danny Russell**, USDA, Soil Conservation Service, Bowie, Texas 76230.

Manuscript received August 1985, revised October 1985.

***HETERONEBO VACHONI* AND *HETERONEBO MUCHMOREI*
ARE SYNONYMS (SCORPIONES, DIPLOCENTRIDAE)**

I described *Heteronebo vachoni* in 1978 (Spec. Publ. Mus., Texas Tech University, No. 14, 92 pp.) on the basis of material deposited at the Muséum National d'Histoire Naturelle, Paris, and labelled in Prof. Max Vachon's handwriting as originating from "Martinique, Sainte Croix, Cotton Valley," collected by R. P. Robert Pinchon. Subsequently, Francke and Sissom (1980, Occas. Pap. Mus., Texas Tech University, No. 65, 19 pp.) described *Heteronebo muchmorei* on the basis of material collected in St. Croix, U. S. Virgin islands, by Dr. W. B. Muchmore. Sometime after the second publication, Dr. Muchmore informed me that there is a Cotton Valley in St. Croix, U. S. Virgin Islands, and further research revealed that there is no locality with that name in Martinique.

Direct comparison of the holotype and numerous "paratopotypes" of *H. vachoni* against numerous specimens of both sexes of *H. muchmorei* from St. Croix revealed that these two nominal taxa are conspecific. The characters given earlier (Francke and Sissom 1980, *loc. cit.*), are slightly more variable than previously known, and reflect populational differences within what I now consider to be a single taxon endemic to St. Croix, U. S. Virgin Islands. This species retains the name *Heteronebo vachoni* Francke, 1978, and its type locality is hereby modified to Cotton Valley, St. Croix, U. S. Virgin Islands. I suspect that R. P. Robert Pinchon collected the specimens there, and sent them to Prof. Vachon from Martinique, thus the confusion on the original label. In the New World the genus *Heteronebo* is known with certainty only from the Greater Antilles and the U. S. Virgin Islands; it is not known from any of the Lesser Antilles east of the Anegada Passage.

Oscar F. Francke, Department of Biological Sciences, Texas Tech University, Lubbock, Texas 79409.

Manuscript received September 1985, accepted November 1985.

NONMENCLATURE NOTES

Opinion 1340.—The International Commission on Zoological Nomenclature ruled under its plenary powers to conserve the name *Attus otiosus* Hentz, 1846 (Araneae, Salticidae) (Bull. Zool. Nomencl., 42:258, 1985).

On 6 December 1985 the Commission gave six months notice of the possible use of its plenary powers in the following case:

Z. N. (S.) 2307.—THAIDIDAE Jousseume, 1888 (Mollusca, Gastropoda) and THAIDIDAE Lehtinen, 1967 (Arachnida, Araneae): proposals to remove homonymy.

The Commission welcomes comments and advice from interested zoologists (Bull. Zool. Nomencl., vol. 42, pt. 4).

THE AMERICAN ARACHNOLOGICAL SOCIETY

President:

Jerome S. Rovner (1985-1987)
Department of Zoology
Ohio University
Athens, Ohio 45701

President-Elect:

William A. Shear (1985-1987)
Department of Biology
Hampden-Sydney College
Hampden-Sydney, Virginia 23943

Membership Secretary:

Norman I. Platnick (appointed)
American Museum of Natural History
Central Park West at 79th Street
New York, New York 10024

Treasurer:

Norman V. Horner (1985-1987)
Department of Biology
Midwestern State University
Wichita Falls, Texas 76308

Secretary:

Brent D. Opell
Department of Biology
V.P.I.S.U.
Blacksburg, Virginia 24061

Archivist:

Vincent D. Roth
Box 136
Portal, Arizona 85632

Directors:

Frederick A. Coyle (1985-1987), **G. B. Edwards** (1984-1986), **Susan E. Riechert** (1985-1987).

Honorary Members:

P. Bonnett, W. J. Gertsch, H. Homann, †B. J. Kaston, R. F. Lawrence, H. W. Levi, G. H. Locket, A. F. Millidge, M. Vachon, T. Yaginuma.

The American Arachnological Society was founded in August, 1972, to promote the study of Arachnida, to achieve closer cooperation between amateur and professional arachnologists, and to publish *The Journal of Arachnology*.

Membership in the Society is open to all persons interested in the Arachnida. Annual dues are \$25.00 for regular members, \$15.00 for student members. Correspondence concerning membership in the Society must be addressed to the Membership Secretary. Members of the Society receive a subscription to *The Journal of Arachnology*. In addition, members receive the bi-annual newsletter of the Society, *American Arachnology*.

American Arachnology, edited by the Secretary, contains arachnological news and comments, requests for specimens and hard-to-find literature, information about arachnology courses and professional meetings, abstracts of papers presented at the Society's meetings, address changes and new listings of subscribers, and many other items intended to keep arachnologists informed about recent events and developments in arachnology. Contributions for *American Arachnology* must be sent directly to the Secretary of the Society.

Research Notes

Las citas de <i>Pachylus chilensis</i> para la Argentina (Opiliones, Gonyleptidae, Pachylinae), <i>Luis Eduardo Acosta</i>	117
A range extension of the purseweb spider <i>Sphodros rufipes</i> (Latreille) in eastern Kansas (Araneae, Atypidae), <i>Willard Morrow</i>	119
Vertical copulation can occur in <i>Lycosa malitiosa</i> Tullgren (Araneae, Lycosidae), <i>Fernando G. Costa</i> and <i>J. Roberto Sotelo, Jr.</i>	121
Chromosomes of <i>Leiobunum japonicum japonicum</i> and <i>Leiobunum paessleri</i> (Arachnida, Opiliones), <i>Nobuo Tsurusaki</i> and <i>Robert G. Holmberg</i>	123
Ontogenetic changes in the web of <i>Epeirotypus</i> sp. (Araneae, Theridiosomatidae), <i>William G. Eberhard</i>	125
Possible parthenogenesis in the huntsman spider <i>Isopoda insignis</i> (Araneae, Sparassidae), <i>David C. Lake</i>	129
Web structure and burrow location of <i>Sphodros niger</i> (Hentz) (Araneae, Atypidae), <i>Joseph A. Beatty</i>	130
Pre-courtship cohabitation of mature male and penultimate <i>Geolycosa turricola</i> (Araneae, Lycosidae), <i>Gary L. Miller</i> and <i>Patricia Ramey Miller</i>	133
A new spider host association for <i>Mantispa viridis</i> (Neuroptera, Mantispidae), <i>Steven M. Roble</i>	135
Use of pheromones by males of <i>Phiddipus johnsoni</i> (Araneae, Salticidae) to detect subadult females that are about to molt, <i>Robert R. Jackson</i>	137
On the male of <i>Sphodros paisano</i> (Araneae, Atypidae), <i>Norman I. Platnick</i>	140
<i>Ummidia</i> trapdoor spider caught in a <i>Steatoda</i> web (Araneae: Ctenizidae Theridiidae), <i>Norman V. Horner</i> and <i>Danny Russell</i>	142
<i>Heteronebo vachoni</i> and <i>Heteronebo muchmorei</i> are synonyms (Scorpiones, Diplocentridae), <i>Oscar F. Francke</i>	143

Other

Nomenclature Notes.....	143
-------------------------	-----

CONTENTS

THE JOURNAL OF ARACHNOLOGY

VOLUME 14

Feature Articles

NUMBER 1

- The ecological effects of burning, mowing, and plowing on ground-inhabiting spiders (Araneae) in an old-field ecosystem, *Mary F. Haskins* and *James H. Shaddy*.....1
- Chactidae (Scorpiones) from Trinidad and Tobago, *Oscar F. Francke* and *Julius Boos*.....15
- Ecology and behaviour in *Portia schultzei*, with notes on related species (Araneae, Salticidae), *Lynn M. Forster* and *Frances M. Murphy*.....29
- Mother-young relationships in *Euscorpius*: Adaptive value of the larval permanence on the mother's back, *A. Ugolini*, *I. Carmignani*, and *M. Vannini*.....43
- A revision of the spider genus *Sason* Simon (Sasoninae, Barychelidae, Mygalomorphae) and its historical biogeography, *Robert J. Raven*.....47
- Spectral sensitivities of the eyes of the orb web spider *Argiope argentata* (Fabricius), *Klaus B. Tiedemann*, *Dora Fix Ventura*, and *Cesar Aedes*.....71
- Analisis de la actividad diaria de *Aphonopelma seemanni* (Araneae, Theraphosidae) en Costa Rica, *Marco V. Herrero* and *Carlos E. Valerio*.....79
- Redefinition of the genus *Olpiolum* and description of a new genus *Banksolpium* (Pseudoscorpionida, Olpiidae), *William B. Muchmore*.....83
- Mygalomorph spiders in the Barychelidae (Araneae) from Costa Rica, *Carlos E. Valerio*.....93
- Albinism and eye structure in an Australian scorpion, *Urodacus yaschenkoi* (Scorpiones, Scorpionidae), *N. A. Locket*.....101

(continued on back inside cover)

Cover photograph, fluorescence of *Sphaleropachylus butleri* (Thorell), by J. C. Cokendolpher

Printed by the Texas Tech Press, Lubbock, Texas, U.S.A.

Posted at Lubbock, Texas, in June 1986

658
nt.

The Journal of ARACHNOLOGY

OFFICIAL ORGAN OF THE AMERICAN ARACHNOLOGICAL SOCIETY

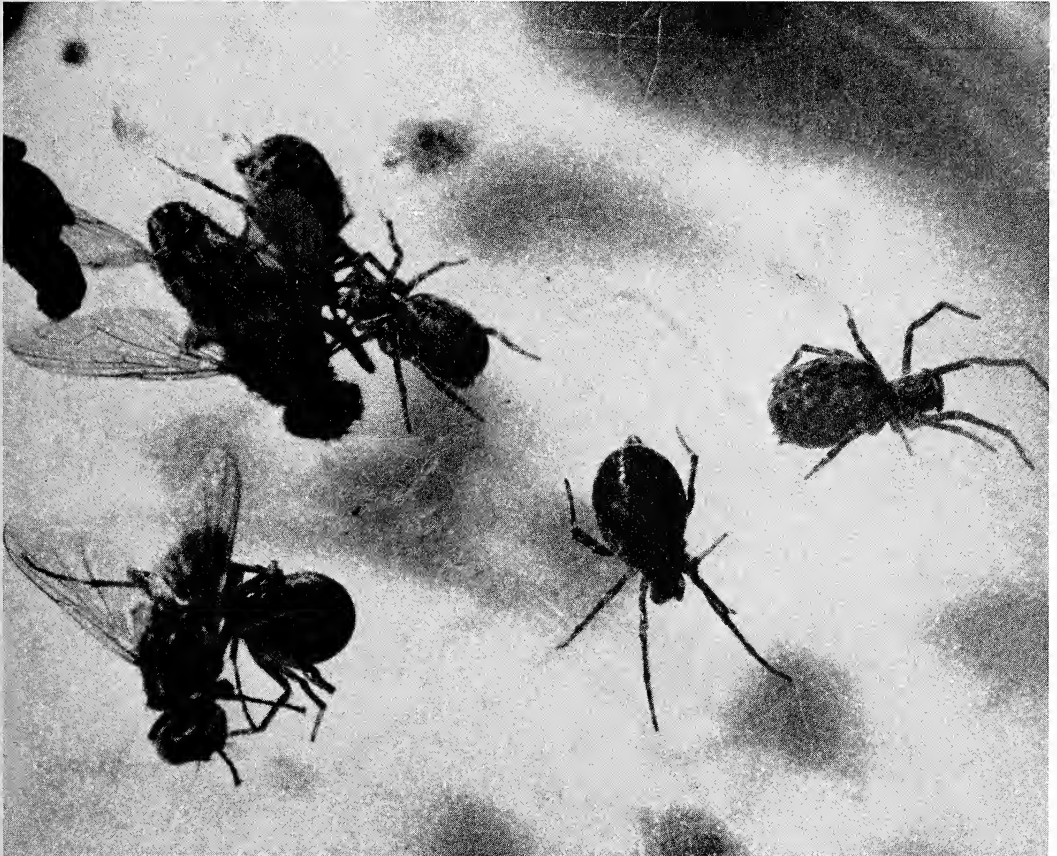

SOCIAL BEHAVIOR IN SPIDERS

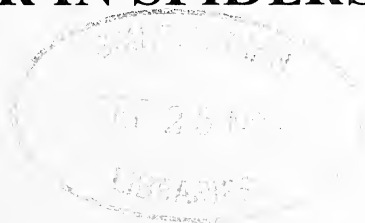

VOLUME 14

SUMMER 1986

NUMBER 2

THE JOURNAL OF ARACHNOLOGY

EDITOR: Oscar F. Francke, Texas Tech University

ASSOCIATE EDITOR: William B. Peck, Central Missouri State University

ASSISTANT EDITOR: James C. Cokendolpher, Texas Tech University

EDITORIAL BOARD: C. D. Dondale, Agriculture Canada; W. G. Eberhard, Universidad de Costa Rica; M. E. Galiano, Museo Argentino de Ciencias Naturales; W. J. Gertsch, American Museum of Natural History; N. F. Hadley, Arizona State University; V. F. Lee, California Academy of Sciences; H. W. Levi, Harvard University; E. A. Maury, Museo Argentino de Ciencias Naturales; W. B. Muchmore, University of Rochester; M. H. Muma, Western New Mexico University; N. I. Platnick, American Museum of Natural History; G. A. Polis, Vanderbilt University; S. E. Riechert, University of Tennessee; M. E. Robinson, U.S. National Zoological Park; V. D. Roth, Southwestern Research Station; J. S. Rovner, Ohio University; W. A. Shear, Hampden-Sydney College; W. J. Tietjen, Lindenwood College; G. W. Uetz, University of Cincinnati; C. E. Valerio, Universidad de Costa Rica; S. C. Williams, San Francisco State University.

THE JOURNAL OF ARACHNOLOGY (ISSN 0161-8202) is published in Spring, Summer, and Fall by *The American Arachnological Society* at Texas Tech Press.

Individual subscriptions, which include membership in the Society, are \$25.00 for regular members, \$15.00 for student members. Institutional subscriptions to *The Journal* are \$35.00. Correspondence concerning subscriptions and memberships should be addressed to the Membership Secretary (see back inside cover). Back issues of *The Journal* are available from Dr. Susan E. Riechert, Department of Zoology, University of Tennessee, Knoxville, TN 37916 U.S.A., at \$10.00 for each number; the Index to Volumes 1-10 is available for \$10.00. Remittances should be made payable to *The American Arachnological Society*. Correspondence concerning undelivered issues should be addressed to the Texas Tech Press, Texas Tech University, Lubbock, Texas 79409, U.S.A.

Change of address notices must be sent to the Membership Secretary.

Detailed instructions for the preparation of manuscripts appear in the Fall issue of each year, and can also be obtained from the Editor and the Associate Editor. Manuscripts that do not follow those instructions will be returned to the author(s) without benefit of review. Manuscripts and all related correspondence must be sent to Dr. William B. Peck, Associate Editor, Department of Biology, Central Missouri State University, Warrensburg, Missouri 64093, U.S.A.

PROOFS, REPRINTS, and CHARGES: Authors will receive a reprint order form along with their proofs. Reprints are billed at the printer's current schedule of costs. All authors will be billed by the printer for page charges. The charge per journal page will be assessed as follows: \$20.00-nonmembers; \$15.00-members acknowledging grant, institutional, or other support; \$10.00-full members who do not have (and do not acknowledge) support; \$5.00-student members who do not coauthor with full members and who do not acknowledge support. Members may have page charges waived or reduced for a limited number of pages; a statement of justification for waiver should accompany the manuscript when it is first sent to the Associate Editor for review.

**EFFECTS OF COLONY SIZE ON WEB STRUCTURE
AND BEHAVIOR OF THE SOCIAL SPIDER
MALLOS GREGALIS (ARANEAE, DICTYNIDAE)¹**

William James Tietjen

Department of Biology
Lindenwood College
Saint Charles, Missouri 63301 U.S.A.

ABSTRACT

Groups of size 1, 2, 5, 10 and 20 *Mallos gregalis* were monitored under laboratory conditions with the aid of a computer-controlled digital camera. Data collected included a measure of the density and complexity of the silk comprising the nest, as well as activity levels and occupation of space within experimental arenas.

Average web density and complexity was related to colony size, with the larger colonies building more complex nests. I suggest that the greater web complexity would allow larger colonies greater opportunities for the exploitation of marginal habitats. The webs built by the two smaller groupings were similar to those built by solitary dictynids and indicated that *M. gregalis* may be a facultatively-social spider. An estimate of mean silk deposition per spider indicated that members of the larger colonies exerted less effort in web construction than spiders in the two smaller groupings.

Colony activity was related to group size and exhibited evidence for a group effect in the patterning of activity bouts. It is possible that this would aid in coordinating colony behavior. Measures of both web structure and colony activity indicated that the changes in colony behavior were not due to a simple arithmetic effect (e.g., size 20 colonies were neither twice as active nor were their webs twice as complex as colonies of size 10).

INTRODUCTION

Although most spiders are solitary, aggregating only early in life or during mating, a few species are social (Shear 1970, Kullman 1972, Burgess 1978, 1979a, Buskirk 1981). Unlike the groups seen among the insect societies, no araneid associations studied to date show evidence of ethological nor morphological caste systems (Wilson 1971, Burgess 1979b). For this reason, studies of social spiders must confront the problem of how such complex groupings are behaviorally organized. The present laboratory study describes some organizing features of colony behavior in a social spider, *Mallos gregalis*, especially the effects of colony size on the patterning of activity, nest complexity and web construction.

Mallos gregalis is a social species living in colonies that may cover three-quarters of an 18-m tree with webbing. Up to 20,000 individuals of both sexes and various stadia may inhabit such nests (Diguet 1909a, 1909b, Burgess 1979b, Uetz 1983). Predation, feeding and web construction are communal, with little or no cannibalism occurring among conspecifics (Witt et al., 1978).

¹Presented in a symposium, "Social Behavior in Spiders," at the National Meeting of the American Arachnological Society, June 17, 1984.

The web is an intricate, sheet-like affair, superficially resembling that of tent caterpillar larvae (*Malacosoma* spp). The outer surface, (the primary prey-capture site), has silk-reinforced tunnel openings to the web interior, silk-reinforced runways, water-resistant papery areas, loosely-woven cribellate silk sheets, as well as the remains of their prey, primarily muscid flies. The web interior has numerous silk-lined tunnels and chambers which gives it a spongy appearance. Spiders spend most of the day within these chambers, moving to the surface only when it is disturbed by struggling prey. Within the web *M. gregalis* courts, mates, constructs egg sacs and deposits silk to reinforce tunnels and chambers. At the surface of the nest spiders capture prey, feed communally, eliminate excreta and deposit silk for web expansion (Tietjen 1986).

MATERIALS AND METHODS

General Methods.—Approximately 350 *Mallos gregalis* from a colony collected near Guanajuato, Guanajuato, Mexico by G. W. Uetz were maintained in a large plexiglass cage (91.0 L X 47.0 W X 35.5 H cm) located near a window to provide a natural photoperiod. This larger colony provided the “seed” individuals used for the experimental colonies. Temperature remained fairly constant at 28.8 ± 2.97 sd°C. Water was provided daily by a fine mist sprayed on the web surface; and animals were fed houseflies (*Musca domestica*) at weekly intervals.

Ninety one experimental colonies were housed in Petri dishes (52.2 cc) during the course of the study (8/22/81-1/28/82). Five group sizes were examined (N = 20, 10, 5, 2 or 1 adult females per container) to determine the effect of group size on colony activity and web structure. Direct observation and preliminary analyses of computer image data (see below) indicated that the rate of silk deposition levels off by day five of nest growth. For this reason, all data were collected from five-day-old experimental colonies. Previous data (Burgess 1979b, Jackson 1979, Tietjen 1982) indicate that *M. gregalis* is nocturnal. Data collection therefore began between 1500 and 1700 hrs, and experiments were terminated between 0630 and 0900 EST. Experimental colonies were fed houseflies (*M. domestica*) one day prior to their introduction to the arenas but were not fed during the five-day growth period. Had spiders been fed during this period, web structures would have been disrupted and measurements of nest complexity would not have been possible. Water was provided daily by depositing a drop near the edge of the Petri dish.

Buskirk (1981) indicates that coloniality in spiders may be related to high prey availability. Thus, the possibility exists that the spiders used in these series of experiments were stressed. Jackson (1980) maintained *M. gregalis* under conditions of starvation for as long as 53 days, and Witt (personal communication) maintained the spiders for four weeks without apparent ill effects. In a similar vein, Witt, Scarboro and Peakall (1978) used radioisotope techniques to determine the number of *M. gregalis* feeding on a single fly. Their data indicates that, even after 24 hr, none of their colonies had spiders that had all fed upon the prey. This minimal feeding level may be related to their low metabolic rate ($88.0 \pm 8.0 \mu\text{l O}_2 / \text{g body weight / hr}$); a value approximately $\frac{1}{4}$ that of *Araneus diadematus* (Witt, personal communication). Under field conditions, *M. gregalis* is likely to be presented with similar periods of high and low prey availability. Burgess (1979b) reports that the nests are sometimes

surrounded by swarms of muscid flies, whereas prey availability at other times is so low that it can not be accurately measured. His results are consistent with the reports of Diguët (1909a, b) and Uetz (personal communication) who report that *M. gregalis* occupies a xeric habitat with fluctuations in prey availability. Although periods of high prey availability may have been important contributing factors in the evolution of sociality in *M. gregalis*, a predictable and consistently high abundance of prey is apparently not required for the maintenance of social behavior in this species under both laboratory and field conditions. For these reasons the short periods of low prey availability encountered in these series of experiments are not likely to affect the general conclusions of this paper.

Recording Methods.—Detailed descriptions of recording methodologies are provided elsewhere (Tietjen 1981, 1982). The system allowed for computer-assisted scanning of colony activity, occupation of space within the arena, and measurement of web structure and growth. In brief, a solid-state television camera (Periphicon Type 511), connected via a suitable interface to a CDP-1802 microprocessor-based computer, was located 0.65m above the experimental colony; and light was transmitted through the arena. The image in the camera's field of view was digitized into a 32 X 32 array providing 1024 picture elements (= pixels) which could potentially be occupied by the spiders and their web. Experimental arena shape reduced the usable recording area to about 620 pixels. Spiders appeared as black dots on a white background with each animal occupying a single pixel in the field of view.

The computer was programmed to record the occupation of space and activity of experimental colonies at approximately 30-sec intervals providing a total of 126,134 exposures. Occupation of space within the arena was recorded on a "map" of the arena in computer memory for each exposure. The number of moving spiders was determined by comparing sequential frames and recording the number of spiders moving from one frame to the next.

By transmitting light through the colony it was also possible to estimate the relative silk density at each pixel. High silk density areas (such as those associated with runways, reinforcement threads and silk-lined chambers) occluded more light than areas of low silk density. Thus, relative silk density and light intensity were inversely proportional. The relative silk density was recorded in 1024 levels of density for positions occupied by the colonies within the 32 x 32 grid. Blocks occupied by spiders or excreta were ignored in the silk density analyses by marking those pixels with the aid of a light pen. I compensated for possible nonlinearities in lighting intensity across the field of view by subtracting a optical density image of a control field from each of the silk density images.

Preliminary tests indicated that data (raw or transformed) did not fit parametric assumptions (Sokal and Rohlf 1969). All analyses were therefore nonparametric and were performed according to the methods of Conover (1971). Even so, all data are presented as the means and their standard deviations. Fourier analyses were based on the algorithm described by Owens (1981).

RESULTS

Web Structure.—*Mallos gregalis* readily built webs within the Petri dishes during the five-day growth period. These webs exhibited many of the structural features found in natural nests including chambers, silk runways and support

Table 1.—Effects of group size on web structure. Measures of web structure are presented in arbitrary units related to the optical density of the nest (see text).

Colony Size	Number of Colonies	Mean Silk Density	Maximum Web Density	Silk Deposition Per Spider
20	18	105.1 ± 13.7	375.0 ± 30.6	5.3 ± 0.7
10	17	78.1 ± 15.0	385.5 ± 30.6	7.8 ± 1.5
5	15	92.3 ± 11.9	305.3 ± 28.8	18.5 ± 2.4
2	20	45.3 ± 5.2	291.2 ± 60.6	22.7 ± 4.2
1	21	47.8 ± 4.2	205.0 ± 34.8	47.8 ± 4.2

threads (Tietjen 1985). The webs had their greatest silk density and structural complexity (i.e., chambers and tunnels) near the perimeter of the arena, with relatively simple, less dense sheets or silk-free areas found in the central parts of the arenas.

The mean silk density differed among groups, and was proportional to colony size (Spearman's rho $\rho = + 0.35$, $P < 0.01$; Kruskal-Wallis Test, $P < 0.001$; Table 1). The relationship between silk density and colony size was non-linear with the three larger colonies exhibiting equal mean silk densities. Silk density in these colonies was greater than, and significantly different from the two smaller groups (Mann-Whitney Test, $P < 0.005$). Visual examination of the webs (Fig. 1) as well as quantitative indices of variation in silk density within nests (Maximum web density [Table 1], standard error and variance to mean ratios among blocks) indicated that the webs of the larger three colonies were more heterogeneous than the smaller two groups (Spearman's rho $\rho = + 0.66$, $P < 0.0001$; Kruskal-Wallis Test, $P < 0.001$). The high silk density areas were associated with chambers and tunnels in the web-interior, therefore variation in silk density is an index of nest structural complexity.

A qualitative estimate of the average silk deposition per spider was calculated by dividing the mean silk density of each web by the number of spiders in the colony (Table 1; Fig. 2). These data indicate that the mean silk deposition per spider is inversely proportional to colony size (Spearman's rho $\rho = -0.86$, $P < 0.001$; Kruskal-Wallis Test, $P < 0.001$).

Colony Activity.—Colony activity, recorded as the number of animals moving per minute, was somewhat proportional to group size (Table 2). The relationship was non-linear, however, with larger colonies exhibiting more activity than expected, and smaller groupings showing less than the expected activity (Spearman's rho $\rho = + 0.69$, $P < 0.0001$; Chi-square, $P < 0.001$).

An examination of individual colony activity indicated that activity in the larger groupings was not constant during the recording period, but rather was clumped into discrete periods of high and low colony movement (Fig. 3). To explore the possibility of periodicities in the behavior, the data were analyzed using a fast Fourier transform and spectrum analysis. A full statistical analysis of the power spectra (a measure of the relative "importance" of each frequency component) was not possible with the available equipment. For this reason, only the shortest significant period was recorded from the power spectra and compared among colonies (Table 2).

Neither of the two smaller groupings exhibited periodicities above the background noise (unresolved or nonsignificant periods) of the power curve, indicating the absence of significant short-term activity bouts during the recording

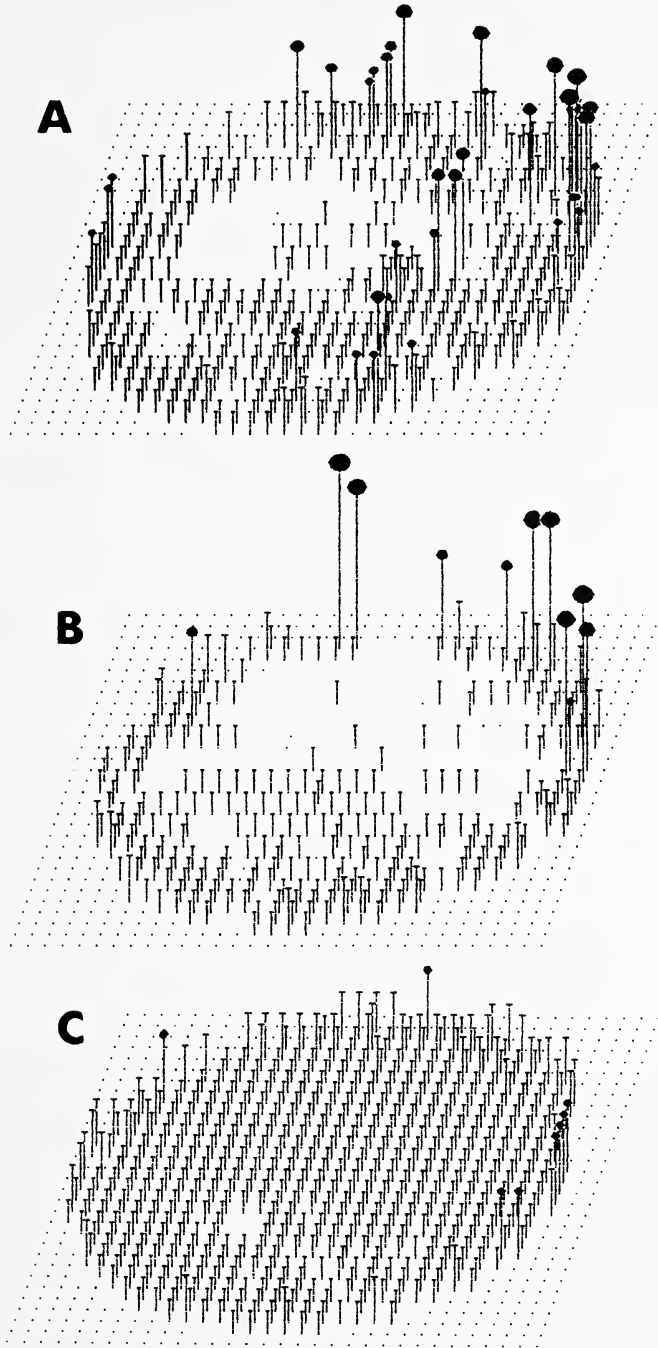

Fig. 1.—Effects of group size on relative silk density and structure. Representative silk density maps are provided for a) Colony size = 20; B) Colony size = 5 and C) Colony size = 1. Vertical bars represent relative silk density as determined by light transmission and displayed on a 0 to 10 scale which was optimized to display low density silk areas. The circles at the top of the bars provide additional cues as to the relative silk density; the larger circles representing denser areas of silk deposition (those blocks having chambers and tunnels). Small dots on the X/Y plane are areas located either outside the arena or blocks within the arena that were occupied by spiders or excreta. These blocks were ignored in the analyses. Note the silk-free areas in A and B and the extended low-density silk sheet in C. Also note the greater variation in web structure for the larger two colonies, and the concentration of silk near the edge of the arena. Experimental colonies of size ten were intermediate to those of size twenty and five. Groupings of size two were similar to those of size one.

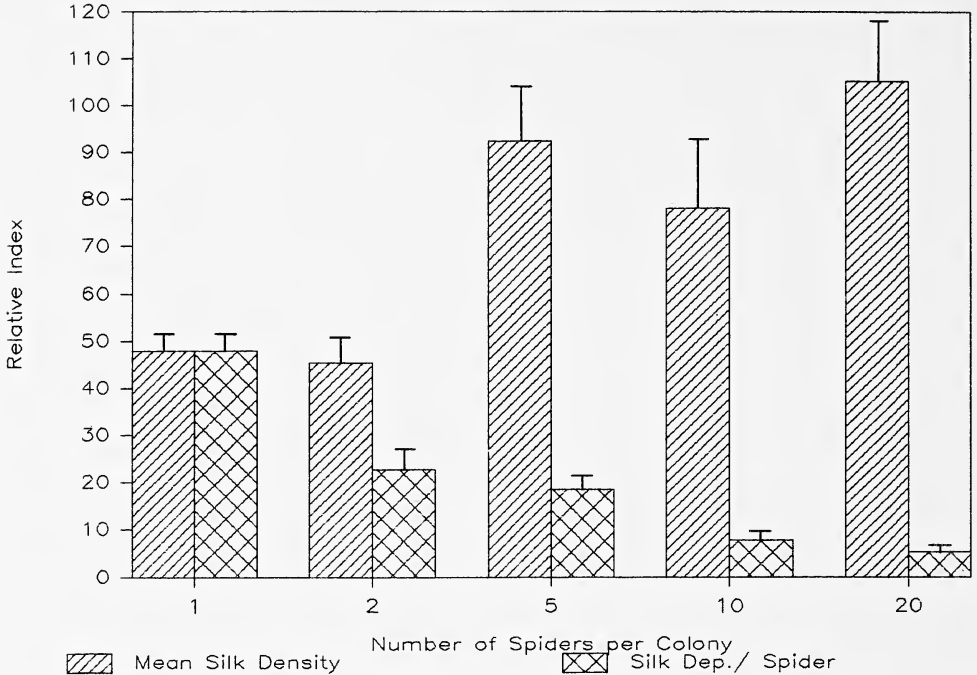

Fig. 2.—Effects of colony size on silk deposition. The relative index is an optical measure of silk deposition by colonies of size one-twenty. The mean silk density is presented as the averaged optical density of the colonies in arbitrary units. The silk deposition per spider is a qualitative index of the "work per spider" in building a nest.

period. Similarly, colony groupings of sizes five and twenty each had one sample with no significant periodicity while all of the remaining groups showed evidence of short-term periodicity. Examination of these remaining power spectra indicated that size-twenty colonies exhibited a shorter period than colonies of size five and ten (Spearman's $\rho = -0.36$, $P < 0.05$; Kruskal-Wallis Test, $P < 0.025$; Mann-Whitney Test, $P < 0.01$). Colonies of size 20, for example, showed peaks in activity every 25.8 minutes whereas colonies of size five and ten had activity peaks separated by over 40 minutes.

The recordings of occupation of space within the arena indicated that, in general, spiders in all groupings mainly occupied the periphery of the arena, those areas characterized by the highest silk density and complexity (Fig. 4). Examination of these data also allowed the determination of two movement indices: an occupation index expressed as blocks occupied per hour per spider, and the percent inactivity. The first is an index of the space occupied by each spider, whereas the second is a measure of the number of runs (for each experimental group) which exhibited evidence of one (or more) animals showing no movement during the recording period (Table 2).

The percent of inactive spiders was inversely proportional to colony size (Spearman's $\rho = -0.82$, $P < 0.0001$ Kruskal-Wallis Test, $P < 0.001$). The occupation index varied directly with colony size (Spearman's $\rho = +0.50$, $P < 0.01$; Kruskal-Wallis Test, $P < 0.005$). Even among the larger colonies, however, the occupation index was below three blocks per hour per spider, indicating that most of the spiders' activity occurred within small areas of the web rather than on the entire web surface (Table 2).

Table 2.—Effects of group size on colony activity and occupation by *Mallos gregalis*. The coordination index is a measure of the shortest periodicity as determined by the Fourier analysis of colony activity. Indices of activity and occupation (blocks occupied per hour) are presented as means for each spider rather than colony means. Both the coordination index and maximum percent inactivity are colony means.

Colony Size	N	Activity Moves/min	Coordination Index (min)	Occupation Index	Maximum % Inactivity
20	11	0.35 ± 0.1	25.8 ± 4.4	2.0 ± 0.7	99.4 ± 1.5
10	10	0.33 ± 0.2	41.5 ± 4.0	2.6 ± 0.6	73.7 ± 27.5
5	10	0.22 ± 0.1	45.1 ± 8.3	1.8 ± 0.3	66.7 ± 22.2
2	12	0.16 ± 0.1	—	1.1 ± 0.2	80.9 ± 18.6
1	14	0.09 ± 0.1	—	0.5 ± 0.2	62.3 ± 35.8

DISCUSSION

Evaluation of Methodology.—The computer-camera apparatus was non-intrusive in the recording of animal position and activity and should have no effect on behavior. The peak sensitivity of the camera (900 nm wavelength) allowed monitoring using a light source which is outside the visual range of many animals, including spiders (DeVoe and Zvargulis 1967, DeVoe 1972).

The use of the computer-controlled camera necessitated confining the spiders within the limited area of a Petri dish. However, *Mallos gregalis* adapt well to such conditions and will construct functional webs in a variety of containers ranging in size from the arenas used in these series of experiments to room-sized environmental chambers. Nonetheless, animals so restricted exhibit apparently normal courtship, mating, prey-capture, and feeding behaviors over several generations (Tietjen 1980, 1986). In addition, by confining the animals to a relatively small and homogeneous area, intercolony variation for web structure within a treatment group is decreased, thus allowing for comparisons among groups using reasonable sample sizes.

The silk density analyses had a bias owing to the necessity of ignoring those blocks occupied by spiders or excreta. This bias, however, would tend to reduce web complexity estimates for the larger colonies, since spiders spent most of their time near the perimeter of the arena (which had the highest silk density). The error would have a greater effect on larger colonies, thus reducing their indices of silk density variation among pixels. In a similar manner, the removal of those blocks occupied by excreta would further reduce overall variability since most waste is deposited in the central part of the arena, that area utilized as the exterior of the web and having the lowest silk density estimates (Tietjen 1980). The two smaller groupings had most of their web surface composed of low-density silk, so ignoring excreta would tend to increase web variability. Thus, the bias in both cases tends to make the measures of web complexity and variability more conservative.

The delicate nature of the web and the availability of equipment made it impossible to correlate the silk density data with an actual quantity of silk at each pixel within the field of view. However, a visual comparison of silk density maps with actual colonies indicated that the silk density image provided an accurate sampling of high silk density sites, especially those associated with runways and chambers within the nest. For this reason, the variation in silk density within a colony is interpreted as a measure of web complexity. Those webs that were

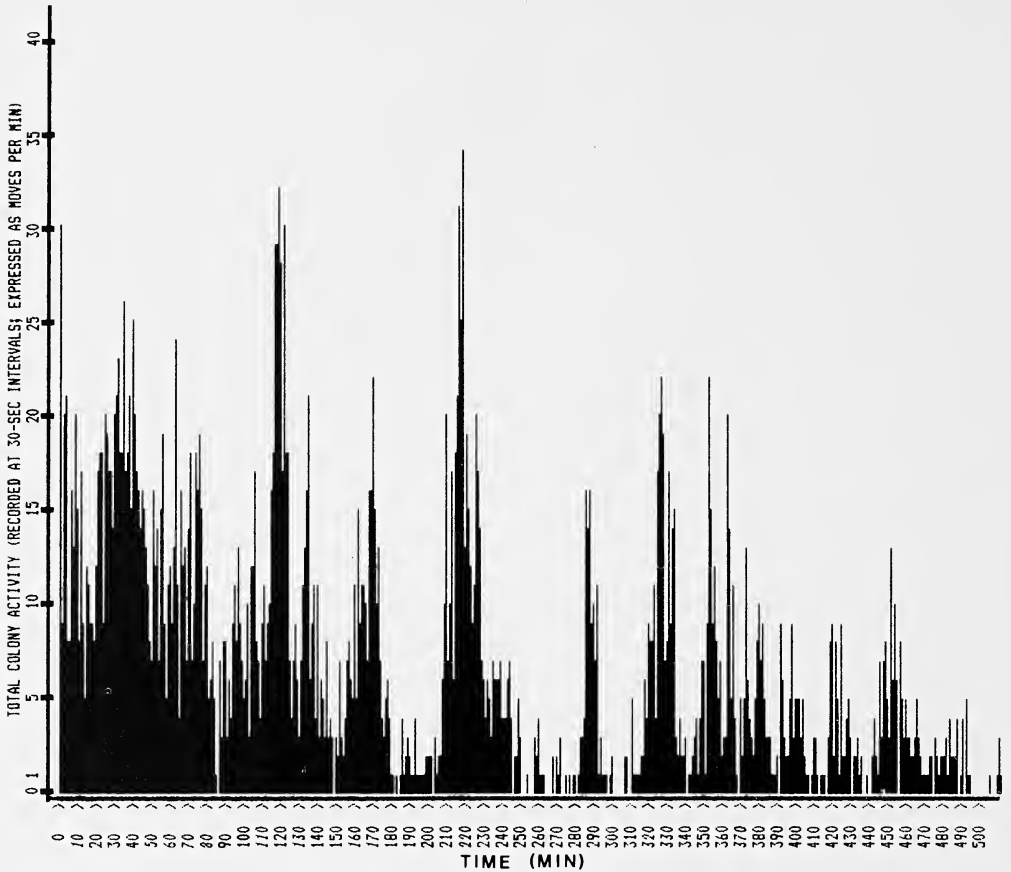

Fig. 3.—Representative activity data for a colony of size twenty. The scale on the abscissa is minutes since the beginning of the experiment. Note the clumping of the spiders' movements into a series of high and low activity bouts during the 8.5-hr recording period.

recorded by the computer as having little variation in silk density were qualitatively more simple in construction than those with relatively greater variation. The colonies with the greatest index of web complexity built webs with a very spongy appearance due to the presence of numerous silk-lined chambers and tunnels.

Web Structure as Related to Group Size.— Group size had a profound effect on the density and complexity of nest structure which extended beyond an arithmetic effect. Colonies of size 20, for example, did not simply deposit twice as much silk as colonies of size 10 since web density was not directly correlated with group size (the three larger colonies exhibited equal mean silk density). These data suggest that, for the larger groupings, a minimal amount of silk was required to support the construction of a nest which was to be occupied by several spiders. Similar results showing adaptation to group size (e.g. non-arithmetic changes in the behavior) are seen for web complexity, maximum silk density and the overall form of the nest.

Nests built by the larger groups had most of the silk concentrated at the edge of the arena. This outer section was characterized by greater structural complexity, including the presence of silk-lined chambers, runways and tunnels. The central portion of the arena had little or no silk, giving the larger nests a

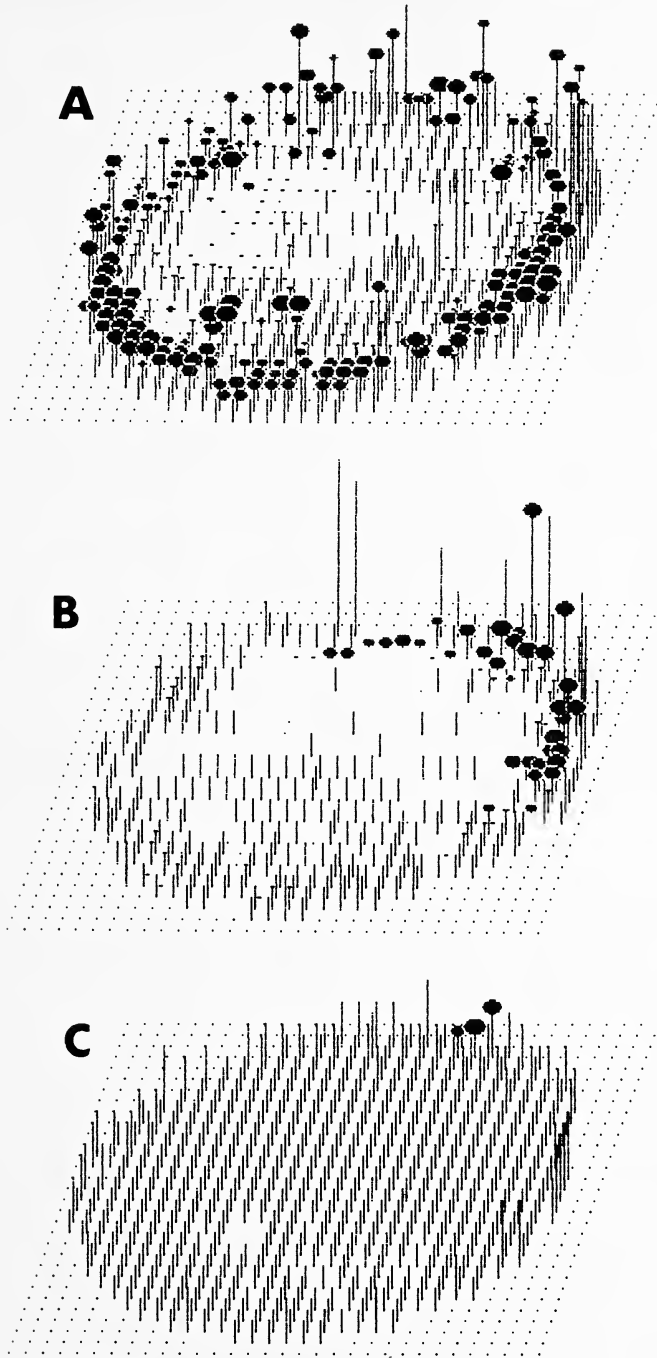

Fig. 4.—Effects of group size on occupation of space within the arenas. Three representative groupings are indicated: A) Colony size = 20; B) Colony size = 5 and C) Colony size = 1. As in Fig. 1, the vertical bars represent relative silk density. The circles at the top of the bars now indicate occupation of blocks within the arena. Those blocks that were most often occupied have the largest circles. Note the tendency for animals in each grouping to remain near the edge of the arena and the lack of long-distance movements by colonies of size one. Tests with groups of size ten were intermediate to those of size twenty and five. Groupings of size two were similar to those of size one.

toroidal distribution of webbing. The greater density of silk near the periphery was largely responsible for the increase in mean silk density with respect to group size. In contrast, webs built by groupings of one or two spiders were far less complex in construction, having few silk-lined retreats, and no runways or tunnels. In addition, a finely spun silk sheet extended through the central portion of the arena. Such sheets of silk were characteristic only of those webs built by the smaller groups.

The greater silk density and complexity produced by the three larger groupings would allow these colonies greater potential for exploitation of marginal habitats. In the laboratory and field, groups of *M. gregalis* roll or tie together leaves of the supporting foliage and construct a prey capture sheet on the surface of the plant, a process which does not kill the underlying foliage. Within the interior of these nests, the spiders build chambers and tunnels between the leaves. Individual spiders do not build such structures under laboratory conditions, but rather confine their building of a prey capture sheet to the surface of adjacent leaves. By taking advantage of the structure provided by the supporting foliage, the larger colonies would be afforded protection from sun, wind and rain, while allowing *M. gregalis* to take advantage of leaf transpiration to cool the nest (Tietjen 1986). In addition, a more dense and complex web would be expected to provide greater protection from potential vertebrate predators (Buskirk 1981, Rypstra 1979, Tietjen 1986). The web structure of the smaller test groupings lacked the complexity seen in the larger groupings. Most of the nests built by the smaller groupings had only one or two silken chambers which could be used as retreats. These nests are qualitatively similar to webs built by solitary dictynids (Chamberlin and Gertsch 1953, Kaston 1948). Even among those groupings having two members, the structure of the web was more similar to that seen in solitary species than to social ones. This suggests that *M. gregalis* is capable of shifting web-building behavior from a communal-cooperative mode of construction to a solitary mode of behavior.

Under unrestrained conditions in the laboratory, individual *M. gregalis* may leave the parent colony and build single-spider webs. Spiders occupying such webs usually remained isolated from the original colony and were competent in prey-capture behavior. These data, in conjunction with the quantitative differences observed in the structure of the nests between the large and small groupings, suggest that *M. gregalis* is, to some extent, a facultatively-social spider.

The silk deposition per spider was inversely proportional to colony size. Although these data do not represent the actual metabolic expenditures for individuals, it is reasonable to assume that the differences observed among the groups do reflect varying physiological burdens. If this is so, the data indicate that another advantage of cooperative nest construction is a decrease in energy expenditure per individual spider. A more complete explanation of this effect will require an analysis of the caloric content of webs built by groups of differing size.

Colony Activity as Related to Group Size.—Measures of mean activity per spider, patterning of activity bouts and occupation of space within the arena were also affected by group size. As was the case for web structure, the changes observed for each of these behaviors extended beyond an arithmetic effect and instead represent shifts in the behavior of *M. gregalis* with changes in colony density.

The data indicate that the mean activity of individuals in larger colonies was greater than that of the smaller, with members of the largest two colonies being three to four times more active than isolates. This evidence, taken alone, might indicate that a major disadvantage of group-living in *M. gregalis* is an increase in metabolic costs due to greater activity. However, most of the activity observed in the larger colonies was short-distance movements and turning in place as shown by the mean number of blocks traversed per hour per spider, this translates to an actual distance of less than 8mm per hour as compared to a distance of 2-4mm per hour for the smaller colonies. Thus, although the movement indices of the larger colonies are higher than those seen in smaller groupings, the actual metabolic cost of the activity is likely to be low. It is possible that greater efficiency in nest construction (e.g., work per spider) more than offsets the slight increase in activity seen among the larger colonies. Nearly 100% of the larger colonies had animals which did not move during the recording period whereas smaller groupings exhibited less total inactivity (Table 2). This suggests that in larger groupings, individuals may have greater opportunity for extended periods of inactivity since they do not have to expend as much time in nest construction. The Fourier analyses indicated that the larger colonies organized their nocturnal rhythms into a series of high-activity bouts. Colonies of size 20 showed greater coordination in the patterning of activity bouts as evidenced by their shorter periodicity as compared to the smaller groupings.

The proximate cause for the patterning of activity seen in the larger groupings is most likely due to web-transmitted vibrations. Thus the vibrations caused by the movements of a single spider could induce movement in other colony members. Similar effects have been described in several social species including *Cyrtophora citricola* (Rypstra 1979), *Metepeira spinipes* (Uetz, in press), and *Oecobius civitas* (Burgess 1976).

Vibrations transmitted through the web by walking spiders are extended below the response window of 30-700 Hz recorded by Burgess (1979a), who suggested that the movements of spiders are damped whereas vibrations of struggling prey are enhanced. Although it is clear from Burgess' work that fly vibrations are accented by the web structure, the potential for low frequency vibrational communication among nest mates is still possible for *M. gregalis*. Hollar (in Tietjen 1986) used a more sensitive photo-optic transducer than was available to Burgess to record web movements and demonstrated that the vibrations of normally walking spiders can be transmitted over distances of 10 cm or more. Similarly, Jackson (1978) reports that the courtship vibrations of male *M. gregalis* occur at about 10 Hz. These data suggest that the vibrations caused by the movements of spiders could provide a means of intra-colony communication.

The occupation index and an examination of the space-utilization figures indicate that members of the larger colonies occupy a greater area within the Petri dishes than do those of the smaller groupings. Examination of the space-utilization figures indicates that nearly all of the recorded activity was short-distance movements (probably turning in place, silk depositions and grooming movements). If the cribellate silk lining of chambers dampens the vibrations caused by the movements of other spiders on the web, then animals located within these structures could effectively remove themselves from the stimulation caused by the activities of their nestmates. Casual observations suggest that animals located outside chambers are more responsive to the movements of other

spiders on the web than are those located within chambers. Thus, the structure of the chambers could allow a proportion of the colony to maintain an in active state without being stimulated to active behavior by the movement of other colony members, as suggested by Tietjen (1982).

The organization of colony behavior among the Araneae does not depend on coordination provided through ethological or morphological caste systems but rather on mass action behavior, chemical communication, vibratory signals, and periodicities in activity and occupation of web sites (Tietjen 1986). Web-transmitted vibrations and interindividual interactions during activity peaks could provide an efficient means for individuals to ascertain current colony conditions related to population density and colony reproductive state. These effects, coupled with web-position dependent behaviors, and chemical communication may aid in organizing colony behavior.

ACKNOWLEDGMENTS

This research was supported by National Science Foundation Grant BNS 79-10186 to W. J. Tietjen. I performed the construction of the computer-camera apparatus at the laboratories of the North Carolina Foundation for Mental Health Research. Data were collected while at the Department of Biology at Georgia College. Statistical analyses were written and performed at Lindenwood College. I am most grateful to Dr. P. N. Witt for the opportunities he provided in electronics and programming as well as many helpful discussions during the course of this research. George Uetz provided the spiders used in these series of experiments. Dr. Jerome Rovner reviewed a preliminary copy of the manuscript. The comments of S. E. Riechert and G. W. Uetz in their review of the manuscript were greatly appreciated.

REFERENCES

- Burgess, J. W. 1976. Social spiders. *Scient. Amer.*, 234(3):100-106.
- Burgess, J. W. 1978. Social behavior in group-living spider species. *Symp. Zool. Soc. London*, 42:69-78.
- Burgess, J. W. 1979a. Web-signal processing for tolerance and group predation in the social spider *Mallos gregalis* Simon. *Anim. Behav.*, 27:157-164.
- Burgess, J. W. 1979b. The spider species *Mallos gregalis*: Behavioral adaptations for living in Mexico. PhD. Dissertation. North Carolina State University, Raleigh, N.C.
- Buskirk, R. E. 1981. Sociality in Arachnida. Pp. 281-367, *In Social Insects* (H. R. Hermann, ed.), vol. II. Academic Press, New York.
- Chamberlin, R. V. and W. J. Gertsch. 1958. The spider family Dictynidae in America North of Mexico. *Bull. Amer. Mus. Nat. Hist.*, 116:1-152.
- Conover, W. J. 1971. *Practical Nonparametric Statistics*. John Wiley and Sons, Inc., New York. 462 pp.
- DeVoe, R. D. 1972. Dual sensitivities of the cells in wolf spider eyes at ultraviolet and visible wavelengths of light. *J. Gen. Physiol.*, 59:247-269.
- DeVoe, R. D. and J. E. Zvargulis. 1967. Spectral sensitivities of vision in wolf spiders and jumping spiders. *Fed. Proc.*, 26:655.
- Diguet, L. 1909a. Sur l'araignée mosquero. *C. R. Acad. Sci. Paris*, 148:735-736.
- Diguet, L. 1909b. Le mosquero: nid d'araignée employé a Mexique comme pie'ge a'mouches. *Naturaliste, Paris*, 31:283-285.
- Jackson, R. R. 1978. Male mating strategies of dictynid spiders with differing types of social organization. *Symp. Zool. Soc. London*, 42:79-88.

- Jackson, R. R. 1979. Comparative studies of *Dictyna* and *Mallos* (Araneae, Dictynidae) II. The relationship between courtship, mating, aggression and cannibalism in species with differing levels of social organization. *Rev. Arachnol.*, 2:103-132.
- Jackson, R. R. 1979. Comparative studies of *Dictyna* and *Mallos* (Araneae, Dictynidae) V. Tolerance and resistance to starvation. *Psyche*, 87:211-220.
- Kaston, B. J. 1948. Spiders of Connecticut. State Geological and Natural History Survey. Hartford, Conn., 874 pp.
- Kullman, E. J. 1972. Evolution of social behavior in spiders (Araneae: Eresidae and Theridiidae). *Amer. Zool.*, 12:395-405.
- Owens, A. J. 1981. On the use of Fourier transforms to explore biological rhythms. *Byte: the Small Systems Journal*, 6:314-326.
- Rypstra, A. L. 1979. Foraging flocks of spiders. *Behav. Ecol. Sociobiol.*, 5:291-300.
- Shear, W. A. 1979. The evolution of social phenomena in spiders. *Bull. British Arachnol. Soc.*, 1:65-76.
- Sokal, R. R. and F. J. Rohlf 1969. *Biometry*. W. H. Freeman, San Francisco, 776 pp.
- Tietjen, W. J. 1980. Sanitary behavior by the social spider *Mallos gregalis* (Dictynidae): Distribution of excreta as related to web density and animal movements. *Psyche*, 87:59-73.
- Tietjen, W. J. 1981. An inexpensive microcomputer-based image digitizer. *Behavior Research Methods and instrumentation*, 13:347-350.
- Tietjen, W. J. 1982. Influence of activity patterns on social organization of *Mallos gregalis* (Araneae, Dictynidae). *J. Arachnol.*, 10:75-84.
- Tietjen, W. J. 1986. Social spider webs with special reference to the web of *Mallos gregalis*. Pp. 100-121, *In Webs and Behavior* (W. Shear, ed.). Stanford Univ. Press, Stanford.
- Uetz, G. W. 1983. Sociable spiders. *Nat. Hist.*, 92:62-69.
- Uetz, G. W. 1985. Environmental and genetic influences on social grouping tendency of a communal spider. Pp. 000-000, *In Evolutionary Genetics of Invertebrate Behavior* (M. A. Huttel, ed.). Plenum Press, New York.
- Wilson, E. O. 1971. *The Insect Societies*. Harvard University Press, Cambridge Mass. 548. pp.
- Witt, P. N., M. B. Scarboro and D. B. Peakall. 1978. Comparative feeding data in three spider species of different sociality: *Araneus diadematus* Cl., *Mallos trivittatus* (Banks) and *Mallos gregalis* (Simon). *Symp. Zool. Soc. London*, 42:89-97.

Manuscript received July 1984, revised September 1984.

Uetz, G. W. and K. R. Cangialosi. 1986. Genetic differences in social behavior and spacing in populations of *Metepeira spinipes*, a communal-territorial orb weaver (Araneae, Araneidae). J. Arachnol., 14:159-173.

**GENETIC DIFFERENCES IN SOCIAL BEHAVIOR AND
SPACING IN POPULATIONS OF *METEPEIRA SPINIPES*,
A COMMUNAL-TERRITORIAL ORB WEAVER
(ARANEAE, ARANEIDAE)¹**

George W. Uetz and Karen R. Cangialosi

Department of Biological Sciences
University of Cincinnati
Cincinnati, Ohio 45221 U.S.A.

ABSTRACT

Metepeira spinipes F. O. Pickard-Cambridge, a communal/territorial orb-weaver from Mexico, shows considerable geographic variation and temporal flexibility in spacing. A series of laboratory studies was conducted to test whether the variation in spacing observed in the field is solely the result of behavioral plasticity in response to environmental conditions, or the result of mechanisms inherent in different populations (i.e., genetic differences in behavior). Spiders from source populations in desert and moist tropical habitats were collected as eggs and raised in the laboratory under identical controlled conditions. Measurements of three-dimensional spacing parameters in laboratory colonies (nearest neighbor distance, within-colony density) have shown significant differences in spatial organization between populations, suggesting a genetic basis to these differences. Behavioral observations confirm that there are behavioral ecotypes within this species, with levels of sociality adapted to the regions in which they occur.

INTRODUCTION

There are constraints on the social behavior of orb weaving spiders (families Araneidae and Uloboridae) that make the evolution of sociality less likely in this group. Unlike the sheet or tangle webbing of spiders in other families which exhibit communal web building (Theridiidae, Agelenidae, Dictynidae, Eresidae, Amaurobiidae, Oecobiidae, Pholcidae), the orb web cannot be built by more than one spider. It is the result of a complex sequence of behaviors which are tightly controlled by the genetic "program" of individual spiders (Witt and Reed 1965, Witt et al. 1968), unlikely to be modified to include participation by others (Lubin 1974, Burgess and Cangialosi 1982). Thus, cooperative web construction, at least of the prey catching portions of the web, is precluded.

Most orb weavers are limited in their social organization to aggregations of potentially of potentially competing individuals building and occupying their own webs within a shared web foundation (Lubin 1974, Buskirk 1975, a,b, Fowler and Diehl 1978, Uetz et al. 1982, Smith 1983). This type of social organization is termed "communal/territorial" (Jackson 1978), and is conceptually (and

¹Presented in a symposium, "Social Behavior in Spiders", at the National Meeting of the American Arachnological Society, June 27, 1984.

sometimes evolutionarily) intermediate between the incipient sociality of fortuitous spider aggregations, and more advanced social spiders (which exhibit cooperation in prey capture, feeding, and brood care) (Buskirk 1981, Burgess and Uetz 1982, Rypstra 1983).

These spiders must reconcile the demands of conflicting behavioral strategies—communal aggregation and defense of space—while at the same time contend with a mosaic of contiguous territories in three dimensions instead of two. The result is a three-dimensional spatial arrangement of group members which is somewhat fixed, yet may change every time webs are renewed (usually on a daily basis) depending on the outcome of aggressive interactions between individuals. The “territory” defended has indistinct boundaries, in that the silk connections between the retreat, the orb or catching spiral, and the space web are connected to and overlap with these of other individuals. In addition, this is a “multipurpose territory” (Davies 1978), in that it may include a foraging site (the orb), a habitation (the retreat), a mating site (orb and/or retreat), and a breeding/egg laying site (the retreat). Thus, the spatial organization of communal/territorial orb weavers reflects a compromise solution to the conflicting selection pressures of competition for space and food resources and for benefits gained from communal foraging. An analysis of spatial organization in these spiders should clarify the relative importance of those selection pressures in the evolution of spider sociality.

For several years, we have studied the behavior and ecology of *Metepeira spinipes* F. O. Pickard-Cambridge (Araneidae), a communal/territorial orb-weaving spider species found in central Mexico (F. O. Pickard-Cambridge 1903). Previous studies have shown considerable between-population variation in the spatial organization of this species (Burgess and Uetz et al. 1982, Uetz 1983, Uetz et al., in press). This variation makes *M. spinipes* an interesting species with which to investigate spacing, and raises questions about the influences of environmental and genetic factors on the social organization of communal-territorial spiders.

BACKGROUND

Metepeira spinipes occurs solitarily, but more frequently occurs in groups of 5 to 150 or more individuals (Burgess and Witt 1976, Uetz and Burgess 1979). *Metepeira spinipes* is the only communal species in this genus (Levi 1977), although there is one other species, *Metepeira daytona* Chamberlin and Ivie, found in the Carribean, which occasionally exhibits group web-building (Schoener and Toft 1983). The genitalia of all specimens examined to date resemble the drawings of Pickard-Cambridge in the species description. In addition, preliminary studies of genetic differentiation between populations in different geographic areas using starch gel electrophoresis tentatively indicate that *M. spinipes* is a single species (Uetz et al., in press).

The web of individual *Metepeira spinipes* (Fig. 1) contains a three-dimensional space (or barrier) web with a retreat, and a sticky orb connected to the retreat by signal threads (Burgess and Witt 1976). Although the sticky orb webs are taken down and renewed on a daily basis, a communal space web persists and acts as a framework for the web building activities of numerous individuals. The



Fig. 1.—Schematic diagram of a colony of *Metepeira spinipes*.

resultant 3-dimensional colony consists of spiders inhabiting interconnected, fixed, foraging locations, potentially changing positions on a daily basis. Individuals maintain and defend orbs and retreats within the colony, and capture their own prey.

Group size in *M. spinipes* varies with habitat (Uetz et al. 1982). In severe habitats where prey availability is low (e.g. desert grasslands), spiders are predominantly solitary or live in small groups. In sites where climate is benign all year and insect abundance is great (e.g. moist tropical forest), colony size is very large. Nearest neighbor distance decreases over the habitat gradient between these sites and in general appears to be inversely related to prey availability (Uetz et al. 1982, Uetz et al. in press). This relationship is further supported by the results of field experiments, in which nearest neighbor distance increased in colonies after relocation to prey-poor sites, except when colonies had prey supplemented (by addition of cow dung to their new sites) (Uetz et al. 1982).

Metepeira spinipes can apparently tolerate conspecifics at closer distances in areas where prey are more abundant, as Riechert (1978a) has found in *Agelenopsis aperta* (Gertsch), a solitary, desert funnel web spider. *Agelenopsis* has a minimum territory size, genetically set at an area that provides the spider with sufficient prey biomass (Riechert 1981, Riechert in press). In contrast, *M. spinipes* shows a rapid change in spacing when food availability changes. This may be explained by the fact that orb weavers, unlike funnel web builders, renew their web on a daily basis (Uetz 1985, Riechert and Gillespie, in press). In this communal/territorial orb weaver, rising hunger and aggression levels associated with food deprivation may result in greater nearest neighbor distances when the webs are rebuilt each day.

Observation of behavior and spacing patterns of spiders in laboratory cages confirm the findings of field studies. Spiders in cages at low levels of prey

availability were spaced at significantly greater distances from each other than those in cages at maintenance or satiation levels of prey (Uetz et al. in press). Instances of cannibalism ($n = 9$) were highest in the low prey availability cages (30%), and very low (3%) in the other treatments. There were no significant differences in nearest neighbor distances of spiders at maintenance and satiation levels of prey. This suggests that there is an intrinsic lower limit of distance (analogous to territory size) at which conspecifics can be tolerated.

Genetic differences in the degree of tolerance of conspecifics are suggested by laboratory observations of differences in the behavior of field collected *M. spinipes* from various localities. In particular, spiders from the tropical site appear far more tolerant of each other. During transport, many individuals can be placed together in small containers with water but no food, and survive for up to two weeks without cannibalism. In contrast, spiders from the other populations cannot exist under these conditions for more than a day or two. In laboratory cages under identical conditions, field collected individuals from the tropical site and desert site show distinct differences in web building behavior, web structure, and inter-individual spacing. These differences are apparent from the first day of introduction to the cages (Uetz et al. in press).

The questions raised by the results of these earlier studies concern the possibility of some genetic control of social organization in this species. Could the very wide range of group size and spacing seen in *M. spinipes* be solely the result of behavioral plasticity in response to climate and food availability? Or, is it possible that different social behavior or tolerance strategies are selected for in different environments and are reflected in the differences seen between populations? To answer this question, an experimental study was conducted in the laboratory using a classic behavior genetics technique—rearing spiders from different populations under identical, controlled conditions.

In this study, most proximal environmental (ecological) factors that might influence spacing in *M. spinipes* (climate, predation, availability of prey, web site availability, colony density) were controlled in the laboratory. Thus, differences in nearest neighbor distance and other spacing parameters between populations that might be attributable to genetic factors inherent in the populations can be revealed. Experiential factors, and the interaction of genes and environment are investigated in another study (Cangialosi and Uetz, in prep.)

METHODS

Representative field sites were chosen in three geographic regions where populations of *M. spinipes* exhibit different levels of social behavior as indicated by group size and spacing: (1) In the northern desert region, near San Miguel de Allende, where *M. spinipes* is found in small groups with maximal inter-individual distances. (2) In the tropical mountainside of Fortin de las Flores, where the spiders are found in very large groups with minimal inter-individual distances. (3) In the central valley of Mexico, in Tepotzotlan, an agricultural area north of Mexico City, where the spiders are found in group sizes and with spatial organization intermediate between (1) and (2) above. These sites represent the range of variation in social spacing seen in this species, and are easily accessible, being located off major highways. The vegetation and environments of these areas

are described in Shelford (1963) and previous data on climate variables, prey insect availability, and aspects of *M. spinipes* natural history are also available (Uetz et al. 1982, Uetz 1985, Benton and Uetz in press).

Egg sacs were collected from the field sites in October 1982 and February 1983 and brought back to Cincinnati, Ohio for laboratory rearing under controlled environmental conditions. Spiderlings used in the experiment were selected from several egg sacs or egg sac strings. Each experimental group was a mixture of eggs from six females, taken from different colonies of equal size at each site, in order to minimize (or at least equalize) possible maternal effects. It is certainly impossible to control for all differences between eggs, especially when collecting them from females in the field (whose precise individual history is not known). However, they were collected from sites (and in some cases, colonies) for which previous ecological data are available, and this selection process undoubtedly reduced the potential for error between experimental groups due to egg differences within each group.

Spiders were housed in a walk-in environment room with light regulated on the same daily regime occurring in their natural habitat (12 hrs light; 12 hrs dark). Spiders were raised to adulthood under conditions of controlled climate (Temperature 27°C; Rel. Humidity 75%). These conditions are optimal for survival of *M. spinipes*, as established from previous research.

Spiders were raised communally through adulthood in groups of 30 individuals in cages (100 cm X 75cm X 80 cm) where cultures of *Drosophila* and *Musca* flies provided prey ad libitum. Three cages of spiders from each population (desert and moist tropical forest) were established. Spiders were supplied with prey ad libitum in order to control for hunger as an influence on spacing. Under conditions of apparent food satiation, a minimal interindividual spacing level is reached (Uetz et al. in press). In a separate study (Cangialosi and Uetz, in prep.) spiders were reared individually in isolation to control for experiential effects.

The fixed colony size (30 spiders per cage) for this experiment was arrived at after many attempts at rearing these animals at a variety of densities, and was chosen for several important reasons. First, by keeping the number of spiders constant in all cages, differences in spacing seen in the field due to the compound influence of population density and dispersion are eliminated. Second, it is important not to set up a false test of spacing differences—where spiders from the desert are overcrowded, experiencing a density far greater than they would in nature, while the tropical spiders spread out their webs in what to them may be wide open space. Having 30 spiders in a cage yields a group size in the upper range for the desert spiders (yet still encountered in nature with a frequency 0.05), and a density of approximately 40 spiders/cubic meter (which is by no means overcrowded—densities far greater are seen frequently in nature). Likewise, this group size and density are not unlike those seen for smaller colonies in the tropical population under natural conditions.

The chosen colony size also serves as a conservative test of the tendency for individuals from the tropical population to be spaced closer together, even when space is not limiting. If inter-individual spacing expands, then it may be assumed that in nature, some aspect of colony size and density (e.g., intrusion by other spiders on individual space), is causing spiders to be spaced more closely together (Hixon, 1980, Schoener 1983). If cages housing individuals representing tropical populations show smaller nearest-neighbor distances (NND) than cages with

spiders from desert populations (as has been observed in previous studies), then an inherent tendency toward closer association with conspecifics will be demonstrated.

Using a fixed number of spiders per cage raises another set of problems that must be addressed—what happens if there is differential mortality in cages? Might this differentially affect nearest neighbor distance? As luck or fate may have it, there was some mortality, but statistical analysis has shown that there is no apparent directionality in its effect; NND and subsequent no. of spiders/ cage are not significantly correlated for all cages from both populations ($r = 0.21$; $p > 0.45$).

Each of the cages was gridded with cm markers on the outside, so that the exact position of each animal within the group could be determined using x, y, z coordinates. Positions of individuals within colony cages were recorded at regular intervals corresponding to developmental stages (immatures: instars 5-7; pre-reproductive adults, reproductive adults), using the aforementioned coordinates. This was done to insure that when measurements were taken, all spiders (from both populations) were at approximately the same stage and size, reflecting equivalent territory sizes. Data collected on location of individuals within colonies were loaded into a computer program used to calculate nearest neighbor distances using the following formula (Buskirk and Uetz 1982, Major and Dill 1978):

$$\text{Distance (1, 2)} = [(X_2 - X_1)^2 + (Y_2 - Y_1)^2 + (Z_2 - Z_1)^2]^{1/2}$$

Distance between all possible pairs of animals may be obtained using this formula, and the computer program calculates means for 1st, 2nd, 3rd...Nth nearest neighbors. Nearest neighbor distance is a widely used measure of animal spacing, and provides a means of quantitatively comparing populations.

Density of spiders within the colony was also calculated. Because the number of spiders per cage remains fairly equal between cages, this measure estimates the internal cohesiveness of individual spacing within the group. A direct measure of density was used by determining the amount of the cage occupied by the communal web, and dividing that into the number of spiders per cage. Thus, if there was any mortality, the measure of density was scaled by the size of the spider colony and not nearest neighbor distance (as in other measures).

Spiders were observed in cages between 6:00 AM and 9:00 AM EST, which is the time period during which webs are built and most behavioral interactions occur (3 hours before "dawn"). A total of 9.5 hours observation time for the desert population, and 8.25 hours of observation time for the tropical population were accumulated in short periods (approximately 30 minutes—1 hr at a time) over several weeks. Numbers of interactions were totalled for each population, and sequences of behavior during each interaction were recorded.

In Fortin de las Flores in August 1983, positions of nearest neighbors relative to each other in 3-dimensional space were examined within a small colony (approx. 100 individuals) and a much larger one (approx. 1500-2000 individuals), determined from location data in both horizontal and vertical aspects. Orientation of individuals facing webs (and thus the direction the web faces) was recorded in xy plane, and set as zero degrees. Location of individuals relative to each other in the xy plane (bearing) and in the xz plane (elevation) was recorded with the vertical axis set at zero degrees.

Table 1.—ANOVA: Nearest neighbor distances of spiders in laboratory cages (* = < 0.05).

Time Period	Development Stage	Source of Variation	F Value
1	immatures (instars 5-7)	Source Population	17.43*
		Replicates	1.38
2	penultimate	Source Population	8.85*
		Replicates	2.53
3	pre-reproductive adult	Source Population	24.64*
		Replicates	4.84
4	reproductive adult	Source Population	35.74*
		Replicates	0.60
5	adult females with eggs	Source Population	7.28*
		Replicates	1.20

RESULTS AND DISCUSSION

In the laboratory, under identical controlled conditions, significant differences were seen in the spacing of spiders from separate source populations at all stages of their juvenile development (Table 1). The spiders from the moist tropical site in Fortin de las Flores had a significantly lower nearest neighbor distance (NND) than spiders from Tepotzotlan or San Miguel de Allende (Duncan's Multiple Range Test, $p < 0.05$). Spiders from the desert grassland population (San Miguel) and the agricultural central valley (Tepotzotlan) showed no significant differences in NND.

NND actually varies very little over several months' time in the laboratory (Figure 2), which suggests that under these conditions, the spiders maintained a minimum NND. This suggestion is supported by a comparison of field and lab data for adult females. In populations from San Miguel and Tepotzotlan, lab NND was significantly lower than field NND (Student's "t" test with unequal variance correction, $p < 0.05$). For the populations from Fortin de las Flores, no difference was seen in lab and field NND, perhaps because prey are so abundant in the field there. At that site, however, female—female distances may be misleading, because all ages are present at one time. In the lab, cohorts of similar ages comprise the colonies.

An early concern in this study was that random mortality might cause the numbers of spiders in each cage to be different, and thus influence NND. However, within each time period or set of cages, NND and number of spiders per cage (after mortality) were not correlated (Person's "r" = 0.21; $p < 0.45$). Even so, to guard against such a possibility, a measure of spacing independent of NND was made by estimating the density within colonies (no. of spiders/m³) by measuring the volume of the webbing and dividing it into the number of spiders in the cage. A comparison of the observed density and the expected density (based on the no. of spiders/volume of cage) (Figure 3) shows a significant difference between spiders from the moist tropical site and those from the other two areas (G test; $p < 0.01$). These data suggested that spatial arrangements within colonies differ between populations, and in fact, consistent differences in the spatial organization within colonies were revealed. When actual positions of spiders were plotted in three dimensional graphic arrays, spiders from Fortin tended to group in a cluster in the upper center of the cage, whereas

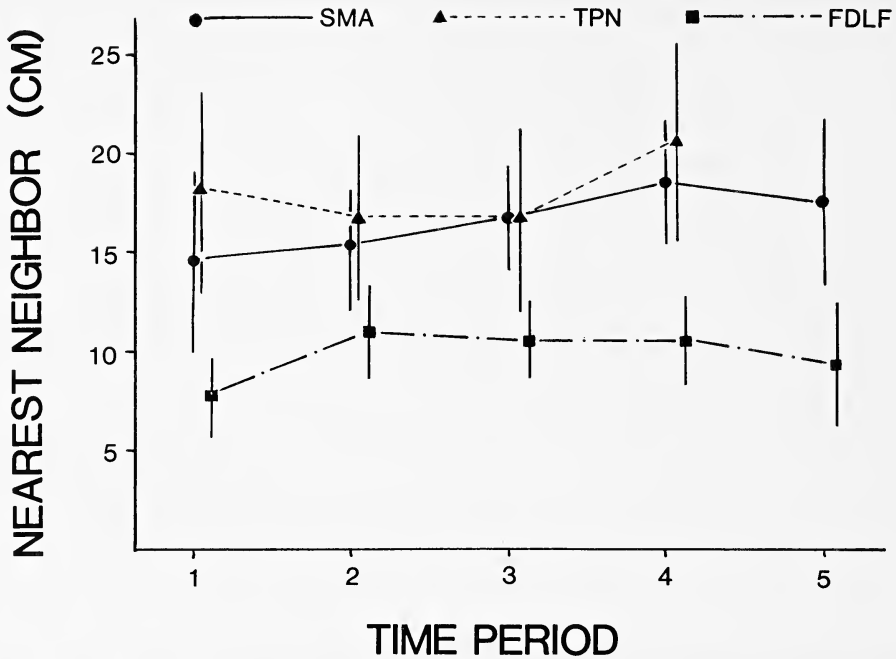

Fig. 2.—Mean nearest neighbor distance \pm 95% conf. limits) of three replicate *M. spinipes* colonies, each set from three different field populations and reared over their life cycle in the laboratory under identical conditions. (SMA = San Miguel de Allende; TPN = Tepetzotlan; FDLF = Fortin de las Flores). Time periods represent developmental stages as indicated in text and Table 1.

spiders from Tepetzotlan and San Miguel tended to be dispersed throughout the cage (Fig. 4a, b). These differences were consistent in all cages, and throughout all time periods.

From these findings, it is apparent that populations from the extreme ends of the range of spacing seen in nature show consistent differences in NND when raised under identical conditions (conditions which should result in a minimal level of distance between neighbors). Although the remote possibility of some maternal or egg effect cannot be ruled out entirely, these data suggest some genetic differences, perhaps influencing behavior and thus spacing. It is probable that there are ecotypes (genetically distinct subpopulations), subspecies, or emerging species populations showing differences with respect to social behavior, which have spacing arrangements adapted to environments where they occur. Genetic influences, acting along with environmental influences like climate and food availability, result in the variation in social spacing observed in earlier studies.

An important question that must now be raised concerns the nature of genetic control of spacing behavior. How can genes influence the nearest neighbor distance in a colony of spiders? There would appear to be two main ways in which this could occur, and there are several lines of evidence supporting each mechanism.

It may be possible that there are differences in the interaction strategies of spiders that have become genetically fixed in each population (as has been found for *Agelenopsis* by Riechert 1983, 1984) resulting in clear differences in the levels of aggression shown. More aggressive spiders would be widely spaced, whereas

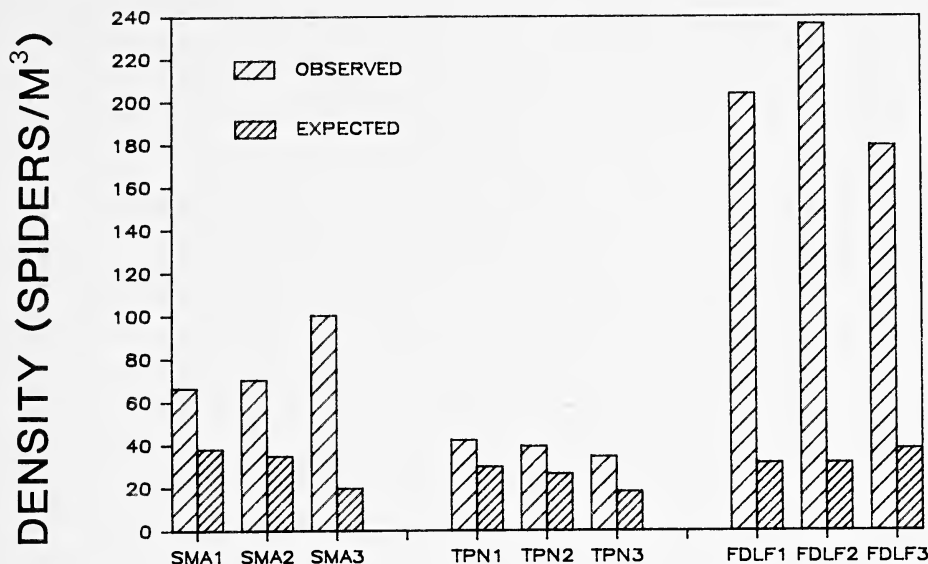

SOURCE POPULATION

Fig. 3.—Density of *M. spinipes* in laboratory colonies (see text for explanation of observed and expected values).

less aggressive ones would be spaced closer together. Spiders from the desert and moist tropical forest populations, maintained in laboratory cages under identical controlled conditions of this study, show differences in their interactive behavior. In 9.5 hours of observation, spiders from the desert population had 40 encounters in which agonistic behavior was seen (0.178/spider-hr). In contrast, in 8.25 hours of observations, the spiders from the tropical forest population had 119 such encounters (0.560/spider-hr). This apparent difference would at first appear counter to both theory and previous findings. An explanation may be found in the actual patterns of behavior seen in these interactions (Figs. 5a, b). In the tropical population, where agonistic encounters are more frequent, a majority of bouts are concluded with a single web pluck exchange (Fig. 5a). In the desert population, bouts are more prolonged, and escalate more quickly to chasing and grappling (Fig. 5b).

These findings are consistent with the predictions of game theory, as demonstrated by Riechert (1982, 1983). Selection would favor an aggressive behavior strategy that is appropriate for the level of resource availability in the local environment. If space and food were the limiting factors, an aggressive behavior strategy which results in the securing of a web site within the colony at the optimum level of cost/benefit would prevail. For the desert population, where web sites and food availability are limited, a strategy of rigorous defense of territory is appropriate. In tropical colonies, where prey are abundant and the quality of web sites within the immense communal web may be more or less equal, the appropriate strategy is for intruders to give up without a fight, and move elsewhere. This may also be true of residents, which have often been observed giving up a web to a more persistent intruder. The outcome of these different strategies is that once settled into web locations, desert spiders move

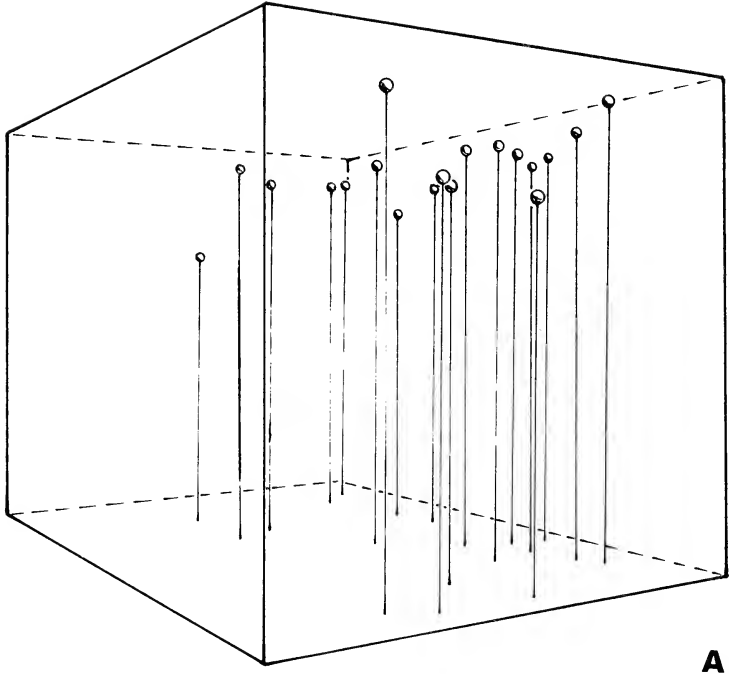

A

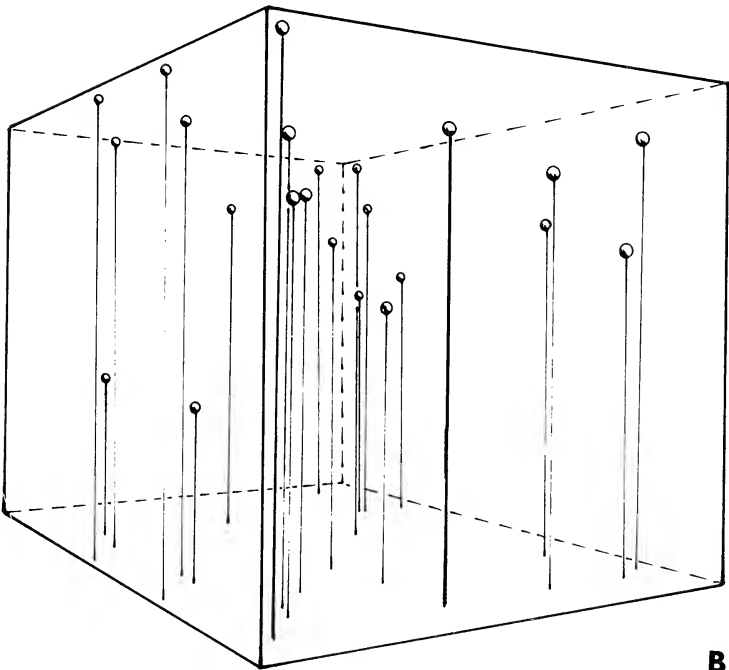

B

Fig. 4.—Location of individual spiders in laboratory colony cages (a) a representative FDLF cage; (b) a representative SMA cage.

considerably less often than tropical spiders do, and thus fewer aggressive encounters occur among them.

It may also be possible that there is a fixed distance at which an intruder on the web "territory" will be met with aggressive behavior, and that this distance varies between populations. The result would be that some populations of spiders are inherently more tolerant of neighbors at closer distances, and would be spaced more closely than others. In communal/territorial web building spiders, the location of nearest neighbors in space, and the orientation of their webs may relate to competition among colony members, or may somehow relate to prey capture success. Observations of encounters between spiders suggest that the presence of an intruder at some point close to the retreat or web will result in the initiation of agonistic behavior sequences. We have observed that the location of the intruder relative to the resident at the time this conflict is initiated varies, which may provide some support for the concept of a variable, 3-dimensional "territory" in these spiders. Differences in territory size between populations might be determined by whatever minimum area is required to provide an individual with sufficient prey, based on its availability in the habitat, as has been shown for *Agelenopsis* by Riechert (1978).

Field studies of spiders from the tropical population have shown that the location of nearest neighbors and the orientation of their webs relative to each other changes with colony size. In these studies, nearest neighbor location data were plotted in hemispheric projection relative to a central point by making the reference individual the one whose nearest neighbor is measured. This type of projection (Fig. 6a, b) was used in order to determine any patterns in nearest neighbor spacing (as in Major and Dill 1978). This also allows a determination of the basic shape of the 3-dimensional territory. As colony size increases, spiders become more tightly packed, with webs facing opposite directions, and a pattern emerges (Fig. 6b) wherein nearest neighbors are located behind and below, or to the side of a spider's web (but never above or below in front of the web). This suggests that territorial space within the colony is asymmetrical and compressible, and that spiders are more tolerant of neighbors in locations where they pose less of a threat to obtaining food. Data are not available for the desert population, but it is possible that the size, shape and degree of compressibility of this 3-dimensional territory may differ there.

The differences in social behavior observed, as well as morphological differences between populations, might indicate that *Metepeira spinipes* is not a single species. There are consistent size differences, and spiders from Fortin are smaller and have shorter legs than spiders from the other populations. There are also consistent differences in the abdominal folium and ventral markings. However, specimens show considerable individual variation (including those from the same colony), and look slightly different, presumably because the flexible scape of the epigynum preserves at varying orientations, and the degree of abdomen distention affects color. Research on genetic similarity of *M. spinipes* populations from these and several other areas in Mexico using polyacridamide gel electrophoresis, has shown all populations to be highly similar. Nei's Index of Similarity (Nei 1972) for these populations was > 0.96 (Uetz et al., in press), a level of genetic similarity in the range of variation seen within many arthropod species populations (Selander and Johnson 1973, Ayala 1976). These studies, however, were done comparing only a few loci within a limited number of

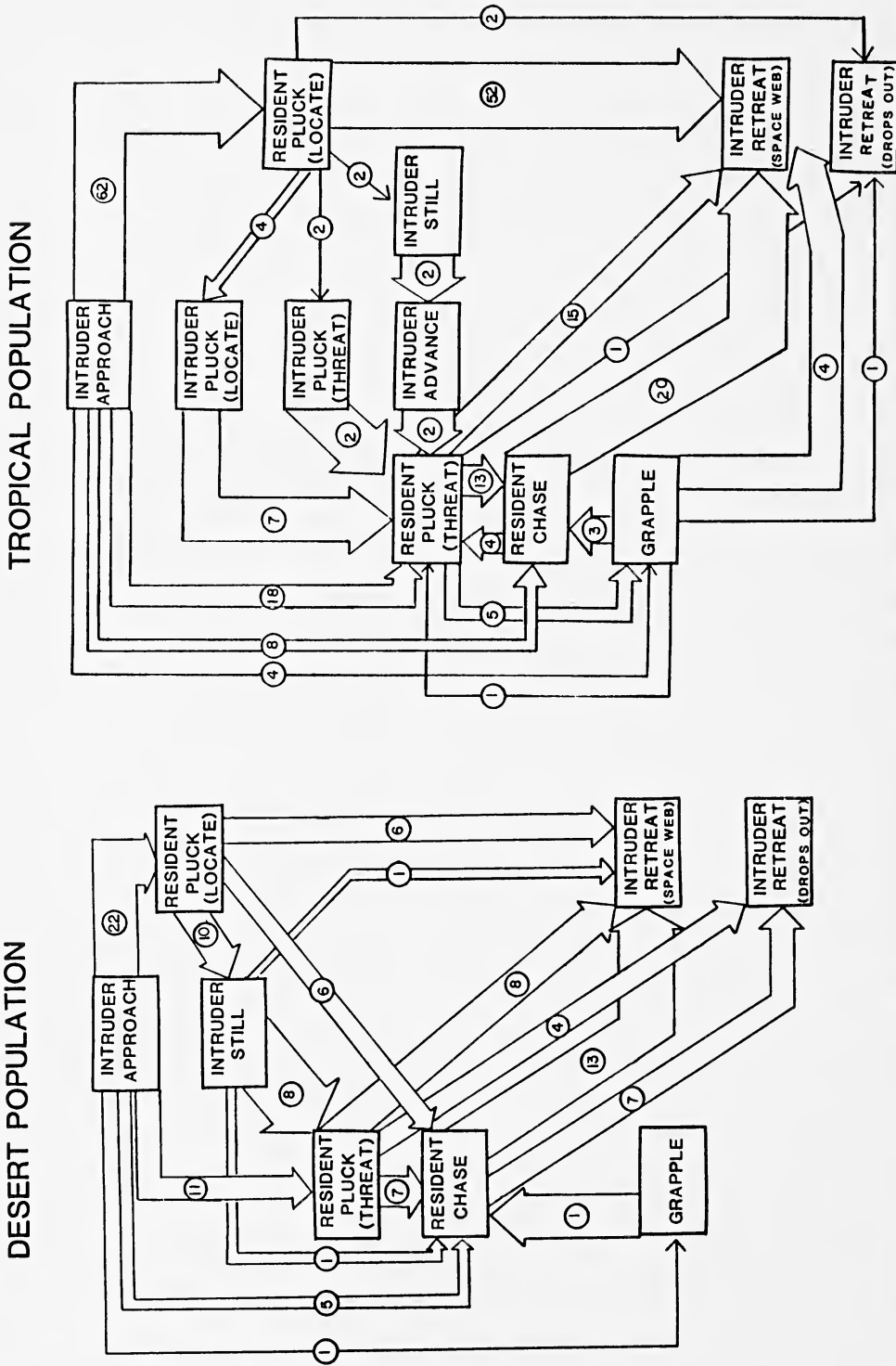

Fig. 5.—Transition frequency diagrams for agonistic interactions between individual *M. spinipes*. Width of arrow is proportional to frequency of transitions from one behavior to another. Number in circle is the actual number of observations: (a) desert population (SMA); (b) tropical population (FDLF).

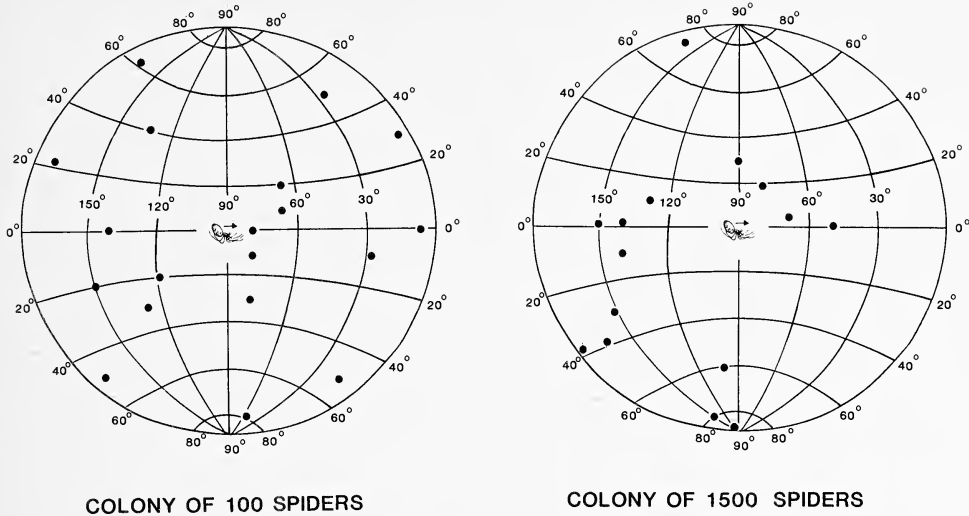

Fig. 6.—Hemispheric projection of *M. spinipes* nearest neighbor locations in Fortin de los Flores (see text for explanation): (a) a colony of 100 spiders; (b) a colony of 1500-2000 spiders.

samples, and conclusions drawn are tentative. Attempts to mate individuals from different populations have yielded inconclusive results. When pairs of males and females were isolated no courtship or mating behavior was ever observed. Egg sacs were produced, but the spiderlings never hatched, and no cause of the hatching failure was apparent. We couldn't determine if this failure to crossbreed is indicative of species isolation, or the result of age incompatibility, or some other factor.

CONCLUSION

Evidence presented here strongly suggests that both environmental and genetic factors influence the variation in spatial organization observed in *Metepeira spinipes* colonies. These findings must then mean that populations from the desert and tropical forest habitat represent either separate genetic subgroups within the species, or newly evolved species with different types of social behaviors. The differences in social spacing and agonistic behavior seen in these populations are likely to be adaptive, and result in improved survival and reproduction in the environments in which they occur. These populations (or species) might then represent early stages in the evolution of increasing social tolerance in spiders.

ACKNOWLEDGMENTS

We express our appreciation to a number of people for assistance in this research. Thomas Kane, Gail Stratton, Michael Benton, Curtis Meininger, Bob Hollis, Kathy Duncan, James Chapman and Debbie Fritz have all assisted in the field, while Mary Klus, Bob Hollis, Tracy Troyan and Debbie Fritz have assisted in the lab. We are especially grateful to Roger Steubing for statistical guidance and computer consultation. We thank Leah Hammons for typing the manuscript.

Portions of this research have been submitted in partial fulfillment of the requirements for the degree of Master of Science in Biological Sciences at the University of Cincinnati (Karen Cangialosi). This research has been funded by grants from the National Geographic Society, the American Philosophical Society, the Society of Sigma Xi, and the University of Cincinnati Research Council.

LITERATURE CITED

- Burgess, J. W. and G. W. Witt. 1982. Social spacing strategies in spiders. *In* Spider Communication, Mechanisms and Ecological Significance (P. N. Witt and J. S. Rovner, eds.). Princeton Univ. Press, 440 pp.
- Burgess, J. W. and P. N. Witt. 1976. Spider webs: design and engineering. *Interdisc. Sci. Rev.*, 1:322-355.
- Buskirk, R. E. 1975a. Aggressive display and orb defense in a colonial spider, *Metabus gravidus*. *Anim. Behav.*, 23:560-567.
- Buskirk, R. E. 1975b. Coloniality, activity patterns and feeding in tropical orb-weaving spider. *Ecology*, 56:1314-1328.
- Buskirk, R. E. 1981. Sociality in the Arachnida. *In* Social Insects (H. R. Hermann, ed.). Vol. II, Ch. 7.
- Davies, N. B. 1978. Ecological questions about territorial behaviour. Pp. 317-350, *In* Behavioural Ecology: an Evolutionary Approach (J. R. Krebs and N. B. Davies, eds.). Sinauer Assoc., Sunderland, Mass.
- Fowler, H. G. and J. Diehl. 1978. Biology of a Paraguayan orb-weaver, *Eriophora bistrata* (Rengger) (Araneae, Araneidae). *Bull. British Arachnol. Soc.*, 4:241-250.
- Jackson, R. R. 1978. Comparative Studies of *Dictyna* and *Mallos* (Araneae: Dictynidae). I: social organization and web characteristics. *Rev. Arachnol.*, 1:133-164.
- Levi, H. W. 1977. The orb weaver genera *Metepeira*, *Kaira* and *Aculepeira* in America North of Mexico (Araneae: Araneidae). *Bull. Mus. Comp. Zool.*, 148:185-238.
- Lubin, Y. D. 1974. Adaptive advantages and the evolution of colony formation in *Cyrtophora* (Araneae: Araneidae). *Zool. J. Linn. Soc.*, 54:321-339.
- Major, P. F. and L. M. Dill. 1978. The three-dimensional structure of airborne bird flocks. *Behav. Ecol. Sociobiol.*, 4:111-122.
- Maynard-Smith, J. and S. E. Riechert. 1984. A conflicting tendency model of spider agonistic behavior: Hybrid-pure line comparisons. *Anim. Behav.*, 32:564-578.
- Nei, M. 1972. Genetic distance between populations. *Amer. Nat.*, 106:283-292.
- Pickard-Cambridge, F. O. 1903. Arachnida: *Metepeira*, gen. nov. *Biol. Centrali-Americana*, 2:457-460.
- Riechert, S. E. 1978a. Energy-based territoriality in populations of the desert spider, *Agelenopsis aperta* (Gertsch). *Symp. Zool. Soc. London*, 42:211-222.
- Riechert, S. E. 1978b. Games spiders play: behavioral variability in territorial disputes. *Behav. Ecol. Sociobiol.*, 3:135-162.
- Riechert, S. E. 1979. Games spiders play II: Resource assessment strategies. *Behav. Ecol. Sociobiol.*, 6:121-128.
- Riechert, S. E. 1982a. The consequences of being territorial: spiders, a case study. *Amer. Nat.*, 117:871-892.
- Riechert, S. E. 1982b. Spider interaction strategies: communication vs. coercion. *In* Spider Communication, Mechanisms and Ecological Significance (P. N. Witt and J. S. Rovner, eds.). Princeton Univ. Press, 440 pp.
- Riechert, S. E. 1984. Games spiders play III: Cues underlying context associated changes in agonistic behavior. *Anim. Behav.*, 32:1-15.
- Riechert, S. E. (in press). Between population variation in spider territorial behavior: Hybrid-pure line comparisons. *In* Evolutionary Genetics of Invertebrate Behavior (M. A. Huettel, ed.). Plenum Press.
- Rypstra, A. L. 1979. Foraging flocks of spiders—a study of aggregate behavior in *Cyrtophora citricola* Forskal (Araneae: Araneidae) in West Africa. *Behav. Ecol. Sociobiol.*, 5:291-300.
- Rypstra, A. L. 1983. The importance of food and space in limiting web-spider densities: a test using field enclosures. *Oecologia*, 59:312-316.

- Schoener, T. W. and C. A. Toft. 1983. Dispersion of a small-island population of the spider *Metepeira daytona* (Araneae: Araneidae) in relation to web-site availability. *Behav. Ecol. Sociobiol.*, 12:121-128.
- Shelford, V. E. 1963. *The Ecology of North America*. Univ. Illinois Press, Chicago. IL.
- Smith, D. R. 1983. Reproductive success of solitary and communal *Philoponella oweni* (Araneae: Uloboridae). *Behav. Ecol. Sociobiol.*, 11:149-154.
- Uetz, G. W. and J. W. Burgess. 1979. Habitat structure and colonial behavior in *Metepeira spinipes* (Araneae: Araneidae), an orb weaving spider from Mexico. *J. Arachnol.*, 7:121-128.
- Uetz, G. W., T. C. Kane and G. E. Stratton. 1982. Variation in the social grouping tendency of a communal web-building spider. *Science*, 217:547-549.
- Uetz, G. W. 1983. Sociable Spiders. *Nat. Hist.*, 92:62-79.
- Uetz, G. W. (in press). Web-building and prey capture in communal orb weavers. *In Spider Webs and Spider Behavior* (W. A. Shear, ed.). Stanford Univ. Press.
- Uetz, G. W., T. C. Kane, G. E. Stratton and M. J. Benton (in press). Environmental and genetic influences on the social grouping tendency of a communal spider. *In Evolutionary Genetics of Invertebrate Behavior* (M. A. Huettel, ed.). Plenum Press.
- Witt, P. N. and C. F. Reed. 1965. Spider-web building. *Science*, 149:1190-1197.
- Witt, P. N., C. F. Reed and D. B. Peakall 1968. *A Spider's Web*. Problems in Regulatory Biology. Springer Verlag. Berlin.

Manuscript received January 1985, revised October 1985.

**THE ECOLOGY OF THE COOPERATIVE SPIDER
AGELENA CONSOCIATA IN EQUATORIAL AFRICA
(ARANEAE, AGELENIDAE)¹**

Susan E. Riechert, Rosemarie Roeloffs and Arthur C. Echternacht

Department of Zoology
University of Tennessee
Knoxville, Tennessee 37996, U. S. A.

ABSTRACT

The ecology of the spider *Agelenopsis consociata* in rain forest habitats in Gabon was investigated with reference to factors that might underlie its cooperative foraging behavior. Colonies consisted of local clusters of from one to 27 nests and associated web traps. The composition of individual nests also was highly variable, ranging from one adult spider to as many as 1100 adults. Nest survivorship was a positive function of group size as estimated by the number of adult females in a nest. Analysis of the energy budget of single adult females indicated that the high rate of extinction of small nests might result from insufficient prey availabilities during the two rainy seasons when webs are destroyed on 40% of the days. Individuals associated with larger nests do not experience this energy deficit because individual investment in the web trap decreases with increasing colony size. Dispersal problems may also favor the maintenance of groups: we observed heavy predation on individuals that were released experimentally. On the negative side, individual foraging success and production of eggs decreased with increasing nest size in our experimental groups, perhaps due to the deleterious effects of interference. In addition, we consider that the continuity of generations permitted by the equatorial environment fosters the cooperative life style compared to other adaptations that might be exhibited in response to environmentally imposed energy deficits.

INTRODUCTION

Most work dealing with the evolution of cooperative behavior in spiders involves the mechanisms by which this has been achieved; e.g., changes that occur in spider behavior and patterns of association to permit communal living and the sharing of resources (Shear 1970, Wilson 1971, Brach 1977, Buskirk 1981). Equally important, however, are the ecological influences; external factors that favor the development of cooperative traits. The study of these influences requires field observation and experimentation. That the majority of the communal and actually cooperative spider species are restricted to the lower latitudes, in fact, suggests that some characteristic of the tropical environment is requisite to interindividual tolerance and cooperative behavior in the Araneae which are, for the most part, highly competitive and even cannibalistic.

In an attempt at identifying important parameters we have undertaken an investigation of the behavioral ecology of the highly cooperative spider *Agelena*

¹Presented in a symposium, "Social Behavior in Spiders," at the National meeting of the American Arachnological Society, June 17, 1984.

consociata Denis (Agelenidae) which inhabits primary rain forests in equatorial west Africa. Specifically, we consider its local distribution in the rain forest and assess environmental effects on its success in colonies consisting of different numbers of individuals.

AGELENA CONSOCIATA

Agelena consociata, one of two species of *Agelena* that inhabit the Old World tropics, is a funnel web spider that occurs in groups of a few to hundreds of individuals of all age classes (Chauvin and Denis 1965). These individuals share a group nest and a web trap consisting of a flat sheet and attached vertical scaffolding (Fig. 1). Unlike the solitary agelenids, there are multiple retreats, rather than a single retreat, extending into the nest. There is variability both in the composition of the individuals making up the nest and in its physical structure. The latter is formed by the binding of branches and leaves with silk (Pain 1964). Because groups of nests are frequently connected to one another by scaffolding or part of the web sheet, and because individuals move freely among these nests, we define a colony in this paper as consisting of one or more nests in a local area.

Cooperation takes the form of group prey capture, web maintenance and feeding (Krafft 1969). All larger individuals participate in construction of the web trap and scaffolding, though the effort apparently is not a coordinated one (Darchen 1965). Small prey are attacked by single individuals, whereas as many as 25 spiders may be involved in the capture of larger prey that struggle violently in the web (Chauvin and Denis 1965). Only one individual will drag a subdued prey to a retreat. It is during transport that potential competition is observed, with some pushing or shoving evident (our observations and Krafft 1969). Although the winner of the pushing contest has the first opportunity to feed on the prey, it frequently merely deposits the prey in the retreat and moves off without feeding. Twenty to forty spiders may be observed simultaneously feeding on a large prey item (e.g., Krafft 1969 and our observations). We have also observed behaviors that suggest that adults regurgitate digested food to spiderlings.

STUDY AREA

Agelena consociata is probably widely distributed throughout the rain forests of equatorial west Africa, but its range is poorly known. The species has been studied extensively only at a single locality near Makokou, in the Ogooué-Ivindo region of Gabon (Darchen 1975, 1978, 1979, 1980, 1984, Pain 1964, Riechert 1985). Most of these investigations have been conducted at M'Passa, a field station of the Institut de Recherché en Ecologie Tropicale (I.R.E.T.), which is administered by the Centre National de la Recherché Scientifique et Technologique of Gabon. M'Passa is located at approximately 00°34' N latitude, 12°50' E longitude, on the west bank of the Ivindo River about 10 km southwest of Makokou. The station, which lies at an average elevation of about 500 m, is part of a 13,000 hectare United Nations Biosphere Reserve and is, thereby, afforded at least nominal protection from human disturbance.



Fig. 1.—*Agelena consociata* colony showing two nests (N) and associated web trap (W), scaffolding (S), and nest retreats (R). Many more retreats are present than indicated.

With the exception of a laboratory clearing, the entire reserve is covered by closed primary or old secondary evergreen rain forest. Our investigations were conducted in a 140 hectare area of the reserve which has been divided into a grid of one hectare quadrats, each 100 m on a side and bounded by paths about 1 m wide. The terrain is generally flat, but slopes gently from the northwest to the Ivindo and Nyame Pendé rivers to the southwest. Darchen (1980) identified four types of forest within the grid system at M'Passa. Two of these can be designated as layered forest and two as unlayered. The layered forests are distinguished by differing heights of the understory, and the unlayered forests by differences in the density of shrubs and vines under the tree canopy. A profile of the annual climatic cycle at M'Passa is presented in Figure 2, together with seasonal trends in insect biomass derived from those reported by Charles-Dominique (1977) and our own data. Precipitation at M'Passa is very unevenly distributed over the year and is the basis for recognizing four seasons (Charles-Dominique 1977, Cruiziat 1966, Hladik 1978). The area receives an average of 1691 mm of precipitation annually, nearly 40 per cent falling during the period September–November. This is the major wet season. It is followed by a minor dry season, December–February, which is characterized by less precipitation and maximum insolation. The minor wet season of March–May is a time of “important rainfall and tropical storms” (Hladik 1978). Finally, the months of June–August constitute the major dry season with minimum precipitation (less

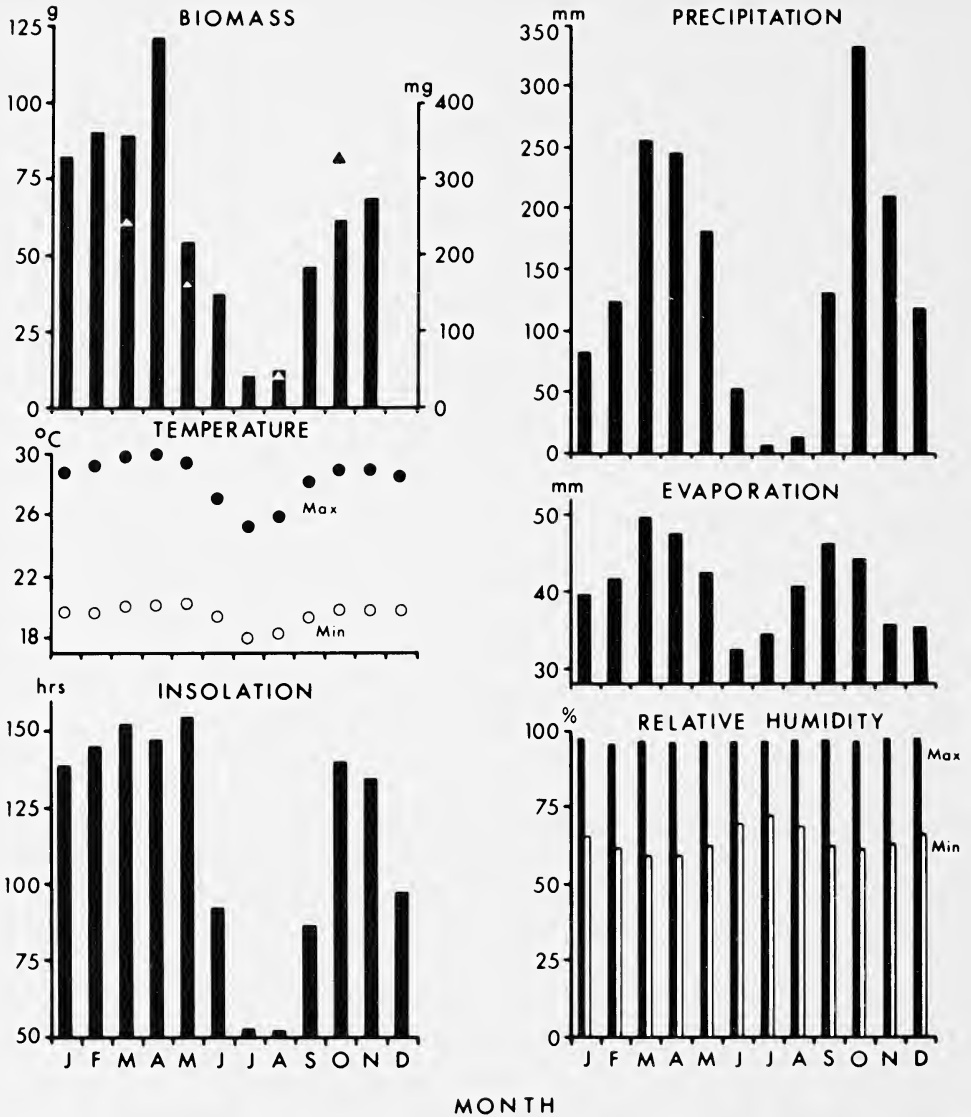

Fig. 2.—Seasonal variation in insect biomass and mean monthly climatic variables at M'Passa. Climatic data are from records of the Gabonese Meteorological Service station at Makokou. Insect biomass is expressed as (bars) monthly means (except December) of grams dry weight of daily light trap collections (from Charles-Dominique, 1977, Fig. 10), and as (triangles) milligrams dry weight per trap per day (this study; see text for details).

than 5 percent of the annual mean), but also minimum temperatures and insolation. Because of the constantly overcast skies, relative humidity remains high and evaporation low during this season. As might be expected at a locality so near the equator, monthly variation in temperature is slight, mean monthly temperatures ranging from 21.7°C in June to 25°C in April. *Agelena consociata* is active throughout the year at this locality.

METHODS

Colony Structure and Habitat Association.—Three 9 hectare study areas were established within the reserve (Fig. 3). Two of the locations were selected to provide data on spider habitat associations in layered and unlayered forest types. The third area is representative of the habitat used by Darchen in his 1980 study of the distribution of *Agelena consociata* in the reserve. Each study area was inspected for colony locations by walking all 100 m transect lines within the areas and traversing each one hectare quadrat within each area at 30 m intervals. The locations of all nests in the plots were first mapped in February 1982. The following measurements (in cm) were taken on each nest: height off the ground, nest volume (maximum height by length by width), web sheet area (maximum length by width), vertical scaffolding height and distances to other nests within the colony. Twenty-one nests were collected off of the reserve for use in regressing nest volume against spider numbers. The age and sex of each individual were tallied as they were removed from the nests. We used the resulting regression coefficients in estimating individual numbers in nests censused on the study areas where destructive sampling was not possible.

In addition to the web structure measurements, the following habitat features were recorded at 10 cm intervals along a 2 m transect beneath each web: the presence of leaf litter under the nest, the presence of tree cover, the presence of vegetation within 1 m above the nest, the presence of non-herb vegetation below the nest, the presence of narrow (< 10 cm), medium (10-20 cm) and broad leaves (> 20 cm) below and above the nest, numbers of leaf layers below the nests, numbers of branches [narrow (< 1 cm), medium (1-4 cm), wide (4.1-16 cm) and giant (> 16 cm)], below the nest and the presence of herbs. The transect was oriented such that its 50 cm mark was positioned at the center of the nest and it paralleled the longest axis of the web trap. The distance from the nest to the canopy was estimated using a rangefinder.

For each nest within the two main study areas, a random site within the reserve was located by picking random coordinates. The line intercepts were repeated at each of these sites using the compass orientation determined for the line intercept of the actual site and the respective web heights in the positioning of the sample. These sites and their corresponding nest sites were *not* treated as paired samples in subsequent analyses. Multiple discriminant analyses were applied to the transect data to determine to what extent the habitat characteristics of nest sites were representative of the general habitat and how habitat utilization might vary with forest type.

Environmental Correlates.—Three additional environmental correlates were considered: solar radiation, precipitation, and prey availability. At all nest sites and their corresponding random sites within the two main study grids, solar radiation striking the web at hourly intervals was scored at 0, partial, or total, through visual censusing. In addition, precipitation readings were taken at all nests and associated random locations that were < 3 m in height. Rain gauges were placed directly above or adjacent to the nests and at comparable nest heights in the random sites. These precipitation estimates were referenced to those provided by a rain gauge placed in the laboratory clearing. This allowed us to use the station's precipitation records in estimating the number of days per rainy season in which web-damaging rains occur.

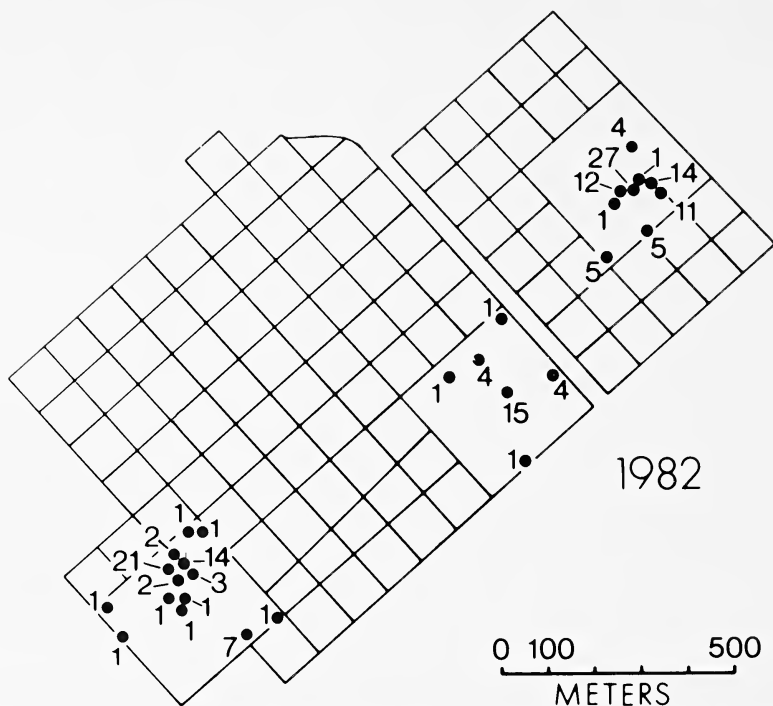

Fig. 3.—Distribution of colonies of *Agelena consociata* in study plots at M'Passa at the initiation of censusing in February 1982. Numbers refer to numbers of nests in the respective colonies. Plot 1 is in the center, 2 in the upper right, and 3 in the lower left of the figure.

Five nest sites, each from a different colony, were selected outside the study areas for prey availability determinations. The nests were removed and sticky traps measuring 6,525 cm² were substituted. The trap consisted of horizontal and vertical sheets of hardware cloth approximating the linear dimensions of the web sheet and scaffolding, respectively, of the average *A. consociata* web trap. The entire surface was coated with a thin coat of a sticky tree banding compound (Stikem Special: Michel Pelton Co.). Random trap locations corresponding to each actual nest-site were chosen as in the vegetation analyses. Potential prey were collected from the traps each morning during the course of the censusing, which was carried out in each of the four seasons. All prey caught on the traps were scored as to Order and size class (0-4, 4.1-8, 8.1-12, etc. in mm). The contents of each trap were placed in a small cloth bag and oven dried at 40°C for 24 hours (The sticky material evaporated during the course of the drying process). The samples were then weighed. The number of days over which the sampling was completed for each season was determined by setting the standard error of mean number of prey at ten percent and solving for number of days (13-14 days in different seasons).

Extinctions.—During the course of each of 4 two month field seasons the fate of each nest in the grids was followed through weekly censuses. The sampling periods were: February-March (Minor Dry Season), 1982; June-July (Major Dry Season), 1982; October-November (Major Rainy Season), 1983; and April-May (Minor Rainy Season), 1984. As new nests were found during the course of censusing, web and habitat measurement were collected as described for the initial sample. At the beginnings and ends of each 2 month census period, nest volume

and web area measurements were repeated. In addition to the weekly censuses, nests below 3 m in height were checked for web sheet and scaffolding damage following rains during the Minor Wet Season of 1982.

Energy Budget.—A combination of field and lab studies were used to complete comparative energy budgets for individuals at small (1-4 adult females) versus large (>25 adult females) nests. We used sticky trap collections of potential prey in estimating energy availability. The data collected to show seasonal variability in prey availability were used in the case of the large nests. Using the same methodology, sticky traps providing a surface area of 484 cm² (the average trap area associated with small nests) were also censused for prey numbers and composition.

Estimates of prey consumption rates under unlimited food, the frequency of foraging activity, and energy expenditure in construction of the web trap were obtained from laboratory studies. Individuals maintained in plastic boxes in groups of one, two, four and six individuals, respectively, were offered an abundance of prey (moths, flies and disabled crickets) on a daily basis. Record was kept of individual rates of consumption, weight gain, and egg production over a two month period. Approximately 50 individuals representing each class were measured. In the second experiment, 25 individuals were weighed and placed in 0.5m³ containers. After 24 hrs, the individuals were removed and reweighed. The webs each had built during the period were also collected and weighed. The third experiment consisted of eighteen days of observation of the foraging activity of five captive groups of individuals. Each group consisted of 25 individuals, 15 of which were adult females. All spiders were individually paint-marked using a fast-drying enamel paint. Thirty minute watches were made of each group following the introduction of prey once a day, and individuals active in web construction, prey capture and feeding were noted.

Microbomb calorimetry was used in making mass conversions of joules and in estimating what proportions of available prey were available for consumption by the spiders. Twenty-five individuals of each of the major prey orders contacting *Agelena* webs were collected, weighted, killed by freezing, dried as for the sticky trap samples, and reweighed. Prey wet weight averaged 2.32 times dry weight. The joule equivalent of 1 mg dry weight was 20.83 averaged over all prey types. Finally, an average of 5.56% of the prey was ash. This quantity was subtracted from the sticky trap estimates in calculating prey availabilities.

Population Structure.—During each of the four field study sessions, at least 20 nests were inspected to determine to what extent the age structure of *Agelena* varies with season. Individuals were removed as the nests were dissected and were tallied as to approximate age (spiderlings, juveniles, penultimates and adults) and sex.

There is no known record of active dispersal by *Agelena consociata*, nor did we observe such a phenomenon during the course of our study. We did observe the destruction of nests by rain, falling objects and animal movements (birds and mammals). A release experiment was thus performed to assess the survivorship of individuals that lose contact with their nests during such stochastic events. In the experiment, all preexisting *Agelena* nests within a 50 m radius of a chosen site were recorded and marked with plastic flagging. Spiders were collected from five different nests from other areas of the forest, were paint marked and then released using the following protocol: 1) Forty-eight spiders were released

individually and their movements followed until each had moved out of the cleared release area; 2) The remaining spiders were released in groups of up to five individuals. In the latter case individual movement within the release area was not followed. Rather, a daily search was made for new nests built by released spiders within the area. The location, size, and distance from the release site were recorded for each new nest along with the identity of the resident spider.

Genetic relatedness of spiders within nests and colonies was assessed using electrophoretic techniques. Twenty-five spiders were collected from each of one to three nests/colony for 30 colonies to allow estimation of degree of relatedness for individuals within the same nest, the same colony, and separate colonies. The collected spiders were subjected to starch gel electrophoresis in the Population Genetics Laboratory at the University of Tennessee. Whole individual spiders were ground using the methodology described in Selander et al. (1971). The gel electrophoresis techniques used were similar to those described in the same paper. The following loci were assayed: Esterases 1 and 2 (EST1 and EST2), Fumarase 1 and 2 (FUM1 and FUM2), Galactosaminidase (GAM), Glutamic Oxaloacetic Transaminase 1 and 2 (GOT1 and GOT2), α -Glycerophosphate Dehydrogenase 1 and 2 (GPD1 and GPD2), β -N-Acetylglucose-aminidase (HEX), Isocitrate Dehydrogenase (IDH), Lactate Dehydrogenase 1 and 2 (LDH1 and LDH2), Malate Dehydrogenase (MDH), Malic Enzyme (ME), Mannose Phosphate Isomerase (MPI), Octanol Dehydrogenase (ODH), Peptidase (PEP), Phosphoglucose Isomerase (PGI), and Superoxide Dismutase (SOD). Of these, three were polymorphic: PEP (three alleles), EST1 (three alleles), and EST2 (two alleles).

RESULTS

Colony Structure.—Statistics pertaining to colony structure are presented in Table 1 for the 29 colonies in existence at the time of the initial census (Fig. 3). Colonies frequently were represented by more than one nest, and in 40 per cent of these multiple cases nests were interconnected by either a shared web sheet or scaffolding. Because it was impossible to determine the number of individuals occupying different nests without destruction of the nest, a relationship was established between the numbers of individuals and nest volume, using nests collected off the reserve. We found that the highest correlation between nest volume and colony size was achieved when only adult female occupants were included ($r^2 = 96.8\%$). All of the colony size estimates used in this paper thus were calculated from the following regression relationship:

$$\text{No. of Adult Females} = 0.0012 \text{ Nest Volume (cm}^3\text{)} - 4.13$$

Habitat Association.—The results of the discriminant analyses comparing the vegetation characteristics of actual nest sites with random sites are presented in Figure 4. Colony habitat associations are apparently non-random, differing markedly in character from the general habitat available. Inspection of the discriminant function coefficients representing each habitat variable indicate that the nests tend to be constructed above multilayered shrubs under a full tree canopy, but without branches immediately overhead (i.e., within 1 m).

Table 1.—Basic colony statistics for 29 colonies of *Agelena consociata*

		COLONY STRUCTURE		
		Mean	Standard Error	Range
Number Nests/Colony		5.3	1.6	1-27
Nest Volume (cm ³)		53094.2	879.4	120-1,848,000
Web Area (cm ²)		5726.9	129.1	192-63,000
Scaffolding Height (cm)		131.4	0.7	0-550
Adult Females/Nest*		16	14-22	0-2213
*Median and 95% confidence interval based on regression relationship: $No. = 0.0012$ (Nest Volume)-4.13. ($r = 0.958$)				
		NEST HEIGHT		
Study Area	Forest Type	Nest Height		
		Mean	Standard Error	
Plot 1	Layered, Low Understory	163.9	4.3	
Plot 2	Unlayered, Lianas	287.6	1.7	
Plot 3	Layered, High Understory	410.8	6.4	

Nest height varies with colony location in the forest (Table 1b). Nests are highest in Plot 3 (Fig. 3) characterized by understory with little shrubbery. Nests are lower in forest in which the understory is in the recovery phase (Plot 1) and intermediate in the closed forest characterized by lianas and fallen trees (Plot 2). Despite the differences in nest height, spider use of habitat appears to be similar in the three habitats. Of particular interest is the comparison between spider utilization of habitat features in our first two study plots with the section of forest lacking an understory (Plot 3) which was characterized by Darchen (1980) as prime *Agelena* habitat. The nests measured in this third grid were not included in the initial discriminant analyses. Rather, scores for each nests were calculated post facto using the discriminant coefficients derived from the analysis for each habitat feature measured. Discriminant scores for nests censused in Plots 1 and 2 did not differ from those for the higher nests (Mann Whitney test, $P > 0.25$).

The vegetation features utilized by *Agelena consociata* might be predicted on the basis of web structure alone, because the nest is constructed of curled branches and leaves and must be supported by some underlying structure. In addition, the vertical scaffolding requires an empty space but with points of attachment present. There are, however, possible additional influences on habitat association. Incident precipitation at actual nest sites, for instance, is significantly less than that encountered at the corresponding random sites in the reserve ($N = 46$, Sign Test: $P < 0.001$; median ratio of precipitation at nest sites to random sites = 0.61). The variance in rainfall at random sites does not differ significantly from that characteristic of nest sites (Siegel Tukey Test: $P < 0.35$). In one season, at least, prey numbers and biomass are significantly higher at nest sites than at random sites (Table 2). Solar radiation reaching the nests was estimated by visiting each nest and associated random site once during each of 9 daytime hour intervals (clear days only). The differences between light counts at nest sites and associated random sites was highly significant (Sign Test: $P < 0.0001$), with more direct solar radiation hitting actual nests (Mean = 3.12 ± 0.02 intervals) than random sites (Mean = 1.94 ± 0.02).

Extinctions.—The marked variability in colony sizes and nests sizes in particular suggests a corresponding variability in colony success in the rain forest

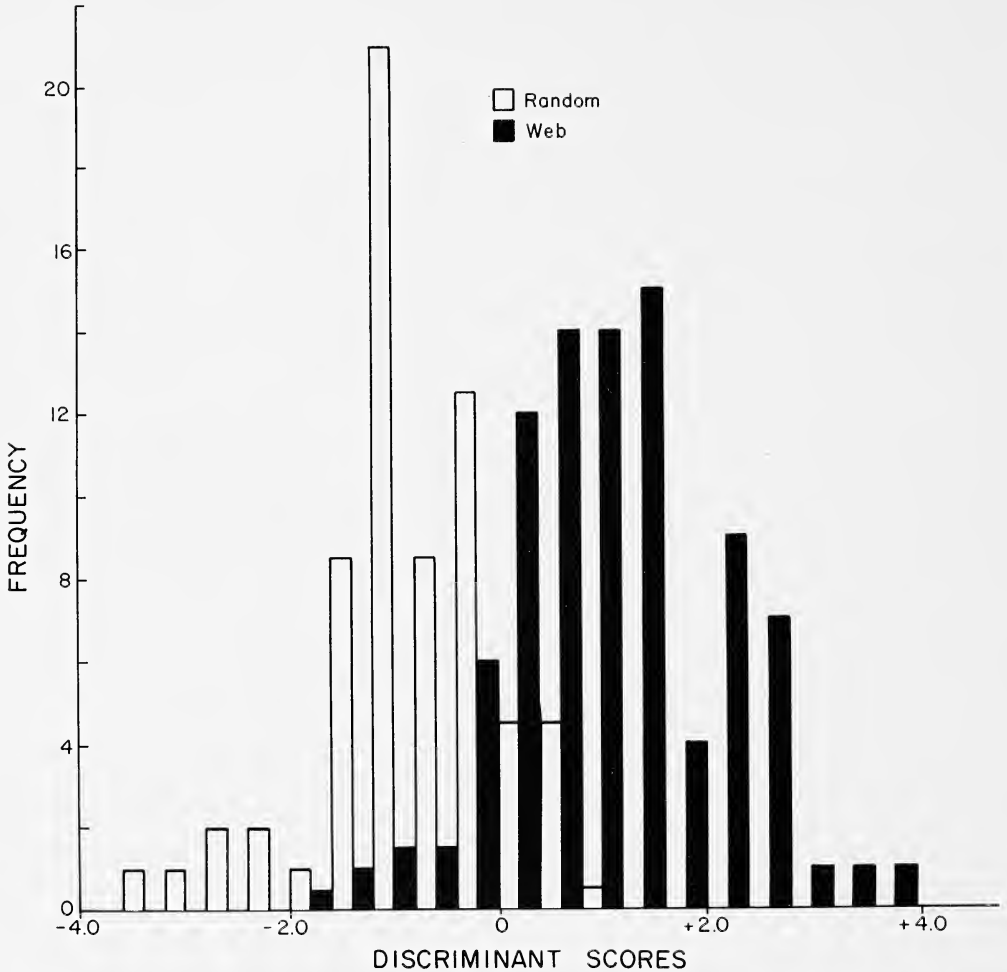

Fig. 4.—Results of discriminant analyses of habitat variables at *Agelena consociata* nest sites and random sites in the original study plots (two upper right plots, Fig. 3). Scores represent sample placement on the basis of vegetation characteristics at a particular site.

habitat. Inspection of the nest census data collected over the two year period of this study shows that smaller nests went extinct significantly more often than did larger nests (Mann Whitney Test: $P < 0.0001$). The median number of adult females occupying the 37 nests that went extinct was 1 with a 95 per cent confidence interval of 0-4 adult females/nest. The median number of adult females occupying nests that were not lost during the censusing was 16 with a 95 per cent confidence interval of 14-22. Most of these extinctions occurred during the two wet seasons, as is indicated by the nest numbers present at the end of the respective seasons (Table 3). This is despite the fact that larger nests tended to receive more precipitation than did smaller nests ($r = 0.38$; $P < 0.05$). Our nest and web censuses following rains in which precipitation levels were recorded both at the sites and in a nearby clearing shows that at least 50 per cent of the web trap and scaffolding are destroyed at 84 per cent of the nest sites when 6 mm of precipitation is recorded at the clearing within a 24 hr period. This quantity of rain is equivalent to between 20 and 40 mm of rainfall at the

Table 2.—Comparison of prey encounter estimates for paired *Agelena consociata* nest sites and random sites over 4 seasons. Mean and standard errors mg dry weight/dry. Probabilities refer to results of sign tests. NS = Non-significant.

Season	PREY BIOMASS				Probability
	Nest Sites		Random Sites		
Major Wet	321.1	4.8	318.9	4.1	NS
Minor Wet	240.9	6.7	234.4	3.4	NS
Minor Dry	176.4	1.6	129.2	1.2	P<0.0001
Major Dry	48.0	0.7	30.6	0.5	NS

Season	PREY NUMBERS				Probability
	Nest Sites		Random Sites		
Major Wet	65.6	0.6	62.7	0.4	NS
Minor Wet	58.4	0.4	71.1	0.4	NS
Minor Dry	49.5	0.2	36.8	0.2	P<0.0001
Major Dry	38.1	0.2	39.6	0.2	NS

actual nest sites due to channeling by branches and foliage. Utilizing six years of precipitation records for the clearing site on the reserve, we found that during the two wet seasons totaling six months of the year, such web trap destruction occurs on the average every two out of five days.

Energy Budget.—Solitary *Agelena consociata* expend an average of 360 ± 1.2 J per day in the capture of prey and in metabolic expenditures ($N = 50$ individuals measured over 60 days). An average of 6.5 ± 0.4 J is further put into biomass and egg production per day when food is presented *ad libitum*. The construction of a single layer of web trap costs an average of 366.8 ± 2.8 J. Web construction, then, doubles the daily energy expenditure of an individual spider.

Of the 52 nest sites censused for prey availability, only 27 per cent provided the prey levels necessary to support web construction by a solitary individual at the required frequency of two times/five days. This is, in fact, an overestimate because it assumes that a spider captures all prey that encounter its web.

By living in groups, *Agelena consociata* can overcome this limiting factor, because web trap area in this social group decreases with increasing numbers of individuals (Table 4). Thus, significantly smaller trap areas per individual are associated with increasingly larger nests. Our activity census data indicate that solitary individuals in captive nests were active in silk laying or prey capture in every foraging period (median and 95 per cent confidence interval = 1), whereas individuals belonging to nests containing 25 spiders were active only every third foraging period (confidence interval = 3-4).

Population Structure.—The survivorship of *Agelena consociata* nests and colonies may also be affected by population structure. Nest censuses show that within the same season the proportion of adult males represented relative to females varies considerably from nest to nest (range = 0-58 per cent of the adult

Table 3.—Number of *Agelena consociata* nests present in study grids at end of each season.

MONTHS	SEASON	NUMBER OF NESTS
Sept-Nov	Major Wet	52
Dec-Feb	Minor Dry	150
Mar-May	Minor Wet	82
June-Aug	Major Dry	144

Table 4.—Change in web investment per adult *Agelena consociata* (cm²) with number of individuals in a colony. Significant changes (Mann Whitney test) denoted by broken lines. (1= $p < 0.05$; 2= $p < 0.001$).

NUMBER OF INDIVIDUALS	MEAN	STANDARD ERROR	NUMBER OF NESTS
1- 5	930	421	43
6- 25	738	158	47
26-125	400	139	27
126-625	333	151	17
626-3125	14	20	3

spiders present). Further, significantly more small nests (0-4 adult females) had no males than larger nests (> 4 adult females: Chi square test, $X^2 = 4.64$, $DF = 1$, $P < 0.05$). With such low numbers of males, smaller nests and single nest colonies may become extinct because there is no sperm supply and hence no production of offspring.

It is improbable that males immigrate from neighboring nests to supplement a declining population. This conclusion is based both on the results of our release experiments and genetic studies. After 4 weeks of following the release of 94 individuals onto the rain forest floor, a total of only 8 spiders had relocated and all of these relocations constituted newly formed nests. Ten per cent of the 48 individuals whose dispersal was tracked after release, in fact, suffered predation within the first hour after release. Electrophoretic analyses completed on these populations also indicate that there is no migration between colonies. Nei's (1972) Genetic Identity scores (I) were calculated for attached nests ($I = 0.9982 \pm 0.001$) and unattached nests (0.9982 ± 0.001) within colonies. Therefore, individuals in nests within a colony are almost identical genetically and colonies may consist of single families. Similarly high genetic identities among family groups have been reported for other taxa (e.g., marmots, Schwartz and Armitage 1981). However, nests separated by as little as 38 m (and occurring in different colonies) have lower Genetic Identity scores ($I = 0.9340 \pm 0.005$) and may be fixed for different alleles at the same polymorphic locus.

Predation Efficiency.—One of the major explanations given for cooperative behavior is the increased efficiency of feeding, particularly on large prey [See Buskirk (1981) for review]. From the sticky trap data, however, it is apparent that the majority of prey available to *A. consociata* are of smaller size classes, ones that can be readily handled by solitary foragers (Fig. 5). Furthermore, we found that food intake per spider decreases with group size (Fig. 6). This could reflect an inhibitory effect of conspecifics on the feeding level of associated individuals or it may indicate that as group size increases, individuals expend less energy and thus require less food. In the same experiment, egg production rates decreased with increasing group size (Fig. 7). This supports the first alternative: that conspecifics inhibit the feeding activity of nest mates, an effect that increases with group size (Fig. 7). Capture efficiency, then, does not appear to underly the differential extinction of smaller nests.

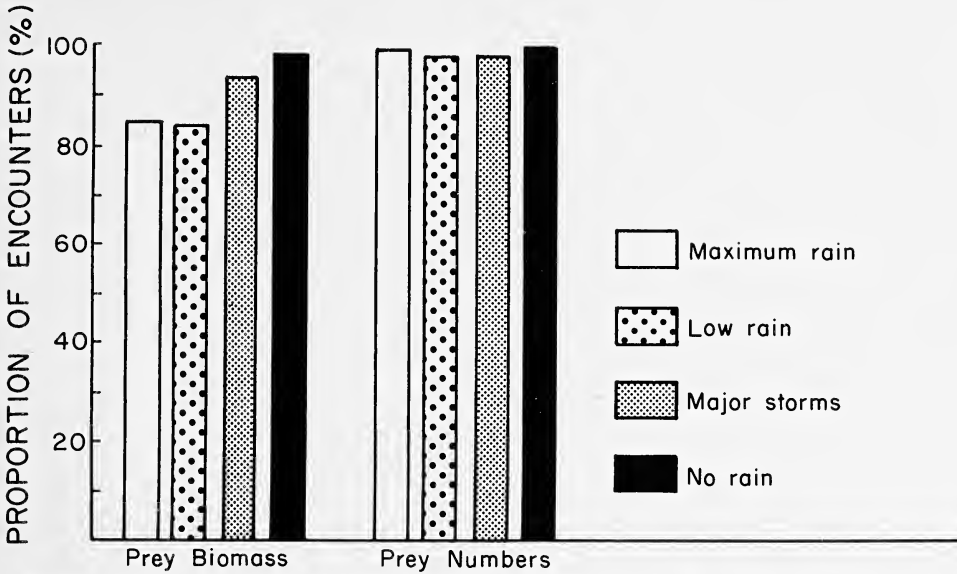

Fig. 5.—Proportion of prey contacting *Agelena consociata* webs that can be readily captured by single penultimate-adult spiders (prey lengths equal to or less than the body lengths of these spiders: Riechert and Luczak 1982).

DISCUSSION

The behavior of an individual is governed by the degree of relative advantage that behavior affords. This advantage is generally expressed in terms of individual fitness or the number of surviving offspring an individual produces. Cooperation in foraging, nesting, and defense against predators, however, does occur and the origin of such behavior is difficult to explain by natural selection operating on the individual. From a game theoretic view, if a population initially consists of competitors, for instance, it is difficult for an altruistic mutant gene to invade, because the payoff to the competitor when interacting with a cooperative individual would always be higher (e.g., Axelrod 1984).

Three conditions have been identified as contributing to the evolution of sociality: mutual benefit to the interacting individuals, kin selection, and reciprocity. Under the first condition, cost/benefit factors are such that it pays individuals to interact in a cooperative manner. This would be the case if the majority of prey available to *A. consociata* were larger in size than could be readily captured by solitary individuals. [See Michener (1974) and West-Eberhard (1975) for examples.] Under kin selection, relatives share more genes than the population at large and thus, by aiding kin, individuals increase the survival of copies of their own genes (Hamilton 1964a,b, Dawkins 1976). Reciprocity denotes the exchange of altruistic acts occurring with a time lag: individual A benefits B on day one and B benefits A at some later date (Trivers 1971). If there are repeated interactions between individuals, and individual recognition in larger groups, reciprocity can invade a competitive system, but only if the invasion is by groups of individuals (Axelrod 1984).

Spiders are a particularly interesting group within which to examine the underlying causes of cooperative behavior because the vast majority of the species are highly competitive and even cannibalistic towards conspecifics. Why is the

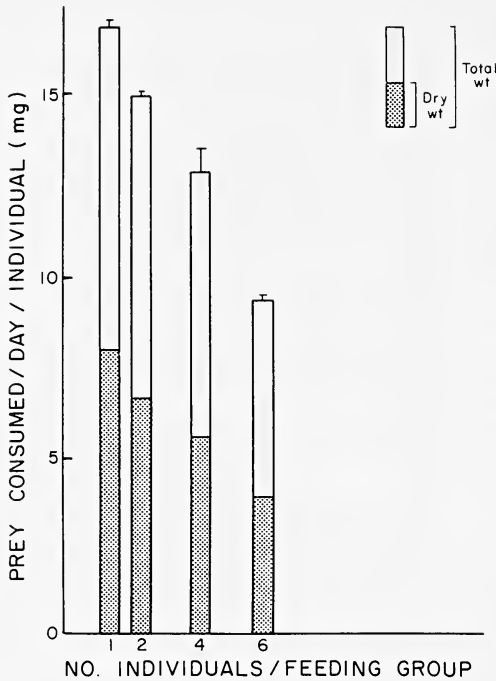

Fig. 6.—Results of Prey consumption feeding experiments for individual *Agelena consociata* maintained in cages housing indicated number of individuals (N = ca. 50 individuals per category). Bars represent mean total weight of prey consumed per day; standard errors indicated by lines at tops of bars.

exhibition of cooperative behavior limited in this group to the tropics and which if any of the three conditions underlies it? Some clues to these problems are provided in this ecological study of *Agelena consociata*.

A major limiting factor to the success of individual funnel spiders in the rain forest habitat of Gabon is heavy rainfall. The energetic deficit incurred through frequent web trap replacement during these periods is not balanced by food intake at the majority of nest sites. Three adaptations might have been exhibited by *Agelena consociata* in response to this energetic constraint. 1) Spiders might remain dormant during the rainy seasons. 2) Habitat selection might be refined such that greater protection from rain damage is afforded. 3) Spiders might live in family groups where individual energy expenditure in maintenance of the web trap and other foraging activities is markedly reduced. The first two adaptations are typically exhibited by temperate spider species, but, at least the first is not particularly well suited to *A. consociata*. Spiders would have to be dormant during six months of the year alternating three months of activity with three months of dormancy. Besides the logistical problem associated with cuing activity on and off on such a schedule when day lengths and temperatures vary little, there is the additional fact that this dormancy would coincide with times of maximum insect densities (Table 2). Spiders would, by necessity, be dormant during periods when they could best maximize their intake of prey. (Note that *Agelena consociata* is the only common sheetline weaver in this rain forest study site.)

Agelena consociata exhibits a non-random association with habitat features, one which does lend some protection from precipitation. The major obstacle to increased use of habitat selection criteria to this species, however, is the apparently high cost of dispersal. The release experiments demonstrate that *A. consociata* moving across the forest floor suffer a high mortality rate to ants and

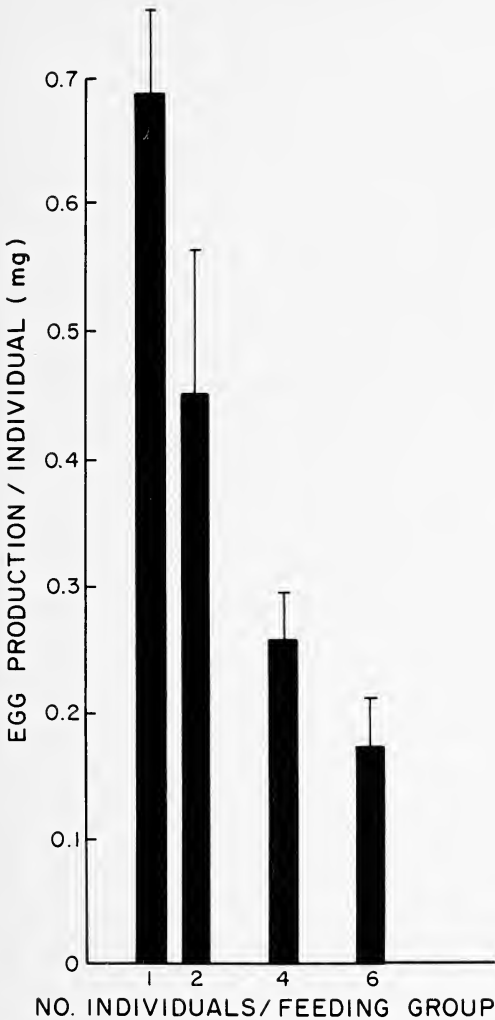

Fig. 7.—Mean and standard error of egg production (mg wet weight) per individual *Agelena consociata* with respect to number of individuals in feeding group (same experiment as depicted in Fig. 6).

other invertebrate predators. All indications are that if dispersal does occur, it is a rare event. We consider that the break up of colonies into smaller nests is mainly achieved through the action of rain and falling limbs. Colonization, on the other hand, probably involves passive transport of pieces of nests by bats that live in them and by birds and mammals that may occasionally fly or walk through them.

The long term cohesiveness of family groups is favored by the rain forest environment for several reasons. First, the cost of dispersal is high. Second, the apparent energetic advantage of construction of a group web trap overcomes the limiting constraint of rain damage to nest success. These benefits apparently outweigh the negative effects of group living on individual foraging efficiency observed in our laboratory experiments. Finally, and what we consider key to the tropical dilemma, is the fact that in this equatorial environment, year around moderate temperatures allow a continuity of generations (Table 5) that is difficult to achieve by the spiders in temperate environments. By Occam's razor, continuous colony function permits the evolution of cooperative behavior with the minimum of adaptive modifications (*sensu* Wilson, 1975). It is this continuity

Table 5.—Age class representation of *Agelena consociata* in nests by seasons.

SEASON	PROPORTION OF INDIVIDUALS PER NEST				PROPORT. NESTS WITH EGGS	PROPORT. NESTS BOTH AGES PRESENT
	ADULTS		JUVENILES			
	MEAN	SE	MEAN	SE		
Major Rain	0.12	0.03	0.88	0.03	—	1.0
Minor Dry	0.53	0.01	0.49	0.01	0.17	0.98
Minor Rain	0.57	0.02	0.26	0.03	0.33	1.0
Major Dry	0.63	0.01	0.36	0.01	0.93	1.0

that explains the fact that cooperative behavior is limited in spiders to tropical areas.

Both mutual benefit and kin selection may underly the cooperative behavior exhibited by *Agelena consociata*. An influence by reciprocity is less certain since work by Krafft (1971, 1974) shows that there is no individual recognition, and group sizes are frequently too large for the action of this phenomenon in the absence of individual recognition. Delineation of the relative contributions of mutualism and kin selection awaits further work, particularly with colonies of intermediate-large size. Kin selection may not have been requisite to the development of cooperative behavior in this species because of the marked benefits associated with group living in the rain forest environment, but inclusive fitness effects might have accelerated the development of the system.

ACKNOWLEDGMENTS

We thank Alain Pasquet and Deborah Smith for help with the field work and the Centre National de la Recherche Scientifique et Technologique of Gabon for the use of their facilities. We are especially indebted to Paul Posso, Director of the Institute de Recherche sur l'Ecologie Tropicale of Gabon, for facilitating our studies and making our brief visits to Libreville both pleasant and memorable. Yael Lubin and Ann Rypstra provided helpful comments concerning a previous draft of the manuscript. The study was completed under the auspices of two grants from the Harry Frank Guggenheim Foundation.

LITERATURE CITED

- Axelrod, R. 1984. *The Evolution of Cooperation*. Basic Books, New York.
- Brach, V. 1977. *Anelosimus studiosus* (Araneae: Theridiidae) and the evolution of quasisociality in theridiid spiders. *Evolution*, 31:154-161.
- Buskirk, R. E. 1981. Sociality in the Arachnida. Pp. 281-367, *In Social Insects* (H. R. Herman, ed.), vol. 2. Academic Press, New York.
- Charles-Dominique, P. 1977. *Ecology and Behaviour of Nocturnal Primates*. Columbia Univ. Press, New York.
- Chauvin, R. and J. Denis. 1965. Une araignée sociale du Gabon. *Biol. Gabonica*, 1:93-99.
- Cruziat, P. 1966. Note sur le microclimat de la strate inférieure de la forêt équatoriale comparé à celui d'une clairière. *Biol. Gabonica*, 2:361-402.
- Darchen, R. 1965. Ethologie d'une araignée sociale, *Agelena consociata*. *Biol. Gabonica*, 1:117-146.

- Darchen, R. 1975. La foundation de nouvelles colonies d'*Agelena consociata* et d'*Agelena republicana*, araignées sociales du Gabon. Problèmes éco-éthologiques. C. R. IIIème Coll. Arachnol. Express. franc., Les Eyzies. pp. 20-39.
- Darchen, R. 1978. Les essaimages de l'araignée sociale, *Agelena consociata* Denis (Araneide, Labidognathe), dans la forêt gabonaise (III). C. R. Acad. Sc. Paris, 287:1035-1037.
- Darchen, R. 1979. Relations entre colonies d'Agélénides sociaux du Gabon. Précision sur les essaimages. II. Bull. Biol. Française-Belgique, 117:3-29.
- Darchen, R. 1980. Les populations d'*Agelena consociata* Denis, araignée sociale, dans la forêt primaire gabonaise. Leur répartition et leur densité. Ann. Sc. Nat., Zool., 2:19-26.
- Darchen, R. 1984. Trois et après . . . Variations de la densité de la répartition des colonies de l'araignée sociale *Agelena consociata* Denis dans la forêt gabonaise. Rev. Arachnol., 5:185-191.
- Dawkins, R. 1976. The Selfish Gene. Oxford Univ. Press, Oxford.
- Hamilton, W. D. 1964a. The genetical evolution of social behaviour. I. J. theor. Biol., 7:1-16.
- Hamilton, W. D. 1964b. The genetical evolution of social behaviour. II. J. theor. Biol., 7:17-32.
- Hladik, A. 1978. Phenology of leaf production in rain forest of Gabon: Distribution and composition of food for folivores. Pp. 51-71, *In The Ecology of Arboreal Folivores* (C. C. Montgomery, ed.). Smithsonian Inst. Press, Washington, D. C.
- Krafft, B. 1969. Various aspects of the biology of *Agelena consociata* Denis when bred in the laboratory. American Zool., 9:201-210.
- Krafft, B. 1970. Les rythmes d'activité d'*Agelena consociata* Denis: Activité de tissage et activité locomotrice. Biol. Gabonica, 6:99-130.
- Krafft, B. 1971. Les interactions entre les individus chez *Agelena consociata*, araignée sociale du Gabon. Proc. 5th Internat. Congr. Arachnol., pp. 159-164.
- Krafft, B. 1974. La tolérance réciproque chez l'araignée sociale *Agelena consociata* Denis. Proc. 6th Internat. Congr. Arachnol., pp. 107-111.
- Michener, C. D. 1974. The Social Behavior of the Bees. Belknap/Harvard Univ. Press, Cambridge, Massachusetts.
- Nei, M. 1972. Genetic distance between populations. American Nat., 106:283-292.
- Pain, J. 1964. Premières observations sur espèces nouvelle d'araignées sociales. Biol. Gabonia, 1:47-48.
- Riechert, S. E. 1985. Why do some spiders cooperate?, *Agelena consociata*, a case study. Insect Behav. Ecol. symp. 1984. Florida Entomologist, 17:105-116.
- Riechert, S. E. and J. Luczak. 1982. Spider foraging: Behavioral responses to prey. Pp. 353-385, *In Spider Communication: Mechanisms and Ecological Significance* (P. N. Witt and J. Rovner, eds.). Princeton Univ. Press, Princeton, New Jersey.
- Schwartz, O. A. and K. B. Armitage. 1981. Social substructure and dispersion of genetic variation in the yellow-bellied marmot (*Marmota flaviventris*). Pp. 139-159, *In Mammalian Population Genetics* (M. H. Smith and J. Joule, eds.). University of Georgia Press, Athens, Georgia.
- Selander, R. K., M. H. Smith, S. Y. Yang, W. E. Johnson and J. B. Gentry. 1971. Biochemical polymorphisms and systematics in the genus *Peromyscus* I. Variation in the old field mouse. Studies in Genetics VI (Univ. Texas Publ. 7103):49-90.
- Shear, W. A. 1970. The evolution of social phenomena in spiders. Bull. British Arachnol. Soc., 1:65-76.
- Trivers, R. L. 1971. The evolution of reciprocal altruism. Quart. Rev. Biol., 46:35-57.
- West-Eberhard, M. J. 1975. The evolution of social behavior by kin selection. Quart. Rev. Biol., 50:1-33.
- Wilson, E. O. 1971. The Insect Societies. Belknap/Harvard Univ. Press, Cambridge, Massachusetts.
- Wilson, E. O. 1975. Sociobiology. Belknap/Harvard Univ. Press, Cambridge, Massachusetts.

HIGH PREY ABUNDANCE AND A REDUCTION IN CANNIBALISM: THE FIRST STEP TO SOCIALITY IN SPIDERS (ARACHNIDA)¹

Ann Lundie Rypstra

Department of Zoology
Miami University
1601 Peck Boulevard
Hamilton, Ohio 45011, U.S.A.

ABSTRACT

Spiders of the species, *Achaearanea tepidariorum* (Araneae; Theridiidae), were held in enclosures under two prey regimes. One group of 100 spiders was provided with 100 fruit flies (Diptera; Drosophilidae; *Drosophila melanogaster*) per day and the second group of 100 spiders was provided with 1000 fruit flies per day. The number of spiders in enclosures dropped during the first six days in both groups. However, a higher rate of cannibalism in the low prey group caused the spider numbers in that enclosure to drop more rapidly than the high prey group. A greater proportion of the spiders in the low prey group settled into recognizable territories in the first six days than in the high prey group. Spiders in the high prey group tended to move more and therefore encounter conspecifics more frequently during observations. It is projected that tolerance, observed in these normally solitary spiders when large amounts of prey are present, could lead to more complex sociality if maintained under such conditions for an evolutionary period of time.

INTRODUCTION

Spatial patterns are a critical determinant of sociality in animals. If individuals rarely, or never, come in contact with conspecifics then it is difficult to imagine how sociality could evolve. Spiders are stereotyped as quick response predators that are frequently cannibalistic. Given those characteristics, one would expect that sociality would be extremely unlikely.

The spatial patterns displayed by many spider species appear to be strongly influenced by the distribution of prey (Burgess and Uetz 1982, Rypstra 1983). In species that maintain well-defined territories, those territories are small in populations living with high prey availability relative to populations living where prey are scarce (Riechert 1978, 1981, Uetz et al. 1982). In some natural populations of solitary spiders, aggregations have been observed in association with locally elevated insect abundances (Valerio and Herrero 1977, Honjo 1977, Burgess and Uetz 1982, Rypstra 1985). In enclosures the number of web-spiders that coexist is directly correlated with the amount of prey provided (Rypstra 1983). The fact that high prey levels can exert such control over the spatial

¹Presented in a symposium, "Social Behavior in Spiders," at the National Meeting of the American Arachnological Society, June 17, 1984.

patterns of solitary spiders makes it tempting to hypothesize that an abundance of prey is prerequisite to the evolution of sociality in some species (Buskirk 1981, Rypstra 1983, 1985).

The study reported here is an investigation of the behavior of a solitary spider maintained in high densities within enclosures with a large amount of insect prey available. In earlier experiments Rypstra (1983) found that intra-individual tolerance increased and cannibalism decreased in several spider species when maintained at extremely high prey levels in similar enclosures. Here, one of the species that appeared tolerant, *Achaearanea tepidariorum* (Araneae, Theridiidae), is observed more closely under two prey regimes. The goal of this study is to determine more specifically what happens during the first few days within enclosures as the spiders sort themselves out and an equilibrium density is attained. Various behavior patterns including aggressive interactions and cannibalism are quantified to gain a better understanding of how the high densities are maintained.

METHODS

Mature or penultimate females of *Achaearanea tepidariorum* were collected around homes and buildings in the city of Hamilton, Butler Co., Ohio U.S.A. All spiders were between 4.5-5.0 mm in length. Prior to experimentation, individuals were held in six dram vials for 48 hours during which they were provided with water but no food. At the beginning of an experiment 100 spiders were released into an enclosure measuring 2.5 x 2 x 2 m. Laboratory-raised *Drosophila melanogaster* (Diptera, Drosophilidae) were released into these cages each day at 1100 h as prey for the spiders. In one enclosure 100 *Drosophila* were released and in the second 1000 *Drosophila* were released daily.

The animals were observed during a three-hour period (1300-1600 h) each afternoon for six days. At the end of each two-minute interval I recorded the number of spiders involved in various activities. Special attention was paid to the proportion of spiders participating in prey capture, feeding, spinning, and interactions with other spiders. After the observation period, I removed any prey remains and debris in the webbing and on the floor of the cage. It was possible to sort out the dead spiders from the dead *Drosophila*. In addition I was able to discern whether a particular item had been fed upon by the presence of silk wrapping and a characteristic shrunken appearance.

RESULTS

In both experimental groups the total number of spiders alive in the enclosures dropped during the six-day period (Fig. 1, Table 1). Significantly more spiders were lost in the low prey treatment than in the high prey treatment (Wilcoxon Paired Comparisons, $p < 0.05$) (Fig. 1, Table 1).

In both treatment groups about 13% of the spiders were involved in spinning or web maintenance during observation periods (Chi-squared Test, $p > 0.05$) (Table 2). However, more prey capture and feeding activity took place in the group provided with 1000 flies per day versus the group with 100 flies available (Chi-squared Test, $p < 0.05$) (Table 2).

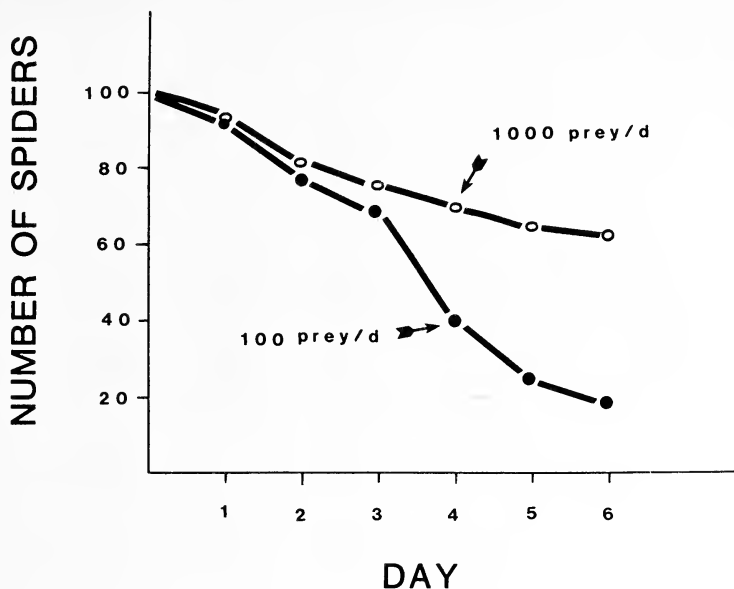

Fig. 1.—Total number of spiders living in enclosures maintained at two prey densities for six days.

I recovered close to 90% of the prey items over the course of the experiment (Table 1). In the group which had been provided 1000 flies/day, the number of flies that appeared consumed dropped during the six-days of the experiment (Kendall's Tau = -0.87 , $p < 0.05$) (Table 1). In the other group the number consumed remained approximately the same over the whole period (Kendall's Tau = 0.20 , $p > 0.05$) (Table 1). Of the spiders lost about 86% of them appeared to have been cannibalized in both groups which translates into a higher number

Table 1.—Numbers of *A. tepidariorum* and the prey they ate during a six-day period in which they were maintained in enclosures at either high prey (1000 fruit flies per day) or low prey (100 fruit flies per day) densities.

Day	Number of Living Spiders	Number in Territories	Number Spiders Cannibalized	Number of Prey Recovered	Number of Prey Fed Upon
<i>Low Prey Group</i>					
1	91	0	4	96	74
2	78	0	6	90	79
3	67	3	15	89	80
4	40	4	21	97	76
5	25	10	18	98	82
6	19	14	6	95	76
Cumulative					
Total	19	14	70	565	467
<i>High Prey Group</i>					
1	90	0	3	911	672
2	82	0	4	856	714
3	76	1	3	898	628
4	70	2	7	932	588
5	66	2	7	842	487
6	61	4	6	927	431
Cumulative					
Total	61	4	30	5366	3520

Table 2.—Percent of three hour observation times that spiders in enclosures were engaged in the activities of prey capture, feeding, web spinning and maintenance. All other behaviors including agonistic interactions, simple movement and holding still in web were lumped in the "other" category.

Day	Percent Time Spent Spinning		Percent Time Spent in Prey Capture ^a		Percent Time Spent Feeding ^a		Percent Time Spent in Other Activities ^a	
	low prey group	high prey group	low prey group	high prey group	low prey group	high prey group	low prey group	high prey group
1	12.8	13.7	25.6	32.5	15.7	28.2	45.9	25.6
2	19.2	15.8	20.1	33.1	18.9	44.7	41.8	6.4
3	14.2	14.5	19.8	34.8	17.3	39.2	48.7	11.5
4	10.2	12.1	20.2	38.1	31.8	38.8	37.8	11.0
5	13.2	12.5	28.4	37.8	34.2	43.1	24.2	6.6
6	11.1	11.7	26.2	36.1	30.1	35.2	32.6	17.0
Total	13.4	13.4	23.4	35.4	24.6	38.2	38.5	13.0

^aA significant difference was found between low prey and high prey groups for these categories ($p < 0.05$).

cannibalized in the low prey treatment than in the high prey treatment (Wilcoxon, $p < 0.05$) (Table 1).

Spiders in both experimental groups interacted with one another regularly (Table 3). In a typical encounter one spider would orient toward the other with its first two pairs of legs extended and give the webbing one or two firm jerks. The approached spider usually reacted with a similar action. Interactions could intensify with a series of such exchanges for up to three minutes. Most interactions, however, ended after two to three exchanges spanning only a 40 to 80 sec time range (Table 3). Such bouts usually terminated with the retreat of one of the spiders. In the spider group maintained with 100 flies/day the aggressor was usually the one that retreated (Table 3). In the group maintained at 1000 flies/day, the recipient of the aggression was more likely to retreat (Table 3). In about 10% of all such encounters one spider actively chased the other away. Four observed aggressive bouts in the low prey experiment ended in cannibalism (Table 3). Only one bout ended in cannibalism in the high prey treatment group (Table 3). Significantly more interactions took place between conspecifics in the high prey experiment than in the low prey experiment (Wilcoxon, $p < 0.05$) (Table 3). Presumably a portion of this difference results from the greater number of individuals in one group. However, even if the number of interactions is standardized for the number of spiders present, each group has a distinct level of aggressive interactions (Wilcoxon, $p < 0.05$) (Figure 2). This difference is more pronounced after the third day of each experiment (Fig. 2). During more than 80% of the interactions a prey item was involved (Table 3). Several interactions in the high prey treatment ended with the fly abandoned by both spiders, whereas on only one occasion was a prey abandoned in the low prey treatment group (Table 3). Interchanges observed were slightly longer in duration in the low prey group than they were in the high prey group (Table 3).

As the days progressed more of the webs characteristic of this species appeared in the enclosures (Table 1). Although the enclosure into which the most prey were provided filled up with webbing more quickly than the other, the low prey enclosure contained more distinct webs than the other (Table 1). In addition, single individuals were observed occupying the webs in the low prey group for

Table 3.—Agonistic encounters between *A. tepidariorum* individuals in enclosures provided with low prey (100 fruit flies per day) and high prey (1000 fruit flies per day).

Parameter	Low Prey Group	High Prey Group
Number of Encounters Observed ^a	72	176
Number Encounters Involving Prey Item ^a	60 (83%)	141 (80%)
Number in Which Prey Item was Abandoned ^b	1 (1%)	3 (2%)
Number in Which Aggressor Retreated ^a	63 (88%)	60 (34%)
Number in Which Recipient Retreated ^a	12 (17%)	116 (67%)
Number ending in Cannibalism ^b	4 (6%)	1 (0.6%)
Mean Duration in seconds (range) ^a	58.4 (29.2-210.3)	41.5 (13.1-72.4)

^aA significant difference was found between low prey and high prey groups for these categories ($p < 0.05$).

^bThere was insufficient data to test for a difference in these categories.

a two to three day span of time. Whereas spiders maintained in the high prey container moved in and out of spaces in the webbing approximately every 21 min, so that it was not possible to identify specific territorial boundaries.

DISCUSSION

These results further document an increase in tolerance for conspecifics displayed by the spider species, *Achaearanea tepidariorum*, at high prey densities that has been reported before (Rypstra 1983). This species reduces the amount of cannibalism, becomes non-territorial, and changes the nature of its interactions with conspecifics when plenty of food is provided. Under high prey conditions

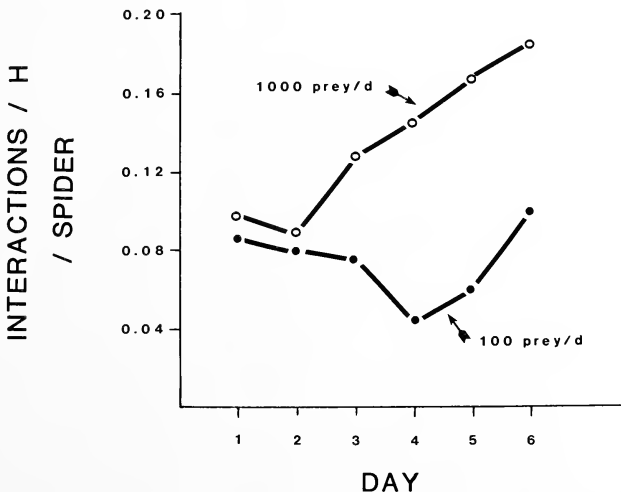

Fig. 2.—Number of aggressive interactions observed per spider per observation hour. Interactions took place among individuals maintained in enclosures at two prey densities for six days.

the behavior of this species becomes very similar to that of regularly social species that inhabit tropical regions (Buskirk 1981, Rypstra pers. obs.).

Prey abundance has been implicated in evolution of sociality in spiders in many cases. Aggregations of the orb-weaver, *Nephila clavipes* (Araneae, Araneidae), form around areas of high prey abundance in Peru (Rypstra 1985). Some species that build big web conglomerates do so to take advantage of high insect densities (Lubin 1973, 1974, Buskirk 1975, Rypstra 1979, Uetz et al. 1982). In addition there are numerous reports of solitary species in temperate regions clustered in areas where insects are abundant (Honjo 1977, Valerio and Herrero 1977, Burgess and Uetz 1982). These examples indicate that high prey abundance is important in the evolution of sociality via the parasocial route (sensu Wilson 1971). The alternative route to sociality in spiders involves an extension of the social tendencies frequently displayed by juveniles (Shear 1970, Buskirk 1981). Krafft et al. (1986) have been able to prolong the juvenile social period by providing the young with an abundance of food. Their experiments imply that food abundance could also be an important aspect in the evolution of sociality via this second pathway. Further evidence is provided by the geographical distribution of social spider species. All species are tropical or subtropical (Buskirk 1981), and live in areas characterized by consistently high insect abundances (Janzen 1973, Janzen and Pond 1975, Rypstra 1986).

One of the functions of territoriality is to insure access to resources (Brown 1964, Morse 1980). When food is super-abundant and resources are not limited, territorial behavior may break down. Carpenter and MacMillan (1976) developed a model permitting them to predict when nectar-feeding birds would shift from territorial to non-territorial states. The birds became non-territorial when resource availability was high in a manner similar to that displayed by the spiders in this study. When resources are super-abundant, no advantage is gained by defending a specific area that functions to guarantee access to those resources (Brown 1964).

In the high prey group the frequency of interactions between pairs of individuals is higher than in the low prey group (Fig. 2). Some part of the difference is due to the fact that fewer of these individuals settled into territories and more of them moved throughout the enclosure (Table 1). A similar difference has been observed in some studies of bird flocks. Pulliam et al. (1974) reported that individuals in flocks showed less aggression as conditions deteriorated. The birds accomplished this by reducing the number of encounters per individual and maintaining a defined inter-individual distance. This pattern is similar to what I observed the spiders doing in this experiment.

In part, the high frequency of interactions between conspecifics in the high prey treatment represents a stereotyped orientation response that they have to any vibration in their web. The number of fruit flies and the number of spiders moving throughout the intertwined webbing would naturally increase the number of times the spiders would have to orient and respond. The reduction in the intensity of the interactions is presumably because the spiders are not hungry and therefore are not driven to escalate the interactions. Some highly social cooperative spider species have a high rate of encounter interactions as they move through the webbing (Vollrath and Rohde-Arndt 1982, Rypstra pers. obs.), which operates as a form of communication network (Krafft 1982). With time these encounters which now appear aggressive could ameliorate into a more standard form of communication between individuals within a colony as sociality evolves.

ACKNOWLEDGMENTS

Funding for this research was provided by the American Museum of Natural History, Miami University (Hamilton Campus), and the Faculty Research Committee of Miami University (Oxford Branch). D. H. Morse, E. J. Mury Meyer and G. Stratton provided helpful comments on an earlier draft of this manuscript. Thanks are extended to G. W. Uetz for organizing the symposium that generated this manuscript.

LITERATURE CITED

- Brown, J. L. 1964. The evolution of diversity in avian territorial systems. *Wilson Bull.*, 76:160-169.
- Burgess, J. W. and G. W. Uetz. 1982. Social spacing strategies in spiders. Pp. 317-351, *In Spider Communication: Mechanisms and Ecological Significance* (P. N. Witt and J. S. Rovner, eds.). Princeton University Press, Princeton, New Jersey.
- Buskirk, R. E. 1975. Coloniality, activity patterns and feeding in a tropical orb-weaving spider. *Ecology*, 56:1314-1328.
- Buskirk, R. E. 1981. Sociality in the Arachnida. Pp. 281-367, *In Social Insects*. Vol. II (H. R. Hermann, ed.). Academic Press, New York.
- Carpenter, F. L. and R. E. MacMillan. 1976. Threshold model of feeding territoriality and test with a Hawaiian honeycreeper. *Science*, 194:639-642.
- Honjo, S. 1977. Social behavior of *Dictyna follicola* Bos et Str. (Araneae: Dictynidae). *Acta Arachnol.*, 27:213-219.
- Janzen, D. H. 1973. Sweep samples of tropical foliage insects: effects of seasons, vegetation types, elevation, time of day, and insularity. *Ecology*, 54:687-708.
- Janzen, D. H. and C. M. Pond. 1975. A comparison, by sweep sampling, of the arthropod fauna of secondary vegetation in Michigan, England, and Costa Rica. *Trans. Roy. Entomol. Soc. London*, 127:33-50.
- Krafft, B. 1982. The significance and complexity of communication in spiders. Pp. 15-66, *In Spider Communication: Mechanisms and Ecological Significance* (P. N. Witt and J. S. Rovner, eds.). Princeton University Press, Princeton, New Jersey.
- Krafft, B., A. Horel and J.-M. Julita. 1986. Influence of food supply on the duration of the gregarious phase of a maternal-social spider, *Coelotes terrestris* (Araneae, Agelenidae). *J. Arachnol.*, 14: 219-226.
- Lubin, Y. 1973. Web structure and function: the non adhesive orb-web of *Cyrtophora moluccensis* (Doleschall) (Araneae: Araneidae). *Forma et Functio*, 6:337-358.
- Lubin, Y. 1974. Adaptive advantages and the evolution of colony formation in *Cyrtophora* (Araneae: Araneidae) *Zool. J. Linnean Soc.*, 54:321-339.
- Morse, D. H. 1980. *Behavioral Mechanisms in Ecology*. Harvard University Press, Cambridge Mass.
- Pulliam, H. R., K. A. Anderson, A. Misztal and N. Moore. 1974. Temperature-dependent social behaviour in juncos. *Ibis*, 116:360-364.
- Riechert, S. E. 1978. Energy-based territoriality in populations of the desert spider *Agelenopsis aperta* (Gertsch) *Symp. Zool. Soc. London*, 42:211-222.
- Riechert, S. E. 1981. The consequences of being territorial: spiders, a case study. *Amer. Nat.*, 117:871-892.
- Rypstra, A. L. 1979. Foraging flocks of spiders: a study of aggregate behavior in *Cyrtophora citricola* Forskal (Araneae; Araneidae) in west Africa. *Behav. Ecol. Sociobiol.*, 5:291-300.
- Rypstra, A. L. 1983. The importance of food and space in limiting web-spider densities; a test using field enclosures. *Oecologia*, 59:312-316.
- Rypstra, A. L. 1985. Aggregations of *Nephila clavipes* (L.) (Araneae, Araneidae) in relation to prey availability. *J. Arachnol.*, 13:71-78.
- Rypstra, A. L. 1986. Web-spiders in temperate and tropical forests: relative abundance and environmental correlates. *Amer. Midland Nat.*, 115:42-51.
- Shear, W. A. 1970. The evolution of social phenomena in spiders. *Bull. British Arachnol. Soc.*, 1:65-76.

- Uetz, G. W., T. C. Kane and G. E. Stratton. 1982. Variation in the social grouping tendency of a communal web-building spider. *Science*, 217:547-549.
- Valerio, C. E. and M. V. Herrero. 1977. Tendencia social en adultos de la Araña *Leucauge*, sp. (Araneae, Araneidae) en Costa Rica. *Brenesia*, 10/11:69-79.
- Vollrath, F. and D. Rohde-Arndt. 1983. Prey capture and feeding in the communal spider *Anelosimus eximius* Z. *Tierpsychol.*, 61:313-324.
- Wilson, E. O. 1971. *The Insect Societies*. Belknap Press, Cambridge, Massachusetts.

Manuscript received April 1985, revised August 1985.

POPULATION GENETICS OF *ANELOSIMUS EXIMIUS* (ARANEAE, THERIDIIDAE)¹

Deborah R. R. Smith

Department of Entomology
Cornell University
Ithaca, New York 14853²

ABSTRACT

Anelosimus eximius is a cooperative, group-living neotropical spider. Colonies consist of up to several thousand individuals, and colonies may be aggregated into local colony clusters. The colony clusters are patchily distributed, and are often separated from their neighbors by a km or more. In this study individuals were collected from colonies located in Panama and Suriname. These individuals were subjected to horizontal starch gel electrophoresis and screened for polymorphisms in 46 enzyme systems. A total of 51 scorable loci were found, of which seven were polymorphic. The results were analyzed with Wright's F statistics which were used to investigate the amount of genetic differentiation in the population attributable to subdivision of the population into colonies, colony clusters, local populations and the geographic regions of Panama and Suriname.

Most of the genetic differentiation in the *A. eximius* sampled was due to subdivision of the population into colony clusters and into geographic regions. There was no evidence of differentiation among colonies in a colony cluster, and little differentiation among collection sites within Panama or Suriname. In contrast, within a local population, samples from adjacent colony clusters were sometimes fixed for different alleles at one or more loci, and the Panama and Suriname samples were fixed for different alleles at three loci.

INTRODUCTION

Anelosimus eximius (Keyserling) (Theridiidae) is among the best known of the cooperative or quasisocial spiders. Its natural history has been studied most recently by Brach (1975), Christenson (1984), Overal and Ferreira da Silva (1982), Vollrath (1982), Vollrath and Rohde-Arndt (1983) and others (L. Aviles, Y. Lubin, A. Rypstra, pers. comm.). *Anelosimus eximius* is found in rainforest and second growth habitat from Panama to southern Brazil, and from Peru to Trinidad and eastern Brazil (Levi 1963). The webs of *A. eximius* consist of a large, more or less oval horizontal sheet of nonsticky silk, one or more retreats made of green and dry leaves curled and held in place with silk, and vertical threads ("knock down threads") extending from the sheet and retreat to leaves and branches above the web. Webs can be found from ground level to at least 20 m up in the forest canopy (personal observation). Webs range in size from tiny structures 10-25 cm long containing only one or a few spiders, to large

¹Presented in a symposium, "Social Behavior in Spiders," at the National Meeting of the American Arachnological Society, June 17, 1984.

²Current address: Museum of Zoology, Insect Division, University of Michigan, Ann Arbor, Michigan 48109

colonies 2-3 m or more in length containing hundreds or thousands of individuals.

Established colonies contain adult females and males, and immatures. The social interactions of *A. eximius* have been described by Brach (1975), Christenson (1984), Vollrath (1982), and Vollrath and Rohde-Arndt (1983). These behaviors include cooperative construction, maintenance and cleaning of the web; cooperative prey capture and feeding on large prey by several individuals; and regurgitation feeding of young. Females regurgitate food for offspring other than their own (Christenson 1984) and there is some evidence that some adult females in colonies do not reproduce (Vollrath and Rohde-Arndt 1983; Overal and Ferreira da Silva 1982). The adult sex ratio is highly biased towards females; males make up only a small portion of the adult population of colonies: 5% to 22% (six colonies of 100 to 200 individuals; Overal and Ferreira da Silva 1982); 7% (4 of 55 adults in one web; Christenson 1984). The bias in sex ratio is already apparent in the penultimate instar, when males and females can be distinguished (Aviles 1983). Reproduction takes place year round, at least in some populations (Overal and Ferreira da Silva 1982).

Two types of colony foundation have been described for this species: budding and dispersal (Vollrath 1982). In budding a large established colony splits into two or more webs, either because the web is broken by falling branches, debris etc., or because small groups of spiders leave the main web and begin a new web nearby (Overal and Ferreira da Silva 1982). During dispersal, large numbers of mated females leave their original colony and disperse singly to build new solitary webs. The females in the solitary webs may later be joined by other females, apparently dispersing females whose new webs have failed. All newly founded webs have a very high failure rate, but they stand a better chance for survival if they are later joined by other females (Christenson 1984). Vollrath notes (1982) that dispersing females always traveled alone, and only after the webs were built did other females join. These multi-foundress colonies were generally in the proximity of a larger established colony. Webs more distant from a large established web were usually single female webs.

These two methods of colony foundation, budding and dispersal, may be the cause of two superimposed patterns of colony distribution. Colonies or webs are often found in local aggregations, or colony clusters which may contain two to 40 or more distinct webs. This pattern of distribution may be the result of budding; if so, colonies within colony clusters should be genetically very similar. The colony clusters themselves are patchily distributed, separated from neighboring clusters by as little as a few tens of meters or as much as several km. This may be partly due to new colony foundation by dispersal and founder events.

Based on observations of natural history, it is likely that gene flow among the colonies within a colony cluster is high. The webs are in close proximity, sometimes touching, and may share parts of the knockdown threads. The extent of gene flow among colony clusters is unknown. There are four potential avenues for gene flow among colony clusters: 1) new colonies may be founded by unrelated dispersing females; 2) males may disperse out of their natal colony clusters and into different clusters to mate; 3) immatures or females may disperse and join established colony clusters; and 4) spiders may be accidentally transported to new webs (e.g. by wind, rivers, animals or humans).

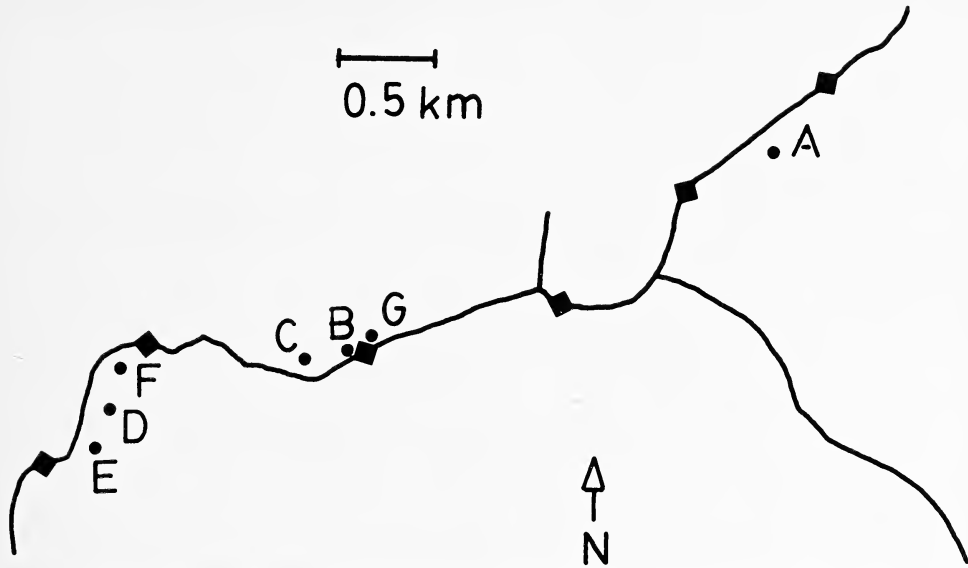

Fig. 1.—Map of Browns Berg collection site, Brokopondo, Suriname. Solid lines indicate trails, solid circles indicate *Anelosimus eximius* colonies or colony clusters, and solid diamonds are km markers.

If colonies are founded by a single female lineage (one female or a group of sibling females who mated before leaving their natal nest), and if there is no subsequent migration into a colony by any age-sex class, then the individuals within colonies and colony clusters would by necessity inbreed. In addition each family lineage would be isolated from others in the population as it went through cycles of dispersal, colony foundation, growth, budding and more dispersal. Subdivision of the population into isolated genetic lineages may contribute to more rapid or more frequent speciation than would be found in a more freely mixing population.

Genetic variability at loci coding for structural proteins can be detected using protein electrophoresis. This technique has been widely used in population studies of both vertebrates and invertebrates (Selander and Whittam 1983, and references therein). Pennington (1979) used protein electrophoresis to distinguish immatures and females of similar species of *Meta* (Araneidae). The data presented here are the results of a pilot study investigating the feasibility of using protein electrophoresis to study genetic variation within and among colonies, colony clusters, and populations of *A. eximius*. The questions addressed are:

- 1) Is there a high level of genetic similarity within colonies?
- 2) Is there a high level of genetic similarity within colony clusters?
- 3) Is there genetic differentiation among populations, and if so on what geographic scale?

METHODS AND MATERIALS

Collection.—*Anelosimus eximius* were collected from colonies in Panama (August 1983) and Suriname (April and May 1984). The Panama collections were made in two locations. The first was along the El Llano—Carti Road in Panama province east of the Panama Canal ($9^{\circ}15'N$, $79^{\circ}5'W$), at an elevation of

approximately 100-200 m. The area along the road was recently forested, but is now mainly agricultural land and second growth forest. The second collection site was outside of the town of El Valle in Penonome Province west of the Panama Canal (8°37'N, 80°6'W). This area was higher in elevation (approximately 400-500 m) in the bowl of an extinct volcano, and is covered with cooler, wet cloudy forest. Here and at El Llano the spiders were collected by bagging a retreat and cutting it out of the web.

Suriname collections were also made at two localities, the Browns Berg Nature Park and the Voltzberg-Raleighvallen Reserve. The Browns Berg Reserve (Brokopondo province, 4°50'N, 55°15'W) is located along the western shores of the Brokopondo reservoir. The study area was on the Mazaroni plateau at an elevation of 400-450 m. The vegetation here is rainforest which had been selectively logged at some time in the past. Colony clusters were found along a 12 km trail across the plateau.

The Voltzberg-Raleighvallen reserve (Saramacca province, 4°45'N, 56°10'W) is located along the Coppename river in central Suriname. Park headquarters are on Foengoe Island. Colonies were found on Foengoe Island, on the west bank of the river (outside the reserve lands) and at the Voltzberg camp in the forest east of the river. Both here and at Browns Berg spiders were collected by shaking the web and catching the spiders in a bag or box as they jumped off the edge of the web.

All spiders collected in Panama and Suriname were transported live to the United States. The animals were starved for at least 1 week and stored frozen at -70°C .

Electrophoresis.—Spiders were analyzed for enzyme polymorphisms using horizontal starch gel electrophoresis. The techniques employed are described in detail in May et al. (1979), May (1980), Harris and Hopkinson (1976), and Brewer (1970); recipes for stains follow Harris and Hopkinson (1976) and Shaw and Prasad (1970). Four buffer systems were used: "R" (Ridgway et al. 1970), "C" (Clayton and Tretiak 1972), "M" (Markert and Faulhaber 1965), and "4" (modified from Selander et al. 1971) (recipes for the buffers are given in Appendix 1). Gels were made of 42 g (thin gels) or 70 g (thick gels) of a 1:1 mixture of hydrolyzed potato starch and electrostarch, and 300 or 500 ml respectively of one of the four buffers. Individual spiders were homogenized in 2-3 drops of 0.05 M Tris HCl (Appendix 1). Heavy weight filter paper wicks (Whatman #3 filter paper) approximately 0.5 x 3 x 8 mm were used to carry samples of the homogenates; one spider provided enough homogenate for two to four wicks. Running conditions followed those described in May et al. (1979) and May (1980). After the proteins migrated a sufficient distance each gel was sliced horizontally into four (thin gel) or six (thick gel) layers approximately 1.5 mm thick and each slice was stained to indicate the position of a single enzyme.

A screen of 46 enzyme systems using each of the four buffer systems was carried out to determine 1) which enzymes could be detected in *A. eximius*, 2) which buffers gave the best results for each enzyme system, and 3) which enzymes showed detectable polymorphisms. In the screen two thick gels of each buffer system were run, for a total of 8 gels. Ten spiders were run on each gel; one spider produced enough homogenate for four wicks, so that four replicates of the ten spiders were placed on a gel. (Sometimes it was not possible to get four wicks from a single homogenized spider, so samples from another ten spiders from the

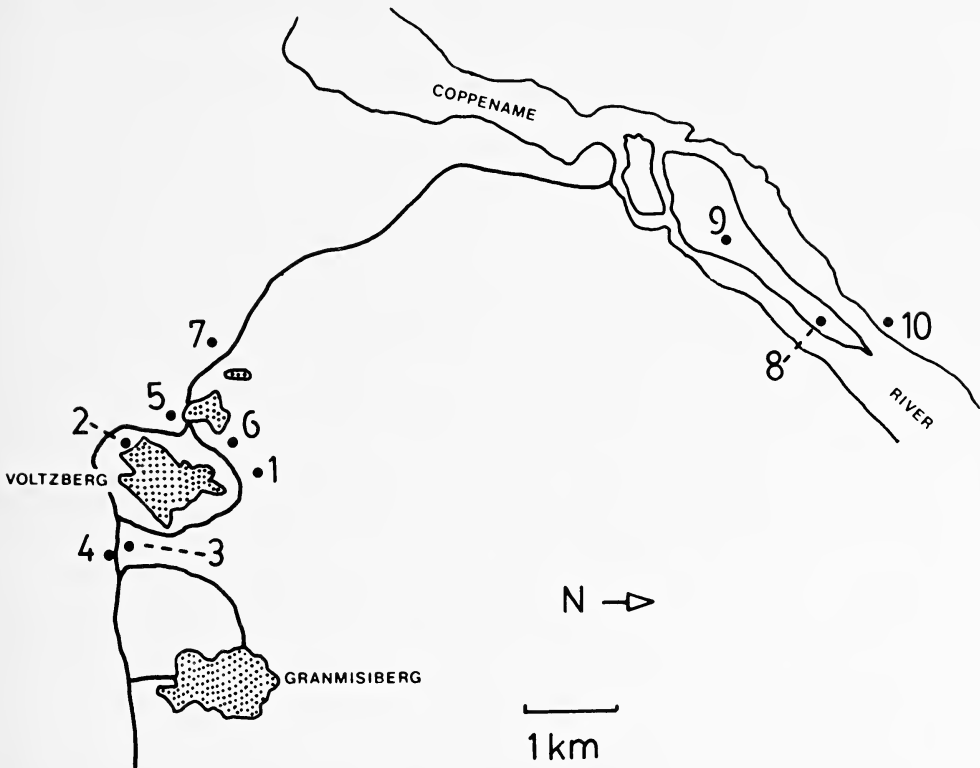

Fig. 2.—Map of Voltzberg collection site, Saramacca, Suriname. Thick solid lines indicate trails, solid circles indicate *Anelosimus eximius* colonies or colony clusters, and stippling indicates granite outcrops in the form of bergs and plates. Colonies 8 and 9 are on Foengoe Island in the Coppename River.

same web were used for one of the replicates). After the gels had been subjected to electrophoresis they were cut into four “mini gels.” Each mini gel was sliced horizontally into six layers, giving a total of 48 gel layers for each type of buffer. One slice of each buffer type was stained for one of the 46 enzyme systems investigated. The ten spiders in the replicates were chosen so that every buffer and stain combination was tried on spiders from each of the four collection sites and from as many different colonies as possible. The list of enzyme systems screened and the buffers which gave best results is given in Appendix 2.

Based on the results of the screen, a survey of each colony was carried out examining each apparently polymorphic locus on the buffer system giving the best results. In the survey of polymorphic enzymes 7 to 14 spiders were sampled from each of 23 webs for a total of 187 spiders. An additional 22 spiders were sampled from one web in which heterozygotes were discovered (see results below).

Analysis.—Mean heterozygosity in the *Anelosimus eximius* samples was calculated as the arithmetic mean of the heterozygosities calculated for every scorable locus. Heterozygosity at a single locus was calculated as though all members of the population were potentially freely interbreeding, so that heterozygosity of a single locus with two alleles occurring with frequencies “p” and “q” is $2pq$; for three alleles with frequencies “p,” “q” and “r” it is $2(pq + pr + qr)$, etc. I computed mean heterozygosities and standard errors according to the method of Nei (1978) and Nei and Roychoudhury (1974) for populations

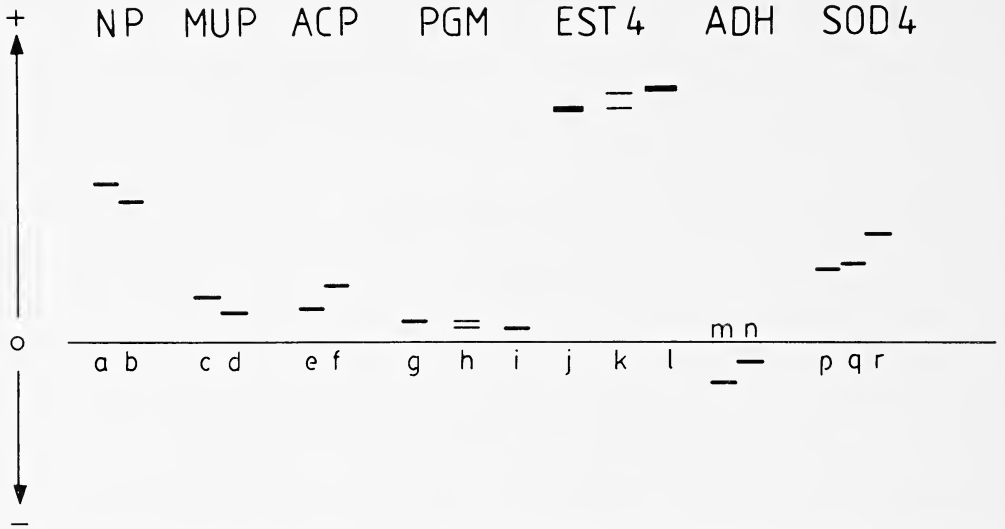

Fig. 3.—Banding patterns observed for seven polymorphic enzymes. “o” is the point of origin on the gel, and arrows indicate the direction of migration by the protein (+ towards positive terminal, —towards negative terminal). The presumed genotype for each band is given in the arbitrary numbering system used in the text (e.g. 11, 12, 22) and in the percentage system described in Allendorf et al. (1977). NP: a = 11 or 100/100, b = 22 or 89/89; MUP: c = 22 or 158/158, d = 11 or 100/100; ACP: e = 11 or 100/100, f = 22 or 164/164; PGM: g = 11 or 100/100, k = 12 or 100/106.5, l = 22 or 106.5/106.5; ADH: m = 11 or 100/100, n = 22 or 42/42; SOD-4: o = 11 or 100/100, p = 33 or 107/107, q = 22 or 145/145.

consisting of the total *A. eximius* sample, the Panama and Suriname samples separately, and for colony clusters which contained heterozygotes, using a program written by Dowling and Moore (1984) modified for the IBM PC.

When colony clusters contained individuals heterozygous at a particular locus, I calculated the frequencies of genotypes expected given the allele frequencies calculated from the samples, and compared them with observed frequencies using a Chi² goodness-of-fit test.

I calculated Wright's F statistics (F_{dt} , F_{st} and F_{ds}) for each polymorphic locus (Wright 1951, 1978; Hartl 1980). F statistics provide measures of the extent of population structuring based on the departure of the frequencies of genotypes observed from those expected under conditions of panmixia. Non-random mating within populations and division of the population into sub-populations and demes are examples of departure from panmixia which may lead to a reduction in the observed frequency of heterozygotes compared to homozygotes. F statistics are hierarchical in nature. Reduction in heterozygosity in the population as a whole (F_{dt}), can be partitioned into that due to sub-populations within the total population (F_{st}), and in demes within sub-populations (F_{ds}). I performed two sets of calculations; in both I treated the colony clusters as demes, and all *A. eximius* sampled as the total population. In one set of calculations I treated the four collecting sites (El Llano, El Valle, Browns Berg and Voltzberg) as sub-populations, and in the other I considered the Panama and Suriname samples to be sub-populations.

Table 1.—Presumed genotypes found for seven polymorphic loci in El Llano (EL), El Valle (EV), Browns Berg (BR) and Voltzberg (VB) samples of *Anelosimus eximius*. N is number of individuals sampled.

Locality	ACP	ADH	MUP	NP	SOD-4	PGM	EST-4	N
EL	11	11	11	11	11	11	11	26
EV	11	11	11	11	22	11	11,12,22	37
BR	22	22	22	22	22,33	11	22	23
VB	22	22	22	11,22	22,33	11,12,,22	22	101*

*plus an additional 22 spiders sampled for PGM.

RESULTS

Collections.—At the El Llano collection site two colony clusters were found about 1 km apart, each consisting of a single web. I collected spiders from each of these two webs. At the El Valle site a group of webs was found along a 135 m portion of a path. At this site there were 40 webs ranging in size from 10 cm across to 4 m across, and containing one spider to several hundred spiders. No web was more than 22 m from its nearest neighbor, so that it appeared likely that this was one very large colony cluster. I took spiders from five webs. Seven colony clusters (which I labelled a A through G) were found at the Browns Berg park. Cluster A consisted of four webs and cluster B consisted of three; the rest consisted of single webs. The relative positions of these colony clusters are shown in Figure 1. I collected spiders from each colony cluster except for cluster G, which was 10 m up a tree. However, after collection a problem with excess moisture killed all but the samples from two webs in cluster A and the sample from cluster C. Ten colony clusters were found at the Voltzberg reserve. The locations of these clusters are shown in Figure 2. Clusters 2, 3 and 7 contained two webs each, the rest only single webs. I collected samples from each web in each colony cluster.

Electrophoresis.—Thirty-seven of the 46 proteins screened gave clear and scorable results on at least one buffer system. Ten enzymes were apparently coded for by more than one locus (indicated in Appendix 2 by a numerical suffix, e.g. MDH-1, MDH-2) giving a total of 51 scorable loci. Of these, 44 were monomorphic for all individuals sampled, and only seven, or 13.7%, were polymorphic. These seven were methylumbelliferyl phosphatase (MUP), alcohol dehydrogenase (ADH), acid phosphatase (AC), an esterase (EST-4), a superoxide dismutase (SOD-4), nucleoside phosphorylase (NP), and phosphoglucosmutase (PGM). SOD-4 was represented by three presumed alleles, the rest by two. The banding patterns found, along with the presumed genotypes producing the patterns, are presented in Figure 3.

The genotypes at these seven loci in each collection site are presented in Table 1. Of the seven polymorphic loci, three (MUP, ADH and ACP) show fixed differences between the Panama and Suriname samples. NP and PGM were monomorphic in the Panama samples, and EST-4 was monomorphic in the Suriname samples. Thus in the Suriname sample three (5.9%) of the 51 loci sampled were polymorphic, and in the Panama sample two (3.9%) were polymorphic.

The gene frequencies found for EST-4, NP, PGM and SOD-4 in each web are given in Table 2. Most samples taken from any one colony are made up of

Table 2.—Gene frequencies of NP, SOD-4, PGM and EST-4 in webs sampled from El Llano (EL), El Valle (EV), Browns Berg (BR) and Voltzberg (VB). The convention 1-1 is used to indicate colony cluster 1, web 1, etc. N is number of individuals sampled from each web.

allele:	NP		SOD-4			PGM		EST-4		N
	1	2	1	2	3	1	2	1	2	
EL 1-1	1	0	1	0	0	1	0	1	0	14
EL 2-1	1	0	1	0	0	1	0	1	0	12
EV 1-1	1	0	0	1	0	1	0	0.86	0.14	9
EV 1-2	1	0	0	1	0	1	0	0.36	0.64	7
EV 1-3	1	0	0	1	0	1	0	0.64	0.36	7
EV 1-4	1	0	0	1	0	1	0	0.86	0.14	7
EV 1-5	1	0	0	1	0	1	0	0.86	0.14	7
BR A-1	0	1	0	1	0	1	0	0	1	8
BR A-2	0	1	0	1	0	1	0	0	1	7
BR C-1	0	1	0	0	1	1	0	0	1	8
VB 1-1	0	1	0	10	01	0	0	1	7	
VB 2-1	0	1	0	1	0	1	0	0	1	7
VB 2-2	0	1	0	1	0	1	0	0	1	7
VB 3-1	1	0	0	1	0	1	0	0	1	7
VB 3-2	1	0	0	1	0	1	0	0	1	7
VB 4-1	1	0	0	0	1	0	1	0	1	7
VB 5-1	1	0	0	0	1	0	1	0	1	9
VB 6-1	1	0	0	1	0	0	1	0	1	8
VB 7-1	0	1	0	1	0	0.58	0.42	0	1	8*
VB 7-2	0	1	0	1	0	0.47	0.53	0	1	8**
VB 8-1	0	1	0	1	0	0	1	0	1	8
VB 9-1	0	1	0	1	0	1	0	0	1	8
VB 10-1	0	1	0	1	0	0	1	0	1	10

* three individuals unscorable.

** plus an additional 22 individuals to calculate frequencies of PGM alleles.

individuals identically homozygous at all loci sampled. Samples from colonies within a cluster (the El Valle samples, cluster A from Browns Berg and clusters 2, 3, and 7 from Voltzberg) did not differ in alleles present. There are two instances of heterozygosity. Within colony cluster 7 at Voltzberg the enzyme PGM was polymorphic, and within the El Valle colony cluster the enzyme EST-4 was polymorphic; in each instance all three potential genotypes were present (11, 12, 22). In Voltzberg cluster 7, 30 spiders from one web and 5 from the other in the cluster were scored for their PGM phenotype. In El Valle a total of 37 spiders were examined for their EST-4 phenotype. In both, the proportion of individuals of each genotype in the cluster (data for the two webs which comprised cluster 7 combined, and data for the 5 El Valle webs combined) did not differ from that predicted by the Hardy-Weinberg equation given the allele frequencies calculated from the data (Table 3). There were no significant differences in the frequencies of the three genotypes (11, 12, 22) found in the two webs which made up colony cluster 7 ($\chi^2 = 1.75$, 2 df, $p = 0.42$). Sample sizes were not large enough to make comparisons among the five El Valle webs sampled.

Comparison of the genotypes found within colony clusters presented in Table 2 with the spatial locations of colony clusters in Browns Berg and Voltzberg (Figs. 1 and 2), shows that adjacent colonies (e.g. Voltzberg clusters 3 and 4, separated by 70 m) may be fixed for different alleles of one or more enzyme.

Table 3.—Observed frequencies of genotypes found in Voltzberg 7 and El Valle 1 colony clusters compared with the frequencies expected under Hardy-Weinberg conditions, given gene frequencies calculated from the samples.

EST-4: El Valle webs 1 through 5 combined, frequency of allele 1 = 0.72, frequency of allele 2 = 0.28			
Genotype:	11	12	22
observed	19	15	3
expected	19.2	14.8	3
chi ² = 0, 2 d.f., p = 1			
PGM: Voltzberg webs 1 and 2 from colony cluster 7 combined, frequency of allele 1 = 0.53, frequency of allele 2 = 0.47			
Genotype:	11	12	22
observed	8	21	6
expected	9.8	17.4	7.7
chi ² = 0.93, 2 d.f., p = 0.63			

Mean heterozygosity for the total *A. eximius* sample is 0.060 with a standard error of 0.021, and the values for the Panama and Suriname samples are 0.017 (s.e. 0.012) and 0.024 (s.e. 0.012) respectively. Heterozygosity values within colony clusters are zero, except for the El Valle cluster (0.0080) and Voltzberg cluster 7 (0.0099).

For each enzyme studied the biochemical phenotypes of 7 to 14 spiders from each web were determined. In any individual web sampled, alleles that occurred with a frequency of 0.19 or more would have been detected with a probability of 0.05 or better. In future studies larger sample sizes (> 30 spiders per web) will increase the probability that all alleles present in a colony are detected, and that samples which show only one allele are representative of a monomorphic colony. The pooled samples total 187 spiders; thus the conclusion of extreme monomorphism in *A. eximius* is based on strong evidence.

F statistics for the seven polymorphic loci are presented in Table 4. F_{dt} describes the reduction in observed heterozygosity in the population as a whole; a value of zero implies that there is no difference between the observed and expected frequency of heterozygotes, whereas values close to 1 imply a great reduction in heterozygosity. F_{st} tells how much of the reduction in heterozygosity observed in the population is associated with division of the total population into sub-populations. A value of F_{st} close to zero indicates that little of the observed loss of heterozygosity is associated with division of the total population into sub-populations, and values close to 1 indicate that all or most of the observed loss is associated with division of the population into sub-populations. F_{ds} describes what portion of the reduction in observed heterozygosity is associated with the division of sub-populations (e.g. El Valle, El Llano, Browns Berg and Voltzberg) into demes (colony clusters). A value of F_{ds} close to zero would indicate that little of the observed reduction in heterozygosity is associated with division of the sub-populations into colony clusters, whereas values close to 1 indicate that most or all of the observed reduction is associated with division of the sub-population into demes.

All of the values of F_{dt} presented in Table 4 are large, indicating a large reduction in the occurrence of heterozygotes in the population. The polymorphic enzymes fall into two groups. For the enzymes EST-4, MUP, ACP and ADH all of the observed reduction in heterozygosity is associated with division of the total

Table 4.—Partitioning of total genetic variance in *Anelosimus eximius* into components associated with division of the total population into demes (F_{ds}) and sub-populations (F_{st}) for polymorphic enzyme systems.

A. demes = colony clusters, sub-populations = El Valle, El Llano, Browns Berg and Voltzberg.			
	F_{ds}	F_{st}	F_{dt}
NP	1.0	0.37	1.0
PGM	0.90	0.18	0.92
SOD-4	1.0	0.43	0.93
EST-4	0.0	0.93	0.93
MUP	0.0	1.0	1.0
ACP	0.0	1.0	1.0
ADH	0.0	1.0	1.0
B. demes = colony clusters, sub-populations = Panama and Suriname.			
	F_{ds}	F_{st}	F_{dt}
NP	1.0	0.32	1.0
PGM	0.91	0.05	0.92
SOD-4	1.0	0.17	1.0
EST-4	0.53	0.86	0.93
MUP	0.0	1.0	1.0
ACP	0.0	1.0	1.0
ADH	0.0	1.0	1.0

population sample into sub-populations, in particular into the Panama and Suriname sub-populations, and none is associated with division of the local populations into colony clusters. For the enzymes NP, PGM and SOD-4 the observed reduction in heterozygosity is largely associated with division of the total population and the sub-populations into colony clusters; relatively little is associated with division of the total population into sub-populations. The F statistics for EST-4, MUP, ACP and ADH imply that the Panama and Suriname populations are highly differentiated. The corresponding values for the enzymes NP, SOD-4 and PGM indicate that within large geographic areas (i.e. Panama and Suriname) there is little differentiation among local populations but a great deal of differentiation among colony clusters.

DISCUSSION

Social Structure and the Genetic Composition of Colonies.—*Anelosimus eximius* is highly monomorphic; within the Suriname samples only three loci out of 51 were polymorphic, and within the Panama samples only two. To interpret these results, that is, to decide whether these levels of homozygosity are unusually high or simply typical of spiders in general, it is necessary to compare these data with studies of genetic variability in other cooperative and non-cooperative spiders; however, very little comparative information is available. Riechert, Roeloffs and McCracken are studying genetic variation in the cooperative West African spider, *Agelena consociata* Denis (Agelenidae), and have found very few polymorphic systems and few heterozygotes (Riechert, pers. comm.). Lubin and Crozier (1985) examined 22 loci in 615 individuals of the New Guinea cooperative spider *Achearanea wau* Levi (Theridiidae) taken from four localities, and found only one polymorphic locus with two alleles. Using these data and Dowling and Moore's program for mean heterozygosity (1984), I calculated a mean

heterozygosity for *A. wau* of 0.02. I also calculated the mean levels of heterozygosity from data for three non-cooperative species: two species of *Philophonella* (Uloboridae) from Arizona (Smith, ms in prep) and for the California trap door spider *Bothriocyrtum californicum* (O. P.-Cambridge) (Ctenizidae) (Galindo-Ramirez and Beckwith 1983). Calculated mean heterozygosity for *Philophonella oweni* (Chamberlin) is 0.085, s.e. 0.048 (11 loci sampled in 18 individuals). For *Philophonella* sp. (undescribed species) calculated mean heterozygosity is 0.12, s.e. 0.052 (11 loci sampled in 12 individuals). For *B. californicum*, mean heterozygosity was 0.09, s.e. 0.06 (11 loci sampled in at least 64 individuals). These three non-cooperative species show higher levels of heterozygosity than the two cooperative species, perhaps because the cooperative societies examined are characterized by high levels of inbreeding within colonies. However, to establish that this is due to inbreeding and not to generally low levels of heterozygosity in the genus *Anelosimus* or the family Theridiidae, similar studies of related non-cooperative species are needed.

Colonies within a colony cluster do not appear to be genetically differentiated, given the limitations imposed by sample size. This suggests that the colony clusters are the result of budding rather than (for example) aggregations of unrelated webs at particularly favorable sites. However, samples taken from neighboring colony clusters, even when separated by as little as 70 m, may be fixed for different alleles at one or more loci. This implies that adult males probably do not leave their natal colonies and enter new webs to mate, and also suggests that effective migration by females and immatures into established webs does not occur. These data do not exclude the possibility that unrelated females may join (either occasionally or routinely) to found a new colony during the dispersal phase. The two colony clusters which contained heterozygotes might in fact be the result of colony foundation by unrelated females.

Social Behavior, Population Structure, and Speciation.—The genetic variation that occurs in the populations of *A. eximius* sampled is attributable to subdivision of the population into demes (colony clusters), and into geographic regions (Panama versus Suriname). Little or no variation is due to division of the population into sub-populations within a geographic area. Thus in comparing Browns Berg and Voltzberg, genetic variation appears to be attributable to division of the population into colony clusters, not to differences between Browns Berg and Voltzberg sub-populations as a whole. Thus, based on this sample, one can say that the structure of the *A. eximius* population is a genetic mosaic, with each piece in the mosaic consisting of one colony cluster. However, the samples were relatively small and sampled only two points out of the large range of *A. eximius*; thus what appears as a fixed difference at three loci between Panama and Suriname populations may actually be two extremes in a continuum of allelic frequencies across northern South America. Larger samples from Panama and Suriname encompassing more colony clusters and more localities, and samples from more of the range of *A. eximius* are needed.

Animal social systems have been proposed as an important agent shaping the genetic structure of populations and rates of speciation. Mammals show a rapid speciation rate and a high level of chromosomal diversity in comparison to other vertebrate groups (Bush et al. 1977). Several authors have attributed this to the mammalian propensity for social structuring (Wilson et al. 1975, Bush 1975), proposing that many types of mammalian social structure lead to the formation

of breeding units with small effective size and little gene flow among demes. This theoretically would create the same genetic environment as a founder event — a small, isolated gene pool in which stochastic events can act rapidly to fix unique genotypes or chromosomal types that are maladaptive in the heterozygous state and that would rapidly be eliminated by selection in a large panmictic population.

This hypothesis has been investigated many times by many authors (e.g. Daly 1981 with wild rabbits; McCracken 1984 with two species of bats; Patton and Feder 1981 with pocket gophers; review by Patton and Sherwood 1983). All reported that gene flow among social units, particularly by dispersing young, was sufficient to overcome any genetic effects caused by social structuring of the population. The hypothesis that social structuring alone has an effect on speciation rates does not appear to hold for mammals, the group for which it was originally proposed; however the cooperative or quasisocial spiders may be a perfect model for testing this hypothesis.

Templeton (1980a, 1980b) has provided a more refined analysis of the role of founder events in speciation in the context of a more general discussion of types of speciation. The three major elements in his analysis are: 1) the mechanism of speciation; 2) the structure of the ancestral population; and 3) the type of split between two potentially speciating populations.

1) Templeton (1980b) describes three mechanisms for speciation: genetic transilience, chromosomal transilience, and divergence. In the genetic transilience mechanism a founder event leads to a period of inbreeding during which alleles are subject to selection for their contribution to fitness in the homozygous state and against a more stable genetic background than (presumably) existed in the ancestral population. But rather than relying on accumulation of fixations and novel combinations at many loci, this model relies on changes in a few loci with major developmental and regulatory effects leading rapidly to a new “adaptive peak.” In chromosomal transilience, a chromosomal translocation which is detrimental in its heterozygous form can quickly become established in small populations and provide a rapid barrier to gene flow with the ancestral population. Genetic divergence occurs by the accumulation of neutral and adaptive changes in allelic frequencies in populations separated by physical barriers, distance along a cline, host differences, etc.

2. The genetic structure of the ancestral population can be considered as one of two extreme types: a large panmictic population with high genetic variability, or a population divided into many tiny demes with little gene flow between them.

3) The type of split between populations can also be considered as one of two extremes: division of a population into two large, roughly equal populations, or a separation of small populations from a large parental population.

Genetic transilience is most likely to occur when a small founder population splits off from a large panmictic population; it is least likely to occur when the founding population splits off from an ancestral population which is already low in genetic diversity. In particular, it is unlikely to occur when the ancestral population consists of small highly inbred demes, because the founder population is unlikely to produce any novel genetic combinations by selection of alleles that are more fit against a uniform and homozygous background because the genome of the parent population has already been subject to selection for fitness in a uniform genetic background.

Chromosomal transilience is most likely to occur when the ancestral population consists of small inbreeding demes. Because chromosomal translocations are often deleterious in the heterozygous state, they are likely to persist only in small populations where they can rapidly become fixed by stochastic processes. Gradual divergence, with or without a physical barrier to gene flow, is also most likely to occur against a genetic background of small, isolated demes. Carson and Templeton (1984) conclude that although speciation via founder events probably occurs only under a restricted set of conditions, this mode of speciation may nonetheless be important for certain groups of organisms, or for organisms living under certain ecological conditions (but see Barton and Charlesworth 1984). The cooperative social spiders may be one such group of animals. *Anelosimus eximius* as it exists today apparently consists of many small inbred demes with little genetic variability; when a founder event takes place (such as foundation of a new colony), the emigrants also possess little genetic variability and there is little or no scope for novel genetic combinations to enter a new adaptive peak. Thus it is unlikely that *A. eximius* has given rise to new species by genetic transilience. Speciation by chromosomal transilience is more probable for modern *A. eximius* populations; if a chromosomal translocation occurred in one of the dispersing foundress females, it could rapidly become established in a homozygous form among her descendants. Finally, speciation by gradual divergence may also occur; in particular, the viscous nature of the population, and subdivision into small non-interacting demes, would accentuate the effects of natural geographic barriers to gene flow.

Speciation by chromosomal and genetic transilience are not expected to lead to high levels of genetic differentiation as detected by electrophoresis, producing full species which may be very similar electrophoretically. As a result, genetic distance measures are not expected to be good indicators of the species status of populations in which genetic or chromosomal transilience are frequent speciation mechanisms. Thus before any conclusions can be drawn about genetically differentiated populations, such as the Panama and Suriname populations of *A. eximius*, it will be necessary to do comparative studies of the genetic distances among morphologically recognized species of *Anelosimus*.

ACKNOWLEDGMENTS

This work was supported by grant no. 2747-83 from the National Geographic Society. I would like to thank T. Christenson, Y. Lubin, and D. Windsor for their help in making the Panama collections. Stinasu, the Suriname Nature Conservancy, and Dienst 'sLands Bosbeheer Suriname, the Suriname Forest Service, gave me permission to work and collect in the Browns Berg and Voltzberg reserves. The staff of Stinasu, in particular F. L. J. Baal and K. Mohadin, provided logistic assistance and smoothed out the paperwork; L. Roberts of the Suriname Forest Service provided expert assistance in the field. M. Galindo-Ramirez, G. Uetz and F. Vollrath gave welcome criticism on the manuscript. I am especially grateful to R. Hagen for his help in making collections in Suriname and his critical comments on the numerous drafts of this manuscript.

LITERATURE CITED

- Allendorf, F. W., N. Mitchell, N. Ryman, and G. Stahl. 1977. Isozyme loci in the brown trout (*Salmo trutta* L.): detection and interpretation from population data. *Hereditas* 86:179-190.
- Aviles, L. 1983. Sex ratio in the social spider *Anelosimus* sp. IXth International Arachnology Congress, Panama City, Panama, August 1-8, 1983.
- Barton, N. H. and B. Charlesworth. 1984. Genetic revolutions, founder effects, and speciation. *Annu. Rev. Ecol. Syst.*, 15:133-164.
- Brach, V. 1975. The biology of the social spider *Anelosimus eximius* (Araneae: Theridiidae). *Bull. So. Cal. Acad. Sci.*, 74:37-41.
- Brewer, G. W. 1970. Introduction to isozyme techniques. Academic Press, New York.
- Bush, G. L. 1975. Modes of animal speciation. *Annu. Rev. Ecol. Syst.*, 6:339-364.
- Bush, G. L., S. M. Case, A. C. Wilson and J. L. Patton. 1977. Rapid speciation and chromosomal evolution in mammals. *Proc. Natl. Acad. Sci. U.S.A.*, 74(9):3942-3946.
- Carson, H. L. and A. R. Templeton. 1984. Genetic revolutions in relation to speciation phenomena: the founding of new populations. *Annu. Rev. Ecol. Syst.*, 15:97-131.
- Christenson, T. E. 1984. Behavior of colonial and solitary spiders of the Theridiid species *Anelosimus eximius*. *Anim. Behav.*, 32:725-734.
- Clayton, J. W. and D. N. Tretiak. 1972. Amine citrate buffers for pH control in starch gel electrophoresis. *J. Fish. Res. Bd. Can.*, 29:1169-1172.
- Daly, J. C. 1981. Effects of social organization and environmental diversity on determining the genetic structure of a population of the wild rabbit, *Oryctolagus cuniculus*. *Evolution*, 35:689-706.
- Dowling, T. E. and W. S. Moore. 1984. A program for estimating genetic variability within and between populations. *J. Heredity*, 75:416.
- Galindo-Ramirez, M. and R. Beckwith. 1983. Genetic diversity between isolated populations of the California trap-door spider, *Bothriocyrtum californicum* (Mygalomorphae, Ctenizidae). IXth International Arachnology Congress, August 1-8, 1984, Panama City, Panama.
- Harris, H. and D. A. Hopkinson. 1976. Handbook of enzyme electrophoresis in human genetics. American Elsevier, New York.
- Hartl, D. 1980. Principles of population genetics. Sinauer Assoc. Inc., Sunderland, Mass.
- Levi, H. W. 1963. The American spiders of the genus *Anelosimus* (Araneae: Theridiidae). *Trans. Amer. Micros. Soc.*, 82:30-48.
- Lubin, Y. D., and R. H. Crozier. 1985. Electrophoretic evidence for population differentiation in a social spider, *Achaearanea wau* (Theridiidae). *Insectes Sociaux* 32:297-304.
- Markert, C. L. and I. Faulhaber. 1965. Lactate dehydrogenase isozyme patterns of fish. *J. Exp. Zool.*, 159:319-332.
- May, B. 1980. The salmonid genome: evolutionary restructuring following a tetraploid event. Ph. D. Thesis, The Pennsylvania State University.
- May, B., J. E. Wright, M. Stoneking. 1979. Joint segregation of biochemical loci in Salmonidae: results from experiments with *Salvelinus* and review of the literature on other species. *J. Fish. Res. Bd. Can.*, 36:1114-1128.
- McCracken, G. F. 1984. Social dispersion and genetic variation in two species of Emballonurid bats. *Z. Tierpsychol.*, 66:55-69.
- Nei, M. 1978. Estimation of average heterozygosity and genetic distance from a small number of individuals. *Genetics*, 89:583-590.
- Nei, M. and A. K. Roychoudhury. 1974. Sampling variances of heterozygosity and genetic distance. *Genetics*, 76:379-390.
- Overall, W. L. and R. Ferreira da Silva. 1982. Population dynamics of the quasisocial spider *Anelosimus eximius* (Araneae: Theridiidae). *In The Biology of Social Insects* (M. D. Breed, C. D. Michener and H. E. Evans, eds.). Proceedings of the IXth Congress of the International Union for the Study of Social Insects, Boulder, Colorado, August 1982.
- Patton, J. L. and J. H. Feder. 1981. Microspatial genetic heterogeneity in pocket gophers: non-random breeding and drift. *Evolution*, 35:912-920.
- Patton, J. L. and S. W. Sherwood. 1983. Chromosome evolution and speciation in rodents. *Annu. Rev. Ecol. Syst.*, 14:139-158.
- Pennington, B. J. 1979. Enzyme genetics in taxonomy: diagnostic enzyme loci in the spider genus *Meta*. *Bull. British Arachnol. Soc.*, 4:377-392.
- Ridgway, G. W., S. W. Sherburne and R. D. Lewis. 1970. Polymorphism in the esterases of Atlantic herring. *Trans. Amer. Fish. Soc.*, 99:147-151.

- Selander, R. K., M. H. Smith, S. Y. Yang, W. E. Johnson and J. B. Gentry. 1971. IV. Biochemical polymorphism and systematics in the genus *Peromyscus* I. Variation in the old-field mouse (*Peromyscus polionotus*). In *Studies in Genetics VI.*, Univ. Texas Publ. 7103.
- Selander, R. K. and T. S. Whittam. 1983. Protein polymorphism and the genetic structure of populations. Pp. 89-114, in *Evolution of genes and proteins* (M. Nei and R. K. Koehn, eds.). Sinauer Assoc., Inc., Sunderland, Mass.
- Shaw, C. R. and R. Prasad. 1970. Starch gel electrophoresis of enzymes: a compilation of recipes. *Biochem. Genet.*, 4:297-320.
- Templeton, A. R. 1980a. Modes of speciation and inferences based on genetic distances. *Evolution*, 34:719-729.
- Templeton, A. R. 1980b. The theory of speciation via the founder principle. *Genetics*, 94:1011-1038.
- Vollrath, F. 1982. Colony formation in a social spider. *Z. Tierpsychol.*, 60:313-324.
- Vollrath, F. and D. Rohde-Arndt. 1983. Prey capture and feeding in the social spider *Anelosimus eximius*. *Z. Tierpsychol.*, 61:334-340.
- Wilson, A. C., G. L. Bush, S. M. Case and M.-C. King. 1975. Social structuring of mammalian populations and rate of chromosomal evolution. *Proc. Natl. Acad. Sci. U.S.A.*, 72(12):5061-5065.
- Wright, S. 1951. The genetical structure of populations. *Ann. Eugen.*, 15:323-354.
- Wright, S. 1978. *The Evolution and Genetics of Populations*. Volume 4 Variability within and among natural populations. The University of Chicago Press, Chicago.

Manuscript received January 1985, revised October 1985.

Appendix 1.—Recipes for buffering systems and running conditions for gels.

R: described by Ridgway, Sherburne, and Lewis (1970). Electrode buffer = 0.06 M lithium hydroxide, 0.3 M boric acid, pH 8.1; gel buffer = 0.03 M Tris, 0.005 M citric acid, 0.0006 M lithium hydroxide, 0.003 M boric acid. Running conditions = pre-run 75 mA, main run < 225 V and < 75 mA.

C: described by Clayton and Tretiak (1972). Electrode buffer = 0.04 M citric acid, pH adjusted to 6.1 with N-(3-Aminopropyl)-morpholine; gel buffer = electrode buffer diluted 1:10. Running conditions = pre-run 75 mA, main run 75 mA and < 200 V.

M: described by Markert and Faulhaber (1965). Electrode buffer = 0.18 M Tris, 0.1 M boric acid, 0.004 M Na EDTA; gel buffer = electrode buffer diluted 1:4. Running conditions = pre-run 250 V, main run 275 V and < 75 mA.

4: adjusted from Selander *et al.* (1971). Electrode buffer = 0.223 M Tris (pH 7.0), 0.094 M citric acid, pH adjusted to 6.3 with NaOH; gel buffer = Tris and Tris HCl to pH 6.1, 0.003 M citric acid, final pH adjusted to 6.7 with 1 M NaOH. Running conditions = pre-run 75 mA, main run 75 mA.

grinding or extraction buffer: 5.36 g Tris, 5.16 g Tris HCl, 8 l H₂O, pH 7.10.

Appendix 2.—List of enzymes screened, standard abbreviations and buffer systems which gave the best results in each case. The buffers are R, C, M, and 4 (see appendix 1 for references); NA indicates no detectable activity on any gel/buffer system.

<i>ENZYME</i>	<i>ABBREVIATION</i>	<i>BUFFER</i>
acid phosphatase	ACP	C
aconitase	AC	R
adenosine deaminase	ADA	4
adenylate kinase	AK	C
alcohol dehydrogenase	ADH	4
aldolase	ALD	R
alphaglycerophosphate dehydrogenase	AGP	R
aspartate aminotransferase	AAT	R
diaphorase	DIA	4
esterase	EST-1	R,M,4
	EST-2	R,M,4
	EST-3	R,M,4
	EST-4	R,M,4
fructose diphosphatase	FDP	M
fumarase	FUM	4
galactosaminidase	GAM-1	C
	GAM-2	C
beta-glucosidase	beta-GLU	NA
glyceraldehyde-3-phosphate dehydrogenase	GAPDH	4
guanine deaminase	GDA	NA
glucokinase	GK	R
glucose-6-phosphate dehydrogenase	G6P	R
glucosephosphate isomerase	GPI	R,C,M,4
glutamic dehydrogenase	GDH	NA
glutamic pyruvic transaminase	GPT-1	C
	GPT-2	C
glutathione reductase	GR	4
hexoseaminidase	HA-1	R
	HA-2	R
hydroxybutyric dehydrogenase	HBDH	R
isocitrate dehydrogenase	IDH-1	C
	IDH-2	C
lactose dehydrogenase	LDH-1	C
	LDH-2	C
leucine aminopeptidase	LAP	NA
malate dehydrogenase	MDH-1	C
	MDH-2	C
malic enzymes	ME	R
mannosephosphate isomerase	MPI	R
alpha-mannosidase	alpha-MAN	NA
methylumbelliferyl phosphatase	MUP	C
nucleoside phosphorylase	NP	4
octanol dehydrogenase	ODH	NA
peptidase with leucyl-alanine	PEP-LA	M
peptidase with leucyl-leucyl-leucine	PEP-LLL-1	M
	PEP-LLL-2	M
peptidase with phenyl-alanyl-proline	PEP-PAP	M
phosphoglucomutase	PGM	4
phosphogluconate dehydrogenase	PGD	C
phosphoglycerate kinase	PGK	4
pyruvic kinase	PK	NA
protein	PRO	C
sorbitol dehydrogenase	SDH	R

Appendix 2.—cont.

superoxide dismutase	SOD-1	C,4
	SOD-2	C,4
	SOD-3	C,4
	SOD-4	C,4
triosephosphate isomerase	TPI	R,C,M,4
xanthine dehydrogenase	XDH	NA

Krafft, B., A. Horel and J.-M. Julita. 1986. Influence of food supply on the duration of the gregarious phase of a maternal-social spider, *Coelotes terrestris* (Araneae, Agelenidae). *J. Arachnol.* 14:219-226.

**INFLUENCE OF FOOD SUPPLY ON THE DURATION
OF THE GREGARIOUS PHASE OF A
MATERNAL-SOCIAL SPIDER, *COELOTES TERRESTRIS*
(ARANEAE, AGELENIDAE)¹**

Bertrand Krafft, Andre Horel and Jean-Michel Julita

Laboratoire de Biologie du Comportement
Universite de NANCY I
B.P. 239
54506 Vandoeuvre-Les-Nancy, Cedex, France

ABSTRACT

In spiders, modes of social organization range from solitary to communal living. The "maternal-social" spiders represent an intermediate step, where the young disperse before adulthood after a gregarious phase of variable length depending on the species. Why does social life disappear in these species? Several arguments lead us to involve trophic factors and to formulate the hypothesis that food shortages, resulting from the increase in the young's food requirements and from the limitation of the colony's prey supply, induce the spiderlings to emigrate.

To test this hypothesis, laboratory-reared colonies (mother + offspring) of the funnel-web spider *Coelotes terrestris* (Wider) were given either an ad-libitum diet, or a reduced diet. We observed that prey consumption increased with developmental age, and that under-fed colonies dispersed significantly earlier than did ad-libitum-fed colonies. The significance of such social plasticity in the evolution of spider societies is discussed.

INTRODUCTION

Taking into account the intensity, duration and complexity of intraspecific interactions, spiders appear to exhibit quite a variety of social organization, ranging from solitary to social living. Sociality is generally supposed to have originated via two different evolutionary routes (Shear 1970, Burgess 1976, 1978, Buskirk 1981): grouping of solitary individuals (Valerio and Herrero 1977), and extension of the mother-offspring association (Kullmann 1972).

Intermediate forms of social organization, called "semi-social", "periodic-social" or "subsocal" (Shear 1970, Kullmann 1972, Krafft 1979) are of special interest. By making it possible to investigate the costs and benefits of various types of organization in various ecological conditions (Buskirk 1975, Fowler and Diehl 1978, Jackson 1978, Lubin 1980, Smith 1983, Christenson 1984), these diverse forms provide insights about the possible causes and mechanisms of social evolution.

¹Presented in a symposium, "Social Behavior in Spiders," at the National Meeting of the American Arachnological Society, June 17, 1984.

Since Riechert's work (1976, 1978) on the territoriality of *Agelenopsis aperta* (Gertsch), the importance of trophic effects on intraspecific interactions and on social spacing has also been shown by a number of authors with other species (for a review on social spacing, see Burgess and Uetz 1982). Recently, Smith (1983) observed that in the facultatively communal uloborid spider *Philoponella oweni* (Chamberlin) "communal groups are located at sites where insects are particularly abundant. Solitary females appear to be located at sites where the insects abundance... is at the 'background level.' A similar phenomenon was observed and experimentally studied in another facultatively communal orb-weaver, the araneid *Metepeira spinipes* F.P. Cambridge (Uetz, Kane and Stratton 1982).

However, nothing is known of a possible influence of trophic factors on the "maternal-social" spiders (Burgess and Uetz 1982), i.e., those species exhibiting maternal care, with the offspring staying in a group and being fed by their mother for a variable period of time, depending on the species (Krafft and Horel 1979). The mother-offspring association represents a high concentration of individuals in a limited space. We hypothesize that the food needs of the offspring increase along with their development, and that after a lapse of time the food needs exceed the food supply, which is limited by prey abundance in the habitat and the prey catching capacity of the colony. Eventually, food shortage induces the spiderlings to disperse. Accordingly, it should be possible to modify the duration of the gregarious phase, by experimentally modifying the abundance of prey.

We chose as a model a maternal funnel-web spider *Coelotes terrestris* (Wider), belonging to a family (Agelenidae) which includes typical solitary species as well as two highly social species: *Agelena consociata* Denis (Darchen 1965, Krafft 1970) and *Agelena republicana* Darchen (Darchen 1967).

Considering the relationship between social structure and trophic factors, we studied the effect of prey availability on the duration of the gregarious phase of this maternal social spider, by subjecting laboratory-reared colonies (mother + offspring) either to a restricted or to an ad-libitum diet.

MATERIAL AND METHODS

Coelotes terrestris is a terricolous species, living under stones, bark of dead logs, etc., common in many European forests. It usually spins a tube opening at the ground surface through a small sheet web. The female lays 30 to 70 eggs. The young hatch after a 3-4 week incubation period. They stay for about one month in the tube, feeding on prey caught by the female. Insects are captured on the sheet-web (diameter 10-20 cm), carried into the tube, then dropped in the vicinity of the young. Feeding of young through regurgitation, though suspected by Tretzel (1961) has never been demonstrated. The offspring stay with their mother for about one month (34 days according to Tretzel 1961), and exhibit a clumping tendency even in the mother's absence (Horel, Roland and Leborgne 1979, Horel Leborgne and Roland 1982). Sometimes the mother dies before the offspring's dispersal, but the presence of a live mother does not prevent the offspring from dispersing.

Inseminated females, collected in beech forests around Nancy (Lorraine-France), were individually reared in the laboratory in glass boxes (20 x 20 x 12

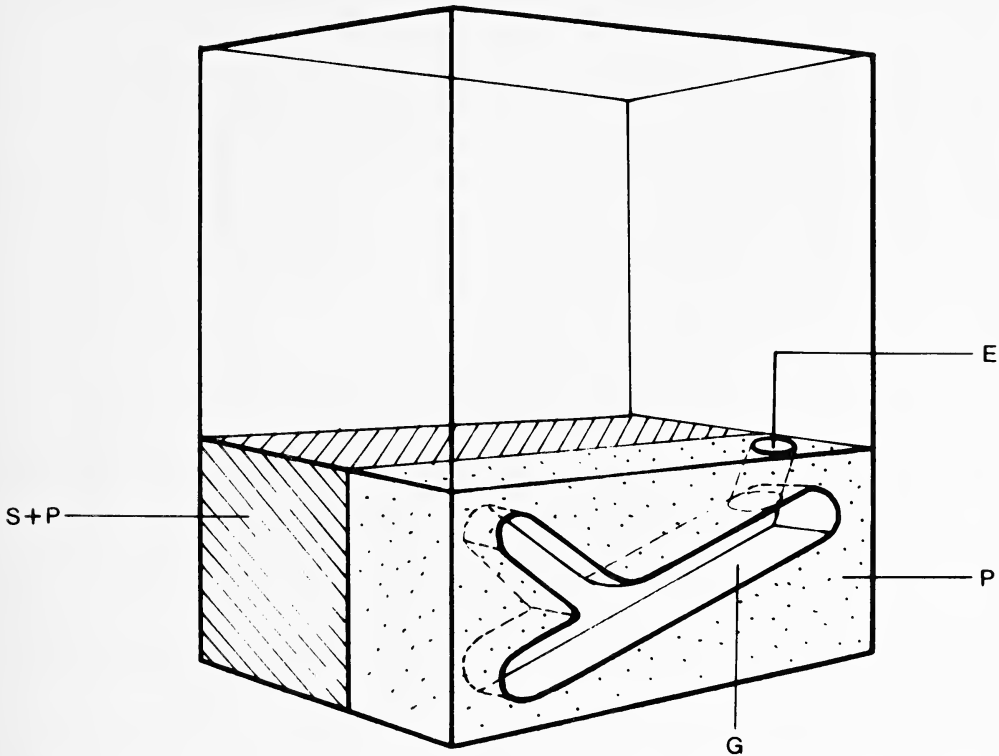

Fig. 1.—Rearing box. Dimensions: H = 20 cm, W = 20 cm, D = 12 cm, S + P = sand + peat, P = block of plaster, G = gallery, E = gallery's entrance.

cm) containing a mixture of sand and peat to facilitate humidification, and a block of plaster with a gallery where the female could spin its tube (Fig. 1).

The spiders were fed crickets (*Gryllus domesticus*, *Gryllus bimaculatus*). During the experiment, medium size (about 14 mg) cricket nymphs were provided exclusively. Such prey could easily be captured by the female (150-200 mg), but not by the young (max: 30 mg).

Predation was restricted to the mother to make easier the control of the colony's food intake. The effect of the young's predation is now under study.

After the spiderlings' emergence, colonies were randomly assigned to 2 treatments: 1. "Set +"; 10 colonies (median number of young: 37) were fed ad libitum. The number of live crickets was checked every day, and when necessary, adjusted up to 6 in each box. This set provided data to evaluate prey capture rate during development. 2. "Set -"; 9 colonies (median number of young: 36) had a restricted diet. They were provided only one nymph per week. Under such conditions, "set -" ate approximately 15 times less than "set +". The rearing boxes were carefully examined daily, and the positions of the spiderlings inside or outside the tube were checked.

RESULTS

Changes in colony food requirements.—A steady increase in the mean prey capture rate of the ad libitum fed "set +" was observed after the emergence of the

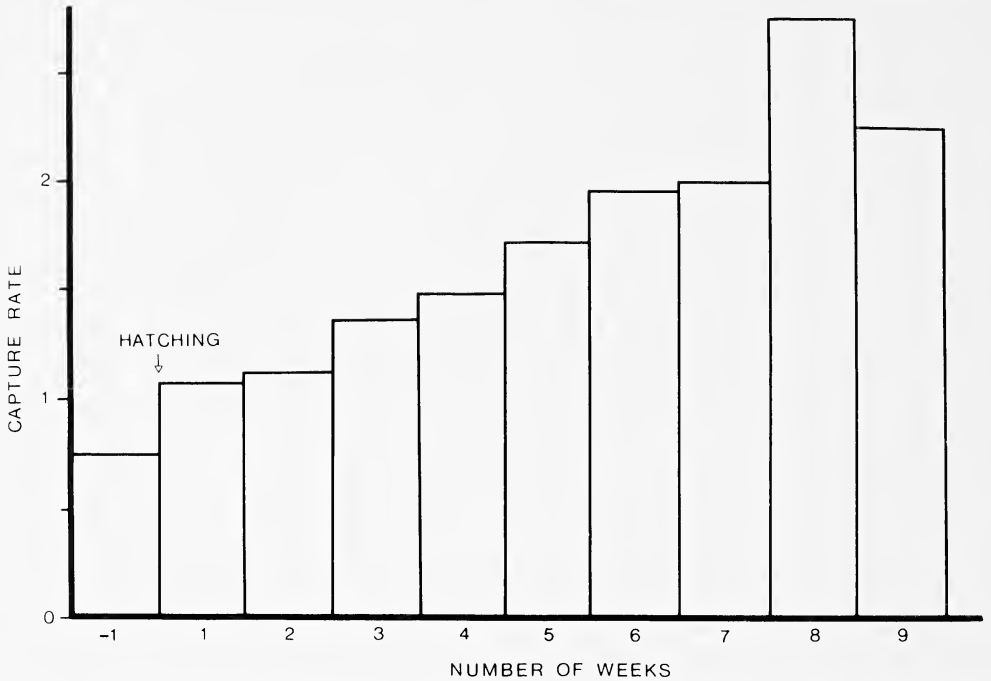

Fig. 2.—Developmental changes in the prey capture rate of ad-libitum fed colonies (Mean daily number of crickets captured during a week per colony). Statistical comparisons (sign test): Pre-emergence week versus post-emergence week 1: $p = 0.002$; Post-emergence week 1 versus post-emergence week 2: N.S.; Post-emergence week 1 versus post-emergence weeks 3-9: from $p < 0.05$ to $p < 0.001$.

young (Fig. 2). There was a significant difference between the pre-emergence week and the first post-emergence week (Sign test: $p = 0.002$). This increase in the capture rate can be considered as indicative of an increase in the spiderlings' food requirements, as other experiments under progress show that artificial suppression, or natural dispersal, of the offspring reduce the mother's prey capture rate to its pre-emergence level.

Extension of the colony in the gallery.—Owing to the difficulty of observation through the silk layer, it was not possible to determine the exact position of every spiderling in the gallery. Thus, the gradual expansion of the colony was estimated by the distance between the most distant visible spiderlings.

After emergence, the young spiders stayed close together, initially constituting a very tight aggregate, then extending more and more in the gallery as they got older (Fig. 3). Treatments did not differ in this respect (Sign test: N.S.).

Dispersal.—The difficulties of observation led us to choose as an index of dispersal the date when, for the first time, one spiderling was located outside the gallery during day-time. The accuracy of this index was tested by observing the dispersal of a colony of 20 spiderlings from a rearing-box introduced into a large enclosure (180 x 60 cm). Such an enclosure made it possible for the young to widely disperse, while still being easily spotted. When outside the gallery, the spiderlings went off as far as possible, and, once initiated, the process of going out never reversed (Fig. 4). So, the first appearance of a young spider outside the gallery can be considered to mark the beginning of dispersal.

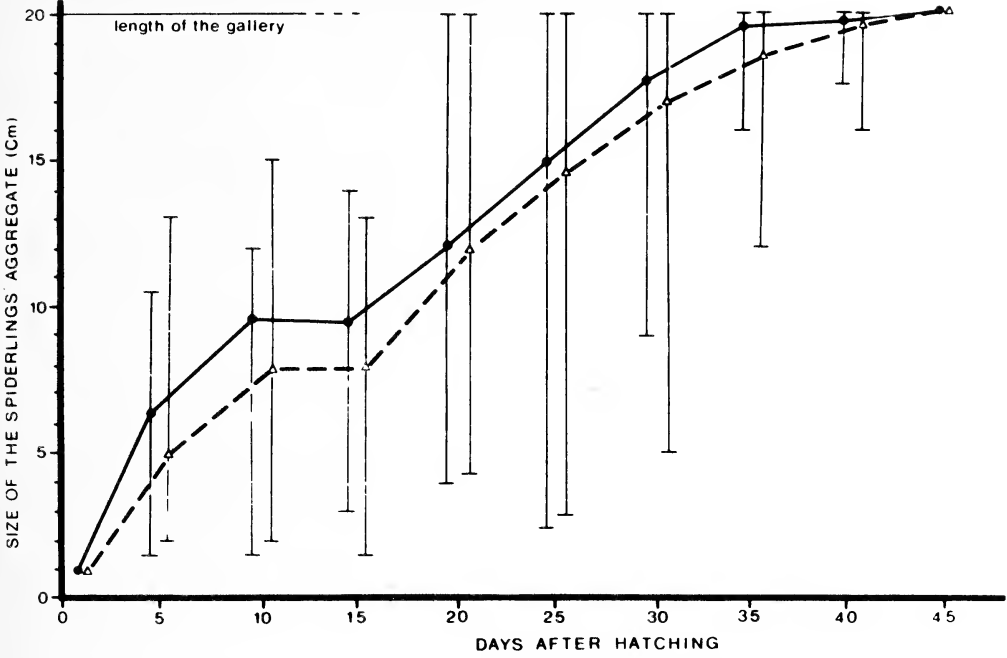

Fig. 3.—Expansion of the colony in the gallery (Mean size [in cm] of the aggregate every 5 days \pm range): Solid lines = "Set -" (Restrictively fed colonies, n = 9); Dotted lines = "Set +" (Ad-libitum fed colonies, n = 10).

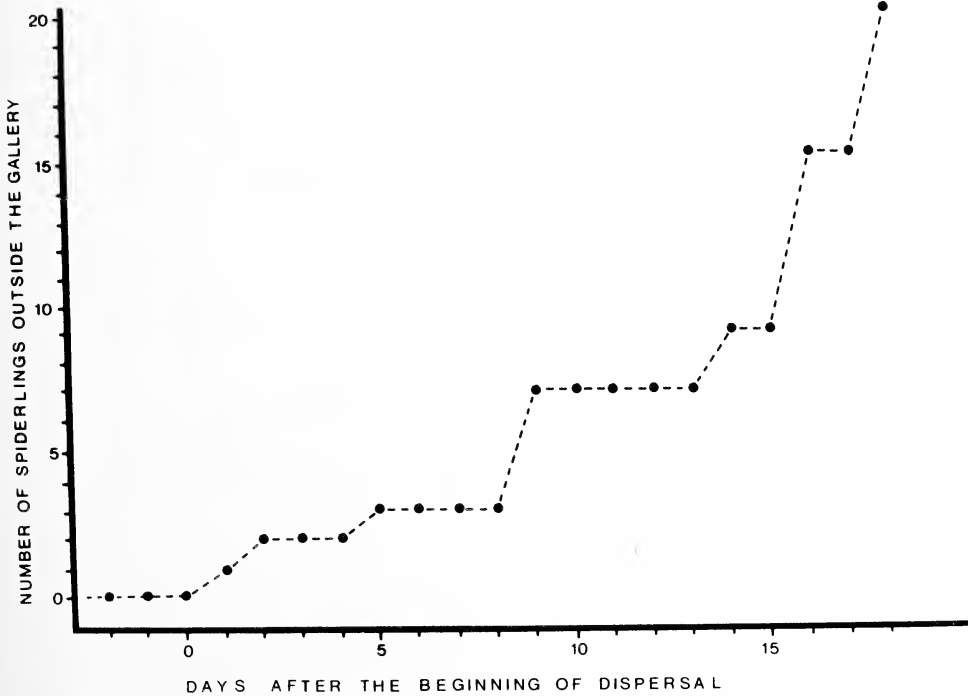

Fig. 4.—Dispersal of a colony of 20 spiderlings in a large enclosure (Day 0 is the day preceding the first spiderling's going out).

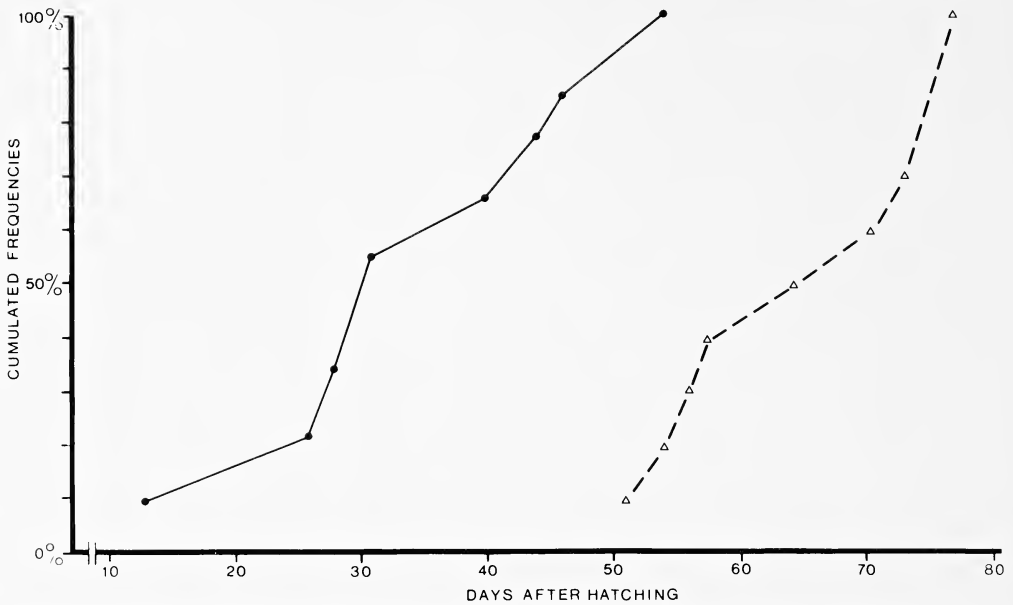

Fig. 5.—Cumulative distribution of the duration of the gregarious phase according to prey abundance in two sets of colonies: Solid lines = “Set -” (Restrictively fed colonies, $n = 9$); Dotted lines = “Set +” (Ad-libitum fed colonies, $n = 10$) (Mann and Whitney test: $U = 2$; $p < 0.001$).

Figure 5 represents the cumulative frequencies, in both sets, of the gregarious phase durations, i.e. the lapse of time between the hatching of the young from the egg-sac and the beginning of their dispersal. Young of the restricted diet set dispersed fairly earlier than those of the ad-libitum fed set (Mann-Whitney test $U = 2$, $p = 0.001$). The median gregarious period was 64 days in “set +”, whereas it was 31 days in “set -.”

DISCUSSION

This experiment shows, first, that the colony's food requirements increase along with the development of young. When these requirements eventually exceed the supply which can be obtained by the colony, the spiderlings abandon their communal behavior and disperse. Food shortage was produced in “set -” by the low number of prey items provided; however, the factors responsible for “set +” dispersal are not yet clearly known. Genetic factors cannot be ruled out entirely. Other factors concerning the predatory behavior of the mother are also unclear because of the limitations placed on the observation of her behavior by our experimental design.

We have shown that well-fed young dispersed significantly later than did underfed young. This indicates that the temporary social structure of *Coelotes terrestris* contains a certain degree of plasticity, because its duration can be modified by prey availability. Such a plasticity is an argument in favor of the familial or “maternal-social” origin of at least some spider societies (Krafft 1982).

The actual behavioral mechanisms related to dispersal of young are not yet clearly known. They might involve a fading of interattraction, or an increase in agonistic behavior induced by food competition, as observed in several solitary

or social species (Riechert 1976, 1978; Burgess and Uetz 1982, Rypstra 1985). These phenomena, as well as the development of mother-offspring interactions (namely during predatory activities), are currently under study in our laboratory.

It is very instructive to compare the results obtained with a maternal-social sheet-web spider and those obtained with *Metepeira spinipes*. This orb-weaver from Mexico, (as *Philoponella oweni*, Smith, 1983) may be solitary or live in groups according to the habitat's prey abundance. In field experiments, Uetz et al. (1982) demonstrated in *M. spinipes* a "flexible social spacing pattern and rapid responses to changes in prey availability." Thus, although differing in their geographical location, taxonomic position, web structure and type of social living, these species show a similar plasticity in their social organization, depending on prey abundance. Such a convergence is another argument in favor of a multiple origin of sociality in spiders, and of the significance of trophic factors (among other ecological factors) in these evolutionary events.

ACKNOWLEDGMENTS

We express our thanks to Dr. G. W. Uetz for his assistance in the translation of the manuscript, and Drs. J. S. Rovner and T. H. Christenson for their useful comments. This study was partially supported by C.N.R.S. Grant R.C.P. 08 - 0723, and a D.G.R.S.T. Grant was attributed to J.M. J.

LITERATURE CITED

- Burgess, J. W. 1976. Social spiders. *Sci. Amer.*, 234:100-106.
- Burgess, J. W. 1978. Social behavior in group-living spider species. *Symp. Zool. Soc. London*, 42:69-78.
- Burgess, J. W. and G. W. Uetz. 1982. Social spacing strategies in spiders. Pp. 317-351, *In Spider communication: mechanisms and ecological significance.* (P. N. Witt and J. S. Rovner, eds.) Princeton University Press, Princeton, 440 pp.
- Buskirk, R. E. 1975. Coloniality, activity patterns and feeding in a tropical orb-weaving spider. *Ecology*, 56:1314-1328.
- Buskirk, R. E. 1981. Sociality in Arachnida. Pp. 281-387, *In Social Insects* (H. R. Hermann, ed.) Academic Press, New York.
- Christenson, T. E. 1984. Behaviour of colonial and solitary spiders of the theridiid species *Anelosimus eximius*. *Anim. Behav.*, 32:725-734.
- Darchen, R. 1965. Ethologie d'une araignee sociale, *Agelena consociata* Denis. *Biologia Gabonica*, 1:117-146.
- Darchen, R. 1967. Une nouvelle araignee sociale du Gabon *Agelena republicana* Darchen. *Biologia Gabonica*, 3:31-42.
- Fowler, H. G. and J. Diehl. 1978. Biology of a Paraguayan colonial orb-weaver *Eriophora bistrata* (Rengger) (Araneae: Araneidae). *Bull. British Arachnol. Soc.*, 4:241-250.
- Horel, A., C. Roland and R. Leborgne. 1979. Mise en evidence d'une tendance au groupement chez les jeunes de l'araignee solitaire *Coelotes terrestris*. *Rev. Arachnol.*, 2:157-164.
- Horel, A., R. Leborgne and C. Roland. 1982. Effet du groupement et de la presence de la mere sur le developpement des jeunes de l'araignee *Coelotes terrestris* (Agelenidae). *C. R. Colloq. Internation. U.I.E.I.S. (Barcelona)*, 207-214.
- Jackson, R. R. 1978. Comparative studies of *Dictyna* and *Mallos* (Araneae, Dictynidae). I Social organization and web characteristics. *Rev. Arachnol.*, 1:133-164.
- Krafft, B. 1970. Contribution a la biologie et a l'ethologie d'*Agelena consociata* (Araignee sociale du Gabon) I. *Biologia Gabonica*, 3:197-301.
- Krafft, B. 1979. Organisation et evolution des societes d'araignees. *Journal de Psychologie*, 1:32-51.

- Krafft, B. 1982. Eco-ethology and evolution of social spiders. Pp. 73-84. *In* Social Insects in the Tropics (P. Jaisson, ed.) Universite Paris-Nord, Paris.
- Krafft, B. and A. Horel. 1979. Le comportement maternel et les relations mere-jeunes chez les araignees. *Reprod. Nutr. Develop.*, 20:747-758.
- Kullmann, E. 1972. Evolution of social behavior in spiders (Araneae: Eresidae and Theridiidae). *Amer. Zool.*, 12:419-426.
- Lubin, Y. D. 1974. Adaptive advantages and the evolution of colony formation in *Cyrtophora* (Araneae: Araneidae). *Zool. J. Linn. Soc.*, 54:321-339.
- Lubin, Y. D. 1980. Population studies of two colonial orb-weaving spiders. *Zool. J. Linn. Soc.*, 70:265-287.
- Riechert, S. E. 1976. Web-site selection in the desert spider, *Agelenopsis aperta* (Gertsch). *Oikos*, 27:311-315.
- Riechert, S. E. 1978. Energy-based territoriality in populations of the desert-spider, *Agelenopsis aperta* (Gertsch). *Symp. Zool. Soc. London*, 42:211-222.
- Rypstra, A. L. 1985. Aggregations of *Nephila clavipes* (L.) (Araneae, Araneidae) in relation to prey availability. *J. Arachnol.*, 13:71-78.
- Shear, W. A. 1970. The evolution of social phenomena in spiders. *Bull. British Arachnol. Soc.*, 1:65-76.
- Smith, D. R. R. 1983. Ecological costs and benefits of communal behavior in a presocial spider. *Behav. Ecol. Sociobiol.*, 13:107-114.
- Tretzel, E. 1961. Biologie, Oekologie und Brutpflege von *Coelotes terrestris* (Wider) (Araneae: Agelenidae). *Z. Morph. Okol. Tiere*, 50:375-542.
- Uetz, G. W., T. C. Kane and G. E. Stratton. 1982. Variation in the social grouping tendency of a communal web-building spider. *Science*, 217:547-549.
- Valerio, C. E. and M. V. Herrero. 1977. Tendencia social en adultos de la araña *Leucauge* sp. (Araneae, Araneidae) en Costa Rica. *Brenesia*, 10/11:69-76.

Manuscript received November 1984, revised November 1985.

SOCIETIES OF SPIDERS COMPARED TO THE SOCIETIES OF INSECTS¹

Roger Darchen and Bernadette Delage-Darchen

Station Biologique
24620 Les Eyzies, France

ABSTRACT

Since the earliest studies of social behavior in spiders, their social structure has often been compared with that of social insects. A preliminary conclusion was that the degree of evolution of spider societies was significantly lower than that found in insects. However, we wonder if the problem has been correctly posed. In light of Wilson's and Michener's works, enriched by those of the French School (Grasse, LeMasne), we accept the definition of insect societies with all the terms which seem necessary to characterize them, namely inter-attraction and its multiple consequences, social polymorphism and dominance. In our analysis, we evoke overlap of generations and the foundation of societies to demonstrate the inherent contradiction of comparing social behavior of insects and spiders. The sociality of spiders, which actually seems to exclude the dominance and hierarchy of individuals, is paradoxically catalogued among inferior societies. With insight gained from recent studies, we suggest here that social evolution in spiders has developed along a clearly alternate track, which has rarely been followed in the animal kingdom. This type of egalitarian society is difficult to achieve in nature, and thus it is quite rare; and social spiders, whose societies are based on this principle, represent in fact very few species.

INTRODUCTION

Knowledge of social phenomena in spiders has developed considerably more recently than that in insects. It was therefore inevitable that the latter should be used as a reference point, especially as the first in-depth studies on the biology of social spiders had been carried out by entomologists who were specialists of social insects. As with insects, spiders show various levels of social evolution, from the solitary species to those which live in groups all their life. However, unlike insects, and despite the huge number of species, there are very few spiders which have passed the ultimate steps to social life. It would appear that they have followed quite a different path in their evolution, because under close examination, their sociality is noticeably different from that of insects. The social organization of insects can, to some extent, be compared to that of a number of societies of vertebrates, whereas the schemes adopted by social spiders are rarely realized in nature.

We shall not examine the whole picture of evolution of social phenomena in insects and spiders here; it would not be useful as the work has already been done by others (Shear 1970, Kullman 1972, Burgess 1976 Brach 1977, Krafft 1979,

¹Presented in a symposium, "Social Behavior in Spiders," at the National Meeting of the American Arachnological Society, June 17, 1984.

1982, Buskirk 1981). We shall, instead, compare the characters which are considered to define eusociality in insects, and examine how social spiders may be compared to this scheme. We shall then be in a better position to understand what is essentially original in spider societies.

SOCIETIES OF INSECTS

Wilson (1971) and Michener (1969, 1974) suggest that a "eusocial" species is defined by 1) an overlap of generations, with the mother often surviving its offspring, 2) adults taking care of the young, and 3) the presence of castes.

This general definition needs to be enriched by what has been written on this subject for a long time by other authors (for example LeMasne 1952, and Grasse 1938, 1952).

Inter-attraction in Societies of Insects and its Consequences.—The preliminary basis necessary for any social life is the inter-attraction between individuals of a conspecific group. This is certainly not particular to eusocial forms, and this is probably why Wilson (1971) does not mention it. However, in highly evolved societies, this factor is of prime importance, as inter-attraction is the *compulsory* characteristic with which all individuals have to comply. For a eusocial insect under experimental conditions, survival in isolated conditions is possible. Eusocial insects in nature, however, are never solitary, except where the individual remains isolated, but only during a transitory period, and at a very specific moment of its existence.

The fact that in evolved societies, each individual is necessarily associated with the other members of the group to which it belongs, leads consequently to an interdependence between individuals. As eusocial insects live socially all their lives, one finds in such a society, animals of all ages, and at all stages of development; this distinguishes them from the lower forms of sociality, where the individuals live in groups only at a particular stage of their life, such as the larvae of the same generation (e.g., processionary caterpillars, Balfour-Browne 1926, O'Byrne 1927). Consequently, the colony will have defined composition, and to be in equilibrium, certain standards will have to be respected. Directly linked with the structural pattern of societies and the mutual interdependence of individuals, is the observation that these societies are often close to any individuals from another colony (even conspecific).

Another important consequence of inter-attraction is the appearance of collective tasks, i.e. some members of an insect society momentarily undertaking the same task are capable of accomplishments that individuals working separately cannot achieve (Darchen 1958). About this subject, Grasse (1952) wrote: "Fortune and misfortune of social life: the group takes possession of the individuals' potentials, increases them, exalts them and makes even new ones appear; but its members lose their freedom of action and cannot subsist outside of it." In other words, the study of the isolated bee or termite is of limited value. There are, in fact, so many physiological interactions, behavior patterns and regulations among social insect groups that there can be no doubt about the integration of the characteristics of the individuals of the group. In short, social insects groups present problems that are unique to them.

From the species belonging to lower societies, to the eusocial ones, there is an increasing complexity of tasks. However, the level of complexity of tasks is not

always proportionate to levels of complexity of the other features of sociality in a given species. Thus, for example, constructions of the pine processional caterpillar are far more sophisticated than the nests of some ants, although there can be no comparison between a group of these caterpillars and a society of such ants. It is, however, in the highly evolved societies that the highest sum of varied collective activities can be found. Cleaning of nests, construction, "agricultural" activities, and care of the young are all examples of behavioral development schemes requiring complex coordination between individuals. Care of the young represents in fact only one of the manifestations of sociality. This behavior can also appear in species which, from another point of view are frankly solitary (such as the forficulid *Labidura riparia*) (Vancassel 1977, Caussanel and Karlinsky 1984). Thus, the overall level of activity issuing from the inter-attraction of social insects is a more exact index of the level of sociality of the species considered, than the simple consideration of the care of the young.

The evolved society even behaves as a super-organism which has its own laws and surpasses those of the individual. Thus in the *Apis mellifera* bee, the groups of wax-making workers in charge of construction have a degree of efficiency which cannot be compared with the skill of an isolated worker who is unable to build anything (Darchen 1958, 1978). The heat produced by the metabolism of one bee is insignificant, but the whole hive maintains the temperature at around 31°C, thanks to subtle coordination between the animals which are grouped around strategic points or disperse themselves and produce ventilation according to the need to heat or cool the hive, mainly in relation to larvae. Finally, the "stigmery" behavior (Grasse 1939, 1952) means an interaction between the result of a given act (state of construction, for instance) and the individual which perceives it; this allows an adjustment, in time and space, of behavior with regard to the task to be done, thus assuring the coordination of the operations in the group.

In evolved societies, the collective tasks and regulation systems which modulate them reach peaks of perfection, thanks to the existence of many communication systems which interact. In this respect, the ultimate level reached in the evolution of inter-attraction in eusocial insects, is the development of forms of language (tactile, chemical) essentially needed for the coordination of the group life. The society is not a simple summation of individuals, but the product of inter-action between animals, which are behaviorally linked to one another.

Social Polymorphism: Castes and Hierarchies.—Another characteristic of insect societies is social polymorphism. In some insects where a group effect is present (acridids, aphids, etc.) a certain polymorphism can be noted, but no where does it attain such an intensity as in eusocial insects. Except in a few cases (for instance some wasps), the morphology and physiology of the adult individual is determined during the larval stage. The soldier termite will never reproduce; the worker will have feeding glands, atrophied ovaries and working wax glands; the queen bee will never produce royal jelly or wax, but will be an egg laying machine, etc. Thus, the social polymorphism of eusocial insects corresponds to the existence of specialized castes. It allows for greater efficiency of individuals and constitutes one of the unique traits of this type of insect.

The existence of hierarchies is an essential characteristic of insect societies, so that two notions of hierarchy formation and evolved insect societies are fundamentally linked. These hierarchies can in fact be constitutional or acquired:

(a) Constitutional hierarchies can be found, for example, in *Apis mellifera* where the queen bee is morphologically, anatomically, physiologically and ethologically different from the worker; (b) On the contrary, the queen wasps *Polistes gallicus* the hierarchy can be acquired in time and according to the circumstances (Deleurance 1957). In effect in spring time it is not infrequent that several young queens group together to start a nest. Together, things work out better than if alone, but these colonies are normally monogynous; this is why, after some days of collaboration, dominance behavior appears among these queens, and a hierarchy is created among them. The most dominant wasp systematically devours the eggs laid by its companions and lays in their place. The other wasps eventually accept this pattern, and do not lay any more. Their physiological castration becomes real and they then take the rank of worker. Thus the castes are being established de facto before the hatching of the first eggs which will only then produce "normal" workers. It should be mentioned that in this species the implementation of such a hierarchy is possible because there is not, as with *Apis*, an anatomic gap between workers and queens.

Apart from these dominance phenomena and existence of castes, which are the rule in social insects, polyethism can also be noted, i.e., the assignment of different tasks to the same insect during its life time. The successive changes of assignments are linked not only to the age of the insects, but also to individual behavior in relation to some momentary needs of the society. The appearance of polyethism may occur in relation to behavioral dominance, but not necessarily.

The individuals belonging to a particular caste have a certain anatomy, morphology, physiology and a behavior which distinguish them from those belonging to other castes, but among females of the same group, no fundamental genetic differences have been demonstrated. Caste determination is an induced phenomenon, although sometimes it occurs very early in life [e.g., the case of the ant *Pheidole pallidula* (Passera 1980) or the termite *Schedorhinotermes* (Renoux 1976)].

The Foundation of Insect Societies.—The insects belonging to an evolved society are socialized all their life long and the colony forms a closed system: thus the problem is how such societies can reproduce themselves.

The evolved societies essentially reproduce themselves according to two mechanisms:

(1) There may be a temporary isolation of reproductive individuals, which leave the original colony to start another one, e.g., Termites go by pairs (male and female). In the case of hymenoptera, these are fecund females (queens) who only undertaken the foundation of colonies. They do so either alone or by groups of queens, but in all cases these reproducing individuals produce the first broods of workers without the assistance of other castes.

(2) Sociotomy and multiplication may occur by splitting, which constitutes reproduction of colonies. In the case of sociotomy (called swarming in bees), a colony breeds a young queen which will be fecund. At a certain period the colony will divide into two, one section of the workers will stay with the young queen and the other with the old one. The larvae will remain either with one of the two groups, as in bees or will be shared between the two groups, as in army and driver ants. There is not in this case at any moment a solitary phase for any individual of the colony (Raignier 1972, Leroux 1982). The species which multiply by splitting, in order to increase the number of colonies, also do not have a

solitary phase. This mechanism is found in the case of primitive termites or in evolved ants of the genus *Formica*.

In termites, immature individuals may become mature when they have remained for too long without any contact with the royal, couple. Apart from the soldiers, which cease molting, and the white soldiers and nymphs, which are very close to their imago molt, most of the individuals of these colonies retain the potential of molting and having neotenic generation, even if they temporarily serve the function of workers. The castes in primitive termites are thus relatively dynamic and reproduction by splitting is long. In ants, the colonies which multiply by splitting are to be found in the species with polygynous colonies; these recruit queens through swarming processes. These queens can either come from the mother colony or from neighboring colonies swarming at the same time.

When a colony of ants becomes too large, a group of individuals emigrate further away. They first establish a camp of workers. This camp can organize and recruit larvae and queens. Then a satellite colony is installed, and retains contact, with the mother colony. Then after a period, one obtains either a group of independent colonies which are genetically related or a super colony composed of a certain number of satellite colonies. There is therefore no general and single system for the foundation of colonies in social insects. Ants may be those which show the greatest diversity in the modes of foundation.

One of the factors of sociality in insects which has been observed for a long time is of course the overlap of generations. The mother must survive its descendants and keep close links with them so that the society can survive. It is indispensable that the reproductive individuals (at least) have a sufficiently long life. In monogynous colonies, the life span of a colony is related to that of the queen, as occurs in some species of ants and bees. A possibility of control exists, however; in case of urgent need a colony can prepare a new queen (in *Apis* this possibility is well known) but this system remains fragile (for example the number of colonies of *Leptothorax* ants found without a queen is not negligible); such colonies are destined to extinction (Plateaux 1970, Poussardin 1984). Eusocial insects have therefore developed ways to solve this situation, and polygyny is one of them. For example, the large colonies of *Formica*, the nests of wasps *Polybia* and *Nectarina* are in principle immortal, their longevity is considerably greater than that of any individual (for example the wasp nests of *Synoecca cyanea*, 60 years (Evans and West-Eberhard 1970). The overlap of generations in such species reaches its peak and the longevity of the reproducing individuals does not affect the chances of survival of the society.

As we have seen, the three definitions proposed by Wilson to characterize a society of invertebrates clearly are too simplified, and need to be enriched by new ones.

SOCIETIES OF SPIDERS

Inter-attraction in Spider Societies.—The first study defining features of sociality in spiders was that of Kullman (1972). It was thus nearly contemporaneous with the book of Wilson (the Insect Societies, 1971). For the German author there are three real characteristics of social life in spiders: (1) tolerance, (2) inter-attraction, and (3) cooperation. There is nothing to say against

this definition, but it was certainly not established using the same criteria as those given with insect societies in mind.

First, we can note that inter-attraction, which for Kullman (1972) is a pertinent characteristic, was not mentioned by Wilson (1971), as this is probably implicit for him. Yet we have seen that in insects various very important corollaries arise from the idea of inter-attraction. As in insects, inter-attraction arises sometimes in spiders whether or not they are completely social. But in the most social species it means a compulsory link which unites the members of the group. Usually no individuals live alone except for some females who are about to lay eggs and leave the nest to start a new colony.

The fact that the isolated individual of social spiders is unknown in nature poses, of course, the problem of the type of links which unite the animals among themselves. In contrast with insects, each spider is theoretically able to satisfy its needs alone. It can hunt, spin its web, lay eggs and thus survive outside this society. Naturally, one is inclined to think that inter-attraction is linked to the continuation of aggregative behavior of the young, and is essentially based on the olfactory sense. Nevertheless, it would be very interesting to have more detailed information on this phenomenon.

In this respect, it would be very instructive to make a comparative study on the physiology and behavior of two very close species, e.g., *Achaeearanea disparata* (Denis) and *Achaeearanea tessellata* (Keyserling). The first species is strictly found in the Gabonese forests and is at this time unknown anywhere else in the world. This is a social spider from all viewpoints and spends its entire life in a group; it spins its web and hunts in association with its companions, and forms spectacular colonies very high in the trees. *Achaeearanea tessellata* is also a tropical species, but very widespread on all continents. Curiously, these two species are virtually morphologically identical. However, from an ethological viewpoint there is no possible doubt as to the fact that *Achaeearanea tessellata* is solitary. What has thus happened during the evolution of the common stock of these two spiders so that they now form two different species which are, at the same time, so close and so different? A comparative study on this subject is certainly desirable.

In the spider societies of all species that have been studied, there are no closed social groups. It is possible to add to a given society individuals of any age of the same species but coming from very different locations without causing any fights. The tolerance which can be noted here, is thus one of the essential characteristics of this type of social structure. Spiders recognize their own species but show no restriction at the level of the social group. In accordance with the "non-closing" of societies, the importance of the social groups might theoretically be unlimited. However, in spiders, as in insects, each species has its standards and the population does not increase indefinitely as, beyond a certain threshold, there is a splitting of societies.

Overlap of generations is also in this instance indispensable for the survival of the society. However, in *Mallos gregalis* (Simon) there are seasonal variations in the age structure of the population of the society diminishes. In other species, as in *Anelosimus studiosus* (Hentz), the societies disperse after some months and all adult individuals separate to go here and there and initiate new families. It is clear that the cyclic diminution of the number of larvae is also known in social insects. It seems that the authors who have studied the social spiders with a short

cycle have some reluctance in conceding them a social status which in fact is not refused for similar insects.

As with insects, we also find in social spiders a number of collective tasks which make these groups real entities which are very different from a summation of individuals living on their own. These collective tasks, which are called "cooperation" by Kullman are one of the corollaries of the fundamental phenomenon of inter-attraction. They concern the care of the nest (cleaning, construction, repairs), hunting, care of the eggs and cocoons (Witt, Scarboro and Peakall 1978). The analysis of collective tasks is relatively disappointing because each animal often seems to work on its own and independently of the others; however, cooperation in hunting activities has been well identified in *Achaearanea disparata* for example, and building activities in *Mallos gregalis*. From an overall viewpoint, "community behavior" is clearly present among the social spiders, and the detail of the individual movements in spiders does not differ very much from what has been observed in various insects.

In social spiders inter-attraction is accompanied, as in insects, by forms of communication, and this communication is the crucial issue. The communication system in spiders is largely based on pheromones and vibrations (Darchen 1965, 1975, Krafft 1982). The web plays an important role in the transmission of "language" as it constitutes a substratum for the smells, is a vibratory system which carries sorts of coded information. The mode of perception in spiders is probably too remote from ours for us to understand the real role a web holds for the animal that builds it and spends its life on it. If this mode of perception and communication is fundamental in spiders which make webs, it can also be found in wasps, for example *Rhopalidia cincta* where cardboard construction can also, in a way, be used as a vehicle for vibratory information for coordinating the activity of the different members of the society at a given time. The needs of the community, inherent in any social life, have thus found ways of expressing themselves (both in insects and spiders) which are essentially based on tactile auditory and odoriferous perceptions.

The existence of this "language" is perhaps what makes the essential difference between *A. disparata* and *A. tessellata*. It is impossible to ignore the importance of communication in the establishment of social life, and it is a pity that Wilson has completely neglected it.

Absence of Castes in Social Spiders.—Although the presence of castes in social insects is a fundamental characteristic of eusociality, any attempt to find them in social spiders have remained unfruitful: no worker castes, no reproductive castes, and nothing which resembles classical structures of insect societies can be found in spiders.

Curiously, insect societies with more structure and hierarchy are regarded as highly derived. In contrast, those societies where the relationships between individuals fluctuate more will be catalogued as less derived, and the same happens with spider societies.

The concept of eusociality (which goes along with that of hierarchy, where the individual loses its autonomy to live in the group) obviously has a valorizing connotation whereas the social forms which have not reached the top level of hierarchy development are, we must admit, given a pejorative judgement. This is certainly why spiders have never been granted the status of advanced or derived societies; they could deserve this qualification which might in fact be of another order.

Thus, we humans show (but without confessing it, because this is probably done unconsciously) some admiration of the more hierarchical forms of society which are of an absolute monarchy type—and a much lower attraction for the forms without castes of a democratic type. However, in most modern human societies nobody would dare to give such a judgement. This finding is surprising and it shows that research even in “pure” biology sometimes leads to types of conclusions which are unconsciously biased by some cultural prejudices, and nobody in fact notices them because these prejudices are more or less the same for all.

In social spiders the tolerance pointed out by Kullman is of great importance. We have seen that it can exist vis-a-vis conspecifics coming from other colonies. We still find this tolerance in another form in these societies: first, the males are neither excluded nor attacked; and second good relations exist between females, each one having the opportunity to lay eggs and achieve the various tasks of the society. But besides this tolerance, which is the fundamental rule, it should be interesting to study the polyethism with marked animals, as research in this field is sorely lacking. The data we have on *Mallos gregalis* for example show how this field of research is interesting. This would allow us to have a more precise idea of the succession of tasks carried out by the different individuals. It is difficult to discuss in the absence of experiments, and it is only when we are in possession of precise ethograms that we can assess the degree of cohesion which links the members of a group in the various species of social spiders.

Foundation of Spider Societies.—As for insects, it is important to know how a spider society starts as this is a source of information on the nature of this society. Here again we have relatively few reliable observations (Darchen 1965, 1976, 1978, 1979, Kullman 1968, Wickler 1973, Jacson and Joseph 1973, Fowler and Levi 1980, Lubin 1981, Vollrath 1982). A spider society may start either through individuals, or through small groups of individuals who leave to make a colony nearby, or through groups of mature and immature animals which emigrate some distance from their original society.

In *Agelena consociata* individual separations have never been discovered, but the two other types of splitting are known. The individuals which leave separately are either gravid females or immature animals (*Stegodyphus sarasinorum* Karsch, Grasse and Joseph, 1973). *Anelosimus eximius* also shows solitary foundation, but not exclusively. Vollrath (pers. comm.) who has also studied the solitary foundation of societies of the latter species notes that isolated females have very few chances of survival but their chances are improved if several females join forces. We have then a type of foundation which is comparable to the polygynous type practiced by *Polistes gallicus*; in *Anelosimus eximius*, however, Vollrath does not indicate dominance of behavior among groups of females. Here again this great difference between the social systems of insects and spiders can be found, which makes the close comparisons a bit difficult.

In studying the foundation of societies, overlap of generations and the longevity or reproductive individuals are important factors to be taken into consideration. Spider species establishing large colonies have freed themselves from the constraint of individual longevity, somewhat like the social insects such as ants of the genera *Formica* or *Polyergus*. For example, Vollrath mentions a complex of colonies of *Anelosimus eximius* which is at least 14 years old, and we have seen one *Agelena consociata* colony which we have observed for 10 years. Spiders reach this result without the existence of castes.

Table 1.—Summary comparison of characteristics of insect and spider societies.

Characters	Societies of Insects	Societies of Spiders
Inter-Attraction	Obligatory. In nature, an isolated insect (excepted during a transitory period of time) does not exist, nor can it survive a long time.	Obligatory. In nature an isolated spider (excepted during a transitory period of time), does not exist. However, an experimentally isolated individual is able to survive a long time.
Stability of Societies	Equilibrium preserved by numerous internal controls.	No data.
Closure of Societies	Antagonism towards newcomers from other conspecific societies.	Tolerance. Societies open to conspecific newcomers.
Castes and Social links	Hierarchical origin of castes. Psychological castration (Dominance).	No psychological castration. All the adults are fecund. Apparent equality of all members.
Origin of Castes	Trophic origin of castes.	No castes.
Communications	Chemical (pheromones), mechanical (tactile).	Chemical (pheromones), mechanical (vibratory, tactile).
Collective Works	Complex coordination of tasks.	Complex coordination of tasks.
Polyethism	Present, linked to the physiological evolution of the individuals.	Possible, but not enough data.
Foundation of Societies	Various types of foundation -Isolation of reproductive individuals -no isolation of reproductive individuals -sociotomy -splitting Possible splitting: neotonic workers in the primitive societies of Termites, polygyny of some ants societies and wasps ones.	Scarce data. These 2 types of foundations exist, but the most successful one is realised through splittings. The splitting of the colonies are easy because all the spiders are reproducers.
Overlap of Generations	Yes, with some corollaries like brood care and nest defense.	Yes, with some corollaries like care and nest defense.
Cycle of societies	Annual and perennial.	Annual and perennial.
A "Super-Organism"?	The society is a super-organism with its own "laws" transcending the ones of isolated individuals.	Unclear due to the absence of hierarchies. However, spider societies are certainly greater than the sum of the individuals of the colony. Data are lacking.

The longevity of the founding mother is often proposed as a factor of the social life in spiders. There would be in fact a certain conflict between the overlap of generations which is indispensable to the appearance of the social life, and the death of the mother following the feeding of larvae. In this respect, social behaviors that provide individuals to take care of the brood, lead to economy in the life of the laying mothers. Then it is possible to say that social life induces the longevity of females and not the opposite (that longevity is a prerequisite to social life). This is, of course speculation, but the present behavior where the

mother takes care of the young and dies soon after may be considered as a stage of the evolution of spiders towards sociality.

CONCLUSION

Tolerance, lack of caste and hierarchy, which appear among social spiders, cannot be attributed to a lower range of sociality than that of the eusocial insects, but rather, as we have tried to demonstrate, to a different kind of sociality.

A question comes to mind when considering social spiders: why has this type of society not been more successful in nature? Why are there so few social species despite the fact that they can be found in various families?

The studies which have already been carried out on these animals come to the conclusion that among the advantages of spider sociality there is: (1) an economy in the number of eggs laid; (2) better success of the hatching; (3) no repression of female reproductive capability.

We may ask ourselves again why they did not conquer more of the world, as they do not show aggression between different social groups within the species, and thus have greater chances to co-exist. One could probably reply that there are other constraints, such as difficulty for the societies to disperse over long distances (cf., Vollrath 1982), and many other arguments which could be considered in this respect.

Finally, it is certain that these spider societies are unique, given the mechanisms of tolerance they have developed and which can be contrasted to the dominance which generates castes in social insects (Table 1). It must be, that even in invertebrates, democracy is a difficult goal to achieve.

ACKNOWLEDGMENTS

We thank Dr. H. G. Fowler and Dr. R. E. Buskirk for the helpful comments on an earlier version of the manuscript. We are grateful to Dr. G. W. Uetz for his help in the publication of this work.

LITERATURE CITED

- Balfour-Browne, F. 1925. The evolution of social life among caterpillars. 3e Cong. Int. Entomol., Zurich, 1925 (1926):334-340.
- Brach, V. 1977. *Anelosimus studiosus* (Araneae: Theridiidae) and the evolution of quasi-sociality in theridiid Spiders. *Evolution*, 31:154-161.
- Burgess, J. W. 1976. Social Spiders. *Scient. American*, 243:100-106.
- Buskirk, R. E. 1981. Sociality in the Arachnida. Pp. 281-359, In H. R. Hermann, ed. *Social Insects*. Vol. 2.
- Caussanel, C. and A. Karlinsky. 1981. Les soins maternels d'un perce-oreille. *La Recherche*, 125:1004-1007.
- Darchen, R. 1959. L'Abeille, Insecte Social. *J. Psychol. Norm. Pathol.*, 1:75-98.
- Darchen, R. 1959. Les techniques de construction chez *Apis mellifera*. *Ann. Sc. Nat.*, 1:113-209.
- Darchen, R. 1965. Ethologie d'une Araignée Sociale, *Agelena consociata* Denis. *Biol. Gabonica*, 1:117-146.
- Darchen, R. 1967. Une nouvelle Araignée Sociale du Gabon, *Agelena republicana* Darchen. *Biol. Gabonica*, 3:31-42.

- Darchen, R. 1967. Ethologie de quelques Araignées Sociales. L'interattraction, la construction et la chasse. C. R. V. Congress U. I. E. I. S., Toulouse, 1365-1367.
- Darchen, R. 1968. Ethologie d'*Achaeareana disparata* Denis, Araignée Sociale du Gabon. Biol. Gabonica, 4:5-25.
- Darchen, R. 1975. Les communications sociales chez *Agelena consociata* Denis. C. R. Acad. Sc. Paris, 281:575-578.
- Darchen, R. 1976. La fondation de nouvelles colonies d'*Agelena consociata* et d'*Agelena republicana*, Araignées Sociales du Gabon. Problèmes éco-éthologiques. C. R. III col. Arach. Fr., Les Eyzies, 20-39.
- Darchen, R. 1976. *Rhopalidia cincta*, guêpe sociale de la savane de Lamto (Cote d'Ivoire) (Hym. Vesp.). Ann. Soc. Entomol. France, 12:579-601.
- Darchen, R. 1978. Les essaimageurs lointains de l'Araignée Sociale, *Agelena consociata*, dans la forêt gabonaise (III). C. R. Acad. Sc. Paris, 287:1035-1037.
- Darchen, R. 1978. Le comportement constructeur des Abeilles Sociales. Courier du CNRS, 30:39-45.
- Darchen, R. and J.-C. Ledoux. 1978. *Achaeareana disparata* Denis, Araignée Sociale du Gabon, synonyme ou espèce jumelle d'*A. tessellata*, solitaire? Rev. Arachnol., 1:121-132.
- Darchen, R. 1979. Relations entre les colonies d'Agelenides Sociaux du Gabon. Précisions sur les essaimageurs (II). Bull. Biol. France et Belgique, 113:3-29.
- Darchen, R. 1980. Les populations d'*Agelena consociata*, Araignée Sociale, dans la forêt primaire gabonaise. Leur répartition et leur densité. Ann. Sc. Nat. Zool., 2:19-26.
- Darchen, R. 1982. Problèmes écologiques soulevés par une étude biométrique des individus de colonies de l'Araignée Sociale, *Agelena republicana* Darchen. C. R. V. Col. Arachnol., Modène, Pise.
- Deegener, P. 1920. Soziologische Studien an Raupen, und Bemerkungen über Licht und Statische Sinn. Arch. f. Naturgesch., 86:91-154.
- Deleurance, E. P. 1957. Contribution à l'étude du comportement des *Polistes* (Hymenopteres, Vespidae). Thèse, Fac. Sc. Paris Masson Edit., 222 pp.
- Evans, H. E. and M. J. West-Eberhard. 1970. The Wasps. Univ. Michigan Press, Ann Arbor. 265 pp.
- Fowler, H. G., Levi, H. W. 1980. A new quasi social *Anelosimus* spider (Araneae, Theridiidae) from Paraguay. Psyche, 86:11-18.
- Grasse, P. P. 1939. La reconstruction du nid et le travail collectif chez les Termites Supérieurs. J. Psych. Norm. Path., 30:370-376.
- Grasse, P. P. 1952. La régulation sociale chez les Isoptères et les Hyménoptères. Col. Intern. C. M. R. S., 34:322-331.
- Jacson, C. C. and K. J. Joseph. 1973. Life-history, bionomics and behaviour of the social spider, *Stegodyphus sarasinorum* K. Insectes Sociaux, 20:189-204.
- Krafft, B. 1971. Les interactions entre les individus chez *Agelena consociata*, Araignée Sociale du Gabon. Proc. Int. Arachnol. Congr., 5th, 1970, 159-164.
- Krafft, B. 1979. Organisation et evolution des Societes d'Araignées. J. Psychol., 1:23-51.
- Krafft, B. 1982. Eco-ethology and evolution of social Spiders. Pp. 73-84, *In Social Insects in the Tropics*.
- Kullman, E. J. 1971. Versuche zur toleranz bei der permanent sozialen Spinnenart *Stegodyphus sarasinorum* K. (Eresidae). C. R. 5. Congr. Arach. Brno.
- Kullman, E. J. 1972. Evolution of Social Behavior in Spiders (Araneae; Eresidae and Theridiidae). Ann. Zool., 12:419-426.
- LeMasne, G. 1952. Classification et caracteristiques des principaux types de groupements sociaux realises chez les invertebres. *In Structure et physiologie des Societes Animales*, Coll. Intern. C. N. R. S., 1950.
- Leroux, J. M. 1982. Ecologie des populations de Dorylines *Anomma nigricans* dans la region de Lamto (Cote d'Ivoire). These Univers. Paris, pp. 157.
- Lubin, Y. 1981. Dispersal by swarming in a social Theridiid. Amer. Arachnol., 24:18.
- Michener, C. D. 1969. Comparative social behavior of bees. Ann. Rev. Entomol., 14:299-342.
- Michener, C. D. 1974. The social behavior of the Bees. Harvard Univ. Press. Cambridge, 404 pp.
- Mosebach-Pukowsky, E. 1937. Über die Raupengesellschaften von *Vanessa io* und *Vanessa urticae*. Zeitschr. Morph. Oekol. Tiere, 33:358-380.
- O'Byrne, H. I. 1927. Gregarious caterpillars. Proc. Missouri Acad. Sci., 3:103-108.

- Passera, L. 1980. La ponte d'eufs préorientés chez la fourmi *Anelosimus eximius* Nyl. Insectes Sociaux, 27:79-95.
- Plateaux, L. 1970. Sur le polymorphisme social de la fourmi *Leptothorax nylanderi* F. Ann. Sc. Nat., Zool., Paris.
- Poussardin, C. 1984. Recherches sur la biologie et l'écologie d'une population de *Leptothorax nylanderi* F. (Hym., Formicidae) en forêt d'Orléans. Thèse 3eme cycle, Orléans.
- Raignier, A. 1972. Sur l'origine des nouvelles sociétés des Fourmis voyageuses africaines (Hymenop. Formicidae, Dorylinae). Insectes Sociaux, 3:158-170.
- Renoux, J. 1976. le polymorphisme de *Schedorhinotermes* (Sjostedt) (Isoptera-Rhinotermitidae). Insectes Sociaux, 23(3bis):279-494.
- Shear, W. A. 1970. The evolution of social phenomena in spiders. Bull. British Arachnol. Soc., 1:65-76.
- Vancassel, M. 1977. Le développement du cycle parental de *Labidura riparia*. Biol. Comp., 2:51-75.
- Vollrath, F. 1982. Colony foundation in a social spider. Z. Tierpsychol., 60:313-324.
- Wickler, N. 1973. Über koloniegründung und soziale Bindung von *Stegodyphus mimosarum* Pavesi und anderen sozialen Spinnen. Z. Tierpsychol., 32:522-531.
- Wilson, E. O., The Insect Societies. Harvard Univ. Press, Cambridge, 548 pp.
- Witt, P. N. M. B. Scarboro and D. B. Peakall. 1978. Comparative feeding data in three spider species of different sociability: *Araneus diadematus* Cl., *Mallos trivittatus* B. and *Mallos gregalis* S. Symp. Zool. Lond., 42:89-97.

Manuscript received August 1984, revised December 1985.

COURTSHIP AND ALTERNATIVE MATING TACTICS IN A SOCIAL SPIDER¹

Yael D. Lubin

Smithsonian Tropical Research Institute
Balboa, Republic of Panama²

ABSTRACT

Males of a social theridiid spider, *Achaearanea wau* Levi, have a prolonged and complex courtship in the communal web. They also mate opportunistically, by copulating with females engaged in molting or feeding. Ritualized aggression occurs between males during attempts to mate with molting females and during courtship. I describe the courtship, mating, and agonistic behaviors observed in *A. wau* and the conditions in which the different behaviors occur and discuss ways in which the social organization may have modified mating behavior. This is the first detailed description of the mating system of a highly social species of spider.

INTRODUCTION

Mating behavior and the mating system are influenced by social organization (Thornhill and Alcock 1983). Sexual selection in social species, as in nonsocial ones, may produce (1) exaggerated traits associated with mating and (2) synchronization of mating effort. Because communication in social groups is complex and there are more opportunities for repeated interactions among individuals, we might expect sociality to favor greater ritualization of both courtship and agonistic behaviors (than in nonsocial species). Therefore, the mating tactics of a social species should be instructive in elucidating the factors that influence the evolution mating systems.

Many species in which complex male courtship displays occur have one or more alternative mating tactics, used either by different kinds of individuals or in different circumstances (Thornhill and Alcock 1983). (I use tactics throughout to mean complex behavior sequences). Often males attempt to obtain matings without engaging in time-consuming (and often risky) courtship displays. This may be done either by sneaking copulations or by mating with females while they are engaged in some other activity or are incapable of preventing the male's advances. Such tactics are often referred to as "opportunistic mating" (Robinson and Robinson 1980; for reviews of alternative mating behaviors, particularly in invertebrates, see Blum and Blum 1979, Thornhill and Alcock 1983). Alternative mating behaviors were described in several species of solitary spiders (Robinson

¹Presented in a symposium, "Social Behavior in Spiders," at the National Meeting of the American Arachnological Society, June 17, 1984.

²Present Address: Mitrani Center for Desert Ecology, Jacob Blaustein Institute for Desert Research, 84990 Sede Boqer, Israel.

1978a, Robinson and Robinson 1980, Christenson 1984), but have not been observed previously in social species.

Only fragmentary accounts are available of mating behavior of social spiders (Robinson 1978b, Jacson and Joseph 1973); therefore, a detailed description of mating in the social theridiid spider, *Achaeearanea wau* Levi is warranted. I describe here the different mating behaviors and the conditions in which they occur, and discuss the possible functions of the different tactics and the evolution of the mating system of *A. wau*. I show that (1) mating behavior in *A. wau* is complex, involving stereotyped courtship and at least two alternative tactics that do not involve courtship, and (2) mating is synchronized and spatially localized in the colony. A quantitative analysis of alternative mating tactics is provided elsewhere (Lubin, ms).

METHODS

Natural History.—*Achaeearanea wau* Levi (Theridiidae) is a social spider found in montane forest and forest edge in Papua New Guinea (Levi et al. 1982). The communal web of a colony consists of a nonsticky, horizontal sheet with a tangled maze of nonsticky threads (the barrier web) above it and one or more curled-leaf retreats suspended in the barrier web by strong threads (Fig. 1). The spiders sit in or below the leaf retreats during the day and are active mainly at night; prey capture and web maintenance activities are cooperative, feeding takes place in leaf retreats and spiders share prey. Females and their offspring overlap in time. Females tend eggsacs and capture prey for the young (of other females as well as their own). Accounts of colony structure and activities of spiders are provided elsewhere (Lubin 1982, Lubin and Crozier 1985).

Achaeearanea wau colonies have discrete, overlapping generations. No more than two generations are present in a colony at any time, and adults of consecutive generations do not overlap. Females mature at the seventh instar and most females in a colony mature at the same time. Males are smaller than females (body length: males 2 mm, females 4.5 mm) and mature at the fifth instar, about 3-4 weeks before the females (Table 1). The sex ratio is skewed towards females, with about six females per male. Courtship and mating activities take place in the parent colony over a period of 3-7 weeks, but most of the activity is concentrated during a 2-3 week period (Table 1). Females produce one or two eggsacs each, one to two weeks after mating. Dispersal is by means of mass swarming of adult females and does not occur in every generation (Lubin and Robinson 1983).

Observations and Analyses.—Observations of courtship and mating behaviors were of spiders in colonies that were maintained in semi-captivity in the gardens and coffee plantations of the Wau Ecology Institute (Wau, Morobe Province, Papua New Guinea, elevation ca. 1100 m) and in natural populations in the vicinity of Wau.

Colonies were collected from natural populations and released onto open wooden frames (60x60x60 cm) provided with wire-mesh screens across their lower faces (used to collect prey remains and other spider rejects) and perched on legs at about 1.5 m above ground. There was no need to enclose the spiders completely; when the collapsed web with leaf retreats (brought in from the field)



Fig. 1.—Web of *A. wau* showing the sheet (S), barrier web (B), and curled-leaf retreats (L).

was suspended from the frame, the spiders generally rebuilt the communal web during the following two nights, sometimes attaching lines to the surrounding vegetation as well as to the wooden frame. The colonies in semi-captivity were in a habitat similar to the forest edge and treefall clearing habitats that they normally occupy. The colonies were checked at least twice a week (generally daily) to determine the onset of the various developmental stages (Table 1).

Courtship activities were observed in 10 colonies during the period October 1979-January 1981. Observations of males in these colonies were made for periods of 1-20 days per colony, for a total of 60 days. Most observations were of unmarked males: males were too small to mark with dots of acrylic paint. I watched an individual male and recorded its activities for periods of 30 sec to 10 min, until he moved out of sight or became inactive. Timed observations of individual males (a total of 678 min for all colonies combined) were supplemented by routine, nightly censuses of spider activity in all colonies. Observations were made mainly at dusk and at night, when the males were most active. I recorded when and where females molted and if they were approached by males, as well as any other activities in the colony (kleptoparasite activity, feeding, etc.). Details of male behavior, particularly the courtship sequences, were observed with the aid of a pair of 10 x 40 binoculars mounted on a tripod and fitted with a +3 diopter close-up lens on one eyepiece. Super-8 movie films and videorecordings (using a SONY AV-3400 videorecorder) were made at night using artificial lighting.

COURTSHIP AND MATING BEHAVIORS

Sexual activities in *A. wau* include searching for a mate, pre-copulatory displays, female responses to male advances and finally mating (or mating attempts). I also include male-male interactions and sperm induction, as these behaviors occur only in the context of courtship and mating activities.

Table 1.—Chronology of events related to courtship and mating activities in colonies of *A. wau* maintained in semi captivity. (a) A = Mt. Missim, 1500 m; B = Wau Ecology Institute, 1200 m; C = Mt. Kaindi (Kunai Creek), 1700 m; D = Mt. Kaindi (Namie Creek), 1600 m; E = Mt. Kaindi, elevation unknown. (b) Number of days from the first appearance of mature males and females to first observations of courtship or mating activities. Negative numbers indicate that males began courting before females matured. (c) Colony collected while courtship was already in progress.

Colony No.	Origin (a)	Days to First Courtship		Mating Season	
		Male	Female	Month	No. Days
1	A	4	-15	Feb.	39
2	C (c)	—	—	Mar.	—
3	D	28	0	May	26
4	E	29	3	May	28
5	B	28	0	Jun.	22
6	A	17	-6	Oct.	32
7	B	11	1	Nov.	31
8	B	15	2	Dec.	51
9	C	21	0	Dec.	36
10	B	11	-5	Dec.	29

Mean duration of mating season + S.D. = 32.7 + 8.5 days

Courtship and mating took place in the communal barrier web, primarily in the region of the curled-leaf retreats. A male became active and began to search for a female. If he encountered an adult female (sometimes subadult females were apparently not distinguished from adults), he either attempted directly to mate with her (Fig. 2A), or constructed a mating arena and began courting (Fig. 2B). A nearby female sometimes responded to the courtship display by approaching, touching legs with the male and then hanging from a thread in a receptive posture; the male then attempted to copulate. A searching male that encountered a female in the process of molting attempted to copulate without courting (Fig. 2C). Males sparred over molting females, and in certain other contexts as well. The different behaviors are described in detail below.

MALE REPRODUCTIVE BEHAVIORS

Sperm induction.—Sperm induction began with the male cutting out barrier web threads and putting in his own draglines. The sperm “web” of *A. wau* is not a web at all, but a single thread that is reinforced several times. The male then dabbed sperm onto the thread with his abdomen and a shiny, white spot became visible on the thread. While filling the palps, the male was supported in an inverted position by all 8 legs. The palps were filled one at a time, alternating left and right, and repeating the process several times. When first applied to the droplet of sperm, the palp was vibrated rapidly; this was followed by slow pulsating movements. As each palp was removed from the sperm droplet, it was shaken rapidly a few times. The male then remained sitting and passed each palp through the chelicerae (cleaning?), sometimes pausing to wave the palp up and down gently for 10-30 sec. After sperm induction, the male remained sitting and occasionally cleaning the palps for more than 15 min.

Sperm induction was observed on five occasions: twice in the morning and three times in the afternoon and early evening. one male began construction of the sperm web about 10 minutes after a copulation. Charging of palps after a

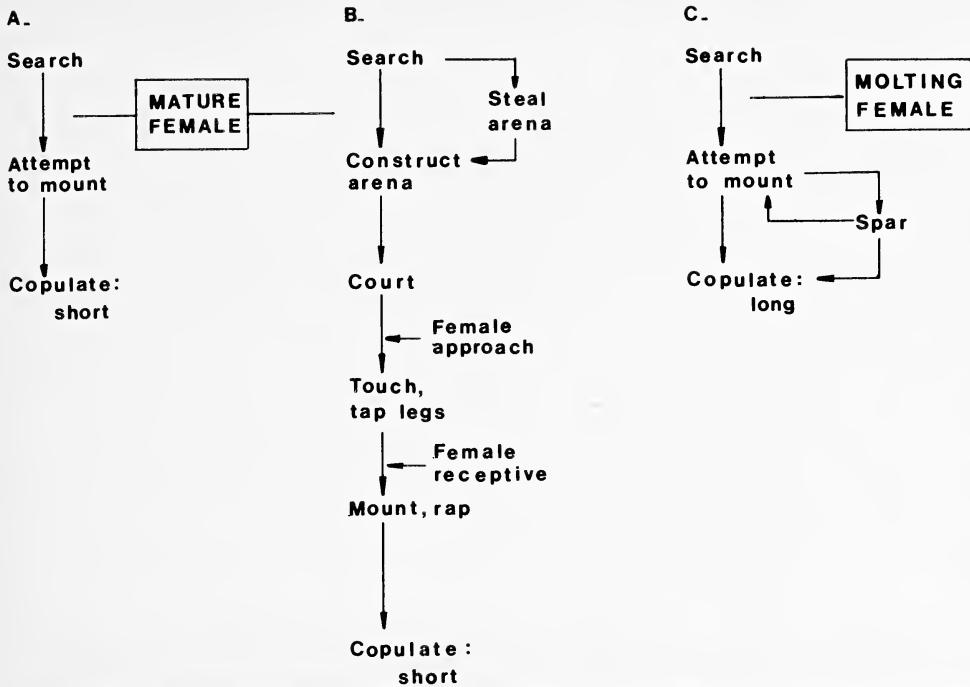

Fig. 2.—Schematic diagram of male mating behaviors, given encounters with mature (non-molting) females (A and B) or with a molting female (C). In courtship sequences with mature females (B), males mount only if females adopt a receptive posture.

copulation has been reported in other spiders (e.g., *Sicarius* sp., Levi 1967). Sperm deposition lasted 15 sec in one instance and about 36 sec in another. Two complete sequences of charging of palps lasted 9 and 17 min, respectively. Each subsequent palp application was of longer duration than the previous one; two such sequences were 23, 27, 40, 62 and 31, 37, 42, 52, sec, alternating palps each time.

Searching.—At the beginning of an activity bout, males walked around near and below the leaf nests, and made tapping and rotary movements with legs I, frequently touching females that they encountered. Searching graded into courtship or into attempts to copulate with a female.

Are these male perambulations in the web in fact 'searching' behavior, and are they specifically aimed at finding females? The evidence in support is as follows. First, the tapping and rotary movements of legs I were indistinguishable from exploratory movements used in other contexts (e.g., web-building or approaching foreign objects in the web), which suggests that the spider is receiving tactile and/or chemical cues. Second, the males were active almost exclusively in the immediate vicinity of the leaf nests, where females could be found either feeding or inactive. This is quite unlike the behavior of females, or juveniles or either sex and of males before the onset of sexual behavior: when these spiders became active, they moved away from the leaf nests into the barrier web or onto the sheet where most colony activities (web repair, prey capture) took place. Finally, during "normal" colony activities there was little physical contact between individuals, whereas searching males frequently touched females and indeed, moved from one female to the next.

Courtship: the display.—Males courted in small lacunae in the barrier web which they prepared just before courting (Fig. 3). The male cut out a small volume of barrier web threads and laid down one or more dragline threads. These threads might be considered functionally equivalent to the mating thread of araneids (Bristowe 1958). Most display courts were situated near or just below the leaf nests. Courtship was not always preceded by construction of mating threads; apparently males displaced one another from display courts, or simply used courts abandoned by other males. In practice, it was difficult to recognize a display court unless one observed the male building it. Small, thread-free spaces occurred naturally in the barrier web (for example, where an insect had been removed from the barrier web) and the male's mating threads were not distinguishable (to the observer) from other silk lines.

The behavior of cutting out segments of the females' web before or during courtship, thereby reducing the capture area of the web, is sometimes interpreted as a mechanism for minimizing the risk to a male of being attacked by the female and treated as prey (e.g., *Fecenia* sp., Robinson and Lubin 1979), or as a means of cutting off the female's escape route from the male (e.g., in *Latrodectus hesperus* Chamberlin and Ivie, Ross and Smith 1979). Neither of these explanations is applicable here, since the females are neither aggressive nor do they show a tendency to escape from the web. More apposite is Rovner's (1968) suggestion that web removal reduces the possibility of interference from other males and isolates the female from extraneous signals (such as those of insect prey) that might interfere with mating.

Courtship involved two distinct displays, abdomen vibrating and twanging, which were sometimes accompanied by tapping and rotary movements of first legs. Abdomen vibrating (AVing) involved high frequency, low amplitude, vertical oscillations of the abdomen from the pedicel. A single oscillation lasted about 1/9 sec (2 frames of super-8 film at 18 fps) and displaced the mating thread by 2 mm. While AVing, all legs rested on threads and only the abdomen moved (Fig. 3). The vibrations induced were probably transmitted via the legs and dragline to the mating thread and thence to threads in contact with the female.

Similar abdomen movements occur as part of the courtship behaviors of other species, e.g., in the linyphiid, *Frontinella pyramitella* (Walckenaer) (Suter and Renkes 1984) and in the theridiids *Achaearanea tepidariorum* (C. L. Koch) (Bonnet 1935), *Teridion pallens* Blackwell (Locket 1926) and *Latrodectus hesperus* (Ross and Smith 1979). In the theridiids *Steatoda* (= *Teutana*) *grossa* (C. L. Koch) and *S. bipunctata* (Linnaeus), stridulatory organs on the abdomen are coupled with abdomen vibrating movements to produce vibrations or clicks (sometimes audible) that may be transmitted through the web (Gwinner-Hanke 1970). A stridulatory organ was not found in *A. wau* males examined under scanning electron microscopy (H. W. Levi, pers. comm.).

Twanging is described by Robinson and Robinson (1980, p. 13) as "a movement on mating threads in which the thread is rapidly tensioned and then the tension suddenly released." Twanging or plucking of threads occurs as a component of courtship in many web spiders (e.g., *A. tepidariorum*, Bonnet 1935; *Teridion pallens*, Locket 1926). In *A. wau*, the male pulled the mating thread by flexing legs I and II and released it suddenly with legs I (and perhaps II), causing a violent backwards jerk of the whole body. Both the spider and the mating



Fig. 3.—Male courting in the barrier web. Note that all legs hold threads.

thread were displaced during a twang which may produce large amplitude oscillations of the mating thread (Fig. 4).

Tapping and rotary movements of first legs occurred during AVing and between twangs. One leg I lightly touched the mating thread or nearby threads in a slow, gentle motion that did not visibly deflect the thread. Sometimes the tapping leg I did not strike a thread and continued to wave about in the air in a circular movement, similar to leg I movements made when walking in the barrier web and searching for females.

Courtship displays followed a stereotyped sequence, always starting with a bout of AVing and followed by alternating bouts of twanging and AVing of variable duration. A few patterns emerge from analyses of Super-8 films of courtship sequences: (1) Twangs were often given in short bursts of 2-4 at a time. Intervals between twangs within a burst were distributed bimodally, with peaks at 2/9 to 1/6 sec (4-6 frames of super-8 movie film, at 18 fps) and at 13/18 to 5/6 sec (13-15 frames; Fig. 5A). (2) Bouts of AVing were most frequently 2/9-2/3 sec (4-12 frames) in duration, with a mean of 0.77 sec (SD = 0.75, range 0.06-4.28, N = 102; Fig. 5B). No regular pattern could be detected in either the frequency or duration of alternating bouts of AVing and twanging within a display sequence. However, individual variation was not studied.

AVing occurred off the mating thread in two contexts besides during courtship: males AVed while following or attempting to mount females and during male-male sparring bouts (described below). In neither of these contexts was AVing accompanied by twanging.

Courtship: interactions.—Are male displays directed at particular females or are they addressed to any female within 'hearing' distance? Searching behavior, placement of the display thread and the display itself all seemed to be directed at one or a group of females. The male investigated several females from close range while searching; the display thread was attached at its proximal end to

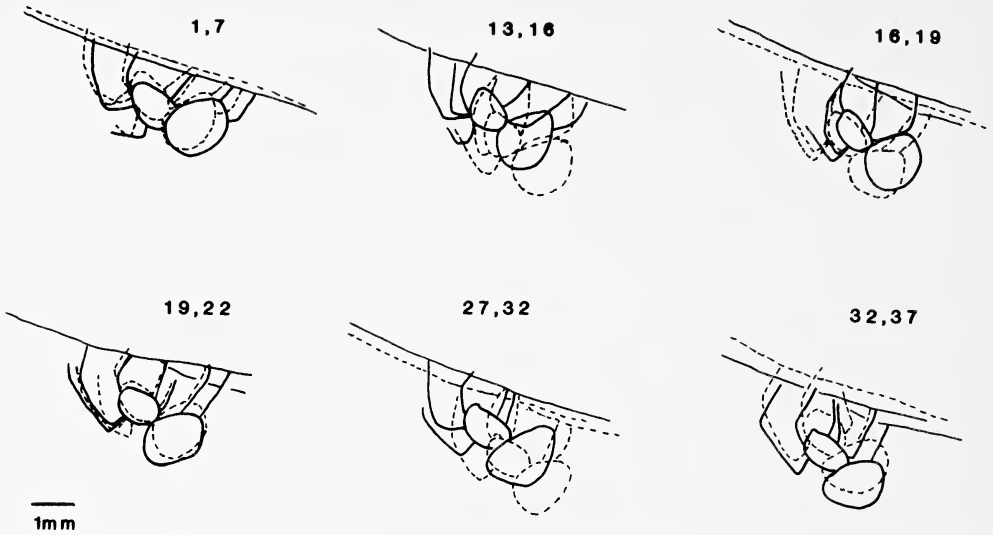

Fig. 4.—Twanging. Drawings based on a sequence of frames from Super-8 movie film. Two frames are superimposed in each drawing, the first in solid lines and the second in dotted lines; frame numbers are shown above each drawing. Note that in some frames not all legs were visible. The backward jerking portion of the twang was seen as a blur on a single frame (15). Two twangs are shown (frames 13-16 and 27-32). A small, forward movement precedes the twang (1-7, 7-13). The vertical displacement of the thread was about 4 mm.

threads on which one or more females rested and while building the display thread, the male frequently approached and touched these females; and finally, the male displayed facing one or more females at a distance of 1-5 cm. Apparently, however, the displays were not perfectly directional; females sometimes approached displaying males from behind or from the side. Courting males responded to frontal approaches by attempting to copulate in 89% of 89 observations, and in only 20% of 56 observations of approaches from other directions ($\chi^2 = 66.85$, $p < 0.001$, $df = 2$).

The behavior of a displaying male on the approach of a female depends on the response of the female (see Female Behaviors). Usually, there was mutual touching and tapping of legs, after which the female adopted an acceptance posture and the male mounted. Sometimes, however, the female approached the male to within 1 cm or less and sat. The male either went up to the female, touched her and resumed displaying, attempted to climb directly onto her ventral side and copulate, or left to search for a new display site. The cues that trigger the different male responses are not known.

Interference from other males during the display resulted in the termination of courtship in nearly 10% of 197 courtship bouts in one colony. After such interruptions, the 'resident' male either resumed displaying or searched for a new site. Likewise, when a courting male failed to attract a female or when a female approached and then rejected the male, he often moved away from the display court and resumed searching.

COPULATION AND COPULATION ATTEMPTS

If a female adopted a receptive posture (see below) following the male's display, the male moved to the female's ventral side and drummed on her epigynum with

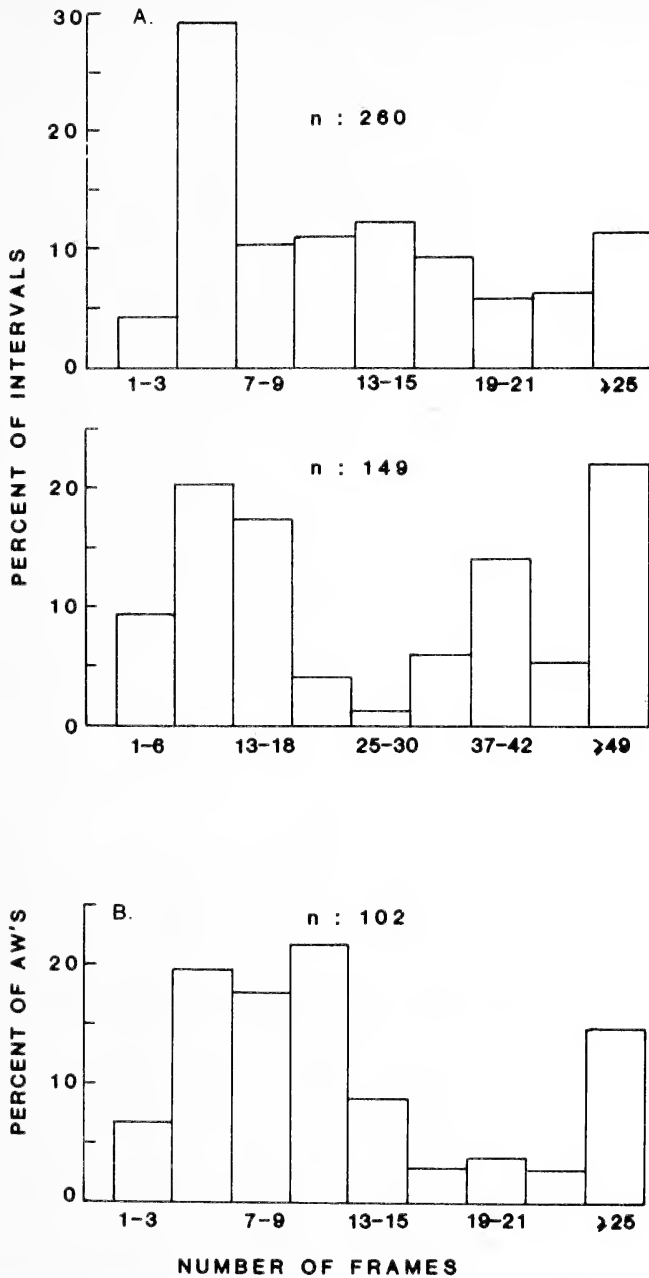

Fig. 5.—Frequency distributions of components of courtship. (a) Intervals between successive twangs, based on Super-8 movie films at 18 fps (upper) and on videorecordings at approximately 30 fps (lower). (b) Durations of abdomen vibrating (AVing), in frames of Super-8 movie film at 18 fps.

the palps, alternating them rapidly. Males also drummed on the epigyna of females that were busy feeding, in attempts to copulate. Montgomery (1903) commented that male *Achaearanea tepidariorum* appeared to have difficulty inserting the palp once the female adopted a receptive posture. This appeared to be the case in *A. wau*. Palpal drumming may be a way of stimulating the female to allow copulation and, as such, is an important part of courtship. Palpal drumming may have a function similar to that of the pre-mating insertions in

Frontinella pyramitella (Helsdingen 1965) or the post-mount courtship display of *Phiddipus johnsonii* (Peckham and Peckham) (Jackson 1982).

If successful in stimulating the female, the male inserted one palp and pumping movements of the abdomen could be seen. A male copulated only once, with one palp, and then was usually chased away by the female. Copulations with mature (non-molting) females were of short durations: all but one of nine timed copulations lasted less than one minute, and all were terminated by the female. There was no evidence of a copulatory plug, nor did males break off one of their emboli, although both of these phenomena are known to occur in other theridiids (e.g., Braun 1956).

If a female was not receptive there often ensued a frantic scramble on and around her abdomen, as the males(s) tapped and drummed on her abdomen with his palps and legs and attempted to gain access to her ventral side. This behavior was observed in *A. wau* in three contexts. First, males pursued and attempted to mount females that were attracted initially to the male courtship display, but then rejected the male and moved away. I never observed a copulation following such a pursuit. Second, when copulation attempts were interrupted by another male, both males scrambled around the female as she moved away. Third, *A. wau* males scrambled and sparred with one another on molting females, and even on exuvia of newly molted females and on females that had died during molting (see below).

During copulation with mature as well as with molting females, the male's long axis was parallel to that of the female and the two spiders faced in the same direction. Sometimes, however, the movements of a recently molted female attempting to dislodge a copulating male, caused the male to turn around so that his body was at a right angle to that of the female, or even facing in the opposite direction.

MALE-MALE INTERACTIONS

There were four possible outcomes to an encounter between two (or more) males: (1) the males ignored one another, (2) they touched one another and one or both moved away, (3) one male chased another away, and (4) they sparred and one eventually fled, often chased by the other. Sparring males tapped, pushed and grappled with one another, using the legs and palps. I never saw injury of any sort to a male as a result of sparring, nor did I see males with missing appendages. Sparring appears to be a form of ritualized fighting and occurred only in the context of male sexual activities. No other form of fighting was observed. Although males matured before females and were thus present as adults in the colony for several weeks before courtship began, neither male-male aggression nor male-male interactions of any other sort, were observed before the onset of the mating season.

Sparring bouts and chases occurred most frequently when one male interfered with courtship activities of another either during a display or while attempting to mate with a female. They also occurred when males encountered one another during searching and when building a mating thread. A searching male was more likely than a displaying male to 'give up' and move away after an encounter (Table 2).

Table 2.—Outcomes of male-male encounters during courtship and attempted copulations (C/AC) and during searching (S), based on observations of males in 10 colonies. Group sparring events are excluded. Male #1 is the instigator of the encounter (in searching males) or the resident in encounters during C/AC. Possible outcomes were: either male #1 or male #2 left first, or there was no clear winner (both males left or both remained inactive). Expected values are in parentheses. The null hypothesis that there is no difference in the outcomes of encounters of C/AC and S males is tested (G test, $df=2$). [$G = 15.713$, $p < 0.005$ (two-tailed)].

Male #1	First male to leave			Totals
	Male #1	Male #2	Both/Neither	
C/AC	22 (23.2)	45 (34.0)	15 (24.8)	82
S	21 (19.8)	18 (29.0)	31 (21.2)	70
Totals	43	63	46	152

As a mating tactic, male interference and attempts to displace courting males appear to be unsuccessful. In no instance did I observe an interfering male gain access to a female ($N = 152$ attempts) and these contests generally ended with one or both males moving away. Nonetheless, there may be other advantages: an interfering male may disrupt the courtship display of another male sufficiently to cause him to move away, whereupon the invading male can usurp the display site. Displacements of this sort occurred, although more frequently the displaying male chased the intruder away (Table 2). The possibility of size advantage in these contests (Rovner 1968, Suter and Keiley 1984) was not examined.

Intense sparring bouts occurred over molting females and sometimes clusters of males could be seen sparring over a molting female (Fig. 6) or over a recent exuvium. The latter behavior suggests that chemical cues present in the molt trigger male copulation attempts. A phenomenon that remains largely unexplained is that of 'spontaneous' clustering of sparring males, with no female to be seen nearby, nor even an exuvium to indicate that a molting female had been there. Males entered a cluster, engaged in pushing and shoving matches, left to sit in nearby threads or walked about tapping nearby females, and then returned to the cluster to resume sparring. Such clusters persisted, with changes in the number and identities of the contestants, for up to an hour,

How do such sparring contests start and what attracts males to them? Many sparring contests (55% of 29 contests observed in one colony) began in the presence of a molting or recently molted female or her exuvium, but continued long after the females had moved away. Clusters of sparring males also shifted location in the web as males left and entered them. Perhaps males are attracted to such clusters initially by chemicals produced by molting females and, later, by cues (chemical or vibrational) from the sparring males themselves.

Two explanations for the occurrence of these group sparring bouts are suggested: (1) that they are a product of a state of high sexual "excitement" on the part of the males and the likelihood of finding a molting female in the center of such a cluster, and (2) that they involve the establishment of a dominance hierarchy among males that, in the long run, determines access to females.

The occurrence of clusters of sparring males mainly early in the mating season when molting females are present in colonies supports both explanations. During this period males may be highly motivated to search for and attempt to mate with molting females (see following sections for the reasons why this might be the case). Likewise, a dominance hierarchy would be established early in the period of sexual activity, as females are maturing and molting to adults. The presence

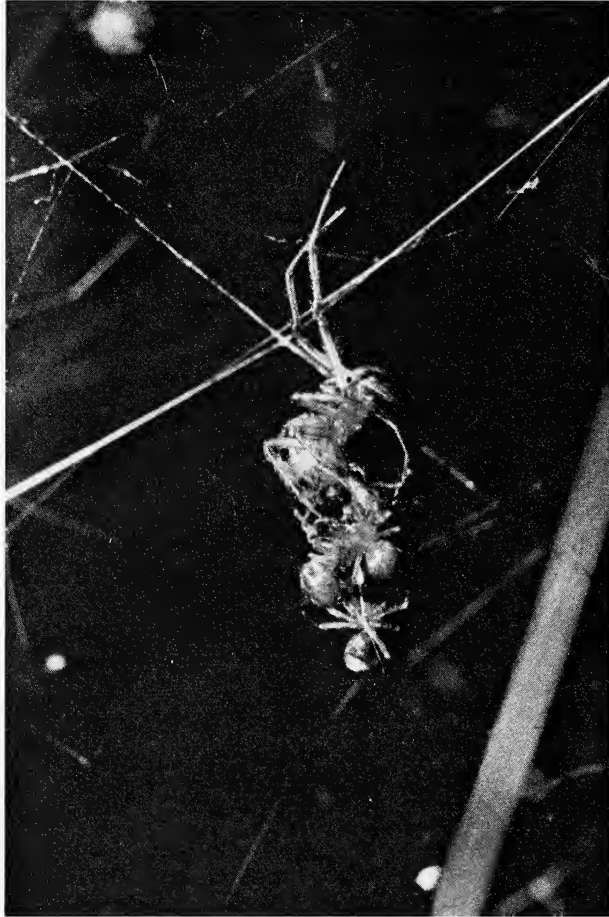

Fig. 6.—A group of males of *A. wau* sparring over a recently molting female. The female is able to move her legs and is pushing the males away.

of a dominance hierarchy implies individual recognition, a possibility which was not examined. Further observations, particularly of marked males, are clearly necessary.

AVing occurred in the context of male aggression (1) when several males attempted to mate with a molting female, (2) during sparring bouts and (3) during interference with a male that was courting or attempting to copulate. AVing during male-male interactions appeared to be of lower frequency and higher amplitude (slower and more pronounced oscillations of the abdomen) than while courting a female. Possibly different messages are conveyed by differences in the frequency and amplitude of the vibrations produced in AVing. Abdomen twitching was observed in both courtship and male aggression in a salticid spider (Jackson 1978a) and, indeed, the use of similar signals of different intensities in both courtship and male-male aggression is common in many animals (c.f., Cade 1979).

FEMALE BEHAVIORS

Mature, non-molting females responded to male courtship by tapping him with legs I and II. If the female was receptive, she adopted an acceptance posture, in which she hung from the threads (the male's mating threads?) by legs IV, while legs I and II were held together either flexed over the cephalothorax or downward and away from the body. As the male attempted to mate, the female often held him with one or both legs III.

If a male persisted in drumming on the female's ventral side without succeeding in inserting the palp, the female then began to push him away with the legs, at first gently, then more sharply and sometimes ending in a lunge at the male and an apparent attempt to seize and bite him. The male reacted to the pushing by either attempting to follow the female and scramble back onto her or moving away, and to the lunge, by dropping several centimeters into the lower barrier web. I never saw a female actually seize a male.

Much of the time, nearby females showed no response to courting males. When a searching male approached and touched a female, she either remained motionless or moved away. If the male persisted in following, she moved into the lower barrier threads, or even under the sheet, pushing the male away with her hind legs. Later in the reproductive season, females aggressively lunged at courting or pursuing males and chased them into the lower barrier web. As in the case of male-male sparring, I never saw any damage to a male thus 'attacked' by a female. Bonnet (1935) described similar behavior in *Achaearanea tepidariorum* where older, mated females chased courting males aggressively, but never harmed them.

COPULATIONS WITH MOLTING FEMALES

Molting females hung by legs I-III, while their flexed legs IV held onto the web near the cephalothorax. After molting, the spider remained hanging by a thread from the exuvium in an inverted posture, such that all legs hung down and were slightly flexed. One molt from last instar to adult female lasted 23 min from the start of pumping movements to the first coordinated leg movements of the adult female. During this period the female was defenseless. Another 22 min elapsed before the female broke the attachment to the exuvium and moved away.

During the molt from penultimate instar to adult, females were sometimes mated by one or more males. As many as 15 males were observed clustered around a single molting female. I saw four instances of multiple copulations, one of which involved four males in succession. Sometimes one male succeeded in mating 2-3 times with the same molting female. This suggests that the male did not transfer all of the sperm in one palp in the first insertion. Copulations with molting females were terminated by the male, or as a result of interference from other males, and were of longer duration than copulations with mature females following courtship (molting females: $n = 19$, median = 60 sec, range 15-540 sec; mature females: $n = 9$, median = 18 sec, range 6-129 sec; $0.01 < p < 0.025$, Wilcoxon two-sample test).

Of 140 females observed molting in 8 different colonies, 40.7% were discovered by males, and of these 59.6% were mated during molting, corresponding to 24.3%

of all molting females. Females that molted at night in the vicinity of the leaf retreats were more likely to be discovered and mated than were individuals that molted during the day and away from the retreats. In one colony in which molting females were observed throughout the mating season, 4 of 6 females that molted at night were discovered by males who attempted to copulate with them, whereas only 14.8% of 81 females that molted during the day were discovered by males. Furthermore, about 2/3 of the molting females (109 of 152) were observed during the day (0600-1600), a distribution that reflects a real preference for molting during the day. Of 64 females that molted near leaf retreats, 52% were discovered by males who then attempted to copulate with them, whereas only 1 (2%) of 45 females that molted in the upper barrier web was discovered ($\chi^2 = 29.81$; $p < 0.001$, $df = 1$).

There is an immediate risk to a female to being discovered and copulated with during molting, aside from possible long-term disadvantages involving loss of reproductive fitness. As the female's exoskeleton begins to harden, it becomes difficult for a copulating male to withdraw the embolus and he may become 'stuck.' Upon separating one such pair, I noticed a sticky secretion of unknown origin covering the embolus and epigynum. As soon as the female was capable of moving, she attempted to free herself from the copulating male by pushing him with her legs III and IV. The male at first remained passive, then attempted to withdraw the palp. Pairs often remained stuck for more than 12 hours. Males became stuck in 40% of 40 observed copulations with molting females and on at least four occasions (10% of all matings with molting females), both members of the pair died while still *in copula*.

The risk of discovery by males during molting may be a strong selective pressure for molting in locations and at times when males are least likely to be active. Females molting during the day in the upper barrier web may be exposed to risks of predation (by kleptoparasitic spiders of the genus *Argyrodes* (Theridiidae), mimetids and salticids as well as by wasps and birds.) Although I did not observe predation directly, I did find *Argyrodes* feeding on dead *A. wau* individuals in the barrier web. Furthermore, females were found in the upper barrier threads during the day only in two circumstances: during rare excursions to capture prey or during the last molt. All other (pre-adult) molts occurred in the vicinity of the leaf nests, and predominantly at night.

Matings with molting females give the appearance of forced copulations (a term less emotionally charged than 'rape;' Thornhill and Alcock 1983). First, molting females have no control over the mating; second, as soon as females can move, they attempt to free themselves of the male; and third, females molt in circumstances that minimize the chance of being found by males. Forced copulations may be undesirable for females because (1) they allow no choice of mate and (2) they carry a high risk (higher for the females, who loses all, than for the male, who may have already mated with other females).

DISCUSSION

Variable Mating Tactics.—Intraspecific variation in male mating tactics is to be expected when the 'interests' of males and females do not coincide exactly, as is the case when females are choosier than males in accepting mates (Maynard

Smith 1982). The most thoroughly studied example of variable male mating tactics in nonsocial spiders is that of a salticid, *Phiddipus johnsonii* (Jackson 1977, 1978a). Males of this species have three distinct tactics: they may court females outside their nests with a species-typical, visual display; search for and mate with females in nests, using vibratory courtship only; or cohabit in nests of subadult females and copulate with a minimum of ceremony when females molt to maturity. Unlike *A. wau*, females of *P. johnsonii* can terminate copulations both in the nest and outside it. Thus, although males have alternative mating tactics which differ in their probabilities of success and in the durations of the resulting copulations, there is apparently no tactic by which males circumvent female control of mating.

In many araneids that have large sexual size dimorphism (e.g. the Nephilinae and some species of *Argiope*), the small males either court the female from a distance on her own web, wait to copulate when the female is busy with prey, or cohabit in webs of subadult females and copulate as soon as the female molts to adulthood (Farr 1977, Robinson and Robinson 1980, Alcock 1984b). The tactic of waiting until the female is feeding before approaching occurs in many species, e.g. *Meta segmentata* (Clerck) (Araneidae), *Zosis geniculatus* (Oliver) (Uloboridae), and *Pisaura mirabilis* (Clerck) (Pisauridae), where the male provides a 'gift' of food before copulating (Gerhardt 1927, Bristowe 1958, Blanke 1974). Although females control mating in these cases, the likelihood of the male being rejected may be reduced. Matings with recently molted females have been reported sporadically in the literature, e.g. in a gnaphosid, *Drassodes lapidosus* (Walckenaer) (Bristowe 1958, p. 119) and a clubionid, *Clubiona robusta* L. Koch (Austin 1984). It is not clear from these reports if females are indeed capable of rejecting males under these circumstances.

In these examples and in *A. wau*, a species-typical male courtship tactic is replaced by a more direct tactic under specific conditions, namely, when the likelihood of being rejected by the female is reduced because she is either occupied or incapable of doing so. In contrast to the examples cited above, opportunistic mating in *A. wau* takes an extreme form of forced copulation of females that are in the process of molting (and are completely defenseless), and often by several males in succession. The frequent occurrence of these behaviors in *A. wau* (Lubin, ms.) suggests that female choice acts to increase the variation in male mating success and that this provides strong selection on males to adopt alternatives to courtship.

Male Fighting.—Male-male fighting occurs as well in other web-building species, particularly in those in which males cohabit in females' webs before or after copulation (or both). Males of *Nephila clavipes* (Linnaeus) for example, fight for a position at the hub of the female's web (where access to the female is easiest) and interfere with one another during mating attempts (Farr 1977, Christenson and Goist 1979, Vollrath 1980). In the linyphiid, *Frontinella pyramitella*, a male on a female's web defends it against intruding males before and after he copulates (Austad 1982, Suter and Keiley 1984) as may be the case in some pholcids (Eberhard and Briceno 1983). Ritualized aggression occurs in all of these species. Often contests are settled before any direct contact is made and, if fighting breaks out, damages to the contestants occur infrequently. Austad (1982) and Suter and Keiley (1984) suggested that intruding males of *F. pyramitella* are often unable to assess accurately the ability of the resident male

to defend the web and may do so only by increasing the intensity of the aggressive interaction up to the point of a physical contest.

Male-male interactions in *A. wau* differ from those described above: of the three types of interactions seen in *A. wau*—interference and displacement during courtship and mating attempts, fights over access to molting females and group sparring contests—only the first is similar to behaviors seen in non-social species. Nonetheless, sparring over molting females and group fights may also be derived from male-male interactions typical of non-social species. The highest intensity interaction seen between males of *A. wau* was sparring, a ritualized fighting that apparently never caused damage to the participants and at most resulted in one male chasing another away. Sparring bouts were often preceded by, and interspersed with, AVing, which in this context appears to be an aggressive signal of lower intensity. Escalation of aggression from AVing to sparring carried virtually no immediate risk of damage to the contestants in this social species; there already exist strong inhibitions to damaging one another. The outcome of a contest may depend on the stamina or persistence of the contestants rather than on their ability to do damage. The reward may be immediate access to a molting female, or as suggested earlier (and if individual recognition occurs), a higher rank in a male dominance hierarchy which could determine access to females later in the season.

Evolution of the Mating System of *Achaearanea wau*.—Comparable studies of mating behaviors of other social spiders are lacking. Krafft (1969) observed a male *Agelena consociata* Denis (Agelenidae) drumming his palps (on the web?) as he approached a female, but the female moved away; *Mallos gregalis* (Simon) (Dyctinidae) males courted by plucking the web and twitching their abdomens, but the mating system was not described (Jackson 1978b); there are no published observations of courtship or mating behavior in another social theridiid, *Anelosimus eximius* Simon, although this is perhaps the best studied of all the social spiders (Brach 1975, Vollrath 1982, Vollrath and Rohde-Arndt 1983, Tapia and de Vries 1980, Christenson 1984). However, Vollrath (pers. comm.) observed a male *A. eximius* fight with another male that was attempting to mount a female. Clearly, none of these social species exhibits the frenetic, synchronized mating season seen in *A. wau*. *Achaearanea wau* is apparently unique among the social species studied until now in that (1) it has a communal mating season (2) males have prolonged and complex courtship, (3) forced copulations are common, and (4) males engage in ritualized sparring contests. Can these behaviors be explained in the context of the social biology of *A. wau*?

The synchronous, communal mating season in *A. wau* is a consequence of colony dynamics and life history. New colonies are established by means of synchronous swarming of mated females (Lubin and Robinson 1982). The stage of a colony in its life cycle, rather than seasonal events, determines the timing of swarming. Communal brood defense also imposes a degree of synchrony: several days before females are ready to lay eggs, they remove the capture web, leaving only the leaf nests supported by strong guy threads. The females hang their eggsacs inside the leaf nests, seal the openings and brood the eggsacs for 1-2 weeks. Those females that cannot produce eggsacs during this period (due perhaps to lack of resources) are unlikely to reproduce successfully later (unpublished data).

The courtship of *A. wau* males remind one of the displays of males in leks, and indeed, shares some of the characteristics of lekking behaviors. Males defend small arenas that are used exclusively for courting females and copulating with them; these arenas are concentrated in a relatively small area of the spider's home range (i.e., the colony); and, a female may visit (and perhaps compare) many displaying males during a short period. Most lekking vertebrate (c.f. Bradbury 1981) and some lekking social insects (e.g., harvester ants; Holldobler 1976), use traditional lekking sites. *Achaearanea wau* males, however, change courtship arenas frequently and, indeed, the display site itself may be of little importance except in relation to the position of females in the web.

'Lekking' in *A. wau* males can be understood in the contexts of male mating strategy and the same colony life history characters discussed above. Given that a male's sole investment in his offspring is sperm, his best strategy is to put all his efforts into finding mates and copulating with them. Finding females in the colony presents little difficulty, particularly when females within a colony mature simultaneously. Consequently, during a relatively short mating season, males display vigorously and almost incessantly in sectors of the colony in which receptive females are most likely to be found.

Both female choosiness and male eagerness might select (by means of sexual selection) for elaborate and persistent male displays. Furthermore, given the female's apparent reluctance to accept mates, males should adopt opportunistic mating tactics whenever possible as a means of circumventing female choosiness (see above). In this respect, copulations with molting females may be particularly advantageous (in spite of the risks), since a male may be able to completely fill a female's spermathecae and ensure that all of her offspring will be his own. As molting females are a scarce resource, males are expected to compete for them and fight over them.

The evolution of this mating system from one of a less social or solitary theridiid must remain speculative, given the paucity of comparable observations of other species. *Achaearanea wau* shares certain mating behaviors with other theridiids (*Achaearanea tepidariorum* is the best known example), including elements of the courtship displays (AVing, twanging and post-mount rapping); the occurrence of numerous, short copulations that are generally terminated by the female; and a relative lack of aggression between females and cohabiting males (Bonnet 1935; Montgomery 1903). In addition, males of both *A. tepidariorum* and of a subsocial species, *A. mundula* (L. Koch), congregate on webs of receptive adult females and often cohabit their webs for several days. I predict that male-male interactions and competitive male displays occur in these species, although perhaps less ritualized and less frequent than in *A. wau*.

The differences between *A. wau* and these solitary or subsocial species are related specifically to the social adaptations discussed earlier, low fecundity, skewed sex ratios and dispersal by swarming of adult females resulting in developmental synchrony within colonies. I propose that the unique mating system of *A. wau* is the result of the modification of a 'traditional' theridiid mating system to accommodate these social adaptations.

ACKNOWLEDGEMENTS

This work was funded by a Smithsonian Institution Scholarly Studies Research Award to M. H. Robinson and the author, and by the Smithsonian Tropical Research Institute. I am grateful to M. H. Robinson, B. C. Robinson and the late J. L. Gressitt, to my field assistant, Lukas K., and the staff of the Wau Ecology Institute for helping in many ways. I thank M. J. Eberhard, W. G. Eberhard, R. R. Jackson, B. Kotler, R. B. Suter and F. Vollrath for reading and commenting on drafts of the manuscript, A. Decae for thought-provoking discussions, and G. W. Uetz for realizing the publication of the symposium.

LITERATURE CITED

- Alcock, J. 1979. The evolution of intraspecific diversity in male reproductive strategies in some bees and wasps. Pp. 381-402, *In Sexual Selection and Reproductive Competition in Insects* (M. S. Blum and N. A. Blum, eds.). Academic Press, New York.
- Austin, A. D. 1984. Life history of *Clubiona robusta* L. Koch and related species (Araneae, Clubionidae) in South Australia. *J. Arachnol.*, 12:87-104.
- Austad, S. N. 1982. First male sperm priority in the bowl and doily spider, *Frontinella pyramitella* (Walckenaer). *Evolution*, 36:777-785.
- Blanke, R. 1974. Rolle der Beute beim Kopulationsverhalten von *Meta segmentata* (Cl.) (Araneae, Araneidae). *Forma et Functio*, 7:83-94.
- Blum, M. S. and N. A. Blum, eds. 1979. *Sexual Selection and Reproductive Competition in Insects*, Academic Press, New York.
- Bonnet, P. 1935. *Teridion tepidariorum* C. L. Koch, araignée cosmopolite. *Bull. Soc. Hist. nat. Toulouse*, LXVIII:335-386.
- Braun, R. 1956. Zur Biologie von *Teutana triangulosa* (Walck.) (Araneae: Theridiidae, Asagenae). *Z. Wiss. Zool.*, 159:255-318.
- Bristowe, W. S. 1958. *The World of Spiders*. Collins, London. 304 pp.
- Cade, W. 1979. The evolution of alternative male reproductive strategies in field crickets. Pp. 343-379, *In Sexual Selection and Reproductive Competition in Insects* (M. S. Blum and N. A. Blum, eds.). Academic Press, New York.
- Christenson, T. E. 1984a. Behavior of colonial and social of the theridiid species *Anelosimus eximius*. *Animal Behavior*, 32:725-734.
- Christenson, T. E. 1984b. Alternative reproductive tactics in spiders. *Amer. Zool.*, 24:321-332.
- Christenson, T. E. and K. C. Goist. 1979. Costs and benefits of male-male competition in the orb-weaving spider, *Nephila clavipes*. *Behav. Ecol. Sociobiol.*, 5:87-92.
- Eberhard, W. G. and D. Briceno. 1983. Chivalry in pholcid spiders. *Behav. Ecol. Sociobiol.*, 13:189-195.
- Farr, J. A. 1977. Social behavior of the golden silk spider, *Nephila clavipes* (Linnaeus) (Araneae, Araneidae). *J. Arachnol.*, 4:137-144.
- Gerhardt, U. 1927. Neue biologische Untersuchungen an einheimischen und ausländischen Spinnen. *Z. Morph. Okol. Tiere*, 8:96-186.
- Gwinner-Hanke, H. 1970. Zum Verhalten zweier stridulierenden Spinnen *Steatoda bipunctata* Linné und *Teutana grossa* Koch (Theridiidae, Araneae), unter besonderer Berücksichtigung des Fortpflanzungsverhaltens. *Z. Tierpsychol.*, 27:649-678.
- Helsdingen, P. J., van. 1965. Sexual behavior of *Lethyphantes leprosus* (Ohlert) (Araneida, Linyphiidae) with notes on the function of the genital organs. *Zool. Mededelser*, 41:15-42.
- Jackson, R. R. 1977. Courtship versatility in the jumping spider *Phiddipus johnsonii* (Araneae: Salticidae). *Anim. Behav.*, 25:953-957.
- Jackson, R. R. 1978a. An analysis of alternative mating tactics of the jumping spider *Phiddipus johnsonii* (Salticidae, Araneae). *J. Arachnol.*, 5:185-230.
- Jackson, R. R. 1978b. Male mating strategies of dictynid spiders with differing types of social organization. *Symp. Zool. Soc., London*, 42:79-88.
- Jackson, R. R. 1980. The mating strategy of *Phiddipus johnsonii* (Araneae, Salticidae): II. Sperm competition and the function of copulation. *J. Arachnol.*, 8: 217-240.

- Jackson, R. R. 1982. The behavior of communicating in jumping spiders (Salticidae). Pp. 211-247. *In* Spider Communication, Mechanisms and Ecological Significance (P. N. Witt and J. S. Rovner, eds.). Princeton Univ. Press, Princeton, New Jersey.
- Jacson, C. C. and K. J. Joseph. 1973. Life-history, bionomics and behavior of the social spider, *Stegodyphus sarasinorum* Karsh. *Insectes Sociaux*, 20:189-204.
- Levi, H. W. 1967. Predatory and sexual behavior of the spider *Sicarius* (Araneae: Sicariidae). *Psyche*, 74:320-330.
- Levi, W. H., Y. D. Lubin and M. H. Robinson. 1982. Two new *Achaearanea* species from Papua New Guinea, with notes on other theridiid spiders (Araneae: Theridiidae). *Pacific Insects*, 24:105-113.
- Locket, G. H. 1926. Observations of the mating habits of some web-spinning spiders. *Proc. Zool. Soc. London*, 22:1125-1146.
- Lubin, Y. D. 1982. Does the social spider, *Achaearanea wau* (Theridiidae), feed its young? *Z. Tierpsychol.*, 60:127-134.
- Lubin, Y. D. and R. C. Crozier. 1985. Electrophoretic evidence for population differentiation in a social spider, *Achaearanea wau* (Theridiidae). *Insectes Sociaux*, 32:297-304.
- Lubin, Y. D. and M. H. Robinson. 1982. Dispersal by swarming in a social spider. *Science*, 216:319-321.
- Maynard Smith, J. 1982. *Evolution and the Theory of Games*. Cambridge Univ. Press.
- Montgomery, T. H. 1903. Studies on the habits of spiders, particularly those of the mating period. *Proc. Acad. Nat. Sci., Philadelphia*, 1903:59-149.
- Robinson, M. H. and Y. D. Lubin. 1979. Specialists and generalists: The ecology and behavior of some web-building spiders from Papua New Guinea. II. *Psechrus argentatus* and *Fecenia* sp. (Araneae: Psechridae). *Pacific Insects*. 21:133-164.
- Robinson, M. H. and B. Robinson. 1980. Comparative studies of the courtship and mating behavior of tropical araneid spiders. *Pacific Insects Monogr.*, 36:1-218.
- Ross, K. and R. L. Smith. 1979. Aspects of the courtship behavior of the black widow spider, *Latrodectus hesperus* (Araneae, Theridiidae) with evidence for the existence of a contact sex pheromone. *J. Arachnol.*, 7:69-77.
- Rovner, J. S. 1968. Territoriality in the sheetweb spider, *Linyphia triangularis* (Clerck) (Araneidae, Linyphiidae). *Z. Tierpsychol.*, 25:232-242.
- Savory, T. H. 1928. *The Biology of Spiders*. Macmillan Co., New York, 376 pp.
- Suter, R. B. and M. Keiley. 1984. Agonistic interactions between male *Frontinella pyramitella* (Araneae: Linyphiidae). *Behav. Ecol. Sociobiol.*, 15:1-7.
- Suter, R. B. and G. Renkes. 1984. The courtship of *Frontinella pyramitella* (Araneae, Linyphiidae): patterns, vibrations and functions. *J. Arachnol.*, 12:37-54.
- Thornhill, R. and J. Alcock. 1983. *The Evolution of Insect Mating Systems*. Harvard Univ. Press, Cambridge.
- Vollrath, F. 1980. Male body size and fitness in the web-building spider *Nephila clavipes*. *Z. Tierpsychol.*, 53:61-78.
- Vollrath, F. 1982. Colony foundation in a social spider. *Z. Tierpsychol.*, 60:313-324.
- Vollrath, F. and D. Rohde-Arndt. 1983. Prey capture and feeding in the social spider *Anelosimus eximius*. *Z. Tierpsychol.*, 61:334-340.

ORB-WEAVING SPIDERS IN AGGREGATIONS MODIFY INDIVIDUAL WEB STRUCTURE¹

Ruth E. Buskirk

Institute for Geophysics and Brackenridge Field Laboratory
University of Texas at Austin
Austin, Texas 78713

ABSTRACT

Orb-weaving spiders that live in groups modify their web structure and activity periods, in contrast to solitary araneids that build more individually distinctive orbs. Individually marked spiders ($n = 62$) of the colonial *Metabus gravidus* (Araneidae) in Costa Rica were monitored for 5-day periods during which all webs spun were measured. Variation in web characters (particularly web angle and viscid spiral measures) within an individual is related to time of day and degree of aggregation. Comparisons of six orb-weaving species suggest that spiders joining aggregation vary their web characteristics when in groups.

INTRODUCTION

The geometric orb webs of spiders in the families Araneidae, Uloboridae, and Tetragnathidae usually have characteristics that are typical of the genus or species (Risch 1977, Eberhard 1982). In addition, individual spiders that build their orbs in a controlled environment, with standardized web support structures and attachment sites, often build orbs of the same size and pattern day after day (Witt et al. 1968, Peters 1969). Changes in web structure with age of spider, molting condition, nutritional status, configuration of attachment sites and time of day have all been documented especially in laboratory work (Szlep 1958, 1961, Witt et al. 1968, Peters 1970, Eberhard 1972, Ramousse and LeGuelte 1984). Variability of web structure under natural conditions has not been as well quantified.

Previous observations of the colonial spider *Metabus gravidus* (Cambridge) (Araneae, Araneidae) in Costa Rica (Buskirk 1975a) suggested that orb structure was highly variable within an individual, unlike the comparatively predictable orbs found in laboratory studies of other araneids (e.g., Witt et al. 1968). For this study I gathered data on webs of these colonial spiders, both those in aggregations and a few isolated individuals, to determine the effect of colony participation on orb structure. For additional comparison I analyzed webs of other orb-weaving species which occasionally formed aggregations. This study determines the extent of individual variation in orb webs in different species and its relation to the tendency of the species to form aggregations.

¹Presented in a symposium, "Social Behavior in Spiders," at the National Meeting of the American Arachnological Society, June 17, 1984.

METHODS

The colonial orb-weaving spider *M. gravidus* is abundant at the study site chosen on the Rio Guacimal (Monteverde, Costa Rica, elevation 1350 m). Individually marked adult or subadult females were monitored hourly for periods of 5 days in June or July (rainy season), during which every orb spun was measured. Each of 62 individuals built at least 5 orbs, and some as many as 14 orbs, during the observation periods. About 15% of these orbs were webs rebuilt in the same site. In this process the old web is destroyed, and the spider immediately reinforces support lines and radii then completely renews the viscid spiral. In all webs I measured radius, number of radii, number of spiral turns, and angle from the horizontal.

RESULTS FOR A COLONIAL SPECIES

Orb web measurements of individual *M. gravidus* in colonies can vary more than 30% within a period of a day or two. For example, the web formula consisting of (A) number of radii, (B) number of spiral turns and (C) orb radius in cm varied as follows for one adult female (day and time, A, B and C, respectively): day 1 (07:00 h)—13, 18, 15.0; day 1 (17:30 h)—11, 15, 12.8; day 2 (12:00 h)—12, 11, 12.2; day 3 (06:30 h)—9, 16, 10.8; day 3 (17:00 h)—10, 17, 14.0. In a sample of webs the variability within individuals was as great as between individuals for the orb radius and number of radii, as shown below.

One source of high variance in orb measures in *M. gravidus* is the time of day at which orbs are built. These spiders may emerge from the retreat and build a new orb at any daylight hour (Buskirk 1975a) and often respin webs once or twice during the day. Webs either built or respun in the last two hours of the diurnal activity period (Evening Webs in Table 1) have significantly smaller radii ($t = 2.39$, $p < 0.025$), fewer radii ($t = 2.70$, $p < 0.01$) and larger mesh size ($t = 2.81$, $p < 0.01$) than morning webs. Analysis of variance for radius length and number of radii, however, indicates that even when morning and evening webs are distinguished, variability within a spider is high (Table 1).

In 169 web-spinning observations spiders averaged a speed of nearly one cm/sec in spinning the viscid spiral, but there was much variation over the day. At dawn (06:00-07:00 h) the sticky thread of the viscid spiral was spun at a quicker rate than in mid-morning ($t = 2.41$, $p < 0.05$) with no significant changes in radius or mesh. In the evening period (16:00-18:00 h) an increased speed (1.4 cm/sec) is accompanied by a smaller average radius (9.7 cm) and coarser mesh (6.1 sq. cm). These times of rapid spinning (dawn and dusk) coincide with heightened insect activity, and the evening period is one of increased number of adult spiders occupying and building orbs (Buskirk 1975a).

To test the effect of the colony participation on orb variance, I examined web radius and number of radii in all webs spun by 62 individually marked spiders during the five day observation period. Ten spiders that were temporarily isolated and not building in colonies built less variable webs than the other 52 individuals that built in colonies. For example, variance of the radius length (mean = 13.2 cm) in all orbs spun by a given individual ranged from 0.6-6.7 in aggregated individuals but was only 0.8-3.0 in solitary spiders. Orb radius varied at least 50%

Table 1.—Individual variability of orb webs in 62 *Metabus gravidus* adult female spiders within a colony (p values are for One-Way ANOVA; ** indicates $p < 0.10$; NS indicates $p > 0.10$.) For time of day analysis time blocks used were 06:00-09:00 h (morning webs), 10:00-12:00 h, 13:00-15:00 h, and 16:00-17:00 h (evening webs).

		Morning Webs Combined:	Evening Webs Combined:
Radius	$\bar{x} \pm s.d.$	13.2 \pm 4.0 cm	11.7 \pm 3.7 cm
	ANOVA, by spider	** ($p < 0.05$, df 5, 14)	** ($p < 0.02$, df 5, 14)
	ANOVA, by date	NS ($p > 0.10$, df 5, 14)	NS ($p > 0.10$, df 5, 14)
	ANOVA, by time	All Webs:	** ($p < 0.02$, df 3, 40)
Number of Radii:	$\bar{x} \pm s.d.$	11.5 \pm 4.2	8.2 \pm 5.3
	ANOVA, by spider	** ($p < 0.05$, df 5, 14)	** ($p < 0.05$, df 5, 14)
	ANOVA, by date	** ($p < 0.05$, df 5, 14)	** ($p < 0.05$, df 5, 14)
	ANOVA, by time	All Webs: **	($p < 0.10$, df 3, 40)
Mesh:	$\bar{x} \pm s.d.$	3.9 \pm 2.1 cm ²	5.8 \pm 3.9 cm ²
	ANOVA, by spider	NS ($p > 0.10$, df 5, 14)	NS ($p > 0.10$, df 5, 14)
	ANOVA, by date	NS ($p > 0.10$, df 5, 14)	NS ($p > 0.10$, df 5, 14)
	ANOVA, by time	All Webs:	NS ($p > 0.10$, df 3, 40)

of the mean radius for over a third of the clustered individuals. Previous measurements (Buskirk 1975a) indicate that the average orb radius in the direction of a close neighbor (within 25 cm) was shorter than other radii of the same orb, presumably as a result of aggressive encounters with the neighbor during orb construction (Buskirk 1975b).

EFFECTS OF CLUSTERING IN OTHER ORB-WEAVING SPIDERS

In other species of facultatively gregarious spiders, joining an aggregation may also have an effect on web-building. I observed six other species of orb-weavers at field sites in Texas and Costa Rica (see Table 2). The species examined represent spectrum of gregarious tendencies from those like *M. gravidus* in which spiders routinely cluster their orbs to those species which rarely cluster. Web characters chosen for comparison were orb radius, angle of the orb's plane from horizontal and presence of any unique structural elements such as barrier webs. I determined the percent of individuals aggregated from censuses of 30 or 50 individuals of each species. Additional spiders were surveyed for web measures. Web data (radius and angle) from aggregated individuals were considered different from those of solitary individuals if they were significant at the $p < 0.05$ level (Mann-Whitney U test).

As indicated in Table 2 some web characters varied with degree of aggregation. In Texas webs of *Nephila clavipes* (Linnaeus) and *Mecynogea lemniscata* (Walckenaer) are occasionally found in clusters, especially in open woodland or edge areas where insects are abundant and web support structures are not limited. Aggregated females of these species use the support lines of their neighbors as web attachment points, but they do not generally modify their web by reducing the knockdown strands or barrier webs. Presence of barrier webs in *N. clavipes* may vary, but no consistent pattern in aggregations has yet been determined (L. Higgins, pers. comm.). Similarly, *Metazygia wittfeldae* (McCook), which are usually solitary, do not produce smaller or modified webs when they aggregate,

Table 2.—Web characteristics in seven orb weaving species that aggregate occasionally (top of list) or regularly (bottom of list). Yes = web radius or angle from horizontal was significantly different in clumped individuals (Mann-Whitney U test, $p < 0.05$). *= in one case barrier web was reduced.

Species and Site	Number Censused	Percent Sharing Support Lines	Smaller Orbs in Clusters?	Different Web Angle in Clusters?	Orb Structure Modified in Clusters?
<i>Metazygia wittfeldae</i> (Monteverde, Costa Rica)	50	6%	No	No	No
<i>Mecynogea lemniscata</i> (Austin, Texas)	30	7%	No	No	No
<i>Nephila clavipes</i> (Galveston, Texas)	50	10%	No	No	No*
<i>Tetragnatha elongata</i> (Austin, Texas)	50	20%	Yes	No	No
<i>Leucauge venusta</i> (Monteverde, Costa Rica)	50	34%	No	Yes	No*
<i>Cyclosa caroli</i> (Monteverde, Costa Rica)	50	52%	Yes	Yes	Yes
<i>Metabus gravidus</i> (Monteverde, Costa Rica)	50	90%	Yes	Yes	No

and the angle of the web continues to vary from just above horizontal to vertical (Table 2).

Like *M. gravidus*, *Tetragnatha elongata* (Walckenaer) build simple wide-meshed orbs, often over water. In tetragnathid aggregations I found orb radii to be shorter, but no other structural modifications were noted. Solitary *T. elongata* adults prefer to build horizontal orbs, but in aggregations the angle of the web differed from horizontal. When adult females of *Leucauge venusta* (Walckenaer) build in aggregations, they put their orbs in a more nearly horizontal plane and spin less dense support threads than do solitary individuals. Despite the presence of such modifications, the orb radius in these aggregated *L. venusta* webs did not differ significantly from that of solitary webs. On the other hand, aggregated individuals of *Cyclosa caroli* (Hentz) displayed a typical vertical web but produced smaller orbs.

VARIABILITY IN ORB-BUILDING

Several factors are known to contribute to the dimensions and regularity of web structures. Reed et al. (1965) and Eberhard (1972) found spiders can regulate orb structure and central angles via measuring behavior of the first pair of legs. During ontogeny, web mesh size increased in *Araneus diadematus* (Clerck) (Witt and Baum 1960). Mesh width is directly correlated with leg length, especially in adults (Risch 1977). Benforado and Kistler (1973) found that web radius increases with body size within an age class, primarily as a result of differential feeding. In comparison to individuals whose webs are destroyed, spiders permitted to ingest their web daily produce subsequent orbs up to 15% larger in radius with the number of spiral turns greater by 17-38% (Witt et al. 1968).

Species-specific patterns of orb-building and placement of radii account for some differences in variability. For example, Nentwig (1983) found that the mesh size and distance between spirals were much more variable in *A. diadematus* than

in species such as *Zygiella x-notata* (Clerck) which insert additional radius lines midway out from the hub. Web-building traits such as hub construction, spiral attachment, and placement of barrier webs are typical of the genus (Eberhard 1982). In species that normally add barrier webs near the orb, individuals joining aggregations can construct webs with reduced or no barrier webs. Since barriers are usually constructed later than the frame and initial orb, sometimes hours or days later, the spider could receive feedback from the behavior of neighbors or prey capture rate that prevents barrier construction.

Orb size can depend upon the size of available area in the substrate for frame attachment. Adult *A. diadematus* in laboratory frames produced daily webs that varied in radius by less than 5% (Witt et al. 1968). The number of radii (means + s.d. = 26.1 + 4.2) and number of spiral turns (21.4 + 8.2) were more variable. Web radius and shape are modified, however, by *A. diadematus* as frame size decreases, while the angle of the web is last to change (Szlep 1958). In a field study of adult *Argiope trifasciata* (Forsk.) and *A. aurantia* (Lucas), Brown (1981) found some variance in web radius, but variation was much greater for other measures such as web height. Studies of adult individuals of solitary orb-weavers show relatively little variance in web radius under standardized conditions.

SIGNIFICANCE FOR SPIDER SOCIAL BEHAVIOR

Two general evolutionary pathways to sociality in spiders have been proposed, one emphasizing prolonged parental care and cooperation within a cohort of young and one depending upon tolerance and aggregation of unrelated individuals (Shear 1970). Because orb-weavers must build orbs individually the degree of cooperation in producing a communal web is limited (Buskirk 1981). One might predict that stereotyped, individual web-building would be more efficient and would confer a selective advantage to orb-weaving spiders in general.

On the other hand, there are ecological advantages for building webs in aggregations. Field observations and manipulations of social and facultatively social spiders have confirmed that spiders are more likely to aggregate in rich prey patches and obtain as much or more food per individual in these groups (Buskirk 1975a, Uetz et al. 1982, Rypstra 1983, 1985, Riechert 1985). The tendency to cluster is strongest when food and web attachment sites are patchy. Long-term aggregation may also provide protection from predators or climatic changes. In addition, web clustering may result in more silk lines per individual for entangling and slowing down prey (Burgess 1978).

In aggregations the higher density of spiders will be costly if there is much effort spent in defending individual areas and if many supplantings of individuals from their webs occurs. If species recognition and tolerance has evolved in the behavioral repertoire or if high prey capture rates induce tolerance (e.g., Rypstra 1983), then individual spiders can successfully occupy the aggregated webs for long periods of prey capture.

Besides the orb-weavers addressed in this study, other araneids show some modification of individual web structure when aggregated in favorable resource sites. *Metepeira spinipes* (Cambridge) build orbs in aggregations of up to hundreds of individuals, and group size is larger in areas of greater prey availability (Uetz et al. 1982). Larger colonies are more dense, with smaller

individual web areas, and individuals share space web and support threads (Uetz and Burgess 1979). The congeneric *Metepeira datona* (Chamberlin and Ivie) in the Bahama Islands sometimes form aggregations and may share retreats (Schoener and Toft 1983). Web-sharing usually involves spiderlings or males associating with large females, not aggregations of adult females. Solitary webs of large spiders tend to be vertical and oriented to minimize the wind, while those in aggregations are more variable in position.

Spiders that join aggregations can modify their web-building behavior to increase both silk efficiency and tolerance of neighbors. In the groups surveyed in Table 2 species that are regularly found in clusters show more modification of orb structure. Patchy resources account for the ecological advantages of group living in these spiders. Behavioral adaptability, in the form of variability in web construction, allows these species to take advantage of the ecological opportunities. Species with greater ability to modify individual foraging strategies are more likely to be facultatively gregarious.

ACKNOWLEDGMENTS

I gratefully acknowledge the research facilities of the University of Texas Brackenridge Field Laboratory and the Organization for Tropical Studies that made this study possible. Parts of the research were supported by the Whitehall Foundation and the Bache Fund. I thank Linden Higgins for helpful discussion and George Uetz for organizing the Social Spider symposium of June 1984.

LITERATURE CITED

- Benforado, B. J. and K. H. Kistler. 1973. Growth of the orb weaver, *Araneus diadematus*, and correlation with web measurements. *Psyche*, 80:90-100.
- Brown, K. M. 1981. Foraging ecology and niche partitioning in orb-weaving spiders. *Oecologia*, 50:380-385.
- Burgess, J. W. 1978. Social behavior in group-living spider species. *Symp. zool. Soc. London*, 42:69-78.
- Buskirk, R. E. 1975a. Coloniality, activity patterns and feeding in a tropical orb-weaving spider. *Ecology*, 56:1314-1328.
- Buskirk, R. E. 1975b. Aggressive display and orb defense in a colonial spider, *Metabus gravidus* (Araneae: Araneidae). *Anim. Behav.*, 23:560-567.
- Buskirk, R. E. 1981. Sociality in the Arachnida. Pp. 281-367, *In Social Insects* (H. R. Hermann, ed.). Vol. II. Academic Press, New York.
- Eberhard, W. G. 1972. The web of *Uloborus diversus* (Araneae: Uloboridae). *J. Zool.*, 166:417-465.
- Eberhard, W. G. 1982. Behavioral characters for the higher classification of orb-weaving spiders. *Evolution*, 36:1067-1095.
- Nentwig, W. 1983. The non-filter function of orb webs in spiders. *Oecologia*, 58:418-420.
- Peters, H. M. 1969. Maturing and coordination of web-building activity. *American Zool.*, 9:223-227.
- Peters, P. J. 1970. Orb web construction: interaction of spider (*Araneus diadematus* Cl.) and thread configuration. *Anim. Behav.*, 18:478-484.
- Ramousse, R. and L. LeGuelte. 1984. Strategies de construction de la toile chez deux especes d'araignees (*Araneus diadematus* et *Zygiella x-notata*). *Rev. Arachnol.*, 5:255-265.
- Reed, C. F., P. N. Witt and R. L. Jones. 1965. The measuring function of the first legs of *Araneus diadematus* Cl. *Behaviour*, 25:98-119.
- Riechert, S. E. 1985. Why do some spiders cooperate? *Agelena consociata*, a case study. *Florida Ent.*, 68:105-116.
- Risch, P. 1977. Quantitative analysis of orb web patterns in four species of spiders. *Behav. Genet.*, 7:199-238.

- Rypstra, A. L. 1983. The importance of food and space in limiting web-spider densities; a test using field enclosures. *Oecologia*, 59:312-316.
- Rypstra, A. L. 1985. Aggregations of *Nephila clavipes* (L.) (Araneae, Araneidae) in relation to prey availability. *J. Arachnol.*, 13:71-78.
- Schoener, T. W. and C. A. Toft. 1983. Dispersion of a small-island population of the spider *Metepeira datona* (Araneae: Araneidae) in relation to web-site availability. *Behav. Ecol. Sociobiol.*, 12:121-128.
- Shear, W. A. 1970. The evolution of social phenomena in spiders. *Bull. British Arachnol. Soc.*, 1:65-76.
- Szlep, R. 1958. Influence of external factors on some structural properties of the garden spider (*Aranea diademata*) web. *Folia Biol.* 6:287-306.
- Uetz, G. W. and J. W. Burgess. 1979. Habitat structure and colonial behavior in *Metepeira spinipes* (Araneae: Araneidae), an orb weaving spider from Mexico. *Psyche*, 86:79-89.
- Uetz, G. W., T. C. Kane and G. E. Stratton. 1982. Variation in the social grouping tendency of a communal web-building spider. *Science*, 217:547-549.
- Witt, P. N. and R. Baum. 1960. Changes in orb webs of spiders during growth (*Araneus diadematus* Clerck and *Neoscona vertebrata* McCook). *Behaviour*, 16:309-318.
- Witt, P. N., C. F. Reed and D. B. Peakall. 1968. *A Spider's Web*. Springer-Verlag, New York. 107 pp.

Manuscript received June 1985, revised January 1986.

ENVIRONMENT, REPRODUCTION AND THE SEX RATIO OF THE SOCIAL SPIDER *ANELOSIMUS EXIMIUS* (ARANEAE, THERIDIIDAE)¹

Fritz Vollrath

Smithsonian Tropical Research Institute
Balboa, Republic of Panama²

ABSTRACT

Three populations of the neotropical theridiid *Anelosimus eximius* were studied, one in the lowlands where the year shows distinct seasonal cycles, a second in the intermediate uplands, and a third in the mountains where seasonal changes in climate are less pronounced. Colonies in the lowlands showed a large monthly variation in egg production, presence of immature spiderlings and colony biomass. Colonies in the mountains showed less variation. In all sites the sex ratios were variable but were always skewed in favor of females. The sex ratio bias was independent of seasonal factors. It was presumably also independent of other environmental factors, with the exception of predation, which apparently was suffered more by females.

INTRODUCTION

Even in the tropics, seasonal change in the environment has an observable influence on the presence of many short lived organisms. In tropical Panama many terrestrial invertebrates like insects (Wolda 1977, 1978) and spiders (Robinson and Robinson 1970, Lubin 1978, 1980) show clear annual cycles or seasonal depressions in activity and/or abundance. Towards the end of the dry season, for example, very few spiders are present in the lowlands whereas they are quite abundant at most other times of the year. Colonies of the social spider *Anelosimus eximius*, however, persist for many years at the same location and are active in the dry season when most other spiders have vanished.

The effects of the environment on *A. eximius* were studied by comparing colonies in several sites with different degrees of seasonal change. Colonies generally raise about two generations a year and special interest was taken in the reproductive aspect of a colony's cycle, including egg production and the ratio of the sexes. Like in other social spiders (Buskirk 1981) but unlike the solitary spiders (in Lit.), the sex ratio of *A. eximius* is heavily skewed in favor of females (Christenson 1984, Vollrath 1985, Aviles in press).

Anelosimus eximius (Keyserling) is a neotropical social theridiid (Levi 1956, 1972). Many individuals share a communal web (nest, colony) and cooperate in web-building and prey capture (Simon 1891, Brach 1975, Tapia and DeVries 1980, Vollrath 1982, Christenson 1984). Colonies forming part of a cluster are

¹Presented in a symposium, "Social Behavior in Spiders," at the National Meeting of the American Arachnological Society, June 17, 1984.

²Mailing address: Department of Zoology, South Parks Road, University of Oxford, Oxford, OX1 3PS, UK.

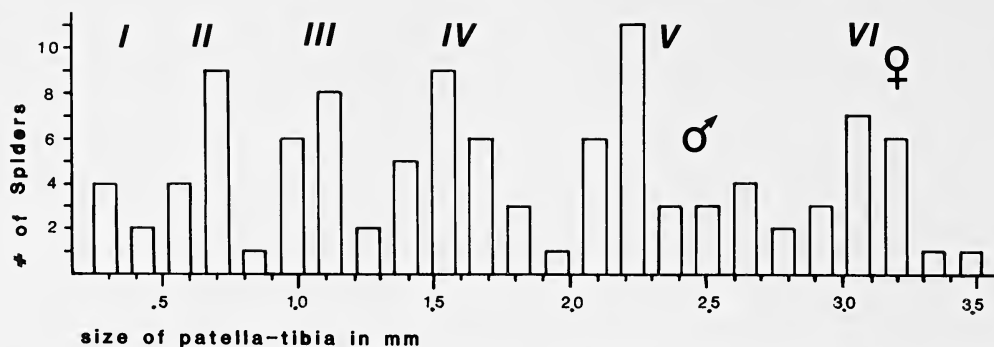

Fig. 1.—Histogram displaying the size distribution of *Anelosimus eximius* collected in two colonies in Panama. The length of the patella-tibia of the first leg was measured. Mature males were found in size 2.4 mm, mature females from size 3 mm upwards. The roman numerals above the columns indicate the instars (beginning with I at eclosion from the egg sac).

founded by budding, or by one female which may be joined by others (Christenson 1984), all having been inseminated in the parental nest (Vollrath 1982). Colonies far from other colonies are presumably founded by single females since emigrant females seem to travel alone (Vollrath 1982). A well established colony can grow to contain many thousand individuals in one nest, and a colony cluster with its offshoot nests may persist for many years in one site (Robinson pers. comm., Vollrath unpubl.). However, few single female foundations are successful and colony clusters are few and far between (Vollrath 1982, Christenson 1984).

Adult males are smaller and weigh less than adult females (Levi 1963). It appears that after emergence from the egg case the male undergoes four molts to reach maturity, whereas the females mature in the fifth or sixth instar (Fig. 1). Both sexes reach maturity about two months following eclosion, (Aviles in press) although growth can be slightly faster or considerably slower (Overall and Ferreira 1982). In the field adult females have been observed to live for approximately three months (Aviles in press), and under laboratory conditions they may live up to 4 months, males lived up to two months in the lab (Vollrath unpubl.).

The egg cases are spheres 4 mm in diameter, covered with tough grey silk and containing from 17 to 53 eggs, depending on the locality and the nutritional state of the colony (Vollrath unpubl.). The spiderlings are ready to leave the egg case after about 20 to 30 days (Overall and Ferreira 1982, Aviles in press). They emerge readily when the average relative humidity is high, but when it is low they stay inside the protective egg case and may even die there. Egg sacs are constructed in the center of the colony and are tended (guarded) there by subadult or adult females. Tending entails carrying the egg sac in the chelicerae and manipulating it with the mouth parts (Christenson 1984). It is possible that the spiderlings cannot open the egg sac by themselves, and need a female's help. Egg sacs may be cannibalized—opened by members of the colony and the contents eaten (Christenson 1984).

All members of the colony from instar three onward (with the notable exception of the adult males) contribute towards colony maintenance, web construction and repair, and prey capture (Tapia and DeVries 1980, Christenson 1984). Like most male spiders, males of *A. eximius* leave a dragline behind when

moving about but they do not appear to do so in the orderly fashion of an immature or a female *Anelosimus* repairing the nest or the capture threads. Male prey only on small insects which they do not share. Males do, however, join female feeding aggregations. Spiderlings of the first instar may feed on prey captured and predigested by older instars. More often they are seen soliciting and receiving regurgitation fluid from females (compare Kullmann and Kloft 1968, Lubin 1982).

In Panama, *A. eximius* is found at forest edges or inside the forest, in clearings or tree falls, where the webs are built at heights between 1 to 6 meters. The communal web consists of a horizontal, tightly woven bowl (the retainer web) with a loose network of vertical threads (the snare) above. Flying or jumping insects are arrested in their path by the vertical threads and tumble onto the retainer web, where they are chased by the spiders. The bowl section of the web consists of many layers of silken threads, laid down continuously during the entire life of the nest. It is remarkably strong, comparable to a fine fabric. Holes ripped by falling twigs or cut by foraging ants are quickly repaired. In the dry season, the spiders are less active, and leaves accumulate in the web changing the appearance of the colony (compare Fig. 2 in Simon 1891; Fig. 1 in Brach 1975; Fig. 1 in Vollrath 1982; Fig. 1 in Christenson 1984).

The numbers of spiders in a colony (colony size) is correlated with the size of the bowl webbing (Fig. 2), which enabled me to estimate the spider population of colony clusters from the size of individual webs. The estimate for one colony complex in El Valle was about 40,000 spiders in 37 colonies (nests), stretching 30 meters along the edge of a small forest. The estimated mean colony size was 1130 spiders (\pm sd 1150).

In the same habitat, and often adjacent to colonies of *A. eximius*, one may find single nests of the subsocial congeneric *Anelosimus juncundus* (O. P.-Cambridge). On rare occasions, as observed in the El Valle highlands, the small individual webs of single *A. juncundus* females were joined by a dense network of threads, thus forming large webs containing several mature females and their offspring. These webs correspond in their dimensions to colonies of *A. eximius* (Fig. 2) and closely resemble nests of this species. Adult females in aggregations of *A. juncundus* are highly aggressive towards one another and spread themselves out inside the shared web structure. The immatures, in contrast, mingle freely. In *A. eximius* individuals of all stages seem to be attracted to one another, during the day they form dense aggregations of spiders in the retreats.

MATERIALS AND METHODS

The data presented here were collected during a study of *A. eximius* in Panama (April 1978-May 1979), where three sites were studied in detail: (a) the lowland semi-deciduous forest (altitude 30 meters above sea level) on the Bohio Peninsula (79°49', 9°11') and the Pipeline Road Site (Parque Nacional Soberania 79°45', 9°10'), (b) a similar site at a higher elevation (300 meters) at the El Llano-Carti Road (79°4', 9°15'), and (c) two locations in the cloud forest near El Valle (elevation 880 meters, 80°9', 8°37'). Colonies were also collected from Anchiote Road (80°, 9°29'), Mahe-Bayano (78°49', 9°81') and El Cope (80°27', 8°38').

The climate in lowland Panama has two distinct seasons: a rainy season from May to December and a dry season from January to April. Although neither air

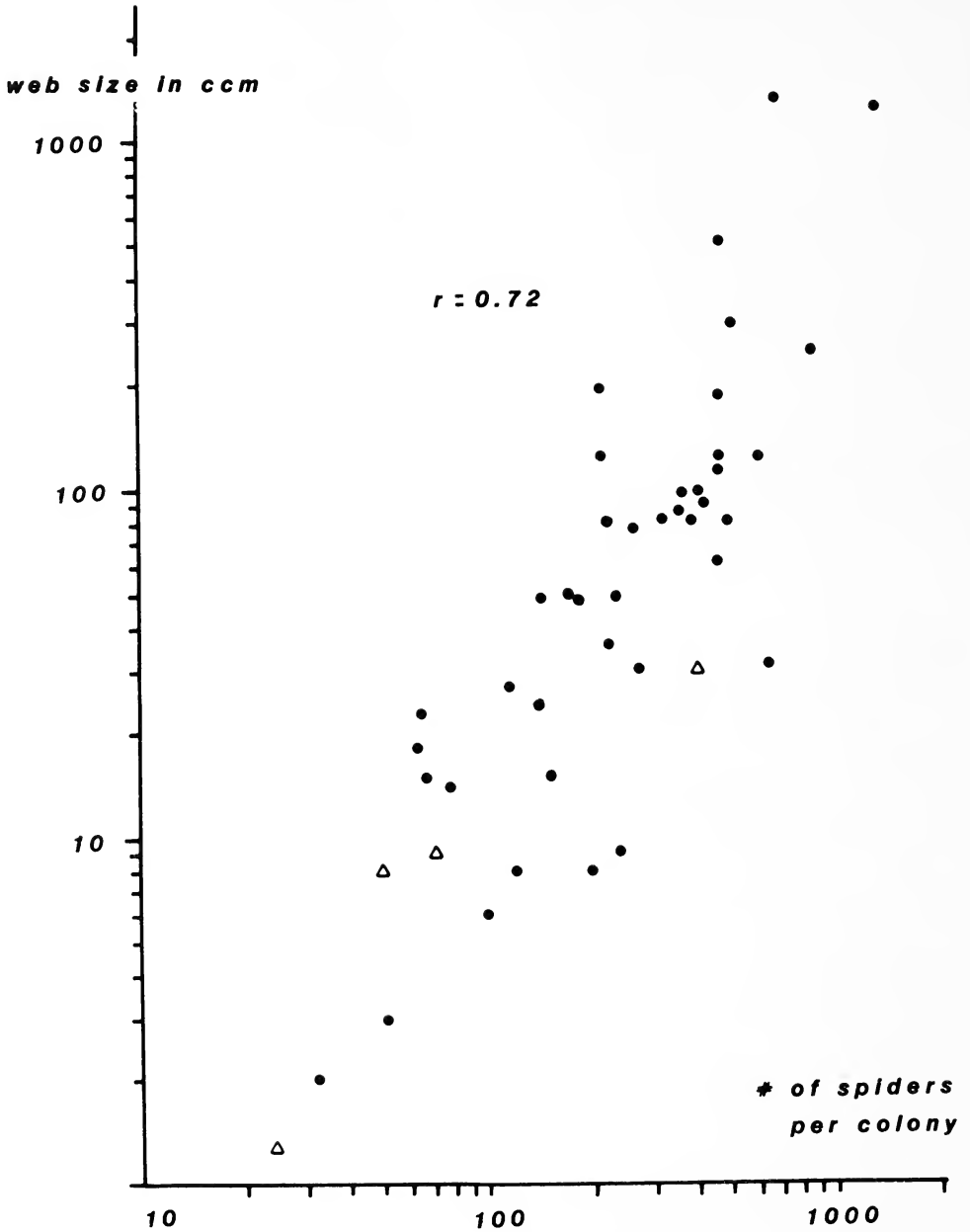

Fig. 2.—Scattergram and correlation coefficient (r) of the size (volume) of the retainer web and the number of *Anelosimus eximius* inhabiting it. Volume was calculated using the equation $2:3 \text{ phi}^i \cdot a \cdot b \cdot c$ (a = height of bowl, b = width, c = length of bowl). The formula of the regression line was $y = x^a + b$. Each point represents one colony of *A. eximius*, the triangles represent colonies of the subsocial congeneric *A. juncundus*.

temperature nor humidity changes drastically inside the forest (ESPI report 1976), the presence or absence of rain and wind, as well as the seasonal distribution of prey insects (Robinson and Robinson 1970, Wolda 1977, 1978) allow the assignation of different environmental qualities to each season (Vollrath 1980); in the lowlands, for instance, March is a rather severe month for spiders (Lubin 1978). The effects of the seasons are less pronounced in the higher elevations,

especially in the cloud forest, where light afternoon showers fall throughout the year (unpubl. RENARE data).

Suitable colonies were collected in the field and taken into the laboratory where they were analyzed: the spiders were extracted, classified, and counted. Classification was by size, and the different size classes were presumed to represent instars (see Fig. 1). Suitability was judged by the apparent health of the colony and by the ease with which the web could be tipped into a large plastic bag without the loss of animals. Sometimes the area underneath a web was covered with sheets which were later inspected for escapees, showing that only strong shaking initiated escape responses in all but the first and second instar spiderlings. Older instars escaped in similar proportions, which permits the comparison of all collection data (even in the few cases where spiders might have escaped during collection), as long as the data are represented as percentages. In addition to sampling whole colonies (data in Table 1) I censused other colonies in the field, without disturbance, repeatedly over a one year period, counting spiders in situ. Most of these data were not used in the analysis (but see Fig. 7), since rarely was the vision good enough to count and classify all spiders.

The calculations of biomass (wet weight) use weight measurements of 5 live spiders of each size class, which gave the following mean weights: size class 1 = 0.5 mg, 2 = 1 mg, 3 = 2 mg, 4 = 3 mg, 5 = 7 mg, female (6) = 15 mg and male = 7 mg (Vollrath unpubl.). I give no standard variation since the spiders had been preselected to be of roughly medium weight for their size class, as judged by the state of their abdomens.

RESULTS

Effects of seasonality.—The three sites: lowland, intermediate and high elevation were compared in the effects they exert on the population dynamics of *A. eximius*. The colony cluster on the El Llano-Carti Road initially (April 1978) consisted of over 20 large (about 2000 spiders each) to medium sized colonies (about 600 spiders each). Later (June) many new colonies were founded in the vicinity by single females which were often joined by other females. During the time from May until September gravid females emigrated from most of the old (mature) colonies (Vollrath 1982), departing from the top of the vertical threads. It is unusual for *Anelosimus* to be active during the day in these parts of the nest, and since I only twice saw a male here, I assume that males do not take part in the emigration. In September the colonies in this site began to dwindle, with many sickly or dead spiders hanging in the webbing. It is conceivable that a virus had spread and contaminated all or most colonies. At the end of December only two nests were left, much reduced in size. Because of the combined effects of emigration and possible epidemic, the interpretation of data from the El Llano site will only be referred to qualitatively.

Seasonal changes in the composition of size classes were more apparent in the lowland sites of Bohio and Pipeline than in the highland El Valle sites (Fig. 3 and Table 1). The lowland colonies contained very few egg sacs in April, the end and severest month of the dry season. With two exceptions however, they had plenty of egg sacs throughout the rainy season and at the beginning of the dry season. In March/April I found only a single egg sac in 4 colonies, the mean

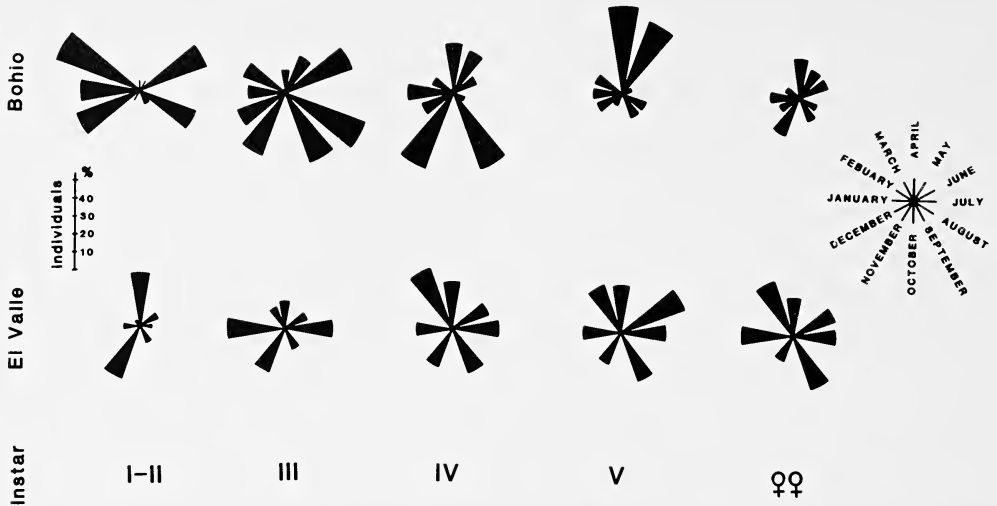

Fig. 3.—Size class composition of colonies collected in the lowland (Bohio) and the highland sites (El Valle). Each circular histogram represents the annual cycle (reading clockwise), the length of each sector gives the relative proportion of spiders (in percent) of the particular size class (indicated by the roman numeral) at the sampling month (compare Table 1).

number of egg sacs in 4 colonies was 6 in August/September (Table 1a). The El Valle colonies, in contrast, had egg sacs throughout the year: in 5 high elevation colonies I found a mean number of 6.4 egg sacs during March/April, and a mean of 15.2 during August/September (Table 1c). Even the El Llano site had a fair number of egg sacs in April (Table 1b).

The proportion of young in each colony also gives some indication about the seasonality of reproduction. In the lowland sites no first or second instar young were found in April/May and very few in September/October. In the highland sites young were present throughout the year. In both sites the composition of other instars varied. This is not astonishing since colonies even at the same site seemed to differ from one another, in exposure to the elements, to prey, parasites and predation. However, in the lowland site fourth and fifth instars showed marked preponderances during certain times of the year, fourth instars at the end of the rainy season and fifth instars at the beginning of the rainy season. In both sites adult females were present throughout the year, so were males. The difference between the sites is most easily expressed by the coefficient of variation (CV, Simpson et al. 1960) of the instar composition. The CV for the lowland colonies was $CV = 60$ ($n = 14$), for the high elevation colonies it was $CV = 36$ ($n = 14$): the colonies in the elevation site showed greater uniformity throughout the year than those in the lowlands.

The proportional representation of instar numbers masks the true extent of the difference between the two sites. The seasonal investment in reproduction is better represented by the proportion of a colony's biomass tied up in the different age classes, which depicts the differences better (Fig. 4). The seasonal aspect in the lowland colonies is apparent in the biomass distribution of the early instars which is concentrated in February and September. In the lowlands, most of a colony's biomass at the beginning of the dry season consists of females, while during the dry season a large proportion consists of young. At the beginning of the next rainy season nearly all biomass is tied up again in subadult or adult females,

Table 1.—Colony composition at the three study areas. The sample month is given first, followed by the total number of spiders (spids), the number of adults (ads), the number of males ($\delta\delta$), the adult sex ratio (ratio = males as proportion of adults), the number of egg sacs (eggs), and finally the ratios of females to egg sacs (♀ : eggs) and males to egg sacs (♂ : eggs). Lowland colonies were collected in: Bohio (a), Pipeline Road (b), Anchiote Road (c), Bayano-Mahe (d); two colonies are shown, which were not collected, but where censused accurately in the field (*).

BIOHIO (a), PIPELINE (b), ACHIOTE (c), BAYANO (d)

Month	spids	ads	$\delta\delta$	ratio	eggs	♀ :eggs	♂ :eggs
Jan. (b)	493	74	12	0.17	21	3.0	0.6
Feb. (a)	413	32	4	0.13	0	—	—
March (d)	379	51	10	0.2	0	—	—
April (c)	213	90	6	0.07	0	—	—
(a)	574	72	12	0.13	1	60.0	12.0
(a)	365	86	14	0.17	2	36.0	7.0
May (b)	787	147	30	0.2	8	14.6	3.8
June (a)	425	65	3	0.05	11	5.6	0.3
(d)	459	160	24	0.15	17	8.0	1.4
Aug. (a)	844	95	4	0.04	1	91.0	4.0
(a)	999	120	5	0.04	9	12.9	0.6
Sept (b)	476	8	7	0.5	0	—	—
Nov. (a)	228	46	3	0.07	14	3.1	0.2
Dec. (b)	398	55	13	0.25	5	8.4	2.6
\bar{x}	503	79	10.5	0.16	6.4	24.3	3.3
\pm sd	227	42	8.1	0.12	7.1	29.5	3.8

EL VALLE

Month	spids	ads	$\delta\delta$	ratio	eggs	♀ :eggs	♂ :eggs
Jan.	423	117	10	0.08	19	5.6	0.5
March	463	147	11	0.07	6	22.7	1.8
	598	172	19	0.11	11	13.9	1.7
April	671	146	14	0.1	10	13.2	1.4
	268	56	12	0.2	9	4.9	1.3
	631	123	24	0.14	13	8.4	1.9
June	365	59	12	0.2	2	13.5	6.0
	485	111	11	0.1	3	33.3	3.7
	1002	340	32	0.09	76	4.1	0.4
July	738	168	17	0.1	40	3.8	0.4
	298	77	12	0.17	3	21.7	4.0
Sept.	145	22	4	0.17	8	2.3	0.5
	386	50	12	0.25	21	1.8	0.6
Nov.	619	64	16	0.25	4	12.0	4.0
\bar{x}	506	118	14.7	0.15	16.1	12.2	2.1
\pm sd	221	80	6.8	0.06	20.0	9.7	1.7

EL LLANO-CARTI

Month	spids	ads	$\delta\delta$	ratio	eggs	♀ :eggs	♂ :eggs
March	1305	301	42	0.14	0	—	—
April	434	43	15	0.35	14	2.0	1.0
	1226	128	10	0.06	7	12.8	0.7
May	190	61	9	0.08	5	6.8	0.6
July	490	90	14	0.18	16	6.4	1.1
	475	232	5	0.18	41	46.4	8.2
Aug.	210	26	3	0.12	2	7.7	0.7
Sept.	379	189	21	0.11	14	13.5	1.5
Sept.*	(200)	52	0	—	0	—	—
Nov.*	(270)	18	12	0.66	0	—	—
\bar{x}	588	134	14.9	0.15	12.4	13.7	2.0
\pm sd	433	98	12.4	0.09	12.9	15.0	2.8

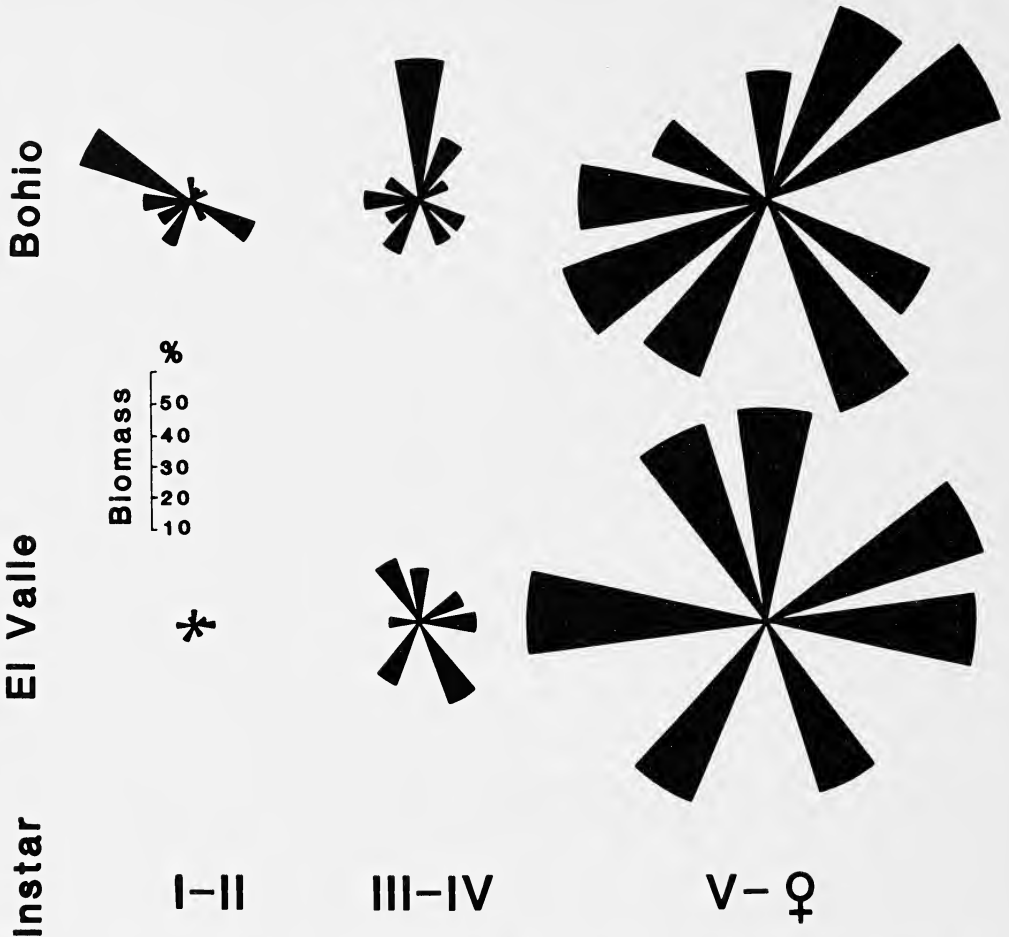

Fig. 4.—Representation of the distribution of colony biomass in the different size classes. The biomass was calculated using the mean wet weight of 5 spiders for each class (see methods). For explanation of the circular histograms see Fig. 3.

ready to reproduce and rear a second generation. No such variation was found in the biomass distribution of colonies in the highland sites.

The quantitative observations on 38 colonies are supported by qualitative observations on about a hundred colonies which were not disturbed (Vollrath unpubl.). They allow the generalization that in different parts of the country colonies in similar habitats show similar trends in egg production and instar representation, with pronounced seasonal influences in the lowlands.

Colonies in the El Llano site were intermediate in their reproductive cycle (Table 1b). The average colony size was similar in all three sites. The average ratios of adults to juveniles was also quite similar between the two upland locations: 0.23 in El Llano and 0.23 in El Valle. It was considerably lower in the lowlands (0.16) where colonies generally had a smaller proportion of adults. The average number of egg sacs produced in the upland site was intermediate (12) between the altitude site (16) and the lowlands (6). The ratio of adult females to egg sacs was also intermediate (14) when compared with the lowlands (24) and the highlands (12). These differences are not statistically significant because of the large variation in all sites.

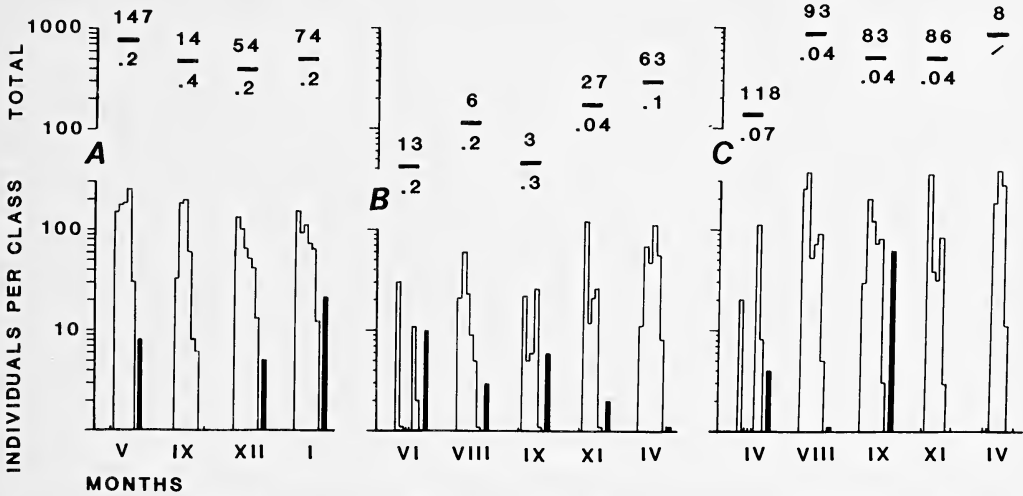

Fig. 5.—Dynamics of three *Anelosimus eximius*' colonies censused repeatedly in the field at the lowland sites of Bohio and Pipeline Road in 1978-1979. The X-axis denotes the month (roman numerals). The upper horizontal bars show the total number of spiders in the colony. The number above each bar give the number of adult spiders, numbers under the bars denote the sex ratio (male proportion of adults). The dark columns give the number of egg sacs. The actual numbers of spiders of the different size classes (1 to 5 and ♀♀) is shown for the sample months by histogram outlines.

In order to study the dynamics of individual nests, many webs were examined regularly in the field, with minimal disturbances. Only in few cases was the visibility inside the colony consistently good enough to view 80 to 90% of all spiders, thus allowing me to use these data. Figure 5 shows the changes in the population of three colonies in a lowland site during the course of one year. Colony A contained no egg sacs in September, colonies B and C had few egg sacs in November and April. The age profiles of the three colonies differed in several aspects, which may be explained by the differences in size. Colony A, initially being the largest with 1000 individuals, maintained a stable age distribution throughout the year. Both colonies B and C were growing in size, B was the smaller of the two. The instar composition of the two colonies B and C was similar in most months, often showing a depression in the middle instars. No similar depression was found in the age structure of the mature colony A. Other colonies, monitored with less accuracy (Vollrath unpubl.), showed similar variations in egg production and age structure, again possibly correlated with colony size.

In the El Valle site *Anelosimus juncundus* also seems to reproduce throughout most of the year. There I found many nests, each containing one adult female with eggs in the months of April, June, July, September and November. In the other sites *A. juncundus* may be seasonal, but I found too few individuals to make a definite statement. In the El Llano site 6 females and egg sacs were found in July, and in the lowland site of Cerro Galera I found only two females with eggs, in May. Although *A. juncundus* was at times found abundantly in the high elevation and the intermediate sites, it appeared to be rare in the lowlands.

Sex ratios.—In all three habitats the adult sex ratios were highly variable but (with a few notable exceptions) heavily biased in favor of females (Table 1, 2). There were no differences in the mean sex ratios between the three habitats (0.16,

Table 2.—Composition of new foundations in the El Llano-Carti site. The July column shows the number of first instar spiderlings. 64 days later, in September, all had progressed to the fourth instar, when the males show their sex. Only 4 males were then still immatures (included in ♂♂), the other males had just matured. Immature females are denoted by IV (fourth instar).

	July	IV	September ♀♀	♂♂	mortality	sex ratio
	32	12	8	4	25%	0.17
	21	0	9	2	48%	0.18
	78	4	30	2	54%	0.06
	39	12	8	4	38%	0.17
	40	20	4	2	35%	0.08
	31	6	6	1	58%	0.08
	41	5	15	2	46%	0.09
\bar{x}	40	8	12	2	43%	0.12
\pm sd	17	6	9	1	11%	0.04

0.15, 0.15). On average, colonies in all three sites contained about five females for every male.

We have seen that pronounced local environmental factors influence the reproduction and instar composition of colonies. It is conceivable that the large variance in the sex ratios could be the result of environmental influences, comparable to the effect of temperature on the sex determination of a turtle egg (Bull 1981). Such effects might show in a correlation between the colony sex ratio and the time of year. No significant correlation was found (Fig. 6a), suggesting that a direct seasonal influence on the sex ratio is not likely. What about indirect influence?

Seasonality expresses itself in changes of the abiotic as well as the biotic factors. In the lowland the exposure to desiccation by wind and sun increases during the dry season when the trees are shedding their leaves. At the same time the number of prey decreases while predation presumably increases (Robinson and Robinson 1970). Inside a nest of *A. eximius* these factors are probably buffered, the degree of insulation depending on colony size. For example, on a sunny afternoon in the dry season the relative humidity was 74% inside a (1000 individual) lowland colony, when outside it was 60% (dry/wet bulb temperature measurements). Large colonies have large collections of leaves which provide more shelter and also chambers of relatively constant conditions. Large colonies may also be affected less by predation (Fig. 5, and Vollrath and Windsor in press).

A scattergram of colony size plotted against the sex ratio shows no significant trend if all data are lumped (Fig. 6b). However, a weak correlation ($r = 0.36$) was found for the high elevation site, where the sex ratio of larger colonies was more female biased. This correlation improved and became significant ($r = 0.663$, $0.05 < P < 0.01$) when the number of mature spiders only (instead of all individuals of a colony) was plotted against the sex ratio (Fig. 7a). If analyzed this way, colonies in the lowlands which were censused repeatedly also showed some correlation ($r = 0.479$, $0.1 < P < 0.05$, Fig. 7c), whereas still no correlation was found for the collected lowland colonies (Fig. 7b).

Colony size can be taken, to a very limited degree, as an indicator for the age of a colony. Isolated small nests are generally new foundations, isolated large nests are several generations older (Vollrath 1982). Since most of the colonies

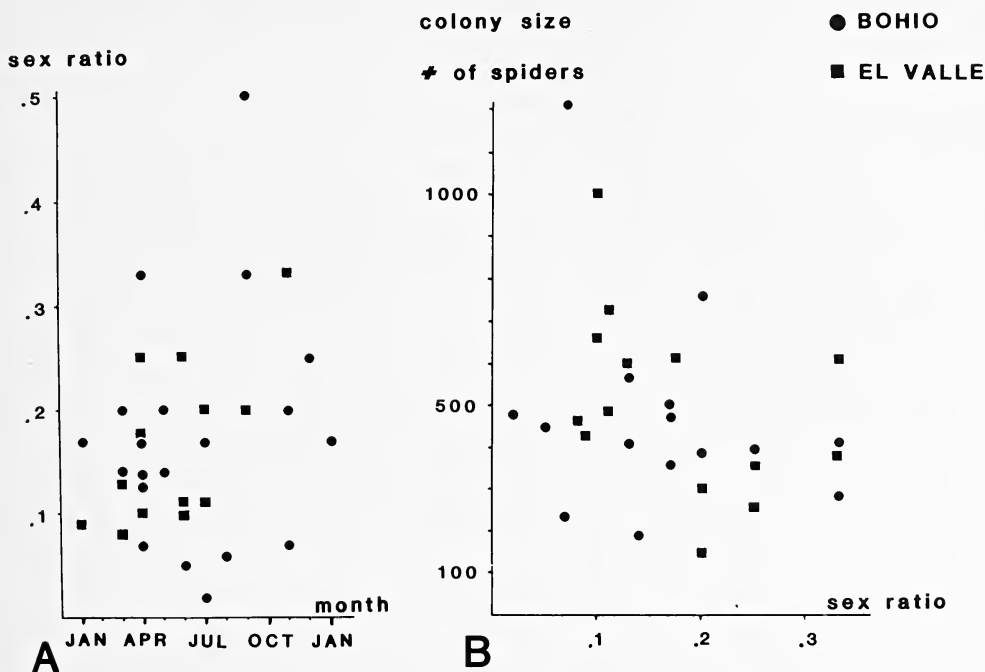

Fig. 6.—Scattergrams of: (A) colony sex ratio and the time of year, and (B) colony sex ratio and colony size. Sex ratios were calculated as the male proportion of all adults.

sampled had been taken from colony clusters, they may have been recent offshoots of much older foundations. None of the new foundations that I either observed to occur naturally or which I experimentally started, survived for longer than 6 months (Vollrath 1982). However, I do have, from some of these natural foundations, some information on the sex ratios of new colonies (Table 2). The mean ratio (\pm s.d.) in these colonies was $0.12 (\pm 0.04)$, this is lower than the primary sex ratio of $0.08 (\pm 0.01)$, Vollrath 1986) but higher than the average ratio of mature colonies (0.15 ± 0.09).

Reproduction is measured by the number of offspring produced, and we saw that reproduction was clearly seasonal in the lowland sites and may have had a seasonal component in the highland site. Reproduction is presumably also a joint effort of the male as well as female since no spider is known to be parthenogenetic. Although the sex ratios showed seasonal trends, the possibility remains that a correlation may be found between reproductive effort and the relative abundance of either sex. The ratios of males or females to the number of egg sacs present in a colony are given in Table 1. There were no differences in the sex ratios between the two sites. There were, however, pronounced differences in the average number of egg sacs produced by colonies in the two sites, production was more than double in the altitude sites when compared with the lowland sites (16 versus 6). Accordingly the ratio of females to egg sacs was also lower: in the altitude site one egg sac was produced for every 12 females, in the lowlands it was one egg sac for every 24 females. A similar trend was found in the ratio of males to egg sacs. This analysis of colony composition and presence of egg sacs shows that the ratio of females to egg sacs was generally more than 10 to one, whereas the ratio of males to egg sacs was roughly two to one (Vollrath 1986).

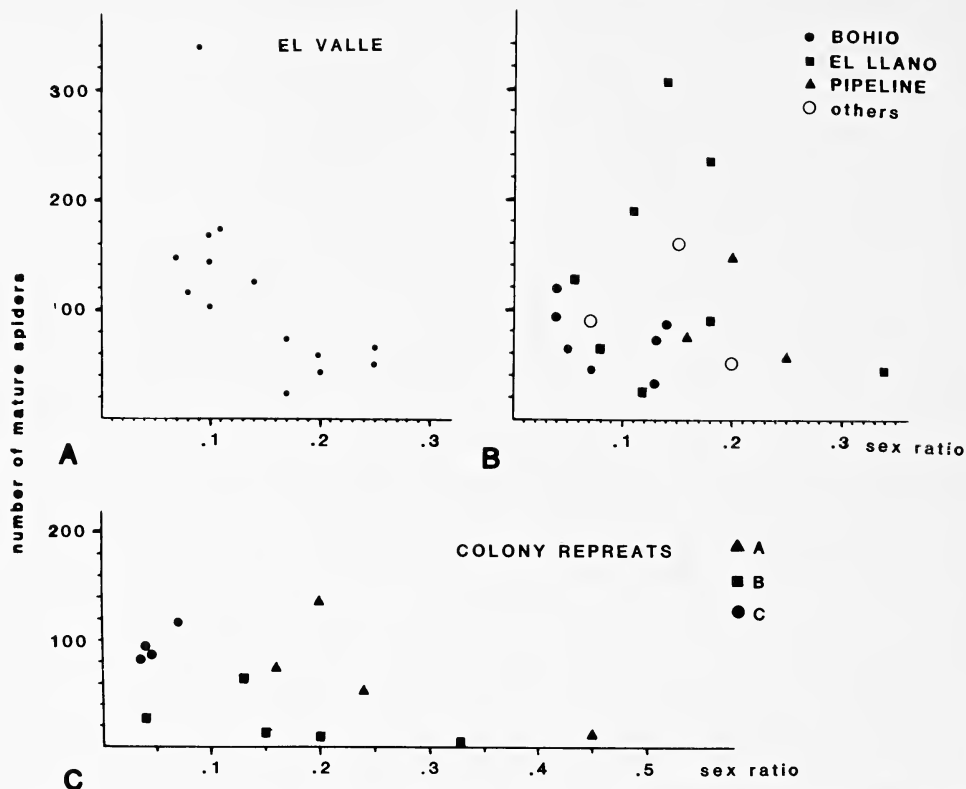

Fig. 7.—Scattergram of adult colony size and sex ratio for (A) highland colonies, (B) lowland and altitude colonies, and (C) colonies in the lowlands which were censused repeatedly. A and B represent data from Table 1, C represents the colonies from Fig. 5.

DISCUSSION

Population dynamics and seasonality.—It emerges from the data on instar composition of colonies, and even more from the calculations of colony biomass, that the populations of *A. eximius* had different dynamics in the two main sites, highlands and lowlands. It is most likely that these differences were due to the differences in environmental parameters, which had a clear seasonal component. It cannot be inferred from the data that the differences in colony composition were due entirely to abiotic factors. Heavy rainfall, for example, destroys the capture threads and may force “the colony” to spend much energy in frequent rebuilding during the rainy season. On the other hand, active spiders desiccate quickly in very dry conditions (Davies and Edney 1952). In order to conserve water in the dry season colony activities are possibly reduced to the extent of neglecting the web, thus foregoing prey capture and nutrient uptake. However, it is more likely that a combination of biotic and abiotic factors was responsible for the observed differences in the two sites. Most prey insects, for example, have activity cycles clearly delineated by the seasons (Wolda 1977, 1978, ESPI report 1976). Predators, especially predatory arachnids and insects, will presumably also show seasonality to match the temporal distribution of their spider prey. Lubin (1978) has shown that most solitary spiders in the lowland forest of Panama have distinct seasonal distribution and reproduction. My study suggests that the social

spider *A. eximius* is less seasonal than its solitary sympatric, which practically disappear from the habitat in the late dry season.

The seasonality of *A. eximius* expresses itself most strongly in the presence of egg sacs, it appears that in the lowlands reproduction stops during the height of the dry season, in March and April. The highland colonies, on the other hand, had egg sacs all year round. Although egg production was markedly different between the two sites, the sex ratios showed no comparable trends.

Sex ratios and environment.—The sex ratios in colonies of *A. eximius* were heavily biased in favor of females (Overal and Ferreira 1982, Christenson 1984, Aviles in press, Vollrath 1982, Vollrath 1986). In some reptiles the sex ratio in a population can be affected by the environment during the time of egg development (Bull 1981), because ambient temperature has a modifying effect on the hormonal control of sex determination. In spiders the sex is not determined hormonally but by the chromosomal set of each cell individually [(viz the presence of gynandromorphs, comparable to insects (White 1973)]. Still, abiotic factors in the environment could conceivably influence the sex determination of a developing egg. This possibility seems unlikely since the observed variation in sex ratios, although quite large, showed neither seasonal nor locality differences (Table 1). Moreover, colonies collected at the same time in the same location showed as large a variation as colonies collected at different times in different locations.

If abiotic factors are ruled out, could possibly biotic factors be responsible for the sex ratio bias? Three main agents of biotic influence can be distinguished: parasitism, predation and prey (nutrition). Of these nutrition is the most difficult to separate from abiotic effects, since the activity of prey insects is in itself often triggered by abiotic factors. Direct, long-term observations of prey capture for the discussed colonies is lacking (but compare Nentwig 1985), therefore prey intake was deduced from colony size, for this spider biomass may be a better measure than number of individuals. Since environmental conditions might have been unique at the time when the measured sex ratio of a colony was fixed (i.e. when the adult spiders developed), adult numbers or biomass would have to be compared with the sex ratio of each colony. However, different rates of the mortality of males and females could easily mask any effect nutrition might have had.

The highland sites showed a clear and significant negative correlation between the number of adults and the sex ratio. A similar effect was apparent in the three colonies censused repeatedly in the lowland site, but it was not visible in the other lowland colonies. How can we explain the observation that colonies with fewer adults contained relatively more males? If we assume the same mortality for both sexes, this observation would lead us to deduce that fewer male eggs were laid at times when prey was abundant, and the colony was growing. Such an effect would be independent of absolute colony size, as a comparison of the altitude and the censused colonies shows. However, could not all the data, including the observations on all lowland colonies, be better interpreted by the alternative assumption that males and females experience different mortality?

In *A. eximius* the average primary sex ratio was much lower than the average adult sex ratio observed in the field (Vollrath 1986), this suggests that many females have either died or left the colony between hatching, maturation, and older age. *A. eximius*' males rarely venture far from the retreats, and they do not

assist in web construction nor in prey capture. The females, on the other hand, expose themselves to predators during the daily routine of capture-thread construction, and to injury during the attack and subduction of potentially dangerous prey insects (Vollrath and Rohde-Arndt 1983). They may even defend the colony with considerable risks to their own lives (Vollrath and Windsor in press). It would appear that female mortality was on average twice male mortality (difference between primary and actual sex ratios: 0.08 vs 0.15), if the hypothesis of higher female mortality is correct. Such an interpretation of the sex ratio data would be supported by the observation that large colonies survive better than small colonies (Vollrath 1982), an indication that in nests with many "workers" more of them survive. This is supported by the observation that small foundations had on the whole a lower mean sex ratio than the larger mature colonies (0.12 vs 0.15). The data on new foundations comes from nests in which the sexes are about to mature, or have just done so (Table 2). It appears that at this moment already more female than male spiderlings have died. After maturation this ratio shifts even more towards the males (to 0.15), since male and female adults are presumably more dissimilar than the juveniles.

Instead of mortality, female emigration might account for the rate of female "disappearance", which was 50% higher than that of the males. In *A. eximius* emigration seems to be a well defined phenomenon, associated with a particular behavior pattern (Vollrath 1982). Females move into the upper strands of the capture area, where they depart, using their floating dragline as a bridge. This behavior, combined with the observation that it occurs during the morning, a time when the spiders normally are at rest in the retreats, makes emigration quite obvious. The many hundreds of females I observed moving in the capture threads prior to departure were only twice joined by a male, which both times retreated back into the colony. Only one of the 380 single or multiple female foundations examined contained a male which presumably had followed the females to their new nest a few meters away from the likely parental colony (Vollrath unpubl.). Emigration seems to occur at specific times of the year and the day, and it is unlikely that females leave in any significant numbers at other times (Vollrath 1982). Males presumably leave their parental colony only rarely, and possibly accidentally. It is concluded that emigration is not a likely explanation for the observed bias in the sex ratios.

Summarizing the discussion on the sex ratio bias I want to conclude that the sex ratio in *Anelosimus eximius* is probably not influenced by abiotic environmental factors. The strong bias in favor of females is due to the fact that many more female eggs are laid. This effect of a biased primary sex ratio is slightly softened by higher female mortality due to predation, which is a biotic vector of the environment with considerable local and temporal variation.

ACKNOWLEDGMENTS

I thank M. and B. Robinson, D. Windsor and Y. Lubin for many critical discussions during the course of the study, and I thank M. Ridley, D. Smith and especially Y. Lubin for helpful critique of the manuscript. The study was financed by a Smithsonian Postdoctorate Fellowship and I thank the director and staff of STRI for their continuous help. The American Arachnological Society generously supported a trip to present this work at the meetings in New Orleans.

LITERATURE CITED

- Aviles, L. in press. Sex ratio bias in the social spider *Anelosimus eximius*, with comments on the possibility of group selection. *Amer. Nat.*
- Brach, V. 1975. The biology of the social spider *Anelosimus eximius*. *Bull. S. California Acad. Sci.*, 74:37-41.
- Bull, J. J. 1981. Sex determination in reptiles. *Quart. Rev. Biol.*, 55:3-16.
- Buskirk, R. 1981. Sociality in Arachnida. Pp. 281-387, *In Social Insects* (H. R. Hermann, ed.). Academic Press, New York.
- Christenson, T. 1984. Behaviour of colonial and solitary spiders of the theridiid species *Anelosimus eximius*. *Anim. Behav.*, 32:725-734.
- Davies, M. E. and E. B. Edney. 1952. The evaporation of water from spiders. *J. Exp. Biol.*, 29:571-582.
- ESPI Report. 1976. Environmental Science Program. Vol. IV, D. Windsor, ed. Smithsonian Tropical Research Institute, Panama.
- Kullmann, E. and W. Kloft. 1968. Traceruntersuchungen zur Regurgitationsfuetterung bei Spinnen. *Zool. Anz.*, 32:487-497.
- Levi, H. W. 1956. The spider genera *Neottiura* and *Anelosimus*. *Trans. Amer. Microsc. Soc.*, 75:407-421.
- Levi, H. W. 1963. The American spiders of the genus *Anelosimus* (Araneae, Theridiidae). *Trans. Amer. Microscop. Soc.*, 82:30-48.
- Levi, H. W. 1972. Taxonomic-nomenclatural notes on misplaced Theridiid spiders, with observations on *Anelosimus*. *Trans. Amer. Microscop. Soc.*, 91:533-538.
- Lubin, Y. D. 1978. Seasonal Abundance and diversity of web-building spiders in relation to habitat structure on Barro Colorado Island, Panama. *J. Arachnol.*, 6:31-51.
- Lubin, Y. D. 1980. Population studies of two colonial orb-weaving spiders. *Zool. J. Linn. Soc.*, 70:265-287.
- Lubin, Y. D. 1982. Does the social spider *Achaearanea wau* (Theridiidae), feed its young? *Z. Tierpsychol.*, 60:127-134.
- Nentwig, W. 1985. Social spiders catch larger prey: a study of *Anelosimus eximius* (Araneae, Theridiidae). *Behav. Ecol. Sociobiol.*, 17:79-85.
- Overall, W. L. and Pa. Ferreira da Silva. 1982. Population dynamics of the quasisocial spider *Anelosimus eximius* (Theridiidae). *In The Biology of Social Insects* (M. D. Breed, C. D. Michener and H. E. Evans, eds.). Proceedings of the IXth Congress International Union for the Study of Social Insects, Boulder, Colorado.
- Robinson, M. H. and B. Robinson. 1970. Prey caught by a sample population of the spider *Argiope argentata* in Panama. *Zoo. J. Linn. Soc.*, 49:345-357.
- Simon, E. 1891. Observations biologiques sur les Arachnides. *Ann. Soc. Ent. France*, 60:5-14.
- Simpson, G. G., A. Roe and R. C. Lewontin. 1960. *Quantitative Zoology*. Harcourt, Brace and World, Inc., New York.
- Tapia, Y. and T. DeVries. 1980. Tolerancia y cooperation en la Araña social *Anelosimus juncundus* del bosque tropical Rio Palenque, Ecuador. *Rev. Univ. Cat. Ecuador*, 8:51-74.
- Vollrath, F. 1980. Male body size and fitness in the web-building spider *Nephila clavipes*. *Z. Tierpsych.*, 53:61-78.
- Vollrath, F. 1982. Colony foundation in a social spider. *Z. Tierpsych.*, 60:313-324.
- Vollrath, F. 1986. Eusociality and extraordinary sex ratios in spider. *Behav. Ecol. Sociobiol.*, 18:283-287.
- Vollrath, F. and D. Rohde-Arndt. 1983. Prey capture and feeding in the social spider *Anelosimus eximius*. *Z. Tierpsych.*, 61:334-340.
- Vollrath, F. and D. Windsor in press. Subsocial and social *Anelosimus*: a comparison especially of nest defense. *In Proceedings IXth Internatl. Arachnol. Congress* (M. H. Robinson, ed.).
- White, M. J. D. 1973. *Animal cytology and evolution*. 3rd ed., Cambridge Univ. Press, Cambridge, UK.
- Wolda, H. 1977. Fluctuation in abundance of some Homoptera in a neotropical forest. *Geo-Eco-Trop*, 31:229-257.
- Wolda, H. 1978. Seasonal fluctuations in rainfall, food and abundance of tropical insects. *J. Anim. Ecol.*, 47:369-381.



THE AMERICAN ARACHNOLOGICAL SOCIETY

President:

Jerome S. Rovner (1985-1987)
Department of Zoology
Ohio University
Athens, Ohio 45701

President-Elect:

William A. Shear (1985-1987)
Department of Biology
Hampden-Sydney College
Hampden-Sydney, Virginia 23943

Membership Secretary:

Norman I. Platnick (appointed)
American Museum of Natural History
Central Park West at 79th Street
New York, New York 10024

Treasurer:

Norman V. Horner (1985-1987)
Department of Biology
Midwestern State University
Wichita Falls, Texas 76308

Secretary:

Brent D. Opell
Department of Biology
V.P.I.S.U.
Blacksburg, Virginia 24061

Archivist:

Vincent D. Roth
Box 136
Portal, Arizona 85632

Directors:

Frederick A. Coyle (1985-1987), **W. G. Eberhard** (1986-1988), **Susan E. Riechert** (1985-1987).

Honorary Members:

P. Bonnett, W. J. Gertsch, H. Homann, †B. J. Kaston, R. F. Lawrence, H. W. Levi, G. H. Lockett, A. F. Millidge, M. Vachon, T. Yaginuma.

The American Arachnological Society was founded in August, 1972, to promote the study of Arachnida, to achieve closer cooperation between amateur and professional arachnologists, and to publish *The Journal of Arachnology*.

Membership in the Society is open to all persons interested in the Arachnida. Annual dues are \$25.00 for regular members, \$15.00 for student members. Correspondence concerning membership in the Society must be addressed to the Membership Secretary. Members of the Society receive a subscription to *The Journal of Arachnology*. In addition, members receive the bi-annual newsletter of the Society, *American Arachnology*.

American Arachnology, edited by the Secretary, contains arachnological news and comments, requests for specimens and hard-to-find literature, information about arachnology courses and professional meetings, abstracts of papers presented at the Society's meetings, address changes and new listings of subscribers, and many other items intended to keep arachnologists informed about recent events and developments in arachnology. Contributions for *American Arachnology* must be sent directly to the Secretary of the Society.

CONTENTS

THE JOURNAL OF ARACHNOLOGY

VOLUME 14

NUMBER 2

Symposium: Social Behavior in Spiders

George W. Uetz, University of Cincinnati, organizer and editor of symposium

- Effects of colony size on web structure and behavior of the social spider *Mallos gregalis* (Araneae, Dictynidae), *William James Tietjen*.....145
- Genetic differences in social behavior and spacing in populations of *Metepeira spinipes*, a communal-territorial orb weaver (Araneae, Araneidae), *George W. Uetz* and *Karen R. Cangialosi*.....159
- The ecology of the cooperative spider *Agelena consociata* in Equatorial Africa (Araneae, Agelenidae), *Susan E. Riechert*, *Rosemarie Roeloffs*, and *Arthur C. Echternacht*.....175
- High prey abundance and a reduction in cannibalism: The first step to sociality in spiders (Arachnida), *Ann Lundie Rypstra*.....193
- Population genetics of *Anelosimus eximius* (Araneae, Theridiidae), *Deborah R. R. Smith*.....201
- Influence of food supply on the duration of the gregarious phase of a maternal-social spider, *Coelotes terrestris* (Araneae, Agelenidae), *Bertrand Krafft*, *Andre Horel*, and *Jean-Michel Julita*.....219
- Societies of spiders compared to the societies of insects, *Roger Darchen* and *Bernadette Delage-Darchen*.....227
- Courtship and alternative mating tactics in a social spider, *Yael D. Lubin*.....239
- Orb-weaving spiders in aggregations modify individual web structure, *Ruth E. Buskirk*.....259
- Environment, reproduction and the sex ratio of the social spider *Anelosimus eximius* (Araneae, Theridiidae), *Fritz Vollrath*.....267

Cover photograph, *Mallos gregalis* Simon, by G. W. Uetz

Printed by the Texas Tech Press, Lubbock, Texas, U.S.A.

Posted at Lubbock, Texas, in August 1986

58
t.

The Journal of ARACHNOLOGY

OFFICIAL ORGAN OF THE AMERICAN ARACHNOLOGICAL SOCIETY

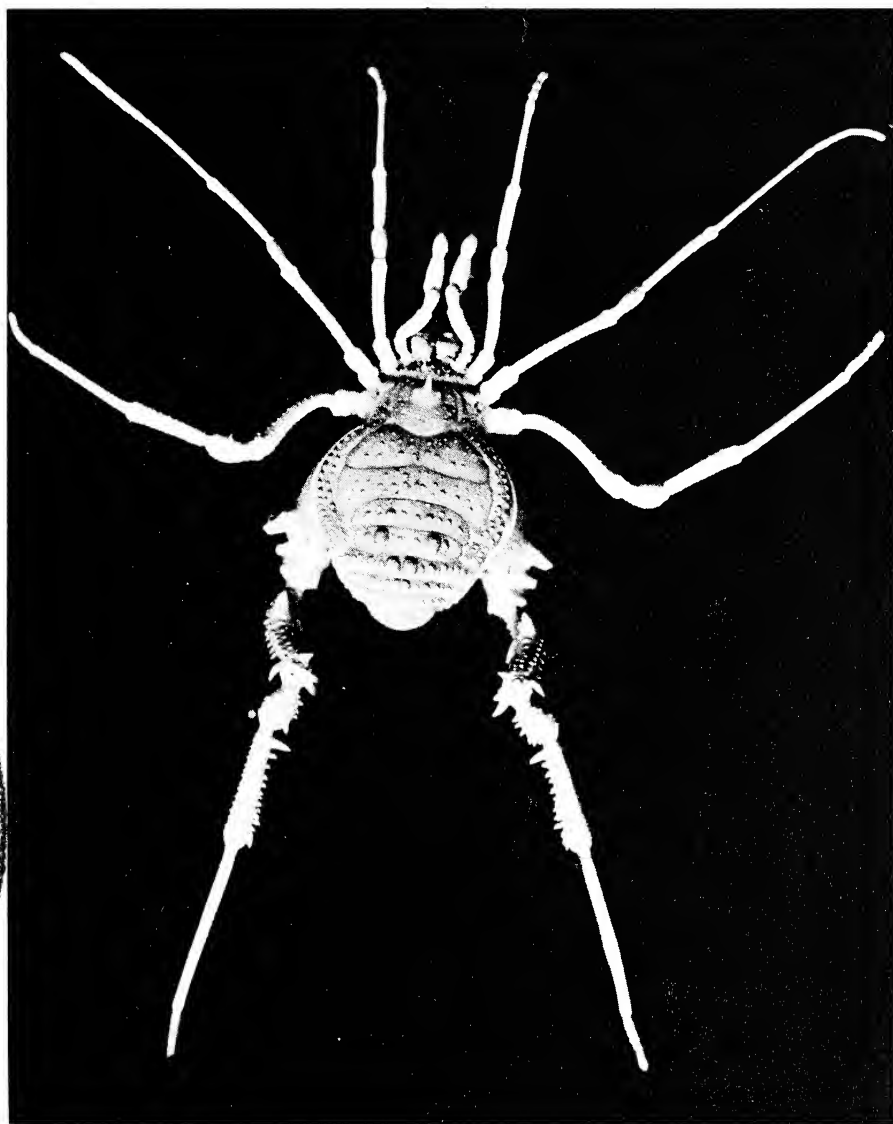

SEP 10 1987
LIBRARIES

VOLUME 14

FALL 1986

NUMBER 3

THE JOURNAL OF ARACHNOLOGY

EDITOR: James E. Carico, Lynchburg College

ASSOCIATE EDITOR: William B. Peck, Central Missouri State University (Until 30 April 1987); Jerome S. Rovner, Ohio University (After 1 May 1987)

ASSISTANT EDITOR: James C. Cokendolpher, Texas Tech University

EDITORIAL BOARD: C. D. Dondale, Agriculture Canada; W. G. Eberhard, Universidad de Costa Rica; M. E. Galiano, Museo Argentino de Ciencias Naturales; W. J. Gertsch, American Museum of Natural History; N. F. Hadley, Arizona State University; V. F. Lee, California Academy of Sciences; H. W. Levi, Harvard University; E. A. Maury, Museo Argentino de Ciencias Naturales; W. B. Muchmore, University of Rochester; M. H. Muma, Western New Mexico University; N. I. Platnick, American Museum of Natural History; G. A. Polis, Vanderbilt University; S. E. Riechert, University of Tennessee; M. E. Robinson, U.S. National Zoological Park; V. D. Roth, Southwestern Research Station; J. S. Rovner, Ohio University; W. A. Shear, Hampden-Sydney College; W. J. Tietjen, Lindenwood College; G. W. Uetz, University of Cincinnati; C. E. Valerio, Universidad de Costa Rica; S. C. Williams, San Francisco State University.

THE JOURNAL OF ARACHNOLOGY (ISSN 0161-8202) is published in Spring, Summer, and Fall by *The American Arachnological Society* at Texas Tech Press.

Individual subscriptions, which include membership in the Society, are \$25.00 for regular members, \$15.00 for student members. Institutional subscriptions to *The Journal* are \$40.00. Correspondence concerning subscriptions and memberships should be addressed to the Membership Secretary (see back inside cover). Back issues of *The Journal* are available from Dr. Susan E. Riechert, Department of Zoology, University of Tennessee, Knoxville, TN 37916 U.S.A., at \$10.00 for each number; the Index to Volumes 1-10 is available for \$10.00. Remittances should be made payable to *The American Arachnological Society*. Correspondence concerning undelivered issues should be addressed to the Texas Tech Press, Texas Tech University, Lubbock, Texas 79409, U.S.A.

Change of address notices must be sent to the Membership Secretary.

Detailed instructions for the preparation of manuscripts appear in the Fall issue of each year, and can also be obtained from the Editor and the Associate Editor. Manuscripts that do not follow those instructions will be returned to the author(s) without benefit of review. Manuscripts and all related correspondence must be sent to Dr. Jerome S. Rovner, Associate Editor, Department of Zoological Sciences, Ohio University, Irvine Hall, Athens, Ohio 45701, U.S.A.

PROOFS, REPRINTS, and CHARGES: Authors will receive a reprint order form along with their proofs. Reprints are billed at the printer's current schedule of costs. All authors will be billed by the printer for page charges. The charge per journal page will be assessed as follows: \$20.00-nonmembers; \$15.00-members acknowledging grant, institutional, or other support; \$10.00-full members who do not have (and do not acknowledge) support; \$5.00-student members who do not coauthor with full members and who do not acknowledge support. Members may have page charges waived or reduced for a limited number of pages; a statement of justification for waiver should accompany the manuscript when it is first sent to the Associate Editor for review.

BIOGRAPHY

B. J. KASTON, AMERICAN ARANEOLOGIST 1906-1985: A BIOGRAPHY AND BIBLIOGRAPHY

Leonard S. Vincent

Division of Biological Sciences
Fullerton College
Fullerton, California 92634

When B. J. Kaston did not attend the June, 1985, American Arachnological Society meeting in Los Angeles, many of us who knew him well suspected his health had worsened. A small delegation was sent to his home in nearby Santa Ana to present him with an award for his special contribution to arachnology and a huge home-made get-well card signed by the meeting's attendants. B. J. died two months later on August 24, 1985, in, as he would put it, his 80th year of life.

In preparing this biography, I expected to find evidence of B. J.'s dedication to araneology. To be sure, testimonials to his enormous contribution were abundant. What was surprising was to find that his contributions were done in his spare time—nights and weekends. B. J.'s academic appointments were teaching positions, a situation which might have caused a less disciplined and determined person to become a frustrated researcher and a mediocre teacher. B. J. Kaston, however, turned a series of difficult situations into positive ones, excelling as both teacher and researcher.

B. J. (Benjamin Julian) was born July 2, 1906, in New York City. His early home life was less than ideal. His mother died when he was six and he disliked his father, a real estate salesman. In later years, B. J. seldom wrote or spoke of his parents or his two sisters and brother.

Unlike some other luminaries in arachnology, B. J. was not given to the study of spiders early in his life. However, his high regard for intellectual achievement was established early in his academic career. B. J. graduated June 24, 1926, from the esteemed De Witt Clinton High School in New York City, scoring in the 99th percentile in all of the comprehensive Regent's Exams. On the other hand, he kept a low social profile in high school; he did not join science clubs or participate in other high school activities of record.

B. J. entered Ohio State University as a zoology major in 1926 and remained one year before transferring to North Carolina State University at Raleigh. At NCSU, B. J., also known at the time as "Doc", earned a B. S. in zoology by taking an extensive range of zoology courses with a minor in botany on top of 23 hours of chemistry. In spite of rigorous course loads, he managed to earn membership in the Pine Burr Society (a local scholarship group), Phi Kappa Phi



Fig. 1.—B. J. Kaston 1941.



Fig. 2.—B. J. Kaston 1978 (courtesy H. Levi).

(a national honor fraternity), and the Leazar Literary Society (a debate and oratory organization). He was also a member of the wrestling squad and chemistry club. His interest in photography, recognized even then, was noted in the 1930 NCSU year book *Agromeck*: "He was a familiar figure around the campus chasing bugs and snakes. Of course, wherever he went he took his trusty photographic outfit . . ." This would aptly describe B. J. in his later years as well. To support his studies at NCSU during the depression years, he worked as a lifeguard and as a teaching assistant in zoology and botany.

At NCSU, B. J. met Elizabeth Haban who later became his wife, collecting partner, rearer of spiders collected, and illustrator for his Ph.D. dissertation, for *How To Know The Spiders*, and *Spiders of Connecticut*. Elizabeth persuaded him, many years later, to accept the invitation of H. E. Jaques, the individual in charge of the *Pictured-Key Nature Series*, to write *How to Know the Spiders*. B. J. graduated from NCSU in June of 1930 and entered the Ph.D. program in zoology at Yale in September of that year. There he met Alexander Petrunkevitch, who suggested that B. J. study spiders. Previous to this, B. J. had not expressed more than a casual interest in spiders. Four years later B. J. finished his dissertation: "A Study of The Senses and Sense Organs Involved in the Courtship of Some Vagabond Spiders."

Much to his disappointment, B. J.'s first full-time job after graduating from Yale in June of 1934 did not involve teaching. He obtained a position at the Connecticut Experiment Station where he worked on elm beetles and Dutch Elm Disease for the next four years. His tendency to work nights and weekends on spiders became evident and continued throughout his long professional career.

While at the Experiment Station, he published 15 papers on spiders. He also collected many of the spiders that were used in his major monograph, *Spiders of Connecticut*, a project he conceived of doing as early as 1935. These spiders, as well as the bulk of the rest of his collection, he donated to the Smithsonian in 1984.

In 1938, he obtained his first teaching appointment in Gainesville, Georgia, at Brenau College, a small, four-year liberal arts college for women, where he had a heavy teaching load. His spare time included many trips to the American Museum of Natural History to study their spider collection (a practice he retained for years) and to visit his good friend Willis Gertsch. He often embarked on short combined collecting and sightseeing tours which always seemed to include a visit with fellow araneologist H. K. Wallace in Florida. He also continued writing long, detailed letters to colleagues requesting or giving advice and information on spiders or the latest news on other “spiderologists”, a habit maintained until his death. Much of his non-teaching time in his early years at Brenau must have been spent working on *Spiders of Connecticut*, which he finished in 1941. The seven year delay (to 1948) in publication was a constant source of frustration for him.

B. J.’s tenure at Brenau was interrupted by a one-year sojourn (1943-1944) in the army, identifying mosquitoes that were sent in from various army bases in the southern U.S. as part of a malaria control project. Partial deafness in one ear precluded him from other responsibilities. The president of Brenau managed to communicate to the authorities that B. J.’s capabilities were more valuable in the classroom, and B. J. was released from further service.

Judging from the comments of several of his former Brenau students, B. J. was considered a great teacher. One wrote that he had “tremendous energies—and managed to impart an excitement in all the courses he taught” and that “he stimulated questions and thought and encouraged us whenever he saw a spark of interest.” Others commented that he “made learning a joy,” and was a “teacher one would never forget.”

After a summer research fellowship at Harvard in 1945, B. J. joined the faculty of the Zoology Department of Syracuse University in New York. While there he set to the task of updating the *Spiders of Connecticut* whose publication was still delayed due to the war. B. J. remained at Syracuse University only one year before accepting an offer from the Teachers College of Connecticut (now the Central Connecticut State University). This offered close proximity to the Yale libraries and the Connecticut Agricultural Experiment Station. Unfortunately, there was no graduate program in biology; consequently, he recommended to those students who expressed an interest in doing graduate studies on spider biology that they work with H. K. Wallace at the University of Florida. John F. Anderson was the only undergraduate student of B. J.’s to eventually complete a dissertation on spiders and to continue working on them professionally. Many others gained an appreciation for spiders and continued studying them as an avocation. Some students benefited from funds which B. J. donated anonymously for academic scholarships.

His major spare time project during his beginning years at Teachers College was the preparation of what he referred to as his “little book”, *How to Know the Spiders*. Since the book was limited in size by the publisher, B. J. felt that it would not be able to contain much for the specialist but would better serve the beginner in the field.

At this time, B. J. was also in demand for his popular talks on nature photography. His skills as a photographer had earned him a Five Star rating in nature slides from the Photographic Society of America and a medal at the Rochester International Exhibit. B. J. eventually donated most (several thousand) of his slides to the American Museum of Natural History.

B. J. remained at Teachers College until his retirement in July of 1963. His breadth of teaching experience was unusual: he taught every one of the 14 courses that Teachers College and Brenau College offered in biology! In spite of his teaching schedule, he still found time to advise and encourage students on matters relating to graduate studies. A laboratory at Central Connecticut State University will be given B. J.'s name in remembrance of his contributions.

In 1964, B. J. accepted a lectureship at San Diego State College and also remarried. His new wife, Barbara (Szymanski), a former student of B. J.'s at Teachers College and now a practicing psychiatrist in California, did graduate work in cytogenetics at SDSC. Barbara worked with black widow chromosomes.

In 1967, B. J. received a three-year NIH grant to study black widows. In 1969, he began the preparation of his revised edition of *How to Know the Spiders*, which became available in 1972. He was president of the Arachnologists of the Southwest for 1970 and 1971.

Thus, B. J. remained in high gear at San Diego State College for nine years until his second retirement in 1973. In that year, he wrote Wallace of his planned retirement, noting that he was "the last of our crowd to do so," the crowd being Gertsch, Lowrie, Muma, and Wallace. In the same letter he mentioned that he would be taking on "some" of the editorial work of the newly formed Journal of Arachnology. B. J. served on the editorial board for the next 12 years. He was appointed (1980) to Associate Editor, a position he held until his death. Also, in 1973 he attended the seminal meeting of the American Arachnological Society in Silver City, New Mexico. B. J. participated in the founding of the A.A.S. and later, 1978, was elected for a three-year term to the three-member Board of Directors.

To gain a fuller appreciation of B. J. and the magnitude of his contribution to araneology, one needs to go beyond a mere chronology of his life. An analysis of his publications and correspondence with colleagues reveals his independent nature, his perfectionism, his descriptive rather than experimental approach to research, his dedication and determination, his forthrightness and liberal use of a barbed pen, and his breadth of knowledge and interests regarding araneology and araneologists.

B. J. published 86 papers; in all but six he was the sole author. Of the six, he was the senior author of five. His collaborative papers dealt mostly with his elm beetle work. Surely part of his lone araneology was due to his being isolated in Georgia for many years and to the circumstance of most of his employment: 100 % teaching positions in colleges without graduate programs.

B. J.'s publications were legend for their accuracy and detail, both in style and content. Herb Levi (pers. comm.) wrote, "I still cannot see how any man can produce a work (*Spiders of Connecticut*, 1948) with so few misprints and so few mistakes." Martin Muma, as well as B. J. himself, referred to Kaston as an "old maid" on terminology and detail.

The publications on spiders of B. J. Kaston began in 1935 and continued for fifty years. His early major papers were on pheromones and courtship behavior.

The many shorter works were on parasites of spiders, black widow distributions, and nomenclatural notes. Taxonomic papers first appeared in 1938. Shortly after his monumental *Spiders of Connecticut* (1948), the first of his many reviews appeared. Post-1960 papers covered various morphological topics such as intersexes, ocular anomalies, a review of little known aspects of spider behavior, an interpretation of the evolution of webs, and a descriptive monograph on the comparative biology of black widows. There were more papers on nomenclature, many more reviews, and, of course, two more editions of *How to Know the Spiders*, a large supplement to *Spiders of Connecticut*, and a revised *Spiders of Connecticut*. The black widow on the cover of this edition of *Spiders of Connecticut* reflected B. J.'s interest in the *Latrodectus* group.

B. J. continued writing until shortly before his death, since he could do this in relative comfort. Other activities associated with his study of spiders were gradually eliminated as various ailments worsened in his seventies. His poor eyesight, angina, and arthritic back restricted him to sedentary activities such as microscope work and editorial tasks. Eventually, peering into his scope became too painful. He still was able to critique the spider works of others and he determinedly continued to do so.

As a reviewer, B. J. was no less a perfectionist. Levi wrote, "B. J. was always the first one to point out a missing comma or some other minor mistake overlooked by the editor. I have always felt that I became more watchful lest B. J. discover any error or misprint or missing comma in one of my papers."

In manuscript reviews B. J. wanted to maintain high standards of writing, precision of illustration, and thorough reporting of literature. It was the non-araneologists and publishers who often received his sharpest, and often vehement, attacks. For example, in closing his 1950 book review of Duncan's *Webs In The Wind*, B. J. wrote, "Why the editor and the publisher saw fit to inflict such a volume on an unsuspecting public is incomprehensible. They would aid the humanizing of science most by suppressing the sale of such a mass of misinformation . . ."

Clearly, B. J. was forthright in his reviews, no matter who the writer. In his 1950 review of his friend Gertsch's *American Spiders*, B. J. used many superlatives and closed with "... the outstanding volume on these much maligned but extremely interesting animals." However, B. J. pointed out, "It is regrettable that the morphology of the reproductive organs has not been described sufficiently. . . ."

B. J.'s own publications are but a part of his overall contributions to araneology—a part, however, that can be quantified. The first edition of his "little book," *How to Know the Spiders*, sold over 16,000 copies. The second edition, 20 years later, sold close to 7,000 copies, and the last edition, 1978, has so far sold close to 7,000 copies. The 1948 edition of *Spiders of Connecticut* is the most widely used bulletin of the series (there are over 110), especially out of state. Indeed, it was listed 66 times in Science Citation Index from 1965 to 1984.

B. J.'s crusade for perfection and thoroughness was just as evident throughout his teaching career. His teaching assistants and students from the late thirties and early forties found him to be a "born teacher." Students from the 1950's and 1960's at Teachers College, who went on to get higher degrees in a biological science, wrote the following: B. J. "was the epitome of the professor's professor. Always known for his candor . . . Respected by those who knew and sensed his

dedication to the rigors of study and feared by those who were inept . . . [he] instilled a deep and abiding love for the scientific method” and “in class, he was a relentless pursuer . . . if you didn’t prepare or think, God help you; he could and would be merciless.” Lastly and perhaps most insightful: “He was similar to other men given to strong beliefs, he was sometimes wrong, but never in doubt.”

It is within B. J.’s prolific correspondence with colleagues that one can best sense his utter dedication to araneology. Reading his long, detailed letters to Exline-Frizzell, Gertsch, Muma, and Wallace, letters that covered close to half a century, one can observe certain aspects of the history of our discipline unfold, and its contributors come and go or come and stay. B. J.’s letters—he would sometimes write two or three a month to each of the above—usually consisted of a brief greeting and inquiry into family matters before they would dive into some aspect of araneology. Typically, he was either requesting information or, more often, providing information.

Simple questions put to B. J. often received detailed answers. In a 1951 letter, Harriet Exline-Frizzell referring to a statement in *Spiders of Connecticut* where B. J. indicated his preference for the use of Agelenidae over Agalenidae, asked B. J. if he was still of the same opinion considering that “the new rules call for correction of caligraphy or orthography in deriving Latin terms.” This triggered over a 500 word reply by B. J., part of which read: “ My opinion . . . still stands as on page 278. I try to follow the rules carefully, and as stated in the footnote, we have only Thorell’s opinion that there was a mistake in the translation from the Greek. Actually, Walckenaer did not give any derivation, and on pg 51 in *Tabl. Aran.* (of which I have a personal copy) appears this line ‘G. Agelene (*Agelena*) and in a footnote is given the species *naevia*. That it is not a typographic error can be shown by the fact that the spelling is the same in the running head of the page, and in the index. See opinion 34 of the Rules, and read what I say on page 52 of my monograph. See also p. 132 in Thorell’s “European Spiders”. Gaining momentum, B. J. continued “I am not adverse to changing the orthography when it can be shown that there is justification, e.g., *Chiracanthium*, p. 369, since this is covered by the transcription matter in the Rules. But I certainly am not going to change just because Pete, by fiat, issues an edict!” This led to a further exposé and criticism of Petrunkevitch’s preference of Aranei over Araneae, and B. J.’s strong endorsement of Araneae over Araneida.

Over the years, B. J.’s correspondence, in a large sense, served as unofficial newsletters or a clearing house of sorts, since he often had knowledge of who was doing what and where they were last seen. In these letters, he often expressed his concern about the lack of jobs for araneologists, lamented the loss of several of our colleagues to other professions, and referred to those who remained biologists but never worked on spiders beyond their dissertations as “still-born” Ph.Ds. All this with genuine sincerity.

B. J.’s outspoken participation in meetings of the A.A.S., his careful research and reviews, his consummate editorial expertise—B. J., always the scientist and teacher, will be missed. There will be no fourth edition of B. J.’s “little book”.

I thank the many friends, students, and associates of B. J.’s who contributed to this biography. I owe special gratitude to: J. F. Anderson, T. Cohn, A. Fuller, W. Gertsch, E. (Haban) Howard, R. Judd, B. Kaston, H. Levi, W. Peck, M. Muma, J. Rovner, E. Schlinger, B. Vincent, and H. K. Wallace.

BIBLIOGRAPHY OF B. J. KASTON

- 1935 The slit sense organs of spiders. *J. Morph.*, 58:189-209.
- 1936 and W. B. Becker. *Spathius canadensis* Ashm., a parasite of *Hylurgopinus rufipes* (Eichhoff). *J. Econ. Ent.*, 29:807.
- The senses involved in the courtship of some vagabond spiders. *Entom. Americana*, n.s., 16:97-167.
- The morphology of the elm bark beetle, *Hylurgopinus rufipes* (Eichhoff). *Connecticut Agr. Exper. Sta. Bull.*, 387:613-650.
- 1937 The distribution of black widow spiders. *Science*, 85:74.
- and D. S. Riggs. Studies on the larvae of the native elm bark beetle. *J. Econ. Ent.*, 30:98-108.
- Notes on hymenopterous parasites of elm insects in Connecticut. *Connecticut Agr. Exper. Sta. Bull.*, 396:351-361.
- Structural anomalies in spiders. *Bull. Brooklyn Ent. Soc.*, 32:104.
- The black widow spider in New England. *Bull. New England Mus. Nat. His.*, No. 65, p. 1-11, 11 figs.
- and G. E. Jenks. Dipterous parasites of spider egg sacs. *Bull. Brooklyn Ent. Soc.*, 32:160-165.
- Notes on dipterous parasites of spiders. *J. New York Ent. Soc.*, 45:415-420.
- 1938 Notes on little known New England Spiders. *Canadian Entom.*, 70:12-17.
- Family names in the order Araneae. *American Midl. Nat.*, 19:638-646.
- Mantispidæ parasitic on spider egg sacs. *J. New York Ent. Soc.*, 46:147-153.
- A note on synonymy in spiders. *Entom. News*, 49:258-259.
- Check list of elm insects. *Connecticut Agr. Exp. Sta. Bull.*, 408:235-242.
- and D. S. Riggs. On Certain habits of elm bark beetles. *J. Econ. Ent.*, 31:467-469.
- North American spiders of the genus *Agroeca*. *Amer. Midl. Nat.*, 20:562-570.
- New spiders from New England, with notes on other species. *Bull. Brooklyn Ent. Soc.*, 33:173-191.
- Check list of the spiders of Connecticut. *Connecticut Geol. Nat. Hist. Survey Bull.*, No. 60, p. 175-201.
- Notes on a new variety of black widow from southern Florida. *Florida Ent.*, 21:60-61.
- 1939 The native elm bark beetle in Connecticut. *Connecticut Agr. Exp. Sta. Bull.*, 420:1-39.
- and D. S. Riggs. Report of a survey of elm bark beetle populations in western Connecticut. *Connecticut Agr. Exp. Sta. Bull.*, 428:80-83.
- 1940 Another *Mantispa* reared. *Bull. Brooklyn Ent. Soc.*, 35:21.
- Flies and other insects that triumph over spiders. *J. Tennessee Acad. Sci.*, 15:413.
- 1941 *Mastophora cornigera* (Hentz), a spider new to New England, *In: Miscell. Notes*, 40th Report State Entom. [for 1940]. *Connecticut Agr. Exp. Sta. Bull.*, 445:379-380.
- 1943 Supplementary notes on family names in the Order Araneae. *Amer. Midl. Nat.*, 30:765-768.
- 1945 New spiders in the group *Dionycha*, with notes on other species. *Amer. Mus. Nov.*, No. 1290, p. 1-25.
- New Micryphantidae and Dictynidae with notes on other spiders. *Amer. Mus. Nov.*, No. 1292, p. 1-14.
- Notes on nematode parasites of spiders. *Trans. Connecticut Acad. Sci.*, 36:241-244.
- 1946 North American spiders of the genus *Ctenium*. *Amer. Mus. Nov.*, 1306:1-19.
- 1948 Spiders of Connecticut. *Connecticut Geol. Nat. Hist. Surv. Bull.* No. 70, p. 1-874, 2198 figs.
- 1949 The spiders of Hispaniola by E. B. Bryant. [Review] *Quart. Rev. Biol.*, 24:362.
- The Salticidae of Panama by A. M. Chickering. [Review] *Quart. Rev. Biol.*, 24:363.
- 1950 American Spiders by W. J. Gertsch. [Review] *J. Econ. Ent.*, 43:231.
- American Spiders by W. J. Gertsch. [Review] *Quart. Rev. Biol.*, 25:208-209.
- Webs in the Wind by W. Duncan. [Review] *Quart. Rev. Biol.*, 25:209-210.
- 1951 Pseudoscorpions of Illinois by C. C. Hoff. [Review] *Quart. Rev. Biol.*, 26:210.
- Phalangida from tropical America by C. J. and M. L. Goodnight. [Review] *Quart. Rev. Biol.*, 26:210.
- The spider genus *Tmarus* in Panama by A. M. Chickering. [Review] *Quart. Rev. Biol.*, 26:404.
- 1952 Guide to some common Colorado spiders by W. van Riper. [Review] *Quart. Rev. Biol.*, 27:216.
- The arachnid order Solpugida in the United States by M. H. Muma. [Review] *Quart. Rev. Biol.*, 27:216.
- The Life of the Spider by John Crompton. [Review] *Quart. Rev. Biol.*, 27:313-314.

- 1953 How to Know the Spiders. Wm. C. Brown, Dubuque, Iowa, 220pp.
- 1954 Is the black widow spider invading New England? *Science*, 119:192-193.
- Structure and function of the genitalia in some American agelenid spiders by R. L. Gering. [Review] *Quart. Rev. Biol.*, 29:74.
- The spider genera *Xysticus*, *Coriarachne*, and *Oxyptila*, etc., by W. J. Gersch. [Review] *Quart. Rev. Biol.*, 29:266.
- 1955 A check list of Illinois spiders. *Trans. Illinois Acad. Sci.*, 47:165-172.
- 1956 The genus *Eustala* in Central America by A. M. Chickering. [Review] *Quart. Rev. Biol.*, 31:55-56.
- 1957 Correct exposure with flash, for close-ups. *J. Photog. Soc. Amer.*, 23:40-43.
- 1959 Anatomy and Physiology Laboratory Manual and Workbook. Edwards Brothers, Ann Arbor, Mich., 200 pp.
- Laboratory manual and study guide for Biology. Edwards Brothers, Ann Arbor, Mich., 139 pp.
- The Tarantula by W. J. Baerg. [Review] *Quart. Rev. Biol.*, 34:146-147.
- Notes on pompilid wasps that do not dig burrows to bury their prey. *Bull. Brooklyn Ent. Soc.*, 54:103-113.
- The spider family Dictynidae by R. V. Chamberlin and W. J. Gertsch. [Review] *Quart. Rev. Biol.*, 34:313.
- The spider genera *Achaearanea*, *Theridion*, and *Sphyrotinus* from Mexico by H. W. Levi. [Review] *Quart. Rev. Biol.*, 35:153.
- 1961 A check list for directors arranging slide programs. *Turtlox News*, 39:284.
- Spider gynandromorphs and intersexes. *J. New York Ent. Soc.*, 69:177-190.
- 1962 Ocular anomalies in spiders. *Bull. Brooklyn Ent. Soc.*, 57:17-21.
- 1963 Deformities of external genitalia in spiders. *J. New York Ent. Soc.*, 71:30-39.
- Abnormal duplication of the epigynum and other structural anomalies in spiders. *Trans. Amer. Microsc. Soc.*, 82:220-223.
- 1964 The evolution of spider webs. *Amer. Zool.*, 4:191-207.
- 1965 Some little known aspects of spider behavior. *Amer. Midl. Nat.*, 73:336-356.
- 1966 Evolution of the web. *Natural History*, 75(4):126-133.
- 1967 Contribution a l'etude des Araignees de la famille des Lycosidae, etc., by Y. Guy. [Review] *Quart. Rev. Biol.*, 42:550.
- 1968 Remarks on black widow spiders, with an account of some anomalies. *Entom. News*, 79:113-124.
- 1970 Comparative biology of American black widow spiders. *Trans. San Diego Soc. Nat. Hist.*, 16:33-82.
- 1972 How to Know the Spiders, 2nd. Ed., Wm. C. Brown, Dubuque, Iowa, 290 pp.
- 1972 Some name changes in spiders. *Entom. News*, 83:105-106.
- Book reviews: Yates, *Spiders of Southern Africa*; Child, *Australian Spiders*; and Mascord, *Australian Spiders in Colour*. *Amer. Arachnol.*, No. 7:11-14.
- On *Tessarops maritima*, a nomen oblitum in spiders. *Entom. News*, 83:117-118.
- Some notes on pronunciation in Arachnology. *Notes Arachnol. Southwest*, No. 3:5-6.
- Web making in young *Peucetia*. *Ibid.*, pp. 6-7.
- Book reviews: Main, 1964, *Australian Spiders*. Hickman, V. V., 1967, *Some Common Tasmanian Spiders*, and Forster, R. R., 1967, 1968, 1970, *The Spiders of New Zealand*. *American Arachnol.*, No. 8:19-20.
- 1973 Four new species of *Metaphidippus*, with notes on related jumping spiders (Araneae, Salticidae) from the eastern and central United States. *Trans. Amer. Microsc. Soc.*, 82:106-122.
- 1974 Remarks on the names of families and higher taxa in spiders. *J. Arachnol.*, 2:47-51.
- Book review. *Spiders of the United States* by R. Headstrom. *J. Arachnol.*, 2:205-207.
- 1975 Book review. *New Zealand Spiders* by R. R. and L. M. Forster. *J. Arachnol.*, 3:211.
- 1976 Supplement to the Spiders of Connecticut. *J. Arachnol.*, 4:1-72.
- 1978 How to Know the Spiders, 3rd. ed., Wm. C. Brown Co., Dubuque, Iowa, 272 pp.
- Recent bites by spiders other than *Latrodectus* and *Loxocoles*. *California Vector Views*, 25:25-27.
- 1981 Spiders of Connecticut. *Bull. Dept. Environm. Prot., State Geol. Nat. Hist. Surv.*, 70:1020 pp.
- W. J. Gertsch: a bibliography and biography. *Bull. Amer. Mus. Nat. Hist.*, 170:7-14.
- 1982 Additional ocular anomalies in spiders. *J. Arachnol.*, 10:279-281.

- 1983 Book review. Spider Communication, Mechanisms and Ecological Significance, P. N. Witt and J. S. Rovner (eds.). *J. Arachnol.*, 11:103-104.
- , Aldred, D. M. and B. J. Kaston. A list of Utah spiders, with their localities. *Great Basin Nat.*, 43:494-522.
- 1985 Book review. The spiders of Great Britain and Ireland by M. J. Roberts. *J. Arachnol.*, 13:275-276.

Invited paper.

FEATURE ARTICLES

POSTEMBRYONIC DEVELOPMENT OF *LATRODECTUS HASSELTII* THORELL (ARANEAE, THERIDIIDAE)

Michael F. Downes

Zoology Dept., James Cook University of North Queensland
Post Office, James Cook University
Queensland, 4811, Australia

ABSTRACT

In northern Queensland the eggs of *Latrodectus hasselti* have a lower developmental temperature threshold than do postembryos which in turn have a lower threshold than first instar spiderlings prior to emergence from the egg sac. Emerged spiderlings, however, develop normally at temperatures below that which would prevent emergence from the egg sac. Arrested development of free-living first instar spiderlings may require a temperature of 10°C or less (Forster 1984). The subsequent stadia for both sexes are in general shorter than for the American species of *Latrodectus* which mature later and live longer than *L. hasselti*. For all species of *Latrodectus* for which temperature-controlled data are available males have consistently longer early stadia than do females, partly compensating for an asynchrony in time to maturity. *L. hasselti* males usually matured in the fourth instar, females in the sixth.

INTRODUCTION

The genus *Latrodectus* Walckenaer occurs widely throughout the tropical and temperate regions of the world. Since 1959 the Australian species was known as *Latrodectus mactans hasselti* and was considered conspecific with *L. mactans* Fabricius populations as far distant as the Mediterranean (Levi 1959, 1966). However, this is no longer tenable, and the taxonomy of the genus is still largely unresolved (Levi 1983). Recent investigations (Forster and Kingsford 1983, Forster 1984) uphold the view that it is a species in its own right, *Latrodectus hasselti* Thorell, and it appears to have become established in New Zealand (Forster 1984) where two related species, *L. katipo* Powell and *L. atritus* Urquhart occur (Forster and Kingsford 1983).

Being one of the few genera of spiders whose venomous bite has in some cases been fatal to humans, *Latrodectus* has been the subject of numerous clinical investigations and toxicological studies. In Australia an early survey of araneism (see Maretic 1984) reported 98 cases, including seven deaths, of envenomation by the bite of *L. hasselti*, but concluded that the mortality rate for the population at large could not be estimated (Ingram and Musgrave 1933). Cleland (1942) reported further Australian case histories and Hornabrook (1951) gave a clinical account of *L. katipo* araneism in New Zealand. Sutherland and Trinca (1978)

reported 2144 cases occurring in Australia and New Zealand in the eight years to 1976.

The general and developmental biology of *Latrodectus* is best known for those species occurring in the Americas, a particularly detailed and extensive account being that of Kaston (1970). Rempel (1957) gave a comprehensive description of the embryology of *L. mactans*.

The most notable reports on the postembryonic development of *Latrodectus* are those of Deevey and Deevey (1945), Deevey (1949), McCrone and Levi (1964, 1966), Cariaso (1967), Kaston (1970), Gonzales (1979), Forster and Kingsford (1983) and Forster (1984). Developmental studies of this kind have proved to be of fundamental importance in the elucidation of complex taxonomic problems in a number of spider genera including *Latrodectus* (Seligy 1970).

Some useful data on the postembryonic development of *L. hasselti* in Australia were given by Softly and Freeth (1970); unfortunately, that study gave fewer details for females than for males, and temperature was not controlled. Forster (1984) was able to contribute significantly to our knowledge of *L. hasselti* development using specimens introduced to New Zealand from Australia. The latter study included the rearing of spiderlings to maturity at a constant temperature of 25°C, enabling direct comparison with the present data and those of some other authors.

The data presented in this report were obtained from laboratory studies conducted in 1973, 1977, 1979 and 1981. Over these years it has become apparent that although *L. hasselti* is more numerous in the field in summer, all stages of its life cycle can be found throughout the year in northern Queensland, as expected in a tropical region; field populations seemed unusually abundant in the cooler seasons (June-August) of 1973 and 1975. Regrettably, field studies, other than that of Smith (1971) which detailed the habitat preferences of *L. katipo* in New Zealand, have to date been neglected in this region.

MATERIALS AND METHODS

The laboratory conditions under which this study was conducted, unless otherwise stated, included a constant temperature of 25°C and a 14/10 hour light/dark cycle.

Latrodectus hasselti females of field origin in Townsville produced in the laboratory the egg sacs required for the study. For determination of hatch times and duration of early stadia, eggs were put into glass cavity blocks, the glass lids of which were separated from the rim of the blocks by a layer of non-absorbent cotton wool, with a little vaseline as adherent. This allowed for adequate aeration and easy observation while excluding mites and fungal spores. Intact egg sacs were observed simultaneously to disclose the effect, if any, that exposure of the eggs in the described manner might have on the normal course of development.

The main series of developmental studies used spiderlings that had emerged from intact egg sacs in the normal way. In all, 440 spiderlings were used, these being derived from 17 egg sacs each of which was produced by a different female parent. Each spiderling was isolated in a glass tube 50 mm x 25 mm with a perforated plastic stopper.

Insects utilized as food for the developing spiders included *Drosophila melanogaster* Meigen, *Tenebrio molitor* L. larvae (mealworms), muscoid flies and

cockroach early nymphs. Prey of a size appropriate to each spider was given two or three times a week; food supply was therefore varied and adequate but not quantified. Water was not provided. Forster (1984) has confirmed that the provision of water is not only unnecessary for rearing *Latrodectus* but may be detrimental.

Weighing of food before and after feeding would be the only method of quantifying food intake and even that would not allow feeding to be rigorously correlated with development, for three reasons. First, disturbance of the spider and its web by meticulously removing food remains would be detrimental, to a varied and unknown extent, to normal development. Second, the amount of energy expended in capturing prey varies enormously between individual spiders, depending to a large degree on the extent of their webs. Third, the food provided is only assumed to be nutritionally suitable. One recent study (MacKay 1982) shows that *L. hesperus* Chamberlin and Ivie is an important predator of the ant *Pogonomyrmex rugosus* Emery, but by and large natural prey preferences and nutritional requirements are poorly understood. An instance of this is the preference shown by *L. mactans* and *L. variolus* Walckenaer for housefly maggots in the study of McCrone and Levi (1964); housefly maggots were rejected, without exception, on the numerous occasions they were offered to *L. hasselti* in the present study. *Tenebrio* larvae, however, were almost invariably eaten but they were not used extensively as food because they were not easily trapped in the web and they sometimes ate dead or weak spiders, posing a threat to spiders undergoing a molt.

Of the 440 first instar spiderlings comprising the main series, 288 subsequently provided the developmental data reported here. There were two sources of attrition. First, data for specimens that died before their sex could be determined were excluded. Second, ten specimens of each instar to maturity for each sex were taken for a morphometric study; where this involved destruction of the specimen before its sex was determined, the data on its development were excluded.

It cannot be overemphasized that the results of this and similar studies, while not invalid, can only be interpreted and compared in the light of the methodological shortcomings. Without field comparisons, laboratory results are artificial and confusing, and artificial diets have been shown to influence carapace width and number of molts in lycosid spiders (Whitcomb 1978).

RESULTS AND DISCUSSION

For the present purpose eclosion is considered to be the shedding of the chorion and to mark the close of the embryonic period. The stage following eclosion and ending with the first true integument molt is termed the postembryo and the stage following the first molt is termed the first instar. It is normally the first instar which emerges from the egg sac in *L. hasselti*. Among the most recent struggles with the terminology, since Peck and Whitcomb's (1970) exhaustive review, that of Peaslee and Peck (1983) is commendable.

The duration of development prior to emergence from the egg sac is summarized in Table 1 for four of the five temperatures used in this part of the study. Five egg sacs were incubated for four months at 15 °C but no development occurred; on transfer to 25°C for a further six months there was still no

Table 1.—Effect of temperature on the development of *Latrodectus hasselti* between oviposition and emergence from the egg sac. Figures are given as mean numbers of days, with numbers of egg sacs in parentheses (figures without (n) are derived estimates—see text). EXP = Eggs exposed for direct viewing. INT = Egg sac left intact. COMB = Combined mean. NFD = No further development. NE = No emergence from egg sac.

Stage of Development		Temperature (°C)			
		18	20	25	30
Oviposition to hatching	EXP	41 (3)		11 (9)	9 (4)
	INT	44 (9)	34 (5)	13 (21)	11 (3)
	COMB	43 (12)	34 (5)	12 (30)	10 (7)
		NFD—(11)			
Hatching to first molt	EXP	25 (1)		10 (9)	5 (4)
	INT		17 (5)	7 (3)	5 (3)
	COMB	25 (1)	17 (5)	10 (12)	5 (7)
		NE—(1)		NE—(5)	
First molt to emergence	EXP				
	INT				
	COMB			11	6
Total (Oviposition to emergence)	EXP				
	INT			33 (47)	21 (19)
	COMB			33 (47)	21 (19)

development although some of the eggs had not dehydrated. Development rarely proceeded beyond the postembryo stage at 18°C and first instar spiderlings did not emerge from the egg sac at 20°C; but after four months (from oviposition) at these temperatures the spiderlings were still viable. Despite these effects, first instar spiderlings that had hatched and emerged at 25°C developed normally, at a reduced rate, at 18°C (see Table 2). In Western Australia *L. hasselti* eggs failed to hatch at 9°C but spiderlings that had hatched at higher temperatures withstood periods of 56 days at 7–9°C, emerging from their egg sacs and thriving on return to room temperature (Softly and Freeth 1970). Similarly, Forster (1984) reported tolerance of temperatures less than 10°C in first instar *L. hasselti* spiderlings.

Whether these temperature tolerances are related to or comparable with the seasonal overwintering that occurs in other *Latrodectus* species is unknown. Smithers (1944) recorded overwintering of up to 212 days in egg sacs of *L. indistinctus* O. P. Cambridge (also synonymized with *L. mactans* by Levi (1959)). In Tasmania, where a similar phenomenon might be expected to occur, the oviposition—emergence period for *L. hasselti* is 50 days in January (summer) and 70 days in November (spring) (Hickman 1967). Data for the winter months would be interesting.

The upper limit of temperature tolerance for development to emergence is close to 30°C (Table 1). Only 10 to 20 spiderlings emerged from four of the egg sacs and the first instar spiderlings of one sac failed to emerge at all. 30°C would not be an unusually high temperature in the field in Townsville; it seems likely that *L. hasselti* web sites are normally positioned to preclude any prolonged exposure to temperatures of 30°C or higher. However, Softly and Freeth (1970) reported that at 37°C *L. hasselti* eggs hatched in eight days and the first instar spiderlings emerged from the egg sac seven days later.

Table 2.—Postembryonic development of *Latrodectus hasselti* at temperatures above and below optimum. Figures are given as mean numbers of days with numbers of individuals in parentheses. First stadium does not include the portion spent in the egg sac.

Temp. (°C)	Sex	Stadium			
		1	2	3	4
30	Male	14 (7)	10 (7)	15 (7)	12 (4)
	Female	10 (9)	7 (9)	12 (9)	11 (5)
18	Male	29 (5)	27 (5)	47 (4)	
	Female	24 (6)	23 (6)	21 (6)	39 (6)

It is difficult to determine the point of hatching and that of the first molt in intact egg sacs of *L. hasselti*. The former was judged largely as the point at which the mass of eggs ceased to roll freely in the sac, and the latter involved a darkening of the sac contents due to pigment development in the first instar spiderlings. Table 1 clearly shows that either the incubation period prior to hatching is overestimated by the above method or exposure of the eggs shortens the time of incubation. Cariaso (1967) found the reverse: *L. hasselti* eggs, judged from observation of intact egg sacs to hatch in 7.5 days at 27-29°C, took 9-13 days to hatch when exposed.

Since the time of emergence from the egg sac is not applicable in the case of exposed eggs, the time between the first molt and emergence is given as a single value derived by subtraction of the oviposition—first molt time from the mean oviposition—emergence time.

Cariaso (1967) found a wider range (16-44 days) of times from oviposition to emergence at 27-29°C than the corresponding ranges of the present study at 25°C and 30°C which were 26-43 days and 17-24 days respectively. His mean of 28.7 days is reasonably consistent with the results in Table 1.

The three American species of *Latrodectus* studied by Kaston (1970) have exactly corresponding hatch times at 25°C to that of *L. hasselti* given in Table 1; however, subsequent development up to emergence must be faster than it is in the Australian species, emergence taking place between 26 days (*L. variolus*) and 30 days (*L. hesperus*). This is peculiar in view of development rates after emergence.

Figure 1 shows the results of the main series of developmental studies for which 288 spiders, whose sexes were determined, provided data on the duration of the post-emergence stadia. Mortality, to the extent it is meaningful in the artificial conditions of the study, can be taken to be 20-25% (see Methods).

The appropriate data for the earlier (unsexed) stages are included to give a complete picture of the ranges in the duration of all life-history stages; only the period from the first molt to emergence from the egg sac is a derived estimate, without a range, for the reasons given above.

Despite uncontrolled temperature the results of Softly and Freeth (1970) can be reconciled with the ranges of the present data, except that Fig. 1 shows that some *L. hasselti* males molt six times, once more than found for *L. hasselti* in Western Australia. Five was the maximum number of molts undergone by *L. hasselti* males in the study of Forster (1984), while Cariaso (1967) found a maximum of but four molts for *L. hasselti* males in the Philippines.

Two features of the data in Fig. 1 are of particular interest when compared with the results of those studies on the same or related species of *Latrodectus*

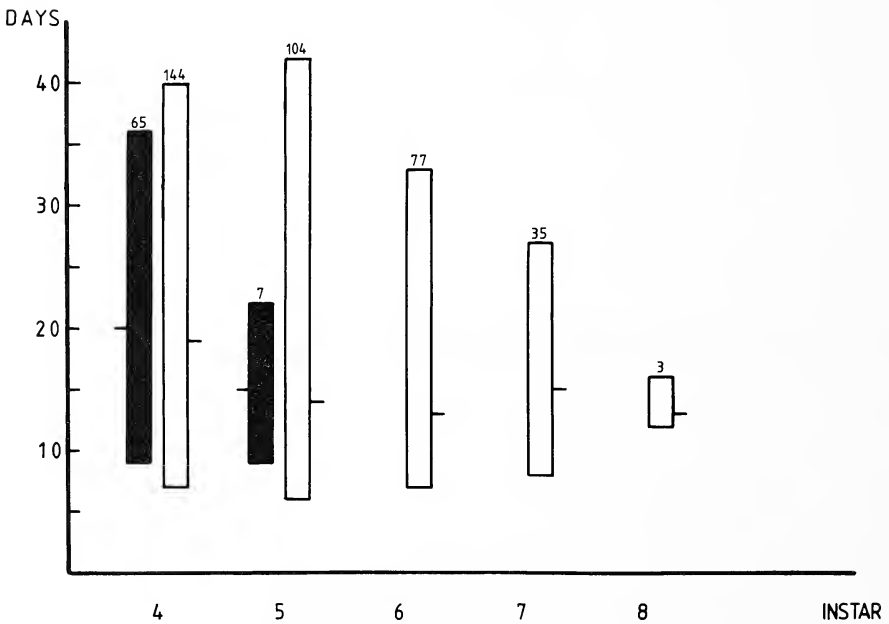
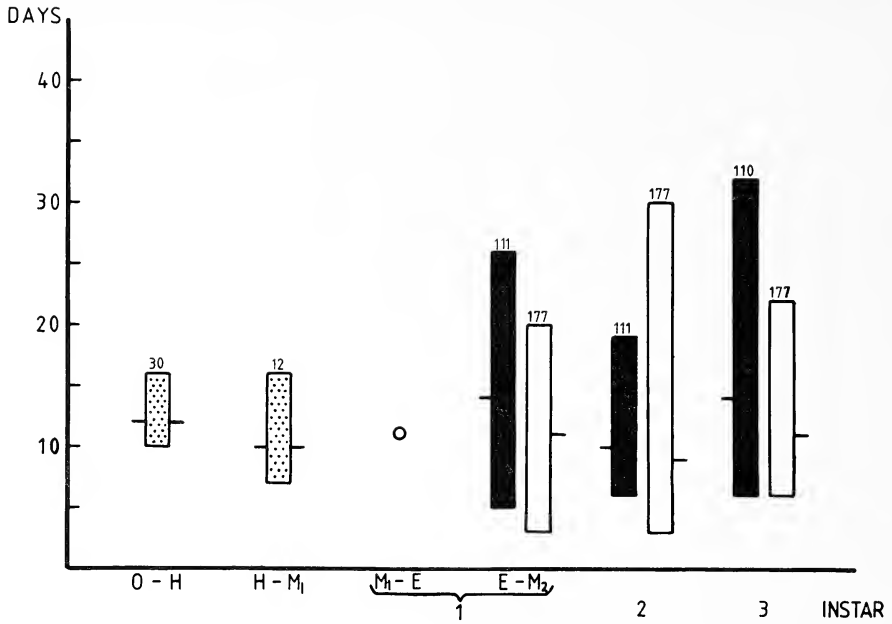

Fig.1.—Mean and range of stadia of *Latrodectus hasselti* at 25°C. Dark columns, males; light columns, females; stippled columns, both sexes combined. ○ is a derived estimate (see text). Numbers above columns are numbers of individuals. O = oviposition; H = hatching; M = molt; E = emergence from egg sac.

which were carried out at constant and comparable temperature (Cariaso 1967, Forster 1984, Forster and Kingsford 1983, Kaston 1970, McCrone and Levi 1964, 1966). The first is that the two studies on *L. hasselti* show stadia durations comparable with those given in Fig. 1, especially with regard to the absence of any tendency towards significantly longer duration of the later stadia. By contrast, Kaston's (1970) results, and particularly those of McCrone and Levi (1964, 1966), show that much longer periods of time are spent in the later instars in the American species of *Latrodectus*. The results of Gonzales (1979), although for specimens reared at a temperature that varied between 20-25°C, show the same feature. A similar, though less marked, pattern of longer late stadia is found in the New Zealand species (Forster and Kingsford 1983). The second notable feature is that all six of these comparable studies consistently show, as does Fig. 1, that males spend longer in the early instars than do females. Again, the data of Gonzales, though not constant temperature data, show precisely the same feature. It has been suggested (Downes 1981) that this tendency compensates for their having fewer instars to maturity than females, the latter phenomenon being a direct result of the sexual dimorphism in size that has evolved in this genus.

Not surprisingly, lower and higher temperatures retard and accelerate development respectively. Table 2 shows these effects. It is apparent that stadia remain longer for males than for females regardless of temperature.

The shortest time between oviposition and maturity for a female *L. hasselti* was 58 days. Females usually matured in the sixth instar, males in the fourth. The greatest longevity observed for a female *L. hasselti* was for a specimen that was collected mature in the field and died 229 days later in the laboratory (a lifespan well in excess of 300 days can be inferred from this). For a male, 136 days from emergence was the maximum recorded longevity at 25°C, and 211 days from emergence at 18°C. The American species of *Latrodectus*, then, develop more slowly, mature later and live longer than *L. hasselti* of the Philippines and Australia.

The development of the palpal organs, characteristic of maturing males, was sometimes apparent in the second instar but was occasionally not evident even in the third instar. Those individuals that died before their fourth instar, therefore, unless clearly males, were excluded from the study. Of the remaining individuals 111 were male and 177 female. Males tended to construct inferior webs and expend more energy in trapping prey than did females; more males than females may therefore have died before maturity. A similar situation may have influenced the observations of Softly and Freeth (1970) who reported a male:female sex ratio of 1:5 for *L. hasselti*. There is no reliable report of a sex ratio other than 1:1 in the literature on *Latrodectus*.

There remains, in this and other similar studies, a marked variability in the number and duration of the stadia in *Latrodectus* (see Kaston 1970), despite stringent efforts to apply uniform conditions. Apart from the difficulties (discussed above) of controlling food supply and feeding there is another factor, other than inherent genetic variability, contributing to this: the production and use of trophic eggs (Downes 1985). Reports of the occurrence of this phenomenon continue to accumulate and it occurred in the present study as it did in Kaston's (1970) study of *Latrodectus* in the United States. Its effects, investigated by Schick (1972) and Valerio (1974), may influence subsequent development more than has hitherto been recognized. An extensive investigation

has been made of egg-feeding in *Theridion rufipes* Lucas, one of four Townsville theridiid spiders, including *L. hasselti*, whose first instar spiderlings have been seen to feed on inviable eggs prior to emergence from the egg sac. The results of that study will be available in the near future.

ACKNOWLEDGEMENTS

I thank Lyn Forster, Rhondda Jones, Barbara Main and Alister Spain for their valuable comments on the numerous forerunners of this paper.

LITERATURE CITED

- Cariaso, B. L. 1967. A biology of the black widow spider, *Latrodectus hasselti* Thorell (Araneida: Theridiidae). Philippine Agric., 51:171-180.
- Cleland, J. B. 1942. Injuries and diseases in Australia attributable to animals (insects excepted). Series V: mammals, fish, spiders, mites and ticks et cetera, shell fish, sponges, protozoa. Med. J. Australia, 3 October 1942:313-320.
- Deevey, G. B. 1949. The developmental history of *Latrodectus mactans* (Fabr.) at different rates of feeding. American Midl. Nat., 42:189-219.
- Deevey, G. B. and E. S. Deevey. 1945. A life table for the black widow. Trans. Connecticut Acad. Sci., 36:115-134.
- Downes, M. F. 1981. Sexual dimorphism in *Latrodectus* (Araneae, Theridiidae). Australian J. Ecol., 6:289-290.
- Downes, M. F. 1985. Fecundity and fertility in *Latrodectus hasselti* (Araneae: Theridiidae). Australian J. Ecol., 10:261-264.
- Forster, L. M. 1984. The Australian redback spider (*Latrodectus hasselti*): its introduction and potential for establishment and distribution in New Zealand. Pp. 273-289, In: Commerce and the Spread of Pests and Disease Vectors. (M. Laird ed.) Praeger, New York.
- Forster, L. M. and S. Kingsford. 1983. A preliminary study of development in two *Latrodectus* species (Araneae: Theridiidae). New Zealand Entomol., 7:431-438.
- Gonzales, A. 1979. Observaciones bioecológicas sobre una especie del género *Latrodectus* (Walckenaer, 1805) del grupo *mactans*, de Sierra de la Ventana (Provincia de Buenos Aires, Argentina) (Araneae, Theridiidae) III—Desarrollo post-embionario. Acta Zool. Lilloana, 35:97-100.
- Hickman, V. V. 1967. Some common Tasmanian spiders. Tasmanian Mus. Publ., 112 pp.
- Hornabrook, R. W. 1951. Studies in preventive hygiene from the Otago Medical School. The katipo spider. New Zealand Med. J., April 1951:131-138.
- Ingram, W. W. and A. Musgrave. 1933. Spider bite (Arachnidism): A survey of its occurrence in Australia, with case histories. Med. J. Australia, 1 July 1933:10-15.
- Kaston, B. J. 1970. Comparative biology of American black widow spiders. Trans. San Diego Soc. Nat. Hist., 16:33-82.
- Levi, H. W. 1959. The spider genus *Latrodectus* (Araneae, Theridiidae). Trans. American Microscop. Soc., 78:7-43.
- Levi, H. W. 1966. The three species of *Latrodectus* (Araneae), found in Israel. J. Zool. (London), 150:427-432.
- Levi, H. W. 1983. On the value of genitalic structures and coloration in separating species of widow spiders (*Latrodectus* sp.) (Arachnida: Araneae: Theridiidae). Verh. Naturwiss. Ver. Hamburg, 26:195-200.
- McCrone, J. D. and H. W. Levi. 1964. North American widow spiders of the *Latrodectus curacaviensis* group (Araneae: Theridiidae). Psyche, 71:12-27.
- McCrone, J. D. and H. W. Levi. 1966. Postembryological development of spiderlings from two Peruvian *Latrodectus* populations. Psyche, 73:180-186.
- MacKay, W. P. 1982. The effect of predation of western widow spiders (Araneae: Theridiidae) on harvester ants (Hymenoptera: Formicidae). Oecologia (Berlin), 53:406-411.

- Maretić, Z. 1984. Discrimination between the terms Araneism, Araneidism and Arachnidism. *Newsl. British Arachnol. Soc.*, 40:5.
- Peaslee, J. E. and W. B. Peck. 1983. The biology of *Octonoba octonarius* (Muma) (Araneae: Uloboridae). *J. Arachnol.*, 11:51-67.
- Peck, W. B. and W. H. Whitcomb. 1970. Studies on the biology of a spider, *Chiracanthium inclusum* (Hentz). *Univ. Arkansas Agric. Exp. St. Bull.*, 753:1-76.
- Rempel, J. G. 1957. The embryology of the black widow spider, *Latrodectus mactans* (Fabr.). *Canadian J. Zool.*, 35:35-74.
- Schick, R. X. 1972. The early instars, larval feeding and the significance of larval feeding in the crab spider genus *Misumenops* (Araneida: Thomisidae). *Notes Arachnol. Southwest*, 3:12-19.
- Seligy, V. L. 1970. A method for studying spiders at various stages of development. *Canadian J. Zool.*, 48:406-407.
- Smith, D. J. 1971. The habitat and distribution of the katipo spider at South Brighton Beach, Christchurch, New Zealand. *New Zealand Entomol.*, 5:96-100.
- Smithers, R. H. N. 1944. Contributions to our knowledge of the genus *Latrodectus* (Araneae) in South Africa. *Ann. South African Mus.*, 36:263-312.
- Softly, A. and G. E. Freeth. 1970. The laboratory maintenance of *Latrodectus mactans*. *J. Inst. Anim. Tech.*, 21:117-126.
- Sutherland, S. K. and J. C. Trinca. 1978. Survey of 2144 cases of red-back spider bites. Australia and New Zealand, 1963-1976. *Med. J. Australia*, 30 December 1978:620-623.
- Valerio, C. E. 1974. Feeding on eggs by spiderlings of *Achaearanea tepidariorum* (Araneae, Theridiidae), and the significance of the quiescent instar in spiders. *J. Arachnol.*, 2:57-63.
- Whitcomb, W. H. 1978. Lycosid life-history research: a critique. *Symp Zool. Soc. London*, 42:423-427.

Manuscript received July 1985, revised December 1985.

SPIDERS ON RED SPRUCE FOLIAGE IN NORTHERN MAINE¹

Daniel T. Jennings

Northeastern Forest Experiment Station
USDA Building, University of Maine
Orono, Maine 04469

and

Judith A. Collins

Department of Entomology
University of Maine
Orono, Maine 04469

ABSTRACT

Spiders of 10 families, 16 genera, and at least 21 species were collected from foliage of *Picea rubens* Sarg. in northern Maine. Foliage samples were collected from tree crowns using an extendable pole pruner. Of 157 individuals, erigonids were numerically dominant (36%), followed by philodromids (18%) and salticids (15%). Mean spider densities/m² of foliage area were nonsignificant among sampling sites, but significantly more ($P = 0.05$) spiders were collected during the second sampling period (24-25 July) than during the first sampling period (7-8 June). Differences in spider densities between sampling periods were attributed to 1) seasonal activities and reproductive cycles of individual species, 2) weather during collection of foliage samples, and 3) two sampling methods (i.e., pole pruner with clamping device or pole pruner with catchment basket). Spider-budworm relationships and spider-habitat associations are discussed.

INTRODUCTION

Spiders are among the dominant predatory arthropods in forest ecosystems. In northeastern spruce-fir forests, spider densities are estimated to range from about 75,000/acre (187,500/hectare) (Morris 1963) to 125,000/acre (312,500/hectare) (Haynes and Sisojevic 1966a). Despite common occurrence and relative abundance of spiders, little is known about the arboreal spider fauna of coniferous tree species. Jennings (1976) summarized spider-faunal studies of North American trees; only nine species of conifers were included. Recent faunistic studies include spiders on balsam fir, *Abies balsamea* (L.) Mill., in New Brunswick (Renault and Miller 1972); on white fir, *Abies concolor* (Gord. and Glend.) Lindl. ex Hildebr., in California (Dahlsten et al. 1977) and in Oregon (Mason and Torgersen 1983); and on red pine, *Pinus resinosa* Ait., white spruce, *Picea glauca* (Moench) Voss, and white cedar, *Thuja occidentalis* L., in Minnesota (Stratton et al. 1979).

¹Mention of a commercial or proprietary product does not constitute endorsement by the U.S. Department of Agriculture, the Forest Service, or the University of Maine.

During our studies of the spruce budworm, *Choristoneura fumiferana* (Clem.), in northern Maine (Collins 1985), we sampled budworms and spiders on foliage of 160 red spruce, *Picea rubens* Sarg., trees. This paper reports spider species composition on red spruce foliage, compares relative abundances and densities during two sampling periods, and evaluates two sampling methods for arboreal spiders.

METHODS

Study Area.—The study area was located on Great Northern Paper Company lands about 60 km northwest of Millinocket, Piscataquis County, Maine. Individual study sites (8) were located along the eastern edge of Township 4, Range 12, WELS (45°58' North; 69°13' West), about 2.6 km east of Ripogenus Pond, and 2.5 km northwest of Soubunge Mt. (USGS, Harrington Lake Quadrangle, 1954). Elevations were about 335 m.

Five strip clearcuts were chosen for study in a spruce-fir forest infested with the spruce budworm. The strip clearcuts consisted of alternating uncut residual stands and clearcut strips from which trees had been harvested in 1977. The strips were oriented east-west, $\bar{x} = 94^\circ$, range 90-96°. The study area had been sprayed by the Maine Forest Service with Seven-4-oil® for spruce budworm suppression in 1981. No further chemical-insecticide treatments were made, including the study year of 1984.

Forest-Stand Characteristics.—Forest-stand parameters were measured on 16 variable-size plots established along the north and south edges of uncut residual strips (Fig. 1): two plots at each of eight study sites (A, B, C...H). Within each plot, a species inventory was taken of all trees ≥ 1.0 cm in diameter at breast height (dbh). Tree heights of three dominant or codominant softwoods were measured (m) on each plot with a Haga® altimeter. Stand ages were determined from tree increment cores ($n = 48$).

Foliage Samples.—Spruce budworm and spider populations were estimated during two sampling periods. The first sampling, 7 and 8 June 1984, corresponded with the budworm's L₃-L₄ larval stages; the second sampling, 24 and 25 July 1984, corresponded with the budworm's pupal stage. Within each plot, 10 dominant or codominant red spruce were selected for sampling. Trees were flagged and numbered so that the same trees could be used for both population estimates.

For the first sampling, we used an extendable pole pruner equipped with a clamping device (Stein 1969) to prune two midcrown branches (≥ 45 cm) from each tree. The clamping device holds the branch after it has been severed from the tree. Pruned branches were lowered or dropped to a ground cloth (3.6 x 3.6 m). All loose larvae and spiders were collected and preserved in vials containing 75% ethanol. Branches, associated vials, and labels were placed in clear plastic bags (30 x 61 cm) and transported to the laboratory for examination.

The same procedure and sampling intensity were followed for the second sampling, except that the pole pruner was equipped with a metal hoop and fine mesh net (16 x 18 mesh, 46 cm diam, 69 cm deep) which formed a basket beneath the cutting head of the pruner. Severed branches and any dislodged insects or spiders were caught in the basket and lowered to the ground by disassembling the poles.

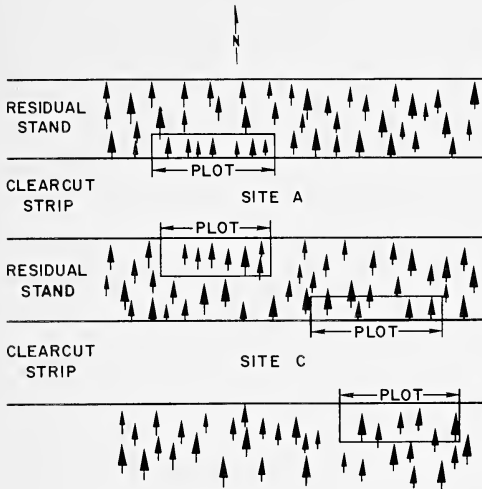

Fig. 1.—Schematic of strip clearcut spruce-fir forest showing residual stands, clearcut strips, variable plot sizes (16), and two of eight sampling sites (A, B, C . . . H), Piscataquis County, Maine.

In the laboratory, branches were stored in a walk-in cooler (3-4°C) until examined. All branches were examined by trained technicians within two weeks of collection. Foliated branch lengths and widths were measured (cm) and branch areas (A) calculated by the formula: $A = \text{length} \times \text{width} / 2$ (Sanders 1980). Each branch was cut into small, easily handled pieces (10-15 cm) with hand pruners. The pieces were then examined carefully for spruce budworms and spiders. All spiders were preserved in vials containing 75% ethanol. Population densities were expressed as budworm larvae-pupae and spiders per m^2 of branch foliage area. Sample sizes were: 2 branches/tree \times 10 trees/plot \times 16 plots (2/site) = 320 branches/sampling period, and 640 branches total.

Weather.—Because weather affects spider activity, temperature and rainfall data were obtained from the Great Northern Paper Company's weather station maintained at Ripogenus Dam, about 12.2 km SSE of the study area (NOAA, Climatological Data, New England, vol. 96 (6,7), 1984).

Spider Identifications.—Most of the spiders were identified with the identification keys and species descriptions of Kaston (1981). Additional consulted sources were: Chamberlin and Gertsch (1958) for the dictynids; Levi (1957) for the theridiids; Dondale (1959) for the erigonids; Berman and Levi (1971) and Levi (1974, 1977) for the araneids; Dondale and Redner (1982) for the clubionids; Dondale and Redner (1978) for the philodromids and thomisids; and Kaston (1973) for species of *Metaphidippus*. Following Platnick and Shadab (1981), we considered *Poecilochroa* a synonym of *Sergiolus*.

Because species descriptions are based chiefly on the genitalia, only sexually mature spiders were identified to species. Juvenile and penultimate stages were identified to generic level only, except for those of *Philodromus*, which were assigned to one of three species groups (*rufus*, *aureolus*, or *histrion*) based on color patterns of the legs, carapace, and abdomen (Dondale 1961a; Dondale and Redner 1968, 1975). Representative specimens of all identified species are deposited in the arachnid collection, U.S. National Museum, Washington, DC.

Data Analyses.—Because the observed spider densities were not distributed normally (Figs. 2 and 3) and variances were nonhomogenous (Hartley's test), even after transformations, we used nonparametric statistics for most analyses. The

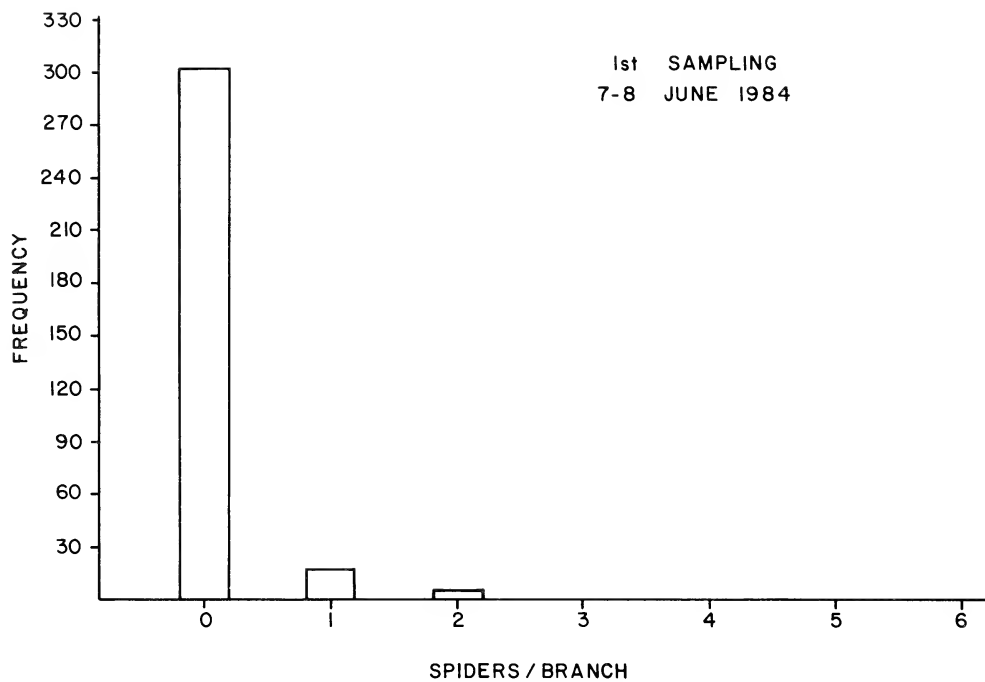

Fig. 2.—Frequency distribution of spiders on red spruce foliage, first sampling, 7-8 June 1984, Piscataquis County, Maine.

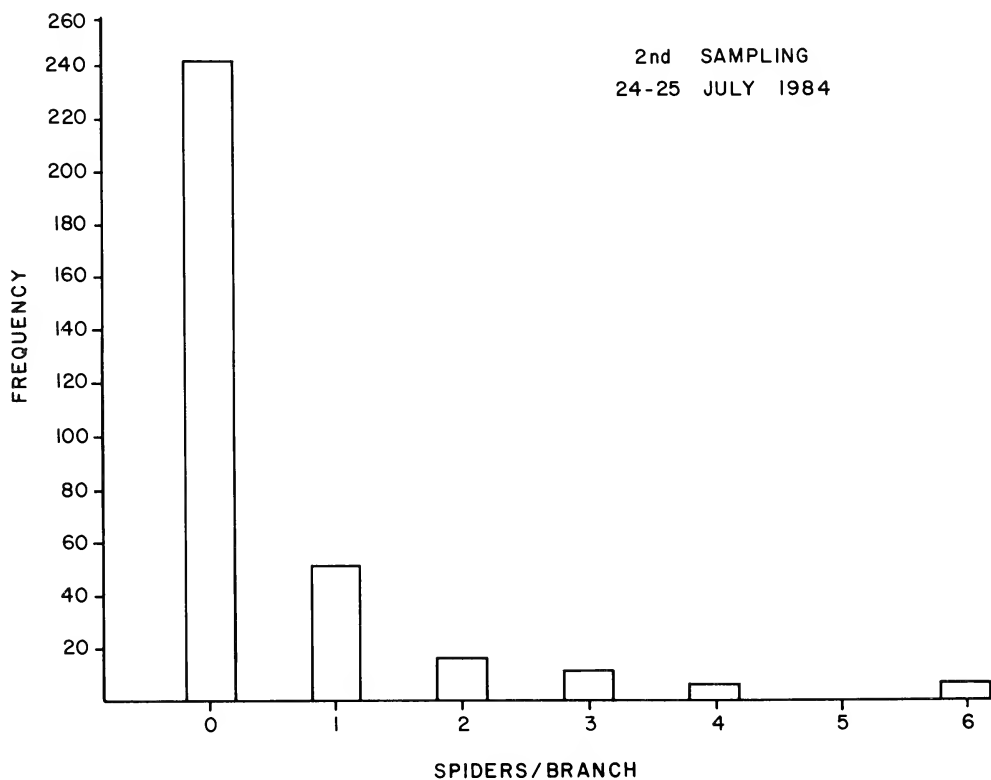

Fig. 3.—Frequency distribution of spiders on red spruce foliage, second sampling, 24-25 July 1984, Piscataquis County, Maine.

STP procedure (Sokal and Rohlf 1981) for multiple comparisons, based on the Mann-Whitney U-test, was used to compare spider densities among sites within sampling periods ($P = 0.05$). The Wilcoxon 2-sample test was used to compare densities between sampling periods for individual sites ($P = 0.05$) and over all sites ($P = 0.01$). Likewise, the Wilcoxon 2-sample test was used to test the independence of distributions between spider foraging groups (web spinners, hunters) ($P = 0.05$), and to compare spider densities between aspects (N, S exposure) over all sites ($P = 0.05$). Simple linear regressions were used to test for possible relationships between spider densities (dependent variable) and spruce budworm densities (independent variable), where $R^2 =$ coefficient of determination.

To estimate absolute populations, we converted spider densities per m^2 of foliage area to densities per ha (hectare) by the method of Morris (1955). Populations were computed as:

$$\text{spiders/ha} = \bar{x} \text{ spiders/m}^2 \text{ of foliage} \cdot \left(\sum_{sp=1}^N \text{BSA}_{sp} \right), \text{ where}$$

$\sum \text{BSA}_{sp}$ = sum of branch surface areas of spruce. The following equation was used to calculate branch surface area per tree: $\text{BSA}_{sp} = 2.64 + 3.34 \text{ dbh}_{cm}$, after Dimond (unpublished data).

RESULTS AND DISCUSSION

Forest Stands.—Species composition by percent basal area (m^2/ha) indicated a predominantly softwood component of red spruce (69.5%); northern white cedar (11.6%); white spruce (10.2%); white pine, *Pinus strobus* L. (2.7%); and balsam fir (4.6%). The hardwood component was composed of paper birch, *Betula papyrifera* Marsh. (1.5%), and red maple, *Acer rubrum* L. (<0.1%).

Red spruce trees averaged 13.7 ± 0.3 cm dbh and 12.4 ± 0.4 m height. Mean stand age was 62.1 ± 1.5 years.

Spruce Budworm Densities.—Mean larval and pupal densities per m^2 of foliage area were: L_3 - L_4 \bar{x} 's = 27.2 ± 2.6 over all sites, range 7.9 ± 2.1 to 39.4 ± 9.1 among sites; pupal \bar{x} 's = 5.4 ± 0.6 over all sites, range 3.3 ± 1.3 to 8.0 ± 2.2 among sites. As expected, larval densities were significantly greater ($P = 0.05$) than pupal densities among sites and over all sites (Collins 1985). No doubt, some of the age-interval mortality between budworm larval and pupal stages was due to spider predation; however, predation by spiders was not measured in this study.

Spider Species Composition.—Spiders of 10 families, 16 genera, and at least 21 species were collected from foliage of red spruce in northern Maine (Table 1). Of the 157 individuals collected, more were web spinners (54%) than hunters (46%). More species of hunters (12) were collected than web spinners (9); however, the same number of genera (8) were represented in each spider group. The erigonids were numerically dominant (36%), followed by the philodromids (18%) and the salticids (15%). Each of the remaining families accounted for fewer than 10% of the total individuals.

Table 1.—Spiders on red spruce foliage, Piscataquis County, Maine.

Family, <i>Species</i>	1st Sampling			2nd Sampling			Σ	%
	J	M	F	J	M	F		
WEB SPINNERS								
Dictynidae							4	2.5
<i>Dictyna brevitarsus</i> Emerton						1		
<i>Dictyna</i> sp.				3				
Theridiidae							4	2.5
<i>Theridion montanum</i> Emerton						3		
<i>Theridion murarium</i> Emerton						1		
Linyphiidae							10	6.4
<i>Pityohyphantes costatus</i> (Hentz)			1			4		
<i>Pityohyphantes</i> sp.				5				
Erigonidae							56	35.7
<i>Grammonota angusta</i> Dondale		1	2		1	11		
<i>Grammonota</i> sp.				41				
Araneidae							11	7.0
<i>Eustala anastera</i> (Walckenaer)						1		
<i>Eustala</i> sp.				1				
<i>Neoscona arabesca</i> (Walckenaer)						1		
<i>Araneus</i> sp.				5				
<i>Araniella displicata</i> (Hentz)						1		
<i>Araniella</i> sp.			2					
Subtotals		1	3	57	1	23	85	54.1
HUNTERS								
Gnaphosidae							2	1.3
<i>Haplodrassus</i> sp.				1				
<i>Sergiolus</i> sp.				1				
Clubionidae							3	1.9
<i>Clubiona canadensis</i> Emerton						1		
<i>Clubiona</i> sp.				2				
Philodromidae							29	18.5
<i>Philodromus exilis</i> Banks			1			1		
<i>Philodromus placidus</i> Banks						2		
<i>Philodromus</i> sp. (<i>rufus</i> grp.)	2			12				
<i>Philodromus</i> sp. (<i>aureolus</i> grp.)	1			6				
<i>Philodromus</i> sp. (<i>histrion</i> grp.)				4				
Thomisidae							15	9.6
<i>Misumena vatia</i> (Clerck)		1						
<i>Xysticus discursans</i> Keyserling						1		
<i>Xysticus punctatus</i> Keyserling			1					
<i>Xysticus</i> sp.	4			8				
Salticidae							23	14.6
<i>Salticus scenicus</i> (Linnaeus)			1					
<i>Metaphidippus flavipedes</i> (G. & E. Peckham)		1	1		1	2		
<i>Metaphidippus</i> sp.	2			15				
Subtotals	9	2	4	49	1	7	72	45.9
Totals	9	3	7	106	2	30	157	100.0

Web spinners were represented by only two families, two genera, and two species in the first sampling; this compares with five families, eight genera, and nine species in the second sampling. Hunting spiders were represented by three families, five genera, and six species in the first sampling; this compares with five families, six genera, and nine species in the second sampling. Combining web spinner and hunter groups, the number of taxa doubled between sampling periods; i.e., five families, seven genera, and eight species in the first, and 10 families, 14 genera, and 18 species in the second.

Juveniles of the *Philodromus rufus* group (Table 1) likely represent both *P. exilis* Banks and *P. placidus* Banks; juveniles of the *aureolus* group probably are *P. pernix* Blackwall, a common inhabitant of coniferous foliage. Juveniles of the *histrion* group are most likely *P. mysticus* Dondale and Redner, a species collected from black spruce, *Picea mariana* (Mill.) B.S.P., from white spruce, and from balsam fir (Dondale and Redner 1975).

Spider Age and Sex Ratios.—The ratio of juvenile to adult spiders was 0.9 for the first sampling and 3.3 for the second sampling. The ratio of males to females was 0.4 for the first sampling and 0.1 for the second sampling. Seasonal activities and reproductive cycles may account for some of these differences in life stages between sampling periods. For example, some arboreal species attain reproductive maturity and lay eggs that produce young spiderlings in midsummer to late summer (Dondale 1961b).

Spider Densities.—Only 5.3% of the 320 pruned branches had one or more spiders at the first sampling (Fig. 2). During the second sampling, 24.7% of the 320 pruned branches had one or more spiders (Fig. 3). The maximum number of individuals per branch was two during the first sampling, and six during the second sampling.

Frequency distributions between spider foraging groups (web spinners, hunters) were not significantly different ($P = 0.05$) by the Wilcoxon 2-sample test.

Mean densities of spiders per m^2 of foliage area ranged from 0.0 to 1.4 for the first sampling and from 1.5 to 16.6 for the second sampling (Table 2). None of these densities were significantly different ($P = 0.05$) among sites by the Mann-Whitney U-test, STP procedure (Sokal and Rohlf 1981). All sites showed increases in spider densities from the first to the second samplings; all but sites A, B, and D showed significantly greater densities by the Wilcoxon 2-sample test ($P = 0.05$) for the second sampling period. Between sampling periods, overall mean densities were significantly greater (Wilcoxon 2-sample test; $P = 0.05$) for the second sampling period (Table 2). Possible factors contributing to these differences were: 1) seasonal activities and reproductive cycles of the various species, 2) weather during field collection of branch samples, and 3) sampling methods.

We observed 92% more juveniles and 69% more adults during the second sampling than during the first sampling. No doubt, some of these differences can be attributed to the reproductive cycles of individual species and the production of young spiderlings in midsummer. For example, *Pityohyphantes costatus* (Hentz) produces eggs in early July in Quebec (Manuel 1984); *Araniella displicata* (Hentz) reaches sexual maturity in May and June and produces eggs in early July in Connecticut (Kaston 1981). However, juveniles of biennial species should have been prevalent during both sampling periods. At least six of the species found on red spruce foliage, *Theridion murarium* Emerton, *Araniella displicata*,

Table 2.—Spider densities on red spruce foliage, Piscataquis County, Maine ($n = 320$ branches/sampling). Column means within sampling periods are not significantly different by Mann-Whitney U-test, STP procedure (Sokal and Rohlf 1981), $P = 0.05$. Row means (a, b) followed by the same letter are not significantly different by Wilcoxon 2-sample test, $P = 0.05$. Overall means (x, y) are significantly different by Wilcoxon 2-sample test, $P < 0.01$.

Site	1st Sampling		2nd Sampling	
	\bar{x}/m^2	(\pm S.E.)	\bar{x}/m^2	(\pm S.E.)
A	1.17a	(0.58)	1.47a	(0.76)
B	0.40a	(0.40)	2.34a	(1.00)
C	0.89a	(0.64)	9.69b	(2.91)
D	1.39a	(0.81)	5.42a	(2.47)
E	0.00a	(0.00)	7.20b	(2.29)
F	1.27a	(0.64)	16.57b	(5.86)
G	0.74a	(0.55)	8.67b	(1.88)
H	0.26a	(0.26)	5.75b	(1.95)
Overall	0.76x	(0.18)	7.14y	(1.68)

Misumena vatia (Clerck), *Xysticus punctatus* Keyserling, *X. discursans* Keyserling, and *Philodromus placidus*, have biennial life histories (Dondale 1961b, 1976). Dondale (1961b, p. 785) noted that "biennialism is fairly prevalent among tree and shrub spiders of the North Temperate Zone." Juveniles of *Xysticus* and *Philodromus* were collected during both sampling periods but were more abundant during the second sampling. This suggests that weather or sampling method differences were important.

Mean daily temperatures were about the same for both sampling periods—17.2°C (7 June) and 20.8°C (8 June) for the first sampling, and 20.9°C (24 July) and 17.2°C (25 July) for the second sampling. About equal amounts of precipitation fell during both branch-collection periods, 1.6 cm (1st) and 1.1 cm (2nd). During the first sampling, most of the trees (sites A-F) were sampled when the foliage was dry; whereas, during the second sampling, most of the trees (sites A-E) were sampled when the foliage was wet. We suspect that spider activity may have been retarded during the second sampling due to the wet foliage, thereby increasing the probability of collection. Conversely, spider activity probably was not adversely affected by the clear, warm, and sunny weather during the first sampling, thus diminishing the probability of capture. Lowrie (1971) found that sweep-net catches of *Oxyopes* spiders were significantly greater in herbaceous vegetation when the dew was heavy.

The two sampling methods used in this study also may have contributed to the differences in spider densities between sampling periods. Some spiders may have been lost with either sampling method, i.e., a pole pruner equipped with a clamping device, or a pole pruner equipped with a basket. However, we suspect that spiders were dislodged more readily and lost without the catchment basket. Although Churcher (1981) showed there were no significant differences in budworm counts on red spruce foliage sampled with and without baskets in New Brunswick, spiders may be more susceptible to disturbance, particularly species that build their webs between branch apices. Because manipulation of a pole pruner equipped with a basket is difficult, adjacent branches often are brushed; this may add spiders to a branch sample. Both sampling methods need to be tested at the same time and place for spiders.

We found no significant difference in spider densities by aspect over all sites. Trees north (southerly exposed) and trees south (northerly exposed) of the clearcut strips had comparable populations per m² of foliage area; N tree \bar{x} 's = 0.48 ± 0.20 (1st sampling), 8.67 ± 1.71 (2nd sampling); S tree \bar{x} 's = 1.05 ± 0.33 (1st sampling), 5.60 ± 1.08 (2nd sampling). Although some individual sites varied, overall means within sampling periods were not significantly different between aspects by the Wilcoxon 2-sample test, $P = 0.05$.

Absolute population densities were estimated as 68,995 spiders/ha for the first sampling and 645,853 spiders/ha for the second sampling. The latter density is double that reported by Haynes and Sisojevic (1966a) for spiders in a balsam fir stand in northern New Brunswick. We suspect that spruce may support more spiders, both individuals and species, than fir. Stratton et al. (1979) found that white spruce had the highest number of individuals and species compared with red pine and white cedar in Minnesota.

Spider-Budworm Relationships.—Regression analyses indicated very weak correlations between spider and budworm densities on red spruce foliage; $R^2 = 0.004$ ($P = 0.28$) for the first sampling, and $R^2 = 0.018$ ($P = 0.02$) for the second sampling, where $n = 320$ branches each sampling period. More refined sampling techniques are needed to fully assess the density independent-dependent relationships between spiders and spruce budworms.

All life stages of the spruce budworm—eggs, larvae, pupae, and adults—are susceptible to predation by spiders. Some of the species found on red spruce foliage during this study have been observed in previous studies feeding on various stages of the spruce budworm. The salticid, *Metaphidippus flavipedes* (G. & E. Peckham), feeds on eggs and first instars (Jennings and Houseweart 1978). The web spinners, *Theridion murarium* and *Araniella displicata*, capture budworm moths in their webs (Jennings and Crawford 1985). In laboratory tests, *Grammonota angusta* Dondale readily captured and fed on second instars of the spruce budworm (Haynes and Sisojevic 1966b). *Dictyna phylax* Gertsch and Ivie, a species related to *D. brevitarsus* Emerton, caused considerable mortality to second instars of the spruce budworm on "stocked" balsam fir branches in New Brunswick (Renault and Miller 1972); survival of budworm larvae was only 3% on branches with *D. phylax* and 60% on branches without spiders.

Detailed serological studies of spider predation on the spruce budworm by Loughton et al. (1963) indicated that: 1) the erigonids, particularly *Grammonota pictilis* (= *G. angusta* according to Dondale (1959)), were the most important group because of their large numbers, 2) the theridiids were the most effective predators, based on percentages showing positive feedings on budworm, and 3) the salticids were important predators at all stages of larval development, including the late instars. Mortality during the late larval stage influences generation survival of the spruce budworm (Morris 1963). At low larval densities, Watt (1963) estimated that only 0.46 larvae/10 ft² (0.49 larvae/m²) of foliage would have to be eaten by predators, including spiders, to account for a decrease in population survival rate. Additional studies are needed to fully evaluate the predatory impact of red spruce spiders on spruce budworm populations, especially at low pest densities.

Spider Habitat Associations.—None of the species of spiders collected from red spruce foliage are restricted to that habitat; most of the adult species have been collected from two or more species of conifers (Jennings and Collins 1987). Our

collections of *Salticus scenicus* (Linnaeus), *Haplodrassus* sp., and *Sergiolus* sp. appear unusual because *S. scenicus* generally is associated with domestic habitats (Kaston 1981) and species of both gnaphosid genera generally are ground dwellers (Platnick and Shadab 1975; Kaston 1981). However, *S. scenicus* has been collected from loblolly pine, *Pinus taeda* L., in Oklahoma (Bosworth et al. 1971); *Haplodrassus* sp. from shortleaf pine, *Pinus echinata* Mill., and loblolly pine in Arkansas (Peck et al. 1971); *Poecilochroa* sp. from white fir in Oregon (Mason and Torgersen 1983) and from shortleaf and loblolly pines in Arkansas (Peck et al. 1971); and *P. montana* Emerton from Douglas-fir, *Pseudotsuga menziesii* (Mirbel) Franco, in British Columbia (Turnbull 1956).

The crab spider *Misumena vatia* frequently is collected from flowering shrubs and forbs; however, it has also been taken from several conifer species (Jennings and Collins 1987). Collections of *Xysticus discursans* usually are made by pitfall traps and sweep nets in both grassland and wooded areas (Dondale and Redner 1978); our collections of this and other spider species from red spruce foliage represent new, previously unknown habitat associations.

The remaining species of spiders found on red spruce foliage are arboreal in habit; however, none are restricted to trees and to conifers. Some, e.g., *Philodromus placidus* and *Xysticus punctatus*, are more frequently collected from coniferous trees than from deciduous trees.

CONCLUSIONS

With conventional budworm sampling techniques, our results indicate a relatively sparse spider fauna (21 species) associated with red spruce foliage. No doubt other sampling methods (e.g., knockdown sprays, beating-cloth collections, destructive whole-tree samples) and sampling over a more extended period (e.g., April-October) would add additional species to the spider faunal list for red spruce. The objectives of this study were to sample spiders during only two restricted time periods of budworm development, L₃-L₄ larval stages and the pupal stage. With additional samplings, spider species composition, age, sex ratio, and density are all apt to change due to individual life histories, reproductive cycles, and seasonal activities. Conventional budworm sampling methods are useful for determining frequencies and densities of common associated spiders; however, these methods are inadequate for determining important predator-prey relationships. More refined sampling methods and direct or indirect methods of assessing predation are needed (e.g., serological techniques for detecting target-prey antigens or tagging potential prey with radioisotopes).

Our hypotheses regarding possible factors affecting spider densities (i.e., sampling methods, weather conditions during sampling, seasonal activities and reproductive cycles of individual spider species, and tree physiognomies) need further testing in independent studies with controlled conditions. Such studies may elucidate important spider-tree associations.

ACKNOWLEDGMENTS

We thank the Great Northern Paper Company for permission to conduct these studies on their lands. Richard A. Hosmer, USDA Forest Service, Northeastern

Forest Experiment Station, provided computer programming assistance; John B. Dimond, Department of Entomology, University of Maine, provided field-crew assistance for collection of branches. We also thank Drs. Frederick A. Coyle, Bruce Cutler, David Wise, and Gail Stratton for their review comments. Donald W. Seegrift, Northeastern Forest Experiment Station, provided statistical review. This research was supported by funds provided by the USDA Forest Service, Northeastern Forest Experiment Station, NE-1151, to the Department of Entomology, College of Life Sciences and Agriculture, University of Maine, Orono (Cooperative Research Agreement 23-805).

LITERATURE CITED

- Berman, J. D. and H. W. Levi. 1971. The orb weaver genus *Neoscona* in North America. *Mus. Comp. Zool. Bull.*, 5:465-500.
- Bosworth, A. B., H. G. Raney, E. D. Sturgeon, R. D. Morrison, and R. D. Eikenbary. 1971. Population trends and location of spiders in loblolly pines, with notes of predation on the *Rhyacionia* complex (Lepidoptera: Olethreutidae). *Ann. Entomol. Soc. Amer.*, 64: 864-870.
- Chamberlin, R. V. and W. J. Gertsch. 1958. The spider family Dictynidae in America north of Mexico. *Amer. Mus. Nat. Hist. Bull.*, 116. 152 pp.
- Churcher, J. 1981. The utility of baskets fitted to pole pruners for the collection of spruce budworm larval samples. *Canadian For. Serv. Res. Notes*, 1:31-32.
- Collins, J. A. 1985. Population enhancement and nesting height preferences of trap-nesting wasps (Hymenoptera: Eumenidae) preying on spruce budworm (Lepidoptera: Tortricidae) in spruce-fir forests of Maine. MS Thesis, Univ. of Maine. 65 pp.
- Dahlsten, D. L., R. F. Luck, E. I. Schlinger, J. M. Wenz, and W. A. Cooper. 1977. Parasitoids and predators of the Douglas-fir tussock moth, *Orgyia pseudotsugata* (Lepidoptera: Lymantriidae), in low to moderate populations in central California. *Canadian Entomol.*, 109:727-746.
- Dondale, C. D. 1959. Definition of the genus *Grammonota* with descriptions of seven new species. *Canadian Entomol.*, 91:232-242.
- Dondale, C. D. 1961a. Revision of the *aureolus* group of the genus *Philodromus* (Araneae: Thomisidae) in North America. *Canadian Entomol.*, 93:199-222.
- Dondale, C. D. 1961b. Life histories of some common spiders from trees and shrubs in Nova Scotia. *Canadian J. Zool.*, 39:777-787.
- Dondale, C. D. 1977. Life histories and distribution patterns of hunting spiders (Araneida) in an Ontario meadow. *J. Arachnol.*, 4:73-93.
- Dondale, C. D. and J. H. Redner. 1968. The *imbecillus* and *rufus* groups of the spider genus *Philodromus*. *Mem. Entomol. Soc. Canada*, 55. 78 pp.
- Dondale, C. D. and J. H. Redner. 1975. The *fuscmarginatus* and *histrion* groups of the spider genus *Philodromus* in North America. *Canadian Entomol.*, 107:369-384.
- Dondale, C. D. and J. H. Redner. 1978. The crab spiders of Canada and Alaska (Araneae: Philodromidae and Thomisidae). *Canadian Dep. Agric. Publ.*, 1663. 255 pp.
- Dondale, C. D. and J. H. Redner. 1982. The sac spiders of Canada and Alaska (Araneae: Clubionidae and Anyphaenidae). *Canadian Dep. Agric. Publ.*, 1724. 194 pp.
- Haynes, D. L. and P. Sisojevic. 1966a. Predatory behavior of *Philodromus rufus* Walckenaer (Araneae: Thomisidae). *Canadian Entomol.*, 98:113-133.
- Haynes, D. L. and P. Sisojevic. 1966b. The predatory behavior of *Grammonota angusta* Dondale (Araneae: Erigonidae). *For. Res. Lab., Fredericton, New Brunswick. Internal Rep.*, M-15. 42 pp.
- Jennings, D. T. 1976. Spiders on black walnut. *Amer. Midland Nat.*, 95:111-119.
- Jennings, D. T. and M. W. Houseweart. 1978. Spider preys on spruce budworm egg mass. *Entomol. News*, 89:183-186.
- Jennings, D. T. and H. S. Crawford, Jr. 1985. Predators of the spruce budworm. *U.S. Dep. Agric., Agric. Handb.* 644. 77 pp.
- Jennings, D. T. and J. A. Collins. 1987. Coniferous-habitat associations of spiders (Araneae) on red spruce foliage. *J. Arachnol.*, 14:315-326.
- Kaston, B. J. 1973. Four new species of *Metaphidippus*, with notes on related jumping spiders from the eastern and central United States. *Amer. Microsc. Soc. Trans.*, 92:106-122.

- Kaston, B. J. 1981. Spiders of Connecticut. Bull. Connecticut State Geol. Nat. Hist. Surv., 70. 1020 pp.
- Levi, H. W. 1957. The spider genera *Enoplognatha*, *Theridion*, and *Paidisca* in America north of Mexico. Amer. Mus. Nat. Hist. Bull., 112:5-123.
- Levi, H. W. 1974. The orbweaver genera *Araniella* and *Nuctenea*. Mus. Comp. Zool. Bull., 146:291-316.
- Levi, H. W. 1977. The American orbweaver genera *Cyclosa*, *Metazygia* and *Eustala* north of Mexico. Mus. Comp. Zool. Bull., 148:61-127.
- Loughton, B. G., C. Derry, and A. S. West. 1963. Spiders and the spruce budworm. Pp. 249-268. In The dynamics of epidemic spruce budworm populations. (R. F. Morris, ed.). Mem. Entomol. Soc. Canada 31. 332 pp.
- Lowrie, D. C. 1971. Effects of time of day and weather on spider catches with a sweep net. Ecology, 52:348-351.
- Manuel, R. L. 1984. The egg sac of *Pityohyphantes costatus* (Hentz) (Araneae, Linyphiidae) and its phorid parasite. J. Arachnol., 12:371-372.
- Mason, R. R. and T. R. Torgersen. 1983. Mortality of larvae in stocked cohorts of the Douglas-fir tussock moth, *Orgyia pseudotsugata* (Lepidoptera: Lymantriidae). Canadian Entomol., 115:1119-1127.
- Morris, R. F. 1955. The development of sampling techniques for forest insect defoliators, with particular reference to the spruce budworm. Canadian J. Zool., 33:225-294.
- Morris, R. F., (ed.) 1963. The dynamics of epidemic spruce budworm populations. Mem. Entomol. Soc. Canada 31. 332 pp.
- Peck, W. B., L. O. Warren, and I. L. Brown. 1971. Spider fauna of shortleaf and loblolly pines in Arkansas. J. Georgia Entomol. Soc., 6:87-94.
- Platnick, N. I. and M. U. Shadab. 1975. A revision of the spider genera *Haplodrassus* and *Orodorassus*. Amer. Mus. Novitates, No. 2583. 40 pp.
- Platnick, N. I. and M. U. Shadab. 1981. A revision of the spider genus *Sergiolus* (Araneae, Gnaphosidae). Amer. Mus. Novitates, No. 2117. 41 pp.
- Renault, T. R. and C. A. Miller. 1972. Spiders in a fir-spruce biotype: abundance, diversity, and influence on spruce budworm densities. Canadian J. Zool., 50:1039-1046.
- Sanders, C. J. 1980. A summary of current techniques used for sampling spruce budworm populations and estimating defoliation in eastern Canada. Canadian For. Serv., Great Lakes For. Res. Cent. Rep., 0-X-306. 33 pp.
- Sokal, R. R. and F. J. Rohlf. 1981. Biometry. 2nd ed. W. H. Freeman Co., New York. 859 pp.
- Stein, J. D. 1969. Modified tree pruner for twig sampling. USDA For. Serv., Rocky Mount. For. Range Exp. Sta. Res. Notes, RM-130. 2 pp.
- Stratton, G. E., G. W. Uetz, and D. G. Dillery. 1979. A comparison of the spiders of three coniferous tree species. J. Arachnol., 6:219-226.
- Turnbull, A. L. 1956. Spider predators of the spruce budworm, *Choristoneura fumiferana* (Clem.) at Lillooet, B. C., Canada. Proc. 8th Pac. Sci. Congr., IIIA:1579-1593.
- Watt, K. E. F. 1963. The analysis of the survival of large larvae in the unsprayed area. Pp. 52-63. In The dynamics of epidemic spruce budworm populations. (R. F. Morris, ed.). Mem. Entomol. Soc. Canada 31. 332 pp.

Manuscript received July 1985, revised January 1986.

CONIFEROUS-HABITAT ASSOCIATIONS OF SPIDERS (ARANEAE) ON RED SPRUCE FOLIAGE

Daniel T. Jennings

Northeastern Forest Experiment Station
USDA Building, University of Maine
Orono, Maine 04469

and

Judith A. Collins

Department of Entomology
University of Maine
Orono, Maine 04469

ABSTRACT

Coniferous-habitat associations were determined for 16 species of adult spiders collected from red spruce foliage in northern Maine. Most of the spiders have been found on three or more (range one to 15) conifer species. Spider-conifer habitats were positively correlated ($r = 0.96$) with geographic states and provinces. Mean conifer-habitat associations did not differ between web spinner and hunter species. Significantly more species of spiders from red spruce foliage were associated with northern conifers than with western conifers, but not with southern conifers.

Comparison of the red spruce fauna with 16 selected spider-tree faunal studies showed that 1) Sørensen's similarity quotients (QS) were significantly greater for genera than for species, and 2) mean species QS values were significantly greater for northern than for southern but not for western conifers. The spider fauna on red spruce is closely allied with that on other northern conifers; however, none of the 16 spider species are restricted to conifers.

INTRODUCTION

The arboreal spider fauna of North American trees has received little attention; fewer than 25 coniferous and deciduous tree species have been studied in detail (Jennings 1976). Recent studies include: spiders on red pine, *Pinus resinosa* Ait., white spruce, *Picea glauca* (Moench) Voss, and northern white-cedar, *Thuja occidentalis* L., in Minnesota (Stratton, Uetz, and Dillery 1979); spiders on white fir, *Abies concolor* (Gord. and Glend.) Lindl. ex Hildebr., in California (Dahlsten et al. 1977) and in Oregon (Mason and Torgersen 1983). Additional spider-tree association records are scattered throughout the araneological and entomological literature; most records are incidental to other study objectives.

During our investigations on natural enemies of the spruce budworm, *Choristoneura fumiferana* (Clem.), we collected spiders of 10 families, 16 genera, and 21 species from foliage of red spruce, *Picea rubens* Sarg., in northern Maine. Mean spider densities during two sampling periods and spider-budworm

relationships were discussed in an earlier paper (Jennings and Collins 1987). Here we summarize the known coniferous-habitat associations for each of the 16 species found on red spruce foliage, and compare the spider fauna on red spruce with that of other coniferous species in North America. Our purposes for these comparisons were: 1) to identify (by spider and conifer species) the known spider-coniferous habitat associations, 2) to determine possible relationships between spider-coniferous habitats and geographic states and provinces, 3) to determine the degree of similarity between the spider fauna on red spruce and that found on other conifers, and 4) to determine possible patterns of association or differences in association among geographic regions. This information may be useful to forest pest managers who are concerned with identifying potentially important predators of coniferous pests.

METHODS

Habitat Associations.—We searched the araneological and entomological literature for spider-tree faunal studies and for habitat-association records of spiders collected from North American conifers. Standard reference sources were consulted including Biological Abstracts, Zoological Record, and Centre International de Documentation Arachnologique Liste. In addition, a DIALOG search was made from the AGRICOLA database at the National Agricultural Library, Beltsville, Maryland. The database search was limited to North American literature that included information and identities of both spiders and trees.

Because tree habitats may vary by spider species, and spiders identified to generic level only may include numerous species, we restricted our search to the 16 species of adult spiders found on red spruce foliage (Jennings and Collins 1987). In searching the older literature, recent spider synonymies were considered, e.g., *Pityohyphantes phrygianus* (Koch) [= *P. costatus* (Hentz)] (Kaston 1981), *Neoscona minima* F.O.P.-Cambridge [= *N. arabesca* (Walck.)] (Berman and Levi 1971), and *Araneus displicata* (Hentz) [= *Araniella displicata* (Hentz)] (Levi 1974). Consistent with Dondale (1959), records of *Grammonota pictilis* (O. P. Cambridge) collected on balsam fir, *Abies balsamea* (L.) Mill., in New Brunswick were considered to belong to *G. angusta* Dondale.

Habitat associations were recorded by spider and tree species. Only coniferous tree species were considered, though many of the red spruce spiders also occur on broad-leaved deciduous trees. Common and scientific names of trees follow Little (1979). Both evergreen and cone-bearing species of the families Cupressaceae, Pinaceae, and Taxodiaceae were included.

Data Analyses.—Although our literature search did not represent a random sample (i.e., all known available studies were included), we considered the data generated by these faunal studies to meet random-sample criteria (i.e., all potential coniferous habitats were available for study; none were selectively biased for our comparison purposes). We used nonparametric procedures (Sokal and Rohlf 1981) for statistical comparisons. The Wilcoxon two-sample test was used to test for differences between and among means ($P = 0.05$). For comparisons involving more than two means, all 2-mean combinations were performed.

Correlation analysis (Sokal and Rohlf 1981) was used as a measure of association between spider-coniferous habitats and geographic states and

provinces. We defined a spider-coniferous habitat as the collection of a spider species from or on a conifer species, e.g., *Dictyna brevitarisus* Emerton collected from foliage of *Abies balsamea* (L.) Mill. in New Brunswick (Renault 1968). Regression analysis was not used because we were interested in the degree of association (interdependence) between the two variables, not the dependence of one on the other. Habitat records without geographic locality were excluded from the analysis.

Sørensen's similarity quotient (QS), as defined by Price (1975), was used to determine the degree of similarity between the spider fauna on red spruce and that found on other coniferous species. The formula used was: $QS = 2c \times 100 / (a + b)$, where a = the number of spider genera or species in study A; b = the number of spider genera or species in study B; and c = the number of spider genera or species common to both studies.

To determine possible patterns of association among geographic areas, each conifer species was assigned to one of three broadly defined regions—northern, southern, or western—based on distributional ranges of trees given by Little (1979). We then calculated mean QS values for each region and performed statistical tests to determine possible differences and associations among regions. Likewise, mean numbers of spider species in common with red spruce were determined and compared for each region.

RESULTS AND DISCUSSION

Coniferous-Habitat Associations.—The 16 species of adult spiders found on red spruce foliage and their habitat associations with North American conifers are summarized in Table 1. With only one exception, *Xysticus discursans* Keyserling, most of the spiders have been collected from three or more conifer species (range 1 to 15). Included are habitat affinities with balsam fir, *Abies balsamea* (L.) Mill., and white fir, *A. concolor* (Gord. and Glend.) Lindl. ex Hildebr.; oldfield common juniper, *Juniperus communis* var. *depressa* Pursh., and *Juniperus* spp. (may include *J. chinensis* L., eastern red cedar, *J. virginiana* L., and Rocky Mountain juniper, *J. scopulorum* Sarg.); tamarack, *Larix laricina* (Du Roi) K. Koch, and western larch, *L. occidentalis* Nutt.; Norway spruce, *Picea abies* (L.) Karst., white spruce, *P. glauca* (Moench) Voss, and red spruce, *P. rubens* Sarg.; jack pine, *Pinus banksiana* Lamb., sand pine, *P. clausa* (Chapm. ex Engelm.) Vasey ex Sarg., lodgepole pine, *P. contorta* var. *latifolia* Engelm., shortleaf pine, *P. echinata* Mill., Jeffrey pine, *P. jeffreyi* Grev. and Balf., ponderosa pine, *P. ponderosa* Dougl. ex Laws., red pine, *P. resinosa* Ait., eastern white pine, *P. strobus* L., Scotch pine, *P. sylvestris* L., loblolly pine, *P. taeda* L., and Virginia pine, *P. virginiana* Mill.; Douglas-fir, *Pseudotsuga menziesii* (Mirb.) Franco; baldcypress, *Taxodium* sp.; and northern white-cedar, *Thuja occidentalis* L.

Predictably, coniferous-habitat associations were positively and highly correlated ($r = 0.96$) with geographic states and provinces (Fig. 1). This indicates that, within limits, the more localities sampled, the greater the likelihood of finding more coniferous-habitat associations. However, numbers of available coniferous species vary among states and provinces, and some spider species have limited ranges.

Considering habitat association by spider foraging group indicates that web spinners have been found and reported from more species of conifers ($\bar{x} = 7.9$

Table 1.—Coniferous-habitat associations of spiders from red spruce foliage.

Conifer species	Locality	Reference(s)
	<i>Dictyna brevitarus</i> Emerton	
<i>Abies balsamea</i>	New Brunswick	Loughton et al. (1963), Renault (1968) Renault and Miller (1972)
<i>Picea rubens</i>	Maine	Jennings and Collins (1987)
<i>Picea</i> sp.	New Brunswick	Renault and Miller (1972)
<i>Pinus strobus</i>	Wisconsin	Coppel and Smythe (1963)
	<i>Theridion montanum</i> Emerton	
<i>Abies balsamea</i>	New Brunswick	Loughton et al. (1963), Renault (1968) Renault and Miller (1972)
<i>Picea rubens</i>	Maine	Jennings and Collins (1987)
<i>Picea</i> sp.	New Brunswick	Renault and Miller (1972)
	New Mexico	Levi (1957)
<i>Pinus ponderosa</i>	New Mexico	Levi (1957)
	<i>Theridion murarium</i> Emerton	
<i>Abies balsamea</i>	New Brunswick	Loughton et al. (1963), Renault (1968) Renault and Miller (1972)
<i>Abies concolor</i>	Oregon	Mason and Torgersen (1983)
<i>Juniperus communis</i> var. <i>depressa</i>	Michigan	Drew (1967)
<i>Juniperus</i> spp.	Kansas	Heinrichs and Thompson (1968)
	New Mexico	Levi (1957)
<i>Picea abies</i>	Massachusetts	Taylor (1928) ¹
<i>Picea rubens</i>	Maine	Jennings and Collins (1987)
<i>Picea</i> sp.	New Brunswick	Renault and Miller (1972)
	Connecticut	Kaston (1981)
<i>Pinus banksiana</i>	Michigan	Allen et al. (1970)
	Indiana	Lowrie (1948)
<i>Pinus echinata</i>	Arkansas	Peck et al. (1971) ¹
<i>Pinus ponderosa</i>	New Mexico	Levi (1957)
<i>Pinus resinosa</i>	Ontario	Martin (1966)
<i>Pinus strobus</i>	Wisconsin	Coppel and Smythe (1963)
	Massachusetts	Taylor (1928)
<i>Pinus sylvestris</i>	Massachusetts	Taylor (1928)
<i>Pinus taeda</i>	Arkansas	Peck et al. (1971)
	Oklahoma	Bosworth et al. (1971)
<i>Pinus virginiana</i>	Maryland	Howden and Vogt (1951)
<i>Pinus</i> sp.	Connecticut	Kaston (1981)
<i>Pseudotsuga menziesii</i>	British Columbia	Turnbull (1956)
<i>Thuja occidentalis</i>	Michigan	Drew (1967)
	<i>Pityohyphantes costatus</i> (Hentz)	
<i>Abies balsamea</i>	New Brunswick	Loughton et al. (1963), Renault (1968) Renault and Miller (1972)
<i>Abies concolor</i>	Oregon	Mason and Torgersen (1983)
	California	Ohmart and Dahlsten (1979)
<i>Picea glauca</i>	Quebec	Manuel (1984)
<i>Picea rubens</i>	Maine	Jennings and Collins (1987)
<i>Picea</i> sp.	New Brunswick	Renault and Miller (1972)
<i>Pinus contorta</i> var. <i>latifolia</i>	Alberta	Powell (1971)
<i>Pinus resinosa</i>	Minnesota	Stratton et al. (1979)
	Connecticut	Bean and Godwin (1955)
<i>Thuja occidentalis</i>	Michigan	Drew (1967)

Table 1.—Continued.

	<i>Grammonota angusta</i> Dondale	
<i>Abies balsamea</i>	New Brunswick	Loughton et al. (1963), Renault (1968) Renault and Miller (1972)
<i>Larix laricina</i>	Manitoba	Ives (1967)
<i>Picea rubens</i>	Maine	Jennings and Collins (1987)
<i>Picea</i> sp.	New Brunswick	Renault and Miller (1972)
<i>Pinus banksiana</i>	Manitoba	Bradley and Hinks (1968)
	<i>Eustala anastera</i> (Walckenaer)	
<i>Abies balsamea</i>	New Brunswick	Levi (1977)
<i>Juniperus</i> spp.	Kansas	Heinrichs and Thompson (1968)
	Nebraska	Worley and Pickwell (1927)
<i>Larix occidentalis</i>		Levi (1977)
<i>Picea glauca</i>	New Brunswick	Levi (1977)
<i>Picea rubens</i>	Maine	Jennings and Collins (1987)
<i>Pinus banksiana</i>	Michigan	Allen et al. (1970)
<i>Pinus clausa</i>	Florida	Levi (1977)
<i>Pinus echinata</i>	Arkansas	Peck et al. (1971)
<i>Pinus taeda</i>	Arkansas	Peck et al. (1971), Levi (1977)
<i>Taxodium</i> sp.		Levi (1977)
	<i>Neoscona arabesca</i> (Walckenaer)	
<i>Abies balsamea</i>	New Brunswick	Renault (1968)
<i>Abies concolor</i>	Oregon	Mason and Torgersen (1983)
<i>Juniperus communis</i> var. <i>depressa</i>	Michigan	Drew (1967)
<i>Juniperus</i> sp.		Berman and Levi (1971)
<i>Larix laricina</i>		Berman and Levi (1971)
<i>Picea rubens</i>	Maine	Jennings and Collins (1987)
<i>Pinus echinata</i>	Arkansas	Peck et al. (1971)
<i>Pinus strobus</i>	Wisconsin	Coppel and Smythe (1963)
<i>Pinus taeda</i>	Arkansas	Peck et al. (1971)
	Oklahoma	Bosworth et al. (1971)
<i>Pinus virginiana</i>	Maryland	Howden and Vogt (1951)
	<i>Araniella displicata</i> (Hentz)	
<i>Abies balsamea</i>	New Brunswick	Loughton et al. (1963) Renault and Miller (1972)
<i>Juniperus communis</i> var. <i>depressa</i>	Michigan	Drew (1967)
<i>Picea glauca</i>	Minnesota	Stratton et al. (1979)
<i>Picea rubens</i>	Maine	Jennings and Collins (1987)
<i>Picea</i> sp.	New Brunswick	Renault and Miller (1972)
<i>Pinus banksiana</i>	Manitoba	Bradley and Hinks (1968)
	Michigan	Allen et al. (1970)
<i>Pinus echinata</i>	Arkansas	Peck et al. (1971)
<i>Pinus jeffreyi</i>	California	Dahlsten (1961) ¹
<i>Pinus ponderosa</i>	California	Dahlsten (1961)
<i>Pinus resinosa</i>	Ontario	Martin (1966)
<i>Pinus strobus</i>	Wisconsin	Coppel and Smythe (1963)
	Maine	Procter (1946)
<i>Pinus taeda</i>	Arkansas	Peck et al. (1971)
	Oklahoma	Bosworth et al. (1971)
<i>Pseudotsuga menziesii</i>	British Columbia	Turnbull (1956)
	<i>Clubiona canadensis</i> Emerton	
<i>Abies balsamea</i>	New Brunswick	Loughton et al. (1963) Renault (1968) Renault and Miller (1972)

Table 1.—Continued.

<i>Picea rubens</i>	Maine	Jennings and Collins (1987)
<i>Picea</i> sp.	New Brunswick	Renault and Miller (1972)
<i>Thuja occidentalis</i>	Michigan	Drew (1967)
	<i>Philodromus exilis</i> Banks	
<i>Abies balsamea</i>	New Brunswick	Renault (1968)
<i>Abies</i> sp.		Dondale and Redner (1968)
<i>Juniperus</i> sp.		Dondale and Redner (1968)
<i>Picea glauca</i>	Ontario	Dondale (pers. comm.)
	Nova Scotia	
	New Brunswick	
<i>Picea rubens</i>	Maine	Jennings and Collins (1987)
<i>Pinus strobus</i>	Ontario	Dondale (pers. comm.)
	Nova Scotia	
<i>Thuja occidentalis</i>	Ontario	Dondale (pers. comm.)
	<i>Philodromus placidus</i> Banks	
<i>Abies balsamea</i>	New Brunswick	Loughton et al. (1963)
		Renault (1968)
		Renault and Miller (1972)
<i>Juniperus communis</i> var. <i>depressa</i>	Michigan	Drew (1967)
<i>Picea rubens</i>	Maine	Jennings and Collins (1987)
<i>Picea</i> sp.	New Brunswick	Renault and Miller (1972)
<i>Pinus banksiana</i>	Manitoba	Bradley and Hinks (1968)
	Michigan	Allen et al. (1970)
<i>Pinus echinata</i>	Arkansas	Peck et al. (1971)
<i>Pinus resinosa</i>	Minnesota	Heimer et al. (1984)
<i>Pinus</i> sp.	Maine	Procter (1946)
<i>Pinus taeda</i>	Arkansas	Peck et al. (1971)
	<i>Misumena vatia</i> (Clerck)	
<i>Juniperus communis</i> var. <i>depressa</i>	Michigan	Drew (1967)
<i>Picea rubens</i>	Maine	Jennings and Collins (1987)
<i>Pinus banksiana</i>	Manitoba	Bradley and Hinks (1968)
<i>Pinus echinata</i>	Arkansas	Peck et al. (1971)
<i>Pinus taeda</i>	Arkansas	Peck et al. (1971)
<i>Pseudotsuga menziesii</i>	British Columbia	Turnbull (1956)
	<i>Xysticus discursans</i> Keyserling	
<i>Picea rubens</i>	Maine	Jennings and Collins (1987)
	<i>Xysticus punctatus</i> Keyserling	
<i>Abies balsamea</i>	New Brunswick	Renault (1968)
<i>Picea glauca</i>	Minnesota	Houseweart and Kulman (1976)
<i>Picea rubens</i>	Maine	Jennings and Collins (1987)
<i>Pinus banksiana</i>	Manitoba	Bradley and Hinks (1968)
	Michigan	Allen et al. (1970)
<i>Pinus echinata</i>	Arkansas	Peck et al. (1971)
<i>Pinus resinosa</i>	Minnesota	Heimer et al. (1984)
<i>Pinus strobus</i>	Wisconsin	Coppel and Smythe (1963)
<i>Pinus taeda</i>	Arkansas	Peck et al. (1971)
	Oklahoma	Bosworth et al. (1971)
<i>Pseudotsuga menziesii</i>	British Columbia	Turnbull (1956)
	<i>Salticus scenicus</i> (Linnaeus)	
<i>Picea rubens</i>	Maine	Jennings and Collins (1987)
<i>Pinus echinata</i>	North Carolina	Ramsey (1941) ¹
<i>Pinus taeda</i>	North Carolina	Ramsey (1941)
	Oklahoma	Bosworth et al. (1971)

Table 1.—Continued.

	<i>Metaphidippus flavipedes</i> (G. & E. Peckham)	
<i>Abies balsamea</i>	Maine	Jennings and Housewart (1978)
	New Brunswick	Loughton et al. (1963) Renault (1968) Renault and Miller (1972)
<i>Juniperus communis</i> var. <i>depressa</i>	Michigan	Drew (1967)
<i>Picea glauca</i>	Minnesota	Housewart and Kulman (1976)
<i>Picea rubens</i>	Maine	Jennings and Collins (1987)
<i>Picea</i> sp.	New Brunswick	Renault and Miller (1972)
<i>Pinus banksiana</i>	Manitoba	Bradley and Hinks (1968)
	Michigan	Allen et al. (1970)
<i>Pinus echinata</i>	Arkansas	Peck et al. (1971)
<i>Pinus resinosa</i>	Ontario	Martin (1966)
	Minnesota	Heimer et al. (1984)
<i>Pinus strobus</i>	Wisconsin	Coppel and Smythe (1963)
<i>Pinus taeda</i>	Arkansas	Peck et al. (1971)
<i>Pseudotsuga menziesii</i>	British Columbia	Turnbull (1956)
<i>Thuja occidentalis</i>	Michigan	Drew (1967)

¹Collections not separated by tree species.

± 1.6) than have hunters ($\bar{x} = 5.8 \pm 1.2$); however, the means for these two groups were not significantly different by the Wilcoxon two-sample test. Coniferous foliage is a suitable habitat substrate for both spider groups. Stratton et al. (1979) found greater percentages of web-builders than hunters on pine, spruce, and cedar in Minnesota; but the relative composition of the two foraging groups was not significantly different among tree species.

Exotic conifers excepted, i.e., *Picea abies* and *Pinus sylvestris*, significantly more ($P = 0.02$) species of spiders from red spruce foliage were associated with northern conifers ($\bar{x} = 7.4 \pm 1.5$) than with western conifers ($\bar{x} = 2.9 \pm 0.8$), but not with southern conifers ($\bar{x} = 4.4 \pm 1.9$). This supports our hypothesis that the spider fauna on red spruce is closely allied with other northern conifers; however, elements may also occur on southern conifers, and to a lesser degree on western conifers. Mean numbers of red spruce species associated with western and southern conifers did not differ significantly.

Among individual species, *Theridion murarium* Emerton showed the greatest range of coniferous habitats, being found on at least 15 species of conifers. Six other spider species have been collected from seven or more conifer species: *Araniella displicata* (Hentz) (12), *Metaphidippus flavipedes* (G. & E. Peckham) (11), *Xysticus punctatus* Keyserling (9), *Eustala anastera* (Walckenaer) (8), *Neoscona arabesca* (Walckenaer) (8), and *Pityohyphantes costatus* (Hentz) (7). The remaining spiders from red spruce foliage are reported from six or fewer conifers. Apparently *Xysticus discursans* has been collected and reported from only one conifer, *Picea rubens*; however, this association may be accidental because the normal habitat for this spider is near the ground (Dondale and Redner 1978).

The number of coniferous-habitat associations for individual spider species does not necessarily correspond with or indicate their habitat specificity. None of the 16 species found on red spruce are restricted to that tree species, or to

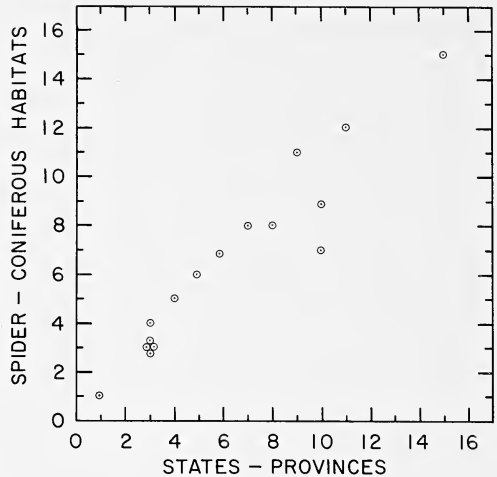

Fig. 1.—Relationship between spider-coniferous habitats and states and provinces; correlation analysis, $r = 0.96$ (Sokal and Rohlf 1981). Each point represents the number of conifer species and states and provinces from which one of the red spruce spiders ($n = 16$) has been reported.

conifers. For example, many of the species, including *Theridion murarium*, *Metaphidippus flavipedes*, *Araniella displicata*, *Eustala anastera*, and *Neoscona arabesca*, also occur on a variety of broad-leaved trees and shrubs. *Misumena vatia* (Clerck) and *Clubiona canadensis* Emerton are frequently collected from shrubs and forbs; *Salticus scenicus* (Linnaeus) is found in synanthropic habitats (Kaston 1981). *Xysticus discursans* is usually taken by pitfall traps and sweep nets in both grassland and wooded areas (Dondale and Redner 1978). *Grammonota angusta* Dondale, *Philodromus placidus* Banks, and *Xysticus punctatus* are typically found on conifers.

Spider-Faunal Studies.—Sørensen's similarity quotients (QS values) for 16 spider-tree faunal studies are shown in Table 2. Not included are studies lacking complete species lists (Dahlsten et al. 1977; Renault and Miller 1972; Stratton et al. 1979) and studies where tree-habitat association was uncertain (Fox and Griffith 1976). As expected, QS values were significantly greater ($P < 0.01$) for genera than for species, i.e., more genera than species were shared in common among the studies. QS values for species were generally < 30 , no doubt because sampling methods and intensities varied considerably among the studies. However, despite these differences, the red spruce fauna showed more similarities with spider faunas on northern conifers than on southern or western conifers. Mean species QS values were significantly greater ($P = 0.03$) for northern conifers ($\bar{x} = 18.4 \pm 2.2$) than for southern conifers ($\bar{x} = 9.0 \pm 1.5$), but not for western conifers ($\bar{x} = 13.2 \pm 0.8$). Southern and western QS means also did not differ significantly; however, the level of statistical significance ($P = 0.08$) shows possible distinction. With only two exceptions, *Larix laricina* and *Pinus resinosa*, QS values for northern conifers were generally > 15 ; whereas, those for southern and western conifers were generally < 15 .

The apparent similarity among spider faunas on northern conifers is also evidenced by comparable QS values, particularly for tree species often found growing in the same forest stand, e.g., *Abies balsamea*, *Pinus strobus*, and *Thuja occidentalis* (Table 2). Surprisingly, *Larix laricina*, a common resident of northeastern spruce-fir forests, had a very low QS value; conversely, *Juniperus communis* var. *depressa*, an inhabitant of old fields and cutover forests, had a relatively high QS value. We are unable to explain these dissimilarities.

Table 2.—Comparison of red spruce spider fauna with spider faunas of other coniferous species by geographic region. QS = Sørensen's similarity quotient.

Conifer species	State- Province	QS value		Reference
		Genera	Species	
NORTHERN REGION				
<i>Abies balsamea</i>	New Brunswick	30.4	19.5	Renault (1968)
<i>Abies balsamea</i>	New Brunswick	37.7	24.0	Loughton et al. (1963)
<i>Juniperus communis</i> var. <i>depressa</i>	Michigan	57.1	27.8	Drew (1967)
<i>Larix laricina</i>	Manitoba	51.8	6.1	Ives (1967)
<i>Pinus banksiana</i>	Michigan	46.2	21.4	Bradley and Hinks (1968)
<i>Pinus banksiana</i>	Michigan	38.5	18.8	Allen et al. (1970)
<i>Pinus resinosa</i>	Ontario	25.8	10.5	Martin (1966)
<i>Pinus strobus</i>	Wisconsin	59.5	19.4	Coppel and Smythe (1963)
<i>Thuja occidentalis</i>	Michigan	38.5	18.2	Drew (1967)
SOUTHERN REGION				
<i>Juniperus</i> spp.	Kansas	37.5	9.5	Heinrichs and Thompson (1968)
<i>Pinus echinata</i> and <i>P. taeda</i> ¹	North Carolina	25.9	3.2	Ramsey (1941)
<i>Pinus echinata</i> and <i>P. taeda</i> ¹	Arkansas	27.7	10.3	Peck et al. (1971)
<i>Pinus taeda</i>	Oklahoma	32.4	11.6	Bosworth et al. (1971)
<i>Pinus virginiana</i>	Maryland	32.3	10.5	Howden and Vogt (1951)
WESTERN REGION				
<i>Abies concolor</i>	Oregon	54.6	14.0	Mason and Torgersen (1983)
<i>Pseudotsuga menziesii</i>	British Columbia	36.7	12.5	Turnbull (1956)

¹Collections not separated by tree species.

In addition to geographic region, tree height and growth form may also influence resident spider faunas. For example, within the same northern region, spider faunas on young, plantation red pine and on tamarack generally had low QS values compared with other species. Martin (1966) concluded that young red pine seedlings planted in an old field do not form an influential part of the community, and ecological conditions remain those of an old field. No doubt the sparse, clumped needles of tamarack provide fewer microhabitats for spiders than the dense, dispersed foliage of spruce. Stratton et al. (1979) found the highest number of spider species and individuals on foliage of white spruce compared with red pine and northern white-cedar.

Notably absent from these faunistic comparisons, including our own study, are investigations involving two or more coniferous species sampled at the same time, place, and intensity. For such studies, we predict that QS values will be much higher, particularly for conifers growing in the same forest stand and of similar growth form, height, and age. Under these conditions, faunal similarities may approach the QS-50 limit, below which communities are arbitrarily considered distinct (Price 1975). None of the species faunistic comparisons in Table 2 approached this limit, probably because the conifers studied were widely separated in time, place, and sampling methodology.

Finally, the paucity of information about spider-coniferous habitat associations is evident from both Tables 1 and 2. Apparently less than 30% of the 82 native species of conifers (Little 1979; families Cupressaceae, Pinaceae, and Taxodiaceae) have even been examined for spiders, much less studied in detail. The maximum

number of conifer species sampled in any one state or province was four; likewise, only one conifer, *Picea glauca*, has been studied in five states and provinces. We conclude that additional faunistic studies are needed: 1) to define the spider fauna of any one conifer species, and 2) to determine habitat specificities and associational ranges of individual spider species. Such information will help to elucidate potential predator-prey relationships involving spiders and pests of conifers.

ACKNOWLEDGMENTS

We thank Daniel Starr, who at the time of this study was with USDA Forest Service, National Agricultural Library, Beltsville, Maryland, for assistance with literature searches. Richard A. Hosmer provided computer programming assistance and is with the USDA Forest Service, Northeastern Forest Experiment Station, Orono, Maine.

We are grateful to our reviewers, Bruce Cutler, Charles D. Dondale, James H. Redner, and Dave Walter for their constructive comments, and to Donald W. Seegrift, Biometrician, Northeastern Forest Experiment Station, for statistical review.

Portions of this research were supported by funds provided by the USDA, Forest Service, Northeastern Forest Experiment Station, NE-1151, to the Department of Entomology, College of Life Sciences and Agriculture, University of Maine, Orono (Cooperative Research Agreement 23-805).

LITERATURE CITED

- Allen, D. C., F. B. Knight, and J. L. Foltz. 1970. Invertebrate predators of the jack-pine budworm, *Choristoneura pinus*, in Michigan. *Ann. Entomol. Soc. Amer.*, 63:59-64.
- Bean, J. L. and P. A. Godwin. 1955. Description and bionomics of a new red pine scale, *Matsucoccus resinosa*. *For. Sci.*, 1:164-176.
- Berman, J. D. and H. W. Levi. 1971. The orb weaver genus *Neoscona* in North America. *Mus. Comp. Zool. Bull.*, 5:465-500.
- Bosworth, A. B., H. G. Raney, E. D. Sturgeon, R. D. Morrison, and R. D. Eikenbary. 1971. Population trends and location of spiders in loblolly pines, with notes of predation on the *Rhyacionia* complex (Lepidoptera: Olethreutidae). *Ann. Entomol. Soc. Amer.*, 64:864-870.
- Bradley, G. A. and J. D. Hinks. 1968. Ants, aphids, and jack pine in Manitoba. *Canadian Entomol.*, 100:40-50.
- Coppel, H. C. and R. V. Smythe. 1963. Occurrence of spiders on eastern white pine trees infested with the introduced pine sawfly, *Diprion similis* (Htg.). *Univ. Wisconsin Forestry Res. Notes No.* 102. 7 pp.
- Dahlsten, D. L. 1961. Life history of a pine sawfly, *Neodiprion* sp., at Willits, California (Hymenoptera: Diprionidae). *Canadian Entomol.*, 93:182-195.
- Dahlsten, D. L., R. F. Luck, E. I. Schlinger, J. M. Wenz., and W. A. Copper. 1977. Parasitoids and predators of the Douglas-fir tussock moth, *Orgyia pseudotsugata* (Lepidoptera: Lymantriidae), in low to moderate populations in central California. *Canadian Entomol.*, 109:727-746.
- Dondale, C. D. 1959. Definition of the genus *Grammonota* with descriptions of seven new species. *Canadian Entomol.*, 91:232-242.
- Dondale, C. D. and J. H. Redner. 1968. The *imbecillus* and *rufus* groups of the spider genus *Philodromus*. *Entomol. Soc. Canada Mem.*, 55. 78 pp.
- Dondale, C. D. and J. H. Redner. 1978. The crab spiders of Canada and Alaska (Araneae: Philodromidae and Thomisidae). *Canadian Dept. Agr. Publ.*, 1663. 255 pp.

- Drew, L. C. 1967. Spiders of Beaver Island Michigan. Publications of the Museum, Michigan State Univ., 3(3):153-208.
- Fox, R. C. and K. H. Griffith. 1976. Predation of pine cinaran aphids by spiders. J. Georgia Entomol. Soc., 11:241-243.
- Heinrichs, E. A. and H. E. Thompson. 1968. Parasites, predators, and other arthropods associated with *Choristoneura houstonana* (Lepidoptera: Tortricidae) on *Juniperus* species in Kansas. Canadian Entomol., 100:33-39.
- Heimer, S., W. Nentwig, and B. Cutler. 1984. The spider fauna of the Itasca State Park (Minnesota, USA). Faun. Abh. Mus. Tierk. Dresden, 11, Nr. 6, 1983:119-124.
- Houseweart, M. W. and H. W. Kulman. 1976. Life tables of the yellowheaded spruce sawfly, *Pikonema alaskensis* (Rohwer) (Hymenoptera: Tenthredinidae) in Minnesota. Environ. Entomol., 5:859-867.
- Howden, H. F. and G. B. Vogt. 1951. Insect communities of standing dead pine (*Pinus virginiana* Mill.). Ann. Entomol. Soc. Amer., 44:581-595.
- Ives, W. G. H. 1967. Relations between invertebrate predators and prey associated with larch sawfly eggs and larvae on tamarack. Canadian Entomol., 99:607-622.
- Jennings, D. T. 1976. Spiders on black walnut. Amer. Midland Nat., 95:111-119.
- Jennings, D. T. and J. A. Collins. 1987. Spiders on red spruce foliage in northern Maine. J. Arachnol., 14:303-313.
- Jennings, D. T. and M. W. Houseweart. 1978. Spider preys on spruce budworm egg mass. Entomol. News, 89:183-186.
- Kaston, B. J. 1981. Spiders of Connecticut. Bull. Connecticut State Geol. Nat. Hist. Surv., 70: 1020 pp.
- Levi, H. W. 1957. The spider genera *Enoplognatha*, *Theridion*, and *Paidisca* in America north of Mexico. Amer. Mus. Nat. Hist. Bull., 112:5-123.
- Levi, H. W. 1974. The orbweaver genera *Araniella* and *Nuctenea*. Mus. Comp. Zool. Bull., 146:291-316.
- Levi, H. W. 1977. The American orbweaver genera *Cyclosa*, *Metazygia* and *Eustala* north of Mexico. Mus. Comp. Zool. Bull., 148:61-127.
- Little, E. L., Jr. 1979. Checklist of United States trees (native and naturalized). For. Serv., U.S. Dep. Agr., Washington, D.C. Agr. Handbk., No. 541. 375 pp.
- Loughton, B. G., C. Derry, and A. S. West. 1963. Spiders and the spruce budworm. Pp. 249-268. In The dynamics of epidemic spruce budworm populations. (R. F. Morris, ed.). Mem. Entomol. Soc. Canada 31. 332 pp.
- Lowrie, D. C. 1948. The ecological succession of the spiders of the Chicago area dunes. Ecology, 29:334-351.
- Manuel, R. L. 1984. The egg sac of *Pityohyphantes costatus* (Hentz) (Araneae, Linyphiidae) and its phorid parasite. J. Arachnol., 12:371-372.
- Mason, R. R. and T. R. Torgersen. 1983. Mortality of larvae in stocked cohorts of the Douglas-fir tussock moth, *Orgyia pseudotsugata* (Lepidoptera: Lymantriidae). Canadian Entomol., 115:1119-1127.
- Martin, J. L. 1966. The insect ecology of red pine plantations in central Ontario. IV. The crown fauna. Canadian Entomol., 98:10-27.
- Ohmart, C. P. and D. L. Dahlsten. 1979. Biological studies of bud mining sawflies, *Pleroneura* spp. (Hymenoptera: Xyelidae), on white fir in the central Sierra Nevada of California. III. Mortality factors of egg, larval, and adult stages and a partial life table. Canadian Entomol., 111:833-888.
- Peck, W. B., L. O. Warren, and I. L. Brown. 1971. Spider fauna of shortleaf and loblolly pines in Arkansas. J. Georgia Entomol. Soc., 6:87-94.
- Powell, J. M. 1971. The arthropod fauna collected from the comandra blister rust, *Cronartium comandrae*, on lodgepole pine in Alberta. Canadian Entomol., 103:908-918.
- Price, P. W. 1975. Insect Ecology. John Wiley & Sons, New York, 514 pp.
- Procter, W. 1946. Biological survey of the Mount Desert Region Incorporated. Part VII. Wistar Institute of Anatomy and Biology. Philadelphia., 566 pp.
- Ramsey, H. 1941. Fauna of pine bark. Elisha Mitchell Sci. Soc., 57:91-97.
- Renault, T. R. 1968. An illustrated key to arboreal spiders (Araneida) in the fir-spruce forests of New Brunswick. Canada Dep. Fisheries and Forestry, For. Res. Lab., Fredericton, New Brunswick. Internal Rep. M-39, 41 pp.
- Renault, T. R. and C. A. Miller. 1972. Spiders in a fir-spruce biotype: abundance, diversity, and influence on spruce budworm densities. Canadian J. Zool., 50:1039-1046.

- Stratton, G. E., G. W. Uetz, and D. G. Dillery. 1979. A comparison of the spiders of three coniferous tree species. *J. Arachnol.*, 6:219-226.
- Sokal, R. R. and F. J. Rohlf. 1981. *Biometry*. 2nd ed. W. H. Freeman and Company. New York, 859 pp.
- Taylor, R. L. 1928. The arthropod fauna of coniferous leaders weeviled by *Pissodes strobi* (Peck). *Psyche*, 35:217-225.
- Turnbull, A. L. 1956. Spider predators of the spruce budworm, *Choristoneura fumiferana* (Clem.) at Lillooet, B.C., Canada. *Proc. 8th Pacific Sci. Congr. Vol. IIIA*:1579-1593.
- Worley, L. G. and G. B. Pickwell. 1927. The spiders of Nebraska. *University Studies, University of Nebraska*, 27 (1-4):1-129.

Manuscript received October 1985, revised January 1986.

NESTS OF TERRESTRIAL SPIDERS MAINTAIN A PHYSICAL GILL: FLOODING AND THE EVOLUTION OF SILK CONSTRUCTIONS

Jerome S. Rovner

Department of Zoological Sciences
Ohio University, Irvine Hall
Athens, Ohio 45701

ABSTRACT

Individuals of *Dysdera crocata* and *Ariadna bicolor* usually drown during the first day of submersion in aerated water (21 to 25°C). However, if submerged while in their nests, they remain capable of activity for up to 10 days. Those residing underwater for the average of 3 days or for a longer period cannot continue to rely on the original oxygen supply of the nest's air store, which is less than a 2-day supply. A decrease in dissolved oxygen in the water, as measured in closed systems, indicates that the bubble held in the nest acts as a physical gill, with oxygen uptake averaging 3 to 4 $\mu\text{l h}^{-1}$ for the nests of adult spiders. Thus, the spider's survival underwater depends on the nest's preventing the Ege effect from diminishing the bubble. Flooding, which could occur in any of the terrestrial habitats of various ancestral arthropods, should be included among the several factors hypothesized to have favored the evolutionary origin of silk nests in spiders and similar constructions in certain other arthropod taxa.

INTRODUCTION

The use of silk by submerged spiders to maintain a bubble that acts as a physical gill has been shown to be significant only in the aquatic species *Argyroneta aquatica* (Clerck) (Schollmeyer 1913, Braun 1931, Thorpe 1950). While the ability of coastal species to survive tidal submergence attracted the attention of many workers (e.g., Abrahams 1924, 1926, Arndt 1915, Bethge 1973, Bristowe 1923, 1930, 1931, Heydemann 1967, Lamoral 1968, McQueen and McLay 1983, McQueen et al. 1983, Schaefer 1974, 1976), only McQueen and McLay included tests of spiders that were inside silk nests. They found that the physical gill effect did not substantially increase the survival time underwater in the intertidal spider *Desis marina* (Hector), since this spider's nest, built beneath the holdfasts of bull kelp, was always within a cavity that held an air supply adequate for many days of submergence. But what of inland, terrestrial, ground-dwelling spiders trapped in their nests during rain-caused flooding, wherein the nest surface itself is directly covered by water for days in many cases?

Many spiders carry a bubble when submerged, which was shown to act as a physical gill in two intertidal species (Lamoral 1968), just as it does in many insects (Ege 1915, Thorpe 1950). In all spiders examined so far—even *Argyroneta aquatica*—the hydrofuge hairs are not specialized like the critically spaced

hydrofuge hairs of certain aquatic insects; therefore, spiders cannot maintain a bubble or air film as a permanent plastron (Thorpe 1950). The bubble gradually disappears during a number of hours because of the outward diffusion of nitrogen (the "Ege effect"). Without a bubble, the spider cannot extract oxygen from the water, and it drowns.

Like the wintertime web of *A. aquatica*, the silk nests of various terrestrial spiders might prevent the dissolution of the entrapped bubble, thereby maintaining a physical gill during prolonged submergence. I decided to investigate this possibility, being curious about how our local, ground-dwelling spiders survive rain-caused flooding.

Since many or most terrestrial spiders climb vegetation to escape rising flood waters (Cooke 1962), I chose to study two species which spend much or all of their time in silken structures built among or beneath stones. *Dysdera crocata* C. L. Koch (Dysderidae) builds closed sacs used for molting, brood care, and retreats that may be occupied for over a month (Cooke 1965) and also can be found beneath lumps of mud in marshes (Cooke 1967). *Ariadna bicolor* (Hentz) (Segestriidae) dwells in a tubular retreat from which it darts for prey capture. (To save space, I shall use the term "nest" henceforth for both types of structures.) I assumed that these spiders tend to remain in their nests at the onset of flooding in nature, since they always did so in laboratory simulations. Such behavior was observed in the field in a terrestrial clubionid (*Clubiona phragmitis* C. L. Koch) by Bristowe (1931), who found the spiders "enclosed in dense silken cells attached to the underside of stones the tops of which were only just appearing above the surface of the lake, which had overflowed its ordinary boundaries."

In the present laboratory study the spiders survived as long as 10 days in their nests under water that was relatively warm, while they typically drowned within 12-24 h if outside the nest in such water. Measurements made with oxygen electrodes showed that oxygen diffuses from the water into the nests, thereby supporting an hypothesis that the nest-maintained bubble serves as a physical gill, a heretofore unsuspected adaptive advantage of the nests of terrestrial spiders. A possible flood-survival role for the silk added to the burrows of ancestral spiders was suggested by this study.

MATERIALS AND METHODS

I collected the two species of spiders beneath or between loose bricks and stones in locations shaded by vegetation (summer and fall, 1983 and 1984; Athens County, Ohio, USA). Vertically standing plastic vials (24 mm diameter, 50 mm height for small individuals; 32 mm diameter, 70 mm height for large) housed most spiders. Nests were built where the vial wall and bottom came together, often beneath a piece of plastic screen that leaned against the wall. Drinking water was injected through the air hole of the cap every few days. Some *D. crocata* were housed in plastic cages (7.0 × 12.5 × 7.0 cm high). *D. crocata* preyed on isopods, while *A. bicolor* fed on *Drosophila melanogaster* and *Tenebrio molitor*. Room temperatures ranged from 21 to 25°C, depending on the time of year. All the housing containers were placed behind and beneath cardboard sheets to maintain low illumination, like that found beneath stones. I used a Kahn electronic analytical balance (model TA-450) to weigh spiders. Means are followed by standard errors of the mean.

Survival Times After Submersion.—To compare resistance to drowning in spiders without vs. within their nests, I submerged them 10 cm below the surface in aerated aquarium water. Spiders without nests were given a strip of paper for a foothold. I used a syringe to withdraw the bubble trapped beneath the screen cover of the vial after submergence. The vials were held horizontally beneath glass bowls and had their screen-covered openings facing the center of the 5-gallon aquarium, where bubbles issued from an air stone connected to an air pump, a setup modified from Lamoral (1968). Cardboard sheets over and around the aquarium insured dim illumination, except at brief intervals when I removed them to view the spiders. Spiders in nests were made partly visible by backlighting with microscope illuminators during the brief inspection. Water and home-vial air temperatures were similar, which minimized acclimation effects.

Spiders without nests were removed from the water after a limited period, usually 12, 18, 24, or 36 h; placed ventral side up (if unable to stand upright); and given 1 day to recover. Spiders within nests were checked at intervals; I tapped the vial and, if there was no response, prodded the nest with a dissecting needle inserted through the screen cover of the vial. If still no response, the vial was removed from the water and the nest was opened. Such spiders soon showed activity and, therefore, could have remained submerged a longer time. These individuals constituted the category of spiders that had "limited residency."

The majority of nest submersions involved "unlimited residency," in which case the spider was removed from the aquarium only after it had "chosen" to leave its nest. Since spiders without nests can survive some number of hours underwater, the time recorded for the duration of each unlimited residency represents the time spent in the nest plus some unknown amount of time in the water outside the nest, the latter not exceeding the nighttime interval (maximum = 8 h).

I estimated nest volume in *D. crocata* by filling empty nests with water from a 0.01 ml-calibrated syringe; values were rounded up to the nearest 0.05 ml. Since the spider would occupy some space (roughly 15%), nest volumes exceeded maximum possible bubble volumes.

Oxygen Diffusion into Submerged Nests.—To test an hypothesis that the nest-trapped bubble serves as a physical gill, I used closed systems based on two setups, A and B, each providing a check for the other. I compared the decrease during 2 h in the percent oxygen saturation of previously well-aerated aquarium water surrounding an inhabited nest to that of such water (fresh sample) surrounding the same nest, now empty and flattened. A similar approach, employing a micro-Winkler technique, established a physical gill function for the bubble adhering to the body in two species of intertidal spiders (Lamoral 1968).

In setup A, a housing jar served as the test chamber and a Markson oxygen meter (model 230) for the measurements. I added a piece of plastic screen shaped to encourage nest construction by the spider dwelling near the bottom of each jar (jar size: 25 mm diameter \times 58 mm high).

To make each measurement I used the following procedure. After turning the jar to a horizontal position, I placed a tiny (2.0 \times 8.5 mm) stirring bar inside near the opening and taped a magnet to the jar's exterior at the bar's location, the latter insuring control of the bar's location during subsequent steps. Returning the jar to a vertical position, I slowly filled it with aerated aquarium water. Next, the jar was screwed upward into a cap through which projected the

vertically clamped oxygen probe. (Aquarium sealer filled the tiny gap between the cut surface of the cap and the probe.) I then placed the probe and its now-attached jar in a horizontal position and removed the magnet. (If a bubble were trapped, appropriate steps were repeated to eliminate such a source of error.) Finally, the probe/jar were positioned 5 mm above the center of a magnetic stirrer, so that the bar would spin at the far end of the jar, away from the spider's nest (Fig. 1).

For the initial and each of the two subsequent hourly oxygen readings, I switched on the stirrer and oxygen meter, allowing 1.5 min for equilibration before taking the reading; the stirrer and meter were then switched off. Readings were made at 22 to 24°C, depending primarily on room temperature but also, as to the initial reading, on my handling of the jar during the closure procedure. Because of the latter, the oxygen value for the initial reading was later calculated to the higher value it would have at the 1 to 2° lower temperature recorded at the two subsequent hourly readings. (A thermistor inside the probe of the Markson meter provided all the temperature readings in setup A.) The volume of water present in the closed jar with the probe tip inserted was 19 ml.

Setup B involved a YSI oxygen monitor (model 53), a macro-bath stirrer assembly (YSI 5302), and a circulator (Forma 2066). The advantage of this setup was in having a constant water temperature ($\pm 0.02^\circ$) throughout each run and among all runs. I used 25°, the lowest temperature of the range recommended for the YSI oxygen monitor, to stay close to the temperatures used in setup A, as well as to avoid subjecting the spiders to a significant change in temperature from that in their home cage; previous thermal history affects the metabolic rate measured at a sufficiently different temperature (Anderson 1970). In setup B the volume of water was approximately 25 ml and, unlike setup A, the stirring bar spun and the oxygen electrode was on throughout the 2-h period. Individuals ranged in mass from 70 to 158 mg (mean = 116 ± 36).

The disadvantage of setup B was that the bath-stirrer required that the stirring bar be placed on the bottom of the chamber beneath a screen. This prevented use of the measurement chamber as a site for nest building. Instead, laboratory nests were built inside 10 mm-diameter \times 25 mm plastic screen (no. 18 mesh) cylinders offered to some of the spiders in their home cages (Fig. 2). A few nests collected intact in the field were placed into stainless-steel screen (no. 30 mesh) holders; two such nests were subsequently revealed to be shared with broods—a 121-mg female with 80 young (88 mg) and a 158-mg female with 115 young (155 mg) (Fig. 3).

The method of calculating oxygen consumption was as follows. Oxygen concentration (mg/l) at each temperature was obtained from an appropriate table of oxygen solubilities in water (Wetzel 1983). (Since such tables are for pure rather than aquarium water, values determined in the present study are only approximate.) Multiplication by 0.70046 converted the value for mass to a volumetric value (ml/l (*ibid.*)), which provided the basis for values expressed as $\mu\text{l/ml}$. Multiplication of the latter by the total volume of water in the chamber (19 or 25 ml) gave an approximate value for the total volume of oxygen present in such a volume of water under ideal aerated conditions. This figure was then multiplied by the difference in percent oxygen saturation between the initial and final readings, thus yielding a rough estimate of oxygen decrease in the water



Fig. 1.—Setup A for determining oxygen diffusion into submerged nests of *Dysdera crocata*. The spider is visible within the backlighted nest, which was built upon plastic mesh at the bottom of the originally vertical jar (jar diameter = 25 mm). The stirring bar is located to the left of the probe, which projects through the cap (at right). This photograph was not taken during an actual run.

during the 2-h period. Half of this value then expressed the approximate drop in oxygen concentration per hour ($\mu\text{l h}^{-1}$).

Since a determination of actual oxygen consumption was not a goal of my study, I did not control for possible minor effects of diel variation. Starving the spiders prior to testing did minimize the effect of food assimilation (Anderson 1970).

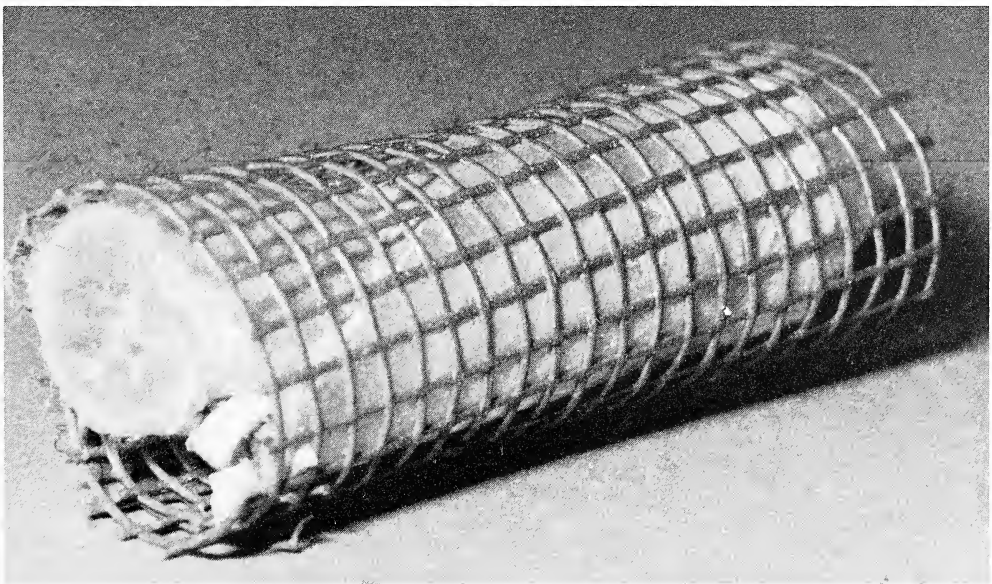

Fig. 2.—Plastic screen cylinder (length = 25 mm) containing a silken nest built by an adult female *Dysdera crocata*.

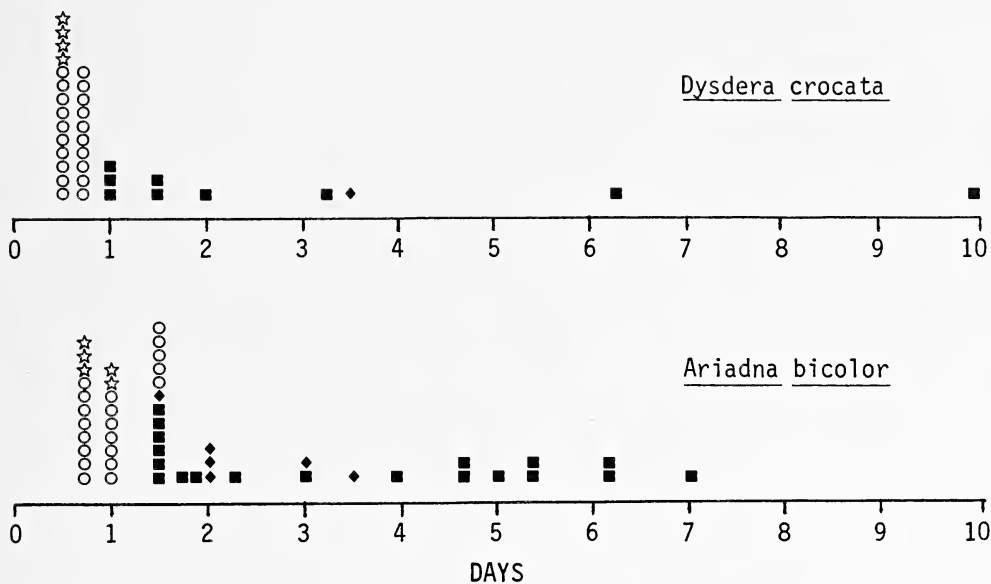

Fig. 3.—Field-collected, debris-covered brood nest of *Dysdera crocata* just removed from the water after a 2-h run in setup B. The interior and inhabitants remained dry during submergence in the swirling water. (Body length of now-emerged female = 13 mm)

RESULTS

Survival Times After Submersion.—Spiders submerged without nests ($N = 49$) crawled around the vial at intervals, *D. crocata* moreso than *A. bicolor*. *D. crocata* lost its adhering bubble and drowned sooner than did *A. bicolor*. When removed from the water after 12 h submergence, 10 of 14 *D. crocata* had drowned; all 10 of those submerged for 18 h drowned (mean for drownings = 15.0 h). (Tests of 60 spiderlings of *D. crocata* showed them to be no more resistant to drowning than the much larger instars: 9 of 20 drowned in a 6-h test; 19 of 20 in a 12-h test; and all of 20 in a 24 h test, all tests at 24°C.) Since *A. bicolor* often survived 12 h in preliminary trials, it was tested for longer periods: 8 of 11 drowned within 18 h; 7 of 9 within 24 h; and all of 5 within 36 h (mean for drownings = 24.2 h) (Fig. 4).

Spiders submerged while in their nests ($N = 35$), although inactive for most of the time, occasionally groomed, deposited silk, and re-positioned themselves; some molted. (I did not determine whether spiders in nests that had not been submerged showed similar levels and types of activity. I was interested only in whether spiders in submerged nests entered a state of immobility suggestive of very low metabolic rates, precluding "normal" behavior; they did not.) Seven spiders that had not responded to direct prodding of their nests emerged from their subsequently opened nests; i.e., they had not drowned during the period of "limited residency." During one inspection an *A. bicolor* left its nest (after 5 days of submergence), wandered in the water for several minutes, and then returned to its nest for an additional day of residency.



○ no nest; drowned
 ☆ no nest; survived
 ■ in nest; unlimited residency
 ◆ in nest; limited residency

Fig. 4.—Duration of underwater survival in two species of terrestrial spiders tested within ($N = 35$) or without ($N = 49$) their nests.

Throughout nest residency, spiders were inside a typically ovoid bubble that had stabilized at a length greater than that of the spider's body, although initial reduction in size had occurred following submergence. For example, after 6 days a *D. crocata* still had a bubble large enough to allow the spider to make a 180° turn and to stand with its legs spread as if on an open surface. However, in some very thin-walled nests, the bubble decreased to a size little wider than the spider's tightly drawn-in legs; indeed, a few individuals rested with their anterior legs projecting through a nest opening into the water. The nest volumes in *D. crocata* ranged from 0.15 to 0.60 ml for solitary individuals and from 0.75 to 0.80 ml for nests shared by females and their broods.

Most spiders eventually left the nest, even though the bubble was still present inside. They took part of this nest bubble with them when leaving, carrying the adhering bubble primarily on the opisthosoma and sometimes being buoyed up in the water to a variable extent as a result.

For spiders residing at least 1 day, the duration of nest residency in *D. crocata* was 3.1 ± 0.9 days ($N = 10$); maximum = 10 days (21°; 43 mg spider). For those *A. bicolor* residing at least 1.5 days, nest residency = 3.2 ± 0.4 days ($N = 25$); maximum = 7 days (23°; 20 mg spider) (Fig. 4). Although not included in the above data, even females with spiderlings or eggs eventually left the nest; however, they remained near the nest with the aid of a dragline.

Oxygen Diffusion into Submerged Nests.—Decreases in relative oxygen saturation readings were greater for water surrounding inhabited nests than for water surrounding empty nests (Table 1). Decreases in readings were due partly

Table 1.—Mean (\pm S.E.M.) decrease during 2 h in the relative reading for percent oxygen saturation of water surrounding nests with bubble-enclosed spiders vs. water surrounding empty nests. Setup A had 19 ml of water; B had 25 ml. Significance of differences (one-tailed paired *t*-tests, d.f. = *N* - 1) and mean volume of oxygen entering an inhabited nest are given. Abbreviations: *n*, number of spiders; *N*, number of paired runs; *d*, mean difference; D. c., *Dysdera crocata*; A. b., *Ariadna bicolor*. Two females (*) shared their nests with broods.

Setup	Species	<i>n</i>	<i>N</i>	Inhabited nest	Empty nest	<i>d</i>	<i>t</i>	<i>P</i>	O ₂ entry ($\mu\text{l hr}^{-1}$)
A	D. c.	3	7	10.1 \pm 1.5	4.6 \pm 0.6	5.5	3.51	<0.01	3.1
	A. b.	1	2	6.0 \pm 1.0	1.0 \pm 1.0	5.0	2.50	NS	3.0
B	D. c.	5	5	30.8 \pm 4.6	25.2 \pm 4.1	5.6	4.63	<0.005	4.1
	D. c.*	2	2	62.5 \pm 18.6	36.5 \pm 20.6	26.0	13.00	<0.025	18.8

to downward drift (which preliminary tests showed to occur at a higher rate in the equipment of setup B than in that of setup A); also I did not assess the measurement errors and the mechanical and electrical drift associated with the use of these electronic oxygen probes. I therefore regarded all readings as relative measures of pO₂. Furthermore, I assumed (but had no evidence) that the rate of drift affected experimental and control readings within each setup similarly, and that the difference between experimental and control readings was an absolute measure of oxygen diffusion into the nests.

The approximate volume of oxygen that entered the nest of each solitary *D. crocata* averaged 3 to 4 $\mu\text{l h}^{-1}$ (22 to 25°) (Table 1). The diffusion rates for nests with solitary spiders were similar between setups A and B, suggesting that both systems of measurement were reliable. On the basis of mass, group B of solitary *D. crocata* (106 \pm 16 mg) showed oxygen diffusing into nests at a mean rate of 0.038 $\mu\text{l mg}^{-1} \text{h}^{-1}$ (25°). (Lacking the mass of one *D. crocata* of group A, I could not make such an estimate from the data of that group.)

DISCUSSION

Spiders submerged while in their intact nests were able to survive for much longer than those outside of nests: *D. crocata* inside nests endured submergence up to at least 16 times (mean = 5.0 times) longer, and *A. bicolor* did so up to at least 7 times (mean = 3.2 times) longer than did conspecifics submerged without nests. Furthermore, the 10- and 7-day maxima for the two species may not be the upper limits for their survival underwater, since they reflected the spiders' "decision" to leave the nest-trapped bubble. Nonetheless, the persistence of the bubble for these many days, unlike its disappearance from the body of "naked" spiders within a matter of hours, indicates clearly that the silken construction can maintain a physical gill far more effectively than can the spider's setae. Also, the ability of the spiders to perform various behaviors, as well as molt, while within the underwater nest shows that the physical gill was able to provide for an adequate level of oxygen diffusion from the aerated water.

The volume of oxygen entering the nest of each solitary *D. crocata*, as estimated from measured changes in percent oxygen saturation of the surrounding water in closed systems, was 3 to 4 $\mu\text{l h}^{-1}$. This falls within the range of about 1 to 5 $\mu\text{l h}^{-1}$ determined as the oxygen consumption rates for 10- to 100-mg individuals of the intertidal spider *Desis marina* in air and at a cooler

temperature (17.5°C) (McQueen et al. 1983). The uptake into the nest on the basis of mass ($0.038 \mu\text{l mg}^{-1} \text{h}^{-1}$ at 25°C) in *D. crocata* was about 30 percent lower than the $0.055 \mu\text{l mg}^{-1} \text{h}^{-1}$ oxygen consumption rate for *D. marina* of similar mass (100 mg; 17.5°C) in air, which was a rate lower than that of any previously tested terrestrial spider (ibid.).

The very low rate for oxygen diffusion into nests of *D. crocata* may reflect one or more of several factors: (1) *D. crocata* is more "primitive" than *D. marina*, based on the dysderid's possession of paired, anteriorly located tracheal spiracles and the desid's having a single, posterior spiracle. Anderson (1970) found that spiders with relatively primitive respiratory systems generally have lower metabolic rates than do spiders with more advanced respiratory systems. (2) Spiders residing in nests underwater may be less active or have lower metabolic rates than spiders exposed in air-filled glassware, the latter being the arrangement used in oxygen consumption studies. (3) The presence of some material in the nest wall or at the air-water interface may slow gas diffusion. McQueen et al. (1983) suggested that spiders may produce an excretory product or other material that could have caused a reduced rate of diffusion across the bubble-water interface in their study of *Desis marina*. Nonetheless, while the rate of diffusion estimated here for the nests of *D. crocata* may be lower than the rate of oxygen consumption by this species in air, it is clear that the nest-trapped bubble provides a physical gill, just as does the temporary bubble carried on the body of the marine intertidal spiders studied by Lamoral (1968).

Conservative use of the data on oxygen uptake into nests, together with liberal estimates of the amount of oxygen available in the nest's initial air store, indicate that the air store is not adequate for prolonged submersion in *D. crocata*. For example, a 100-mg individual using only $3 \mu\text{l h}^{-1}$ of oxygen needs $72 \mu\text{l day}^{-1}$; however, even the largest nest of a solitary *D. crocata* holds <0.60 ml of air, i.e., $<120 \mu\text{l}$ of oxygen, which is less than a 2-day supply. Likewise, the *D. crocata* that survived 10 days underwater was in a 0.20 ml nest, i.e., $<40 \mu\text{l}$ of oxygen. Even if it could have survived by consuming oxygen at a reduced rate of as little as $1 \mu\text{l h}^{-1}$ (and had the ability to take up oxygen at eventually very low partial pressures), it had less than a 2-day supply in the air store. Thus, the nest's maintenance of a physical gill is probably essential for much or most of the submergence period of spiders residing in nests as long as, or longer than, the average of 3 days.

"The hazard of flooding is a very real one for mygalomorph spiders, whether they live in rainforest or deserts" (Cloudsley-Thompson 1983), just as it is for burrowing lycosid spiders living in salt lakes (McKay 1976), and for numerous other ground-dwelling forms. My findings suggest that the silk nest enables such terrestrial spiders to endure a temporary aquatic existence imposed occasionally during their lives. This is particularly important for any spider trapped while molting (a lengthy process of many hours in primitive spiders) as well as for females and their eggs or offspring, which in primitive forms typically share a nest prior to dispersal of the spiderlings.

Secretion of a silk precursor probably arose in ancestral spiders for the protection of eggs or sperm (J. Shultz, in prep.). Since the earliest spiders were most likely burrow dwellers (Decae 1984), the first non-reproductive use of silk was probably to line the burrow. Due to the surface tension of water, a relatively simple meshwork would have been sufficient to keep excess soil water from

entering a burrow. If the meshwork were later extended to cover the burrow opening, a bubble would have been trapped during flooding, which could occur in any of the habitats of ancestral spiders.

Protection from drowning may have been important for the ancestors of other silk-producing arthropods. Pseudoscorpions use anteriorly secreted silk to build nests for molting, brood care, and overwintering, as well as nests for intertidal sites (Gabbutt 1966, Weygoldt 1969). As to silk-using insects, Hinton (1953) stated that the cocoons of Lepidoptera and Hymenoptera pupating on the ground maintain a physical gill during rain-caused flooding. The same may be true for the silken tunnels of the Embioptera (webspinners). Thus, survival during flooding may have been one of the selection pressures underlying the evolutionary origin or diversification of silk use within each of several arthropod taxa in which shelter construction is the primary use for this secretion. In these groups, as well as in spiders, early adaptations for the improved production and application of silk probably were favored by the multiple advantages derived from building some type of enclosure—protection from predation, prevention of desiccation during drought, and maintenance of a physical gill during flooding.

ACKNOWLEDGMENTS

This study was supported by an Ohio University Baker Fund Award. I thank W. D. Hummon for an equipment loan and for critical reading of the manuscript, M. C. Modrzakowski for an equipment loan, M. L. Trivett for permitting me to use her property for collecting spiders, and J. W. Shultz and V. D. Roth for pointing out some relevant papers.

LITERATURE CITED

- Abraham, H. C. 1924. Some mygalomorph spiders from the Malay Peninsula. Proc. Zool. Soc. London, 1924:1091-1124.
- Abraham, H. C. 1926. A marine spider of the family Attidae. Proc. Zool. Soc. London, 1926:1357-1363.
- Anderson, J. F. 1970. Metabolic rates of spiders. Comp. Biochem. Physiol., 33:51-72.
- Arndt, C. H. 1915. Some insects of the between tides zone. Proc. Indiana Acad. Sci., 1914:323-333.
- Bethge, W. 1973. Ökologisch-physiologische Untersuchungen über die Bindung von *Erigone longipalpis* (Araneae, Micryphantidae) an das Litoral. Faun.-ökol. Mitt., 4:223-240.
- Braun, F. 1931. Beiträge zur Biologie und Atmungsphysiologie der *Argyroneta aquatica* Cl. Zool. Jb. (Syst.), 62:175-262.
- Bristowe, W. S. 1923. A British semi-marine spider. Ann. Mag. Nat. Hist., Ser. (9) 12:154-156.
- Bristowe, W. S. 1930. Notes on the biology of spiders. II. Aquatic spiders. Ann. Mag. Nat. Hist., Ser. (10) 6:343-347.
- Bristowe, W. S. 1931. Notes on the biology of spiders. IV. Further notes on aquatic spiders, with a description of a new species of pseudoscorpion from Singapore. Ann. Mag. Nat. Hist., Ser. (10) 8:457-465.
- Cloudsley-Thompson, J. L. 1983. Desert adaptations in spiders. J. Arid Environ., 6:307-317.
- Cooke, J. A. L. 1962. Spiders from tidal marshes near Flatford Mill, Suffolk. Entomol. Monthly Mag., 98:21-22.
- Cooke, J. A. L. 1965. A contribution to the biology of the British spiders belonging to the genus *Dysdera*. Oikos, 16:20-25.
- Cooke, J. A. L. 1967. Factors affecting the distribution of some spiders of the genus *Dysdera* (Araneae, Dysderidae). Entomol. Monthly Mag., 103:221-225.

- Decae, A. E. 1984. A theory on the origin of spiders and the primitive function of spider silk. *J. Arachnol.*, 12:21-28.
- Ege, R. 1915. On the respiratory function of the air stores carried by some aquatic insects (Corixidae, Dystiscidae, *Notonecta*). *Z. Allg. Physiol.*, 17:18-124.
- Gabbutt, P. D. 1966. An investigation of the silken chambers of the marine pseudoscorpion *Neobisium maritimum*. *J. Zool.*, London 149:337-343.
- Heydemann, B. 1967. Die biologische Grenze Land-Meer im Bereich der Salwiesen. Franz Steiner Verlag, Wiesbaden.
- Hinton, H. E. 1953. Some adaptations of insects to environments that are alternately dry and flooded, with some notes on the habits of the Stratiomyidae. *Trans. Soc. British Entomol.*, 11:209-227.
- Lamoral, B. H. 1968. On the ecology and habitat adaptations of two intertidal spiders, *Desis formidabilis* (O. P. Cambridge) and *Amaurobioides africanus* Hewitt, at "The Island" (Kommetjie, Cape Peninsula), with notes on the occurrence of two other spiders. *Ann. Natal Mus.*, 20:151-193.
- McKay, R. J. 1976. The wolf spiders of Australia (Araneae: Lycosidae): 8. Two new species inhabiting salt lakes of western Australia. *Mem. Queensland Mus.*, 17:417-423.
- McQueen, D. J. and C. L. McLay. 1983. How does the intertidal spider *Desis marina* (Hector) remain under water for such a long time? *New Zealand J. Zool.*, 10:383-392.
- McQueen, D. J., L. K. Pannell and C. L. McLay. 1983. Respiration rates for the intertidal spider *Desis marina* (Hector). *New Zealand J. Zool.*, 10:393-399.
- Schaefer, M. 1974. Experimentelle Untersuchungen zur Bedeutung der interspezifischen Konkurrenz bei 3 Wolfspinnen-Arten (Araneida: Lycosidae) einer Salzweise. *Zool. Jb.(Syst.)*, 101:213-235.
- Schaefer, M. 1976. Experimentelle Untersuchungen zum Jahreszyklus and zur Überwinterung von Spinnen (Araneida). *Zool. Jb.(Syst.)*, 103:127-289.
- Schollmeyer, A. 1913. *Argyroneta aquatica*: Biologie mit besonderer Berücksichtigung der Atmung. *Ann. Biol. lacustre Brux.*, 6:314-338.
- Thorpe, W. H. 1950. Plastron respiration in aquatic insects. *Biol. Rev.*, 25:344-390.
- Wetzel, R. G. 1983. *Limnology*, 2nd ed. Saunders Publ., New York.
- Weygoldt, P. 1969. *The Biology of Pseudoscorpions*. Harvard Univ. Press, Cambridge, Massachusetts.

Manuscript received August 1985, revised January 1986.

WEB-BUILDING BEHAVIOR OF ANAPID, SYMPHYTOGNATHID AND MYSMENID SPIDERS (ARANEAE)

William G. Eberhard

Smithsonian Tropical Research Institute
and
Escuela de Biología, Universidad de Costa Rica
Ciudad Universitaria, Costa Rica

ABSTRACT

The web building behavior of species of *Anapis* and *Anapisona* (Anapidae), *Patu* (Symphytognathidae), and *Maymena* and *Mysmena* (Mysmenidae) is homologous with orb construction of other araneoids. Possible behavioral synapomorphies linking these three families, and linking Anapidae with Mysmenidae are proposed.

INTRODUCTION

The families Anapidae and Mysmenidae were recently separated from the family Symphytognathidae (Forster and Platnick 1977) on the basis of morphological differences. These authors speculated that web building behavior would provide "some of the best clues" to resolve the present difficulties in understanding the relationships between these and other families formerly grouped in Symphytognathidae. Recent work with other orb-weaving spiders has shown that some details of web building behavior are indeed useful in indicating relationships (Eberhard 1982, Coddington 1986a and b, in prep.), and this paper is an attempt to use direct observations of building behavior by six species and indirect evidence from finished webs of at least seven others as indicators of the relationships between these three families. The observations, which are generally in agreement with the fragmentary notes of previous authors, are also compared with those of orb-weavers in the families Araneidae and Theridiosomatidae.

Anapid webs and behavior are better known than those of the other two families. Horizontal orb webs are built by species in the genera *Anapis*, *Anapisona* (Platnick and Shadab 1978, Eberhard 1981, Coddington 1986a), *Chasmocephalon* (Forster 1959, Coddington 1986a), *Conoculus* (Shinkai and Takano 1984), *Risdonius* (Hickman 1938), and probably *Pseudanapis* (Forster and Forster 1973). In the first three genera there are one or a few radii above the plane of the orb, and a few sticky lines are attached to them. Several details of the construction behavior of *Anapis* and *Anapisona* are given in Eberhard 1981 and 1982, and Coddington (1986a) noted that both horizontal and non-horizontal radii of *Chasmocephalon shantzii* Gertsch are laid before the sticky line is produced. Some anapids' webs have "supplementary" radii that differ from the other radii both in being thinner (Hickman 1938) and in the angles they make

with sticky lines (e.g., Coddington 1986a), but the construction behavior associated with these lines has not been carefully described.

In Symphytognathidae at least four species of *Patu* plus an unidentified Puerto Rican genus are known to construct fine-meshed horizontal orbs (Marples 1955, Forster 1959, Forster and Platnick 1977, Coddington 1986a), while *Symphytognatha globosa* Hickman makes a "web . . . of a few irregular threads in a more or less horizontal plane . . . the web seems to be made on the under-surface of the stones . . . The threads do not appear to be adhesive." (V. V. Hickman in Forster and Platnick 1977). There are no direct observations of the spiders' building behavior.

In Mysmenidae Marples (1955) noted that the webs of *Mysmena* (= *Tamesesia*) *rotunda* Marples and *M. acuminata* Marples consist "of a set of threads radiating in all directions from a centre . . . The space between the radials is filled with threads of a sticky silk, so fine that the droplets can only be seen under the microscope . . . the general impression is of an orb web in three dimensions." Photographs of webs of *M. jobi* (Kraus) (Shinkai 1977), *M. guttata* Bishop and Crosby and *M. sp.* in Coddington 1986a conform to this description. The web of *Maymena ambita* (Barrows) however resembles the orbs of anapids (Coddington 1986a). Marples (1955) observed that when *M. acuminata* spins sticky lines "the spider keeps going quickly out along different radials. Apparently it attaches a thread to a radial and carries the other end to the centre and out along another radial to attach it there. The web is built from the periphery inwards." Coddington (1986a) also found that radial and frame lines were laid before sticky lines in *M. sp.*, and that in the center of *M. guttata* webs some radii ended on other radii rather than all ending at the central point or system of lines (hub).

MATERIALS AND METHODS

The spiders of this study are all minute, the smallest, *Mysmena sp.*, being less than 0.5mm long at maturity. The lines they spin are thus normally invisible to the naked eye except under unusually favorable light conditions. It was nevertheless possible to acquire a relatively detailed picture of web construction by combining several techniques. Paths of moving spiders were followed closely and used as indicators of the positions of lines already in place. A strong headlamp was used to observe lines at favorable angles to the light. Those angles between lines that are indicative of tensions on the lines were watched especially closely to deduce whether the spider broke certain lines as it moved (see Eberhard 1981 for a description of this technique). The entire set of lines which a spider had laid was made visible periodically by breathing gently on the web. Due to the very humid microhabitats in which the webs were built (tropical rain forest leaf litter), this caused tiny drops of water to condense on all the lines, thus making the entire web easily visible (this technique was discovered independently by J. Carico in humid forests in New Zealand). The drops soon evaporated, leaving the web undamaged. The spider was generally disturbed briefly by being blown on, but in all but one case it resumed building, sometimes so soon afterward that the droplets were still on the lines, allowing for still more detailed observations.

I assumed, based on studies of larger and more easily observed species (e.g., Jacobi-Kleeman 1953, Eberhard 1982) that many details of web construction are highly stereotyped; thus when I succeeded in seeing a given detail of behavior clearly, I assumed that similar behaviors were executed in homologous situations which were less easily observed.

Finally, both partially built and finished webs were collected on microscope slides and examined with a compound microscope. It was found that when the edges of the slide were wetted just before the slide was pressed against the web, the positions of web lines were usually only slightly distorted by the process of collection.

Some of the species mentioned here are identified only to genus due to present incomplete taxonomic knowledge of the groups. Voucher specimens are deposited in the Museum of Comparative Zoology, Cambridge, Mass. 02138 U.S.A. The numbers and letters after names refer to labels in the vials with the specimens. Webs were photographed after being lightly coated with cornstarch or talcum powder.

The behavior reported here was compared to that of other orb weavers with respect to characteristics useful in the characterization of families and subfamilies (Eberhard 1982). The italicized letters and numbers (*A1*, *B2*, etc.) used below designate character states used in that study.

There is some inconsistency in the literature regarding terms that designate radii made before and after sticky spiral construction. Szlep (1961) used the terms "ordinary" and "additional"; Eberhard (1977) spoke of "original" and "supplementary" radii, and Coddington (1986a) termed them "structural" and "accessory" radii. Although the lines may have evolved independently in Uloboridae and the araneoids, they are geometrically and probably functionally analogous, so it seems desirable to standardize terminology. Some previous terms have imprecise or misleading connotations: ordinary and original imply character transformations which have not been established; and radii which are not "structural" are by implication not part of the structure. An additional problem is that some obvious alternative names (primary, secondary) have already been used to distinguish different radii of the first type that are laid at different stages of radius construction (e.g., LeGuelte 1966). I thus propose that radii laid before sticky spiral construction commences be called "elementary" radii, and those after the sticky spiral is complete "supplementary" radii. These terms are used in the descriptions that follow.

Throughout this paper "sticky" lines are those which have small balls of liquid distributed along their lengths, and "non-sticky" lines are those which lack such balls.

RESULTS

Anapidae.—Webs: The webs of the individuals whose building behavior was observed, *Anapisona simoni* Gertsch (No. 2166), *Anapis calima* Platnick and Shadab (SJ1-39-A1), and *Anapis* sp. (SJ1-69-K), shared several characteristics. They were horizontal orbs with one or a few non-sticky lines running upward from the hub and variable numbers of sticky lines attached to these lines (Figs. 1-3). In the web of *Anapis calima* only about 10-20 elementary radii were



Fig. 1—Web of *Anapis anchicaya* Platnick and Shadab with a single non-sticky line above the hub that has no sticky lines attached to it. Photograph is 7.4 cm wide.

fastened together at the hub, and the supplementary radii were either attached to the elementary radii or ended on sticky lines near the hub (Fig. 4).

Anapidae.—Building Behavior: Frame construction, which was observed only in *Anapisona simoni*, was similar to that of araneids and theridiosomatids (Savory 1952, pers. obs.) both with respect to the sequence of attachments made

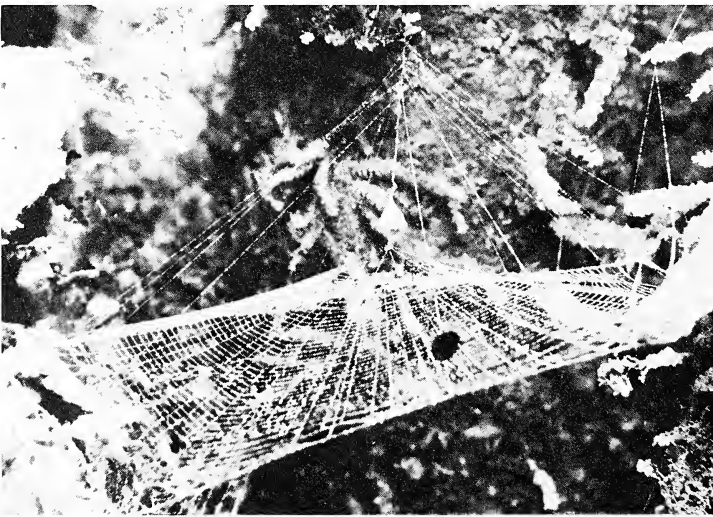

Fig. 2—Web of *Anapis heredia* Platnick and Shadab with a single non-sticky line running upward from the hub. The slanting lines attached to this line are excursions of the sticky spiral (see text). The large object just above the spider at the hub is an egg sac. Photograph is 4.7 cm wide.



Fig. 3—Web of *Anapisona simoni* Gertsch with multiple non-sticky lines running upward from the hub. Numerous sticky lines are attached to these lines. Photograph is 15.6 cm wide.

to the radii bordering the sector that was spanned by the new frame line, and the fact that a single new radius was laid in the process of each frame construction. Construction of the rest of the elementary radii, also observed only



Fig. 4—Web of *Anapis calima* Platnick and Shadab. Many supplementary radii are broken near the hub. A single line runs upward from the hub to an egg sac, and pulls the hub slightly above the plane of the rest of the orb. Photograph is 10.0 cm wide.

in *A. simoni*, continued after the frames were complete, and was similar to typical araneid and theridiosomatid behavior (character state *FI* of Eberhard 1982) in that a single radius was laid for each trip away from the hub, and the line laid on the way out from the hub was apparently broken and rolled up and replaced by a new one laid on the trip back (breakage was deduced from observations of angles between web lines and from observations of a small white mass of loose silk at the center of the hub—in araneids similar masses accumulate during radius construction as a result of broken radial lines being rolled up and left there—Eberhard 1982). The construction behavior for radii out of the plane of the orb was the same in *A. simoni* as that for horizontal radii, and they were laid interspersed in the sequence of construction of horizontal radii. No hub loops were laid by this species during radius construction.

Subsequent behavior of at least two species deviated from typical araneid behavior. In *Anapisona simoni* radius construction was followed by hub construction, but then, instead of laying a temporary spiral of non-sticky silk, the spider immediately began laying sticky spiral. For each segment of sticky line it moved all the way from the edge of the web in to the hub, then back out again (character state *H3* of Eberhard 1982). *Anapis keyserlingi* Gertsch also failed to build a temporary spiral.

Sticky spiral construction began at the edge of the planar part of the web (not verified but probably also true in *Anapis calima*, which was observed laying only the last five, innermost loops of sticky spiral), and the spider gradually worked inward as do all orb weavers. In all species the spider faced away from the hub as it moved out a radius prior to attaching (character state *A1* or *A4* of Eberhard 1982), then turned briskly 180° to attach near the innermost sticky line already in place. I could not be certain in *Anapisona simoni* and *Anapis calima* whether the spider touched the inner sticky line before turning; it apparently did touch it in *Anapis keyserlingi* (SJ1-69-K).

Sticky lines were laid to the radii above the plane of the web during sticky spiral construction in both *Anapisona simoni* and *Anapis keyserlingi* (SJ1-69-K) and were actually continuous with the planar sticky spiral. The spider attached the sticky line to a horizontal radius, went to the hub as usual, but then climbed one of the radii above the hub rather than going back out the next horizontal radius. It walked along this radius for approximately the same distance it had walked inward toward the hub, then attached the sticky line. From here it returned to the hub, and either walked out another horizontal radius (not the one it had started from) and attached the sticky line there, thus producing an inverted "V" of sticky line above the orb, or else it went back up another radius above the web plane, attached the sticky line there to form a more or less horizontal segment of sticky line above the web plane, and then returned to the hub and went out a horizontal radius (e.g. Fig. 3). In *Anapisona simoni* sticky lines were laid above the plane of the orb only during the early part of sticky spiral construction, so all sticky lines above the orb were attached near the orb's periphery. Photographs of *Anapis heredia* Platnick and Shadab webs (Fig. 2, Coddington, 1986a) suggest the same is true for that species.

When the sticky line was all in place, the spiders performed several behaviors which have not been described in any other orb-weavers. *Anapis calima* laid another series of radial lines (supplementary radii). Each line was laid by walking out a pre-existing radius, moving along the frame, attaching the drag-line to the frame, and then returning to the hub and apparently attaching the line there or

near there. One *Anapis keyserlingi* Gertsch (No. 2166) made only a single supplementary radius; one *Anapisona simoni* did not make any (Fig. 3) while another, figured in Coddington (1986a), made only a few. There was a clear tendency to place consecutive supplementary radii on nearly opposite sides of the hub. No obvious hub lines were laid during the intervals between trips to lay new supplementary radii. The total number of supplementary radii in one web of *Anapis calima* was about 48.

The path traced by the spider as it returned to the hub during supplementary radius construction indicated that the radial line laid on the trip away from the hub was broken near the frame and was replaced with another as the spider moved back to the hub. The spider descended far below the web plane, and climbed nearly directly upward as it arrived at the hub. The placement of supplementary radii resulted in a characteristic radius-sticky spiral pattern in finished webs in which the sticky spiral changed direction whenever it crossed an elementary radius, but crossed supplementary radii without deviating (Figs. 1, 2, 11). No supplementary radii were laid out of the plane of the orb.

Finally, in all species (except perhaps *Anapis calima*—I was not able to observe it well enough to be certain) the spider performed another unique behavior somewhat similar to hub destruction by theridiosomatids (character state *G4* of Eberhard 1982). Starting at the hub, the spider moved a few steps out an elementary radius, turned 180° to face toward the hub, and broke the radius. The spider evidently attached its drag-line near the outermost broken end and then payed out a length of silk, as the sticky spirals attached to that radius moved away from the hub. The spider returned to the hub as it slackened the radius or just afterward, reeling up the inner broken end of the radius and replacing it with the drag-line which it then attached at the hub. Since at least some supplementary radii were broken at or near the inner edge of the sticky spiral in finished webs (see Figs. 9 and 11), these lines were probably also broken during the loosening process, but I was unable to resolve this detail. Coddington (pers. comm.) found this to be the case in *heredia* and *Anapisona simoni*. Consecutive loosening operations tended to occur on more or less opposite sides of the web. Loosening operations on radii above the orb, which caused the orb to become less conical and more nearly planar, were interspersed with those on the others.

The loosening process continued until most or all of the elementary radii were lengthened; one *Anapisona simoni* did not loosen all of the radii, and microscopic inspection of two *Anapis keyserlingi* webs (SJ1-69-H, SJ1-69-K) showed that 15 of 18 and 11 of 11 elementary radii had been broken near the hub and presumably loosened.

Finally the spider finished the web by laying two or three tight hub loops connecting the new inner ends of the planar elementary radii (determined by direct observation in *Anapisona simoni*; in the other two species I was not certain that lines were laid as the spider turned slowly at the hub, but microscopic examination of two finished *Anapis keyserlingi* webs (No. 2166, SJ1-69-K) revealed two to three hub loops—Fig. 5). As it turned while making the hub, the spider removed the mass of rolled-up lines at the center of the hub and apparently ingested it (the white speck disappeared). The hub spiral caused sharp deflections of the radii where it was attached to them (Fig. 5), indicating that the hub line was relatively tight. Finally the spider assumed its waiting position at the hub. In none of the species observed did it flex the web, and when disturbed

it climbed one of the radii above the orb. In contrast to many theridiosomatids, the spiders did not destroy any of their webs as they moved.

Symphytognathidae.—Webs: The web of the only symphytognathid observed, *Patu* sp. (No. 2194), was identical to the description of anapid webs with supplementary radii above except there were no lines above the plane of the orb.

Symphytognathidae.—Building Behavior: The presence of a white speck at the center of the hub in the web of *Patu* sp. after radius construction ended suggested that radius construction behavior was similar to that described above (character state *FI* of Eberhard 1982). After spinning about five loops of temporary spiral which spiralled outward from near the hub (character state *HI* of Eberhard 1982) the spider began spinning sticky spiral, starting from the edge and working inward. It faced away from the hub as it moved out each radius preparatory to attaching (apparently *AI* of Eberhard 1982), then turned 180° to attach. It did not maintain contact with the temporary spiral as it laid sticky spiral (*DI* of Eberhard 1982). When the sticky spiral was finished, the spider immediately began laying supplementary radii as described above except that it did not “sag” as dramatically below the orb plane as it returned to the hub. I was thus not certain whether the new supplementary radial lines were broken and rolled up as the spider moved back to the hub, but the white speck of loose silk at the hub did seem to grow. Finally the spider loosened the elementary radii as described above for anapids, and then turned slowly about three times at the hub and the white speck at the center disappeared (probably *G4* of Eberhard 1982).

Mysmenidae.—Webs: Two web forms were observed in this family. The webs of *Mysmena* sp. or spp. (Nos. 1034, 1122, 1173, 1174, 1175, 1188, 1366, 1679, and 2195) were similar to the *Mysmena* webs described and figured by Marples (1955) and Coddington (1986a). They consisted of about 20-30 non-sticky lines radiating in three dimensions from a central area or hub, with many sticky lines attached to them (Fig. 6). Some of the radii were attached directly to a support (leaf, twig, etc.), but most ended on short frame lines which were in turn attached to supports. Only two to four radii were attached to a single frame line. Microscopic examinations of webs were complicated by the webs' three dimensional structure, but in two cases (SJ1-69-M and SJ1-C) a clear hub was found. In both cases many radial lines did not extend all the way to the hub but terminated on other radial lines. Not all of the radial lines near the hub of the web of SJ1-69-M were of equal thickness.

The cloud of fine, slack sticky lines was attached to the radii in the space between the hub and the frames. These lines were so numerous and dense that it was not possible to discern any pattern in their arrangement. Microscopic examination showed that these sticky lines were thinner than the radial lines.

The webs of *Mysmena* sp. or spp. (Nos. 1608, 1687, 1689, SJ1-69-N, and SJ1-69-G) were different, being anapid-like horizontal orbs with a superstructure above. The building behavior of *Maymena* will thus be described separately below.

***Mysmena*.—Building Behavior:** Frame construction, which followed “exploratory” behavior, marked the discernable beginning of web construction, and was identical to that seen in most araneoids (above). Observations of changes in radius-frame angles during frame construction indicated that the radial line laid on the trip away from the hub was broken near the new frame and replaced as the spider returned to the hub. Subsequent elementary radii were also laid with typical araneid behavior (*FI* of Eberhard 1982). The formation of a white speck

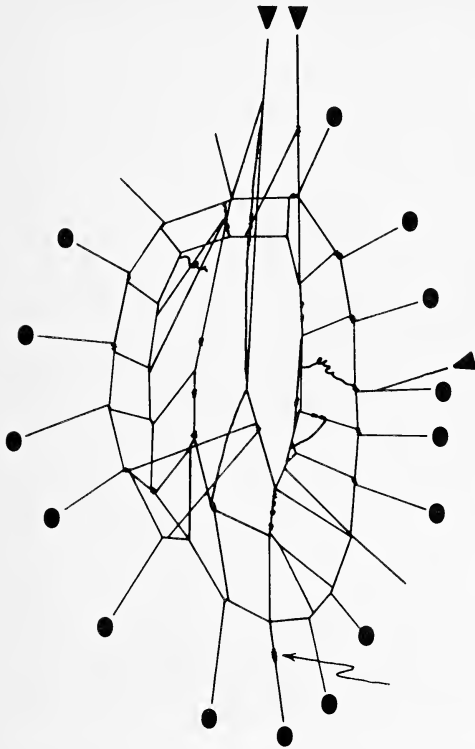

Fig. 5—Drawing of the hub of a finished web of *Anapis keyserlingi* Gertsch as seen on a slide under a compound microscope. Those lines marked with black dots had apparently been broken and repaired during web construction, since near the innermost edge of the sticky spiral each one had a mass of material (like that indicated by the arrow) which was probably pyriform silk used to attach lines together. The three lines marked with triangles were probably above the plane of the web; sticky lines were not attached to them in the central area of the web.

at the hub during radius and frame construction supported this conclusion, and microscopic examination of two webs collected at the end of this stage also revealed a tangled mass of lines at the hub which apparently corresponded to this white speck. No hub lines were laid during radius construction (direct observations were confirmed by microscopic examinations of the two unfinished webs). The spider “loosened” a few radii, moving a few body lengths away from the hub and then turning back and returning to the hub as do some other araneids (Eberhard 1981). The first radii were not concentrated in a single plane; I could not discern any pattern in the order in which radii were added. Coddington (1986a) also saw *Mysmena* build radii and frame lines before starting the sticky spiral.

After all or nearly all of the radii and frames had been laid, the spider began laying sticky lines without first making a temporary spiral (*H3* of Eberhard 1982). Coddington (1986a) also noted the absence of a temporary spiral in a *Mysmena* web. The spider moved quickly to the end or near the end of a radius, attached a sticky line there, then went quickly back to the hub and out another radius to attach again (Fig. 7). As it moved out a radius it faced away from the hub, but I was not sure if it made contact with the innermost sticky line already attached there (*A1* or *A4* of Eberhard 1982). Coddington (1986a) thought some attachments were made without contacting the inner loop. One spider which moved more slowly clearly paused just before each attachment to make several quick pulling movements with alternate strokes of legs IV (Eberhard 1981 gives evidence that such movements in other species result in more sticky line being pulled from the spinnerets). This same spider “pushed” the new sticky line away from its body with one leg IV just before the attachment was made (*C1* of

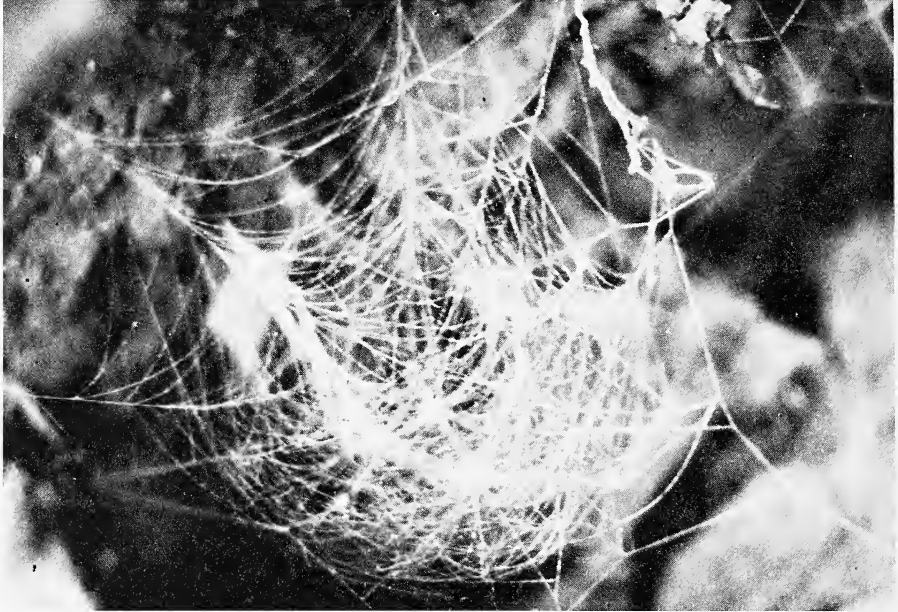

Fig. 6—"Three dimensional orb" of *Mysmena* sp. (No. 1188). The spider is at the point of convergence of lines in the center of the web. Photograph is 4.3 cm wide.

Eberhard 1982). Two spiders made most or all of the early attachments to radii above the hub.

Each successive sticky line was attached to the hub side of the point where the previous innermost sticky spiral segment was attached. The distances between successive attachments varied, the largest being more than twice the smallest.

The spider probably slid one tarsal claw along the radius as it moved out from the hub since the tiny water drops which were sometimes present on the radius were removed when the spider passed, and a single apparently larger drop was left just inside the point where the sticky line was attached to the radius.

The estimated angles between radii to which spiders made successive attachments of sticky lines were recorded in two webs. Although the data are somewhat suspect since angles were estimated rather than measured and I was not confident that all of my estimates were accurate, it appears that spiders chose radii which made angles of less than 90° more often than expected by chance. Of 243 pairs of attachments, 111 were to radii which made angles of less than 90° , and 76 were to radii which made angles of greater than 90° (56 others made angles close to 90°) (Chi Squared = 6.55, $p < 0.01$ assuming equal numbers of radii at less than and more than 90°). If such a tendency exists, it would explain why sticky lines are at least sometimes concentrated near the periphery of the web (Fig. 6, Coddington 1986a) since a sticky line laid from one radius to another 180° opposite would run near the hub.

One spider which was laying sticky spiral was disturbed when I blew on and apparently damaged its web. The spider remained immobile for several minutes, then laid several radial lines before returning to sticky spiral construction.

When the sticky spiral was complete, the spider loosened some of the radii near the hub (perhaps all in some cases) in the manner described above for anapids. That the radii were indeed broken and lengthened in this process was confirmed in one case by noting that a small white spot on the radius moved away from

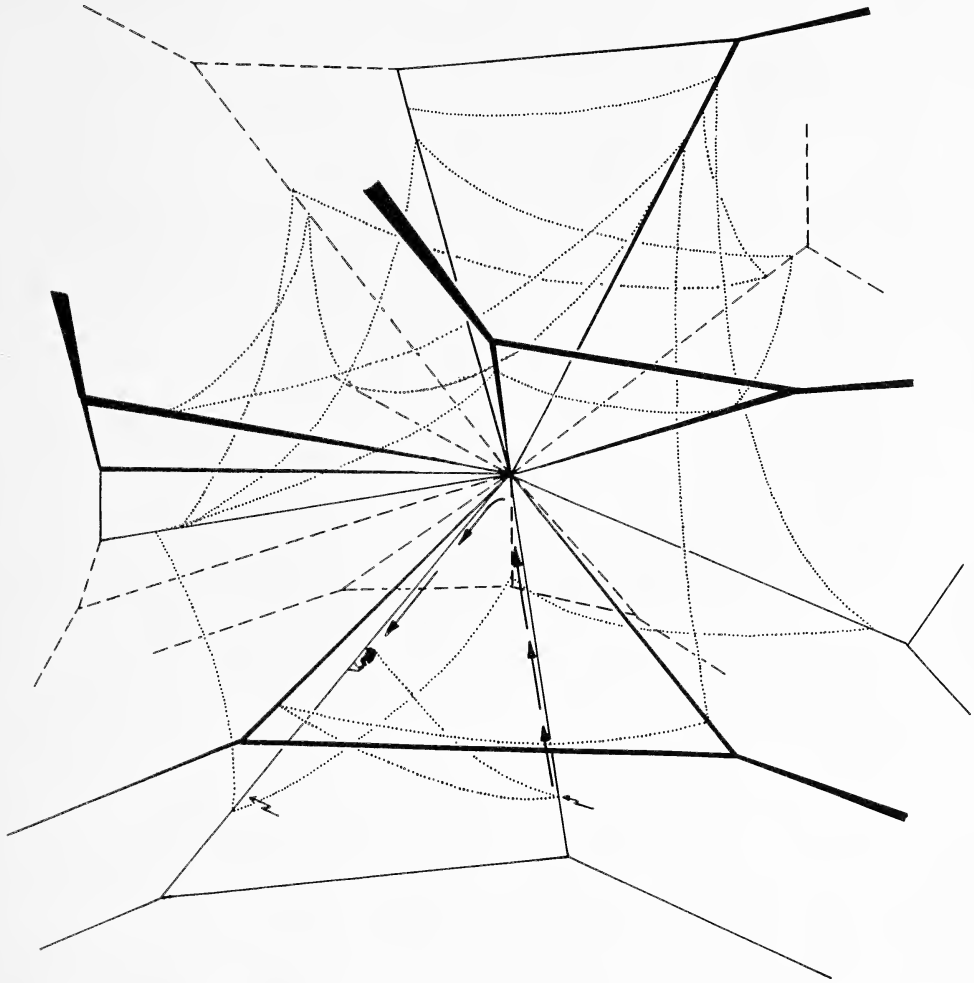

Fig. 7—Drawing of *Mysmena* sp. early in the process of sticky spiral construction. Straight lines (solid and dashed) are the non-sticky radii and frame lines. The dotted, curved lines are the sticky spiral. The spider travels all the way in to the hub and then back out (large arrows) between one attachment of the sticky spiral and the next (small arrows).

the hub as the spider moved back toward the hub. In several other cases I saw that the spider made quick alternate pulling movements with its legs IV apparently on the drag-line as it neared the hub, probably pulling additional silk as it did so. In one case the loosening behavior was at first confined to radii in the lower half of the web, and some upward-directed radii were not loosened. In finished webs that were examined microscopically, 5 of 23 radii in the web of one (SJ1-69-M) and 14 of the 19 radii which could be followed in the web of another (Fig. 8) had "pyriform masses" on them similar to those on the elementary radii of anapids and *Maymena* (below) that had been broken and lengthened.

When the loosening was completed, the spider slowly turned about 360° at the hub (3 of 3 cases), making movements which may have involved attaching the radii there together. Two completed webs on slides had a single loop of hub line (Fig. 8). As the spider turned, its anterior end was on the white speck at the center of the hub, and when it finished turning the speck was gone, presumably

ingested (apparently *G4* of Eberhard 1982). One apparently finished web however had a tangled mass of threads of the hub which probably corresponded to the white speck. Most radial lines did not extend all the way to the hub, but instead formed a branching pattern (Fig. 8) similar to that of some theridiosomatids (McCook 1889). Coddington (1986a) saw a similar pattern of radii in the web of *M. guttata*.

The spider rested at the hub of the finished web. It did not tighten the web as it waited, and when disturbed it moved out along one of the radii without noticeably damaging the radii or frame lines.

Maymena.—Building Behavior: The building behavior of *Maymena* sp. (SJ1-69-D) and No. 2168) resembled that of the anapids described above in most respects. A white speck present at the center of the hub during sticky spiral construction suggested the same type of radius construction behavior (*F1* of Eberhard 1982). Several loops of temporary spiral were laid spiralling away from the hub (*H1* of Eberhard 1982). Microscopic examination of the web of SJ1-AA showed that the temporary spiral lines (broken in the finished web) were made of lines of at least approximately the same thickness as those of the elementary radii.

The spiders moved extraordinarily rapidly during sticky spiral construction and were thus difficult to observe, but it was clear that they faced away from the hub as they moved out radii to attach the sticky spiral and came close to touching the inner loop of sticky spiral already in place (*A1* of Eberhard 1982). They did not maintain contact with the temporary spiral as they worked near the edge of the orb (*D1* of Eberhard 1982). It appeared that one leg IV pushed the sticky spiral just as it was attached to a radius (*C1* of Eberhard 1982), but I could not be certain. The spider attached sticky line to the radii above the orb during sticky spiral construction as in anapids. In one case (No. 2168) several such lines were laid early during sticky spiral construction, then none were laid until the sticky spiral was between two thirds and three quarters complete, and then 10-15 more were laid in quick succession. Since these webs had temporary spirals, the spiders must have walked to the hub on top of rather than beneath the radii, and somehow they kept the sticky spiral free of entanglement with the radius. I was not able to see how these feats were accomplished.

After finishing the sticky spiral, the spider paused at the hub for 10-30 seconds, then began to lay supplementary radii. The spider clearly sagged far below the plane of the orb as it returned to the hub, and thus apparently broke the line it had laid as it moved away from the hub. In one case (SJ1-69-D) it was clear that successive supplementary radii tended to be laid on nearly opposite sides of the web, and also that the spider made a series of quick, alternating pulling movements with its legs IV as it reached the hub, suggesting that additional line was being pulled from the spinnerets. Microscopic examinations of the webs of SJ1-69-D, SJ1-69-AA, and SJ1-69-G (Fig. 9) showed that the supplementary radii were much thinner than elementary radii. They could only barely be distinguished at 450X, while elementary radii were distinct even at 200X. These examinations also confirmed that only elementary radii were attached to the hub, and that the sticky spiral lines were attached only to elementary radii. No supplementary radii were laid out of the plane of the orb.

Spider No. 2168 was "distracted" by capturing and eating a series of three prey as it laid supplementary radii, and no further behavior was observed, but SJ1-69-D followed supplementary radius construction by cutting each elementary

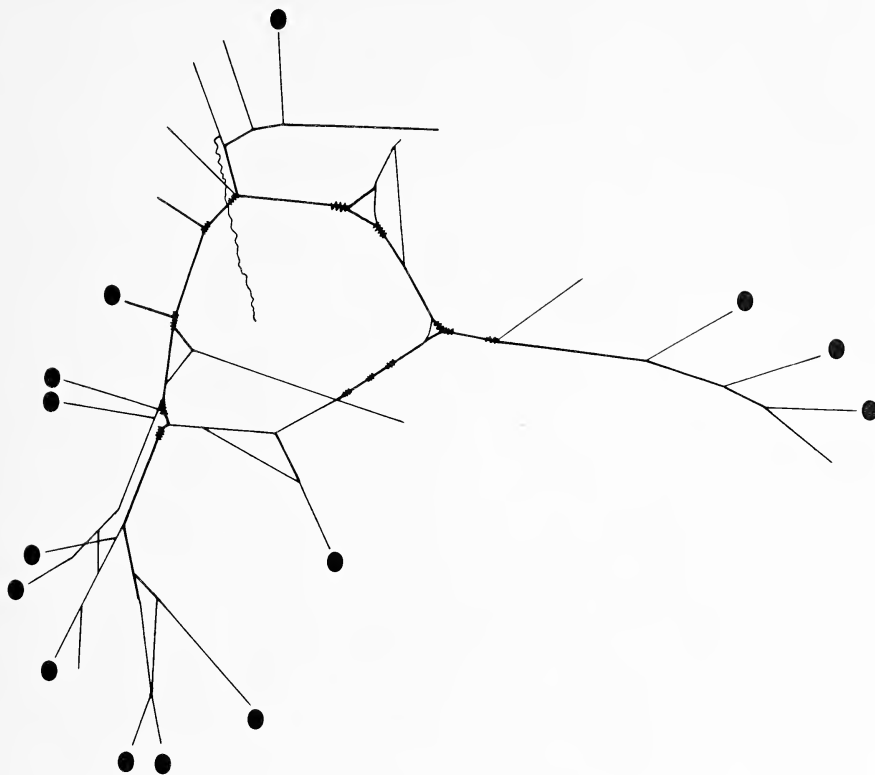

Fig. 8—Drawing of lines in the center of a finished three dimensional orb of *Mysmena* sp. (SJ1-C) which was pressed onto a flat glass slide and observed under a compound microscope. The lines with a black dot had pyriform masses on them farther from the hub, indicating that they had been broken and repaired during construction. Only 19 of the 24 radial lines could be followed far from the hub, and others may have also had pyriform masses. Lines on which others converged in the central area were thicker.

radius near the hub, lengthening it, and then reattaching it. At least some supplementary radii were also cut while elementary radii were being lengthened. I also noted pulling movements with legs IV as the spider returned to the hub during this process. The accumulation of broken supplementary radii and sticky spiral lines which had stuck together formed a "halo" of silk around the spider that was visible even in unpowered webs (Fig. 10). Examinations of webs under the microscope confirmed both that all elementary radii were lengthened and reattached at the hub, and that all supplementary radii ended on the sticky spiral or an elementary radius and none of them reached the hub (Figs. 9, 11).

Finally the spider laid two loops of hub line around the accumulation of loose silk at the center of the hub, and in the process removed this silk (apparently *G4* of Eberhard 1982). The apparently complete web of SJ1-69-D, however, had a small mass of loose silk at the center of the hub.

Finished Webs of Other Species.—Some of the distinctive behaviors described above result in webs whose designs are also distinctive, allowing one to deduce details of building behavior from finished webs. Supplementary radii, distinguished by lack of deflection of sticky spiral lines crossing them, greater sag under the weight of cornstarch used for photography, and failure to pull frame lines to which they are attached out of straight lines, occur in the webs of the

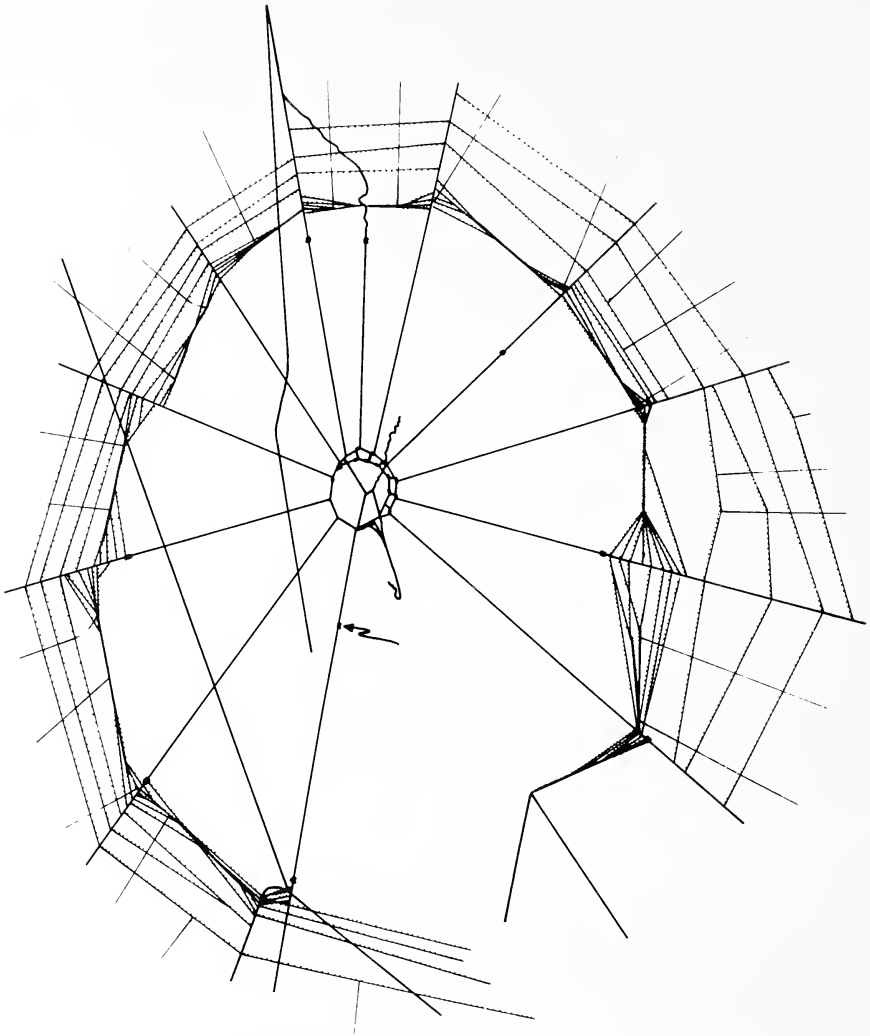

Fig. 9—Drawing of the central portion of the web of a *Maymena* sp. (No. SJI-69-G) web that was collected on a slide and observed under a compound microscope. Thin lines with dots represent sticky lines. All elementary radii (thicker lines with larger dots) are connected to the hub, while supplementary radii (thinner lines with dots) end on sticky lines or elementary radii. The 5:00 sector of the web was evidently damaged during collection. The lines extending upward at 11:30 were probably above the plane of the orb. Pyriform masses are indicated by dark spots on the elementary radii (arrow).

anapids *Anapis anchicaya* Platnick and Shadab, *A. felidia* P. and S., *A. herediae* P. and S., the mysmenid *Maymena* sp. (No. 1687), and the symphytognathid *Patu saladito* Forster and Platnick. One web of *Anapisona hamigera* (Simon) clearly did not have supplementary radii.

When a spider which has laid supplementary radii then loosens the elementary radii, the pattern of threads near the hub is like that in Fig. 11, a pattern not seen in the web of any orb weaver which does not perform this behavior. This pattern is clear in photographs of the webs of all the species just mentioned.

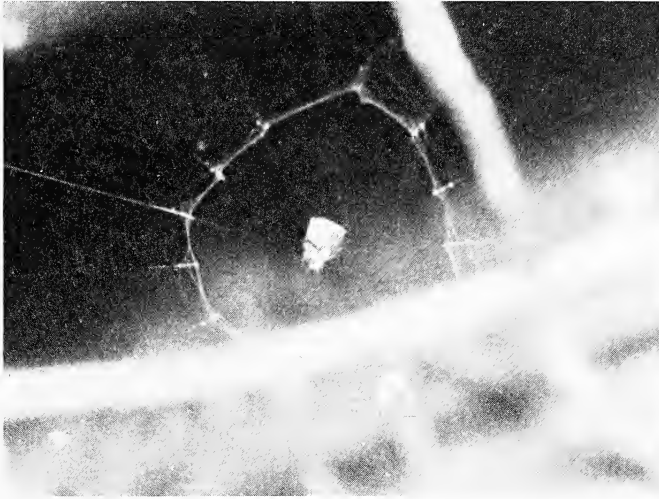

Fig. 10—*Maymena* (?) sp. (No. 1687) at the hub of its unpowdered web. The circular line ("halo") around the spider is the accumulation of sticky and non-sticky lines formed when the spider replaced the hub after finishing supplementary radius construction (see Fig. 9). Photograph is about 3 cm wide.

DISCUSSION

Studies of web building behavior of other groups of orb-weavers have shown that many details are quite conservative (Eberhard 1982), so although the numbers of species of anapids, mysmenids and symphytognathids whose webs

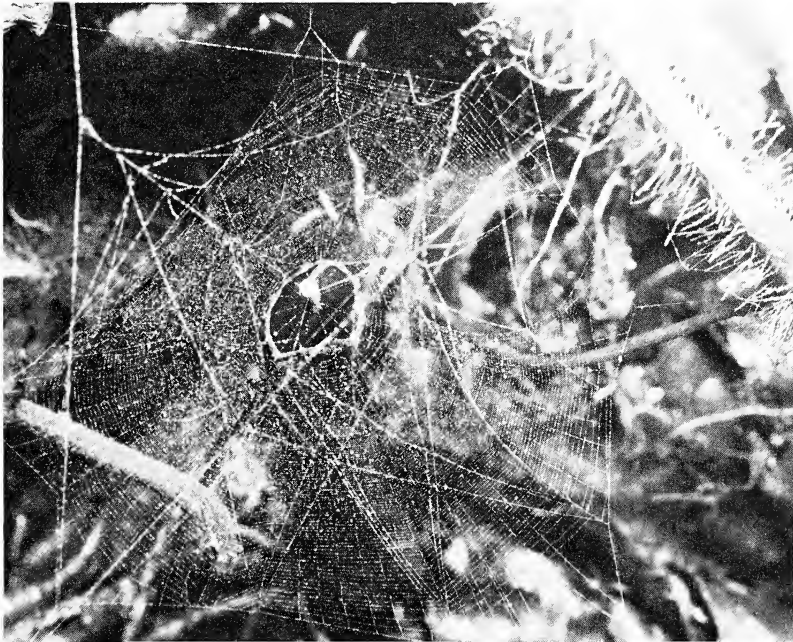

Fig. 11—Powdered web of *Maymena* (?) sp. (No. 1608). The white object above the hub is an egg sac. Supplementary radii and the "halo" of lines around the hub are visible. Photograph is 5.6 cm wide.

and building behavior have been observed is still small, the fact that they share apparently derived characters never seen in better studied groups is strong evidence that they are closely related. The data are combined with those of Eberhard (1982) and Coddington (1986a) and summarized in Fig. 12. Several synapomorphies are suggested. The term "radius" is used in Fig. 12 only for lines to which sticky lines are attached (thus excluding the "spring line" of some theridiosomatids). The relationships are in agreement with those of Coddington (1986a) based on other characters in addition to web form.

Several assumptions were made in constructing the cladogram. Convergent loss of characters was considered more likely than convergent origin; thus both ancestral possession of temporary spiral with convergent losses in anapids and some mysmenids and ancestral possession of supplementary radii with subsequent losses in some anapids and some mysmenids were preferred over alternative possibilities. Loosening radii was taken to be derived with respect to absence of this behavior since loosening involves an additional behavior. The decision to attribute late construction of the definitive hub and the use of leg IV to hold the radius to which the sticky spiral has just been attached away from the sticky spiral line (Eberhard 1981) to the presumptive ancestor of the non-araneid families was arbitrary, and early hub construction and not sliding leg IV could equally well be considered derived characters of araneids, unless uloborids and/or dinopids are taken as the sister group of araneoids. As argued in Eberhard (1981), holding the radius away with leg IV is probably associated with relatively small spider size in relation to the distances between lines in the orb. I was not able to observe the mysmenids and symphytognathids in sufficient detail to ascertain whether they perform this behavior. If the relationships in Fig. 12 are correct, at least some of them probably do.

Loss of both temporary spiral and supplementary radii in *Mysmena* webs is probably a consequence of the three dimensional orb design, since it is difficult to imagine an effective three-dimensional temporary spiral, and it is probably impossible to lay supplementary radii through a dense three-dimensional array of sticky lines (the spider must move through them, however, when it captures prey). The secondary loss of supplementary radii proposed for anapids is supported by the observation of *Anapis* sp. (No. 2166) laying a single (vestigial?) supplementary radius, and the low numbers of supplementary radii in the webs of *Anapisona simoni* (Coddington 1986a) and *Anapis atuncela* Platnick and Shadab.

"Radial anastomosis" (convergence of some radii before they reach the hub) was not included in the characters used to make the cladogram even though it may be a useful taxonomic character (Coddington 1986a) because I was unable to determine whether the occasional supplementary radius terminating on an elementary radius near the hub (e.g. Fig. 7) was actually attached there or whether it fell against the elementary radius as the spider broke lines while loosening the elementary radii. It was clear that elementary radii did not "anastomize" in the orbs of any of the species studied other than *Mysmena*.

Coddington (1986a) pointed out the similarity between supplementary radii of symphytognathoids and the additional radii spun by some young uloborids (Szlep 1961, Eberhard 1977), and suggested that the possibility of homology should be considered in more detail. Supplementary radii are apparently similar to the uloborid lines in not being produced by the ampullate glands (at least they have very different diameters from those of elementary radii and hub lines). They differ however in being single lines placed on the web in radial directions rather than

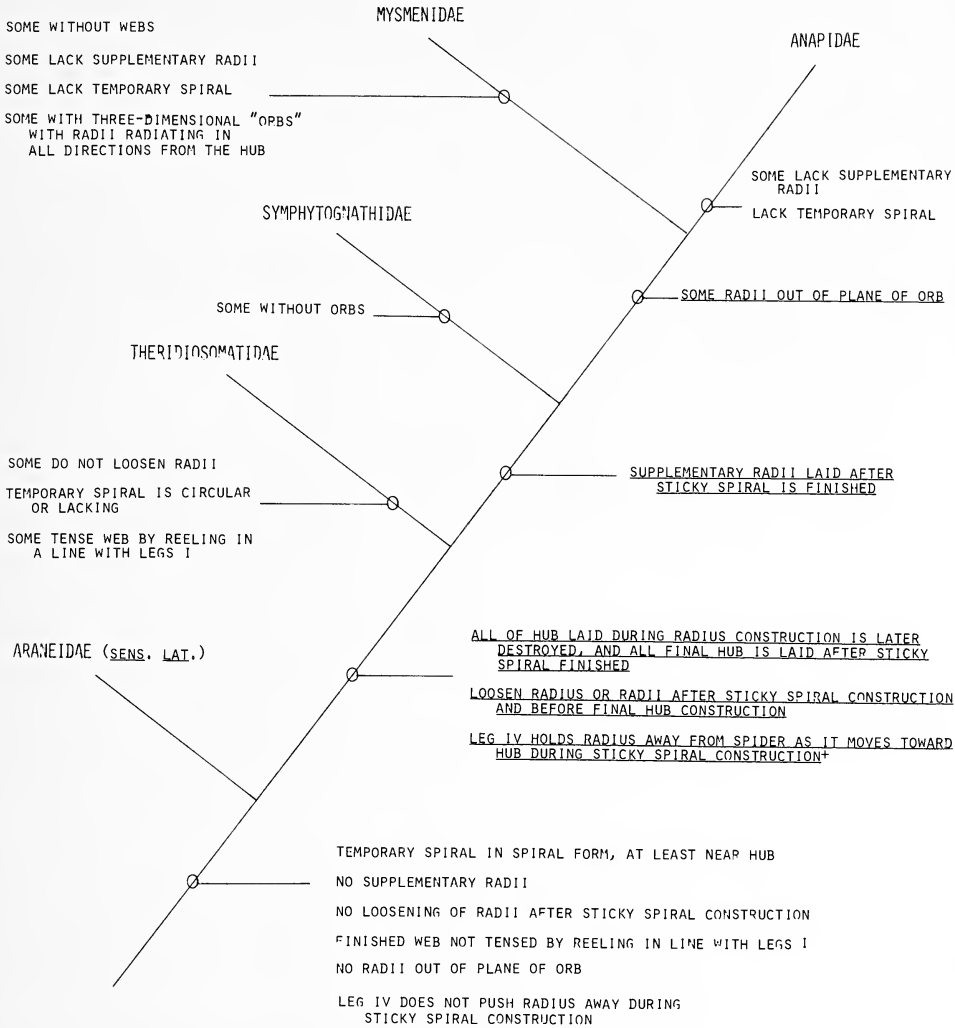

* KNOWN IN THERIDIOSOMATIDAE AND ANAPIDAE; NO CERTAIN OBSERVATIONS OF SYMPHYTOGNATHIDAE OR MYSMENIDAE

Fig. 12—Most likely system of relationships between different families based on behavioral characters (see text for assumptions made in analysis). Proposed synapomorphies are underlined.

clouds of fine fibers that often do not run radially as in uloborids (Eberhard 1977). Homology is thus unlikely.

The building behavior of *Mysmena* sp., the radial design of its web, and the orb web of the related *Maymena* clearly support the idea of Marples (1955) that *Mysmena* webs are best considered as three-dimensional orbs. Radii and frame lines are laid first, and involve behavior apparently identical to that of other araneoid orb-weavers. The tendency to lay some radii out of the plane of the orb, which also occurs in anapids and *Maymena*, is accentuated. As in all known orb-weavers, the sticky line is laid from the edge of the web moving inward so that each successive sticky spiral attachment to a radius is to the hub side of the last. As with the sticky lines of anapids and *Maymena* which are attached to radii out of the plane of the orb, all *Mysmena* sticky lines are very slack and sag under their own weight. When the sticky spiral is finished the spider lowers the tension

on most radii by breaking them and lengthening them just as do all known orb-weaving anapids, *Maymena*, and the symphytognathid *Patu*. Finally, the accumulation of rolled-up lines at the hub is eliminated, apparently by ingestion, and the only circular hub lines which persist in the finished web are added after the web is otherwise complete as in all anapids, those theridiosomatids with hubs (Eberhard 1982, Coddington 1986a), and *Maymena*. Thus *Mysmena* behavior is apparently homologous at many points with that of species making typical orbs.

ACKNOWLEDGEMENTS

I am grateful to Norman Platnick for kindly identifying many tiny specimens. Jonathan Coddington and M. J. West-Eberhard read a preliminary version of the manuscript. Financial support was provided by the Vicerrectoría de Investigación of the Universidad de Costa Rica.

LITERATURE CITED

- Coddington, J. 1986a. The monophyletic origin of the orb web. *In* Spiders—Webs, Behavior, and Evolution. (W. A. Shear ed.). Stanford Univ. Press.
- Coddington, J. 1986b. Orb webs in "Non-orb weaving" ogre-faced spiders (Araneae: Dinopidae): a question of genealogy. *Cladistics*, 2:53-67.
- Eberhard, W. G. 1977. The webs of newly emerged *Uloborus diversus* and of a male *Uloborus* sp. (Araneae: Uloboridae). *J. Arachnol.*, 4:201-206.
- Eberhard, W. G. 1981. Construction behavior and the distributions of tensions in orb webs. *Bull. British Arachnol. Soc.*, 5:189-204.
- Eberhard, W. G. 1982. Behavioral characters for the higher classification of orb-weaving spiders. *Evolution*, 36:1067-1095.
- Forster, R. R. 1959. The spiders of the family Symphytognathidae. *Trans. Roy. Soc. New Zealand*, 86:269-329.
- Forster, R. R. and L. M. Forster, 1973. *New Zealand Spiders*. Collins, London.
- Forster, R. R. and N. I. Platnick. 1977. A review of the spider family Symphytognathidae (Arachnida: Araneae). *Amer. Mus. Novitates*, 2619:1-29.
- Hickman, V. V. 1938. On a dipneumone spider (*Risdonius parvus*, gen. et sp. n.), the female of which has reduced palpi. *Proc. Zool. Soc. London*, 108:655-660.
- Jacobi-Kleemann, R. 1953. Ueber die Locomotion der Kreuzspinne *Aranea diademata* beim Netzbau (nach Filmanalysen). *Z. vergl. Physiol.*, 34:606-654.
- LeGuelte, L. 1966. Structure de la toile de *Zygiella x-notata* Cl. (Araignees, Argiopidae) et facteurs que regissent le comportement de l'araignee pendant la construction de la toile. *These Pub. Univ. Nancy*. 1-77.
- Marples, B. J. 1955. Spiders from Western Samoa. *J. Linnaean Soc. Zool.*, 42:453-504.
- McCook, H. C. 1889. *American Spiders and their Spinningwork*. Vol. 1. published by the author, Philadelphia.
- Platnick, N. I. and M. Shadab. 1978. A review of the spider genus *Anapis* (Araneae: Anapidae) with a dual cladistic analysis. *Amer. Mus. Novitates*, 2663:1-23.
- Shinkai, E. 1977. Spiders of Tokyo III (in Japanese). *Acta Arach.*, 27:321-336.
- Shinkai, E. and S. Takano, 1984. *A Field Guide to the Spiders of Japan*. Tokai Univ. Press, Tokyo.
- Szlep, R. 1961. Developmental changes in the web-spinning instinct of Uloboridae: construction of the primary type web. *Behaviour*, 27:60-70.

A NEW MYGALOMORPH SPIDER GENUS FROM MEXICO (NEMESIINAE, NEMESIIDAE, ARACHNIDA)

Robert J. Raven

Queensland Museum
P.O. Box 300, South Brisbane
Queensland, Australia

ABSTRACT

A new mygalomorph genus, *Mexentypesa*, and its type species *Mexentypesa chiapas*, new species, are described from southern Mexico. The presence of claw tufts in association with biserially dentate paired claws in both males and females allies the genus to both the theraphosids and nemesiids; its sister group is suggested to be *Calisoga*.

INTRODUCTION

During a revision of mygalomorph genera previously placed in the Diplurinae, I examined two new genera that presented a new combination of characters that challenged my hypotheses of relationships of nemesiids and cyrtaucheniids (see Raven 1985). The problem arose because both of those genera have claw tufts, unlike most other co-familial taxa but like the theraphosoids. In mygalomorphs, claw tufts are found in barychelids, theraphosids, one paratropidid genus, plus the nemesiid *Neodiplothele* (see Raven 1985). That occurrence prompted me to treat the presence of claw tufts as a synapomorphy of the Theraphosoidina (Theraphosidae, Paratropididae, plus Barychelidae). Because the Nemesiidae is the sister group of the Theraphosoidina, the synapomorphic nature of claw tufts in the latter must be re-examined. The first of those genera is described here for an apparently unknown species.

MATERIALS AND METHODS

All eye measurements are given in ocular eyepiece units with interspaces expressed in diameters of an AME. All other measurements are in millimeters. Abbreviations are standard for the Mygalomorphae, except possibly for MOQ, median ocular quadrangle.

Claw tufts are each considered to be a dense cluster of hair arising from a separate cuticular pad lying between the outer edges of the bases of each paired claw and the tarsus. Hairs arising from the cuticle on the legs (as in some Australian *Aname* species) are merely extensions of the scopulae. A pseudosegmented tarsus is evident as a single ventral transverse weakness in the cuticle or as a reticulated area of weak cuticle resembling cracking mud; the effect of either condition is the downward flexion of the tarsus.

Mexentypesa, new genus

Type.—The type species of this genus is *Mexentypesa chiapas*, new species. The name is feminine and derives from a combination of Mexico and *Entypesa*, which the genus resembles.

Diagnosis.—Females may be distinguished from barychelids, paratropidids, and theraphosids by the biserially dentate paired claws, and from the barychelids *Monodontium* and *Troglothele* and the nemesiid *Spelocteniza* by the presence of well developed eyes and/or a digitiform apical segment to the posterior lateral spinnerets. Males are unique in the combination of biserially dentate paired claws, claw tufts, and all tarsi pseudosegmented. Both sexes are readily distinguished from all other nemesiids, save *Neodiplothele* (which has only two spinnerets), by the presence of claw tufts and from the cyrtaucheniid by lacking a third claw on any leg.

Description.—As for species.

Mexentypesa chiapas, new species

Fig. 1-9, Tables 1, 2

Types.—Male holotype, female paratype, from Ocosingo (altitude 900 m, Chiapas, Mexico, June 25, 1950 (C. and N. Goodnight, L. J. Stannard); deposited in AMNH.

Diagnosis.—As for genus.

Description.—*Holotype male.* Carapace, chelicerae, and legs reddish brown; sternum, maxillae, and labium yellow brown; abdomen dorsally brown with white mottling, ventrally with brown areas on pallid yellow, booklung covers orange.

Carapace 4.16 long, 2.72 wide; few black setae on caput; lateral margins with strong setae for two thirds of carapace; caput flat, as high as thoracic region behind fovea; fovea short, recurved, with posterior indentation.

Eight eyes in two rows on distinctly raised tubercle; ratio of AME:ALE:PME:PLE, 10:9:6:8; from above, front row straight, back row recurved. Group occupies 0.46 of headwidth, 1.88 times wider than long. MOQ 1.47 times wider behind than long, and 1.16 times wider behind than in front. Eye interspaces: AME-AME, 0.3; AME-ALE, 0.1; ALE-PLE, 0.1; PME-PLE, 0; PME-PME, 1.3.

Chelicerae short, slightly geniculate, with strong setae dorsally; rastellum of six stout spines (each about four times longer than wide at the base) curving down over fang. Fang smooth, slender. Intercheliceral face not modified; promargin with four large and five small spaced teeth, basomesally with four small teeth. Labium 0.25 long, 0.70 wide, without cuspules, two large sigilla in labiosternal suture; with transverse ridge medially. Maxillae 1.13 long in front, 1.25 long behind, 0.60 wide, anterior lobe smooth, distinct, without serrula; eight cuspules on inner angle, not on mound; lyra absent. Sternum 2.04 long, 1.84 wide, domed in cross-section; six sigilla oval, marginal, posterior pair 0.14 long.

Leg formula 41(2=3). Tarsi I-IV curved, pseudosegmented. Leg I incassate; tibia incassate with distinct megaspine on retroventral edge, metatarsus with distinct, proximal cuticular thorn retrolaterally. Preening combs absent. Scopulae: light, distal on metatarsus I, light on tarsus I, very thin on metatarsus and tarsus

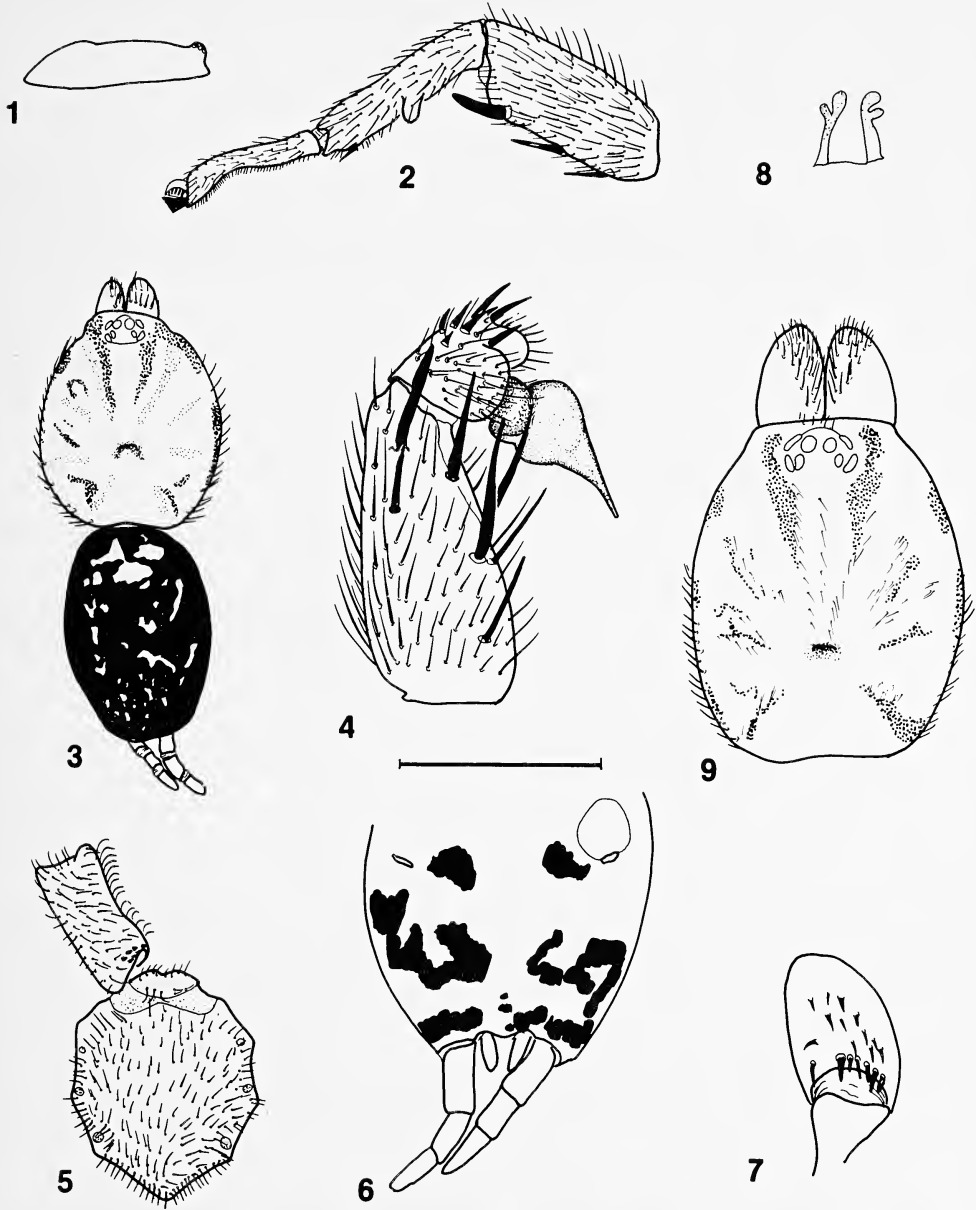

Figs. 1-9—*Mexentypesa chiapas*, new species: 1-7. Male holotype: 1, cephalothorax, lateral view; 2, tibia, metatarsus, and tarsus I, retrolateral view; 3, cephalothorax, chelicerae, and abdomen, dorsal view; 4, palpal tibia, cymbium, and bulb, prolateral view; 5, sternum, maxilla, and labium; 6, abdomen and spinnerets, ventral view; 7, distal chelicera and fang, oblique anterior view. 8, 9. Paratype female: 8, spermathecae, ventral view; 9, cephalothorax and chelicerae, dorsal view. Scale lines = 4 mm for figs. 1, 3; 1 mm for figs. 4, 7, 8; 2 mm for others.

II, only scattered scopuliform setae on tarsi III and IV, absent elsewhere. Spines (no spines on tarsi): leg I, femur pl, d4, patella 0, tibia p2, v5 + megaspine, metatarsus v2 + process; leg II, femur pl, d4, patella p2, tibia p2, v6, metatarsus pl, v5; leg III, femur p3, d3, r4, patella p2, rl, tibia, p2, d3, r2, v6, metatarsus, p6, dl, r4, v7; leg IV, femur p2, d3, rl, patella p2, rl, tibia p2, dl, r4, v6, metatarsus p4, d2, r3, v8.

	Leg 1	Leg 2	Leg 3	Leg 4	Palp
Femur	2.75	2.50	2.31	2.94	1.69
Patella	1.75	1.63	1.31	1.75	1.00
Tibia	1.75	1.50	1.31	2.13	1.25
Metatarsus	1.69	1.50	2.13	3.19	—
Tarsus	<u>1.13</u>	<u>1.06</u>	<u>1.13</u>	<u>1.38</u>	<u>0.63</u>
Total	9.07	8.19	8.19	11.39	4.57

Palp (Fig. 4) with pyriform bulb; embolus lacks keels and tips of both appear to have been broken; cymbium without scopula, divided into two similar lobes, apically with four thick and four thinner spines; tibia incrassate. Spines: femur pl, d3, patella pl, patella pl, tibia p2, v4, tarsus 8 apical.

Paired claws with two long, juxtaposed rows each of about nine teeth; unpaired claws absent on all tarsi; on all legs, two small thin tufts on distinct cuticular extension.

Ten to 15 trichobothria in row extending for full length of tibiae, curving row of 8-10 on metatarsi, and 10-12 proximal of crack or pseudosegmentation. Tarsal organ a low dome with 3-4 shallow central concentric ridges; cuticle surface smooth; bothria corrugiform almost to base.

Abdomen 4.11 long, 2.89 wide; lungbook apertures broad, slit-like. Posterior median spinnerets 0.43 long, 0.30 wide, 0.25 apart. Basal, middle, apical segments of posterior lateral spinnerets 0.75, 0.70, 0.65 long, respectively; apical segment digitiform.

Paratype female. Carapace orange brown with brown markings radiating along strial edges, on lateral carapace, and caput; chelicerae orange brown; legs yellow brown with brown annulations on distal and proximal metatarsi, annulations lateral on tibiae and patellae, distolateral on femora; sternum, maxillae, and labium yellow brown; abdomen similar to male with less white.

Carapace 3.16 long, 2.68 wide; setae weaker than in male; caput flat, as high as thoracic region behind fovea; fovea short, straight.

Ratio of AME:ALE:PME:PLE, 7:10:8:10; from above, front row slightly procurved, back row recurved. Group occupies 0.47 of headwidth, 1.94 times wider than long, slightly wider behind than in front. MOQ 1.53 times wider behind than long, 1.35 times wider behind than in front. Eye interspaces: AME-AME, 0.4; AME-ALE, 0.3; ALE-PLE, 0.3; PME-PLE, 0.1; PME-PME, 2.0.

Chelicerae similar to male but rastellum entirely absent; promargin with seven spaced teeth, basomesally with few granules. Labium 0.18 long, 0.64 wide, without cuspules. Maxillae 0.96 long in front, 1.16 long behind, 0.60 wide, anterior lobe less distinct than in male; six cuspules on inner angle. Sternum 1.54 long and wide; all sigilla oval, marginal.

Leg formula 41(2=3). Only tarsi IV distinctly cracked. Preening combs absent. Scopulae: very thin to absent on metatarsi I, II, almost absent on tarsi I, II, absent elsewhere. Spines (no spines on tarsi, femora I-IV with one long dorsal basal spine): leg I, femur d4, patella 0, tibia 0, metatarsus v3; leg II, femur d4, patella 0, tibia 0, metatarsus v4; leg III, femur dl, rl, patella p2, rl, tibia p2, dl, rl, v3, metatarsus p3, d3, r3, v7; leg IV, femur dl, rl, patella pl, tibia p2, dl, r3, v4, metatarsus p3, d3, r3, v8.

	Leg 1	Leg 2	Leg 3	Leg 4	Palp
Femur	2.20	1.92	1.88	2.00	1.44
Patella	1.48	1.36	1.12	1.44	0.96
Tibia	1.40	1.16	1.04	1.72	0.96
Metatarsus	1.08	1.12	1.52	2.56	—
Tarsus	<u>0.76</u>	<u>0.80</u>	<u>0.80</u>	<u>1.08</u>	<u>0.96</u>
Total	6.92	6.36	6.36	8.80	4.32

Palp with thin scopulae on tarsi and four spines on ventral tibia.

Claws, tufts, tarsal organ, and trichobothria similar to male.

Abdomen 4.08 long, 2.68 wide; lungbook apertures broad, oval. Posterior median spinnerets 0.32 long, 0.14 wide, 0.26 apart. Basal, middle, apical segments of posterior lateral spinnerets 0.50, 0.40, 0.38 long, respectively; apical segment digitiform. Spermathecae two (Fig. 8), each a short lobe divided for apical one half into two dissimilar ectally directed lobes.

Distribution.—Known only from the type locality in Chiapas, Mexico.

RELATIONSHIPS

Mexentypesa lacks the keels on the palpal bulb and intercheliceral tumescence that would otherwise qualify it for membership in the Pycnothelinae (see Raven 1985). It shares with the Californian genus *Calisoga* (Nemesiinae) the pseudosegmented tarsi of males and the digitiform apical segment of the posterior lateral spinnerets. If those two genera are considered sister groups, an hypothesis is required to explain the degree of difference in scopulae development: very dense in *Calisoga* but almost nil in *Mexentypesa*. In the current sister group of *Calisoga*, *Nemesia* plus *Brachythele*, the scopulae are also weak but generally not so weak as in *Mexentypesa*. Most parsimoniously, the presence of scopulae is considered an autapomorphy of *Calisoga* (congruent with the clavate setae on the upper inner faces of the chelicerae), and the weak scopulation of *Mexentypesa* is either homologous to the condition in *Nemesia* plus *Brachythele* or simply a species autapomorphy. Hence, the sister group of *Mexentypesa* is considered to be *Calisoga*.

The inclusion of *Mexentypesa* in the Theraphosoidina is rejected for three reasons. First, the inclusion of *Mexentypesa* in the Nemesiidae requires only the acquisition of claw tufts, thus incurring one additional step in the family cladogram (Raven 1985, Fig. 1). Second, its inclusion in the Theraphosoidina requires several homoplasies (not including those also required in the Nemesiidae): biserially dentate paired claws in females; absence of theraphosoid coupling spurs; long distinct maxillary lobe; numerous maxillary and labial cuspules; and pseudosegmented tarsi in males. Third, its association with the barychelids with biserial dentition of the claws in females (*Troglithele*, *Monodontium*) would require the proposal of other homoplasies, e.g., digitiform apical segment of the posterior lateral spinnerets, weak leg scopulae, plesiomorphic eye group configuration. However, males of those barychelid genera are not known; hence, their relationships are in doubt and no further discussion is warranted. In summary, *Mexentypesa* is currently accommodated in the Nemesiidae with the minimum of homoplasy.

ACKNOWLEDGEMENTS

I am grateful to Dr. Norman I. Platnick, Department of Entomology, American Museum of Natural History, New York, for allowing me access to the collection in his care, and to Dr. Frederick A. Coyle, Western Carolina University, Cullowhee, who also reviewed the manuscript.

LITERATURE CITED

- Raven, R. J. 1985. The spider infraorder Mygalomorphae (Araneae): cladistics and systematics. Bull. Amer. Mus. Nat. Hist., 181:1-180.

Manuscript received August 1985, revised March 1986.

Wharton, R. A. 1987. Biology of the diurnal *Metasolpuga picta* (Kraepelin) (Solifugae, Solpugidae) compared with that of nocturnal species. *J. Arachnol.*, 14:363-383.

BIOLOGY OF THE DIURNAL *METASOLPUGA PICTA* (KRAEPELIN) (SOLIFUGAE, SOLPUGIDAE) COMPARED WITH THAT OF NOCTURNAL SPECIES¹

Robert A. Wharton

Desert Ecological Research Unit
P.O. Box 953
Walvis Bay 9190
South West Africa/Namibia²

ABSTRACT

Metasolpuga picta (Kraepelin) is a diurnal solifuge restricted to the Namib Desert of SWA/Namibia. Burrowing, mating, oviposition, and feeding behaviors are described and compared with other solifuge species. Thermoregulatory behavior, previously undocumented for solifuges, is associated with diurnal habits. Populations were bivoltine in 1979, whereas all solifuges previously studied have been univoltine. The biology of *M. picta* is otherwise similar to that of nocturnal species from North African, South-west Asian, and North American deserts.

INTRODUCTION

Despite extensive work on some North American species (Muma 1966a-e, 1967), solifuges are relatively poorly studied (Cloudsley-Thompson 1977, Savory 1977). Since the publication of Cloudsley-Thompson's (1977) review, Muma (1974a,b, 1975a,b, 1979, 1980a,b), Gore and Cushing (1980), Thaler (1982), and Aliev and Gadzhiev (1983) have published additional biological information; and Aruchami and Sundara Rajulu (1978), Alberti (1979, 1980), Haupt (1982), and Bauchhenss (1983) have contributed morphological studies. Nevertheless, detailed biological data have been published for only four of the approximately 1000 described species of solifuge arachnids (Heymons 1902, Cloudsley-Thompson 1961a,b, Junqua 1966, and Muma 1966c). Published biological data on Solifugae are restricted primarily to members of the families Galeodidae, Eremobatidae, and Ammotrechidae. Little or nothing is known about the other nine solifuge families.

Cloudsley-Thompson (1977) stated that solifuges are nocturnal, with only "a few small colourful species" exhibiting diurnal habits. Previous biological studies have dealt almost exclusively with these nocturnal species. However, there are

¹Approved as TA No. 18797 by the Texas Agricultural Experiment Station.

²Present address: Department of Entomology, Texas A&M University, College Station, Texas 77843, U.S.A.

several large, diurnal solifuge species in the arid regions of southern Africa (Lawrence 1963, Wharton 1981).

Based on trap catches of 14 individuals, Holm and Scholtz (1980) determined that *Metasolpuga picta* (Kraepelin) was diurnal, and restricted to the interdune valley habitat of the Namib Desert dune ecosystem at Gobabeb (South West Africa/Namibia). Its biology is detailed here for comparison with its better known nocturnal relatives. Prior to Holm's studies of dune arthropods (Holm and Edney 1973, Holm and Scholtz 1980), only five specimens of *M. picta* had ever been collected (Kraepelin 1899, Purcell 1899, Lawrence 1963, 1965, 1967). The following account represents the first detailed biological study of a member of the family Solpugidae.

MATERIALS AND METHODS

Solifuge behavior was observed between November, 1978 and February, 1980 within a 5 km radius of Gobabeb (23°24'S, 15°03'E), in the Namib Desert of South West Africa/Namibia. This region consists of a southern dune habitat and a northern gravel plain bisected by the sporadically flowing Kuiseb River. Holm and Edney (1973), Holm and Scholtz (1980), Robinson and Seely (1980), Seely and Louw (1980), and Wharton and Seely (1982) have described and figured the dune and gravel plains habitats in this region. Nearly all observations were made directly in the field, on both sides of the Kuiseb River. Eleven individuals were also maintained for varying periods in laboratory cages to supplement field data on oviposition, feeding, response to temperature, and intraspecific aggression.

Although most solifuges, including those from the Namib Desert, readily climb out of pitfall traps, *M. picta* was unsuccessful in doing so unless the sides of the traps were exceptionally rough. As a consequence, populations could be readily sampled throughout the year using smooth-sided, metal, bowl-shaped traps (20 cm diameter x 12 cm deep). These traps could be quickly set in the sand and easily removed at the end of a trapping period with little disturbance to the habitat. Traps were placed in an interdune valley (1 km wide x 5 km long) on 10 different occasions throughout 1979 to record phenology and obtain estimates of population age structure. A minimum of 57 traps was used during each trapping period. Traps were monitored at least twice daily until a total of 24 *M. picta* had been captured. During June and July, decreased solifuge activity precluded capture of 24 solifuges within a 2 week period, and trapping was therefore terminated before the desired quantity was obtained. Trapped solifuges were taken to the laboratory, where they were measured and, if adult, sexed. Adult males were readily recognized by the presence of a flagellum, females by differences in development of the genital operculum. All identifications were done by the author. Solifuges were either maintained in the laboratory until the end of the current trapping period, or immediately marked and released (none of the 75 marked individuals was ever recovered). Cheliceral length was measured to ± 0.1 mm using vernier calipers. Measurements of other body parts proved considerably less reliable, based on repeated measurements of the same individual: the opisthosoma was capable of considerable stretching; endpoints of legs and palps were difficult to pinpoint; and the prosoma was flexible and subject to some distortion depending on position of chelicerae. While there was some evidence of wear on the cheliceral tips of a few of the larger adults, this

was not observed in immatures. Results of trap catches were plotted as size-frequency distributions, using 0.5 mm size classes. The 0.5 mm size class was based on a 0.4 mm range in measurements of 2nd instars.

Meteorological data for the study period (including ground surface temperatures) were obtained from the First Order Weather Station, Gobabeb. Additional temperature records were made using a YSI® rapid-response telethermometer, calibrated to correspond with Gobabeb Weather Station measurements. A Mettler® balance was used for weights recorded in the text. Where not otherwise stated, averages reported in the text are means (\bar{m}) \pm standard deviations. The term "pebble" is used repeatedly in the text, and refers to small pieces of quartz and CaCO₃ weighing 5 gm or less.

RESULTS AND DISCUSSIONS

Phenology and Diel Periodicity.—*Metasolpuga picta* was observed in the field between 0915 and 1845. Trap catches indicated that they were only active during the daylight hours, confirming the data presented by Holm and Scholtz (1980). Of 65 solifuges encountered in the field, only two were observed after 1745, and seven before 1200. This activity was confirmed during pitfall trap censuses (Fig. 1), where 79% of the individuals were trapped in the afternoon.

Both adult and immature *M. picta* were observed in the field during every month except June and July. No individuals were trapped during a 2-wk interdune valley pitfall trap census in June; and only one immature *M. picta* during a 9-day census in July. A pitfall trap census was not conducted in August. Results of remaining censuses are shown in Fig. 1.

Solifuges were active in the field at ground surface temperatures between 40 and 61°C. Nevertheless, caged individuals maintained at lower ambient temperatures of 25-30°C still actively burrowed, and quickly responded to stimulation of leg IV setae. Two individuals placed at 20 \pm 1°C, however, became lethargic and responded only weakly to the same stimuli. At 5-10°C, *M. picta* became completely torpid. Of approximately 190 individuals subjected to refrigeration at 5-10°C for up to 30 min during census periods (to facilitate cheliceral measurement), all recovered completely, usually within 10 min. There was no noticeable difference in response to refrigeration among the various instars.

Reduced *M. picta* activity during June and July was correlated with low temperatures (a relationship first noted by Heymons (1902) for solifuges). In 1979, June, July, and August (austral winter) were the only months in which mean monthly ground surface temperatures at 1400 were 40°C or less (Table 1). Assuming an activity threshold between 20 and 25°C, however, temperatures in overnight burrows (see burrowing section below) are more likely to be a limiting factor for activity than are surface temperatures. During June and July, monthly means at 1400, 10 cm below the surface, were 23.5 \pm 1.8 and 22.0 \pm 1.9°C (more than 10°C lower than the means for January and February). It is thus possible that *M. picta* remained lethargic in burrows during cool days or weeks, but emerged on warm days throughout the mild Namib Desert winter.

Based on trap catches (Fig. 1) and field observations, the interdune valley population was essentially bivoltine in 1979. Eggs were deposited primarily in the

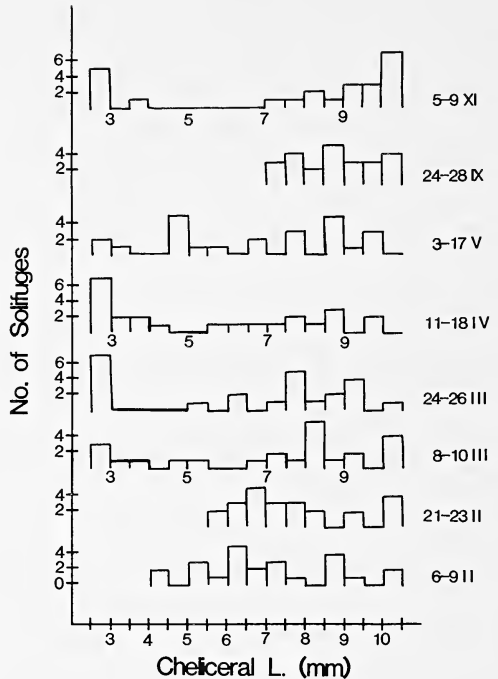

Fig. 1.—Size-frequency distributions representing 8 pitfall trap samples of *Metasolpuga picta* (Kraepelin) taken from an interdune valley population in 1979; 24 solifuges per trapping period. Adults > 10.5 mm combined with the 10.0-10.5 mm class.

spring (September-October) and again in late summer (February-early April). Data presented by Heymons (1902), Cloudsley-Thompson (1961b), Muma (1963, 1974a), and Junqua (1966) on 11 other solifuge species suggest that they are all univoltine.

Figure 1 shows the appearance of the first motile instar (=2nd instar), with cheliceral length 2.5-3.0 mm, beginning in November and March of 1979. Cloudsley-Thompson (1977) has stated that in the Sudan and western North America, production of young solifuges occurs in the summer, during the time of annual desert rains. Andrewartha and Birch (1954) and Nichols et al. (1976) have discussed similar correlations between precipitation and natality in desert invertebrates and vertebrates. Rainfall in the Namib is sporadic (Schulze 1969, Robinson and Seely 1980), and production of young *M. picta* was not correlated with it. In 1979, for example, total monthly rainfall was >10 mm only in June. In 1978, such rains occurred in February, March, and April. In 1980, they did not occur. Similarly, production of young *Eremobates durangonus* Roewer (Muma 1966e) occurs even when it doesn't rain (Muma, personal communication).

Cheliceral length of adult males from the interdune valley ranged from 7.2-11.0 mm ($\bar{m} = 8.7 \pm 0.9$; $N = 42$), and adult females from 7.2-12.3 mm ($\bar{m} = 10.4 \pm 1.1$; $N = 28$). However, about half the individuals in Fig. 1 with cheliceral length ≥ 7.5 mm were still immature. Adults from the gravel plain were larger, with female cheliceral length 8.0-16.2 mm ($\bar{m} = 12.7 \pm 2.8$; $N = 12$). Only one male, with cheliceral length of 13.0 mm, was available for measurement from the gravel plain. These findings support those of Junqua (1966) that adult size is not fixed.

Cheliceral lengths of all individuals measured from the interdune valley population (trap catches plus hand-collected specimens) are shown in Fig. 2. The peak at 2.8 mm represents the first active or motile instar (= second instar). The

Table 1.—Mean (\bar{m}) monthly ground surface temperatures at 1400, during 1979 pitfall trap censuses. No trapping conducted in August and October. No *Metasolpuga picta* trapped during 2-week census in June; only one *M. picta* trapped during 9-day census in July.

Month	\bar{m}	# days to	
		trap 24 <i>M. picta</i>	# traps
Feb.	57.9	3	57
		3	63
Mar.	55.1	3	63
		3	65
Apr.	49.1	8	61
May	42.7	14	60
June	36.0	-	60
July	40.2	-	52
Aug.	40.4	-	-
Sept.	47.1	5	59
Oct.	50.9	-	-
Nov.	55.6	5	60

first instar is inactive and passed within the oviposition chamber in the Solpugidae; and the existence of a post-embryo was not determined during this study. These data suggest that there are at least four active instars before adulthood. The peak between 7.5 and 8.0 mm consists of nearly an equal number of immatures and adult males (only one female). Since smaller adults are almost entirely males, either females have one more instar than males, or male and female chelicerae grow at different rates.

These data on cheliceral lengths serve only as a rough estimate for number of instars; and Francke and Sissom (1984) have recently discussed the limitations of such indirect methods. Such estimates are of value as a basis for future work, however, especially in light of the difficulty of rearing solifuges in captivity. Similar estimates are available for only two other species. Muma (1966c) estimated 8-10 instars for *E. durangonus*; and Junqua (1962, 1966) estimated six instars for *Othoes saharae* Panouse. Junqua (1962, 1966) also stated that, because of considerable observed variation in size, some individuals probably achieved adulthood at the 4th instar, and others at the 9th or 10th instar.

Only five males were trapped in censuses from February through May (Fig. 1). Although males dominated trap catches in late September (15 of 23 adults), they had largely disappeared by early November (3 of 24 individuals, 3 of 15 adults). This change in dominance from slightly more males than females in September to many more females than males in November was corroborated by field observations. Muma (1963, 1966e, 1974a) discussed an apparently similar seasonal appearance of males before females in some North American species. The appearance of males before females supports the hypothesis that males may have one less instar than females. These data further suggest that adult male *M. picta* are short-lived; and die after a relatively brief mating period. This can be attributed to the high energy demands and low food intake observed during mate location (discussed below). Females may be longer-lived because of the time required for egg development and oviposition following mating. Supporting data for *M. picta*, however, is meager. A single field-collected female oviposited after one week in the laboratory, and died 2 weeks following oviposition.

Cloudsley-Thompson (1961b), Junqua (1962, 1966), and Muma (1963, 1966c) have also presented evidence suggesting adults are short-lived; and that solifuges

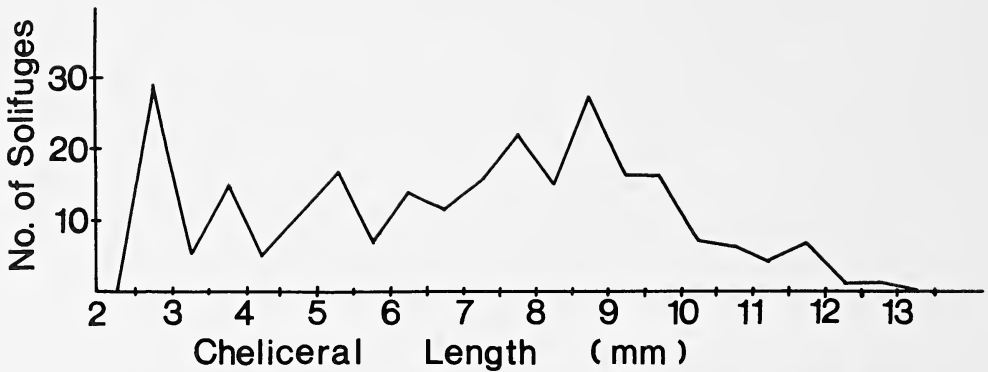

Fig. 2.—Size-frequency distribution for *Metasolpuga picta* (Kraepelin) chelicerae measured on solifuges collected from interdune valley habitat, 1/1979-1/1980 ($N = 257$). Includes solifuges from pitfall traps plus those collected by hand. Peaks at 2.8, 3.8, 5.3, and 6.3 mm suggest the presence of at least four nymphal instars between the first (immobile and spent in oviposition chamber) and the adults (starting at 7.2 mm). Peaks beyond 6.3 mm difficult to interpret because they represent mixtures of immatures and adults.

do not live more than one year. Junqua (1966) showed that male *O. saharae* lived for only about one week, but Muma (1966c) kept male *E. durangonus* alive for up to one month.

Burrowing.—Solifuge burrowing behavior has been described by several workers (Hutton 1843, Turner 1916, Hingston 1925, Junqua 1966, Muma 1966d, Cloudsley-Thompson 1977). Burrows are constructed for digestion, oviposition, ecdysis, hibernation, and retreats during inactive periods (Muma 1966d, Cloudsley-Thompson 1977). Solifuges also burrow as a displacement activity following disturbance (Cloudsley-Thompson 1961b).

Although solifuges studied elsewhere use rocks, logs, or other surface debris as shelters, or to conceal burrows, these were generally not present on the sandier substrates preferred by *M. picta*. The few large rocks available were not utilized by this species. Thus the generalization by Newlands (1978) that in southern Africa only hexisopodids occurred in sandy areas, and that members of other solifuge families sheltered under stones, does not hold for at least some Namib species. Otherwise, burrowing by *M. picta* was generally similar to that reported for other solifuge species.

Metasolpuga picta either excavated a new burrow or occupied an abandoned one at the end of each activity period. Although chelicerae are used extensively in burrowing by other solifuge species (as detailed in reviews by Muma 1966d and Cloudsley-Thompson 1977), they were utilized less readily by *M. picta*. Instead, the sandy soil was rapidly excavated primarily with the second pair of walking legs. As in other solifuges (Muma 1966d: 254), *M. picta* tossed soil out beneath the opisthosoma (in canine fashion) while excavating (Fig. 3). Chelicerae and the first pair of walking legs were used only rarely to loosen more compact soil particles. Chelicerae were also used to carry out larger pebbles during excavations. One adult male and two large immatures were each observed transporting pebbles weighing 0.6-0.7 gm. The pebbles weighed 2-5 times that of the solifuges (wet weight).

Position reversal within the tunnel during burrowing was accomplished with a simple turn rather than the more complicated operation described by Muma



Fig. 3.—*Metasolpuga picta* (Kraepelin) in the act of burrowing. From original kindly furnished by M. Seely.

(1966d) for several North American species. Plowing was accomplished by lowering the chelicerae onto the base of the accumulated refuse, and pushing the soil out of the hole. The palps and first pair of legs were held on either side of the pile. Burrow construction (total or partial) was observed in the field for 7 males, 9 females, and 4 immatures; and all excavated in this fashion. Burrow length ranged from 50-300 mm ($N = 13$), and angle of penetration about 30-70° from horizontal.

Solifuges plugged the entrance of overnight burrows with excavated sand 72.2% of the time ($N = 18$). All newly excavated burrows were plugged, but 62.5% of the solifuges occupying old, abandoned burrows ($N = 8$) left the entrance completely open. Both Turner (1916) and Cloudsley-Thompson (1961a) noted irregular plugging of burrows. Junqua (1966) and Muma (1966d), however, reported that burrows were regularly plugged.

Excavation of oviposition chambers by females differed from excavation of burrows used as overnight shelters. Of four females observed preparing oviposition chambers in the field, one completed the task in 25 min, but the others took at least 60 min. Muma (1966d) reported a similar range of burrowing times for both males and females of 4 North American species. Mean excavation time of *M. picta* overnight burrows, however, was only 7 min ($N = 5$).

Oviposition burrows were plugged much more thoroughly than overnight shelters, and it was difficult to trace them for measurements of burrow depth. Only three of the presumed oviposition burrows were successfully excavated, and these were 70, 120, and 170 mm deep. Mean vertical depth of overnight burrows was 54 mm ($N = 8$).

The dimensions of *M. picta* burrows compare favorably with those reported for most other solifuge species. Berland (1932) reported burrows of *Galeodes* up to 240 mm deep. Cloudsley-Thompson (1961a) described variation in burrow length of 100-200 mm. Muma (1966d) recorded burrow lengths of 6-54 mm for immatures and males, and 38-229 mm for females of 6 different species. Muma (1966d) also noted variation in length and depth of burrows used for egg deposition. Junqua (1966), however, reported a "remarkably constant" burrow configuration for *O. saharae* and a burrow length of about 80-90 mm.

Excavation of overnight shelters, as well as digging during prey and mate location (discussed below), was generally rapid. Thus the general conclusion by

Muma (1966d: 251) that solifuge "burrowing, although conducted with extreme vigor and activity, seems to be accomplished inefficiently and laboriously" is not appropriate for this species. In *M. picta*, there are six spatulate setae posteriorly on the second pair of walking legs. Most other members of the family Solpugidae have five apically pointed setae in this position. The spatulate setae are clearly adaptations to facilitate digging in sandy substrates.

Gore and Cushing (1980) concluded on the basis of four observations that males of a North American species normally returned to the same sheltered depressions for at least three consecutive nights to conserve energy. Unfortunately, the authors did not indicate whether the solifuges were marked to allow individual recognition or whether they were all given the same mark. Also, data on two of the four observed males (Gore and Cushing 1980: Table 1) may have been misinterpreted. In one case, only the depression was marked, rather than the solifuge, and the solifuge which occupied the depression on a subsequent day may not have been the same. In a second case, apparently two different individuals occupied a single depression on successive nights. In the case of *M. picta*, it is unnecessary to invoke homing as a means of conserving energy, since burrows abandoned by other arthropods and small vertebrates are plentiful, and readily occupied by this species.

Foraging.—Solifuges are extremely active, with most of their above-ground activity spent foraging or (in adult males) locating mates. Although Muma (1967) has interpreted much of their activity as simply "investigating their surroundings," I interpret such activity as typical foraging behavior in a cursorial predator.

Few field observations on solifuge foraging behavior have been made because species previously studied were nocturnal, and were difficult to follow in the dark. Diurnal solifuges in the Namib Desert were also difficult to observe because they were easily disturbed, extremely fast, and surprisingly cryptic.

Sixty-five *M. picta* were observed foraging in the field. Fifteen of these were followed continuously for at least 15 min each. Females and immatures searched the habitat by thoroughly covering the area in a rapid, zig-zag pattern. They probed all burrows, pebbles, and small pieces of detritus. Dead grass clumps and the few larger stones present in the study area were also thoroughly searched when encountered. However, nearly all of the foraging observed during this study occurred in the open. Actual distances covered by females and immatures during foraging generally could not be determined because of their rapid, zig-zag motion. However, seven individuals followed for periods ranging from 5-87 min traveled a mean straight-line distance of only 106.8 m/h. The single individual running more or less in a straight line traveled 978.9 m/h. This latter figure is comparable to velocities achieved by males.

Searching behavior of adult males differed from that of females and all immatures. Adult males traveled at nearly the same speed as females and immature, but rarely exhibited the intense, zig-zag searching behavior of the latter. They thus covered much greater straight-line distances (1062.1 ± 593.1 m/h; $N = 9$, range of observations, 5-100 min). When extensive searching of a limited area by males was observed, males searched in a more deliberate, circling pattern. Only two of 18 males found searching in the field searched in a zig-zag pattern for more than 10% of the observation time.

One immature with a body length of 13 mm was observed for 1.5 h on the gravel plain. It foraged mostly in the open, pawing at pebbles about a third its

body length or less. It used primarily the second pair of walking legs for digging, and the palps and the first pair of walking legs for perception. Although there were several dead grass clumps in the area being searched, the solifuge only foraged through one of these. The solifuge dug one burrow, but it collapsed shortly after the start of excavation. The solifuge also cleared the entrance to an abandoned burrow, and stayed within the tunnel for 4 min before resuming foraging. On four occasions, the solifuge stopped for 3 sec, then resumed foraging. The only other breaks in the foraging pattern occurred when four small invertebrates of undetermined identity were dug up from around four different pebbles and immediately fed upon. The solifuge covered an area of roughly 40 m² in 1.5 h. This foraging pattern was typical of all females and immatures observed, with variation limited to number of holes dug or occupied, number of feeding bouts or pauses unrelated to feeding, and amount of time spent around grass clumps.

Females and immatures fed, or attempted to feed, on every invertebrate encountered in the field. Males were observed feeding only twice, even though total observation time for males (5.5 h) was slightly more than that for females and immatures. Moreover, males on seven different occasions ran into potential prey (species eaten by similarly sized females or immatures) without attempting to feed on them.

Prey items were located primarily by direct contact (as detailed by Bolwig (1952)) during running, or while pawing around pebbles. Because of the frequency with which *M. picta* entered holes for short periods during foraging, it is possible that prey were also trapped and eaten in these holes. Field-captured prey of females and immatures were rarely identified because of their small size and the speed with which they were captured and ground up in the chelicerae. The single item positively identified was the tettigoniid *Comicus* sp.

Two of the nocturnal *Comicus* were excavated by a single solifuge. In each case, the solifuge dug three small holes 30 mm apart, with each hole about 30 mm from the cricket. The resulting pattern formed a square, with the cricket at one corner and excavations at the other three corners. The solifuge quickly alternated from one hole to the next, spending about 5 sec at each hole. At the first excavation site, the cricket emerged from its burrow 4 min after the solifuge began excavating, and jumped away. The solifuge pursued, but was unable to follow after two jumps of the tettigoniid. In the second excavation, the solifuge dug for 3 min, then ran immediately to the buried cricket and pulled it out of the sand with chelicerae and palps. The solifuge macerated the cricket for 15 sec, then carried it into a hole. The solifuge remained in the hole for 5 min before resuming foraging.

In both cases, there was no visible evidence of the cricket or its burrow on the surface of the soil. Thus, *M. picta* is capable of detecting prey other than visually or by direct contact. Muma (1966b) has discussed the interactions of sight, touch, and vibration in prey location by solifuges. Prey location is even more complex than this, however. Detection by means of a kairomone is possible, since the malleoli are chemoreceptors (Brownell and Farley 1974); and they touch the ground while the solifuge forages (Cloudsley-Thompson 1961a). Moreover, detection of sound waves through sandy soils has been shown to be an important method of prey detection in scorpions (Brownell 1977, Brownell and Farley 1979), and this method may be used by solifuges as well.

Caged *M. picta* ate all soft-bodied prey offered. These included termites (*Hodotermes mosambicus* (Hagen) and *Psammotermes allocerus* (Silvestri), mealworms (*Tenebrio molitor* L.), moths, roaches, and silverfish. Larger Coleoptera larvae were chewed apart at intersegmental membranes. Tips of the chelicerae were then used to scoop out soft parts from the otherwise intact exoskeleton. Numerous zophosine and two adesmiine Tenebrionidae were also fed upon in this fashion after head and prothorax had been severed from the rest of the body. In the field, only two encounters between adult beetles and *M. picta* were observed. In the first encounter, the solifuge picked up the beetle, but dropped it after one sec. In the second encounter, the solifuge touched the beetle with its palps, then ignored it. The hard exoskeleton of beetles and the normally rapid inspection of potential prey items by the solifuge would seem to preclude adult Coleoptera from being an important component of *M. picta*'s diet, even though this species is clearly capable of eating them.

Although Newlands (1978) stated that solifuges relied solely on the chelicerae to capture prey, *M. picta* occasionally brought prey to the chelicerae with the palps. Muma (1966b) has provided a good discussion of variation in the use of chelicerae and palps in prey capture.

The cheliceral teeth of male solifuges are often smaller, blunter, and/or less numerous than those of females and immatures of the same species. This is also true of *M. picta*. Reduced cheliceral teeth are correlated with reduced feeding by the males, and are also of benefit to the male during courtship (described below), since larger, sharper teeth might puncture the female opisthosoma during the massaging phase. The reduced cheliceral teeth and marginal interest in feeding support the hypothesis derived from phenological data that males are very short-lived.

Junqua (1966) accurately noted that potential prey of desert solifuges are often scarce, in part because solifuges feed largely on relatively soft-bodied invertebrates. Solifuges are also voracious predators (e. g. Hutton 1843, Bernard 1897, Heymons 1902, Turner 1916, Lawrence 1949, Cloudsley-Thompson 1958); and Muma (1966b) and Cloudsley-Thompson (1977) have reviewed their feeding habits. Extreme activity, voracious appetites, and widely dispersed prey (at least for desert species) are interrelated: to locate a sufficient quantity of food in a desert, solifuges must forage over large areas (or be highly specific such as some of the termitophilous species). By increasing foraging speed, they cover more territory per unit time, and therefore increase the probability of encountering prey. But increased foraging speed results in increased water loss, and is energy expensive. Therefore, to replenish energy stores used in foraging, solifuges must eat large quantities.

Opisthosomal Elevation.—Of the 15 solifuges observed foraging on the surface for more than 15 min, five frequently elevated the opisthosoma in scorpion-like fashion (Fig. 4), and one did so only rarely (3X in 1.7 h). The five which regularly exhibited this behavior were observed when ground surface temperatures were 55–60°C. Only three other *M. picta* were observed for more than 15 min at these temperatures. Although none raised the opisthosoma, two regularly stopped in the shade of grass clumps for 0.5–3.0 min periods.

Berland (1932), following Walter (1889), interpreted opisthosomal elevation as a defense reaction in the Galeodidae. Cloudsley-Thompson (1949) hypothesized that this behavior mimics scorpions, especially in some of the Rhagodidae.



Fig. 4.—Elevation of opisthosoma by *Metasolpuga picta* (Kraepelin) as an apparent thermoregulatory response. From original kindly furnished by C. K. Brain.

However, since the opisthosoma is the softest part of the body (easily punctured, for example, by insect mandibles), elevation may be as important in protection (Pocock 1898) as in mimicry.

In *M. picta*, opisthosomal elevation was observed only during activity at high ground surface temperatures, and never during flight or defense behavior (see description of predator avoidance below). I therefore interpret opisthosomal elevation as a thermoregulatory response. The scorpion *Opisthophthalmus latimanus* (Koch) also elevates the opisthosoma as an adaptation to heat stress (Alexander and Ewer 1958). Krakauer (1972) and Robinson and Robinson (1974) have also discussed this behavior in detail for the spider *Nephila clavipes* (Linnaeus). The predictions of Robinson and Robinson (1974) regarding complex thermoregulatory behavior for cryptic species at low latitudes fit well for *M. picta*.

Predator Avoidance and Predators.—*Metasolpuga picta* responded to vibrations and tactile stimuli, and was also visually oriented. Flight response consisted of traveling several meters at greatly increased speed, with chelicerae and prosoma usually angled toward the source of the disturbance. This was followed either by resumption of normal foraging behavior and speed or a sudden stop, depending on strength of stimulus. When motionless, *M. picta* was not readily detected in the field by the human eye from a distance ≥ 2 m. The orange propeltidium and chelicerae resembled the many orange pebbles in the interdune valley and gravel plain. The yellow and black pattern on the rest of the body broke up the outline, and thus contributed to the crypsis. Solifuges in the field exhibited flight responses to a hovering sarcophagid fly, a hunting wasp (bembicine Sphecidae), and to other solifuges as well as the author. However, flight response and crypsis are more logically adaptations to visually oriented predators, such as vertebrates, than to these other disturbances.

Gore and Cushing (1980) concluded that there was little evidence of natural predators of solifuges. However, a number of mammals (Bothma 1966, 1971, Smithers 1971, Viljoen and Davis 1973, Roer 1975, Bigalke 1978, Nel 1978), reptiles (Louw and Holm 1972, Haacke 1976, Robinson and Cunningham 1978, Holm and Scholtz 1980), and birds (Distant 1892, Willoughby 1971, Brain 1974, Brain and Brain 1977, Dixon 1981, Clark et al. 1983) are known to eat solifuges in southern Africa, and there is one report of a hymenopteran predator (Bristowe 1973). During the present study, one large sparassid (Araneae) was observed capturing and eating a male *M. picta*; and *M. picta* chelicerae were found in one Ludwig's bustard (*Otis ludwigii* Ruppell) dropping and several raptor pellets (= regurgitations).

Of 80 pellets collected from beneath one roost on the gravel plain (occupied primarily by a greater kestrel, *Falco rupicoloides* A. Smith), 43 contained *M. picta* chelicerae, or moveable cheliceral fingers probably belonging to *M. picta*. There was an average of 1.2 complete sets (one set per solifuge) per pellet. Four other raptor pellets, two from an interdune valley and two from the gravel plain, were collected during the study period. All four contained *M. picta* chelicerae, and averaged 5.2 cheliceral sets per pellet. Chelicerae of *M. picta* were not found in several cape fox (*Vulpes chama* (A. Smith)), black-backed jackal (*Canis mesomelas* Schreber), or lizard (*Meroleo cuneirostris* (Strauch), *Aporosaura anchietae* (Bocage), and *Mabuya occidentalis* (Peters)) droppings collected during this study. Thus, raptors may be the most important predators of larger solifuges active on the surface. This would help explain their visual sensitivity to objects moving overhead (such as the fly and wasp noted above). Predation of lethargic solifuges in subterranean burrows may also be important, but would be extremely difficult to document.

Ruggiero et al. (1979) studied the effects of certain prey characteristics on kestrel predatory behavior in a North American species. They found that the highest rates of attack were elicited by moving, familiar prey. Aberrant movement enhanced acceptability of familiar prey. They hypothesized that operation of these two factors should lead to selection for a uniform, immobile response in species which are heavily preyed upon. The quick flight and sudden stop of *M. picta* fits this model. Pianka and Pianka (1970) and Pianka (1971) have described similar escape responses for agamid lizards in sparsely vegetated habitats in Australia.

Mate Location.—Mate location may be summarized as follows: 1) male searches in a straight-line pattern; 2) female in burrow emits chemical or auditory cues; 3) male encounters cues, and switches from straight-line pattern to more intensive circular or criss-cross pattern; or, 3a) male directly encounters female on surface; 4) from step 3, male locates area directly above buried female and initiates digging; 5) female responds by coming to soil surface; 6) from steps 3a and 5, male touches female and jumps back; 7) male grabs female opisthosoma in his chelicerae.

Males of *M. picta* located conspecific females either by direct contact or by indirect detection through the soil surface. Five males were observed to detect females beneath the soil surface. In two of the encounters, different males successfully mated with the same female. In each case, the female was excavated at a spot showing no visible evidence of a burrow. The burrow opening which the female entered after the first mating was several centimeters away from the point of excavation by the second male. In the third encounter observed, a male

started excavating in an area where the soil was uneven (indicating recent burrowing), but with no visible burrow entrance. In all three cases, females came to the surface in response to the males' digging. Thus male digging may serve as a stimulus to the female rather than as an attempt to actually excavate her. In the fourth and fifth observations, males discovered open burrows occupied by females, and waited at the entrance until the females appeared.

Another five males detected females by direct encounter, while females were either excavating at the entrances of burrows or foraging. Only one of the encounters resulted in mating. This mating occurred after a male ran into a foraging female, then ran into her again a few minutes later as she was starting to dig a burrow. One additional mating was observed in the field, but the initial encounter was not witnessed.

The intense, zig-zag searching behavior of females is replaced in males by a pattern of long, straight-line runs. These long-distance runs (one male traveled 2 km in 1.7 h) were interrupted at intervals by intensive searching of restricted areas. Such searches were characterized by slow circling or pacing back and forth, rather than the high intensity zig-zagging of females and immatures. With one exception, these more restricted searches led to eventual discovery of females in burrows. The three females in closed-off burrows were located more quickly than those actively excavating.

Unreceptive females (including four of the five encountered while burrowing) exhibited three different responses. They often ignored males, continuing their foraging or burrowing without interruption. Alternatively, some exhibited a weak aggressive response towards the males. This consisted of raising the prosoma, extending the palps, and opening the chelicerae slightly. More rarely, burrowing females took one step towards the males before running back down the burrow for another load of soil.

Males which encountered unresponsive females in the act of burrowing remained at the burrow until the female closed off the entrance. Three such males remained for 47, 101, and 123 min before excavating their own overnight shelters. During these vigils, males usually stood near the entrance, with their palps overhanging the hole.

As in detection of concealed prey (described above), observations on mate location may be interpreted as evidence for either chemical or auditory cues (or both). If the malleoli are truly chemoreceptors (Brownell and Farley 1974), then their role in detection of a female pheromone is strongly suggested by their greater size in males. A single observation favors auditory over chemical cues: a searching male stopped in an area lacking a visible burrow or surface anomaly, and detected a large sparassid concealed within a trap-door covered tunnel. The solifuge exhibited none of the typical flight responses of disturbed *M. picta* when the spider sprang from its tunnel. Instead, the solifuge approached the spider with palps extended until direct contact was made. At this point, the sparassid pounced on the solifuge, killed it, and pulled it into its burrow. The sparassid was roughly the same size and shape as an adult *M. picta*, and the male solifuge exhibited the same behavior towards the sparassid as did other males encountering female *M. picta*. In this instance, the ability of the sparassid to mimic auditory stimuli of female *M. picta* can be explained by the similar size of these two burrowing arachnids. However, mimicry of chemical cues by the sparassid is also possible, and cannot be completely ruled out without further testing.

Males were unable to successfully pursue unresponsive females encountered on the soil surface, and lost them within seconds after the first encounter. Two males ran within 5 and 10 cm respectively of females burrowing and foraging on the surface without contacting them, and apparently without detecting them. One of these males, as well as a third one, ran by other females at least once before direct contact was made minutes later. These observations suggest that males of *M. picta* are unable readily to detect or follow females on the surface when passing within short distances of them, unless physical contact is actually made. Moreover, the sense used to locate mates (or prey) buried beneath the surface is apparently insufficient or at best inefficient for locating individuals on the surface in this species. These observations do not necessarily contradict the hypothesized role of vision in predator detection since the eyes are dorsally placed in solifuges, and much better adapted to detect motion from above, than laterally.

Mating.—Males initiated courtship by grabbing the posterior end of the female opisthosoma with their chelicerae, while touching the female prosoma and chelicerae with their palps. Females folded their legs up against their bodies, and their palps against their chelicerae, when grabbed in this fashion. Receptive females remained quiescent as the male thoroughly massaged the opisthosoma with his chelicerae. Males gradually worked forward onto the prosoma and female chelicerae. Unreceptive females began struggling as males moved anteriorly. In both observations on unreceptive females, females broke away, and males were unable to capture them. In the four successful matings observed, males massaged females in this fashion for 2.5 min. At the completion of the massaging phase, males were standing directly over females, both facing the same direction. Males held the females' legs and palps against their bodies (as described by Heymons (1902) and Junqua (1966)). Males then released a single spermatophore from the genital pouch at the base of the opisthosoma. Males next moved quickly backwards, used their chelicerae to pick up the spermatophore lying on the female's dorsum, lifted the female opisthosoma to a vertical position, and inserted the cheliceral tips and spermatophore directly into the female's genital opening. The flagellum was also inserted into the genital opening at this time. Although the flagellum in the family Solpugidae has an immovable base, the shaft is flexible. The shaft was held at a 45-90° angle from its resting position while inserted in the female's genital opening, but quickly returned to lie along the chelicerae after mating. Males held females in this position for 2.5-3.0 min. They used their palps (and to a lesser extent their first pair of legs) to hold the females; and constantly probed into the genital opening with the tips of the chelicerae. Females recovered from their torpor while in this position, and terminated mating by struggling free from the males. Total mating time was 5-6 min ($N = 3$). Two males ran off quickly after the female struggled free, but the other two remained in place. After mating, males wiped the tips of their chelicerae in the soil and flexed them for about 1 min before resuming a typical searching behavior. Two of the females re-entered burrows from which they emerged in response to males' digging stimuli, a third found and entered another burrow, and the fourth ran off.

Mating in solifuges has been described by Heymons (1902), Cloudsley-Thompson (1961b), Amitai et al. (1962), Junqua (1962, 1966), and Muma (1966c,e, 1967). All previous observations were limited to three genera in two families (Eremobatidae and Galeodidae). Detailed field observations were made only by Heymons (1902) and Junqua (1966).

Heymons (1902) and Junqua (1966) stressed the importance of the suddenness of the "attack" by the male in subduing the female (inducing torpor) and preventing her counter-attack. The reports by Amitai et al. (1962) and Muma (1966e, 1967) also suggest that the attack phase was critical. However, the females they studied were generally more passively subdued. In all species studied to date, including *M. picta*, both pedipalps and cheliceral massaging played a role in the initial phase of mating. Heymons (1902) and Junqua (1966) attempted to determine the relative importance of palps and chelicerae in mating, but were largely unsuccessful. Junqua (1966), however, was able to induce the catatonic state in receptive females with his fingertips, and Heymons (1902) by using forceps. Thus the submissive state in solifuges is produced mechanically, as a response to sudden attack. Heymons (1902) equated it to a similar phenomenon commonly seen in vertebrates. This state was also produced very briefly in two *M. picta* during initial rough handling when captured in the field.

Heymons (1902) stressed the importance of female receptivity on induction of torpor in *Galeodes*. Female receptivity was also important in *M. picta*, since males were unable to hold onto unreceptive females. A few observations (Junqua 1966, Wharton unpublished) suggest that torpor, once induced, was maintained even when the male was removed. Cloudsley-Thompson's observations on mating in *Galeodes granti* Pocock also suggest this. Thus, continued massaging during mating may not be necessary to maintain the torpid condition of the female.

In *M. picta* and the Galeodidae, chelicerae were used to massage the genital opening and to quickly transfer the spermatophore to the opening. Spermatophores were carried by only one chelicera in *Galeodes* (Amitai et al. 1962, Cloudsley-Thompson 1961b), and between both fixed cheliceral fingers in the galeodid *Othoes* (Junqua 1966). In the nocturnal or crepuscular galeodids, spermatophores were deposited, probably on the soil, while the female's abdomen was bent back over the prosoma. In *M. picta*, however, the spermatophore was deposited on the female's dorsum before her opisthosoma was pushed back over her head. This reflects either a basic difference between galeodids and solpugids, or a need to protect the spermatophore from the soil by the diurnal solpugid in response to high ground surface temperatures. In Eremobatidae, Muma (1966e) observed direct transfer of the spermatophore from the genital opening of the male to that of the female. Nevertheless, male eremobatids still massaged the area around the genital opening before and after transfer. This massaging may function in part in liberating the sperm from the spermatophore.

Mating was of approximately equal duration in all species studied thus far. Massaging of the female by the male chelicerae, especially after spermatophore transfer, was of longer duration in *M. picta* than in most other species. Recovery from torpor after spermatophore transfer was also longer in *M. picta* than in galeodids, but comparable to that in eremobatids. Heymons (1902), Amitai et al. (1962), Cloudsley-Thompson (1961b) and Junqua (1966) all reported at least some males picking up females with their chelicerae and carrying them about. This was not observed in *M. picta*.

Use of the flagellum has not been previously reported for any solifuge. Junqua (1966), in the most detailed study yet published on mating behavior, was unable to discern the function of this structure. Lamoral (1975) presented morphological evidence that the flagellum operates in storage and transmission of an exocrine secretion. Based on Lamoral's work, Cloudsley-Thompson (1977) suggested a role in "brief displays of territoriality among males during the mating season."

Male solifuges often have longer appendages than females of the same species. The longer legs and palps are correlated with the manipulation and containment of the female during mating, and also with the long-distance mate-searching behavior of the male.

Oviposition.—Actual oviposition by *M. picta* was observed only once. A female confined in a cage dug a deep burrow one week after capture. Construction of this burrow lasted several hours, and was similar to that described above for presumed oviposition burrows in the field. The female spent considerably more time packing soil to close off the burrow than she did during construction of overnight shelters. The female emerged from this oviposition chamber after 5 days, leaving 63 eggs behind. She then covered over her emergence hole. The female remained lethargic for nearly 2 weeks, did not feed, and did not return to the eggs. She then ate actively for one day before she died.

Oviposition in Solpugidae was previously observed by Lawrence (1947, 1949). He recorded the nocturnal *Zeria caffra* (Pocock) producing 192 eggs and *Z. hostilis* (White) 64 eggs. Muma (1966a) presented data for the Eremobatidae; and summarized findings for other Solifugae. He also noted that the number of eggs per mass was intraspecifically variable.

Confinement.—The effects of caging and temperature must be considered when interpreting solifuge behavior. This is particularly true for diurnal species such as *M. picta*. For caged *M. picta*, movement of the terrarium from a shaded laboratory into direct sunlight altered behavior. Solifuges which responded only weakly to tactile stimuli at 20-25°C in shaded cages usually responded quickly and aggressively to the same stimuli when cages were placed in the sun at 30-35°C.

Burrowing and feeding by *M. picta* was influenced by caged conditions. Unless the soil was of sufficient depth, quality, and compactness, burrows were not constructed efficiently, frequently collapsed, and often were not completed. Caged solifuges often huddled on the surface throughout the night instead of seeking shelter. Caged solifuges generally ate more than was available to them in the field per unit time. Moreover, heavily sclerotized invertebrates (such as many of the tenebrionids) were more readily eaten in cages than in the field. Ability or willingness to feed on adult beetles is directly related to continued contact in caged environments.

Mating behavior was also influenced by confinement, and especially by size of the arena. Field observations on *M. picta* suggest that males are generally able to flee from unreceptive females, or from females with which they had recently mated. When caged, however, fighting and resulting cannibalism are more common (e.g. Muma 1966b, Cloudsley-Thompson 1977). In confinement, males of *M. picta* were usually unable to approach females undetected, females generally exhibited more aggression towards males than in the field, and males were unable to flee from unresponsive females without constantly running into them again. Polis and Farley (1979) studied cannibalism-minimizing behavior during mating in the scorpion *Paruroctonus mesaensis* Stahnke. In the field, mating behavior in *M. picta* produces comparable results.

Construction of the oviposition chamber, incubation, and the maternal care observed by some workers (e.g. Hutton 1843, Lawrence 1949, Junqua 1966, Cloudsley-Thompson 1967) may be similarly affected by laboratory confinement. While maternal care in the Galeodidae is probable, it has not been observed in

Eremobatidae and Ammotrechidae (Turner 1916, Muma 1966a). Observations on *Z. caffra* (Lawrence 1949) and *M. picta* need to be supplemented to determine whether or not maternal care occurs in Solpugidae.

Muma (1966e, 1967) noted that caged individuals invariably reduced activity, became lethargic, and eventually died. He termed this behavior "taming"; and Cloudsley-Thompson (1977) has unfortunately followed this usage. This behavior would seem to be a natural result of confining any highly active animal. By greatly reducing the foraging area, and constantly offering food, the solifuge cannot balance energy expenditure with food intake. Moreover, contamination caused by increasing food and waste products in a confined area may also affect activity.

Since the great majority of published data on solifuge biology was obtained from caged individuals, behavioral comparisons must be made with caution. More field data are needed to verify and expand the limited biological information available from studies of caged individuals.

Distribution.—No attempts were made to determine the range of *M. picta*, but several predictions can be made, based on the above findings. Leg morphology (especially spatulate setae) and rapid burrowing behavior indicate that this species is limited to sandy substrates. The construction of discrete burrows, and *M. picta's* inability to burrow in loose sand, further restrict this species' activities to more compact soils (and thus to inerdune valleys rather than the loose sands of the Namib dune slopes). Distribution north of the Kuiseb River and east of the dune ecosystem should be fairly limited due to the harder substrates. Suitable sandy conditions exist along the coast, but cooler temperatures brought about by the Benguela Current may preclude activity there.

SUMMARY

Metasolpuga picta is a diurnal, bivoltine species active throughout most of the year on compact, sandy soils in the Namib Desert. Thermoregulatory capabilities are vital to species such as this which are active at high temperatures in habitats largely devoid of vegetational and mineralogical shelters; and this topic merits further investigation. Activity at high daytime temperatures is counterbalanced by lethargy induced by the same cooler temperatures (20-25°C) at which many nocturnal species are active. Feeding, burrowing, and mating behaviors are similar to those reported for other solifuge species, but there are some differences. The voracious nature of solifuges was generally confirmed, with the exception of adult males. Both prey and mates concealed beneath the surface can be detected by *M. picta*, but the mechanism for such detection is unknown. Differences were observed in the types of burrows constructed or occupied, with overnight shelters being constructed much more rapidly than previously reported for solifuge burrows. Mating was similar to that reported for galeodids, but use of the flagellum during mating has not been previously recorded. Its function is still uncertain since possible uses (rupture of spermatophore, destruction of sperm or spermatophores from previous matings, transport of spermatophore up oviduct) do not explain species specificity in flagellum configuration. The absence of the flagellum in certain solifuge families leaves its function even more difficult to explain. The effect of vertebrate predators on solifuge behavior needs to be more

thoroughly explored, especially for nocturnal species. Vertebrates, especially small raptors, are important predators of *M. picta*.

ACKNOWLEDGMENTS

The support of the C.S.I.R., Transvaal Museum, and staff of D.E.R.U. during my stay at Gobabeb is greatly appreciated. The Division of Nature Conservation and Tourism, South West Africa/Namibia, provided facilities and kindly granted permission to work in part of the Namib-Naukluft Park. I wish to thank C. K. Brain, W. Haacke, E. Holm, R. Lawrence, P. leRoux, W. Savary, M. Seely, R. Tilson, and H. Williams for discussions on various aspects of solifuge biology; and especially T. Friedlander, J. Roth, and an anonymous reviewer for supplying criticisms of an earlier draft. C. K. Brain and M. Seely also kindly granted permission to use their photographs. I am particularly grateful to F. von Blotnitz for translating some difficult German passages, and S. Bethune and M. Vandevallé for technical assistance. Much of this work could not have been completed without the able assistance of S. Falconer and V. Gray, and to them I am deeply indebted. Finally, I acknowledge my debt to previous workers, especially M. Muma and J. Cloudsley-Thompson, for providing a basis on which to work, and for helpful comments on the submitted draft.

LITERATURE CITED

- Alberti, G. 1979. Licht- und elektronenmikroskopische Untersuchungen an Coxaldruesen von Walzenspinnen (Arachnida: Solifugae). *Zool. Anz.*, 203:48-64.
- Alberti, G. 1980. Zur Feinstruktur des Hodenepithels und der Spermien von *Eusimonia mirabilis* Roewer 1934 (Solifugae, Arachnida). *Zool. Anz.*, 204:345-352.
- Alexander, A. J. and D. W. Ewer. 1958. Temperature adaptive behaviour in the scorpion, *Opisthophthalmus latimanus* Koch. *J. Expt. Biol.*, 35:349-359.
- Aliev, Sh. I. and A. T. Gadzhiev. 1983. Solpugids (Arachnida, Solifugae) in the Azerbaijan SSR. *Izv. Akad. Nauk Azerbaijan SSR, Ser. Biol.*, 4:43-46.
- Amitai, P., G. Levy, and A. Shulov. 1962. Observations on mating in solifugid *Galeodes sulfuripes* Roewer. *Bull. Res. Council Israel (B) Zool.*, 11:156-159.
- Andrewartha, H. G. and L. C. Birch. 1954. *The Distribution and Abundance of Animals*. University of Chicago Press, Chicago. 782 pp.
- Aruchami, M. and G. Sundara Rajulu. 1978. An investigation on the poison glands and the nature of the venom of *Rhagodes nigrocinctus* (Solifugae: Arachnida). *Nat. Acad. Sci. Letters (India)*, 1:191-192.
- Bauchhenss, E. 1983. Morphology and ultrastructure of sensilla ampullacea in Solifugae (Chelicerata: Arachnida). *Int. J. Insect Morphol. Embryol.*, 12:129-138.
- Berland, L. 1932. Les Arachnides. *Encycl. Entomol.*, (A) 16:33-43.
- Bernard, H. M. 1897. 'Wind scorpions', a brief account. *Sci. Prog.*, 1:317-343.
- Bigalke, R. 1978. Mammals. Pp. 981-1048. *In Biogeography and Ecology of Southern Africa*. (M. J. A. Werger and A. C. Van Bruggen, eds.). Dr. W. Junk B. V., The Hague.
- Bolwig, N. 1952. Observations on the behavior and mode of orientation of hunting Solifugae. *J. Entomol. Soc. Southern Africa*, 15:239-240.
- Bothma, J. du P. 1966. Food of the silver fox *Vulpes chama*. *Zool. Africana*, 2:205-210.
- Bothma, J. du P. 1971. Reports from the mammal research unit: 2. Food habits of some Carnivora (Mammalia) from Southern Africa. *Ann. Transvaal Mus.*, 27:15-26.
- Brain, C. K. 1974. The use of microfaunal remains as habitat indicators in the Namib. *South African Archeol. Soc. (Goodwin Ser.)*, 2:55-60.
- Brain, C. K. and V. Brain. 1977. Microfaunal remains from Mirabib: some evidence of palaeo-ecological changes in the Namib. *Madoqua*, 10:285-293.

- Bristowe, W. S. 1973. A new lycosid spider in the Seychelles and an endemic eumenid wasp which stores spiders. *Entomologist*, 106:220-222.
- Brownell, P. 1977. Compressional and surface waves in sand: used by desert scorpions to locate prey. *Science*, 197:479-481.
- Brownell, P. H. and R. C. Farley. 1974. The organization of the malleolar sensory system in the solpugid, *Chanbria* sp. *Tissue and Cell*, 6:471-485.
- Brownell, P. H. and R. D. Farley. 1979. Prey-localizing behavior of the nocturnal desert scorpion, *Paruroctonus mesaensis*: orientation to substrate vibrations. *Anim. Behav.*, 27:185-193.
- Clark, W. H., D. R. Frohlich, and P. L. Comanor. (1982) 1983. Shrike predation on the scorpion *Anuroctonus phaidactylus* (Wood) and on a solpugid (Scorpionida: Vaejovidae; Solpugida). *Pan-Pacific Entomol.*, 58:164.
- Cloudsley-Thompson, J. L. 1949. Notes on Arachnida, 9. Do Solifugae mimic scorpions? *Entomol. Monthly Mag.*, 85:47.
- Cloudsley-Thompson, J. L. 1958. Spiders, Scorpions, Centipedes, and Mites. Pp. 87-98 (revised ed., 1968, pp. 105-123). Pergamon, Oxford. 228 pp.
- Cloudsley-Thompson, J. L. 1961a. Some aspects of the physiology and behavior of *Galeodes arabs*. *Entomol. Exp. Appl.*, 4:257-263.
- Cloudsley-Thompson, J. L. 1961b. Observations on the natural history of the "camel-spider" *Galeodes arabs* C. L. Koch (Solifugae: Galeodidae) in the Sudan. *Entomol. Monthly Mag.*, 97:145-152.
- Cloudsley-Thompson, J. L. 1967. Reproduction in Solifugae. *Entomol. Monthly Mag.*, 103:144.
- Cloudsley-Thompson, J. L. 1977. Adaptational biology of the Solifugae (Solpugida). *Bull. British Arachol. Soc.*, 4:61-71.
- Distant, W. L. 1892. Are the Solpugidae poisonous? *Nature*, 46:247.
- Dixon, J. E. W. 1981. Diet of the owl *Glaucidium perlatum* in the Etosha National Park. *Madoqua*, 12:267-268.
- Francke, O. F. and W. D. Sissom. 1984. Comparative review of the methods used to determine the number of molts to maturity in scorpions (Arachnida), with analysis of the post-birth development of *Vaejovis coahuilae* Williams (Vaejovidae). *J. Arachnol.*, 12:1-20.
- Gore, J. A. and B. S. Cushing. 1980. Observations on temporary foraging areas and burrows of the sun spider, *Ammotrechula penninsulana* (Banks) (Arachnida: Solpugida). *Southwest. Nat.*, 25:95-102.
- Haacke, W. 1976. The burrowing geckos of Southern Africa, 2 (Reptilia: Gekkonidae). *Ann. Transvaal Mus.*, 30:13-28.
- Haupt, J. 1982. Hair regeneration in a solfugid chemotactile sensillum during molting (Arachnida: Solifugae). *Wilhelm Roux's Arch. dev. Biol.*, 191:137-142.
- Heymons, R. 1902. Biologische Beobachtungen an asiatischen Solifugen. *Abh. Preussischen Akad. Wiss.*, 190:1-65.
- Hingston, R. W. 1925. Nature at the Desert's Edge; Studies and Observations in the Bagdad Oasis. Whitherby, London. 299 pp.
- Holm, E. and E. B. Edney. 1973. Daily activity of Namib Desert arthropods in relation to climate. *Ecology*, 54:45-56.
- Holm, E. and C. H. Scholtz. 1980. Structure and pattern of the Namib Desert dune ecosystem at Gobabeb. *Madoqua*, 12:5-39.
- Hutton, T. 1843. Observations on the habits of a large species of *Galeodes*. *Ann. Mag. Nat. Hist.*, 12:81-85.
- Junqua, C. 1962. Donnes sur la reproduction d'un solifuge: *Othoes saharae* Panouse. *C. R. Acad. Sci., Paris*, 225:2673-2675.
- Junqua, C. 1966. Recherches biologiques et histophysiologiques sur un solifuge Saharien *Othoes saharae* Panouse. *Mem. Mus. Natn. Hist. Nat., Paris (A)*, 43:1-124.
- Kraepelin, K. 1899. Zur Systematik der Solifugen. *Mitt. Naturh. Mus. Hamburg*, 16:187-259.
- Krakauer, T. 1972. Thermal responses of the orb-weaving spider *Nephila clavipes* (Araneae: Argiopidae). *Amer. Midland Nat.*, 88:245-250.
- Lamoral, B. H. 1975. The structure and possible function of the flagellum in four species of male solifuges of the family Solpugidae. *Proc. 6th Int. Congr. Arachnol.*, pp. 136-141.
- Lawrence, R. F. 1947. Some observations on the eggs and newly hatched embryos of *Solpuga hostilis* White (Arachnida). *Proc. Zool. Soc. London*, 117:429-434.
- Lawrence, R. F. 1949. Observations on the habits of a female solifuge, *Solpuga caffra* Pocock. *Ann. Transvaal Mus.*, 21:197-200.

- Lawrence, R. F. 1963. The Solifugae of South West Africa. *Cimbebasia*, 8:1-28.
- Lawrence, R. F. 1965. New and little known Arachnida from the Namib Desert, S. W. Africa. *Sci. Papers Namib Desert Res. Stn.*, 27:1-12.
- Lawrence, R. F. 1967. Additions to the fauna of South West Africa: solifuges, scorpions and Pedipalpi. *Sci. Papers Namib Desert Res. Stn.*, 34:1-19.
- Louw, G. N. and E. Holm. 1972. Physiological, morphological and behavioural adaptations of the ultrapsammophilous Namib Desert lizard, *Aporosaura anchietae* (Bocage). *Madoqua*, (II)1:67-85.
- Muma, M. H. 1963. Solpugida of the Nevada Test Site. *Sci. Bull. Brigham Young Univ. (Biol. Ser.)*, 3:1-13.
- Muma, M. H. 1966a. Egg deposition and incubation for *Eremobates durangonus* with notes on the eggs of other species of Eremobatidae (Arachnida: Solpugida). *Florida Entomol.*, 49:23-31.
- Muma, M. H. 1966b. Feeding behavior of North American Solpugida (Arachnida). *Florida Entomol.*, 49:199-216.
- Muma, M. H. 1966c. The life cycle of *Eremobates durangonus* (Arachnida: Solpugida). *Florida Entomol.*, 49:233-242.
- Muma, M. H. 1966d. Burrowing habits of North American Solpugida (Arachnida). *Psyche*, 73:251-260.
- Muma, M. H. 1966e. Mating behavior in the solpugid genus *Eremobates* Banks. *Anim. Behav.*, 14:346-350.
- Muma, M. H. 1967. Basic behavior of North American Solpugida. *Florida Entomol.*, 50:115-123.
- Muma, M. H. 1974a. Maturity and reproductive isolation of common solpugids in North American deserts. *J. Arachnol.*, 2:5-10.
- Muma, M. H. 1974b. Solpugid populations in southwestern New Mexico. *Florida Entomol.*, 57:385-392.
- Muma, M. H. 1975a. Two vernal ground-surface arachnid populations in Tularosa Basin, New Mexico. *Southwest. Nat.*, 20:55-67.
- Muma, M. H. 1975b. Long term can trapping for population analyses of ground-surface, arid-land arachnids. *Florida Entomol.*, 58:257-270.
- Muma, M. H. 1979. Arid-grassland solpugid population variations in southwestern New Mexico USA. *Florida Entomol.*, 62:320-328.
- Muma, M. H. 1980a. Comparison of three methods for estimating solpugid (Arachnida) populations. *J. Arachnol.*, 8:267-270.
- Muma, M. H. 1980b. Solpugid (Arachnida) populations in a creosotebush vs. a mixed plant association. *Southwest. Nat.*, 25:129-136.
- Nel, J. A. J. 1978. Notes on the food and foraging behavior of the bat-eared fox, *Otocyon megalotis*. *Bull. Carnegie Mus.*, 6:132-137.
- Newlands, J. 1978. Arachnida (except Acari). Pp. 685-702, *In Biogeography and Ecology of Southern Africa*. (M. J. A. Werger and A. C. Van Bruggen, eds.). Dr. W. Junk B. V., The Hague, 1439 pp.
- Nichols, J. D., W. Conley, B. Batt, and A. Tipton. 1976. Temporally dynamic reproductive strategies and the concept of r- and K- selection. *Amer. Nat.*, 110:995-1005.
- Pianka, E. R. 1971. Ecology of the agamid lizard *Amphibolurus isolepis* in Western Australia. *Copeia*, 1971:527-536.
- Pianka, E. R. and H. D. Pianka. 1970. The ecology of *Moloch horridus* (Lacertilia: Agamidae) in Western Australia. *Copeia*, 1970:90-103.
- Pocock, R. I. 1898. On the nature and habits of Pliny's Solpuga. *Nature*, 57:618-620.
- Polis, G. A. and R. D. Farley. 1979. Behavior and ecology of mating in the cannibalistic scorpion, *Paruroctonus mesaensis* Stahnke (Scorpionida: Vaejovidae). *J. Arachnol.*, 7:33-46.
- Purcell, W. F. 1899. New and little known South African Solifugae in the collection of the South African Museum. *Ann. South African Mus.*, 1:381-432.
- Robinson, M. D. and A. B. Cunningham. 1978. Comparative diet of two Namib Desert sand lizards (Lacertidae). *Madoqua*, 11:41-53.
- Robinson, M. D. and M. K. Seely. 1980. Physical and biotic environments of the southern Namib dune ecosystem. *J. Arid Environ.*, 3:183-203.
- Robinson, M. H. and B. C. Robinson. 1974. Adaptive complexity: the thermoregulatory posture of the golden-web spider, *Nephila clavipes*, at low latitudes. *Amer. Midland Nat.*, 92:386-396.
- Roer, H. 1975. Zur Kenntnis der Chiropterenfauna Suedwestafrikas. *J. South West Africa Sci. Soc.*, 29:105-127.

- Ruggiero, L. F., C. D. Cheney, and F. F. Knowlton. 1979. Interacting prey characteristic effects on kestrel predatory behavior. *Amer. Nat.*, 113:749-757.
- Savory, T. 1977. *Arachnida* (2nd ed.). Academic Press, London, New York, San Francisco. 340 pp.
- Schulze, B. R. 1969. The climate of Gobabeb. *Sci. Papers Namib Desert Res. Stn.*, 37:5-12.
- Seely, M. K. and G. N. Louw. 1980. First approximation of the effects of rainfall on the ecology and energetics of a Namib Desert dune ecosystem. *J. Arid Environ.*, 3:25-54.
- Smithers, R. H. N. 1971. The mammals of Botswana. *Mem. Mus. Nat. Hist. Rhodesia.*, 4:1-340.
- Thaler, K. 1982. Die Primaerlarve der Walzenspinne *Gylippus* cf. *cypriotica* Lawrence (Arachnida, Solifugae, Karschiidae). *Mitt. schweizerischen entomol. Ges.*, 55:93-95.
- Turner, C. H. 1916. Notes on the feeding behavior and oviposition of a captive American false spider. *J. Anim. Behav.*, 6:160-168.
- Viljoen, S. and D. H. S. Davis. 1973. Notes on stomach contents analyses of various carnivores in Southern Africa (Mammalia: Carnivora). *Ann. Transvaal Mus.*, 28:353-363.
- Walter, A. 1889. Transcaspische Galeodiden. *Zool. Jb. (Syst.)*, 4:1094-1109.
- Wharton, R. A. 1981. Namibian Solifugae (Arachnida). *Cimbebasia Mem.*, 5:1-87.
- Wharton, R. A. and M. Seely. 1982. Species composition and biological notes on Tenebrionidae of the lower Kuiseb River and adjacent gravel plain. *Madoqua*, 13:5-25.
- Willoughby, E. J. 1971. Biology of larks (Aves: Alaudidae) in the Central Namib Desert. *Zool. Africana*, 6:133-176.

Manuscript received January 1986, revised March 1986.

GENETIC DIFFERENTIATION IN THE GENUS *PHIDIPPUS* (ARANEAE, SALTICIDAE)¹

A. C. Terranova and S. H. Roach

Cotton Production Research Unit
Agricultural Research Service
U.S. Department of Agriculture
P.O. Box 2131
Florence, South Carolina 29503

ABSTRACT

Electromorph profiles of seven *Phidippus* species found in South Carolina were compiled by acrylamide gel electrophoresis. Twelve gene loci from 10 enzymes were analyzed. Mean heterozygosity of the seven species populations was 0.117 with an average proportion of polymorphic loci of 0.416. The mean genetic distance of all spider populations was 0.56 ± 0.04 . *P. otiosus* (Hentz) and *P. regius* C. L. Koch were more closely related to each other ($I = 0.781$) than were any other pair of jumping spiders.

INTRODUCTION

Roach and Edwards (1984) reported the occurrence of seven species of *Phidippus* in South Carolina, and Terranova and Roach (1987) developed an electrophoretic key to identify these seven species in both immature and adult forms.

In a partial revision of the genus *Phidippus*, Edwards (1980) divided the genus into two subgenera. One subgenus contains the South Carolina species *Phidippus putnami* (Peckham and Peckham), and the other subgenus contains all other species observed in South Carolina.

According to the classification of Edwards (1980), *P. whitmani* Peckham and Peckham and *P. clarus* Keyserling belong to the *cardinalis* group. *P. audax* (Hentz), *P. otiosus* (Hentz) and *P. regius* C. L. Koch belong to the *audax* group, and *P. princeps* Peckham and Peckham belongs to the *princeps* group which Edwards (1980) states may be related to the *audax* group.

Edwards (1980) presented a cladogram of phylogenetic relationships among these seven species of *Phidippus* and others not reported from South Carolina based primarily on morphological characters. He further presented evidence of courtship relationships which supported his revised classification scheme (Edwards 1980).

In this report, we present information to elucidate the genetic relationships among the seven members of South Carolina *Phidippus*. This information is

¹In cooperation with the South Carolina Agricultural Experiment Station. Mention of a commercial or proprietary product does not constitute endorsement by the USDA.

Table 1.—Enzyme systems studied and their polymorphic (P) or monomorphic (M) status in one or all species of *Phidippus*. Presumed subunit structure of observed electromorphs is indicated.

Enzyme	Enzyme commission number	Abbreviation and locus	Polymorphic (P)	Subunit ^a no.
			or monomorphic (M)	
Aspartate aminotransferase	2.6.1.1	Aat-1	P	2
Amylase	3.2.1.1	Amy-1	P	1
Fumarase	4.2.1.2	Fum-1	M?	?
α -Glycerophosphate dehydrogenase	1.1.1.8	α -Gpd-1	P	?
Isocitrate dehydrogenase	1.1.1.42	Idh-1	P	2
		Idh-2	P	2
Malate dehydrogenase	1.1.1.37	Mdh-1	P	2
		Mdh-2	P	2
Phosphoglucose isomerase	5.3.1.9	Pgi-1	P	2
Phosphoglucomutase	2.7.5.1	Pgm-1	P	1
Superoxide dismutase	1.15.1.1	Sod-1	M	?
Tyrosinase	1.10.3.1	Tyr-1	P	1

^a1 = Monomeric protein; 2 = dimeric proteins.

derived from the patterns of genetic variability at 12 presumptive gene loci in each *Phidippus*. The techniques of polyacrylamide gel electrophoresis and isozyme detection were used to obtain this information.

METHODS

Spiders used in these studies were either field-collected *Phidippus* mainly from eastern South Carolina or progeny obtained from laboratory-reared spiders. The species *P. audax*, *P. clarus*, and *P. princeps* occurred widely and were fairly abundant, whereas *P. otiosus*, *P. putnami*, *P. regius*, and *P. whitmani* were rarely collected due to their scarcity or their habitat specificity.

The electrophoretic techniques and the isozyme staining techniques used have been previously described (Terranova 1978, 1980, 1981a,b). A total of 12 gene loci represented by 10 enzyme systems were studied in every species in which they were present (Table 1).

Analysis of electrophoretic data was accomplished using program GELDAT (Terranova and Smith unpub.). Population statistics and dendograms were based on Ferguson (1980). Genetic divergence between species was determined by the genetic similarity (I) and genetic distance (D) statistics of Nei (1972). Similarity values (I) are a measure of the proportion of loci at which the allelic constituents of two populations are essentially identical. Similarity values range from zero (no identity) to one (complete identity). Genetic distance (D) values estimate the effective number of complete allelic substitutions per locus which have accumulated since any two populations diverged from a common ancestor.

RESULTS

The data presented in Table 2 show that the percent of polymorphic loci ranges from 16.7% in *P. putnami* to 58.3% in *P. audax*, *P. clarus*, and *P. whitmani* with

Table 2.—Levels of genetic variation in seven *Phidippus* species observed in South Carolina.

Species	Individuals sampled	Mean % \pm S.E. heterozygotes expected per locus	Percent polymorphic loci ^a	Mean no. alleles per locus
<i>P. audax</i>	58	17.2 \pm 5.0	58.3	1.83
<i>P. clarus</i>	38	11.8 \pm 4.3	58.3	1.83
<i>P. otiosus</i>	11	6.1 \pm 3.9	25.0	1.33
<i>P. princeps</i>	33	17.3 \pm 5.7	50.0	1.75
<i>P. putnami</i>	7	5.9 \pm 4.3	16.7	1.17
<i>P. regius</i>	21	4.7 \pm 3.3	25.0	1.25
<i>P. whitmani</i>	10	17.9 \pm 5.1	58.3	1.75

^aFrequency of the most common allele ≤ 0.99 .

an average for all seven species of 41.6% out of 12 loci. The expected mean frequency of heterozygous individuals per locus ranges from 4.7% in *P. regius* to 17.9% in *P. whitmani*, and the average for the genus is $11.7 \pm 4.5\%$. The lower percent of heterozygotes per locus observed in the species *P. otiosus*, *P. putnami*, and *P. regius* as compared to the remaining species is probably due to the small number of field-collected spiders. For example, the low heterozygosity observed in *P. regius* is more than likely the result of most specimens belonging to the same family. In this case, only one wild adult was ever found. The remaining specimens were collected as spiderlings, presumably from the same mother. The electromorph [= allele, see Berlocher (1980) for discussion] frequencies at the 12 genetic loci as shown in Table 3.

The levels of genetic variation found in the genus *Phidippus* compared to other invertebrates show that they are characteristic of invertebrates in general. The data presented by Ferguson (1980) show a mean percent polymorphism of 51% and a mean percent heterozygosity of 15.5% for a wide assortment of invertebrates compared to 41% and 11.7%, respectively, for *Phidippus*.

Estimates of genetic similarity (I) and genetic distance (D) between all species pairs are given in Table 4. Genetic distance ranges from 0.247 for *P. regius* vs. *P. otiosus* to 0.846 for *P. princeps* vs. *P. putnami* with an average value of D for all pair-wise comparisons of 0.56 ± 0.04 . Thus, on average, about 0.56 electrophoretically detectable electromorphic substitutions per locus have occurred in the separate evolutions of any two species.

Figure 1 shows the distribution of genetic similarities among loci. Generally, pairs of species are essentially identical ($I = \leq 0.95$) at nearly 52% of the loci and completely different ($I = \leq 0.005$) at about 32% of the loci, and few loci have genetic similarities in the broad range between 0.05 and 0.95. Again, our data correlate nicely with those reported for other invertebrate species (e.g. *Drosophila willistoni* group; Ayala et al. 1974a,b). Ferguson (1980) comments that this U-shaped distribution may be representative of most outcrossing sexual organisms. Among others, Ferguson (1980) and Avise and Ayala (1976) state that the significance of this bimodality of distribution is that for a given locus, any two species are either identical in electromorphic composition or completely distinct with unique electromorphs. This is important from a systematist's point of view in that it is not essential to sample many individuals at each locus since electromorphic frequency differences are not an important feature of interspecific studies (Ferguson 1980).

Table 3.—Frequencies of electromorphs in seven species of *Phidippus*.

Gene &	electro- morph	Species						
		<i>audax</i>	<i>clarus</i>	<i>otiosus</i>	<i>princeps</i>	<i>putnami</i>	<i>regius</i>	<i>whitmani</i>
Aat-1	36	-	0.013	-	-	-	-	-
	46	0.053	-	-	-	-	-	-
	55	0.947	0.987	1.000	1.000	1.000	1.000	1.000
Amy-1	23	-	0.048	-	-	-	-	-
	30	-	0.077	-	-	-	-	-
	34	-	-	0.667	-	-	-	-
	36	0.121	-	-	-	-	-	-
	40	-	0.712	0.208	0.204	-	0.976	0.182
	45	0.638	0.067	0.125	0.278	1.000	0.024	0.500
	50	0.233	-	-	0.315	-	-	0.273
	55	-	0.096	-	0.093	-	-	-
	58	0.009	-	-	-	-	-	-
Fum-1	63	-	-	-	0.111	-	-	0.045
	55	-	1.000	1.000	1.000	-	-	-
	58	1.000	-	-	-	1.000	1.000	1.000
ldh-1	38	0.588	0.900	-	0.222	-	-	0.786
	50	0.412	0.100	1.000	0.778	1.000	1.000	0.214
ldh-2	55	0.921	1.000	1.000	0.852	1.000	1.000	0.938
	65	0.079	-	-	0.148	-	-	0.063
α -Gpd-1	116	-	-	-	0.256	-	-	0.167
	120	1.000	-	-	-	-	-	-
	124	-	1.000	1.000	0.750	-	1.000	0.917
	129	-	-	-	-	1.000	-	0.083
Mdh-1	21	-	0.056	0.062	-	-	-	-
	25	0.589	-	-	-	0.429	-	-
	30	-	0.944	-	-	0.571	-	-
	35	0.411	-	0.938	1.000	-	0.700	1.000
	43	-	-	-	-	-	0.300	-
Mdh-2	123	0.905	0.941	0.938	0.950	0.786	0.900	0.836
	143	0.095	0.059	0.062	0.050	0.214	0.100	0.164
Pgm-1	65	-	-	-	1.000	-	-	0.600
	70	1.000	0.067	1.000	-	1.000	1.000	0.400
	76	-	0.333	-	-	-	-	-
Pgi-1	45	-	0.041	-	0.147	-	-	-
	55	1.000	0.959	1.000	0.853	1.000	1.000	-
	60	-	-	-	-	-	-	0.143
Sod-1	134	-	-	1.000	-	-	-	-
	138	-	-	-	-	-	1.000	-
	143	-	-	-	-	1.000	-	-
	156	-	1.000	-	1.000	-	-	-
	159	1.000	-	-	-	-	-	1.000
Tyr-1	27	0.066	-	-	-	-	-	-
	33	0.920	1.000	-	-	-	-	-
	37	-	-	-	-	1.000	-	-
	44	0.020	-	1.000	1.000	-	1.000	1.000

In order to more easily visualize the information in Table 4, we evaluated the data by an agglomerative clustering procedure, the unweighted pair-group method with arithmetic means (UPGMA, Sneath and Sokal 1973). The resultant dendrogram is presented in Figure 2. The relationship based on the biochemical similarities between *Phidippus* species are discussed in relation to the interpretations of Edwards (1980).

Table 4.—Matrix of genetic distance (above diagonal) and genetic similarities (below diagonal) between species in *Phidippus* based on 12 loci. Distances and similarities calculated using the method of Nei (1972).

Species	Species						
	<i>audax</i>	<i>clarus</i>	<i>otiosus</i>	<i>princeps</i>	<i>putnami</i>	<i>regius</i>	<i>whitmani</i>
<i>P. audax</i>	-	0.558	0.633	0.771	0.423	0.672	0.443
<i>P. clarus</i>	0.573	-	0.480	0.416	0.763	0.726	0.752
<i>P. otiosus</i>	0.531	0.619	-	0.261	0.647	0.247	0.502
<i>P. princeps</i>	0.463	0.660	0.770	-	0.846	0.416	0.402
<i>P. putnami</i>	0.655	0.466	0.524	0.429	-	0.672	0.829
<i>P. regius</i>	0.511	0.484	0.781	0.659	0.511	-	0.301
<i>P. whitmani</i>	0.642	0.471	0.606	0.669	0.437	0.740	-

DISCUSSION

The cladogram presented by Edwards (1980) depicting hypothetical phylogenies of the *Phidippus* species was constructed utilizing morphological characters considered primitive or derived. His observations on the overall courtship behaviors of *Phidippus* proved to be a good indicator of these phylogenetic relationships (Edwards 1980).

Both the cladogram of Edwards, based on morphological characters, and our dendrogram based on biochemical electromorph differences agree in one important aspect; that of the relationship between *P. otiosus* and *P. regius*.

Edwards (1980) stated that the two species, *P. otiosus* and *P. regius*, appeared to be closely related, and further, that *P. otiosus* is assumed to be the parent species because it is hypothesized that *P. regius* evolved as an isolated population on islands formed when the Florida peninsula was partially submerged during

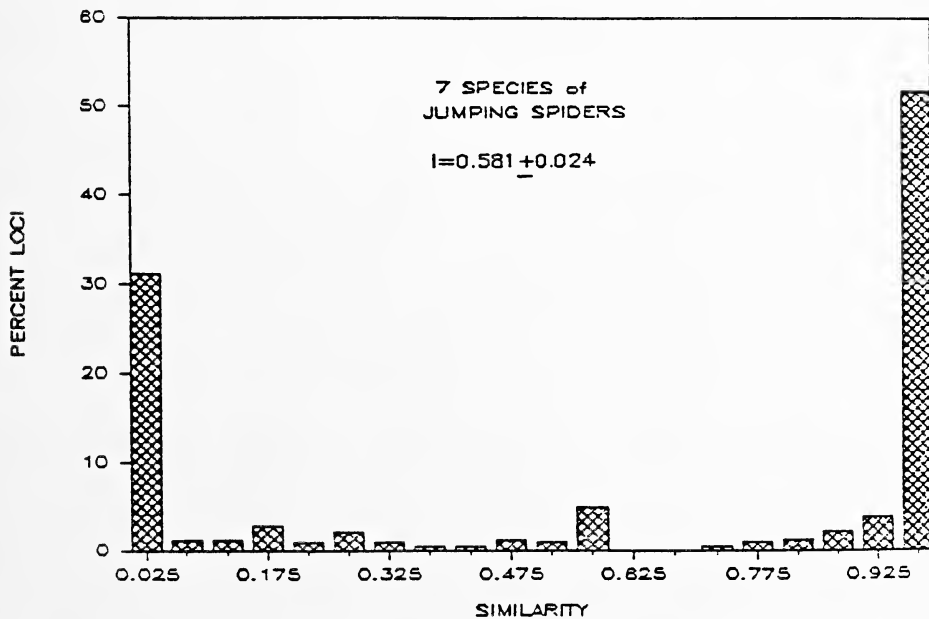
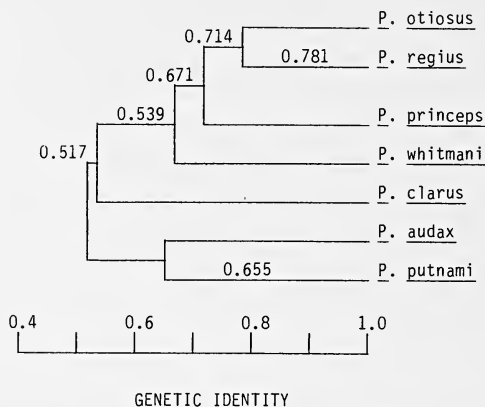

Fig. 1.—Percentage of loci within a given range of genetic similarity values in the comparisons among seven species of South Carolina *Phidippus*.

Fig. 2.—Dendrogram of South Carolina *Phidippus* based on the unweighted pair group method with arithmetic mean (UPGMA). Scale is in units of genetic identity, I.



prehistoric times. He based these assumptions on morphological similarities, and on field and laboratory observations. Morphologically, the basic structure of body markings and the genitalia are similar in both species, but the color patterns are different. The ranges of both species overlap greatly, and both species have been observed sharing the same ecological niche. The most convincing evidence presented by Edwards (1980), however, is the fact that hybridization attempts between *P. otiosus* males \times *P. regius* females were successful in the laboratory and produced viable young. Edwards (1980) also collected apparent hybrids in xeric woods habitat, and he recorded that a colleague, Dr. John F. Anderson, collected a male *P. otiosus* in copula with a female *P. regius*, 19 September 1980 (Edwards 1980).

Our results support Edwards' hypothesis that these two species are closely related. From the paired comparisons of Table 4, these two species show the least overall genetic divergence ($D = 0.247$) and the most overall genetic identity ($I = 0.781$). Thus, about 24.7 electrophoretically detectable electromorphic substitutes per 100 loci have occurred between *P. otiosus* and *P. regius* as compared to 84.6 between *P. princeps* and *P. putnami* or compared to an average of 56 substitutions per 100 loci in the evolution of the genus as a whole. These results compare favorably with other surveys in which hybridizing species are completely distinct in allelic composition at almost one third to one half of their loci (Avice 1974).

These results are interesting when looked at in light of Edwards' (1980) discussion on hybridization in which he states that hybridization was successful between *P. otiosus* and *P. regius* from a similar part of their range (northern peninsular Florida), but unsuccessful when attempts to hybridize the same two species were made with individuals from widely separated sources. A thorough study of these two species throughout their ranges by isozyme analysis and hybridization studies could reveal a number of significant factors concerning their evolution.

Other similarities between the cladogram of Edwards (1980) and our dendrogram exist. Edwards states that the courtship behavior of *P. clarus* has more in common with the *audax* group than to its apparent morphological relatives in the *cardinalis* group. The relationship of *P. clarus* to *P. otiosus* and *P. regius* in our data would tend to substantiate this in that the latter two species are classified by Edwards as belonging to the *audax* group. Our data, like Edwards', also show that *P. clarus* and *P. whitmani* are related. However, our

data differ from Edwards' in that *P. audax* is more distantly related to the previously named species. *P. princeps* is apparently more related to the *P. witmani*, *P. otiosus*, *P. regius* group than to *P. audax*. This would concur with Edwards' premise that *P. princeps* may be related to the *audax* group. Our data also differ from Edwards' in that *P. putnami* is also distantly related to *P. audax*.

Overall, our results fit the classification of Edwards with the exception of *P. audax*. By including other congeneric species, a more certain phylogeny is possible for the genus *Phidippus*, as has been shown with other invertebrate groups. In *Drosophila* for example, Nair et al. (1971), Yang et al. (1972), Lakovaara et al. (1972) found agreement between similarity based on classical systematic criteria, and those based on electrophoretic data. Avise (1974) concluded that attempts to utilize electrophoretic data for classifying closely related species would appear justified.

LITERATURE CITED

- Avise, J. C. 1974. Systematic value of electrophoretic data. *Syst. Zool.*, 23:465-481.
- Avise, J. C., and F. J. Ayala. 1976. Genetic differentiation in speciose versus depauperate phylids: evidence from the California minnows. *Evolution*, 30:46-58.
- Ayala, F. J., M. L. Tracey, L. G. Barr, J. F. McDonald, and S. Perez-Salas. 1974a. Genetic variation in natural populations of five *Drosophila* species and the hypothesis of the selective neutrality of protein polymorphism. *Genetics*, 77:343-384.
- Ayala, F. J., M. L. Tracey, D. Hedgecock, and R. C. Richmond. 1974b. Genetic differentiation during the speciation process in *Drosophila*. *Evolution*, 28:576-592.
- Berlocher, S. H. 1980. An electrophoretic key for distinguishing species of the genus *Rhagoletis* (Diptera: Tephritidae) as larvae, pupae, or adults. *Ann. Entomol. Soc. Amer.*, 73:131-137.
- Edwards, G. B. 1980. Taxonomy, ethology, and ecology of *Phidippus* (Araneae: Salticidae) in eastern North America. Ph.D. Dissertation, Univ. of Florida. 354 pp.
- Ferguson, A. 1980. *Biochemical Systematics and Evolution*. John Wiley and Sons, New York. 194 pp.
- Lakovaara, S., A. Saura, and K. Falk. 1972. Genetic distance and evolutionary relationships in the *Drosophila obscura* group. *Evolution*, 26:177-184.
- Nair, P. S., D. Banck, and K. Kojima. 1971. Isozyme variations and evolutionary relationships in the *Mesophragmmatica* species group of *Drosophila*. *Studies in genetics VI*. Univ. Texas Publ., 7103:17-28.
- Nei, M. 1972. Genetic distance between populations. *Amer. Natur.*, 106:283-292.
- Roach, S. H., and G. B. Edwards. 1984. An annotated list of South Carolina Salticidae (Araneae). *Peckhamia*, 2:49-57.
- Sneath, P. H. A., and R. R. Sokal. 1973. *Numerical Taxonomy*. W. H. Freeman, San Francisco. 573 pp.
- Terranova, A. C. 1978. A multifunctional electrophoresis system: specifications, construction, and operation. USDA Publ., ARS-S-179/June. 61 pp.
- Terranova, A. C. 1980. Diazo transparencies of polyacrylamide slab gels. *Anal. Biochem.*, 107:443-445.
- Terranova, A. C. 1981a. A rotating temperature-controlled water bath for isozyme development in polyacrylamide slab gels. *Anal. Biochem.*, 112:232-235.
- Terranova, A. C. 1981b. Polyacrylamide gel electrophoresis of *Anthonomus grandis* Boheman proteins: profile of a standard boll weevil strain. USDA Publ., ARR-S-9/July. 48 pp.
- Terranova, A. C., and S. H. Roach. 1987. An electrophoretic key for distinguishing immature and adult species of the genus *Phidippus* (Araneae: Salticidae) from South Carolina. *Ann. Entomol. Soc. Amer.* (in press).
- Yang, S. Y., L. L. Wheeler, and I. R. Bock. 1972. Isozyme variation and phylogenetic relationships in the *Drosophila bipectinata* species complex. *Studies in genetics VII*. Univ. Texas Publ., 7203:213-227.

RESEARCH NOTES

***PHIDIPPUS AUDAX* (ARANEAE, SALTICIDAE) PREDATION
UPON A CICADA (*TIBICEN* SP.) (HOMOPTERA, CICADIDAE)**

In Washington Co., Mississippi, at 1200 on 30 July 1985, an annual cicada (*Tibicen* sp.) (Homoptera) was observed perching in a plum tree in a residential area. This cicada was situated one meter above the ground, 0.5 m from the main trunk on a branch ascending at a 45° angle. Ten cm further up the branch was perched a penultimate instar female of *Phidippus audax* (Hentz) (Araneae, Salticidae). When the cicada began to sing, the jumping spider immediately changed the orientation of its body by 180 degrees so that it was facing the cicada. The spider then approached until it was within 5 cm, paused ca. 5 seconds, then jumped upon the cicada. The cicada immediately stopped singing and fell to the ground with the spider's chelicerae attached to the frons region. On the ground the spider remained attached and the cicada did not move for 5 minutes, whereupon both predator and prey were placed in a 95 mm diam, 65 mm high screen-clear plastic container and moved indoors for further observations. At an ambient temperature of ca. 25°C and local photoperiod, the spider in the next 5½ hours appeared to feed from seven different attachment sites on the cicada as follows: 1200, frons between clypeus and right eye; 1430, prothorax between dorso-ventral margin and right procoxa; 1445, prothorax at rear edge of right operculum; 1500, abdomen between left ventral segments 4 and 5; 1530, abdomen at ventral midline of 2nd segment; 1545, prothorax between metacoxae; 1600, prothorax at left dorso-ventral margin. The prey was finally abandoned at 1730, with the spider positioning itself in an upper corner of the container at the maximum possible distance from the cicada. Observations at 15 minute intervals until 2400 indicated a lack of spider movement. When observations were resumed at 0600 the next morning, the spider was wandering about the container but did not touch the dead cicada. This behavior continued until 0800, when the spider was removed to another container.

The body length of the *P. audax* was 12 mm and the body length (excluding wings) of the *Tibicen* sp. was 38 mm, indicating a predator:prey size ratio of 1:3.2. The weight of the cicada after the spider had completed feeding was 0.77 g and the weight of the spider after feeding was 0.35 g, indicating a predator:prey weight ratio of ca. 1:2.2.

We believe these observations to be important because of the paucity of information both on the predators of cicada species and on the prey of *P. audax*. The principal predators of adult cicadas are probably birds (e.g. Maier 1982), though large orb-web species are probably also important (e.g. Fitch 1963). We have found no records in the literature of *Phidippus* spp. predation on adult cicadas (e.g. Edwards 1980). It is generally believed that salticids are limited to prey smaller than themselves or to soft-bodied/defenseless forms (Enders 1975). In the genus *Phidippus*, this has been documented by field observations on *P. johnsoni* (Jackson 1977) and by laboratory experiments with *P. coccineus* (Gardner 1966). *Phidippus audax* may be an exception to this generalization, however. In the field, this species has been observed attempting to catch flying

dragonflies considerably larger than itself (Fritch 1963), and has been observed eating prey (cockroach, grasshopper, wasp) of much larger size (Bilsing 1920, Edwards 1980). In laboratory experiments, prey larger than itself has been consumed, though prey the same size as the spider seems to be preferred (Givens 1978, Freed 1984).

Robinson and Valerio (1977) describe a technique employed by several neotropical salticids for capturing prey larger and/or stronger than themselves. After jumping upon a large prey in an arboreal situation, the spider drops below the substrate on its dragline and holds the prey with its chelicerae, letting the prey hang below while envenomation or exhaustion occurs. This technique may have been attempted by the *P. audax* individual described herein, but the cicada prey may have been too heavy and was not supported by the dragline.

The observed predation by *P. audax* on a singing and stationary cicada leads to the intriguing suggestion that the spider was able to orient to the prey by receiving auditory and/or vibratory signals and that these signals were sufficient to release the final attack on the prey. Prior to the start of our observations, the spider may have seen the cicada fly to the branch site and begun to move toward the site. When our observations began, the spider may have just arrived and made a reorientation to the prey based on non-visual cues. Thus the initial orientation to the prey may have been by visual detection of movement, thought to be a requirement for eventual prey capture (Land 1971). There is sufficient general evidence to suggest that the spider could have detected auditory and/or vibratory signals from a singing cicada (Barth 1982), though the demonstration of this specific phenomenon has yet to be recorded.

LITERATURE CITED

- Barth, F. G. 1982. Spiders and vibratory signals: sensory reception and behavioral significance. Pp. 67-122, *In* Spider Communication: Mechanisms and Ecological Significance. (P. N. Witt and J. S. Rovner, eds.). Princeton University Press, Princeton.
- Bilsing, S. W. 1920. Quantitative studies in the food of spiders. *Ohio J. Sci.*, 20:215-260.
- Edwards, G. B., Jr. 1980. Taxonomy, ethology, and ecology of *Phidippus* (Araneae: Salticidae) in eastern North America. Ph.D. Thesis, University of Florida, Gainesville. 354 pp.
- Enders, F. 1975. The influence of hunting manner on prey size, particularly in spiders with long attack distances (Araneidae, Linyphiidae, and Salticidae). *Amer. Natur.*, 109:737-763.
- Fitch, H. S. 1963. Spiders of the University of Kansas Natural History Reservation and Rockefeller Experimental Tract. *Univ. Kansas Mus. Nat. Hist., Misc. Publ.*, 33:1-202.
- Freed, A. N. 1984. Foraging behavior in the jumping spider *Phidippus audax*: bases for selectivity. *J. Zool., Lond.*, 203:49-61.
- Gardner, B. T. 1966. Hunger and characteristics of the prey in the hunting behavior of salticid spiders. *J. Comp. Physiol. Psychol.*, 62:475-478.
- Givens, R. P. 1978. Dimorphic foraging strategies of a salticid spider (*Phidippus audax*). *Ecology*, 59:309-321.
- Jackson, R. R. 1977. Prey of the jumping spider *Phidippus johnsoni* (Araneae: Salticidae). *J. Arachnol.*, 5:145-149.
- Maier, C. T. 1982. Observations on the seventeen-year periodical cicada, *Magicicada septendecim* (Hemiptera: Homoptera: Cicadidae). *Ann. Entomol. Soc. Amer.*, 75:14-23.
- Robinson, M. H., and C. E. Valerio. 1977. Attacks on large or heavily defended prey by tropical salticid spiders. *Psyche*, 84:1-10.

Timothy C. Lockley and Orrey P. Young. P.O. Box 3, Stoneville, Mississippi 38776.

**PREY OF THE STRIPED LYNX SPIDER
OXYOPES SALTICUS (ARANEAE, OXYOPIDAE),
 ON COTTON IN THE DELTA AREA OF MISSISSIPPI**

Spiders have received considerable attention as potentially important predators of arthropod pests in agroecosystems (Riechert and Lockley 1984). Much of this attention has been focused on the striped lynx spider, *Oxyopes salticus* Hentz (Young and Lockley 1985). This species is particularly abundant in cotton, to the extent that it is often the most abundant beneficial predator (e.g., Laster and Brazzel 1968, Dean et al. 1982). The known prey of *O. salticus* in cotton include such economically important pests as the tobacco budworm and bollworm (*Heliothis* spp.) (Whitcomb 1967, McDaniel et al. 1981), and the mirid plant bugs *Lygus lineolaris* (P. de B.) (tarnished plant bug) (Whitcomb and Bell 1964), *Adelphocoris rapidus* (Say) (rapid plant bug) (Kagan 1943), and *Pseudatomoscelis seriatus* (Reuter) (cotton fleahopper) (Almand 1974). A survey of the literature has made it quite clear, however, that very little is known about the prey of *O. salticus* in cotton, particularly the proportion of harmful and beneficial insects in its diet (Young and Lockley 1985).

Observations and collections were conducted on a farm in Sunflower County, Mississippi, during June-July, 1983. A 16.4 ha field planted in "Stoneville 213" cotton was subdivided into forty 0.41 ha plots as a part of a long-term experiment involving aldicarb treatments (Scott et al. 1985). Eight untreated check plots were randomly distributed in this field and were the sites for the research reported herein.

Field observations were conducted one day each week for five consecutive weeks during the hours of ca. 0730-1030, a period of maximal *O. salticus* activity (pers. obs.). Cotton plants were examined until an individual *O. salticus* was discovered. It was then observed (≤ 15 minutes) until a prey was captured, whereupon the spider was disturbed and forced to release its prey. Field identification of the prey was then attempted, but if unsuccessful the specimen was brought back to the lab for examination under magnification. Approximate body length measurements of the predator and prey were obtained in the field.

During 11 h 15 min of field observations over a five week period, 48 *O. salticus* were detected capturing or already in possession of prey (Table 1). These prey included adult and/or immature forms of 14 insect species in five orders. Eight of these species represent new feeding records for *O. salticus*, and significantly increase the previous total of 33 species of prey (Young and Lockley 1985). Seventy-one percent of the 48 prey items were in the orders Hemiptera and Homoptera, with nymphs of the tarnished plant bug representing the most frequently captured prey (35%). Of the 14 species of prey, five can be considered beneficial, eight harmful, and one (*Aedes* sp.) neutral. The five beneficial species, however, represent only 10% of the prey items. Thus *O. salticus* may have minimal direct impact on the beneficial arthropod population.

The mean body lengths of each instar of *O. salticus* ranged from 3.1 to 6.0 mm with a mean sample length of 4.85 mm. Eighty-one percent of the spiders were ≥ 4.3 mm and 7th instar or older. The body length of the prey ranged from 2 to 7 mm with a mean of 4.19 mm. Twenty-one percent of the prey were ≥ 6.0 mm, the maximum size of the predator. Although the frequency distribution of the various sizes of prey is unknown, these data indicate that most captured

Table 1.—Prey of *Oxyopes salticus* observed in cotton, Sunflower County, Mississippi. H = harmful, B = beneficial, N = neutral.

Taxon	Prey Stage	No. of Observations	Length of Prey (mm)	Economic Status
Orthoptera				
Tettigoniidae				
<i>Neoconocephalus</i> sp.	nymph	2	5, 6	H
Hemiptera				
Anthocoridae				
<i>Orius insidiosus</i> (Say)	adult	1	3	B
Lygaeidae				
<i>Geocoris punctipes</i> (Say)	nymph	1	3	B
Miridae				
<i>Lygus lineolaris</i> (P. de B.)	nymph	17	3 (8 obs.), 4 (7 obs.), 5, 6	H
" "	adult	2	6	H
<i>Pseudatomoscelis seriatus</i> (Reuter)	nymph	1	3	H
" "	adult	3	4	H
Pentatomidae				
<i>Podisus maculiventris</i> (Say)	nymph	1	2	B
Homoptera				
Cicadellidae				
<i>Chlorotettix viridus</i> (V.D.)	nymph	2	4	H
" "	adult	1	6	H
<i>Empoasca fabae</i> (Harris)	nymph	3	3	H
" "	adult	1	5	H
<i>Graphocephala versuta</i> (say)	adult	1	6	H
Lepidoptera				
Noctuidae				
<i>Trichoplusia ni</i> (Hubner)	larva	2	6, 7	H
<i>Spodoptera ornithogalli</i> (Guenee)	larva	1	6	H
Diptera				
Culicidae				
<i>Aedes</i> sp.	adult	7	3 (3 obs.), 5 (4 obs.)	N
Dolichopodidae				
<i>Condylostylus</i> sp.	adult	1	4	B
Syrphidae				
<i>Syrirta pipiens</i> L.	adult	1	5	B

prey were about the same length as the predator. This may be a result, however, of the preponderance of relatively large *O. salticus* in the sample. Previous research has indicated that small and young *O. salticus* may have difficulty capturing prey as large or larger than itself, but that large and mature *O. salticus* are quite capable of obtaining as large/larger prey (Young and Lockley 1986).

The absence of evidence for *O. salticus* predation on conspecifics or any other spider is noteworthy. Most spiders will feed on almost any suitable-sized animal that they may encounter, including spiders (Turnbull 1960). Studies of ground-foraging spiders in agricultural situations have demonstrated substantial predation on spiders, including cannibalism (Edgar 1969, Kiritani et al. 1972). Since almost all spiders can be considered beneficial in that they frequently feed on pest species, a low predation rate on spiders by *O. salticus* is a very significant characteristic for the most abundant spider in a cotton field.

LITERATURE CITED

- Almand, L. K. 1974. Seasonal abundance, dispersal, and control of the cotton fleahopper on certain host plants. Ph.D. Thesis, Texas A&M Univ., College Station. 67 pp.
- Dean, D. A., W. L. Sterling, and N. V. Horner. 1982. Spiders in eastern Texas cotton fields. *J. Arachnol.*, 10:251-260.
- Edgar, W. D. 1969. Prey and predators of the wolf spider *Lycosa lugubris*. *J. Zool.*, 159:405-411.
- Kagan, M. 1943. The Araneida found on cotton in central Texas. *Ann. Entomol. Soc. Amer.*, 36:257-258.
- Kiritani, K., S. Kawahara, T. Sasaba, and F. Nakasuji. 1972. Quantitative evaluation of predation by spiders on the green rice leafhopper, *Nephotettix cincticeps*, by a sight-count method. *Res. Popul. Ecol.*, 13:187-200.
- Laster, M. L., and J. R. Brazzel. 1968. A comparison of predator populations in cotton under different control programs in Mississippi. *J. Econ. Entomol.*, 61:714-719.
- McDaniel, S. G., W. L. Sterling, and D. A. Dean. 1981. Predators of tobacco budworm larvae in Texas cotton Southw. *Entomol.*, 6:102-108.
- Riechert, S. E., and T. C. Lockley. 1984. Spiders as biological control agents. *Ann. Rev. Entomol.*, 29:299-320.
- Scott, W. P., J. W. Smith, and G. L. Snodgrass. 1985. Response of cotton arthropod populations in cotton to various dosages of aldicarb applied in the furrow at planting time. *J. Econ. Entomol.*, 78:249-257.
- Turnbull, A. L. 1960. The prey of the spider *Linyphia triangularis* (Clerck) (Araneae, Linyphiidae). *Canadian J. Zool.*, 38:859-873.
- Whitcomb, W. H. 1967. Field studies of predators of the second-instar bollworm, *Heliothis zea* (Boddie) (Lepidoptera: Noctuidae). *J. Georgia Entomol. Soc.*, 2:113-118.
- Whitcomb, W. H., and K. Bell. 1964. Predaceous insects, spiders, and mites of Arkansas cotton fields. *Arkansas Agric. Exp. Sta., Bull.*, 690:1-84.
- Young, O. P., and T. C. Lockley. 1985. The striped lynx spider, *Oxyopes salticus* (Araneae: Oxyopidae), in agroecosystems. *Entomophaga*, 30:329-346.
- Young, O. P. and T. C. Lockley. 1986. Predation of striped lynx spider, *Oxyopes salticus* (Araneae: Oxyopidae), on tarnished plant bug, *Lygus lineolaris* (Heteroptera: Miridae): a laboratory evaluation. *Ann. Entomol. Soc. America.*, 79:879-883.

Timothy C. Lockley and Orrey P. Young. P.O. Box 3, Stoneville, Mississippi 38776.

Manuscript received December 1985, revised February 1986.

**MATERNAL BEHAVIOR IN *APOLLOPHANES PUNCTIPES*
(O. PICKARD-CAMBRIDGE) (ARANEAE, THOMISIDAE)**

Maternal defense of eggs has been reported in a number of spider families (see reviews by Burgess, J. W. 1978. Symp. Zool. Soc. Lond., 42:69-78, and Buskirk R. E. 1981. in Hermann, H. (ed.) Social Insects. Vol. 2, Academic Press, New York). Buskirk cites a study showing that the thomisid *Philodromus caespiticolis* defends its egg sacs, but to my knowledge the present note is the first report of maternal behavior in the closely related genus *Apollophanes*.

A female *A. punctipes* was found on 13 Feb. 1983 (first half of the dry season) resting on an egg sac which was on the inner surface of one of three dried leaves which had been fastened to a twig with silk lines attached near their petioles. The twig was about 1.5 m above the ground on a *Anona cherimolia* tree in a grassy yard near San Antonio de Escazu, Costa Rica (el. 1300m). The white silk of the sac formed a relatively thin wall through which the outlines of individual eggs were clearly distinguishable. The leaf with the egg sac was also fastened loosely with silk near its midpoint to the adjacent leaf.

After partially separating the leaves, I dropped a small ant onto the sac, and the spider immediately pounced on it. Seizing it in her chelicerae, she ran to the lower leaf surface below the sac and dropped the ant to the ground. Ten more essentially identical performances were elicited in the next 30 minutes by dropping as many other ants onto the sac.

Several times after dropping the ant, the spider remained on the leaf at or just below the lower edge of the sac with only her rear legs on the sac. When I dropped the ant onto the upper part of the sac where it did not touch the spider and was probably out of her sight because of the curve of the leaf, the spider nevertheless responded immediately, suggesting that she sensed the ant via vibrations of the silk.

There are several interesting parallels between the maternal behavior of *A. punctipes* and that of the salticid *Lyssomanes jemineus* (Eberhard, W. G. 1974. Bull. Br. Arachnol. Soc. 3:51.). Females of both species lay eggs at relatively exposed, aerial sites, and both defend them against ants by causing the ants to fall—the salticid employing quick flicks of its front legs, and the thomisid by use of its chelicerae. Both also make reduced egg sacs—that of the thomisid having relatively thin walls and that of the salticid being almost completely eliminated.

I thank J. H. Redner and C. D. Dondale for identifying the spider, and the Vicerectoría de Investigación of the Universidad de Costa Rica for financial support.

William G. Eberhard. Smithsonian Tropical Research Institute, and Escuela de Biología, Universidad de Costa Rica, Ciudad Universitaria, Costa Rica.

FOSSIL EVIDENCE OF SPIDER PARASITISM BY ICHNEUMONIDAE

A piece of amber containing a spider and associated insect larva was sent to the author by Mr. Jake Brodzinsky of Santo Domingo. The amber originated from the Dominican Republic, was golden brown, transparent and measured 10 by 5 mm. The insect larva, which was located just anterior to the spider's abdomen, appeared to represent a first instar ichneumonid. The body of the spider was 2.2 mm long and the curved legs extended another 1.4 mm on either side of the body. The adjacent insect larva was 0.29 mm long and 0.04 mm wide. It was 0.16 mm from the spider's abdomen. It possessed a distinct head capsule, 12 recognizable abdominal segments and a smooth integument. The spider was identified as an immature male Clubionidae.

Members of the tribe Polysphinctini (Ichneumonidae: Hymenoptera) are contemporary parasites of spiders or predators on spider eggs. The fossil form would fall into the former category. According to Nielsen, (1923. Entomol. Meddel., 14:137-205; 1935. Entomol. Meddel., 19:191-215) who accumulated a considerable amount of information on these "ichneumonid flies", the early instar larvae can remain for months on a spider in an inactive state. Most spider-parasitic Polysphinctini first sting the spider host into unconsciousness, then deposit their egg dorsally or laterally at the base of the spider's abdomen or on the posterior declivity of the cephalothorax (in the fossil form, the parasite is found just adjacent to the base of the spider's abdomen in a dorsal-lateral position). The eggs are attached by a mucilaginous material and the hatched larva sits exposed on the abdomen of its spider host and periodically feeds by puncturing the spider's integument with its mandibles and sucking up the extruded hemolymph. First instar larvae of polysphinctinids are described by Nielsen (1923, 1935) as having a large, sclerotized head, 13 body segments of diminishing width and a bare or minutely-spined integument. First instar larvae of representatives of Polysphinctini that were in the collection at Berkeley

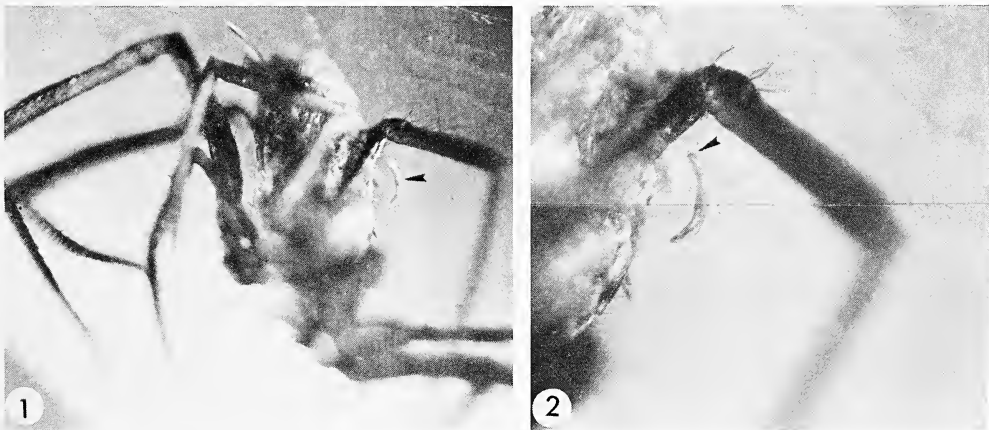

Figs. 1-2—Fossil first stage larva of a member of the Polysphinctini in Dominican amber: (Magnification 20 \times). 1, position of the larva (arrow) in relation to the spider; 2, general shape of larva showing distinct head capsule (arrow) (Magnification 80 \times).

measured 0.45 mm in length. However, the tribe is composed of several genera and a size variation of first stage larvae would be expected.

On the basis of size, morphology and location near the base of the spider's abdomen, it is concluded that the fossil larva is a member of the tribe Polysphinctini and that spider parasitism by these ichneumonids was well established some 20-40 million years ago. This is roughly the age of Dominican amber (Lambert et al., 1985. *Archaeometry*, 27:43-51). Fossil associations showing evidence of parasitism, such as this one, are rare in the geological record. I thank Dr. E. Schlinger for identifying the fossil spider and providing me with present-day larvae of Polysphinctini for comparative studies.

George O. Poinar, Jr. Department of Entomological Sciences, University of California, Berkeley, California 94720.

Manuscript received January 1986, revised March 1986.

X-RAY STERILIZATION OF MALE GOLDEN-WEB SPIDERS *NEPHILA CLAVIPES* (ARANEAE)

In some spider species, females mate with more than one male (Austad 1984). Male sterilization can be used to determine whether a particular male fertilizes a disproportionate number of a given female's eggs (Parker 1970). A popular method requires some females to mate first with an intact male and second with a sterile; other females are presented males in the reverse order. Differential rates of egg hatching between these two groups reveal patterns of male priority in fertilization. There are, however, only a few published papers on irradiation and male sterility in spiders (Jackson 1980, Vollrath 1980, Austad 1982). Austad (1982) presented a relatively detailed methodology which we used as a guide. Because Austad's bowl and doily spiders (*Frontinella pyramitela* (Walck.)) and our *Nephila clavipes* (L.) differ in size and aspects of natural history, a presentation of our methods and findings might be useful to others contemplating sterilization procedures.

This study was done during the summer of 1984 at the F. Edward Hebert Center of Tulane University, about 15 km south of New Orleans. Subjects were selected in mid-July, early in the mating season, because early season eggs are more likely to hatch than later eggs (Christenson, Wenzl and Legum 1979). Sixty adult males were collected from small orbs (probably of their own construction) that contained sperm webs. This insured that males were in the same phase of spermatogenesis at the time of irradiation. Light brown abdomen coloration and the presence of the sperm web indicated that collections were made within three days after the final molt.

After collection, males were refrigerated until inactive and then placed singly in a 1 cm cardboard cube. Twenty received 2000 rad of X-ray radiation, 20 received 5000 rad, and 20 served as controls, being treated in the same manner as experimentals except for irradiation. Radiation was generated by a General Electric Maximar[®] machine at 250 kv through a filter of 1/4 mm copper and 1 mm aluminum situated 39 cm above the center of the holding box. Output was 129 rad/min. These specifications are based upon those that proved effective for Austad (1982).

Males were placed individually with a female collected in her penultimate instar. Subjects were housed in Fiberglas screen boxes (123 × 62 × 62 cm). We placed males with females prior to the female's final molt since unrestrained *N. clavipes* females mate just after the final molt (Christenson, Brown, Wenzl, Hill, and Goist 1985). However, in this species, irradiated males could have been mated to virgin adults since adult females will mate while feeding and such matings result in egg hatching (Wenzl 1980). Males were removed 25 days after irradiation.

When assessing fertilization priority between two males, it is necessary to demonstrate that both males actually mated with the female. Or, if one wished to study eggs fertilized by irradiated sperm, it would be necessary to observe mating to insure that fertilization had occurred since unfertilized eggs and eggs fertilized by inviable sperm are similar in appearance. To document mating, we observed subjects during a morning census and several 1-min time samples taken throughout the day. Mating and egg data presented in this paper are based upon

the 38 pairs that were observed to mate and in which the female lived long enough to produce an egg clutch.

Females laid eggs in the field boxes, with the first appearing about four weeks after the final molt. Eggs were left in the boxes until hatching since laboratory conditions tend to reduce hatching success (unpublished observations). Fourteen of the controls, 13 of the 2 krad group, and 11 of the 5 krad group produced a clutch of eggs. Eggs of thirteen of the control sacs hatched compared to none of the 2-krad or 5-krad clutches ($\chi^2 = 33.874$, $df = 2$, $p < 0.0001$). Eggs of the three groups were of a normal yellow coloration and could not be distinguished by the unaided eye. Eggs fertilized by control males ($n = 3$ clutches) and irradiated males ($n = 3$ clutches) were examined microscopically. Group differentiation was possible about one week prior to hatching, with developmental details obvious on the surface of the eggs fertilized by sperm of control males.

Irradiation did not seem to affect the positioning of males on the female web nor the vigor of overt male sexual behavior. A male who appears on a unrestrained female's web will position himself near the hub; if two or more are present, usually the largest male will defend this position (Christenson and Goist 1979). All males but one (a 2-krad animal) had assumed position near the hub by the morning after introduction. The remaining male did so by the following day. Groups did not statistically differ in terms of males who mated the day the female molted; all but one control, one 5-krad, and three 2-krad males were observed mating ($\chi^2 = 1.856$, $df = 2$, $p < 0.395$). All males were observed to mate for the first time within two days of the female's final molt. All initial mating occurred within 15 days after irradiation.

As Austad (1982) notes, to assess the effectiveness of sterilization procedures used to examine sperm competition and determine paternity, it is necessary to note if the irradiated sperm are motile. To assess motility, we examined microscopically sperm for six females (two controls, two 2-krad, and two 5-krad) 26 days after males were irradiated and at least two weeks after mating had occurred. Collection was made at this time since *Nephila* sperm do not become flagellate (and motile) in the spermathecae until about ten days after mating (Brown 1985). Spermathecae were removed from the abdomen, placed on a clean slide in an uncontrolled drop of saline, cut with a razor, the halves squashed, and sperm immediately examined under a Leitz® phase-contrast microscope. All six sets of spermathecae contained many flagellate, motile sperm. Inviability of eggs of females in the irradiated groups was not due to sperm being aflagellate since oviposition occurred an average of 27 days after copulation, when most sperm are still motile (Brown 1985).

Irradiation influences the lifespan of sperm. Five pairs of spermathecae were removed and examined sixty days after irradiation. One control female and two 2-krad females contained many flagellate sperm, while two 5-krad females contained mostly dead sperm. This presented no problem in *N. clavipes* as fertilization occurs at oviposition, about 27 days after final molt.

Irradiation did not influence male longevity. Sixteen control males, 17 2-krad males, and 16 5-krad males ($\chi^2 = 0.223$, $df = 2$, $p < 0.895$) were alive twenty five days after irradiation. To more fully assess effects on longevity, fifteen males were placed with a second female, after the death of the original female with which they were housed. Males residing with an adult female live longer than those which are not (unpublished observations). Eight controls lived an average of 52.6

(s.d. = 13.6) days and seven 5-krad animals 46.9 (s.d. = 9.4) days ($F_{1,13} = 0.887$, $p > 0.10$).

We do not know exactly how long the initial radiation treatment affects sperm production. As our males were housed with the female for 25 days, they had ample opportunity to mate more than once, first after the final molt, and during subsequent days while the adult female fed. If an irradiated male eventually produced viable sperm, then it is possible that at least some of the eggs of a second female sac would hatch. Thirty three of our females produced a second clutch. Of the 12 second control clutches, 12 second 2-krad clutches, and 9 second 5-krad clutches, 11 (91.7%), 0%, and 0% hatched, respectively ($\chi^2 = 28.875$, $df = 2$, $p < 0.0001$). Our initial radiation treatment was effective for at least 25 days which is comparable to "at least 10 days" noted by Jackson (1980) for the jumping spider *Phidippus johnsoni*. To assess longevity of irradiation effects, further data are needed on the normal course of spermatogenesis in this species and egg productivity of females mated with one irradiated male.

We thank L. E. LaChance of the USDA Metabolism and Radiation Research Laboratory and J. W. Haynes of the USDA Boll Weevil Research Laboratory for helpful comments. This research was supported by NSF grant BNS-8317988 to TC.

LITERATURE CITED

- Austad, S. N. 1982. First male sperm priority in the bowl and doily spider *Frontinella pyramitela*. *Evolution*, 36:777-785.
- Austad, S. N. 1984. Evolution of sperm priority patterns in spiders. In *Sperm competition and the evolution of animal mating systems* (R. L. Smith, ed.). Academic Press, New York.
- Brown, S. G. 1985. Mating behavior of the golden-orb weaving spider, *Nephila clavipes*: II. Sperm capacitation, sperm competition, and fecundity. *J. Comp. Psychol.*, 99:167-175.
- Christenson, T. E., S. G. Brown, P. A. Wenzl, E. M. Hill, and K. C. Goist. 1985. Mating behavior of the golden-orb weaving spider, *Nephila clavipes*: I. Female receptivity and male courtship. *J. Comp. Psychol.*, 99:160-166.
- Christenson, T. E. and K. C. Goist. 1979. Costs and benefits of male-male competition in the orb weaving spider, *Nephila clavipes*. *Behav. Ecol. Sociobiol.*, 5:87-92.
- Christenson, T. E., P. A. Wenzl, and P. Legum. 1979. Seasonal variation in egg hatching and certain egg parameters of the golden silk spider *Nephila clavipes*. *Psyche*, 86:137-147.
- Jackson, R. R. 1980. The mating strategy of *Phidippus johnsoni* (Araneae, Salticidae): II. Sperm competition and the function of copulation. *J. Arachnol.*, 8:217-240.
- Parker, G. A. 1970. Sperm competition and its evolutionary consequences in the insects. *Biol. Rev.*, 45:525-567.
- Vollrath, F. 1980. Male body size and fitness in the web-building spider *Nephila clavipes*. *Zeit. Tierpsychol.*, 53:61-78.
- Wenzl, P. A. 1980. Mating behavior and egg production in the orb weaving spider, *Nephila clavipes*. Unpublished master's thesis, Tulane University.

Terry Christenson, Department of Psychology, Tulane University, New Orleans, Louisiana 70118; **Joseph Schlosser**, M.D., 1521 St. Charles, New Orleans, Louisiana 70130; and **Jeffrey Cohn**, and **Leann Myers**, Department of Psychology, Tulane University, New Orleans, Louisiana 70118.

BOOK REVIEWS

Barth, F. G. (Ed.) 1985. *Neurobiology of Arachnids*. Springer-Verlag, New York. 385 pp. 174 textfigs. (price \$69.50).

In this first monograph on the subject of arachnid neurobiology, most of the coverage (approximately 70 percent) concerns what has been the primary interest of the majority of workers in the field—sensory systems and behaviors mediated by the senses. Nevertheless, the reviews of other aspects of neurobiology sufficiently round out the book and broaden its usefulness.

The central nervous system of arachnids has attracted the attention of relatively few investigators, compared to that of insects and crustaceans. It is treated here in chapters on anatomy (Babu) and ontogeny (Weygoldt), followed by one on neurosecretion (Legendre).

In the lengthiest sections of the book, early chapters on vision in spiders—morphology and optics (Land), photoreceptor functioning (Blest), and spectral sensitivity (Yamashita)—are complemented later by a study of visual discrimination in salticids (L. Forster) and two examinations of visual and idiothetic orientation in agelenids (Görner and Claas; Mittelstaedt). Likewise, coverage of mechanoreceptors—tactile hairs and spines, and scopula hairs (Foelix); trichobothria (Reissland and Görner); and slit sensilla (Barth)—provides a basis for understanding later chapters on the diverse functions of the spider's vibration sense (Barth) and the role of proprioception in mediating locomotion (Seyfarth). An additional aspect of the sensory system, the occurrence of peripheral synapses in arachnids, is presented by its discoverer (Foelix).

Much of the relatively limited information on arachnid motor systems is summarized in a chapter that includes the author's (Sherman) special area, neural control of the heartbeat. How motor output is affected by sensory and central nervous system mechanisms to yield locomotion in scorpions is the topic of the following chapter (Root). The book's final paper (Fleissner and Fleissner) presents an analysis of the neurobiological clock underlying the circadian rhythm of visual sensitivity in scorpions.

While all of the chapters provide useful reviews of their topics, many also include especially large sections devoted to very recent research or contain heretofore unpublished findings. Noteworthy here are the reviews by Blest on the fine structure of spider photoreceptors, by Yamashita on the spectral sensitivity of spider photoreceptors, by Seyfarth on spider proprioception, by Mittelstaedt on spider navigation, and by the Fleissners on circadian clocks in scorpions. Although some of the content of a few chapters (the two by Barth and the one by L. Forster) can be found in previous contributions by their authors to recent books on spider communication and on sense organs, nowhere else can one find the wealth of information and completeness of coverage of the major topics of arachnid neurobiology as in this excellent monograph that Barth has brought together. The availability of this publication should increase the possibility that arachnids will be brought into the laboratories of some of the other neurobiologists, who so far have generally ignored this class of arthropods.

Unlike those many monographs which suffer from publication delays, this one is as up to date as possible, with some of the contributions containing references to papers published in 1985. The book is handsomely illustrated, with clear diagrams and high-quality electron micrographs. Typographical errors are minimal and not distracting, reflecting the carefulness and language skills of the editor. Indeed, although he and about half of the contributors are German, all of the chapters are written clearly in English, reflecting Barth's desire to reach as broad an audience as possible.

Jerome. S. Rovner, Zoological Sciences, Ohio University, Athens, Ohio, 45701.

Eberhard, W. G. 1985. *Sexual Selection and Animal Genitalia*. Harvard University Press, Cambridge, Massachusetts and London, England. 244 pp. (Price \$25.00).

Why are genitalia, particularly male genitalia, so useful as taxonomic characters for distinguishing closely related species? Most of us probably assume that animals evolve genital differences to prevent interspecific mating. Or put another way, animals other than arachnologists also use genitalia for species identification. W. G. Eberhard's provocative new book contends that this traditional interpretation is erroneous, and elaborates a new hypothesis, namely that male genitalia have evolved so rapidly and divergently in response to female mate preference among males of the same species.

In form, the book is an extended argument. Chapter 1 documents the phenomenon. Male intromittant organs are useful in species-level taxonomy in animals ranging from arthropods, planarians and nematodes to sharks, snakes and rodents. Rapid evolution of male genitalia may therefore be one of the most ubiquitous patterns in nature. Chapters 2-4 consider several previous hypotheses, including the species identification hypothesis, and explains why none of these hypotheses adequately explains observed patterns of genital diversity.

Chapter 5 outlines Eberhard's female choice hypothesis. Briefly, the hypothesis assumes that females prefer as mates certain conspecific males on the basis of some genital trait. Even if there is no other adaptive advantage associated with this trait, the fact that females prefer males exhibiting the trait gives those males a fitness advantage, and the trait will spread. If females prefer a more elaborate form of the trait, then the trait will become more and more elaborate until its advantage relative to mating is balanced by its disadvantage relative to survival. A key feature of this argument is that females will prefer traits which are arbitrary with respect to other aspects of male fitness. Thus male genitalia can be expected to evolve the elaborate and bizarre morphology with which arachnologists are so familiar.

Chapters 6-11 consider arguments and evidence for and against Eberhard's hypothesis. Among other things, he demonstrates convincingly that numerous mechanisms exist by which females might influence which of several mates actually succeed in fertilizing her eggs—a necessity for the theory to work. Both in these, and previous, chapters Eberhard uses his extensive knowledge of the arachnid literature to support his arguments. Of more than 700 references cited, nearly 100 pertain to arachnids.

Perhaps the most impressive aspect of this book, aside from the exciting new idea presented, is the creativity with which Eberhard milks the existing literature for information bearing on his, and competing, hypotheses. For instance, he reasons that if genitalia diverged because of their use in species identification, then species which have little opportunity to make species identification errors would be expected to show less divergence than species which frequently contact close relatives. He tests this prediction by examining divergence and elaboration of genitalia in geographically isolated species (island endemics and host-specific parasites, for which hosts are habitat islands) compared with divergence in nonisolated near relatives.

In compiling his arguments, Eberhard by necessity also compiles a fascinating survey of the diversity of animal mating mechanisms. We learn of such phenomena as hypodermic insemination (males insert their genitalia through the female body wall and deposit sperm in the body cavity), exploding spermatophores, and genital scoops for removing females' stored sperm. Therefore, even if the book weren't so well written, so excellently illustrated, and so imaginatively conceived, it would still be worth owning.

Steven N. Austad, Department of Organismic and Evolutionary Biology, Harvard University, The Biological Laboratories, Cambridge, Massachusetts 02138.

NOMENCLATURE NOTES

Opinion 1394.—The International Commission on Zoological Nomenclature ruled under its plenary powers to conserve the names *Centrurus limpidus* Karsch, 1879 and *Centruroides ornatus* Pocock, 1902 (Arachnida, Scorpiones) (Bull. Zool. Nomencl., 43(2):144).

The ICZN also published an application (Bull. Zool. Nomencl., vol. 43, part 4) to confirm *Thomisus hirtus* Latreille 1819 as the type species for *Heriaeus* Simon, 1875 (Arachnida, Araneae). Comment or advice is welcomed by the Commission and should be sent to The British Museum (Natural History), London, England. Please refer to case no. 2447.

THE JOURNAL OF ARACHNOLOGY

Instructions to Authors

GENERAL COMMENTS

Manuscripts are acceptable in English, French, Portuguese, or Spanish, and must be **TYPED DOUBLE- OR TRIPLE-SPACED THROUGHOUT**. Good quality paper should be used and erasable bond is specifically excluded. Leave margins at least 1.5 in. (4 cm) on the left and 1 in. (2.5 cm) on the top, bottom, and right. Do not hyphenate any words at the right margin. Avoid using right justification in manuscripts prepared on word processors. Do not edit your own manuscript. *Italics* are permitted only to indicate scientific names; only the TITLE, PRIMARY HEADINGS (e.g., INTRODUCTION, etc.) and RUNNING HEADS should be typed in capital letters. Follow the recommendations of *Council of Biological Editors (CBE) Style Manual*, Third Edition, unless indicated otherwise below. To facilitate prompt review by two or more referees, send to the Associate Editor three identical copies of the typed material, one of which should be designated as the "original," together with copies of the illustrations.

Manuscripts longer than about 1500 words (five double-spaced typewritten pages in Elite, six double-spaced typewritten pages in Pica) should be prepared as Feature Articles, shorter papers as Research Notes. Manuscripts and all related correspondence must be sent to the Associate Editor: Dr. Jerome S. Rovner, Department of Zoological Sciences, Ohio University, Irvine Hall, Athens, Ohio 45701.

FEATURE ARTICLES

Arrange the various part of feature articles in the following sequence: (1) mailing address, (2) title, (3) by-line, (4) abstract, (5) body of text, (6) acknowledgments, (7) literature cited, (8) figure legends, (9) footnotes, (10) running head, (11) tables with legends, (12) figures. Put only parts 1, 2 and 3 on page 1, and start page 2 with part 4. All other pages are numbered consecutively.

Mailing address.—Include the complete address and telephone number of that author with whom all correspondence with the Editors should be handled.

Title.—When using common or scientific names in the title, be sure to include in parentheses the appropriate higher taxa (order, family, . . .). Include footnote indication if appropriate (e.g., to acknowledge grant support), but type footnote separately (see part 9 above). The title should be typed in capital letters and may not exceed 48 characters and spaces per line.

By-line.—Include the name(s) of author(s) as customarily written (less titles) and complete address(es), including zip code or other postal designation. Include footnote indication(s) if appropriate (e.g., to indicate change of address), but type footnote separately (see part 9 above). Leave three spaces between title and by-line, and four spaces between name(s) and address(es).

Abstract.—The abstract should be a summary of the basic findings, and should not exceed two to three percent of the text in length. Papers in a language other than English must be accompanied by an English abstract as well as an abstract in the language of the text. Papers written in English but focusing on a subject pertaining to a country where another of the accepted languages is used, may include an abstract in that language.

Body of text.—Use whatever form seems best to accommodate the necessary description of research. Be concise. Conform to standard references for abbreviations, i.e. the *CBE Style Manual* for scientific abbreviations, and a good language reference such as *The Little, Brown Handbook* for abbreviations of English words. Use the metric system for all measurements (the English system is acceptable only when transcribing locality data accompanying museum specimens), and note that abbreviations of metric units of measurements are not punctuated (e.g., mm and km, but ft. and mi.). Citations should be in the following form: Bellrose (1950); Bellrose (1950:33); or (Bellrose 1950). The complete scientific name of a species or genus, including author(s), must be given the first time they are mentioned in the text. Use single-line notation for fractions [e.g., 1/4 and not ¼; (4-12)/3 and not $\frac{4-12}{3}$].

The following special directions apply to authors of taxonomic papers:

(a). Do not use abbreviations in a primary heading to indicate that a new name or a new combination is being proposed (e.g., *A-us x-us*, **new species**, rather than *A-us x-us*, **n. sp.** or comparable abbreviations).

(b). Keys must be typed as follows:

1. Use Arabic numerals to designate the leading entry of the couplet. 2
Do not designate the second entry of a couplet, either by means of numbers, letters or other
marks. *A-us x-us*
2. Type numbers flush to left margin, and start entry on fifth space. *A-us y-us*
Subsequent lines of any entry must also be indented five spaces. *A-us z-us*

(c). Synonymies must follow the abbreviated style shown below:

A-us x-us Jones 1930:3, 1935:9; Russell 1945:453; Smith 1954a:16, 1954b:678; Cooper and Lim
1955:18 (in part).

A-us y-us Bates 1932:18, fig. 4. NEW SYNONYMY.

A-us z-us: Miranda 1948:98 (misidentification); Harris 1951:3 (in part?). (*nec A-us z-us*
Zimmer).

(d). Lists of specimens examined of a given taxon must be the last items typed in the treatment of that taxon as they will be set in smaller type. Adhere to the following style for listing specimens examined: Country: State or comparable political subdivision; County or District, detailed locality (elevation), 14 July 1945 (collector): 2 males, 5 females (acronym of institution where specimens are deposited), next detailed locality within that County, etc.; next County in the same State; etc.: next State in the same Country; etc. Next Country: etc. Punctuation rules are very simple. Use a period to separate countries, a colon to separate states, a semi-colon to separate counties, and a comma to separate specific localities.

Acknowledgments.—Avoid overlooking persons who have in some substantial way assisted with the work. Authors of taxonomic papers should spell out the name and indicate parenthetically the acronym of institutions where specimens studied are deposited, if not mentioned elsewhere in the text.

Literature Cited.—Include only those publications to which reference is made in the text. Adhere to the *CBE Style Manual* and refer to a previous issue of *The Journal of Arachnology* for style. Do not abbreviate place names in journal citations. Repeat name(s) of author(s) in case of multiple entries.

Figure Legends.—Provide one legend for each illustration which will be reproduced separately, or for each “plate” consisting of several illustrations. Adhere to the following styles:

Figs. 1-4.—*A-us x-us*, male from Timbuktu: 1, left leg, 2, right chelicera; 3, dorsal aspect of genitalia; 4, ventral aspect of abdomen.

Figs. 27-34.—Right chelicerae of species of *A-us* from Timbuktu: Figs. 27, 29, 31, 33.—Dorsal views; Figs. 28, 30, 32, 34.—Prolateral views of movable finger; Figs. 27-28: *A-us x-us*, holotype male; Figs. 29-30: *A-us w-us*, male; Figs. 31-32: *A-us z-us*, holotype male; Figs. 33-34: *A-us t-us*, male. Scale = 1.0 mm.

Type all figure legends consecutively on the same page(s), double spacing lines within each legend and leaving four spaces between legends. Keep in mind that 99 characters and spaces represent one printed line, and that 4 mm for each printed line must be subtracted from the maximum height permissible on full-page illustrations.

Footnotes.—Footnotes will be permitted on page one when it is appropriate to acknowledge grant support and to indicate change of address, etc. No footnotes will be permitted on any other page. Type footnotes together on a separate page.

Running head.—At the top of each right hand page will be printed the author(s)’ last name(s) and an abbreviated title. This running head may not exceed 60 characters and spaces, must be typed in capital letters, and a hyphen must separate the name(s) from the title.

Tables with legends.—Prepare all tables precisely as they are to be typeset. Construct tables as simply as possible. Include the legend at the top of each. Make marginal notations in the text which clearly indicate the appropriate point of insertion of each table. Note that in these instructions “graphs” are regarded as “figures,” not “tables.”

The size of the printed page imposes a limit on the size of tables that can be accepted. In a normal, upright table these limits are 99 characters and spaces per line and 56 lines in height, including legend. Sideways tables are difficult to typeset and present problems during paste-up; therefore, they will be accepted in exceptional cases only, as most tables that are “too wide” can usually be rearranged to fit into the more desirable, upright position. Any table that exceeds the dimensions given above will not be accepted for publication. Tables must be typed double-spaced throughout, and the legend must be in the following style:

Table 1.—Incorporate into the legend all information necessary to make the data presented clearly understandable. Do not use footnotes.

Figures.—Figures are the only parts of the paper for which the author is responsible for preparation of camera-ready material, and therefore they must be executed with great care. Drawings should be made with black drawing ink on high quality, smooth, white, heavy paper. Drawings made in some manner not employing black ink (e.g., shaded pencil drawings) are difficult to print, more so than photographs. When such a technique is used, the drawings should be fairly dark, have good contrast, and be well executed. The largest dimensions on the printed page on which illustrative material (with legends) will be printed is 127 by 200 mm. Decisions as to size of originals, placement of several smaller drawings on a single page, etc., should be based upon this format. Where several smaller drawings are to appear together on a single page, it is the responsibility of the author(s) to furnish an assembled “plate” precisely as it should appear in print. An effort should be made to efficiently utilize the available space within the limits of the original “plate.” The “plate” must be prepared to allow for inclusion of the legend beneath the drawings on the same printed page. Number all drawings consecutively using Arabic numerals; do not designate illustrations with letters, and never designate plates. Labeling should be neat, secure, and done with a method which produces flat characters, e.g., pressure-sensitive transfer characters or a lettering apparatus employing black ink. Photographs should have good contrast, be glossy or semi-glossy, and printed slightly larger (up to 2X) than anticipated published size. Photographs and inked drawings should not be grouped together in a single plate, because they will be difficult to print. ***Illustrative material of any kind larger than two times the anticipated printed size will not be accepted.*** Larger illustrations are difficult to handle and are easily damaged or lost in the mail. Authors preparing larger illustrations should consult local photo shops and print firms about the availability of PMT’s (PhotoMechanical Transfer) for reducing their illustrations to an acceptable size. PMT’s are high contrast, direct positive-to-positive reproductions on semi-glossy paper, which will also give the author(s) a good idea of how the illustrations will look when printed. PMT’s can be obtained at a reasonable cost in a number of sizes, usually 8 by 10 in. or 9 by 12 in., with any amount of figure reduction desired within that space. Sending PMT’s rather than originals avoids the loss of art work in the mail, and if the PMT’s get lost or damaged they can be replaced. Illustrations, PMT’s, and photographs must be securely mounted on stiff white paper or mounting board (Scotch Magic Transparent Tape can be used on the white portions of illustration paper). On the back of each plate include author’s name(s), abbreviated title of manuscript (or running head), figure numbers included, and orientation (= topside). Illustrative material that is poorly prepared, too large, or not mounted properly will be returned to the author.

RESEARCH NOTES

Arrange the various parts of your research notes in the following sequence: (1) mailing address, (2) title, (3) body of text, (4) by-line, (5) figure legends, tables with legends, and illustrations. Follow instructions given above for feature articles unless otherwise indicated below. Do not include footnotes anywhere. References to grant support and all other acknowledgments should be made in a statement in the body of the text. If an indication of change of address is desired, it should be included parenthetically after the credited institution as “present address.” For citation of literature, follow the same instructions as for Feature Articles. The by-line must be typed in paragraph form after the body of the text or the literature cited when one is present. When possible, Research Notes will take priority over Feature Articles in the publication sequence.

THE AMERICAN ARACHNOLOGICAL SOCIETY

President:

Jerome S. Rovner (1985-1987)
Department of Zoology
Ohio University
Athens, Ohio 45701

President-Elect:

William A. Shear (1985-1987)
Department of Biology
Hampden-Sydney College
Hampden-Sydney, Virginia 23943

Membership Secretary:

Norman I. Platnick (appointed)
American Museum of Natural History
Central Park West at 79th Street
New York, New York 10024

Treasurer:

Norman V. Horner (1985-1987)
Department of Biology
Midwestern State University
Wichita Falls, Texas 76308

Secretary:

Brent D. Opell
Department of Zoology
V.P.I.S.U.
Blacksburg, Virginia 24061

Archivist:

Vincent D. Roth
Box 136
Portal, Arizona 85632

Directors:

Frederick A. Coyle (1985-1987), **W. G. Eberhard** (1986-1988), **Susan E. Riechert** (1985-1987).

Honorary Members:

P. Bonnet, W. J. Gertsch, H. Homann, R. F. Lawrence, H. W. Levi, G. H. Locket, A. F. Millidge, M. Vachon, T. Yaginuma.

The American Arachnological Society was founded in August, 1972, to promote the study of Arachnida, to achieve closer cooperation between amateur and professional arachnologists, and to publish *The Journal of Arachnology*.

Membership in the Society is open to all persons interested in the Arachnida. Annual dues are \$25.00 for regular members, \$15.00 for student members. Correspondence concerning membership in the Society must be addressed to the Membership Secretary. Members of the Society receive a subscription to *The Journal of Arachnology*. In addition, members receive the bi-annual newsletter of the Society, *American Arachnology*.

American Arachnology, edited by the Secretary, contains arachnological news and comments, requests for specimens and hard-to-find literature, information about arachnology courses and professional meetings, abstracts of papers presented at the Society's meetings, address changes and new listings of subscribers, and many other items intended to keep arachnologists informed about recent events and developments in arachnology. Contributions for *American Arachnology* must be sent directly to the Secretary of the Society.

Research Notes

<i>Phidippus audax</i> (Araneae, Salticidae) predation upon a cicada (<i>Tibicen</i> sp.) (Homoptera, Cicadidae), <i>Timothy C. Lockley</i> and <i>Orrey P. Young</i>	393
Prey of the striped lynx spider, <i>Oxyopes salticus</i> (Araneae, Oxyopidae), on cotton in the delta area of Mississippi, <i>Timothy C. Lockley</i> and <i>Orrey P. Young</i>	395
Maternal behavior in <i>Apollophanes punctipes</i> (O. Pickard-Cambridge) (Araneae, Thomisidae), <i>William G. Eberhard</i>	398
Fossil evidence of spider parasitism by Ichneumonidae, <i>George O. Poinar, Jr.</i> ...	399
X-Ray sterilization of male golden-web spiders <i>Nephila clavipes</i> (Araneae), <i>Terry Christenson</i> , <i>Joseph Schlosser</i> , <i>Jeffrey Cohn</i> , and <i>Leann Myers</i>	401

Book Reviews

Neurobiology of Arachnids, by F. G. Barth, <i>Jerome S. Rovner</i>	404
Sexual Selection and Animal Genitalia, by W. G. Eberhard, <i>Steven N. Austad</i>	405

Other

Nomenclature Notes.....	406
Instructions to Authors.....	407

CONTENTS

THE JOURNAL OF ARACHNOLOGY

VOLUME 14

Biography

NUMBER 3

- B. J. Kaston, American Araneologist 1906-1985: a biography and bibliography, *Leonard S. Vincent*.....283

Feature Articles

- Postembryonic development of *Lactrodectus hasselti* Thorell (Araneae, Theridiidae), *Michael F. Downes*.....293
- Spiders on red spruce foliage in northern Maine, *Daniel T. Jennings* and *Judith A. Collins*.....303
- Coniferous-habitat associations of spiders (Araneae) on red spruce foliage, *Daniel T. Jennings* and *Judith A. Collins*.....315
- Nests of terrestrial spiders maintain a physical gill: flooding and evolution of silk constructions, *Jerome S. Rovner*.....327
- Web-building behavior of anapid, symphytognathid and mysmenid spiders (Araneae), *William G. Eberhard*.....339
- A new mygalomorph spider genus from Mexico (Nemesiinae, Nemesiidae, Arachnida), *Robert J. Raven*.....357
- Biology of the diurnal *Metasolpuga picta* (Kraepelin) (Solifugae, Solpugidae) compared with that of nocturnal species, *Robert A. Wharton*.....363
- Genetic differentiation in the genus *Phidippus* (Araneae, Salticidae), *A. C. Terranova* and *S. H. Roach*.....385

(continued on back inside cover)

Cover photograph, fluorescence of *Sphaleropachylus butleri* (Thorell), by J. C. Cokendolpher

Printed by the Texas Tech Press, Lubbock, Texas, U.S.A.

Posted at Lubbock, Texas, in May 1987

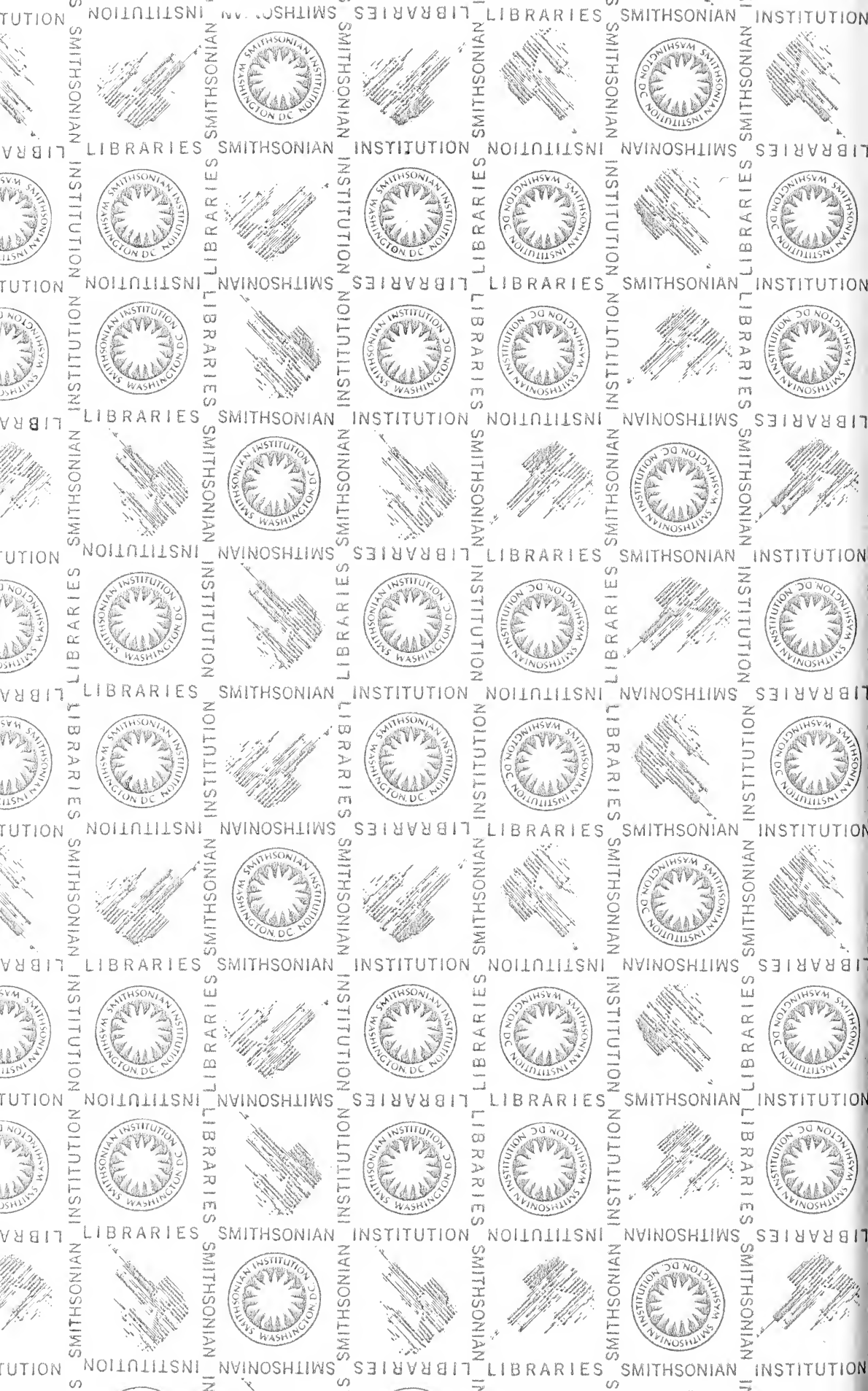

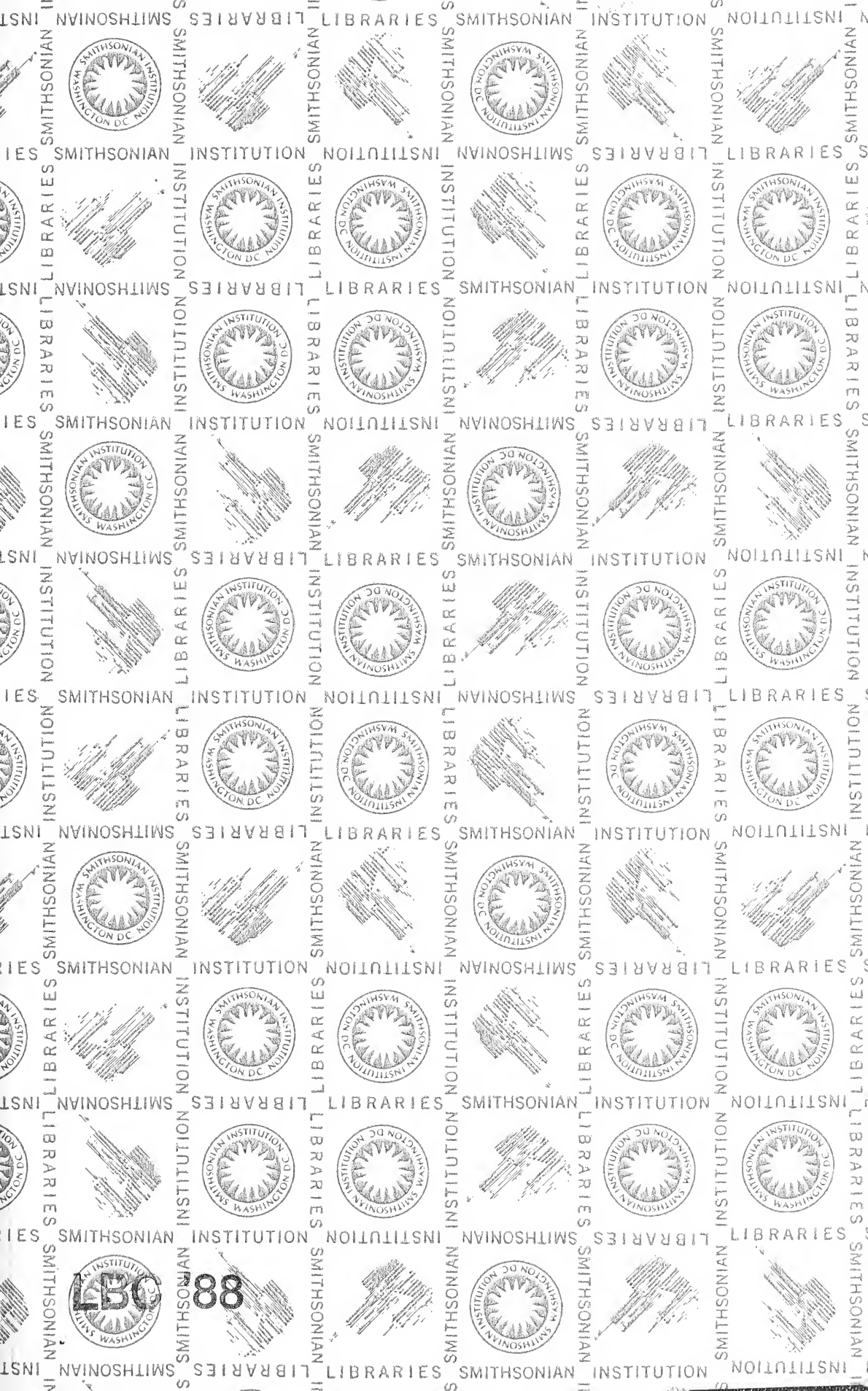

LBC

88

SMITHSONIAN INSTITUTION LIBRARIES



3 9088 01059 4232