



東京帝國大學  
理 科 大 學 紀 要

第 三 拾 八 冊

THE  
JOURNAL

OF THE

COLLEGE OF SCIENCE,  
IMPERIAL UNIVERSITY OF TOKYO.

VOL. XXXVIII.



東京帝國大學印行

PUBLISHED BY THE UNIVERSITY.

TOKYO, JAPAN.

1916—1917.

TAISHO 5-6.

**Publishing Committee.**

Prof. **J. Sakurai**, *LL. D.*, *Rigakuhakushi*, Director of the College (*ex officio*).

Prof. **I. Ijima**, *Ph. D.*, *Rigakuhakushi*.

Prof. **F. Ōmori**, *Rigakuhakushi*.

Prof. **S. Watasé**, *Ph. D.*, *Rigakuhakushi*.



2971

# CONTENTS.

---

- Art. 1.**—Über die Ausflussmenge des Blutungssaftes einiger Bäume.  
Mit 4 Textfiguren. By M. MIYOHJI.—Publ. February 25th, 1916.
- Art. 2.**—A monograph of Japanese Ophiuroidea, arranged according  
to a new classification. With 7 plates. By H. MATSUMOTO.—  
Publ. March 31st, 1917.
- Art. 3.**—The great eruption of Sakura-jima in 1914. With 24 plates  
and 49 textfigures. By B. KOTO.—December 25th, 1916.
- Art. 4.**—Contributionen novae ad floram bryophyton japonicam. Pars  
.secunda. With 42 textfigures. By S. OKAMURA.—Publ. July  
25th, 1916.
- Art 5.**—On some Japanese calcareous sponges belonging to the  
family Heteropiidæ. With 2 plates. By I. HÔZAWA. —Publ.  
September 30th, 1916.
- Art. 6.**—Injection Experiments on Plants. With 2 plates. By Y.  
YENDO.—Publ. May 15th, 1917.

11151





# Über die Ausflußmenge des Blutungssaftes einiger Bäume.

Von

**Manabu MIYOSHI,**

*Rigakushi, Rigakuhakushi.*

*Professor der Botanik an der Kaiserlichen Universität zu Tokyo.*

---

Mit 4 Textfiguren.

---

Unter den in Japan einheimischen Baumarten zeigen nach meinen Untersuchungen *Cornus controversa* HEMS.<sup>1)</sup> und *Carpinus jedoensis* MAXIM. einen hohen Blutungsdruck, welcher bis zwei Atmosphären erreicht.<sup>2)</sup>

Gleichzeitig mit den Messungen des Blutungsdruckes wurde auch die tägliche Menge des Blutungssaftes, welcher aus einem an der Stammbasis gemachten Bohrloch ausfloß, beobachtet.

Die Hauptergebnisse, die ich im Folgenden mitteile, stimmen einerseits mit den Resultaten früherer Forscher überein, zeigen andererseits aber einige Eigentümlichkeiten unserer Versuchspflanzen.

Die beiden Baumarten, mit denen ich experimentierte, stehen

---

1) Nach der in neuerer Zeit zuerst von HEMSLEY (Botanical Magazine T. 8261, 1909) vorgeschlagenen Benennung sollte unser Baum, welcher undeutlich alternierende Blätter besitzt, statt *macrophylla*, *controversa* heißen. Um Verwechslung zu vermeiden ist unsere Pflanze mit dem neuen Namen bezeichnet.

2) Über den Blutungsdruck bei *Cornus macrophylla* vergl. MIYOSHI, Botan. Centralb. Bl. LXXXIII. No. 11. 1900; Ber. Deutsch. Botan. Ges. Bd. XXVII. p. 457. 1900; Ann. d. Jard. Bot. de Buit. 2. ser. suppl. III. p. 97. 1909.

im Botanischen Garten der Universität zu Tokyo. Der Umfang des Stammes ca 50 cm über dem Boden mißt bei *Cornus* 1,66 m und bei *Carpinus* 2,35 m. Das Bohrloch, welches ca 2,3 cm breit und ca. 5 cm tief war, befand sich bei beiden Bäumen ca 50 cm über dem Boden. Das Loch wurde üblicherweise mittelst eines durchlöcherten Gummistöpsels fest verstopft, und durch den letzteren ging ein Glasrohr ins Loch hinein, um den ausfließenden Saft weiter durch ein Gummirohr ins große Meßgefäß abzuleiten. Um den Verschuß zu sichern, wurde die Ansatzstelle des Gummistöpsels mit einer Schicht Paraffin-Kolophonium überzogen.

Das Zeichen des ersten Saftausflusses kann man in Tokyo bei *Carpinus* schon am Anfang oder in der Mitte Januar und bei *Cornus* am Ende desselben Monats beobachten. Die Zeit ist aber von dem Standorte des Baumes abhängig; an besonnten Stellen wird sie früher eintreten als an schattigen.

Die tägliche Zunahme der Ausflußmenge im Januar und Februar ist kaum zu erkennen, vielmehr zeigt sie durch äußere Einflüsse bedeutende Schwankungen. Erst mit dem Eintritt der Frühlingswitterung (höhere Temperatur und größere Niederschläge) im März nimmt der Ausfluß auffallend zu. Gegen Ende März oder Anfang April erreicht die Ausflußmenge ihren maximalen Wert, indem sie bei *Cornus* auf 17 l und bei *Carpinus* auf 40 l pro 24 Stunden steigt.<sup>1)</sup> Kurz nach dem Maximum nimmt die Menge ab, bis der Ausfluß gewöhnlich Mitte April vollständig aufhört. Durch die Einflüsse der Witterung und andere Umstände, vornehmlich Verstopfung (siehe unten), zeigt der Kurvenverlauf der Saftmenge manche Unregelmäßigkeiten.

Bevor ich in die Erörterung störender Ursachen eingehe, ist

---

1) Über die Ausflußmengen von *Cornus* und *Carpinus* habe ich bereits in meinen in japanischer Sprache geschriebenen Handbüchern, „Die Pflanzenwelt Japans,“ 1910, p. 41, und „Vorlesungen über Botanik,“ 4. Aufl. Bd. I, 1911, p. 518, einiges mitgeteilt.

es angebracht als Beispiele die Ausflußmengen der Jahre 1911 und 1914 in folgenden Tabellen anzugeben.

TAB. I.<sup>1)</sup>

Zeit <sup>2)</sup>	Ausflußmenge in Litern			Temperatur <sup>3)</sup>		Relative Feuchtigkeit %	Witterung	Bemerkung
	<i>Cornus controversa</i> I. Baum	<i>Cornus controversa</i> II. Baum	<i>Carpinus japonensis</i>	Maxima C	Minima C			
23. I. 1911.	etwas	etwas	0,550	7°	-1.8°	50.7	klar	
24	0	0	0,175	3.9°	-1.1°	52.6	„	
25	0	0	0,866	8.7°	-3.5°	67.9	„	
4. nachm. 26	0,039	0,026	2,700	11.1°	-2.2°	62.2	trüb	
10. vorm. 27	0,002	0,009	0,440	8.1°	1.4°	59.7	„	
4. nachm. „			0,830					
Summe			1,270					
28	0	0	0	3.7°	0.4°	91.8	Regen	
29	0,063	0,021	1,840	12.4°	3.6°	82.5	trüb	
30	0,004	0	0,260	11.2°	2.4°	81.3	„	
31	0	0	0	7.6°	5.0°	92.3	Regen	
1. II.	0,005	0	0,031	10.5°	4.0°	93.3	trüb	
4. nachm. 2	0,075	0	0,776	14.3°	3.4°	73.1	klar	
3	0	0	0,088	10.0°	-0.1°	53.7	„	
4. nachm. 4	0	0	1,036	8.7°	-1.8°	53.1	klar	
5	0,001	0	1,125	10.3°	-1.8°	62.0	„	
6	0	0	1,050	10.1°	-2.1°	56.6	„	Um 4.30 nachm. bei <i>Cornus</i> I u. II 1.5 liter tiefer gebohrt
4. nachm. 7	0	0	0,588	8.8°	-3.8°	59.3	„	
4. nachm. 8	0	0	1,350	9.8°	-2.2°	65.6	trüb	
9	0	0	0,172	6.5°	-0.1°	45.0	klar	
10	0	0	0,119	8.3°	-3.4°	56.1	„	Der Saft mehr oder weniger getrübt;

1) Die Messungen der Ausflußmenge wurden von meinem früheren Assistenten Herrn Dr. K. KORIWA übernommen.

2) In dieser und den folgenden Tabellen ist die Saftmenge von Mittag zu Mittag angegeben, sonst ist die Zeit der Messung stets erwähnt.

3) Die Ziffern der Temperatur und Feuchtigkeit sind aus dem amtlichen Wetterberichte des Zentralen Meteorologischen Observatoriums in Tokyo entnommen.

Zeit	Ausflußmenge in Litern			Temperatur		Relative Feuchtigkei- tigkeit %	Witterung	Bemerkung
	<i>Cornus controversa</i> I. Baum	<i>Cornus controversa</i> II. Baum	<i>Carpinus jedoensis</i>	Maxima C	Minima C			
11	0	0	0,158	16.1°	-1.5°	58.4	klar	Trübung deutlicher.
12. II.	0	0	0,004	9.9°	1.1°	44.2	„	Stark getrübt
13	0	0	0	10.2°	1.0°	50.7	„	
14	0	0	0,635	12.3°	2.9°	73.4	trüb	Bei <i>Carpinus</i> Loch tiefer gebohrt
4. nachm. 15	0	0	<b>2,279</b>	18.6°	6.7°	77.5	Regen	
16	0	0	1,420	12.0°	3.5°	46.7	klar	
17	0	0	0	6.1°	0.9°	55.7	„	
18	0	0	0,011	5.5°	0.1°	53.9	trüb	
19	0	0	0,120	6.5°	-1.3°	48.4	klar	
20	0	0	0,070	7.9°	-3.3°	51.6	„	Alte Löcher geschlossen, neue Löcher gebohrt
4. nachm. 21	<b>0,470</b>	<b>0,042</b>	<b>0,389</b>	10.5°	-2.5°	54.7	trüb	Effekt der Löchererneuerung schon deutlich
22	0,013	0,011	0,035	8.8°	0.3°	64.9	klar	
23	0,160	0,090	0,018	11.2°	-0.5°	54.4	„	
24	0	0	0	5.5°	1.4°	76.3	trüb	
25	0,176	0,100	0	11.0°	3.8°	85.1	Regen	
26	0	0	0	9.3°	6.3°	80.7	trüb	
10. vorm. 27	1,175	0,627	—	14.0°	4.5°	71.3	„	Bei <i>Carpinus</i> , altes Loch geschlossen, neues Loch gebohrt
4. nachm. „	1,310	0,380	3,410					
Summe	2,485	1,007	—					
10. vorm. 28	1,210	0,270	1,750					
4. nachm. „	0,770	0,170	1,830	10.4°	6.8°	73.6	trüb	
Summe	1,980	0,440	3,580					
4. nachm. 1. III	3,010	1,070	7,390	14.3°	7.0°	87.3	Regen	Der Saft bei <i>Cornus</i> I etwas getrübt
10. vorm. 2	2,400	0,990	10,360					
4. nachm. „	0,870	0,340	5,000	17.3°	3.3°	64.0	trüb	Effekt der Bohrlöchererneuerung deutlich
Summe	3,270	1,330	<b>15,360</b>					
10. vorm. 3	1,120	0,655	6,230					
4. nachm. „	0,410	0,260	2,120	13.4°	0.1°	65.5	trüb	Bei <i>Carpinus</i> Trübung durch weiße Hefemassen
Summe	1,530	0,915	8,650					
10. vorm. 4	0,610	0,490	0,590					
4. nachm. „	0,390	0,240	1,070	13.5°	0.4°	58.0	klar	
Summe	1,000	0,730	1,660					
4. nachm. 5	0,590	0,490	0,640	13.3°	2.8°	55.0	„	

Zeit	Ausflußmenge in Litern			Temperatur		Relative Feuch- tigkeit %	Witter- ung	Bemerkung
	<i>Cornus con- troversa</i> I. Baum	<i>Cornus con- troversa</i> II. Baum	<i>Carpinus yedoensis</i>	Maxima C	Minima C			
10. vorm. 6	0,185	0,500	0,070	14.6°	4.5°	71.8	trüb	
4. nachm. „	0,062	0,251	0,070					
Summe	0,247	0,751	0,140					
10. vorm. 7	0,160	0,255	0,865	18.8°	6.4°	58.5	Regen	Löcher tiefer gebohrt
4. nachm. „	0,070	0,090	0,275					
Summe	0,230	0,345	1,140					
10. vorm. 8	4,530	2,350	11,280	13.6°	2.9°	57.2	klar	
4. nachm. „	2,025	0,880	4,550					
Summe	6,555	3,230	15,830					
10. vorm. 9	5,020	2,490	9,840	19.2°	6.4°	74.4	„	Effekt der Löcher- vertiefung ist deutlich
4. nachm. „	2,170	0,850	6,600					
Summe	<b>8,190</b>	<b>3,340</b>	16,440					
10. vorm. 10	5,400	2,160	12,560	11.0°	4.2°	81.7	trüb	
4. nachm. „	1,790	0,590	6,420					
Summe	7,190	2,750	<b>18,980</b>					
10. vorm. 11	5,340	1,450	11,380	4.4°	0.3°	90.0	Schnee	
4. nachm. „	1,690	0,410	3,610					
Summe	7,030	1,860	14,990					
4. nachm. 12	5,750	1,080	8,150	9.1°	-2.6°	71.7	klar	
10. vorm. 13	4,450	1,130	4,980	18.6°	4.1°	83.7	trüb	
4. nachm. „	1,630	0,390	4,240					
Summe	6,080	1,520	9,220					
10. vorm. 14	5,370	1,160	5,790	12.5°	7.4°	94.7	„	
4. nachm. „	1,900	0,360	1,422					
Summe	7,270	1,520	7,212					
10. vorm. 15	5,030	0,960	1,490	13.0°	4.7°	57.9	trüb	Altes Loch bei <i>Car- pinus</i> geschlossen, neues Loch gebohrt
4. nachm. „	1,650	0,330	0,270					
Summe	6,680	1,290	1,760					
10. vorm. 16	3,750	0,735	18,300	8.2°	3.3°	73.9	klar	Effekt der Löcher- erneuerung ist deutlich
4. nachm. „	1,320	0,250	5,000					
Summe	5,070	0,985	<b>23,300</b>					
10. vorm. 17	3,080	0,680	7,050	5.2°	0.5°	94.4	Schnee	
4. nachm. „	1,300	0,210	3,070					
Summe	4,380	0,890	10,120					
10. vorm. 18	3,820	0,640	7,670	16.1°	5.1°	73.9	trüb	
4. nachm. „	1,370	0,220	4,800					
Summe	5,190	0,860	12,470					
4. nachm. 19	5,450	0,800	12,500	8.8°	1.0°	69.6	Regen	
10. vorm. 20	3,450	0,510	3,850	9.3°	0.1°	43.4	klar	
4. nachm. „	1,200	0,180	1,800					
Summe	4,650	0,690	5,650					

Zeit	Ausflußmenge in Litern			Temperatur		Relative Feuch- tigkeit %	Witter- ung	Bemerkung
	<i>Cornus con- troversa</i> I. Baum	<i>Cornus con- troversa</i> II. Baum	<i>Curpinus yedoensis</i>	Maxima C	Minima C			
10. vorm. 21	3,100	0,425	1,125	9.5°	0.8°	45.4	klar	
4. nachm. „	1,220	0,160	3,100					
Summe	4,320	0,585	4,225					
10. vorm. 22	2,850	0,405	0,550	9.3°	1.8°	67.9	trüb	
4. nachm. „	1,050	0,140	1,950					
Summe	3,900	0,545	2,500					
10. vorm. 23	2,930	0,410	1,650	9.6°	5.6°	83.7	„	
4. nachm. „	1,000	0,150	1,250					
Summe	3,930	0,560	2,900					
10. vorm. 24	2,980	0,430	2,950	10.4°	4.9°	69.0	Regen	
4. nachm. „	1,120	0,140	0,880					
Summe	4,100	0,570	3,830					
10. vorm. 25	3,110	0,390	1,350	12.1°	3.1°	67.4	„	
4. nachm. „	0,950	0,130	0,530					
Summe	4,060	0,520	1,880					
10. vorm. 26	1,980	0,375	0,970	11.0°	3.9°	81.7	„	
4. nachm. „	0,760	0,125	0,240					
Summe	2,740	0,500	1,210					
4. nachm. 27	0,360	2,790	0,440	17.0°	2.8°	76.3	klar	
4. nachm. 28	0,170	2,230	0,370	16.7°	4.3°	59.1	„	Das Loch bei <i>Car- pinus</i> tiefer gebohrt
11. nachm. 28			11,270					
10. vorm. 29	1,450	0,265	17,850	18.6°	6.7°	72.2	trüb	
4. nachm. „			11,150					
Summe			<b>40,270</b>					Effekt der Lochver- tiefung sehr deut- lich
11. nachm. 29			7,500					
10. vorm. 30	1,190	0,100	11,050	13.8°	8.4°	81.5	„	
4. nachm. „			8,640					
Summe			27,190					
11. nachm. 30			7,650					
10. vorm. 31	0,950	0,085	12,050	19.4°	6.9°	53.6	Regen	
4. nachm. „			4,920					
Summe		0,085	24,620					
4. nachm. 1 IV	—	0,050	7,950	10.6°	1.6°	41.9	trüb	
4. nachm. 2	0,530	0,030	2,750	12.5°	-1.1°	57.0	„	
4. nachm. 3	0,360	0,010	1,280	8.4°	5.1°	87.0	„	
4. nachm. 4	0,150	—	0,430	17.6°	6.9°	57.5	„	
4. nachm. 5	0,060	0	0,020	17.0°	6.7°	50.1	„	
4. nachm. 6	0,020	0	0	19.5°	8.0°	44.2	klar	

TAB. II.\*

Zeit	Ausflußmenge in Litern		Durchschnittliche Temperatur C	Relative Feuchtig-keit %	Witterung	Bemerkung
	<i>Cornus con-troversa</i>	<i>Carpinus jedoensis</i>				
11. vorm. 7 III. 1914	2.4	2.0	17.9°	65.5	etwas geregnet	
8	3.4	2.2	13.5°	45.5	klar	
9	3.3	2.7	4.5°	89.7	Regen	
10	4.4	2.4	5.2°	75.7	klar	
11	3.2	3.9	4.7°	71.5	„	
12	8.2	4.5	5.5°	95.0	Regen	
13	9.2	5.7	11.7°	97.5	„	
14	10.4	7.1	7.2°	92.7	„	
9. vorm. 15	11.3	6.2	4.2°	71.0	klar	
16	12.0	4.8	5.4°	57.5	„	
17	9.7	9.9	7.9°	64.6	„	
18	<b>11.9</b>	10.8	9.7°	82.2	etwas geregnet	Gewöhnliches Maximum bei <i>Cornus</i>
19	8.9	19.7	6.3°	49.4	klar	
20	10.7	20.6	8.5°	60.0	„	
21	9.4	20.7	11.1°	82.4	„	
22	11.3	30.2	12.2°	72.7	Regen	
23	11.7	<b>34.5</b>	12.4°	81.6	„	Gewöhnliches Maximum bei <i>Carpinus</i>
24	8.9	34.1	12.9°	95.8	Regen	
4. nachm. 25	10.9	26.8	13.9°	85.6	„	
26	8.2	19.0	9.3°	88.7	„	
27	7.7	14.3	4.0°	74.2	etwas geschneit	
28	7.2	6.2	5.9°	61.0	klar	
29	6.3	1.7	8.1°	65.5	„	
30	5.2	0.5	8.1°	89.6	Regen	
31	4.7	1.4	11.2°	63.2	klar	
1. IV	4.3	0.2	13.2°	57.2	„	
2	4.1	0	9.7°	81.2	„	
3	2.9	0	4.7°	79.7	„	
4	0.4	0	1.1°	71.1	Schnee	
5	0	0	4.6°	67.2	klar	

\* Vorliegende Beobachtungen wurden von meinem Assistenten Herrn Dr. S. HIBINO gemacht.

Die Zifferen in Tab. I zeigen den ganzen Verlauf der täglichen Ausflußmengen, die im letzteren Teile der Blutungsperiode viele Schwankungen erfahren. In der Tabelle sieht man, daß unsere Versuchsbäume in den Tagesstunden also, von 10 Uhr vormittags bis 4 Uhr nachmittags, verhältnismäßig stärker bluteten als in allen übrigen Stunden.

Tab. II stellt die Ausflußmengen eines Abschnittes der Blutungsperiode dar, hier ist der Kurvenverlauf im Gegensatz zu demjenigen der Tab. I beinahe glatt. Auf diesen und anderen Punkte werde ich weiter unten zurückkommen.

Um die äußeren Einflüsse auf die Größe des Ausflusses genauer zu konstatieren, muß man, wie frühere Forscher getan haben, nur mit Topfpflanzen experimentieren.<sup>1)</sup> Bei unseren im Freien stehenden Pflanzen war es natürlich nicht möglich derartige Versuche anzustellen; wir können jedoch unseren wiederholten Beobachtungen gemäß schließen, daß in der kälteren Zeit von Januar bis Anfang oder Mitte März die Temperatur von größter Bedeutung ist, in späteren wärmeren Perioden hingegen die Feuchtigkeit der Luft und des Bodens eine große Rolle spielt.

Fig. 1, 2 und 3 veranschaulichen die eben erwähnten Verhältnisse. Wie man in Fig. 1 und 2 sieht, zeigen die Kurven der Ausflußmenge und Temperatur beinahe gleichartigen Verlauf, die Tage größerer oder geringerer Ausflußmenge fallen mit denjenigen höherer, resp. niederer Temperatur zusammen. In Fig. 3 ist der Einfluß der Feuchtigkeit auf die Ausflußmenge erkennbar, und zwar bei *Carpinus* deutlicher als bei *Cornus*, während der Effekt der Temperatur bei beiden Versuchspflanzen in dem Zeitabschnitte nicht mehr zu voller Geltung kommt. Es muß hier bemerkt werden, daß diese Verhältnisse wegen der Inkonstanz äußerer

1) Vergl. WIELER, Das Bluten der Pflanzen. (COHNS Beitr. z. Biol. d. Pfl. Bd. VI. 1893. p. 48 u. 57), und auch PFEFFER, Pflanzenphysiologie. II. Aufl. Bd. I. 1897. p. 245.



Fig. 1.

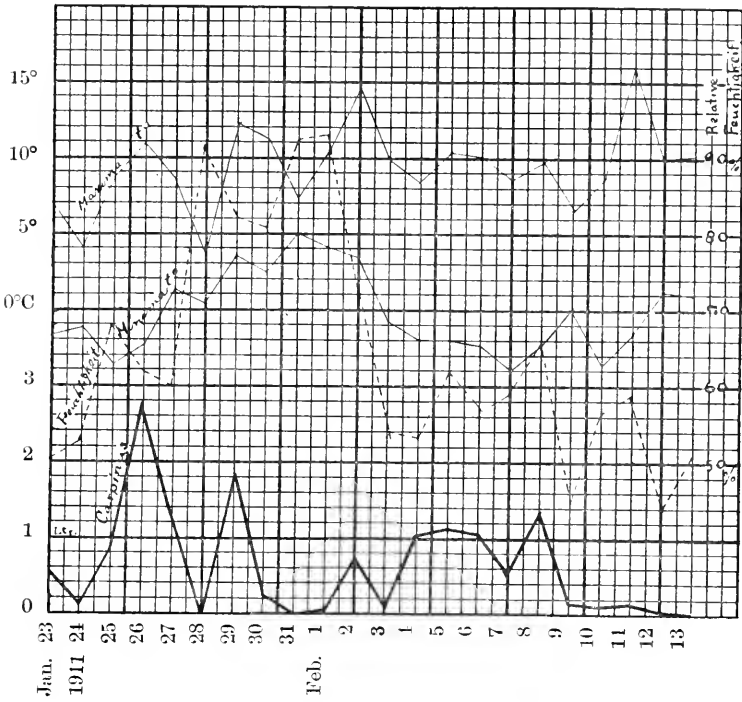

Fig. 2.

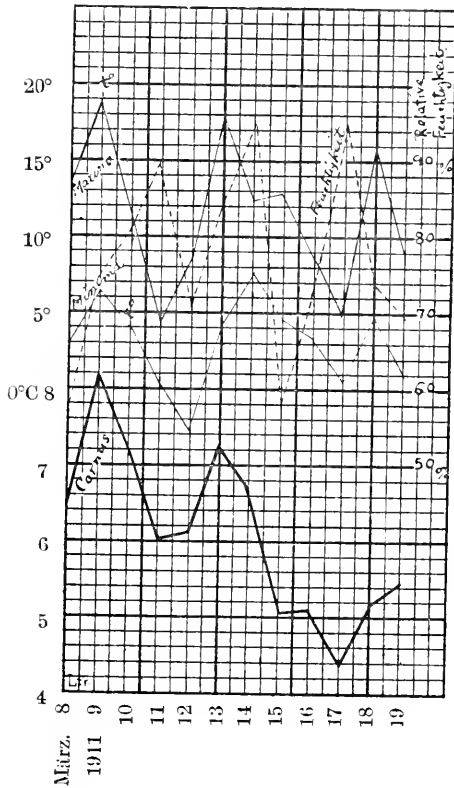
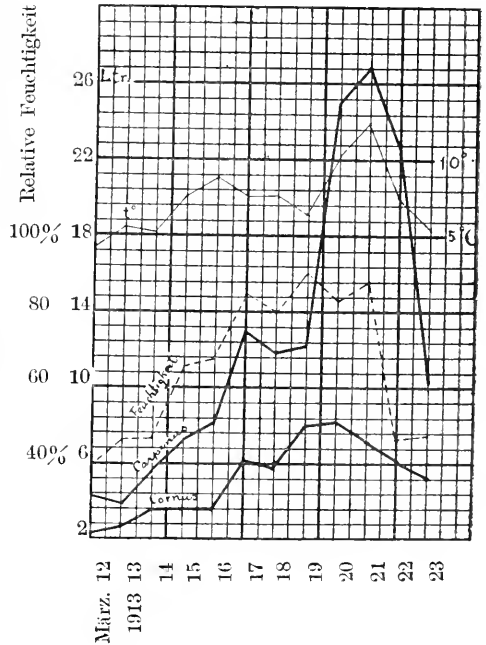

Fig. 3.



Bedingungen nicht immer zu sehen sind, und ferner, daß ein spezifischer, ja sogar individueller Unterschied in dieser Beziehung zu existieren scheint.

Auch dient Tab. III als ein eklatantes Beispiel des Feuchtigkeitseffektes auf die Ausflußmenge. Hier war die Bohrlocherneuerung, die allerdings spät ausgeführt worden ist, wirkungslos geblieben, erst nach einem Regenguß, der bald darauf folgte, trat ein lebhafter Ausfluß ein.

TAB. III.

Zeit	Ausflußmenge in Litern <i>Carpinus</i> <i>jedoensis</i>	Durchschnitt- liche Temperatur C	Relative Feuchtigkeit %	Witterung	Bemerkung
2. IV. 1913	3.0	12.8°	56.4	klar	
3	1.8	12.0°	70.7	..	
4	1.6	12.8°	70.0	..	
5	0.2	14.3°	68.6	..	
6	0	16.6°	67.3	..	
7	0	16.3°	71.3	..	Ein neues Loch wurde gebohrt. Kein Saftausfluß
8	—	12.3°	92.5	frühmorgens Regen	Durch Regen begann der Saftausfluß
9	<b>10.8</b>	5.9°	80.5	Regen	Großer Saftausfluß
10	0.6	7.3°	57.9	klar	Zwischen 1-2 Uhr nachmittags hörte der Saftausfluß auf

Wie in den oben stehenden Tabellen, besonders in Tabelle II ersichtlich ist, nimmt der Ausfluß an den späteren Tagen der Blutungszeit rasch ab, bis er beinahe sistiert. Dies ist aber keineswegs das Zeichen des totalen Aufhörens des Blutens. Denn ein lebhafter, oft erstaunlich großer Saftausfluß wird sogleich erzielt, sobald man der alten Erfahrung gemäß das Loch noch tiefer bohrt, oder den inneren Flächenteil wegscneidet, ev. ein neues Loch aufmacht.

Als Beispiele mögen folgende Fälle bei *Carpinus yedoensis* aus Tab. I. Erwähnung finden.

I. Fall. Am Mittag des 14. Februar wurden 0,635 l Saft für die letzten 24 Stunden gefunden. Sofort wurde das Loch tiefer gebohrt, worauf die Saftmenge bis 4 Uhr nachmittags des nächsten Tages auf 2,278 l stieg. Darauf nahm der Ausfluß bald ab.

II. Fall. Vom 19. mittags bis nächsten Mittag war die Saftmenge 0,070 l. Sodann wurde das Loch geschlossen und ein neues Loch gebohrt. In den folgenden 28 Stunden erreichte die Ausflußmenge 0,389 l. Am Tage darauf floß aber nur wenig Saft aus.

III. Fall. Um 4 Uhr nachmittags des 27. war die Ausflußmenge der vorangehenden 28 Stunden 3,410 l. Es wurde sogleich ein neues Loch gebohrt, aus welchem in den nachfolgenden drei Tagen 3,580, 7,390, resp. 15,360 l Saft pro 24 Stunden flossen. Dann nahm der Ausfluß rasch ab.

IV. Fall. Um 4 Uhr nachmittags des 15. März wurden 1,760 l Saft für die vorangehenden 24 Stunden gefunden. Ein neues Loch wurde sogleich gebohrt und die Ausflußmenge erreichte am nächsten Mittag 23,300 l. Nachher trat eine schnelle Verminderung ein.

V. Fall. Von 4 Uhr nachmittags des 27. bis zu derselben Zeit des nächsten Tages kamen aus dem Bohrloch 0,370 l Saft. Darauf wurde das Loch tiefer gebohrt und in den nachfolgenden drei Tagen flossen 40,270, 27,190 resp. 24,620 l Saft pro 24 Stunden aus. Nachher wurde die Ausflußmenge schnell geringer.

Fig. 4 zeigt auch einen anderen Fall bei *Carpinus* sehr deutlich. Der Saftausfluß hörte schon vom 4. April bis zum Morgen des 8. fast auf. Sodann wurde gegen Mittag ein neues Loch gebohrt, aus welchem 22 l Saft bis nächsten Mittag ausflossen. Obgleich der Ausfluß am folgenden Tage etwas abnahm, erreichte er am

Fig. 4.

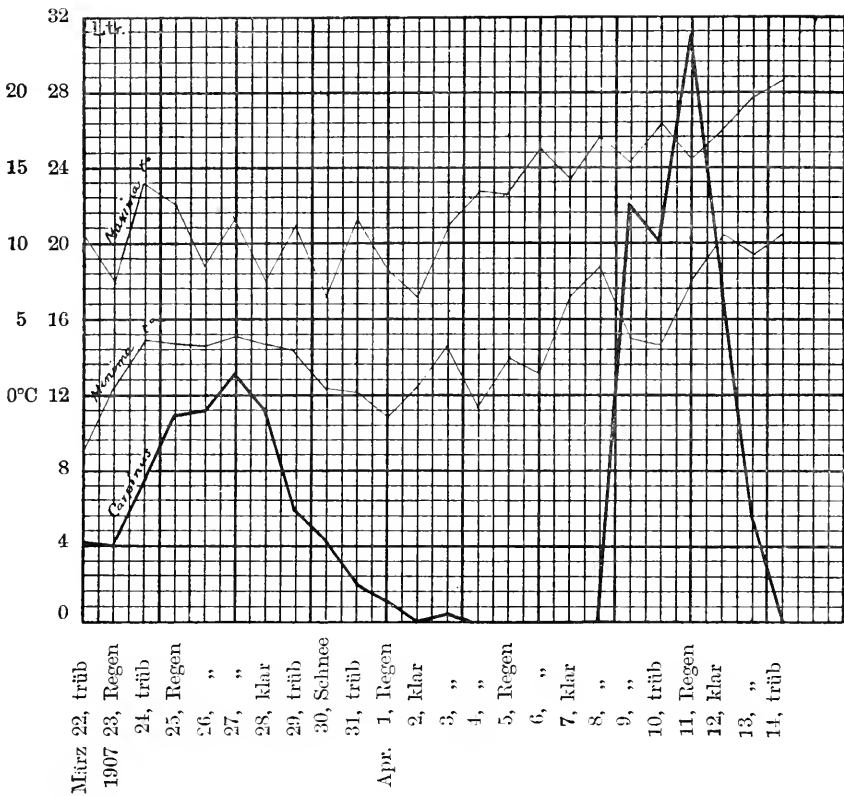

Mittag des 11. in Folge des Regensfalls 31,1 l, also die maximale Menge des Jahres (1907).

Diese Tatsache selbst ist keineswegs neu, auffallend ist nur, daß eine so große Menge Blutungssaft sogleich nach Erneuerung des Bohrlochs ausfloß.

Man kann nun auf dem Kurvenverlauf der Ausflußmenge zweierlei Maxima unterscheiden. Das eine, welches nach einmaliger Bohrung des Lochs erscheint, kann das gewöhnliche Maximum genannt werden, während das andere, welches jedesmal nach der Bohrlocherneuerung eintritt, das ungewöhnliche sein würde. Das letztere ist im Allgemeinen viel höher als das erstere. Tab. II zeigt nur das gewöhnliche Maximum, welches aber durch Bohr-

locherneuerungen wie in Tab. I eine Reihe ungewöhnlicher Maxima hätte folgen lassen.

Die Verminderung des Saftausflusses ist bekanntlich durch Verstopfung des Lochinnern verursacht, in unserem Fall hauptsächlich durch Ansiedelung von Hefen und Bakterien. Daß die Verstopfung gewöhnlich in den späteren Zeitabschnitten der Blutungsperiode eintritt, ist auf diese Tatsache zurückzuführen. Eine oder die andere innere Ursache, wie die Thyllenbildung oder das Eindringen ungelöster Körper, könnte auch vorhanden sein, doch ließ sich bei unseren Versuchsobjekten eine solche nicht sicher ermitteln.<sup>1)</sup>

Schon am Anfang oder Mitte März erfährt nach unseren Beobachtungen der im Meßgefäß sich ansammelnde Blutungssaft nach 24 Stunden eine Trübung. Unter dem Mikroskop findet man in der Flüssigkeit *Torulazellen* und andere hefeartige Organismen, die zuweilen schwache Gärung hervorrufen. Bald beobachtet man an der Mündung des Bohrlochs die Bildung von dichten, weißen Hefeflocken, oft mit Beimengung von Bakterienschleim und Schimmelpilzfäden, die zur Verstopfung der Ausflußbahnen führen. Die Verstopfung hat natürlich einen großen Saftreichtum im Stamminnern zur Folge, und so kann es nicht wundernehmen, daß nach dem Beseitigen dieser Hindernisse sofort wieder ein übermäßiger Ausfluß beginnt. Auch ist begreiflich, warum die Saftmenge nach dem lebhaften Ausfließen bald abnimmt.

Wie groß nun die Verstopfung sein kann, muß je nach den Pflanzenarten ungleich sein; es hängt von strukturellen Eigentümlichkeiten der an der Schnittfläche liegenden Elemente ab. Die Zusammensetzung des Blutungssaftes ist auch für die Entwicklung der zur Verstopfung führenden Organismen maßgebend.

---

1) Über die Verstopfung und ihre Ursache vergl. WIELER, l. c. p. 149 und PFETTER l. c. p. 279.

Für das Leben des Baumes dürfte die zeitig erzielte Verstopfung vorteilhaft sein, indem sie den Baum vor dem ununterbrochenen Ausfluß des Blutungssaftes schützt, der ohne diesen regulatorischen Vorgang durch die Bohrwunde einen beträchtlichen Stoff- und Energieverlust erleiden müßte.

Aus den vorstehenden Beobachtungen geht hervor, daß genaue Untersuchungen über die Ausflußmenge während längerer Zeitdauer einer Blutungsperiode mittelst der üblichen Methode, d. h. durch einmalige Bohrung des Lochs, nicht ausgeführt werden können. Eine lokale Verstopfung findet unvermeidlich statt, nur in der ersten Blutungszeit ist eine solche Störung weniger zu erwarten. Es folgt ferner, daß die früheren Angaben über die tägliche Ausflußmenge der Bohrlochversuche ohne Berücksichtigung des Verstopfungsvorgangs keinen richtigen Maßstab der Blutungstätigkeit darstellen.

Tokyo, Mitte Juli, 1914.\*

---

\* Das Manuskript vorliegender Arbeit, welches ursprünglich an einer anderen Stelle publiziert werden sollte, wurde Ende Juli nach Europa geschickt. Wegen der Verkehrsstörung infolge des bald darauf ausbrechenden Krieges konnte es leider sein Ziel nicht erreichen. Durch die lebenswürdige Bemühung des Herrn PROFESSOR DR. COPELAND, welchem ich an dieser Stelle bestens danke, war es mir möglich das Manuskript, welches inzwischen fast um die Erde gewandert war, vor kurzem zurückgesandt zu erhalten, und dasselbe ist nun in unveränderter Form in diesem Journal publiziert.

Nachträglich sei hier erwähnt, daß eine kurze Mitteilung „über die Ausflußmenge des Blutungssaftes bei *Carpinus jedoensis* MAXIM.“ von mir kürzlich in „The Botanical Magazine“ (Tokyo) Vol. XXIX, No. 316, Oct. 1915 erschienen ist.

**A Monograph of Japanese Ophiuroidea, arranged  
according to a New Classification.**

By

**Hikoshichirô MATSUMOTO,**

Lecturer in the College of Science, Tôhoku Imperial University, Sendai.

---

*With 7 Plates and 100 Figures and 1 Chart in Text.*

---

**Introductory.**

The marine fauna of Japan is interesting by reason of its peculiar facies due to the mingling of tropical and arctic elements. This peculiarity is also apparent in the ophiuran fauna, which is by no means poor in species. The Japanese ophiurans in the collection of the Zoological Institute of the Imperial University of Tokyo number more than one hundred species, but they have not been thoroughly studied. Dr. IZUKA was the first Japanese zoologist who undertook a study of this group, and he was followed by Mr. KAWAMURA, who has kindly handed over to me his drawings and separates of several valuable papers in his possession. To Dr. IZUKA also I am indebted for the use of some publications, and to both gentlemen for helpful advices.

My own study of this group was undertaken at the suggestion of Prof. GOTO, to whom my thanks are due for supervision and the revision of the manuscript. Dr. TAKAHASHI of the First High School and Mr. IKEDA of the Seventh High School have kindly permitted me to study the specimens in their charge. I owe specimens to many other friends, to all of whom my hearty thanks are due. Especially, I have received a great help from Dr. HURBERT L. CLARK of the Museum of Comparative Zoology at Harvard College, in the form of many precisely determined specimens in his charge and of some very helpful advices, and my best thanks are due to him; and it was due to his kind suggestion that a preliminary paper of the present study was published in America. Finally, I ever recall in mind my friend, HIDEKI CHIBA, who met with an untimely death a few days after assisting me in dredging for my materials in the Sagami Sea, and to his memory I dedicate the present paper.

My original purpose in undertaking the present study was merely to identify and name species. But I soon found that, the classifications of *Ophiuroidea* hitherto proposed were very unsatisfactory. Indeed, their imperfections became a haunt to me; so I determined to adopt a new classification of my own.

For this purpose, I have dissected representatives of as many genera as are accessible to me; and the following are some of the more important results obtained.

### A. Morphological.

1. Those forms that have arms, which are capable of being coiled vertically, have very compact oral skeleton: the adoral shields are entirely proximal to the oral shield, being firmly united to it; the oral frames are very stout, those of the same radius



being firmly united together; the peristomial plates are entire and more or less soldered to the oral frames; &c. The vertebrae are very short and stout and have streptospondyline articulation; and all or some arm spines are converted into compound hooks. E. g. *Ophiobryinae* mihi; *Trichasteridae* mihi; *Gorgonocephalidae*, *Ophiacanthidae* pars; *Hemicuryalidae* mihi; *Ophiopholis*; and *Ophiotrichidae* pars (certain forms, as *Ophiopholis* and *Ophiotrichidae* pars, in which the tendency of coiling of the arms is not very strong, have, however, rather zygospondyline articulation of the vertebrae).

2. The more or less divided vertebrae are found only in certain genera with horizontally flexible arms, but never in those forms in which the arms are capable of being coiled vertically. These two results are evidently serious objections to BELL'S classification, because the greater part of BELL'S *Streptophiuræ* have, according to my own observations, horizontally flexible arms and more or less divided vertebrae, of which the articulation is typically zygospondyline, instead of being "primitive streptospondyline."<sup>1)</sup> For the same reason, I am unable to believe that, GREGORY'S Palæozoic *Streptophiuræ*, or STÜRTZ'S *Protophiuræ* have streptospondyline articulation of the vertebrae.

3. The more or less divided vertebrae are of two kinds.

a. Those which are divided into halves by a single fusiform pore, are found in those forms in which the dorsal side of the arms is more or less unprotected. E. g. *Ophiohelus*; *Ophiogercn*; *Ophiosciasma*; *Ophiostiba*; *Ophichyalus*; *Ophiomyxa*; &c.

---

1) As to the imperfection of BELL'S classification, see the following papers:—IGERNA B. J. SOLLAS, On *Oncyroaster*, a Carboniferous Brittle-Star; Philos. Transact. Ser. B, Vol. 204, 1913;—TH. MORTENSEN, On the Alleged Primitive Ophiuroid, *Ophioterresis elegans* BELL, &c.; Mindeskr. for JAPETUS STEENSTRUP, 1913.

b. Those which are divided into halves by a series of small pores or by a moniliform pore, are found in those forms in which the dorsal side of the arms is entirely protected. E. g. *Microphiura*; *Ophiologimus*; *Ophiothammus* emend.; “*Ophiactis*” pars, i.e. my *Amphiactis*; “*Ophioconis*” pars, i.e. my *Ophiuroconis* and *Ophiurodon*; *Astrophiura*; &c.

4. Those forms with quadrangular and stout teeth have oral frames with well developed lateral wings for the attachment of voluminous masticatory muscles. E. g. *Amphiuridae* mihi; *Ophiotrichidae*; *Ophioceramis*; *Ophionereidinae* mihi; and *Ophiocomidae*.

### B. Systematic.

1. *Astroceras*, *Trichaster* and *Euryale* have a certain common structure, by which they may be distinguished from either *Asteronyx* or *Asteroschema*.

2. *Astrotoma* and its allies have a certain distinctive character in contrast to *Asteroporpa*, *Astrochele*, *Gorgonocephalus*, *Astrodrum*, *Astrocladus* and their allies.

3. The *Amphiuridae* mihi and *Ophiotrichidae* stand in a very intimate relation in their internal structures.

4. “*Ophiactis*” pars, i.e. my *Amphiactis* is a connecting link between the *Ophiacanthidae* and *Amphiuridae*.

5. The *Ophiolepididae*, *Ophiodermatidae* and *Ophiocomidae* form together another compact group.

6. The “*Amphiuridae*” pars, i.e. my *Ophiochitonidae* are by no means allied to the genuine *Amphiuridae*, but are very near to the *Ophiodermatidae* and *Ophiocomidae*.

7. *Ophiopsila* is, as a matter of fact, nothing else than an ally of the *Ophiocomidae*.

8. “*Ophioconis*” pars, i.e. my *Ophiuroconis* and *Ophiurodon*,

and "*Ophiochaeta*" pars, i.e. my *Ophiurochaeta*, may be clearly distinguished from *Ophiolimna* emend. by certain internal structures.

Prefixing so much, I now proceed to the exposition of my own views, leaving them to be judged by their own merits.

I have several representatives of Palæozoic ophiurans in hand, and I purpose to publish a revision and classification of them in the near future.

The greater part of the present study was done in the Zoological Institute of the Imperial University of Tokyo, to which the type specimens of all the new species described in this paper belong. Such new genera as *Astrothamnus*, *Ophiosemnotes*, *Haplphiura*, *Amphiophiura*, *Ophiozonella*, *Ophiuroconis*, *Ophiurochaeta*, &c., are directly or indirectly based upon the specimens in Dr. H. L. CLARK'S charge. All the text and plate figures in this paper were drawn by me.

#### Subclass I. **ÆGOPHIUROIDA** MATSUMOTO.

*Ophiuroidea* with external ambulacral grooves and without ventral arm plates. Radial shields, genital plates and scales, oral shields, peristomial plates and dorsal arm plates also absent. Ambulacral plates alternate or opposite; in the latter case, they may often be soldered in pairs to form the vertebrae. Adambulacral plates, i.e. lateral arm plates, subventral in position. Madreporite either dorsal or ventral, often large and similar in shape to that of an asteroid.

This subclass mostly consists of Palæozoic forms, and lacks all the fundamental characters by which the recent ophiurans are clearly distinguished from the asteroids. Indeed, the distinction of

the present subclass from the asteroids depends merely upon the different development of certain common structures.

### Subclass II. **MYOPHIUROIDA** MATSUMOTO.

*Ophiuroidea* without external ambulacral grooves, and with ventral arm plates. Radial shields, genital plates and scales, oral shields, peristomial plates and dorsal arm plates usually present; but sometimes, some or all of them may be rudimentary or absent. Ambulacral plates opposite, usually completely soldered in pairs to form the vertebræ. Madreporite represented by one, or sometimes all, of the oral shields.

This subclass includes certain Palæozoic forms and all the ophiurans from the Mesozoic downwards.

The Palæozoic *Myophiuroida* appear to me to represent a distinct order by themselves; but I defer the question to a future paper.

#### Order i. **PHRYNOPHIURIDA** MATSUMOTO.

Disk and arms covered by skin. Radial shields either very rudimentary or long and bar-like. The radial shield and genital plate of either side of each radius articulate with each other by means of a simple articular face or a transverse ridge of either plate. Peristomial plates large, entire, double or triple. Oral frames entire, without well developed lateral wings. Lateral arm plates subventral or ventral in position, while the dorsal arm plates are either entirely absent or rudimentary, so that the dorsal side of the arms is mostly unprotected. Vertebral articulation zygospondyline or streptospondyline.

**Key to families of *Phrynophiurida*.**

- A*—Radial shields very rudimentary or more or less long and bar-like; arms not exceedingly long, always simple; lateral arm plates sub-ventral in position; arm spines not confined to the ventral side of the arm; vertebræ rather slender, not exceedingly short and discoidal; vertebral articulation either zygospondyline or streptospondyline; both upper and lower muscular fossæ of the vertebræ large. . . . . *Ophiomyxidæ*.
- AA*—Radial shields very long and bar-like; arms exceedingly long, either simple or branched; lateral arm plates ventral in position; arm spines confined to the ventral side, all serving as tentacle scales; vertebræ very stout, exceedingly short and discoidal; vertebral articulation typically streptospondyline; upper muscular fossæ of the vertebræ extremely large, the lower very small.
- a*—Teeth very stout, arranged in a single vertical row; oral and dental papillæ not very well developed; adoral shields very stout; arms not annulated by rows of hook-bearing granules; arm spines covered by thick skin. . . . . *Trichasteridæ*.
- aa*—Teeth and dental papillæ, often also oral papillæ, all similar, spiniform; adoral shields not very stout; arms annulated by double rows of hook-bearing granules; arm spines naked or covered by very thin skin. . . . . *Gorgonocephalidæ*.

**Family 1. *Ophiomyxidæ* (LJUNGMAN, 1866) mihi, 1915.**

Disk and arms covered by a soft skin. Radial shields very rudimentary or more or less long and bar-like. The radial shield and genital plate articulate with each other by a simple face. Genital scales slender, bar-like, articulated with the genital plate at a distance inwards from the outer end of the latter. Peristomial plates very large, either double or triple, and thin or entire and

very thick. Oral frames either long and slender or short and very stout, without well developed lateral wings. Arms slender, not exceedingly long, always simple. Dorsal arm plates absent or rudimentary, lateral arm plates subventral in position, so that the dorsal side of the arms is mostly unprotected. Arm spines not confined to the ventral side, skin-covered. Vertebrae rather slender, not very short and discoidal, often incompletely calcified and more or less divided into halves by a longitudinal, fusiform pore. Vertebral articulation zygospondyline, the articular peg being well developed, or streptospondyline, the peg being very rudimentary or entirely absent. Both upper and lower muscular fossæ large.

This family includes twenty-two genera, which may be grouped into two subfamilies as follows :

Subfamily 1. *Ophiomyxine* mihi, 1915.—Oral shields small, separated from the first lateral arm plates by the outer lobes of the long and slender adoral shields; vertebrae long and very slender, often divided into halves; wings of the vertebrae very much thinner laterally than dorsally, so that the vertebrae are fairly rhomboidal in dorsal view; vertebral articulation zygospondyline, the articular peg being well developed.

I. Second oral tentacle pores opening outside the oral slits.

a. Teeth present, arranged in a single vertical row.

*Ophiohelus* LYMAN, 1880.

*Ophiosciasma* LYMAN, 1878.

*Ophiogeron* LYMAN, 1878.

*Astrogeron* VERRILL, 1899.

*Ophiostyracium* CLARK, 1911.

*Ophiocynodus* CLARK, 1911.

b. Teeth almost absent.

*Ophiosyngus* CLARK, 1911.

*Ophioleptoplax* CLARK, 1911.

II. Second oral tentacle pores opening entirely within the oral slits.

a. Teeth and oral papillæ acute, not widened and serrate.

*Ophioscolex* MÜLLER & TROSCHER, 1842.

*Neoplax* BELL, 1884.

*Ophiostiba* MATSUMOTO, 1915.

*Ophiomora* KØHLER, 1907.

b. Teeth and oral papillæ widened and serrate along the free end:

*Ophiohyalus* MATSUMOTO, 1915.

*Ophiomyxa* MÜLLER & TROSCHER, 1842.

*Ophiodera* VERRILL, 1899.

*Ophiohymen* CLARK, 1911.

Subfamily 2. *Ophiobyrsince* MATSUMOTO, 1915.—Oral and adoral shields very thick, intimately joined to each other, the latter being entirely proximal to the former; vertebræ short and stout, always entire; wings of the vertebræ very thick laterally as well as dorsally; vertebral articulation streptospondyline, the articular peg being very rudimentary or entirely absent.

I. Oral shields absent, except in one interradius; a single genital slit to each interradius.

*Ophioschiza* CLARK, 1911.

II. Oral shields well developed; two genital slits to each interradius.

*Ophiophrizus* CLARK, 1911.

*Ophiobyrsa* LYMAN, 1878.

*Ophiobyrsella* VERRILL, 1899.

*Ophiosmitax* MATSUMOTO, 1915.

*Ophiobrachion* LYMAN, 1883.

The difference between the *Ophiomyxinae* and *Ophiobyrsinae* appears to me to be very sharp, especially in the internal structures. In *Ophiodera anisacantha*, the peristomial plates are triple, the unpaired one filling up, like a wedge, the outer open angle formed by the paired ones, which are very long and boot-shaped. The oral frames are stout, with a distinct groove for the ambular canal. The first few vertebrae are very short, with very thin wings. The genital plates are very slender, articulating with the genital scale at a distance inwards from the outer end. The articulation of the genital plate and radial shield is very simple, without any articular condyle or pit. Each vertebra outside of the base is composed of a slender body and very thin wings. The vertebral articulation is zygospondyline. The articular peg is well developed, connected with the halves of the articular shoulder by a short, narrow ridge, so that the whole trio is shaped like an **M**, of which the upper open angle corresponds to the pit for the articular umbo and the lower open angles to the pits for the articular knobs of the next vertebra. The articular umbo is very stout, elongated rhomboidal, while the articular knobs are rather feeble, separated from each other by the pit for the articular peg. In *Ophiomyxa flaccida* MÜLLER & TROSCHEL and *O. australis* LÜTKEN, the peristomial plates are double, nearly soldered together; especially in very small specimens of the last species, the double plates are very firmly soldered together, so as to appear almost entire. The vertebral articulation of the last species is rather peculiar: the trio of the articular peg and halves of the articular shoulder are closely set side by side, so as to appear like a united mass leaving a furrow-like pit for the articular umbo of the next vertebra above them; the articular umbo is very prominent, while the articular knobs are scarcely developed, being represented only



by two insignificant ridges between the pits for the articular peg and the halves of the articular shoulder. In *Ophiohyalus gotoi* the peristomial plates are usually double, with oblong halves, but are triple in some interradii, the unpaired one being quadrangular and overlapping the paired ones. In *Ophiostiba hidekii* the peristomial plates are double, often with unequal halves, one of which overlaps the other. According to LYMAN, *Ophioscolex glacialis* MÜLLER & TROSCHEL has triple peristomial plates and slender, cylindrical oral frames, without distal wings.<sup>1)</sup>

In *Ophiobyrsa rudis* LYMAN, the internal structures of which were studied by LYMAN, the characteristics of the *Ophiobyrsina* appear to be well realised. The whole oral skeleton is very compact. The peristomial plates are entire, stout, intimately soldered to the oral frames, which are also stout. The radial shields, as well as the genital plates and scales, are comparatively small, the plates and scales bounding only the outer part of the long genital slits. The vertebræ are stout, short, more or less discoidal, the wings being very thick laterally as well as dorsally; a number of basal vertebræ are especially discoidal, like those of the next two families. The vertebral articulation is perfectly streptospondyline, the articular peg being entirely absent. The articular shoulder is divided into two long, stout, parallel condyles by a median groove. The articular umbo is very stout, the downward prolongation connected without any boundary with the upward prolongation of the soldered mass of the articular knobs, so that the whole of the umbo and knobs taken together is long dumb-bell shaped. In *Ophiosmilax mirabilis* the vertebral articulation is essentially similar, but there persists a well marked line of contact between the articular umbo and the soldered mass of the articular knobs.

---

1) This peculiarity will be discussed in a future paper.

In both species, the upper and lower muscular fossæ are both large, a characteristic of the "common ophiurans" in contrast to the next two families, to which the *Ophiobrysinæ* rather approach in almost all characters.

### Key to Japanese genera of *Ophiomyxinae*.

- A*—Second oral tentacle pores opening outside the oral slits.
- a*—Disk free of spines; radial shields absent; arm spines not very conspicuously thorny; a few oral and dental papillæ present; no teeth.
- b*—Dorsal arm plates entirely absent; arm spines connected together by a web-like membrane..... *Ophiosyzygus*.
- bb*—Rudimentary dorsal arm plates present, entire and hyaline; arm spines free from each other. .... *Ophiodeptoplax*.
- aa*—Disk beset with a number of long, acute, conspicuous spines; radial shields conspicuous, each bearing one long, acute, conspicuous spine; arm spines very conspicuously thorny; a few spiniform oral papillæ, besides one short and rounded outermost one, which arises from the first ventral arm plate ..... *Ophiostyracium*.
- AA*—Second oral tentacle pores opening within the oral slits.
- c*—Teeth and oral papillæ triangular, acute, not hyaline; radial shields very rudimentary; marginal disk scales present; dorsal arm plates entirely absent; arm spines converted into compound hooks. .... *Ophiostiba*.
- cc*—Teeth and oral papillæ flattened, with widened and serrate end more or less hyaline.
- d*—Marginal disk scales present.
- e*—Rudimentary dorsal arm plates always *entire*; radial shields very rudimentary; vertebrae divided into halves, except in several basal arm joints; arm spines converted into compound hooks. . *Ophiohyalus*.
- cc*—Rudimentary dorsal arm plates divided into several secondary plates, except in the distal arm joints; radial shields not very rudimentary;

- vertebræ entire, except in very distal arm joints; arm spines not converted into compound hooks, except in the very distal arm joints. . . . . *Ophiomyxa*.
- dd*—Marginal disk scales absent.
- f*—Radial shields present; dorsal arm plates usually absent (or sometimes present, being divided into several secondary plates, as in the Japanese species); arm spines free from each other. . . *Ophiodera*.
- ff*—Radial shields absent; dorsal arm plates entirely wanting; arm spines connected together by a web-like membrane. . . . *Ophiohymen*.

***Ophiosyzygus disacanthus* CLARK.**

*Ophiosyzygus disacanthus*: CLARK, Bull. U. S. Nat. Mus., LXXV, 1911, p. 276, fig. 139.

Off Kagoshima Gulf; 103–152 fathoms (CLARK). Uraga Channel; 88 fathoms (CLARK).

***Ophioleptoplax megapora* CLARK.**

*Ophioleptoplax megapora*: CLARK, Bull. U. S. Nat. Mus., LXXV, 1911, p. 279, fig. 141.

Eastern Sea; 71 fathoms (CLARK).

***Ophiostyracium trachyacanthum* CLARK.**

*Ophiostyracium trachyacanthum*: CLARK, Bull. U. S. Nat. Mus., LXXV, 1911, p. 253, fig. 124.

Eastern Sea; 440 fathoms (CLARK).

***Ophiostiba* MATSUMOTO, 1915.**

Disk and arms covered by a soft, thin skin, which contains some granules in the former. Marginal disk scales present. Radial shields very rudimentary, forming a continuous row with the marginal disk scales. Teeth and oral papillæ present, triangular,

with acute tips. Dental papillæ absent. Second oral tentacle pores opening entirely within the oral slits. Vertebræ more or less divided into halves by a longitudinal fusiform pore in the outer half of the arm. Dorsal arm plates entirely absent, lateral arm plates more or less subventral in position, so that the dorsal side of the arm is mostly unprotected. Two or three arm spines, all converted into compound hooks. Tentacle scales absent.

This genus differs from *Ophiocolax* chiefly in the presence of the marginal disk scales and in the conversion of the arm spines into compound hooks; and from *Neoplax* in the fewer arm spines, which are all converted into compound hooks, and in the absence of the tentacle scales.

*Ophiostiba hidekii* MATSUMOTO.

*Ophiostiba hidekii*: MATSUMOTO, Proc. Acad. Nat. Sci. Philadelphia, LXVII, 1915, p. 47.

Two specimens; Mera-out-Oisegaké, Sagami Sea; 300 fathoms.

Diameter of disk 3.5 mm. Length of the longest arm 16 mm. Width of the same at base 0.8 mm.

Disk hexagonal, with concave interbrachial borders, rather convex dorsally, covered by a soft skin, which contains fine, scattered, calcareous granules. Marginal disk scales present, but rudimentary, liable to be overlooked. Radial shields very rudimentary, insignificant, forming a continuous row with the marginal disk scales. Genital slits very small and short.

Oral shields rhomboidal, with perfectly rounded outer and lateral angles; convex, slightly longer than wide; all serving as madreporites. Adoral shields narrow, but with widened outer end, which entirely separates the oral shield from the first lateral arm plate; adradially concave, meeting each other within. Four or

five oral papillae on either side of each jaw, triangular, with acute apices, the proximal parts being covered by a common skin. Teeth stout, triangular, acute.

Six arms, of which three are longer than the other three, as a result of schizogony and regeneration; very slender, only horizontally flexible. Outer vertebræ divided into bar-

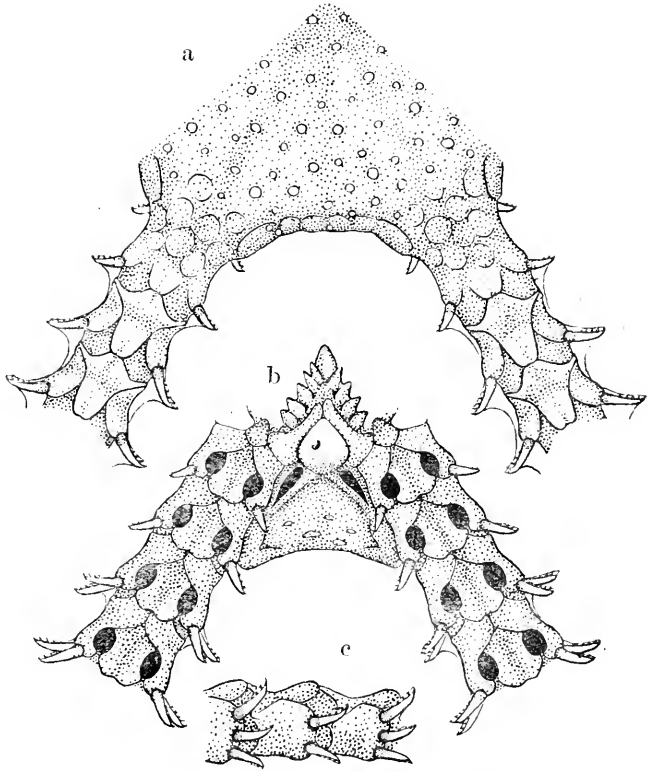

Fig. 1. *Ophiostiba hiteki*.  $\times 20$ . a. From above. b. From below. c. Side view of three arm joints near disk.

like halves by a longitudinal fusiform pore. Dorsal arm plates entirely absent; and the dorsal side of the vertebræ are seen through the skin to be rhomboidal, long and narrow. Lateral arm plates low, subventral in position; those of both sides meeting each other below, but widely separated above. First ventral arm plate very small, rhomboidal, with the inner sides longer than the outer, longer than wide. Those beyond heptagonal, with strongly concave inner lateral and outer sides, the former corresponding to the tentacle pores; much longer than wide, widest at the outer

ends of the tentacle pores; the calcification is very feeble along the median line, so that the plates appear as if grooved. Two or three arm spines, transparent, except the ball-like base, which is opaque; all converted into compound hooks, with four or five denticles along the abradial side; the lowest spine is slightly shorter than the upper ones, which are about two-thirds as long as the corresponding arm joint, except in the very basal arm joints, where they are shorter. The uppermost spines of either side of successive arm joints are connected together by a hyaline membrane, except in the very basal and very distal parts of the arm. Tentacle pores large, without any scales.

Colour in alcohol: disk deep chocolate brown, except the calcareous granules, which are white; arms brownish yellow.

This species evidently reproduce by schizogony, as indicated by the heteractiny and by the occurrence of six madreporites.

### **Ophiohyalus** MATSUMOTO, 1915.

Disk covered by a soft skin, with a row of marginal scales. Radial shields very rudimentary, insignificant, forming a continuous row with the marginal scales. Oral papillæ and teeth present, flattened and serrate along the free edge. Dental papillæ absent. Arms very slender, only horizontally flexible. Vertebrae more or less, or entirely, divided into halves by a longitudinal fusiform pore. Dorsal arm plates present, entire, but very rudimentary, transparent, separated from each other by a naked space. Two or three arm spines, all converted into compound hooks. Tentacle scales absent.

This genus is very near to *Ophiomyxa*, but differs from it in the very rudimentary radial shields, in the more markedly

divided vertebrae, in the entire rudimentary dorsal arm plates and in the conversion of all the arm spines into compound hooks; and in almost all characters, this genus retains more embryonal features.

*Ophiohyalus gotoi* MATSUMOTO.

*Ophiohyalus gotoi*: MATSUMOTO, Proc. Acad. Nat. Sci. Philadelphia, LXVII, 1915, p. 48.

Two specimens; probably off Misaki.

Diameter of disk 9 mm. Length of arms 28 mm. Width of arms at base 1 mm.

Disk pentagonal, with concave interbrachial borders, very flat, covered by a very thin, naked skin. Marginal disk scales present but very feeble. Radial shields very rudimentary, insignificant, forming a continuous row with the marginal scales. Genital slits very small, short, extending from the outer end of the adoral shield to that of the second lateral arm plate.

Oral shields large, triangular, with perfectly rounded lateral angles, inner sides forming together a brace-shape, outer side slightly concave; two and a half times as wide as long. Adoral shields large, triangular, very long, acutely tapered inwards, not meeting with each other. Oral plates long and narrow. The space encircled by the oral and adoral shields and oral plates is strongly depressed. Three or four oral papillae on either side, thin, transparent and finely serrate along the free edge. Two or three short, wide, flattened teeth, with rounded and finely serrate ends. Deep in the oral slits, on either side, occurs one conical, rough papilla.

Arms slender, covered by a very thin, transparent skin. The halves of the vertebrae are incompletely soldered together, except

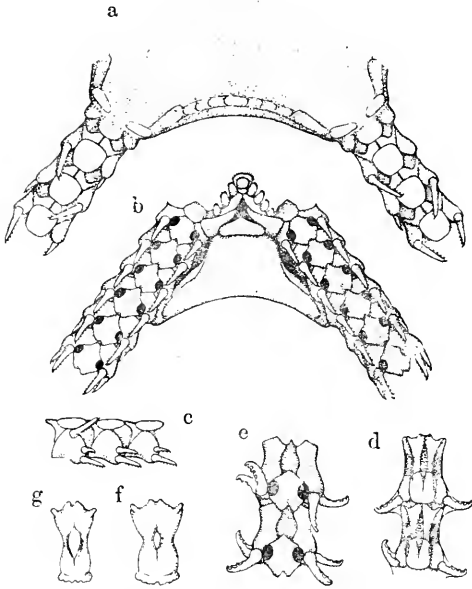

Fig. 2. *Ophiomyxus gotoi*. a. From above.  $\times 7$ . b. From below.  $\times 7$ . c. Side view of three arm joints near disk.  $\times 7$ . d. Dorsal view of two arm joints near the extremity.  $\times 14$ . e. Ventral view of two arm joints somewhat near the extremity.  $\times 16$ . f. Dorsal view of the vertebra of the fourth free arm joint.  $\times 14$ . g. Dorsal view of the vertebra of the tenth free arm joint.  $\times 14$ .

within the disk and at the base of the arms, where the fusion is complete. Each vertebra has at its middle part a longitudinally fusiform pore, which becomes larger and longer in the more distal part of the arm and finally divides the vertebra into halves. Dorsal arm plates small, oval, thin, transparent, longer than wide, wider within than without, separated from each other; they lie over the distal parts of the vertebrae of the corresponding arm joints, and become very small and delicate towards the extremity of the arm. Lateral arm plates slightly flared, successive plates not in contact with each

other, but separated by a naked space, which is widened upwards and continued into a large naked space bounded by the dorsal and lateral arm plates and the vertebra. First ventral arm plate not very small, quadrangular, with strongly curved outer edge, much wider without than within. Those beyond nearly rhomboidal in outline, with a conspicuous notch at the outer end and a half pore for the tentacle at each lateral angle; much longer than wide, being widest at the outer ends of the tentacle pores; successive plates not in contact with each other,



except in the disk. The lateral arm plates do not however meet each other in the ventral median line, so that there is left here a naked, depressed space, which is especially well marked near the extremity of the arm. Two arm spines, subventral, unequal, glassy, all converted into compound hooks, with a series of hooklets along their ventral side, covered by a thin, transparent membrane; the lower one is much larger than the other. In some basal joints, there occurs on the lateral arm plates one more spine, which is placed on the dorsal margin of the plate and also bears a series of hooklets on one side; it is larger than the other two, and nearly as long as the corresponding arm joint. No tentacle scale.

Colour in alcohol yellowish white.

*Ophiomyxa australis* LÜTKEN.

*Ophiomyxa australis*: LÜTKEN, Addit. ad Hist. Oph., III, 1869, p. 45 & 99; LYMAN, Rep. Challenger, V, 1882, p. 246; LYMAN, Bull. Mus. Comp. Zool., X, 1883, p. 274; BROCK, Zeitschr. wiss. Zool., XLVII, 1888, p. 532; KÖHLER, Bull. Sci. Fr. Belg., XXXI, 1898, p. 123; KÖHLER, Ibid., XLI, 1907, p. 341; CLARK, Mem. Austral. Mus., IV, 1909, p. 547; CLARK, Bull. U. S. Nat. Mus., LXXV, 1911, p. 271.

Four specimens; Mera-out-Oisegaké, Sagami Sea; 300 fathoms.

Off Suno Saki, Sagami Sea; 41–50 fathoms (CLARK). Korea Strait; 59 fathoms (CLARK). Eastern Sea; 95 fathoms (CLARK).

Amboina; 100 fathoms (LYMAN). Sulu Sea; 82–102 fathoms (LYMAN). Tongatabu Is.; 18–240 fathoms (LYMAN). Near Fiji Is.; 310–315 fathoms (LYMAN). Southern Australia and Bass Strait; 38–120 fathoms (LÜTKEN, LYMAN, CLARK). New Zealand (KÖHLER).

My specimens are all small, the largest being 7 mm. across

the disk. The colour is purplish brown in alcohol, the disk being beautifully spotted with darker shades.

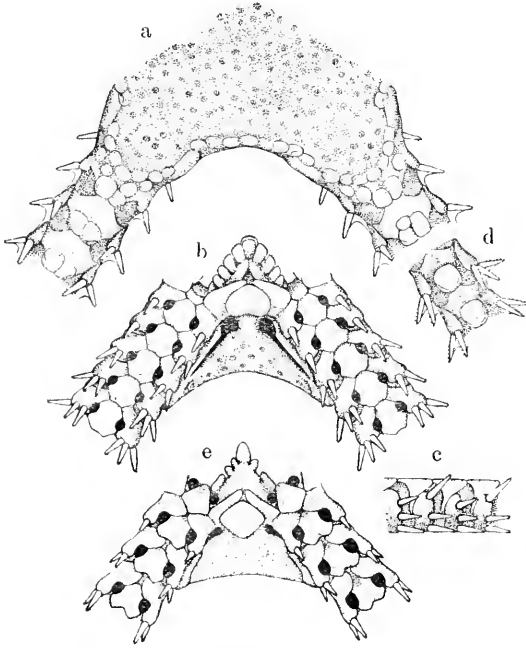

Fig. 3. *Ophiomyx australis*. a. From above.  $\times 7$ . b. From below.  $\times 7$ . c. Side view of four arm joints near disk.  $\times 7$ . d. Dorsal view of two arm joints at the middle part.  $\times 7$ . e. Young specimen; from below.  $\times 14$ .

The rudimentary dorsal arm plates are entire and transparent at the outer parts of the arms, but are divided into two or three opaque, secondary plates in the basal arm joints. The smallest specimen, with the disk diameter of 3.5 mm., has entire dorsal arm plates throughout, and has only one or two granule-like oral papillæ on either side and less flattened and not serrate teeth, besides a very short and wide distal papilla, situated deep within the oral slit. The

second oral tentacle pores of the same specimen open outside the oral slits, and the first ventral arm plates are comparatively large. A specimen with the disk diameter of 4 mm. has three of the jaws with typical papillation, and two papillated as in the smallest specimen mentioned. Probably, the oral papillæ next the apex of the jaws are the first to appear, and the more distal ones are formed later. The distal papilla of the smallest specimen is not a true oral papilla, lying at a higher level than the ordinary ones. It may be distinguished as the primary oral papilla in contrast to

the genuine or secondary oral papillæ. The primary oral papillæ are usually predominant in many genera, which have exposed second oral tentacle pores.

*Ophiodera anisacantha* (CLARK).

*Ophiomyxa anisacantha*: CLARK, Bull. U. S. Nat. Mus., LXXV, 1911, p. 277, fig. 136.

One specimen; Suruga Gulf; 115 fathoms. One specimen Mera-out-Oisegaké, Sagami Sea; 300 fathoms. Five specimens; Sagami Sea. One specimen; Uraga Channel; 125 fathoms.

Uraga Channel; 197 fathoms (CLARK). Suruga Gulf; 108–131 fathoms (CLARK). Off Suno Saki, Sagami Sea; 83–158 fathoms (CLARK). Eastern Sea; 95–181 fathoms (CLARK).

Diameter of disk 28 mm. Length of arms 140 mm. Width of arms at base 4 mm.

Disk pentagonal or five-lobed, with concave or slightly notched interbrachial borders, covered by a thick skin, which is finely and almost concentrically wrinkled in alcohol.

The radial shields can be observed by drying the specimens; they are exceedingly small and club-shaped. Genital slits long, not quite reaching the disk margin, narrow in the outer part, bordered adradially by the stout genital plates, much widened in the inner part

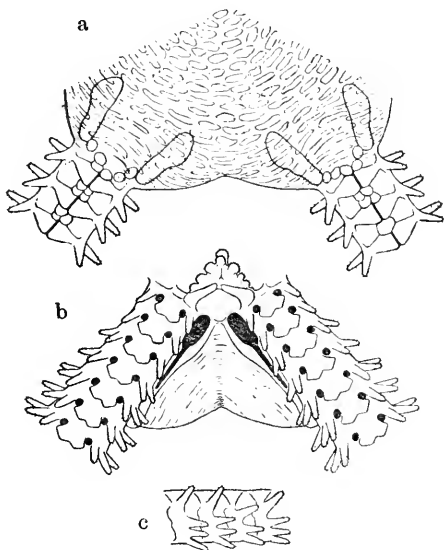

Fig. 4. *Ophiodera anisacantha*.  $\times 3$ . a. From above. b. From below. c. Side view of four arm joints near disk.

lying within the genital plates, where they present elongated oval outlines. The genital plates and scales are distinguishable, though they are covered by the skin.

The oral skeleton can be observed by drying the specimens. The oral shields are transversely oval, or rather rhomboidal, with an obtuse inner angle, and widely rounded outer and lateral angles. Adoral shields small, curved abradially as a whole, tapering inwards, where they do not meet each other. Four oral papillæ on either side, flat, thin, translucent, and finely serrate along the free edge. Five to seven teeth, short, flat, with rounded, finely serrate or nearly entire end; the uppermost one is longer and more or less conical. Below the first oral tentacle pore in the oral slit, occur one to three spiniform papillæ.

Arms slender, covered by a thick skin. The arm plates and vertebrae can be observed by drying the specimens or by boiling an arm piece in potash. The vertebrae are rhomboidal when viewed from above, much wider than long, with a conspicuous median groove. Between them, there are, in the proximal parts of the arms, a few irregular scales, perhaps representing the dorsal arm plates. Lateral arm plates subventral, meeting below, where they are soldered together and with the ventral arm plates of the corresponding joints. The ventral arm plates are eight-sided; two sides embracing a conspicuous notch at the outer end of the plate; inner sides the longest, straight, meeting each other in a wide angle; inner lateral sides concave, corresponding to the tentacle pores; wider than long, widest at the outer ends of the tentacle pores. Three or four arm spines, short, stout, conical, blunt, enclosed in skin, rough at the end; the uppermost one is the longest, nearly as long as the corresponding arm joint, somewhat isolated from the rest which are near together. The arm spines

are smaller in the basal joints, and only one is present in the first and second, but two in the third and fourth. No tentacle scale.

Colour in alcohol: disk bluish gray; arms light yellow; disk and arms of younger specimens light grayish pink.

In the smaller specimens, the disk skin is seen to contain, when examined under a microscope, very fine scales scattered in it, much resembling the perforated spicules of a holothurian; but in the larger ones they are entirely absent. The oral papillæ, the papillæ just below the first oral tentacle pores, the teeth and the arm spines appear to increase in number with the growth of the animal. In the specimens before me, the arm spines are not so long and so slender as are shown in CLARK'S figure. Further, his figure appears to me to be inaccurate in so far as it represents the arm spines as being two in number and equally long already in the first arm joint.

*Ophiohymen gymnodiscus* CLARK.

*Ophiohymen gymnodiscus*: CLARK, Bull. U. S. Nat. Mus., LXXV, 1911, p. 277, fig. 140.

Eastern Sea; 107-139 fathoms (CLARK).

**Key to Japanese genera of *Ophiobryinae*.**

*A*—Radial shields more or less long and bar-like; disk or, at least, radial shields spinulate; arm spines spiniform, not all converted into compound hooks.

*a*—Dorsal arm plates entirely absent; arm spines very long and serrate. . . . . *Ophiophrissus*.

*aa*—Rudimentary dorsal arm plates present, being divided into a number of secondary plates; arm spines rather short and not serrate. . . . . *Ophiobrysa*.

AA—Radial shields very rudimentary, disk entirely free of spines; arm spines all converted into compound hooks.....*Ophiosmilax*.

***Ophiophriscus acanthinus* CLARK.**

*Ophiophriscus acanthinus*: CLARK, Bull. U. S. Nat. Mus., LXXV, 1911, p. 273, fig. 137.

Off Seno Umi, Suruga Gulf; 94–150 fathoms (CLARK).

**Key to Japanese species of *Ophiobyrsa*.**

A—Each dorsal arm plate represented by a zone of a mosaic of small, irregular, secondary plates, each of which carries a spinule; six or seven arm spines not webbed together, the lowest one is converted into a compound hook and serves as a tentacle scale. ....  
..... *acanthinobrachia*.

AA—Each dorsal arm plate represented by a row of secondary plates, of which the median two are the largest, none of them spinulate; four arm spines connected together by a web-like membrane .....  
..... *synaptacantha*.

***Ophiobyrsa acanthinobrachia* CLARK.**

*Ophiobyrsa acanthinobrachia*: CLARK, Bull. U. S. Nat. Mus., LXXV, 1911, p. 269, fig. 134.

Suruga Gulf; 108 fathoms (CLARK). Eastern Sea; 95 fathoms (CLARK).

***Ophiobyrsa synaptacantha* CLARK.**

*Ophiobyrsa synaptacantha*: CLARK, loc. cit., p. 270, fig. 135.

Eastern Sea; 152 fathoms (CLARK).

***Ophiosmilax* MATSUMOTO, 1915.**

Disk and arms covered by a thick skin, which may contain

some fine scales in the former. Radial shields very rudimentary (apparently "absent"), lying marginally. Oral slits small. Single oral papilla on either side, and two or three dental papillæ at the apex of each jaw. Teeth in a single vertical row. Teeth and papillæ all alike, stout, stumpy, conspicuously thorny at tip. Second oral tentacle pores opening outside the oral slits, each provided with a thorny, stumpy papilla, which arises from the adoral shield. Arms vertically coiled. Vertebrae very stout, with saddle-shaped articulation. Dorsal arm plates entirely absent, while the lateral arm plates are subventral, so that the dorsal side of the arms is covered merely by a naked skin. Two or three arm spines, all converted into compound hooks. Tentacle scales absent.

This genus rather resembles *Ophiophrivus* in the total absence of the dorsal arm plates, but differs from it in the very rudimentary radial shields, in the peculiarities of the teeth and papillæ, and in the conversion of all the arm spines into compound hooks. This last character is also found in *Ophiobrachion*, but the present genus differs from it in the total absence of the disk spines, in the peculiarities of the teeth and papillæ, and in the fewer arm spines.

*Ophiosmilax mirabilis* MATSUMOTO.

*Ophiosmilax mirabilis*: MATSUMOTO, Proc. Acad. Nat. Sci. Philadelphia, LXVII, 1915, p. 50.

One specimen; Mera-out-Oisegaké, Sagami Sea; 300 fathoms.

Diameter of disk 2 mm. Length of arms 12 mm. Width of arms at base 0.8 mm.

Disk flat, pentagonal, with concave interbrachial borders, covered by a thick skin, which contains very fine, thin, trans-

parent scales. Radial shields very rudimentary, insignificant, lying on the disk margin. Genital slit short and very small.

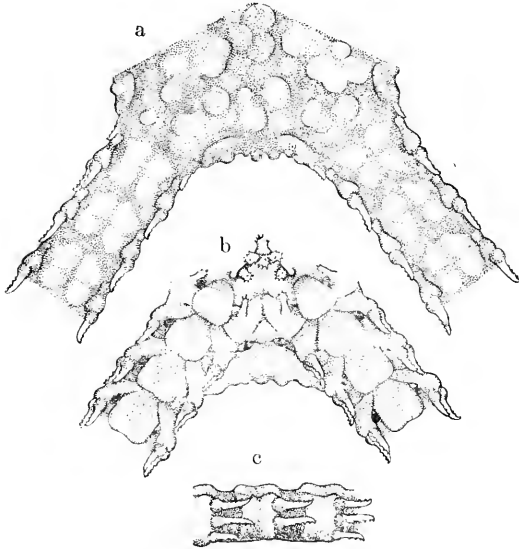

Eig. 5. *Ophiomilax mirabilis*.  $\times 20$ . a. From above. b. From below. c. Side view of three arm joints near disk.

Oral shields triangular, with convex outer border. Adoral shields large, quadrangular, longer than wide, wider outwards than inwards, fully meeting with each other within. Oral slits short, fairly closed up. Single oral papilla on either side, stout, stumpy, conspicuously thorny at tip, turned up ventrally, instead of projecting towards the oral slit. Two or three dental papillae at the apex

of each jaw, similar in shape and size to the oral papilla, also turned up ventrally. Teeth in a single vertical row, also stout, stumpy and thorny at tip. Second oral tentacle pores opening entirely outside the oral slits, each provided with a stumpy and thorny papilla, which arises from the adoral shield.

Arms more or less vertically coiled, covered by a thick skin. Dorsal arm plates entirely absent. Lateral arm plates subventral, strongly flared laterally. First ventral arm plate large, quadrangular, with rounded angles, slightly longer than wide, much wider without than within. Those beyond larger, hexagonal, the inner and inner lateral sides being very short; outer angles perfectly rounded; as long as, or slightly longer than wide, feebly



calcified and transparent, except the outer and lateral peripheries, where the calcification is complete and the plate is opaque. Two or three arm spines lying flat on the arm, all covered into compound hooks, transparent, except the ball-like basal portions, which are opaque. The uppermost two are subequal, about two-thirds as long as the corresponding arm joint, while the third, the lowest, is very small and about half as long as the same. The smaller compound hooks have two or three denticles in one plane, while the larger ones have six or seven denticles in two planes, making certain acute angles with the axis of the spine. Tentacle pores small, free of tentacle scales.

Colour in alcohol brownish yellow.

Family 2. **Trichasteridæ** (DÖDERLEIN, 1911) mihi, 1915.

Disk and arms covered by a thick skin, which may contain fine scales or granules. Radial shields long, bar-like, forming a system of radiate ribs. The radial shield and genital plate articulate with each other by means of a transverse ridge on both the plates. Genital plates long and stout, while the genital scales are rather very small. Oral shields small, adoral shields very stout. Teeth very stout, arranged in a single vertical row; oral and dental papillæ rudimentary as a rule, sometimes absent. Peristomial plates entire, stout, soldered with the also very stout oral frames. Arms exceedingly long, simple or dichotomously branched, vertically coiled. Dorsal arm plates either entirely absent or represented by very insignificant double rows of fine subcutaneous scales, which are soldered together to form two, right and left, secondary plates in the free arm bases of the adult in certain genera; entirely free of rows of minute hooks. Lateral

and ventral arm plates, as well as the skin-covered arm spines, confined to the ventral side of the arm. Vertebrae very short and exceedingly stout, discoidal, with typically streptospondyline articulation. Upper muscular fossae of the vertebrae extremely large, the lower very small.

This family includes ten genera, which may be grouped into three subfamilies as follows :

Subfamily 1. *Asteronychinae* mihi, 1915.—Disk large and arms slender; only a single madreporite is present; perihæmal canal entirely closed; peritoneal cavity divided into five separate compartments by the interradial attachments of the gastral pouches to the body wall; genital bursæ free from the perihæmal canal, but communicating with each other in radial pairs; lateral arm plates of either side separated from each other by the comparatively large ventral arm plates; more than three arm spines on each plate.

*Astrodia* VERRILL, 1899.

*Asteronyx* MÜLLER & TROSCHEL, 1842.

Subfamily 2. *Trichasterinae* mihi, 1915.—Disk moderately large and arms moderately stout; one madreporite to each interradius; perihæmal canal and genital bursæ with open communications; lateral arm plates of either side separated from each other by the ventral arm plates, distal ones projecting ventrally in the form of hanging rods; two subequal arm spines on each plate.

I. Arms simple.

*Ophiuroopsis* STUDER, 1884.

*Astroceras* LYMAN, 1879.

II. Arms divided.

*Trichaster* AGASSIZ, 1835.

*Sthenocephalus* KÖHLER, 1898.

*Euryale* LAMARCK, 1816.

Subfamily 3. *Asteroschematinae* mihi, 1915.—Disk very small and arms very stout; one madreporite to each interradius; perihæmal canal closed; genital bursæ free from the perihæmal canal or from each other; lateral arm plates of either side meeting each other in the ventral median line, distal ones not projecting ventrally in the form of hanging rods; two unequal arm spines on each plate.

*Asteroschema* ERSTED & LÜTKEN, 1856.<sup>1)</sup>

*Astrocharis* KÖHLER, 1904.

*Astrogymnotes* CLARK, 1914.

A very characteristic feature of the *Asteronychinae* is the position of the genital scales, which articulate with the genital plates near the inner ends of the latter, while in the other subfamilies, the scales articulate with the plates near the outer ends of the latter. In *Asteronyx loveni* MÜLLER & TROSCHEL, the radial shields are composed of several lamellar secondary plates, which overlap and fuse together. The wall of the gastral cavity is attached to the body wall at the central part on the dorsal side of the disk and along the interradial lines above and below, so that the peritoneal cavity is perfectly divided into five radial compartments, which are filled up by the folded generative glands. The perihæmal canal is entirely closed. The genital bursæ are very spacious, but do not communicate with the perihæmal canal, and are separated from the peritoneal cavity by a thin, folded membrane. Each radial pair of the bursæ however communicate with each other just above the outer end of the oral frames and the first

---

1) Including *Ophiocreas* LYMAN, 1869.

As far as the external characters are concerned, *Ophiocreas atherens* STUDEE, 1884, and *Asteroschema köhleri* DÜDERLEIN, 1898, appear to be referable to the *Trichosterinae*; they may possibly be young forms of *Astroceras*.

vertebra. In very young specimens, the genital plates are very high in position, lying nearly dorso-laterally to the first two vertebrae, and the lower muscular fossae of the vertebrae are not notably smaller than the upper, so that the genital plates and vertebrae rather remind one of those of the *Ophiobryinae*.

A most important internal character of the *Trichasterinae* is that the genital bursae communicate with the perihæmal canal. In *Astroceras*, *Trichaster* and *Euryale*, I was able to observe this communication; and I believe that this character is a decisive proof for the close relationship of these genera, as stated by LYMAN and KÖHLER. In *Astroceras pergamena* LYMAN, the genital bursae communicate merely with the perihæmal canal, while in *Trichaster elegans* LUDWIG, they communicate also with each other in radial pairs, the communications taking place above the vertebrae just inside the disk margin; in both the genera, the peritoneal cavity, as well as the generative glands, is confined to the arm bases. The skin of the arm consists of two layers, which are easily separated by boiling in potash. The inner layer, which is thicker than the outer, contains the rudiments of the dorsal arm plates, which are in smaller specimens very insignificant, being represented by double rows of very feeble calcareous scales, continued above from the lateral arm plates, as stated by LYMAN in *Euryale aspera* LAMARCK. But in larger specimens, with the generative glands extending into the arm bases, the dorsal arm plates become conspicuous in the proximal arm joints containing the generative glands, so that the arm bases are strongly ribbed. At this stage, each dorsal plate is represented by a pair of bar-like plates in *Astroceras*, and by a pair of about triple rows of nodule-like secondary plates in *Trichaster*. In *Trichaster elegans*, the genital plates and scales are very stout, lying very closely side by side

to form very solid interbrachial borders. The peristomial plates are stout, without median groove, soldered with the oral frames and oral plates. A single, very long dental plate is present at the apex of each jaw. The adoral shields are very stout, divided into inner and outer halves, so that there are four in each interradius, closely set together. The radial shields are stout, composed of several secondary plates, which are soldered together. The ventral arm plates are large, often divided into two or three secondary plates. The lateral arm plates are very small, those of the two sides not meeting each other; in the distal arm joints outside the second bifurcation, they are projected ventrally in the form of hanging rods, bearing two hook-shaped arm spines. The dorsal arm plates are represented by three or four rows of nodule-like secondary plates on either side of each proximal arm joint, two rows being internal and the other one or two external. According to LYMAN, the genital slits in *Euryale aspera* penetrate directly into the "peritoneal cavity," which communicates with the perihæmal canal, and the generative glands lie in the "peritoneal cavity," the "genital bursæ" being entirely absent. As far as I can judge, LYMAN seems to be mistaken in his interpretation of the parts. In my opinion, his "peritoneal cavity" is not the genuine peritoneal cavity but merely the genital bursa, which are in direct communication with the perihæmal canal and are very spacious and provided with a very thin membrane; and the genuine peritoneal cavity is perfectly divided into five radial compartments, which are entirely filled up by the folded generative glands. The correctness of this interpretation of mine is proved by the fact that, the generative glands do not lie in the "peritoneal cavity," as LYMAN thinks, but are separated from it by a thin but distinct membrane and the brachial body cavity, which is the direct con-

tinuation of the true peritoneal cavity is entirely free from LYMAN'S "peritoneal cavity." Thus, it may clearly be seen that, *Euryale* is similar to *Astroceras* and *Trichaster* in having direct communication between the genital bursæ and the perihæmal canal, and to the *Asteronychinæ* in having the generative glands and the peritoneal cavity lying in the disk instead of being confined to the arm bases.

The *Asteroschematince* are similar to the *Asteronychinæ* in the perihæmal canal being entirely free from the genital bursæ, but differ from them in the genital bursæ being free from each other. In *Asteroschema japonicum* (KÆHLER), the genital plates are long, stout, lie oblique to the arm axis; and curve abradially in the outer half of their entire length, so as to narrow the ventral interbrachial spaces. The genital scales are very small, directed laterally to support the disk borders, instead of supporting the abradial border of the genital slits. The genital bursæ are very spacious, but do not communicate with the perihæmal cavity or with each other. The radial shields are very long, bar-like, composed of several secondary plates, so that they are capable of bending like elastic bars. The peristomial plates are very stout, with notched outer borders, distinctly grooved in the radial line on the dorsal surface. The oral frames are stout, more or less cylindrical, without distinct distal wings. LUDWIG'S 'first ventral arm plate' is present at the dorsal outer corner of each oral slit. Oral plates strongly projecting ventrally as well as dorsally, and provided on the adradial sides with low, smooth, pavement-like grains, corresponding to the oral papillæ. The dental plates are in a single piece for each jaw, with a canal between plate and jaw. Teeth very stout, arranged in a single vertical row. Adoral shields entire, very large; the outer open angle between each

interradial pair is filled by the oral shield, the madreporite, which is rather large and pear-shaped. The ventral arm plates are very small and granule-like, except the first and second, which are comparatively large, the first being triangular, with the apex directed inwards, and the second being fan-shaped with a convex, longest outer side. The lateral arm plates are transversely bar-like, meeting each other in the ventral median line. Their outer ends are forked, the arm spines arising from the ventral process, while the row of plates which correspond to the dorsal arm plates proceed dorsally from the dorsal process. In the proximal joints of large, sexually mature specimens, each dorsal arm plate is represented by a pair of simple, bar-like rows of secondary plates, while in the distal joints, as throughout in smaller specimens, each dorsal plate is represented by a double row of very fine, insignificant scales. In *Asteroschema caudatum* (LYMAN), the structure is essentially similar, but the lateral arm plates are stouter than in the foregoing species, and the ventral arm plates are often divided into two secondary plates.

*Asteronyx loveni* MÜLLER & TROSCHEL.

*Asteronyx loveni*: MÜLLER & TROSCHEL, Sys. Ast., 1842, p. 119, Pl. X, figs. 3-5; CLARK, Bull. U. S. Nat. Mus., LXXV, 1911, p. 285; DÖDERLEIN, Abh. Math.-Phys. Kl. K. Bayer. Akad. Wiss., Suppl.-Bd. I, 1911, p. 115; MORTENSEN, Zeitschr. wiss. Zool., CI, 1912, pp. 264-289, Pls. XIV-XVIII.

*Asteronyx loveni*: LYMAN, Rep. Challenger, V, 1882, p. 285; KÖHLER, Ech. Ind. Mus. Deep-sea. Oph., p. 74; KÖHLER, Exp. Siboga, XLV, Pt. 1, 1904, p. 167.

One specimen; Hokkaidô, more precise locality unknown. Several specimens, clinging to *Isis* and other gorgonaceans; off Misaki.

Japan ; 350 fathoms (LYMAN). Hiuga Sea ; 405–578 fathoms (CLARK). Off Omai Zaki ; 475–918 fathoms (CLARK). Off Suno Zaki, Sagami Sea ; 83–158 fathoms (CLARK). Off Kinkwa San ; 129 fathoms (CLARK). Off Kii, Kumano Sea ; 440–649 fathoms (CLARK). Okhotsk Sea ; 100–510 fathoms (CLARK).

Indian Ocean (KOEHLER). Malaysian waters (KOEHLER). Bering Sea (CLARK). Alaska (CLARK). Washington (CLARK). California (CLARK). Eastern coasts of North America. West Indies. Norwegian coasts. Finmark. Scotland.

The specimen from Hokkaidô is very large, and is 42 mm. in the disk diameter, 500 to 590 mm. in the arm length and 5.5 to

6.5 mm. in the arm width at the base ; the largest arm having about six hundred and twenty joints. The other specimens are all young, with the disk diameter of 6 to 7 mm., and hardly showing the specific characters of the oral apparatus and arm spines. The oral papillæ and teeth are flat, serrate along the free margin, covered over by skin, except at the free margin ; so that, they are quite similar to those of *Astrodia*. On the disk, there are several scattered, delicate scales embedded in the skin, which remind us of the disk scales of *Astrodia*, and are destined to be absorbed in older examples.

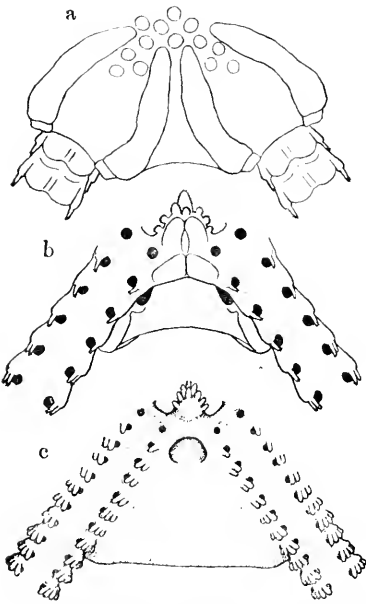

Fig. 6. *Asteronaja loveni*. a. From above,  $\times 10$ . b. From below,  $\times 10$ . c. From below,  $\times 1\frac{1}{2}$ . a and b. Young.



**Key to Japanese genera of *Trichasterinae*.**

- A*—Arms simple; generative glands extending into the arm bases as two pairs of ribbon-like bodies; in basal arm joints of adult specimens, each dorsal arm plate is represented by a pair of transversely bar-like plates, which bear a stumpy tubercle at the upper end ..  
 ..... *Astroceras*.
- AA*—Arms dichotomously divided.
- a*—Arms divided only near the tip; generative glands extending into the arm bases as four pairs of ribbon-like bodies; in basal arm joints of adult specimens, each dorsal arm plate is represented by a pair of about triple rows of nodule-like plates..... *Trichaster*.
- aa*—Arms divided nearly from the base; generative glands confined to the disk; dorsal arm plates always very insignificant..... *Euryale*.

***Astroceras pergamena* LYMAN.**

*Astroceras pergamena*: LYMAN, Bull. Mus. Comp. Zool., VI, 1879, p. 62, Pl. XVIII, figs. 478–480; LYMAN, Rep. Challenger, V, 1882, p. 284, Pl. XXXIV, figs. 1–5; CLARK, Zool. Anz., XXV, 1902, p. 671; KÖHLER, Exp. Siboga, XLV, Pt. 1, 1904, p. 159; CLARK, Bull. U. S. Nat. Mus., LXXV, 1911, p. 284; DÖDERLEIN, Abh. Math.-Phys. Kl. K. Bayer. Akad. Wiss., Suppl.-Bd. I, 1911, p. 61, Pl. VI, figs. 4–4*b*, Pl. VIII, fig. 13.

*Astroschema* sp.; DÖDERLEIN, *ibid.*, p. 57, Pl. VII, fig. 3.

Numerous specimens; Sagami Sea; 100 fathoms. Numerous specimens; off Ukishima, Uruga Channel; 300 fathoms.

Eastern Sea; 95–106 fathoms (CLARK). Yenshû Sea; 565 fathoms (LYMAN). Off Omai Zaki; 34–37 fathoms (CLARK). Suruga Gulf; 52–180 fathoms (CLARK, DÖDERLEIN).

Timor; 216 m. (KÖHLER).

The largest one of my specimens is 7 mm. across the disk. The first ten basal free joints of the arms are wide and provided with transverse plates, which form ridges on either side and are

well developed in every second or third joint, in which they bear each a conspicuous, movably articulated tubercle at the upper end.

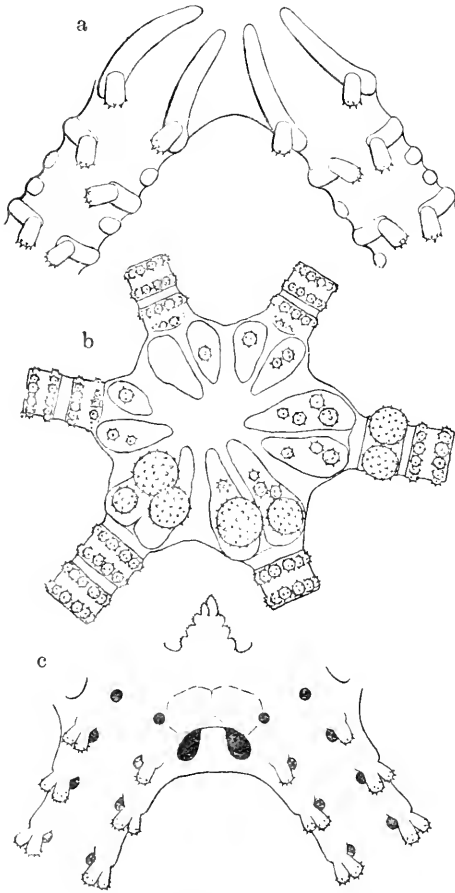

Fig. 7. *Astroceras pergamena*. a. From above.  $\times 7$ . b. From above.  $\times 8$ . c. From below.  $\times 14$ . b and c. Young.

Most specimens are quite young and smaller than 4 mm. in the disk diameter. They are mostly six-armed, rarely five or seven-armed. On the upper side of each arm joint, there are two transverse rows of rough, skin-covered nodules, six to eight in each row. Similar nodules occur on the radial ribs; and in the larger specimens they are also found on the joints of the slender parts of the arms.

I have also some six-armed specimens, in which the middle one of the three regenerating arms is distinctly smaller than the other two; but I do not agree with CLARK in looking upon the smaller arm as being destined for resorption, so that the

animal would become five-armed. The smaller size of the arm in question is perhaps due to its unfavourable position with regard to the supply of nutrition. In fact, we see in many ophiurans which reproduce by schizogony, that the regenerating arms do not often keep to the original number, and the same occurs also in

this species. I have five-armed specimens, in which two of the arms are smaller and are undoubtedly regenerated ones; so that, the five-armed condition may be attained by the final regeneration of only two arms in place of three, in the equally divided halves of six-armed individuals.

### Key to species of *Trichaster*.

- A*—Interbrachial ventral surfaces extremely narrow, so that the two genital slits are so close together as to form a single aperture; arms almost triangular in section; about sixty-two arm joints within the first bifurcation; each proximal arm joint bearing a pair of stumpy tubercles on the dorsal side; arm width at the first bifurcation being about one-third of that at the base. . . . . *palmiferus*.
- AA*—Interbrachial ventral surfaces not extremely narrow, so that the two genital slits are rather well separated from each other; arms quadrangular in section; thirty-nine to fifty-three, usually forty-five, arm joints within the first bifurcation; arms entirely free of stumpy tubercles; arm width at the first bifurcation being less than one-fourth of that at the base. . . . . *elegans*.

### *Trichaster palmiferus* (LAMARCK).

*Euryale palmiferum*: LAMARCK, Hist. Nat. Anim. sans Vert., II, 1816, p. 539.

*Trichaster palmiferus*: AGASSIZ, Mem. Soc. Sci. Nat. Neuchâtel, I, 1835, p. 139<sup>1)</sup>; MÜLLER & TROSCHEL, Sys. Ast., 1842, p. 120; LYMAN, Rep. Challenger, V, 1882, p. 267; CLARK, Bull. U. S. Nat. Mus., LXXV, 1911, p. 287; DÖDERLEIN, Abh. Math.-Phys. Kl. K. Bayer. Akad. Wiss., Suppl.-Bd. I, 1911, p. 62; BOMFORD, Rec. Ind. Mus., IX, Pt. 4, 1913, p. 220, Pl. XIII, fig. 2.

*Trichaster fragellifer*: V. MARTENS, Wieg. Arch. Nat., XXXII, 1877, p. 87.<sup>1)</sup>

1) These papers were not seen by me.

Colnett Strait; 83–84 fathoms (CLARK).

Bay of Bengal. Ceylon. Malaysian waters. Hong-kong.

*Trichaster elegans* LUDWIG.

*Trichaster elegans*: LUDWIG, Zeitschr. wiss. Zool., XXXI, 1878, pp. 59–67, Pl. V, figs. 1–9; LYMAN, Rep. Challenger, V, 1882, p. 267; BOMFORD, Rec. Ind. Mus., IX, Pt. 4, 1913, p. 220, Pl. XIII, figs. 3 & 4.

Two specimens; Tanabé Bay, Kii.

Pacific Ocean (LUDWIG). India (BOMFORD).

DÖDERLEIN thinks that the present species is a young form of *T. palmiferus*; but like BOMFORD I can not agree with this opinion. My two specimens are quite large, and are of course adult and sexually mature. The large arm tubercles, which are characteristic of *T.*

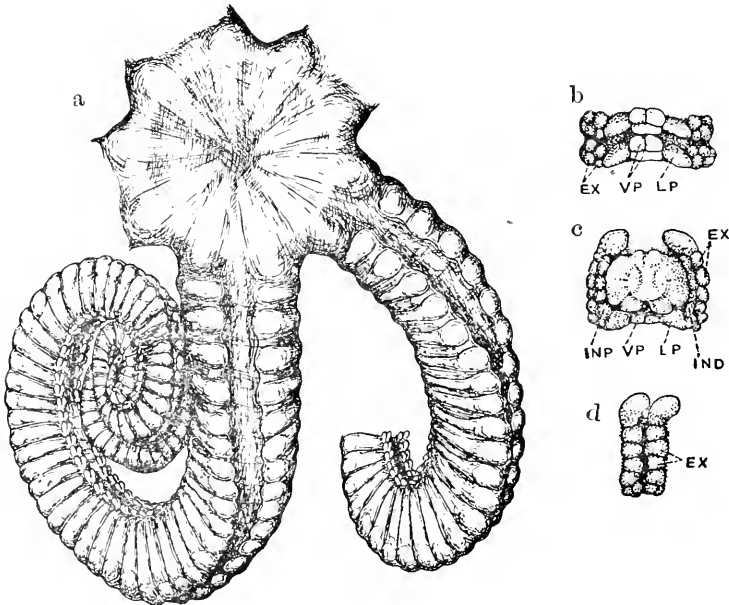

Fig. 8. *Trichaster elegans*.  $\times 1$ . a. From above. b. Ventral view of skeleton of two arm joints. c. Frontal view of skeleton of an arm joint. d. Lateral view of skeleton of two arm joints.

EX. External row of nodules. IND. Internal distal row of nodules. INP. Internal proximal row of nodules. LP. Lateral arm plate. VP. Ventral arm plate.

*palmiferus*, at least in the adult, are entirely absent in my specimens. DÖDERLEIN states that, the part of the arm within the first bifurcation is composed of about sixty-two joints in *T. palmiferus*, while in my specimens, that part is composed of from forty-three to forty-five joints, except in an arm of one of the specimens, in which that part is composed of fifty-three joints. LUDWIG makes no statement on this point, but in his fig. 1, about forty-six joints are indicated in the part in question. This number almost agrees with what obtains in my specimens, but is very far from that given by DÖDERLEIN. BOMFORD records thirty-nine to fifty-two joints in the part in question. So I must agree with BOMFORD in recognising the present species as distinct from *T. palmiferus*.

In one of my two specimens, the disk is 33 mm. in diameter, and the arms are divided six times and about 310 mm. in total length. In the other specimen, the disk is 32 mm. in diameter, and the arms are divided five or six times and about 290 mm. in total length. As to the ratio of the width to height of the arms the two specimens stand in striking contrast, as shown in the following table.

Disk diameter of specimen.	Width and height of arm at base.	Ditto at the 20th. free joint.	Ditto at the 40th. free joint.
33 mm.	W. 17 mm. H. 15 mm.	W. 12 mm. H. 13 mm.	W. 7.5 mm. H. 8 mm.
32 mm.	W. 17 mm. H. 13 mm.	W. 13 mm. H. 12 mm.	W. 8 mm. H. 7.5 mm.

The generative glands extend into the arms as four pairs of ribbon-shaped bodies for each arm. Microscopical examinations of the generative glands showed that, the larger one of the two specimens was male and the smaller one female. The testicular

ribbons are much more slender than the ovarial; so that, the dorsal median groove of the arms is much deeper and narrower in the male than in the female. I am inclined to think that, the striking contrast of the ratio of the width to height of the arms in the two specimens is a sexual difference.

I have one more statement to make about the smaller specimen, viz. that it is four-armed. Not only the arms but the body generally is quadrimerous throughout, and there are no indications of external injury. The great width of the arms in this specimen might be looked upon as a result of the quadrimerism; but I think it only explains the great width of the arm bases, and not that of the distal part of the arms within the first bifurcation.

### Key to species of *Euryale*.

- A*—Proximal parts of arms beset with two rows of large stumpy tubercles; some similar tubercles are found also on the radial ribs. . . .  
 ..... *aspera*.
- AA*—Arms entirely free of stumpy tubercles, but some very small tubercles present on the radial ribs. .... *anopla*.

### *Euryale aspera* LAMARCK.

*Euryale asperum*: LAMARCK, Hist. Nat. Anim. sans Vert., II, 1816, p. 535.

*Astrophyton asperum*: MÜLLER & TROSCHEL, Sys. Ast., 1842, p. 124; LUDWIG, Zeitschr. wiss. Zool., XXXI, 1878, p. 66.

*Euryale aspera*: LYMAN, Rep. Challenger, V, 1882, p. 266; STUDER, Abh. K. Akad. Wiss. Berlin, 1882, p. 53, Pl. V, fig. 10; KÖHLER, Bull. Sci. Fr. Belg., XXXI, 1898, p. 114.

*Euryale studeri*: LORIOI, Rev. Suisse Zool., VIII, 1900, p. 8, Pl. VIII, fig. 4, Pl. IX, fig. 1; KÖHLER, Exp. Siboga, XLV, Pt. 2, 1905, p. 132; KÖHLER, Bull. Sci. Fr. Belg., XLI, 1907, p. 350.

*Euryala aspera*: DÖDERLEIN, Abh. Math.-Phys. Kl. K. Bayer. Akad. Wiss., Suppl.-Bd. I, 1911, p. 65 & 98, fig. 16, Pl. V, figs. 7 & 7a.

One specimen; Okinawa.

Eastern and western Australia. Malaysian waters. Philippines. Gulf of Siam. Southern China.

This specimen is very small, being only 4 mm. in the disk diameter. The arms are branched about eight times, and are about 27 mm. in total length. At the central region of the disk, six very small, rather inconspicuous primary plates are present. Each radial rib bears near its outer end one large, cylindrical, blunt

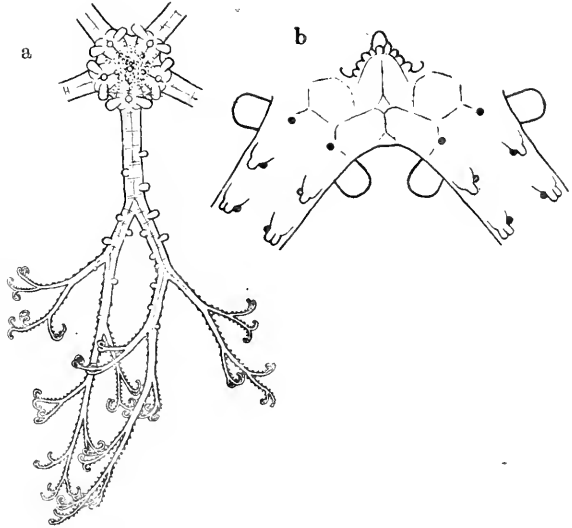

Fig. 9. *Euryala aspera*. a. From above.  $\times 2$ .  
b. From below.  $\times 10$ .

tubercle joined by a movable articulation. A grain is present in the radial line somewhere between each pair of the tubercles. Further, some of the arm joints bear each one short, cylindrical, blunt tubercle joined by a movable articulation. Such a tubercle never lies in the median line, but in such a position as to suggest that it is one of a pair, of which the fellow is absent.

### *Euryala anopla* CLARK.

*Euryala anopla*: CLARK, Bull. U. S. Nat. Mus., LXXV, 1911, p. 294, fig. 144.

*Euryala anopla*: DÖDERLEIN, Abh. Math.-Phys. Kl. K. Bayer. Akad. Wiss., Suppl.-Bd. I, 1911, p. 98.

Eastern Sea; 103-152 fathoms (CLARK).

### Key to Japanese genera of *Asteroschematinae*.

- A*—Radial shields entirely covered over; interbrachial ventral surfaces not so narrowed as to be slit-like; arm bases strongly ribbed in adult specimens; arm spines not very small. . . . . *Asteroschema*.
- AA*—Radial shields partially naked; interbrachial ventral surfaces very narrow and slit-like; arm bases much widened, not strongly ribbed, but almost smooth; arm spines exceedingly small . . . . . *Astrocharis*.

### Key to Japanese species of *Asteroschema*.

- A*—Disk and arms closely covered with granules. . . typical *Asteroschema*.
- a*—Radial ribs narrow, not occupying the entire dorsal side of disk; arms about fourteen times as long as the disk diameter; three or four granules in 1 mm. on the dorsal side of the arm bases; oral tentacle pores and some ten first tentacle pores opening by means of tubes. . . . . *tubiferum*.
- aa*—Radial ribs stout, almost occupying the entire dorsal side of the disk; five or six granules in 1 mm. on the dorsal side of the arm bases; oral tentacle pores and only a few first tentacle pores opening by means of tubes.
- b*—Ventral side of arms closely covered with granules, like the other parts; arms about nine times as long as the disk diameter. . . . .  
. . . . . *glaucum*.
- bb*—Ventral side of the arms covered by a skin, which is almost free of granules; arms about twelve times as long as the disk diameter  
. . . . . *hemigymnum*.
- AA*—Disk and arms covered by a thick, naked skin, which may, how-



- ever, contain fine granules in younger stages. . . . section *Ophiocreas*.
- c*—Arms one-third to one-fourth as wide as the disk diameter.
- d*—Arms thirteen to seventeen times as long as the disk diameter.
- e*—Skin of the disk and arms very thick ; arm spines not very slender ; no large depressions just outside the tentacle pores. . . . . *caudatum*.
- ee*—Skin of the disk and arms very thin ; arm spines long and very slender ; a large depression present just outside each tentacle pore. . . . . *japonicum*.
- dd*—Arms about eight times as long as the disk diameter ; skin of the disk and arms moderately thick ; arm spines short ; genital slits very short, situated near the interbrachial angle. . . . . *abyssicola*.
- ce*—Arms about one-half as wide as the disk diameter, and nine to twelve times as long as the same ; skin of the disk and arms thick, covering the underlying parts very loosely. . . . . *glutinolum*.

It is by no means easy to distinguish clearly the species of *Asteroschema*, especially those of the section *Ophiocreas*, owing to the fact that, this genus assumes different appearances according to its developmental stages. The oral papillæ are papilliform and arranged in a single horizontal row in younger stages, but are converted into flattened and pavement-like grains in larger specimens. The generative glands extend into the arm bases as two pairs of ribbon-shaped bodies only in the adult, the extent of the lobes increasing with growth. The parts of the arms containing the generative glands are much widened and knotted, owing to the appearance of a transverse row of secondary plates on either side of each arm joint. In the section *Ophiocreas*, the younger specimens are more granular, and the full-grown ones are almost entirely naked. The ratio of the arm length to the disk diameter increases with growth. In exceedingly young specimens of a certain species, only a single arm spine (the adradial one in the larger specimens) is present for each tentacle pore. On the basis

of these considerations, I am convinced that, the identification and naming of *Asteroschema* merely on the ground of the oral papillæ, widened or not widened arm bases, degree of granulation, arm length, &c., without reference to the size of the specimens, would inevitably lead to a great confusion. Thus, I am obliged to transfer several species set up by eminent authors to the list of synonyms.

*Asteroschema tubiferum* MATSUMOTO.

*Asteroschema tubiferum* : MATSUMOTO, Proc. Acad. Nat. Sci. Philadelphia, 1915, p. 52.

Two specimens; Okino-sé, Sagami Sea. One specimen; off Misaki, Sagami Sea.

Diameter of disk 16 mm. Length of arms 230 mm. Width of arms at base 4.5 mm.

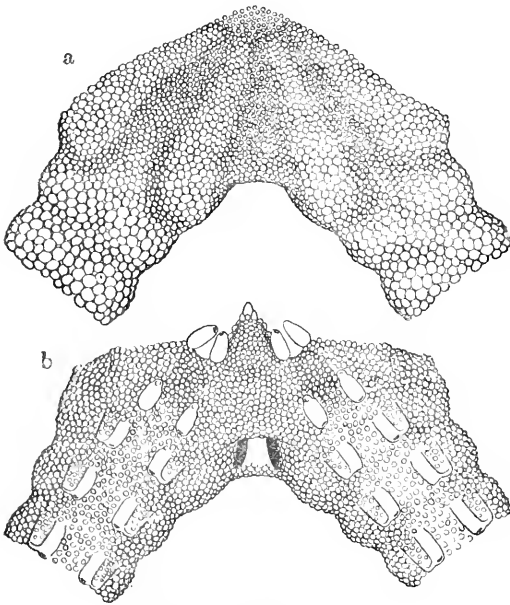

Fig. 10. *Asteroschema tubiferum*.  $\times 4$ . a. From above.  
b. From below.

Disk rather arched, a little higher than the arms, closely covered with very fine smooth granules. Radial ribs long and narrow, narrower within, nearly reaching the centre. The disk granules are finer and rather well spaced towards the centre, but coarser and very close-set on the radial ribs. Interbrachial ventral surfaces rather vertical, forming a notch, in which lie

the two rather large, nearly parallel genital slits. On the floor of each notch, opens one madreporic pore. Oral angles convex laterally and downwards, almost filling up the oral slits. Eleven or twelve teeth in a single vertical row, triangular and stout. On either side of the oral angle, there are several flat, smooth, pavement-like grains corresponding to the oral papillae.

Arms long and slender, as high as wide near the base, not smoothly rounded, but inclined to be quadrangular in transverse section, wider above than below; more distally arched above and plane below, higher than wide; closely covered with fine, smooth granules, of which three or four lie in 1 mm. on the dorsal side near the arm base. Arm joints rather distinct. First tentacle pore without arm spines, next three or four pores with one, and the rest with two spines. The abradial spine is very small, conical, enclosed in skin, with rough end. The adradial one is short and conical in the basal joints; more distally they become longer, stouter and club-shaped, finally about as long as two arm joints; enclosed in skin, rough; the minute thorns at the end of the spines become distally rather concentrated on the inner side of the spines. Oral tentacle pores and some ten basal tentacle pores opening by means of tubes, in which they are enclosed; each tube, except that of the oral and the first tentacle, is attached to the adradial arm spine on its adradial side.

Colour in alcohol light pinkish brown or flesh-coloured.

This species is quite near to *A. rubrum* LYMAN, but differs from it chiefly in the much coarser granules on the basal parts of the arms, in having tentacle tubes not only for the oral tentacles but also for some ten first tentacles, and in the club-shaped and relatively longer and stouter arm spines.

*Asteroschema glaucum* MATSUMOTO.

*Asteroschema glaucum*: MATSUMOTO, Proc. Acad. Nat. Sci. Philadelphia, 1915, p. 53.

Three specimens; Dôketsuba, Sagami Sea; 110 fathoms.

Diameter of disk 11 mm. Length of arms 100 mm. Width of arms at base 4 mm.

Disk five-lobed, the lobes being continued without any distinct demarcation into the arms; flat, about as high as the arms, closely covered with very fine, smooth granules. Radial ribs rather indistinct. Interbrachial ventral surfaces rather vertical, very narrow, forming a deep notch, in which lie the two rather large, parallel genital slits. Oral angles convex laterally and downwards, almost filling up the oral

slits. Six or seven teeth in a single vertical row, triangular and stout. On either side of the oral angle, there are several flat, smooth, pavement-like grains corresponding to the oral papillæ. Sometimes a few round smooth grains occur below the teeth.

Arms as high as wide, very stout at the base, so that the interbrachial spaces are very narrow below; distally rather slender and higher than wide; covered

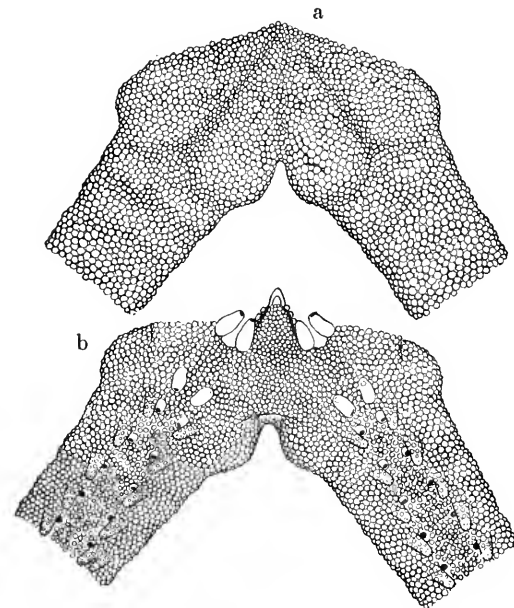

Fig. 11. *Asteroschema glaucum*.  $\times 4$ . a. From above.  
b. From below.

with fine, smooth, close-set granules, of which there are about six in 1 mm. on the radial ribs and the arm bases. Arm joints indistinct in the basal parts. First tentacle pore without arm

spines; next four or five with one, and the rest with two spines. The abradial spine is very small, conical, enclosed in skin, with rough end. The adradial one is small and conical in the basal joints, distally longer and somewhat club-shaped, and slightly longer than the arm joint itself; enclosed in skin, rough; the minute thorns at the end of the spine become distally rather concentrated on the inner side of the spine, and finally, towards the very extremity of the arms, the arm spines are transformed into compound hooks, each with three or four hooklets. Oral tentacles enclosed in tubes. The first two or three tentacle pores are also provided with tubes, though rudimentary.

Colour in alcohol pale gray.

This species is very near to *A. salyx* LYMAN, but differs from it chiefly in the coarser granules of the disk and arm bases, in the stout arm bases being as wide as high, in the much shorter arm spines, and in the oral tentacles being enclosed in tubes.

*Asteroschema hemigymnum* MATSUMOTO.

*Asteroschema hemigymnum*: MATSUMOTO, Proc. Acad. Nat. Sci. Philadelphia, 1915, p. 53.

One specimen; off Misaki, Sagami Sea.

Diameter of disk 10 mm. Length of arms 120 mm. Width of arms at base 3 mm.

Disk rather flat, divided into ten lobes corresponding to the radial ribs by ten radiating furrows, covered by a skin, which contains very fine, smooth, close-set granules. Interbrachial ventral surfaces rather vertical, narrow, forming a deep notch, on the floor of which opens one madreporic pore. Genital slits rather short, a little diverging dorsally. The ventral surface of the disk is covered by a finely and rather sparsely granulated skin. Oral

angles not markedly set off from the outer parts. Six or seven teeth

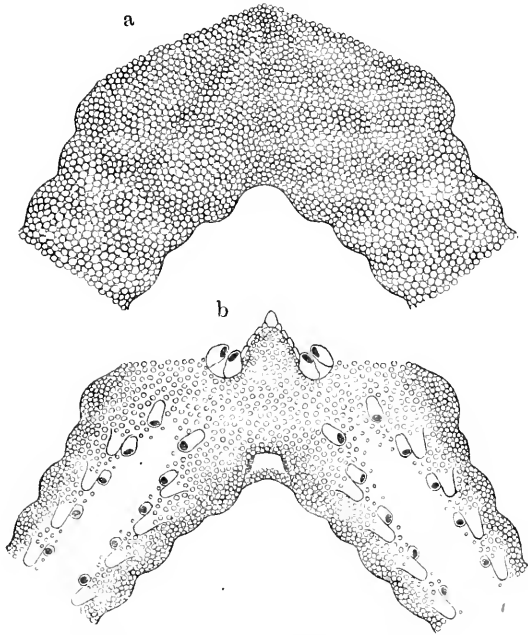

Fig. 12. *Asteroschema hemigymanum*.  $\times 6$ . a. From above. b. From below.

arranged in a single vertical row, very stout. On either side of the oral angles, there occur several coarse, flat, smooth, pavement-like grains corresponding to the oral papillæ.

Arms very stout for the first three or four free joints, but becoming rather slender further out; their width just outside the fourth free joint is 2.5 mm. They constantly taper outwards, so that they are exceedingly slender to-

wards the extremities, and acute at the tips. Dorsal and lateral surface of the arms covered by a skin, which is similar to that of the disk and contains very fine, smooth, close-set granules, of which there are about five in 1 mm. on the dorsal surface of the arm bases. The granules become much finer outwards, and almost disappear nearer the extremity of the arm. The vertebræ are visible through the skin, but the surface of the arms is practically smooth and without distinct demarcations of the joints, except in the first three or four free joints, which are marked off by shallow constrictions. The ventral surface of the arms is entirely naked, and the lateral and ventral arm plates are clearly visible through the skin. First tentacle pore without arm spines; next four or five with one, and the rest with two spines. The abradial spine

is very small, cylindrical, enclosed in skin, more or less rough at the free end. The adradial one is club-shaped, enclosed in skin, very rough at the free end. The arm spines are largest at the middle of the arms, the adradial one being one and a half times as long as, and the abradial one a little shorter than, the corresponding arm joint. They are transformed into compound hooks with three to six hooklets towards the very extremity of the arm. The oral tentacle pore and the first three or four tentacle pores are provided with tubes.

Colour in alcohol grayish brown.

Like *A. intectum* LYMAN and *A. migrator* KÖHLER, this species appears to be an intermediate form between the sections *Asteroschema* s. str. and *Ophiocreas*.

*Asteroschema (Ophiocreas) caudatum* (LYMAN).

*Ophiocreas caudatus*: LYMAN, Bull. Mus. Comp. Zool., VI, 1879, p. 64, Pl. XVI, figs. 439-442; LYMAN, Rep. Challenger, V, 1882, p. 281, Pl. XXXII, figs. 5-8.

*Ophiocreas oedipus*: CLARK Bull. U. S. Nat. Mus., LXXV, 1911, p. 283. (Non LYMAN, 1879.)

*Asteroschema (Ophiocreas) sagaminum*: DÖDERLEIN, Abh. Math.-Phys. Kl. K. Bayer. Akad. Wiss., Suppl.-Bd. I, 1911, p. 60, Pl. VI, figs. 6 & 6 a, Pl. VII, fig. 10.

*Asteroschema (Ophiocreas) caudatum*: DÖDERLEIN, *ibid.*, p. 113.

One specimen; Ôtaba, Sagami Sea; 420 fathoms. Numerous specimens; outside Okinosé, Sagami Sea; 330 fathoms. Numerous specimens; Sagami Sea.

These specimens range from very small to very large ones. In the largest one, the disk is 25 mm. in diameter, and the arms are 420 mm. in length and 7.5 mm. in width. The oral tentacle

pores and some ten basal tentacle pores open by means of tubes,

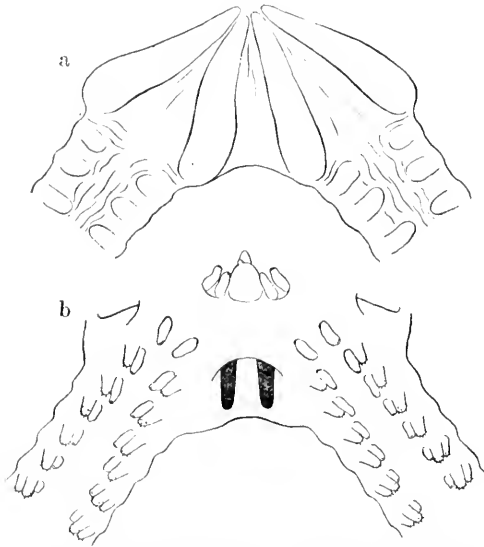

Fig. 13. *Astroschema (Ophiocreas) caudatum*.  
x4. a. From above. b. From below.

a character which was overlooked by LYMAN. Colour in alcohol, light pinkish brown, or dark brownish purple, if the specimens have not lain in alcohol for a long time. The dermal granules, which are present in the arm bases and the disk, are more conspicuous in smaller specimens. I have failed to find any important distinguishing characters between *A. sagaminum* DÖDERLEIN and the young specimens of corresponding size of the

present species, so that I consider the former as a synonym of *A. caudatum*.

In this species, the ribbon-shaped generative glands reach out to an enormous extent. In a specimen with the disk diameter of 25 mm., they extend outwards about 180 mm. and as far as the seventieth free arm joint. The parts of the arms containing the generative glands are quadrangular in transverse section, covered dorsally by a much wrinkled skin, and have, on the dorsal and lateral sides of each joint, a row of plates supporting and protecting the cavity in which the generative glands lie. These plates are replaced by double rows of minute scales in the sterile parts of the arms. In smaller specimens, the generative lobes are confined to the short basal portion of the arms, which is much widened. Thus, specimens of about 12 mm. in the disk diameter



much resemble the type of *A. edipus* (LYMAN), but are distinguished from it chiefly by the presence of abundant dermal granules, by the much shorter and stouter arms, and by the tentacle pores with a single spine extending further into the arms.

Through Dr. H. L. CLARK's kindness, I was able to examine a specimen of his "*Ophiocreas edipus*" from Japan. It is, in my opinion, undoubtedly referable to the present species, so I have no hesitation to drop *Asteroschema (Ophiocreas) edipus* from the list of Japanese ophiurans.

*Asteroschema (Ophiocreas) japonicum* (KOEHLER).

*Ophiocreas japonicus*: KOEHLER, Bull. Sci. Fr. Belg., XII, 1907, p. 346, Pl. XIV, fig. 54.

*Ophiocreas papillatus*: CLARK, Bull. Mus. Comp. Zool., LI, 1908, p. 298.

*Asteroschema (Ophiocreas) japonicus*: DÖDERLEIN, Abh. Math.-Phys. Kl. K. Bayer. Akad. Wiss., Suppl.-Bd. I, 1911, p. 59, Pl. VI, figs. 5 & 5 a, Pl. VII, fig. 9.

*Asteroschema (Ophiocreas) monacanthum*: ibid., p. 58, Pl. VI, figs. 9-9 b.

*Asteroschema (Ophiocreas) enoshimumun*: ibid., p. 60, Pl. VI, figs. 8 & 8 a.

One specimen; Suruga Gulf. Three specimens; Okinosé. Sagami Sea; 290 fathoms. Numerous specimens; outside Okinosé: 330 fathoms. Numerous specimens; Sagami Sea.

These specimens range from very small to very large ones representing all growth stages. In the larger ones, the skin is entirely free of granules. In somewhat smaller specimens, the skin contains some granules in the disk and arm bases, while in still smaller ones, the skin is strongly granulated on the dorsal, as well as on the ventral, surface of the disk and arms. The oral

papillæ appear to have been overlooked by K  HLER and D  DERLEIN, but they are present in the form of several flat, smooth, pavement-like grains, which are however not very distinct in larger

specimens, but are more prominent and papilliform in smaller ones. K  HLER, CLARK and D  DERLEIN erroneously call the depression just outside the tentacle pore large tentacle pore, but this large depression is distinct from the pore itself. D  DERLEIN doubts the taxonomic value of this depression, but it is present in all my specimens and in no other species in my knowledge. I have examined pieces of arms of

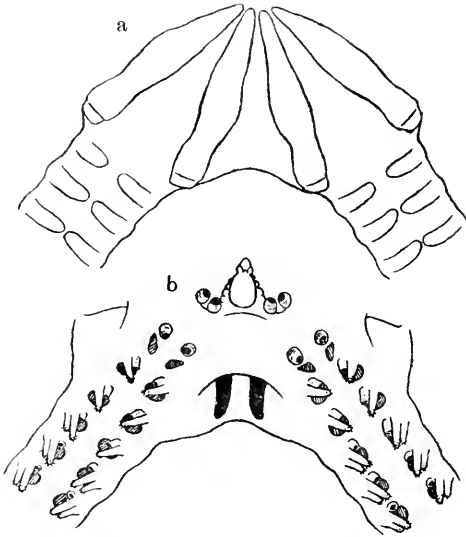

Fig. 14. *Asteroschema (Ophiocreas) japonicum*.  $\times 4$ .  
a. From above. b. From below.

the foregoing and the present species after boiling them in potash. In *A. caudatum*, the bar-like lateral arm plates are stout, with much widened adradial ends, and the ventral arm plates are divided into right and left halves, so that the spaces for the tentacles are very small. In *A. japonicum*, the bar-like lateral arm plates are very slender, with feebly widened adradial ends, and the ventral arm plates are very small and granuliform, so that the spaces for the tentacles are very large. Thus, I have no doubt that, the depression in question of the present species is a specific character.

I have compared *Ophiocreas papillatus* CLARK, *A. enoshimanum* D  DERLEIN and *A. monacanthum* D  DERLEIN with the corresponding

specimens of the present species, and I am quite satisfied as to their specific identity. The three forms just mentioned are, in my opinion, merely younger stages of the present species before the disappearance of the dermal granules and the occlusion of the oral papillæ; *A. monucanthum*, being the youngest, is only 4 mm. across the disk and has only the adradial arm spine. In slightly larger specimens, the abradial spine begins to appear as a very small rudiment.

The specimens are light pinkish brown or flesh-coloured in alcohol, or dark brownish purple, if they have not lain in alcohol for a long time, or sometimes yellowish brown, when badly preserved in weak alcohol.

*Asteroschema (Ophiocreas) abyssicola* (LYMAN).

*Ophiocreas abyssicola*: LYMAN, Bull. Mus. Comp. Zool., VI, Pt. 2, 1879, p. 64, Pl. XVII, figs. 470-473; LYMAN, Rep. Challenger, V, 1882, p. 282, Pl. XXXII, figs. 1-4.

*Asteroschema (Ophiocreas) abyssicola*: DÖDERLEIN, Abh. Math.-Phys. Kl. K. Bayer. Akad. Wiss., Suppl.-Bd. I, 1911, p. 113.

Eastwards from Honshû; 2,300 fathoms (LYMAN).

*Asteroschema (Ophiocreas) glutinosum* DÖDERLEIN.

*Asteroschema (Ophiocreas) glutinosum*: DÖDERLEIN, Abh. Math.-Phys. Kl. K. Bayer. Akad. Wiss., Suppl.-Bd., I, 1911, p. 59, Pl. VI, figs. 5 & 5 a, Pl. VII, fig. 9.

One specimen (belonging to the First High School); Sagami Sea. Numerous specimens, clinging to a gorgonacean, together with some specimens of *A. caudatum* and *A. japonicum*; outside Okinosé, Sagami Sea; 330 fathoms.

The ratio of the arm length to the disk diameter is much

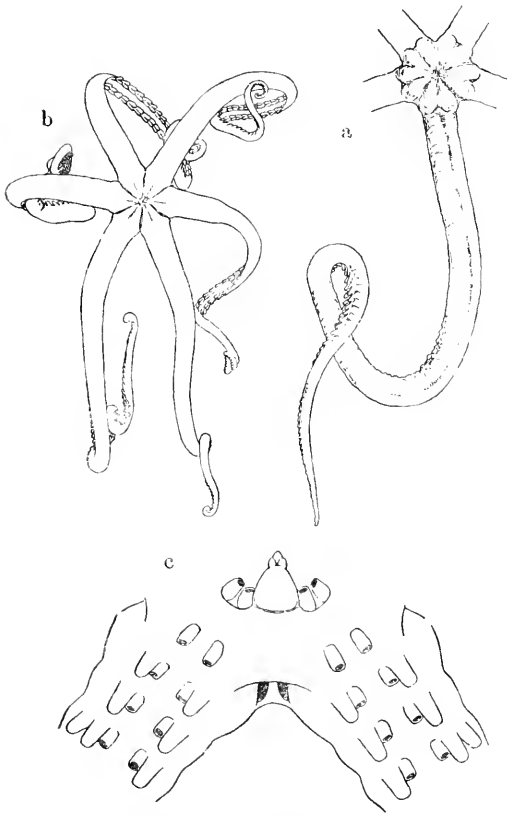

Fig. 15. *Astroschema (Ophioceras) glutinosum*. a. From above.  $\times \frac{2}{3}$ . b. From above.  $\times \frac{2}{3}$ . c. From below.  $\times 3$ .

smaller in smaller specimens. Three of the above specimens are six-armed, but there is no trace of schizogony. On either side of the oral angles, there are several flat, smooth pavement-like granules, which are however not very distinct. Sometimes, there occur one or two papilliform grains below the teeth. The colour is white in alcohol, or brown, if the specimens have not lain in alcohol for a long time.

In *Astroceras*, *Astroschema* and *Trichaster*, the generative glands extend into the arms as ribbon-shaped bodies, and as a consequence, the arms present certain peculiar features. The parts of the arms containing the generative lobes are more or less widened, quadrangular in transverse section, strongly knotted, and has a conspicuous dorsal median groove. In *Astroceras* and *Astroschema*, there are two pairs of generative glands in each arm, and the parts containing them present a knotted appearance, owing to the presence of transverse ridges on either side. In the first named genus, these ridges are formed by bar-like plates, but in the latter

by a row of plates, supporting and protecting the cavity in which the generative glands lie. In the sterile parts of the arms, these plates are replaced by two rows of nodules in each joint in *Astroceras*, and by two rows of minute scales in *Asteroschema*. In *Trichaster*, there are four pairs of generative glands in each arm, which bears masses of irregular nodules. These nodules are arranged in two layers and form three or four rows on either side of each joint in the proximal parts of the arms: two of the rows belonging to the internal layer, two to the external layer on the ventral side and one on the lateral side. Besides, there is a large nodule on the upper end of the ridge formed by the rows of nodules on either side of each joint. These nodules form two longitudinal rows of humps on each arm. In the sterile part of the arms, the nodules are replaced by two rows of scales in each joint. The species in which the extension of the generative glands into the arms has been observed are shown below, together with some additional facts.

Species.	Disk diameter of specimen.	Free basal arm joints containing the generative glands.	Length of the foregoing part.
<i>Astroceras pergamena</i>	7 mm.	10	9 mm.
<i>Asteroschema tubiferum</i>	16 mm.	8	15 mm.
„ <i>glaucum</i>	11 mm.	0	0
„ <i>hemigymnum</i>	10 mm.	4	5 mm.
„ <i>caudatum</i>	25 mm.	70	180 mm.
„ „	12 mm.	6	10 mm.
„ <i>japonicum</i>	31 mm.	46	120 mm.
„ „	22 mm.	10	20 mm.
„ <i>glutinosum</i>	25 mm.	12	25 mm.
„ „	15 mm.	9	15 mm.
<i>Trichaster elegans</i>	33 mm.	56 <sup>(2. bifur- cation.)</sup>	165 mm.
„ „	32 mm.	36	120 mm.

*Astrocharis ijimai* MATSUMOTO.

*Astrocharis ijimai*: MATSUMOTO, Proc. Acad. Nat. Sci. Philadelphia 1915, p. 54.

Numerous specimens, clinging to a coral; Misaki, Sagami Sea. Diameter of disk 4.5 mm. Length of arms 50 mm. Width of arms at base 2.5 mm.

Disk five-lobed, with deeply indented interbrachial borders, with the lobes emarginate towards the arms, flat, sunken at the central region, raised at the lobes, covered with very fine, smooth, irregular scales; which are very closely set and partly imbricated.

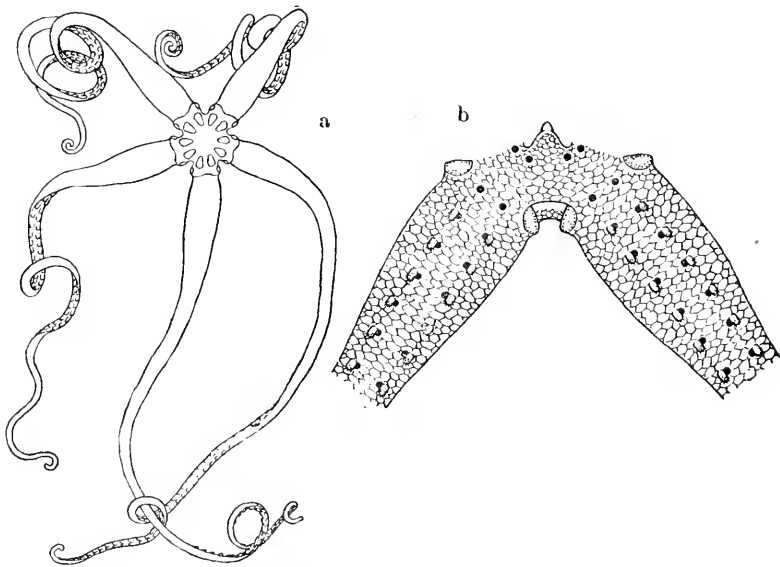

Fig. 16. *Astrocharis ijimai*. a. From above.  $\times 2$ . b. From below.  $\times 10$ .

Radial shields naked, very small, triangular, with the apex turned within, tuberculous when examined under the microscope. Interbrachial ventral surfaces forming very deep notches, exceedingly narrowed by the very wide arm bases. Two genital slits, small, parallel, nearly vertical. On either side of each lobe of the disk,

lies the naked genital plate, which is large, oval, and tuberculous under the microscope like the radial shields. Thus, each inter-brachial ventral surface is bounded on either side by the genital plate. Oral angles puffed laterally, almost filling up the oral slits. Teeth small, triangular, arranged in a single vertical row. No oral or dental papillæ.

Arms very wide at the base, keeping the same width to the distance of about 4 or 5 mm., then rather rapidly narrowed, becoming slender and cylindrical, with the width of about 1 mm.; covered with scales similar to those of the disk. Arm joints invisible in the proximal part, but more or less distinct distally. First tentacle pore without arm spine, the following ones with one spine, which is very small, short, peg-like, somewhat flattened, rough at the end under the microscope, lying flat on the ventral surface of the arm. Half way out in the arms, the tentacle pores are each provided with two spines, of which the second or the abradial one is exceedingly small and rather inconspicuous; while the adradial one is a little longer and erect.

Colour in alcohol white or light pale yellow.

In smaller specimens, the arms are scarcely widened at the base, which is also the case in regenerating ones; for, schizogony takes place in this species, as in the genotype, *A. virgo* KØHLER. Most specimens are five-armed, but the arms are often unequal, two or three being larger than the others. I have, however, one specimen with six arms, three larger and three smaller. In the four-armed specimens, two or three of the arms may be larger and the other two or one smaller. Still another specimen has only three arms and three pairs of radial shields, doubtless indicating that it has lately undergone division, and that the lost parts have not been regenerated. It can be easily observed in

this species that, only two arms may sometimes be regenerated in place of three, or one in place of two.

This species can be distinguished very easily from the genotype, *A. ringo*. The arms are slightly less widened at the base and keep their width for a less extent. The arm spines are only one to each tentacle pore for over half the length of the arms, while in the genotype, two are present even in the basal region. Finally, the disk and arms are covered with fine scales instead of granules.

In this species, the widening of the arm bases is caused by the widening of the vertebrae, and is not accompanied by the extension of the generative glands, so that even in the widened part, the arm covering of the dorsal side is in direct contact with the vertebrae. I suppose that this condition is a generic character, though there is no observation on this point in the genotype.

### Family 3. **Gorgonocephalidæ** (DÖDERLEIN, 1911) mihi, 1915.

Disk and arms covered by a thick skin, which contains granules, very often beset with stumpy tubercles. Radial shields long, bar-like, forming a system of radiate ribs. The radial shields and genital plates articulate with each other by means of a transverse ridge on both the plates. Genital plates long and stout, genital scales small. Oral and adoral shields very small, the former being often separated from the latter by a mosaic of supplementary plates. Teeth and dental papillæ, often as well as oral papillæ, similar, spiniform, acute, forming a clump or cluster at the apex of each jaw. Peristomial plates entire, stout, soldered with the also very stout oral frames. Arms exceedingly long, simple or branched, vertically coiled. Dorsal arm plates represent-



ed by double rows of hook-bearing granules, so that the arm is annulated by the minute hooks. Lateral and ventral arm plates confined to the ventral side of the arm. More than three arm spines, all ventral in position, serving as tentacle scales. Vertebrae very short and exceedingly stout, discoidal, with typically streptospondyline articulation. Upper muscular fossæ of the vertebrae extremely large, the lower very small. This family includes twenty-four genera, which may be grouped into two subfamilies.

Subfamily 1. *Gorgonocephalinae* mihi, 1915:—Teeth, dental papillæ and oral papillæ all similar, spiniform; oral angles not strongly projected ventrally; genital slits small, often pore-like, lying near the disk border; basal vertebrae not very small, not covered over by the muscles lying between the basal vertebrae and genital plates; arms simple or divided; those forms with arms simple or divided a few times have no supplementary plates in the spaces between the oral angles and the interbrachial ventral surfaces, while those with arms divided many times have well developed supplementary plates in the spaces mentioned.

I. Arms simple or divided a few times; no supplementary plates in the spaces between the oral angles and the interbrachial ventral surfaces.

a. Arms simple.

*Astrogomphus* LYMAN, 1869.

*Astrochlamys* KÆHLER, 1912.

*Astrochele* VERRILL, 1878.

*Asteroporpa* ERSTED & LÜTKEN, 1856.

b. Arms divided a few times.

*Astrocnida* LYMAN, 1872.

*Conocladus* CLARK, 1909.

II. Arms divided many times; supplementary plates well

developed between the oral angles and the interbrachial ventral surfaces.

a. Madreporite single.

*Astroconus* DÖDERLEIN, 1911.

*Gorgonocephalus* LEACH, 1815.

*Astrodendrum* DÖDERLEIN, 1911.

*Astrocladus* VERRILL, 1899.

*Astrospartus* DÖDERLEIN, 1911.

*Astroboa* DÖDERLEIN, 1911.

*Astrophyton* MÜLLER & TROSCHEL, 1842.

*Astrochalcis* KÖEHLER, 1905.

*Ophiocrene* BELL, 1894.

b. Madreporites five.

*Astrogordius* DÖDERLEIN, 1911.

*Astrocyclus* DÖDERLEIN, 1911.

*Astrocaneum* DÖDERLEIN, 1911.

*Astrodactylus* DÖDERLEIN, 1911.

Subfamily 2. *Astrotominae* MATSUMOTO, 1915 :—Teeth and dental papillæ similar, spiniform; oral papillæ very rudimentary or entirely absent; oral angles strongly projected ventrally; genital slits rather large, long, extending nearly from the inner corners of the interbrachial ventral surfaces to the disk border; basal vertebrae very small, distinctly narrower than those just beyond, covered over by the muscles lying between the basal vertebrae and genital plates; arms simple or divided a few times; well-developed supplementary plates present in the spaces between the oral angles and the interbrachial ventral surfaces.

a. Arms simple.

*Astrothamnus* MATSUMOTO, 1915.

*Astrothrombus* CLARK, 1909.

*Astrothorax* DÖDERLEIN, 1911.

*Astrotoma* LYMAN, 1878.

b. Arms divided a few times.

*Astrocolon* LYMAN, 1879.

LYMAN, whose erroneous interpretation of certain parts in *Euryale aspera* was pointed out before, has made a similar mistake in the present family, inasmuch as he states that, in *Astrocnida isidis* (DUCHASSAING), *Gorgonocephalus arcticus* LEACH [= *G. agassizi* (LYMAN)] and *G. chilensis* (PHILIPPI), the genital slits are not surrounded by any "bursa" but directly penetrate into the "peritoneal cavity," in which the generative glands lie. I have studied the internal structure of *Astrochele lymani* VERRILL, *Asteroporpa hadracantha* CLARK, *Gorgonocephalus tuberosus* DÖDERLEIN, *G. arcticus*, *G. caryi* (LYMAN), *G. dolichodactylus* DÖDERLEIN, *Astrodendrum sagaminum* (DÖDERLEIN), *Astrocladus annulatus* MATSUMOTO, *A. coniferus* (DÖDERLEIN), *Astroboa arctos* MATSUMOTO, *Astrothamnus echinaccus* MATSUMOTO and *Astrotoma sobrina* MATSUMOTO, and am convinced that, LYMAN'S "peritoneal cavity" is not the genuine peritoneal cavity but merely the genital bursæ, which are very spacious and communicate with each other, and usually also with the perihæmal canal, so as to form a single compound cavity; the genuine peritoneal cavity is perfectly divided into five radial compartments, which are entirely filled up by the very voluminous, folded generative glands, and no longer appear as cavities; the generative glands do not lie in LYMAN'S "peritoneal cavity," i.e. genital bursæ, but are separated from them by a thin but distinct membrane and lie morphologically outside them. As I have already pointed out in *Euryale aspera*, the fact that the brachial body cavity, which is the direct continuation of the true peritoneal cavity, has no direct communication with LYMAN'S "peritoneal cavity,"

i.e. genital bursæ, also in these genera, is a decisive proof against LYMAN'S interpretation.

According to LYMAN, *Astrogomphus vallatus* LYMAN has a very simple oral skeleton, which "somewhat recalls the shape in *Ophioscolex*, though the peristomial plates are entire and transversely oval." LUDWIG'S 'first ventral arm plate' is present at the upper outer corner of the oral slit. The radial shields are long, bar-like, narrow, composed of several overlapping secondary plates soldered together. Again, according to LYMAN, in *Astrocnida isidis* the digestive cavity has its roof firmly attached to the body wall, but the floor is entirely and the sides partially free. The perihæmal canal is entirely closed, and judging from LYMAN'S statements, the genital bursæ appear to communicate with one another so as to form a single compound cavity, regarded by LYMAN as the "peritoneal cavity." I do not know any other genus of the present family with entirely closed perihæmal canal.

My own observations have been made upon *Astrochele lymani* and *Asteroporpa hadracantha*, as representatives of the simple-armed genera of the *Gorgonocephalinae*. In the first named species, the radial shields are long, narrow, bar-like, almost reaching the centre of the disk, composed of several overlapping secondary plates soldered together. The genital plates are stout, lying close to the sides of the basal vertebrae. The genital scales are very small, flat, lamella-like, articulated to the genital plates at a short distance from the outer ends of the latter. The basal vertebrae within the disk are not covered over by the muscles lying between them and the genital plates. The peristomial plates are entire, very large, roughly pentagonal, with the longest side inwards and the most obtuse angle outwards, much wider than long, closely soldered with the oral frames, which are rather

simple and not very stout. LUDWIG'S 'first ventral arm plate' is present at the upper outer corner of the oral slit. The oral plates are very slender and rather long. The interradial attachments of the floor of the gastral cavity extend from the middle of the peristomial plates outwards, and the radial attachments from the outer end of the first vertebrae outwards. The perihæmal canal and genital bursæ communicate with each other, so as to form a single cavity, which is however divided into ten radiating compartments by the radial and interradial attachments of the floor of the gastral cavity. The peritoneal cavity is perfectly divided into five radial compartments, which is entirely filled up by the generative glands. The ventral arm plates are present, being represented by two or three secondary plates. The minute hooks of the arm annulations are comparatively coarse, being composed of from one to three supplementary hooklets, besides the main terminal one. In *Asteropora hadracantha*, the radial shields are entire instead of being composed of several secondary plates, stout and very thick. The interradial attachments of the floor of the gastral cavity extend from the outer end of the peristomial plates outwards. The ventral arm plates are entire, quadrangular, slightly separated by the adradial parts of the bar-like lateral plates. The minute hooks are much finer than those of the foregoing species, having only a single supplementary hooklet besides the main one, as in many higher genera. The other structures are almost similar to those of the preceding species. In higher genera with the arms branched many times, the genital plates lie at the lower lateral sides of the basal vertebrae, and do not extend inwards to the first vertebrae, as they do in the simple-armed genera.

The species of *Gorgonocephalus* may be divided into three groups on the basis of the attachments of the gastral pouches to

the basal vertebræ, *G. tuberosus* representing the first, *G. arcticus* the second, and *G. dolichodactylus* the third. In *G. tuberosus*, the floor of the gastral cavity is almost free from the basal vertebræ, except in the very peripheral parts, where it is attached to the one or two vertebræ just inside the disk border. In *G. arcticus*, the floor of the gastral cavity is firmly attached to the basal vertebræ within the disk, save one or two first vertebræ which are free from the gastral wall. *G. caryi* and, according to LYMAN, also *G. chilensis* belong to this type. In *G. dolichodactylus*, the attachments of the floor of the gastral cavity to the basal vertebræ extend from the second to the sixth vertebræ, so that the two compartments of the perihæmal canal plus genital bursæ on either side of a radius communicate together in two places, one lying inwards just above the second vertebra and the other outwards just above the sixth vertebra. In all the three types, the gastral cavity is divided into ten radiating compartments, the radial and interradial gastral pouches, of which the walls again present radiating folds and are thickened by the presence of the inner layer of yellowish or brownish glandular cells, the foldings and thickenings being however more prominent in the second and third types than in the first; and the peritoneal cavity is perfectly divided into five radial compartments, which are entirely filled up and obliterated by the very voluminous, strongly folded generative glands. The internal differences appear to me to be correlated with certain external features; the first type being characterised by the high disk and strongly concave interbrachial ventral surfaces, the second by the low disk and flat interbrachial ventral surfaces, and the third by the very high outer ends of the genital slits. *Astrodendrum sagaminum* is almost similar to the second type of *Gorgonocephalus* in its internal structure. In *Astrocladus annulatus*,

the general plan of the internal structure is similar to that of the second type of *Gorgonocephalus*; while in *Astrocladus coniferus*, the plan is that of the third type, though the foldings of the gastral pouches, as well as of the generative glands, are more complex and the layer of the glandular cells of the wall of the gastral cavity is extraordinarily thick, so that the cavity itself is much less spacious. In *Astroboa arcetos*, the internal structure is essentially similar to that of the preceding, but there is often a fenestra in each interradial septum between the two compartments of the perihæmal canal plus genital bursæ on either side of an interradial line, placing the two in communication with each other. In this species, the inner side of the dorsal surface of the vertebræ is strongly convex, and the outer side correspondingly concave.

DÖDERLEIN has divided the *Gorgonocephalidae* into two sub-families according to the presence or absence of supplementary plates in the spaces between the oral angles and the interbrachial ventral surfaces. But his statement is in my opinion based on an error, because my *Astrotominae* evidently have the supplementary plates in question. In *Astrothammus echinaceus*, the supplementary plates in question are well developed, and the adoral shields are separated by them from the interbrachial ventral surfaces. Besides, there occurs a not very large supplementary plate among the adoral shields and oral plates. The greater inner parts of the oral plates markedly project ventrally. The oral skeleton is firmly soldered together. The peristomial plates are entire, irregular in shape, with convex dorsal surface. The oral frames are humped dorsally near the outer ends, being much higher than the basal vertebræ. LUDWIG'S 'first ventral arm plate' is present at the dorsal side of the distal end of each oral slit, being firmly soldered with the oral frames. The second to sixth vertebræ are markedly

small and narrow, being narrower than the first vertebra and the basal free vertebræ of the arms, and are covered over by the muscles lying between them and the genital plates. The genital plates are very stout, lying close on the sides of the adjacent vertebræ. The genital scales are very small, articulated to the outer parts of the genital plates. The radial shields are long, narrow, thick, with humped interior surfaces, nearly reaching the disk centre. The gastral cavity is divided into ten radiating pouches, the roof being firmly attached to the body wall. The floor of the gastral cavity has ten attachments, the radial ones extending from the second vertebra to the disk margin and the interradiation ones from the peristomial plate to the same. The perihæmal canal communicates with the genital bursæ, which are very spacious. The peritoneal cavity is perfectly divided into five radial compartments, which are entirely filled up by the generative glands. The ventral arm plates are rhomboidal, much wider than long, separated from one another by the lateral arm plates, which meet each other in the ventral median line. The abradial parts of the lateral plates strongly project ventrally to form a very prominent spine ridge. The minute hooks of the annuli of the arms are compound, being composed of a terminal main hooklet and of three to five comb-like supplementary ones. In *Astrotoma sobrina*, the essential structure is almost similar, but the supplementary plates in the spaces between the oral angles and the interbrachial ventral surfaces are better developed; the muscles lying between the basal vertebræ and the genital plates are more massive; the radial shields are distinctly keeled ventrally; the radial attachments of the floor of the gastral cavity extend from the first vertebræ to the disk border; and the minute hooks of the annuli of the arms are composed of from one to three supplementary hooklets, besides



the terminal main one. According to DÖDERLEIN, the minute hooks of the annuli of the arms of *Astrothorax misakiensis* DÖDERLEIN have a single supplementary hooklet, besides the terminal main one. The position of the madreporic shield of *Astrotoma agassizi* LYMAN is almost the same as in *Astrospartus*, and such a position of the shield is hardly possible unless the supplementary plates are present in the space inside the interbrachial ventral surface.

### Key to Japanese genera of *Gorgonocephalinae*.

- A*—Arms simple; no supplementary plates in the spaces between the oral angles and the interbrachial ventral surfaces; annulations of the arms continued onto the dorsal side of the disk, so that the latter is concentrically annulated as a whole . . . . . *Asteroporpa*.
- AA*—Arms divided from the base; supplementary plates present in the spaces between the oral angles and the interbrachial ventral surfaces; disk not concentrically annulated.
- a*—Arm spines present from the very base.
- b*—Interbrachial margins of the disk with a row of marginal scales . . . . . *Gorgonocephalus*.
- bb*—Marginal disk scales absent . . . . . *Astrodendrum*.
- aa*—Arm spines absent at least within the first bifurcation; marginal disk scales absent.
- c*—Arm spines present within the second or third bifurcation . . . . . *Astrocladus*.
- cc*—Arm spines absent at least within the fourth bifurcation . . *Astroboa*.

### *Asteroporpa hadracantha* CLARK.

*Asteroporpa hadracantha*: CLARK, Bull. U. S. Nat. Mus., LXXV, 1911, p. 280, fig. 142.

One specimen; Uji-shima, Ôsumi; 80–90 fathoms. One speci-

men ; Oniga-sé, Sagami Sea ; 150-200 fathoms. One specimen ; locality unknown, probably Sagami Sea.

Eastern Sea ; 103 fathoms (CLARK). Off Omai Zaki, Yenshû Sea ; 34-37 fathoms (CLARK). Off Suno Saki, Sagami Sea ; 44-50 fathoms (CLARK).

The largest one of my specimens measure 7 mm. across the disk and 35 mm. in the length of the arms. In one specimen, some of the superficial granules of the disk and arms, both above and below, bear here and there a very long glassy hair.

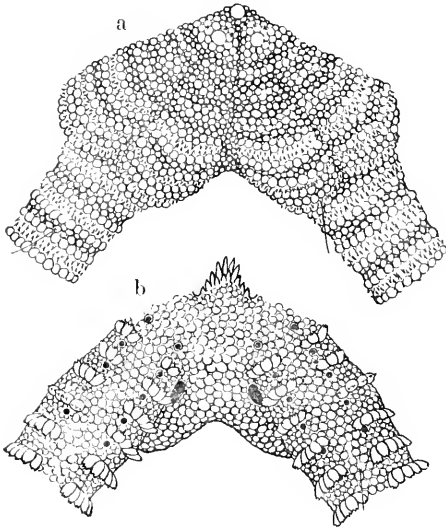

Fig. 17. *Asteroporpa hadracantha*.  $\times 8$ . a. From above. b. From below.

#### **Ophiocrene** BELL and the *Ophiocrenoid* stage.

The curious genus, *Ophiocrene* BELL, is characterised by the disk being covered mostly by the naked primary plates and by the radial shields being not long and bar-like but short and rounded. I have two very small, generically and specifically indeterminable specimens, which are almost similar to *Ophiocrene* in dorsal view, but differ from it in the occurrence of arm spines even in the very base of the arms. According to LYMAN and GRIEG, very young specimens of *Gorgonocephalus arcticus* LEACH (= *G. agassizi*) also have the disk essentially similar to that of *Ophiocrene*. I therefore imagine that, the disk characters of *Ophiocrene* occur in a certain young stage of many—presumably all—genera of the *Gorgonocephalidæ*, and

propose the name *ophiocrenoid* for it. Judging from the presence of a single madreporite and the absence of the arm spines in the basal parts of the arms, *Ophiocrene* may probably be the *ophiocrenoid* stage either of *Astroboa* or of *Astrochalcis*; and if this connection should be proved, *Ophiocrene* has priority as a generic name.

An *Ophiocrenoid* stage of one of the *Gorgonocephalinae*.

Two specimens; Mera-out-Oisegaké, Sagami Sea; 300 fathoms.

Diameter of disk 2.5 mm. Arms twice divided; length of the primary shafts 3 mm., of the secondary shafts 2.5 mm., and of the last shafts 1.5 mm. Width of arms at base 0.7 mm.

Disk five-lobed, rather high, with strongly concave interbrachial borders, covered by a pavement of naked plates, among which the central, five radials, five interradials, as well as the radial shields are most conspicuous, with convex surfaces. The secondary plates are very small and inconspicuous, and form a system of zones surrounding the primaries. Ventral side of disk covered by a granulated skin, through which the oral

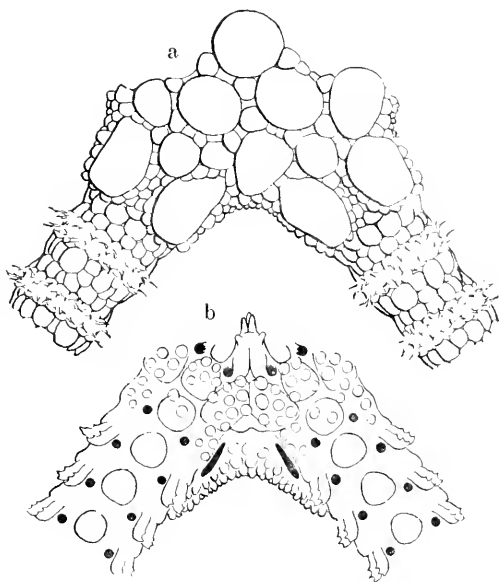

Fig. 18. An *Ophiocrenoid* (? *Gorgonocephalus* or *Astrochalcis*).  $\times 20$ . *a*. From above. *b*. From below.

and adoral shields can be seen as being entire and without sup-

plementary plates. Teeth, dental papillæ and oral papillæ very few in number.

Arms covered by a pavement of flattened, polygonal granules, and distinctly annulated by double rows of compound hooks, of which the terminal hooklet is smaller than the accessory one. Ventral side of arms covered by a naked skin, through which the ventral and lateral arm plates are visible. Two small, peg-like arm spines occur on the second and outer lateral arm plates.

Colour in alcohol white.

The smaller one of the two specimens is only 1 mm. across the disk and has the arms divided only once. The disk is entirely covered with the primaries and the radial shields, secondary plates being absent. The arms are not yet annulated by the double rows of compound hooks, but there are from three to five secondary plates in place of each dorsal arm plates, so that the dorsal view of the arms reminds us of that of *Hemicuryale*.

### Key to Japanese species of *Gorgonocephalus*.

- A*—Arms composed of short shafts; arm spines almost as long as the corresponding arm joint.
- a*—Teeth and papillæ, as well as arm spines, very acute; internal structure of the first type. . . . . *tuberosus*.
- aa*—Teeth and papillæ, as well as arm spines, blunt; internal structure of the second type. . . . . *caryi*.
- AA*—Arms composed of long shafts; arm spines shorter than half the corresponding arm joint; internal structure of the third type. . . . .  
 . . . . . *dolichodactylus*.

### *Gorgonocephalus tuberosus* DÖDERLEIN.

*Gorgonocephalus tuberosus*: DÖDERLEIN, Zool. Anz., XXV, 1902, p.

322; DÖDERLEIN, Abh. Math.-Phys. Kl. K. Bayer. Akad. Wiss., Suppl.-Bd. I, 1911, p. 33, Pl. II, figs. 1 & 2.

Four specimens; off Misaki, Sagami Sea.

Sagami Sea; 240 m. (DÖDERLEIN).

The largest one of my specimens is 56 mm. across the disk, which is beset with very numerous rough tubercles. One specimen (fig. c), measuring 27 mm. across the disk, closely resembles the next species, almost agreeing with LYMAN'S description of the same, except that the apparent granules, which are scattered on the disk, are in reality very fine, rough spinules as ascertained by an examination under the microscope. A vertical section of this specimen showed that it had the internal structure of the first type. I am inclined to regard this specimen as possibly a natural hybrid between the typical *G. tuberosus* and the next species, as the two occur almost in the same place.

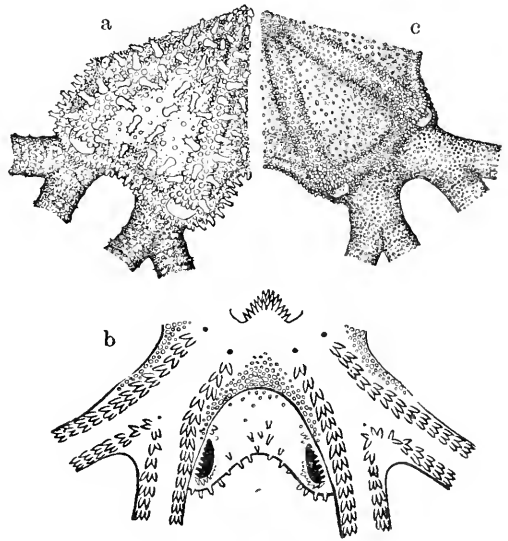

Fig. 19. *Gorgonocephalus tuberosus*. a. From above.  $\times 1\frac{1}{2}$ . b. From below.  $\times 1\frac{1}{2}$ . c. From above.  $\times 2$ .

### *Gorgonocephalus caryi* (LYMAN).

*Astrophyton caryi*: LYMAN, Proc. Boston Soc. Nat. Hist., VII, 1860, p. 424<sup>1)</sup>; LYMAN, Ill. Cat. Mus. Comp. Zool., I, 1865, p. 184.

1) This paper was not seen by me.

*Astrophyton stimpsonii* : VERRILL, Proc. Boston Soc. Nat. Hist., XII, 1869, p. 388.<sup>1)</sup>

*Gorgonocephalus caryi* : LYMAN, Rep. Challenger, V, 1882, p. 264 ; CLARK, Bull. U. S. Nat. Mus., LXXV, 1911, p. 287.

*Gorgonocephalus stimpsoni* : LYMAN, loc. cit., 1882, p. 264.

*Gorgonocephalus japonicus* : DÖDERLEIN, Zool. Anz., XXV, 1902, p. 322 ; DÖDERLEIN, Abh. Math.-Phys. Kl. K. Bayer. Akad. Wiss., Suppl.-Bd. I, 1911, p. 31, Pl. I, figs. 1-3, Pl. VII, figs. 1-2c.

*Gorgonocephalus sagaminus* : DÖFLEIN, Ostasienfahrt, 1906, p. 204, fig. (Non DÖDERLEIN, 1902.)

Four specimens ; off Misaki, Sagami Sea.

Sagami Sea ; 150-800 m. (DÖDERLEIN). Off Ôsé Zaki, Suruga Gulf ; 63-75 fathoms (CLARK). Eastern Sea ; 181-391 fathoms (CLARK). Korea Strait ; 66 fathoms (CLARK). Korea (DÖDERLEIN). Sea of Japan ; 59-428 fathoms (CLARK). Saghalin ; 40-43 fathoms (CLARK). Saghalin (DÖDERLEIN). Ochotsk Sea ; 73 fathoms (CLARK). Ochotsk Sea (VERRILL).

Arctic Sea. Bering Sea. Alaska to California.

One of my specimens is evidently the *japonicus* type, the surfaces just inside the interbrachial ventral surfaces, as well as the ventral side of the arms being entirely free of granules. The lower margins of both sides of the arms are covered with irregularly polygonal plates, without granules, as shown in DÖDERLEIN'S fig. 2a, Pl. VII. DÖDERLEIN has not found the *caryi* type in Japanese waters. But my two specimens agree well with LYMAN'S description, the granulations of the interbrachial ventral surfaces distinctly extending as far as the base of the oral angles and the outer end of the oral slits. The ventral side of the arms is rather sparsely granulated, the granules being however finer

1) This paper was not seen by me.

than those of the outer parts. The lateral sides of the arms are entirely covered with fine granules, as shown in DÖDERLEIN'S fig. 1a, Pl. VII. In the arm coverings, these two specimens are therefore quite similar to DÖDERLEIN'S "*japonicus* var." The disk is rather sparsely and uniformly granulated. The internal structure is of the second type in all the four specimens.

*Gorgonocephalus dolichodactylus* DÖDERLEIN.

*Gorgonocephalus dolichodactylus*: DÖDERLEIN, Abh. Math.-Phys. Kl. K. Bayer. Akad. Wiss., Suppl.-Bd. I, 1911, p. 34, Pl. I, figs. 4 & 5, Pl. VII, figs. 3-4b.

Two specimens;  
off Misaki, Sagami  
Sea.

Sagami Sea; 150-  
200 m. (DÖDERLEIN).

One of these  
specimens is very ab-  
normal, all the pairs  
of the radial shields  
being fused into one  
almost along the entire  
adradial border, though  
remaining separate to-  
wards the centre, so  
that there is here a  
bifurcation.

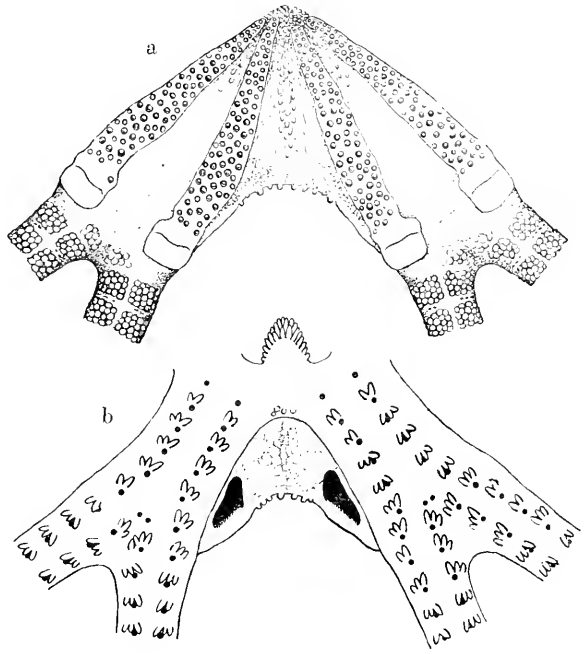

Fig. 20. *Gorgonocephalus dolichodactylus*.  $\times 1\frac{1}{2}$ . a. From above. b. From below.

*Astrodendrum sagaminum* (DÖDERLEIN).

*Gorgonocephalus sagaminus*: DÖDERLEIN, Zool. Anz., XXV, 1902, p. 321; CLARK, Bull. U. S. Nat. Mus., LXXV, 1911, p. 292.

*Astrodendrum sagaminum* : DÖDERLEIN, Abh. Math.-Phys. Kl. K. Bayer. Akad. Wiss., Suppl.-Bd., I, 1911, p. 38, Pl. II, figs. 3-5, Pl. VII, fig. 8 ; BOMFORD, Rec. Ind. Mus., IX, Pt. 4, 1913, p. 220.

Numerous specimens ; off Misaki, Sagami Sea ; 100-200 fathoms.

Ôse Zaki, Suruga Gulf ; 63-75 fathoms (CLARK). Eastern Sea ; 95 fathoms (CLARK). Sea of Japan ; 59-172 fathoms (CLARK). Sagami Sea (DÖDERLEIN).

Indian Ocean (BOMFORD).

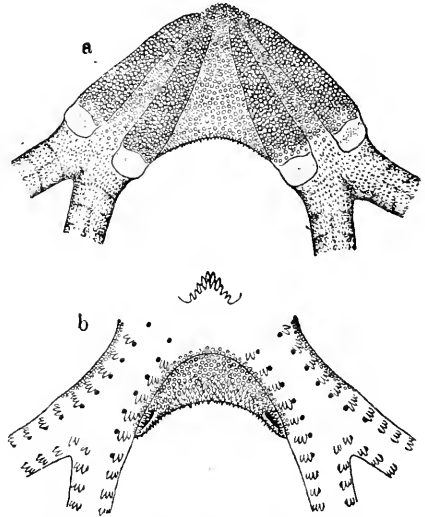

Fig. 21. *Astrodendrum sagaminum*. × 3  
a. From above. b. From below.

**Key to Japanese species and varieties of *Astrocladus*.**

- A—Disk covered by an apparently smooth skin, in which however very fine, insignificant, close-set granules are contained ; internal structure as in the second type of *Gorgonocephalus* . . . . . *annulatus*.
- AA—Disk covered by a pavement of granules, which have acute, spiny tips ; internal structure as in the third type of *Gorgonocephalus* . . . . . *coniferus*.
- a—Disk and arms free of tubercles, or a conical, blunt tubercle may occur on each radial rib near the outer end.
- b—Colour variegated, with whitish ground colour and purplish brown patches of various shape and size . . . . . var. *pardalis*.
- bb—Colour simple, deep purplish brown or purplish black . . . . . typical *coniferus*.
- aa—Disk and arms beset with numerous hemispherical, or more or less conical, tubercles ; colour variegated, or simply deep purplish brown or purplish black . . . . . var. *dofleini*.



*Astrocladus annulatus* MATSUMOTO.*Astrocladus annulatus*: MATSUMOTO, Proc. Acad. Nat. Sci., 1915, p. 56.

One specimen; off Misaki, Sagami Sea.

Diameter of disk .. .. .	22 mm.
Distance from the centre of the disk to the interbrachial margin .. .. .	8.5 mm.
From the outer end of the oral slit to the 1 <sup>st</sup> . bifurcation .. .. .	11 mm.
From the disk margin to the 1 <sup>st</sup> . bifurca- tion .. .. .	1.5 mm.
From the 1 <sup>st</sup> . bifurcation to the 2 <sup>nd</sup> . .. ..	7 mm.
From the 2 <sup>nd</sup> . to the 3 <sup>rd</sup> . .. .. .	8.5 mm.—6.5 mm.
From the 3 <sup>rd</sup> . to the 4 <sup>th</sup> . .. .. .	5.5 mm.—9 mm.
From the 4 <sup>th</sup> . to the 5 <sup>th</sup> . .. .. .	9 mm.—4 mm.
From the 5 <sup>th</sup> . to the 6 <sup>th</sup> . .. .. .	4 mm.—9 mm.
From the 6 <sup>th</sup> . to the 7 <sup>th</sup> . .. .. .	10 mm.—4 mm.
From the 7 <sup>th</sup> . to the 8 <sup>th</sup> . .. .. .	4 mm.—7.5 mm.
From the 8 <sup>th</sup> . to the 9 <sup>th</sup> . .. .. .	7 mm.—3.5 mm.
From the 9 <sup>th</sup> . to the 10 <sup>th</sup> . .. .. .	3.5 mm.—8 mm.
From the 10 <sup>th</sup> . to the 11 <sup>th</sup> . .. .. .	8 mm.—3.5 mm.
From the 11 <sup>th</sup> . to the 12 <sup>th</sup> . .. .. .	3 mm.—7 mm.
From the 12 <sup>th</sup> . to the 13 <sup>th</sup> . .. .. .	9 mm.—3 mm.
From the 13 <sup>th</sup> . to the 14 <sup>th</sup> . .. .. .	2.5 mm.—5 mm.
From the 14 <sup>th</sup> . to the 15 <sup>th</sup> . .. .. .	5 mm.—2.5 mm.
From the 15 <sup>th</sup> . to the 16 <sup>th</sup> . .. .. .	2 mm.—3.5 mm.
From the 16 <sup>th</sup> . to the 17 <sup>th</sup> . .. .. .	3.5 mm.—2 mm.
From the 17 <sup>th</sup> . to the 18 <sup>th</sup> . .. .. .	1.5 mm.—3.5 mm.
From the 18 <sup>th</sup> . to the 19 <sup>th</sup> . .. .. .	3 mm.—1.5 mm.
From the 19 <sup>th</sup> . to the end .. .. .	1 mm.—2 mm.

Total length of the arm . . . . .	126 mm.
Width of the ventral side of the arm base within the disk . . . . .	4.5 mm.

Disk five-lobed, with concave interbrachial borders, covered by a thick skin, which is apparently smooth, but contains very fine and close-set granules of microscopic size. On the radial ribs, these granules are very flattened and smooth, and coarser, being visible even to the naked eye. Several smooth, hemispherical

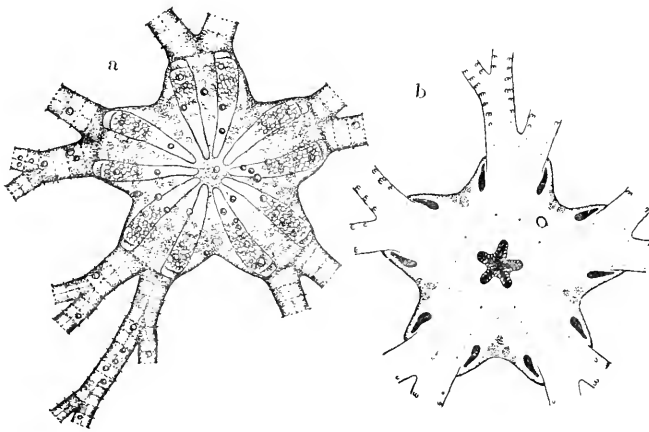

Fig. 22. *Astrocladus ananulatus*.  $\times 1\frac{1}{2}$ . a. From above.  
b. From below.

tubercles are scattered on the disk. Radial ribs gently raised and forming rounded ridges, with rather indistinct outlines, not quite reaching the centre; their back is marked with concentrically arranged swellings, corresponding to the imbricating, soldered plates, of which the radial shields are composed. The ventral surface of the disk appears very smooth to the naked eye. Genital slits not very large. Madreporic shield single, at the inner corner of one of the interbrachial ventral surfaces, small, transversely oval. The teeth and dental papillæ are conical and rather stout. The oral papillæ and lower dental papillæ are smaller and very short; their number for each oral angle is not very great.

Arms slender and branched, with distinction of trunk and

lateral branch even at the basal region, covered on the upper side by a finely and closely granulated skin, with several scattered, smooth, hemispherical tubercles on the more proximal shafts, distinctly annulated with hook-bearing segments throughout. Ventral surface of the arm entirely smooth to the naked eye. The arm spines which are present beyond the first bifurcation, are very fine, and three or four in number for each tentacle pore.

Colour in alcohol: disk mottled, arms annulated with yellowish and grayish brown.

This species can be easily distinguished from the other species of *Astrocladus* by the entirely smooth disk covering and by the arms being distinctly annulated with hook-bearing segments even at the very basal region.

*Astrocladus coniferus* (DÖDERLEIN).

*Astrocladus coniferus* var. *pardalis* (DÖDERLEIN).

*Astrocladus coniferus* var. *dofleini* (DÖDERLEIN).

*Astrophyton pardalis*: DÖDERLEIN, Zool. Anz., XXV, 1902, p. 323; CLARK, Bull. U. S. Nat. Mus., LXXV, 1911, p. 293.

*Astrophyton coniferum*: DÖDERLEIN, loc. cit., p. 325.

*Astrocladus dofleini*: DÖDERLEIN, SCHULTZE—Zool. Ergebn., IV, 1910, p. 256<sup>b</sup>; DÖDERLEIN, Abh. Math.-Phys. Kl. K. Bayer. Akad. Wiss, Suppl.-Bd. I, 1911, p. 41, fig. 9, Pl. II, fig. 6, Pl. III, figs. 1-4, Pl. IV, figs. 15-15b; BOMFORD, Rec. Ind. Mus., IX, Pt. 4, 1913, p. 200, Pl. XIII, fig. 1.

*Astrophyton cornutum*: CLARK, Bull. U. S. Nat. Mus., LXXV, 1911, p. 292. (Non KÖHLER, 1909.)

*Astrocladus coniferus*: DÖDERLEIN, loc. cit., 1911, p. 46 & 76, Pl. II, figs. 7 & 7a, Pl. IV, figs. 1-3a, Pl. VI, figs. 5-6a & 16.

Numerous specimens; Misaki. Several specimens; off Moroiso, Misaki; 10 fathoms.

1) This paper was not seen by me.

Sagami Sea. Suruga Gulf; 108 fathoms (CLARK). Off Omai Zaki, Yenshû Sea, 34–36 fathoms (CLARK). Kagoshima (DÖDERLEIN). Colnett Strait; 83–84 fathoms (CLARK). Eastern Sea; 103–152 fathoms (CLARK). Fusan, Korea (CLARK).

Wladiwostok (DÖDERLEIN). ? Off Agattu Is.; 482 fathoms (CLARK). Indian Ocean.

I fail to find any marked distinction between the *coniferus* and the *dofleini* type. There are many specimens which must be

referred to the *coniferus* type in most characters, but are beset with a few or many large hemispherical tubercles on the dorsal side of the arms, as observed by DÖDERLEIN himself, but there are others which gradually pass over into the *dofleini* type. The large tubercle on the back of each radial shield near its outer end, present in most specimens of the *coniferus* and in some of the *pardalis* type, is also often present in smaller and moderately large specimens of the *dofleini* type. Such a tubercle is indicated on some of the radial shields in DÖDERLEIN'S fig. 5, Pl. IV. This tubercle later becomes

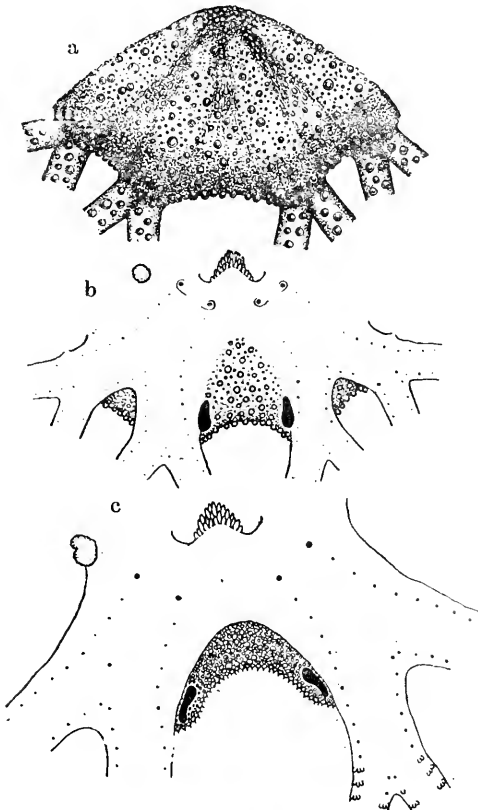

Fig. 23. *Astrocladus coniferus*. a. From above.  $\times \frac{2}{3}$ . b. From below.  $\times \frac{2}{3}$ . c. From below.  $\times 2$ .

quite indistinguishable, owing to the increase in number of similar

tubercles on the entire dorsal surface of the disk. In distinguishing *A. dofleini* from the *coniferus* and *pardalis* type, DÖDERLEIN seems to lay weight upon the fact that, the granules of the arm bases of the former have no acute tips, but are smooth. But, one of my specimens, measuring 55 mm. across the disk, has very abundant hemispherical tubercles on the arms and easily recognizable acute granules on the arm bases, the latter being distributed as far out as the fifth bifurcation. The colour of the same specimen is simply deep purplish black, and the disk coverings are almost similar to those of the *coniferus* type, though the conical tubercles on the radial ribs near the outer ends are not present.

### Key to Japanese species of *Astroboa*.

- A*—Madreporic shield lying at the inner angle of the interbrachial ventral surface.
- a*—Annulations of double rows of hook-bearing granules distinct even in the stout proximal parts of arms; colour purplish black .. *nigra*.
- aa*—Annulations of double rows of hook-bearing granules absent in the stout proximal parts of arms; colour dark grayish brown. .. *arcos*.
- AA*—Madreporic shield lying on the hard part just inside the interbrachial ventral surface, being almost free from the latter; colour light pinkish brown ..... *globifera*.

### *Astroboa nigra* DÖDERLEIN.

*Astrophyton clavatum*: PFEFFER, Mitteil. Naturh. Mus. Hamburg, XIII, 1896, p. 48.<sup>1)</sup> (Non LYMAN.)

*Astroboa nigra*: DÖDERLEIN, Abh. Math.-Phys. Kl. K. Bayer. Akad. Wiss., Suppl.-Bd. I, 1911, p. 83, Pl. IX, figs. 9 & 9a.

1) This paper was not seen by me.

Hirado Strait ; 72 m. (DÖDERLEIN).

Zanzibar (DÖDERLEIN).

*Astroboa arctos* MATSUMOTO.

*Astroboa arctos* : MATSUMOTO, Proc. Acad. Nat. Sci., 1915, p. 57.

Two specimens ; off Moroiso, Misaki ; 5–10 fathoms. Four specimens ; off Misaki.

Diameter of disk .....	65 mm.
Distance from the centre of the disk to the interbrachial margin. . .	25 mm.
From the outer end of the oral slit to the 1 <sup>st</sup> . bifurcation .....	32 mm.
From the 1 <sup>st</sup> . bifurcation to the 2 <sup>nd</sup> . .....	10 mm.
From the disk margin to the 2 <sup>nd</sup> . bifurcation .....	4 mm.
From the 2 <sup>nd</sup> . to the 3 <sup>rd</sup> . . . . . 12 mm.—16 mm. . . . . 14 mm.—13 mm.	
From the 3 <sup>rd</sup> . to the 4 <sup>th</sup> . . . . . 18 mm.—8 mm. . . . . 11 mm.—15 mm.	
From the 4 <sup>th</sup> . to the 5 <sup>th</sup> . . . . . 10 mm.—18 mm. . . . . 16 mm.—11 mm.	
From the 5 <sup>th</sup> . to the 6 <sup>th</sup> . . . . . 17 mm.—9 mm. . . . . 10 mm.—18 mm.	
From the 6 <sup>th</sup> . to the 7 <sup>th</sup> . . . . . 9 mm.—16 mm. . . . . 14 mm.—11 mm.	
From the 7 <sup>th</sup> . to the 8 <sup>th</sup> . . . . . 15 mm.—8 mm. . . . . 9 mm.—17 mm.	
From the 8 <sup>th</sup> . to the 9 <sup>th</sup> . . . . . 8 mm.—16 mm. . . . . 14 mm.—11 mm.	
From the 9 <sup>th</sup> . to the 10 <sup>th</sup> . . . . . 16 mm.—8 mm. . . . . 8 mm.—14 mm.	
From the 10 <sup>th</sup> . to the 11 <sup>th</sup> . . . . . 8 mm.—16 mm. . . . . 13 mm.—8 mm.	
From the 11 <sup>th</sup> . to the 12 <sup>th</sup> . . . . . 15 mm.—6 mm. . . . . 7 mm.—20 mm.	
From the 12 <sup>th</sup> . to the 13 <sup>th</sup> . . . . . 6 mm.—17 mm. . . . . 11 mm.—7 mm.	
From the 13 <sup>th</sup> . to the 14 <sup>th</sup> . . . . . 15 mm.—6 mm. . . . . 7 mm.—11 mm.	
From the 14 <sup>th</sup> . to the 15 <sup>th</sup> . . . . . 6 mm.—10 mm. . . . . 10 mm.—5 mm.	
From the 15 <sup>th</sup> . to the 16 <sup>c</sup> . . . . . 14 mm.—6 mm. . . . . 5 mm.—9 mm.	
From the 16 <sup>th</sup> . to the 17 <sup>th</sup> . . . . . 6 mm.—11 mm. . . . . 11 mm.—5 mm.	
From the 17 <sup>th</sup> . to the 18 <sup>th</sup> . . . . . 14 mm.—5 mm. . . . . 6 mm.—9 mm.	
From the 18 <sup>th</sup> . to the 19 <sup>th</sup> . . . . . 4 mm.—12 mm. . . . . 14 mm.—5 mm.	
From the 19 <sup>th</sup> . to the 20 <sup>th</sup> . . . . . 16 mm.—5 mm. . . . . 6 mm.—10 mm.	

From the 20 <sup>th</sup> . to the 21 <sup>st</sup> . . . . .	5 mm.-12 mm. . . . .	9 mm.-4 mm.
From the 21 <sup>st</sup> . to the 22 <sup>nd</sup> . . . . .	11 mm.-5 mm. . . . .	4 mm.-9 mm.
From the 22 <sup>nd</sup> . to the 23 <sup>rd</sup> . . . . .	4 mm.-10 mm. . . . .	9 mm.-4 mm.
From the 23 <sup>rd</sup> . to the 24 <sup>th</sup> . . . . .	8 mm.-4 mm. . . . .	4 mm.-9 mm.
From the 24 <sup>th</sup> . to the 25 <sup>th</sup> . . . . .	4 mm.-10 mm. . . . .	9 mm.-4 mm.
From the 25 <sup>th</sup> . to the 26 <sup>th</sup> . . . . .	11 mm.-4 mm. . . . .	3 mm.-6 mm.
From the 26 <sup>th</sup> . to the 27 <sup>th</sup> . . . . .	4 mm.-11 mm. . . . .	7 mm.-3 mm.
From the 27 <sup>th</sup> . to the 28 <sup>th</sup> . . . . .	9 mm.-3 mm. . . . .	3 mm.-6 mm.
From the 28 <sup>th</sup> . to the 29 <sup>th</sup> . . . . .	5 mm.-9 mm. . . . .	4 mm.-3 mm.
From the 29 <sup>th</sup> . to the 30 <sup>th</sup> . . . . .	7 mm.-4 mm. . . . .	2 mm.-4 mm.
From the 30 <sup>th</sup> . to the 31 <sup>st</sup> . . . . .	3 mm.-8 mm. . . . .	3 mm.-2 mm.
From the 31 <sup>st</sup> . to the 32 <sup>nd</sup> . . . . .	6 mm.-4 mm. . . . .	2 mm.-3 mm.
From the 32 <sup>nd</sup> . to the 33 <sup>rd</sup> (or to the end) . . . . .	3 mm.-6 mm. . . . .	2 mm.-1 mm.
From the 33 <sup>rd</sup> . to the 34 <sup>th</sup> . . . . .	6 mm.-4 mm.	.....
From the 34 <sup>th</sup> . to the 35 <sup>th</sup> . . . . .	4 mm.-5 mm.	.....
From the 35 <sup>th</sup> . to the 36 <sup>th</sup> . . . . .	3 mm.-2 mm.	.....
From the 36 <sup>th</sup> . to the 37 <sup>th</sup> . . . . .	2 mm.-3 mm.	.....
From the 37 <sup>th</sup> . to the end . . . . .	2 mm.-1 mm.	.....
Total length of the arm . . . . .	421 mm. . . . .	324 mm.
Width of the ventral surface of the arm within the disk . . . . .		17 mm.
Width of the shaft between the 1 <sup>st</sup> . and 2 <sup>nd</sup> . bifurcations. . . . .		10 mm.
Width of the main (adradial) shaft between the 2 <sup>nd</sup> . and 3 <sup>rd</sup> . bifurcations . . . . .		7 mm.

Disk decagonal, with concave interbrachial and brachial borders, the former being longer and more concave than the latter; very convex, but with more or less depressed central region, covered by a thick skin, which is chagreened by the presence of very fine, close-set granules. The granules are smooth, not acute, irregular in size when viewed under the microscope, the coarser ones being more numerous on the radial ribs than in the intercostal spaces.

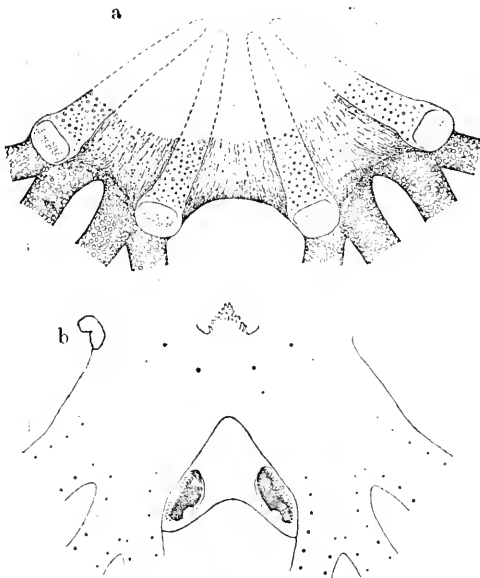

Fig. 24. *Astroboa arctos*.  $\times 1\frac{1}{8}$ . a. From above.  
b. From below.

The radial ribs are bar-like, narrow, widest at the outer end, suddenly narrowed for a very short distance, then uniformly tapered inwards, nearly reaching to the centre. Interbraechial ventral surfaces covered by a thick, apparently smooth skin, which contains very fine granules. Adradial border of the genital slits closely spinulated. The madreporic shield, situated at the inner angle of the interbraechial ventral surface, is more or

less semilunar, with a semicircular inner side and a distinctly notched outer side, the lateral angles being rounded. The spaces inside the interbraechial ventral surfaces are apparently smooth, but in reality closely covered with very fine granules of microscopic size, the granules being rather coarse and distinct at the oral angles. Teeth and papillæ very numerous. The oral and dental papillæ are rather small, spiniform, not very acute, while the teeth are much larger and longer than the papillæ, and are distinctly spatulate and flattened at the tip, the upper teeth being larger and more pronouncedly spatulate than the lower.

The two main stems of each arm are not 'equally' developed, but one is longer, stouter, and richer in bifurecations than the other, as shown in the preceding table of dimensions. Dorsal and lateral sides of arms covered by a thick skin, which is very



finely and closely granulated, the granules being very irregular in size and roughly distinguishable into two kinds. The finer granules are entirely covered over by the skin, and are flat and irregularly polygonal, forming together a sort of mosaic; while the coarser granules, which are coarser than any granules of the disk, are hemispherical and tubercle-like, and are uniformly scattered. Ventral surface of arms apparently smooth, but really covered by a mosaic of flat and irregularly polygonal granules of microscopic size. The first pair of tentacle pores are distinct and open in slight depressions. The second are often visible. The following three or four pairs are entirely absent, those beyond being again distinct. The arm spines are entirely absent in the proximal joints, but are present from the fourth or fifth bifurcation outwards. They are exceedingly minute and granule-like, two to four of them occurring for each tentacle pore. The double rows of hook-bearing granules are present only in very fine twigs, the main stems within the fourteenth or fifteenth bifurcation being free of them. The shaft between the first and second bifurcations usually contains four arm joints. The outer shafts are composed of from six to eight, usually seven, joints.

Colour in alcohol, as well as in a dry state; dark grayish brown above, and dark yellowish brown below.

Of the five known species of *Astroboa*, *A. clavata* (LYMAN) is distinguished from the others by the spiny granules of the disk and arms, and *A. globifera* (DÖDERLEIN) by the position of the madreporic shield. *A. nuda* (LYMAN) and *A. nigra* DÖDERLEIN have distinct annulations of hook-bearing granules on the arms, while *A. ernæ* DÖDERLEIN has no such annulation on the greater proximal parts of the arms. This species is therefore very near to the last named but differs from it in the less distinct and much finer

granules of the disk, and in the less number of arm joints contained in a shaft. In the last characters, *A. arctos* rather resembles *A. nigra* from Zanzibar and Hirado Strait, Japan.

This species is common in the shallow waters around Misaki, and occurs in the same localities with the foregoing species.

***Astroboa globifera* (DÖDERLEIN).**

*Astrophyton globiferum* : DÖDERLEIN, Zool. Anz., XXV, 1902, p. 324.

*Astroboa globifera* : DÖDERLEIN, Abh. Math.-Phys. Kl. K. Bayer. Akad. Wiss., Suppl.-Bd. I, 1911, p. 51, Pl. II, figs. 8-9; Pl. VII, figs. 7 & 7a.

One specimen; off Kōtsu-jima, Izu.

Sagami Sea; 150-200 m. (DÖDERLEIN).

**Key to genera of *Astrotominae*.**

- A*—Interannuli of the arm covered with two rows of coarse granules; arms simple.
- a*—Disk more or less closely beset with thorny tubercles or spiny granules ..... *Astrothamnus*.
- aa*—Disk covered with rounded plates, which are surrounded by belts of granules.
- b*—Disk plates irregular in size; two or three arm spines ..... *Astrothrombus*.
- bb*—Disk plates regular in size; three to seven arm spines. *Astrothorax*.
- AA*—Interannuli of the arm covered with many rows of fine granules; disk also covered with fine granules.
- c*—Arms simple. .... *Astrotoma*.
- cc*—Arms divided a few times near the tip ..... *Astroclon*.

***Astrothamnus* MATSUMOTO, 1915.**

Disk divided into ten radiating lobes by radial and interradiial furrows, closely covered with coarse, thick granules, which are

more or less stumpy and usually have spiny tips. Interradial ventral surfaces strongly concave, each with two large, nearly parallel genital slits. A single madreporic shield is present at the inner border of an interbrachial ventral surface. Teeth and dental papillæ similar, spiniform, forming clusters at the apices of jaws. Oral papillæ absent, so that the sides of the oral slits are naked. Arms simple, covered by a pavement of granules, distinctly annulated by zones of densely set, minute, compound hooks, each of which consists of one main and several supplementary hooklets. Three to five arm spines, peg-like, usually with rough tips, serving as tentacle scales.

This genus includes *Astrotoma bellator* KÖHLER, 1904, *recors* KÖHLER, 1904, and *rigens* KÖHLER, 1910, besides the genotype, *Astrothamnus echinaceus*. They may be distinguished as follows.

### Key to species of *Astrothamnus*.

- A*—Brachial ventral surfaces smooth; spaces just inside the interbrachial ventral surfaces, as well as oral angles, beset with slender spines; three arm spines.
- a*—Basal arm spines unusually long and stout, longer than the corresponding arm joints ..... *rigens*.
- aa*—Basal arm spines not unusually long and stout, nearly as long as the corresponding arm joints ..... *recors*.
- AA*—Brachial ventral surfaces, spaces just inside the interbrachial ventral surfaces, as well as oral angles, beset with coarse, stumpy granules.
- b*—Three arm spines not very small, nearly as long as the corresponding arm joints ..... *echinaceus*.
- bb*—Five arm spines very small, hardly half as long as the corresponding arm joints ..... *bellator*.

The distribution of *Astrothamnus* is very interesting, for, as

shown in the foregoing key, there are two specific groups in this genus, each represented by a Malaysian species. The Arabian species, *A. rigens*, is nearly allied to the Malaysian *A. recors*, and the Japanese type, *A. echinaceus*, to the Malaysian *A. bellator*.

*Astrothamnus echinaceus* MATSUMOTO.

*Astrothamnus echinaceus*: MATSUMOTO, Proc. Acad. Nat. Sci. Philadelphia, 1915, p. 55.

Diameter of disk 22 mm. Length of arms 140 mm. Width of arms at base 4 mm.

Disk distinctly five-lobed, with five interradial furrows, each lobe being again divided into two secondary lobes by the radial furrow. Radial ribs very prominent, large, occupying almost the whole dorsal surface of disk, leaving between them only ten narrow

furrows radiating from the centre; closely covered with rather large stumpy tubercles with thorny crowns, between which lie thick, irregularly polygonal plates. Interbrachial ventral surfaces strongly concave, closely covered with stumpy tubercles terminating with one or a few thorny points. Genital slits rather large, more or less parallel. Madreporic shield distinct, small, irregular in outline. The area inside the interbrachial

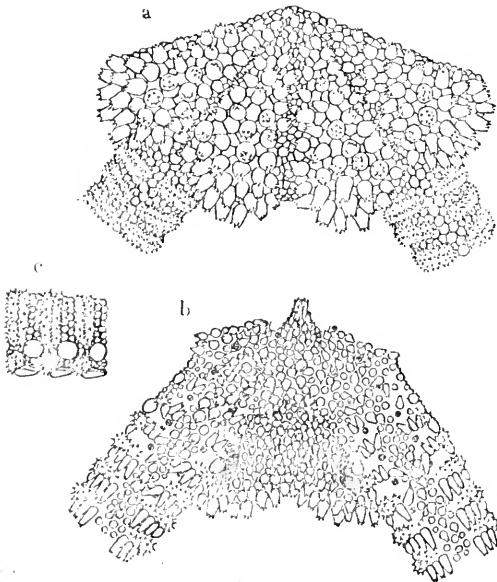

Fig. 25. *Astrothamnus echinaceus*.  $\times 23$ . a. From above. b. From below. c. Side view of three arm joints near disk.

ventral surfaces, as well as the brachial spaces, are also closely covered with tubercles similar in form to those of the interbrachial ventral surfaces. Oral angles covered with close-set, sharp, conical tubercles, which become, towards the mouth, somewhat indistinguishable from the dental papillæ. Dental papillæ and teeth similar, conical and very acute. No oral papillæ.

Arms rather slender, uniformly tapered, with alternating annuli of two forms, one with two rows of granules entirely covered over with very densely set minute hooks, the other with two irregular rows of smooth, naked granules. Ventro-laterally on either side of the arms, in line with the annuli formed by the smooth granules, there is a series of large, round, naked plates. In the arm bases, the hook-covered annuli are usually broken at the dorsal median line by conical granules terminating with one or a few thorny points. Ventral surface of the arms with rather well spaced tubercles, which are conical or terminate with one or a few thorny points; these tubercles become rounded and smooth distally. The first and second tentacle pores without arm spines, the third with one or two spines, the fourth with two or three, and the rest with three. The arm spines of the basal pores are somewhat indistinguishable from the conical or thorned tubercles, but the rest are peg-like, nearly as long as the corresponding arm joints, and bear two or three denticles at the end. The oral tentacle pores and the first and second tentacle pores open by means of short tubes bearing a few spinules.

Colour in alcohol dull grayish purple.

*Astrothorax misakiensis* DÖDERLEIN.

*Astrothorax misakiensis*: DÖDERLEIN, Abh. Math.-Phys. Kl. K. Bayer. Akad. Wiss., Suppl.-Bd. I, 1911, p. 24, Pl. VI, figs. 2-2*b*, Pl. VII, figs. 12 & 14*b*.

Sagami Sea (DÖDERLEIN).

*Astrotoma sobrina* MATSUMOTO.

*Astrotoma murrayi*: DÖDERLEIN (non LYMAN, 1879), Abh. Math.-Phys. Kl. K. Bayer. Akad. Wiss., Suppl.-Bd. I, 1911, p. 23, fig. 1, Pl. VI, figs. 1 & 1a, Pl. VII, figs. 14-14b.

Five specimens; off Misaki, Sagami Sea.

Diameter of disk 34 mm. Length of arms 200 mm. Width of arms at base 7 mm.

Disk five-lobed, flat, rather sunken towards the centre, covered with very fine, smooth, closely soldered granules and many small, oval plates, which are sunken below the level of the granules; there are also on the disk numerous, large, smooth, spherical or slightly cylindrical tubercles with rounded ends. Radial ribs

almost indistinguishable. Interbrachial ventral surface covered by a thick, leather-like skin, which becomes granulated on drying. Genital slits rather large and divergent. The madreporic shield is small, but very distinct, more or less oval, vertical, lying at the inner corner of one of the interbrachial ventral surfaces. The area inside the ventral interbrachial surfaces, as well as the brachial spaces, are covered with thick, irregular, pavement-like plates and smooth, scattered tubercles, which are

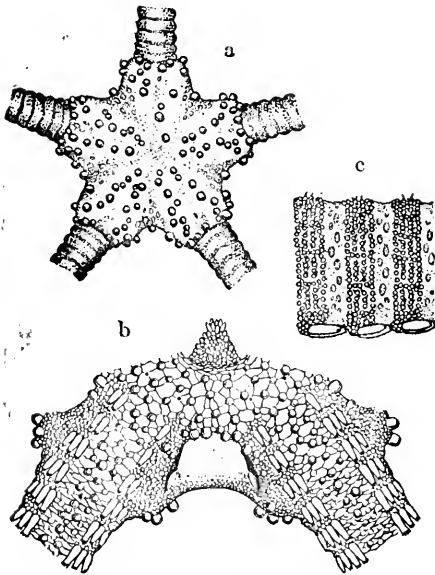

Fig. 26. *Astrotoma sobrina*. a. From above.  $\times \frac{1}{3}$ . b. From below.  $\times 1\frac{1}{4}$ . c. Side view of three arm joints near disk.  $\times 3$ .

smaller and more numerous than on the dorsal surface of the disk. Oral region surrounded by a circular groove, and distinctly set off from the outer parts. Oral angles strongly puffed downwards, covered with close-set granules of various sizes. Teeth and dental papillæ similar, spiniform, short and slender, acute, forming vertical clumps at the apices of the jaws. No oral papillæ.

Arms rather stout, uniformly tapered towards the extremity, dorsally and laterally with raised and depressed annuli; on the raised annuli, the granules are coarser, rather distinct and well spaced, arranged in four irregular rows, of which the middle two bear hooks, the series of hooked granules being interrupted by smooth ones; on the depressed annuli, the granules are very fine and form a smooth covering, with many small, oval plates, which are sunken below the plane of the granules. Ventral surface of the arms covered by the continuation of the ventral brachial space of the disk, with a pavement of irregular plates, which are so arranged as to bring about transverse wrinkles in the skin, and bear smooth, scattered tubercles, which distally become smaller and indistinguishable from the smooth granules. No arm spine to the first tentacle pore; one or two spines to the second; two or three spines to the third; and three or four spines to those beyond; but only two spines to each pore near the extremity of the arm. The arm spines are peg-like and flattened, and terminate with three or four thorny points; those situated adradially are somewhat longer than the abradial ones, and beyond the basal arm joints the most adradial spine becomes almost as long as the corresponding arm joint.

Colour in alcohol reddish or yellowish brown.

In younger specimens, the disk tubercles are much less

numerous, and the disk is less distinctly set off from the arms. In larger specimens, the disk tubercles are more numerous and show a tendency to arrange themselves, though very irregularly, in ten radiating rows, one on each radial rib.

The present species is very near to *A. murrayi* LYMAN, but differs from it in the much narrower brachial lobes of the disk; in the narrower interbrachial ventral surfaces, in the longer genital slits, in the fewer and larger tubercles in the spaces just inside the interbrachial ventral surfaces, in the much shorter arms and in the slightly fewer arm spines.

*Astroclon suenisoni* MORTENSEN.

*Astroclon suenisoni*: MORTENSEN, Vidensk. Medd. Naturhist. Foren. Kjobenhavn, LXIII, 1911, p. 209.

Off Amakusa, Eastern Sea (MORTENSEN).

Order ii. LÆMOPHIURIDA MATSUMOTO.

Disk covered by a soft skin, or with fine scales or plates, very often beset with granules, spines or stumpy tubercles. Radial shields sometimes rudimentary. The radial shield and genital plate articulate with each other by means of a simple face or a transverse ridge on both the plates. Peristomial plates very large, usually entire. Oral frames without well developed lateral wings. Arms entirely covered by the three kinds of arm plates, of which the dorsal and ventral ones are usually very small, while the lateral ones are very well developed, very often approximating dorsally as well as ventrally. Vertebral articulation either zygospondyline or streptospondyline.

This order is very near to the *Phrynophiurida*, especially the *Ophiomyxida*, but differs from them essentially in the entirely



protected dorsal side of the arms. Further, there are two types of primitive ophiurans differing in the embryonal condition of the vertebræ, one being the Phrynophiuridan type and the other the Læmophiuridan. In the Phrynophiuridan type, the distal vertebræ are divided into halves by a single fusiform pore, the middle parts of the halves being widely separated from each other. These vertebræ are proved to be present in *Ophiohelus*, *Ophiogeron*, *Astrogeron*, *Ophiosciasma*, *Ophiohyalus*, *Ophiomyxa*, *Ophiostiba*, &c. In the Læmophiuridan type, the distal vertebræ are divided into halves by a series of small pores, the halves being connected with each other by a series of bridges between every two pores. These vertebræ are present in *Microphiura*, *Ophiothammus*, *Ophiologimus*, *Amphiactis*, &c. In *Astrophiuura*, the vertebræ of the free arm joints are divided into halves by a moniliform pore, the halves being closely set against each other, so that the condition, though rather near to the Læmophiuridan type, is intermediate between the two types.

### Key to the families of *Læmophiurida*.

- A*—Disk and arms of slender build, the disk scales or plates, as well as arm plates, being not very stout; the genital plate and scale on either side of a radius articulate with each other, instead of being soldered together; vertebræ not very stout, often divided into halves..... *Ophiacanthidæ*.
- AA*—Disk and arms of very heavy build, the disk and arm plates being very stout; the genital plate and scale on either side of a radius are firmly soldered together; vertebræ very stout, always entire, though the ventral median groove is very prominent. *Hemicuryalidæ*.

Family 1. **Ophiacanthidæ** (PERRIER, 1891) mihi, 1915.

Disk covered by a soft skin or with fine scales, and usually beset with granules, spines or stumpy tubercles. The radial shield and genital plate articulate with each other by means of a transverse ridge or a simple face on both the plates. The genital plate and scale on either side of each radius articulate with each other, and are not soldered together. Peristomial plates entire, or rarely triple, very large. Oral frames entire, without well developed lateral wings. Teeth and oral papillæ always present, spiniform as a rule. Dental papillæ rarely present, similar to the oral papillæ. Arms usually knotted, the spine ridges of the lateral arm plates being very prominent; inserted very often laterally, but sometimes ventrally, to the disk. Dorsal and ventral arm plates very small, while the lateral arm plates are very well developed, covering most parts of the arms. Numerous arm spines, variable in number in successive arm joints, long, flagellate, often hyaline and serrate. Vertebrae slender, often incompletely divided into halves by a series of pores. Vertebral articulation zygospondyline or streptospondyline. Upper and lower muscular fossæ equally large.

This family includes thirty-three genera, which may be artificially grouped as follows :

A. Tentacle pores very large and open.

- I. Disk extraordinarily bulged up, covered by a naked skin or with fine scales; radial shields absent.

*Ophiotholia* LYMAN, 1880.

*Ophiomyces* LYMAN, 1869.

- II. Disk not very high, covered by a naked skin or merely with fine scales; radial shields small or rudimentary.

*Ophiocymbium* LYMAN, 1880.

*Ophiologimus* CLARK, 1911.

*Amphipsila* VERRILL, 1899.

*Ophiophrura* CLARK, 1911.

*Ophiotoma* LYMAN, 1883.

*Ophioblenna* LÜTKEN, 1859.

III. Disk beset with granules or spines ; radial shields small or rudimentary.

*Ophiopora* VERRILL, 1899.<sup>1)</sup>

*Ophiotrema* KÖHLER, 1907.<sup>1)</sup>

*Ophiambix* LYMAN, 1880.<sup>2)</sup>

*Ophiomedeia* KÖHLER, 1906.

*Ophiopristis* VERRILL, 1899.

*Ophioprium* CLARK, 1915.

B. Tentacle pores small and inconspicuous.

IV. Radial shields small, short.

*Microphiura* MORTENSEN, 1910.

*Ophiolinna* VERRILL, 1899.

*Ophiomitrella* VERRILL, 1899.

*Ophiophthalmus*, nov.

*Ophientrema* VERRILL, 1899.

*Ophioscalus* VERRILL, 1899.

*Ophiocopa* LYMAN, 1893.

*Ophiochondrella* VERRILL, 1899.

*Ophiosemmotes*, nov.

1) These genera have been stated by CLARK, 1915, to be congeneric with *Ophiotoma*, notwithstanding that they differ from it in the covering of the disk. It is of course true that these three genera resemble one another in the large tentacle pores. But this character is also common to all the genera belonging to the group A. So that I am obliged to disagree with him.

2) This genus is very doubtful in position. I provisionally refer it here, merely because the tentacle pores and scales remind us of those of *Ophiophrura* and *Ophiotrema*.

## V. Radial shields long, narrow, bar-like.

*Ophiacantha* MÜLLER & TROSCHEL, 1842.*Ophialceea* VERRILL, 1899.*Ophiacanthella* VERRILL, 1899.*Ophiolebes* LYMAN, 1878.

## VI. Radial shields large, long, wide.

*Ophiothamnus* LYMAN, 1869 (= *Ophioleda* KOEHLER, 1906).*Ophiurothamnus*, NOV.*Ophiomytis* KOEHLER, 1904.*Ophioplinthaca* VERRILL, 1899.*Ophiomitra* LYMAN, 1869.*Ophiocamax* LYMAN, 1878.

As the present family includes both those forms with only horizontally flexible arms and those with more or less coiled arms, two types of internal structures are also distinguishable roughly. The first type, found in those forms with only horizontally flexible arms, is characterised by the very thin, delicate, sometimes divided peristomial plates, the slender oral plates and frames, the very slender vertebræ, the very thin wings of the basal vertebræ, the more or less divided distal vertebræ and the zygospondyline vertebral articulation. The second type, found in those with more or less coiled arms, is characterised by the very thick, always entire peristomial plates, the more or less stout oral plates and frames, the more or less short, stout, always entire vertebræ, the more or less thick wings of the basal vertebræ and the usually streptospondyline vertebral articulation. The internal structures of *Ophiothamnus venustus* MATSUMOTO is almost perfectly similar to those of *O. vicarius* LYMAN. The peristomial plates are very large, thin and triple, the two paired secondary plates forming an out-

wardly open angle, which is occupied by the unpaired median one. The oral plates and frames are short and slender. The genital plates are long, more or less club-shaped, lying closely parallel in pairs, just above the arm base. The genital scales are absent. The genital bursæ are very rudimentary, being represented merely by the creases between the interbrachial ventral surfaces and the arm bases. The generative glands are enclosed in a membranous sac, the wall of which contains fine, thin, transparent scales, when viewed under the microscope, just as is stated by MORTENSEN to be the case in *Ophiopus arcticus*. The vertebræ are very slender, and those of the distal arm joints are imperfectly divided into halves by a series of pores, just as in *Microphiura* according to MORTENSEN. The last named genus is stated to lack the genital plates and scales and to have entire or divided peristomial plates, besides an additional plate, which is perforated by a pore just between the peristomial plates and the oral shield. I imagine that, the perforated plate just referred to may correspond to the unpaired secondary plate of the peristomial system, because I know that in certain genera the unpaired secondary plate has a half pore on its outer border. In *Ophiolimna antarctica* (LYMAN) and *O. papillata* (CLARK), the peristomial plates are large, wide, short, thin, imperfectly divided, with soldered halves, the oral plates and frames are short and slender, and the genital plates and scales and genital bursæ are normal. In *Ophiologinus hexactis* CLARK, the internal structures are essentially similar to those of *Ophiolimna*, which has also imperfectly divided peristomial plates. The radial shields though externally invisible, are present and short and rounded. Also in this species I was able to prove that the distal vertebræ are imperfectly divided by a series of pores. According to LYMAN, *Ophiomyces*

*frutectosus* LYMAN has no peristomial plates, but the oral plates and frames are of an elegant shape and curiously twisted; the genital plates are thin, wide, long, and curved over the dorsal side of the arm base; no genital scales; the basal vertebræ, have large and thin wings without marginal grooves, and the vertebral articulation is very peculiar with a large articular umbo and no articular peg.

Certain species of *Ophiacantha* appear to stand at the very base of the second type, which is found in those forms with the arms more or less capable of coiling vertically. In *Ophiacantha bidentata* (LINNÉ), the peristomial plates are very large, simple, rather thick, the oral plates and frames are more or less stout, the vertebræ are comparatively stout, and the vertebral articulation is perfectly streptospondyline, the articular peg being absent. On the contrary, *Ophiacantha cuspidata* LYMAN is stated by the author to have the zygospondyline vertebral articulation, with a well formed articular peg. In *Ophiolebes tuberosa* MATSUMOTO, the peristomial plates are very large, wide, thick, firmly fixed to the oral frames, which are also very stout, and bear each two small supplementary plates on the outer border. The vertebræ are short and stout, with decidedly thick wings. The vertebral articulation is of course streptospondyline. The genital plates and scales are peculiarly undulated. The radial shields are narrow and bar-like. The internal structures of *Ophiosemmotes adidisca* (CLARK) much resemble those of the preceding, save that the radial shields are wide, rounded and joined in pairs in internal view. According to LYMAN, *Ophiocamax hystrix* LYMAN has very stout oral plates and frames, to which the peristomial plates are perfectly soldered, very stout and short vertebræ with very thick wings and a perfectly streptospondyline vertebral articulation. The vertebræ of *Ophio-*

*chondrella squamosa* (LYMAN) are quite like those of *Ophirolebes*. Taking all the characters into consideration, *Ophirolebes*, *Ophiosemmotes*, *Ophiochondrella*, *Ophiocamax*, &c. appear to me to represent one of the two types of the *Ophiacanthida*.

### Key to Japanese genera of *Ophiacanthida*.

- A*—Tentacle pores very large and open; oral shields entirely separated from the first lateral arm plates by the adoral shields.
- a*—Disk extraordinarily bulged up, covered with fine scales; radial shields absent; numerous large, flat, spatulate oral papillæ; numerous flattened arm spines; tentacle scales spatulate . . . . . *Ophiomyces*.
- aa*—Disk not very high.
- b*—Disk finely imbricated, entirely free of granules or spines; tentacle scales present.
- c*—Outer oral papillæ not especially long; ventral arm plates longer than wide; three arm spines; two very small, leaf-like tentacle scales . . . . . *Ophiologimus*.
- cc*—Outermost three oral papillæ very long, slender, spiniform, arising from the adoral shields; ventral arm plates wider than long; four arm spines; three or four spiniform tentacle scales. . . . *Ophiophrura*.
- bb*—Disk closely beset with granules or spines.
- d*—Dorsal arm plates entire; no tentacle scales. . . . . *Ophiopora*.
- dd*—Dorsal arm plates absent, dorsal side of arms, as well as disk, being closely beset with spines; three or four spiniform tentacle scales. . . . . *Ophiambix*.
- AA*—Tentacle pores small and inconspicuous.
- e*—Arm plates and arm spines not covered over by a cereous skin.
- f*—Radial shields small or moderate.
- g*—Radial shields short, rounded or triangular.
- h*—Disk closely covered with granules; oral shields separated from the first lateral arm plates by the adoral shields; oral angles beset with granules; outermost oral papilla large and operculiform. . *Ophiolimna*.

- lh*—Disk scales visible, sparsely beset with granules, spines or stumpy tubercles; oral shields usually joined with the first lateral arm plates; oral angles free of granules.
- i*—Arms strongly knotted, with very prominent spine ridges; arm spines of both sides of free basal joints approximating dorsally; dorsal arm plates very small, widely separated from each other by the lateral arm plates ..... *Ophiomitrella*.
- ii*—Arms not very knotted; arm spines of both sides not approximating dorsally; dorsal arm plates not very small, in contact with each other at least in proximal arm joints.
- j*—Basal tentacle pores not especially large; single flat tentacle scale to each pore; radial shields oval ..... *Ophiophthalmus*.
- jj*—Several first tentacle pores especially large, while the outer ones are very small; no true tentacle scales, which are represented by a number of lowest arm spines much smaller than the upper ones...  
..... *Ophientrema*.
- gg*—Radial shields long, narrow, bar-like.
- k*—Radial shields separated from each other; disk, as well as radial shields, more or less closely covered with granules, spines or stumpy tubercles ..... *Ophiacantha*.
- kk*—Radial shields perfectly joined in pairs, naked; disk sparsely beset with spines or granules, the disk scales being quite distinct.....  
..... *Ophiacanthella*.
- ff*—Radial shields large, long and wide; disk scales quite distinct.
- l*—Oral papillæ arranged in a regular series.
- m*—Outermost oral papillæ large and operculiform; arms strongly knotted, with very prominent spine ridges; arm spines of both sides of free basal joints approximating dorsally; dorsal arm plates very small, widely separated from each other by the lateral arm plates.
- n*—Disk distinctly five-lobed; radial shields divergent, those of a pair slightly in contact in the outer parts; oral shields small, separated from the first lateral arm plates by the adoral shields; interbrachial ventral surfaces covered with numerous fine scales; genital bursæ



- rudimentary, being represented merely by the creases between the interbrachial ventral surfaces and arm bases. . . . . *Ophiolummus*.
- m*—Disk not distinctly five-lobed; radial shields joined in pairs nearly along the entire length; oral shields large, joined with the first lateral arm plates; each interbrachial ventral surface covered chiefly with two or three very large scales; genital bursæ well developed. . . . . *Ophiurothammus*.
- mm*—Outermost oral papilla not especially large; arms not very knotted; arm spines of both sides never approximating dorsally; dorsal arm plates rather large, in contact with each other at least in proximal arm joints; disk distinctly five-lobed; special marginal disk scales well developed. . . . . *Ophioplinthaca*.
- ll*—Numerous oral papillæ not in a single series, but clustered along the sides and at the top of each jaw, or at least on both sides of the outer end of each oral slit.
- o*—Disk distinctly five-lobed; special marginal disk scales well developed; radial shields separated from each other; single tentacle scale to each pore. . . . . *Ophiomitra*.
- oo*—Disk not distinctly five-lobed; special marginal disk scales absent; radial shields joined in pairs along the entire length; usually three tentacle scales forming a tube for the ventrally turned up tentacle. . . . . *Ophiocamax*.
- ce*—Arm plates and arm spines covered over by a cereous skin.
- p*—Radial shields long, narrow, bar-like . . . . . *Ophiolobes*.
- pp*—Radial shields short, rounded or triangular. . . . . *Ophiosemnotes*.

***Ophiomyces spathifer* LYMAN.**

*Ophiomyces spathifer*: LYMAN, Bull. Mus. Comp. Zool., VI, Pt. 2, 1879, p. 47, Pl. XIV, figs. 386-388; LYMAN, Rep. Challenger, V, p. 240, Pl. XIX, figs. 10-12.

Yenshû Sea; 565 fathoms (LYMAN).

***Ophiologimus hexactis* CLARK**

*Ophiologimus hexactis*: CLARK, Bull. U. S. Nat. Mus., LXXV, 1911, p. 252, fig. 123.

One specimen ; Mera-out-Oisegaké, Sagami Sea ; 350 fathoms.

One specimen ; off Ôshima ; 90–100 fathoms.

Off Suno Saki, Sagami Sea ; 83–158 fathoms (CLARK).

Though the radial shields are externally invisible, they have been proved to be present by dissection, and are very small, short, bar-like, widely separated from each other. My specimens also invariably show an indication of schizogony, for they are six-armed, three arms being distinctly smaller than the other three.

*Ophiophrura liodisca* (CLARK).

*Ophiophrura liodisca* : CLARK, Bull. U. S. Nat. Mus., LXXV, 1911, p. 249, fig. 121.

Off Omai Saki, Yenshû Sea ; 475–505 fathoms (CLARK).

*Ophiopora megatrema* (CLARK).

*Ophiacantha megatrema* : CLARK, Bull. U. S. Nat. Mus., LXXV, 1911 p. 237, fig. 113.

Off eastern Japan ; 587–943 fathoms (CLARK).

As stated by KÖHLER, *Ophiopora* and *Ophiotrema* are closely related to each other. All the members of these genera, i.e. *Ophiopora bartletti* (LYMAN, 1883), *O. paucispina* (LÜTKEN & MORTENSEN, 1899), the present species and *Ophiotrema alberti* KÖHLER, 1894, have visible disk scales, large adoral shields, which separate the oral shields from the first lateral arm plates, narrow oral angles, gaping oral slits, very large tentacle pores and distally notched ventral arm plates. I look upon the present species to be an *Ophiopora* standing next to *Ophiotrema*, because the distal oral papillæ are differentiated in size from the inner ones, quite like those of *Ophiotrema*, while the total absence of tentacle scales is a character of *Ophiopora*.

*Ophiambix aculeatus* LYMAN.

*Ophiambix aculeatus*: LYMAN, Anniv. Mem. Boston Soc. Nat. Hist., 1880, p. 11, Pl. II, figs. 29-31; LYMAN, Rep. Challenger, V, 1882, p. 235, Pl. XXVII, figs. 10-12; CLARK, Bull. U. S. Nat. Mus., LXXV, 1911, p. 114.

Colnett Strait; 1,008 fathoms (CLARK).

Near Fiji Is.; 1,350 fathoms (LYMAN).

*Ophiolimna* VERRILL, 1899, emend.

Disk covered with fine granules, the radial shields being usually concealed. Oral shields large, wide, separated from the first lateral arm plates by the adoral shields. Oral angles more or less granulated. Four to six oral papillæ, of which the outermost one is very large and operculiform. Arms slender, horizontally flexible. Ventral arm plates wider than long, not in contact with each other. Four to seven arm spines, long, glassy. Single large, leaf-like tentacle scale to each pore.

This genus includes *Ophiacantha bairdi* LYMAN, 1883 (referred to *Ophiolimna* by VERRILL, 1899), *Ophioconis antarctica* LYMAN, 1879, *Ophiacantha perfida* KÖEHLER, 1904, *Ophiolimna operculata* KÖEHLER, 1907, *Ophioconis diastata* CLARK, 1911, *O papillata* CLARK, 1911 and *Ophiacantha lambda* CLARK, 1911.

*Ophiochaeta*(?) *mixta* LYMAN, 1878 (referred to *Ophiolimna* by VERRILL, 1899) and *Ophiolimna littoralis* KÖEHLER, 1912, are in my opinion not genuine *Ophiolimna*, being different from it in the more numerous oral papillæ, of which the outermost one is small and stretches inwards above the next papilla; in the well developed ventral arm plates, which are fully in contact with each other; and in the presence of two tentacle scales, of which the abradial

one overlaps the base of the lowest arm spine. (See under *Ophiodermatidae*.)

### Key to Japanese species of *Ophiolinna*.

- A*—Radial shields entirely covered over.
- a*—Disk granules very fine; four to five arm spines rather blunt, somewhat longer than the corresponding arm joint ..... *diastata*.
- aa*—Disk granules coarse, mingled with some scattered spines; seven acute arm spines, longer ones about thrice as long as the corresponding arm joint ..... *bairdi*.
- AA*—Radial shields partially naked; disk granules coarse and elongated; five acute arm spines, of which the uppermost is the longest and about thrice as long as the corresponding arm joint..... *lambda*.

#### *Ophiolinna diastata* (CLARK).

*Ophiocoris diastata*: CLARK, Bull. U. S. Nat. Mus., LXXV, p. 27, fig. 3.  
Off Shio Misaki; 244–253 fathoms (CLARK).

#### *Ophiolinna bairdi* (LYMAN).

*Ophiacantha bairdi*: LYMAN, Bull. Mus. Comp. Zool., X, 1883, p. 256, Pl. V, figs. 70–72; LÜTKEN & MORTENSEN, Mem. Mus. Comp. Zool., XXIII, 1899, p. 177, Pl. VIII, figs. 9–13; CLARK, Bull. U. S. Nat. Mus., LXXV, 1911, p. 230.

*Ophiolinna bairdi*: VERRILL, Bull. Labor. Nat. Hist. State Univ. Iowa, V, No. 7, 1899, p. 44<sup>1)</sup>; VERRILL, Transact. Connecticut Acad., X, 1899, p. 345.

Off Mikawa, Yenshû Sea; 943 fathoms (CLARK).

Bering Sea. Alaska. Washington. Gulf of Panama. Caribbean Sea. Eastern Atlantic.

1) This paper was not seen by me.

*Ophiolimna lambda* (CLARK).

*Ophiacantha lambda*: CLARK, Bull. U. S. Nat. Mus., LXXV, 1911, p. 231, fig. 108.

Off Hiuga, southern Japan; 437 fathoms (CLARK).

**Key to Japanese species of *Ophiomitrella*.**

*A*—Radial shields wider than long; four oral papillae, of which the outermost one, arising from the first ventral arm plate, stretches above the next papilla; ventral arm plates not in contact with each other; seven or eight arm spines, of which the uppermost is the longest ..... *stellifera*.

*AA*—Radial shields about as wide as long; six oral papillae on either side; ventral arm plates slightly in contact with each other; nine or ten arm spines, of which the uppermost and lowest are the shortest ..... *polyacantha*.

*Ophiomitrella stellifera*, sp. nov.

Two specimens; off Inatori, Izu. One specimen; Locality unknown.

Diameter of disk 4 mm. Length of arms 20 mm. Width of arms at base 0.8 mm.

Disk almost circular but with a small indentation in each interbrachial border, flat, covered with coarse, stout, partly imbricated scales, which almost invariably bear each a large stumpy tubercle with a six-rayed stelliform crown. Radial shields very small, irregularly triangular, with much rounded inner angle, a little larger than the disk scales, wider than long, separated from each other. Interbrachial spaces below covered with a few coarse, irregular, imbricated scales, without any stumpy tubercles. Genital slits short.

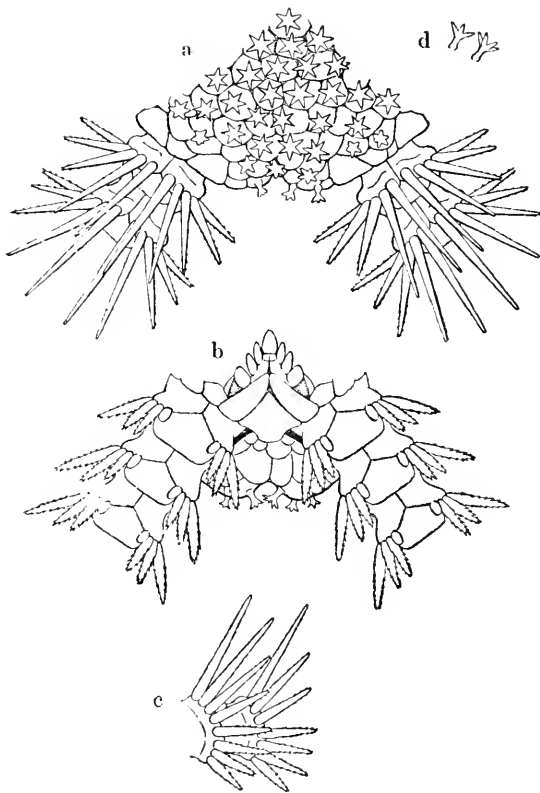

Fig. 27. *Ophiomitrella stellifera*.  $\times 12$ . a. From above.  
 b. From below. c. Side view of two arm joints near disk.  
 d. Side view of two disk tubercles.

which arises from the first ventral arm plate and is directed inwards. Teeth stout, triangular, obtuse.

Arms strongly knotted. Dorsal arm plates in the proximal part very small, three-sided, with strongly convex outer side and very wide inner angle, much wider than long, with convex surface; more distally, they become more or less regularly triangular and as long as, or longer than, wide. Lateral arm plates very well developed, strongly constricted at the middle of each joint, those of the two sides meeting each other both above and below. First

Oral shields large and stout, pentagonal, with acute inner and lateral angles, rounded outer angles, concave outer lateral sides and curved outer side. Adoral shields large, long, stout, three-sided, with rounded angles and nearly straight adradial and convex abradial sides, meeting each other. Three oral papillæ on either side; the outermost one is very large, flattened and blunt; the rest are conical, somewhat flattened, obtusely pointed. There is an additional pointed papilla,

ventral arm plate small, pentagonal, with wide and truncated inner angle and curved outer side, wider than long. The rest are large, pentagonal, with wide inner angle and perfectly rounded outer angles, much wider than long. Arm spines long, slender, hyaline, flattened and thorny, except the uppermost one or two which are nearly terete; upper ones longer; the uppermost spine is about two to three times, and the lowest one about two-thirds, as long as the corresponding arm joint. From the seventh or eighth joint outwards the lowest spine is transformed into a compound hook, being slightly bent inwards and bearing series of hooklets on the inner side. The arm spines are seven or eight in number and approximated dorsally in the basal joints, but rapidly decrease in number outwards, so that they are four or five in the tenth joint. One tentacle scale, small, oval and flat.

Colour in alcohol white.

In one of the specimens, the tubercles of the disk are fewer, but in the second, they are larger, and the stelliform crowns are more complex, some of the rays bearing two or three denticles each. In the third specimen, the disk scales are coarser than in the other two, and the radial shields are slightly longer than wide.

This new species is near to *Ophiomitrella partita* (LÜTKEN & MORTENSEN, 1899), but differs from it chiefly in the smaller radial shields, in the disk tubercles having more slender stem and larger crown, in the arm spines being approximated dorsally in the first basal joints, and in the lowest arm spine being transformed into a compound hook. The six rays of the crown of the disk tubercles are formed by the bifurcation of the three primary rays, so that the disk tubercles are fundamentally of the same plan in both species.

*Ophiomitrella polyacantha* (CLARK).

*Ophiomitra polyacantha*: CLARK, Bull. U.S. Nat. Mus., LXXV, 1911, p. 187, fig. 86.

Eastern Sea ; 103 fathoms (CLARK).

**Ophiophthalmus**, g. nov.

Disk covered with more or less imbricating, irregular scales, and may be beset with coarse granules. Radial shields naked, rounded or oval. Three to six oral papillæ on either side. Teeth arranged in a single vertical row. Dental papillæ absent. Dorsal arm plates in contact with each other in the basal arm joints. Numerous arm spines, long, conical, opaque, hardly serrate, never approximating dorsally. Usually a single large, flat, leaf-like tentacle scale to each pore.

This new genus includes *Ophiacantha normani* LYMAN, 1879 (referred to *Ophiomitra* by LYMAN, 1882), *Ophiomitra granifera* LÜTKEN & MORTENSEN, 1899, *Ophiacantha relicta* KÖHLER, 1904, *Ophiomitrella mutata* KÖHLER, 1904, *O. languida* KÖHLER, 1904, *O. placida* KÖHLER, 1904, *Ophiomitra microphylax* CLARK, 1911, *O. codonomorpha* CLARK, 1911, *Ophiacantha leucorhabdota* CLARK, 1911, *O. euryppoma* CLARK, 1911, *O. hylacantha* CLARK, 1911, *Ophiomitrella americana* KÖHLER, 1914, &c., besides the genotype, *Ophiacantha cataleimnoida* CLARK, 1911.

The present genus is very nearly allied to *Ophiomitrella*, but differs from it in the comparatively well developed dorsal arm plates, the basal ones being in contact with each other, and in the arm spines not approximating dorsally in the basal arm joints. Further, this genus differs from the genuine *Ophiacantha* in the short and rounded radial shields and in the coarser disk scales.



In my opinion, the shape of the radial shields is an important character in the systematic of the present family. The radial shields of the genuine *Ophiacantha* are long, narrow and bar-like. In VERRILL's key, the species of *Ophiophthalmus* would appear as belonging to *Ophiacantha*, but the latter is a close ally of *Ophiacantha*, with long and bar-like radial shields.

### Key to Japanese species of *Ophiophthalmus*.

- A*—Disk beset with some granules, or sometimes with spines; a single large tentacle scale to each pore.
- a*—Disk with granules only, without spines.
- b*—Disk granules abundant, uniformly distributed on both the dorsal and ventral sides.
- c*—Radial shields small, widely separated from each other; several granules occur at the outer border of the dorsal arm plates of basal free arm joints; four or five oral papillæ, of which the outermost one arises from the first ventral arm plate.
- d*—Disk scales coarse; outer second oral papilla very large, wide; six or seven arm spines ..... *cataleimmoidus*.
- dd*—Disk scales fine; innermost oral papilla largest; four arm spines ..  
..... *normani*.
- cc*—Radial shields large, lying closely side by side in pairs, but not in contact with each other; six oral papillæ on either side; eight or nine arm spines ..... *leucorhabdotus*.
- bb*—Disk granules few, being present only in the central parts of the dorsal surface, radial shields large, widely separated from each other; three oral papillæ on either side; eight arm spines.....  
..... *codonomorpha*.
- aa*—Disk beset with stout rough spines, besides granules; radial shields moderately large; four oral papillæ on either side; eight arm spines ..... *hylacantha*.
- AA*—Disk beset with many stumpy tubercles with stelliform crowns; radial

shields very small, widely separated from each other; six or seven oral papillæ on either side, the outermost two arising from the adoral shield; oral shields separated from the first lateral arm plates; six arm spines; a single very small tentacle scale. . *microphylax*.

*Ophiophthalmus cataleimmoidus* (CLARK).

*Ophiacantha cataleimmoïda*: CLARK, Bull. U. S. Nat. Mus., LXXV, 1911, p. 217, fig. 100.

Three specimens; off Misaki, Sagami Sea. Numerous specimens, probably the young of the present species; off Misaki, Sagami Sea.

Off Omai Zaki; 475–624 fathoms (CLARK).  
Uruga Channel; 302 fathoms (CLARK).  
Yen-shû Sea, 507 fathoms (CLARK).  
Off Kurile Is.; 229 fathoms (CLARK).

Bering Sea. Alaska.

The disk scales are very coarse, stout, partially imbricated, or rather tessellated and with distinct sutures, each scale bearing several granules, which are never situated on the sutures, except in the peripheral zones of the

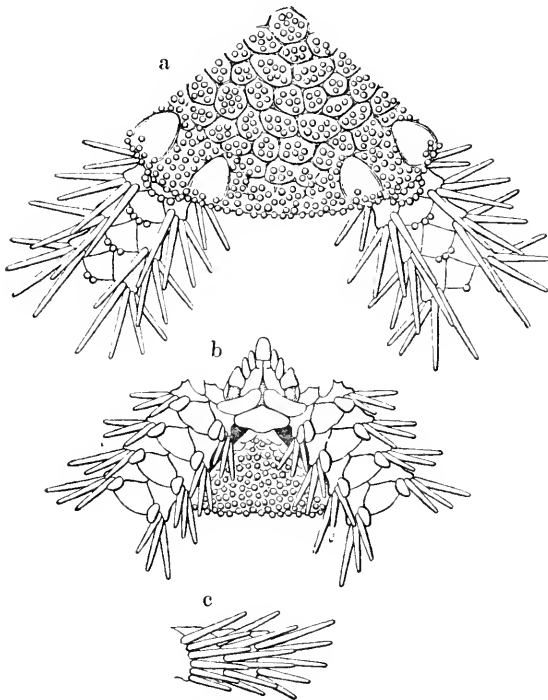

Fig. 28. *Ophiophthalmus cataleimmoidus*.  $\times 5\frac{1}{3}$ . *a*. From above. *b*. From below. *c*. Side view of three arm joints near disk.

disk, where the sutures are more or less obscured.

*Ophiophthalmus normani* (LYMAN).

*Ophiacantha normani*: LYMAN, Bull. Mus. Comp. Zool., VI, Pt. 2, 1879, p. 58, Pl. XVI, figs. 414-416; LÜTKEN & MORTENSEN, Mem. Mus. Comp. Zool., XXIII, 1899, p. 170, Pl. XVI, figs. 1-4; VERRILL, Trans. Connecticut Acad., X, 1899, p. 349 & 353; CLARK, Bull. U. S. Nat. Mus., LXXV, 1911, p. 215.

*Ophiomitra normani*: LYMAN, Rep. Challenger, V, 1882, p. 208, Pl. XXVI, figs. 9-11.

Eastern Sea; 95-106 fathoms (CLARK). Yenshû Sea; 565-662 fathoms (LYMAN, CLARK). Sagami Sea; 345-775 fathoms (LYMAN, CLARK). Off eastern Japan; 440-629 fathoms (CLARK). South of Hokkaido; 464 fathoms (CLARK). Yezo Strait; 533 fathoms (CLARK). Okhotsk Sea; 75-510 fathoms (CLARK).

Bering Sea. Alaska. Off Washington. West coast of Mexico.

*Ophiophthalmus leucorhabdotus* (CLARK).

*Ophiacantha leucorhabdota*: CLARK, Bull. U. S. Nat. Mus., LXXV, 1911, p. 222, fig. 102.

Eastern Sea; 103-152 fathoms (CLARK).

*Ophiophthalmus codonomorpha* (CLARK).

*Ophiomitra codonomorpha*: CLARK, Bull. U. S. Nat. Mus., LXXV, 1911, p. 189, fig. 87.

Off Mikawa, Yenshû Sea; 943 fathoms (CLARK).

*Ophiophthalmus hylacantha* (CLARK).

*Ophiacantha hylacantha*: CLARK, Bull. U. S. Nat. Mus., LXXV, 1911, p. 227, fig. 106.

Off Omai Zaki; 918 fathoms (CLARK).

*Ophiophthalmus microhylax* (CLARK).

*Ophiomitra microhylax*: CLARK, Bull. U. S. Nat. Mus., LXXV, 1911, p. 184, fig. 84.

Eastern Sea; 103–152 fathoms (CLARK).

*Ophientrema* VERRILL, 1899.

CLARK<sup>1)</sup> says that his *Ophiacantha leucosticta* “is almost certainly entitled to be the type of a new genus, the large amount of uncalcified skin and the peculiar condition of arm spines and tentacle scales furnishing good generic characters.” As far as I can judge, the species in question belongs to VERRILL’S subgenus *Ophientrema*, being identical with *Ophiacantha* (*Ophientrema*) *scolopendrica* LYMAN, 1883.

Though *Ophientrema* was established as a subgenus of *Ophiacantha*, I am inclined to rank it as a distinct genus, because the shape of the radial shields, the large basal tentacle pores, the peculiar lower arm spines and tentacle scales, &c. are different from those of the genuine *Ophiacantha*. This procedure would naturally satisfy the need felt by CLARK.

**Key to species of *Ophientrema*.**

- A—Disk covered with fine imbricating scales, and with minute, thorny, scattered tubercles ..... *euphylacteum*.  
 AA—Disk covered by a soft skin, scales being distinct only near the radial shields, and with minute, scattered granules.. *scolopendricum*.

*Ophientrema euphylacteum*.

*Ophiacantha euphylactea*: CLARK, Bull. U. S. Nat. Mus., LXXV, 1911, p. 225, fig. 105.

1) Bull. U. S. Nat. Mus., LXXV, 1911, p. 236.

Off Manazuru Zaki, Sagami Sea; 120–265 fathoms (CLARK).

*Ophientrema scolopendricum* (LYMAN).

*Ophiacantha scolopendrica*: LYMAN, Bull. Mus. Comp. Zool., X, 1883, p. 259, Pl. VI, figs. 85–87.

*Ophiacantha (Ophientrema) scolopendrica*: VERRILL, Transact. Connecticut Acad., X, 1899. p. 332.

*Ophiacantha leucosticta*: CLARK, Bull. U. S. Nat. Mus., LXXV, 1911, p. 235, fig. 111.

Yenshû Sea; 565 fathoms (LYMAN), 507 fathoms (CLARK).

**Key to Japanese species of *Ophiacantha*.**

*A*—Oral papillæ arranged in a single series.

*a*—Single tentacle scale to each pore.

*b*—Arm spines smooth.

*c*—Disk covered with spines or stumpy tubercles.

*d*—Disk tubercles ending with a thorny crown.

*e*—Four to seven arm spines.

*f*—Four arm spines, which are shorter than the corresponding arm joint . . . . . *dallasii*.

*fj*—Five or more arm spines, of which the upper ones are distinctly longer than the corresponding arm joint.

*g*—Five or six arm spines; outer end of the radial shields naked. . . . . *enigmatica*.

*gg*—Seven arm spines; radial shields entirely covered over.

*h*—Outermost oral papilla very large and wide.

*i*—Outermost oral papilla much wider than long; tentacle scales acute. . . . . *levispina*.

*ii*—Outermost oral papilla longer than wide; tentacle scales large, flat, blunt . . . . . *omoplata*.

*hh*—Outermost oral papilla not especially large and wide.

*j*—Oral shields wide, with acute lateral angles; tentacle scales very small, spiniform and acute. . . . . *pentagona*.

- jj*—Oral shields not very wide, with rounded lateral angles; tentacle scales oval, flat, bluntly pointed ..... *adiaphora*.
- ee*—Ten or eleven arm spines; stumpy tubercles of the disk very short; oral shields wide; tentacle scales large, long, acute..... *anchilabra*.
- dd*—Disk covered only with spines.
- k*—Three oral papillæ on either side; no spines along the outer border of basal dorsal arm plates.
- l*—Disk spines smooth; outermost oral papilla very long and spiniform; eight or nine arm spines; tentacle scales conical, acute.....  
..... *lophobrachia*.
- ll*—Disk spines rough; outermost oral papilla flat and clavate; ten or eleven arm spines; tentacle scales long and flat..... *acanthinotata*.
- kk*—Six oral papillæ on either side; a row of spines present along the outer border of basal dorsal arm plates; eight arm spines; tentacle scales acute..... *inutilis*.
- cc*—Disk covered with granules; seven or eight arm spines; tentacle scales large..... *bidentata*.
- bb*—Arm spines serrate.
- m*—Oral papillæ and tentacle scales smooth.
- n*—Disk covered with fine scales and sparsely beset with rough, stout spines; six arm spines ..... *prionota*.
- nn*—Disk covered with thorny, stumpy tubercles, among which several long, thorny spines are mingled; nine arm spines ..... *diploa*.
- mm*—Oral papilla and tentacle scales rough; disk tubercles ending with a thorny crown; six to eight arm spines ..... *rhachophora*.
- aa*—Two tentacle scales to each pore; disk covered with fine granules; six arm spines, flattened, smooth ..... *bisquamata*.
- AA*—Oral papillæ not arranged in a single series, but the outer ones clustered around the second oral tentacle pore; disk covered with short, granule-like spines; twelve serrate arm spines; single tentacle scale to each pore ..... *rosea*.

*Ophiacantha dallasii* DUNCAN.

*Ophiacantha dallasii*: DUNCAN, Journ. Linn. Soc. London, XIV, 1879, p. 471, Pl. XI, figs. 25-27; LYMAN, Rep. Challenger, V, 1882, p. 199; DÖDERLEIN, SEMON-Zool. Forschungsr. Australien u. Malayischen Archipel, V, 1896, p. 291, Pl. XIV, figs. 3a-3c, Pl. XVI, figs. 12-12a.

Off Korea, Sea of Japan; 50 fathoms (DUNCAN).

Amboina (DÖDERLEIN).

*Ophiacantha enigmatica*, sp. nov.

Seven specimens; off Misaki, Sagami Sea.

Diameter of disk 5 mm. Length of arms 25 mm. Width of arms at base 1.2 mm.

Disk pentagonal, with concave interbrachial borders, flat, thin, covered by a thick skin, containing rather fine, rounded, thin, irregular scales, which become distinct when dried; sparsely beset with small stumpy tubercles, which are bifid or crown-

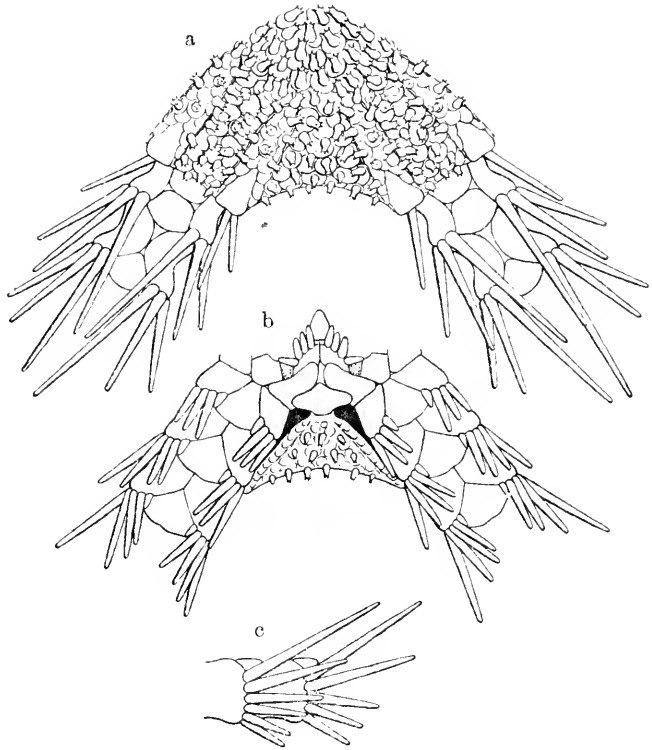

Fig. 29. *Ophiacantha enigmatica*.  $\times 12$ . a. From above. b. From below. c. Side view of two arm joints near disk.

ed with a few thorns. Radial shields raised, long, narrow, about two-thirds as long as the disk radius, those of the same pair parallel to each other. They are covered by the skin, and usually also by the scales except at the outer ends. In some specimens, they are almost entirely free from the scales. Interbrachial ventral surfaces similar to the dorsal side, but the stumpy tubercles are fewer and finer. Genital slits large, long, almost reaching the disk margin, much widened and rounded at the inner ends.

Oral shields small, rhomboidal, with concave sides and perfectly rounded lateral and outer angles, inner angle like a beak, so that the inner sides form a brace-shape; very short, about twice as wide as long. Adoral shields large, stout, with concave adradial side, more or less separated from each other by a naked, depressed space, or sometimes entirely in contact. Three or four oral papillæ on either side, long, conical, rather obtuse; the outermost one is directed laterally and protects the second oral tentacle pore; the next is the stoutest. Five or six teeth, obtuse or sometimes widened at the free end, with two or three irregular denticles, except the uppermost one, which is acute and is the longest.

Arms rather stout, uniformly tapered, knotted, with very long joints. First two dorsal arm plates quadrangular, with very convex outer side, wider than long, in contact with each other. The second is the largest, and is wider without than within. Those following are small, triangular, with very convex outer side, slightly longer than wide, not in contact with each other. Lateral arm plates well developed, with prominent spine ridges, meeting each other above and below, except between the first and second ventral arm plates and between the first and second dorsal plates; besides, the second and third dorsal plates often do not meet,



leaving a long, narrow, naked space. First ventral arm plate small, hexagonal, with concave inner side, about as wide as long. The second is the largest, and is triangular, with truncated inner angle and curved outer border, a little wider than long, in contact with the first plate. The rest are triangular, with acute inner angle and curved outer border, wider than long, separated from each other by the lateral arm plates. The outer border of the ventral plates consists indistinctly of three portions, of which the median is very slightly concave. Five or six arm spines, long, slender, spiniform, terete, solid, entire, except the lower spines, which are slightly thorny at the tips. The upper spines are longer than the lower. The uppermost one is about twice as long as, and the lowest a little shorter than, the corresponding arm joint. The lower spines are crowded and lie flat on the ventral surface of the arms. One tentacle scale, very minute, acutely pointed.

Colour in alcohol: disk light yellowish gray, arms light yellow.

This species is very near to *O. trachybaetra* CLARK, 1911, but differs from it chiefly in the fewer disk tubercles, in the fewer oral papillæ, in the shape of the oral shields and ventral arm plates, and in the fewer arm spines, which are never club-shaped.

Like *O. trachybaetra*, this species has some external resemblances to *Ophioblebes*. However, I believe with CLARK, that it is more natural to place it in *Ophiacantha* than in *Ophioblebes*.

### *Ophiacantha levispina* LYMAN.

*Ophiacantha levispina*: LYMAN, Bull. Mus. Comp. Zool., V, 1878, p. 147, Pl. X, fig. 277; LYMAN, Rep. Challenger, V, 1882, p. 196, Pl. XXV, figs. 1-3; CLARK, Bull. U. S. Nat. Mus., LXXV, 1911, p. 198.

Sea of Japan ; 224–248 fathoms (CLARK). Off Kii, Kumano Sea ; 507–649 fathoms (CLARK). Off Omai Zaki ; 624 fathoms (CLARK). Off Hiuga ; 720 fathoms. Eastern Sea ; 361–440 fathoms (CLARK).

Malaysian waters.

*Ophiacantha omoplata* CLARK.

*Ophiacantha omoplata* : CLARK, Bull. U. S. Nat. Mus., LXXV, 1911, p. 202, fig. 93.

Off Korea ; 136 fathoms (CLARK).

*Ophiacantha pentagona* KÖHLER.

*Ophiacantha pentagona* : KÖHLER, Ann. Sci. Nat. Zool., 8<sup>e</sup> Ser., IV, 1897, p. 342 ; KÖHLER, Ech. Indian Mus., Deep-sea Oph., 1899, p. 53, Pl. IV, figs. 27–29 ; CLARK, Bull. U. S. Nat. Mus., LXXV, 1911, p. 196.

*Ophiacantha pentagona* var. *armata* : KÖHLER, Rés. Camp. Sci. Monaco, XII. 1198, p. 55.

Numerous specimens ; Uraga Channel. Numerous specimens ; Sengenzuka-Aoyamadashi, Sagami Sea ; 85 fathoms. Numerous specimens ; Mera-out-Oisegaké, Sagami Sea ; 300 fathoms. Numerous specimens ; off Ôshima ; 90–100 fathoms.

Off Kii, Kumano Sea ; 191–253 fathoms (CLARK). Off Mikawa, Yenshû Sea ; 943 fathoms (CLARK). Off Port Heda ; 161–167 fathoms (CLARK). Sagami Sea ; 52–153 fathoms (CLARK). Suruga Gulf ; 45–131 fathoms (CLARK). Off Omai Zaki ; 918 fathoms (CLARK). Eastern Sea ; 95–369 fathoms (CLARK). Korea Strait ; 59 fathoms (CLARK).

Malaysian waters. West of Africa.

*Ophiacantha adiaphora* CLARK.

*Ophiacantha adiaphora*: CLARK, Bull. U. S. Nat. Mus., LXXV, 1911, p. 199, fig. 91.

Sagami Sea; 622 fathoms (CLARK). Sea of Japan; 90–207 fathoms (CLARK). Okhotsk Sea; 68 fathoms (CLARK).

Bering Sea.

*Ophiacantha anchilabra* CLARK.

*Ophiacantha anchilabra*: CLARK, Bull. U. S. Nat. Mus., LXXV, 1911, p. 205, fig. 95.

One specimen; locality unknown, probably Sagami Sea.

Off Kii, Kumano Sea; 649 fathoms (CLARK). Off Omai Zaki; 918 fathoms (CLARK).

*Ophiacantha lophobrachia* CLARK.

*Ophiacantha lophobrachia*: CLARK, Bull. U. S. Nat. Mus., LXXV, 1911, p. 232, fig. 109.

Eastern Sea; 152 fathoms (CLARK).

*Ophiacantha acanthinotata* CLARK.

*Ophiacantha acanthinotata*: CLARK, Bull. U. S. Nat. Mus., LXXV, 1911, p. 203, fig. 94.

Numerous specimens; Okinosé, Sagami Sea. Two specimens; Mera-out-Oisegaké, Sagami Sea; 300 fathoms.

Gulf of Tokyo; 169 fathoms (CLARK). Eastern Sea; 181 fathoms (CLARK).

*Ophiacantha inutilis* KÖHLER.

*Ophiacantha inutilis*: KÖHLER, Exp. Siboga, XLV, Pl. 1, 1904, p. 111, Pl. XXI, figs. 6–8; CLARK, Bull. U. S. Nat. Mus., LXXV, 1911, p. 208.

Off Kii, Kumano Sea ; 191 fathoms (CLARK). Uruga Channel ; 70–197 fathoms (CLARK). Eastern Sea ; 440 fathoms (CLARK). Malaysian waters.

*Ophiacantha bidentata* (RETZIUS).

*Asterias bidentata* : RETZIUS, Diss., 1805, p. 33.<sup>1)</sup>

*Ophiura retzii* : NILSSON, Coll. Zool. Scand., 1817, p. 15.<sup>1)</sup>

*Ophiocoma arctica* : MÜLLER & TROSCHER, Sys. Ast., 1842, p. 103.

*Ophiacantha spinulosa* : MÜLLER & TROSCHER, *ibid.*, p. 106 ; LÜTKEN, Addit. ad Hist., I, 1861, p. 65, Pl. II, fig. 14 ; LYMAN, Ill. Cat. Mus. Comp. Zool., I, 1865, p. 93, figs. 6 & 7.

*Ophiacantha grönländica* : MÜLLER & TROSCHER, Arch. Naturg., 1844, p. 183.<sup>1)</sup>

*Ophiocoma echinulata* : FORBES, SUTHERLAND'S Journ. Voy. Baffin's Bay II, App., 1852, p. 205.<sup>1)</sup>

*Ophiacantha bidentata* : LJUNGMAN, Öfv. K. Vet. Akad. Forh. XXVIII, 1871, p. 652<sup>1)</sup> ; LYMAN, Bull. Mus. Comp. Zool., V, 1878, p. 149 ; KÖHLER, Rés. Camp. Sci. Monaco, XII, 1898, p. 55 ; GRIEG, Fauna Arctica, I, 1900, p. 267 ; RANKIN, Proc. Acad. Nat. Sci. Philadelphia, 1901, p. 179 ; NORMAN, Ann. Mag. Nat. Hist., 7th. Ser., XII, 1903, p. 407 ; KÖHLER, Mem. Soc. Zool. Fr., XIX, 1906, p. 6 ; KÖHLER, Exp. Sci. Travailleur et Talisman, VIII, 1907, p. 289 ; KÖHLER, Bull. Sci. Fr. Belg., XXXIV, 1907, p. 317 ; KÖHLER, Bull. Mus. d'Hist. Nat., 1909, p. 123 ; KÖHLER, Rés. Camp. Sci. Monaco, XXXIV, 1909, p. 184 ; KÖHLER, Bull. Mus. d'Hist. Nat., 1909, p. 123 ; CLARK, Bull. U. S. Nat. Mus., LXXV, 1911, p. 195 ; KÖHLER, Bull. Mus. d'Hist. Nat., 1913, p. 14 ; KÖHLER, Bull. U. S. Nat. Mus., LXXXIV, 1914, p. 80.

One specimen ; locality unknown.

Sea of Japan ; 130–536 fathoms (CLARK). Gulf of Tartary 318 fathoms (CLARK). Off Kurile Is. ; 229 fathoms (CLARK).

1) These papers were not seen by me.

Bering Sea. Arctic Ocean. North Atlantic.

*Ophiacantha prionota* CLARK.

*Ophiacantha prionota*: CLARK, Bull. U. S. Nat. Mus., LXXV, 1911, p. 213, fig. 99.

Off Tanega-shima; 1,008 fathoms (CLARK).

*Ophiacantha diploa* CLARK.

*Ophiacantha diploa*: CLARK, Bull. U. S. Nat. Mus., LXXV, 1911, p. 207.

Off Iiuga; 437 fathoms (CLARK).

*Ophiacantha rhachophora* CLARK.

*Ophiacantha rhachophora*: CLARK, Bull. U. S. Nat. Mus., LXXV, 1911, p. 201, fig. 92.

Four specimens; off Inatori, Izu.

Eastern Sea; 106–139 fathoms (CLARK). Off Omai Zaki; 475–505 fathoms (CLARK). Off Ôse Zaki, Suruga Gulf; 63–100 fathoms (CLARK). Sagami Sea; 83–153 fathoms (CLARK). Uraga Channel; 197 fathoms (CLARK). Off Kii; 191–253 fathoms (CLARK). Sea of Japan; 90–207 fathoms (CLARK).

Bering Sea.

I hesitated at first to refer these specimens to the present species. The distal end of the radial shields is naked but not conspicuous, and the outermost oral papilla arises from the adoral shield. Besides, there occurs one scale-like papilla on the first ventral arm plate, projecting inwards and vertically. These characters are not apparent in CLARK'S figure; but it is to be remarked that the insertion of the outermost oral papilla is very liable to be misunderstood when the papilla is not turned up but

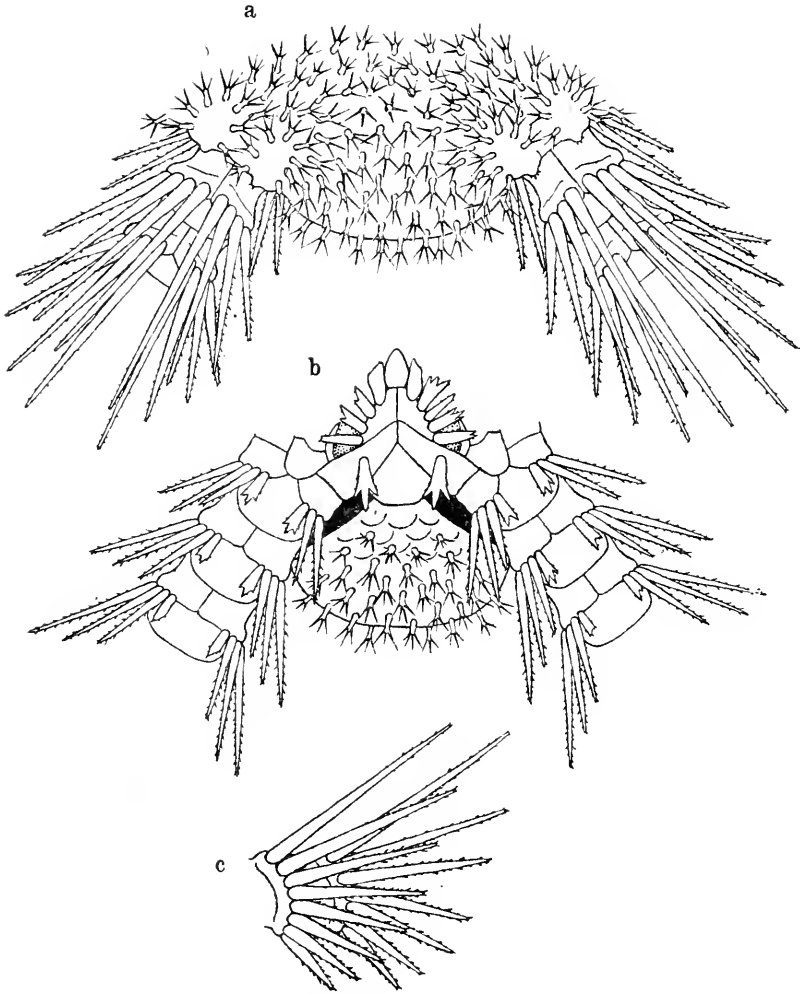

Fig. 30. *Ophiacantha rhachophora*.  $\times 18$ . a. From above. b. From below. c. Side view of two arm joints near disk.

directed in the same direction with the others, so that in such a case the oral papillae appear as shown in CLARK'S figure.

*Ophiacantha bisquamata* MATSUMOTO.

*Ophiacantha bisquamata*: MATSUMOTO, Proc. Acad. Nat. Sci. Philadelphia LXVII, 1915, p. 62.

Two specimens; off Ôshima, Sagami Sea; 75-85 fathoms.

Diameter of disk 6 mm. Length of arms 34 mm. Width of arms at base 1.5 mm.

Disk pentagonal, with nearly straight or slightly convex interbrachial borders, flat, soft, closely covered with fine granules, of which eight or nine are contained in 1 mm. Radial shields entirely covered over, very small, bar-like, separated from each other. Interbrachial ventral surfaces similar to the dorsal side, but free of granules and covered with fine scales in the inner parts. Genital slits long, nearly reaching the disk margin.

Oral shields small, rhomboidal, with convex inner sides and rounded outer angle, nearly as long as, or slightly longer than, wide, joined with the first lateral arm plates. Adoral shields small, triangular, pointed inwards, meeting with each other. Five or six oral papillæ on either side of each jaw; the outermost two are

flat, leaf-like and protect the second oral tentacle pore, while the others are very narrow and acute; the innermost one, which forms a pair with that of the other side, is infradental. Four or five teeth in a single vertical row, more or less stout, obtuse.

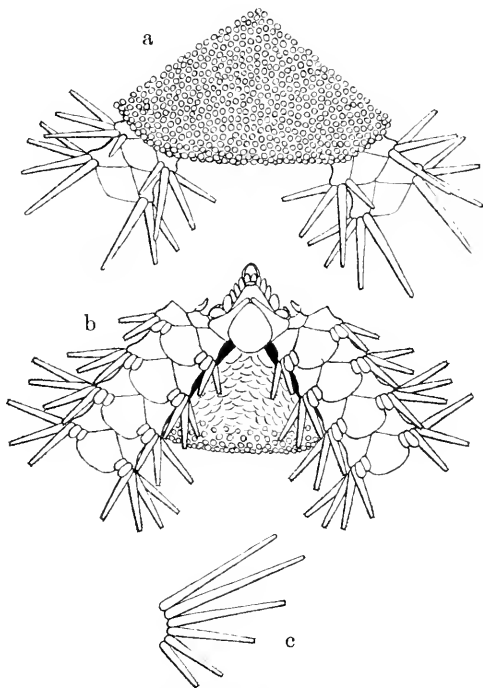

Fig. 31. *Ophiacantha bisquamata*.  $\times 8$ . a. From above. b. From below. c. Arm spines of one side of an arm joint near disk.

Arms composed of short and wide joints, uniformly tapered. Dorsal arm plates rhomboidal, with very obtuse outer angle, wider than long, slightly in contact with each other, with a more or less distinct median keel, so that the dorsal side of the arm is keeled as a whole. Lateral arm plates with prominent spine ridges, meeting neither above nor below. First ventral arm plate very small, quadrangular, with concave inner side, longer than wide. Those following are moderately large, pentagonal, with convex but slightly notched outer side and rounded outer angles, about as wide as long. Six arm spines, long, flattened, more or less curved, truncate, translucent, but not serrate; the uppermost or the next spine is the longest and is about two and a half times as long as the corresponding arm joint, while the lowest one, the shortest, is slightly longer than the same. Two oval, thin, leaf-like tentacle scales to each pore.

Colour in alcohol: disk grayish brown; one specimen with five white patches, which correspond to the radial shields, the other without any; arms banded with grayish brown and white. The grayish brown parts are dark green and the white parts vivid red in life, according to my own observation on board the "Ikuomaru."

This species more or less resembles *O. bidentata* in the disk coverings, though precise comparison may be dispensed with. The presence of two tentacle scales to each pore, together with the very fine granulation, makes the present species very easy to be recognised.

*Ophiacantha rosea* LYMAN.

*Ophiacantha rosea*: LYMAN, Bull. Mus. Comp. Zool., V, 1873, p. 139, Pl. X, figs. 267 & 268; LYMAN, Rep. Challenger, V, 1882, p. 148, Pl. XXV, figs. 10-12.



Sagami Sea ; 420-775 fathoms (LYMAN).

! Lat.  $46^{\circ} 40' S.$ , long.  $37^{\circ} 50' E.$ ; 310 fathoms (LYMAN). ! Lat.  $50^{\circ} 10' S.$ , long.  $74^{\circ} 42' E.$ ; 175 fathoms (LYMAN).

*Ophiacanthella acantophora* (CLARK).

*Ophiomitra acantophora* : CLARK, Bull. U. S. Nat. Mus., LXXV, 1911, p. 190, fig. 88.

Off Kurile Is.; 229 fathoms (CLARK).

Bering Sea. Alaska. Off Aleutian Is.; 1,213 fathoms (!) (CLARK).

This species appears to be distinguished from the genotype, *O. troscheli* (LYMAN, 1878), by the total absence of the disk granules, by the more numerous disk spines, which have a few denticles near the tip, by the fewer oral papillae and arm spines, and by the smaller dorsal arm plates, which are not in contact with each other. I consider that, it is more natural to refer this species to the present genus than to any other known one.

Revision of **Ophiothamnus**, s. ext.

It is a wonder that, the present genus has been long left in a great confusion. As far as I can judge, those species which have been referred to the present genus by modern systematists correspond to a type, which was not considered to be *Ophiothamnus* by LYMAN, while certain species, which must be congeneric with LYMAN'S type of *Ophiothamnus*, have been referred to various other genera. For example, the so-called "*Ophiothamnus*" of modern systematists includes *Ophiomitra exigua* LYMAN, 1879 (referred to *Ophiothamnus* by VERRILL, 1899), *Ophiothamnus levis* LÜTKEN & MORTENSEN, 1899, *O. stultus* KÖHLER, 1904, &c., while the genuine *Ophiothamnus*, referred to other genera by modern systematists,

includes *Ophioleda minima* KÖHLER, 1906 (= *Ophioplinthaca oclusa* KÖHLER, 1907), *Ophiomitra habrotata* CLARK, 1911, &c. The differences between these two groups may be given as follows:

Genuine *Ophiothammus*:—Disk marked out into five brachial lobes by deep interradi al notches of the interbrachial borders, and strongly puffed out interbrachially; disk scales fine; radial shields not perfectly joined, but in contact with each other only at the outermost parts (except in *O. remotus*); oral shields very small, separated from the first lateral arm plates by the adoral shields, which are very large; interbrachial ventral surfaces large, covered with numerous fine scales; arms very slender, composed of long and slender joints; arm spines not serrate, the lowest one being never hook-shaped; ventral arm plates very small, much narrower than the corresponding arm joint; genital bursæ very rudimentary, being represented merely by the creases between the interbrachial ventral surfaces and the arm bases; genital plates very closely set in radial pairs, lying above the basal vertebræ; genital scales absent; generative glands covered by a membrane, which contains fine scales; peristomial plates triple; distal vertebræ incompletely divided into halves by a longitudinal series of pores.

So-called *Ophiothammus*:—Disk not distinctly lobed; disk scales coarse; radial shields joined in pairs along nearly the entire length; oral shields large, in contact with the first lateral arm plates; adoral shields large, lying entirely proximal to the oral shields; interbrachial ventral surfaces small, covered with rather few coarse scales, of which two or three are large and conspicuous; arms stout at the base, composed of short and stout joints; arm spines usually

serrate, the lowest one being hook-shaped in distal arm joints; ventral arm plates large, wide, nearly as wide as the corresponding arm joint; genital bursæ well developed; genital plates, genital scales, generative glands and peristomial plates unknown, but probably normal; distal vertebrae unknown.

In view of these differences, the two groups can hardly be united in a single genus. I therefore propose the name *Ophiurothamnus*, nov., for the so-called *Ophiothamnus*, to distinguish it from the genuine *Ophiothamnus*.

There are two other species, viz. *Ophiothamnus gracilis* STUDER, (1882) 1883, and *Ophiacantha gracilis* VERRILL, 1885 (referred to *Ophiothamnus* by V., 1899), which have been referred to *Ophiothamnus*, but probably belong neither to the genuine *Ophiothamnus* nor to *Ophiurothamnus*. Though I am not able to settle their systematic position owing to their very imperfect descriptions, they may possibly be referable to *Ophiacantha*.

***Ophiothamnus* LYMAN, 1869, emend.**

Syn. *Ophiolelda* KÄHLER, 1906.

Disk divided into five brachial lobes, covered with fine, imbricating scales, and beset with scattered spines. Radial shields large, naked, more or less joined in pairs outwards. Genital bursæ very rudimentary, being represented by the creases between the disk and the arm bases. Oral shields small, separated by the large adoral shields from the first lateral arm plates. Three or four oral papillæ on either side of each jaw, the outermost one being very large and operculiform. Peristomial plates very large, triple. Arms inserted ventrally to the disk, composed of long, slender, hour-glass-shaped joints. Arm spines long, slender, spini-

form, acute, glassy, but not serrate, the lowest one being never hook-shaped.

This genus includes *Ophiothamnus vicarius* LYMAN, 1869, *O. affinis* LJUNGMAN, 1871, *O. remotus* LYMAN, 1878, *Ophioleđa minima* KÖHLER, 1906, *Ophiomitra habrotata* CLARK, 1911 and *Ophiothamnus venustus* MATSUMOTO, 1915, the first being the genotype.

I consider *Ophioleđa* KÖHLER as a synonym of *Ophiothamnus* LYMAN, because I am not able to make any essential distinctions of generic character between the two genotypes, judging from the descriptions and figures of LYMAN and KÖHLER.

### Key to Japanese species of *Ophiothamnus*.

- A*—Disk spines dimorphic, a few very long, acute spines being present, besides very minute ones; interbrachial ventral surfaces entirely free of spines; dorsal arm plates comparatively large, longer than half the corresponding arm joint in free basal joints; eight or nine arm spines.....*habrotatus*.
- AA*—Disk spines monomorphic, very minute; interbrachial ventral surfaces also beset with several spines; dorsal arm plates very small, much shorter than half the corresponding arm joint; nine or ten arm spines.....*venustus*.

#### *Ophiothamnus habrotatus* (CLARK).

*Ophiomitra habrotata*: CLARK, Bull. U. S. Nat. Mus., LXXV, 1911, p. 182, fig. 83.

Eastern Sea; 95-106 fathoms (CLARK).

#### *Ophiothamnus venustus* MATSUMOTO, 1915.

*Ophiothamnus venustus*: MATSUMOTO, Proc. Acad. Nat. Sci. Philadelphia, 1915, p. 63.

Numerous specimens; off Inatori, Izu, Sagami Sea.

Diameter of disk 3 mm. Length of arms 23 mm. Width of arms at base 0.5 mm.

Disk five-lobed, i.e. divided by five radiating interradial furrows into five heart-shaped lobes, with large radial shields and

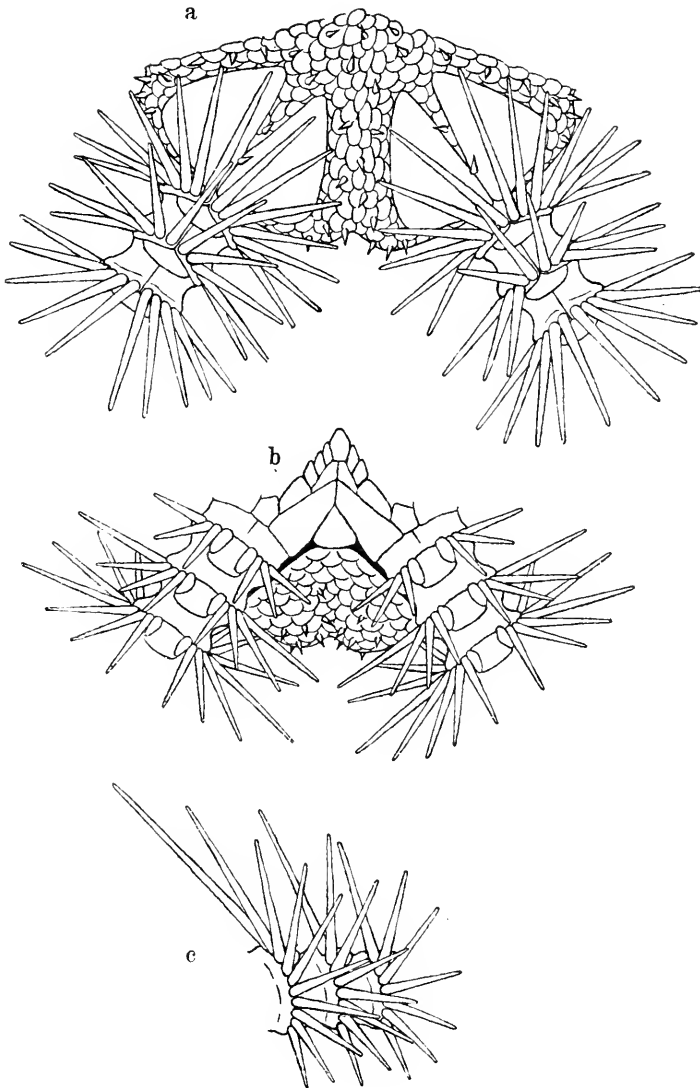

Fig. 32. *Ophiothaenus venustus*.  $\times 20$ . a. From above. b. From below. c. Side view of three arm joints near disk.

fine, imbricating scales, the latter bearing here and there very short, acute spines. The radial shields are very large, triangular, with rather acute inner and perfectly rounded abradial angles; the adradial side is the longest, three-fourths as long as the disk radius; the shields are about twice as long as wide, and are apposed to each other by the outer one-third to one-fourth of the adradial sides. Interbrachial ventral surfaces covered by fine, imbricating scales and beset with short, acute spines; the latter being less numerous than on the dorsal surface.

Oral shields very small, triangular, with acute inner and rounded outer angles, slightly longer than wide. Adoral shields very large, long, stout, wider outwards, tapered inwards, meeting with each other. Oral plates exceedingly small. Three or rarely four oral papillæ on either side; the outermost one arises from the adoral shield and is very large and unusually wide; the rest are very small; there is often one additional infradental papilla. Teeth four, blunt, with widened free end, except the uppermost one, which is the longest and is acute.

Arms slender and long, strongly knotted. Dorsal arm plates very small, three-sided, with extremely wide inner angle and curved outer border, extremely short, much wider than long. Lateral arm plates extremely well developed, meeting each other above and below, and so well soldered below that the line of suture is hardly visible; with well developed spine ridges; strongly constricted at the middle. First ventral arm plate exceedingly small, pentagonal. The rest are quadrangular, with curved outer side, wider than long, decreasing in size outwards. The arm spines are needle-like, very long, acute. They are nine or ten in number and approximated dorsally in the first two or three free joints. In the first free joint, the uppermost spine is about three

times, and the lowest one about one and a half times, as long as the corresponding arm joint. More distally, the arm spines become rather rapidly fewer and shorter, so that in the tenth free arm joint, they are five in number and about as long as the corresponding arm joint. One tentacle scale, comparatively large, blunt in the basal joints, but pointed more distally.

Colour in alcohol white.

I have observed the internal structures of this species, and ascertained that the internal oral skeleton, genital plates and generative glands are quite similar to those of the genotype (LYMAN, Challenger Rep., Pl. XLII, fig. 1).

### **Ophiurothamnus, g. nov.**

Disk covered with rather coarse scales. Radial shields large joined in pairs nearly along the entire length. Interbrachial ventral surfaces small, with a pair of large, distinct plates joined to each other in the interradiial line. Another large, prominent plate is present at the middle of the interradiial margin, lying just outside the paired plates mentioned. Genital bursæ well developed. Oral and adoral shields stout, the latter being entirely proximal to the former. Three or four oral papillæ on either side, the outermost one being usually very large and wide. Teeth arranged in a single vertical row. Dental papillæ absent. Arms strongly knotted, with hour-glass-shaped joints. Dorsal arm plates very small. Lateral arm plates well developed, those of the two sides meeting above as well as below. Ventral arm plates short, very wide, as wide as the corresponding arm joint. Arm spines long, slender, usually serrate; those of the first one or two free arm joints approximated dorsally. Lowest spine of the outer arm joints hook-shaped. One tentacle scale to each pore.

The present genus includes *Ophiomitra exigua* LYMAN, 1879 (referred to *Ophiothamnus* by VERRILL, 1899), *Ophiothamnus laevis* LÜTKEN & MORTENSEN, 1899, and *Ophiothamnus stultus* KÖEHLER, 1904, besides the genotype, *Ophiomitra dicycla* CLARK, 1911.

*Ophiurothamnus* is very near to *Ophiomytis* and *Ophioplinthaca*, but differs from the former chiefly in the very small dorsal arm plates and in the basal arm spines approximating dorsally; from the latter in the absence of the marginal disk scales, in the smaller interbrachial ventral surfaces, which are covered with fewer, coarser scales, in the smaller dorsal arm plates, and in the basal arm spines approximating dorsally. Further, this genus differs from *Ophiothamnus* in the coarser disk scales, in the radial shields being joined along the whole length, in the fewer and coarser scales of the interbrachial ventral surface, in the well developed genital bursæ, in the stout oral shields, which are in contact with the first lateral arm plates, in the stouter arms, in the very wide ventral arm plates, which are as wide as the corresponding arm joints, in the serrate arm spines, and in the usually hook-shaped lowest spines in the distal arm joints.

*Ophiurothamnus dicyclus* (CLARK).

*Ophiomitra dicycla*: CLARK, Bull. U. S. Nat. Mus., LXXV, 1911, p. 181, fig. 82.

Eastern Sea; 434 fathoms (CLARK). Bungo Channel; 437 fathoms (CLARK).

*Ophioplinthaca cardiomorpha* (CLARK).

*Ophiomitra cardiomorpha*: CLARK, Bull. U. S. Nat. Mus., LXXV, 1911, p. 179, fig. 81.



Eastern Sea ; 361-440 fathoms (CLARK). Bungo Channel ; 720 fathoms (CLARK). Off' Shio Misaki ; 587 fathoms (CLARK). Off' Omai Zaki ; 624 fathoms (CLARK).

**Key to Japanese species of *Ophiomitra*.**

- A*—Disk scales coarse ; radial shields very narrow, widely separated from each other ; oral shields rhomboidal or pentagonal, about as wide as long ; five or six arm spines, of which the uppermost or the next one is the longest and about twice as long as the corresponding arm joint .....*bythiaspis*.
- AA*—Disk scales fine ; radial shields not very wide, lying rather closely side by side ; oral shields much wider than long ; six or seven arm spines, of which the uppermost or the next one is the longest and about thrice as long as the corresponding arm joint. .*lithosora*.

***Ophiomitra bythiaspis* CLARK.**

*Ophiomitra bythiaspis* : CLARK, Bull. U. S. Nat. Mus., LXXV, 1911, p. 185, fig. 58.

Off Yenshû Sea ; 943 fathoms (CLARK).

***Ophiomitra lithosora* (CLARK).**

*Ophiocamax lithosora* : CLARK, Bull. U. S. Nat. Mus., LXXV, 1911, p. 191, fig. 89.

Off Kii ; 244-253 fathoms (CLARK). Eastern Sea ; 361 fathoms (CLARK).

In the genuine *Ophiocamax*, the disk is not very deeply lobed and the radial shields are joined in pairs along the whole length. The present species lacks these characteristics of *Ophiocamax*, but exhibits all the characteristics of *Ophiomitra* as emended by VERRILL, 1899.

*Ophiocamax polyptoca* CLARK.

*Ophiocamax polyptoca* : CLARK, Bull. U. S. Nat. Mus., LXXV, 1911, p. 193, fig. 90.

Eastern Sea ; 95–152 fathoms (CLARK). Kagoshima Gulf ; 85 fathoms (CLARK).

**Key to Japanese species of *Ophioteles*.**

- A*—Four oral papillæ on either side of each jaw ; ventral arm plates not notched outwards at least within the disk ; seven arm spines ; single tentacle scale to each pore ; disk beset with numerous small, rather well spaced, stumpy tubercles ..... *brachygnatha*.
- AA*—Three oral papillæ on either side ; ventral arm plates distinctly notched outwards even within the disk ; five arm spines ; tentacle scales absent.
- a*—Disk closely beset with very numerous small, rather granule-like, stumpy tubercles ..... *asaphes*.
- aa*—Disk sparsely beset with rather large, conical tubercles, which are more or less numerous on the radial shields, but few in the other parts..... *tuberosa*.

*Ophioteles brachygnatha* CLARK.

*Ophioteles brachygnatha* : CLARK, Bull. U. S. Nat. Mus., LXXV, 1911, p. 240, fig. 115.

Off Simushir Is.; 229 fathoms (CLARK).

*Ophioteles asaphes* CLARK.

*Ophioteles asaphes* : CLARK, Bull. U. S. Nat. Mus., LXXV, 1911, p. 239, fig. 114.

Off Kinkwasan ; 182 fathoms (CLARK). Off Hokkaido ; 175–349 fathoms (CLARK). Off Saghalin ; 100 fathoms (CLARK).

*Ophiolebes tuberosa* MATSUMOTO.

*Ophiolebes tuberosa*: MATSUMOTO, Proc. Acad. Nat. Sci. Philadelphia, 1915, p. 64.

Numerous specimens; Okinosé (a submarine bank), Sagami Sea.

Diameter of disk 10 mm. Length of arms 38 mm. Width of arms at base 1.5 mm.

Disk five-lobed, with strongly concave interbrachial borders, deeply hollowed at the central region, covered by a thick, cereous skin, which contains well spaced, coarse granules or thick, rounded scales of various size; beset with several short, conical,

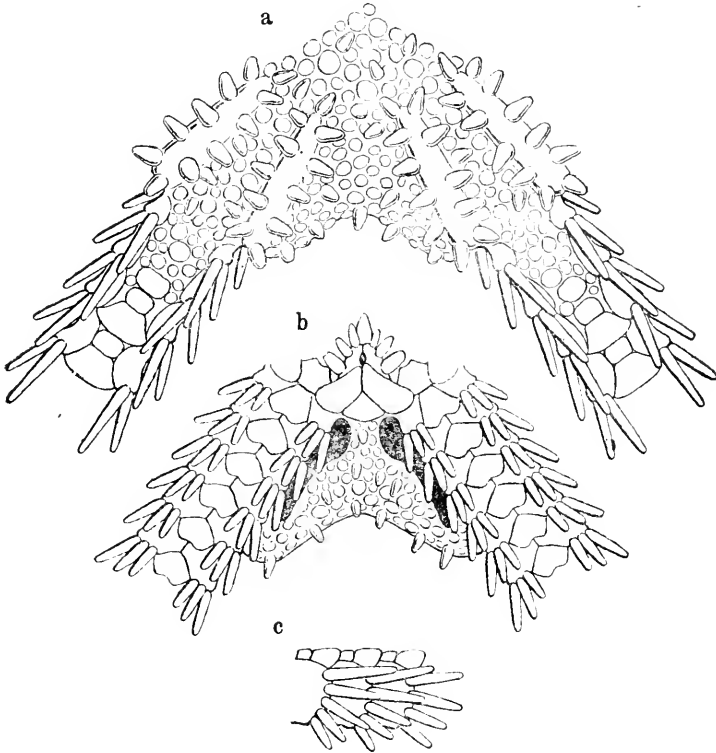

Fig. 33. *Ophiolebes tuberosa*.  $\times 8$ . a. From above. b. From below. c. Side view of three arm joints near disk.

stout, obtuse tubercles, which are larger and more numerous on the radial shields. Radial shields also covered by the skin, long, narrow, strongly raised, about two-thirds as long as the disk radius. Interbrachial ventral surfaces covered by a skin similar to that of the dorsal surface, the granules and tubercles being however smaller. Genital slits large, long, but not reaching the disk margin.

Oral skeleton also covered by the cereous skin. Oral shields rather small, thick, rhomboidal, wider than long, with wide, rounded outer angle and convex surface. Adoral shields large, quadrangular, with perfectly rounded outer angles and strongly convex surface, wider without than within, meeting with each other inwards. Between each pair of oral plates, occurs a more or less distinct buccal pore. Three or sometimes four oral papillæ on either side, conical and blunt; inner ones smaller; the outermost papilla is very large and stout. There occurs often one additional papilla just below the teeth. The oral papillæ project laterally so as to reach beyond the radial axis, and those of the two sides of each oral slit are placed alternately. Teeth conical, stout, obtuse.

Arms slender, covered by a thin, cereous skin. Dorsal arm plates two to each joint; the inner one has convex surface, and is small, quadrangular, wider than long, but in the more distal part of the arm is often longer than wide; the outer one is large, fan-shaped, much wider without than within, and has convex surface. The dorsal side of the basal region of the arms is covered by the continuation of the disk covering, so that it bears coarse, rounded, smooth, convex, well spaced granules or scales of various size in place of the dorsal arm plates. Lateral arm plates somewhat flared outwards, meeting below for a short

extent. First ventral arm plate comparatively large, hexagonal, with concave inner side and convex surface, widest at the lateral angles, as long as or slightly longer than wide, in contact with the next plate, which is the largest of all, pentagonal, widest at the lateral angles, as long as or slightly longer than wide, and has convex surface and a conspicuous notch at the outer angle. The rest separated from one another, rhomboidal, with a conspicuous notch at the outer angle, with strongly convex surface; more distally they become smaller, oval or round, and the surface is so convex as to appear like hemispherical tubercles. The arm spines are five in number in the proximal joints, but four in the more distal ones. They are conical, blunt, solid, terete; dorsal ones longer and stouter; in the basal joints of the arms, the uppermost spine is about one and a half times, and the lowest one about two-thirds, as long as the corresponding arm joint.

Colour in alcohol yellowish brown.

In younger specimens, the skin of the disk and arms is very thick, and the buccal pores are often indistinct.

This species is apparently near to *O. brachygnatha*, especially in the disk coverings. But a careful comparison will show that, the present species is more closely allied to *O. asaphes* than to *O. brachygnatha*, as shown in the foregoing key.

#### **Ophiosemmotes**, g. nov.

Disk high and convex, covered by a cereous skin, which obscures the underlying stout scales; beset with granules or stumpy tubercles. Radial shields exposed, rounded or triangular, more or less separated from each other. Three or four oral papillæ on either side of each jaw. Teeth in a single vertical series. Dental

papillæ absent. Arms also covered by a cereous skin. Dorsal arm plates entire. Arm spines conical, blunt, stout, opaque. A single conical, blunt tentacle scale to each pore.

This new genus includes *Ophiolebes tylota* CLARK, 1911, *O. pachybaetra* CLARK, 1911, *Ophiactis clavigera* LJUNGMAN, 1866 (referred to *Ophiolebes* by LYMAN, 1882), *Ophiacantha ædidisca* CLARK, 1911, *Ophiolebes diaphora* CLARK, 1911, *O. paucispina* CLARK, 1911, and *O. brevispina* CLARK, 1911, the first being the genotype.

*Ophiosemmotes* differs from the genuine *Ophiolebes* chiefly in the short, rounded or triangular, exposed radial shields and in the entire dorsal arm plates. In *Ophiolebes* as here restricted, the radial shields are long, narrow, bar-like and not exposed, and the dorsal arm plates are divided into two, inner and outer, secondary plates. *Ophiosemmotes* is very near to *Ophiochondrella*, but differs from it in the short ventral arm plates, which are separated from one another, and in the single thick, not leaf-like tentacle scale to each pore. In *Ophiochondrella* the ventral arm plates are quadrangular, as long as the corresponding arm joint and joined to one another, and the tentacle pores are provided with two thin, leaf-like scales.

### Key to Japanese species of *Ophiosemmotes*.

*A*—Disk closely covered with fine granules; radial shields oval, separated from each other; dorsal arm plates rather large, in contact with each other in the free basal arm joints, bearing a row of granules along the outer border; arm spines rather short, upper ones being nearly as long as the corresponding arm joint; lower arm spines not clavate.....*ædidisca*.

*AA*—Disk sparsely beset with clavate tubercles and granules; radial

shields triangular, more or less separated or the pairs slightly in contact at the outermost part; dorsal arm plates small, separated from each other by the lateral arm plates, entirely free of granules; arm spines long, the uppermost one being nearly thrice as long as the corresponding arm joint; lower arm spines clavate . . . . .*tylota*.

*Ophiosemnotes ædidisca* (CLARK).

*Ophiocantha ædidisca*: CLARK, Bull. U.S. Nat. Mus., LXXV, 1911, p. 220, fig. 101.

One specimen; Albatross station 4958, off Hiuga; 405 fathoms.

Off Hiuga; 405-578 fathoms (CLARK). Off Omai Zaki; 505 fathoms (CLARK). Off Kii; 544-545 fathoms (CLARK).

Though this species apparently resembles certain species of *Ophiophthalmus*, the high and convex disk, the very

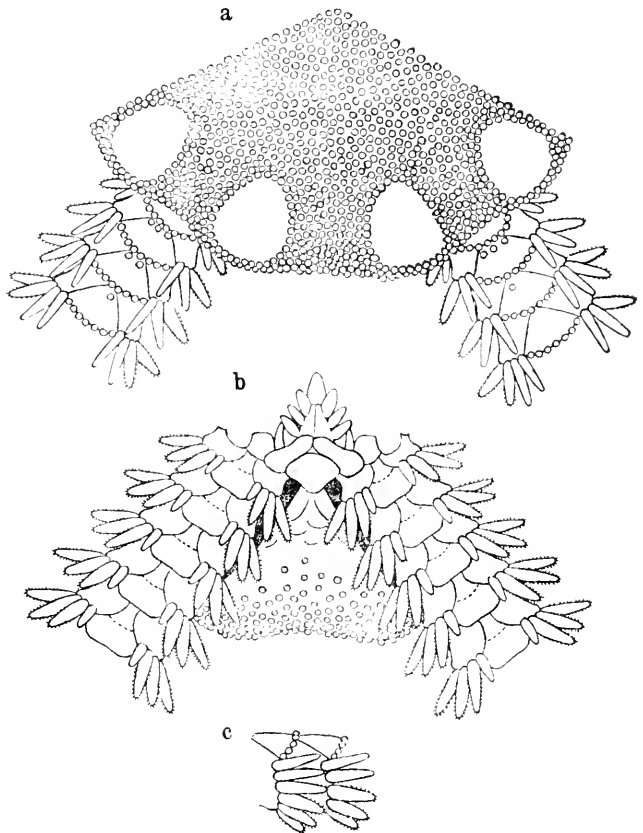

Fig. 34. *Ophiosemnotes ædidisca*. ×8. a. From above. b. From below. c. Side view of two arm joints near disk.

small oral region, the slender, skin-covered arms, the narrow ventral arm plates, of which the outer border is slightly notched, the short, stout, skin-covered arm spines and the conical, not leaf-like tentacle scales show that it is only distantly related to that genus. On the other hand, the present species is very near to *O. diaphora*, which appears to me to find its natural place in this genus.

*Ophiosemnotes tylota* (CLARK).

*Ophioteles tylota* : CLARK, Bull. U. S. Nat. Mus., LXXV, 1911. p. 243, fig. 117.

Sea of Japan; 90–207 fathoms (CLARK).

Bering Sea.

Family 2. **Hemieuryalidæ** (VERRILL, 1899) mihi, 1915.

Disk covered with very heavy plates and stout radial shields, the primaries being usually very conspicuous. Interbrachial ventral surfaces very small, with very short genital slits. Oral and adoral shields very thick. Three or four flat oral papillæ on either side of each jaw. Teeth triangular, arranged in a single vertical series. Dental papillæ absent. Peristomial plates simple, stout, soldered with the oral frames, which are also very stout. Genital plate and scale of the same side of a radius soldered together, very stout. Arms very stout, covered with very heavy arm plates, vertically coiled. Vertebrae stout. Vertebral articulations streptospondyline, articular pegs being very rudimentary or entirely absent.

This family includes seven genera, which may be grouped into two subfamilies as follows.

Subfamily 1. *Ophiochondrinæ* (VERRILL, 1899) mihi, 1915.—



Dorsal arm plates entire, without supplementary plates; five to eight arm spines, moderately long, conical; no tentacle scales proper, but the lowest arm spine may serve as one.

*Ophiochondrus* LYMAN, 1869.<sup>1)</sup>

*Ophiomaris* KÖEHLER, 1904 (= *Ophiurases* CLARK, 1911).

*Ophiogyptis* KÖEHLER, 1905.

Subfamily 2. *Hemieuryalinae* MATSUMOTO, 1915.—Dorsal arm plates often accompanied by supplementary plates or replaced by a mosaic of secondary plates; three arm spines and one tentacle scale, both being very short and flat.

*Sigsbeia* LYMAN, 1878.

*Ophioholcus* CLARK, 1915.

*Ophioplus* VERRILL, 1899.

*Hemieuryale* VON MARTENS, 1867.

According to LYMAN, *Ophiochondrus convolutus* LYMAN, 1869 has a very heavy armature, which lies under the disk skin. The radial shields are bar-like, long, thick and solid. The genital plates are massive, a full half of the length being occupied by the club-shaped head, while the comparatively small shaft is rounded and tapering. About half way along the length of the genital plate, there is soldered to it the small, rounded genital scale. The peristomial plates are simple, very thick and strong. Within the disk, the vertebræ are short and discoid; but beyond the disk margin, they take on a curious elongate shape. Their outer face has a wide massive articular shoulder to support the large umbo of the next vertebra: the articular peg is very small, and there is no distinct hole for its reception in the next vertebra. The important structures of *Ophiomaris projecta* MATSUMOTO, 1915 are

1) *Ophioplus armatus* KÖEHLER, 1907 (referred to *Ophiochondrus* by K., 1914) and *Ophiochondrus granulatus* KÖEHLER, 1914, are in my opinion referable to the genuine *Ophiobes*.

almost similar to those of the preceding, but the radial shields are more massive and the inner parts of the genital plates, as well as the genital scales, are thin and plate-like.

According to LYMAN'S statements, the internal structures of *Hemieuryale pustulata* VON MARTENS, 1867 are essentially similar to those of *Ophiochondrus*, but more specialised. The genital plate and scale of the same side of a radius are also soldered together. The peristomial plates are simple and comparatively small. The articular shoulder of each vertebra is very stout, while the articular peg is entirely absent.

### Key to Japanese species of *Ophiomæris*.

- A*—Disk entirely free of large, spherical tubercles; each radial pair of radial shields separated from each other by a row of two or three plates ..... *obstricta*
- AA*—Large, spherical tubercles present along the outer margins of the radials and along the adradial borders of the radial shields; radial shields joined in pairs along the whole length..... *projecta*

### *Ophiomæris obstricta* (LYMAN).

*Ophioceramis*(?) *obstricta* : LYMAN, Bull. Mus. Comp. Zool., V. 1878, p. 124, Pl. VI, figs. 164–166; LYMAN, Rep. Challenger, V, 1882, p. 26, Pl. XI, figs. 1–3.

*Ophiomæris obstricta* : KÄHLER, Exp. Siboga, XLV, Pt. 1, 1904, p. 17.

*Ophiurases obstrictus* : CLARK, Bull. U. S. Nat. Mus., LXXV, 1911, p. 250, fig. 122.

Eastern Sea; 95–135 fathoms (CLARK).

Lat. 5° 42' S., long. 132° 25' E.; 129 fathoms (LYMAN).

*Ophiomæris projecta* MATSUMOTO.

*Ophiomæris projecta*: MATSUMOTO, Proc. Acad. Nat. Sci. Philadelphia, 1915, p. 65.

Two specimens; off Uki-shima; 300 fathoms. One specimen; Uji-shima, Ôsumi.

Diameter of disk 4 mm. Length of arms 13 mm. Width of arms at base 1.5 mm.

Disk five-lobed, with concave interbrachial borders, with a very regular rosette of the central, basal and radial plates, surrounded by

the radial shields. Central plate circular, rather large. Radials rhomboidal, considerably larger than the central plate, separated from each other by the small and oblong basals. The radials may be in contact with the central plate, or separated from it by one or two very

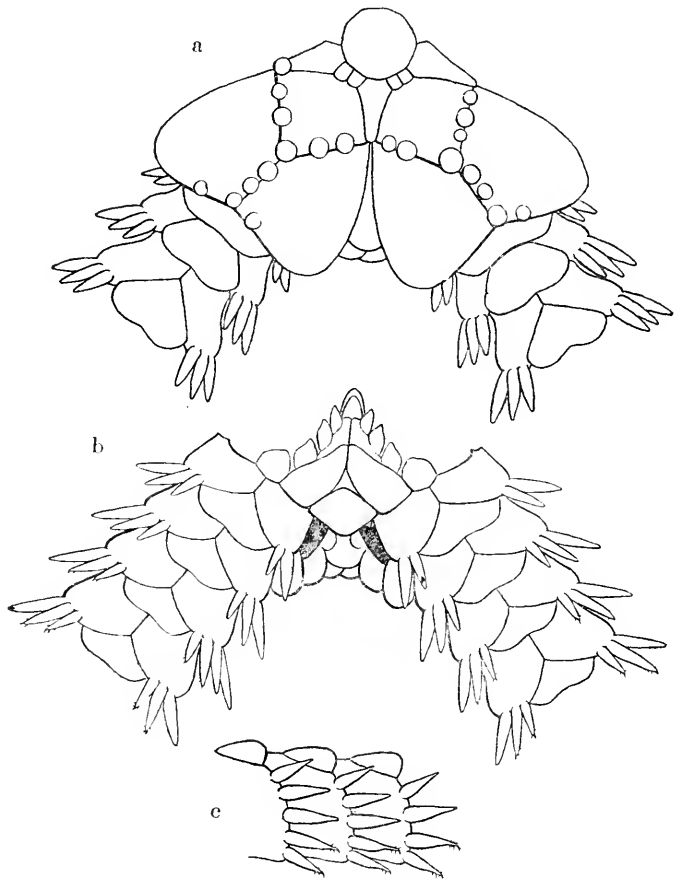

Fig. 35. *Ophiomæris projecta*.  $\times 10$ . a. From above. b. From below. c. Side view of three arm joints near disk.

small, intervening scales, and bear several very prominent, spherical tubercles along the outer margins. Radial shields very large and stout, triangular, with an acute inner angle, longer than wide, each pair in contact by the outer half of their whole length, and narrowly separated from the next pair by a sunken, oblong plate. The radial shields do not lie in the same plane with the central rosette, but are inclined outwards and interradially, so that the central rosette appears elevated above its surroundings. The radial shields also bear prominent tubercles along or on their adradial borders, as well as often along their outer margins. Just outside and below the outer edge of the radial shields, there is a very stout and nearly vertical plate, on which the radial shields rest elevated above the general surface of the arm. Interbrachial spaces below very small, covered by a few convex plates. Genital slits small, lying just outside the oral shields.

Oral shields large, rhomboidal, wider than long in surface view, but the outer angle is prolonged upwards like a beak. Adoral shields longer than the oral shields, wider without, tapered inwards and meeting each other. Three oral papillæ on either side, rather close-set, outermost one quadrangular, largest of all, wider than long; the next bluntly and the last acutely pointed, both being longer than wide. Four or five teeth, stout, spear-head-shaped, the uppermost one longer and acuter than the rest.

Arms stout and short, uniformly tapered outwards. Dorsal arm plates triangular, with straight inner sides and two-lobed outer, wider than long, strongly convex, separated from one another by the lateral arm plates, which are very stout and strongly flared outwards. First ventral arm plate small, pentagonal, longer than wide, wider within than without, if we except the pointed portion. Second and following triangular, with concave

inner sides, outer side convex as a whole, but slightly concave at the middle, wide and very short. Successive plates separated from one another; distally they become rapidly smaller, and the outer border is then entire. Arm spines conical, acute, short, shorter than the corresponding arm joint; upper ones longer, lower ones somewhat rough at the end, looking like compound hooks towards the extremity of the arms. They are about seven in number in the first basal joints, but rapidly decrease in number as well as in size, so that, on the eighth lateral plate, they are only four and about half as long as the corresponding joint.

The plates of the disk and arms are shagreened.

Colour in alcohol: disk gray, arms banded with grayish brown and white.

The present species is very closely related to *O. obstricta* (LYMAN), but differs from it chiefly in the presence of the prominent tubercles on the disk and in the radial shields joining in pairs in the radial line. In the first mentioned character, this species closely resembles *Ophiogyptis nodosa* KÄHLER, 1905.

### Order iii. GNATHOPHIURIDA MATSUMOTO.

Disk covered with fine, imbricating scales, which are very regular in size and arrangement. Radial shields well developed, each having a conspicuous articular pit near the outer end for the reception of a large, ball-like articular condyle of the genital plate. Genital plates usually fixed to the basal vertebræ. Genital scales short, wide, flat, leaf-like, articulating with the genital plates near the outer end of the latter. Besides, an additional scale is present on the abradial border of the innermost part of each genital slit, being also short, wide, flat, leaf-like and firmly fixed to the oral

shield. Peristomial plates entire, or rarely double, usually very small. Oral frames very stout, with strongly developed lateral wings as a rule, for the attachment of voluminous masticatory muscles. Oral and dental plates usually very stout, the two plates usually presenting an **X**-shape in dorsal view. Oral papillæ few, often entirely absent. Dental papillæ well developed only in forms without oral papillæ. Teeth stout, usually quadrangular, with widened, straight or wavy apical edge. Arms slender, inserted ventrally to the disk, horizontally flexible, or sometimes more or less coiled vertically. Vertebral articulation zygospondyline. Dorsal, lateral and ventral arm plates all well developed.

### Key to families of *Gnathophiurida*.

- A*—Teeth triangular, not very stout; peristomial plates large; oral frames entire, without well developed lateral wings; genital plates free, not fixed to the basal vertebræ; oral papillæ present; no dental papillæ ..... *Amphilepididæ*.
- AA*—Teeth quadrangular, very stout; peristomial plates small; oral frames with well developed lateral wings; genital plates firmly fixed to the basal vertebræ.
- a*—Oral papillæ present; no vertical clump of dental papillæ.....  
..... *Amphiuridæ*.
- aa*—Oral papillæ absent; dental papillæ well developed, forming a vertical clump at the apex of each jaw ..... *Ophiotrichidæ*.

### Family 1. *Amphilepididæ* MATSUMOTO, 1915.

Disk covered with fine, imbricating scales. Radial shields sometimes very rudimentary but often well developed, with a

conspicuous articular pit near the outer end for the reception of a large, ball-like articular condyle of the genital plate, which is entirely free from the basal vertebrae. Genital scales short, wide, flat, leaf-like. Peristomial plates entire, very large. Oral frames not very stout, without well developed lateral wings. Oral plates long and slender in interior view. Dental plates very small, or absent. Teeth and oral papillae present; but no dental papillae. Arms slender, inserted ventrally to the disk, being only horizontally flexible. Dorsal, lateral and ventral arm plates all well developed. Three to five arm spines, conical or cylindrical, with smooth surface. One or two tentacle scales. Vertebrae slender, with zygospondyline articulation; in the distal part of the arms, they are often incompletely divided into halves by a longitudinal series of pores.

This family includes three genera, which may be grouped as follows.

- I. Second oral tentacle pores opening more or less outside the oral slits, so that the latter are gaping.

*Amphilepis* LJUNGMAN, 1866.

- II. Second oral tentacle pores opening entirely within the oral slits, so that the latter are closed by the oral papillae.

*Amphiactis* MATSUMOTO, 1915.

*Ophiochytra* LYMAN, 1880.

Though the present family much resembles the next family, *Amphiuridae*, in external features, the internal structures are rather *Laemophiuridan*, with large peristomial plates and entire oral frames. The articulation of the radial shield and genital plate, as well as the flat, thin genital scales, however, gives ground for placing this family in the present order. In short, the present family is the

least specialised among the Gnathophiurida, and stands next to the Læmophiurida.

In *Amphiactis umbonata* MATSUMOTO, the genital plate and radial shield articulate with each other by means of a hemispherical articular condyle of the former and a large articular socket of the latter, the former being entirely free from the basal vertebrae. The genital scales are flat and thin, articulating with the genital plates near the outer end. The peristomial plates are simple and very large. The oral frames are small and entire, without well developed lateral wings. The oral plates are long and slender in internal view. The dental plates are absent. According to LYMAN, the internal structures of *Amphilepis norvegica* LJUNGMAN, 1866, appear to be essentially similar to those of the above mentioned species, save that the peristomial plates are somewhat smaller and the dental plates are present.

#### *Amphilepis tenuis* LYMAN.

*Amphilepis tenuis*: LYMAN, Bull. Mus. Comp. Zool., VI, Pt. 2, 1879, p. 35, Pl. XVI, figs. 432-434; LYMAN, Rep. Challenger, V, 1882, p. 151.

Southwards from Boshû; 1,875 fathoms (LYMAN).

#### *Amphiactis* MATSUMOTO, 1915.

Disk covered with imbricating scales, radial shields moderately large. Four or five oral papillæ on either side, unequal in size, arranged almost in a continuous series. Teeth arranged in a single vertical row. Peristomial plates entire, very large; oral frames slender and without lateral wings. Arms long and slender, only horizontally flexible. Distal vertebrae often imperfectly divided into



halves by a series of pores. Three to five arm spines. One or two tentacle scales to each pore.

This genus includes *Amphiura duplicata* LYMAN, 1875, *A. canescens* LYMAN, 1879, *A. patula* LYMAN, 1879, *A. partita* KÖEHLER, 1897, *Ophiactis dissidens* KÖEHLER, 1904, and *O. parata* KÖEHLER, 1904, besides the genotype, *Amphiactis umbonata* MATSUMOTO, 1915.

The representatives of the present genus were formerly referred to *Amphiura* by LYMAN, and then to *Ophiactis* by LÜTKEN & MORTENSEN. *Amphiactis* differs from *Amphioplus* in the absence of the paired infradental papillæ, and from *Ophiactis* in having numerous oral papillæ arranged in a continuous series, so that the oral slits are entirely closed. Further, the internal structures are entirely different from those of the *Amphiurida*. Again, the present genus differs from *Ophiocytra* in the well developed radial shields.

*Amphiactis umbonata* MATSUMOTO.

*Amphiactis umbonata*: MATSUMOTO, Proc. Acad. Nat. Sci. Philadelphia, 1915, p. 67.

Two specimens; off Misaki, Sagami Sea.

Diameter of disk 7 mm. Length of arms 30 mm. Width of arms at base 1.2 mm.

Disk circular, flat, covered with rather coarse and irregular scales. Central plate large, circular, surrounded by ten small scales, corresponding in position to the infrabasals and basals. The five radials large, larger than the central plate, with strongly curved abcentral border, which almost forms a semicircle. The central and radials have each a small but distinct central or subcentral

boss. The second radials and the first to third interradials may also be distinguished, and are large and prominent. Thus, the

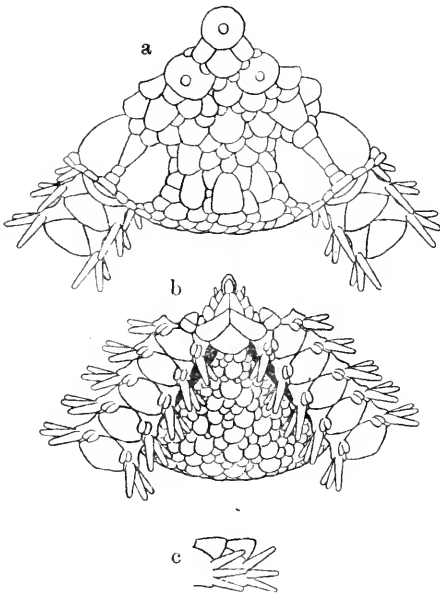

Fig. 36. *Amphictis umbonata*.  $\times 8$ . *a*. From above. *b*. From below. *c*. Side view of two arm joints near disk.

disk squamation is rather similar to that of *Ophiozona*. Radial shields comparatively small, oblong ovate, about two-fifths as long as the disk radius, twice as long as wide, wider without, more convex abradially than adradially, separated from each other by a row of three or four plates, of which the inner ones are larger. In each interradial space, there are five to seven irregularly radiating rows of scales. Interbrachial ventral surfaces covered with coarse, irregular, imbricating scales. Genital slits long, near-

ly reaching the margin of the disk. Genital scales invisible.

Oral shields small, rhomboidal, with acute inner and rounded lateral and outer angles, and slightly concave inner sides. Adoral shields wider without, nearly or quite meeting within. Four oral papillæ on either side of the oral angle, inner ones smaller and more acute. Deep in the oral slits, on either side of the oral angle, there occurs one long, acute, needle-like papilla. Five teeth, all blunt, except the uppermost one, which is pointed.

Five arms, slender, flattened, uniformly tapered toward the extremity. Dorsal arm plates large, fan-shaped, twice as wide as long; inner sides slightly convex and forming an obtuse angle

within, outer side decidedly convex, outer angles rounded; successive plates separated by the lateral arm plates, except the basal two or three. Lateral arm plates low, not very prominent. First ventral arm plate small, divided into two pieces, of which the inner one is triangular and the other quadrangular. Those beyond large and hexagonal, except the second plate which is pentagonal; much wider than long, widest at the outer lateral angles, with concave lateral sides and slightly convex inner and outer sides, swollen along the outer borders and especially at the outer angle, so that the arms appear keeled along the ventral median line. Three arm spines, subequal, about as long as the corresponding arm joint, but the uppermost one is slightly longer; cylindrical, tapered and blunt. Two flat, oval tentacle scales to each pore, but sometimes three to the first.

Colour in alcohol white.

The present species may be easily distinguished from all the other species of *Amphiactis* by the *Ophiozona*-like squamation, and especially by the presence of the umbonated primary plates.

Family 2. **Amphiuridæ** (LJUNGMAN, 1867) mihi, 1915.

Disk covered with fine, imbricating scales, or rarely by a naked skin, sometimes beset with minute spines. Radial shields well developed, with a conspicuous articular socket on the ventral surface near the outer end, fitting to the large, ball-like articular condyle of the genital plate. Genital plates firmly fixed to the basal vertebræ. Genital scales short, wide, flat, articulating with the genital plates near the outer end of the latter. Besides, there occur a pair of short, flat scales, just outside each oral shield, supporting the proximal abradial border of the genital slits. Peristomial plates very small, usually entire. Oral frames very

stout, with well developed lateral wings for the attachment of voluminous masticatory muscles. The oral and dental plates are very stout in internal view, the two presenting an **X**-shape. One to six oral papillæ on either side, the innermost one being often infradental. Teeth very stout, widened, squarish, with wavy or notched cutting ends. Arms inserted ventrally to the disk, horizontally flexible, or rarely capable of coiling vertically. Dorsal side of the vertebræ entire, not strongly notched inwards. Vertebral articulation zygospondyline, the articular peg being always present. Arm spines moderately long, conical, stout, opaque. Usually one or two leaf-like tentacle scales, sometimes none.

The present family includes eighteen genera, which may be grouped into two subfamilies as follows.

Subfamily 1. *Ophiactininae* MATSUMOTO, 1915:—No paired infradental papillæ.

*Ophiactis* LÜTKEN, 1856.

*Hemipholis* (AGASSIZ) LYMAN, 1865.

*Ophiopus* LJUNGMAN, 1866.

*Ophiopholis* MÜLLER & TROSCHEL, 1842.

Subfamily 2. *Amphiurinae* mihi, 1915:—Paired infradental papillæ present.

- I. Four or more oral papillæ on either side, the outermost one or two arising from the adoral shield; one additional papilla is present just outside and above the infradental one; oral slits closed by the oral papillæ.

*Amphioplus* VERRILL, 1899.

*Amphichilus*, nov.

*Amphiacantha*, nov.

*Amphilimna* VERRILL, 1899.

- II. Three, rarely four, oral papillæ on either side, none

arising entirely from the adoral shield; no additional papilla just outside and above the infradental one, which therefore is the highest in position of all; oral slits closed by the oral papillæ.

*Amphiodia* VERRILL, 1899.

*Ophiophragmus* LYMAN, 1865.

*Ophiocnida* LYMAN, 1865.

- III. Three oral papillæ on either side, the outermost one being very large and operculiform; no additional papilla just outside and above the infradental one, which therefore is the highest in position of all; oral slits closed by the oral papillæ.

*Amphipholis* LJUNGMAN, 1867.

*Ophiostigma* LÜTKEN, 1856.

- IV. Two, sometimes three, oral papillæ on either side, the outermost one or two arising from the adoral shield; one additional papilla is present just outside and above the infradental one; oral slits gaping.

*Amphiura* FORBES, 1842 (= *Ophionepluthys* LÜTKEN, 1869).

*Ophionema* LÜTKEN, 1869.

*Ctenamphiura* VERRILL, 1899.

*Paramphiura* KÖHLER, 1895.

*Ophiocentrus* LJUNGMAN, 1866 (= *Amphiocnida* VERRILL, 1899).

I have dissected several specimens of *Ophiactis pteropoma* CLARK, *Hemipholis elongata* (SAY), *Ophiopholis aculeata* (LINNÉ), *Amphioplus ancistrotus* (CLARK), *Amphiacantha acanthina* (CLARK), *A. dividua*, nov., *Ophiophragmus japonicus* MATSUMOTO, *Amphipholis kochii* LÜTKEN, *Amphiura koreæ* DUNCAN, *A. trachydisea* CLARK, *A.*

*vadicola* MATSUMOTO, *Ophiocentrus verticillatus* (DÖDERLEIN), &c., and am strongly impressed by the uniformity of the internal structures of this family. The oral frames are especially stout, with very well developed lateral wings for the attachment of voluminous masticatory muscles; those of *Ophiactis pteropoma* are less stout than those of the representatives of the other genera. The oral and dental plates are very stout and more or less **X**-shaped in internal view. The peristomial plates are rather or very small and usually entire, save in the representatives of *Amphiura* and *Ophiocentrus*, in which they are double or rarely triple; they are comparatively large in *Ophiopholis aculeata*, *Amphioplus ancistrotus*, *Amphiura korea*, *A. trachydisca* and *Ophiocentrus verticillatus*, but exceedingly small in *Hemipholis elongata*, *Ophiophragmus japonicus* and *Amphiura vadicola*. The genital plates are firmly fixed to the basal vertebræ, save in *Amphiacantha dividua*, nov., in which they are free from the basal vertebræ. This peculiarity of the species just mentioned is probably due to the fact that, the single type specimen is very small and young. The genital plates of *Ophiocentrus verticillatus* are somewhat unusual in position, lying entirely dorsal, but not lateral, to the basal vertebræ. As to the genital scales and the articulation of the genital plate and radial shield, the statement in the diagnosis of the present order holds true for all the representatives of the genera thus far studied by myself. The dorsal side of the vertebræ is usually entire, without any conspicuous notch inwards; and only in *Ophiocentrus verticillatus* is it distinctly notched inwards and more or less **Y**-shaped, rather reminding us of that of the next family. According to MORTENSEN, *Ophiopus arcticus* LJUNGMAN has very rudimentary genital bursæ, which are represented merely by the creases between the arm bases and the interbrachial ventral surfaces, and the genera-

tive glands are covered by a sac-like membrane, which contains very fine and delicate scales when viewed under the microscope.

### Key to Japanese genera of *Ophiactininae*.

- A*—Oral angles not exceedingly short; oral papillæ arising from the oral plate; dorsal arm plates entire, without supplementary ones . . . . . *Ophiactis*.
- AA*—Oral angles exceedingly short; oral papillæ arising from the adoral shield; dorsal arm plates hemmed by a row of supplementary ones along the outer, and often also lateral, sides . . . . . *Ophiopholis*.

### Key to Japanese species of *Ophiactis*.

- A*—Three arm spines; disk nearly or entirely free of spines.
- a*—Five arms; oral shields much wider than long . . . . . *brachygenys*.
- aa*—Six arms; reproducing by schizogony; oral shields about as wide as long.
- b*—Radial shields separated from each other by a row of three scales; uppermost arm spine the longest . . . . . *pteropoma*.
- bb*—Radial shields separated from each other by a single wedge-shaped scale, except at the outer ends, where they are in contact; middle arm spine the longest . . . . . *dyscrita*.
- AA*—Four or more arm spines; disk beset with a number of spines.
- c*—Four arm spines.
- d*—Five arms; disk scales fine; radial shields separated from each other by a row of four scales . . . . . *affinis*.
- dd*—Six arms; disk scales coarse; radial shields partially joined in pairs . . . . . *macrolepilota*.
- cc*—Five or more arm spines; six arms; reproducing by schizogony.
- e*—Five arm spines in free basal arm joints; dorsal arm plates exceedingly wide, about thrice as wide as long; single oral papilla on either side . . . . . *modesta*.

*ce*—Six arm spines in free basal arm joints; dorsal arm plates less than, or nearly, twice as wide as long; two or three oral papillæ on either side.

*f*—Adoral shields meeting with each other both in the radial and interradial lines; interbrachial ventral surfaces covered with fine scales ..... *savignyi*.

*ff*—Adoral shields not meeting with each other either in the radial or interradial lines; interbrachial ventral surfaces covered by a naked skin ..... *gymnochora*.

***Ophiactis brachygenys* CLARK.**

*Ophiactis brachygenys*: CLARK, Bull. U. S. Nat. Mus., LXXV, 1911, p. 135, fig. 51.

Off Manazuru Zaki, Sagami Sea; 120–265 fathoms (CLARK).

Off Hiuga; 437–720 fathoms (CLARK).

***Ophiactis pteropoma* CLARK.**

*Ophiactis pteropoma*: CLARK, Bull. U.S. Nat. Mus., LXXV, 1911, p. 134, fig. 50.

One specimen; Misaki.

Sea of Japan; 195 fathoms (CLARK). Off Kii; 191–253 fathoms (CLARK).

This species appears to me to be very near to *O. profunda* LÜTKEN & MORTENSEN, 1899, differing from it merely in the arm spines being unequal instead of being subequal.

***Ophiactis dyscrita* CLARK.**

*Ophiactis dyscrita*: CLARK, Bull. U. S. Nat. Mus., LXXV, 1911, p. 137, fig. 52.

Six specimens, clinging to a hexactinellid sponge; off Ôshima, Sagami Sea; 75–85 fathoms.



Kagoshima Gulf; 58 fathoms (CLARK).

The largest one of my specimens measures only 2 mm. across the disk and 10 mm. in the arm length. In some arm joints, the uppermost one of the three arm spines is longer than the middle one, which is usually the longest. The colour in alcohol of these specimens is not gray, but light green.

*Ophiactis affinis* DUNCAN.

*Ophiactis affinis*: DUNCAN, Journ. Linn. Soc. London, XIV, 1879, p. 469, Pl. X, fig. 23, Pl. XI, fig. 24; LYMAN, Rep. Challenger, V, 1882, p. 115; KÖHLER, Bull. Sci. Fr. Belg., XXXI, 1898, p. 71; KÖHLER, Res. Exp. Siboga, XLV, Pt. 2, 1905, p. 26.

Korean seas (DUNCAN).

Indian Ocean and Malaysian waters (KÖHLER).

*Ophiactis macrolepidota* MARKTANNER.

*Ophiactis macrolepidota*: MARKTANNER-TURNERETSCHER, Ann. K. K. Naturhist. Hofmus. Wien, II, 1887, p. 298, Pl. XII, figs. 12 & 13; DÖDERLEIN, Denkschr. Med. Nat. Ges. Jena, VIII, 1898, p. 484, Pl. XXXVII, figs. 1 & 1a.

One specimen; Uraga Channel. Three specimens; Asami Bay, Tsushima.

Sidney (MARKTANNER-TURNERETSCHER). Amboina (DÖDERLEIN).

The specimens at hand were all found adhering to *Ophiothrix koreana*. The largest one is 1.8 mm. in the disk diameter and 7 mm. in the arm length. Unlike MARKTANNER-TURNERETSCHER'S type, imbricating scales are visible in the interbrachial ventral surfaces in all the specimens. The disk is yellowish and the arms are light greenish above and light yellowish below in alcohol.

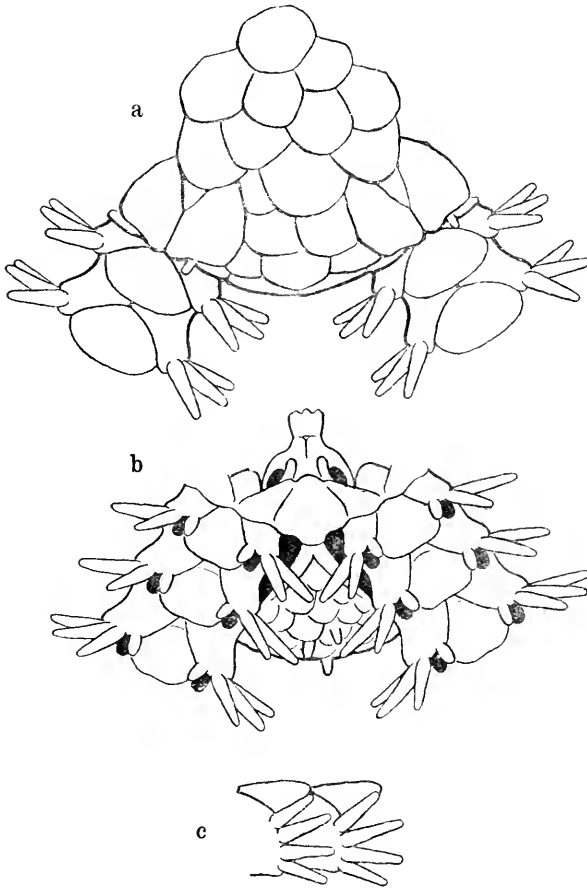

Fig. 37. *Ophiactis macrolepidota*.  $\times 40$ . *a*. From above. *b*. From below. *c*. Side view of two arm joints near disk.

### *Ophiactis modesta* BROCK.

*Ophiactis modesta* : BROCK, Zeitschr. wiss. Zool., XLVII, 1888, p. 482 ;  
 DÖDERLEIN, SEMON - Zool. Forschungsr. in Austr. u. Malay. Archip., 1896, p.  
 285, Pl. XIV, fig. 1, Pl. XV, fig. 5 ; KÖHLER, Mem. Soc. Zool. Fr., XVII,  
 1904, p. 63, figs. 10 & 11.

Numerous specimens ; Misaki.

Amboina.

The largest one of the specimens at hand is 4 mm. in the

disk diameter and 20 mm. in the arm length. With the exception of three which are five-armed, they are all six-armed. One of the five-armed specimens has three larger and two smaller arms, while another has two larger and three smaller ones.

The ventral arm plates have each an hour-glass shaped depression on the surface, which seems to me to be a distinctive character of this species, though apparently unnoticed by previous authors. In DÖDERLEIN'S photograph, this depression is faintly visible.

Colour in alcohol: dull green; disk with two or three patches of very dark green; arms banded, two darker joints alternating

with four or five lighter ones; each dorsal arm plate with three yellowish spots on the outer margin.

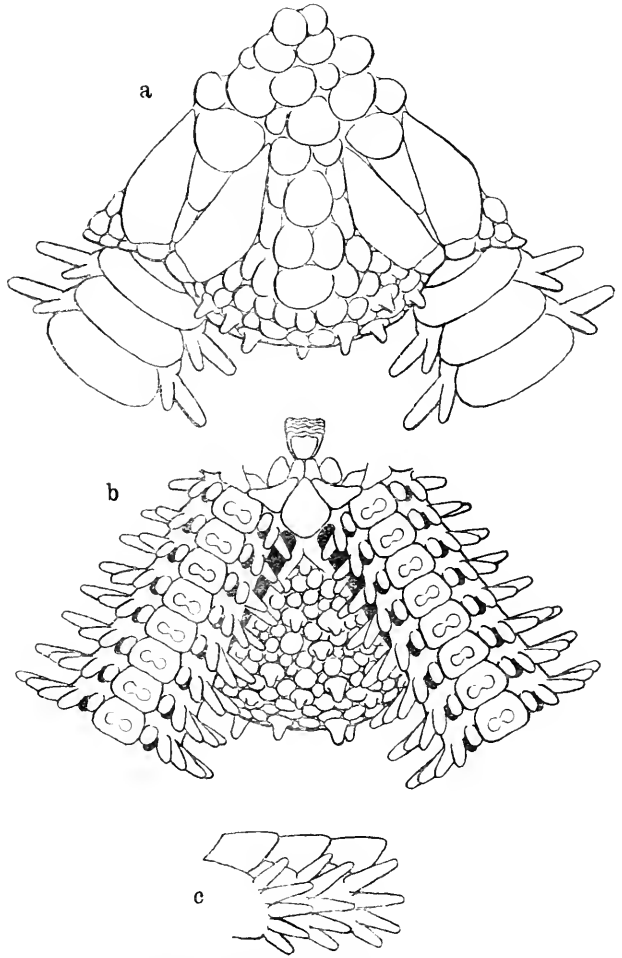

Fig. 38. *Ophiactis modesta*.  $\times 20$ . a. From above. b. From below. c. Side view of three arm joints near disk.

*Ophiactis savignyi* (MÜLLER & TROSCHEL).

*Ophiolepis savignyi* : MÜLLER & TROSCHEL, Sys. Ast., 1842, p. 95.

*Ophiolepis sex-radia* : GRUBE, WIEG. Arch. Naturg., 1857, p. 343.<sup>1)</sup>

*Ophiactis sex-radia* : LÜTKEN, Addit. ad Hist., II, 1853, p. 126 ; LYMAN, Ill. Cat. Mus. Comp. Zool., I, 1865, p. 115 ; CLARK, Ann. New York Acad., XI, 1893, p. 412<sup>1)</sup>; KÖHLER, Bull. Sci. Fr. Belg., XXXI, 1898, p. 72.

*Ophiactis krebsii* : LÜTKEN, loc. cit.; LYMAN, loc. cit., p. 111 ; LJUNGMAN, Ofv. K. Vet. Akad. Förh., 1866, p. 323<sup>1)</sup>; VERRILL, Transact. Connect. Acad., I, 1867, p. 265 ; DUNCAN, Journ. Linn. Soc. London, XIV, 1879, p. 465 ; LJUNGMAN, loc. cit., 1871, p. 627 ; RATHBUN, Transact. Connect. Acad., V, 1880, p. 153 ; VERRILL, Bull. Lab. Nat. Hist. Iowa, V, 1899, p. 34<sup>1)</sup>; CLARK, Bull. U. S. Fish Comm., II, 1901, p. 246.

*Ophiactis reinhardti* : LÜTKEN, loc. cit., p. 161, Pl. III, fig. 7.

*Ophiactis savignyi* : LYMAN, Rep. Challenger, V, 1882, p. 115 ; LUDWIG, Mem. Couronn. Sav. Acad. Belg., XLIV, 1882, p. 14 ; LÜTKEN & MORTENSEN, Mem. Mus. Comp. Zool., XXIII, 1899, p. 140 ; KÖHLER, Exp. Siboga, XLV, Pt. 2, 1905, p. 26 ; KÖHLER, Bull. U. S. Nat. Mus., LXXXIV, 1914, p. 41.

Two specimens ; Koajiro, Misaki. Numerous specimens (belonging to the First High School); Misaki.

Korean Seas (DUNCAN).

Malaysian waters. Australia. Sandwich Is. Gulf of California. West Indies.

The larger one of the two specimens mentioned first is 3.5 mm. in the disk diameter and 10 mm. in the arm length. The smaller one is 2 mm. across the disk. Both are six-armed, and have no distinct central plate. In the larger specimen, the dorsal arm plates are often divided into two or three pieces, and are scarcely lobed on the outer side ; the colour is yellowish brown in alcohol, and faintly banded on the arm near the extremity. In the

<sup>1)</sup> These papers were not seen by me.

smaller one, the colour is vivid green in alcohol; the arms have darker and lighter bands of the same colour; and each dorsal arm plate has three white spots on the outer margin, which are especially conspicuous in the dark bands. It seems that, in this species, the colour changes in alcohol from green to brown in the course of time.

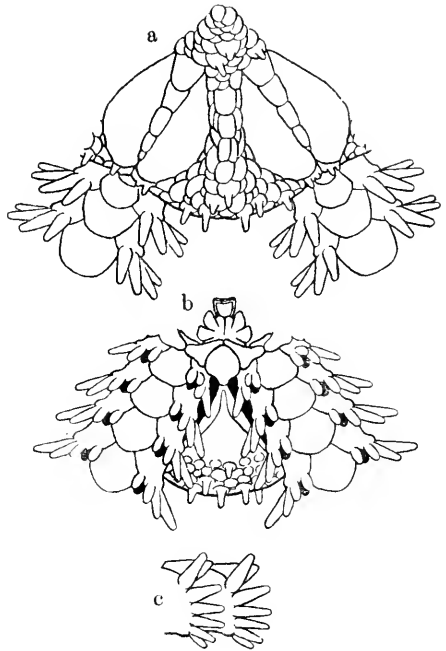

Fig. 39. *Ophiactis savignyi*. ×16. a. From above. b. From below. c. Side view of two arm joints near disk.

***Ophiactis gymnochora* CLARK.**

*Ophiactis gymnochora*: CLARK, Bull. U. S. Nat. Mus., LXXV, 1911, p. 139, fig. 54.

Tanega-shima (CLARK).

**Key to Japanese species and varieties of *Ophiopholis*.**

- A—One very large supplementary plate present on either side of each dorsal arm plate, besides the smaller supplementary ones. . . . . *mirabilis*.
- AA—No especially large supplementary dorsal arm plates, though there is present a row of small supplementary plates along the outer, and often also lateral, borders of each dorsal arm plate.
- a—Supplementary dorsal arm plates occurring along both the outer and lateral borders of the primary ones; oral papillæ short and stout. . . . . *aculeata*.
- b—Arm spines short, stout, flattened, blunt; radial shields mostly or entirely covered with granules or spines . . . . . typical *aculeata*.

- bb*—Arm spines long, slender, conical, rather pointed; radial shields mostly or entirely naked ..... var. *japonica*.  
*aa*—Supplementary dorsal arm plates occurring only along the outer border of the primary ones; oral papillæ long and slender....  
 ..... *brachyactis*.

*Ophiopholis mirabilis* (DUNCAN).

*Ophiolepis mirabilis*: DUNCAN, Journ. Linn. Soc. London, XIV, 1879, p. 460, Pl. IX, fig. 12, Pl. X, figs. 13 & 14.

*Ophiopholis mirabilis*: LYMAN, Bull. Mus. Comp. Zool., VI, 1879, p. 43; LYMAN, Rep. Challenger, V, 1882, p. 115; KÖHLER, Rés. Camp. Sci. Monaco, XXXIV, 1909, p. 168; CLARK, Bull. U. S. Nat. Mus., LXXV, 1911, p. 117, fig. 43.

Numerous specimens; off Misaki. Numerous specimens (belonging to Mr. R. SAITÔ, Imperial Museum at Uyeno, Tokyo); Aomori Bay. Four specimens; off Hokkaidô, Okhotsk Sea.

Korea (DUNCAN). Uruga Channel; 58 fathoms (CLARK). Off Doumiki Saki; 61 fathoms (CLARK). Off Ando Zaki; 76–79 fathoms (CLARK). Off Kinkwasan; 78 fathoms (CLARK). Hakodate Bay; 11.5–22 fathoms (CLARK).

The largest of these specimens is 10 mm. in the disk diameter and 40 mm. in the arm length. Most specimens are brownish gray in alcohol, variegated or spotted on the disk and banded on the arms with dark gray, and often patched on the disk with white. Some other specimens are yellowish brown, variegated and banded with dark brown, while still others are light brown, not variegated or banded. One specimen is entirely white. The relative size of the dorsal arm plates and the two large supplementary plates is also variable, ranging from 2:1 to 1:1.

*Ophiopholis aculeata*

(LINNÉ).

*Asterias aculeata*: LINNÉ,  
 Sys. Nat., 1767, p. 1101.

*Ophiopholis aculeata* :  
 GRAY, Rad. Anim. Brit.  
 Mus., 1848, p. 25<sup>v</sup>; LÜTKEN,  
 Addit. ad Hist. Oph., I,  
 1861, p. 60, Pl. II, figs. 15  
 & 16; LYMAN, Rep. Chal-  
 lenger, V, 1882, p. 112, Pl.  
 XLVI, fig. 6; LUDWIG, Zool.  
 Jahrb., I, 1885, p. 285;  
 BELL, Cat. Brit. Mus.  
 Echinod., 1892, p. 125;  
 GRIEG, Bergens Mus. Aarbog,  
 1892 (1893), No. 3, p. 9;  
 GRIEG, Fauna Arctica, I,  
 1900, p. 264; MICHAÏLOVSKY,  
 Ann. Mus. Pétersbourg,  
 1902, p. 494; GRIEG, Ber-  
 gens Mus. Aarbog, 1902, p.

13; NICHOLS, Proc. R. Irish Acad., XXIX, 1903, p. 257; NORMAN, Ann. Mag.  
 Nat. Hist., Ser. 7, XII, 1903, p. 407; CLARK, Bull. U. S. Fish Comm., 1904,  
 p. 559, Pl. V, figs. 24-27, Pl. VII, figs. 41 & 52; KÖHLER, Bull. Sci. Fr.  
 Belg., XLI, 1907, p. 298; KÖHLER, Rés. Camp. Sci. Monaco, XXXIV, 1909,  
 p. 167; CLARK, Bull. U. S. Nat. Mus., 1911, p. 128, fig. 48; NICHOLS, Proc.  
 R. Irish Acad., XXXI, 1911, p. 57; KÖHLER, Bull. U. S. Nat. Mus.,  
 LXXXIV, 1914, p. 38.

Eleven specimens (belonging to Mr. H. ASANO, Imperial Bureau  
 of Fishery); off Kitami; 60 fathoms.

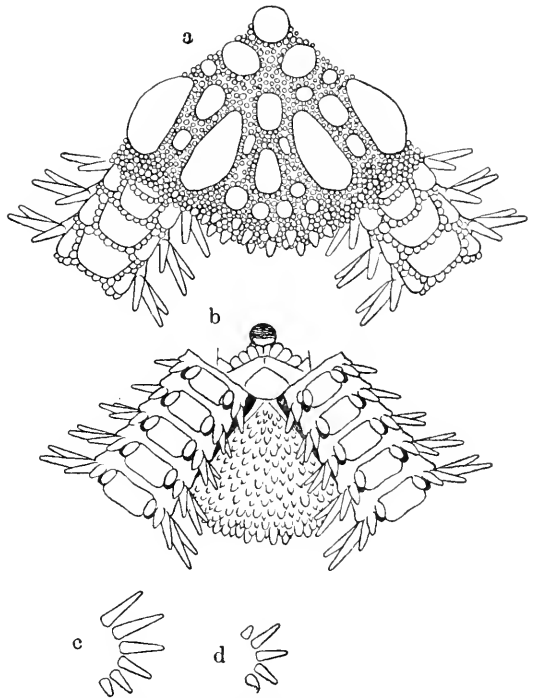

Fig. 40. *Ophiopholis mirabilis*.  $\times 6\frac{2}{3}$ . *a*. From above. *b*. From below. *c*. Arm spines of one side of an arm joint near disk. *d*. Arm spines of one side of an arm joint near the extremity.

1) This paper was not seen by me.

Sea of Japan; 59–190 fathoms (CLARK). Gulf of Tartary; 318 fathoms (CLARK). Okhotsk Sea; 64–73 fathoms (CLARK). North Pacific. Arctic Ocean. North Atlantic.

*Ophiopholis aculeata* var. *japonica* (LYMAN).

*Ophiopholis japonica*: LYMAN, Bull. Mus. Comp., Zool., VI, Pt. 2, 1879, p. 42, Pl. XIII, figs. 374–376; LYMAN, Rep. Challenger, V, 1882, p. 111, Pl. XXIII, figs. 13–15; K EHLER, R es. Camp. Sci. Monaco, XXXIV, 1909, p. 168.

*Ophiopholis aculeata* var. *japonica*: CLARK, Bull. U. S. Nat. Mus., LXXV, 1911, p. 123, fig. 47.

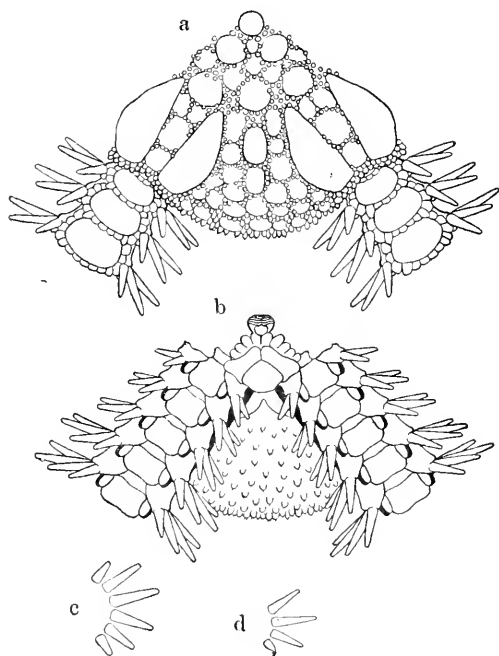

FIG. 41. *Ophiopholis aculeata* var. *japonica*.  $\times 6$ . *a*. From above. *b*. From below. *c*. Arm spines of one side of an arm joint near disk. *d*. Arm spines of one side of an arm joint near the extremity

Numerous specimens; off Misaki, Sagami Sea. Three specimens; off Hokkaid o, Okhotsk Sea. One specimen; Albatross station 4784. One specimen; Albatross station 4791.

Off Omai Zaki, Yensh u Sea; 475–565 fathoms (CLARK, LYMAN). Sagami Sea; 369–775 fathoms (CLARK, LYMAN), Uraga channel; 58–302 fathoms (CLARK). Off Kinkwasan; 82 fathoms (CLARK). Off Port Arari; 400–726



fathoms (CLARK). Off Kii; 244-649 fathoms (CLARK). Off southern Hokkaidô; 175-349 fathoms (CLARK). Off Korea, Sea of Japan; 163 fathoms (CLARK). Sea of Japan; 59-428 fathoms (CLARK). Gulf of Tartary; 318 fathoms (CLARK). Off Saghalin; 21-32 fathoms (CLARK). Okhotsk Sea; 64-100 fathoms (CLARK). Yezo Strait; 86 fathoms (CLARK). Off Simushir Is.; 229 fathoms (CLARK).

Bering Sea. Alaska. Kamchatka.

*Ophiopholis brachyactis* CLARK.

*Ophiopholis brachyactis*: CLARK, Bull. U. S. Nat. Mus., LXXV, 1911, p. 117, fig. 44.

Numerous specimens; off Misaki. Numerous specimens; off Uki-shima, Uruga Channel. One specimen, attached to *Synallactes ishikawai* MITSUKURI; Albatross station 5092.

Off Ando Zaki; 79 fathoms (CLARK). Off Kii; 191 fathoms (CLARK). Uruga Channel; 88-197 fathoms (CLARK). Off Manazuru Zaki, Sagami Sea; 153 fathoms (CLARK). Suruga Gulf; 108-131 fathoms (CLARK). Eastern Sea; 103-361 fathoms (CLARK).

The largest of these specimens is 11 mm. in the disk diameter and 66 mm. in the arm length; a medium-sized one is 9 mm. in the disk diameter and 34 mm. in the arm length; and the smallest 4 mm. in the disk diameter and 15 mm. in the arm length. Thus, the arms are in none of my specimens so short as CLARK states, and indeed in the first specimen, they are about six times as long as the disk diameter. It appears to me that this species almost passes on into *O. aculeata* var. *japonica*. Some specimens of the latter, especially of Misaki and vicinity, frequently lack the disk spines and are less granulated on the disk, so that they look

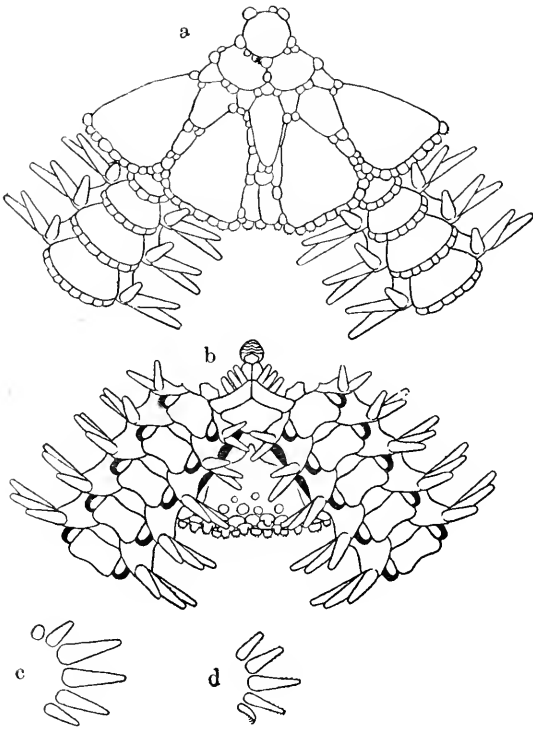

Fig. 42. *Ophiopholis brachyactis*.  $\times 8$ . *a*. From above. *b*. From below. *c*. Arm spines of one side of an arm joint near disk. *d*. Arm spines of one side of an arm joint near the extremity.

almost exactly like *O. brachyactis*, so far as the disk is concerned; others again have very short and stout arm spines like those of the typical *brachyactis*, while the supplementary plates on the sides of the dorsal arm plates are like those of the typical *japonica*. In the neighbourhood of Misaki, the northern *japonica* and the southern *brachyactis* occur side by side, and it is very possible that natural hybridisation may occur. Both these species are found clinging to gorgonaccans and hexactinellids, and are very often found together on the same piece of those animals.

### Revision of the genera of *Amphiurinae*.

The forms which I now bring together under the *Amphiurinae*, have hitherto been referred to several genera chiefly on the ground of the character of the disk coverings, such as the presence or absence of scales, complete or localised squamation, the presence or absence of disk spines, &c. But I believe that, such a classi-

fication is very superficial, being based upon characters of merely secondary importance, as may be seen at once on looking over the whole series of this subfamily. The creation of *Hemilepis* and *Ophiopeltis* by LJUNGMAN and of *Ophionephthys* by LÜTKEN; the referring of those species which I now place in *Amphiactis*, to *Amphiura* by LYMAN; the referring of those genera which I now place in the *Ophiochitonidae*, to the *Amphiuridae* by many authors; the referring of a genuine *Amphiura* to *Hemipholis* by DUNCAN, &c. are, in my opinion, some of the more notable errors which have arisen from this superficial classification.

VERRILL has divided *Amphiura* and *Ophioconida* in a wide sense respectively into five and three distinct genera by the character of the oral papillæ. I am obliged to adopt his subdivisions as a principle, because I believe that, it is scarcely possible otherwise to elucidate the interrelationships of the genera of the *Amphiurinae*. We see that, in almost all the genera of the present subfamily, the oral papillæ are quite similar in form and arrangement to those of any one of VERRILL'S subdivisions of *Amphiura* in a wide sense. Thus, *Ophionephthys*, *Ophionema*, *Paramphiura*, *Ophiocentrus*, and VERRILL'S *Amphiocnida* correspond in the character mentioned to *Amphiura* in VERRILL'S sense; *Ophiophragmus*, as well as *Ophioconida* in VERRILL'S sense, to VERRILL'S *Amphiodia*; *Ophiostigma* to *Amphiipholis* in VERRILL'S sense; and VERRILL'S *Amphilimna* to VERRILL'S *Amphiophus*. I look upon these relations to be of primary importance, being evidently more fundamental than the characters of the disk coverings.

Granting this, I believe there are two ways open for us; one would be to unite most genera of the present subfamily into a single genus, and the other to subdivide *Amphiura* and *Ophioconida* in a wide sense into many genera. The first way appears to me

to be less adapted to the purpose of bringing out the interrelationships of the different subdivisions of this subfamily, which is very extensive and very rich in species and species groups. Therefore, I am obliged to adopt the second way.

We may also ask if VERRILL'S subdivisions of *Amphiura* s. ext. are sharply distinguishable from one another or not. My answer is affirmative. Unfortunately, *Amphiura* s. str. and *Amphiodia*, or *Amphiodia* and *Amphioplus* are frequently confused by certain authors. My method of distinguishing them from each other is as follows.

I distinguish three groups of oral papillæ in the present subfamily: the first group is infradental, arising from the dental plate<sup>1</sup>; the second arises from the oral plate; the third arises from the adoral shield. When a papilla arises partly from the oral plate and partly from the adoral shield, it is referred to the second group. Now, let +I denote the presence of the first group, -I its absence, +II the presence of the second group, &c. Then, the oral papillæ of VERRILL'S subdivisions of *Amphiura* s. ext. may be shown by formulæ as follows.

*Amphioplus*-group: +I +II +III.

*Amphiodia*-group: +I +II -III.

*Amphipholis*-group: +I +II -III.<sup>2</sup>

*Amphiura*-group: +I -II +III, or rarely +I +II +III.

In both the *Amphioplus*- and *Amphiura*-group, there is present an additional papilla just outside and above the infradental one, so that the latter is not the highest in position of all the papillæ.

1) The infradental papillæ arise from the oral plates, notwithstanding its intimate relation to the dental plate in the adult (H. L. CLARK: Growth-changes in Brittle Stars; Publication No. 182 of the Carnegie Inst., Washington, 1914).

2) The outermost oral papilla of the *Amphipholis*-group arises from the adoral shield, notwithstanding its partial relation to the oral plate in the adult (CLARK: loc. cit.).

In both the *Amphiodia*- and *Amphipholis*-group, on the contrary, such an additional papilla is entirely absent, and the infradental one is the highest in position. In the *Amphioplus*-group, all the three groups of oral papillæ are well developed and form a continuous row, while in the *Amphiura*-group, the second group of oral papillæ is entirely,—or mostly, as in certain species of *Amphiura*,—absent. In the *Amphiodia*- and *Amphipholis*-group, the third group of oral papillæ is absent, the two subdivisions being distinguished by the different development of the outermost oral papilla.

It must be clear from the above exposition, that the *Amphiodia*-group is not intermediate between the *Amphioplus*- and *Amphiura*-group, but the latter are directly interrelated without the intermediation of the first. In my opinion, those species of *Amphiura* s. str. with two distal oral papillæ on either side are rather intermediate between *Amphiura* with a single distal papilla and *Amphioplus*, instead of being intermediate between the former and *Amphiodia*.

My division of the *Amphiurinae* into four groups almost coincides with VERRILL'S subdivision of *Amphiura* s. ext., but not with KÖHLER'S. Most species of KÖHLER'S *Amphiodia* (e.g. those in Res. Siboga Exp.), as well as *Amphiodia digitula* CLARK, 1911, appear to me not to be genuine *Amphiodia*, but to be *Amphiura* having however two distal oral papillæ, of which at least the outermost one arises from the adoral shield.

### Key to genera of *Amphiurinae*.

- I. *Amphioplus*-group :—Oral papillæ +I +II +III, four or five on either side, forming a continuous row, so that the oral slits are more or

less perfectly closed; an additional papilla present just outside and above the infradental one.

*a*—Disk entirely free of spines.

*b*—Outermost oral papilla small and not operculiform; radial shields divergent . . . . . *Amphioplus*.

*bb*—Outermost oral papilla very large and operculiform; radial shields more or less perfectly joined . . . . . *Amphichilus*.

*aa*—Disk beset with scattered spines.

*c*—Oral papillæ close-set, the outermost one being not very long and spiniform but short and flat; radial shields divergent; three to five arm spines; tentacle scales short, flat, leaf-like . . . . . *Amphiacantha*.

*cc*—Oral papillæ well spaced and conical, the outermost one being very long and spiniform; radial shields perfectly joined; six to ten arm spines; two spiniform tentacle scales, of which the adradial one is very long and slender . . . . . *Amphilimna*.

II—*Amphiodia*-group:—Oral papillæ +I +II –III, three or four on either side, subequal, forming a continuous row, so that the oral slits are more or less perfectly closed; no additional papilla just outside and above the infradental one.

*d*—Disk free of spines and granules.

*e*—Disk soft, without special marginal scales or spines; radial shields usually divergent . . . . . *Amphiodia*.

*ee*—Disk solid, with a row of special marginal scales or spines, so that the boundary between the dorsal and ventral sides of the disk is very sharp; radial shields perfectly joined . . . . . *Ophiophragmus*.

*dd*—Disk with numerous scattered spines or granules . . . . . *Ophiocnida*.

III—*Amphipholis*-group:—Oral papillæ +I +II –III, three on either side, the outermost one being very large and operculiform; oral slits perfectly closed; no additional papilla just outside and above the infradental one.

*f*—Disk entirely free of spines . . . . . *Amphipholis*.

*ff*—Disk with scattered spines or granules . . . . . *Ophiostigma*.

IV—*Amphiura*-group:—Oral papillæ +I –II +III or sometimes +I

+II +III, two or three on either side, discontinuous, the infradental and distal ones being separated from each other by a wide interval; oral slits gaping; an additional papilla present just outside and above the infradental one; radial shields divergent or separated from each other.

- g*—Disk entirely free of spines.
- h*—No supplementary plates between the oral plates and the adoral shields.
- i*—Oral shields not very stout, not in contact with the first lateral arm plates.
- j*—Disk entirely or partially covered with fine scales; radial shields not very narrow and bar-like ..... *Amphiura*.
- jj*—Disk entirely covered by a smooth naked skin; radial shields exceedingly narrow and bar-like ..... *Ophiocoma*.
- ii*—Oral shields very stout, in contact with the first lateral arm plates; two distal oral papillæ, of which the outer one is small and spiniform, while the inner one is very large and flat; ten arm spines ..... *Ctenamphiura*.
- hh*—Two supplementary plates present between the oral plates and the adoral shields of each interradius ..... *Paramphiura*.
- gy*—Disk beset with numerous spines ..... *Ophiocentrus*.

### Key to Japanese species of *Amphioplus*.

- A*—Two tentacle scales to each pore.
- a*—Three arm spines.
- b*—Tentacle scales unusually large, nearly closing the large pores; ventral arm plates much wider than long; disk unknown ....  
..... *megapomus*.
- bb*—Tentacle scales small, not closing the large pores; ventral arm plates longer than wide; radial shields slender, partly joined in pairs..... *rhadinobranchius*.
- aa*—Four or more arm spines.

- c—Four or five arm spines, of which the second lowermost is hook-shaped at the tip and microscopically serrate along the concave side; radial shields small, divergent; outer end of each genital plate bearing, just distally to the radial shield, a small projection, which is microscopically thorny at the tip. . . . . *ancistrotus*.
- cc—Six arm spines, one or more middle ones terminating with a minute, glassy cross-bar; upper arm plates hexagonal, twice as wide as long; disk unknown . . . . . *hexacanthus*.
- AA—Single tentacle scale to each pore.
- d—Three arm spines, of which the uppermost one is the longest and the lowest one the shortest; disk scales rather coarse, with very distinct six primaries; radial shields very large and wide, divergent; oral shields very small, triangular; ventral arm plates hexagonal, in contact with each other for a short extent; tentacle scales large and oval . . . . . *cermus*.
- dd—Four or five arm spines.
- e—Four arm spines, of which the uppermost and the lowest ones are longer than the middle two; disk scales fine; radial shields slender, partly joined in pairs; interbrachial ventral surfaces covered by a naked skin; oral shields small, rhomboidal; ventral arm plates quadrangular, widely in contact with each other; tentacle scales small and crescentic. . . . . *glaucus*.
- ee—Five arm spines, of which the lowest one is the longest; disk scales fine; radial shields long and rather narrow, divergent; oral shields large, pentagonal, much wider than long; ventral arm plates quadrangular, much wider than long, widely in contact with each other; tentacle scales small and oval. . . . . *macraspis*.

*Amphioptus megapomus* CLARK.

*Amphioptus megapomus*: CLARK, Bull. U.S. Nat. Mus., LXXV, 1911, p. 170.

Off Kii, Kitan Channel; 37 fathoms (CLARK).



*Amphioptus rhadinobrachiis* CLARK.

*Amphiura* sp.: LÜTKEN & MORTENSEN, Mem. Mus. Comp. Zool., XXIII, 1899, p. 158, Pl. XIII, figs. 1-3.

*Amphioptus rhadinobrachiis*: CLARK, Bull. U. S. Nat. Mus., LXXV 1911, p. 169, fig. 74.

Numerous specimens; Okinosé (a submarine bank), Sagami Sea; 85 fathoms.

Sagami Sea; 369-405 fathoms (CLARK). Suruga Gulf; 282-503 fathoms (CLARK).

In the larger specimens, the interbrachial ventral surfaces are almost naked, though in the smaller ones they are distinctly squamated, as shown in CLARK'S figure. LÜTKEN & MORTENSEN'S species, which was not named because the disk was wanting, agrees very well with the present species. Many of my specimens also lack the whole dorsal side of the disk.

*Amphioptus ancistrotus* (CLARK).

*Amphiodia ancistrotata*: CLARK, Bull. U. S. Nat. Mus., LXXV, 1911, p. 161, fig. 69.

Numerous specimens; Okinosé (a submarine bank), Sagami Sea; 85 fathoms. Two specimens; Yahagi-gaké, off Misaki, Sagami Sea; 310 fathoms.

Uraga Channel; 70-197 fathoms (CLARK). Off Manazuru Zaki, Sagami Sea; 153 fathoms (CLARK). Off Ôsé Zaki, Suruga Gulf; 45-65 fathoms (CLARK). Off Kii, Kitan Channel; 191 fathoms (CLARK). Sea of Japan; 61 fathoms (CLARK).

In my specimens, the radial shields are narrower and less divergent than in CLARK'S type. The oral shields are rhomboidal and longer than wide, but variable. On either side of the oral

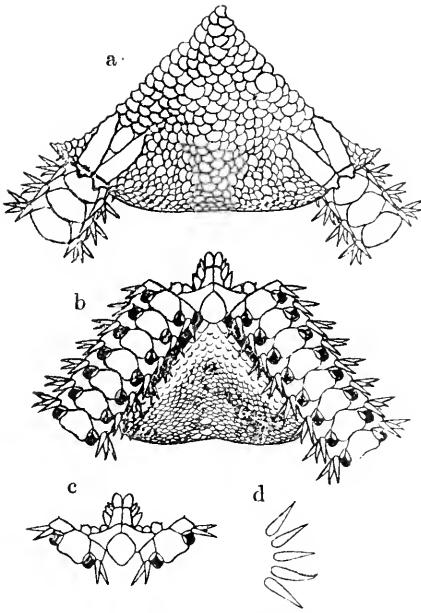

FIG. 43. *Amphioplus ancistrotus*. *a*. From above.  $\times 8$ . *b*. From below.  $\times 8$ . *c*. Ventral view of an oral angle.  $\times 16$ . *d*. Arm spines of one side of an arm joint near disk.  $\times 16$ .

angle, there are usually four oral papillæ, of which the outermost one arises from the adoral shield; besides, there occurs an additional papilla, placed above the level of the ordinary papillæ, but visible from below just between the infradental and the next papilla. In some specimens, there are five ordinary and one additional papillæ, of which the outermost two arise from the adoral shield (fig. *c*). Thus, the mouth parts of the present species present the characters of *Amphioplus*, and not of *Amphiodia*.

### *Amphioplus hexacanthus* CLARK.

*Amphioplus hexacanthus*: CLARK, Bull. U.S. Nat. Mus., LXXV, 1911, p. 70.

Uraga Channel; 88 fathoms (CLARK).

Off California; 50 fathoms (CLARK).

### *Amphioplus cernuus* (LYMAN).

*Amphiura cernua*: LYMAN, Bull. Mus. Comp. Zool., VI, Pt 2, 1879, p. 28, Pl. XII, figs. 323-325; LYMAN, Rep. Challenger, V, 1882, P. 138, Pl. XVII, figs. 13-15.

*Amphioplus cernua*: VERRILL, Transact. Connecticut Acad., X, 1899, p. 315.

Eastwards from Honshû; 2,300 fathoms (LYMAN).

*Amphioplus glaucus* (LYMAN).

*Amphiura glauca*: LYMAN, Bull. Mus. Comp. Zool., VI, Pt. 2, 1879, p. 29, Pl. XII, figs. 326-328; LYMAN, Rep. Challenger, V, 1882, p. 139, Pl. XVIII, figs. 1-3.

*Amphioplus glauca*: VERRILL, Transact. Connecticut Acad., X, 1899, p. 315.

Sagami Sea; 345 fathoms (LYMAN). Yenshû Sea; 420 fathoms (LYMAN).

*Amphioplus macraspis* (CLARK).

*Amphiodia macraspis*: CLARK, Bull. U.S. Nat. Mus., LXXV, 1911, p. 157, fig. 66.

Numerous specimens; Ôtaba, Sagami Sea; 500 fathoms.

Off Honshû; 501-749 fathoms (CLARK). Suruga Gulf; 60-270 fathoms (CLARK). Sagami Sea; 622 fathoms (CLARK). Off Korea; 184 fathoms (CLARK). Gulf of Tartary; 318 fathoms (CLARK).

Off Washington; 115 fathoms (CLARK).

In the larger specimens, the radial shields are rather narrower and the ventral arm plates comparatively wider. As far as I have observed, there is present in all cases a single tentacle scale to each pore. The oral papillæ are very variable. There are present usually four genuine oral papillæ on either side, besides an additional one, which occurs just between the infradental and the distal papillæ. The additional papilla is smaller and

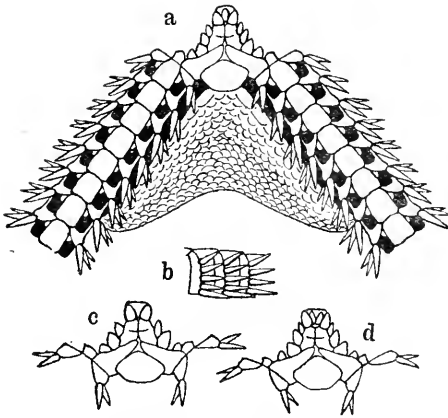

Fig. 44. *Amphioplus macraspis*.  $\times 9$ . *a*. From below. *b*. Side view of three arm joints near disk. *c*. Ventral view of an oral angle. *d*. Ditto.

acuter than the ordinary ones, and is sometimes placed at a higher level than the distal oral papillæ (fig. *d*), but very often forms a continuous series with the latter (fig. *a*). Sometimes, there occur only two genuine distal papillæ (fig. *e*), besides the comparatively large additional one. The outermost papilla is very small, often so small as to be almost imperceptible; the next is the largest of all. These two arise from the adoral shield. Sometimes, a single (fig. *a*) or paired (fig. *d*.) very small additional infradental papillæ are present, just above and between the pair of the ordinary ones.

As already mentioned, *Amphiodia* does not stand intermediate between *Amphiura* and *Amphioplus*, but the last two genera are directly related to each other. In my opinion, the species of *Amphiura* with two distal oral papillæ on either side, such as *A. anomala* LYMAN, *A. crassa* KÖHLER, *A. servata* KÖHLER, *A. grata* KÖHLER, *A. reposita* KÖHLER, *A. koreæ* DUNCAN, *A. assimilis* LÜTKEN & MORTENSEN, *A. digitula* (CLARK), &c. are *Amphioplus*-like *Amphiura*, while the present species is a representative of *Amphiura*-like *Amphioplus*. The oral angle shown in fig. *c* more or less reminds us of that of an *Amphiura*.

**Amphichilus**, g. nov.

Disk covered with fine, imbricating scales. Radial shields small, narrow, usually joined in pairs. One apical and two distal pairs of oral papillæ to each oral angle; the apical pair are infradental, arising from the dental plate; the inner pair of the distal ones arise from the oral plate; the outermost pair are very large, wide, operculiform, arising from the adoral shield. Besides, an additional papilla occurs just above and between the apical and inner distal papillæ, so that the oral slits are perfectly closed. Arms long, slender, flattened, inserted ventrally to the disk, only horizontally flexible. Three arm spines. One or two tentacle scales to each pore.

This new genus includes *Amphiura dalea* LYMAN, 1874, and *A. intermedia* KÖEHLER, 1905, besides the genotype, *Amphichilus trichoides*, nov.

*Amphichilus* differs from *Amphioplus* in the presence of only three genuine oral papillæ, besides an additional one, on either side of each oral angle; in the very large and operculiform outermost oral papilla; and in the usually joined radial shields. It differs from *Amphipholis* in the discontinuous arrangement of the genuine oral papillæ, and in the presence of the additional oral papilla, which fills up the space between the apical and inner distal papillæ.

***Amphichilus trichoides***, sp. nov.

One specimen; locality unknown, perhaps Sagami Sea.

Diameter of disk 6 mm. Length of arms 60 mm. Width of arms at base 0.5 mm.

Disk circular, rather convex dorsally, covered with very fine,

imbricating scales, which are finer outwards and along the sides of the radial shields. Primary plates indistinct. Radial shields long and narrow, acutely pointed within, about one-fifth as long as the disk diameter, meeting with each other for nearly their whole

length but parted at the proximal end. Interbrachial ventral surfaces covered also with imbricating scales, which are somewhat finer than those of the dorsal surface. Genital slits long.

Oral shields ovate, or rather triangular with perfectly rounded angles, lateral sides quite and outer side strongly convex; much longer than wide. Adoral shields triangular, tapered within to a point,

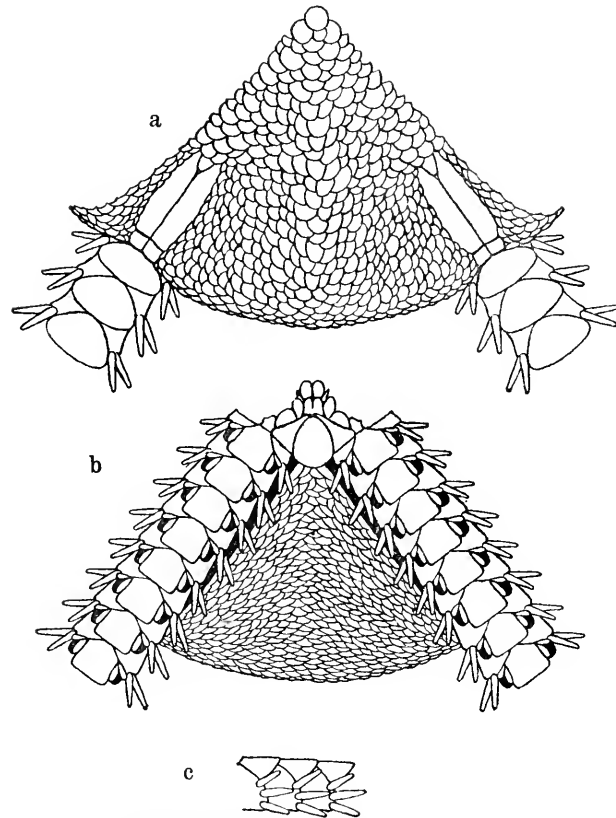

Fig. 45. *Amphichilus trichoides*.  $\times 20$ . a. From above. b. From below. c. Side view of three arm joints near disk.

where they nearly meet. The apical oral papillæ are oval and stout. Two distal oral papillæ on either side; the outer one is the largest of all, much wider than long, flat, thick, has curved free edge, and arises from the adoral shield; the other longer than wide, flat, thick, with obtuse end. Besides, there occur above the

level of the ordinary ones between the apical and the next papilla, an acute additional papilla, which together with the others closes the oral slit.

Arms long and very slender, flattened. Dorsal arm plates triangular, with much rounded angles, inner sides slightly and outer side strongly convex, wider than long, successive plates slightly in contact. Lateral arm plates low, joined on the sides, but not meeting above; below, the plates meet slightly beyond the basal region of the arms. First ventral arm plate very small, pentagonal, longer than wide; those beyond hexagonal, nearly as long as wide, slightly wider without than within, successive plates a little in contact in the basal joints; but more distally, they are separated by the lateral plates, and are pentagonal. Three arm spines, subequal, about as long as the corresponding arm joint, conical and obtuse. Two tentacle scales, a larger adradial and a smaller abradial forming nearly a right angle.

Colour in alcohol light yellowish gray.

This new species differs from *A. daleus* (LYMAN) in the narrower and perfectly joined radial shields, in the smaller adoral shields, in the shape of the ventral arm plates and in the presence of two tentacle scales; and from *A. intermedius* (KÖHLER) in the shape of the radial and oral shields, in the shape of the oral papillæ, especially of the infradental ones, and in the narrower arms. The last species appears to be most nearly allied to the present.

### ***Amphiacantha*, g. nov.**

Disk covered with fine, imbricating scales, and scattered spines. Radial shields usually divergent, sometimes entirely

separated from each other. Four or five pairs of oral papillæ to each oral angle, short, close-set; the apical infradental pair arise from the dental plate, and the outermost pair from the adoral shield. Arms long, slender, flattened, inserted ventrally to the disk, only horizontally flexible. Three to six arm spines. One or two small, leaf-like tentacle scales.

This new genus includes *Ophiostigma formosa* LÜTKEN, 1872, *Ophiocnida sexradia* DUNCAN, 1889, *Amphiura notacantha* LÜTKEN & MORTENSEN, 1899, *A. gastracantha* LÜTKEN & MORTENSEN, 1899, *Ophiocnida libera* KÖHLER, 1907, *O. amphiacantha* McCLENDON, 1909, *Amphilimna pentacantha* CLARK, 1911, and *Amphiacantha dividua*, nov., besides the genotype, *Amphioplus acanthinus* CLARK, 1911.

*Amphiacantha* is practically *Amphioplus* with disk spines, and differs from *Amphilimna* VERRILL (non CLARK, 1911), in the divergent radial shields, in the close-set oral papillæ, in the not very long, but short and flattened outermost oral papilla, in the fewer arm spines, and in the not long and spiniform, but short and leaf-like tentacle scales.

### Key to Japanese species of *Amphiacantha*.

- A*—Three arm spines; two tentacle scales; radial shields not very small, joined or closely set in pairs.
- a*—Disk spines very numerous, very short, blunt, present on both the dorsal and ventral sides; radial shields joined in pairs; oral shields much wider than long; ventral arm plates longer than wide. . . . .  
 . . . . . *formosa*.
- aa*—Disk spines not very numerous, very long, slender, acute, present only on the dorsal side; radial shields divergent, the pairs being in contact only at the outer ends; oral shields much longer than wide; ventral arm plates wider than long . . . . . *acanthina*.



.11.—Four arm spines; single tentacle scale; radial shields very small, widely separated from each other; disk spines not very numerous, very short, blunt, present only on the dorsal side. . . . . *diviua*.

*Amphiacantha formosa* (LÜTKEN).

*Ophiostigma formosa*: LÜTKEN, Oph. Nov., 1872, p. 3, Pl. I-II, figs. 5a & 5b; LYMAN, Rep. Challenger, V, 1882, p. 166; KOEHLER, Bull. Sci. Fr. Belg., XXXI, 1898, p. 76; KOEHLER, Res. Exp. Siboga, XLV, Pt. 2, 1905, p. 24, Pl. II, fig. 1.

Strait of Formosa (LÜTKEN).

Indian Ocean and Malaysian waters.

As far as I can judge from LÜTKEN'S description and figures, this species is evidently not referable to *Ophiostigma*, having four oral papillae, of which the outermost one is very small and rudimentary, quite as in the next species.

*Amphiacantha acanthina*

(CLARK).

*Amphioplus acanthinus*: CLARK, Bull. U.S. Nat. Mus., LXXV, 1911, p. 168, fig. 75.

Two specimens; Uruga Channel; 140 fathoms.

Off Tsurugi Saki; 110–259 fathoms (CLARK). Suruga Gulf; 148 fathoms (CLARK).

The disk scales are fine and regular in one of the

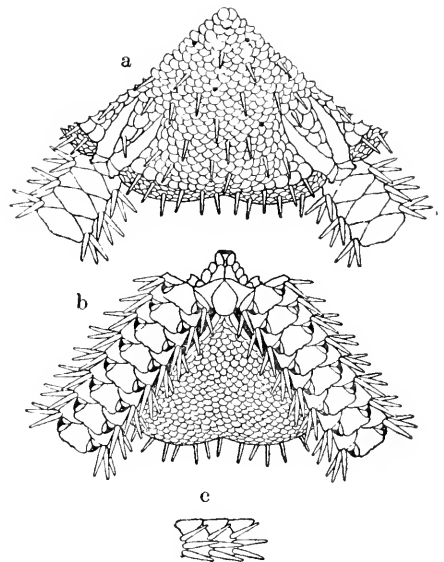

FIG. 46. *Amphiacantha acanthina*.  $\times 5$ . a. From above. b. From below. c. Side view of three arm joints near disk.

specimens, but coarse and irregular in the other. The oral papillae are usually five on either side, but four in some of the oral angles. The outermost papilla is very small. The disk spines are rather more numerous than in CLARK'S type.

*Amphiacantha dividua*, sp. nov.

One specimen; locality unknown, probably Sagami Sea.

Diameter of disk 3 mm. Length of arms 15 mm. Width of arms at base 0.7 mm.

Disk subpentagonal, with slightly convex interradial borders, covered with very fine, imbricating scales and scattered spines, which are very short, conical and obtuse. Radial shields very small, subtriangular, with the adradial side longest, about twice as long as wide. Interbrachial ventral surfaces covered also with imbricating scales, which are somewhat finer than those of the dorsal side; without any spines. Genital slits long.

Oral shields oval, or rather rhomboidal with rounded angles and convex sides, distinctly longer than wide, wider without than within. Adoral shields triangular, long, rather narrow, tapered inwards to an acute point, not

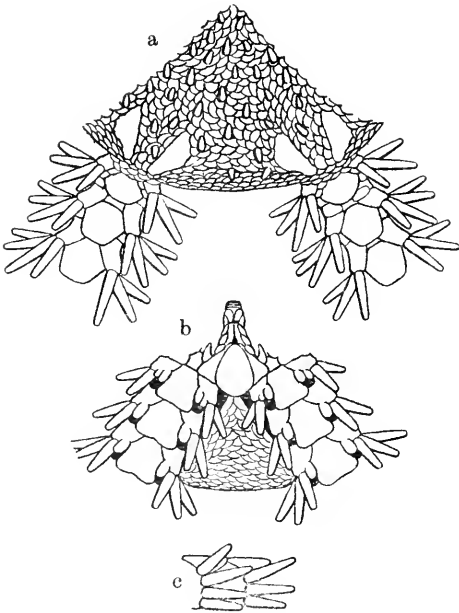

Fig. 47. *Amphiacantha dividua*.  $\times 16$ . a. From above. b. From below. c. Side view of two arm joints near disk.

in contact with each other. Oral plates long and narrow. Six oral papillæ on either side, flat, obtuse, except the outermost one, which has pointed inner end. Teeth quadrangular, stout, with truncate free end.

Six arms, of which three are longer and stouter than the others. Dorsal arm plates hexagonal, with rounded outer angles, slightly longer than wide, widest at the lateral angles, in contact with each other. Lateral arm plates low, those of the two sides not meeting above or below. First ventral arm plate very small, pentagonal, longer than wide. Those beyond hexagonal, with concave lateral and notched outer borders and rounded outer angles, slightly longer than wide, widest at the outer angles. Four arm spines in the free basal joints, cylindrical, tapered, blunt; the second from above which is the longest, is slightly longer than the corresponding arm joint, while the lowest one, which is the shortest, is slightly shorter than the same. A short distance out from the disk, there are only three arm spines on either side of each arm joint, the uppermost being the longest. A single large, oval, flat tentacle scale to each pore, except the first which has usually two scales.

Colour in alcohol bluish.

This new species very much resembles *A. sexradia* (DUNCAN, 1889), but differs from it in the fewer and more widely spaced disk spines, in the quite distinct disk scales and radial shields, in the more numerous oral papillæ, in the longer and narrower oral shields, in the shape of the dorsal and ventral arm plates and in the longer arm spines.

**Key to Japanese species of *Amphiodia*.**

- A*—Radial shields fully in contact in pairs; ventral arm plates pentagonal, as wide as, or wider than, long; four arm spines; two tentacle scales ..... *craterodometa*.
- AA*—Radial shields divergent, slightly or not at all in contact in pairs; ventral arm plates quadrangular, longer than wide; outer two oral papillæ pointed; tentacle scales very rudimentary.
- a*—Interbrachial ventral surfaces finely squamated; four or five arm spines; one or two rudimentary tentacle scales..... *euraspis*.
- aa*—Interbrachial ventral surfaces covered by a naked skin; four or five arm spines; single rudimentary tentacle scale to each pore. . . *psilochora*.

*Amphiodia craterodometa* CLARK.

*Amphiodia craterodometa*: CLARK, Bull. U. S. Nat. Mus., LXXV, 1911 p. 155, fig. 65.

Yezo Strait; 533 fathoms (CLARK). Okhotsk Sea; 58-69 fathoms (CLARK). Off Saghalin; 21-32 fathoms (CLARK). Gulf of Tartary; 318 fathoms (CLARK). Off Korea; 116 fathoms (CLARK). Alaska (CLARK). Bering Sea (CLARK). Arctic Ocean (CLARK).

*Amphiodia euraspis* CLARK.

*Amphiodia euraspis*: CLARK, Bull. U. S. Nat. Mus., LXXV, 1911, p. 158, fig. 67.

Suruga Gulf; 211-293 fathoms (CLARK). Off Korea; 184-250 fathoms (CLARK). Gulf of Tartary; 318 fathoms (CLARK).

Bering Sea (CLARK). California (CLARK).

*Amphiodia psilochora* CLARK.

*Amphiodia psilochora*: CLARK, Bull. U. S. Nat. Mus., LXXV, 1911, p. 165, fig. 72.

Sagami Sea; 292–622 fathoms (CLARK). Off Ôse Zaki, Suruga Gulf; 55–65 fathoms (CLARK). Off eastern Japan; 440 fathoms (CLARK).

*Ophiophragmus japonicus* MATSUMOTO.

*Ophiophragmus japonicus*: MATSUMOTO, Proc. Acad. Nat. Sci. Philadelphia, 1915, p. 70.

Numerous specimens; off Namami, Kagoshima Bay; 8–15 fathoms. Two specimens; Enoura, Suruga. Numerous specimens; off Oginohama, Rikuzen; 10–20 fathoms.

Diameter of disk 7 mm. Length of arms 45 mm. Width of arms at base 1 mm.

Disk five-lobed, with very convex interbrachial borders, covered with very fine, imbricating scales. Six primary plates more or less distinguishable at the central region. Radial shields semilunar, one-third as long as the disk radius, twice as long as wide, separated only at the proximal end, obtusely pointed within. A row of large and squarish marginal scales occurs on the disk. The scales of the interbrachial ventral surfaces just outside the marginal scales are turned up, so as to form a sort of fence. The marginal scales are more elevated than

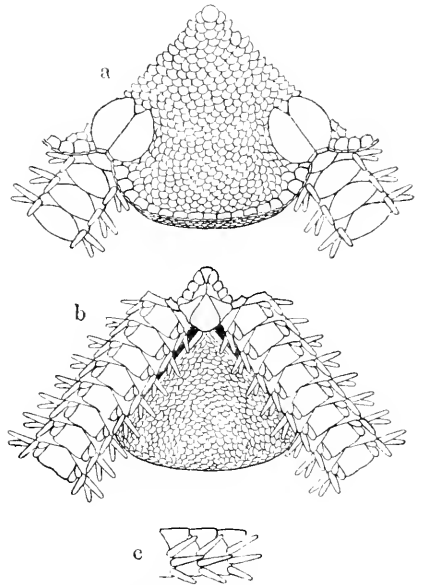

FIG. 48. *Ophiophragmus japonicus*.  $\times 8$ .  
a. From above. b. From below. c. Side view of three arm joints near disk.

the arms, and the interbrachial region of the disk is strongly convex below. Genital slits long.

Oral shields rhomboidal, with the inner sides much longer than the outer, with acute inner and rounded lateral and outer angles, much longer than wide. Adoral shields triangular, tapered within to a point, and not meeting with each other. Four oral papillæ on either side of the oral angle, close-set, continuous, subequal and blunt, the innermost one somewhat stouter.

Dorsal arm plates oval, large, outer border curved, inner border strongly convex, forming part of a circle; as wide as the arms, twice as wide as long, a little in contact with each other. Lateral arm plates inserted like so many wedges between the successive dorsal plates above and ventral plates below; well separated above but closer below. First ventral arm plate very small, quadrangular, much wider than long. Those beyond pentagonal, with very large inner angle and slightly notched outer border, wider than long, only a little in contact with each other. Three arm spines, conical, subequal, blunt, nearly as long as the corresponding arm joint. Two tentacle scales, very flat and thin; abradial one smaller than the adradial, and overlapping its base.

Colour in alcohol light yellow.

This species somewhat resembles *O. affinis* DUNCAN, especially in the number of the oral papillæ, but differs from it in the shape of the radial and oral shields and of the dorsal arm plates. In my opinion, *Amphipholis andree* LÜTKEN, 1872, *Amphiura prestans* KÆHLER, 1905, and *Amphiodia periereta* CLARK, 1911, are referable to *Ophiophragmus*, each showing certain affinities to the present species. I have observed also in younger specimens of the present species that, the marginal disk scales are so prominent as to form a hem-like

row of denticles, so that the disk border is serrate, quite as in CLARK'S fig. 68d of *O. perieretus*.

### Key to Japanese species of *Amphipholis*.

- A*—Radial shields perfectly joined in pairs.
- a*—Arms three to four times as long as the disk diameter; dorsal arm plates distinctly shorter than the corresponding arm joint, without any streak along the median line.
- b*—Disk scales thin, rather indistinct from one another, so that the surface of the disk is very smooth; radial shields not very wide, about two and a half times as long as wide, the united width of each pair being nearly equal to the width of the corresponding arm base; three arm spines, of which the uppermost one is the longest, the lowest one the shortest, and the middle one the stoutest but not distinctly compressed . . . . . *japonica*.
- bb*—Disk scales thickened along the free margins, concave, very distinct from one another, so that the surface of the disk is not very smooth; radial shields very wide, about twice as long as wide, the united width of each pair much exceeding the width of the corresponding arm base; three, sometimes four, arm spines, of which the uppermost one is the longest, and the middle one the shortest and stoutest and distinctly compressed . . . . . *sobrina*.
- aa*—Arm seven to eight times as long as the disk diameter; dorsal arm plates as long as the corresponding arm joint, with a distinct white streak along the median line . . . . . *pugetana*.
- A.1*—Radial shields divergent, being nearly or entirely separated from each other by a row of scales; three arm spines, of which the lowest one is the longest; adradial tentacle scale much larger than the abradial . . . . . *kochii*.

*Amphipholis japonica* MATSUMOTO.

*Amphipholis japonica*: MATSUMOTO, Proc. Acad. Nat. Sci. Philadelphia, 1915, p. 71.

Numerous specimens; Arai Beach, Misaki Marine Biological Station. One specimen; Tomo, Bingo. One specimen; Asami Bay, Tsushima. One specimen; Akuné, Satsuma. Several specimens; Shimabara, Hizen.

Diameter of disk 3 mm. Length of arms 12 mm. Width of arms at base 0.5 mm.

Disk circular, covered with fine, thin, imbricating scales, which are again covered over by a thin skin, so that the surface of the disk is very smooth.

Radial shields comparatively large, pear-seed shaped, slightly shorter than half the disk radius, about two and a half times as long as wide, completely joined in pairs, except at the very inner ends, where they are separated from each other by a triangular, wedge-shaped scale. Interbrachial ventral surfaces covered also

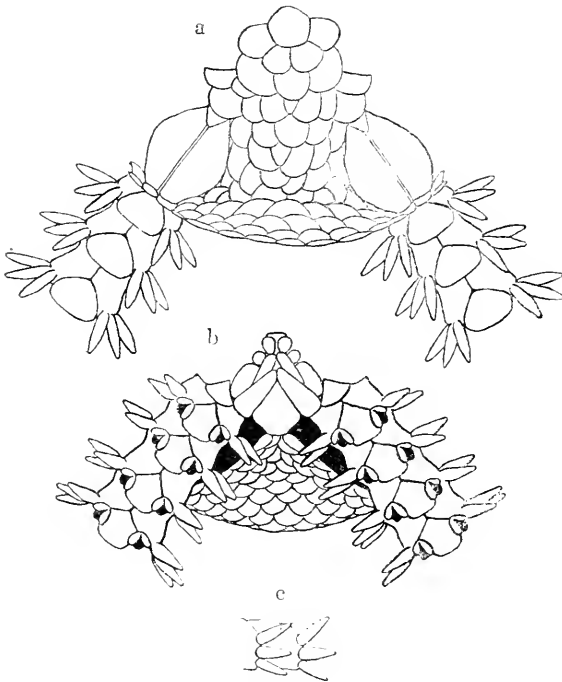

Fig. 49. *Amphipholis japonica*.  $\times 27$ . a. From above. b. From below. c. Side view of two arm joints near disk.



with fine, imbricating scales, which are only slightly finer than those of the dorsal side. Genital slits long.

Oral shields rhomboidal, with very acute inner and rounded lateral and outer angles, inner sides longer than the outer; longer than wide. Adoral shields triangular, long and narrow, wider outwards than inwards, meeting with each other within. Three oral papillae on either side; the inner two are rounded, while the outermost one is very large, wide and operculiform. Teeth quadrangular and stout.

Dorsal arm plates triangular, with rounded angles and convex sides, about one and a half times as wide as long, much shorter than the corresponding arm joints, so that the successive plates are separated from one another. Lateral arm plates rather low, distinctly flared outwards, those of the two sides meeting with each other both above and below. First ventral arm plate small, triangular, with convex outer side, wider than long. Those beyond pentagonal, with acute inner angle, outer lateral angles perfectly rounded, inner sides straight, lateral sides concave, outer side convex; about as long as, or slightly longer than, wide, widest at the inner lateral angles. Three arm spines, conical, acute: the uppermost one is the longest, slightly shorter than, or hardly as long as, the corresponding arm joint; the middle one is the stoutest, but not distinctly compressed; the lowest one is the shortest. Two small, oval, flat, leaf-like tentacle scales, of which the adradial one is slightly larger than the abradial.

Colour in alcohol white or light yellow. In life, the disk is light reddish brown.

I have compared these specimens with those of *A. squamata* (DELLE CHIAJE) from Naples, and found only two trifling differences between them. In the Japanese specimens, the arms are three to

four times as long as the disk diameter and the ventral arm plates have a convex outer border and rounded outer lateral angles, while in the Neapolitan specimens, the arms are two and a half to three times as long as the disk diameter and the ventral arm plates have straight outer border and not rounded outer lateral angles. The difference in the arm length may not be very important in the question of the distinctness of the two species, because in *A. squamata* the arms are said to vary from two and a half to four and a half times as long as the disk diameter. I therefore look upon the difference in shape of the ventral arm plates as the only distinctive character of the present species as compared with *A. squamata*. In the shape of the ventral arm plates, the present species much resembles *A. australiana* CLARK, but differs from it in the more numerous disk scales of the dorsal side and coarser disk scales of the ventral side. The radial shields have each a white spot at the outer end, as in *A. squamata*.

The present species is common in the neighbourhood of Misaki and is found living under stones in fine sand. As to its sensitiveness to the coarseness of the sand, I made the following observations at Arai Beach. In the summer of 1910, there were at first among the rocks numerous spots covered with fine sand, and this species was found very abundantly; but after a tempest, it was reduced to small numbers, owing to the fact that the spots with fine sand became very scanty. In the summer of 1911, spots with fine sand were very scanty, and this species was also few. In the summer of 1912, the beach was entirely covered with coarse sand, and the species could not be found any longer. This ophiuran is very quick in motion, and can instantly conceal itself in the sand, when the stone is turned up.

The present species is undoubtedly viviparous like *A. squamata*.

In summer, the larger individuals contain several embryos. I have once dissected out six embryos from a single adult. Animals containing full grown embryos appear to give birth to them the night after they are placed in an aquarium.

*Amphipholis sobrina*, sp. nov.

Numerous specimens; Mera-out-Oisegaké, Sagami Sea; 300 fathoms. Five specimens; Sengendzuka-Aoyamadashi, Sagami Sea; 85 fathoms. Three specimens; off Ôshima, Sagami Sea; 75-85 fathoms.

Diameter of disk 3 mm. Length of arms 10 mm. Width of arms at base 0.6 mm.

Disk subpentagonal, covered with imbricating scales, which are rather fine, thickened along the free margins, concave, very distinct from one another and coarser inwards than outwards. Six primaries rather distinct, larger than the other scales, separated from one another. Radial shields large, pear-seed shaped, slightly shorter than half the disk radius, about twice as long as wide, completely joined in pairs, except at the very inner ends, where they are separated from each other by a triangular, wedge-shaped scale; the united width of each

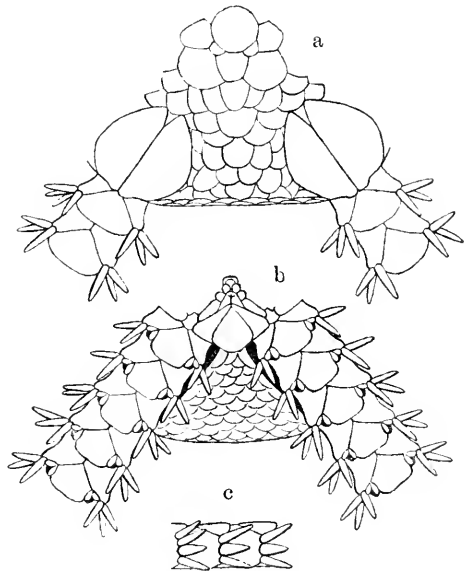

Fig. 50. *Amphipholis sobrina*.  $\times 20$ . a. From above. b. From below. c. Lateral view of three arm joints near disk.

pair distinctly exceeds the width of the corresponding arm base. Interbrachial ventral surfaces covered also with imbricating scales, which are much finer than those of the dorsal side. Genital slits long.

Oral shields rhomboidal, with acute inner and rounded lateral and outer angles, inner sides longer than the outer; slightly longer than, or nearly as long as, wide. Adoral shields triangular, long, tapered inwards, meeting with each other within. Three oral papillæ on either side, the inner two are rounded, and the outermost one is very large, wide and operculiform. Teeth quadrangular and stout.

Dorsal arm plates triangular, with rounded outer lateral angles and convex outer side, one and a half times as wide as long, shorter than the corresponding arm joint, so that the successive plates are not in contact with each other. Lateral arm plates low, flared outwards, those of the two sides slightly meeting with each other both above and below. First ventral arm plate exceedingly small, pentagonal, longer than wide. Those beyond pentagonal, with rounded outer lateral angles and convex outer side, wider than long, widest at the inner lateral angles, not in contact with each other, except the first two or three plates. Three, or sometimes four, arm spines, of which the uppermost is usually the longest, and the middle one is the shortest and stoutest and is distinctly compressed at the base. Two very small, oval, flat, leaf-like tentacle scales, of which the adradial one is slightly larger than the abradial.

Colour in alcohol: white or yellow, except the dorsal side of the disk, which is light bluish; radial shields with a white spot at the outer end, as in *A. squamata* and *A. japonica*.

The present species is very near to *A. japonica*, but differs

from it in the coarser and more distinct disk scales, in the much larger radial shields, in the wider ventral arm plates and in the middle arm spines being the shortest and distinctly compressed at the base.

The specimens from Mera-out-Oisegaké have stouter arms than those from Sengendzuka-Aoyamadashi and from off Ôshima. This difference may probably be due to bathymetrical factor. I regard the specimens from Mera-out-Oisegaké as the type of the present species.

*Amphipholis pugetana* (LYMAN).

*Amphipholis pugetana*: LYMAN, Proc. Boston Soc. Nat. Hist., VII, 1860, p. 193<sup>b</sup>; LYMAN, Ill. Cat. Mus. Comp. Zool., I, 1865, p. 125; LYMAN, Rep. Challenger, V, 1882, p. 145; KOEHLER, Bull. Sci. Fr. Belg., XLI, 1907, p. 305.

*Amphipholis pugetana*: VERRILL, Trans. Conn. Acad., X, 1899, p. 312; McCLENDON, Univ. California Publ. Zool., VI, 1909, p. 43, Pl. II, figs. 12 & 13; CLARK, Bull. U.S. Nat. Mus., LXXV, 1911, p. 166, figs. 73.

One specimen (belonging to Mr. R. SAIÛ, Imperial Museum at Uyeno, Tokyo); Aomori Bay. Four specimens (belonging to Mr. SASAKI, Coll. Agricult., Sapporo); Oshoro, near Otarunai, Hokkaidô. One specimen (belonging to Mr. H. ASANO, Imperial Bureau of Fishery); off Kitami: 60 fathoms.

Puget Sound. California. Washington. Alaska.

The largest one of these specimens measures 4 mm. across the disk and 28 mm. in the arm length. In the larger specimens, the disk scales are very fine and exceedingly numerous, and the primary plates are indistinguishable; while in the smaller speci-

---

1) This paper was not seen by me.

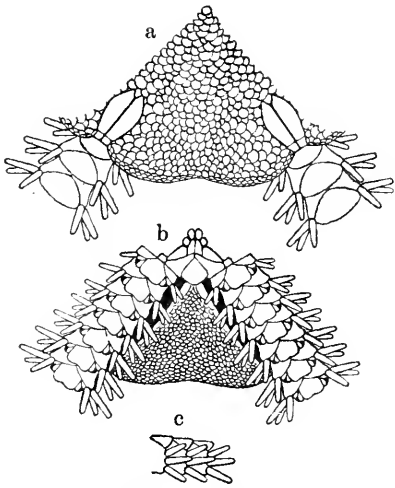

Fig. 51. *Amphipholis yugetana*.  $\times 12$ . *a*. From above. *b*. From below. *c*. Side view of three arm joints near disk.

mens, the disk scales are comparatively coarse and the primary plates very distinct. The arms are long and very slender, being widest at about one-fourth the entire length from the base. The dorsal arm plates are nearly as wide as the corresponding arm joints, and about one and a half times as wide as long. The ventral arm plates are slightly wider than long and have a notched outer border. The dorsal, as well as the ventral, arm plates are not in direct contact with one another, being slightly separated by wedge-like prolongations of the lateral arm plates, except the first two ventral arm plates, which are joined to each other. The colour in alcohol well agrees with LYMAN'S description, but the arms are irregularly banded with grayish shade.

I am informed by Mr. SASAKI that the animals are found attached to the rhizomes of *Zostera marina*. It is interesting to find this species occurring in the northern waters of Japan, since it has been known only from the eastern coast of the North Pacific.

#### *Amphipholis kochii* LÜTKEN.

*Amphipholis kochii*: LÜTKEN, Oph. Nov., 1872, p. 10, Pl. I & II, fig. 6.

*Amphiura kochii*: LYMAN, Rep. Challenger, V, 1882, p. 146.

Numerous specimens: Arai Beach, Misaki Biological Station.

Numerous specimens; Misaki. One specimen (belonging to Mr. R. Saitô, Imperial Museum at Uyeno, Tokyo); Aomori Bay. Uladiwostock (LÜTKEN).

This species is very variable. The disk scales are often coarse and very irregular. The primary plates are sometimes visible. The oral shields are rhomboidal, with the inner sides longer than the outer, and longer than wide; so that in LÜTKEN'S fig. 6b, the upper right one is most natural. The ratio of the arm length to the disk diameter is greater in smaller specimens;

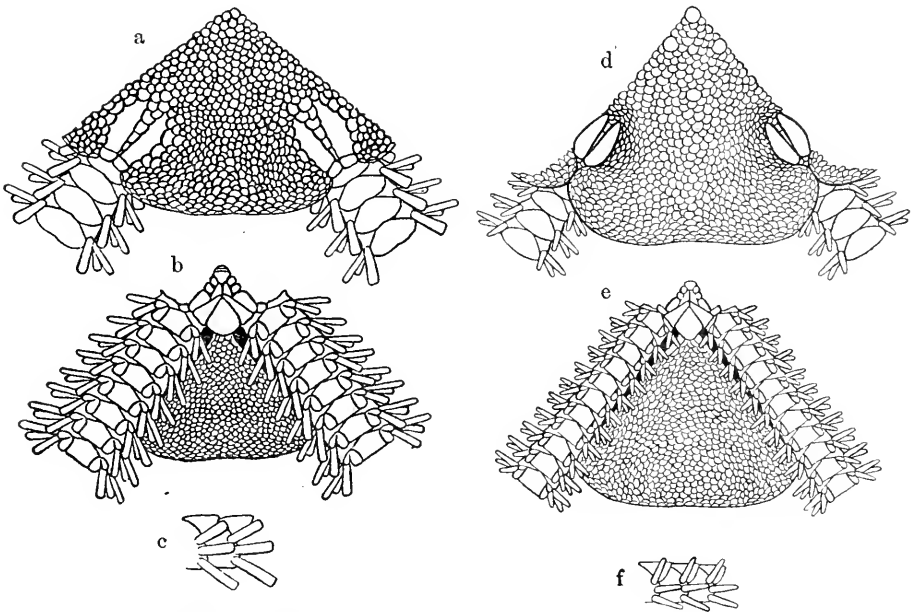

Fig. 52. *Amphipholis kochii*. a. From above.  $\times 8$ . b. From below.  $\times 8$ . c. Side view of two arm joints near disk  $\times 8$ . d. From above.  $\times 6$ . e. From below.  $\times 6$ . f. Side view of three arm joints near disk.  $\times 6$ .

so that the size contrast of the arms is not so striking between two specimens, one of which is 4 mm. and the other is 7 mm. across the disk. In the smaller specimens the disk is flat, sub-

pentagonal, with nearly straight interbrachial borders; while in the larger ones the disk is swollen and the interbrachial regions bulge out more markedly. The radial shields do not take part in this bulging process, and are consequently deeply sunken, while their distance from the centre of the disk is not much greater than in the smaller specimens. The radial shields are distinctly separated in the smaller specimens, but more or less meet with each other in the larger ones. The colour in alcohol, as in life, is also variable. Some specimens are gray or yellowish gray, and spotted on the arms with dark gray; others are dull yellow, with some disk scales gray; the radial shields are usually light yellow, hemmed with dark gray. Specimens with coarse and irregular disk scales are darker in colour.

**Amphiura** (FORBES, 1842) VERRILL, 1899.

Syn. *Ophionephthys* LÜTKEN, 1869.

I look upon *Ophionephthys* LÜTKEN as a synonym of *Amphiura* s. str. The reduction of the disk scales which is a characteristic of *Ophionephthys* is also observed in *Amphiura acrystata*, as well as in some *Amphiura* formerly referred to *Hemilepis*, while the absence of the tentacle scales is characteristic of certain *Amphiura* formerly referred to *Ophiopeltis*. There is not a single character by which *Ophionephthys* can be satisfactorily distinguished from *Amphiura*.

**Key to Japanese species of *Amphiura*.**

A—Tentacle scales present.

a—Two tentacle scales to each pore.



- b*—Two, or sometimes three, distal oral papillæ on either side, besides an additional one, which lies deep within the oral slit.
- c*—Three arm spines, subequal, or the middle one slightly longer than the other two; disk distinctly squamated both above and below, with very prominent primaries; radial shields large, rather wide, each pair being separated from each other by a row of usually three large scales; ventral arm plates wider than long . . . . . *korœa*.
- cc*—Four arm spines, of which the lowest one is the longest and the third from below the shortest; disk distinctly squamated above, but covered with fine granule-like scales below; the primaries are indistinct in larger specimens; radial shields long and very narrow, slightly divergent; outer end of each genital plate, just distal to the radial shield, bearing a projection, which is thorny at the tip; ventral arm plates longer than wide . . . . . *digitula*.
- bb*—Single distal oral papilla on either side, besides an additional one, which lies more or less deep within the oral slit.
- d*—Four arm spines.
- e*—Disk squamated both above and below.
- f*—Disk scales very fine and thin; radial shields long and narrow, about thrice as long as wide, separated from each other; adoral shields not meeting with each other; arm spines subequal . . . *bellis*.
- jj*—Disk scales rather coarse and thick, some of them projecting like a hemisphere, so that the surface of the disk is very rough; radial shields not very long, about twice as long as wide, separated from each other; adoral shields meeting with each other in the interradial line; the uppermost and the lowest arm spines distinctly longer than the middle two . . . . . *trachydisca*.
- ee*—Disk squamated above, but naked below; radial shields partially joined in pairs; adoral shields meeting with each other in the interradial line; middle two of the four arm spines stouter and blunter than the uppermost and lowest . . . . . *microdiscus*.
- dd*—Five to seven arm spines; disk naked at least below.

- g*—Disk rather thick, distinctly squamated above; radial shields short; lower arm spines spur-shaped and rough at the tip . . . . . *euopla*.
- gg*—Disk very thin, mostly naked, the scales persisting only around the radial shields, which are long and rather narrow; arm spines conical, not rough. . . . . *acrystata*.
- aa*—Single tentacle scale to each pore.
- h*—Three arm spines.
- i*—Disk distinctly squamated both above and below.
- j*—Disk scales rather fine; radial shields very wide, widest near the inner end; oral shields rounded, longer than wide; adoral shields widely separated from each other in the interradial line; dorsal arm plates separated from one another by the lateral arm plates; ventral arm plates pentagonal, longer than wide, only slightly in contact with one another; arm spines subequal . . . . . *acacia*.
- jj*—Disk scales coarse; radial shields not very wide, wider outwards oral shields oval, much wider than long; adoral shields widely meeting with each other in the interradial line; dorsal arm plates widely in contact with one another; ventral arm plates hexagonal or heptagonal, widely in contact with one another; middle arm spine longer than the other two. . . . . *pycnostoma*.
- ii*—Interbrachial ventral surfaces naked; radial shields long and narrow; oral shields rounded pentagonal, wider than long; adoral shields not meeting with each other in the interradial line; distal oral papilla long and spiniform; dorsal, as well as ventral, arm plates slightly in contact with one another; arm spines subequal. . . . . *carchara*.
- ll*—Four to seven arm spines.
- k*—Four or five arm spines, of which the lowest is the longest and the third from below the shortest.
- l*—Four, rarely five, conical arm spines, of which the maximum length does not exceed twice the corresponding arm joint; disk scales ill-defined, not distinctly imbricated, but pavement-like; radial shields very long and narrow, bar-like; oral shields large, much wider than

long; distal oral papilla not much larger than the apical papilla and tentacle scales, rather thick; dorsal arm plates very convex in longitudinal section; ventral arm plates not keeled.....*iris*.

*ll*—Five flattened arm spines, of which the maximum length is about thrice the corresponding arm joint; disk scales distinctly imbricated; radial shields not very long, pear-seed shaped; oral shields small, nearly as long as wide; distal oral papilla much larger than the apical papilla and tentacle scales, very flat and thin; dorsal arm plates rather straight in longitudinal section; ventral arm plates with a median keel .....*iridoides*.

*kk*—Six or seven arm spines.

*m*—Six arm spines, of which the third or fourth from above is the longest; radial shields long and narrow; oral shields diamond-shaped, about as long as wide; distal oral papilla subspinous, long, compressed .....*lütkeni*.

*mm*—Six or seven arm spines, of which the lowest one is the longest; radial shields extremely small, short and narrow; oral shields oval, about as long as wide; distal papilla very large, fan-shaped, flat.....*micraspis*.

*AA*—Tentacle scales absent; disk mostly naked, the disk scales persisting only around the radial shields; numerous arm spines, of which the lower ones are rough at the tip.

*n*—Five to seven arm spines; dorsal and ventral arm plates wider than long.

*o*—Five arm spines near disk, but four more distally; dorsal arm plates very large and wide even at the arm bases; arms twelve or thirteen times as long as the disk diameter.....*æstuarii*.

*oo*—Six or seven arm spines near disk, but five or six more distally; dorsal arm plates very small and rudimentary at the arm bases; arms exceedingly long, more than thirty times as long as the disk diameter.....*valicola*.

*nn*—Ten arm spines; dorsal and ventral arm plates much less wide than

long; arms about fourteen times as long as the disk diameter....  
 ..... *conomiotata*.

*Amphiura koreæ* DUNCAN.

*Amphiura koreæ*: DUNCAN, Journ. Linn. Soc. London, XIV, 1879, p. 466. Pl. X, figs. 18 & 19.

*Amphiura coreæ*: LYMAN, Rep. Challenger, V, 1882, p. 146.

*Amphipholis coreæ*: VERRILL, Transact. Connecticut Acad., X, 1899, p. 321.

*Amphiura diomedææ*: LÜTKEN & MORTENSEN, Mem. Mus. Comp. Zool., XXII, 1899, p. 151, Pl. XIII, figs. 1-7; KÖHLER, Exp. Siboga, XLV, Pt. 1, 1904, p. 86; CLARK, Bull. U.S. Nat. Mus., LXXV, 1911, p. 140.

Numerous specimens; Ôtaba, Sagami Sea; 500 fathoms.

Off Manazuru Zaki, Sagami; 120-749 fathoms (CLARK). Off Port Arari; 400-726 fathoms (CLARK). Suruga Gulf; 140-503 fathoms. Off Omai Zaki; 475-662 fathoms (CLARK). Off eastern Japan; 39 fathoms (CLARK). Sea of Japan; 79 fathoms (CLARK). Kagoshima Gulf; 58 fathoms (CLARK).

Pacific side of Central America. Malaysian waters (KÖHLER).

That the specimens at hand are referable to *A. diomedææ* appears to me certain. But an examination of DUNCAN'S description and figures of *A. koreæ*, which is considered by several authors to belong to what is now called *Amphipholis*, has convinced me that DUNCAN'S species in question is merely an *Amphiura* s. str., and is probably identical with *A. diomedææ*. DUNCAN did not

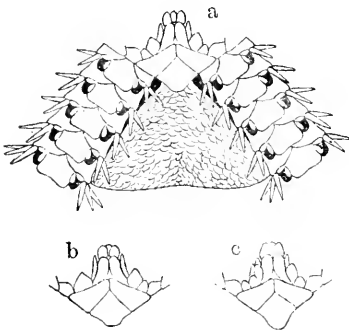

Fig. 53. *Amphiura koreæ*.  $\times 7$ . a. From below. b. Ventral view of an oral angle. c. Ditto.

mention the size of his type specimen; but judging from the magnification of his figures, his specimen must have been much smaller than LÜTKEN & MORTENSEN'S type. The smaller specimens in my hands appear to me to correspond well to DUNCAN'S description and figures, the only essential difference being the shape of the oral shield, which is lyre-shaped and very wide outwards in DUNCAN'S figure. But the oral shields, adoral shields and oral papillæ, &c. of *A. diomedea* are subject to great variation, as stated by LÜTKEN & MORTENSEN. Therefore, I am inclined to look upon *A. koreæ* and *A. diomedea* to be conspecific, the former having the priority.

In the specimens at hand, the arms are mostly four to six times as long as the disk diameter, so that they are usually longer than in DUNCAN'S and KÆHLER'S specimens, but usually shorter than in LÜTKEN & MORTENSEN'S. In some of the oral angles, there may be one to three additional infradental papillæ besides the ordinary pair. The disk is usually light bluish and the arms yellowish or light brownish in colour in alcohol.

*Amphiura digitula* (CLARK).

*Amphiodia digitula*: CLARK, Bull. U.S. Nat. Mus., LXXV, 1911, p. 162, fig. 70.

Four specimens; Mera-out-Oisegaké, Sagami Sea; 300 fathoms.

Off Ôse Zaki, Suruga Gulf; 45-48 fathoms (CLARK). Sea of Japan; 70 fathoms (CLARK).

In my opinion, the present species is evidently referable to *Amphiura* s. str., though CLARK refers it to *Amphiodia*. The distal oral papillæ are usually two in number on either side, both arising from the adoral shield. In some cases, there are three

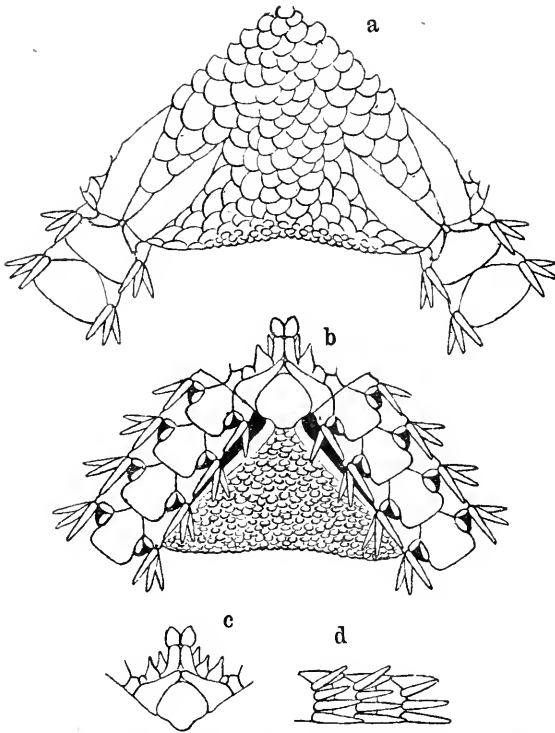

Fig. 54. *Amphiura digitata*.  $\times 15$ . *a*. From above. *b*. From below. *c*. Ventral view of an oral angle. *d*. Side view of three arm joints near disk.

distal oral papillæ, of which one arises from the oral plate (fig. c); besides, there is an additional papilla, which evidently corresponds to the scale of the first oral tentacle, just inside and above the innermost one of the distal papillæ, thus almost approaching the type of the oral papillæ of *Amphioplus*. The disk is light bluish and the arms whitish in colour in alcohol.

### *Amphiura bellis* LYMAN.

*Amphiura bellis*: LYMAN, Bull. Mus. Comp. Zool., VI, Pt. 2, 1879, p. 19; LYMAN, Rep. Challenger, V, 1882, p. 127, Pl. XVIII, figs. 4-6, Pl. XL, figs. 16-18; CLARK, Bull. U. S. Nat. Mus., LXXV, 1911, p. 140.

Sagami Sea; 345-775 fathoms (LYMAN). Off Manazuru Zaki, Sagami Sea; 120-265 fathoms (CLARK). Off Ôsé Zaki, Suruga Gulf; 63-75 fathoms (CLARK). Off Omai Zaki; 624 fathoms (CLARK). Off Kii; 649 fathoms (CLARK).

Lat.  $19^{\circ} 10' S.$ , long.  $178^{\circ} 10' E.$ ; 210-610 fathoms (LYMAN).

*Amphiura trachydisca* CLARK.

*Amphiura trachydisca*: CLARK, Bull. U. S. Nat. Mus., LXXV, 1911, p. 149, fig. 60.

One specimen; Yahagi-gaké, Sagami Sea; 310 fathoms.  
Two specimens; Nakano-yodomi, Sagami Sea; 210 fathoms.  
Numerous specimens; Okinosé, Sagami Sea; 100 fathoms.  
Numerous specimens; Sagami Sea.

Off Heda; 161–167 fathoms (CLARK). Suruga Gulf; 108–148 fathoms (CLARK). Uraga Channel; 88 fathoms (CLARK).

The largest one of these specimens is 15 mm. across the disk. Those from Okinosé are somewhat different from the other specimens, which agree quite well with CLARK's type, and have an almost smooth disk and relatively narrower arms, though there is no doubt that they belong to this species.

*Amphiura microdiscus* DUNCAN.

*Hemipholis microdiscus*: DUNCAN, Journ. Linn. Soc. London, XIV, 1879, p. 467, Pl. X, figs. 20–22; LYMAN, Rep. Challenger, V, 1882, p. 158.

Korea Strait; 51 fathoms (DUNCAN).

According to DUNCAN, this species has two pairs of oral papillæ to each oral angle, the apical ones being infradental and the distal ones arising from the adoral shields. There is therefore no doubt that, this species is a genuine *Amphiura* and not a *Hemipholis*.

*Amphiura euopla* CLARK.

*Amphiura candida*: MARKTANNER-TURNERETSCHER, Ann. K. K. Naturh. Hofmus., II, 1887, p. 299. (Non LJUNGMAN, 1866.)

*Amphiura euopla* : CLARK, Bull. U. S. Nat. Mus., LXXV, 1911, p. 144, fig. 57.

One specimen ; Enoshima, Sagami. Numerous specimens ; Misaki. Numerous specimens ; Izuhara, Tsushima.

Off Ôsé Zaki, Suruga Gulf ;  
45–60 fathoms (CLARK).

The specimen from Enoshima is the largest of all, being 6 mm. in the disk diameter, and is the only one in which the primaries are invisible. The others are all small, and have conspicuous primaries and distinctly squamated interbrachial ventral surfaces. The distal oral papilla is not so long and spini-form as in CLARK'S type, and the oral shields are not so long, but slightly longer than wide. Further, in the smaller specimens, they are as wide as, or wider than, long. The arm spines are much flattened, except in the basal region of the arms, and are thorny at the end, with the exception of the uppermost one or two. In the smaller specimens, they are less flattened and less thorny.

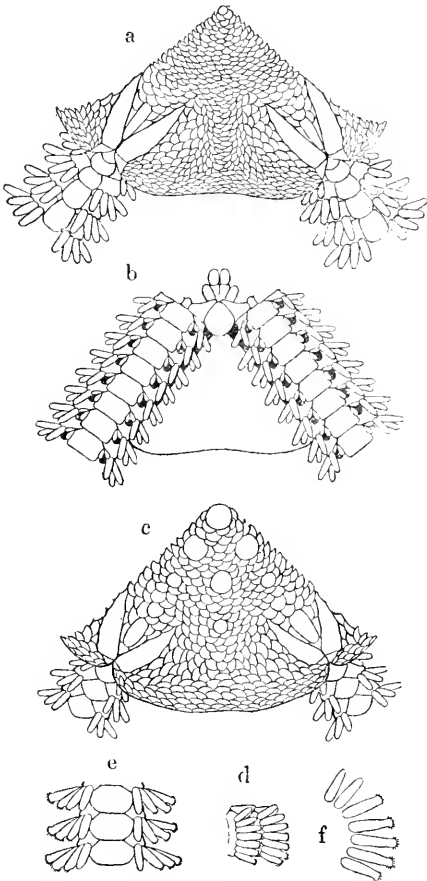

Fig. 55. *Amphiura euopla*. a. From above.  $\times 8$ . b. From below.  $\times 8$ . c. Young specimen, from above.  $\times 14$ . d. Side view of two arm joints near disk.  $\times 8$ . e. Dorsal view of three arm joints near disk.  $\times 8$ . f. Arm spines of one side of an arm joint near disk.  $\times 14$ .



*Amphiura acrystata* CLARK.

*Amphiura acrystata*: CLARK, Bull. U. S. Nat. Mus., LXXV, 1911, p. 145, fig. 58.

Numerous specimens; Okinosé (a submarine bank), Sagami Sea; 85 fathoms.

Off Tsurugi Zaki; 110–259 fathoms (CLARK). Off Kii; 191 fathoms (CLARK). Sea of Japan; 59 fathoms (CLARK). Southwards from Hokkaidô; 269–464 fathoms (CLARK).

California; 8–33 fathoms (CLARK).

In the larger specimens, the disk coverings remind us of those of the *Ophionephthys*-type, the tentacle scales being however well developed. This species may be brought forward to prove the small taxonomic value of the reduction of the disk scales, which is the character separating *Ophionephthys* from *Amphiura*.

*Amphiura acacia* LYMAN.

*Amphiura acacia*: LYMAN, Bull. Mus. Comp. Zool., VI, Pt. 2, 1879, p. 21, Pl. XI, figs. 292–294; LYMAN, Rep. Challenger, V, 1882, p. 130, Pl. XVI, figs. 15–17.

Yenshû Sea; 565 fathoms (LYMAN).

*Amphiura pycnostoma* CLARK.

*Amphiura pycnostoma*: CLARK, Bull. U. S. Nat. Mus., LXXV, 1911, p. 151, figs. 62.

Off Kii, Kumano Sea; 440 fathoms (CLARK).

*Amphiura carchara* CLARK.

*Amphiura carchara*: CLARK, Bull. U. S. Nat. Mus., LXXV, 1911, p. 142, fig. 55.

Sagami Sea; 614 fathoms (CLARK).

Bering Sea. Alaska. Washington.

*Amphiura iris* LYMAN.

*Amphiura iris* : LYMAN, Bull. Mus. Comp. Zool., VI, Pt. 2, 1879, p. 23, Pl. XI, figs. 302-304 ; LYMAN, Rep. Challenger, V, 1882, p. 132, Pl. XVI, fig. 4-6 ; KÖHLER, Exp. Siboga, XLV, Pt. 1, 1904, p. 81.

One specimen ; Mera-out-Oisegaké ; Sagami Sea ; 300 fathoms. Seven specimens ; Okinosé (a submarine bank), Sagami Sea ; 85 fathoms.

Sagami Sea ; 420-775 fathoms (LYMAN).

Malaysian waters ; 1,595m. (KÖHLER).

The first specimen, which is the largest, measures 5.5 mm. across the disk and 25 mm. in the arm length. The disk scales are fine, ill-defined, convex and pavement-like, so that the dorsal surface of the disk appears rough. The radial shields are long, narrow, bar-like, about half as long as the disk radius, about four times as long as wide, completely separated from each other, those of a pair almost parallel. The distal oral papilla is sub-quadrangular, with truncated or indented free end. The apical one is also squarish, but slightly smaller than the distal one. The additional papilla, which corresponds to the scale of the first oral tentacle pore, is also squarish, with truncated or indented free end, smaller than the distal, but larger than the apical one. The dorsal arm plates are rather oval and slightly in contact with one another ; the surface is convex both transversely and longitudinally, so that the plate is more or less humped. The ventral arm plates are subpentagonal, slightly in contact with one another. The arm spines are variable in length ; the ratio of their length to the corresponding arm joint in different parts of an arm may be shown approximately as follows :—

Number of lateral arm plates. Number of arm spines.	1st.	5th.	10th.	15th.	20th.	30th.
Uppermost . . . . .		1.6				
4th. from below . . . . .		1.3	1.2	1.2	1.2	
3rd. from below . . . . .		0.9	0.9	1.0	1.1	1.2
2nd. from below . . . . .	0.5	1.1	1.1	1.2	1.1	1.1
Lowest . . . . .	1.2	1.4	1.8	1.7	1.6	1.4

The tentacle scale is oval and leaf-like, but relatively smaller than in the next species.

*Amphiura iridoides*, sp. nov.

*Amphiura glabra*: MARKTANNER-TURNERETSCHER, Ann. K. K. Naturh. Hofmus., II, 1887, p. 300. (Non LYMAN, 1879.)

Twelve specimens; Mera-out-Oisegaké, Sagami Sea; 300 fathoms.

Diameter of disk 4 mm. Length of arms 20 mm. Width of arms at base 0.9 mm.

Disk subpentagonal, with more or less straight interbrachial borders, covered with rather fine, imbricating scales, which are finer outwards than inwards. Six primaries prominent, distinctly larger than the other scales. Radial shields rather large, pear-seed-shaped, about two-fifths as long as the disk radius, two and a half to three times as long as wide, widest at about one-third of the entire length from the outer end, entirely separated from each other, divergent. Interbrachial ventral surfaces covered also with fine, imbricating scales, which are finer than those of the dorsal side. Genital slits long, extending from the oral shields to the disk border.

Oral shields small, rhomboidal, with obtuse inner and rounded

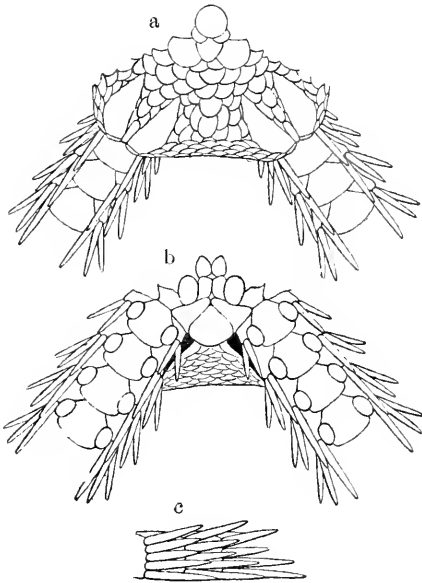

Fig. 56. *Amphura iridoides*.  $\times 14$ . *a*. From above. *b*. From below. *c*. Side view of three arm joints near disk.

lateral and outer angles, about as wide as long. Adoral shields also small, triangular, with concave adradial side, longer than wide, tapering inwards, nearly meeting with each other in the interradian line. Oral plates rather short, very narrow. There is a small, naked, depressed space between the adoral shields and the oral plates of each oral angle. Two oral papillæ on either side; the distal one, arising from the adoral shield, is very large, oval, flat, thin and leaf-like; the apical one is infradental,

small, short, very thick. Teeth quadrangular and thick.

Arms stout in comparison to the disk diameter, more or less cylindrical, wider than high, very gradually tapering outwards. Dorsal arm plates fan-shaped, with convex outer border, wider than long, wider outwards than inwards; the surface is nearly level longitudinally, but decidedly convex transversely. Lateral arm plates rather high, those of the two sides not meeting with each other above or below, except in the very distal arm joints; they are almost covered over by the arm spines. First ventral arm plates not very small, pentagonal, wider than long. Those beyond hexagonal, with the shortest inner lateral sides and longest and convex outer border, lateral sides concave, corresponding to the tentacle pore; about as long as, or longer than, wide, widest at the outer ends of the tentacle pores, faintly

keeled along the longitudinal median line, widely in contact with each other. Five arm spines, long, flattened, acute, unequal in length; the ratio of their length to the corresponding arm joint in different parts of an arm may be shown approximately as follows.

Number of lateral arm plates. Number of arm spines.	1st.	5th.	10th.	15th.	25th.	35th.
Uppermost .....		1.4	1.4	1.3		
4th. from below .....		1.2	1.2	1.1	1.1	1.1
3rd. from below .....		1.0	1.0	1.0	1.0	0.9
2nd. from below .....	1.0	1.3	1.4	1.3	1.2	1.1
Lowest .....	1.3	1.5	2.0	3.0	1.8	1.4

Thus, the lowest spine is always the longest and the third from below the shortest; the lowest one is longest at a certain distance from the disk, being there about thrice as long as the corresponding arm joint. Single, very large, oval, flat, leaf-like tentacle scale to each pore.

Colour in alcohol: whitish, except the dorsal side of the disk, which is frequently light blue.

This new species is very near to *A. iris*, which occurs also in the Sagami Sea, but differs from it in the distinctive characters already mentioned. Further, *A. iridoïdes* appears to me to differ from *A. glabra* LYMAN in the very prominent primary plates, in the distinctly squamated interbrachial ventral surfaces, in the much smaller and narrower oral shields, in the not very distinctly separated adoral shields, in the larger, oval, flattened distal oral papillæ, in the longer and flattened arm spines, and in the larger tentacle scales. Judging from MARKTANNER-TURNERETSCHER'S description, the specimen which he refers to *A. glabra* appears to me likely to belong to *A. iridoïdes*.

*Amphiura lütkeni* DUNCAN

*Amphiura lütkeni*: DUNCAN, Journ. Linn. Soc. London, XIV, 1879, p. 464, Pl. X, fig. 17. (Non LYMAN, 1882.)

*Amphiura duncani*: LYMAN, Rep. Challenger, V, 1882, p. 143; LORIOU, Rev. Suiss. Zool., I, 1893, p. 403; KÖHLER, Res. Exp. Siboga, XLV, Pt. 2, 1905, p. 33.

Korean Seas (DUNCAN).

Malaysian waters (KÖHLER).

The specific name of this species was changed by LYMAN, because he thought that, after the union of LJUNGMAN'S *Amphipholis* with *Amphiura*, *Amphiura lütkeni* was preoccupied by *Amphipholis lütkeni* of LJUNGMAN. Now, the latter species has been referred by VERRILL to *Ophiocnida* or possibly to *Amphiodia*, so that the specific name of the present species can be revived.

*Amphiura micraspis* CLARK.

*Amphiura micraspis*: CLARK, Bull. U.S. Nat. Mus., LXXV, 1911, p. 150, fig. 61.

Off Omai Zaki; 36 fathoms (CLARK).

*Amphiura astuarii* MATSUMOTO.

*Amphiura astuarii*: MATSUMOTO, Proc. Acad. Nat. Sci. Philadelphia, 1915, p. 73.

Numerous specimens; Aburatsubo, Misaki Marine Biological Station.

Diameter of disk 6 mm. Length of arms 75 mm. Width of arms at base 0.8 mm.

Disk five-lobed, covered by a soft naked skin, except along

the abradial and inner borders of the radial shields, where it is covered by fine, imbricating scales, arranged in four or five rows on the inner border but in only one on the outer part of the abradial side, and finer inwards than outwards. Naked part of radial shields large, pear-seed-shaped, more than half as long as the disk radius, more than twice as long as wide, hardly in contact without, slightly divergent within. Interbrachial ventral surfaces also covered by a soft naked skin. Genital slits long.

Oral shields rhomboidal, or pentagonal with a very short inner side and a much rounded outer angle; wider than long; madreporic shield much larger and almost circular.

Adoral shields triangular with concave adradial side, tapered within, where they do not meet. Two pairs of oral papillæ in each oral angle; apical ones oval and very stout; distal ones spiniform, obtuse, arising from the adoral shields. Besides, there occurs one spiniform papilla on either side just above the distal one.

Dorsal arm plates transversely oval, twice as wide as long, successive plates in contact. Lateral arm plates not very prominent, almost concealed by the arm spines, not meeting above

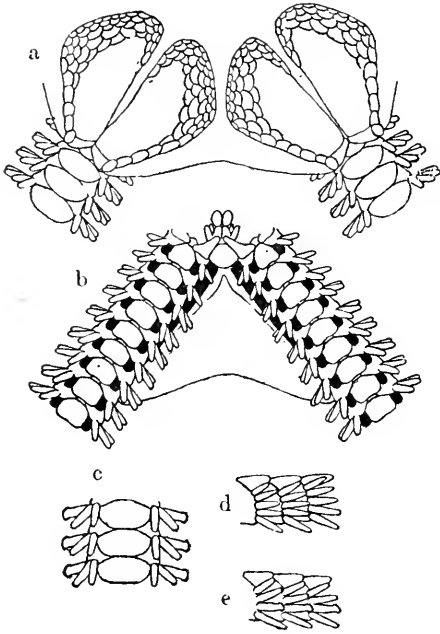

Fig. 37. *Amphipura astuarii*  $\times 10$ . *a*. From above. *b*. From below. *c*. Dorsal view of three arm joints at about one-third of the arm length from the base. *d*. Side view of three arm joints near disk. *e*. Side view of three arm joints at about one-third of the arm length from the base.

or below, not in contact on the sides, but separated by a naked space. First ventral arm plate very small, pentagonal or quadrangular, wider within than without. Those beyond quadrangular, with convex inner side, notched outer side and rounded outer angles; wider than long, except the basal one or two; the successive plates are not in contact but separated by narrow spaces, where the ventral ends of the lateral arm plates are wedged in. Arm spines five in the basal joints, but four in the middle part of the arms, subequal, but slightly longer downwards, nearly equal to, or a little longer than, the corresponding arm joint; they are conical and obtuse in the proximal joints, but are flattened more distally; the second spine from below is especially flattened and rather spur-shaped, with numerous thorns on the very much flattened end; the lowest one, as well as the third from above is also somewhat thorny at the end. Tentacle pores large, without scales.

Colour in alcohol: disk gray, radial shields and arms straw-yellow.

*A. estuarii* differs from *A. phalerata* (LYMAN, 1874) and the next species, *A. radicola*, in the shape of the radial shields, in the much shorter arms and in the dorsal arm plates, which are very wide even in the basal arm joints. *A. estuarii* appears to be closer to *A. phalerata* than to *A. radicola* in the arm spines, which are four or five in number and less flattened and rather conical in the basal arm joints. Further, *A. estuarii* differs from *A. cenomiotata* in the shape of the radial shields, and of the dorsal and ventral arm plates, as well as in the fewer and less thorny arm spines.

*A. estuarii* can be easily obtained together with *A. euopla* by dredging in the muddy bottom of Aburatsubo Cove. It probably



lives buried in mud, as *A. vadicola* does in sand, and I believe that, the reduced disk scales and the numerous and thorny arm spines are correlated with its mode of life.

*Amphiura vadicola* MATSUMOTO.<sup>1)</sup>

*Ophioneplthys phalerata*: MARKTANNER-TURNERETSCHER, Ann. K. K. Naturhist. Hofmus., II, 1887, p. 301. (Non LYMAN, 1874.)

*Amphiura vadicola*: MATSUMOTO, Proc. Acad. Nat. Sci. Philadelphia, 1915, p. 71.

Numerous specimens; Sakura-jima, Kagoshima Gulf. One specimen; Chintô, Korea.

Diameter of disk 8 mm. Length of arms 260 mm. Width of arms at base 1 mm., at the widest part 1.3 mm.

Disk five-lobed, with indented interbrachial borders, covered by a soft naked skin, except along the abradial and inner borders of the radial shields, where it is covered by several rows of fine, imbricating scales. Radial shields large, long, pear-seed-shaped; naked part two-thirds to one-half as

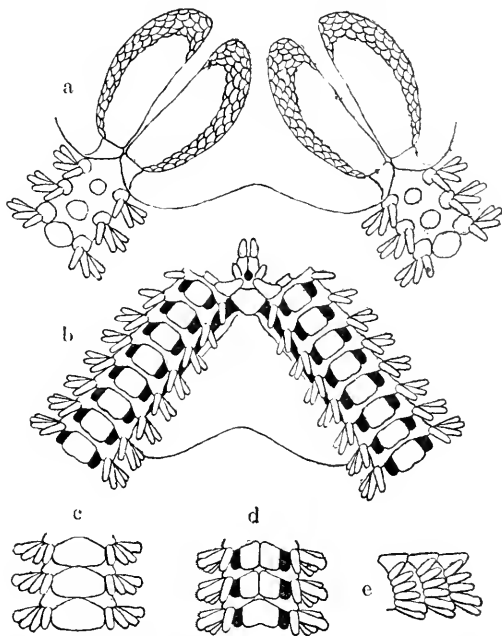

Fig. 58. *Amphiura vadicola*.  $\times 7$ . a. From above. b. From below. c. Dorsal view of three arm joints at about the widest part. d. Ventral view of three arm joints at about the widest part. e. Side view of three arm joints somewhat near disk.

1) As to the interesting life mode of this ophiuran, see Prof. MITSUKURI & HARA'S "The Ophiurian Shoal" in Annot. Zool. Japon., I, 1897, p. 68.

long as the disk radius, and about thrice as long as wide. Inter-brachial ventral surfaces covered also by a soft naked skin. Genital slits long. Genital scales not very conspicuous unless the specimen is dried, arranged in a row and overlapping one another.

Oral shields pentagonal, with rounded angles, outer sides longest, inner side a little concave; madreporic shields much larger and almost circular. Adoral shields triangular, with concave adradial side, neither meeting radially nor interradially. There is a more or less conspicuous depression between the oral plates, as in *Ophiothrix*. Two oral papillae on either side of the oral angle, conical, blunt, very stout; the distal one arises from the adoral shield, and is longer than the apical one.

Arms exceedingly long, more than thirty times as long as the disk diameter; they are widest at about one-third of the entire length of the arms from the base. Dorsal arm plates almost oval, bounded within by two nearly straight lines forming a very large and obtuse angle, and without by a curve, which is nearly flat medially but very convex laterally; about twice as wide as long, successive plates slightly in contact. In the basal joints, they are very small and separated by spaces which are covered by a soft naked skin. Lateral arm plates not very prominent, almost covered over by the arm spines, not meeting above or below, nor in contact on the sides but separated by a naked space. First ventral arm plate very small, quadrangular, wider than long. Those beyond quadrangular, wider than long, except the basal one or two, which are as long as, or longer than, wide. They increase in size, especially in width, outwards, and become pentagonal beyond the disk, with large and obtuse inner angle, rounded outer angles, and notched outer side; the successive plates are separated

by very narrow spaces, where the ventral ends of the lateral arm plates are wedged in. The ventral arm plates are often divided into halves along the median line. Arm spines six or seven near the base, five or six in the middle part of the arms, peg-like, flattened, blunt, longer downwards, nearly equal to, or slightly longer than, the corresponding arm joint; much flattened and thorny at the end, except the uppermost one or two; the second one from below is spur-shaped and very thorny. Large tentacle pores, unprotected.

Colour in alcohol brown; the scales around the radial shields are lighter; arms grayish brown to gray in the outer parts.

This species is very near to *A. phalerata* (LYMAN, 1874) but differs from it in the much larger radial shields, in the not oval but pentagonal oral shields, in the adoral shields being joined neither radially nor interradially, in the more projecting oral angles, in the dorsal arm plates being in contact with one another, in the ventral arm plates being separated from one another and not very wide basally, and in the not cylindrical but much flattened and thorny arm spines. *A. radicola* differs from *A. cenomiotata* CLARK in the exceedingly long arms, in the shape of the dorsal and ventral arm plates, and in the fewer arm spines.

*Amphiura cenomiotata* CLARK.

*Amphiura cenomiotata*: CLARK, Bull. U. S. Nat. Mus., LXXV, 1911, p. 148, fig. 59.

Off Seno-umi, Suruga Gulf; 31-41 fathoms (CLARK).

*Ophiocentrus verticillatus* (DÖDERLEIN).

*Ophiocnida verticillata*: DÖDERLEIN, SEMON-Zool. Forschungsr. Austr.

u. Malay. Arch., 1896, p. 287, Pl. XIV, figs. 2a & b, Pl. XV, figs 7 & 7a  
 KOEHLER, Exp. Siboga, XLV, Pt. 2, p. 29, Pl. II, fig. 4.

One specimen; Enoshima. One specimen; perhaps Misaki.

Malaysian waters.

The first specimen is about 5 mm. across the disk, and has eight arm spines in the basal joints. The second is about 12 mm., and has only seven arm spines notwithstanding its larger size.

The arm spines decrease in number rather rapidly outwards, there being only about five in the middle part of the arms. They are not so flattened as in DÖDERLEIN'S type, and are rather thorny at the end as in KOEHLER'S. The disk is covered, between the spines, by a thick skin; but on drying, the scales around the radial shields become visible, so that the disk is like that of an *Ophiophtlys*, if we leave the spines out of consideration. The colour in alcohol of the larger specimen is dark olive green on the disk and light yellow

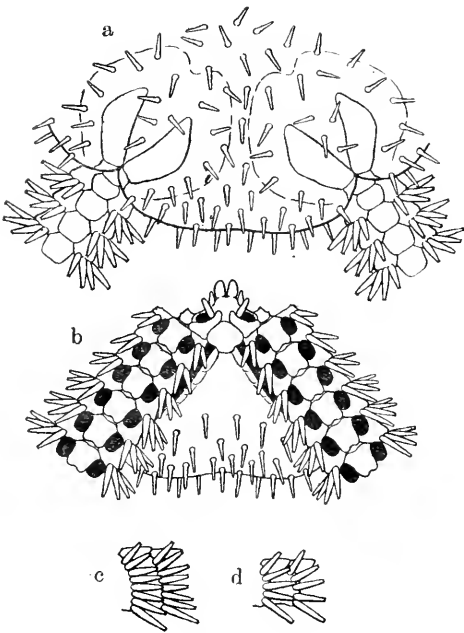

Fig. 59. *Ophiocentrus verticillatus*.  $\times 8$ . *a.* From above. *b.* From below. *c.* Side view of two arm joints near disk. *d.* Side view of two arm joints in the middle part of an arm.

on the arms.

### Family 3. Ophiotrichidæ LJUNGMAN, 1867.

Disk covered with plates or scales, or by a naked skin, very

often beset with minute spines or stumpy tubercles. Radial shields very large, with a conspicuous articular socket on the ventral surface near the outer end, fitting to the large, ball-like articular condyle of the genital plate. Genital plates firmly fixed to the basal vertebrae. Genital scales short, wide, flat, articulating with the genital plates near the outer end of the latter. Besides, there occur a pair of short, flat scales, just outside each oral shield, supporting the proximal abradial border of the genital slits. Peristomial plates small, entire. Oral frames very stout, with well developed lateral wings for the attachment of voluminous masticatory muscles. In internal view the oral and dental plates are very stout, together forming an **X**-shape. Teeth very stout, widened, squarish. Dental papillæ well developed, forming a vertical clump at the apex of each jaw. Oral papillæ absent. Arms inserted ventrally to the disk, horizontally flexible or capable of coiling vertically. Dorsal side of the vertebrae **Y**-shaped, being conspicuously notched inwards. Vertebral articulation zygospondyline, the articular peg being always present. Arm spines either moderately long, conical and opaque, or very long, flattened, serrate and hyaline. Tentacle pores large, with one or two scales or none.

This family includes fifteen genera, as follows.

*Ophiothrix* MÜLLER & TROSCHEL, 1842.

*Ophiopterion* LUDWIG, 1888.

*Ophiocampsis* DUNCAN, 1887.

*Ophiotrichoides* LUDWIG, 1882.

*Ophiomaza* LYMAN, 1871.

*Ophiophthyrus* DÖDERLEIN, 1897.<sup>1)</sup>

*Ophiocnemis* MÜLLER & TROSCHEL, 1842.

---

1) It is possible that, *Ophiophthyrus* may be merely a very young stage of *Ophiomaza* or *Ophiotrichoides* or an allied genus.

*Ophiothela* VERRILL, 1867. (= *Ophioteresis* BELL, 1892).

*Ophiopsammium* LYMAN, 1874.

*Ophiogymna* LJUNGMAN, 1866.

*Lütkenia* BROCK, 1888.

*Gymnolophus* BROCK, 1888.

*Ophio'ophus* MARKTANNER, 1887.

*Ophioethiops* BROCK, 1888.

*Ophiosphaera* BROCK, 1888.

The internal structures of this family are very uniform and essentially similar to those of the *Amphiuridae*. In *Ophiothrix nereidina* (LAMARCK), the oral frames are very stout, with very well developed lateral wings for the attachment of voluminous masticatory muscles. The peristomial plates are very small, entire, transversely bar-like, with a very slight notch at the middle of the outer border. The oral and dental plates are very stout, together forming an X-shape in internal view. The teeth are also very stout and quadrangular. The genital plates are very long, bar-like, firmly fixed to the third to sixth vertebra, with a very conspicuous, ball-like articular condyle near the outer end to fit into the large articular socket of the radial shield; just anterior to the articular condyle, there occurs a wing with a depression for the attachment of the muscle between the genital plate and radial shield. The genital scales are short, wide, flat, leaf-like, articulating with the genital plate near the outer end of the latter. In internal view the radial shields are extremely large and triangular, has a very large articular socket at the outer adradial corner, and are completely joined in pairs. As seen from the dorsal side the first vertebra is very short and rhomboidal; the second, which is the shortest, almost linear transversely; the third like a cross, with

slender transverse and stout longitudinal bars; those beyond **Y**-shaped. The internal structures of *Ophiothrix koreana* DUNCAN are almost similar to those of the preceding, but the peristomial plates are distinctly larger, the genital plates are shorter and firmly fixed only to the third and fourth vertebræ, and the genital scales are much smaller. In *Ophiothela danæ* VERRILL, the oral frames are less stout than in *Ophiothrix nereidina* and *O. koreana*, but have also well developed lateral wings with wavy peripheries. The peristomial plates are small and oval and have a conspicuous notch at the middle of the outer border. The genital plates are firmly fixed to the first to third or fourth vertebræ, and have also a conspicuous ball-like articular condyle near the outer end; the muscle impression just anterior to the articular condyle is not very distinctly differentiated. The genital scales are also short, wide, flat and leaf-like. The dorsal side of the first vertebra is like a cross, with very slender transverse and stout longitudinal bars; and of those beyond **Y**-shaped. Judging from LYMAN'S statements, *Ophiomaza*, *Ophiocnemis*, *Ophiopsammium* and *Ophiogymna* do not appear to differ fundamentally in their internal structures from the forms here described.

### Key to Japanese genera of *Ophiotrichida*.

- A*—Dorsal arm plates entire.  
*a*—Disk beset with spines or stumpy tubercles; arm spines long, flattened, serrate, hyaline. . . . . *Ophiothrix*.  
*aa*—Disk entirely free of spines or tubercles; arm spines of moderate length, conical, entire, opaque . . . . . *Ophiomaza*.  
*AA*—Dorsal arm plates represented by a number of nodule-like granules or secondary plates; disk beset with granules or tubercles; arm spines of moderate length, conical, serrate, hyaline. . . . . *Ophiothela*.

**Key to Japanese species of *Ophiothrix*.**

- A*—Dorsal arm plates more or less rhomboidal, not very wide, only slightly wider than long or longer than wide, only slightly in contact with one another.
- a*—Ventral arm plates notched outwards.
- b*—Arms short, less than five times as long as the disk diameter.
- c*—Radial shields entirely or mostly naked.
- d*—First dorsal arm plate with a tubercle, on which a conspicuous spine is borne; disk closely beset with spines, which are cylindrical, blunt and rough at tip.....*panchyendlyta*.
- dd*—First dorsal arm plate free of tubercles and spines; disk beset with trifold, or rarely bifid, tubercles or thorny spines of various length or with both ..... *koreana*.
- cc*—Radial shields, as well as disk, closely beset with stout, thorny spines of almost uniform length.....*marenzelleri*.
- bb*—Arms long, twelve to fifteen times as long as the disk diameter; radial shields covered by a thick skin, except at the outer adradial border, where they are naked; disk beset on the dorsal side with slender, thorny spines of various length .....*macrobrachia*.
- ca*—Ventral arm plates with entire and convex outer border; arms four to seven times as long as the disk diameter.
- e*—Radial shields naked; disk beset with bifid or trifold tubercles and thorny spines .....*eusteira*.
- ce*—Radial shields, as well as disk, closely beset with stellate tubercles and thorny spines.....*stabilis*.
- AA*—Dorsal arm plates more or less fan-shaped, very wide, much wider than long, widely in contact with one another.
- f*—Dorsal side of disk entirely free of spines or tubercles, or beset with a group of thorny tubercles only at the central region, with a beautiful network of white streaks; each dorsal arm plate with a transverse white streak; arms about fifteen times as long as the disk diameter.....*neveidina*.



- f*'—Disk, and radial shields usually, closely beset with minute tubercles, without a network of white streaks; dorsal arm plates free of transverse white streaks.
- g*—Arms six to thirteen times as long as the disk diameter; arm spines of free basal arm joints not exceedingly short.
- h*—Arms seven to nine times as long as the disk diameter; outer lateral angles of the dorsal arm plates perfectly rounded.
- i*—Arms about seven times as long as the disk diameter; dorsal arm plates less than twice as wide as long, with well defined inner lateral angles and the lateral borders moderately divergent outwards; middle arm spines clavate . . . . . *obtusa*.
- ii*—Arms about nine times as long as the disk diameter; dorsal arm plates more than twice as wide as long, with the lateral borders very strongly divergent outwards, so that the inner and lateral borders practically form one continuous curve; arm spines not clavate . . . . . *hirsuta*.
- hh*—Arms about thirteen times as long as the disk diameter; dorsal arm plates more than twice as wide as long, with the inner and outer lateral angles not rounded but sharp; each plate with three white spots along the outer border; arm spines not clavate. . . . .  
. . . . . *punctolimbata*.
- gy*—Arms about eighteen times as long as the disk diameter; spines of free basal and more internal arm joints exceedingly short; dorsal arm plates about twice or more than twice as wide as long, with very well defined angles and borders . . . . . *longipeda*.

*Ophiothrix pauchyendyta* CLARK.

*Ophiothrix pauchyendyta*: CLARK, Bull. U. S. Nat. Mus., LXXV, 1911, p. 264, fig. 131.

Korea Strait; 59 fathoms (CLARK).

*Ophiothrix koreana* DUNCAN.

*Ophiothrix koreana* : DUNCAN, Journ. Linn. Soc. London, XIV, 1879, p. 473, Pl. XI, figs. 28-32; LYMAN, Rep. Challenger, V, 1882, p. 226; MARKTANNER-TURNERETSCHER, Ann. K. K. Naturh. Hofmus. Wien, II, 1887, p. 308; CLARK, Bull. U. S. Nat. Mus., LXXV, 1911, p. 257, figs. 127 & 128.

Numerous specimens; off Nii-jima, Sagami Sea. Numerous specimens; off Jōga-shima, Sagami Sea. Numerous specimens; Uraga Channel.

Hakodaté Bay; 11.5-15.5 fathoms (CLARK). Gulf of Tokyo; 169 fathoms (CLARK). Uraga Channel, 58-302 fathoms (CLARK). Sagami Sea; 41-153 fathoms (CLARK). Suruga Gulf; 13-150 fathoms (CLARK). Sea of Japan; 44-114 fathoms (CLARK). Korea Strait; 23-59 fathoms (DUNCAN, CLARK). Eastern Sea; 53-181 fathoms (CLARK). Kagoshima Gulf; 58 fathoms (CLARK). Off Satsuma; 39-51 fathoms (CLARK).

Molucca (MARKTANNER-TURNERETSCHER).

The disk covering is very variable, as noted by CLARK. The colour is whitish or partly light pink in alcohol. In some specimens, the arms are annulated with light pink; in others, some of the dorsal arm plates, besides being annulated, bear each a red spot; in still others, the annulation of the arms is very faint, although the red spots are present; in a fourth lot, the red spots are present on all the dorsal arm plates, but the annulations are entirely absent. These red spots may possibly be phosphorescent organs.

*Ophiothrix marezzelleri* KOEHLER.

*Ophiothrix stelligera* : MARKTANNER-TURNERETSCHER, Ann. K. K. Naturh. Hofmus., Wien, II, 1887, p. 310. (Non LYMAN, 1874.)

*Ophiolirix marenzelleri*: KÖHLER, Mem. Soc. Zool. Fr., XVIII, 1904, p. 103, figs. 77-78.

*Ophiolirix hylodes*: CLARK, Bull. U.S. Nat. Mus., LXXV, 1911, p. 263, fig. 130.

Littoral form:—Two specimens; Tomo, Bingo. Two specimens; Toba, Shima. Numerous specimens; Arai Beach to Gorgonian Cave, Misaki Marine Biological Station. Numerous specimens; entrance of the Gulf of Tokyo.

Sublittoral form:—Eight specimens; Kagoshima Gulf; 70 fathoms. Five specimens; Asami Bay, Tsushima. Numerous specimens; off Jôga-shima, Sagami Sea. One specimen; Kominato, Bôshû.

In the littoral form, which may be taken as the type of this species, the disk is closely and uniformly covered with thorny spines. The arm spines are much widened toward the end and somewhat clavate at the top. The colour of the body is very variable, and may be green, blue, brown, or purple, or very often variegated with combinations of these colours. The arms are annulated, and there is on the dorsal side usually a longitudinal white or light-coloured striation hemmed by two lines of a darker shade, running along the entire length of the arm.

In the sublittoral form, the disk is closely and uniformly covered with fine tubercles bearing several thorns on the top and sometimes also on the sides. In some specimens there are also a few long, slender, rough spines on the dorsal surface of the disk. The arm spines are slender like those of *O. korcanai*, and not so widened towards the ends or clavate at the top as in the littoral form. The colour of the body is very variable, but on the whole lighter than in the littoral form. The arms are annulated, but there is no distinct longitudinal striation on the dorsal surface.

The sublittoral form approaches *O. koreana* more closely than the littoral form. It is also somewhat probable that, the present species may prove to be an extreme variety of *O. koreana*, as suspected by CLARK.

*Ophiothrix macrobrachia* CLARK.

*Ophiothrix macrobrachia*: CLARK, Bull. U. S. Nat. Mus., LXXV, 1911, p. 267, fig. 133.

Numerous specimens; Off Nii-jima, Sagami Sea. Numerous specimens; Okinosé, a submarine bank, Sagami Sea. One specimen; off Jôga-shima, Sagami Sea; 75 fathoms. Four specimens; Uraga Channel.

Suruga Gulf; 34-131 fathoms (CLARK). Bungo Channel; 65 fathoms (CLARK). Korea Strait; 59 fathoms (CLARK). Eastern Sea; 95-135 fathoms (CLARK).

In my specimens, the arms are somewhat shorter than in CLARK's type. For example, one specimen has the disk diameter of 10 mm. and an arm length of 115 mm. Some specimens bear one or several individuals of a species of parasitic gastropods, *Stylifer* or its allies. The parasites are attached to the host at the genital slits, as figured by KÆHLER in *Ophiothrix crassispira* KÆHLER, 1904. The shell of the parasites is almost white or light pink in alcohol.

*Ophiothrix eusteira* CLARK.

*Ophiothrix eusteira*: CLARK, BULL. U. S. Nat. Mus., LXXX, 1911, p. 265, fig. 132.

Two specimens; Pinnacle Is. Three specimens; off Jôgashima, Sagami Sea; 75 fathoms. Numerous specimens; off Misaki,

Sagami Sea. Numerous specimens; off Uki-shima, Uraga Channel.  
One specimen; Kominato, Bôshû.

Ôshima (CLARK).

The disk scales become almost visible on drying, and there

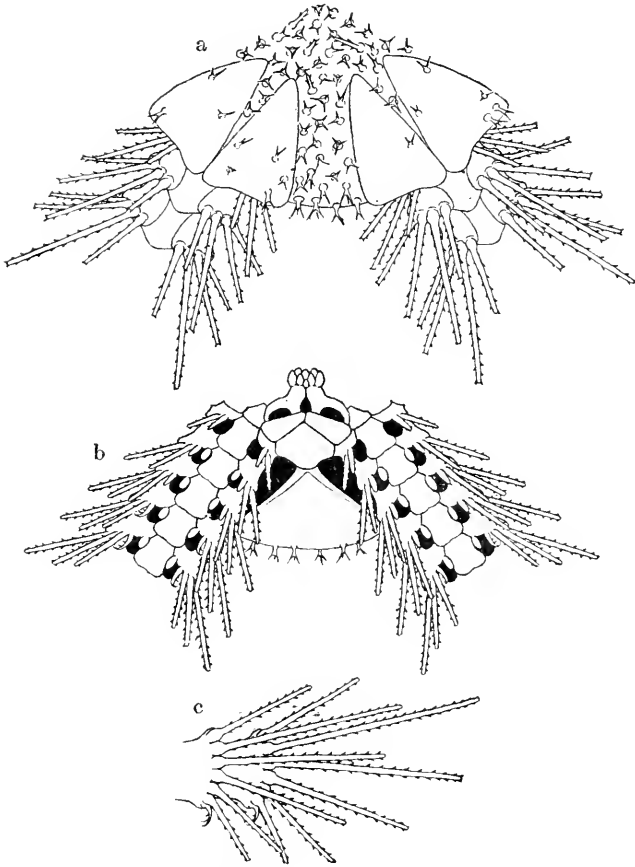

Fig. 60. *Ophiotrix eustera*,  $\times 13$ . *a*. From above. *b*. From below. *c*. Side view of two arm joints near disk.

are four or five rows of them in each interradial space on the dorsal side. In many specimens and especially in younger ones, a small, circular, depressed central plate is visible. The dorsal surface of the disk is usually covered with thorny spines and spiny tubercles, but sometimes with only one of the two forms. The arm spines are

very slender, and often not much flared laterally. The present species appears to resemble *O. galapagensis* LÜTKEN & MORTENSEN in certain points.

*Ophiothrix stabilis* KÖHLER.

*Ophiothrix stabilis*: KÖHLER, Mem. Soc. Zool. Fr., XVII, 1904, p. 84, figs. 46-49.

*Ophiothrix ciliaris*: CLARK, Bull. U. S. Nat. Mus., LXXV, 1911, p. 257. (Non MÜLLER & TROSCHEL, 1842.)

One specimen; Gorgonian Cave, Misaki Marine Biological Station.

Japan (KÖHLER). Kobé; 8 fathoms (CLARK).

The specimen at hand is perfectly similar to KÖHLER's type, except in colour. The disk is purplish black, except just inside the dorsal side of the arm base, where there is a white patch, which is continued on to the longitudinal white streak on the dorsal side of the arm. Arm spines nearly white, with purplish black marginal denticles.

*Ophiothrix nereidina* (LAMARCK).

*Ophiura nereidina*: LAMARCK, Hist. Nat. Anim. sans Vert., II, 1816, p. 544.

*Ophiothrix nereidina*: MÜLLER & TROSCHEL, Sys. Ast., 1842, p. 115; LYMAN, Rep. Challenger, V, 1882, p. 221; STUDER, Abh. K. Preuss. Akad. Wiss. Berlin, 1882, p. 26; MARKTANNER-TURNERETSCHER, Ann. K. K. Naturh. Hofmus. Wien, II, 1887, p. 309; DÖDERLEIN, Zool. Jahrb. Sys., III, 1888, p. 832, Pl. XXXII, figs. 5a-5c; KÖHLER, Bull. Sci. Fr. Belg., XXXI, 1898, p. 97; KÖHLER, Bull. Sci. Fr. Belg., XLI, 1907, p. 334.

*Ophiothrix cataphracta*: VON MARTENS, Arch. Naturg., XXXVI, 1870, p. 259; LYMAN, loc. cit., p. 227; PFEFFER, Abh. Senckenberg. Naturf. Gesell., XXV, 1900, p. 85.

One specimen; Yayeyama, Riu-kiu. One specimen; Okinawa. Two specimens; Shimoda, Izu. Numerous specimens; Arai Beach to Gorgonian Cave, Misaki Marine Biological Station.

Indo-Pacific. So far as known, Misaki is about the northern limit of this species.

This species is one of the most common littoral ophiurans in the vicinity of Misaki. The colour in alcohol is blue, with a

beautiful network of white streaks on the disk and fine regular annulations on the arms; the network consists of the white peripheral zones of the disk plates and of the white, more or less meandering lines on the radial shields, and the annulations are due to the presence of a white, transverse streak on each dorsal arm plate. If I remember aright, the specimens were in life shades of vermilion red in colour and perhaps of dark purplish brown.

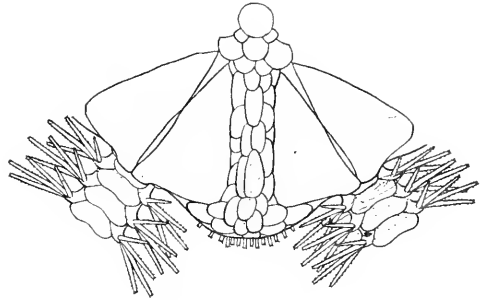

Fig. 61. *Ophiothrix weidini*. From above.  $\times 5\frac{1}{3}$

### *Ophiothrix obtusa* KÖHLER.

*Ophiothrix obtusa*: KÖHLER, Exp. Siboga, XLV, Pt. 2, 1995, p. 98, Pl. XI, figs. 6–10, Pl. XVI, fig. 5.

One specimen; Okinawa, Riu-kiu.

Malaysian waters (KÖHLER).

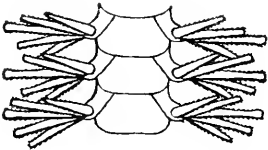

Fig. 62. *Ophiothrix obtusa*. Dorsal view of three arm joints somewhat near disk.  $\times 7$ .

### *Ophiothrix hirsuta* MÜLLER & TROSCHEL.

*Ophiothrix hirsuta*: MÜLLER & TROSCHEL, Sys. Ast., 1842, p. 111; VON MARTENS, Arch. Naturg., XXXVI, 1870, p. 255; LYMAN, Rep. Challenger, V, 1882, p. 226; MARKTANNER-

TURNERETSCHER, Ann. K. K. Naturh. Hofmus. Wien, II, 1887, p. 311, Pl. XIII, figs. 34 & 35; KÖHLER, Bull. Sci. Fr. Belg., XXXI, 1893, p. 96; LUDWIG, Abh. Senckenberg. Naturf. Gesell., XXI, 1889, p. 549; KÖHLER, Exp. Siboga, XLV, Pt. 2, 1905, p. 93; KÖHLER, Bull. Sci. Fr. Belg., XLI, 1907, p. 333.

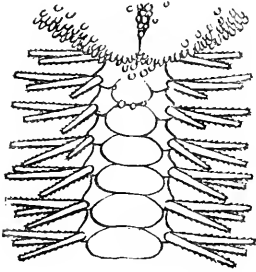

Fig. 63. *Ophiothrix hirsuta*. Dorsal view of an arm base.  $\times 6$ .

*Ophiothrix cheneji*: LYMAN, Proc. Boston Soc. Nat. Hist., VIII, 1861, p. 84<sup>1)</sup>; LYMAN, Ill. Cat. Mus. Comp. Zool., I, 1865, p. 175.

*Ophiothrix variabilis*: DUNCAN, Jour. Linn. Soc. London, XXI, 1886, p. 99, Pl. XIII, figs. 44 & 35.

One specimen; Pinnacle, Riu-kiu.

The specimen at hand appears to belong to the *variabilis*-type, having the radial shields almost free of tubercles.

### *Ophiothrix punctolimbata* VON MARTENS.

*Ophiothrix punctolimbata*: VON MARTENS, Arch. Naturg., XXXVI, 1870, p. 257; LYMAN, Rep. Challenger, V, 1882, p. 227; STUDER, Abh. K. Preuss. Akad. Wiss. Berlin, 1882, p. 26; BELL, Rep. Zool. Coll. Alert, 1884, p. 143; BELL, Proc. Zool. Soc. London, 1888, p. 388; BROCK, Zeitschr. wiss. Zool., XLVII, 1888, p. 512; DÖDERLEIN, Zool. Jahrb. Sys., III, 1888, p. 416, Pl. XV, fig. 2; LORIOLO, Rev. Suisse Zool., I, 1893, p. 416, Pl. XV, fig. 2; BELL, Proc. Zool. Soc. London, 1894, p. 397; DÖDERLEIN, SEMON—Zool. Forschungsr. V, 1897, p. 294, Pl. XIV, figs. 7a & 7b, Pl. XVI, figs. 18 & 18a; KÖHLER, Exp. Siboga, XLV, Pt. 2, 1905, p. 93.

*Ophiothrix hirsuta* var. *punctolimbata*: MARKTANNER-TURNERETSCHER, Ann. K. K. Naturh. Hofmus., II, 1887, p. 312.

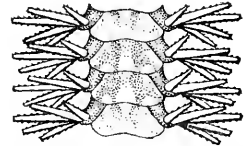

Fig. 64. *Ophiothrix punctolimbata*. Dorsal view of four arm joints somewhat near disk.  $\times 8$ .

1) This paper was not seen by me.



One specimen; locality unknown, perhaps Misaki.  
Indo-Pacific.

*Ophiothrix longipeda* (LAMARCK).

*Ophiura longipeda*: LAMARCK, Hist. Nat. Anim. sans Vert., II, 1816, p. 544.

*Ophiothrix longipeda*: MÜLLER & TROSCHEL, Sys. Ast., 1842, p. 113; LYMAN, Ill. Cat. Mus. Comp. Zool., I, 1865, p. 176; VON MARTENS, Arch. Naturg., XXXVI, 1870, p. 254; LYMAN, Rep. Challenger, V, 1882, p. 220, Pl. XLVII, fig. 4; STUDER, Abh. K. Preuss. Akad. Wiss. Berlin, 1882, p. 26; MARKTANNER-TURNERETSCHER, Ann. K. K. Naturh. Hofmus. Wien, II, 1887, Pl. XIII, fig. 27; BELL, Proc. Zool. Soc. London, 1888, p. 388; BROCK, Zeitschr. wiss. Zool., XLVII, 1888, p. 512; LORIOI, Rev. Suisse Zool., I, 1893, p. 415; BELL, Proc. Zool. Soc. London, 1894, p. 395; DÖDERLEIN, SEMON-Zool. Forschungsr., V, 1899, p. 293, Pl. XIV, figs. 6a-6c, Pl. XVI, figs. 17 & 17a; KÖHLER, Bull. Sci. Fr. Belg., XXXI, 1898, p. 97; LUDWIG, Abh. Senckenberg. Naturf. Gesell., XXI, 1899, p. 550; PFEFFER, *ibid.*, XXV, 1900, p. 85; KÖHLER, Exp. Siboga, XIV, Pt. 2, 1905, p. 92; KÖHLER, Bull. Sci. Fr. Belg., XLI, 1907, p. 334; CLARK, Bull. Mus. Comp. Zool., LI, 1908, p. 298; CLARK, Bull. U. S. Nat. Mus., LXXV, 1911, p. 263.

One specimen; Kominato, Bôshû.  
Two specimens; Tanabé Bay, Kii.

Indo-Pacific. So far as known, Kominato is the northern limit of this species.

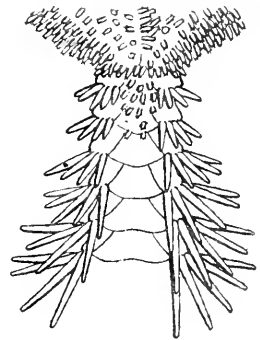

FIG. 65. *Ophiothrix longipeda*.  
Dorsal view of an arm base.  
×6.

*Ophiomaza kanekoi*, sp. nov.

One specimen; Shimabara, Hizen.

Diameter of disk 15 mm. Length of arms 35 mm. Width of arms at base 1.8 mm.

Disk rather flat, covered by the large radial shields and rather coarse, partly imbricated and partly tessellated scales. The scales are covered by skin, so that they are very inconspicuous, especially inside and outside the radial shields, where they are finer than between the radial shields. There are two or three rows of them in each interradius, where they are coarse, irregular, polygonal,

and tessellated. Radial shields large, triangular, with acute inner angle, longer than two-thirds the disk radius, twice as long as wide, those of a pair separated from each other by a single row of oblong, quadrangular scales, three to five in number. Interbrachial ventral surfaces covered by a soft, naked skin. Genital slits large.

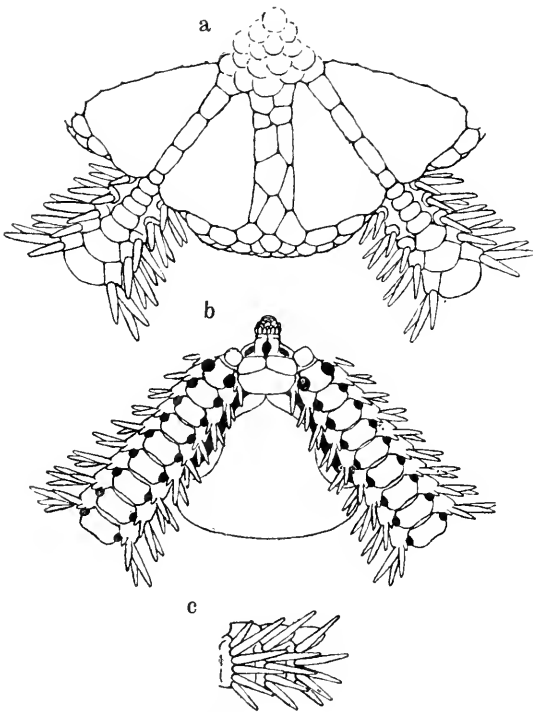

Fig. 66. *Ophiomastix kaneokoi*.  $\times 4$ . a. From above, b. From below. c. Side view of three arm joints near disk.

with a very large inner angle. Adoral shields very small, quadrangular, joined within. The oral and adoral shields have chagreened external surfaces, which are covered by skin. Buccal

pores very small. Dental papillæ about twenty-five in number, forming a vertical, oval clump; in the lower half they are very small and arranged in four rows; in the upper half they are larger and arranged in two or three rows. Three teeth, quadrangular, with truncated ends; the lowest one is about as long as the upper dental papillæ; the others are much longer than the lowest, the uppermost one being the longest and narrowest.

Arms slender and short, vertically coiled, especially in the distal parts. Dorsal arm plates large, quadrangular, with convex outer border, about twice as wide as long, wider without than within, very convex, so that the dorsal side of the arm is strongly keeled as a whole. Four or five basal dorsal arm plates are smaller and continued on to the radial row of disk scales. Some of the dorsal arm plates are divided into equal or unequal halves. Lateral arm plates not very prominent. First ventral arm plate not very small, quadrangular, with curved inner and outer borders and rounded angles, slightly wider than long, wider within than without. Next one or two plates quadrangular, with curved outer and concave lateral borders and rounded outer angles, slightly longer than wide. Those beyond quadrangular, with concave inner and outer borders and rounded outer angles, wider than long. The surface of the ventral arm plates are chagreened and covered by a skin. The successive ventral arm plates are not in contact, but are separated by a naked, depressed, groove-like space. Arm spines six or seven in proximal free joints, conical, terete, tapered, blunt; the uppermost one is short, slightly longer than the corresponding arm joint; the next is the largest, longer than twice the corresponding joint; the others become shorter downwards, the second lowest being slightly longer than the corresponding joint; the lowest spine is very small and short, serving as a tentacle

scale. The spines rapidly become fewer and shorter outwards, so that in the tenth free arm joint, they are four in number, the uppermost two spines, which are the longest, being about one and a half times as long as the corresponding joint. In the distal parts of the arms, the lowest spine is transformed into a compound hook.

Colour brownish black in alcohol, formerly preserved in formalin.

The present species differs from *O. cacotica* LYMAN in the more numerous disk scales, in the absence of a distinct central rosette of the primary plates, in the not regularly arranged marginal disk scales, in the narrower arms, in the concave outer border of the ventral arm plates, and in the more numerous arm spines; from *O. mærens* KÖHLER in the larger radial shields, in the shape of the oral shields, in the narrower arms, in the wider ventral arm plates, of which the inner and outer borders are concave, and in the more numerous and longer arm spines; and from *O. obscura* (LJUNGMAN) in the fewer rows of the dorsal inter-radial disk scales, in the larger radial shields, in the narrower arms, in the markedly narrowed basal dorsal arm plates, and in the more numerous arm spines.

### *Ophiothela dance* VERRILL.

*Ophiothela dance*: VERRILL, Proc. Boston Soc. Nat. Hist., XII, 1869, p. 391<sup>1)</sup>; LYMAN, Rep. Challenger, V, 1882, p. 230; MARKTANNER-TURNERETSCHER, Ann. K. K. Naturh. Hofmus. Wien, II, 1887, p. 313; DÖDERLEIN, SEMON—Zool. Forschungsr., V, 1897, p. 297, Pl. XVII, figs. 25-25b; KÖHLER, Bull.

1) This paper was not seen by me.

Sci. Fr. Belg., XXXI, 1898, p. 89; KÖHLER, Exp. Siboga, XLV, Pt. 2, 1905, p. 117; KÖHLER, Bull. Mus. d'Hist. Nat. Paris, 1905, p. 459.

*Ophiothela isidicola*: LÜTKEN, Bull. Soc. Roy. Copenhagen, 1872, p. 92, Pl. I & II, figs. 4a.-4g; LYMAN, loc. cit., p. 231; BROCK, Zeitschr. wiss. Zool., XLVI, 1888, p. 537; LORIOU, Mem. Soc. Phys. d'Hist. Nat. Genève, XXXII, 1894, p. 52.

*Ophiothela verrilli*: DUNCAN, Journ. Linn. Soc. London, XIV, 1878, p. 477, Pl. XI, fig. 33.

*Ophiothela danae* var. *involuta*: KÖHLER, loc. cit., 1898, p. 89.

Numerous specimens, clinging to *Melitodes*: Moroiso, Misaki; 5-10 fathoms. Numerous specimens; off Misaki.

Strait of Formosa (LÜTKEN). Korea seas (DUNCAN).

Indo-Pacific.

There is no doubt, that *O. danae*, *O. isidicola* and *O. verrilli* are conspecific, as they are connected by an unbroken series of intergrading forms between *danae* and *isidicola* on the one hand and between *isidicola* and *verrilli* on the other.

The first of the two lots above mentioned are mostly of the *danae*-type, while the second is mostly of the *isidicola*- but partly of the *verrilli*-type, both lots containing some intermediate forms. Those of

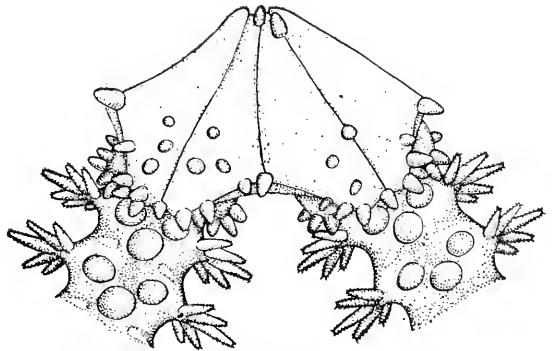

Fig. 67. *Ophiothela danae*. From above.  $\times 20$ .

the *danae*-type are usually dark coloured, being green, blue, purple, or brown, and are annulated on the arms; those of the *isidicola*- and *verrilli*-type are light coloured or white, being light yellow or

very light pink. The *verrilli*-type is closely similar to the *isidicola*-type, so that the two are practically one. I imagine that on an average, the *isidicola*-type (including the *verrilli*-type) has greater bathymetrical range than the *dancæ*-type.

In some specimens, there are as many as seven arms. Again, a few of the disk granules may be conical and pointed. In some of the *dancæ*-type, the dorsal surface of the disk is entirely free of granules or tubercles.

#### Order iv. **CHILOPHIURIDA** MATSUMOTO.

Disk covered with scales or plates, often with superficial granulations. The radial shield and genital plate on the same side of a radius articulate with each other by means of two articular condyles and one pit on both the plates. Peristomial plates double or triple, not very large. Oral frames with or without well developed lateral wings. Oral papillæ well developed, close-set, very often entirely closing the oral slits; the outermost one being pointed inwards above the next papilla which is the largest, but sometimes modified in certain ways by the displacement of the second oral tentacle pores outside the oral slits. Arms only horizontally flexible, the vertebral articulation being zygospondyline. Arm plates usually all well developed. Arm spines very short or long, lying flat on the arm or erect.

#### Key to families of *Chilophiurida*.

*A*—Arm spines short, lying flat on the arm.

*a*—Disk usually free of granules; second oral tentacle pores opening

- either outside or inside the oral slits; arms short and stout, stoutest at the base.....*Ophiolepididae*.
- aa*—Disk covered with granules; second oral tentacle pores opening always within the oral slits; arms moderately or very long.
- b*—Arms slender, inserted ventrally to the disk, stoutest at the base or at a distance from it; arm spines few .....*Ophiocucidae*.
- bb*—Arms stout, inserted laterally to the disk, stoutest at the base; arm spines numerous .....*Ophiodermatidae*, pars.
- AA*—Arm spines long and erect.
- c*—Dental papillæ absent.
- d*—Disk covered with granules; oral angles granulated; arms stout, stoutest at the base; arm spines numerous....*Ophiodermatidae*, pars.
- dd*—Disk usually free of granules; oral angles not granulated; arms slender, stoutest at a distance from the base; arm spines few....  
.....*Ophiochitonidae*.
- cc*—Dental papillæ well developed, forming a vertical clump at the apex of each jaw; arms stout, stoutest at a distance from the base....  
.....*Ophiocomidae*.

### Family 1. *Ophiolepididæ* LJUNGMAN, 1867.

Disk covered with thick scales or plates, among which the primaries are often very prominent. Radial shields usually stout. The radial shield and genital plate on the same side of a radius articulate with each other by means of two articular condyles and one articular pit on both the plates. Genital papillæ very often, and arm combs sometimes, present. Oral papillæ usually few, arranged in a single series; where the second oral tentacle pore opens within the oral slit, the outermost oral papilla is pointed inwards and the next one is the largest. Teeth arranged in a single vertical row. Dental papillæ absent. Peristomial plates small, usually double, rarely simple. Arms inserted laterally to

the disk, short or moderately long, very stout, widest at the base, rapidly tapering outwards, only horizontally flexible. Arm plates either all well developed, or the dorsal and ventral ones may be very rudimentary. Arm spines short, lying flat on the arm. Tentacle scales variable in number, leaf-like, rarely absent.

This family is very extensive and includes thirty-eight genera, which may be grouped into two subfamilies as follows.

Subfamily 1. *Ophiomastinae* MATSUMOTO, 1915:—Second oral tentacle pores opening outside the oral slits.

- I. Several basal lateral arm plates extraordinarily widened; genital slits invisible or very insignificant; disk covered merely with primaries and radial shields.

*Astrophiuura* SLADEN, 1878.

*Ophiophycis* KÖHLER, 1901.

*Ophiomisidium* KÖHLER, 1914.

*Ophiotypa* KÖHLER, 1897.

*Ophiomastus* LYMAN, 1878.

- II. Basal lateral arm plates not much widened; genital slits usually large; disk covered usually with both primaries and secondary scales, besides the radial shields.

*Haplophiura* MATSUMOTO, 1915.

*Anthophiura* CLARK, 1911.

*Aspidophiura* MATSUMOTO, 1915.

*Ophiopyrgus* LYMAN, 1878.

*Stegophiura* MATSUMOTO, 1915.

*Amphiophiura* MATSUMOTO, 1915.

*Gymnophiura* LÜTKEN & MORTENSEN, 1899.

*Ophiosteira* BELL, 1902.

*Ophiochrysis* KÖHLER, 1904.

*Homalophiura* CLARK, 1915.



- Ophiura* LAMARCK, 1816.  
*Ophioperla* KÆHLER, 1912.  
*Ophionotus* BELL, 1902.<sup>1)</sup>  
*Ophiotjalfa* MORTENSEN, 1913.  
*Ophiurolepis* MATSUMOTO, 1915.  
*Ophiogona* STUDER, 1878.  
*Ophioplithus* LYMAN, 1878.  
*Ophiopleura* DANIELSSEN, 1877.  
*Ophiocten* LYMAN, 1854.

Subfamily 2. *Ophiolepidina* mihi, 1915 :—Second oral tentacle pores opening within the oral slits.

I. Tentacle pores limited to a few basal arm joints.

- Ophiomusium* LYMAN, 1869.  
*Ophiolipus* LYMAN, 1878.

II. Tentacle pores present throughout the entire length of the arm.

- Ophiophyllum* LYMAN, 1878.  
*Ophiopenia* CLARK, 1911.  
*Ophiocra'es* KÆHLER, 1904.  
*Ophiomidas* KÆHLER, 1904.  
*Amphipholizona* CLARK, 1915.  
*Ophiozonella* MATSUMOTO, 1915.  
*Ophiozonoida* CLARK, 1915.  
*Ophiozona* LYMAN, 1865.  
*Ophiothyreus* LYMAN, 1865.  
*Ophiolepis* MÜLLER & TROSCHEL, 1840.  
*Ophioplocus* LYMAN, 1861.

---

1) *Ophioglypta hexactis* SMITH, 1876, belongs in my opinion to *Ophionotus*, as distinct from the genuine *Ophiura*.

*Ophioceramis* LYMAN, 1865.

The internal structures of the *Ophiomastinae* are very divergent, but roughly three types may be distinguished according to the character of the peristomial plates. The first type, represented by *Astrophiura* and *Ophioplithus*, lacks the peristomial plates; the second, represented by *Ophiomastus* and *Ophiocten*, has simple peristomial plates; and the third, including the majority of the present subfamily, has double peristomial plates.

The internal structures observed in *Astrophiura kawamurai* are most peculiar. The oral frames and plates are very long and slender, while the dental plates are stout. The peristomial plates are entirely absent, though the peritoneal membranes of the oral region, as well as of the other parts, contain very fine, translucent, perforated scales, much resembling the perforated spicules of holothurians, as seen under a compound microscope. The genital plates and scales are entirely internal, both being very slender and narrow; the former are very short, with the outer end forming a simple articular face for the radial shield; the latter are about twice as long as the former, parallel to, and directed above, the adoral shields, not laterally but terminally articulated with the genital plates. The proximal parts of the first lateral arm plate curve inwards and downwards, passing below the radial shield and the genital plate, and articulate with the first vertebra. The dorsal side of each vertebra is not rhomboidal but almost quadrangular, with a rather shallow median groove; that of the first vertebra is much wider than in the others, the abradial peripheries being very thin and translucent. The ventral side of each vertebra has a rather shallow median groove and a well marked median suture. The vertebrae of the free arms are almost entirely divided into halves by a very narrow moniliform slit, the

halves being very slender and lying very closely side by side. The articulation of the vertebrae is primitive and zygospondyline. The articular peg is situated between the halves of the articular shoulder, the three being almost parallel. In the inner articular face, there is present a well developed articular umbo, the articular knobs being, however, very rudimentary, represented merely by the projecting edges of the central ridge, on which the articular umbo and the pit for the articular peg are placed. *Astrophiuura* appears to remind us more or less of *Ophioplinthus medusae* LYMAN, the internal structures of which have been described and figured by LYMAN, by its long oral frames, the absence of distinct peristomial plates and the quadrangular dorsal side of the basal vertebrae.

According to LYMAN, *Ophiomastus secundus* LYMAN has very long oral frames and plates, a small, simple peristomial plate in each interradius and quadrangular, not discoidal, basal vertebrae. I suppose that, the internal structures of *Ophiophycis*, *Ophiomisidium* and *Ophiotypa* are probably similar to those of such genera as *Astrophiuura*, *Ophioplinthus* and *Ophiomastus*, though they have not been thoroughly studied. *Haplophiura gymnopora* (CLARK) has also simple, transversely bar-like peristomial plates and short, discoidal basal vertebrae. This genus, as well as *Ophiomisidium*, *Ophiophycis* and *Astrophiuura*, lacks the genital bursae and visible genital slits. *Ophiocten sericeum* LYMAN is described by the author to have also simple peristomial plates and short, discoidal basal vertebrae.

*Stegophiura sladeni* (DUNCAN), as well as *St. sterea* (CLARK), has double, transversely bar-like peristomial plates and very high outer ends of the oral frames. The internal structures of *Ophiura kinbergi* are almost similar to those of *Stegophiura* except the oral frames, of which the outer ends are not very high. *Ophiura*

*lymani* (LJUNGMAN) and *Ophiurolepis carinata* (STUDER) (= *Ophioglypha deshayesi* LYMAN) appear to be almost similar to *Ophiura kinbergi* in their internal structures. Those forms with double peristomial plates have always short oral frames and short, discoidal basal vertebrae.

The *Ophiolepidinae* are fairly uniform in their internal structures, the two opposite extremes being represented by *Ophiomusium* and *Ophioceramis*. In *Ophiomusium trychnum* CLARK, which is a representative of the species with only two pairs of tentacles to each arm base, the peristomial plates are double and exceedingly small, the oral plates are very long and slender, and the oral frames and basal vertebrae are also extremely long. In *Ophiomusium cancellatum* LYMAN, which is a representative of the species with three pairs of tentacles to each arm base, the internal structures are almost similar to those of the foregoing, but the peristomial plates are larger and the oral plates, oral frames and basal vertebrae shorter. In *Ophiozonella longispina* (CLARK), the peristomial plates are comparatively large, the oral plates short and stout, the oral frames more or less short, and the basal vertebrae short and more or less discoidal. In these three species the first vertebra, and not the second, is the shortest. In *Ophiomusium*, the teeth are very slender, while in *Ophiozonella*, they are more or less squarish and stout. In *Ophiozona impressa* (LÜTKEN), *Ophiolepis cincta* MÜLLER & TROSCHEL and *Ophioplocus japonicus* CLARK, the peristomial plates are comparatively large, the oral plates and frames very short and stout, the basal vertebrae very short and discoidal, the second being the shortest, and the teeth more or less squarish and stout. In *Ophioceramis januarii* (LÜTKEN), the peristomial plates are also double, but very small and transversely bar-like, the oral plates are very short and stout, the oral frames very

stout with well developed lateral wings, the basal vertebrae very short and discoidal, the second being the shortest, and the teeth squarish and very stout. In all these representatives of the *Ophiolepidinae*, the genital plate and radial shield articulate with each other by means of two condyles and one pit on both the plates, and the genital plate and scale articulate with each other at some distance inwards from the outer end of the latter.

### **Astrophiuura** SLADEN, 1878.

Basal portion of arms very intimately united with the disk proper, so as to form with it a pentagonal "asteroid" body, of which the dorsal surface is entirely covered over by the stout primaries and radial shields of the disk proper and by the dorsal and much widened lateral arm plates of the much modified arm bases. The interradial borders of the "asteroid" body are hemmed by a series of modified arm spines, which are soldered together. The basal lateral arm plates articulate with the vertebrae by means of a bar-like ridge. Arms outside the "asteroid" body very abortive, without dorsal and ventral arm plates, without tentacles. Tentacle pores present only within the "asteroid" body, very large and arranged so as to form a pentamerous petaloid series. Ventral arm plates well developed, forming a continuous series, which extends only as far as the last tentacle pores. Oral shield single or five<sup>1)</sup>; in the former case, it is the madreporite. Adoral shields long and narrow. Oral plates rather stout. A single dental plate is present at the apex of each jaw. Six or seven oral papillae to each jaw, arranged in a single series,

---

1) *A. cavalle* KOEHLER, 1915, has five oral shields.

situated deep within the oral slits; apical two or three of them arise from the dental plate. Teeth and dental papillæ proper not present. Interbrachial ventral surfaces covered by a thin skin, which contains fine, hyaline scales. Genital bursæ absent, genital slits invisible. Genital plates and scales entirely internal, very slender, those on the same side of a radius articulating with each other at the end. Peristomial plates absent. Oral frames very long. Vertebrae of the free arms more or less divided into halves by a moniliform longitudinal slit.

I do not agree with SLADEN in the interpretation of certain structures of the body. SLADEN'S "side mouth shields" are, in my opinion, genuine oral plates, and his "genital scales" true adoral shields, i. e. side mouth shields. SLADEN'S "oral papillæ" may be retained, if the meaning of these terms be extended to include the scales of the first oral tentacles. SLADEN'S "apical oral papilla" or the "single tooth" in my preliminary paper is proved not to be a papilla or tooth, but to be the dental plate. The "septa" or "divisional plates of the ambulacral system" of SLADEN are, according to my own observations, not true plates, but merely ridges projecting ventrally from the basal, or adradial, parts of the modified lateral arm plates, and bearing tentacle scales on the margin.

*Astrophiura kawamurai* MATSUMOTO.

*Astrophiura kawamurai*: MATSUMOTO, Annot. Zool. Japon., VIII, 1913, p. 225, Pl. III, figs. 1 & 2.

One specimen; Okinosé (a submarine bank), Sagami Sea; 330 fathoms.

Diameter of the pentagonal "asteroid" body 12 mm.; that of

the disk proper, or of the circle passing through the outer ends of the radial shields, 7 mm. Length of the free portion of the arms 6 mm. Width of same near the pentagonal body 0.4 mm.

The pentagonal "asteroid" body is very flat, covered entirely by the stout primary plates and radial shields of the disk proper and by the dorsal and lateral arm plates of the modified basal portion of the arms. The primary plates are the central, the five infrabasals, five basals, five radials and five first and five second interradials. The infrabasals, basals and interradials are elevated above the level of the central, radials and radial shields, so as to form a regular symmetric-al system of ridges. The central plate is ten-sided, the sides corresponding to

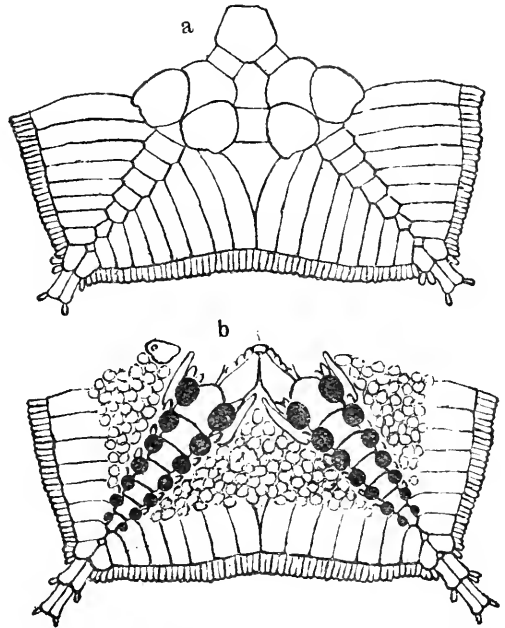

Fig. 68. *Astrophium karamurai*  $\times 6$ . a. From above. b. From below.

the infrabasals being longer than those corresponding to the basals. Infrabasals small, rectangular, wider than long. Basals pentagonal, with truncated inner angle, which abuts on the central plate, lateral edges concave corresponding to the radials, much longer than wide. First interradials rectangular, with concave lateral edges corresponding to the radial shields, much longer than wide. Second interradials large, pentagonal, with short and

concave lateral edges corresponding to the radial shields, outer edges very long and concave corresponding to the first lateral arm plates, and terminating with a very acute outer angle. The elevated plates have slightly raised margins, so that the surface is concave. Radials shaped like maiden hair, with a semicircular inner border and concave outer sides corresponding to the radial shields, and with an acute outer angle; longer than wide. Radial shields irregularly triangular, with perfectly rounded angles, convex inner and slightly concave outer borders; about as long as wide, hardly touching each other. Dorsal arm plates seven or eight in number, confined to the pentagonal body. The first one is triangular, wider than long, smaller than but as wide as the next plate. The following plates, which become smaller outwards, are quadrangular, with truncated outer angles, wider without than within; the second to the fourth plates are wider than long. All the plates are in contact with one another, except the last one or two, which are very rudimentary and isolated. Within the pentagonal body, the lateral arm plates are much elongated laterally, with the width almost equal to the length of the corresponding arm joints, lightly bent outwards, striated parallel to the axis of elongation. They meet with the corresponding dorsal arm plates, except the first, which is separated from the first dorsal by the radial shield. The first lateral arm plates of the neighbouring radii are apposed to each other distally, outside the second interradial. The distal edges of the successive lateral plates form a continuous line, the interradial borders of the pentagonal body, which are slightly indented, and hemmed by a series of soldered papillæ, which are evidently the modified arm spines of the modified lateral arm plates. These papillæ are longer towards the middle of the interradial borders, where they are



about as long as the width of the corresponding lateral arm plates. There are three or four of them for each lateral plate.

With the exception of the peripheral zone, the ventral surface of the interradial spaces of the pentagonal body is covered by a thin skin, which contains fine, close-set, polygonal or rounded, delicate, transparent scales. The peritoneal cavity and the genital glands can be seen through the skin, and apparently extend into the arm bases. The genital bursæ are absent and the genital openings are invisible. There is only one oral shield, the madreporite, which is irregularly triangular, and so transparent and small as to be almost invisible unless the specimen is dried, and distinguishable only with difficulty from the scales of the interbrachial ventral surface, and is moreover separated from the adoral shields by a space. The adoral shields are long and very narrow, tapered within to a point, outer end joined to the first ventral arm plate, inner end free, longer than the first ventral plate. Oral plates large and stout, oblong quadrangular, with exceedingly short inner side, convex abradial and concave or nearly straight adradial side, much wider without than within, joined distally to the first ventral arm plate and proximally to each other along the proximal one-third of the abradial side. A single dental plate is present in each jaw, quadrangular in ventral view with curved inner edge. There are six or seven papillæ to each jaw, arranged in a horizontal, continuous row, situated deep within the oral slits, and directed not laterally but upwards. The two or three apical ones arise from the dental plate, so that they may be regarded as dental papillæ, while the outer papillæ lie just below the first oral tentacle pores and protect the latter, so that they may possibly be the tentacle scales of the same.

Ventral arm plates eight or nine in number, limited to within

the pentagonal body. The first one is very large, hastate, but with much rounded apex, lateral edges strongly concave corresponding to the second oral tentacle pore, and with an indentation at the outer edge, longer than wide, very wide without. Following plates, which become smaller outwards, quadrangular, with strongly concave lateral edges corresponding to the tentacle pore, with a saddle-shaped surface. They are closely apposed to one another, except the last one or two, which are very rudimentary, rhomboidal and isolated. The tentacles are very large, uniformly diminishing in size and lying closer together as they proceed outwards, and arranged in a pentamerous petaloid series as a whole. The first pair of tentacles in ventral view are homologous with the second oral tentacles of other ophiurans, because they are situated between the first ventral arm plate and the adoral shields and belong morphologically to the same arm joint with the latter. They are much larger than the other tentacles. The second pair are the true first arm tentacles. They belong to the same joint with the second ventral and the first dorsal and lateral plates. Each tentacle pore is provided with one or two scales, which are rather small, lanceolate, covered by skin, their concave surface facing the tentacle pore, often turned up. The outermost and smallest tentacle pores have no scale. Each two successive tentacle pores are separated by a ridge of the basal or adradial part of the lateral arm plate, which belongs to the same joint with the outer of the two pores.

The free distal portion of the arms outside the pentagonal body is very abortive, exceedingly slender, uniformly tapered outwards, entirely covered by the lateral plates and easy to break. There is a single, exceedingly small and acute arm spine on each lateral plate; but in the first one or two free joints, there are

two or three spines. It may be observed in some radii, that the lateral plates of the first free arm joint are in process of being absorbed into the pentagonal body.

Colour in alcohol: whitish or light yellow; central and radials, radial shields and inner part of the interradial spaces below bluish gray.

This specimen was found attached to a stone by the ventral surface of the pentagonal body, in the same way as *Chiton* or *Patella*.

The present species differs from the genotype, *A. permira* SLADEN from Madagascar, chiefly in the very regular arrangement of the plates on the dorsal surface of the pentagonal body as a whole, in the larger central plate, in the much smaller and quite regular infrabasals, in the much narrower basals and interradials, in the infrabasals, basals and interradials being elevated so as to form a regular symmetrical system of ridges, in the scarcely joined and not overlapping radial shields, in the absence of the central boss on the primary plates, in the very regular and much narrower dorsal arm plates, in the much smaller and rather inconspicuous madreporic shield, in the longer adoral shields, in the oral plates being somewhat narrower and in contact to a less extent, in the perfectly saddle-shaped ventral arm plates and in the much narrower free portion of the arms. Further, this species differs from CHUN'S *Astrophisura* from Agulhas Bank, which is not yet named, chiefly in the smaller and regular infrabasals, in the narrower basals and interradials, in the elevated infrabasals, basals and interradials, in having two, instead of three, sets of interradials<sup>1)</sup>, in the not overlapping radial shields, in the absence of

---

1) The presence of two or three sets of interradials may not be of specific value, because KOEHLER has observed both cases in his *A. cavellae*.

the central boss on the primary plates, in the much narrower dorsal arm plates and in the much narrower free portion of the arms. Lately, K EHLER has described *A. cavella* from the vicinity of the Cape of Good Hope, from which the present species differs chiefly in the much shorter and smaller infrabasals, in the much narrower basals and interradians, in the radials being not distinctly pentagonal but shaped like maiden hair, in the scarcely joined radial shields, in the absence of the central boss on the primary plates, in the much narrower dorsal arm plates, in the much smaller madreporic shield, in the absence of the ordinary oral shields, in the longer adoral shields, in the oral plates being in contact to a less extent, and in the much narrower free portion of the arms. On the whole, *A. permira*, *A. cavella* and CHUN'S *Astrophiiura* (there is some possibility that it belongs to one of the two first mentioned species) appear to me to be nearer to one another than any of them is to the present species. This fact may be correlated with the geographical separation of the present species from the others, which occur near together.

### **Haplophiura** MATSUMOTO, 1915.

Disk high, much elevated above the arm bases, covered with rather large plates, among which the primaries are very prominent. Radial shields stout, joined in pairs. Interbrachial ventral surfaces covered with fine granules. Genital slits indistinct. Oral papillae soldered together. Teeth in a single vertical row. Dental papillae absent. Arms short, stout. Arm plates convex. First ventral arm plate larger than the following. Few, very small arm spines. Tentacle pores, including the second oral tentacle pore, which opens outside the oral slit, entirely free of scales.

This genus is formed by a single species, *Ophiözona gymnopora* CLARK, 1909.

**Revision of *Ophiura* LAMARCK, 1816 (= *Ophioglypha* LYMAN, 1865).**

As *Ophiura* s. ext. is a very large and diffuse genus, the necessity for subdivision is admitted by many authors. LUDWIG proposed to divide it into two genera according to the presence or absence of the arm combs. But his type of *Ophioglyphina* is, in my opinion, merely a typical *Ophiura*. KÖHLER tried to divide this genus into two sections according as the second oral tentacle pores opened more or less within the oral slits or entirely outside it. In my opinion, the position of the pores in question is not of such value, though it is of some importance in making subdivisions of *Ophiura* s. ext. I cannot agree with those authors who try to subdivide this genus by only one or two characters; all characters should be taken into account. From this point of view, I have come to the conclusion that LYMAN's subdivisions may be accepted in principle. I propose here to divide *Ophiura*, as hitherto understood, into a number of genera, which may be distinguished as follows.

*A*—Adoral shields not oval but long; no supplementary plates among the oral plates and adoral shields; genital papillæ always, and arm combs usually, present.

*a*—Disk high, covered with very stout plates or very thick scales; arms higher than, or as high as, wide, also covered with very thick, heavy arm plates.

*b*—Disk covered chiefly or only with very stout primaries and radial shields; interbrachial ventral surfaces almost entirely occupied by a very stout central plate, besides the very heavy genital scales.

- c*—Disk flat; oral papillæ soldered together; arms consisting of long, knobby joints; dorsal arm plates rudimentary or absent, ventral arm plates very small, both being widely separated from one another; tentacle pores limited to several basal arm joints, very small; those beyond the second oral pores with a single tentacle scale or without any ..... *Aspidophiura*.
- cc*—Disk convex; oral papillæ not soldered together; arms consisting of short, stout joints; dorsal and ventral arm plates not very rudimentary, both being in contact with one another at least in several basal arm joints; tentacle pores present nearly throughout the entire length of the arms, large, with rather numerous scales ..... *Amphiophiura*, pars.
- bb*—Disk, as well as interbrachial ventral surfaces, covered with numerous plates or scales;
- d*—Arms not very short, not very high but cylindrical, gradually tapered outwards, with blunt extremity; a few, or sometimes numerous, arm spines, arranged in a single row, well spaced. . . . . *Amphiophiura*, pars.
- dd*—Arms very short, very high, higher than wide, very stout at the base, rapidly tapered outwards, with very acute extremity; numerous arm spines, very often dimorphic and arranged in two rows. . . . . *Stegophiura*.
- aa*—Disk low and flat, covered with rather thin and delicate plates or scales; arms low, being much lower than wide, or cylindrical, being nearly as wide as high, covered with not very thick arm plates; ventral arm plates small, much wider than long, usually separated from one another even in the arm bases; tentacle pores, except the innermost one or two, very small, with only a few scales. . . . . *Homalophiura* & *Ophiura* restr.<sup>1)</sup>

1) CLARK, 1915, has established *Homalophiura*, removing a number of species from *Ophiura* as diagnosed in my preliminary paper. The two genera may be distinguished as follows.

*a'*—Disk scales rather few and coarse, the primaries being stout and conspicuous; second oral tentacle pores opening entirely outside the oral slits; tentacle pores confined to two or

*AA*—Adoral shields oval; one to three supplementary plates present among the oral plates and adoral shields; genital papillæ and arm combs absent ..... *Ophiurolepis*.

### **Aspidophiura** MATSUMOTO, 1915.

Disk rather high, flat, covered chiefly by the very stout primaries and the very large radial shields, which are joined in pairs almost by their entire length. Arm combs present, with conical and acute papillæ. Interbrachial ventral surfaces covered with a very large central plate, besides the very stout genital scales. Oral shields large, peculiar in shape, with a beak-like inner process. Oral papillæ soldered together. Arms strongly knotted, with long arm joints. Dorsal arm plates rudimentary or absent. Lateral arm plates well developed, flared; those of the two sides meeting both above and below. Ventral arm plates small, rhomboidal or triangular. Three arm spines, conical, usually acute. Tentacle pores rather rudimentary, present only in several proximal arm joints. A single tentacle scale to each pore or none beyond the second arm joint.

This genus includes *Ophioglypha minuta* LYMAN, 1878, and *O. forbesi* DUNCAN, 1789 (= *Ophiura glyptodisca* CLARK, 1911), besides the genotype, *Aspidophiura watasei* MATSUMOTO, 1915.

This genus stands rather between the *solida*-group of *Amphiophiura* and *Anthophiura*, but differs from the former in the

---

three basal arm joints; first ventral arm plate axe-shaped, separated from the next plate ..... *Homalophiura*.  
*aa'*—Disk scales usually numerous and fine; second oral tentacle pores opening more or less inside the oral slits; tentacle pores not confined to a few basal arm joints; first ventral arm plate usually wider than long, and usually in contact with the next plate....  
 ..... *Ophiura*, rest.

In my opinion, *Homalophiura* is close to the *irrorata*-group of *Ophiura*, being however more pædomorphic in certain structures.

flat disk, in the peculiar shape of the oral shields, in the soldered oral papillæ, in the rudimentary dorsal, as well as ventral, arm plates, in the very small tentacle pores, which are limited to the proximal arm joints, and in the very few tentacle scales; and from *Anthophiura* in the entire central plate and in the presence of the genital scales and arm combs.

### Key to Japanese species of *Aspidophiura*.

- A*—The six primaries each with a small but conspicuous central boss; radial shields about as large as the radials; ventral arm plates rapidly diminishing in size outwards; arm spines longer than half the corresponding arm joint; no tentacle scale beyond the disk....  
 ..... *watasei*.
- AA*—The six primaries without a central boss; radial shields distinctly larger than the radials; ventral arm plates very slowly diminishing in size outwards; arm spines shorter than half the corresponding arm joint; single tentacle scale to each pore beyond the disk....  
 ..... *forbesi*.

### *Aspidophiura watasei* MATSUMOTO.

*Aspidophiura watasei*: MATSUMOTO, Proc. Acad. Nat. Sci. Philadelphia, 1915, p. 77.

One specimen; off Misaki, Sagami Sea. One specimen; Uruga Channel.

Diameter of disk 5 mm. Length of arms unknown, but probably about twice the disk diameter. Width of arms at base 1.3 mm.

Disk circular, very flat. The area inside the radial shields is mostly occupied by the six stout primary plates, and the inter-radial spaces of the dorsal surface each by two stout plates. The



pentagonal central, and the hexagonal radials have each a small but conspicuous, mamelon-shaped central boss. Central somewhat smaller than the radials. The first interradials are pentagonal, or quadrangular with irregular inner edge, about as long as wide, wider within than without, a little smaller than the radials, but larger than the second interradials, which are quadrangular, wider than long, and wider without than within. Radial shields about as

large as the radials, as long as wide, irregularly triangular, with convex abradial side, apposed to each other by their entire length. At the meeting points of the radials, first interradials and radial shields, a very small, thick, convex plate is present, and may be duplicated. Radial scales of moderate size, semilunar, with acute, needle-like comb papillæ. Interbrachial ventral surfaces entirely covered over by the large, stout genital scales and a very large, stout plate. Genital slits widened at the inner end, bounded by minute, rather well spaced papillæ.

Oral shields large, stout, triangular as a whole, with widely rounded outer angles and obtuse inner angle, and convex outer and lateral sides, the latter with a blunt notch near the inner end, corresponding to the genital slit; about as wide as long, wider without than within. Adoral shields narrow, of uniform width, meeting with each other. Five oral papillæ on either side,

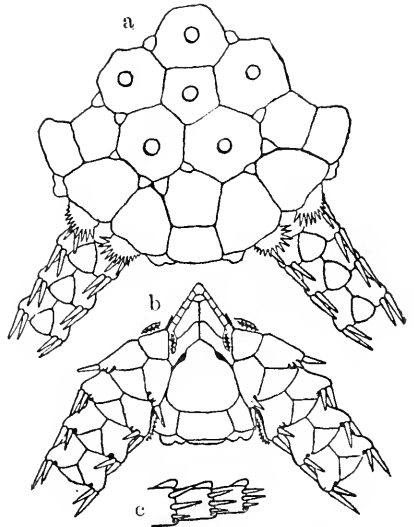

Fig. 69. *Aspidophiura watasei*.  $\times 8$ . *a* From above. *b*. From below. *c*. Side view of three arm joints near disk.

squarish, wider than long, soldered together. Teeth short, rather triangular, stout.

Arms tapered rather rapidly. Dorsal arm plates triangular, with acute inner angle and very convex outer side, about as wide as long, surface very convex. They extend nearly to the extremity of the arms, where they are very rudimentary. Lateral arm plates well developed, conspicuously flared, very convex, meeting both above and below. First ventral arm plate rhomboidal, not very small, as long as wide, inner sides longer than the outer. The second plate, which is the largest, is triangular, with very convex outer side, much wider than long. Those beyond similar to it but smaller, constantly diminishing in size outwards. Three arm spines, needle-like, acute, well spaced; the middle one longer than the rest, and about two-thirds as long as the corresponding arm joint. Second oral tentacle pore opening entirely outside the oral slit, bounded by about four scales both on the abradial and adradial border. Tentacle pores eight or nine pairs to each arm, very small, destitute of any scales, or a small one may be present on the adoral side in the basal joints.

Colour in alcohol: disk yellowish gray above and white below; arms white.

In the specimen from the Uraga Channel, the disk is covered over only by the primaries and radial shields, without any intervening smaller scales; and the central bosses of the six primaries are not very conspicuous.

This species differs from *A. minuta* (LYMAN) in the presence of a central boss on the central and radials, in the well developed arm combs, in the presence of the dorsal arm plates, and in the strongly flared lateral arm plates; and from *A. forbesi* (DUNCAN) in the presence of a central boss on the six primaries,

in the relatively larger radials, in the fewer and smaller intervening scales, in the shape of the first, as well as second, interradians, in the shape of the first ventral arm plate, in the ventral arm plates diminishing in size more rapidly outwards, and in the larger arm spines.

*Aspidophiura forbesi* (DUNCAN).

*Ophioglypha forbesi*: DUNCAN, Journ. Linn. Soc. London, XIV, 1879, p. 449, Pl. IX, figs. 1-3; LYMAN, Rep. Challenger, V, 1882, p. 77; KÆHLER, Bull. Sci. Fr. Belg., XXXI, 1898, p. 63; KÆHLER, Res. Exp. Siboga, XLV, Pt. 2, 1905, p. 22.

*Ophiura glyptodisca*: CLARK, Bull. U. S. Nat. Mus., LXXV, 1911, p. 91, fig. 31.

Korean Sea; 51-59 fathoms (DUNCAN, CLARK).

Indian Ocean and Malaysian waters.

Comparing DUNCAN'S and CLARK'S descriptions and figures, I can not find any tangible characters, by which CLARK'S species is distinguished from DUNCAN'S. I therefore look upon the latter as a synonym of the former. The difference in the number of secondary disk scales, which is the only one I can recognise, appears to me to be due merely to the fact, that CLARK'S type is slightly larger than DUNCAN'S.

**Stegophiura** MATSUMOTO, 1915.

Disk high and arched, covered with thick plates or scales, among which the primaries are conspicuous. Radial shields stout, more or less joined in pairs. Genital papillæ and arm combs well developed; papillæ of the latter long, usually spiniform. Oral shields large, oval or pyriform. Arms very short, stout, higher

than wide at the base, tapering outwards very rapidly, with very acute extremity. Dorsal arm plates very well developed, widely in contact with one another. Lateral arm plates high. Ventral arm plates quadrangular, widely in contact with one another. Numerous arm spines, short, spiniform or peg-like, often dimorphic and arranged in two rows. Tentacle pores very large, with very numerous scales.

This genus includes *Ophiura nodosa* LÜTKEN, 1854, *O. stuwitzii* LÜTKEN, 1857, *Ophioglypha elevata* LYMAN, 1878, *O. sculpta* DUNCAN, 1879, *O. sladeni* DUNCAN, 1879 (= *Ophiura stiphra* CLARK, 1911) *O. striata* DUNCAN, 1879, *O. sterea* CLARK, 1908, *Ophiura brachyactis* CLARK, 1911, &c., besides *Stegophiura vivipara* MATSUMOTO, 1915, the first species being the genotype.

### Key to Japanese species of *Stegophiura*.

- A.*—Arm spines subequal, arranged in a single series.
- a.*—Oral shields very large, almost entirely covering the inter-brachial ventral surfaces, quite reaching to the disk margin; arm spines minute, flat, fitting into small notches on the inner margin of the succeeding lateral arm plate ..... *striata*.
- aa.*—Oral shields not very large, not reaching to the disk margin; arm spines spiniform, acute, free of notches.
- b.*—Radial shields of the same radius overlapping each other; oral shields pear-shaped; seven or eight arm spines, including the tentacle scales, which are indistinguishable from the spines..... *vivipara*.
- bb.*—Radial shields not overlapping, but joined in pairs; oral shields pentagonal; eight arm spines..... *sculpta*.
- AA.*—Arm spines dimorphic, arranged in two rows.
- c.*—Arm spines well spaced, not soldered together.
- d.*—Comb papillæ not very numerous, short, flat, blunt; three to six

arm spines, two of which are larger and longer than the rest, which are very minute.....*nodosa*.

*dd.*—Comb papillæ very numerous, spiniform, acute, but becoming blunter and more flattened as they pass downwards; secondary comb papillæ present, arising from the dorsal and lateral arm plates of the arm base; about five primary arm spines, which are more or less erect, and about ten secondary ones, which lie flat on the arm, are present on each lateral plate of the free basal arm joints.....*sterea*.

*cc.*—Very numerous arm spines, of which the secondary ones, which lie flat on the arm, are soldered together.

*e.*—Three erect primary arm spines, two of which are placed low down and one high up; between the lower two primary spines lies the lowest secondary spine, which is very large and squarish; comb papillæ very numerous, spiniform, acute, but becoming blunter and more flattened as they pass downwards; secondary comb papillæ present, arising from the dorsal and lateral plates of the arm base; oral shields ovate.....*sladeni*.

*ce.*—Two erect primary arm spines, one of which is placed low down and the other high up; comb papillæ flat and blunt; oral shields pear-shaped, much longer than wide.....*brachyactis*.

### *Stegophiura striata* (DUNCAN).

*Ophioglypha striata*: DUNCAN, Journ. Linn. Soc. London, XIV, 1879, p. 452, Pl. IX, figs. 4–5a; LYMAN, Rep. Challenger, V, 1882, p. 77.

Sondai Bay, Korean Sea (DUNCAN).

### *Stegophiura vivipara* MATSUMOTO.

*Stegophiura vivipara*: MATSUMOTO, Proc. Acad. Nat. Sci. Philadelphia, 1915, p. 79.

Numerous specimens; Sagami Sea. Numerous specimens; Sagami Sea; 75–100 fathoms.

Diameter of disk 6 mm. Length of arms 13 mm. Width of arms at base 1.5 mm.

Disk pentagonal or circular (especially when the animal contains many embryos), convex, covered with fifty to sixty plates on the dorsal side, including the radial shields. Central plate pentagonal. Five radials also pentagonal, directly surrounding the central plate, laterally overlapping each other. In each inter-radial space of the dorsal side, there occurs a large squarish

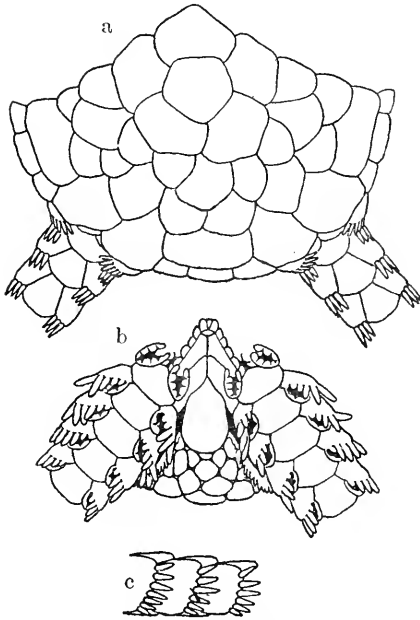

Fig. 70. *Stegophilura vivipara*.  $\times 8$ . *a*. From above. *b*. From below. *c*. Side view of three arm joints near disk.

plate, wider than long, and in contact with the radial shields. The latter are irregular in outline, about as long as wide, one of a pair overlapping the other, instead of being apposed to each other in the radial line. On the ventral side of the disk, the plates are rounded and knob-like, with furrows between; outer ones larger. Genital papillae blunt, close-set; longer outwards and upwards, where they form small arm combs.

Oral shields pear-shaped, much longer than wide, wider without than within, with acute inner angle and perfectly rounded outer border. Adoral shields large, meeting within along their whole width. Five oral papillae on either side, squarish, very short, wide, close-set. A pair of

infradental papillæ at the apex of each jaw, much longer and stouter than the other oral papillæ and rather obtusely pointed. Five teeth, very small, close-set, obtusely pointed.

Arms very short, stout, tapered rapidly outwards. Dorsal arm plates fan-shaped, about as long as wide, convex dorsally. Lateral arm plates convex, those of the two sides separated both above and below in the basal arm joints. First ventral arm plate large, triangular, with obtuse inner angle and convex outer side, wider than long. The following plates are octagonal, with very short inner lateral and outer lateral sides, the former concave at the tentacle pores; wider than long, wider without than within. From the sixth or seventh outwards, the plates are longer than wide, hexagonal, with very short inner and inner lateral, concave lateral and very convex outer sides. Seven or eight arm spines, including the tentacle scales, in the free basal joints, fine, conical, short; middle ones longer than the upper and lower ones, and about half as long as the corresponding arm joint; diminishing in number outwards. The lower spines are much finer and serve as tentacle scales. The second oral tentacle pore is very large, opening outside the oral slit, bounded by three or four scales on both the abradial and adradial sides. The tentacle pores are also large, and bounded in the basal joints by one to three aboral scales, besides the lower arm spines on the adoral side.

Colour pale gray in alcohol.

The arm length varies from one and a half to two and a half times of the disk diameter. The disk plates, including the primaries, are often very irregular in size and arrangement. One monstrous specimen has six arms, of which two arise from a common base, corresponding to a pair of radial shields.

This species is viviparous. I once dissected out twenty-four embryos of various sizes from a single adult.

*Stegophiura sculpta* (DUNCAN).

*Ophioglypha sculpta*: DUNCAN, Journ. Linn. Soc. London, XIV, 1879, p. 455, Pl. IX, figs. 6-8, Pl. XI, fig. 35; LYMAN, Rep. Challenger, V, 1882, p. 77.

*Ophiura sculpta*: CLARK, Bull. U. S. Nat. Mus., LXXV, 1911, p. 73.

Korean Straits; 23 fathoms (DUNCAN). Eastern Sea; 95-139 fathoms (CLARK). Off Honshû; 31-41 fathoms (CLARK).

*Stegophiura nodosa* (LÜTKEN).

*Ophiura nodosa*: LÜTKEN, Vid. Meddel., 1854, p. 6; LÜTKEN, Addit. ad Hist. Oph., I, 1858, p. 48, Pl. II, fig. 9; GRIEG, Fauna Arctica, I, 1900, p. 263; CLARK, Bull. U. S. Nat. Mus., LXXV, 1911, p. 70, fig. 20.

*Ophioglypha nodosa*: LYMAN, Ill. Cat. Mus. Comp. Zool., I, 1865, p. 49; LYMAN, Rep. Challenger, V, 1882, p. 78; KÖHLER, Rés. Camp. Sci. Monaco, XXXIV, 1909, p. 164, Pl. XXVI, figs. 7 & 8.

Okhotsk Sea; 40-109 fathoms (CLARK).

Bering Sea. Off Alaska. Arctic Ocean.

*Stegophiura sterea* (CLARK).

*Ophioglypha sterea*: CLARK, Bull. Mus. Comp. Zool., LI, 1908, p. 243.

*Ophiura sterea*: CLARK, Bull. U. S. Nat. Mus., LXXV, 1911, p. 75, fig. 22.

Numerous specimens; Okinosé (a submarine bank), Sagami Sea; 83 fathoms. Numerous specimens; Uraga Channel; 35 fathoms. One specimen; Namerigawa, Etchû.



Uraga Channel, 70–88 fathoms (CLARK). Suruga Gulf; 124 fathoms (CLARK). Off Kii; 191 fathoms (CLARK). Sea of Japan; 70–114 fathoms (CLARK). Off Korea; 82 fathoms (CLARK). Off Honshû; 57–81 fathoms (CLARK).

The primary arm spines stand out more or less at right angles to the arm axis, and are conical and longer and stouter than the secondary ones; they are five in the free basal arm joints. The secondary arm spines are very fine, conical, rather well spaced, nine to eleven in number in the free basal arm joints. Both the primary and secondary arm spines diminish in number outwards, the latter more rapidly, so that there are only three primary and no secondary spines in the distal arm joints.

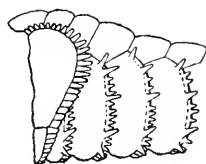

Fig. 71. *Stegophiura sterea*. Side view of an arm base.  $\times 8$ .

### *Stegophiura sladeni* (DUNCAN).

*Ophioglypha sladeni*: DUNCAN, Journ. Linn. Soc. London, XIV, 1879, p. 458, Pl. IX, figs. 9–11; LYMAN, Rep. Challenger, V, 1882, p. 77.

*Ophiura stiphra*: CLARK, Bull. U. S. Nat. Mus., LXXV, 1911, p. 82, fig. 25.

Numerous specimens; Okinosé (a submarine bank), Sagami Sea; 83 fathoms. Numerous specimens; Uraga Channel; 35 fathoms.

Off Ôsé Zaki, Suruga Gulf; 65–125 fathoms (CLARK). Off Kagoshima Gulf; 103–152 fathoms (CLARK). Korea Strait; 66 fathoms (CLARK). Sea of Japan; 44–47 fathoms (CLARK). Off Honshû; 45–70 fathoms (CLARK).

The primary arm spines are erect, conical, acute, three in number, one just above the uppermost secondary spine, one just above and the other just below the lowest secondary spine, which

is extremely wide and squarish. The secondary arm spines, which lie flat on the arm, are squarish, flat, close-set, mostly soldered together, smaller upwards, sixteen to eighteen in number in the free basal arm joints; they increase in number with the growth of the animal, so that they are fewer towards the extremity of the arm, as expected from the law of localised stages.

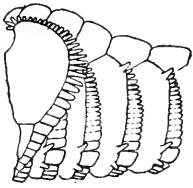

Fig. 72. *Stegophiura sladeni*. Side view of an arm base.  $\times 5$ .

DUNCAN does not mention the size of the type specimen, but judging from the magnification of his figures, the disk diameter must be about 5 mm. Now, my specimens of corresponding size well agree with DUNCAN'S description and figures. In these young specimens, the lowest secondary arm spine is not very distinctly large, and the secondary arm spines and tentacle scales are apparently similar, forming a continuous series. Again, in DUNCAN'S fig. 11, the primary arm spines are shown to stand apart from the series of the secondary arm spines; but this is probably due to inaccuracy of observation or drawing. As to the specific identity of the full grown specimens at hand with *Ophiura stiphra* CLARK, there is no doubt. Thus, my conclusion is that, *Ophioglypha sladeni* and *Ophiura stiphra* are merely different stages of one and the same species, the former name having priority.

*Stegophiura brachyactis* (CLARK).

*Ophiura brachyactis*: CLARK, Bull. U.S. Nat. Mus., LXXV, 1911, p. 87, fig. 28.

Off southern Saghalin; 75–100 fathoms (CLARK).

**Amphiophiura** MATSUMOTO, 1915.

Disk high and arched, covered with very thick plates or scales, among which the primaries are very conspicuous. Radial shields stout, joined in pairs. Genital papillæ, as well as papillæ of arm combs, well developed, either spiniform or squarish. Oral shields very large, oval, pyriform or trefoil-shaped. Arms moderately long, stout, cylindrical or higher than wide at the base, very gradually tapered outwards, with blunt extremity. Dorsal arm plates usually well developed, widely in contact with one another in the free basal part of the arms. Lateral arm plates high. Ventral arm plates of the basal arm joints quadrangular or axe-shaped, in contact with one another. One to numerous arm spines, short, peg-like. Tentacle pores large, with numerous scales.

This genus includes (1) species with very large oral shields, which almost entirely cover the interbrachial ventral surfaces, viz. *Ophioglypha bullata* WYVILLE THOMSON, 1873 (the genotype), *O. convexa* LYMAN, 1878, *O. abdita* KÖHLER, 1901, *O. insolita* KÖHLER, 1904, *O. improva* KÖHLER, 1904; (2) species with the interbrachial ventral surfaces covered over by a very large central plate and very stout genital scales, viz. *O. solida* LYMAN, 1883, *O. stellata* STUDER, 1883 (1882), *O. scutata* LYMAN, 1883, *O. paupera* KÖHLER, 1897, *O. sordita* KÖHLER, 1897, *O. liberata* KÖHLER, 1904, *O. urbana* KÖHLER, 1904, *O. remota* KÖHLER, 1904, *O. latro* KÖHLER, 1904, *Ophiura ædiplax* CLARK, 1911, *O. pompophora* CLARK, 1911; (3) species with the interbrachial ventral surfaces covered with many small plates or scales, and with quadrangular ventral arm plates, viz. *Ophioglypha sculptilis* LYMAN, 1878, *O. lacazei* LYMAN, 1878, *O. lapidaria* LYMAN, 1878, *O. undata* LYMAN, 1878, *O. ponderosa* LYMAN, 1878, *O. prisca* KÖHLER, 1904, *O. laudata* KÖHLER, 1904, *O. distincta* KÖHLER,

1904, *Ophiura megapoma* CLARK, 1911, *O. penichra* CLARK, 1911, *O. hadra* CLARK, 1911; (4) species with the interbrachial ventral surfaces covered with many small plates or scales, and with axe-shaped ventral arm plates, viz. *Ophioglypha radiata* LYMAN, 1878, *O. ornata* LYMAN, 1878, *O. abscisa* LÜTKEN & MORTENSEN, 1899, *O. oblecta* LÜTKEN & MORTENSEN, 1899; besides others.

As above indicated, the present genus is divisible roughly into four sections, of which the first rather approaches *Ophiopyrgus*, the second *Aspidophiura*, the third *Stegophiura* and *Gymnophiura*, and the fourth *Ophiura* s. str.

### Key to Japanese species of *Amphiophiura*.

- A.*—Interbrachial ventral surfaces entirely covered over by the very large oral shield; central rosette of the central plate, radials and interradials very conspicuous; dorsal, as well as ventral, arm plates widely in contact with one another; three arm spines, short, conical, acute ..... *convexa*.
- AA.*—Interbrachial ventral surfaces not entirely covered over by the oral shields.
- a.*—Each interbrachial ventral surface covered with a very large central plate and very stout genital scales.
- b.*—Disk covered only by the primaries and radial shields; dorsal, as well as ventral, arm plates longer than wide; a single very short arm spine ..... *ædiplax*.
- bb.*—Disk covered by the primaries and radial shields and a number of secondary scales; dorsal, as well as ventral, arm plates wider than long; three peg-like arm spines ..... *pompophora*.
- aa.*—Interbrachial ventral surfaces covered with many small plates or scales.
- c.*—Comb papillæ squarish, flat, close-set.
- d.*—Oral shields not very narrow; arm spines peg-like or spiniform, not very numerous, not close-set.

- e.*—Single arm spine; tentacle scales present on both sides of the pore; oral angles free of granules.....*penicbra*.
- ee.*—Four or five arm spines; tentacle scales present only on the inner abradial border of the pore; oral angles often beset with a few granules ..... *megapoma*.
- dd.*—Oral shields very narrow; arm spines very numerous, squarish, flat, close-set; genital papillæ present also on the outer abradial border of the adoral shield; disk plates convex and lumpy.....*ponderosa*.
- cc.*—Comb papillæ spiniform, acute, well spaced, though they become shorter, wider, blunter and more close-set downwards.
- f.*—Disk covered with numerous small scales besides the primaries, which are separated from one another; oral shields rounded pentagonal, with a very acute inner angle; five well spaced arm spines ..... *sculptilis*.
- ff.*—Disk covered with a few secondary plates besides the primaries, which form a central rosette; oral shields trefoil-shaped; thirteen or fourteen arm spines .....*lapidaria*.

*Amphiophiura convexa* (LYMAN).

*Ophioglypha convexa*: LYMAN, Bull. Mus. Comp. Zool., V, 1878, p. 84, Pl. III, figs. 83 & 84; LYMAN, Rep. Challenger, V, 1882, p. 58, Pl. VI, figs. 13–15; LYMAN, Bull. Mus. Comp. Zool., X, 1883, p. 243, Pl. IV, figs. 40–45; KÖHLER, Bull. Sci. Fr. Belg., XLI, 1907, p. 293; KÖHLER, Rés. Camp. Sci. Monaco, XXXIV, 1909, p. 149, Pl. XXV, figs. 1 & 2; KÖHLER, Bull. U. S. Nat. Mus., LXXXIV, 1914, p. 12.

Western North Pacific (type locality); 2,050–2,300 fathoms (LYMAN).

Off western Africa. Caribbean Sea.

*Amphiophiura œdiplax* (CLARK).

*Ophiura œdiplax*: CLARK, Bull. U. S. Nat. Mus., LXXV, 1911, p. 74, fig. 21.

Sea of Japan ; 176–245 fathoms (CLARK).

*Amphiophiura pompophora* (CLARK).

*Ophiura pompophora* : CLARK, Bull. U. S. Nat. Mus., LXXV, 1911, p. 89, figs. 29 & 30.

Off Suno Saki, Sagami Sea ; 83–158 fathoms (CLARK). Eastern Sea ; 181 fathoms (CLARK).

*Amphiophiura penichra* (CLARK).

*Ophiura penichra* : CLARK, Bull. U. S. Nat. Mus., LXXV, 1911, p. 84, fig. 26.

Off Kushiro, Hokkaidô ; 175–464 fathoms (CLARK).

*Amphiophiura megapoma* (CLARK).

*Ophiura megapoma* : CLARK, Bull. U. S. Nat. Mus., LXXV, 1911, p. 79, fig. 23.

Off Noto, Sea of Japan ; 114–163 fathoms (CLARK).

*Amphiophiura ponderosa* (LYMAN).

*Ophioglypha ponderosa* : LYMAN, Bull. Mus. Comp. Zool., V, 1878, p. 93, Pl. II, figs. 52–54 ; LYMAN, Rep. Challenger, V, 1882, p. 69, Pl. VII, figs. 7–9.

*Ophiura ponderosa* : CLARK, Bull. U. S. Nat. Mus., LXXV, 1911, p. 77.

Sagami Sea ; 345 fathoms (LYMAN). Off Omai Saki ; 475–505 fathoms (CLARK). Okhotsk Sea ; 75–440 fathoms (CLARK).

Alaska. California.

*Amphiophiura sculptilis* (LYMAN).

*Ophioglypha sculptilis*: LYMAN, Bull. Mus. Comp. Zool., V, 1878, p. 84, Pl. IV, figs. 115 & 116; LYMAN, Rep. Challenger, V, 1882, p. 59, Pl. VI, figs. 16-18; KÖHLER, Ann. Sci. Nat. Zool., Sér. 8, IV, 1897, p. 301; KÖHLER, Ech. Indian Mus., Deep-sea Oph., 1899, p. 20; KÖHLER, Bull. U. S. Nat. Mus., LXXXVI, 1914, 1914, p. 24.

*Ophioglypha variabilis*: LYMAN, loc. cit., 1878, p. 85, Pl. III, figs. 70, 78 & 79; LYMAN, loc. cit., 1882, p. 60, Pl. VI, figs. 10-12.

*Ophiura sculptilis*: CLARK, Bull. U. S. Nat. Mus., LXXV, 1911, p. 77.

Off Bôshû; 1,875 fathoms (LYMAN). Off Yaku-shima; 1,008 fathoms (CLARK).

Indo-Pacific and Atlantic.

*Amphiophiura lapidaria* (LYMAN).

*Ophioglypha lapidaria*: LYMAN, Bull. Mus. Comp. Zool., V, 1878, p. 90, Pl. III, figs. 67-69; LYMAN, Rep. Challenger, V, 1882, p. 66, Pl. VII, figs. 16-18.

Off Omai Zaki; 565 fathoms (LYMAN).

**Gymnophiura** (LÜTKEN & MORTENSEN, 1899) *mihi*, 1915.

Disk high, covered by a soft skin, but partially with fine scales. Radial shields small, narrow, bar-like, widely separated from one another. Genital papillæ, as well as papillæ of arm combs, short, flat, squarish, close-set. Oral shields not very large, hour-glass-shaped. Arms rather long, stout, cylindrical. Dorsal, as well as ventral, arm plates well developed, widely in contact with one another. Lateral arm plates high, bearing seven or eight short, peg-like spines. Tentacle pores very large, with numerous scales.

This genus contains a single species, *G. mollis* LÜTKEN & MORTENSEN, 1899.

LÜTKEN & MORTENSEN have established the present genus to include two species, i.e. *G. mollis* and *G. cœlurescens* LÜTKEN & MORTENSEN, 1899. As far as I can judge, the two species are not so closely related to each other as to justify their inclusion in the same genus, unless *Ophiura* in a very wide sense be made to serve for it. Judging from the original description and figures, *G. cœlurescens* appears to be conspecific with, or at least very closely related to, *Ophiura flagellata*, which is evidently a typical member of *Ophiura*. The genotype, *G. mollis*, however, rather reminds us of such species as *Amphiophiura ponderosa*, *A. hadra*, *A. penichra*, &c., by its high disk, cylindrical arms and especially by its squarish and flat genital, as well as comb, papillæ. The characters, by which *G. mollis* is distinguished from the above mentioned species of *Amphiophiura*, are the naked disk and the narrow and bar-like radial shields, which are widely separated from one another. I am inclined to look upon the two peculiarities of *G. mollis* as the essential characters of the present genus.

*Homalophiura clasta* CLARK.

*Ophiura clasta*: CLARK, Bull. U.S. Nat. Mus., LXXV, 1911, p. 64, fig. 16.

*Homalophiura clasta*: CLARK, Mem. Mus. Comp. Zool., XXV, 1915, p. 326.<sup>1)</sup>

Off Omai Zaki; 507–918 fathoms.

**Ophiura** (LAMARCK, 1816) restr.

Disk low and very flat, covered with rather small, imbricating

---

1) *Homalophiura* CLARK, 1915, is stated by C. to include *Ophioglyphu inortata* LYMAN, 1878 (the genotype), *O. confragosa* LYMAN, 1878, *O. inortata* LYMAN, 1878, *O. abyssorum* LYMAN, 1873,



scales, among which the primaries are usually very distinct. Radial shields more or less separated from one another. Genital papillæ well developed; arm combs usually present. Second oral tentacle pores opening more or less inside the oral slits, very large, beset with numerous scales, some of which often form a continuous row with the oral papillæ. Arms not very stout but flat or cylindrical, uniformly tapered outwards. Dorsal arm plates usually well developed, often widely in contact with one another. Lateral arm plates low, bearing three to seven arm spines, which lie flat on the arm. Ventral arm plates small, separated from one another at least outside the disk. Tentacle pores of the first one or two arm joints large and beset with rather numerous scales; those beyond are very small and have only one or two scales.

This genus, as now restricted, includes (1) species with spini-form genital papillæ and comb papillæ, such as *Asterias ophiura* LINNÉ, 1758, *Ophiura albida* FORBES, 1839, *Ophiolepis robusta* AYRES, 1851, *Ophiura sarsii* LÜTKEN, 1854, *O. arctica* LÜTKEN, 1854, *O. carnea* (SARS) LÜTKEN, 1859, *O. affinis* LÜTKEN, 1859, *Ophioglypha lütkeni* LYMAN, 1860, *O. kinbergi* LJUNGMAN, 1866, *O. acervata* LYMAN, 1869, *O. brevispina* SMITH, 1876, *O. inermis* LYMAN, 1878, *O. papillata* LYMAN, 1878, *O. flagellata* LYMAN, 1878, *O. imbecillis*, LYMAN, 1878, *O. lepida* LYMAN, 1878, *O. equalis* LYMAN, 1878, *O. ljungmani* LYMAN, 1878, *O. meridionalis* LYMAN, 1879, *O. aurantiaca* VERRILL, 1882, *O. maculata* LUDWIG, 1886, *O. amphitrites* BELL, 1888, *O. indica* BROCK, 1888, *O. thouleti* KÖHLER, 1895, *Ophiozona*

---

*O. tessellata* VERRILL, 1894, *O. inflata* KÖHLER, 1898, *O. divisa* LÜTKEN & MORTENSEN, 1899, *O. nana* LÜTKEN & MORTENSEN, 1899, *O. scutellata* LÜTKEN & MORTENSEN, 1899, *O. frigida* KÖHLER, 1900, *O. gelida* KÖHLER, 1900, *Ophiozona inermis* BELL, 1902, *Ophioglypha brucei* KÖHLER, 1907, *O. mimaria* KÖHLER, 1907, *O. parvula* KÖHLER, 1907, *O. scissa* KÖHLER, 1970, *O. flexibilis* KÖHLER, 1911, *Ophiura clasta* CLARK, 1911, and *Ophioglypha rouchi* KÖHLER, 1912.

*capensis* BELL, 1905, *Ophiura leptoctenia* CLARK, 1911, *O. micracantha* CLARK, 1911, *O. quadrispina* CLARK, 1911, *O. bathybia* CLARK, 1911, *Ophiocten oöplax* CLARK, 1911; (2) species with flat and squarish genital papillæ and comb papillæ, such as *Ophioglypha multispina* LJUNGMAN, 1866, *O. lymani* LJUNGMAN, 1870, *O. irrorata* LYMAN, 1878, *O. undulata* LYMAN, 1878, *O. costata* LYMAN, 1878, *O. albata* LYMAN, 1878, *O. jejuna* LYMAN, 1878, *O. loceni* LYMAN, 1878, *O. fraterna* LYMAN, 1878, *O. rugosa* LYMAN, 1878, *O. ambigua* LYMAN, 1878, *O. tenera* LYMAN, 1883, *O. fulcifera* LYMAN, 1883, *O. verrucosa* STUDER, 1883, *O. aspera* KÖEHLER, 1898, *O. plana* LÜTKEN & MORTENSEN, 1899, *O. clemens* KÖEHLER, 1904, *O. concreta* KÖEHLER, 1901, *O. mundata* KÖEHLER, 1906, *Ophiura monostœcha* CLARK, 1911, *O. atacta* CLARK, 1911, *O. calyptolepis* CLARK, 1911, *O. cryptolepis* CLARK, 1911, *O. paucisquama*, nov. and others.

*Ophionotus*, *Ophioperla* and *Ophiotjalfa* are very close to the present genus—especially to the *ophiura*-group. *Ophionotus* may be defined as *ophiura*-forms with supplementary dorsal arm plates; *Ophioperla* as the same with superficial granulations on the disk; and *Ophiotjalfa* as the same without genital papillæ or arm combs.

### Key to Japanese species of *Ophiura*.

- A.*—Genital papillæ, as well as comb papillæ, spiniform, acute, both or at least the latter being well spaced; second oral tentacle pore opening more or less within the oral slit.
- B.*—Arms flattened, much wider than high at the free arm base; arm spines rather long and stout.....*ophiura*-group (I).
- a.*—Arm combs well developed, rather large in dorsal view.
- b.*—Three arm spines; oral shields wider within than without.
- c.*—Disk scales naked; arm spines not spatulate.

- d.*—Disk scales coarse; comb papillæ very long and slender, eight to ten of them being visible from above.....*kinbergi*.
- dd.*—Disk scales fine; comb papillæ very short, twelve to fourteen of them being visible from above.....*sarsi*.
- cc.*—Disk scales more or less obscured by a thick, soft skin; lower arm spines of basal arm joints spatulate.....*flagellata*.
- bb.*—Four arm spines; oral shields wider without than within; comb papillæ short.....*quadrispina*.
- aa.*—Arm combs rudimentary or entirely wanting, genital papillæ present.
- e.*—Three exceedingly long arm spines; dorsal arm plates oval, longer than wide; disk scales fine; oral shields wider without than within.....*oöplax*.
- ce.*—Four arm spines, not exceedingly long; dorsal arm plates more or less quadrangular, much wider than long; disk scales coarse; oral shields wider within than without.....*maculata*.
- BB.*—Arms cylindrical, about as wide as high\* at the free base; three arm spines, minute, peg-like, short, well spaced.....*imbecillis*-group (II).
- f.*—Disk scales coarse; radial shields joined in pairs; oral shields trefoil-shaped, about as long as wide; arm bases within the disk especially wide; first ventral arm plate very large and rhomboidal; dorsal arm plates separated from one another.....*imbecillis*.
- ff.*—Disk scales fine; radial shields nearly or entirely separated from one another; oral shields not trefoil-shaped; arm bases within the disk not especially wide; first ventral arm plates small; dorsal arm plates meeting with one another.
- g.*—Radial shields short, only slightly longer than wide; oral shields pentagonal, wider than long; uppermost or lowest arm spine longest, middle one shortest, none of them coming up to the length of the corresponding arm joint.....*micracantha*.
- gg.*—Radial shields long, about twice as long as wide; oral shields pear-shaped, much longer than wide; uppermost arm spine longest,

- lowest one shortest, the former being as long as, or longer than, the corresponding arm joint ..... *leptoctenia*.
- AA.*—Genital papillæ and comb papillæ squarish, flat, short, blunt, close-set; second oral tentacle pore opening nearly or entirely outside the oral slit; arms cylindrical, about as wide as high at the base; arm spines minute, short ..... *irrorata*-group (III).
- h.*—Disk scales naked; arm spines well spaced.
- i.*—Three arm spines.
- j.*—The two sets of comb papillæ on the sides of an arm base not continuous; oral shields much wider than long.
- k.*—Oral shields wider without than within; arm spines minute, subequal; tentacle scales very numerous, twelve to fifteen to the second oral tentacle pore, eight to eleven to the first tentacle pore, five to eight to the second tentacle pore, &c. .... *irrorata*.
- kk.*—Oral shields wider within than without; arm spines not very minute, uppermost one longest and lowest one shortest; tentacle scales rather few, eight or nine to the second oral tentacle pore, four or five to the first tentacle pore, three or four to the second tentacle pore, and one or two to those beyond. .... *paucisquama*.
- jj.*—The two sets of comb papillæ on the sides of an arm base forming a single unbroken series; oral shields about as wide as long, wider within than without; arm spines subequal ..... *monostecha*.
- ii.*—Six arm spines, minute, peg-like, subequal, evenly spaced; disk scales thin and hard to distinguish; oral shields pentagonal, slightly longer than wide. .... *albata*.
- hh.*—Disk covered by a thick, soft skin, which obscures the underlying scales; arm spines closely set.
- l.*—Six or seven arm spines; disk scales rather coarse and thick, radial shields present; arm combs rudimentary or entirely absent. .... *calyptolepis*.
- ll.*—Seven to nine arm spines; disk scales and radial shields almost aborted in adult specimens; arm combs well developed ..... *cryptolepis*.

*Ophiura kinbergi* (LJUNGMAN).

*Ophioglypha kinbergi*: LJUNGMAN, Öfv. K. Vet. Akad. Förh., XXVII, 1866, p. 116<sup>b</sup>; LYMAN, Rep. Challenger, V, 1882, p. 38, Pl. IV, fig. 70; KÖHLER, Exp. Siboga, XLV, Pt. 2, 1905, p. 22; KÖHLER, Bull. Sci. Fr. Belg., XLI, 1907, p. 294.

*Ophioglypha sinensis*: LYMAN, Ill. Cat. Mus. Comp. Zool., VI, 1871, p. 12, Pl. I, figs. 1 & 2; LYMAN, Bull. Mus. Comp. Zool., V, 1878, p. 99; LYMAN, loc. cit., 1882; DÖDERLEIN, SEMON-Zool. Forschungsr., V, 1896, p. 281, Pl. XV, figs. 3 & 3a; KÖHLER, Bull. Sci. Fr. Belg., XXXI, 1898, p. 60, Pl. IV, fig. 39; KÖHLER, Ech. Indian Mus., Shallow-water Oph., 1900, Pl. XV, figs. 6 & 7.

*Ophioglypha ferruginea*: LYMAN, loc. cit., 1878, p. 68, Pl. III, fig. 76.

*Ophiura kinbergi*: CLARK, Bull. U. S. Nat. Mus., LXXV, 1911, p. 37, fig. 9.

Numerous specimens; Tsushima. One specimen; Tomo, Bingo. Two specimens; mouth of Koajiro Bay, Misaki; 10 fathoms. Numerous specimens; Misaki. Numerous specimens; Uraga Channel.

Off Yokohama; 8-15 fathoms (LYMAN). Inland Sea; 15 fathoms (LYMAN).

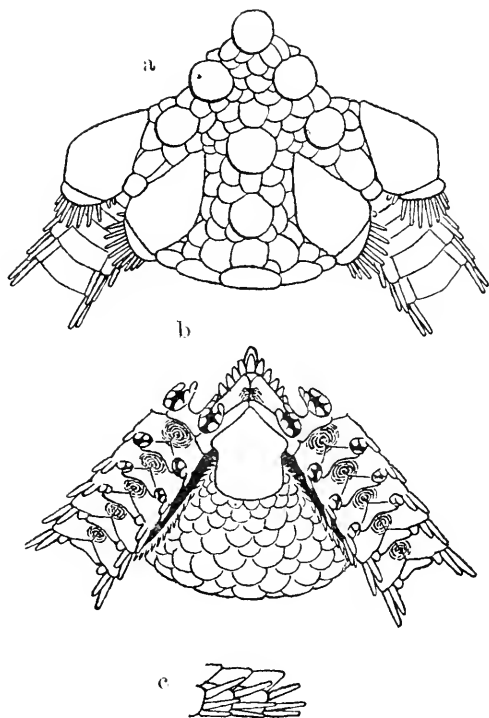

Fig. 73. *Ophiura kinbergi*.  $\times 7$ . a. From above. b. From below. c. Side view of three arm joints near disk.

1) This paper was not seen by me.

Eastern Sea ; 53 fathoms (CLARK). Off Echigo, Sea of Japan ; 70 fathoms (CLARK).

Indo-Pacific ; ranging southwards as far as Bass Straits.

*Ophiura sarsii* LÜTKEN.

*Ophiura sarsii*: LÜTKEN, Vid. Meddel., Nov., 1854, p. 7; LÜTKEN, Addit. ad Hist. Oph., I, 1861, p. 42. Pl. I, figs. 3 & 4; GRIEG, Fauna Arctica, I, 1900, p. 262; NORMAN, Ann. Mag. Nat. Hist., Ser. 7, XII, 1903, p. 467; NICHOLS, Proc. R. Irish Acad., XXIV, Sect. B, 1903, p. 254; CLARK, Bull. U. S. Nat. Mus., LXXV, 1911, p. 37.

*Ophioglypha sarsii*: LYMAN, Ill. Cat. Mus. Comp. Zool., I, 1865, p. 41, figs. 2 & 3; LYMAN, Bull. Mus. Comp. Zool., V, 1878, p. 99; LYMAN, Rep. Challenger, V, 1882, p. 40; KOEHLER, Bull. Sci. Fr. Belg., XLI, 1907, p. 296; KOEHLER, Rés. Camp. Sci. Monaco, XXXIV, 1909, p. 115, Pl. VII, fig. 3; KOEHLER, Bull. U. S. Nat. Mus., LXXXIV, 1914, p. 23, Pl. I, figs. 5-6.

Four specimens; off Namerikawa, Etchû,

Okhotsk Sea ; 75-109 fathoms (CLARK). Gulf of Tartary ; 318 fathoms. Sea of Japan ; 59-428 fathoms (CLARK). Hakodaté Bay ; 15.5-47 fathoms (CLARK). Off Urakawa, southern coast of Hokkaidô ; 175-349 fathoms (CLARK). Off Kinkwasan ; 57 fathoms (CLARK). Uruga Channel ; 70 fathoms (CLARK). Off Korea ; 163-335 fathoms (CLARK). Eastern Sea ; 181 fathoms (CLARK).

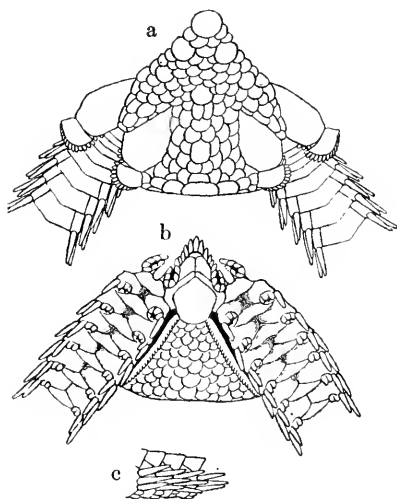

Fig. 74. *Ophiura sarsii*.  $\times 2$ . a. From above. b. From below. c. Side view of four arm joints near disk.

North Pacific. Arctic Ocean. North Atlantic.

In these Japanese specimens, the primary plates are rather small and have a flat surface, so that the disk is very smooth.

The plates and scales of the disk, as well as the arm plates, are light gray, with whitish peripheries. In one specimen, the primaries are especially dark, so that the disk appears spotted.

*Ophiura flagellata* (LYMAN).

*Ophioglypha flagellata*: LYMAN, Bull. Mus. Comp. Zool., V, 1878, p. 69, Pl. II, figs. 49-51; LYMAN, Rep. Challenger, V, 1882, p. 52, Pl. IV, figs. 16-18; KÖHLER, Ann. Sci. Nat. Zool., Sér. 8, IV, 1896, p. 299; KÖHLER, Ech. Indian Mus., Deep-sea Oph., 1899, p. 18; KÖHLER, Exp. Siboga, XIV, Pt. I, 1904, p. 56; KÖHLER, Mém. Soc. Zool. Fr., XIX, 1906, p. 6; KÖHLER, Bull. Sci. Fr. Belg., XLI, 1907, p. 294; KÖHLER, Exp. Sci. Travailleur et Talisman, VIII, 1907, p. 261.

*Gymnophiura carulescens*: LÜTKEN & MORTENSEN, Mem. Mus. Comp. Zool., XXIII, 1899, p. 114, Pl. VII, figs. 4-6.

*Ophiura flagellata*: CLARK, Bull. U. S. Nat. Mus., LXXV, 1911, p. 60, fig. 15.

Three specimens; Okinosé, off Misaki; 100 fathoms.

Uruga Channel; 70-302 fathoms (CLARK). Sagami Sea; 292-405 fathoms (CLARK). Off Rikuzen, eastern Japan; 182 fathoms (CLARK). Off Omai Zaki; 475-505 fathoms (CLARK). Eastern Sea; 361 fathoms (CLARK).

Bering Sea and off Alaska (CLARK). Indian Ocean and Malaysian waters (KÖHLER). South-eastern Atlantic (KÖHLER).

The arm spines are much flattened, the lowest one being more or less spatulate. The second oral tentacle pore opens in the oral slit, with four or five abradial and three or four adradial scales, the former showing a tendency to form a continuous series with the oral papillæ. There are three adoral scales to the first

six or seven tentacle pores and two to those beyond; of the aboral scales there are three to the first, two to the second, and one to the third. All the tentacle scales are flat, thin and leaf-like.

I have carefully compared this species with the description and figures of *Gymnophiura caeruleescens* LÜTKEN & MORTENSEN, and have come to the conclusion that the two species agree in almost all characters, e. g. the radial shields, arm combs, interbrachial ventral spaces of the disk, oral shields, adoral shields, oral papillæ, dorsal as well as ventral arm plates, arm spines, tentacle scales, &c. The only difference between my specimens and the type of *G. caeruleescens* is that in the former the scales are present all over the disk, while in the latter there is a star-shaped naked central space on the dorsal side. But LYMAN says that, the disk of the present species is "covered with a thick skin, under which the thin small scales are scarcely, or not at all, distinguishable." Further, CLARK remarks that, his specimens "show a most remarkable difference in the calcification of the disk, for while several of them have the disk covering thick, with the scales hardly distinguishable, as in LYMAN's type, others have it much thinner with the scales evident, while still others have a greater or less part of the disk covered by a naked skin, the calcification being confined to the vicinity of the radial shields and to the interradial margins," and that "the gradation between the two extremes is so complete that there can be no doubt that the amount of calcification is an individual and not a specific or even a local matter." I therefore look upon *G. caeruleescens* as a synonym of the present species.



*Ophiura quadrispina* CLARK.

*Ophiura quadrispina*: CLARK, Bull. U. S. Nat. Mus., LXXV, 1911, p. 55, fig. 13.

Okhotsk Sea; 109–188 fathoms (CLARK). Yezo Strait; 533 fathoms (CLARK). Sea of Japan; 325–428 fathoms (CLARK).

Bering Sea. Alaska.

*Ophiura oöplax* (CLARK).

*Ophiocten oöplax*:

CLARK, Bull. U. S. Nat. Mus., LXXV, 1911, p. 99, fig. 37.

One specimen;  
Albatross station  
(number?).

Off Honshû; 94–  
507 fathoms (CLARK).  
Sagami Sea; 292–  
614 fathoms (CLARK).  
Eastern Sea; 369–  
440 fathoms (CLARK).

In my opinion,  
this species is evi-  
dently a typical  
*Ophiura*, though  
CLARK has referred  
it to *Ophiocten*. In  
the genuine *Ophioc-*  
*ten*, the tentacle pores

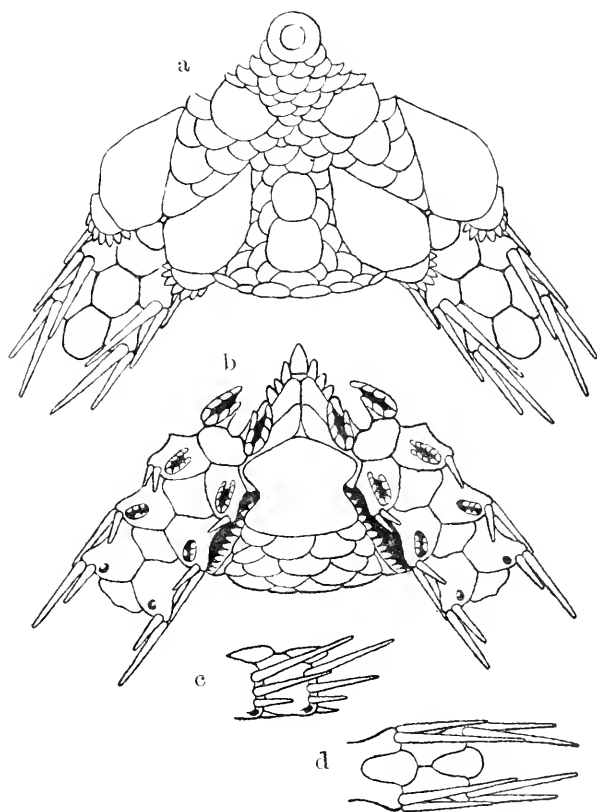

Fig. 75. *Ophiura oöplax*.  $\times 15$ . *a*. From above. *b*. From below. *c*. Side view of two arm joints near disk. *d*. Dorsal view of two arm joints somewhat near disk.

are of nearly uniform size and the tentacle scales few or none throughout, while in the present species the tentacle scales are very numerous in the very basal pores and rapidly diminish in number outwards. I am not able to find any character distinguishing this species from the genuine *Ophiura*.

*Ophiura maculata* (LUDWIG).

*Ophioglypha maculata*: LUDWIG, Zool. Jahrb. Sys., I, 1886, p. 233, Pl. VI, figs. 11 & 12; CLARK, Bull. U. S. Nat. Mus., LXXV, 1911, p. 49, fig. 11.

Two specimens (belonging to Mr. H. ASANO, Imperial Bureau of Fishery); off Kitami; 60 fathoms.

Bering Sea. Alaska.

*Ophiura imbecillis* (LYMAN).

*Ophioglypha imbecillis*: LYMAN, Bull. Mus. Comp. Zool., V, 1878, p. 78, Pl. III, figs. 63 & 64; LYMAN, Rep. Challenger, V, 1882, p. 46, Pl. IV, figs. 11-13; KÖHLER, Ann. Sci. Nat. Zool., Sér. 8, IV, 1897, p. 303; KÖHLER, Ech. Indian Mus., Deep-sea Oph., 1899, p. 21.

*Ophiura imbecillis*: CLARK, Bull. U. S. Nat. Mus., LXXV, 1911, p. 62.

Uraga Channel; 302 fathoms (CLARK). Sagami Sea; 340-405 fathoms (LYMAN, CLARK). Off Kii; 393 fathoms (CLARK). Off Hiuga; 437 fathoms (CLARK). Eastern Sea; 361 fathoms (CLARK).

Indian Ocean. Malaysian waters.

*Ophiura micracantha* CLARK.

*Ophiura micracantha*: CLARK, Bull. U. S. Nat. Mus., LXXV, 1911, p. 47, fig. 10.

Two specimens; Okinosé, Sagami Sea; 100 fathoms.

Uraga Channel; 197 fathoms (CLARK). Off Kagoshima Gulf; 152 fathoms (CLARK). Off Gotô Is., Eastern Sea; 139 fathoms (CLARK).

*Ophiura leptoctenia* (CLARK).

*Ophiura leptoctenia*: CLARK, Bull. U. S. Nat. Mus., LXX, 1911, p. 51, fig. 12.

Okhotsk Sea; 73–119 fathoms (CLARK). Gulf of Tartary; 318 fathoms (CLARK). Sea of Japan; 92–429 fathoms (CLARK). Southward of Hokkaidô; 175–349 fathoms (CLARK). Off eastern Japan; 191–507 fathoms (CLARK). Off Omai Zaki; 624–662 fathoms (CLARK). Off Korea; 335 fathoms (CLARK).

Bering Sea. Alaska. British Columbia. Oregon. Washington.

*Ophiura irrorata* (LYMAN).

*Ophioglypha irrorata*: LYMAN, Bull. Mus. Comp. Zool., V, 1878, p. 73, Pl. IV, figs. 106–108; LYMAN, Rep. Challenger, V, 1882, p. 47, Pl. V, figs. 7–9.

*Ophioglypha orbiculata*: LYMAN, Bull. Mus. Comp. Zool., V, 1878, p. 74, Pl. IV, figs. 103–105; LYMAN, Rep. Challenger, V, 1882, p. 48, Pl. VIII, figs. 10–12.

*Ophioglypha grandis*: VERRILL, Proc. U. S. Nat. Mus., XLII, 1894, p. 293.

*Ophioglypha involuta*: KÆHLER, Ann. Sci. Nat. Zool., Sér. 8, IV, 1897, p. 295, Pl. VI, figs. 16–18; KÆHLER, Ech. Indian Mus., Deep-sea Oph., 1899, p. 15, Pl. VIII, figs. 61–63.

*Ophioglypha tumulosa*: LÜTKEN & MORTENSEN, Mem. Mus. Comp. Zool., XXIII, 1899, p. 120, Pl. I, figs. 8–13.

*Ophiura irrorata*: CLARK, Bull. U. S. Nat. Mus., LXXV, p. 62.

Okhotsk Sea; 1,800 fathoms (CLARK). Off Omai Zaki; 624–

918 fathoms (CLARK). Yenshû Sea ; 943 fathoms (CLARK). Off Kii ; 649 fathoms (CLARK). Off Hiuga ; 720 fathoms (CLARK).  
Cosmopolitan.

*Ophiura paucisquama*, sp. nov.

One specimen ; off Misaki, Sagami Sea.

Diameter of disk 5.5 mm. Length of arms 20 mm. Width of arms at base 1 mm.

Disk pentagonal, with nearly straight interbrachial borders, very flat, thin, covered with numerous coarse, irregular, imbricated scales. The central plate is indistinguishable, but the radials are distinct, and somewhat larger than the other scales. A large, squarish plate is present in each interradius, just touching the disk margin. Radial shields irregularly triangular, with acute inner and much rounded outer angles, a little longer than one-third the disk radius, somewhat longer than wide, not in contact with each other. Arm combs very small, with fine, short, blunt, flat, close-set comb papillæ, of which about seven are visible from above. Interbrachial ventral surfaces covered also with coarse, irregular, imbricated scales. Genital slits long, with fine, short, blunt, close-set genital papillæ on the abradial border.

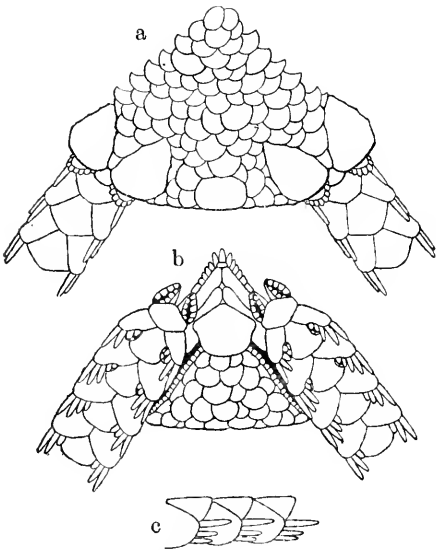

Fig. 76. *Ophiura paucisquama*.  $\times 10$ . a. From above. b. From below. c. Side view of three arm joints near disk.

Oral shields pentagonal, or rather lyre-shaped, with straight inner and notched lateral sides and a slightly convex outer side, wider than long, widest at the inner lateral angles; outer angles perfectly rounded. Adoral shields very long, narrow, meeting with each other within, constricted at about the middle by the second oral tentacle pores and the inner lateral angles of the oral shields; the outer lobe separates the oral shields from the first ventral and lateral arm plates; the inner lobe is wider within than without. Oral plates parallel to the adoral shields, also long and narrow. Four or five oral papillæ on either side, close-set, inner ones longer, narrower and acuter; the outermost one is very wide and short. Besides, there occur two or three long, conical, acute apical papillæ in each jaw. Teeth conical, acute, stout.

Arms slender, uniformly tapered outwards. The first dorsal arm plate is exceedingly small, situated between the pairs of radial shields and of arm combs; the second is also rather small. The third is the largest, pentagonal, with very short inner side and rounded outer angles, about as long as wide. The fourth is similarly pentagonal, but longer than wide, and the inner side much shorter. These plates are in contact with one another, but the rest are separated by the lateral arm plates, rhomboidal, with acute inner and rounded outer angles, longer than wide. They constantly diminish in size outwards, and become exceedingly small near the extremity of the arms. Lateral arm plates flared, meeting both above and below, except in the first joint, in which they do not meet below, and the first three or four free joints, in which they do not meet above. First ventral arm plate not very small, hexagonal, with very short lateral sides and rounded angles, much wider than long, about as wide as, but shorter than, the next plate. The latter is the largest, hexagonal, with very short

inner and very convex outer sides ; inner lateral and lateral sides concave, the former being in contact with the lateral arm plates and the latter with the tentacle pores ; longer than wide, wider without than within, in contact with the first plate. The third plate is pentagonal, with concave inner and lateral sides and strongly convex outer side, about as wide as long. Those beyond are triangular, with wide inner angle and very convex outer side, wider than long ; separated from one another and constantly diminishing in size outwards. Three arm spines, conical, acute, the uppermost is longer and stouter than the others, and are two-thirds as long as the corresponding arm joints ; in the free basal joints the lowermost two are half as long as the corresponding joints. The second oral tentacle pore opens hardly within the oral slit, with four or five scales on both the abradial and adradial borders. The first four or five tentacle pores have each two scales on the adoral border, but the rest have only one. Besides, the first and second pores have two very small scales on the aboral border, which are almost covered over by the adoral scales.

Colour in alcohol : disk very light brown, arms white.

The present species differs from *O. irrorata* (LYMAN) in the shape of the oral shields, in the longer arm spines, and in the fewer tentacle scales ; from *O. plana* (LÜTKEN & MORTENSEN) in the shape of the radial and oral shields, in the coarser scales of the interbrachial ventral surfaces, and in the fewer tentacle scales ; and from *O. mindata* in the shape of the radial and oral shields, in the longer arm spines, and in the fewer tentacle scales.

*Ophiura monostœcha* CLARK.

*Ophiura monostœcha*: Bull. U. S. Nat. Mus., LXXV, 1911, p. 65, fig. 17.

Off Honshû ; 153 fathoms (CLARK). Suruga Gulf ; 270 fathoms (CLARK). Off Hiuga ; 405-578 fathoms (CLARK).

*Ophiura albata* (LYMAN).

*Ophioglypha albata*: LYMAN, Bull. Mus. Comp. Zool., V, 1873, p. 77, Pl. IV, figs. 95-97 ; LYMAN, Rep. Challenger, V, 1882, p. 51, Pl. V, figs. 13-15.

Sagami Sea ; 775 fathoms (LYMAN).

*Ophiura calyptolepis* (CLARK).

*Ophiura calyptolepis*: CLARK, Bull. U. S. Nat. Mus., LXXV, 1911, p. 67, fig. 18.

Uraga Channel ; 70-197 fathoms (CLARK). Sagami Sea ; 153-405 fathoms (CLARK).

*Ophiura cryptolepis* (CLARK).

*Ophiura cryptolepis*: CLARK, Bull. U. S. Nat. Mus., LXXV, 1911, p. 1911, fig. 19.

Off Omai Zaki ; 475-505 fathoms (CLARK).

Bering Sea. Alaska. Washington.

**Ophiurolepis** MATSUMOTO, 1915.

Disk covered with two kinds of scales, the larger ones being surrounded by a zone of smaller ones. Radial shields moderately large, rounded, widely separated from one another. Genital

papillæ and arm combs absent. Adoral shields oval, with pointed outer end. One to three supplementary plates present among the oral plates and adoral shields. Oral papillæ close-set, completely closing the oral slits. Teeth in a single vertical row. Dental papillæ absent. Arms long, stout, with very short arm joints. Dorsal arm plates well developed, wide, strongly convex. Ventral arm plates triangular, nearly in contact with, or separated from, one another. Second oral tentacle pore opening entirely outside the oral slit, long, entirely closed by the tentacle scales, which are so modified as to appear like supplementary plates. A single arm spine and three tentacle scales, both being very small and peg-like.

This genus includes a single species, *Ophiolepis carinata* STUDER, 1876 (referred to *Ophioglypha* by STUDER, 1883, after the publication of *Ophioglypha deshayesi* by LYMAN, 1878).

In my opinion *Ophiolepis carinata* STUDER and *Ophioglypha deshayesi* LYMAN are conspecific, the former having priority. Through Dr. HUBERT L. CLARK'S kindness, I was enabled to examine one of LYMAN'S specimens and I am convinced that, it agrees fairly well with STUDER'S description and figures, though the latter are rather imperfect and inaccurate. LYMAN did not take into account *Ophiolepis carinata* when describing *Ophioglypha deshayesi*, probably because he took STUDER'S statement as to genus on trust. It may be remarked that, both STUDER'S and LYMAN'S specimens were taken from the vicinities of Kerguelen Island, the former at the depth of 60–65 fathoms, the latter at 28–150 fathoms.

*Ophiurolepis* is not very close to any other subdivision of *Ophiura* s. ext., though it more or less resembles the *irrorata*-group of *Ophiura* s. str. *Ophiurolepis* resembles *Ophiolepis* and *Ophiozona* restr., merely in the squamation of the disk.



Key to Japanese genera of *Ophiolepidinae*.

- A*—Tentacle pores limited to a few basal arm joints; disk plates or scales, as well as radial shields, more or less intimately soldered together; oral papillæ more or less soldered together to form a single piece; arm joints long and hour-glass-shaped; dorsal and ventral arm plates more or less rudimentary; arm spines very minute and peg-like. . . . . *Ophiomusium*.
- AA*—Tentacle pores well developed throughout the entire length of the arm; disk plates or scales imbricating; oral papillæ not soldered together; arm joints not very long; dorsal and ventral arm plates usually well developed; arm spines not very minute.
- a*—No true tentacle scales, though the lower arm spines may sometimes serve as one; disk covered with fine, granule-like scales; genital slits very minute, placed at the inner corners of the inter-brachial ventral surfaces; dorsal arm plates more or less widely separated from one another by supplementary plates or naked spaces; ventral arm plates separated from one another at least in the basal arm joints. . . . . *Ophiopenia*.
- aa*—Tentacle scales always well developed.
- b*—Dorsal arm plates entire, without supplementary plates; ventral arm plates rhomboidal and separated from one another except at the arm base; lateral arm plates of either side meeting both above and below except at the arm base; disk covered with large plates and smaller scales; radial shields very stout; one or two tentacle scales. . . . . *Ophioxonella*.
- bb*—Dorsal arm plates not entire, accompanied by supplementary plates; ventral arm plates quadrangular, widely in contact with one another; lateral arm plates of either side not meeting above or below.
- c*—Dorsal arm plates proper not divided, accompanied by small supplementary plates on both sides or also along the outer border; disk covered with two kinds of scales, the larger ones surrounded by a zone of smaller ones; radial shields moderately stout; two tentacle scales, together forming an oval . . . . . *Ophiolepis*.

*cc*—Dorsal arm plates proper divided into halves, which are widely separated from each other by a mosaic of supplementary plates; disk covered with very fine scales; radial shields very small; three or four tentacle scales. . . . . *Ophioplocus*.

### Key to Japanese species of *Ophiomusium*.

*A*—Two pairs of tentacle pores to each radius; genital slits free of papillæ; genital scales extremely stout; a very conspicuous, large, central plate is present in each interbrachial ventral surface; disk covered with very stout plates and very large radial shields.

*a*—Genital slits very short and pore-like, or invisible, free from the oral and adoral shields, which are completely joined; no ventral arm plates beyond the third.

*b*—Disk margin free of tubercles; disk with some secondary plates, besides the primaries and radial shields; two or three arm spines.

*c*—Disk plates more or less imbricated, or arranged like steps. . . . . *scalare*.

*cc*—Disk plates tessellated. . . . . *simplex*.

*bb*—Disk margin beset with tubercles; disk with only the primaries, besides the radial shields; five arm spines. . . . . *granosum*.

*aa*—Genital slits long, peculiarly situated between the oral and adoral shields, the former being almost axe-shaped.

*d*—No ventral arm plates beyond the third.

*c*—Disk covered with rather small primaries and smaller secondary plates, besides the radial shields, which are separated from one another; dorsal side of the disk and arms usually very tubercular; interbrachial ventral surfaces covered with a large central and several secondary plates, besides the stout genital scales. . . . *lymani*.

*ce*—Disk with only very stout primaries, besides the radial shields, which are joined in pairs; dorsal side of the disk and arms smooth; interbrachial ventral surfaces covered only by a very large central plate, besides the very stout genital scales. . . . . *lumare*.

- dd*—Ventral arm plates present throughout the entire length of the arm.
- f*—Disk covered with stout primaries and smaller secondary plates, besides the radial shields; each primary plate bearing a very large central umbo; five or six peg-lik arm spines.....*trychnum*.
- ff*—Disk covered only by very stout primaries and radial shields; no central umbo on them; three very large, acute, erect arm spines, of which the uppermost and largest is placed on the dorsal surface of the lateral arm plate.....*lütkeni*.
- AA*—Three pairs of tentacle pores to each radius; genital slits provided with papillæ; genital scales not very stout; interbrachial ventral surfaces covered with many small plates or scales, without very prominent central plate; disk covered with many small plates or scales, besides the radial shields.
- g*—Genital slits not reaching to the disk margin; each tentacle pore provided with one scale on the abradial border and often also with an additional one on the adradial border; a group of papillæ present on either side of each arm base, just outside the genital slit and radial shield; three close-set arm spines.
- h*—Oral shields triangular, about as wide as long, wider without than within.....*cancellatum*.
- hh*—Oral shields pear-shaped, much longer than wide, wider within than without.....*joltiense*.
- gg*—Genital slits reaching to the disk margin, each tentacle pore provided with two scales on the abradial border; no papillæ on the sides of the arm base; oral shields triangular, about as wide as long; four well spaced arm spines.....*laqueatum*.

***Ophiomusium scalare* LYMAN.**

*Ophiomusium scalare*: LYMAN, Bull. Mus. Comp. Zool., V, 1878, p. 117, Pl. I, figs. 1-3; LYMAN, Rep. Challenger, V, 1882, p. 95, Pl. I, figs. 4-6; KÖEHLER, Ann. Sci. Nat. Zool., Sér. IV, 1896, p. 308, Pl. VI, figs. 24 &

25 ; KÖHLER, Ech. Indian Mus., Deep-sea Oph., 1899, p. 26, Pl. II, figs. 12 & 13, Pl. III, fig. 21 ; KÖHLER, Exp. Siboga, XLV, Pt. 1, 1904, p. 65 ; KÖHLER, Mém. Soc. Zool. Fr., XIX, 1906, p. 6 ; KÖHLER, Exp. Sci. Travailleur et Talisman, VIII, 1907, p. 266.

Two specimens ; off Ukishima, Uraga Channel ; 300 fathoms.  
Indo-Pacific. Atlantic.

Diameter of disk 9 mm. Length of arms 28 mm. Width of arms at base 2 mm.

Disk pentagonal, rather flat. Dorsal surface covered with about sixty-six stout, somewhat imbricated plates, besides the radial shields ; the central plate, basals, first radials, second radials,

first interradials and second interradials being the largest. Central plate pentagonal, with the rounded angles placed interradially. First radials semicircular or diamond-shaped, wider than long, separated from the central plate by the small, oblong infrabasals, and from one another by the diamond-shaped basals. First interradials longer than wide, much wider at the outer end than at the inner. Second

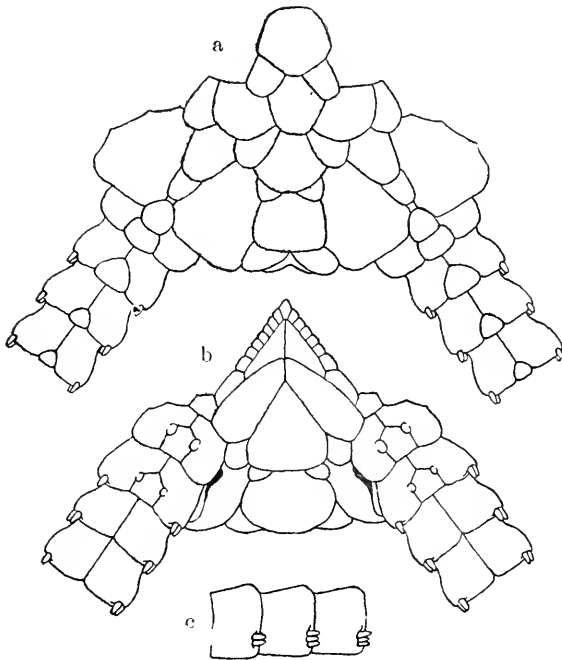

Fig. 77. *Ophiomusium scalare*  $\times 10$ . *a.* From above. *b.* From below. *c.* Side view of three arm joints near disk.

interradials quadrangular, wider than long. Radial shields large

and stout, irregularly triangular, longer than wide, longer without than within; those of a pair separated from each other by the large second radial, small third radial and the small first dorsal arm plate. Interbrachial ventral surfaces covered chiefly by the very large, stout genital scales and a very large, stout, convex plate, lying directly outside the oral shield. Genital slits small, very short and narrow.

Oral shields large, pentagonal, with very long inner and very short lateral sides, an acute inner and rounded outer angles, stout, longer than wide, wider without than within. Adoral shields very large, stout, long, wide, tapered inwards, meeting with each other. Seven or eight oral papillæ on either side, squarish, flat, soldered together, and obscuring the original number; the outermost one is exceedingly large and wide, and arises from the adoral shield; the next is much smaller and narrower than the preceding, but distinctly larger and wider than the following. Three teeth, small, triangular, pointed.

Arms cylindrical, gradually tapered. First dorsal arm plate very small, rounded triangular, convex, wedged in between the radial shields. The next is also small, quadrangular, with rounded angles and convex sides, wider than long, with convex surface, in contact with the first. The five or six remaining are small and triangular, with rounded angles and convex sides and surface, and diminish in size outwards. Lateral arm plates well developed, covering almost the entire surface of the arms, convex, flared. Only three ventral arm plates: the first small, pentagonal, wedged in between the adoral shields; the second and third also small, but a little larger than the first, pentagonal, with the tentacle pores at the lateral angles. Only two pairs of tentacle pores and scales; the latter small and oval, the first scales being larger than

the second. Two or three arm spines, very minute, peg-like, situated close together in a notch.

The plates of the disk and arms are minutely tuberculated.

Colour in alcohol white or pale gray.

In the smaller one of these specimens, the tentacle pores and scales are entirely absent, so that the second and third ventral arm plates are triangular instead of being pentagonal.

LYMAN'S type was much smaller and KÖHLER'S specimens much larger than mine. The disk plates are therefore fewest in LYMAN'S and most numerous in KÖHLER'S; they are moreover separated from one another by narrow grooves in the type, but imbricated in both KÖHLER'S specimens and mine. The radial shields are closely in contact in the type, but separated in my specimens, and more so in KÖHLER'S. The oral papillæ are most numerous in mine. The two small plates shown in my figure between the oral shield and the largest interbrachial plate do not occur in the type, and are also absent in KÖHLER'S specimens and the smaller one of mine. Both in the type and in my specimens, the dorsal surface of the disk and arms is not so prominently tuberculated as is indicated in KÖHLER'S figures.

### *Ophiomusium simplex* LYMAN.

*Ophiomusium simplex*: LYMAN, Bull. Mus. Comp. Zool., V, 1878, p. 115, Pl. I, figs. 10 & 11; LYMAN, Rep. Challenger, V, 1882, p. 93, Pl. I, figs. 7-9; CLARK, Bull. U. S. Nat. Mus., LXXV, 1911, p. 109.

*Ophiomusium sanctum*: KÖHLER, Exp. Siboga, XLV, Pt. I, 1904, p. 59, Pl. XI, figs. 7-9.

Eastern Sea; 71-139 fathoms (CLARK).

Amboyna. Malaysian waters.

*Ophiomusium granosum* LYMAN.

*Ophiomusium granosum*: LYMAN, Bull. Mus. Comp. Zool., V, 1878, p. 118, Pl. I, figs. 12 & 13; LYMAN, Rep. Challenger, V, 1882, p. 96, Pl. I, figs. 10-12.

Off Boshû; 1,875 fathoms (LYMAN).

*Ophiomusium lymani* WYVILLE THOMSON.

*Ophiomusium lymani*: WYVILLE THOMSON, Depth of the Sea, 1873, p. 172, figs. 32 & 33; LYMAN, Bull. Mus. Comp. Zool., V, 1878, p. 113; LYMAN, Rep. Challenger, V, 1882, p. 90; LYMAN, Bull. Mus. Comp. Zool., X, 1883, p. 245, Pl. V, figs. 55-57; BELL, Cat. Brit. Ech., 1892, p. 115; KÖHLER, Résult. Camp. Sci. Caudan, 1896, p. 72; KÖHLER, Mém. Soc. Zool. Fr., IX, 1896, p. 204 & 242; KÖHLER, Résult. Camp. Sci. Monaco, XII, 1898, p. 42; LUDWIG, Sitzungsber. Akad. Wiss. Berlin, 1899, p. 220; LÜTKEN & MORTENSEN, Mem. Mus. Comp. Zool., XXIII, 1899, p. 137, Pl. III, figs. 8-11; KÖHLER, Exp. Siboga, XLV, Pt. I, 1904, p. 58; KÖHLER, Résult. Camp. Sci. Monaco, XXXIV, 1909, p. 161, Pl. III, fig. 1, Pl. IV, fig. 1; McCLENDON, Univ. California Public., Zool., VI, Pt. 3, 1909, p. 36, Pl. I, figs. 4 & 5; CLARK, Bull. U. S. Nat. Mus., LXXV, 1911, p. 107; MORTENSEN, Meddel. om Grønland, Kjøbenhavn, XXIII, 1913, p. 354; KÖHLER, Bull. U. S. Nat. Mus., LXXXIV, 1914, p. 26.

Eastern Sea; 152 fathoms (CLARK). Off Omai Zaki; 624-914 fathoms (CLARK). Off eastern Japan; 507-720 fathoms (CLARK). Widely distributed both in the Indo-Pacific and Atlantic.

*Ophiomusium lunare* LYMAN.

*Ophiomusium lunare*: LYMAN, Bull. Mus. Comp. Zool., V, 1878, p. 116, Pl. I, figs. 4-6; LYMAN, Rep. Challenger, V, 1882, p. 84, Pl. I, figs. 13-15; KÖHLER, Exp. Siboga, XLV, 1904, p. 58; CLARK, Bull. U. S. Nat. Mus., LXXV, 1911, p. 107.

Eastern Sea ; 103–152 fathoms (CLARK).

Malaysian waters.

*Ophiomusium trychnum* CLARK.

*Ophiomusium trychnum* : CLARK, Bull. U. S. Nat. Mus., LXXV, 1911, p. 109, fig. 40.

Two specimens ; Iwatogaké, Sagami Sea ; 300 fathoms. Two specimens ; Okinosé, Sagami Sea. Three specimens ; locality unknown.

Suruga Gulf ; 94–150 fathoms (CLARK). Uraga Channel ; 70–302 fathoms (CLARK). Off eastern Japan ; 191–578 fathoms (CLARK).

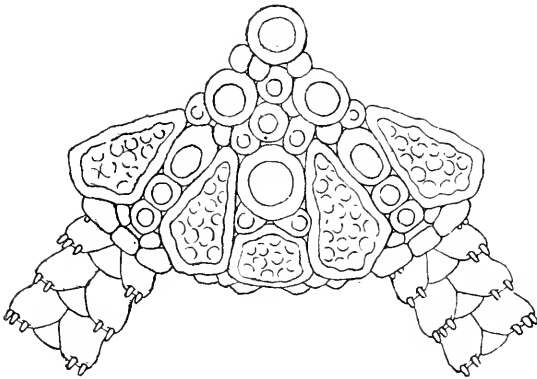

Fig. 78. *Ophiomusium trychnum*. From above.  $\times 4$ .

In my specimens, there are always two, instead of three, very large plates in each dorsal interbrachial space. The radial shields and the large interradi- al marginal plates are often very rough and tubercular. The dorsal side of the arms also shows

a tendency to be rough and uneven.

*Ophiomusium lütkeni* LYMAN.

*Ophiomusium lütkeni* : LYMAN, Bull. Mus. Comp. Zool., V, 1878, p. 114, Pl. V, figs. 138–140 ; LYMAN, Rep. Challenger, V, 1882, p. 91, Pl. I, figs. 16–18 ; CLARK, Bull. U. S. Nat. Mus., LXXV, 1911, p. 107.

Eastern Sea ; 139–152 fathoms (CLARK).



Arafura Sea ; 129 fathoms (LYMAN).

*Ophiomusium cancellatum* LYMAN.

*Ophiomusium cancellatum* : LYMAN, Bull. Mus. Comp. Zool., V, 1878, p. 111, Pl. I, figs. 17 & 18 ; LYMAN, Rep. Challenger, V, 1882, p. 88, Pl. II, figs. 16-18 ; CLARK, Bull. U. S. Nat. Mus., LXXV, 1911, p. 106.

Numerous specimens ; Uraga Channel.

Colnett Strait ; 1,008 fathoms (CLARK). Off Heda ; 168 fathoms (CLARK). Suruga Gulf ; 65-297 fathoms (CLARK). Off Omai Zaki ; 475-505 fathoms (CLARK). Sagami Sea ; 369-775 fathoms (CLARK, LYMAN). Uraga Channel ; 197 fathoms (CLARK). Off eastern Japan ; 191-578 fathoms (CLARK).

Off Bermudas (LYMAN).

*Ophiomusium jolliense* McCLENDON.

*Ophiomusium jolliense* : McCLENDON, Univ. California Public., Zool., VI, Pt. 3, 1909, p. 36, Pl. I, figs. 2 & 3 ; CLARK, Bull. U. S. Nat. Mus., LXXV, 1911, p. 111, fig. 41.

Off Heda ; 167 fathoms (CLARK). Uraga Channel ; 197 fathoms (CLARK). Off eastern Japan ; 191-505 fathoms (CLARK).

California. Washington.

*Ophiomusium laqueatum* (LYMAN).

*Ophiomusium laqueatum* : LYMAN, Bull. Mus. Comp. Zool., V, 1878, p. 113, Pl. I, figs. 14-16 ; LYMAN, Rep. Challenger, V, 1882, p. 90, Pl. II figs. 10-12 ; CLARK, Bull. U. S. Nat. Mus., LXXV, 1911, p. 106.

Eastern Sea ; 103-152 fathoms (CLARK).

Lat.  $5^{\circ} 42'$  S., long.  $132^{\circ} 25'$  E.; 129 fathoms (LYMAN).

*Ophiopenia disacantha* CLARK.

*Ophiopenia disacantha* : CLARK, Bull. U. S. Nat. Mus., LXXV, 1911, p. 102, fig. 38.

Sea of Japan ; 176–200 fathoms (CLARK).

Bering Sea. Alaska.

**Revision of Ophiozona.**

I have great doubt about the generic value of *Ophiozona* as now understood. The genotype, *Ophiolepis impressa* LÜTKEN, 1859, has very numerous small disk plates surrounded by a zone of much finer scales, and well developed, quadrangular dorsal, as well as ventral, arm plates, which are perfectly joined to one another. A characteristic feature is the presence of a group of three disk plates between the outer parts of each pair of radial shields. In every character, the genotype is very nearly allied to the genuine *Ophiolepis* and distinguished from it merely by the absence of supplementary dorsal arm plates. But most species of *Ophiozona* as understood at present, differ much from the genotype, having less numerous large disk plates and less well developed, rhomboidal dorsal, as well as ventral, arm plates, which are separated from one another outside the arm base by the lateral arm plates. Moreover, the trio of disk plates above mentioned is entirely absent. Another atypical group of *Ophiozona* is represented by *O. gymnopora* CLARK, 1909, which is characterised by the disk being elevated high above the arm bases, by the completely joined radial shields, by the granulated interbrachial ventral surfaces, by the indistinct genital slits, by the first ventral arm plate being larger than the following, by the second oral tentacle pore opening entirely outside the oral slit, and by the total absence of the

tentacle scales. I propose to distinguish the first atypical group as *Ophiozonella* and the second as *Haplophiura* from the genuine *Ophiozona*, the distinctive characters of the three groups being as follows.

*A*—Disk low and flat, not much higher than the arm bases; radial shields separated from one another; interbrachial ventral surfaces free of granules; genital slits long; first ventral arm plate smaller than the following; second oral tentacle pore opening within the oral slit; tentacle scales present.

*a*—Disk covered with very numerous small plates, of which the larger ones are surrounded by a zone of smaller ones; a trio of disk plates distinct between the outer parts of each pair of radial shields; arms very gradually tapering outwards, with rather blunt extremity; dorsal, as well as ventral, arm plates almost quadrangular, widely in contact with one another through almost the entire length of the arm . . . . . *Ophiozona*, restr.

*aa*—Disk covered with less numerous large plates mingled with smaller ones; no trio of disk plates between each pair of radial shields; arms rather rapidly tapering outwards, with very acute extremity; dorsal, as well as ventral, arm plates less well developed, separated from one another by the lateral arm plates except at the arm base, where they may be in contact . . . . . *Ophiozonella*.

*A.t*—Disk elevated high above the arm bases; radial shields joined in pairs; interbrachial ventral surfaces closely covered with granules; genital slits indistinct; first ventral arm plate larger than the following; second oral tentacle pore opening entirely outside the oral slit; tentacle scales absent. . . . . *Haplophiura*.

There are two species referred to *Ophiozona*, viz. *O. inermis* BELL, 1902, and *O. capensis*, BELL, 1905, which are left out of account in the above key. The latter is in my opinion referable to *Ophiura* s. str., while the former is referred to *Homalophiura* by CLARK.

**Ophiozonella** MATSUMOTO, 1915.

Disk covered with stout plates mingled with smaller ones. Radial shields large, usually separated from one another, but sometimes slightly in contact in pairs. Oral and adoral shields rather stout. Four or five oral papillæ on either side of each jaw; the outermost one is pointed inwards above the next papilla, which is the largest. Teeth arranged in a single vertical row. Dental papillæ absent. Genital slits not reaching to the disk margin. Arms short, very stout at base, rather rapidly tapered outwards to very slender extremities. Dorsal, as well as ventral, arm plates more or less rhomboidal, not very widely in contact or mostly separated from one another. Two to four arm spines, short, lying flat on the arm. One or two tentacle scales to each pore.

This genus includes (1) species with two tentacle scales to each pore, viz., *Ophiozoua nivea* LYMAN, 1875, *O. tessellata* LYMAN, 1878, *O. marmorea* LYMAN, 1883, *O. clypeata* LYMAN, 1883, *O. hispinosa* KÖHLER, 1897, *O. molesta* KÖHLER, 1904, *O. elevata* CLARK, 1911, *O. platydisca* CLARK, 1911; (2) species with one tentacle scale to each pore, viz., *O. insularia* LYMAN, 1868, *O. stellata* LYMAN, 1878, *O. antillarum* LYMAN, 1878, *O. depressa* LYMAN, 1878, *O. alba* LÜTKEN & MORTENSEN, 1899, *O. contigua* LÜTKEN & MORTENSEN, 1899, *O. casta* KÖHLER, 1904, *O. depressa* var. *media* KÖHLER, 1904, *O. projecta* KÖHLER, 1905, *O. longispina* CLARK, 1908, *O. polyplax* CLARK, 1911, and *O. tjalpiana* MORTENSEN, 1913, the genotype being *O. longispina*.

**Key to Japanese species of *Ophiozonella*.**

1—Two tentacle scales to each pore.

- a*—Disk convex, covered with one hundred to one hundred and fifty large plates. . . . . *elevata*.
- aa*—Disk flat, covered with about two hundred small plates. . . . . *platydisca*.
- AA*—One tentacle scale to each pore, often also with one to three small, supplementary ones on the adradial border of the pore in a few basal arm joints.
- b*—Disk convex; arms long and slender, five to eight times as long as the disk diameter; colour reddish or yellowish brown in alcohol. . . . . *projecta*.
- bb*—Disk flat; arms short, three or four times as long as the disk diameter; colour white in alcohol.
- c*—Disk plates fine; radial shields rather small, about one-third as long as the disk radius; arm spines shorter than the corresponding arm joint. . . . . *polyplax*.
- cc*—Disk plates large; radial shields very stout, about half as long as the disk radius; arm spines of basal arm joints longer than the corresponding joint. . . . . *longispina*.

*Ophiozonella elevata* (CLARK).

*Ophiozona elevata*: CLARK, Bull. U. S. Nat. Mus., LXXV, 1911, p. 31, fig. 6.

Off Gotô Is., Eastern Sea; 95–106 fathoms (CLARK).

*Ophiozonella platydisca* (CLARK).

*Ophiozona platydisca*: CLARK, Bull. U. S. Nat. Mus., LXXV, 1911, p. 34, fig. 7.

Off Hiro Misaki; 191 fathoms (CLARK).

*Ophiozonella projecta* (KOEHLER).

*Ophiozona projecta*: KOEHLER, Exp. Siboga, XLV, Pt. 2, 1905, p. 19, Pl. I, figs. 16–18; CLARK, Bull. U. S. Nat. Mus., LXXV, 1911, p. 36.

Numerous specimens; off Nii-jima, Sagami Sea. Numerous specimens; off Misaki, Sagami Sea.

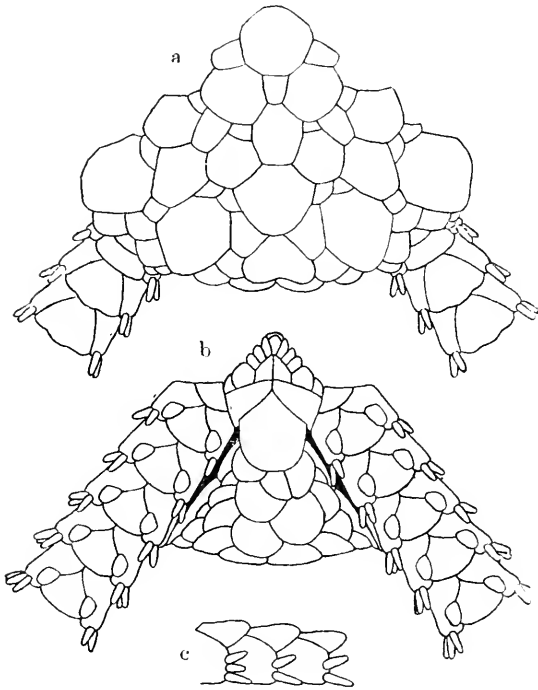

Fig. 79. *Ophiozonella projecta*.  $\times 14$ . a. From above. b. From below. c. Side view of three arm joints near disk.

one being much longer than the inner. In some of the basal free arm joints, there are three arm spines instead of two.

Off Gotō Is., Eastern Sea; 95–106 fathoms (CLARK).

Malaysian waters.

Sagami Sea is probably the northern limit of this Indo-Pacific species.

The arms are very long and slender, being five to eight times as long as the disk diameter, so that they are longer than in KÖHLER'S type. The genital scales are two to each slit, the outer

### *Ophiozonella polyplax* (CLARK).

*Ophiozona polyplax*: CLARK, Bull. U. S. Nat. Mus., LXXV, 1911, p. 35, fig. 8.

Off southern Japan; 437 fathoms (CLARK). Off Shio Misaki; 440–587 fathoms (CLARK).

*Ophiozonella longispina* (CLARK).

*Ophiozona longispina*: CLARK, Bull. Mus. Comp. Zool., LI, 1908, p. 290; CLARK, Bull. U. S. Nat. Mus., LXXV, 1911, p. 33.

Numerous specimens; Suruga Gulf. Numerous specimens; Sagami Sea.

Off Heda; 337 fathoms (CLARK). Suruga Gulf; 45-124 fathoms (CLARK). Uraga Channel; 58 fathoms (CLARK). Off eastern Japan; 191 fathoms (CLARK).

The supplementary tentacle scales are very well developed. In the basal arm joints, there are one or two of them on the adradial border of each pore, beside one large, oval ordinary scale on the abradial border. So that, the tentacle scales of this species, as well as of *Ophiozonella alba* (LÜTKEN & MORTENSEN), remind us of those of *Ophiodoris* and of certain species of *Ophiochiton*. The dorsal and ventral arm plates are relatively wider than in many other species of this genus. The

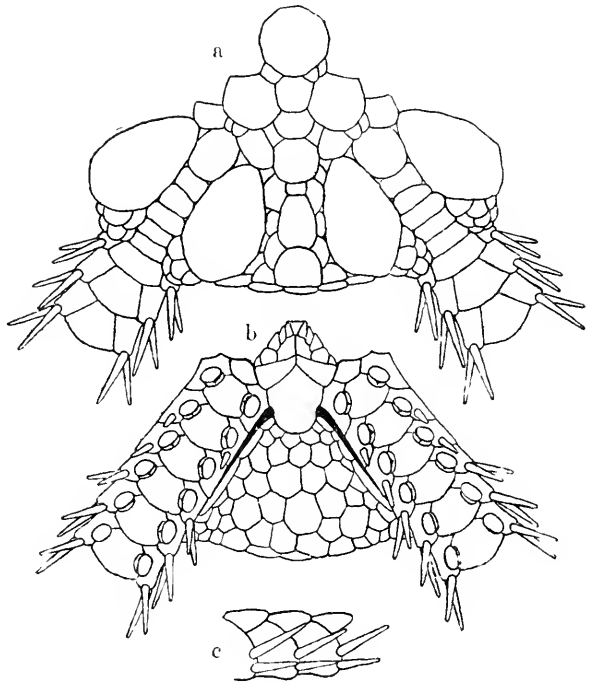

FIG. 80. *Ophiozonella longispina*.  $\times 3.3$ . *a*. From above. *b*. From below. *c*. Side view of three arm joints near disk.

arm spines are also very long, in contrast to those of other species.

**Ophiozona** (LYMAN, 1865) restr.

Disk covered with very numerous small plates, the larger ones being surrounded by a zone of smaller ones. Radial shields small, separated from one another. A trio of disk plates distinctly present between the outer parts of each pair of radial shields. Two long genital slits in each interradius. Oral and adoral shields small. Four or five oral papillæ on either side of a jaw; the outermost one is pointed inwards above the next papilla, which is the largest. Teeth arranged in a single vertical row. Dental papillæ absent. Arms rather long and slender, very gradually tapering outwards, with obtuse end. Dorsal as well as ventral arm plates well developed, almost quadrangular, widely in contact with one another through almost the entire length of the arm. Lateral arm plates of either side not meeting above or below. Four or five short arm spines. Two tentacle scales to each pore.

This genus, as here restricted, includes *Ophiolepis impressa* LÜTKEN, 1859, and *O. pacifica* LÜTKEN, 1859, the former being the genotype.

*Ophiozona* is very near to *Ophiolepis*, being distinguished from it only by the total absence of supplementary dorsal arm plates.

*Ophiozona* is wholly a littoral form, like *Ophiolepis*, and ranges to the West Indies and the Pacific side of Panama. The faunæ of either side of Panama closely resemble each other, apparently as a result of a former open communication. The distribution of *Ophiozona*, as well as of *Ophioderma*, is interesting in this respect.



**Key to Japanese species of *Ophiolepis*.**

- A*—Radial shields about as large as the ordinary disk plates; arms slender; supplementary dorsal arm plates present along the outer and lateral borders of the dorsal arm plates proper; three or four arm spines ..... *cincta*.
- AA*—Radial shields much larger than the ordinary disk plates; arms stout; supplementary dorsal arm plates present only on either side of the dorsal arm plates proper; five to seven arm spines.....  
..... *annulosa*.

***Ophiolepis cincta* MÜLLER & TROSCHEL.**

*Ophiolepis cincta*: MÜLLER & TROSCHEL, Sys. Ast., 1842, p. 90; LÜTKEN, Adit. ad Hist. Oph., II, 1859, p. 101, Pl. II, figs. 6a & 6b; VON MARTENS, Arch. Naturg., XXXVI, 1870, p. 245<sup>1)</sup>; LYMAN, Rep. Challenger, V, 1882, p. 19, Pl. XXXVII, figs. 7-9; STUDER, Abh. K. Preuss. Akad. Wiss. Berlin, 1882, p. 7; MARKTANNER-TURNERETSCHER, Ann. K. K. Naturh. Hofmus., II, 1887, p. 294; DUNCAN, Journ. Linn. Soc. London, XXI, 1887, p. 86; BROCK, Zeitschr. wiss. Zool., XLVII, 1888, p. 475; BELL, Proc. Zool. Soc. London, 1888, p. 388; DÖDERLEIN, Zool. Jahrb. Sys., III, 1888, p. 831; LORIOI, Rev. Suisse Zool., I, 1893, p. 398; LORIOI, Mém. Soc. Phys. d'Hist. Nat. Genève, XXXII, 1894, p. 9; KÖHLER, Bull. Sci. Fr. Belg., XXXI, 1898, p. 66; LUDWIG, Abh. Senckenberg. Naturf. Gesell., XXI, 1899, p. 514; PFEFFER, *ibid.*, XXV, 1900, p. 83; KÖHLER, Exp. Siboga, XLV, Pt. 2, 1905, p. 16; KÖHLER, Bull. Sci. Fr. Belg., XLI, 1907, p. 287; CLARK, Bull. Mus. Comp. Zool., LI, 1908, p. 289.

*Ophiolepis garrettii*: LYMAN, Proc. Boston Soc. Nat. Hist., VIII, 1862, p. 77<sup>1)</sup>; LYMAN, Ill. Cat. Mus. Comp. Zool., I, 1865, p. 61, Pl. II, fig. 4.

*Ophiolepis cincta* var. *nigra*: STUDER, *loc. cit.*

Two specimens; locality unknown.

1) These papers were not seen by me.

## Indo-Pacific.

The disk is very convex and nearly hemispherical. In one of the specimens, the disk is 14 mm. in diameter and 6 mm. in height. The arms are of unequal length, and are two and a half times to five times as long as the disk diameter. The colour is mottled on the disk, and annulated on the arms, with greenish and yellowish gray.

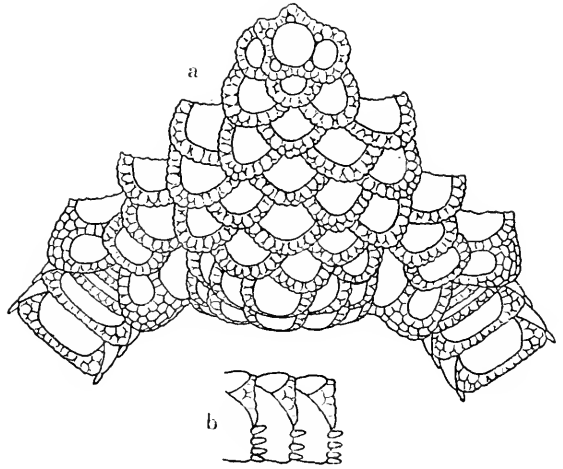

Fig. 81. *Ophiolepis cincta*.  $\times 6$ . *a*. From above. *b*. From below.

*Ophiolepis annulosa* MÜLLER & TROSCHER.<sup>1)</sup>

*Ophiura annulosa*: BLAINVILLE *Mann. Act.*, 1834, p. 244, Pl. XXIV, figs. 1-4<sup>2)</sup>. (Non LAMARCK, 1816.)

*Ophiolepis annulosa*: MÜLLER & TROSCHER, *Arch. Naturg.*, VI, 1840, p. 328<sup>2)</sup>; MÜLLER & TROSCHER, *Sys. Ast.*, 1842, p. 89, Pl. VIII, fig. 4; LÜTKEN, *Addit. ad Hist. Oph.*, II, 1859, p. 101, Pl. II, figs. 5a & 5b; LYMAN, *Ill. Cat. Mus. Comp. Zool.*, I, 1865, p. 58; VON MARTENS, *Arch. Naturg.*, XXXVI, 1870, p. 246<sup>2)</sup>; LYMAN, *Rep. Challenger*, V, 1882, p. 19; BELL, *Proc. Zool. Soc. London*, 1887, p. 140; BELL, *ibid.*, 1888, p. 388; DÖDERLEIN, *Zool. Jahrb. Sys.*, III, 1888, p. 831; LORIOL, *Mém. Soc. Phys. d'Hist. Nat. Genève* XXXII, 1895, p. 10; BELL, *Proc. Zool. Soc. London*, 1894, p. 395; DÖDERLEIN, *SEMOM - Zool. Forschungsr.*, V, 1896, p. 283; LUDWIG, *Abh.*

1) CLARK has recently proposed a new name *Ophiolepis superba* for this species (*Spolia Zeylanica*, X, 1915, p. 89). Though BLAINVILLE's *Ophiura annulosa* is preoccupied by LAMARCK's, MÜLLER & TROSCHER's *Ophiolepis annulosa* is entirely free of homonyms.

2) These papers were not seen by me.

Senckenberg. Naturf. Gesell., XXI, 1899, p. 544; PFEFFER, *ibid.*, XXV, 1900, p. 83; KOEHLER, Exp. Siboga, XLI, Pt. 2, 1905, p. 17; CLARK, Bull. Mus. Comp. Zool., LI, 1908, p. 289.

One specimen; Okinawa.

Indo-Pacific. Okinawa is probably the northern limit of this species.

The radial shields are larger and the space between each radial pair is narrower than in LÜTKEN'S figure. The colour is quite similar to LÜTKEN'S. The arm spines are only five or rarely six in number, so that they are fewer than in MÜLLER & TROSCHEL'S type.

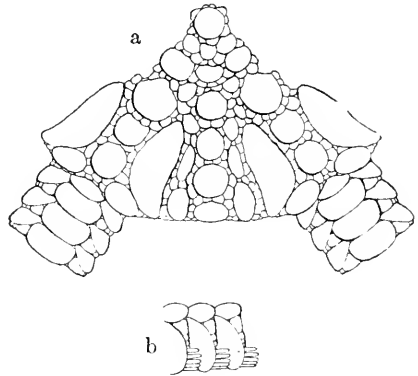

Fig. 82. *Ophiopetis annulosa*.  $\times 3$ . *a*. From above. *b*. Side view of three arm joints near disk.

### Key to Japanese species of *Ophioplocus*.

- A*—Disk scales more or less convex, so that the surface of the disk is rather rough; genital slits very short, pore-like; the halves of each dorsal arm plate proper separated from each other by six larger and a few smaller supplementary plates. . . . . *imbricatus*.
- AA*—Disk scales flat, so that the surface of the disk is very smooth; genital slits rather long, slit-like; the halves of each dorsal arm plate proper separated from each other by eight to ten larger and several smaller supplementary plates. . . . . *japonicus*.

#### *Ophioplocus imbricatus* (MÜLLER & TROSCHEL).

*Ophiopetis imbricata*: MÜLLER & TROSCHEL, Sys. Ast., 1842, p. 93; LÜTKEN, Addit. ad Hist. Oph., II, 1859, p. 160.

*Ophioplocus tessellatus*: LYMAN, Proc. Boston Soc. Nat. Hist., VIII, 1861, p. 76<sup>1</sup>.

*Ophioplocus imbricatus*: LYMAN, Ill. Cat. Mus. Comp. Zool., I, 1865, p. 69; VON MARTENS, Arch. Naturg., XXXVI, 1870, p. 246<sup>1)</sup>; LYMAN, Rep. Challenger, V, 1882, p. 20; STUDER, Abh. K. Preuss. Akad. Wiss. Berlin, 1882, p. 7; MARKTANNER-TURNERETSCHER, Ann. K. K. Naturh. Hofmus. Wien, II, 1887, p. 295; BROCK, Zeitschr. wiss. Zool., XLVII, 1888, p. 477; BELL, Proc. Zool. Soc. London, 1888, p. 388; DÖDERLEIN, Zool. Jahrb. Sys., III, 1888, p. 840; LORIOU, Rev. Suisse Zool., I, 1893, p. 298; LORIOU, Mém. Soc. Phys. d'Hist. Nat. Genève, XXXII, 1894, p. 12; PFEFFER, Jahrb. Wiss. Anstalt, Hamburg, XIII, p. 47; DÖDERLEIN, SEMON—Zool. Forschungsr., V, 1896, p. 283; LUDWIG, Abh. Senckenberg. Naturf. Gesell., XXI, 1899, p. 544; KÖHLER, Exp. Siboga, XLV, Pt. 2, 1905, p. 333; KÖHLER, Bull. Sci. Fr. Belg., XLI, 1907, p. 288; CLARK, Bull. Mus. Comp. Zool., LI, 1908, p. 289; CLARK, Bull. U. S. Nat. Mus., LXXV, 1911, p. 30.

One specimen; Okinawa.

Indo-Pacific. Okinawa may be the northern limit of this species.

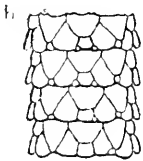

FIG 83. *Ophioplocus imbricatus*.  $\times 5$ . a. Side view of three arm joints near disk. b. Dorsal view of four arm joints near disk.

### *Ophioplocus japonicus* CLARK.

*Ophioplocus imbricatus*: LYMAN, Bull. Mus. Comp. Zool., III, 1874, p. 228 (pars); MARKTANNER-TURNERETSCHER, Ann. K.K. Naturh. Hofmus., II, 1887, p. 295; IVES, Proc. Acad. Nat. Sci. Philadelphia, 1891, p. 4, Pl. V, figs. 6-10.

*Ophioplocus japonicus*: CLARK, Bull. U. S. Nat. Mus., LXXV, 1911, p. 30, fig. 5.

Numerous specimens; Eno-ura, Suruga.

Numerous specimens; Misaki. Numerous specimens; Kominato, Bōshū.

Pacific coast of Honshū, probably eastwards to the limit of the Kuroshio Stream.

1) These papers were not seen by me.

This species is distinguished from *O. imbricatus* chiefly by the longer genital slits and by the more numerous supplementary dorsal arm plates. Further, the disk scales and the supplementary plates are coarser, thicker and more convex in *O. imbricatus* than in *O. japonicus*. I suppose that, MARKTANNER-TURNERETSCHER's specimens from Enoshima are to be referred to the present species, because the occurrence of *O. imbricatus* there is very improbable. *O. japonicus* is undoubtedly the most common ophiuran around Misaki, and perhaps along the entire southern coast of Honshû. It occurs together with *Ophiarachnella goryonia*, but is far more abundant. In a large specimen in my hands, there are four arm spines in some of the proximal free arm joints.

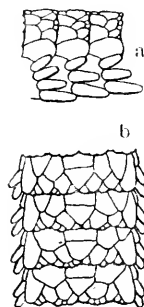

FIG. 84. *Ophioplocus japonicus*.  $\times 5$ . a. Side view of three arm joints near disk. b. Dorsal view of four arm joints near disk.

#### Family 2. **Ophioleucidæ** MATSUMOTO, 1915.

Disk flat, covered with very thick scales with superficial granulations. Radial shields naked or covered with granules; in internal view, they are very large and joined or very close-set in pairs. The radial shield and genital plate articulate with each other by means of two condyles and one pit. Genital slits very long, extending from the oral plate to the disk border, sometimes onto the dorsal side of the disk. Oral and adoral shields of moderate size or often large; each interradial pair of the latter joined to each other just inside the former. Numerous close-set oral papillæ, arranged in a single row. Dental papillæ absent. Teeth arranged in a single vertical series. Peristomial plates

usually double or triple, of moderate length or sometimes very long. The genital plate and scale of the same side of a radius articulate with each other near the outer end, both being very long and narrow. Arms very long and slender, inserted ventrally to the disk. Arm plates all well developed, or sometimes the dorsal and ventral ones may be very rudimentary. Two, or sometimes more, arm spines, short, conical, lying flat on the arm. One or two tentacle scales to each pore, which is sometimes very large.

This family includes seven genera, which may be grouped as follows.

- I. Single tentacle scale; dorsal arm plates well developed, widely in contact with one another.

*Ophiopæpale* LJUNGMAN, 1871.

*Ophiocirce* KÖHLER, 1904.

*Ophioleuce* KÖHLER, 1904.

*Ophiopallas* KÖHLER, 1904.

- II. Single tentacle scale; dorsal arm plates very rudimentary, extremely minute.

*Ophiotrochus* LYMAN, 1878.

- III. Two tentacle scales; dorsal arm plates well developed, widely in contact with one another.

*Ophiernus* LYMAN, 1878.

*Ophiopyren* LYMAN, 1878.

In *Ophioleuce charischema* (CLARK), the peristomial plates are moderately large, triple, the paired ones being usually separated from each other by a median one. The oral plates are long and very slender. The oral frames are also long and slender, without lateral wings. The basal vertebræ are relatively very long, the first one being the shortest and more or less discoidal. The genital plates are long and bar-like, with two articular condyles

and one articular pit at the outer end to fit to the two condyles and one pit of the radial shield. The genital scales are long, wide, thin, leaf-like, L-shaped in transverse section, articulating with the genital plate near the outer end of the latter. The radial shields in internal view are very large and completely joined in pairs. *Ophiopapale goësiانا* LJUNGMAN and *Ophiernus callincola* LYMAN, which were dissected by LYMAN, appear to be essentially similar to the preceding in the internal structures, save that the peristomial plates of the first are not triple but double, and those of the second single for each oral angle. Again, according to LYMAN, the peristomial plates of *Ophiopyren longispinus* LYMAN are double and very long, forming together a complete ring around the mouth. As a whole, the internal structures of the present family resemble those of *Ophiura* and its allies.

**Key to Japanese genera of *Ophioteuclidæ*.**

- A—Tentacle pores small, each provided with a single scale.
  - a—Oral papillæ not soldered together, uniform in size, or the outermost one is larger than the others; arm joints short; dorsal arm plates well developed, widely in contact with one another; arm spines uniform in length ..... *Ophioteuclæ*.
  - aa—Oral papillæ soldered together, except the outermost two, which are exceedingly large; dorsal arm plates very rudimentary, exceedingly minute; basal arm spines especially long, the others short.....  
..... *Ophiotrochus*.
- AA—Tentacle pores large, each provided with two scales; dorsal arm plates very well developed; ventral plates entire, in contact with one another; arm spines uniform in length..... *Ophiernus*.

### Key to Japanese species of *Ophioleuce*.

- A*—Dorsal side of disk, including the radial shields, closely covered with granules; oral shields longer than wide; outermost oral papilla not especially large; arm spines more than half as long as the corresponding arm joint ..... *charischema*.
- AA*—Radial shields, as well as the larger disk scales, partially free of granules; oral shields wider than long; outermost oral papilla very large and operculiform; arm spines less than half as long as the corresponding arm joint ..... *brevispinum*.

#### *Ophioleuce charischema* (CLARK).

*Ophiocten charischema*: CLARK, Bull. U. S. Nat. Mus., LXXV, 1911, p. 97, fig. 35.

Numerous specimens; Mera-out-Oisegaké, Sagami Sea; 300 fathoms.

Eastern Sea; 95–152 fathoms (CLARK). Off Honshû; 63 fathoms (CLARK).

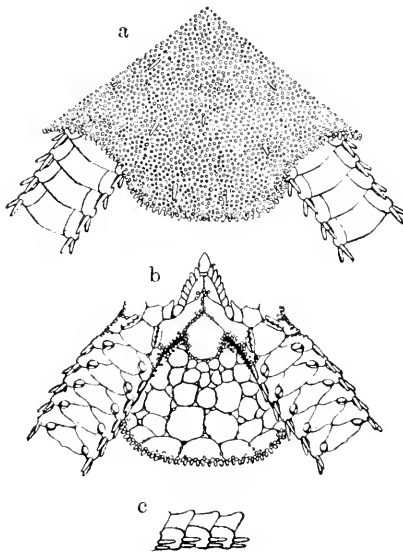

Fig. 35. *Ophioleuce charischema* ×6.  
*a*. From above. *b*. From below. *c*. Side view of four arm joints near disk.

In my specimens, several spines are present on the disk, mingled with granules; they fall off easily on rubbing. The smaller specimens have the dorsal disk plates and radial shields partially naked.

#### *Ophioleuce brevispinum* (CLARK).

*Ophiocten brevispinum*: CLARK, Bull. U. S. Nat. Mus., LXXV, 1911, p. 98, fig. 36.



Eastern Sea ; 361 fathoms (CLARK).

***Ophiotrochus longispinus* CLARK.**

*Ophiotrochus longispinus* : CLARK, Bull. U. S. Nat. Mus., LXXV, 1911, p. 94, fig. 33.

Sagami Sea ; 918 fathoms (CLARK).

***Ophiernus adspersus* LYMAN.**

*Ophiernus adspersus* : LYMAN, Bull. Mus. Comp. Zool., X, 1883, p. 236, Pl. III, figs. 19-21 ; KÖHLER, Ann. Sci. Nat. Zool., Sér. 8, IV, 1896, p. 316 ; KÖHLER, Ech. Indian Mus., Deep-sea Oph., 1899, p. 32 ; CLARK, Bull. U. S. Nat. Mus., LXXV, 1911, p. 96, fig. 34.

*Ophiernus annectens* : LÜTKEN & MORTENSEN, Mem. Mus. Comp. Zool., XXIII, 1899, p. 107, Pl. V, figs. 4-6.

Eastern Sea ; 440 fathoms (CLARK). Colnett Strait ; 1,008 fathoms (CLARK). Off Hiūga ; 578 fathoms (CLARK). Off Kii ; 244-290 fathoms (CLARK).

West Indies. Eastern Atlantic. Eastern and western Pacific. Indian Ocean.

Family 3. **Ophiodermatidæ** LJUNGMAN, 1867.

Disk closely covered with fine granules, and sometimes with scattered spines. Oral angles, sometimes also the oral shields, covered with granules. Numerous close-set oral papillæ, of which the outermost is pointed inwards and projects above the next papilla, which is the largest. Dental papillæ absent. Peristomial plates triple. Oral frames without well developed lateral wings. Radial shield and genital plate of the same side of a radius articulating with each other by means of two condyles and one pit.

Arms moderately long, stout, cylindrical; stoutest at the base, horizontally flexible. Arm plates all well developed. Numerous arm spines, short or moderately long, lying flat on the arm or erect. One or two tentacle scales to each pore; when there are two, the abradial scale overlaps the base of the lowest arm spine.

This family includes sixteen genera, which may be grouped into two subfamilies as follows.

Subfamily 1. *Ophiarachninae* MATSUMOTO, 1915.—Arm spines not very short, erect.

- I. Oral shields entirely covered with granules; arm plates usually concentrically striated; arm spines hyaline.

*Ophiuroconis* MATSUMOTO, 1915.

*Ophiurodon* MATSUMOTO, 1915.

- II. Oral shields naked; arm plates not concentrically striated; arm spines opaque.

*Ophiurochata* MATSUMOTO, 1915.

*Ophiarachna* MÜLLER & TROSCHEL, 1842.

Subfamily 2. *Ophiodermatinae* MATSUMOTO, 1915.—Arm spines very short, lying flat on the arm.

- A. Single tentacle scale to each pore.

- I. Oral shields entirely covered with granules.

*Ophioconis* LÜTKEN, 1869 (= *Ophiocormus* CLARK, 1915).<sup>1)</sup>

---

1) I can not find in CLARK'S description and figures any tangible character, by which his *Ophiocormus* is distinguished from the genuine *Ophioconis*. The blunt tip of the arms and the very short and appressed arm spines of his *Ophiocormus* are not at all Ophiocanthine but perfectly Ophiodermatine. CLARK'S unique specimen, on which his genus is based, is certainly very young, measuring only 3 mm. across the disk and 6 mm. in the arm length. So that, all the "notable" characters are merely what may be expected in such a young specimen. In my opinion, *Ophiocormus* is a genuine *Ophioconis*, if indeed it is not a young stage of *Cryptopella*.

*Cryptopelta* CLARK, 1909.

II. Oral shields naked.

*Bathypectinura* CLARK, 1909.

B. Two tentacle scales to each pore.

III. Genital slits entire.

*Pectinura* FORBES, 1842.

*Ophiopezella* LJUNGMAN, 1871.

*Ophiocheva* LÜTKEN, 1869.

*Ophiarachnella* LJUNGMAN, 1871.

*Ophiochasma* LJUNGMAN, 1871.

IV. Genital slits divided into two secondary pores.

*Ophioderma* MÜLLER & TROSCHER, 1842.

*Ophioncus* IVES, 1889.

*Diopederma* CLARK, 1912.

*Ophiocryptus* CLARK, 1915.

This family is very uniform in its internal structure. The peristomial plates are always triple, one of the three secondary plates filling up the outer open angle formed by the other two, as observed by myself in *Ophiuroconis monolepis* MATSUMOTO, *Ophiurodon grandisquama* (KÖHLER), *Ophiurochæta mixta* (LYMAN), *Ophiarachna incrassata* (LAMARCK), *Pectinura anchista* CLARK, *Bathypectinura gotoi* MATSUMOTO, *Ophiarachnella gorgonia* (MÜLLER & TROSCHER), *Ophioderma januarii* LÜTKEN, *O. brevicauda* LÜTKEN, &c. In *Ophiarachna incrassata* and *Bathypectinura gotoi*, the oral frames are very long and have distinct, V-shaped grooves for the ambulacral ring canal, while in the others they are short and have no distinct grooves for the ring canal. In *Ophioderma*, the genital plate and scales of the same side of a radius are soldered together at the middle, so that the genital slit is divided into two secondary pores, an inner and an outer. An important characteristic of the present

family is that the radial shield and genital plate of the same side of a radius articulate with each other always by means of two articular condyles and one articular pit.

### Revision of *Ophioconis*, s. ext.

In my opinion, *Ophioconis* as hitherto understood is a very heterogeneous genus and is divisible into many natural groups, each of which is quite compact and worthy of forming a distinct genus. In treating of *Ophioconis diastata* and *papillata*, CLARK<sup>1)</sup> expresses a serious doubt as to the systematic position of *Ophioconis* s. ext., and remarks that, he will “not be surprised if some of the species now placed in *Ophioconis*, really belong in the *Ophiacanthidae*, while others are placed in the *Ophiodermatidae*.” KÆHLER<sup>2)</sup> also says that, “les *O. cupida, permixta, cincta* et *grandisquama* forment, dans le genre *Ophioconis*, un groupe à part et qui offre une physionomie différente de celle des autres *Ophioconis*.” Both authors are right in their views. CLARK's species are, in my opinion, referable to *Ophiolimna*, while the species mentioned above by KÆHLER as forming a separate group are to be included in *Ophiurodon* MATSUMOTO. A third atypical group of *Ophioconis* is represented by *O. miliaria* LYMAN, 1878, and *pulverulenta* LYMAN, 1879, which I wish to refer to *Ophiuroconis* MATSUMOTO, while a fourth is represented by *Ophioconis indica* KÆHLER, 1898, for which however I do not dare to propose a new generic name, because I have no specimens of it. Thus the genuine *Ophioconis* includes only two Mediterranean species, viz. *O. forbesii* (HELLER, 1862) and *brevispina* LUDWIG, 1880. The new sub-

1) Bull. U.S. Nat. Mus., LXXV, 1911, p. 28.

2) Exp. Siboga, XLV, Pt. 2, 1905, p. 16.

divisions of *Ophioconis* s. ext., together with certain allied genera, are distinguished as follows.

- A*—Arm spines long and flagellate, erect.
- a*—Outermost oral papilla very large and operculiform; peristomial plates simple, very short and wide, the two halves being soldered together fairly well, without median secondary plate .....  
..... *Ophiolimna*, emend.
- aa*—Outermost oral papilla pointed inwards, projecting above the next papilla, which is the largest; peristomial plates triple, with a median secondary plate, fairly long and wide.
- b*—Oral shields entirely covered with granules; arm plates usually concentrically striated; arm spines hyaline.
- c*—Teeth triangular and pointed, ventral arm plates wider than long, usually separated from one another..... *Ophiuroconis*.
- cc*—Teeth flat, thin, with much widened and often serrate end; ventral arm plates longer than wide, in contact with one another .....  
..... *Ophiurodon*.
- lb*—Oral shields naked; arm plates not concentrically striated; arm spines opaque.
- d*—Disk granulations mingled with a number of spines; accessory oral shields absent..... *Ophiurochæta*.
- dd*—Disk free of spines; accessory oral shields usually present just outside the ordinary ones ..... *Ophiarachna*.
- AA*—Arm spines very short, lying flat on the arm, hyaline.
- e*—Oral shields entirely covered with granules ..... *Ophioconis*, restr.
- ce*—Oral shields naked ..... "*Ophioconis*" *indica*.

*Ophiolimna* emend. is a typical member of the *Ophiacanthidae*; *Ophiuroconis*, *Ophiurodon*, *Ophiurochæta* and *Ophiarachna* form the *Ophiarachnince*; and *Ophioconis* restr. and "*Ophioconis*" *indica* are referable to the *Ophiodermatince*. *Ophioconis* restr. is very near to *Cryptopelta*, but differs from it in the hyaline arm spines, while "*Ophioconis*" *indica* resembles *Pectinura*, differing from it also in

the hyaline arm spines. There is some possibility that, *Ophioconis* and *Cryptopelta* are congeneric and that "*Ophioconis*" *indica* is an extreme form of *Pectinura*.

### ***Ophiuroconis* MATSUMOTO, 1915.**

Disk and oral angles, including the oral shields, closely covered with fine granules. Six or seven oral papillæ on either side of a jaw; the outermost one is pointed inwards and projects above the next papilla, which is the largest. Teeth triangular and obtusely pointed. Dental papillæ absent. Arms not very long, cylindrical, widest at the base, tapering outwards to a very slender tip, where the vertebræ are imperfectly divided into halves by a series of pores. Ventral arm plates wider than long, not in contact with one another except in the very basal joints. Six or more arm spines, long, flattened, hyaline, laterally flared. One or two tentacle scales to each pore.

This genus includes *Ophioconis pulverulenta* LYMAN, 1879, and *O. miliaria* LYMAN, 1878, besides the genotype, *Ophiuroconis monolepis* MATSUMOTO, 1915.

### ***Ophiuroconis monolepis* MATSUMOTO.**

*Ophiuroconis monolepis* : MATSUMOTO, Proc. Acad. Nat. Sci. Philadelphia, 1915, p. 85.

Six specimens; Sengendzuka-Aoyamadashi, Sagami Sea; 85 fathoms. Two specimens; Mera-out-Oisegaké, Sagami Sea; 300 fathoms.

Diameter of disk 5 mm. Length of arms 25 mm. Width of arms at base 1 mm.

Disk nearly circular, slightly puffed interbrachially, very soft,

closely covered with very fine granules, of which eleven or twelve lie in 1 mm. Radial shields entirely covered over. Interbrachial ventral surfaces and oral angles, including the oral and adoral shields, also covered with granules, which are similar to those of

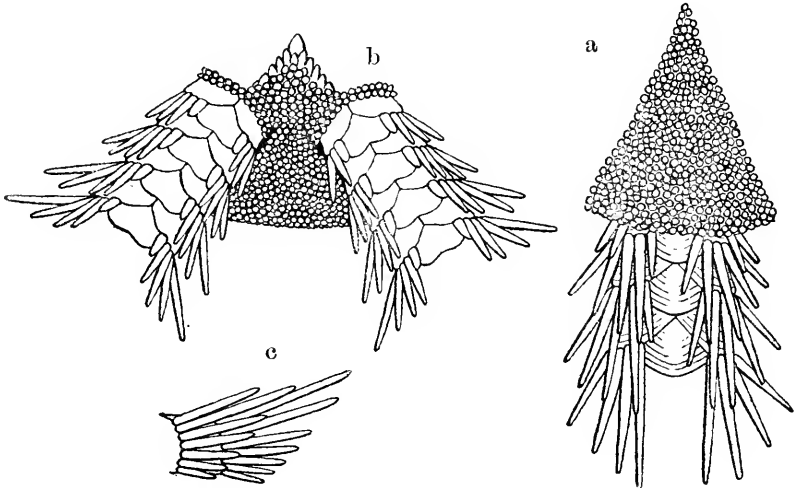

Fig. 86. *Ophiuroconis monolepis*. a. From above.  $\times 15$ . b. From below.  $\times 12$ . c. Side view of two arm joints near disk.  $\times 12$ .

the dorsal side. Genital slits long, nearly reaching to the disk margin. Six or seven oral papillæ on either side, closely set, acute; the outermost one is pointed inwards, projecting above the next papilla, which is slightly larger than the rest and obtuse. Teeth triangular, not very stout, obtusely pointed.

Arms about five times as long as the disk diameter, more or less cylindrical, widest at the base, uniformly tapered outwards to a very slender tip. Dorsal arm plates rather small, fan-shaped, with convex outer border, slightly shorter than the corresponding arm joint, wider than long, convex along the median line, so that the arm is keeled as a whole. Lateral arm plates of the two sides meeting above as well as below. First ventral arm plate extreme-

ly small and very insignificant. Those following small, triangular, with very large inner angle and very long, convex outer border, shorter than the corresponding arm joints, much wider than long; they become smaller and shorter outwards. All the arm plates are concentrically striated, as seen under the microscope. Six or seven arm spines, spiniform, acute, slightly flattened, hyaline, erect; the uppermost one or two are nearly twice as long as the corresponding arm joint, while the lowest one is slightly shorter than the same. Single small, leaf-like, acute tentacle scale to each pore. Vertebrae of the distal arm joints imperfectly divided into halves by a series of pores.

Colour in alcohol light yellow.

This species is at once distinguished from both *O. miliaria* (LYMAN) and *pulverulenta* (LYMAN) by the fewer oral papillae, by the fewer and shorter arm spines and by the presence of only a single tentacle scale to each pore.

### **Ophiurodon** MATSUMOTO, 1915.

Disk, as well as radial shields, closely covered with fine granules, sometimes bearing scattered spines. Oral angles and oral shields also granulated. Four or five oral papillae on either side, the outermost one projecting inwards above the next papilla. Teeth very flat and widened, with very thin and translucent end, arranged in a single vertical series. Dental papillae absent. Arms not very long, widest at the base, tapering outwards to a very slender tip. Dorsal and lateral arm plates usually concentrically striated. Ventral arm plates very narrow, longer than wide, fully in contact with one another. Vertebrae of the distal arm joints often imperfectly divided into halves by a series of pores. More



than six arm spines, long, flared, longer than the corresponding arm joint. Single tentacle scale to each pore.

This genus includes *Ophioconis cincta* BROCK, 1888, *O. permixta* KÆHLER, 1905, and *O. cupida* KÆHLER, 1905, besides the genotype, *O. grandisquama* KÆHLER, 1904.

*Ophiurodon grandisquama* (KÆHLER).

*Ophioconis grandisquama*: KÆHLER, Exp. Siboga, XLV, Pt. 1, 1904, p. 11, Pl. II, figs. 11 & 12.

One specimen; Okinosé, Sagami Sea.

Malaysian waters.

The teeth are very flat, thin, widened, hyaline, but not so sharply serrate as in the three other species of the present genus.

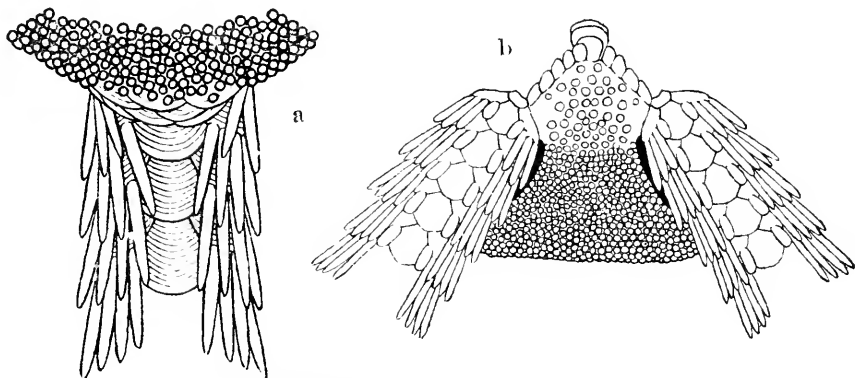

Fig. 87. *Ophiurodon grandisquama*. a. From above.  $\times 20$ . b. From below.  $\times 12$ .

The dorsal and lateral arm plates are concentrically striated. The arm spines are longer than in the three other species, and are much flattened, not uniformly tapered, but retain nearly the same width until very near the end, where they abruptly taper. In the first few arm joints, they are more or less spatulate.

**Ophiurochaeta** MATSUMOTO, 1915.

Disk, as well as radial shields, closely covered with fine granules and bearing scattered spines. Oral angles granulated, oral shields naked. Oral papillæ numerous, close-set, the outermost papilla being pointed inwards above the next papilla, which is the largest. Arms not very long, rather stout, widest at the base. Dorsal, as well as ventral, arm plates well developed, fully in contact with one another. Six or more arm spines, long, flared, longer than the corresponding arm joint. Two tentacle scales to each pore, the abradial one overlapping the base of the lowest arm spine.

This genus includes *Ophiochaeta mixta* LYMAN, 1878 (referred to *Ophiolimna* by VERRILL, 1899), and *Ophiolimna littoralis* KÖHLER, 1912, the first being the genotype.

This genus apparently resembles *Ophiochaeta*, but differs from it in the long and flared arm spines. *Ophiurochaeta* differs from *Ophiolimna* VERRILL, 1899, in the more numerous oral papillæ, of which the outermost one is not very large and operculiform, but pointed inwards above the next papilla, which is the largest; in the well developed dorsal and ventral arm plates, and in the presence of two tentacle scales, of which the abradial one overlaps the base of the lowest arm spine. VERRILL thinks that the internal structures of *O. mixta* are much like those of *Ophiacantha*; but my own observations lead to a quite different conclusion.

I have observed the internal structures of *Ophiuroconis monolepis*, *Ophiurodon grandisquama*, *Ophiurochaeta mixta*, *Ophiarachna incrassata*, *Ophiochiton fastigatus*, *Ophioplax lamellosa*, &c., and satisfied myself that they all belong to the same type. In these forms, the peristomial plates are always triple, one of the secondary

plates filling up the outer open angle formed by the other two; while in *Ophiacantha*, *Ophiolimna*, &c., the peristomial plates are simple, or double with soldered halves, always lacking the unpaired secondary plate. Further, the peristomial plates are relatively to their width distinctly longer in the former type than in the latter.

When I compared a young specimen of *Ophiarachna incrassata* with a specimen of *Ophiurochæta mixta*, kindly presented by Dr. H. L. CLARK, and with KEHLER'S photographs of *O. littoralis*, I was instantly struck by the similarity in their plan of structure. The only differences of *Ophiurochæta* from *Ophiarachna* are the presence of the scattered disk spines and the absence of the accessory oral shields, besides the smaller size. The systematic value of the accessory oral shields is, however, scarcely recognised by CLARK. And I have also observed the absence of accessory shields in some interradii of a certain specimen of *Ophiarachna incrassata*. One may with good reason regard the relation of *Ophiurochæta* to *Ophiarachna* to be parallel to that of *Ophiomastix* to *Ophiozoma* or of *Ophiochæta* to *Pectinura*.<sup>1)</sup>

---

1) CLARK, 1915, has provisionally referred my *Ophiurochæta* to VERRILL'S *Ophiotreta*. The latter genus, which includes six species according to CLARK, is undoubtedly too heterogeneous to be looked upon as a distinct genus; and I can find practically no common characteristic for these six species. I look upon VERRILL'S *Ophiotreta* merely as a section of the genuine *Ophiacantha*. As CLARK'S *Ophiotreta* is very heterogeneous, it is almost useless to compare my *Ophiurochæta* with the rest of CLARK'S *Ophiotreta*. So that I wish here to compare my *Ophiurochæta* with the type of *Ophiotreta*. They differ as follows.

*Ophiurochæta*:—Disk covered with fine granules, besides scattered spines; oral angles regularly triangular, regularly closing the oral slits, distinctly granulated; oral shields situated far inwards, so that the distance from their inner end to the tip of the oral angles is very short; no cluster of dental papillæ, though a few infradental papillæ may be present; oral arm plates fairly wide, so that the arm spines do not approximate dorsally; ventral arm plates distinctly in contact with one another; arm spines not extremely long, opaque and not serrate (at least in adult); two tentacle scales to each pore, the abradial one overlapping the base of the lowest arm spine.

*Ophiacantha (Ophiotreta) lincolata*:—Disk covered with coarse granules, besides scattered spines; oral angles distinctly narrowed at base by the second oral tentacle pores, so that the oral slits are gaping; no granulation on the oral angles; oral shields situated far outwards from

*Ophiarachna incrassata* (LAMARCK).

*Ophiura incrassata*: LAMARCK, Hist. Nat. Anim. sans Vert., II, 1816, p. 542.

*Ophiarachna incrassata*: MÜLLER & TROSCHER, Sys. Ast., 1842, p. 104; LÜTKEN, Addit. Hist. Oph., III, 1869, p. 33; LYMAN, Bull. Mus. Comp. Zool., III, 1874, p. 221; LYMAN, Rep. Challenger, V, 1882, p. 173; BROCK, Zeitschr. wiss. Zool., XLVII, 1888, p. 495; KOEHLER, Exp. Siboga, XLV, Pt. 2, 1905, p. 64; KOEHLER, Bull. Sc. Fr. Belg., XLI, 1907, p. 330; CLARK, Bull. Mus. Comp. Zool., LI, 1908, p. 298; CLARK, *ibid.*, LII, 1909, p. 128.

Three specimens; Bonin Is. One specimen; Okinawa.

Indo-Pacific. Okinawa and Bonin Is. seem to be the northern limits of this species.

One of the specimens from the Bonin Is. and the one from Okinawa agree perfectly with MÜLLER & TROSCHER'S description. The largest one from the Bonin Is. is 50 mm. in the disk diameter, 170 mm. in the arm length and 8 mm. in the arm width at base. Its colour in alcohol differs from that of the others, and is yellowish brown above, dark brown below, being handsomely dotted with lighter shade on the ventral interbrachial spaces, on the oral shields, on the tentacle scales, and on the lower arm spines. The third specimen from the Bonin Is. is notably different from the others: the oral shields are a little longer than wide, and the

---

the tip of the oral angles; cluster of dental papillæ present; dorsal arm plates very narrow, so that the arm spines more or less approximate dorsally in a few basal arm joints; ventral arm plates entirely separated from one another; arm spines extremely long, translucent and finely serrate; single tentacle scale to each pore (two scales to the first pore only), not overlapping the base of the lowest arm spine.

All the distinctive characters of *Ophiurochata* are perfectly Ophiodermatine, and those of the type of *Ophiotreta* thoroughly Ophiacanthine. I believe that, *Ophiurochata* cannot be united with *Ophiotreta*, unless the majority of the now recognised genera of the Ophiuroidea should be united to a single genus.

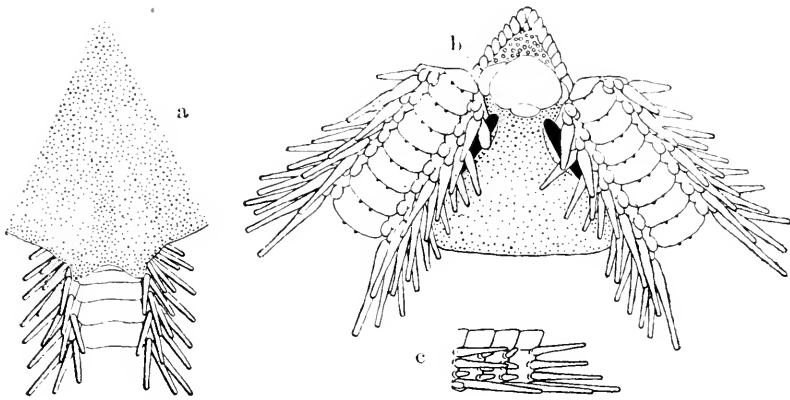

Fig. 88. *Ophiarachna incrassata*.  $\times 1\frac{1}{2}$ . a. From above. b. From below. c. Side view of four arm joints near disk, showing the regenerated arm spines.

accessory oral shields are very rudimentary or absent.<sup>1)</sup> Comparing these four specimens, we find that the arm spines are longer, blunter and more flattened in the larger specimens. The proportion of width to length of the oral shields is not constant. The size ratio of the accessory oral shield to the oral shield proper differs in specimens. The pairs of the adoral shields are sometimes asymmetrical. The arm spines may regenerate.

**Key to Japanese genera of *Ophiodermatinae*.**

- A—Single oval tentacle scale to each pore; three or four arm spines; radial shields partly naked ..... *Bathypectinura*.
- AA—Two tentacle scales, of which the abradial one overlaps the base of the lowest arm spine; six or more arm spines.
  - a—Radial shields covered over ..... *Pectinura*.
  - aa—Radial shields naked ..... *Ophiarachnella*.

1) In *Pectinura*, *Ophiarachnella*, *Bathypectinura* and *Ophiarachna*, the accessory oral shields are not constantly present. I therefore consider it more natural to refer *Ophiopora daubyni* FARQUHAR to *Ophiarachna* than to *Pectinura*, notwithstanding the absence of the accessory oral shields.

*Bathypectinura gotoi* MATSUMOTO.

*Bathypectinura gotoi*: MATSUMOTO, Proc. Acad. Nat. Sci. Philadelphia, 1915, p. 87.

Two specimens; Nishinoyodomi, Sagami Sea; 170 fathoms.

Diameter of disk 50 mm. Length of arms 195 mm. Width of arms at base 7 mm.

Disk pentagonal, flat, closely covered with fine granules, of which four or five occur in 1 mm. Radial shields only partly naked, but distinguishable through the superficial granulations as large, elongated ovate, slight swellings, nearly half as long as the disk radius, and wider outwards; the naked part is very small, ovate, and wider without than within. Genital slits very long, almost reaching to the margin of the disk. Genital plates distinct, long and very stout.

Oral shields small, triangular, with rounded angles and convex sides, almost as wide as long. Accessory oral shields very rudimentary. In one of the two specimens, they

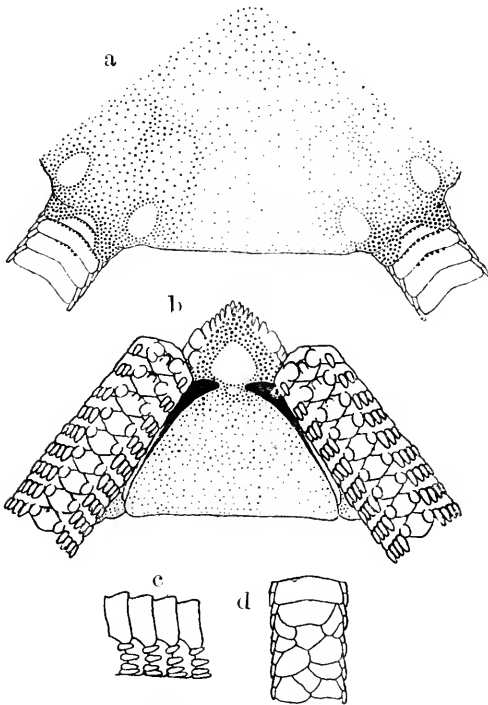

Fig. 89. *Bathypectinura gotoi*.  $\times 1\frac{1}{2}$ . *a*. From above. *b*. From below. *c*. Side view of four arm joints near disk. *d*. Dorsal view of five arm joints somewhat near disk, showing the divided dorsal arm plates.

are absent; but in the other they are indistinctly represented by one or two small scales, separated from the oral shield by granules. The adoral shields are almost, and the oral plates entirely, covered with granules, which are coarser and sparser than in the outer parts. Eight or nine oral papillæ on either side; the outermost two or three are large, flat, thin; the second from the outermost is the largest; inner ones very small, somewhat conical, obtuse. At the apex of the jaw, an unpaired infradental papilla is often present. Five to seven teeth, irregular in shape and size, with pointed or rounded ends, arranged in an irregular vertical row.

Arms long, stout, gradually tapered, with a rather sharp dorsal ridge, triangular in transverse section. Dorsal arm plates large, almost occupying the entire dorsal surface of the arm, quadrangular, with rounded outer corners, a little wider without than within, much wider than long, three to four times as wide as long, with a rather sharp ridge in the median line; some of them divided into several irregular pieces. Lateral arm plates very low, less than half the height of the arm, meeting neither above nor below. Ventral arm plates small, rhomboidal, with the shorter diagonal parallel to the arm axis. The first plate is almost as wide as, but much shorter than, the following. The three or four plates beginning with the second have a median keel, which is more prominent proximally both with regard to one plate and to the arm as a whole. Arm spines four for the most part, but three in the distal part, very short, flattened, lanceolate, obtuse; the lowest one is somewhat longer than the others. One tentacle scale, large, oval, thin, flat; adoral ones larger.

Colour in alcohol light yellowish brown.

This species is quite near to *B. lacertosa* (LYMAN), but

differs from it in the coarser disk granules, in the smaller naked part of the radial shields, in the more strongly ridged dorsal arm plates, in the much lower lateral arm plates, in the ventral arm plates being wider than long and angled inwards as well as outwards, and in the arm spines being much shorter than the corresponding arm joints.

*Pectinura anchista* CLARK.

*Pectinura anchista* : CLARK, Bull. U. S. Nat. Mus., LXXV, 1911, p. 23, fig. 1.

Numerous specimens ; off Misaki, Sagami Sea. One specimen ; off Uki-shima ; 300 fathoms.

Off Suno Saki, Sagami Sea ; 49 fathoms (CLARK). Kagoshima Bay ; 85 fathoms (CLARK). Eastern Sea ; 95–139 fathoms (CLARK).

This species strongly resembles *P. cylindrica* (HUTTON), and it is somewhat doubtful whether the two are really distinct. As to the proportion of the arm length to the disk diameter, the difference pointed out by CLARK has, in my opinion, no significance ; for the specimens in my hands have proportionately shorter arms. One specimen is 9 mm. in the disk diameter and 30 mm. in the arm length, while another specimen is 8 mm. in the disk diameter and 33 mm. in the arm length. The colour seems to change in alcohol with time from purple to pink.

**Key to Japanese species of *Ophiarachnella*.**

- A*--No trio of naked disk plates just outside and between each pair of radial shields ; oral shields longer than wide .....*gorgonia*.  
*AA*--A trio of naked disk plates present just outside and between each pair of radial shields, on the dorsal side of the arm base.



- a*—Radial shields small, not much larger than one of the trio of naked plates; oral shields wider than long ..... *infernalis*.  
*aa*—Radial shields very large, but the trio of naked plates very small; oral shields longer than wide ..... *megalaspis*.

*Ophiarachnella gorgonia* (MÜLLER & TROSCHERL).

*Ophiarachna gorgonia*: MÜLLER & TROSCHERL, Sys. Ast., 1842, p. 105; LYMAN, Ill. Cat. Mus. Comp. Zool., I, 1865, p. 39.

*Pectinura gorgonia*: LÜTKEN, Addit. Hist. Oph., III, 1869, p. 15; LYMAN, Rep. Challenger, V, 1882, p. 15; BELL, Rep. Zool. Coll. Alert., 1884, p. 134; BROCK, Zeitschr. wiss. Zool., XLVII, 1888, p. 471; DÖDERLEIN, Zool. Jahrb. Sys., III, 1888, p. 830; LORIOU, Rev. Suisse Zool., I, 1893, p. 397; KOEHLER, Ech. Indian Mus., Shallow-wat. Oph., 1900, Pl. I, figs. 1 & 2; PFEFFER, Abh. Senckenberg. Naturf. Gesell., XXV, 1900, p. 83; KOEHLER, Exp. Siboga, XLV, Pt. 2, 1905, p. 8; KOEHLER, Bull. Sci. Fr. Belg., XLI, 1907, p. 284; CLARK, Bull. Mus. Comp. Zool., LI, 1908, p. 289.

*Pectinura marmorata*: LYMAN, Bull. Mus. Comp. Zool., III, 1874, p. 222, Pl. V, figs. 1-7; LYMAN, loc. cit., 1882, p. 17.

*Pectinura ramsayi*: BELL, Proc. Zool. Soc. London, 1888, p. 281.

*Pectinura intermedia*: BELL, loc. cit., 1888, p. 386.

*Pectinura stearnsii*: IVES, Proc. Acad. Nat. Sci. Philadelphia, 1891, p. 212, Pl. XI, figs. 1-5.

*Pectinura venusta*: LORIOU, Mém. Soc. Phys. d'Hist. Nat. Genève, XXXII, p. 16, Pl. XXIII, figs. 3-3h.

*Ophiarachnella gorgonia*: CLARK, Bull. Mus. Comp. Zool., LII, 1909, p. 117.

One specimen (belonging to the Seventh High School, Kagoshima); Kagoshima Bay. One specimen; Eno-ura, Suruga. Numerous specimens; Arai Beach, Misaki.

This Indo-Pacific species is one of the most common ophiurans in the vicinity of the Misaki Marine Biological Station.

The first specimen is very typical, and has a coarse squama-

tion distinguishable through the superficial granulations. The rest are of the *stearnsii*-type, being different from the typical *gorgonia*-type in the disk scales being fine, flat and almost indistinguishable through the superficial granulations. The specimen from Eno-ura, however, rather resembles the *venusta*-type in the shape of the oral shields and accessory oral shields. The largest specimen is 26 mm. in the disk diameter and 95 mm. in the arm length. The number of the arm spines increases with the growth of the animal.

*Ophiarachmella infernalis* (MÜLLER & TROSCHEL).

*Ophiarachma infernalis*: MÜLLER & TROSCHEL, Sys. Ast., 1842, p. 105.

*Pectimura infernalis*: LÜTKEN, Addit. Hist. Oph., III, 1869, p. 33; LYMAN, Bull. Mus. Comp. Zool., III, 1874, p. 222, Pl. VII, fig. 1; LYMAN, Rep. Challenger, V, 1882, p. 17; BELL, Rep. Zool. Coll. Alert, 1884, p. 134, Pl. VIII, fig. B; BROCK, Zeitschr. wiss. Zool., XLVII, 1888, p. 471; LOEHOL, Rev. Suisse Zool., I, 1893, p. 397; PFEFFER, Abh. Senckenberg. Naturf. Gesell., XXV, 1900, p. 83; KÖHLER, Exp. Siboga, XLV, Pt. 2; 1905, p. 7, Pl. I, figs. 1-3; KÖHLER, Bull. Sci. Fr. Belg., XLI, 1908, p. 285; CLARK, Bull. Mus. Comp. Zool., LI, 1908, p. 289.

*Pectimura similis*: KÖHLER, loc. cit., 1905, p. 6, Pl. I, figs. 4-6.

*Ophiarachmella infernalis*: CLARK, Bull. Mus. Comp. Zool., LII, 1909, p. 124.

Two specimens; Okinawa. One specimen: Eno-shima, Ôsumi. Two specimens; Eno-ura, Suruga.

Indo-Pacific.

The radial shields

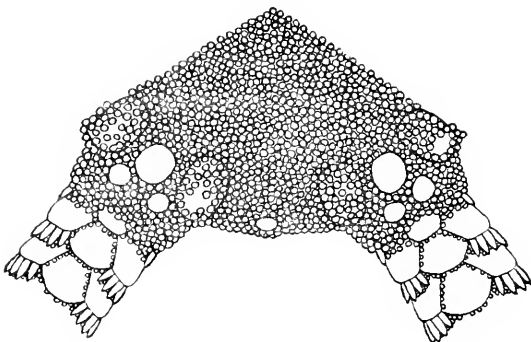

Fig. 90. *Ophiarachmella infernalis*, var. From above.  $\times 10$ .

are rather small, and often covered with granules on their inner borders. One of the specimens from Okinawa notably departs from the typical ones. It is only 6 mm. across the disk. The radial shields are almost covered with granules. Moreover, in the arm bases, granules which are finer than the disk granules occur on the ventral abradial parts of the lateral arm plates, on the proximal parts of the same under the arm spines, along the dorsal border of the same, and along the distal border of the dorsal arm plates.

*Ophiarachnella megalaspis* CLARK.

*Ophiarachnella megalaspis*: CLARK, Bull. U. S. Nat. Mus., LXXV, 1911, p. 25, fig. 2.

Off Suno Saki, Sagami Sea; 44–50 fathoms (CLARK). Eastern Sea; 95–106 fathoms (CLARK).

Family 4. **Ophiochitonidæ** MATSUMOTO, 1915.

Disk covered with fine, imbricating scales, or rarely with fine granules; oral angles always free of granules. Five or six oral papillæ on either side of each jaw; the outermost one is pointed inwards, projecting above the next papilla, which is the largest. Teeth arranged in a single vertical row, either triangular and obtusely pointed, or quadrangular, with very stout, truncated end. Dental papillæ absent. Peristomial plates double or triple. Oral frames with or without well developed lateral wings. Radial shield and genital plate of the same side of a radius articulating with each other by means of two articular condyles and one articular pit. Arms long and slender, widest at some distance from the base, horizontally flexible. Dorsal, lateral and ventral arm plates

all well developed, with cereous lustre. Two to four, usually three, arm spines, moderately long, erect. One or two large, leaf-like tentacle scales on the abradial border of each pore; sometimes one to three very small accessory ones may occur on the adradial border.

This family includes five genera, which may be grouped into two subfamilies as follows.

Subfamily 1. *Ophiochitoninae* MATSUMOTO, 1915.—Oral frames without well developed lateral wings; teeth triangular and obtusely pointed; dorsal surface of vertebrae entire, rhomboidal.

*Ophiochiton* LYMAN, 1878.<sup>1)</sup>

*Ophioplax* LYMAN, 1875.

Subfamily 2. *Ophionereidinae* (LJUNGMAN, 1867) mihi, 1915.—Oral frames with well developed lateral wings; teeth very stout, quadrangular, with truncated end; dorsal surface of vertebrae notched at the inner end and **V**-shaped.

*Ophiodoris* KÖHLER, 1904.

*Ophionereis* LÜTKEN, 1859.

*Ophiocrasis* CLARK, 1911.

As shown in the foregoing diagnoses of the subfamilies, there are two types of internal structures in the present family. The internal structures of the *Ophiochitoninae* are very similar to those of the *Ophiodermatidae*. In *Ophiochiton fastigatus* LYMAN, the peristomial plates are triple, one of the secondary plates filling up the outer open angle formed by the other two. The oral frames are very long, with **V**-shaped grooves for the ambulacral ring canal, as in *Ophiurachma incrassata* and *Bathypectinura gotoi*. The genital

---

1) In my opinion, *Ophiochiton tymani* STUDER, 1883, does not belong here, and is an *Ophiocten*, allied to such species as *Ophiocten hastatum* LYMAN, 1878, and *pacificum* LÜTKEN & MORTENSEN, 1899.

plates and scales are long and slender, being longer and more slender than in the *Ophiodermatidae*. The radial shield and genital plate of the same side of a radius articulate with each other by means of two articular condyles and one articular pit. The dorsal surface of the vertebræ is rhomboidal and slightly notched at the inner end but not so strongly as to be **V**-shaped. In *Ophioplax lamellosa* MATSUMOTO, the peristomial plates are also triple, being however relatively shorter and wider than in the preceding species: the unpaired secondary plate is very small and is slightly notched on the outside. The oral frames are short and much more flared than in the preceding, while the roof of the first oral tentacle pore is less projected adradially. In other respects it is almost similar to the preceding.

In the *Ophionereidinae*, the internal structures approach those of the next family, *Ophiocomidae*, in certain points. In *Ophionereis annulata* (LE CONTE) and *O. reticulata* LÜTKEN, the peristomial plates are double, without the unpaired secondary plate, and much smaller than in the *Ophiochitoninae*. The oral frames are very long, stout, with well developed lateral wings for the attachment of very voluminous chewing museles. The teeth are very stout, quadrangular, with widened and truncated end. The dorsal surface of the vertebræ is strongly notched at the inner end corresponding to the elongated outer end of the preceding vertebra, so as to be markedly **V**-shaped. The radial shields, genital plates and scales are fundamentally similar to those of *Ophiochiton fastigatus*, though the radial shields are much smaller. The internal structures of *Ophiocrasis marktanneri* MATSUMOTO are similar to those of *Ophionereis*, except the peristomial plates, which are triple, with a small unpaired secondary plate. Now we come to a most interesting genus, *Ophiodoris*, which is fairly intermediate in its internal structures between *Ophiochitoninae* and the *Ophionereis-Ophiocrasis*-type. In *Ophiodoris*

*pericalles* CLARK, the peristomial plates are double, without the unpaired secondary plate. The oral frames are not very stout and have more or less distinct lateral wings, which are less well developed than in *Ophionereis* and *Ophiocrasis*. The dorsal surface of the vertebræ is notched at the inner end so as to be fairly **Y**-shaped, but not so strongly as in *Ophionereis* and *Ophiocrasis*. The radial shields, genital plates and scales are similar to those of *Ophionereis* and *Ophiocrasis*.

As to the biological significance of the characters of the present family, we can recognise two lines along which advance has been made from the *Ophiochitoninae* to the *Ophionereidinae*. In the first place, the *Ophionereidinae* have better developed chewing apparatus than the *Ophiochitoninae*, such as stouter teeth, with widened and truncated end, smaller peristomial plates, stouter oral plates with well developed lateral wings and more voluminous muscles. In the second place, the arms of the *Ophionereidinae* are more flexible than those of the *Ophiochitoninae*, as may be judged from the notched, **V**- or **Y**-shaped dorsal surface of the vertebræ. It may be remarked that the arms of *Ophionereis* and *Ophiocrasis* are strongly flexed in alcohol and very freely mobile in life.

#### Key to genera of *Ophiochitoninae*.

- A*—Disk entirely free of granules; arms markedly keeled above and below ..... *Ophiochiton*.  
*AA*—Disk or at least the interbrachial ventral surfaces covered with fine granules; arms not keeled, at least below ..... *Ophioplax*.

#### *Ophiochiton fastigatus* LYMAN.

*Ophiochiton fastigatus*: LYMAN, Bull. Mus. Comp. Zool., V, 1878, p.

132, Pl. VII, figs. 182 & 183; LYMAN, Rep. Challenger, V, 1882, p. 176, Pl. XXIV, figs. 13-15; CLARK, Bull. U. S. Nat. Mus., LXXV, 1911, p. 133.

*Ophiochiton carinatus*: LÜTKEN & MORTENSEN, Mem. Mus. Comp. Zool., XXIII, 1899, p. 164, Pl. XIV, figs. 1-3.

Numerous specimens; off Misaki, Sagami Sea.

Sagami Sea; 110-405 fathoms (CLARK). Uruga Channel; 70-197 fathoms (CLARK). Suruga Gulf; 94-270 fathoms (CLARK). Eastern Sea; 406 fathoms (CLARK).

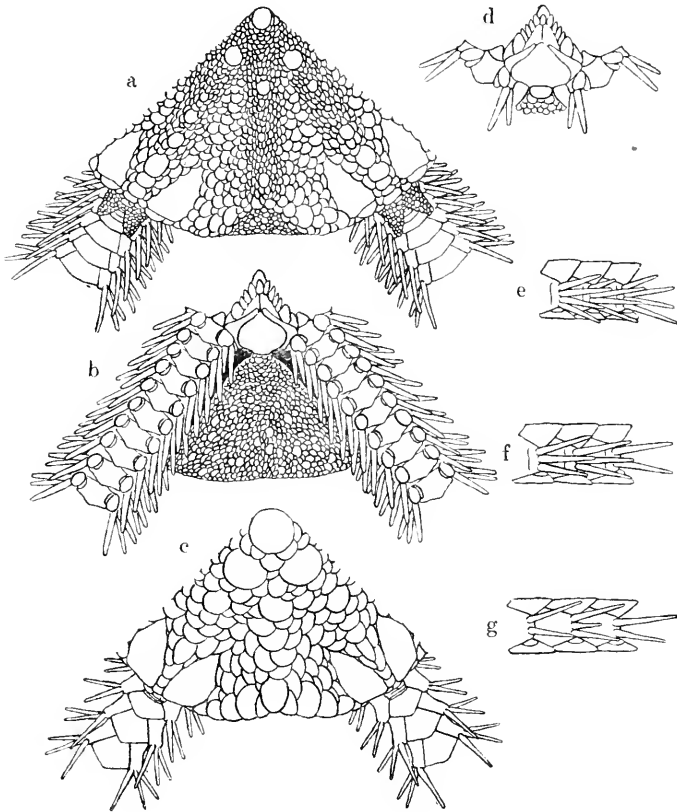

Fig. 91. *Ophiochiton fastigatus*. a. From above.  $\times 2$ . b. From below.  $\times 2$ . c. From above.  $\times 7$ . d. Ventral view of an oral angle, showing the presence of an accessory oral shield.  $\times 2$ . e. Side view of three arm joints near disk.  $\times 2$ . f. Side view of three arm joints near disk of a medium-sized specimen.  $\times 3$ . g. Side view of three arm joints near disk.  $\times 7$ . e. and g. young.

Lat.  $5^{\circ} 41'$  S., long.  $134^{\circ} 4'$  E.; 800 fathoms (LYMAN). Gulf of Panama; 322–546 fathoms (LÜTKEN & MORTENSEN).

The largest of my specimens is 31 mm. in the disk diameter, 400 mm. in the arm length, and 4 mm. in the arm width; and the smallest one 8 mm. in the disk diameter, 52 mm. in the arm length, and 0.8 mm. in the arm width. This species is very variable, and has been remarked upon by CLARK. The adoral shields are sometimes very feeble, but often very well developed, especially in the younger specimens, so as to lie between the oral shields and the first lateral arm plates. Therefore, KÖHLER's subdivision of this genus according as the oral shields are separated or not from the first lateral arm plates, has no meaning at least for the present species. Often, more or less prominent accessory oral shields occur in some of the interradial. This is another fact showing that the present genus is related to *Ophiarachna*.

I consider *O. carinatus* LÜTKEN & MORTENSEN to be a synonym of this species, because specimens of the latter of corresponding size agree almost perfectly with the description and figures of the former. The figures here given, together with those of medium-sized specimens by LÜTKEN & MORTENSEN will give a fair idea of the variability of this species.

*Ophioplax lamellosa* MATSUMOTO.

*Ophioplax lamellosa*: MATSUMOTO, Proc. Acad. Nat. Sci. Philadelphia, 1915, p. 88.

One specimen; off Kōtsu-jima, Sagami Sea.

Diameter of disk 4.5 mm. Length of arms 35 mm. Width of arms at base 0.8 mm.

Disk flat, thin, pentagonal or rather five-lobed, with indented interbrachial borders, covered with fine, imbricating scales, among



which the six primaries are somewhat distinct. Central plate rather large, circular, conspicuous. Radials smaller and less conspicuous than the central plate, separated from one another and from the central plate. Radial shields triangular, with acute inner

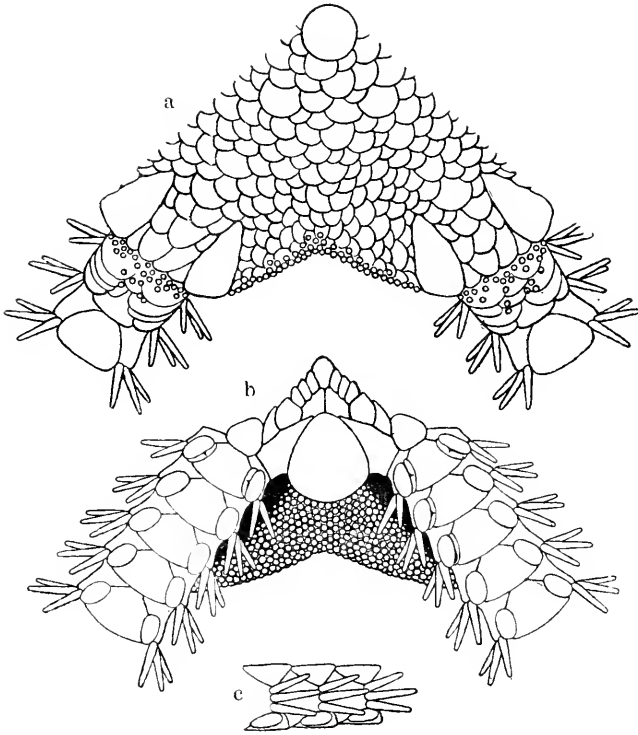

Fig. 92. *Ophioplax umellosa*.  $\times 16$ . a. From above. b. From below.  
c. Side view of three arm joints near disk.

angle, twice as long as wide, those of a pair widely separated from each other. Interbrachial ventral surfaces entirely covered with very fine granules. Genital slits very large, reaching to the margin of the disk.

Oral shields large, triangular, with strongly curved outer border, less curved lateral sides, obtuse inner angle, and perfectly rounded lateral angles; longer than wide. Adoral shields also

large, triangular, long, tapered within to an acute point, where they do not meet. Oral plates naked. Five oral papillæ; outermost one long, acutely pointed within; the second is the largest of all, very wide and flat; the others small, somewhat conical, obtuse. Four or five teeth, very large, with rounded ends, except the uppermost one, which is longer than the others and pointed.

Arms long, slender, thin. Lamellar plates and fine granules occur on the dorsal and lateral surface of the arm bases. First one or two dorsal arm plates small, partly covered over by the lamellar plates. Those beyond triangular at the outset but becoming quadrangular a little further out, with rounded outer corners and curved lateral borders, wider than long, wider without than within. Lateral arm plates not very prominent. First ventral arm plate small, triangular, with rounded angles, nearly as wide as long. Those beyond pentagonal, with an inwardly directed angle, which is covered by the preceding plate; outer border curved, lateral borders concave and bounded by the tentacle pores. Three arm spines, conical, tapering, obtuse, a little longer than the corresponding arm joint, subequal, but the middle one slightly longer than the other two. One tentacle scale on the abradial side of the pore, very large and oval. Besides, on the adradial side of a few basal pores, there occur one or two rudimentary tentacle scales, more or less covered over by the abradial scale.

Colour in alcohol: yellowish gray above and white below; arms banded with dark gray.

It is recorded that the above specimen was taken with a coral net, but the depth is not stated. As the annulation on the arms indicates, this species is not a deep water form, but probably sublittoral.

*Ophioplax lamellosa* is quite near to both *O. ljungmani* LYMAN, 1875, and *custos* (KOEHLER, 1896), as well as to *Ophiopeza reducta*<sup>1)</sup> KOEHLER, 1907. It is distinguished from *O. ljungmani* by the presence of the primary plates, by the coarser disk scales, by the shape of the radial shields, by the disk margin being not so closely granulated, and by the shape of the oral shields; from *O. custos* by the presence of the primary plates, by the coarser disk scales, by the shape of the radial shields, by the adoral shields not meeting within, by the shape of the first and second ventral arm plates, by the presence of the lamellar plates at the arm bases, and by the shape of the dorsal arm plates; and from *O. reducta* by the dorsal surface of the disk being free of granules, by the radial shields not being divergent, and by the shape of the ventral arm plates. KOEHLER states that, in his specimens of *O. custos* the dorsal surface of the disk was also closely covered with fine granules during life, but that they subsequently dropped off. Whether the same holds true for *O. lamellosa* can not be ascertained, as I have not been able to examine living specimens.

### Key to genera of *Ophionereidinae*.

- A*—Accessory dorsal arm plates absent; a row of spines present along the brachial borders of the disk, just above the arm bases.....  
 ..... *Ophiodoris*.
- AA*—Accessory dorsal arm plates present.
- a*—Only two large accessory plates to each dorsal arm plate.....  
 ..... *Ophionereis*.

1) *Ophiopeza reducta*, which CLARK refers to his genus *Bothypectinura*, appears to me to be merely an *Ophioplax*. The presence of only three long, cylindrical arm spines, and of only five papille, the annulation on the arms, and the naked oral plates, are all characters of *Ophioplax*, and not of the genuine *Bothypectinura*.

*aa*—Very small, secondary dorsal accessory plates present besides the two large ones ..... *Ophiocrasis*.

***Ophiodoris pericalles* CLARK.**

*Ophiodoris pericalles* : CLARK, Bull. U. S. Nat. Mus., LXXV, 1911, p. 177, fig. 80.

Off Osé Zaki, Suruga Gulf; 65 fathoms (CLARK). Eastern Sea; 95–106 fathoms (CLARK).

**Key to Japanese species of *Ophionereis*.<sup>1)</sup>**

- A*—Genital papillæ present; ventral arm plates without median notch and eminence.
- a*—Disk scales coarse; dorsal arm plates not very wide, slightly wider than long; three arm spines ..... *porrecta*.
- aa*—Disk scales very fine; dorsal arm plates very wide, twice as wide as long or wider; four arm spines in the basal arm joints ..... *eurybrachioplax*.
- AA*—Genital papillæ absent; ventral arm plates with a median notch and eminence. .... *sinensis*.

***Ophionereis porrecta* LYMAN.**

*Ophionereis porrecta* : LYMAN, Proc. Boston Soc. Nat. Hist., VII, 1860, p. 260<sup>2)</sup>; LYMAN, Ill. Cat. Mus. Comp. Zool., I, 1865, p. 147, figs. 14 & 15; LYMAN, Rep. Challenger, V, 1882, p. 161; BROCK, Zeitschr. wiss. Zool., XLVIII, 1888, p. 495; KÖHLER, Bull. Sci. Fr. Belg., XXXI, 1898, p. 74; KÖHLER, Exp. Siboga, XLV, Pt. 2, 1905, p. 53.

1) CLARK, 1915, has recorded *Ophionereis dubia* from "Japan: mouth of the Bay of Yeddo" (=Gulf of Tôkyô). If his record is based upon Prof. MORSE's specimens, it is probably not *O. dubia* but *Ophiocrasis marktanneri*. Some specimens of the last mentioned species in the Zoological Institute, Imperial University of Tôkyô, were also labelled "*Ophionereis dubia* var." by Prof. MORSE. I have yet to find a specimen of *O. dubia* from the vicinity of the mouth of the Gulf of Tôkyô, though *Ophiocrasis marktanneri* is very common there.

2) This paper was not seen by me.

*Ophionereis squamata*: LJUNGMAN, Oph. viv., Öf. ·K. Akad. Förh., 1866, p. 310.

*Ophionereis variegata*: DUNCAN, Journ. Linn. Soc. London, XIV, 1879, p. 462, Pl. X, figs. 15 & 16.

Two specimens; Okinawa. One specimen; locality unknown. Okinawa, Riu-kiu. Korea Strait; 33 fathoms (DUNCAN). Honolulu.

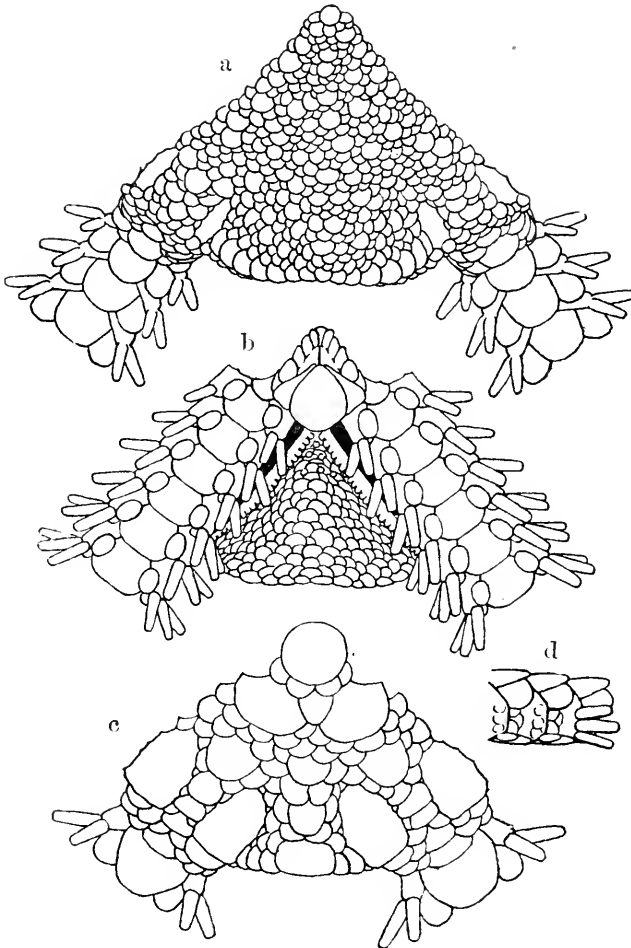

Fig. 93. *Ophionereis porrecta*. *a*. From above.  $\times 15$ . *b*. From below.  $\times 15$ . *c*. Young specimen; from above.  $\times 30$ . *d*. Side view of three arm joints near disk; two sets of arm spines removed to show the accessory scales.  $\times 15$ .

The largest one of my specimens is 5 mm. across the disk, with the arms four or five times as long. The apical pair of oral papillæ are infradental, and there is no unpaired papilla. The arms are lightly keeled both above and below, so that they remind us of *Ophiochiton*. There are two or three scale-like supplementary plates between the lateral arm plates; but they are not very conspicuous, being covered over by the arm spines. In smaller specimens, the disk squamation much resembles that of *Ophiozona* and *Ophiozonella*.

***Ophionereis eurybrachiata* CLARK.**

*Ophionereis eurybrachiata*: CLARK, Bull. U.S. Nat. Mus., LXXV, 1911, p. 173, fig. 78.

Off Kinkwa San; 31–41 fathoms (CLARK).  
California.

***Ophionereis sinensis* (DUNCAN).**

*Ophionereis dubia* var. *sinensis*: DUNCAN, Journ. Linn. Soc. London, XIV, 1879, p. 464.

Korea Strait; 33 fathoms (DUNCAN).

This species is very imperfectly described by DUNCAN as a variety of *O. dubia* (MÜLLER & TROSCHEL, 1842). His remarks read as follows.

“The form from the Korean Sea is well grown, and differs from the type (*O. dubia*) as follow:—The lower arm-plates have a median notch and eminence; the spines are subequal, and they are rarely banded with colour. It has a marsupium, and doubtless, as was commonly the case in these Korean species, it is viviparous.”

If these differences between the Korean form and the typical *O. dubia* really exist, then it is almost certain that the former is not referable to the same species. Therefore, I am inclined provisionally to look upon the former as a distinct species.

### **Ophiocrasis** CLARK, 1911.

Aside from the presence of the secondary supplementary dorsal arm plates, this genus seems to me to be distinguished from *Ophionereis* principally by negative characters and the different degree of development of certain common structures. The disk scales are even and exceedingly fine; no trace of the marginal row of special disk scales; no genital papillæ; arms much narrower than in *Ophionereis*. Schizogonic reproduction may not be a generic character.

### **Key to species of *Ophiocrasis*.**

- A*—Radial shields not very small; ventral arm plates longer than wide throughout; smaller individuals six-armed, reproducing by schizogony .....*dictydisca*.
- AA*—Radial shields exceedingly small and insignificant; ventral arm plates wider than long, at least in the basal parts of the arms; five-armed, not reproducing by schizogony.....*marktanneri*.

### ***Ophiocrasis dictydisca* CLARK.**

*Ophiocrasis dictydisca*: CLARK, Bull. U.S. Nat. Mus., LXXV, 1911, p. 175, fig. 79.

Off Suno Saki, Sagami Sea; 52-73 fathoms (CLARK). Korea Strait; 59 fathoms (CLARK).

*Ophiocrasis marktanneri* MATSUMOTO.

*Ophionereis porrecta* : MARKTANNER-TURNERETSCHER, Ann. K. K. Naturh. Hofmus., II, 1887, p. 302, Pl. XII, fig. 18. (Non LYMAN, 1860.)

'*Ophionereis porrecta* MARKTANNER': KÖHLER, Bull. Sci. Fr. Belg., XXXI, 1898, p. 76.

*Ophiocrasis marktanneri* : MATSUMOTO, Proc. Acad. Nat. Sci. Philadelphia, 1915, p. 90.

Three specimens; Enoshima, Sagami. Numerous specimens; Arai Beach, Misaki Marine Biological Station.

Diameter of disk 9 mm. Length of arms 68 mm. Width of arms at base 1.2 mm.; at the widest part 1.5 mm.

Disk circular, slightly convex, rather soft, covered with

very fine, imbricating scales, which are rather obscured, so that the disk appears as if covered by a thick skin. Radial shields very small, short and exceedingly narrow, tapered within, those of a pair widely separated from each other, also rather obscure. Interbraachial ventral surfaces covered with scales similar to those of the dorsal side, but even more

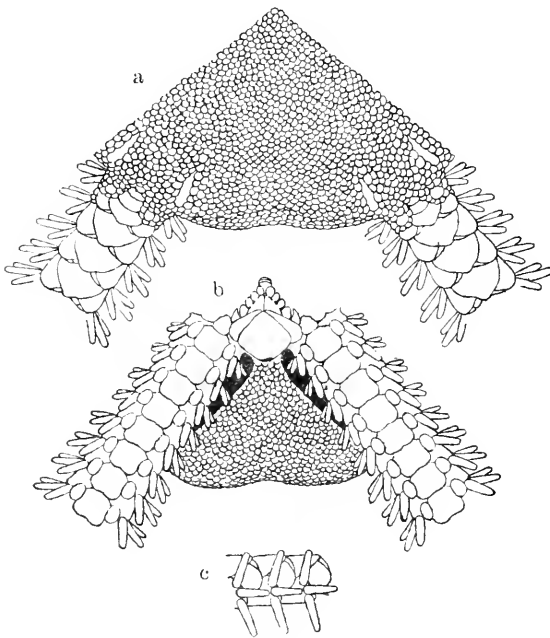

Fig. 94. *Ophiocrasis marktanneri*.  $\times 7$ . *a*. From above. *b*. From below. *c*. Side view of three arm joints near disk.

obscure. Genital slits large, nearly reaching to the border of the disk. No genital papillæ.



Oral shields rhomboidal, with obtuse inner angle, rounded lateral angles, and widely rounded outer angle; nearly as wide as long, except the madreporic shield, which is decidedly longer than wide. Adoral shields small, acutely tapered within, where they nearly or hardly meet. Four or five oral papillæ on either side, unequal, short, rounded, but the outermost one, which is closely associated with the second oral tentacle pore, has pointed inner end. Four teeth, short, very wide and stout.

Arms long and very slender, narrowed at the base, widest at one-fourth to one-third the arm length from the base. Dorsal arm plates mostly triangular, with obtuse outwardly directed apex, rather small, wider than long, successive plates slightly in contact; quadrangular in the more distal parts. On either side of each dorsal arm plate, occurs a large supplementary plate, which is nearly semicircular, about one-half as large as the dorsal arm plate, and bounded along the distal border by one or two very insignificant secondary pieces, which however are present only for a comparatively short extent. Two or three basal dorsal arm plates and their supplementary plates are smaller than those beyond. The supplementary plates become smaller outwards as the dorsal arm plates become quadrangular, and finally disappear. Lateral arm plates not very prominent, not meeting above or below. First ventral arm plate very small, rather pentagonal, longer than wide. Those beyond quadrangular, with rounded outer lateral angles, truncated inner lateral angles, and slightly notched outer border, about as long as wide, but longer than wide outwards. Three arm spines, short, stout, flattened, slightly tapered, blunt. One large and oval tentacle scale.

Colour in alcohol: grayish yellow; disk reticulated, and arms banded, with dark purplish brown.

The arm length varies from six to eight times the diameter of the disk. In the smaller specimens, the arm spines are less flattened; and in those of less than about 4 mm. across the disk, the secondary supplementary pieces on the arms are almost invisible.

This species differs from the genotype, *O. dictydisca* CLARK, in the shape of the dorsal arm plates, in the less well developed secondary supplementary pieces, in the smaller and less distinct radial shields, and in the smaller arm spines of the basal joints. Further, schizogonic reproduction has not been observed in this species, though I have examined many small specimens. On the other hand, *O. marktanneri*, as well as the genotype, resembles *Ophionereis dubia* (MÜLLER & TROSCHEL, 1842) in lacking the genital papillæ, but differs from it chiefly in the presence of secondary supplementary dorsal arm plates, and in the much narrower arms. *O. marktanneri* is by no means near to *Ophionereis porrecta* LYMAN. I could mention some more differences than those enumerated by KÖHLER between these two species, but it will not be necessary to do so here.

This beautiful species is one of the most common ophiurans about Misaki, living under stones and rocks.

#### Family 5. **Ophiocomidæ** LJUNGMAN, 1867.

Disk covered with fine granules or by a naked skin, sometimes bearing scattered spines. Radial shields very stout, but externally invisible, those of a pair widely separated from each other. Four to six oral papillæ on either side, the outermost one being pointed inwards above the next one. Dental papillæ well developed, forming a vertical clump at the apex of each jaw. Teeth quadrangular and very stout. Peristomial plates double.

Oral frames very stout, with extremely well developed lateral wings. The radial shield and genital plate of the same side of a radius articulate with each other by means of two articular condyles and one pit. Arms moderately long, stout, widest at some distance outside the base. Arm plates all well developed. Arm spines long, stout, perpendicular to the arm axis; the uppermost spines of every second or third lateral arm plates often very large and clavate. One or two tentacle scales to each pore.

This family includes five genera, four of which form a subfamily, while the fifth forms another.

Subfamily 1. *Ophiocominae* MATSUMOTO, 1915:—Radial shields very stout, boot-shaped, those of a pair widely separated from each other; three to five arm spines, the uppermost spines of every second or third lateral arm plates being usually very large and club-shaped; tentacle scales short and leaf-like.

*Ophiopteris* SMITH, 1877.

*Ophiocoma* AGASSIZ, 1835.

*Ophiomastix* MÜLLER & TROSCHEL, 1842.

*Ophiarthrum* PETERS, 1851.

Subfamily 2. *Ophiopsilinae* MATSUMOTO, 1915:—Radial shields slender, bar-like, each pair being rather close together at the outer ends corresponding to the dorsal approximation of the outer ends of the genital plates; numerous arm spines, none of which is club-shaped; two tentacle scales, of which the adradial one is very long and lanceolate, while the abradial one is very short and acute.

*Ophiopsila* FORBES, 1842.

The present family is very uniform in its internal structures. I have dissected all the Japanese representatives of this family, viz., *Ophiocoma brevipes* PETERS, *O. scolopendrina* (LAMARCK), *Ophio-*

*masticia miata* LÜTKEN, *O. annulosa* (LAMARCK), *O. lütkeni* PFEFFER and *Ophiarthrum elegans* PETERS. In all of them, the radial shields are very stout and boot-shaped, and each consists of a radial bar and a transverse wing projecting laterally from the outer part of the former. Each shield has two articular condyles and one pit, fitting to the two condyles and one pit of the corresponding genital plate. The latter is bar-like, slightly curved laterally, articulating with the genital scale at some distance inwards from the outer end. The genital scales are also bar-like, more or less flattened, but not so wide and leaf-like as those of the *Gnathophiurida*. The peristomial plates are rather small and double, the two being firmly united together. The oral frames are exceedingly stout, with extremely well developed lateral wings for the attachment of very voluminous masticatory muscles. The oral and dental plates taken together are  $\Pi$ -shaped in dorsal view, the former completely overlapping the latter. They are quite different from those of the *Gnathophiurida*. The teeth are quadrangular and very stout.

In *Ophiopsila riisei* LÜTKEN, 1859, the internal structures are almost similar to those of the preceding, save the radial shields, which are slender and bar-like, without transverse wings, and rather closely set in pairs. *Ophiopsila* is by no means near to the *Amphiurida* in internal structures, so that I have no hesitation to refer it to the present family, forming however a subfamily for it alone.

### Key to Japanese genera of *Ophiocomida*.

A—Disk covered with granules or bearing spines.

a—Disk covered only with granules, entirely free of spines. . . *Ophiocoma*.

- aa*—Disk bearing spines, or both granules and spines . . . . *Ophiomastix*.  
*AA*—Disk covered by a naked skin, entirely free of granules and  
 spines . . . . . *Ophiarthrum*.

**Key to Japanese species and varieties of *Ophiocoma*.**

- A*—Interbrachial ventral surfaces entirely covered with granules; oral  
 shields usually oval; dorsal arm plates with clearly cut outer  
 border; arm spines shorter dorsally than ventrally . . . . . *brevipes*.  
*AA*—Granulations of the interbrachial ventral surfaces not extending to  
 the abradial border of the genital slits, the inner parts being mostly  
 naked; oral shields quadrangular; outer border of the dorsal arm  
 plates not clearly cut; arm spines longer dorsally than ventrally . .  
 . . . . . *scolopendrina*.  
*a*—Disk variegated; arm spines annulated . . . . . typical *scolopendrina*.  
*aa*—Disk as well as arm spines uniformly black.  
*b*—Arm spines not very short and stout; two tentacle scales to each  
 pore . . . . . var. *erinaceus*.  
*bb*—Arm spines exceedingly short and stout; a single tentacle scale to  
 each pore, except in a few basal arm joints . . . . . var. *schaeleinii*.

***Ophiocoma brevipes* PETERS.**

*Ophiocoma brevipes*: PETERS, Arch. Naturg., 1852, p. 85<sup>1)</sup>; LYMAN, Rep. Challenger, V, 1882, p. 172; MARKTANNER-TURNERETSCHER, Ann. K. K. Naturh. Hofmus. Wien, II, 1887, p. 303; BELI, Proc. Zool. Soc. London, 1888, p. 388; DÖDERLEIN, Zool. Jahrb. Sys., III, 1888, p. 831; LORIOL, Mém. Soc. Phys. d'Hist. Nat. Genève, XXXII, 1894, p. 25, Pl. XXIII, fig. 4; DÖDERLEIN, SEMON—Zool. Forschungsr., V, 1896, p. 289; KÖHLER, Exp. Siboga, XLV, Pt. 2, 1905, p. 61; KÖHLER, Bull. Sci. Fr. Belg., XLI, 1907,

1) This paper was not seen by me.

p. 325; CLARK, Bull. Mus. Comp. Zool., LI, 1908, p. 296; CLARK, Bull. U. S. Nat. Mus., LXXV, 1911, p. 256.

Three specimens; Natsui, Hiuga. One specimen; Okinawa. One specimen; Yayeyama, Riu-kiu. Three specimens; Kôshun, Formosa. Three specimens; locality unknown.

Indo-Pacific. Natsui appears to be the northern limit of this species for the present.

The colour in alcohol is very variable. In some specimens, the disk is dark grayish brown and sparsely spotted with black. In others, the disk is light bluish green and variegated with white. The oral shields are nearly oval in some specimens, but more or less oblong quadrangular in others. The disk granules are very fine and close-set. The granules occur also on the abradial end

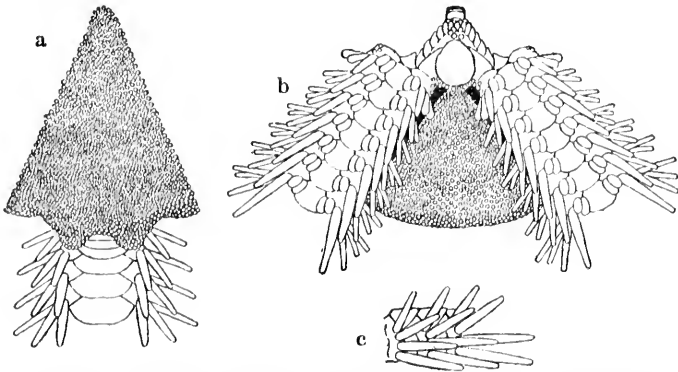

FIG. 95. *Ophiocoma brevipès*.  $\times 4$ . a. From above. b. From below. c. Side view of three arm joints near disk.

of the adoral shields and of the first lateral arm plates. The oral papillæ are comparatively numerous and number five or six on either side. The dorsal brachial margins of the disk are concave. The dorsal arm plates are wide and have clearly cut outer borders. The arm spines are shorter dorsally than ventrally. A few of the lower dental papillæ are very rudimentary and granule-like, reminding us of the granules of the oral angles of the

*Ophiidermatidae*. Many of these characters indicate that the present species is a most primitive form of *Ophiocoma*.

***Ophiocoma scolopendrina* (LAMARCK).**

*Ophiocoma scolopendrina* var. *erinaceus* (MÜLLER & TROSCHIEL).

*Ophiocoma scolopendrina* var. *schaenleinii* (MÜLLER & TROSCHIEL).

*Ophiura scolopendrina*: LAMARCK, Hist. Nat. Anim. sans Vert., II, 1816, p. 54.

*Ophiocoma scolopendrina*: AGASSIZ, Mém. Soc. Nat. Neuchâtel, I, 1835, p. 192<sup>1)</sup>; LYMAN, Rep. Challenger, V, 1882, p. 170; STUDER, Abh. K. Preuss. Akad. Wiss. Berlin, 1882, p. 20; MARKTANNER-TURNERETSCHER, Ann. K. K. Naturh. Hofmus. Wien, II, 1887, p. 302; BELL, Proc. Zool. Soc. London, 1888, p. 388; BROCK, Zeitschr. wiss. Zool., XLVII, p. 495; DÖDERLEIN, Zool. Jahrb. Sys., III, 1888, p. 841; LORIOU, Rev. Suisse Zool., I, 1893, p. 407; LORIOU, Mém. Soc. Phys. d'Hist. Nat. Genève, XXXII, 1894, p. 23; DÖDERLEIN, SEMON-Zool. Forschungsr., V, 1896, p. 288; PFEFFER, Abh. Senckenberg. Naturf. Gesell., XXV, 1900, p. 83; KÖHLER, Exp. Siboga, XLV, Pt. 2, 1905, p. 60; KÖHLER, Bull. Sci. Fr. Belg., XLI, 1907, p. 326; CLARK, Bull. Mus. Comp. Zool., LI, 1908, p. 297.

*Ophiocoma erinaceus*: MÜLLER & TROSCHIEL, Sys. Ast., 1842, p. 98; LYMAN, loc. cit.; STUDER, loc. cit.; MARKTANNER-TURNERETSCHER, loc. cit.; BROCK, loc. cit.; LORIOU, loc. cit., 1893, p. 419; LORIOU, loc. cit., 1894, p. 21; CLARK, loc. cit., p. 296.

*Ophiocoma erinacea*<sup>2)</sup>: DÖDERLEIN, loc. cit., 1888, p. 289; CLARK, Bull. U. S. Nat. Mus., LXXV, p. 257.

*Ophiocoma scolopendrina* var. *erinaceus*: DÖDERLEIN, loc. cit., 1896, p. 289; KÖHLER, loc. cit., 1905; KÖHLER, loc. cit., 1907.

*Ophiocoma schaeleinii*: MÜLLER & TROSCHIEL, loc. cit., p. 99; LYMAN,

1) This paper was not seen by me.

2) I think MÜLLER & TROSCHIEL used the specific name as an appositive noun and not as an adjective, *erinaceus* signifying a hedgehog; so that, there is no reason to change it to "*erinacea*."

Ill. Cat. Mus. Comp. Zool., I, 1865, p. 70; LYMAN, loc. cit., 1882, p. 171; CLARK, loc. cit., 1908, p. 296.

One specimen; Pinnacle Is. Four specimens; Bonin Is. Numerous specimens; Botel Tobago. Numerous specimens; Kôshun, Formosa. Four specimens; Yayeyama, Riu-kiu. Six specimens; Ôshima, Ôsumi. Numerous specimens (belonging to the Seventh High School, Kagoshima); Kagoshima Gulf.

Indo-Pacific. Kagoshima Gulf seems to be the northern limit of this species.

There is no doubt that *O. scolopendrina*, *erinaceus* and *schænleinii* are conspecific, as rightly noted by MARKTANNER-TURNERETSCHER. I have closely examined many intermediate specimens, and am fully convinced that there is no line of demarcation. The continuity of the *scolopendrina*- and *erinaceus*-type has already been remarked upon by LUDWIG, MARKTANNER-

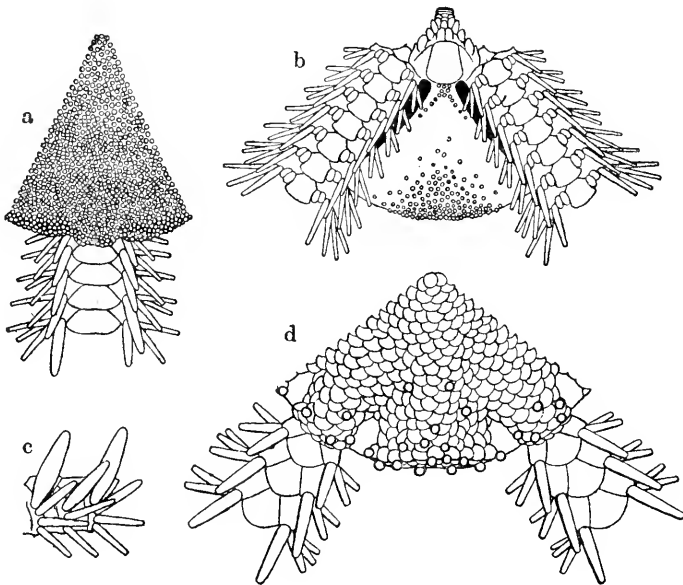

Fig. 96. *Ophiocoma scolopendrina* var. *erinaceus*. a. From above.  $\times 3$ . b. From below.  $\times 3$ . c. Side view of three arm joints near disk.  $\times 3$ . d. Young specimen from above.  $\times 14$ .



TURNERETSCHER, DÖDERLEIN and KÖHLER. Typical specimens of the *schænleinii*-type have very short and exceedingly stout arm spines and only one tentacle scale to each pore, except in a few basal arm joints within the disk. But there are also many specimens of the *erinaceus*-type with only one tentacle scale, instead of two, to each pore in most of the arm joints. Now, there are two classes of specimens which are intermediate between the *erinaceus*- and *schænleinii*-type. In the first, the arm spines are very short and stout, and there is mostly only one tentacle scale to each pore, though often two are present in some of the free arm joints. In the second, the arm spines are not very short and stout, and there is only one tentacle scale, except in a few basal arm joints within the disk. There are also some specimens which are intermediate between the *scolopendrina*- and *schænleinii*-type, in which the arm spines are very short and stout, and not uniformly blackish, as in the *schænleinii*- and *erinaceus*-type, but annulated or spotted with white as in the *scolopendrina*-type, while of the tentacle scale there is mostly only one, though two may be present in some of the arm joints. The numbers of the specimens of each type and of the intermediate ones, together with the localities, are shown in the following table :

Localities : Types :	Bonin Is.	Botel Tobago.	Kôshun.	Yayeyama.	Okinawa.
<i>scolopendrina</i>	2	8	7	1	2
intermediate	1	3	6	0	0
<i>erinaceus</i>	1	9	7	1	1
intermediate	0	4	2	0	1
<i>schænleinii</i>	0	7	1	0	2
intermediate	0	1	2	2	0
<i>scolopendrina</i>	—	—	—	—	—

**Key to Japanese species of *Ophiomastix*.**

- A*—Disk closely covered with granules and bearing a number of very short spines; dorsal arm plates fan-shaped; colour dark red in life and whitish in alcohol .....*mixta*.
- AA*—Disk sparsely covered with spines, or with spines and granules, neither being very close-set.
- a*—Disk sparsely covered with both spines and granules; dorsal arm plates hexagonal; colour black .....*lütkeni*.
- aa*—Disk sparsely covered with spines only; dorsal arm plates rhomboidal; colour grayish brown, disk spines and arm spines finely annulated with white.....*annulosa*.

***Ophiomastix mixta* LÜTKEN.**

*Ophiomastix mixta*: LÜTKEN, Add. Hist. Oph., Pt. III, 1869, p. 44; LYMAN, Ill. Cat. Mus. Comp. Zool., VI, 1870, p. 15; LYMAN, Rep. Challenger, V, 1882, p. 175; BROCK, Zeitschr. wiss. Zool., XLVII, 1888, p. 497; LORICL, Rev. Suisse Zool., I, 1893, p. 414; KÖHLER, Exp. Siboga, XLV, Pt. 2, 1905, p. 68, Pl. VI, fig. 15, Pl. XV, fig. 1; CLARK, Bull. U. S. Nat. Mus., LXXV, 1911, p. 256, fig. 126.

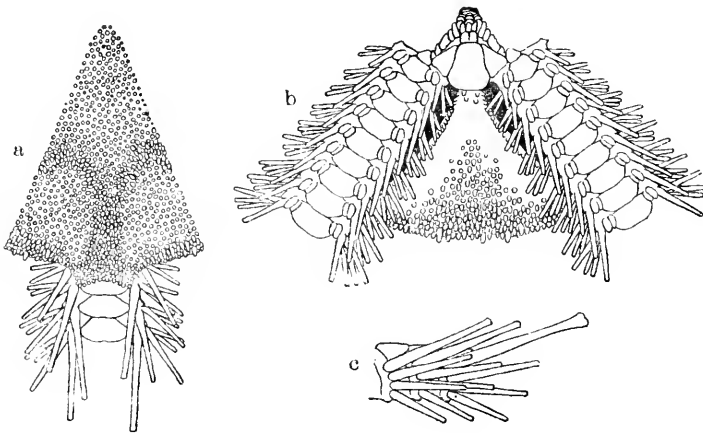

Fig. 97. *Ophiomastix mixta*. ×3. *a*. From above. *b*. From below. *c*. Side view of three arm joints near disk.

One specimen; Enoshima. Numerous specimens; Misaki.

Indo-Pacific. Misaki may be the northern limit of this species.

My specimens have the disk spines not so profusely developed as in the East Indian type, but few, short and inconspicuous; so that they are rather liable to be mistaken for an *Ophiocoma*. The colour is yellowish white in alcohol, but very dark red in life.

*Ophiomastix lütkeni* PFEFFER.

*Ophiomastix lütkeni*: PFEFFER, Abl. Senckenberg. Naturf. Gesell., 1900, XXV, p. 83.

Four specimens; Okinawa.

Philippines (PFEFFER).

The largest one of my specimens is 22 mm. in diameter, 250 mm. in the arm length, and 4 mm. in the arm width at the base. These specimens agree exactly with PFEFFER'S des-

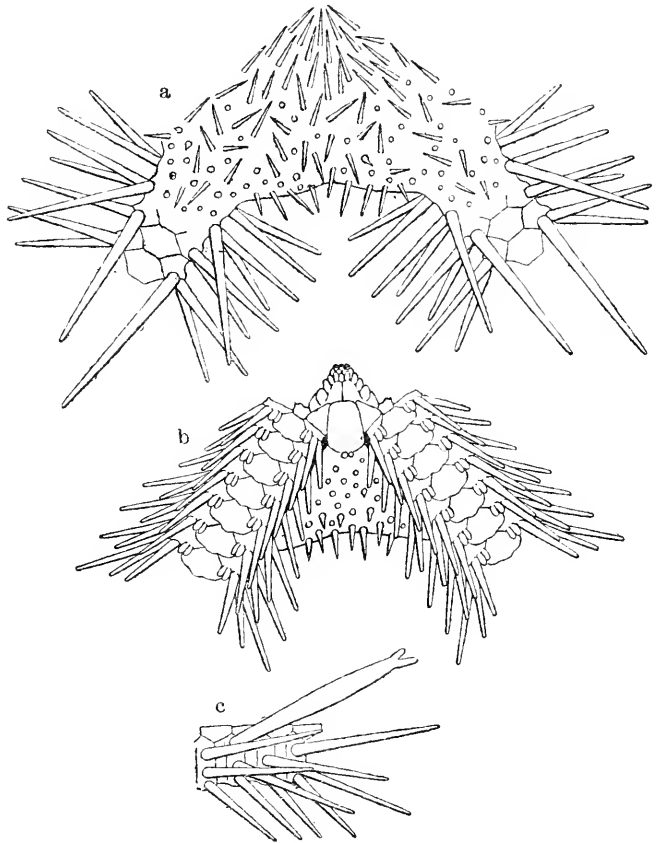

Fig. 98. *Ophiomastix lütkeni*.  $\times 3$ . a. From above. b. From below. c. Side view of three arm joints near disk.

cription, if we make what I consider to be necessary corrections in his expressions: the three rows of teeth mentioned by him are in reality dental papillæ; and above them, deep within the mouth, there is a row of about four teeth, which are hardly visible without dissection. In larger specimens, the uppermost stout arm spine is often bifurcated at the free end. The colour is black as in PFEFFER'S type.

*Ophiomastix annulosa* (LAMARCK).

*Ophiura annulosa*: LAMARCK, Hist. Nat. Anim. sans Vert., II, 1816, p. 543.

*Ophiomastix annulosa*: MÜLLER & TROSCHEL, Sys. Ast., 1842, p. 107; LÜTKEN, Add. Hist. Oph., III, 1869, p. 44; LYMAN, Ill. Cat. Mus. Comp. Zool., VI, 1869, p. 15; LYMAN, Rep. Challenger, V, 1882, p. 175; STUDER, Abh. K. Preuss. Akad. Wiss. Berlin, 1882, p. 21; BROCK, Zeitschr. wiss. Zool., XLVII, 1888, p. 497; DÖDERLEIN, Zool. Jahrb. Sys., III, 1888, p. 832; LORIOL, Rev. Suisse Zool., I, 1893, p. 413; KÄHNER, Mém. Soc. Zool.

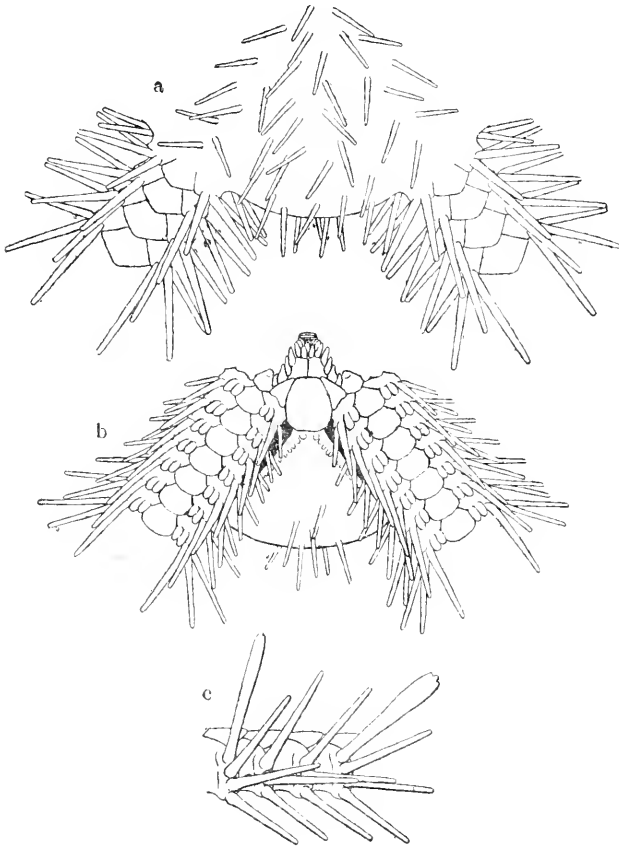

Fig. 99. *Ophiomastix annulosa*.  $\times 3$ . a. From above. b. From below. c. Side view of four arm joints near disk.

Fr., VIII, 1895, p. 403; DÖDERLEIN, SEMON—Zool. Forschungsr., V, 1897, p. 289, Pl. XVI, fig. 111; KÖHLER, Bull. Sci. Fr. Belg., XXXI, 1898, p. 84; PFEFFER, Abh. Senckenberg. Naturf. Gesell., XXV, 1900, p. 85; KÖHLER, Exp. Siboga, XLV, Pt. 2, 1905, p. 65; KÖHLER, Bull. Sci. Fr. Belg., XII, 1907, p. 329; CLARK, Bull. Mus. Comp. Zool., LI, 1908, p. 297.

Four specimens; Pinnacle Is., Riu-kiu. One specimen; Kô-shun, Formosa. Four specimens; Botel Tobago, Formosa.

Indo-Pacific. Pinnacle Is. may be the northern limit of this species.

*Ophiarthrum elegans* PETERS.

*Ophiarthrum elegans*: PETERS, Monatsb. K. Akad. Wiss. Berlin, 1851, p. 463<sup>1)</sup>; PETERS, Arch. Naturg., XVIII, 2, 1852, p. 82<sup>1)</sup>; LYMAN, Rep. Challenger, V, 1882, p. 174; STUDER, Abh. K. Akad. Wiss. Berlin, 1882, p. 21; BROCK, Zeitschr. wiss. Zool., XLVII, 1888, p. 497; DÖDERLEIN, Zool. Jahrb. Sys., III, 1888, p. 831; DÖDERLEIN, SEMON—Zool. Forschungsr., V, 1896, p. 289; KÖHLER, Bull. Sci. Fr. Belg., XXXI, 1898, p. 108, Pl. III, figs. 25 & 26; LUDWIG, Abh. Senckenberg. Naturf. Gesell., XXI, 1899, p. 547; PFEFFER, *ibid.*, XXV, 1900, p. 83; KÖHLER, Ech. Indian Mus., Shallow-wat. Oph., 1890, Pl. XIX, figs. 36 & 37; KÖHLER, Exp. Siboga, XLV, Pt. 2, 1905, p. 73; KÖHLER, Bull. Sci. Fr. Belg., XII, 1907, p. 329; CLARK, Bull. Mus. Comp. Zool., LI, p. 297.

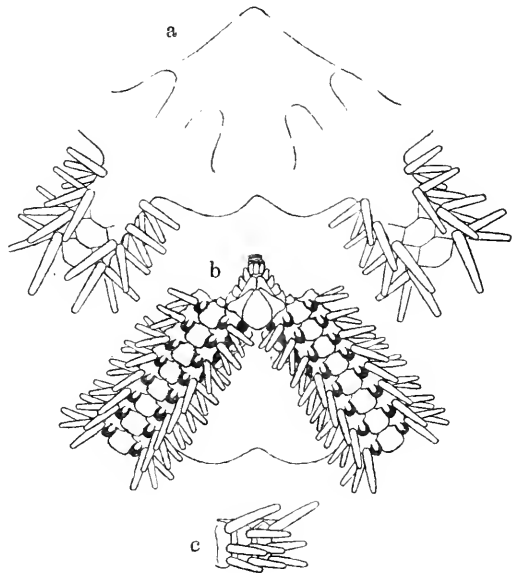

Fig. 100. *Ophiarthrum elegans*.  $\times 3$ . *a*. From above. *b*. From below. *c*. Side view of three arm joints near disk.

1) These papers were not seen by me.

One specimen ; Okinawa, Riu-kiu.

Indo-Pacific. Okinawa may be the northern limit of this species.

### The Ophiuran Fauna of Japan.

H. L. CLARK distinguishes four geographical ophiuran faunæ in the North Pacific, namely Honshû, Bering, American and Oceanic. I will discuss the ophiuran fauna of Japan from a somewhat different standpoint from his.

All the known Japanese ophiurans are referable to eighty-eight genera, which may be divided from the distributional standpoint into five groups as follows.

- I. *Cosmopolitan genera*, which are widely distributed in both the Indo-Pacific and Atlantic, as well as in both the Arctic and Antarctic or either one of the latter. The following genera belong here.

*Ophiacantha*, *Amphiactis*, *Amphiodia*, *Amphipholis*,  
*Amphiura*, *Homalophiura*, *Ophiura*.

7 genera : 8%.

- II. *Arctic genera*, which are essentially circumpolar in distribution or limited to the Bering Sea and very northern Pacific. The following genera belong here.

*Gorgonocephalus*, *Ophiolebes*, *Ophiosemnites*, *Ophiopholis*,  
*Stegophiura*, *Ophiopenia*.

6 genera : 7%.

- III. *Intertropical genera*, which are widely distributed in both the Indo-Pacific and Atlantic, but not in the Arctic or Antarctic. The following genera belong here.

*Ophiopleptax*, *Ophiomyxa*, *Ophiodera*, *Ophiobyrsa*,

*Asteronyxa*, *Asteroschema*, *Asteroporpa*, *Ophiomyces*,  
*Ophiologimus*, *Ophiopora*, *Ophiolimna*, *Ophiomitrella*,  
*Ophiacanthella*, *Ophiothamnus*, *Ophiurothamnus*, *Ophioplinthaca*,  
*Ophiomitra*, *Ophiocamax*, *Amphilepis*, *Ophiactis*, *Amphioplus*,  
*Amphichilus*, *Ophiophragmus*, *Ophiocentrus*, *Ophiothrix*,  
*Amphiophiura*, *Ophiomusium*, *Ophiozonella*, *Ophiolepis*,  
*Ophioleuce*, *Ophiernus*, *Ophiuroconis*, *Bathypectinura*,  
*Pectinura*, *Ophioplax*, *Ophiouneis*, *Ophiocoma*.

37 genera : 42%.

- IV. *Indo-Pacific genera*, which are distributed in the Indo-Pacific, with the centre of distribution chiefly in the vicinity of Malaysia. The following genera belong here.

*Astroceras*, *Trichaster*, *Euryale*, *Astrocharis*, *Astro-dendrum*,  
*Astrocladus*, *Astroboa*, *Astrothamnus*, *Astrotoma*, *Astroclon*,  
*Ophiambix*, *Ophiophthalmus*, *Ophiomæris*, *Amphiacantha*,  
*Ophiomaza*, *Ophiothela*, *Astrophiura*, *Aspidophiura*,  
*Ophioplocus*, *Ophiotrochus*, *Ophiurodon*, *Ophiarachna*,  
*Ophiarachnella*, *Ophiochiton*, *Ophiodoris*, *Ophiomastix*,  
*Ophiarthrum*.

27 genera : 30%.

- V. *Honshû genera*, which are known only from the vicinity of Honshû, Shikoku and Kiushû. The following genera belong here.

*Ophiostyracium*, *Ophiosyzygus*, *Ophiostiba*, *Ophiohyalus*,  
*Ophiohymen*, *Ophiophræus*, *Ophiosmilax*, *Astrothorax*,  
*Ophiophrura*, *Ophientrema*, *Ophiocrasis*.

11 genera : 13%.

With the exception of *Ophiophthalmus*, which is both tropical and Arctic, the Indo-Pacific and Intertropical genera are represen-

tatives of tropical fauna, and form 72% of the total, in contrast to the Arctic elements, which amount to only 7%. Moreover, almost all of the Honshû genera have tropical, but not Arctic, affinities.

Two hundred and thirty-two species of ophiurans are known from Japanese waters, which may be grouped as follows.

- I. *Circumpolar species*, which occur in the North Atlantic, Arctic and North Pacific. The species belonging here and their known southern limits in the North Pacific are as follows.

Species.	Southern limit.
<i>Ophiacantha bidentata</i> :	off southern Korea, Sea of Japan.
<i>Ophiopholis aculeata</i> , typical :	off southern Korea, Sea of Japan.
Ditto, including var. <i>japonica</i> :	off Kii, Kumano Sea.
<i>Stegophiura nodosa</i> :	off Saghalin, Okhotsk Sea.
<i>Ophiura sarsii</i> :	Eastern Sea ; Uraga Channel (on the Pacific side).

4 species : 2%.

- II. *Bering-American species*, which range from the Bering Sea to Japan and to the western coast of U. S. A. The species belonging here and their known southern limits in Japan are as follows.

Species.	Southern limit.
<i>Gorgonocephalus caryi</i> :	Eastern Sea ; Suruga Gulf (on the Pacific side).
<i>Ophiophthalmus normani</i> :	Eastern Sea ; off Kii, Kumano Sea (on the Pacific side).
<i>Amphiodia euryaspis</i> :	off Korea, Sea of Japan.
<i>Ophiura cryptolepis</i> :	off Omai Zaki, Yenshû Sea.
<i>Ophiura leptoctenia</i> :	off southern Korea, Sea of Japan ; off Omai Zaki, Yenshû Sea (on the Pacific side).



5 species : 2%.

III. *Bering species*, which range from the Bering Sea to Japan, but not to the coast of U. S. A. The species belonging here and their known southern limits are as follows.

Species.	Southern limit.
<i>Ophiophthalmus cataleimoidus</i> :	off Mikawa, Yenshû Sea.
<i>Ophiacantha adiaphora</i> :	Sagami Sea.
<i>Ophiacantha rhachophora</i> :	Eastern Sea ; off Kii, Kumano Sea (on the Pacific side).
<i>Ophiacanthella acontophora</i> :	off Kurile Is.
<i>Ophiosemnotes tylota</i> :	off Tsugaru, Sea of Japan.
<i>Amphiodia craterodometta</i> :	off Korea, Sea of Japan.
<i>Ophiura quadrispina</i> :	off Shiribeshi, Sea of Japan.
<i>Ophiura maculata</i> :	off Abashiri, Kitami, Okhotsk Sea.
<i>Ophiopenia disacantha</i> :	off Sado, Sea of Japan.

9 species : 4%.

IV. *Intertropical species*, which are widely distributed in both the Indo-Pacific and Atlantic, but not in the Arctic or Antarctic. The intertropical species usually occur in both the East and West Indies. The species to be referred here and their known northern limits in the North Pacific are as follows.

Species.	Northern limit.
<i>Asteronyx loveni</i> <sup>1)</sup> :	Bering Sea.
<i>Ophiolimna bairdi</i> :	Bering Sea.
<i>Ophiacantha pentagona</i> <sup>1)</sup> :	Sagami Sea.
<i>Ophiacantha rosea</i> :	Sagami Sea.
<i>Ophiactis savignyi</i> <sup>2)</sup> :	Misaki districts.

1) These species have been recorded also from East Indian waters.

<i>Amphiophiura convexa</i> :	Eastern Sea.
<i>Amphiophiura sculptilis</i> <sup>1)</sup> :	off Boshû.
<i>Ophiura flagellata</i> <sup>1)</sup> :	off Kinkwasan, Rikuzen.
<i>Ophiura irrorata</i> <sup>1)</sup> :	Bering Sea.
<i>Ophiomusium scalare</i> <sup>1)</sup> :	Uraga Channel.
<i>Ophiomusium lymani</i> <sup>1)</sup> :	British Columbia.
<i>Ophiomusium cancellatum</i> :	Uraga Channel.
<i>Ophiernus adspersus</i> <sup>1)</sup> :	off Kii, Kumano Sea.

13 species : 6%.

V. *Indo-Pacific American species*, which range from Malaysian waters to the western coast of southern North America or Central America, through Japanese waters. The species belonging here and their known northern limits are as follows.

Species.	Northern limit.
<i>Amphiura korece</i> :	off Echizen, Sea of Japan ; Sagami Sea (on the Pacific side).
<i>Ophiochiton fastigatus</i> :	Uraga Channel.

2 species : 1%.

VI. *Indo-Pacific species*, which range from the Indian Ocean or Malaysian waters to Japan. The species to be referred here and their known northern limits are as follows.

Species.	Northern limit.
<i>Ophiomyxa australis</i> :	Sagami Sea.
<i>Astroceras pergamena</i> :	Uraga Channel.
<i>Trichaster palmiferus</i> :	Colnett Strait.
<i>Trichaster elegans</i> :	Tanabé Bay, Kii.
<i>Euryale aspera</i> :	Okinawa, Riu-Kiu.

---

1) These species have been recorded also from East Indian waters.

- Astrodendrum sagaminum* : off Shiribeshi, Sea of Japan ;  
Sagami Sea (on the Pacific side).
- Astrocladus coniferus* : Wladiostok ; Sagami Sea (on  
the Pacific side).
- Astroboa nigra* : Hirado Strait.
- Ophiambix aculeatus* : Colnett Strait.
- Ophiacantha dallasii* : off Korea, Sea of Japan.
- Ophiacantha levispina* : off Shiribeshi, Sea of Japan ; Yen-  
shû Sea (on the Pacific side).
- Ophiacantha inutilis* : Uraga Channel.
- Ophiomœris obstricta* : Eastern Sea.
- Ophiactis affinis* : Korean seas.
- Ophiactis macrolepidota* : Uraga Channel.
- Ophiactis modesta* : Misaki districts.
- Amphiacantha formosa* : Strait of Formosa.
- Amphiura bellis* : Sagami Sea.
- Amphiura iris* : Sagami Sea.
- Amphiura littkeni* : Korean seas.
- Ophiocentrus verticillatus* : Misaki districts.
- Ophiothrix koreana* : Hakodaté Bay.
- Ophiothrix nereidina* : Misaki districts.
- Ophiothrix obtusa* : Okinawa, Riu-Kiu.
- Ophiothrix hirsuta* : Pinnacle Is., Riu-Kiu.
- Ophiothrix punctolimbata* : precise locality in Japan not  
known.
- Ophiothrix longipeda* : Kominato, Boshû.
- Ophiothela danae* : Misaki districts.
- Aspidophiura forbesi* : Korea Strait.
- Ophiura kinbergi* : off Echigo, Sea of Japan ; Uraga  
Channel (on the Pacific side).

<i>Ophiura imbecillis</i> :	Sagami Sea.
<i>Ophiomusium simplex</i> :	Eastern Sea.
<i>Ophiomusium lunare</i> :	Eastern Sea.
<i>Ophiomusium lütkeni</i> :	Eastern Sea.
<i>Ophiomusium laqueatum</i> :	Eastern Sea.
<i>Ophiozonella projecta</i> :	Sagami Sea.
<i>Ophiolepis cincta</i> :	precise locality in Japan not known.
<i>Ophiolepis annulosa</i> :	Okinawa, Riu-Kiu.
<i>Ophioplocus imbricatus</i> :	Okinawa, Riu-Kiu.
<i>Ophiurodon grandisquama</i> :	Sagami Sea.
<i>Ophiarachma incrassata</i> :	Okinawa, Riu-Kiu ; Bonin Is.
<i>Ophiarachmella gorgonia</i> :	Misaki districts.
<i>Ophiarachmella infernalis</i> :	Eno-ura, Suruga Gulf.
<i>Ophionereis porrecta</i> :	Korea Strait.
<i>Ophiocoma brevipes</i> :	Natsui, Hiuga.
<i>Ophiocoma scolopendrina</i> :	Kagoshima Gulf.
<i>Ophiomastix miata</i> :	Misaki districts.
<i>Ophiomastix lütkeni</i> :	Okinawa, Riu-Kiu.
<i>Ophiomastix annulosa</i> :	Pinnacle Is., Riu-Kiu.
<i>Ophiarthrum elegans</i> :	Okinawa, Riu-Kiu.

50 species : 21%.

VII. *Honshû-American species*, which occur on both the western and eastern coasts of the North Pacific. The following species belong here.

*Amphioplus rhadinobrachius*.

*Amphioplus hexacanthus*.

*Amphioplus macraspis*.

*Amphipholis pugetana*.

*Amphiura carchara*.

*Amphiura acrystata.*

*Amphiophiura ponderosa.*

*Ophiomusium jolliense.*

*Ophionereis eurybrachiola.*

9 species : 4%.

VIII. *Honshû species*, which are known only from the vicinity of Honshû, Shikoku and Kiushû. The following species belong here.

*Ophiosyzygus disacanthus.*

*Ophioleptoplax megapora.*

*Ophiostyracium trachyacanthum.*

*Ophiostiba hidekii.*

*Ophiohyalus gotoi.*

*Ophiodera anisacantha.*

*Ophiohymen gymnodiscus.*

*Ophiobyrsa acanthinobrachia.*

*Ophiobyrsa synaptacantha.*

*Ophioplirixus acanthinus.*

*Ophiosmilax mirabilis.*

*Euryale anopla.*

*Asteroschema tubiferum.*

*Asteroschema glaucum.*

*Asteroschema hemigymnum.*

*Asteroschema caudatum.*

*Asteroschema japonicum.*

*Asteroschema abyssicola.*

*Asteroschema glutinosum.*

*Astrocharis ijimai.*

*Asteroporpa hadracantha.*

*Gorgonocephalus tuberosus.*

*Gorgonocephalus dolichodactylus.*

- Astrocladus annulatus.*  
*Astroboa arctos.*  
*Astroboa globifera.*  
*Astrothamnus echinaceus.*  
*Astrothorax misakiensis.*  
*Astrotoma sobrina.*  
*Astroclon suenisoni.*  
*Ophiomyces spathifer.*  
*Ophiologimus hexactis.*  
*Ophiophrura liodisca.*  
*Ophiopora megatrema.*  
*Ophiolimna lambda.*  
*Ophiolimna diastata.*  
*Ophiomitrella stellifera.*  
*Ophiomitrella polyacantha.*  
*Ophiophthalmus leucorhabdotus.*  
*Ophiophthalmus codonomorpha.*  
*Ophiophthalmus hylacantha.*  
*Ophiophthalmus microhylax.*  
*Ophientrema euphylacteum.*  
*Ophientrema scolopendricum.*  
*Ophiacantha enigmatica.*  
*Ophiacantha omoplata.*  
*Ophiacantha anchilabra.*  
*Ophiacantha lophobrachia.*  
*Ophiacantha acanthinotata.*  
*Ophiacantha prionota.*  
*Ophiacantha diploa.*  
*Ophiacantha bisquamata.*  
*Ophiothamnus habrotatus.*

- Ophiothammus venustus.*  
*Ophiurothammus dicyclus.*  
*Ophioplinthaca cardiomorpha.*  
*Ophiomitra bythiaspis.*  
*Ophiomitra lithosora.*  
*Ophiocamax polyploca.*  
*Ophiolebes brachygnatha.*  
*Ophiolebes asaphes.*  
*Ophiolebes tuberosa.*  
*Ophiosemmotes ædidisca.*  
*Ophiomæris projecta.*  
*Amphilepis tenuis.*  
*Amphiactis umbonata.*  
*Ophiactis brachygenys.*  
*Ophiactis pteropoma.*  
*Ophiactis dyscrita.*  
*Ophiactis gymnochora.*  
*Ophiopholis mirabilis.*  
*Ophiopholis brachyactis.*  
*Amphioplus megapomus.*  
*Amphioplus ancistrotus.*  
*Amphioplus cernuus.*  
*Amphioplus glaucus.*  
*Amphichilus trichoides.*  
*Amphiacantha acanthina.*  
*Amphiacantha dividua.*  
*Amphiodia psilochora.*  
*Ophiophragnus japonicus.*  
*Amphipholis kochii.*  
*Amphipholis japonica.*

- Amphipholis sobrina.*  
*Amphiura digitula.*  
*Amphiura trachydisca.*  
*Amphiura microdiscus.*  
*Amphiura cuopla.*  
*Amphiura pyenostoma.*  
*Amphiura acacia.*  
*Amphiura iridoides.*  
*Amphiura micraspis.*  
*Amphiura estuarii.*  
*Amphiura radicola.*  
*Amphiura ecnomiotata.*  
*Ophiothrix panchyendyla.*  
*Ophiothrix marenzelleri.*  
*Ophiothrix macrobrachia.*  
*Ophiothrix eusteira.*  
*Ophiothrix stabilis.*  
*Ophiomaza kanekoi.*  
*Astrophiuura kavanurui.*  
*Aspidophiuura watasei.*  
*Stegophiuura striata.*  
*Stegophiuura vivipara.*  
*Stegophiuura sculpta.*  
*Stegophiuura sterea.*  
*Stegophiuura brachyactis.*  
*Stegophiuura sladeni.*  
*Amphiophiuura oediplax.*  
*Amphiophiuura pompophora.*  
*Amphiophiuura penichra.*  
*Amphiophiuura megapoma.*



- Amphiophiura lapidaria.*  
*Homalophiura clasta.*  
*Ophiura oöplax.*  
*Ophiura micracantha.*  
*Ophiura paucisquama.*  
*Ophiura monostæcha.*  
*Ophiura albata.*  
*Ophiura calyptolepis.*  
*Ophiomusium granosum.*  
*Ophiomusium trychnum.*  
*Ophiozonella elevata.*  
*Ophiozonella platydisca.*  
*Ophiozonella polyplax.*  
*Ophiozonella longispina.*  
*Ophioplocus japonicus.*  
*Ophioteuce charischema.*  
*Ophioteuce brevispinum.*  
*Ophiotrochus longispinus.*  
*Ophiuroconis monolepis.*  
*Bathypectinura gotoi.*  
*Pectinura anchista.*  
*Ophiarachnella megalaspis.*  
*Ophioplax lamellosa.*  
*Ophiodoris pericalles.*  
*Ophionercis sinensis.*  
*Ophiocrasis dictydisca.*  
*Ophiocrasis marktanneri.*

140 species: 60%.

The three groups of Cirumpolar, Bering-American and Bering species are evidently referable to the Arctic fauna, and form all

together 8% of the total number of Japanese species ; while the three groups of Intertropical, Indo-Pacific American and Indo-Pacific species unquestionably represent the tropical elements, and form all together 28% of the total number.

Among the Arctic species, three have the southern limit in the Okhotsk Sea, three in the Sea of Japan northward of Sado, five in the Sea of Japan off southern Korea, and four in the Eastern Sea ; and along the Pacific coast of Honshû, two in the Sagami Sea and Uruga Channel, four in the Yenshû Sea and Suruga Gulf, and three in the Kumano Sea, off Kii. The Arctic species, which occur in the Eastern Sea, appear to range through the Sea of Japan, but not through the Pacific coast of Honshû.

Among the tropical species, one has the northern limit in the Strait of Formosa, two at Pinnacle Is., seven at Okinawa, one at Bonin Is., three in the Colnett Strait and Kagoshima Gulf, one at Natsui, two in Tanabé Bay and Kumano Sea, one in the Yenshû Sea, one at Eno-ura, twenty-five in the Sagami Sea and Misaki region, one at Kominato, one off Bôshû, one in the Pacific Ocean far off Honshû, one off Kinkwa-san, one in British Columbia and three in the Bering Sea ; and by way of the northern part of the Eastern Sea to the Sea of Japan, six in the Eastern Sea, five in Korea Strait and the Sea of Japan off southern Korea, one off Echizen, one off Echigo, one in Hakodaté Bay, two off Shiribeshi and one at Wladiostok.

Now, neglecting here the very hardy species, which have their northern limit in British Columbia and in the Bering Sea, the zone of mingling of the Arctic and tropical species extends from off Kinkwasan to the Kumano Sea, on the Pacific side, and from off Shiribeshi and Wladiostok to the northern part of the Eastern Sea, on the side of the Sea of Japan. Thus, the geographical

boundary between the two elements is better marked on the Pacific side than on that of the Sea of Japan. The limits of the zone of contact are approximately  $33\frac{1}{2}$ . and  $38\frac{1}{2}$ . parallels on the Pacific side, and 30. and 43. parallels on the side of the Sea of Japan. The axis of the zone of contact is very nearly 36. parallel, which has been stated by CLARK to be the line of contact between his Bering and Honshû faunæ.

The two groups of Honshû-American and Honshû species are evidently heterogeneous. For example, *Amphipholis pugetana*, *Amphiura carchara*, *Gorgonocephalus tuberosus*, *G. dolichodactylus*, *Ophiolebes brachygnatha*, *O. asaphes*, *O. tuberosa*, *Ophiosemnotes ædidisca*, *Ophiopholis mirabilis*, *O. brachyactis*, *Stegophiura striata*, *St. vivipara*, *St. sculpta*, *St. sterea*, *St. brachyactis*, *St. sladeni*, &c. may be derivatives of the Arctic fauna, while the rest are largely derivatives of the tropical, especially Indo-Pacific, fauna.

CLARK has recognised scarcely a dozen species which occur in both the East Indian and Japanese regions. As a result of the present study, I recognise sixty-one species, or more than one-fourth of the total number of Japanese species, that occur also in the East Indian region. On the other hand, the boundary between CLARK's Bering and Honshû faunæ well coincides with that between my Arctic, chiefly Bering, and tropical, chiefly Indo-Pacific or East Indian, elements. Thus, I am led to look upon the Honshû fauna not as a perfectly distinct one, but to be a terminal section of the Indo-Pacific, or East Indian, fauna.

The known northern limits of several more typical, littoral Indo-Pacific species are shown in the accompanying chart.

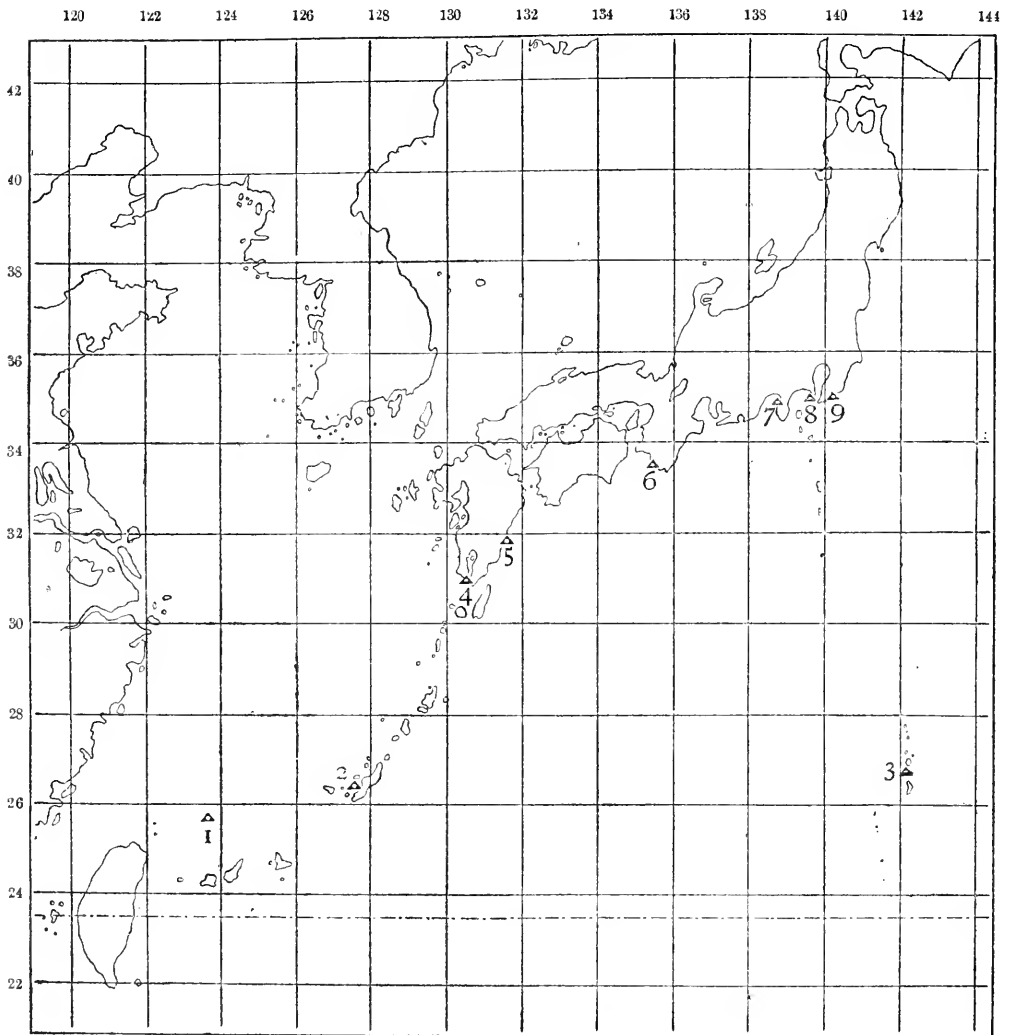

1. Pinnacle Is.—*Ophiotrix hirsuta*, *Ophiomastix annulosa*.
2. Okinawa Is.—*Euryale aspera*, *Ophiotrix obtusa*, *Ophiomastix lütkeni*, *Ophiarthrum elegans*,  
*Ophiolepis annulosa*, *Ophioplocus imbricatus*, *Ophiarachna incrassata*.
3. Bonin Is.—*Ophiarachna incrassata*.
4. Kagoshima Bay.—*Ophiocoma scolopendrina*.
5. Natsui.—*Ophiocoma brevipes*.
6. Tanabé.—*Trichaster elegans*.
7. Eno-ura.—*Ophiarachnella infernalis*.
8. Misaki & Sagami Sea.—*Ophiotrix nereidina*, *Ophiactis modesta*, *Ophiocentrus verticillatus*,  
*Ophiarachnella gorgonia*, *Ophiomastix mixta*.
9. Kominato.—*Ophiotrix longipeda*.

### Phylogeny of the Ophiuroidea.

It is very evident, that the forms with vertically coiled arms are not archetypal, because they have very solid and always undivided vertebrae, as mentioned in the introduction, while the ophiuran vertebrae are palaeontologically, as well as ontogenetically, proved to be primarily divided. Thus, the *Ophiobyrssinae*, *Trichasteridae*, *Gorgonocephalidae*, *Ophiacanthidae* pars, *Hemicuryalidae*, *Ophiactinae* pars, and *Ophiotrichidae* pars are eliminated from primitive ophiurans. The forms with well developed lateral wings of the oral frames are evidently highly specialised. Thus, the *Amphiuridae*, *Ophiotrichidae*, *Ophiolepidinae* pars, *Ophionerecidinae* and *Ophiocomidae* are eliminated from primitive ophiurans. The remaining forms are the *Ophiomyxinae*, *Ophiacanthidae* pars, *Amphilepididae*, *Ophiolepididae* pars, *Ophioleucidae*, *Ophiodermatidae* and *Ophiochitoninae*. Indeed, I have been able to find more or less divided vertebrae in certain representatives of the *Amphilepididae*, *Ophiolepididae* and *Ophiodermatidae*, as well as of the *Ophiomyxinae* and *Ophiacanthidae*.

Though it is my purpose to discuss the results of a study of Palaeozoic ophiurans in a future paper, I will here enumerate some of the more important structures of Palaeozoic *Myophiuroida*, as bearing on the question before us.

1. Disk covered with delicate scales or by a naked skin, without distinct primaries.
2. Radial shields absent.
3. Genital plates and scales absent.
4. Oral shields absent.
5. Adoral shields not very distinctly specialised from the lateral arm plates.

6. Oral plates and frames long and slender.

7. Distinct creases probably present between the interbrachial ventral surfaces and arm bases.

8. Dorsal arm plates entirely absent, or present only in a few basal joints; the dorsal side of the arms therefore largely unprotected.

9. Lateral arm plates with prominent spine ridges, which extend to the ventral side of the arm; those of the two sides not meeting above or below, except in the very distal arm joints.

10. Ventral arm plates higher in position than the lower borders of the lateral arm plates, so that the arm is longitudinally grooved ventrally.

I believe that, the Palæozoic *Myophiuroida* are the stock from which the recent ophiurans have been directly derived, because they show no trace of peculiar specialisation and are fairly intermediate in their organisation as a whole between the *Ægophiuroida* and recent ophiurans. If this view be right, then the most archetypal group of recent ophiurans must be looked for among those forms which have the strongest resemblances to the Palæozoic *Myophiuroida*.

Certain genera of the *Ophiolepididae*, which are frequently said to be primitive, appear to me to be far from being archetypal, though they may evidently be pædomorphic. These genera in the mature stage are in every feature similar to very young stages of other ophiurans, having the disk covered only with the primaries and radial shields, and the arms covered chiefly by the lateral arm plates. But, the existence of such forms in the early ages of the history of the *Ophiuroidea* is entirely unproved. As to the biogenetic law, VON BAER'S view appears to me to be more consonant to facts than F. MÜLLER'S. The term "primitive" may mean

both "archetypal" and "embryonal"; but the two must in my opinion be strictly distinguished. In fact, the genera in question of the *Ophiolepididae* are, in my opinion, embryonal, but not archetypal.

On the contrary, the *Ophiomyxinae* and certain genera of the *Ophiacanthidae* with only horizontally flexible arms, appear to me to be fairly archetypal, being similar to the Palaeozoic *Myophiuroidea* in many structures, the presence of the genital plates, genital scales and oral shields, and sometimes also of the radial shields being the principal differences. As to the radial shields, I look upon them as a modification of the marginal disk scales, often present in both the Palaeozoic and recent ophiurans, which have secondarily become articulated with the genital plates where these have developed; and a very primitive condition of the radial shields may in my opinion be seen in *Ophiostiba*, *Ophiohyalus*, as well as in young specimens of *Ophiomyxa*, &c. This view is in accord with LYMAN'S<sup>1)</sup>, according to which the radial shields are not special plates but are homologous with the other disk scales, and by no means the first to appear.

The ventral arm plates of many genera of the *Ophiomyxinae*, as *Ophiosciasma*, *Ophiocynodus*, *Ophiosyzygus*, *Ophioleptoplax*, *Ophiostryacium*, *Ophiohyalus*, *Ophiomyxa*, *Ophiodera*, *Ophiohymen*, &c., and some of the *Ophiacanthidae*, as *Ophiomyces*, *Ophiologimus*, &c. are long and narrow, being in contact with, or slightly separated by a naked space from, each other, at least in the proximal arm joints. A similar condition may be observed also in certain representatives of Palaeozoic *Myophiuroidea*. In many genera of the *Ophiacanthidae*, the ventral arm plates are very small, short and

---

1) Rep. Challenger, V, 1882. p. 157.

widely separated from one another by the lateral arm plates, which are distinctly in contact with each other in the ventral median line. This condition is also observed in the distal arm joints of the *Ophiomyxinae*; so that, following the law of localised stages, it is evidently more distinctly embryonal than that in which the lateral arm plates are separated by the ventral arm plates. The *Ægophiuroida* had exposed ambulacral grooves; and this groove became covered over by the ventral arm plates for the first time in the Palæozoic *Myophiuroida*; so that, the meeting of the lateral arm plates in the ventral median line can not be a primary condition. Moreover, the assumption that the meeting of the lateral arm plates in the ventral median line is a primary condition, makes it very difficult to assign a probable cause of the acquisition of the ventral arm plates. I therefore think that, the separated condition of the lateral arm plates in the ventral median line is an archetypal but not embryonal feature, while the meeting of those plates is an embryonal but not archetypal feature.

In the *Ophiomyxinae*, the lateral arm plates of the two sides are widely separated from each other on the dorsal side, while in the majority of the *Ophiacanthidae*, they are well in contact. The second condition is what occurs also in the very distal arm joints of the *Ophiomyxinae*, as well as of many Palæozoic ophiurans; so that, following the law of localised stages, it is evidently more distinctly embryonal than the first condition. But, the assumption that the meeting of the lateral arm plates in the dorsal median line is a primary condition makes it very difficult to assign the necessity for the acquisition of the dorsal arm plates. I therefore think that, the meeting of the lateral arm plates in the dorsal median line is an embryonal but not archetypal condition, while the



separation of the same is an archetypal but not embryonal condition. The interpretation put forth in this and the last paragraph is well in accord with the biogenetic law as formulated by VON BAER but not as formulated by F. MÜLLER.

In *Ophioleptoplax* and *Ophiohyalus*, the dorsal arm plates are present but very rudimentary, thin and hyaline. A similar condition may be observed also in the distal arm joints of *Ophiomyxa*, as well as *Ophiodera anisacantha*, though the plates are in these forms divided into several secondary plates in the proximal arm joints. I imagine that, these dorsal arm plates may represent an archetypal condition.

As to the divided vertebræ, those of the *Ophiomyxineæ* appear to me to be more archetypal than those of the *Ophiacanthideæ*, the former reminding us of those of such a Palæozoic form as *Ophiurina*.

Upon the basis of these considerations, I imagine that the *Ophiomyxineæ* are a step more archetypal than the *Ophiacanthideæ*. Those genera of the *Ophiomyxineæ*, in which the second oral tentacle pores open outside the oral slits, have usually very slender adoral shields and very small oral shields, reminding us of the Palæozoic *Myophiuroida*, which are characterised by the second oral tentacle pores opening outside the oral slits, by the adoral shields not being well differentiated from, but almost similar in shape to, the ordinary lateral arm plates, and by the absence of the oral shields. That the second oral tentacle pores open outside the oral slits is a character, which appears to be at once archetypal and embryonal.

The majority of those genera of the *Ophiacanthideæ*, in which the arms are only horizontally flexible, have more or less well developed dorsal and ventral arm plates, which separate the lateral

arm plates of the two sides more or less completely. These genera strongly resemble the *Ophiomyxinae*, especially *Ophioscolex*, save in the presence of well developed dorsal arm plates. I look upon them to be a most archetypal, though not embryonal, group of the *Ophiacanthidae*. I of course believe that the gap between the *Ophiomyxinae* and *Ophiacanthidae* is rather not very important. Thus, the phylogenetic origin of the recent ophiurans may be shown somewhat as follows.

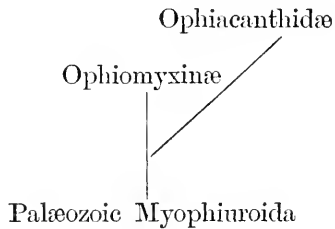

Now, I will trace the *Ophiomyxinae*-line further. The *Ophiobyrinae* are evidently a step more advanced from the *Ophiomyxinae* toward the *Trichasteridae* and *Gorgonocephalidae*, having very compact oral skeleton and more or less short, stout, rather discoidal vertebræ with streptospondyline articulation. The only essential distinction of the *Ophiobyrinae* from the *Trichasteridae* and *Gorgonocephalidae* arises from the fact, that the vertebræ of the subfamily in question are less discoidal and have less well developed upper and better developed lower muscular fossæ, as compared with those of the two last mentioned families.

Among the *Trichasteridae*, the *Asteronychinae* appear to me to be most archetypal, because the disk is large, the arms are comparatively slender, the lower muscular fossæ of the vertebræ are relatively little reduced and the arm spines are numerous, instead of being reduced to two in number, thus more or less reminding

us of the *Ophiobrysinæ*. The *Trichasterinæ* are, in my opinion, nearer to the *Asteronychinæ* than the *Asteroschematinæ* are to the same, because the ventral arm plates of both the *Asteronychinæ* and *Trichasterinæ* are rather well developed and in contact with one another, entirely separating the lateral arm plates, while those of the *Asteroschematinæ* are very much reduced in size and separated from one another by the lateral arm plates, which meet in the ventral median line. This view almost coincides with that of MORTENSEN, who has pointed out the affinity of *Asteronyx* to *Euryale*. The *Asteroschematinæ* are evidently descended from the simple-armed group of the *Trichasterinæ*.

Whether the *Gorgonocephalidæ* are descended from the *Ophiobrysinæ* or from the *Asteronychinæ* is rather hard to decide, though it is very evident, that the *Gorgonocephalidæ* have no direct relation to the *Trichasterinæ* and *Asteroschematinæ*. The minute hooks of the arm annuli stand in an intimate relation with the arm spines, as may be clearly witnessed in the very distal arm joints, where the arm spines are hook-shaped and the upper ones are smaller and show a tendency to shift their positions alternately so as to form a double row. These upper arm spines are evidently the rudiments of the arm annuli. As already mentioned, the lateral arm plates are approximated dorsally in embryonal stages; and such a dorsal approximation occurs, in the present case, in the arm spines. So I imagine that the arm annuli are due to the persistence of an embryonal feature of the arm spines. If this interpretation be right, then the arm annuli of the *Gorgonocephalidæ* remind us of the arm spines of such genera as *Ophiobrachion* and *Asteronyx*. Though *Ophiobrachion* is referred to the *Ophiobrysinæ* of the *Ophiomyxidæ* and *Asteronyx* to the *Asteronychinæ* of the *Trichasteridæ*, the difference between

the two subfamilies is by no means very great. So that, it may not be very unreasonable to look upon the *Trichasteridæ* and *Gorgonocephalidæ* as having a blood relation at the very beginning.

Within the limit of the simple-armed genera of the *Gorgonocephalidæ*, the *Gorgonocephalinæ* are evidently more archetypal than the *Astrotominæ*, because the former have less specialised and less localised oral and dental papillæ and less powerful oral angles than the latter, and the latter have well developed supplementary plates in the spaces between the oral angles and the interbrachial ventral surfaces.

Another point to be noted is that the dividing of the arms occurred independently in three groups, viz. the *Trichasterinæ*, *Gorgonocephalinæ* and *Astrotominæ*, an example of parallelism due to certain biological conditions.

The interrelationships between the members of the *Ophiomyxine*-line, or *Phrynophiurida*, may be shown as follows.

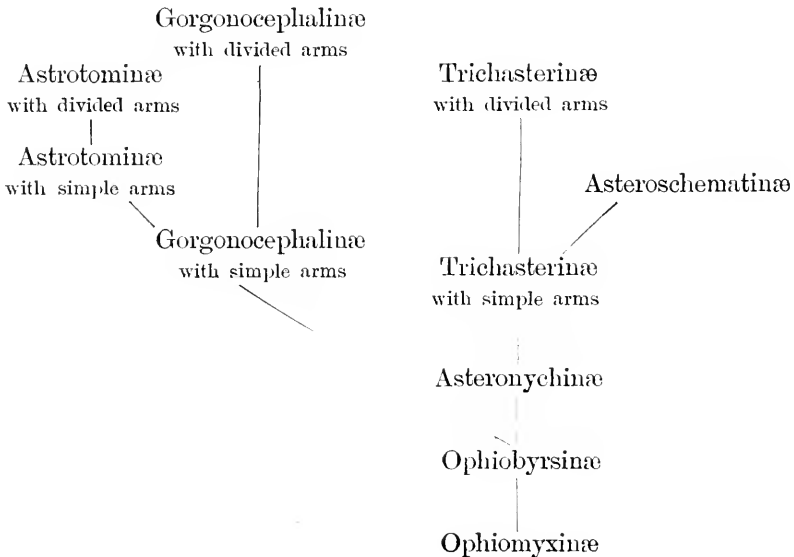

I will now proceed to the consideration of the *Ophiacanthidae*-line. As already mentioned, the genera or species with only horizontally flexible arms are a step more archetypal than those with more or less vertically coiled arms; but the distinction of these two groups can not be very profound, since certain genera include species of both types. As far as the genera examined by myself are concerned, *Ophiologimus* and *Ophiolimna* are typical representatives of the forms with only horizontally flexible arms, and *Ophiotebes*, *Ophiosemmotes* and *Ophiochondrella* of those with more or less vertically coiled arms. *Ophiologimus*, as probably also *Ophiotoma*, *Ophioblenna*, *Ophiomyces*, *Ophiocimbium*, *Amphipsila*, &c. may represent a most archetypal group of the *Ophiacanthidae*, being very close to the *Ophiomyxine* on the one hand and to the *Amphilepididae* on the other. *Microphiura* may be very embryonal, having the oral papillæ completely soldered together and the lateral arm plates extremely well developed. In a very small and young specimen, of which the genus is indeterminable, I have observed that every essential structure is similar to that of *Microphiura*, the oral papillæ being completely soldered together, the genital slits invisible, the second oral tentacle pore opening entirely outside the oral slits, the tentacle pores provided with a crescent-shaped scale, and the lateral arm plates almost completely covering the entire surface of the arm. I therefore consider *Microphiura* to be probably a pædomorphic form, granting that the specimens described by MORTENSEN are sexually mature; it is in my opinion not truly archetypal.

I have already mentioned that the very good development of the lateral arm plates, which separate the dorsal and ventral arm plates from each other, is an embryonal feature. Following this principle, the majority of the *Ophiacanthidae* are embryonal in the

character of the arm plates. The Palæozoic ophiurans are usually very large, one specimen of Palæozoic *Myophiuroidea* at hand being about as large as a very large specimen of *Ophiomyxa flaccida*, and another as large as, or larger than, a very large specimen of *Ophiarachna incrassata*; while the *Ophiacanthidae* are usually very small, and their arms so slender as to equal in thickness only the very distal part of the arms of the Palæozoic *Myophiuroidea*. I imagine that the very small size of the recent *Ophiacanthidae* is intimately correlated to their embryonal characters.

The *Hemieuryalidae* are, in my opinion, evidently a terminal group of the line of specialisation represented at the base by *Ophiolebes*, *Ophiosemmotes*, *Ophiochondrella*, &c., which are characterised by the pronounced vertical coiling of the arms. Among them, the *Ophiochondrinæ* are very close to the *Ophiolebes*-group and more archetypal than the *Hemieuryalinae*.

The interrelationships of the *Læmophiurida* may be shown as follows.

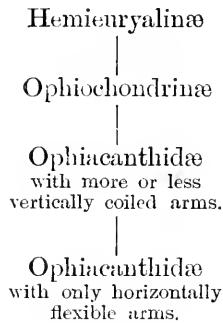

From the *Læmophiurida* upwards, there are, in my opinion, two distinct lines of specialisation: one, forming the *Gnathophiurida*, is characterised essentially by the radial shield and genital plate articulating with each other by means of one large, conspicuous socket of the former and one large, ball-like condyle of the latter;

and the other, forming the *Chilophiurida*, is characterised essentially by the radial shield and genital plate articulating with each other by means of two condyles and one pit of either plate.

Among the *Gnathophiurida*, the *Amphilepididæ* are evidently most archetypal, being closely allied to the *Ophiacanthidæ* with only horizontally flexible arms, in the very large peristomial plates, in the not very stout oral frames without well developed lateral wings, in the very long and slender oral plates, in the genital plates being not fixed to, but free from, the basal vertebræ, and in the often incompletely divided vertebræ.

The *Amphiuridæ* and *Ophiotrichidæ* are characterised by the very small peristomial plates, by the very stout oral frames with well developed lateral wings, by the stout oral and dental plates, by the very stout, quadrangular teeth and by the genital plates being firmly fixed to the basal vertebræ. Among them, the *Ophiactinincæ* are evidently nearest to the *Amphilepididæ*, because neither have paired infradental papillæ or dental papillæ.

In my opinion, the paired infradental papillæ of the *Amphiurincæ* and the dental papillæ of the *Ophiotrichidæ* were acquired as supplementary organs for mastication after the teeth had become quadrangular and very stout. The *Amphiurincæ* might be looked upon as ancestors of the *Ophiotrichidæ*, if the paired infradental papillæ and dental papillæ could be proved to be homologous. But according to CLARK,<sup>1)</sup> the paired infradental papillæ are genuine oral papillæ, while the dental papillæ are modifications of the teeth. Hence it appears that the two kinds of papillæ just mentioned are merely analogous organs adapted to a similar function. The *Amphiurincæ* and *Ophiotrichidæ* are then parallel

---

1) Growth-Changes in Brittle Stars. Publication No. 182 of the Carnegie Institution, Washington, 1914.

groups and not directly related to each other, not to mention that the *Ophiotrichidæ* are the most highly specialised of the *Gnathophiurida*.

It appears to me to be noticeable that in those forms, in which the masticatory apparatus is well developed, the oral papillæ are liable to reduction. In *Ophiactis*, *Ophiopus*, *Hemipholis*, the *Amphiodia*-group, &c., the papillæ which arise from the adoral shields are absent. In *Ophiopholis* and the *Amphiura*-group, the oral plates are almost free of papillæ. In *Ophiopsila* (*Ophiocomidæ*), the outer oral papillæ are strongly reduced. And finally, the *Ophiotrichidæ* entirely lack the oral papillæ. This fact probably has a certain biological meaning.

The interrelationships of the *Gnathophiurida* may be shown approximately as follows.

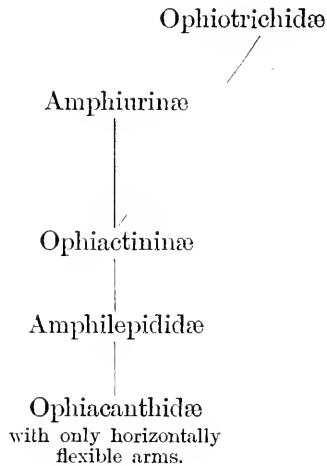

The *Chilophiurida* are very extensive and divergent, and it is very difficult to make out their interrelationships clearly. Certain genera of the *Ophiolepididæ*, e.g. *Astrophiura*, *Ophiomisidium*, *Ophiomastus*, &c., and *Ophiomusium*, are frequently looked upon by certain authors as very primitive. I can agree with these authors,



if by "primitive" they mean "embryonal" in the strict sense. But if they regard the genera in question as archetypal, I must dissent. My reasons for doing so may be stated as follows.

1. The disk of these forms is entirely or largely covered with the primaries and radial shields, a condition observed in very young and small individuals of other ophiurans. The disk structure of these forms is due to the simple growth of the plates found in a very young stage.

2. In these forms, the genital slits are either entirely invisible or exceedingly small. The genital slits are also entirely invisible in very young and small individuals of other ophiurans.

3. The oral papillæ of these forms are usually fused together to form a single piece. This feature probably represents the stage previous to the division of a common rudiment into individual papillæ.

4. The arms of these forms are extremely short, consisting of only a small number of joints, and are covered chiefly by the lateral arm plates. This condition is also observed in very young and small individuals of other ophiurans.

5. In these forms, the tentacle pores are limited to a few basal arm joints. It appears to me very difficult to look upon this condition as archetypal; it may however be embryonal.

6. The wings of the vertebræ are in these forms exceedingly thick even in the very basal arm joints. This condition may be derived from what is observed in a very young stage by simple growth of the vertebræ without change in the relative size of their constituent parts.

Thus, the genera in question appear to me to be pædomorphic in almost all structures; so I look upon them as neotenic forms. That they can not be truly archetypal, and that embryonal i.e.

pædomorphic characters are not always archetypal, is clear from what I have said already.

In my opinion, the *Ophiarachninae* and *Ophiochitoninae* are the most archetypal of the *Chilophiurida*, some of them being so near to the *Ophiacanthidae* as to be distinguished from the latter only with great difficulty. Indeed *Ophiuroconis* and *Ophiurochaeta* have hitherto been confused with *Ophiolimna* of the *Ophiacanthidae* by several authors, and *Ophiochiton* was considered by VERRILL to belong to the *Ophiacanthidae*. Moreover, I have been able to find out incompletely divided vertebræ in certain species of *Ophiuroconis* and *Ophiurodon*.

A next ally of the *Ophiarachninae* is, of course, the *Ophiodermatinae*, which are distinguished from the former by the very short arm spines. Judging from the degree of calcification of the vertebræ, the *Ophiarachninae* are evidently more archetypal than the *Ophiodermatinae*. The *Ophiochitoninae* lead to the *Ophionereidinae*, which are however a step more specialised than the former in having a well developed masticatory apparatus. *Ophiodoris* is evidently intermediate between the *Ophiochitoninae* and the other *Ophionereidinae*. The *Ophionereidinae* are intermediate between the *Ophiochitoninae* and *Ophiocomidae*, so far as the oral skeleton is concerned, and might fairly be looked upon as the direct ancestor of the last mentioned family, if the dorsal surface of the vertebræ were not so strongly notched at the inner end. This last character of the vertebræ of the *Ophionereidinae*, as well as probably of the *Ophiotrichidae*, appears to me to be correlated to the very high flexibility of the arms. The same character is not however equally well developed in all the *Ophionereidinae*, but only very feebly in *Ophiodoris*, which is unique among the *Ophionereidinae* in being destitute of supplementary dorsal arm plates. A parallel character

is found in the *Ophiocomidae*, in which the dorsal surface of the vertebrae is not distinctly notched at the inner end and the dorsal arm plates are entirely free of supplementary plates. Therefore, it appears to me not very improbable that the *Ophionereidinae* and *Ophiocomidae* may finally merge into a common stock at the very base. I have observed that very young specimens of a certain species of *Ophiocoma* have a squamated disk, which is almost free of granules, and arms which in ventral view remind us of those of *Ophioplax* and *Ophionereidinae*. As already pointed out, the oral papillae are liable to be reduced when the masticatory apparatus is very well developed. This tendency is also observable in the *Ophiopsilineae* (*Ophiocomidae*). Moreover, the *Ophiopsilineae* appear to me to be slightly more specialised than the *Ophiocominae*, because the radial shields are fairly bar-like, the outer ends of the genital plates more or less approximated to each other at the dorsal side of the arm base and the tentacle scales very peculiar in shape. I imagine that the *Ophiopsilineae* represent a last phase of the *Ophiocominae*.

As suggested by K EHLER, *Ophiochiton* appears to me to resemble much such genera as *Ophiozona* and *Ophiozonella* of the *Ophiolepidinae*. This resemblance might be of a superficial nature, if the difference of the arm spines being erect or appressed were of primary importance. But this difference is observable even in the proximal and distal parts of a single arm in many genera. I therefore agree with CLARK, who looks upon the difference of the arm spines in question not to be of primary importance. Then, the relation of *Ophiochiton* to *Ophiozona*, *Ophiozonella*, &c. corresponds to that of the *Ophiarachninae* to the *Ophiodermatinae*.

Among the *Ophiolepidinae*, *Ophioceramis* has a very well developed masticatory apparatus. Thus, we see that the masticatory

tory apparatus is very well developed more or less independently in three lines, one of which is represented by the *Amphiuridae* and *Ophiotrichidae*, the second by the *Ophionereidinae* and *Ophiocomidae*, and the third by *Ophioceramis*. As I have already explained, *Ophiomusium* is the most embryonal, i.e. pædomorphic form of the *Ophiolepidinae*.

In my opinion, the *Ophiomastinae* present an almost unbroken series of pædomorphism, of which the terminal members are such genera as *Astrophiuura*, *Ophiophycis*, *Ophiomisidium*, *Ophiotypa*, *Ophiomastus*, *Anthophiuura*, *Aspidophiuura*, *Ophiopyrgus*, &c. The grounds for this opinion have already been stated. If I am right, the *Ophiomastinae*, as well as *Ophiomusium*, must have been derived from the other *Ophiolepidinae* by neoteny.

The *Ophioleucidae* superficially resemble the *Ophiidermatidae*, but their true allies are, in my opinion, the *Ophiolepidinae*. The very thick and solid squamation under the superficial granules of the disk, the usually internally joined radial shields, the rhomboidal or lyre-shaped oral shields, the peculiarly long adoral shields, the comparatively long oral plates, the articulation of the genital plate and scale at their outer ends, the flattened arms, the very few—usually only two—arm spines, &c. are characters usually observed also in *Ophiuura* and its allies. In certain genera of the *Ophioleucidae*, the second oral tentacle pores show a tendency to be displaced outside the oral slits. *Ophiotrochus*, which has partially soldered oral papillæ and very rudimentary dorsal and ventral arm plates, may be the most embryonal, i.e. pædomorphic form of the present family.

It is theoretically to be expected that the very embryonal forms of various families, e.g. *Microphiuura* of the *Ophiacanthidae*, *Astrophiuura*, *Ophiophycis*, *Ophiomisidium*, *Ophiotypa*, *Ophiomastus*,

*Anthophiura*, *Aspidophiura*, *Ophiopyrgus*, &c. of the *Ophiomastinae*, *Ophiomusium* of the *Ophiolepidinae* and *Ophiotrochus* of the *Ophioleucidae*, apparently resemble one another in some characters; but these resemblances have in my opinion no significance for the phylogeny.

The interrelationships of the *Chilophiurida* may be shown as follows.

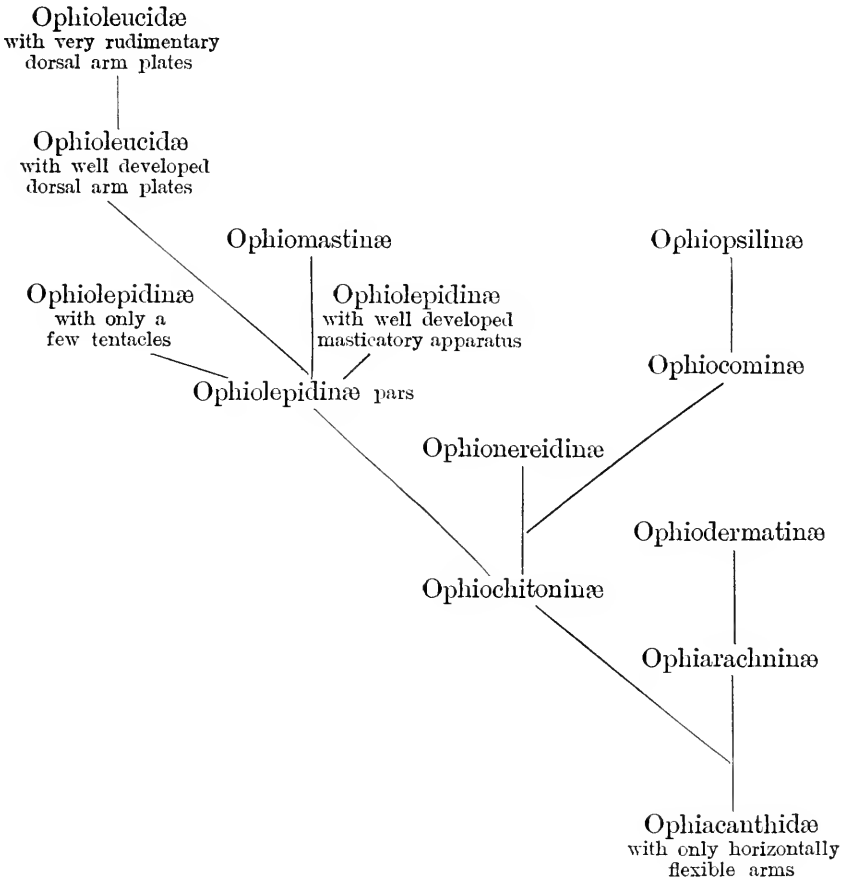

## Postscript.

Recently I received CLARK'S "Catalogue of Recent Ophiurans," Mem. Mus. Comp. Zool., Vol. XXV, No. 4. As this paper of mine was then in press, no reference is made to it in the literature of the species. My opinions or notices upon several parts of his monograph have been added as foot-notes.

## General Explanation of Plates.

Pl. I, figs. 1-9 illustrate the internal structures of the *Ophiomyxinae*. The peristomial plates are double in *Ophiomyxa australis* (figs. 4 & 7) and *Ophiostiba hidekii* (fig. 9), one overlapping the other in the latter species; triple in *Ophiodera anisacantha* (fig. 1); double or triple in *Ophiolajalus gotoi* (fig. 8). It is noteworthy, that the peristomial plates show a tendency to be simple in younger stages, as may be seen in fig. 4, illustrating a younger specimen of *Ophiomyxa australis*. The double or triple (at least in adult), thin, delicate peristomial plates, and not very stout oral plates and frames are characteristics of the *Ophiomyxinae* in contrast to the *Ophiobyrsinae*, *Trichasteridae* and *Gorgonocephalidae*. The articulation of the genital plate and radial shield is illustrated in fig. 1 (*Ophiodera anisacantha*) and fig. 4 (*Ophiomyxa australis*); it is very simple, without any particular condyle and socket, a common character of the *Phrynophiurida* and *Lamophiurida*. In the last two illustrations, the genital scales are seen to articulate with the genital plates at some distance away from the outer ends of the latter, a common character of the *Ophiomyxidae* and *Asteromychinae* in contrast to the *Trichasterinae*, *Asteroschematinae* and *Gorgonocephalidae*; and the dorsal surface of the vertebrae (except the very basal ones) is rhomboidal and the wings of the same very thin on the sides, a characteristic of the *Ophiomyxinae* in contrast to the *Ophiobyrsinae*, *Trichasterinae* and *Gorgonocephalidae*. The articular surfaces of the vertebrae are illustrated in figs. 2 & 3 (*Ophiodera anisacantha*) and 5 & 6 (*Ophiomyxa australis*); the articulation is typically zygospondyline, the umbo and knobs on the inner articular surface, and the shoulder and peg on the outer, being all well developed, a character of the *Ophiomyxinae* in contrast to the *Ophiobyrsinae*, *Trichasterinae* and *Gorgonocephalidae*; the great size of both the upper and lower muscular fossæ is a character common to the *Ophiomyxidae* and the other "common" ophiurans in contrast to the *Trichasteridae* and *Gorgonocephalidae*.

Pl. I, figs. 10 & 11 and Pl. II, fig. 1 illustrate a vertebra of *Ophiomilax mirabilis*, a representative of the *Ophiobyrsinae*. The articulation is typically streptospondyline or saddle-shaped, a common character of the *Ophiobyrsinae*, *Trichasteridae* and *Gorgonocephalidae* in contrast to the *Ophiomyxinae*. The upper and lower muscular fossæ are both large, a character of the *Ophi-*

*myxide* in contrast to the *Trichasteridae* and *Gorgonocephalida*. The vertebra is moderately short and stout (Pl. II, fig. 1), being shorter and stouter than that of the *Ophiomyxinae* but not so very short and stout as in the *Trichasteridae* and *Gorgonocephalida*, a characteristic of the *Ophiobyrsinae*. The wing of the vertebra is very thick laterally as well as dorsally, a common character of the *Ophiobyrsinae*, *Trichasteridae* and *Gorgonocephalida*. As the specimen, from which the illustration has been made, is very small and young, the characteristic shape of the vertebra is not yet fully developed; the vertebrae near the disk of full-grown specimens of the *Ophiobyrsinae* are much more stout and more distinctly discoidal. Pl. I, figs. 12 & 13 show the two forms of arm spines of *Ophiomilax mirabilis*, both being converted into compound hooks. It is noteworthy, that the arm spines of the majority—presumably all—of the *Phrynophiurida* are always hook-shaped in their embryonal stages, as observed in the distal arm joints.

Pl. I, figs. 14–16 illustrate the internal structures of *Asteromyx loveni*, a representative of the *Asteromychinae*. The peristomial plates are simple, stout and firmly soldered to the oral frames, which are also very stout, common characters of the *Ophiobyrsinae*, *Trichasteridae* and *Gorgonocephalida* in contrast to the *Ophiomyxinae*. The very basal vertebrae are not notably shorter than the outer; all the vertebrae are short, stout and discoidal; and the vertebral articulation is typically streptospondyline or saddle-shaped; all these characters are common to the *Ophiobyrsinae*, *Trichasteridae* and *Gorgonocephalida*. The upper muscular fossae are fairly large and the lower rather small; this character is rather intermediate between those of the *Ophiomyxidae* and of the other *Trichasteridae*, for the upper and lower muscular fossae are subequal in size in the former and very unequal in the latter. The relatively small inequality between the upper and lower fossae here illustrated may partially be due to the youngness of the specimen. The genital plates are high in position relatively to the basal vertebrae; this character also approaches to that of the *Ophiomyxidae*. The genital scales articulate with the genital plates near the inner ends of the latter, a characteristic of the *Asteromychinae* in contrast to the *Trichasterinae*, *Asteroschematinae* and *Gorgonocephalida*. The articulation of the genital plate and radial shield is very simple, without any particular condyle and socket, a common character of the *Phrynophiurida* and *Lernophiurida*.

Pl. II, figs. 7 & 8 illustrate the skeletal structure of *Trichaster elegans*, a representative of the *Trichasterinae*. The oral plates are very stout, a common character of the *Ophiobyrsinae*, *Trichasteridae* and *Gorgonocephalida*. The adoral shields are also large and stout, a character of the *Ophiomyxidae* and *Trichasteridae* in contrast to the *Gorgonocephalida*; a peculiar feature is that they are divided into inner and outer halves. The lateral arm plates of the two sides are separated from each other by the ventral arm plates, a character of the *Asteromychinae* and *Trichasterinae* in contrast to the *Asteroschematinae*. The ventral arm plates are divided into two or three secondary plates, a peculiar feature. The interbrachial area is very small and the genital plates and scales are very closely set side by side; this is a generic character. That the genital scales do not lie far inward from the outer ends of the genital plates is a common character of the *Trichasterinae*, *Asteroschematinae* and *Gorgonocephalida* in contrast to the

*Asteronychia*. Text-fig. 8 b-d (p. 38) may also be referred to here. The upper muscular fossae of the vertebrae are much larger than the lower, a common character of the *Trichasteridae* and *Gorgonocephalidae*; each dorsal arm plate being represented by a pair of triple rows of nodule-like secondary plates is a generic character; that each dorsal arm plate is represented by a pair of secondary plates or of groups of secondary plates in the basal arm joints containing the generative glands, is a common character of *Astrocerus*, *Trichaster* and *Asteroschema*,

Pl. II, figs. 2-6 illustrate the internal structure of *Asteroschema japonicum*, a representative of the *Asteroschematinae*. The very stout peristomial plates which are firmly soldered to the also very stout oral frames, the short and stout and markedly discoidal vertebrae, the streptospondyliine vertebral articulation, the markedly unequal upper and lower muscular fossae of the vertebrae, the very simple articulation of the genital plate and radial shield, and the position of the genital scales in relation to the genital plates, are characters which have been already explained. The lateral arm plates are transversely bar-like, and those of the two sides are in contact with each other in the ventral median line, thus separating the very small ventral arm plates from one another, a characteristic of the *Asteroschematinae*. Each dorsal arm plate is represented by a pair of bar-like rows of secondary plates; this is a generic character, though the fact that each dorsal plate is represented by a pair or group of secondary plates is a common character of *Astrocerus*, *Trichaster* and *Asteroschema*, as already explained.

Pl. II, figs. 9 & 10 illustrate the internal structure of *Astrotoma sobrina*, a representative of the *Astrotominae* (*Gorgonocephalidae*). The common characters of the *Trichasteridae* and *Gorgonocephalidae* are sufficiently explained in the text. The basal vertebrae are much narrower and smaller than those beyond, a characteristic of the *Astrotominae* in contrast to the *Gorgonocephalinae*. They are covered over by the muscles between them and the genital plate, also a characteristic of the *Astrotominae*. The adoral shields are very small and insignificant, a characteristic of the *Gorgonocephalidae* in contrast to the *Trichasteridae*. The area just inside the interbrachial ventral surface is occupied by a mosaic of supplementary plates, a characteristic of the *Astrotominae* in contrast to those genera of the *Gorgonocephalinae* with arms simple or divided a few times, and a common character of the *Astrotominae* and those genera of the *Gorgonocephalinae* with arms divided many times. The common character just mentioned may be due to convergence. Pl. II, fig. 11 shows a compound hook of an arm annulus of *Astrothamnus echiniceus*. Such a compound hook with more than two supplementary hooklets besides the terminal one is uncommon among the *Gorgonocephalidae*. The compound hooks of the arm annuli of *Astrotoma sobrina* belong partially to this type with two or three supplementary hooklets and partially to the common type with only a single supplementary hooklet besides the terminal one.

Pl. III, figs. 1-6 illustrate the internal structures of the *Ophiocanthidae*. The peristomial plates of *Ophiocantha bidentata* (fig. 1), *Ophioteles tuberosa* (fig. 4), *Ophiolima antarctica* (fig. 5) and *O. papillata* (fig. 6) are almost or perfectly entire and very large, characters common to most of the genera of the *Lamophiurida* and certain groups of the other orders. That the peristomial plates of the two species of *Ophiolima* just mentioned are almost entire and very wide and short, is a proof of their Ophiocanthine, and not Ophiodermatine, affinity; the peristomial plates



of the *Ophiidermatidae* being always triple and rather long relatively to their width. The oral frames of *Ophiolimna* are very slender, a character of those forms of the *Ophiacanthidae* with zygospondyline vertebral articulation; those of *Ophiolebes* and *Ophiacantha bidentata* are rather stout, a character of those forms of the same family with streptospondyline vertebral articulation. The vertebral articulation of the latter type is illustrated here by *Ophiacantha bidentata* (figs. 2 & 3). It is noteworthy that both the types of vertebral articulation are represented in *Ophiacantha*; *Ophiacantha cuspidata* having zygospondyline vertebral articulation according to LYMAN. The streptospondyline articulation is a common character of a part of the *Ophiacanthidae* and all the *Hemieuryalidae* among the *Leomphiurida*, as well as of the *Ophiobyrsinæ*, *Trichasteridae* and *Gorgonocephalidae* among the *Phrygophiurida*. *Ophiolebes tuberosa* (fig. 4) has short and stout vertebrae, whose wings are rather thick laterally as well as dorsally, also a common character of those forms with streptospondyline vertebral articulation. The articulation of the genital plate and radial shield is, as shown in the figure, very simple, without any special condyle and socket, a common character of the *Phrygophiurida* and *Leomphiurida*. The genital plate and scale merely articulate with each other, without being soldered together, a character of the *Ophiacanthidae* and some other orders in contrast to the *Hemieuryalidae*.

Pl. III, figs. 7 & 8 illustrate the internal structures of *Amphictis umbonata*, a representative of the *Amphilepididae*. The peristomial plates are almost simple and very large, a character distinguishing the present family from all the other *Gnathophiurida*. The oral plates and frames are slender and the latter have no lateral wings, also a character distinguishing the present family from the other *Gnathophiurida*. The dental plate is absent; this is a peculiar character. The teeth are not very stout and thick, though appearing wide in the figure, also a character of the present family in contrast to the other *Gnathophiurida*. The genital plates bear a very conspicuous, ball-like articular condyle on the dorsal side near the outer end; this is a characteristic of the *Gnathophiurida* in contrast to all the other orders. The genital scales are wide, thin and leaf-like and articulate with the genital plates near the outer ends of the latter; these characters of the genital scales are notable in the *Gnathophiurida*, though also found in some *Chilophiurida*. The dorsal surface of the vertebra is rhomboidal, instead of being strongly notched at the inner end, a common character of the *Amphilepididae* and *Amphiuridae* in contrast to the *Ophiotrichidae* among the *Gnathophiurida*. The distal vertebrae (fig. 8) are in this species imperfectly divided into halves by a series of pores. Such vertebrae or those in which the halves are divided by a moniliform pore, are found in several of the genera with the arms perfectly protected by the plates (see also Pl. V, fig. 3); while vertebrae with the halves divided by a fusiform pore are found in the *Ophiomyrina*, in which the dorsal side of the arms is largely unprotected. See text-fig. 2 f & g, p. 18.

Pl. III, figs. 9-13 and Pl. IV, figs. 1-5 illustrate the internal structures of the *Amphiuridae*. The peristomial plates of *Ophiactis pteropoma* (Pl. III, fig. 9), *Ophiopholis aculeata* (Pl. III, fig. 10), *Hemipholis elongata* (Pl. IV, fig. 1), *Amphioplus ancistrotus* (Pl. III, fig. 11), *Amphiacantha dividua* (Pl. III, fig. 12), *Ophiophragmus japonicus* (Pl. IV, fig. 3) and *Amphipholis kochii* (Pl. IV, fig. 2) are simple and very small, a common character of the *Amphiuridae*, with the excep-

tion of the *Amphiuva*-group, and the *Ophiotrichidae*; those of *Amphiuva vulicola* (Pl. III, fig. 13), *A. trachydisca* (Pl. IV, fig. 4) and *Ophiocentrus verticillatus* (Pl. IV, fig. 5) are double and very small, a character of the *Amphiuva*-group. The common outline of the oral and dental plates of all the representatives here illustrated is X-shaped, though that of *Amphiacantha dividua* is slightly atypical owing probably to the fact that the specimen is very small and young. This character is common to the *Amphiuroidae* and *Ophiotrichidae* in contrast to those groups of the *Chilophiurida* with well developed masticatory apparatus. The teeth are very stout, squarish, with wide and truncated tips, and the oral frames are very stout and have well developed lateral wings, characters common to the *Amphiuroidae*, *Ophiotrichidae*, *Ophioceramis*, *Ophionereidinae* and *Ophiocomidae*. The genital plates in *Ophiopholis aculeata* (fig. 10) and *Ophiocentrus verticillatus* (fig. 5) bear each a very conspicuous, ball-like articular condyle on the dorsal side near the outer end; this is a characteristic of the *Gnathophiurida*, as already explained. They are firmly attached to the basal vertebra, a common characteristic of the *Amphiuroidae* and *Ophiotrichidae* in contrast to all the other ophiurans. The genital scales of *Ophiopholis aculeata* (Pl. III, fig. 10) are wide, thin and leaf-like and articulate with the genital plates near the outer ends of the latter; this is also a character of the *Gnathophiurida* and part of the *Chilophiurida*. The vertebrae are seen in fig. 10, Pl. III (*Ophiopholis aculeata*) and fig. 5, Pl. IV (*Ophiocentrus verticillatus*); their dorsal surface is rhomboidal and not very deeply notched at the inner end, a common character of the *Amphilepida* and *Amphiuroidae*, as well as several groups of the other orders, in contrast to the *Ophiotrichidae*.

Pl. IV, figs. 6-8 illustrate the internal structures of the *Ophiotrichidae*. In all the species here illustrated, viz. *Ophiothrix nereidina* (fig. 6), *O. koreanus* (fig. 7) and *Ophiothela danae* (fig. 8), the peristomial plates are simple and small, a common character of part of the *Amphiuroidae*, and the *Ophiotrichidae*; the common outline of the oral and dental plates is X-shaped, a common character of the *Amphiuroidae* and *Ophiotrichidae*; the teeth are very stout, squarish, with wide and truncated ends, and the oral frames are very stout and have well developed lateral wings, characters common to the *Amphiuroidae*, *Ophiotrichidae*, *Ophioceramis*, *Ophionereidinae* and *Ophiocomidae*; the genital plates bear a very conspicuous, ball-like articular condyle on the dorsal side near the outer end, a characteristic of the *Gnathophiurida*; the dorsal surface of the vertebra (except the very basal ones) is Y-shaped, a characteristic of the *Ophiotrichidae* in contrast to the *Amphilepida* and *Amphiuroidae*; the genital scales are wide, thin and leaf-like, a character of the *Gnathophiurida* and part of the *Chilophiurida*. The radial shields are, as seen in fig. 6 (*Ophiothrix nereidina*), very large and triangular, a common character of most of the genera of the *Ophiotrichidae*, and have a very large articular socket to fit to the ball-like articular condyle of the genital plate, a characteristic of the *Gnathophiurida*.

Pl. V, figs. 1-5 show the internal structures of *Astrophiuva kawamurai*. The peristomial plates are absent, though the peritoneal membranes of the oral region and other parts contain very fine scales (fig. 1). It is stated by LYMAN, that *Ophioplinthus medusae* lacks the peristomial plates. The oral frames are very long and slender, also reminding us of those of *Ophioplinthus medusae*. The oral plates are also slender, and the dental plate is stout. The genital

plates and scales are entirely internal and very much reduced in size; the latter are entirely proximal to the former, the two articulating with each other terminally. These features of the genital plates and scales are quite peculiar. The genital plate has no special condyle and socket for articulation with the radial shield, but the outer end itself of the plate serves for an articular facet. It may be thought, that *Astrophium* is not Chilophiuridan but Lamnophiuridan in the articulation of the genital plate and radial shield; but my view is that, this condition is simply a result of the extreme reduction of the genital plates. The very basal vertebrae are large and long, instead of being very small and short, and are quadrangular in dorsal view, again reminding us of those of *Ophioplathus medusae*. The ventral side of each vertebra within the pentagonal "asteroid" body has a well marked median suture (fig. 2). The vertebrae of the free arms are divided into halves by a very narrow moniliform slit (fig. 3). The articulation of the same is zygospondyline (figs. 4 & 5), a common character of the *Ophiomyxine*, *Ophiocanthide* pars, *Gnathophiurida* and *Chilophiurida*.

Pl. V, figs. 6-12 illustrate the internal structures of the more typical genera of the *Ophiolepidida*. In all the species here illustrated, viz. *Stegophiura stuedeni* (fig. 6), *Ophiomusium trychaenum* (fig. 7), *O. cancellatum* (fig. 8), *Ophiozonella longispina* (fig. 9), *Ophiozoua impressa* (fig. 10), *Ophioplocus japonicus* (fig. 11) and *Ophioceramis junavarii* (fig. 12), the peristomial plates are double and small, a character common to the majority of the present family; the double or triple character of the peristomial plates is common to the majority of the *Ophiolepidida* and to all the other families of the *Chilophiurida* (all the members of the *Ophiolepidida* which are atypical on this point are very pedomorphic). The teeth are slender and pointed in *Stegophiura* and *Ophiomusium*, show a tendency to be stout and squarish in *Ophiozonella*, are moderately stout and squarish in *Ophiozoua* and *Ophioplocus*, and very strongly so in *Ophioceramis*. The stoutness of the oral frames increases also almost in the same order; the oral frames of *Ophiozoua* and *Ophioplocus* show a tendency to have lateral wings, and those of *Ophioceramis* have well developed lateral wings. In *Stegophiura*, *Ophiomusium* and *Ophiozonella*, the first vertebra is the shortest; while in *Ophiozoua*, *Ophioplocus* and *Ophioceramis*, the second is the shortest. It is noteworthy, that the very basal vertebrae of *Ophiomusium trychaenum* are not much reduced in length; this is a common character of the more pedomorphic forms.

Pl. V, fig. 13 shows the internal structures of *Ophioleuca charischema*, a representative of the *Ophioleucida*. The peristomial plates are rather large and triple; triple peristomial plates are also found in the *Ophiodermatida* but not in the *Ophiolepidida*. The oral plates and frames are long and slender, and the latter do not bear well developed lateral wings; these characters are found also in the typically deep-water forms of the *Ophiolepidida*. The genital plate has two articular condyles and one articular pit to fit to the two condyles and one pit of the radial shield, a characteristic of the *Chilophiurida*. The genital scales are wide, thin and leaf-like; this character is also found in *Ophiura* and its allies, as also in the *Gnathophiurida*, and is correlated with very long genital slits. The first vertebra, not the second, is the shortest; this condition is also observed in the deep-water forms of the *Ophiolepidida*, as well as some other families.

Pl. VI, figs. 1-7 illustrate the internal structures of the *Ophiodermatidae*. In all the species here illustrated, viz. *Ophiurodon grandisquama* (fig. 1), *Ophiurochacta mixta* (fig. 2), *Ophiuroconis miliaria* (fig. 3), *Ophiarachna incrassata* (fig. 4), *Bathypectinura gotoi* (fig. 5), *Pectinura anchysta* (fig. 6) and *Ophiarachnella gorgonia* (fig. 7), the peristomial plates are moderately large and triple, a common character of the *Ophiodermatidae* and *Ophiochitoninae* as well as *Ophioleuce* and *Ophiocrasis*; the oral frames do not have well developed lateral wings, a common character of the *Ophiolepidae* pars, *Ophioleucidae*, *Ophiodermatidae* and *Ophiochitoninae*, in contrast to the *Ophionereidinae*, *Ophiocomidae* and *Ophioceramis*; the teeth are not very stout, though often squarish. That *Ophiurodon*, *Ophiurochacta* and *Ophiuroconis* have triple peristomial plates is a proof of their being Ophiodermatine and not Ophiacanthine. The majority of the *Ophiacanthidae* have almost entire peristomial plates, and *Ophiothammus*, the only known Ophiacanthine member with triple peristomial plates, is very different from the genera in question. The oral frames of *Ophiarachna incrassata* (fig. 4) and *Bathypectinura gotoi* (fig. 5) are especially long and have V-shaped grooves for the ambulacral ring-canal, much reminding us of those of *Ophiochiton fastigatus* (fig. 8).

Pl. VI, figs. 8 & 9 illustrate the internal structures of the *Ophiochitoninae*, which are almost similar to those of the *Ophiodermatidae*. In both the species here illustrated, viz. *Ophiochiton fastigatus* (fig. 8) and *Ophioplax lamellosa* (fig. 9), the peristomial plates are moderately large and triple, quite as in the *Ophiodermatidae*; the oral frames do not have well developed lateral wings, and the teeth are not very stout, again as in the *Ophiodermatidae* and certain other families; and the dorsal surface of the vertebra is rhomboidal, instead of being strongly notched at the inner end, quite as in many other families, but not as in the *Ophionereidinae*. The oral frames of *Ophiochiton fastigatus* are especially long and have V-shaped grooves for the ambulacral ring-canal, like those of *Ophiarachna incrassata* and *Bathypectinura gotoi*, as already mentioned. The genital plate of *Ophiochiton fastigatus* has two articular condyles and one articular pit to fit to the two condyles and one pit of the radial shield, a characteristic of the *Chilophiurida*.

Pl. VI, figs. 10 & 11 and Pl. VII, figs. 1-3 illustrate the internal structures of the *Ophionereidinae*. The peristomial plates of *Ophiodoris pericalles* (Pl. VI, fig. 10), *Ophionereis annulata* (Pl. VII, fig. 1) and *O. reticulata* (Pl. VII, fig. 2) are double and very small, quite as in the *Ophiocomidae*, and those of *Ophiocrasis marktanneri* (Pl. VII, fig. 3) are triple and very small. The common outline of the oral and dental plates of all the species here illustrated is  $\Pi$ -shaped instead of being  $\Sigma$ -shaped, a common character of *Ophioceramis*, the *Ophionereidinae* and *Ophiocomidae* among the *Chilophiurida*, in striking contrast to the *Amphiurida* and *Ophiotrichidae* among the *Gnathophiurida*. The teeth of all the *Ophionereidinae* are stout and squarish, quite as in *Ophioceramis*, *Ophiocomidae*, *Amphiuridae* and *Ophiotrichidae*. The oral frames of *Ophiodoris* are moderately stout and have more or less well developed lateral wings, and those of *Ophionereis* and *Ophiocrasis* are very stout and have very well developed lateral wings. The dorsal surface of the vertebra of *Ophiodoris* (Pl. VI, fig. 11) is Y-shaped, except in

the very basal one, being moderately notched at the inner end, and that of *Ophionereis* and *Ophioerasis* is **V** shaped, being strongly notched at the inner end. The **Y**- or **V**-shape of the dorsal surface of the vertebra is a common character of the *Ophiotrichidae* among the *Gnathophiurida* and the *Ophionereidinae* among the *Chilophiurida*.

Pl. VII, figs. 4-7 illustrate the internal structures of the *Ophiocominae*. In all the species here illustrated, viz. *Ophiocoma scolopendrina* (figs. 4 & 5), *Ophiomastix annulosa* (fig. 6) and *Ophiarthrum elegans* (fig. 7), the peristomial plates are double and very small, as in *Ophiodoris* and *Ophionereis*; the common outline of the oral and dental plates is **Π**-shaped, as in *Ophioerasis* and the *Ophionereidinae*; the teeth are very stout and squarish and the oral frames are very stout and have well developed lateral wings, as in the *Amphiurida*, *Ophiotrichida*, *Ophioerasis* and the *Ophionereidinae*; the dorsal surface of the vertebra is rhomboidal and not strongly notched at the inner end, a character distinguishing the *Ophiocominae* from the *Ophionereidinae*. The genital plates have, as shown in fig. 7 (*Ophiarthrum elegans*), each two articular condyles and one articular pit to fit to the two condyles and one pit of the radial shield, a characteristic of the *Chilophiurida*. The genital scales are narrow and bar-like and articulate with the genital plates at some distance inwards from the outer ends of the latter, a common character of the majority of the *Chilophiurida*, viz. the *Ophiomastix* pars, *Ophiolepidinae*, *Ophiodermatidae*, *Ophioclitonidae* and *Ophiocomidae*. The radial shields are very large, subtriangular, and consist of the body and a lateral wing, a character distinguishing the *Ophiocominae* from the *Ophiopsilinae*.

Pl. VII, fig. 8 shows the internal structure of *Ophiopsila rüsei*, a representative of the *Ophiopsilinae* with the sole genus *Ophiopsila*. The oral skeleton is throughout similar to that of the *Ophiocominae*. The vertebrae are also similar, though relatively narrower. The genital plates, as well as the radial shields, have each two articular condyles and one pit, and the genital scales are narrow and bar-like and articulate with the genital plates at some distance inwards from the outer ends of the latter, decisive proofs that *Ophiopsila* belongs not to the *Gnathophiurida* but to the *Chilophiurida*, and not to the *Amphiurida* but to the *Ophiocomidae*. The outer ends of the genital plates of the same radius approach more closely to each other than in the *Ophiocominae*. The radial shields are very narrow and bar-like, the lateral wings being scarcely developed, a character distinguishing *Ophiopsila* from all the *Ophiocominae*.

**Abbreviations used in the Explanation of Plates.**

- A . . . . Adoral shield.  
 AP . . . . Articular peg.  
 AS . . . . Articular shoulder.  
 C . . . . Articular condyle of genital plate or radial shield.  
 D . . . . Dental plate.  
 F . . . . Oral frame.  
 G . . . . Genital plate.  
 K . . . . Articular knob.  
 L . . . . Lateral arm plate.  
 LF . . . . Lower muscular fossa.  
 M . . . . Madreporic oral shield.  
 O . . . . Oral plate.  
 OS . . . . Oral shield.  
 P . . . . Peristomial plate.  
 R . . . . Radial shield.  
 S . . . . Genital scale.  
 U . . . . Articular umbo.  
 UF . . . . Upper muscular fossa.  
 V . . . . Ventral arm plate.

## INDEX OF GENERA AND SPECIES.

- Amphiacantha . . . . .150, 168, **177**, 178,  
   353.  
   acantha. . . . .151, 178, **179**, 361.  
   amphacantha . . . . .178.  
   dividua . . . . .151, 152, 178, 179, **180**,  
   361, 387, 388.  
   formosa . . . . .178, **179**, 357.  
   gastracantha . . . . .178.  
   libera . . . . .178.  
   notacantha . . . . .178.  
   pentacantha . . . . .178.  
   sexradia . . . . .178.  
 Amphiacetis . . . . .4, 91, 145, **146**, 165,  
   352.  
   canescens . . . . .147.  
   dissidens . . . . .147.  
   duplicata . . . . .147.  
   parata . . . . .147.  
   partita . . . . .147.  
   patula . . . . .147.  
   umbonata . . . . .146, **147**, 361, 387.  
 Amphichilus . . . . .150, 168, **175**, 353.  
   daleus . . . . .175, 177.  
   intermedius . . . . .175, 177.  
   trichoides . . . . .**175**, 361.  
 Amphilepis . . . . .145, 353.  
   norvegica . . . . .146.  
   tenuis . . . . .**146**, 361.  
 Amphilimna . . . . .150, 165, 168, 178.  
   pentacantha . . . . .178.  
 Amphiocnida . . . . .151, 165.  
 Amphiodia . . . . .151, 165, 166, 167, 168,  
   172, 174, 182, 199,  
   352, 378.  
   ancistrota . . . . .171.  
   craterodonta . . . . .**182**, 355.  
   digitula . . . . .167, 199.  
   euryaspis . . . . .**182**, 354.  
   macraspis . . . . .173.  
   periereta . . . . .184.  
   psilochora . . . . .**182**, 361.  
 Amphiophiura . . . . .5, 234, 248, 249, **261**,  
   262, 266, 353.  
   abscisa . . . . .262.  
   abdita . . . . .261.  
   bullata . . . . .261.  
   convexa . . . . .261, 262, **263**, 356.  
   distincta . . . . .261.  
   hadra . . . . .262, 266.  
   improva . . . . .261.  
   insolita . . . . .261.  
   lacazei . . . . .261.  
   lapidaria . . . . .261, 263, **265**, 363.  
   latro . . . . .261.  
   laudata . . . . .261.  
   liberata . . . . .261.  
   megapoma . . . . .262, 263, **264**, 362.  
   obtecta . . . . .262.  
   œdiplax . . . . .261, 262, **263**, 362.  
   ornata . . . . .262.  
   paupera . . . . .261.  
   penicula . . . . .262, 263, **264**, 266, 362.  
   pompophora . . . . .261, 262, **264**, 362.  
   ponderosa . . . . .261, 263, **264**, 266, 359.  
   prisca . . . . .261.  
   radiata . . . . .262.  
   remota . . . . .261.  
   sculptilis . . . . .261, 263, **265**, 356.  
   scutata . . . . .261.  
   solida . . . . .249, 261.  
   sordita . . . . .261.  
   stellata . . . . .261.

- undata* ..... 261.  
*urbana* ..... 261.  
*Amphioplus* .. 147, 150, 165, 166, 167,  
                   168, 169, 172, 174,  
                   175, 178, 200, 353.  
*acanthinus* ..... 178, 179.  
*ancistrotus* ..... 151, 152, 170, **171**,  
                   361, 387.  
*cernuus* ..... 170, **172**, 361.  
*glaucus* ..... 170, **173**, 361.  
*hexacanthus* ..... 170, **172**, 358.  
*macraspis* ..... 170, **173**, 358.  
*megapomus* ..... 169, **170**, 361.  
*rhadinobrachus* .... 169, **171**, 358.  
*Amphipholis* . 151, 165, 166, 167, 168,  
                   175, 198, 208, 352.  
*andreae* ..... 184.  
*australiana* ..... 188.  
*coreæ* ..... 198.  
*japonica* ..... 185, **186**, 190, 361.  
*kochii* .... 151, 185, **192**, 361, 387.  
*lütkeni* ..... 208.  
*pugetana* ..... 185, **191**, 358, 365.  
*sobriua* ..... 185, **189**, 362.  
*squamata* ..... 187, 188, 190.  
*Amphipholizona* ..... 235.  
*Amphipsila* ..... 93, 375.  
*Amphiura* ... 147, 151, 152, 165, 166,  
                   167, 168, 169, 174,  
                   **194**, 198, 199, 352,  
                   378, 388.  
*acacia* ..... 196, **203**, 362.  
*acrystata* ..... 194, 196, **203**, 359.  
*æstuarii* ..... 197, **208**, 362.  
*anomala* ..... 174.  
*assimilis* ..... 174.  
*bellis* ..... 195, **200**, 357.  
*candita* ..... 201.  
*canescens* ..... 147.  
*carchara* ..... 196, **203**, 358, 365.  
*cernua* ..... 172.  
*coreæ* ..... 198.  
*crassa* ..... 174.  
*dalea* ..... 175.  
*digitula* ..... 174, 195, **199**, 362.  
*diomedæe* ..... 198, 199.  
*duncani* ..... 208.  
*duplicata* ..... 147.  
*cenomiotata* ... 198, 210, **213**, 362.  
*euopla* ..... 196, **201**, 210, 362.  
*gastracantha* ..... 178.  
*glauca* ..... 173.  
*grabra* ..... 205, 207.  
*grata* ..... 174.  
*intermedia* ..... 175.  
*iridoides* ..... 197, **205**, 362.  
*iris* ..... 197, **204**, 357.  
*kochii* ..... 192.  
*koreæ* .. 151, 152, 174, 195, **198**, 356.  
*lütkeni* ..... 197, **208**, 357.  
*micraspis* ..... 197, **208**, 362.  
*microdiscus* ..... 195, **201**, 362.  
*notacantha* ..... 178.  
*partita* ..... 147.  
*patula* ..... 147.  
*pharelata* ..... 210, 211, 213.  
*præstans* ..... 184.  
*pugetana* ..... 191.  
*pynostoma* ..... 196, **203**, 362.  
*reposita* ..... 174.  
*servata* ..... 174.  
*trachydisca* ... 151, 152, 195, **201**,  
                   362, 388.  
*vadicola* ... 152, 197, 210, **211**, 362,  
                   388.  
*Anthophiura* . 234, 249, 250, 382, 383.  
*Aspidophiura* ... 234, 248, **249**, 250,  
                   353, 382, 383.



- forbesi . . . 249, 250, 252, **253**, 357.  
 minuta . . . . . 249, 252.  
 watasei . . . . . 249, **250**, 362.  
 Asterias . . . . . —  
   aculeata . . . . . 161.  
   bidentata . . . . . 118.  
   ophiura . . . . . 267.  
 Asteronyx . . . . . 4, 28, 353, 373.  
   loveni . . . . . 29, **33**, 355, 385.  
 Asteroporpa . . . . . 4, 59, 67, 353.  
   hadracantha . . . . . 61, 62, 63, **67**, 359.  
 Asteroschema . . . . . 4, 29, 42, 43, 44, 49,  
   54, 353.  
   abyssicola . . . . . 42, **53**, 359.  
   caudatum . . . . . 33, 42, 49, **52**, 53, 55,  
     359.  
   enoshimanum . . . . . 51, 52.  
   glaucum . . . . . 42, **46**, 55, 359.  
   glutinosum . . . . . 42, **53**, 55, 359.  
   hemigymnum . . . . . 42, **47**, 55, 359.  
   intestum . . . . . 49.  
   japonicum . . . . . 32, 42, **51**, 53, 55, 359,  
     386.  
   koehleri . . . . . 29.  
   migrator . . . . . 49.  
   monacanthum . . . . . 51, 52, 53.  
   oedipus . . . . . 49, 51.  
   rubrum . . . . . 45.  
   sagaminum . . . . . 49, 50.  
   salix . . . . . 47.  
   tubiferum . . . . . 42, **44**, 55, 359.  
 Astroboa . . . . . 60, 67, 79, 353.  
   arctos . . . . . 61, 65, 79, **80**, 360.  
   clavata . . . . . 83.  
   ornæ . . . . . 83.  
   globifera . . . . . 79, 83, **84**, 360.  
   nigra . . . . . **79**, 84, 357.  
   nuda . . . . . 83.  
 Astrocaelum . . . . . 60.  
 Astroceras . . . . . 4, 28, 29, 30, 32, 35,  
   54, 55, 353, 386.  
   adherens . . . . . 29.  
   koehleri . . . . . 29.  
   pergamena . . . . . 30, **35**, 55, 356.  
 Astrochaleis . . . . . 60.  
 Astrocharis . . . . . 29, 42, 353.  
   ijimai . . . . . **56**, 359.  
   virgo . . . . . 57, 58.  
 Astrochele . . . . . 4, 59.  
   lymani . . . . . 61, 62.  
 Astrochlamys . . . . . 59.  
 Astrocladus . . . . . 4, 60, 67, 74, 353.  
   annulatus . . . . . 61, 64, 74, **75**, 360.  
   coniferus . . . . . 61, 65, 74, **77**, 357.  
   dofleini . . . . . 74, **77**.  
   pardalis . . . . . 74, **77**.  
 Astroclon . . . . . 61, 84, 353.  
   suensoni . . . . . **90**, 360.  
 Astrocnida . . . . . 59.  
   isidis . . . . . 61, 62.  
 Astroconus . . . . . 60.  
 Astrocyclus . . . . . 60.  
 Astrodactylus . . . . . 60.  
 Astrodendrum . . . . . 4, 60, 67, 68, 353.  
   sagaminum . . . . . 61, 64, **73**, 357.  
 Astrodia . . . . . 28, 34.  
 Astrogeron . . . . . 8, 91.  
 Astrogomphus . . . . . 59.  
   vallatus . . . . . 62.  
 Astrogordius . . . . . 60.  
 Astrogymnotes . . . . . 29.  
 Astrophium . . . . . 4, 91, 234, 236, 237,  
   **239**, 353, 378, 382,  
   389.  
   cavellæ . . . . . 239, 245, 246.  
   kawamurai . . . . . 236, **239**, 362, 388.  
   permira . . . . . 245, 246.  
 Astrophyton . . . . . 60.

- asperum* ..... 40.  
*caryi* ..... 71.  
*clavatum* ..... 79.  
*coniferum* ..... 77.  
*cornutum* ..... 77.  
*globiferum* ..... 84.  
*pardalis* ..... 77.  
*stimpsoni* ..... 72.  
*Astrophytum* ..... 60.  
*Astrothamnus* ..... 5, 60, **84**, 353.  
   *bellator* ..... 85, 86.  
   *echinaceus* ..... 61, 65, 85, **86**, 360,  
     386.  
   *rigens* ..... 85, 86.  
   *vecors* ..... 85, 86.  
*Astrothorax* ..... 61, 84, 353.  
   *misakiensis* ..... 67, **87**, 360.  
*Astrothrombus* ..... 60, 84.  
*Astrotoma* ..... 4, 61, 84, 353.  
   *agassizi* ..... 67.  
   *murrayi* ..... 88.  
   *sobrina* ..... 61, 66, **88**, 360, 386.  
*Astrospartus* ..... 60, 67.  
*Bathypectinura* ..... 309, 319, 333, 353.  
   *gotoi* ..... 309, **320**, 326, 363, 390.  
   *lacertosa* ..... 321.  
   *reducta* ..... 333.  
*Conocladus* ..... 59.  
*Cryptopelta* ..... 308, 309, 311, 312.  
*Ctenamphiura* ..... 151, 169.  
*Diopoderma* ..... 309.  
*Euryala* ..... —  
   *anopla* ..... 42.  
   *aspera* ..... 41.  
*Euryale* ..... 4, 29, 30, 32, 35, 40, 353.  
   *anopla* ..... 40, **41**, 359.  
   *aspera* ..... 30, 31, **40**, 61, 356, 366.  
   *asperum* ..... 40.  
   *parmiferum* ..... 37.  
   *studerii* ..... 40.  
*Gorgonocephalus* ..... 4, 60, 63, 67, 69,  
     70, 352, 373.  
   *agassizi* ..... 61, 68.  
   *arcticus* ..... 61, 64, 68.  
   *caryi* ..... 61, 64, 70, **71**, 354.  
   *chilensis* ..... 61, 64.  
   *dolichodactylus* ..... 61, 64, 70, **73**, 359,  
     365.  
   *japonicus* ..... 72, 73.  
   *sagaminus* ..... 72, 73.  
   *stimpsoni* ..... 72.  
   *tuberosus* ..... 61, 64, **70**, 359, 365.  
*Gymnolophus* ..... 216.  
*Gymnophiura* ..... 234, **265**.  
   *cælurescens* ..... 266, 273, 274.  
   *mollis* ..... 266.  
*Haplophiura* ..... 5, 234, **246**, 293.  
   *gymnopora* ..... 237, 247.  
*Hemieuryale* ..... 70, 139.  
   *pustulata* ..... 140.  
*Hemilepis* ..... 163, 194.  
*Hemipholis* ..... 150, 165, 201, 378.  
   *elongata* ..... 151, 152, 387.  
   *microdiscus* ..... 201.  
*Homalophiura* ..... 234, 248, 249, 266,  
     352.  
   *abyssorum* ..... 266.  
   *brucei* ..... 267.  
   *clasta* ..... **266**, 363.  
   *confragosa* ..... 266.  
   *divisa* ..... 267.  
   *flexibilis* ..... 267.  
   *frigida* ..... 267.  
   *gelida* ..... 267.  
   *inermis* ..... 267, 293.  
   *inflata* ..... 267.  
   *inortata* ..... 266.  
   *intorta* ..... 266.

- mimaria ..... 267.  
 nana ..... 267.  
 partita ..... 267.  
 rouchi ..... 267.  
 scissa ..... 267.  
 scutellata ..... 267.  
 tessellata ..... 266.  
 Lütkenia ..... 216.  
 Microphiura . . . 4, 91, 93, 95, 375, 382.  
 Neoplax ..... 9, 14.  
 Ophiacantha . . . 94, 96, 98, 106, 107,  
                                   111, 317, 352, 387.  
   acanthinotata ..... 112, **117**, 360.  
   adiaphora ..... 112, **117**, 355.  
   ænigmatica ..... 111, **113**, 360.  
   anchilabra ..... 112, **117**, 360.  
   armata ..... 116.  
   bairdi ..... 101.  
   bidentata . . . 96, 112, **118**, 354, 386,  
                                   387.  
   bisquamata ..... 112, **120**, 360.  
   cataleimnoida ..... 106, 108.  
   cuspidata ..... 96, 387.  
   dallasii ..... 111, **113**, 357.  
   diploa ..... 112, **119**, 360.  
   euphylactea ..... 110.  
   eurypoma ..... 106.  
   gracilis ..... 125.  
   grönlandica ..... 118.  
   hylacantha ..... 106, 109.  
   inutilis ..... 112, **117**, 357.  
   lambda ..... 101.  
   leucorhabdota ..... 101, 109.  
   leucosticta ..... 110, 111.  
   levispina ..... 111, **115**, 357.  
   lineolata ..... 317.  
   lophobrachia ..... 112, **117**, 360.  
   megatrema ..... 100.  
   normani ..... 106, 109.  
   oelidisca ..... 136, 137.  
   omoplata ..... 111, **116**, 360.  
   pentagona ..... 111, **116**, 355.  
   perfida ..... 101.  
   prionota ..... 112, **119**, 360.  
   relicta ..... 101.  
   rhachophora ..... 112, **119**, 355.  
   rosea ..... 112, **122**, 355.  
   scolopendrica ..... 110, 111.  
   spinnlosa ..... 118.  
   trachybaetra ..... 115.  
 Ophiacanthella ..... 93, 98, 353.  
   acontophora ..... **123**, 355.  
   troscheli ..... 123.  
 Ophiactis . . . 4, 147, 150, 153, 353, 378.  
   affinis ..... 153, **155**, 357.  
   brachygenys ..... 153, **154**, 361.  
   clavigera ..... 136.  
   dissidens ..... 147.  
   dyscrita ..... 153, **154**, 361.  
   gymnochora ..... 154, **159**, 361.  
   krebssii ..... 158.  
   macrolepidota ..... 153, **155**, 357.  
   modesta ..... 153, **156**, 357, 366.  
   parata ..... 147.  
   profondi ..... 154.  
   pteropoma . . . 151, 152, 153, **154**,  
                                   361, 387.  
   reinhardtii ..... 158.  
   savignyi ..... 154, **158**, 355.  
   sexradia ..... 158.  
 Ophialcæa ..... 94, 107.  
 Ophiambix ..... 93, 97, 353.  
   aculeatus ..... **179**, 357.  
 Ophiarachna . . . 308, 311, 317, 319, 330,  
                                   353.  
   danbyi ..... 319.  
   gorgonia ..... 323.  
   incrassata . . . 309, 316, **318**, 326, 358.

	366, 376, 390.		
infernalis . . . . .	324.	mixta . . . . .	101, 316.
Ophiarachnella . . . . .	309, 319, 322, 353.	Ophiochasma . . . . .	309.
gorgonia . . . . .	303, 309, 322, <b>323</b> , 358,	Ophiochiton . . . . .	297, 326, 328, 336, 353,
366, 390.		380, 381.	
infernalis . . . . .	323, <b>324</b> , 358, 366.	carinatus . . . . .	329, 330.
megalaspis . . . . .	<b>323</b> , <b>325</b> , 363.	fastigatus . . . . .	316, 326, 327, <b>328</b> , 356,
Ophiarthrum . . . . .	341, 343, 353.	390.	
elegans . . . . .	342, <b>351</b> , 358, 366, 391.	lymani . . . . .	326.
Ophientrema . . . . .	93, 98, <b>110</b> , 353.	Ophiochondrella . . . . .	93, 97, 136, 375,
euphylacteum . . . . .	<b>110</b> , 360	376.	
leucostictum . . . . .	110.	squamosa . . . . .	97.
scolopendricum . . . . .	110, <b>111</b> , 360.	Ophiochondrus . . . . .	139, 140.
Ophieruus . . . . .	304, 305, 353.	armatus . . . . .	139.
adpersus . . . . .	<b>307</b> , 356.	convolutus . . . . .	139.
annectens . . . . .	307.	granulatus . . . . .	139.
vallincola . . . . .	305.	Ophiochrysis . . . . .	234.
Ophioaethiops . . . . .	216.	Ophiocytra . . . . .	145, 147.
Ophioblenna . . . . .	93, 375.	Ophiocimbium . . . . .	93, 375.
Ophiobrachion . . . . .	9, 25, 373.	Ophiocirce . . . . .	304.
Ophiobyrsa . . . . .	9, 23, 352.	Ophiocnemis . . . . .	215, 217.
acanthinobrachia . . . . .	<b>24</b> , 359.	Ophiocnida . . . . .	151, 165, 168.
rudis . . . . .	11.	amphacantha . . . . .	178.
synaptacantha . . . . .	<b>24</b> , 359.	libera . . . . .	178.
Ophiobyrsella . . . . .	9.	lütkeni . . . . .	208.
Ophiocamax . . . . .	94, 97, 99, 131, 353.	sexradia . . . . .	178.
hystrix . . . . .	96.	verticillata . . . . .	213.
lithosora . . . . .	131.	Ophiocoma . . . . .	341, 342, 343, 349, 353,
polyploca . . . . .	<b>132</b> , 361.	381.	
Ophiocampsis . . . . .	215.	arctica . . . . .	118.
Ophiocentrus . . . . .	151, 152, 165, 169,	brevipes . . . . .	342, <b>343</b> , 345, 358, 366.
353.		echinulata . . . . .	118.
verticillatus . . . . .	152, <b>213</b> , 357, 366,	erinaceus . . . . .	343, <b>345</b> , 346, 347.
388.		schoenleinii . . . . .	343, <b>345</b> , 346, 347.
Ophioceramis . . . . .	4, 236, 238, 381, 382.	scolopendrina . . . . .	342, 343, <b>345</b> , 346,
388, 389, 390, 391.		347, 358, 366, 391.	
januarii . . . . .	238, 389.	Ophiocoris . . . . .	4, 308, 310, 311.
obstricta . . . . .	140.	antarctica . . . . .	101.
Ophiochaeta . . . . .	5, 309, 317.	brevispina . . . . .	310.
		cincta . . . . .	310, 315.

- cupida* ..... 310, 315.  
*diastata* ..... 101, 310.  
*forbesii* ..... 310.  
*grandisquama* ..... 310, 315.  
*indica* ..... 310, 311, 312.  
*miliaria* ..... 310, 312.  
*papillata* ..... 101, 310.  
*permixta* ..... 310, 315.  
*pulverulenta* ..... 310, 312.  
*Ophiocopa* ..... 93.  
*Ophiocormus* ..... 308.  
*Ophiocrasis* .. 326, 327, 328, 334, **337**,  
353, 390, 391.  
*dietydisca* ..... **337**, 340, 363.  
*marktanneri* ... 327, 334, **338**, 363,  
390.  
*Ophiocrates* ..... 235.  
*Ophiocreas* ..... 29, 43, 49.  
*abyssicola* ..... 53.  
*adherens* ..... 29.  
*caudatus* ..... 49.  
*japonicus* ..... 51.  
*cedipus* ..... 49, 51.  
*papillatus* ..... 51, 52.  
*Ophiocrene* ..... 60, **68**.  
*Ophiocryptus* ..... 309.  
*Ophiocten* ..... 235.  
*brevispinum* ..... 306.  
*charischema* ..... 306.  
*hastatum* ..... 326.  
*lymani* ..... 326.  
*oöplax* ..... 268, 275.  
*pacificum* ..... 326.  
*sericeum* ..... 237.  
*Ophiocynodus* ..... 8, 369.  
*Ophiodera* ..... 9, 13, 352, 369.  
*anisacantha* .. 10, **21**, 359, 371, 384.  
*Ophioderma* ..... 298, 309.  
*brevicauda* ..... 309.  
*januarii* ..... 309.  
*Ophiodoris* .. 297, 326, 327, 333, 353,  
380, 390, 391.  
*pericalles* ..... 328, **334**, 363, 390.  
*Ophiogeron* ..... 3, 8, 91.  
*Ophioglypha* ..... 247.  
*abcisa* ..... 262.  
*abdita* ..... 261.  
*abyssorum* ..... 266.  
*acervata* ..... 267.  
*æqualis* ..... 267.  
*albata* ..... 268, 281.  
*ambigua* ..... 268.  
*amphitrites* ..... 267.  
*aspera* ..... 268.  
*aurantiaca* ..... 267.  
*brevispina* ..... 267.  
*brucei* ..... 267.  
*bullata* ..... 261.  
*carinata* ..... 282.  
*elemens* ..... 268.  
*concreta* ..... 268.  
*confragosa* ..... 266.  
*convexa* ..... 261, 263.  
*costata* ..... 268.  
*deshayesi* ..... 238, 282.  
*distincta* ..... 261.  
*divisa* ..... 267.  
*elevata* ..... 254.  
*falcifera* ..... 268.  
*ferruginea* ..... 271.  
*flagellata* ..... 267, 273.  
*flexibilis* ..... 267.  
*forbesii* ..... 249, 253.  
*fraterna* ..... 268.  
*frigida* ..... 267.  
*gelida* ..... 267.  
*grandis* ..... 277.  
*hexactis* ..... 235.

imbecillis . . . . .	267, 276.	radiata . . . . .	262.
improva . . . . .	261.	remota . . . . .	261.
indica . . . . .	267.	rouchi . . . . .	267.
inermis . . . . .	267.	rugosa . . . . .	268.
inflata . . . . .	267.	sarsii . . . . .	272.
inortata . . . . .	266.	scissa . . . . .	267.
insolita . . . . .	261.	sculpta . . . . .	254, 258.
intorta . . . . .	266.	sculptilis . . . . .	261, 265.
involuta . . . . .	277.	scutata . . . . .	261.
irrorata . . . . .	268, 277.	scutellata . . . . .	267.
jejuna . . . . .	268.	sinensis . . . . .	271.
kinbergi . . . . .	267, 271.	sladeni . . . . .	254, 259, 260.
lacazei . . . . .	261.	solida . . . . .	261.
lapidaria . . . . .	261, 265.	sordita . . . . .	261.
latro . . . . .	261.	stellata . . . . .	261.
laudata . . . . .	261.	sterea . . . . .	254, 258.
lepida . . . . .	267.	striata . . . . .	254, 255.
liberata . . . . .	261.	tenera . . . . .	268.
ljungmani . . . . .	267.	tessellata . . . . .	266.
loveni . . . . .	268.	thouleti . . . . .	267.
lütkeni . . . . .	267.	tumulosa . . . . .	277.
lymani . . . . .	268.	undata . . . . .	261.
maculata . . . . .	267, 276.	undulata . . . . .	268.
meridionalis . . . . .	267.	urbana . . . . .	261.
mimaria . . . . .	267.	variabilis . . . . .	265.
minuta . . . . .	249.	verrucosa . . . . .	268.
multispina . . . . .	268.	Ophioglyphina . . . . .	247.
mundata . . . . .	268.	Ophiogona . . . . .	235.
nana . . . . .	267.	Ophiogymna . . . . .	216, 217.
nodosa . . . . .	258.	Ophiogyptis . . . . .	139.
obtecta . . . . .	262.	nodosa . . . . .	143.
orbiculata . . . . .	277.	Ophiohelus . . . . .	3, 8, 91.
ornata . . . . .	262.	Ophioholeus . . . . .	139.
papillata . . . . .	267.	Ophiohyalus . . . . .	3, 9, 12, 16, 91, 353,
partita . . . . .	267.	369, 371.	
paupera . . . . .	261.	gotoi . . . . .	11, 17, 359, 384.
plana . . . . .	268.	Ophiohymen . . . . .	9, 13, 353, 369.
ponderosa . . . . .	261, 264.	gymnodiscus . . . . .	23, 359.
prisca . . . . .	261.	Ophiolebes . . . . .	93, 97, 99, 115, 132, 136,

- 352, 375, 376, 387.  
*armata* ..... 139.  
*asaphes* ..... **132**, 135, 361, 365.  
*brachygnatha* .. **132**, 135, 361, 365.  
*brevispina* ..... 136.  
*clavigera* ..... 136.  
*diaphora* ..... 136.  
*granulata* ..... 139.  
*pachybaetra* ..... 136.  
*pancispina* ..... 136.  
*tuberosa* ... 96, **133**, 361, 365, 386,  
 387.  
*tylota* ..... 136, 138.  
*Ophioleđa* ..... 94, 125, 126.  
*minima* ..... 124, 126.  
*Ophiolepis* .. 235, 282, 283, 292, 298,  
 298, 299, 353.  
*annulosa* ..... 299, **300**, 358, 366.  
*carinata* ..... 282.  
*cineta* ..... 238, **299**, 358.  
*garrettii* ..... 299.  
*imbricata* ..... 301.  
*imprensa* ..... 298.  
*mirabilis* ..... 160.  
*nigra* ..... 299.  
*pacifica* ..... 298.  
*robusta* ..... 267.  
*savignyi* ..... 158.  
*sexradia* ..... 158.  
*superba* ..... 300.  
*Ophioleptoplax* .. 9, 12, 352, 369, 371.  
*megapoma* ..... **13**, 359.  
*Ophioleuce* ..... 304, 305, 306, 353.  
*brevispinum* ..... **306**, 363.  
*charischema* ... 304, **306**, 363, 389.  
*Ophiolimna* .. 5, 93, 97, **101**, 102, 310,  
 311, 316, 353, 375,  
 387.  
*antarctica* ..... 95, 101, 386.  
*bairdi* ..... 101, **102**, 355.  
*diastata* ..... 101, **102**, 310, 360.  
*lambda* ..... 101, 102, 103, 360.  
*littoralis* ..... 101, 316.  
*mixta* ..... 101, 316.  
*operculata* ..... 101.  
*papillata* ..... 95, 101, 310, 386.  
*perfida* ..... 101.  
*Ophiolipus* ..... 235.  
*Ophiologimus* .. 4, 91, 92, 95, 97, 353,  
 369, 375.  
*hexactis* ..... **99**, 360.  
*Ophiomastix* ..... 341, 343, 348, 353.  
*annulosa* .. 342, 348, **350**, 358, 366,  
 391.  
*lütkeni* ... 342, 348, **349**, 358, 366.  
*mixta* ..... 342, **348**, 358, 366.  
*Ophiomastus* .. 234, 236, 237, 378, 382.  
*secundus* ..... 237.  
*Ophiomaza* ..... 215, 217, 353.  
*cacaotica* ..... 230.  
*kanekoi* ..... **227**, 362.  
*mœrens* ..... 230.  
*obscura* ..... 230.  
*Ophiomedea* ..... 93.  
*Ophiomidas* ..... 235.  
*Ophiomisidium* ... 234, 237, 378, 382.  
*Ophiomitra* ..... 94, 99, 131, 353.  
*acontophora* ..... 123.  
*bythiaspis* ..... **131**, 361.  
*cardiomorpha* ..... 130.  
*codonomorpha* ..... 106, 109.  
*dicycla* ..... 130.  
*exigua* ..... 123, 130.  
*granifera* ..... 106.  
*habrotata* ..... 124, 126.  
*lithosora* ..... **131**, 361.  
*microphylax* ..... 106, 110.  
*normani* ..... 106, 109.





- acanthinus ..... **24**, 359.  
 Ophiophrura ..... 93, **97**, 353.  
   iodisca ..... **99**, 360.  
 Ophiophthalmus ... 93, 98, **106**, 107,  
   137, 353.  
   americanus ..... 106.  
   cataleimmoidus ..... 106, 107, **108**,  
     355.  
   codonomorpha .. 106, 107, **109**, 360.  
   eurypona ..... 106.  
   graniferus ..... 106.  
   hylacantha ... 106, 107, **109**, 360.  
   languidus ..... 106.  
   leucorhabdotus .. 106, 107, **109**, 360.  
   microphylax ... 106, 107, **110**, 360.  
   mutatus ..... 106.  
   normani ..... 106, 107, **109**, 354.  
   placidus ..... 106.  
   relictus ..... 106.  
 Ophiophthyrus ..... 215.  
 Ophiophycis ..... 234, 237, 382.  
 Ophiophyllum ..... 235.  
 Ophioplax ... 308, 326, 328, 353, 381.  
   custos ..... 333.  
   lamellosa .. 316, 327, **330**, 363, 390.  
   ljungmani ..... 333.  
   reducta ..... 333.  
 Ophiopleura ..... 235.  
 Ophioplinthaca ..... 94, 99, 353.  
   cardiomorpha ..... **130**, 361.  
   occlusa ..... 124.  
 Ophioplinthus ..... 235, 236, 237.  
   medusæ ..... 237, 388, 389.  
 Ophioplocus .. 235, 284, 301, 353, 389.  
   imbricatus ... **301**, 302, 303, 358,  
     366.  
   japonicus .. 238, 301, **302**, 363, 389.  
   tessellatus ..... 301.  
 Ophioplus ..... 139.  
   armatus ..... 139.  
 Ophiopora ..... 93, 97, 100, 353.  
   bartletti ..... 100.  
   megatrema ..... **100**, 360.  
   paucispina ..... 100.  
 Ophiopristis ..... 93.  
 Ophioprium ..... 93.  
 Ophiopsammium ..... 216, 217.  
 Ophiopsila ... 4, 341, 342, 378, 391.  
   riisei ..... 342, 391.  
 Ophiopteris ..... 341.  
 Ophiopteron ..... 215.  
 Ophiopus ..... 150, 378.  
   arcticus ..... 95, 152.  
 Ophiopyren ..... 304.  
   longispinus ..... 305.  
 Ophiopyrgus ..... 234, 262, 382, 383.  
 Ophioscalus ..... 93.  
 Ophioschiza ..... 9.  
 Ophiosciasma ..... 3, 8, 91, 369.  
 Ophioscolex ..... 9, 14, 62, 372.  
   glacialis ..... 11.  
 Ophiosemmotes ... 5, 93, 97, 99, **135**,  
   136, 352, 375, 376.  
   brevispina ..... 136.  
   claviger ..... 136.  
   diaphora ..... 136, 138.  
   cedidisca ... 96, 136, **137**, 361, 365.  
   pachybaetra ..... 136.  
   paucispina ..... 136.  
   tylota ..... 136, 137, **138**, 355.  
 Ophiosmilax ..... 9, **24**, 353.  
   mirabilis ... 11, **25**, 359, 384, 385.  
 Ophiosphæra ..... 216.  
 Ophiosteira ..... 234.  
 Ophiostiba .. 3, 9, 12, **13**, 91, 353, 369.  
   hidekii ..... 11, **14**, 359, 384.  
 Ophiostigma ..... 151, 165, 168, 179.  
   formosa ..... 178, 179.

- Ophiostyracium* . . . . . 8, 12, 353, 369.  
*trachyacanthum* . . . . . **13**, 359.  
*Ophiosyzygus* . . . . . 8, 12, 353, 369.  
*disacanthus* . . . . . **13**, 359.  
*Ophioteresis* . . . . . 216.  
*Ophiothamnus* . . . . . 4, 91, 94, 99, 123,  
 124, **125**, 353.  
*affinis* . . . . . 126.  
*exiguus* . . . . . 123, 130.  
*gracilis* . . . . . 125.  
*habrotatus* . . . . . 124, **126**, 360.  
*lævis* . . . . . 123, 130.  
*minimus* . . . . . 124.  
*remotus* . . . . . 126.  
*stultus* . . . . . 123, 130.  
*venustus* . . . . . 94, **126**, 361.  
*vicarius* . . . . . 94, 126.  
*Ophiothela* . . . . . 216, 217, 353.  
*danæ* . . . . . 217, **230**, 232, 357.  
*involuta* . . . . . 231.  
*isidicola* . . . . . 231, 232.  
*verrilli* . . . . . 231, 232.  
*Ophiotholia* . . . . . 92.  
*Ophiothrix* . . . . . 212, 215, 217, 218, 353.  
*cataphracta* . . . . . 224.  
*cheneyi* . . . . . 226.  
*ciliaris* . . . . . 224.  
*crassispina* . . . . . 222.  
*ensteira* . . . . . 218, **222**, 362.  
*galapagensis* . . . . . 223.  
*hirsuta* . . . . . 219, **225**, 226, 357, 366.  
*hylodes* . . . . . 221.  
*koreana* . . . . . 155, 217, 218, **220**, 222,  
 357.  
*longipeda* . . . . . 219, **227**, 357, 366.  
*macrobrachia* . . . . . 218, **222**, 362.  
*marenzelleri* . . . . . 218, **220**, 362.  
*neroidina* . . . . . 216, 217, 218, **224**,  
 357, 366.  
*obtusa* . . . . . 219, **225**, 357, 366.  
*panchyendyta* . . . . . 218, **219**, 362.  
*punctolimbata* . . . . . 219, **226**, 357.  
*stabilis* . . . . . 218, **224**, 362.  
*stelligera* . . . . . 220.  
*variabilis* . . . . . 226.  
*Ophiothyreus* . . . . . 235.  
*Ophiotjalfa* . . . . . 235, 268.  
*Ophiotoma* . . . . . 93, 375.  
*Ophiotrema* . . . . . 93, 100.  
*alberti* . . . . . 100.  
*Ophiotreta* . . . . . 317, 318.  
*Ophiotrichoides* . . . . . 215.  
*Ophiotrochus* . . . . . 304, 305, 353, 382,  
 383.  
*longispinus* . . . . . **307**, 363.  
*Ophiotypa* . . . . . 234, 237, 382.  
*Ophiozona* . . . . . 148, 235, 282, 292, 293,  
**298**, 336, 381, 389.  
*alba* . . . . . 294.  
*antillarum* . . . . . 294.  
*bispinosa* . . . . . 294.  
*capensis* . . . . . 268, 293.  
*casta* . . . . . 294.  
*clypeata* . . . . . 294.  
*contigua* . . . . . 294.  
*depressa* . . . . . 294.  
*elevata* . . . . . 294, 295.  
*gymnopora* . . . . . 247, 292.  
*impressa* . . . . . 238, 298, 389.  
*inermis* . . . . . 267, 293.  
*insularia* . . . . . 294.  
*longispina* . . . . . 294, 297.  
*marmorea* . . . . . 294.  
*media* . . . . . 294.  
*molesta* . . . . . 294.  
*nivea* . . . . . 294.  
*pacifica* . . . . . 298.  
*platydisca* . . . . . 294, 295.

- polyplax ..... 294, 296.  
 projecta ..... 294, 295.  
 stellata ..... 294.  
 tessellata ..... 294.  
 tjalifiana ..... 294.  
 Ophiozonella .. 5, 235, 238, 283, 293,  
     **294**, 336, 353, 381,  
     389.  
 alba ..... 294, 297.  
 antillarum ..... 294.  
 bispinosa ..... 294.  
 casta ..... 294.  
 clypeata ..... 294.  
 contigua ..... 294.  
 depressa ..... 294.  
 elevata ..... 294, **295**, 363.  
 insularia ..... 294.  
 longispina .... 238, 294, 295, **297**,  
     363, 389.  
 marmorea ..... 294.  
 media ..... 294.  
 molesta ..... 294.  
 nivea ..... 294.  
 platydisca ..... 294, **295**, 363.  
 polyplax ..... 294, 295, **296**, 363.  
 projecta ..... 294, **295**, 358.  
 stellata ..... 294.  
 tessellata ..... 294.  
 tjalifiana ..... 294.  
 Ophiozonoida ..... 235.  
 Ophiura .. 235, 247, 248, 249, 266, 268,  
     275, 282, 305, 352,  
     382, 389.  
 acervata ..... 267.  
 æqualis ..... 267.  
 affinis ..... 267.  
 albata ..... 268, 270, **281**, 363.  
 albida ..... 267.  
 ambigua ..... 268.  
 amphitrites ..... 267.  
 annulosa ..... 300, 350.  
 arctica ..... 267.  
 aspera ..... 268.  
 atacta ..... 268.  
 aurantiaca ..... 267.  
 bathybia ..... 268.  
 brachyactis ..... 254, 260.  
 brevispina ..... 267.  
 calyptolepis ... 268, 270, **281**, 363.  
 capensis ..... 268, 293.  
 carnea ..... 267.  
 elasta ..... 266, 267.  
 clemens ..... 268.  
 conereta ..... 268.  
 costata ..... 268.  
 cryptolepsis ... 268, 270, **281**, 354.  
 falcifera ..... 268.  
 flagellata .. 266, 267, 269, **273**, 356.  
 fraterna ..... 268.  
 glyptodisca ..... 249, 253.  
 hadra ..... 262.  
 imbecillis ..... 267, 269, **276**, 358.  
 incrassata ..... 318.  
 indica ..... 267.  
 inermis ..... 267.  
 irrorata .. 249, 268, 270, **277**, 280,  
     356.  
 jejuna ..... 268.  
 kinbergi .. 237, 238, 267, 269, **271**,  
     357.  
 lepida ..... 267.  
 leptocenia ... 268, 270, **277**, 354.  
 ljungmani ..... 267.  
 longipeda ..... 227.  
 loveni ..... 268.  
 lütkeni ..... 267.  
 lymani ..... 238, 268.  
 maculata ..... 267, 269, **276**, 355.

- megapoma . . . . . 262, 264.  
 meridionalis . . . . . 267.  
 micracantha . . . . . 268, 269, **276**, 363.  
 monostoecha . . . . . 268, 270, **281**, 363.  
 multispina . . . . . 268.  
 mundata . . . . . 268, 280.  
 nereidina . . . . . 224.  
 nodosa . . . . . 254, 258.  
 œdiplax . . . . . 261, 263.  
 oöplax . . . . . 268, 269, **275**, 363.  
 ophiura . . . . . 267, 263.  
 papillata . . . . . 267.  
 paucisquama . . . . . 268, 270, **278**, 363.  
 penichra . . . . . 262, 264.  
 plana . . . . . 268, 280.  
 pompophora . . . . . 261, 264.  
 ponderosa . . . . . 264.  
 quadrispina . . . . . 268, 269, **275**, 355.  
 retzii . . . . . 118.  
 robusta . . . . . 267.  
 rugosa . . . . . 268.  
 sarsii . . . . . 267, 269, **272**, 354.  
 scolopendrina . . . . . 345.  
 sculpta . . . . . 258.  
 sculptilis . . . . . 265.  
 sterea . . . . . 258.  
 stiphra . . . . . 254, 259, 260.  
 stuwitzii . . . . . 254.  
 tenera . . . . . 268.  
 thouleti . . . . . 267.  
 undulata . . . . . 268.  
 verrucosa . . . . . 268.  
 Ophiurases . . . . . 139, 140.  
   obstrictus . . . . . 140.  
 Ophiurina . . . . . 371.  
 Ophiurochæta . . . . . 5, 308, 311, **316**, 380,  
   390.  
   littoralis . . . . . 101, 316.  
   mixta . . . . . 101, 309, 316, 390.  
 Ophiuroconis . . . . . 4, 5, 308, 310, 311,  
   **312**, 353, 380, 390.  
   miliaria . . . . . 312, 314, 390.  
   monolepis . . . . . 309, **312**, 316, 363.  
   pulverulenta . . . . . 312, 314.  
 Ophiurodon . . . . . 4, 308, 310, 311, **314**,  
   353, 380, 390.  
   cineta . . . . . 315.  
   cupida . . . . . 315.  
   grandisquama . . . . . 309, **315**, 316, 358,  
   390.  
   permixta . . . . . 315.  
 Ophiurolepis . . . . . 235, 249, **281**, 282.  
   carinata . . . . . 238, 282.  
 Ophiuroopsis . . . . . 28.  
 Ophiurothamnus . . . . . 94, 99, 125, **129**,  
   353.  
   dicyclus . . . . . **130**, 361.  
   exiguus . . . . . 130.  
   lævis . . . . . 130.  
   stultus . . . . . 130.  
 Paramphiura . . . . . 151, 165, 169.  
 Pectinura . . . . . 309, 311, 312, 319, 353.  
   anchista . . . . . 309, **322**, 363.  
   cylindrica . . . . . 322.  
   danbyi . . . . . 319.  
   gorgonia . . . . . 323.  
   infernalis . . . . . 324.  
   intermedia . . . . . 323.  
   marmorata . . . . . 323.  
   ramsayi . . . . . 323.  
   similis . . . . . 324.  
   stearnsii . . . . . 323.  
   venusta . . . . . 323.  
 Sigsbeia . . . . . 139.  
 Stegophiura . . . . . 234, 237, 248, **253**, 254,  
   352, 389.  
   brachyactis . . . . . 254, 255, **260**,  
   362, 365.

<i>elevata</i> . . . . .	254.	<i>vivipara</i> . . . . .	254, <b>255</b> , 362, 365.
<i>nodosa</i> . . . . .	254, 255, <b>258</b> , 354.	<i>Sthenocephalus</i> . . . . .	28.
<i>sculpta</i> . . . . .	254, <b>258</b> , 362, 365.	<i>Trichaster</i> . . . . .	4, 28, 30, 32, 35, 37, 54, 55, 353, 386.
<i>sladeni</i> . . . . .	237, 254, 255, <b>259</b> , 362, 365, 389.	<i>elegans</i> . . . . .	30, 37, <b>38</b> , 55, 356, 366, 385.
<i>sterea</i> . . . . .	237, 254, 255, <b>258</b> , 362, 365.	<i>flagellifer</i> . . . . .	37.
<i>striata</i> . . . . .	254, <b>255</b> , 362, 365.	<i>palmiferus</i> . . . . .	<b>37</b> , 38, 39, 356.
<i>stuwitzii</i> . . . . .	254.		

---

## CONTENTS.

	PAGE
Introductory .. .. .	1.
I. Oegophiuroidea .. .. .	5.
II. Myophiuroidea .. .. .	6.
i. Phrynophiurida .. .. .	6.
Ophiomyxidae .. .. .	7.
Trichasteridae .. .. .	27.
Gorgonocephalidae .. .. .	58.
ii. Læmophiurida .. .. .	90.
Ophiacanthidae .. .. .	92.
Hemieuryalidae .. .. .	138.
iii. Gnathophiurida .. .. .	143.
Amphilepididae .. .. .	144.
Amphiuridae .. .. .	149.
Ophiotrichidae .. .. .	214.
iv. Chilophiurida .. .. .	232.
Ophiolepididae .. .. .	233.
Ophiolencidæ .. .. .	303.
Ophiodermatidae .. .. .	307.
Ophiochitonidae .. .. .	325.
Ophiocomnidae .. .. .	340.
Ophiuran Fauna of Japan .. .. .	352.
Phylogeny of Ophiuroidea .. .. .	367.
Postscript .. .. .	384.
General Explanation of Plates .. .. .	384.
Index of Genera and Species .. .. .	393.
Plates I—VII, with Explanations.	

H. MATSUMOTO.  
MONOGRAPH OF JAPANESE OPHIUROIDEA.

PLATE I.

## PLATE I.

- Fig. 1. *Ophiodera anisacantha*. Dorsal view of the skeleton of two oral angles and one arm base, with the radial shields turned up, i.e. in ventral view.  $\times 6$ .
- Fig. 2. Ditto. Inner articular surface of a vertebra near disk.  $\times 6$ .
- Fig. 3. Ditto. Outer articular surface of the same.  $\times 6$ .
- Fig. 4. *Ophiomyxa australis*. Dorsal view of the skeleton of two oral angles and one arm base of a young specimen, with the radial shields turned up, i.e. in ventral view.  $\times 30$ .
- Fig. 5. Ditto. Inner articular surface of a vertebra near disk.  $\times 30$ .
- Fig. 6. Ditto. Outer articular surface of the same.  $\times 30$ .
- Fig. 7. Ditto. Dorsal view of the skeleton of two oral angles.  $\times 15$ .
- Fig. 8. *Ophiolyabus gotoi*. Dorsal view of the skeleton of two oral angles and the first vertebra.  $\times 15$ .
- Fig. 9. *Ophiostiba lidekii*. Dorsal view of the skeleton of two oral angles.  $\times 15$ .
- Fig. 10. *Ophiosmilax mirabilis*. Inner articular surface of a vertebra near disk.  $\times 40$ .
- Fig. 11. Ditto. Outer articular surface of the same.  $\times 40$ .
- Fig. 12. Ditto. A long arm spine, with two series of hooklets.  $\times 40$ .
- Fig. 13. Ditto. A short arm spine, with one main and one supplementary hooklet.  $\times 40$ .
- Fig. 14. *Asteromyxa loveni*. Dorsal view of the skeleton of two oral angles and one arm base of a young specimen, with the radial shields turned up, i.e. in ventral view.  $\times 20$ .
- Fig. 15. Ditto. Inner articular surface of a vertebra near disk.  $\times 20$ .
- Fig. 16. Ditto. Outer articular surface of the same.  $\times 20$ .



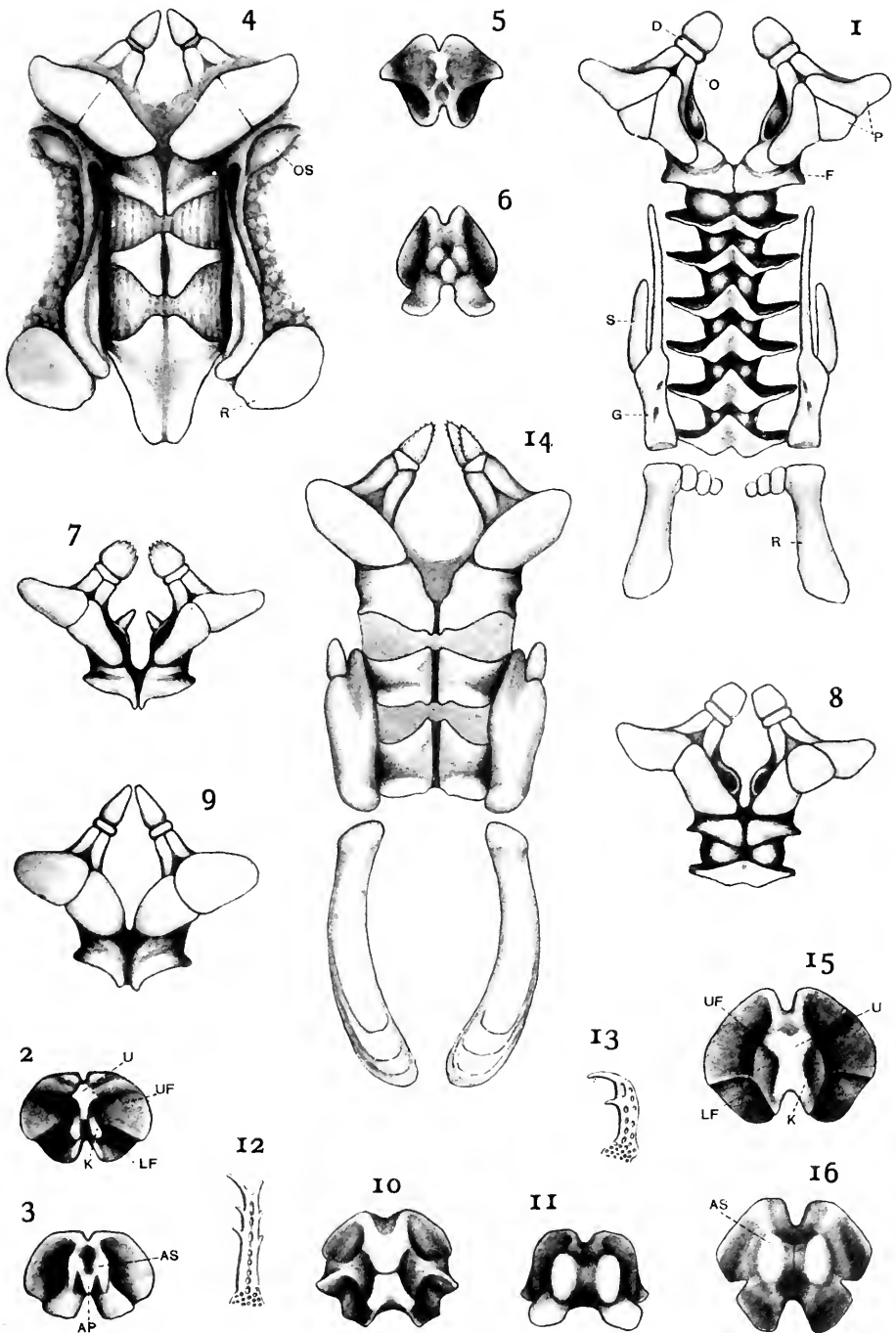



II. MATSUMOTO.  
MONOGRAPH OF JAPANESE OPHIUROIDEA.

PLATE II.

## PLATE II.

- Fig. 1. *Ophiosmilax mirabilis*. Dorsal view of a vertebra near disk.  $\times 40$ .
- Fig. 2. *Asteroschema japonicum*. Dorsal view of the skeleton of two oral angles and one arm base, with the radial shields turned up, i.e. in ventral view.  $\times 3$ .
- Fig. 3. Ditto. Ventral view of the skeleton of two oral angles and one arm base.  $\times 3$ .
- Fig. 4. Ditto. Side view of the skeleton of one oral angle and one arm base.  $\times 3$ .
- Fig. 5. Ditto. Outer view of an arm joint near disk.  $\times 3$ .
- Fig. 6. Ditto. Inner articular surface of a vertebra near disk.  $\times 3$ .
- Fig. 7. *Trichaster elegans*. Ventral view of the skeleton of two oral angles and one arm base.  $\times 2$ .
- Fig. 8. Ditto. Interbrachial lateral view of the skeleton of the disk and two arm bases.  $\times 2$ .
- Fig. 9. *Astrotoma sobrina*. Dorsal view of the skeleton of two oral angles and one arm base, especially showing the muscles between the basal vertebrae and the genital plate.  $\times 3$ .
- Fig. 10. Ditto. Ventral view of the skeleton of two oral angles and one arm base.  $\times 3$ .
- Fig. 11. *Astrothamnus echinaceus*. A compound hook of an arm annulus.  $\times 35$ .

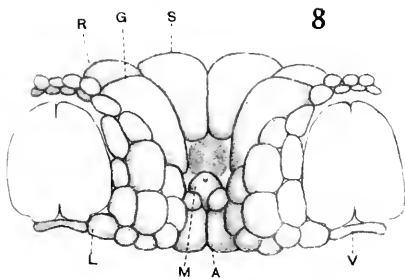
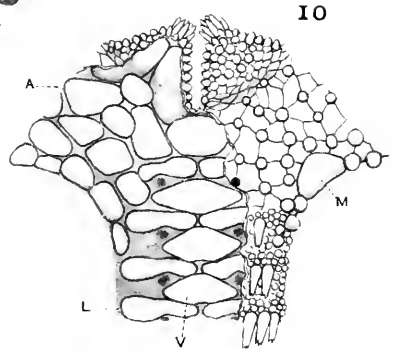
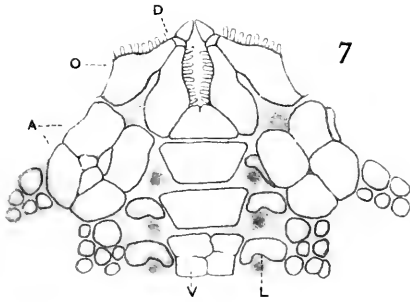
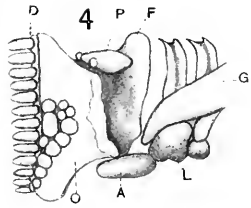
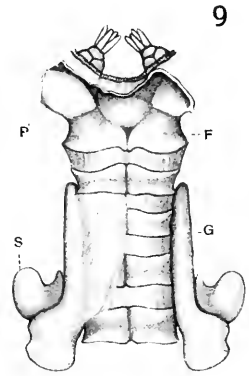
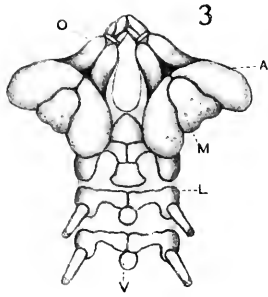
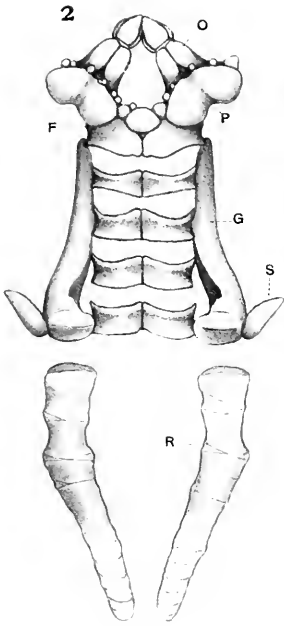



II. MATSUMOTO,  
MONOGRAPH OF JAPANESE OPHIUROIDEA.

PLATE III.

### PLATE III.

- Fig. 1. *Ophiacantha bidentata*. Dorsal view of the skeleton of two oral angles and the first vertebra.  $\times 10$ .
- Fig. 2. Ditto. Inner articular surface of a vertebra near disk.  $\times 10$ .
- Fig. 3. Ditto. Outer articular surface of the same.  $\times 10$ .
- Fig. 4. *Ophiolobes tuberosa*. Dorsal view of the skeleton of two oral angles and one arm base, with the radial shields turned up, i.e. in ventral view.  $\times 10$ .
- Fig. 5. *Ophiolimna antarctica*. Dorsal view of two oral angles.  $\times 10$ .
- Fig. 6. *Ophiolimna papillata*. Dorsal view of two oral angles.  $\times 12$ .
- Fig. 7. *Amphiactis umbonata*. Dorsal view of the skeleton of two oral angles and one arm base.  $\times 20$ .
- Fig. 8. Ditto. Ventral view of a distal vertebra.  $\times 80$ .
- Fig. 9. *Ophiactis pteropoma*. Dorsal view of the skeleton of two oral angles.  $\times 15$ .
- Fig. 10. *Ophiopholis aculeata*. Dorsal view of the skeleton of two oral angles and one arm base.  $\times 6$ .
- Fig. 11. *Amphioplus ancistrotus*. Dorsal view of the skeleton of two oral angles.  $\times 18$ .
- Fig. 12. *Amphiacantha dividua*. Dorsal view of the skeleton of two oral angles of a young specimen.  $\times 35$ .
- Fig. 13. *Amphiura vadicola*. Dorsal view of the skeleton of two oral angles.  $\times 10$ .



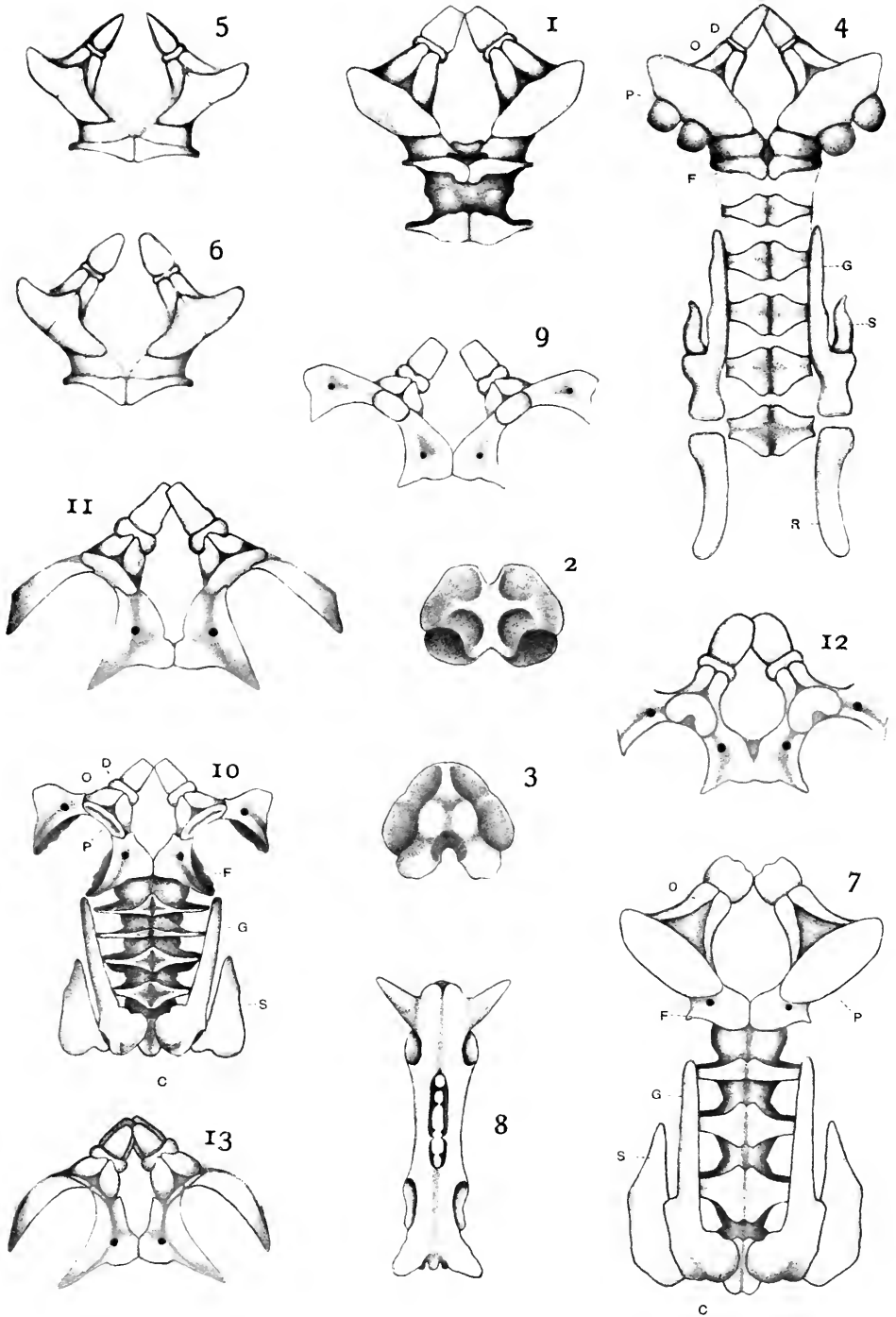



II. MATSUMOTO.  
MONOGRAPH OF JAPANESE OPHIUROIDEA.

PLATE IV.

#### PLATE IV.

- Fig. 1. *Hemipholis elongata*. Dorsal view of the skeleton of two oral angles and the first two vertebræ.  $\times 16$ .
- Fig. 2. *Amphipholis kochii*. Dorsal view of the skeleton of two oral angles.  $\times 18$ .
- Fig. 3. *Ophiophragmus japonicus*. Dorsal view of the skeleton of two oral angles.  $\times 20$ .
- Fig. 4. *Amphiura trachydisca*. Dorsal view of the skeleton of two oral angles.  $\times 8$ .
- Fig. 5. *Ophiocentrus verticillatus*. Dorsal view of the skeleton of two oral angles and one arm base.  $\times 13$ .
- Fig. 6. *Ophiothrix nereidina*. Dorsal view of the skeleton of two oral angles and one arm base, with the radial shields turned up, i.e. in ventral view.  $\times 10$ .
- Fig. 7. *Ophiothrix koronana*. Dorsal view of the skeleton of two oral angles and one arm base.  $\times 10$ .
- Fig. 8. *Ophiotlala danae*. Dorsal view of the skeleton of two oral angles and one arm base.  $\times 10$ .

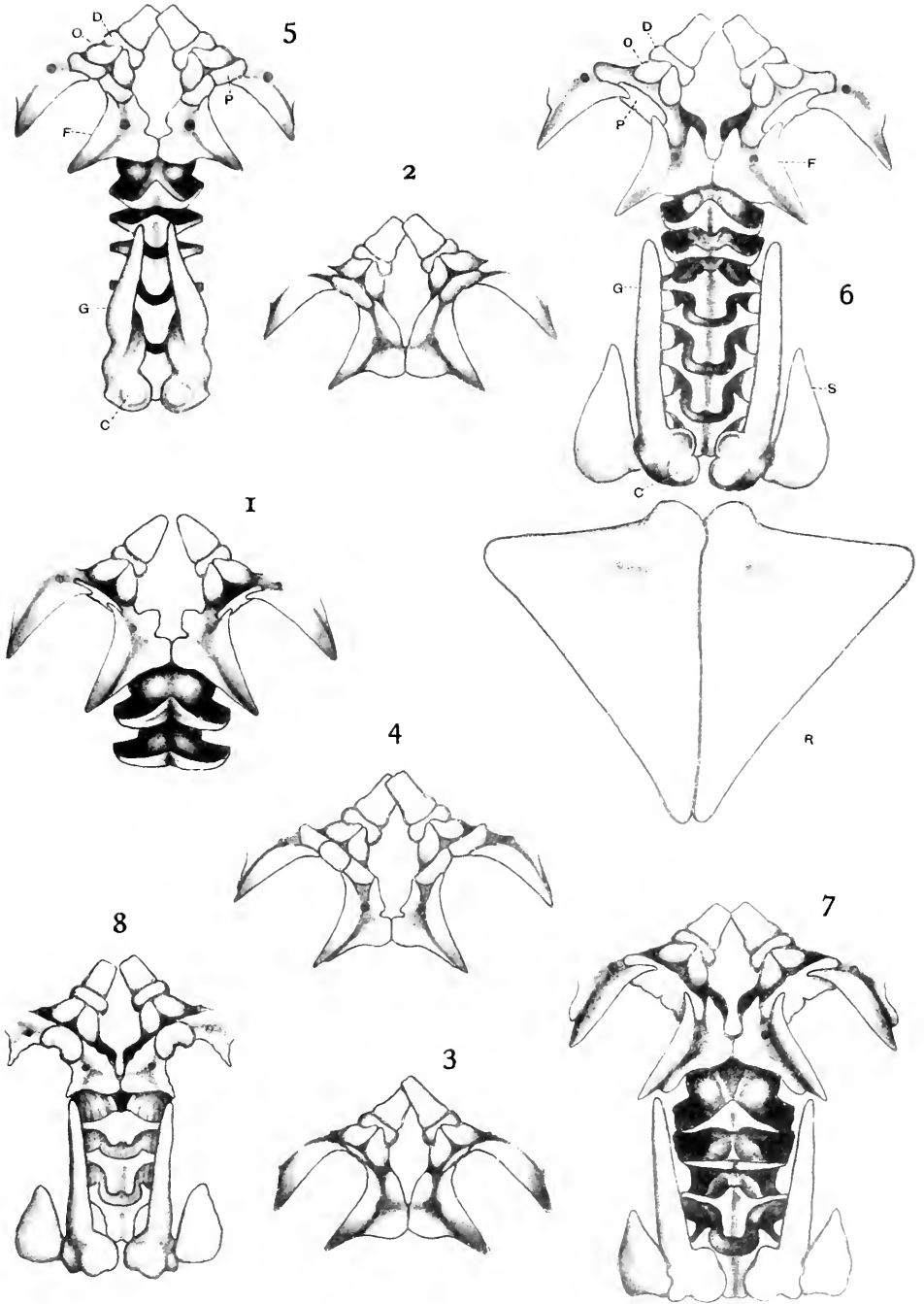

MATSUMOTO del.

Matsumoto: Japanese Ophiuroidea.



II. MATSUMOTO.  
MONOGRAPH OF JAPANESE OPHIUROIDEA.

PLATE V.

## PLATE V.

- Fig. 1. *Astrophiiura kawamurai*. Dorsal view of the skeleton of two oral angles and one arm base.  $\times 10$ .
- Fig. 2. Ditto. Ventral view of the skeleton of three arm joints within the pentagonal body, the ventral arm plates removed to expose the vertebræ.  $\times 10$ .
- Fig. 3. Ditto. Dorsal view of a distal vertebra.  $\times 125$ .
- Fig. 4. Ditto. Inner articular surface of the same.  $\times 125$ .
- Fig. 5. Ditto. Outer articular surface of the same.  $\times 125$ .
- Fig. 6. *Stegophiura sludeni*. Dorsal view of the skeleton of two oral angles and the first two vertebræ.  $\times 18$ .
- Fig. 7. *Ophiomusium trychnum*. Dorsal view of the skeleton of two oral angles and the first two vertebræ.  $\times 10$ .
- Fig. 8. *Ophiomusium cancellatum*. Dorsal view of the skeleton of two oral angles and the first two vertebræ.  $\times 12$ .
- Fig. 9. *Ophiozonella longispina*. Dorsal view of the skeleton of two oral angles and the first two vertebræ.  $\times 6$ .
- Fig. 10. *Ophiozona impressa*. Dorsal view of the skeleton of two oral angles and the first three vertebræ.  $\times 8$ .
- Fig. 11. *Ophioplocus japonicus*. Dorsal view of the skeleton of two oral angles and one arm base.  $\times 8$ .
- Fig. 12. *Ophioceramis januarii*. Dorsal view of the skeleton of two oral angles and the first vertebra.  $\times 10$ .
- Fig. 13. *Ophioleuce churischema*. Dorsal view of the skeleton of two oral angles and one arm base.  $\times 8$ .



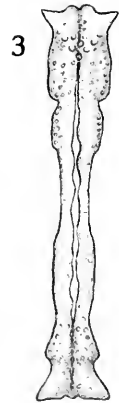
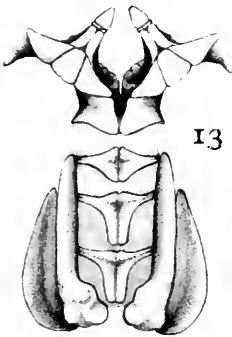
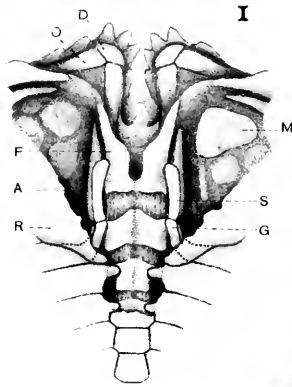
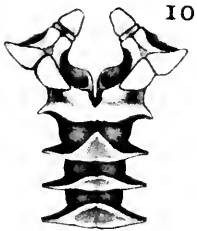
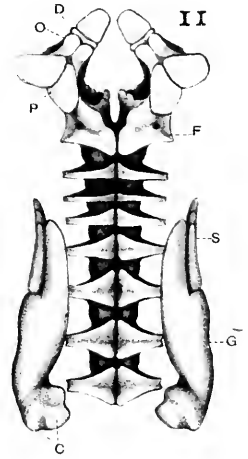
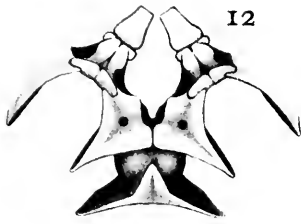



II. MATSUMOTO.  
MONOGRAPH OF JAPANESE OPHIUROIDEA.

PLATE VI.

## PLATE VI.

- Fig. 1. *Ophiurodon grandisquama*. Dorsal view of the skeleton of two oral angles and the first three vertebræ.  $\times 12$ .
- Fig. 2. *Ophiurochæta mixta*. Dorsal view of the skeleton of two oral angles.  $\times 10$ .
- Fig. 3. *Ophiurocoelis miliurica*. Dorsal view of the skeleton of two oral angles.  $\times 10$ .
- Fig. 4. *Ophiarachna incrassata*. Dorsal view of the skeleton of two oral angles and the first two vertebræ.  $\times 2$ .
- Fig. 5. *Bathypectinura gotoi*. Dorsal view of the skeleton of two oral angles and the first two vertebræ.  $\times 2\frac{1}{2}$ .
- Fig. 6. *Pectinura archista*. Dorsal view of the skeleton of two oral angles and the first two vertebræ.  $\times 10$ .
- Fig. 7. *Ophiarachnella gorgonivæ*. Dorsal view of the skeleton of two oral angles and one arm base, with the radial shields turned up, i.e. in ventral view.  $\times 7$ .
- Fig. 8. *Ophiochiton fastigatus*. Dorsal view of the skeleton of two oral angles and one arm base.  $\times 4$ .
- Fig. 9. *Ophioplax lamellosa*. Dorsal view of the skeleton of two oral angles and one arm base.  $\times 20$ .
- Fig. 10. *Ophiodoris pericalles*. Dorsal view of the skeleton of two oral angles and one arm base.  $\times 10$ .
- Fig. 11. Ditto. Dorsal view of two vertebræ near disk.  $\times 10$ .

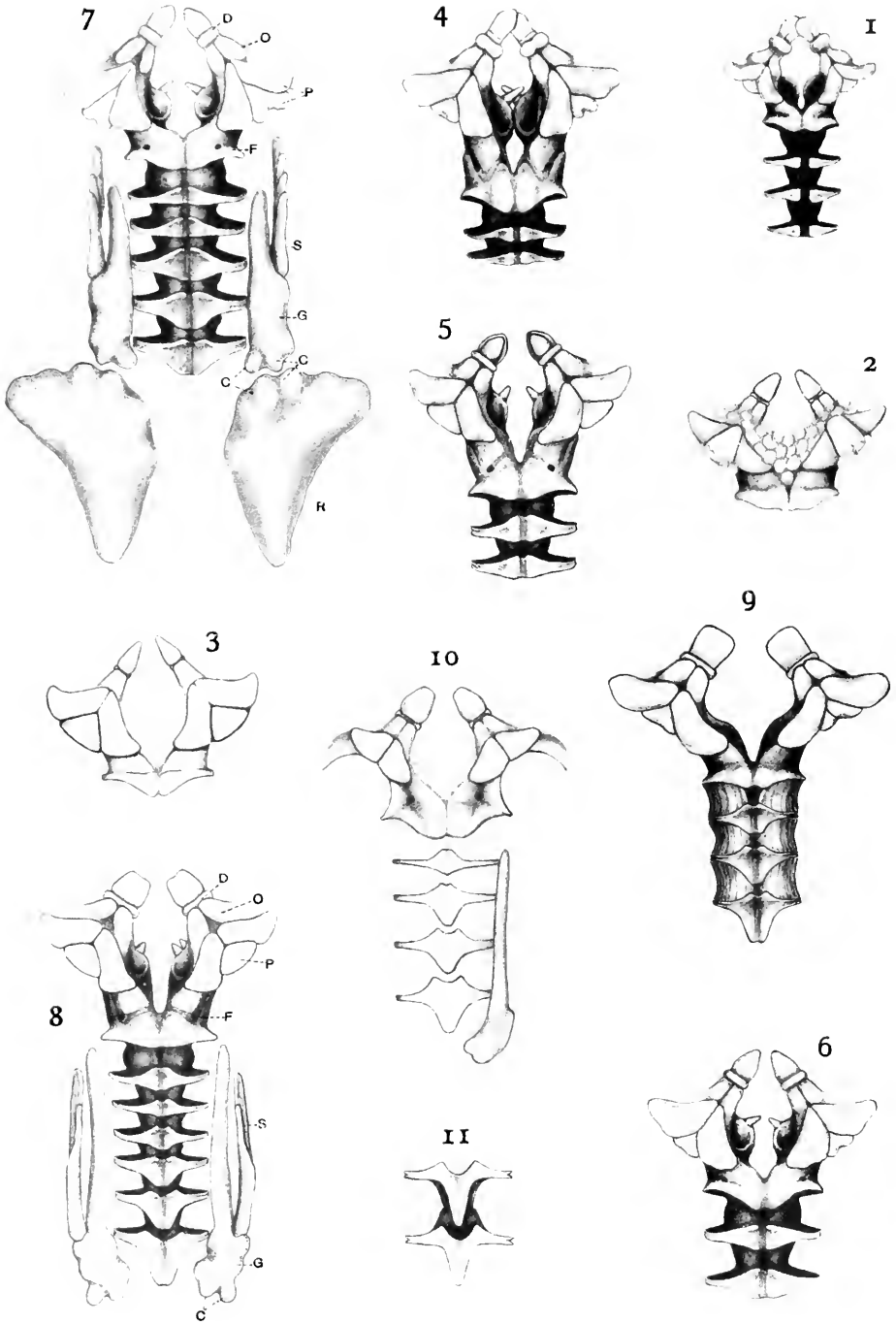



H. MATSUMOTO.  
MONOGRAPH OF JAPANESE OPHIUROIDEA.

PLATE VII.

## PLATE VII.

- Fig. 1. *Ophionereis annulata*. Dorsal view of the skeleton of two oral angles and one arm base.  $\times 10$ .
- Fig. 2. *Ophionereis reticulata*. Dorsal view of the skeleton of two oral angles.  $\times 8$ .
- Fig. 3. *Ophiocrasis marktanneri*. Dorsal view of the skeleton of two oral angles and one arm base.  $\times 15$ .
- Fig. 4. *Ophiocoma scolopendrina*. Dorsal view of the skeleton of two oral angles and the first three vertebræ of a young specimen.  $\times 15$ .
- Fig. 5. Ditto. Dorsal view of the skeleton of two oral angles and one arm base.  $\times 4$ .
- Fig. 6. *Ophiomastix annulosa*. Dorsal view of the skeleton of two oral angles and the first three vertebræ of a young specimen.  $\times 10$ .
- Fig. 7. *Ophiarthrum elegans*. Dorsal view of the skeleton of two oral angles and one arm base, with the radial shields turned up, i.e. in ventral view.  $\times 7$ .
- Fig. 8. *Ophiopsila riisei*. Dorsal view of the skeleton of two oral angles and one arm base, with the radial shields turned up, i.e. in ventral view.  $\times 14$ .



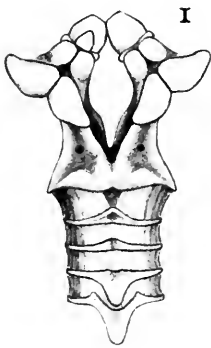
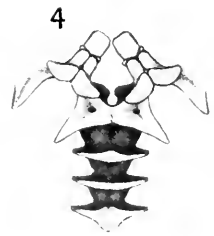
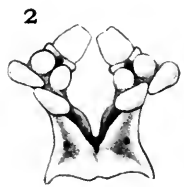
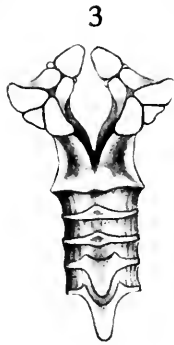
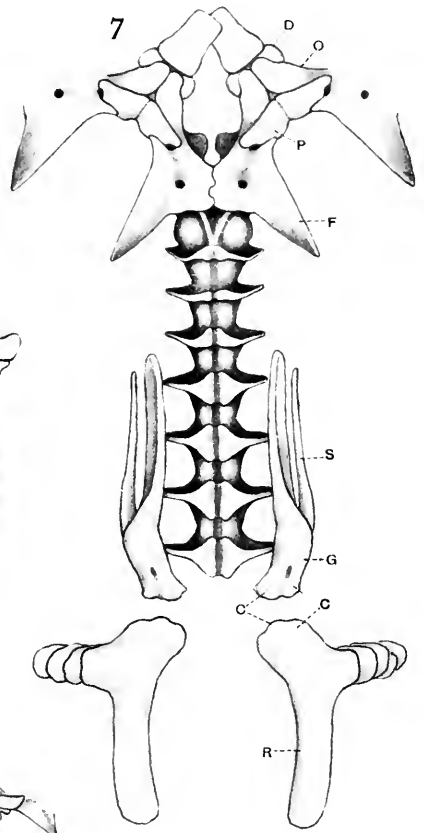
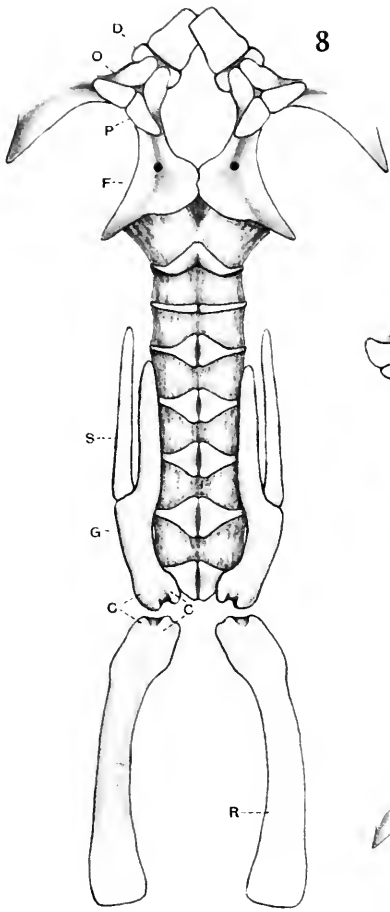





Frontispiece



Suzumoto photo

View of Sakura-jima in eruption, taken from the quay of Kagoshima  
on Jan. 12th, 10.40 A.M., 1914.

Koto : The Eruption of Sakura-jima.

## The Great Eruption of Sakura-jima in 1914.

By

**Bundjirô KOTÔ**, *Ph. D., Rigakuhakushi,*

*Professor of Geology, Science College, Imperial University of Tokyo.*

---

*With 24 plates and 49 text-figures.*

---

### Introduction.

The eruption of the insular volcano of Sakura-jima on January 12th, 1914, was not only unusual in its magnitude, but also in its bilateral eruptions accompanied with copious outpouring of lava-flows which plunged themselves into the surrounding seas. As such remarkable phenomena seldom occur twice in a life-time even in our volcanic Japan, the writer made two trips to the actual scene of activity. Both the University and the Earthquake Investigation Committee granted a generous subsidy for the purpose. The present paper is nothing more than a preliminary record of what he has seen in the field and observed in the laboratory, and does not pretend to be an exhaustive account of the recent subterranean convulsions at the world-known Sakura-jima.

Special acknowledgments are due to Assistant Professor M. KANAI, of the Higher School of Agriculture and Forestry, and

Professors M. UYÉDA and K. YAMAGUCHI, of the Female Normal School of Kagoshima, for their valuable assistance in collecting specimens of lavas and ejecta, and in securing photographs of Sakura-jima before and after the recent eruption. The writer is also indebted to Professor E. JUNKER, of the First Higher School here, for valuable suggestions during the preparation of the manuscript. Thanks are also owing to many other friends and colleagues, whose assistance by their publications and in supplying information is acknowledged in the text.

## Part I. General Outline of the Geologic Structure of Southwest Japan.

### § I. Geographic and Geologic Situation of Southwest Japan.

Among the insular garlands of Eastern Asia, there is an outwardly bending curve of island chain (Fig. 1) that stretches over  $6\frac{1}{2}$  degrees of latitude, and hangs at the north end of Taiwan and the southern terminus of Kyûshû, the latter being one of the three islands that constitute "Old Japan."

This linking chain is the Ryûkyû arc, which the writer has long considered as the geographic and geologic homologue<sup>1)</sup> of the Lesser Antilles with the classic volcanic islands of Martinique and

---

1) C. Brown acquainted us with the geologic homologue of the plateaus of Tibet and the Shan States of Yunnan, both being elevated ancient ocean-floors now undergoing abrasion and reduction to peneplains. The outer edge of each is bounded by a scarp exposing a zone of Archean and Paleozoic rocks which built up the Himalayan chain in the former, and the meridional western Yunnan ridge in the latter. In each case the zone is bounded by a great fault, making escarpment and at the same time forming the inner edge of the fore-deep (the Ganges and Irrawaddy) that separates the edge referred to from the foreland (the Decan and Upper Burma). Lastly, in front of the zone there occur faulted Tertiary strata (the Sub-Himalayan zone and the Tertiary of Upper Burma).

Fig. 1.—Geotectonic Map of S.W. Japan.

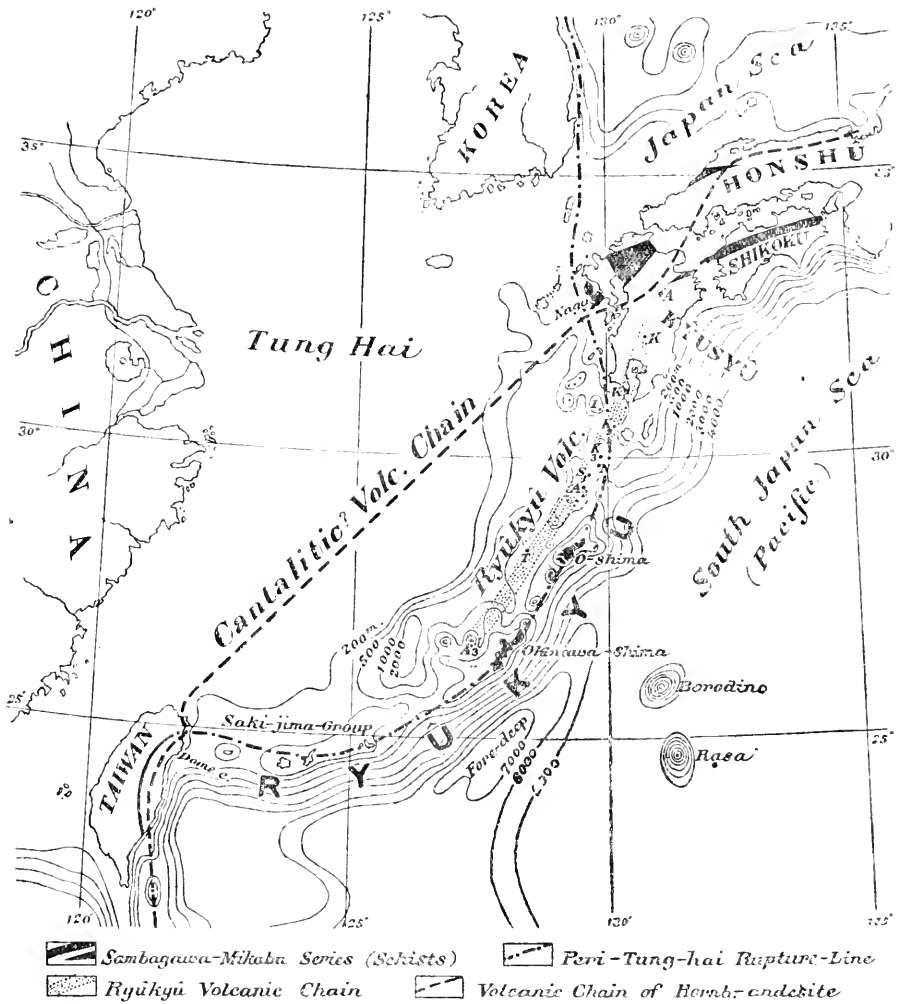

The writer may add the third member to the homologue, and that is the region under discussion. Indeed, the shallow Tung-hai is a submarine plateau bounded on the southeast by a scarp—the cordillera of Ryūkyū, which is also constructed of Paleozoic and green schists. This elevated zone makes the inner edge of the Ryūkyū fore-deep (700 m.) which separates the fore-land of the South Japan Sea, sometimes called Philippine Bay or Mariana Sea—the submarine plateau of 400 m. enclosed by a large sweeping volcanic chain of the Bonin, Mariana and Palau islands. Earthquakes are frequent in the fore-deeps of the Himalaya, the Yunnan-Burma frontier and Ryūkyū. The volcanic chain of Ryūkyū is represented in Upper Burma by sporadic occurrences of volcanoes in the Tong-yueh (騰越) area. We have hitherto failed to find recent volcanoes at the foot of the Himalayas, although Hedin records their occurrence in the inner Tibetan plateau. See C. Brown, *Record Geol. Surv. India*, Vol. XLIII, Part 3, 1913.

St. Vincent. Like the corresponding Atlantic chain, the Ryûkyû arc is built up of three concentric zones, *viz.*, the outer Tertiary and post-Tertiary, the middle Paleozoic, and the inner volcanic. This 'volcanic chain of Ryûkyû' begins with the Togara chain (the Kawabé Seven islands, Linschoten or Cecilia Is.) and its southern extension (Fig. 1,  $A_3$ ), and proceeds northwards toward Kyûshû through a number of active and dormant volcanoes to Kaimon (Fig. 1,  $K_1$ ; Fig. 2,  $K_1$ ), the last being the landmark and outpost of the inland volcanoes, located at the entrance of Kagoshima Bay. Sakura-jima, now under discussion, and also Kirishima should be coördinated with the already mentioned on the northerly prolongation of the same tectonic line, and likewise the *central* cones of the volcano of Aso in central Kyûshû.

---

To go more into detail, the volcanic chain starts from (1) Aguni (Fig. 1,  $A_3$ ), off the larger island of Okinawa. Then comes (2) the active Tori-shima  $T$ , which exploded in 1796, 1868, and April 11, 1903, on its northern prolongation.

Among the Togara chain, which follows with an interruption of 130 *km.*, on its northward extension dotted with twelve islands, we may only mention here (3) the konide of Akuseki  $A_2$ , and (4) the burning Suwanosé  $S_1$ .

Of the latter we have the record of eruptions in 813, 1811, 1827, 1887, 1912, and lastly, on March 21, 1914, when it was spasmodically active every 20–30 minutes, emitting dense clouds, and the quaking of the ground was felt at Ôshima at a distance of 150 *km.* The Meteorological Observatory of Kagoshima reported that from June 29, 1915, peculiar shocks were instrumentally recorded, especially on July 1st and 2nd. On the 6th, a Ryûkyû liner, the 'Okinawa Maru,' while coasting Suwanosé, noticed roaring and



glare from a point at seven-tenths of the altitude on the eastern slope of the highest peak, which emitted strong smoke or ash-clouds to a height of 3-4,000 feet. Suwanosé was again strongly shaken, producing fissures in the ground on September 3rd, 8 p. m., 1915, on account of which almost the whole population (250 souls) fled terror-stricken to Ôshima. The volcanic earthquakes continued then for two weeks with waning energy. The active centre lies within the crater, 800 *m.* high, in the middle of the island. It remained tranquil till the late strong earthquake, whence it slightly revived periodically ejecting ash-clouds. Suwanosé in sea and Kirishima on land ( $S_1$  and  $K$  in Fig. 1) are the two loci in the Ryûkyû volcanic chain which are at present constantly disturbed by volcanic paroxysms.

Then come in the series (5) the imposing solfataric Nakano-shima  $N$ , and (6) the smoking Kuchino-shima  $K_3$  in Fig. 1.

Farther north there lies (7) the solfataric Kuchino-Erabu or 'Front Erabu'  $K_2$  in Figs. 1 and 2. Geologically speaking, the last is already situated within the shattered region (*see* footnote p. 21 and p. 22) of southern Kyûshû. Still farther north we find the geologically connate *equatorial series of three islands*, of which (8) Iwô-jima ( $I$  in Figs. 1 and 2) or 'Sulphur Island'—the Lipari island of South Japan—is active; it exploded on March 31, 1914. Iwô-jima was colonized seven hundred years ago. In annals of old families some records of volcanic activity may be found, if search is made (*see* p. 21).

Beyond the Strait of Ôsumi or Van Diemen Strait on the north, we come to Kaimon and Sakura-jima as far as Aso at an average distance of 45 *km.* from one another. *See* Fig. 2,  $K_1$ ,  $S$ ,  $A$ .

A) The Peri-Tunghai Tectonic Line and the Genesis of the Ryûkyû Arc.—As it has been already stated that Sakura-jima is

one of the members of the 'Ryûkyû volcanic chain,' it will be well here to give a general outline on the geological significance and the genesis of the Ryûkyû arc.

There is a tectonic line of first magnitude in Eastern Asia which, starting from the east coast of Korea, apparently terminates at the south end of Taiwan, thus enclosing the entire region of the shallow Tunghai or Eastern China Sea (Fig. 1). The writer will hereafter call it the *Peri-Tunghai tectonic line*. This rupture line assumes various phases on its long sweep.

EAST COAST  
OF KOREA

a) On the east coast of Korea it appears as step-faults dropping eastward under the deep bottom of the Japan Sea.<sup>1)</sup>

FAULTING  
OF SOUTH  
JAPAN AXIS

b) On its southward course it cuts transversely right through the solid axis of the mountain fold<sup>2)</sup> which constitutes southern Japan, causing the west wing by this time to sink down to the continental shelf of the Tunghai. The shattered coast of western Kyûshû, the 'Ægean Sea of Japan,' owes its formation to this cause. The large crooked indentation of Ariaké, lying to the east of Nagasaki, is, geologically speaking, a part of the easterly lying Inland Sea or *Seto-uchi* that lies between the contracting end of Honshû and the island of Shikoku (Fig. 1).

In western Kyûshû we see a peculiar but highly important crustal movement of the Peri-Tunghai rupture-line, which can be adduced from the orientation of the *Sambagawa-Mikabu Series*<sup>3)</sup>

1) B. Kotô, 'Journey through Southern Korea.' *This Journal*, Vol. XXVI, Art. 2, 1909, Tokyo, p. 3. The faults produced are of the nature of what the Russian geologists call the *disjunctive*, and of the late von Richthofen's *Zerrungsverwerfung*.

2) It is what geotectonists call the *Blatt*, or *heave-fault*.

3) The series is an old prasinite complex of chlorite and graphite schists and overlying limestone, amphibole-schists, and clasto-pyroxenite of gabbroic derivatives, associated with glaucophane and piedmontite schists. In the writer's opinion, the series represents a metamorphic

(See in Fig. 2). The series, shaded black in Fig. 1, conforms to the curvature of South Japan in detached bands. In northern Kyûshû it widens and suddenly deflects southward near Nagasaki, continuing farther southward along the west coast of the islands of Amakusa. After an interruption of four degrees it reappears unexpectedly in Ôshima, whence it follows the curviform structure of the Ryûkyû arc (see Fig. 1).

MONOCLINAL  
RYÛKYÛ  
ARC

c) The Ryûkyû arc is monoclinial<sup>1)</sup> in structure, dipping westward, and facing its tilted edge toward the fore-deep of the Ryûkyû *Graben* (7,000 *m.*) on the open Pacific (Fig. 1). The overthrusting movement of crust-wave upon the fore-deep, accompanied perhaps contrariwise with underthrust, seems to the writer to be the cause of the curvilinear alignment of the submarine cordillera, whose crests appear as the serial islands of Ryûkyû. A reactionary regressive movement on the continental side caused depression (500–1,000 *m.*) and loosened the crust within the continental shelf—the Asiatic bank, giving occasion later to the outburst of magma. It is the inner zone and at the same time the VOLCANIC CHAIN OF RYÛKYÛ. (Fig. 1)

The Peri-Tungshai tectonic movement happened between the Cretaceous and pre-Lepidocyclus Tertiary times.<sup>2)</sup> From the main distribution of typical marine Tertiary beds which fringe the outer side of the cordillera and also Taiwan, it seems probable that the

---

facies of the whole Lower Paleozoicum, especially of the Devonian. As it is the oldest complex in our islands, excepting the basement gneiss which is of limited occurrence, the writer has chosen that as the exponent of the stratified bed.

1) It is usually spoken of as a portion of folded mountains which constitute the axis of the southern wing of the main Japanese islands. So far as the writer knows at present, there are no folded mountains in existence, but that of isoclinal *flexure*-ranges which simulate the folded structure.

2) Prof. Yabé informs me on a specimen which I sent him that a Nummulite, *Pellastispira*, occurs in the limestone from Motobu in Okinawa Island. He assigned the age of the rock to be either the Oligocene or the Eocene.

principal form-casting tectonic disturbance occurred before the deposition of the Tertiary complex in question. The faulting and other vertical movements, however, took place in the later Tertiary, or early Quaternary period, which movements still continue down to the present, as is evinced by frequent earthquakes. This geodynamic history is in conformation with that of Central Asia and peripheral China.<sup>1)</sup> The volcanic activity of the Ryûkyû chain began concomitantly with the above-mentioned later movements after the deposition of the thick *lapilli bed*, and the formation of the trench bay of Kagoshima. It will be referred to again in the sequel (p. 17).

The volcanic chain, as is frequently the case, traverses indifferently and in the present case obliquely, the ground structure of the Ryûkyû arc, and enters right through the middle of southern Kyûshû, Sakura-jima being one of the vents upon the chain. An inspection of the bathymetric conditions in Sketch-map Fig. 1, can tell the facts better than the writer.

Located between the two parallel deeps—the Ryûkyû fore-deep (*Graben*) and the inner rift-valley (Fig. 1), the Ryûkyû cordillera might have suffered ‘framed folding’ (Suess’s *Rahmenfaltung*). It is an open question whether the present volcanic chain stands on the margin of ‘relaxed’ *horst*, here meant by the Ryûkyû cordillera, as in Sumatra,<sup>2)</sup> or not; but at the distal end of the chain in southern Kyûshû several well-known volcanoes lie within a negative land-form—of which the trench depression, Kagoshima Bay, gives us unequivocal evidence (Fig. 2). We have to speak about it later on.

1) Machatschek, ‘Neuere Arbeiten zur Morphologie von Zentral-Asien.’ *Geogr. Zeitschr.*, 1914.

2) Volz, ‘Die geomorphologische Stellung Sumatras.’ *Geogr. Zeitschr.*, 15. Jahrg., 1909. S. 11. See also ‘Die Gajoländer,’ by the same author, Berlin, 1912.

It is contrary to modern views that here the volcano of Sakura-jima and many others sit upon the compressed, wedged-in bottom of a rift-valley instead of the loosened high edge of the same. Such examples are, however, not wanting in fissure-eruptions and effusions in Iceland.

TAIWAN AS  
PROLONGA-  
TION OF THE  
RYŪKYŪ  
ARC

d) In passing, the writer may mention for the sake of completeness the southern extension of the *outcurve* of the Ryūkyū arc. Adhering still to the same principle, we trace the trend of the ancient, green schistose Sambagawa-Mikabu beds through a detached group of the Saki-jima Group toward the stupendous diorite cliff of the Dome Cape of Taiwan (Fig. 1). Just as in the Ryūkyū arc, the fundamental structure of Taiwan remains the same, being homoclinal and also dipping westward. The same series in Taiwan, however, pursues a southward course, *curving inward* and westward; consequently, the east side of the island corresponds to the inner zone, and indeed a volcanic chain runs along the inner, east side. See Fig. 1.

In short, the guide line of the southwest islands of the Japanese territory describes an unbalanced sigmoidal course, the Ryūkyū curve faces its convex, and the Taiwan curve<sup>1)</sup> its concave side to-

---

1) The geologic structure of Taiwan is unique. The festoon islands of Eastern Asia, as in all similar cases of curvilinear island chains elsewhere, face their convex side toward an open ocean, while Taiwan alone (see Fig. 1) behaves contrariwise. The late von Richthofen in his oft-cited *Morphologische Studien aus Ostasien* called our attention to this point, and said of this island that it is geologically *neutral*, while leaving the question open on the cause which produced this peculiar geologic structure. The writer also believes that Taiwan is indeed a neutral region, and has been at a standstill, while the Philippine and Japanese islands disproportionately *bulged* out toward the western arm of the Pacific, which is a gigantic depression on the ancient continental border of Eastern Asia, and which the writer habitually calls the 'South Japan Sea.'

As a result of a conference with Messrs. Yamané and Noda, of the Geological Survey, who recently made journeys through South China, the writer is impressed with the idea that the *inclined tableland* of Fo-kien, together with the adjacent portions of Kwang-tung and Che-kiang, conforms to the *incurve* of Taiwan, with tilted edge this time toward the interior of China. This is the all important tectonic line in southeastern China, which has hitherto escaped the observation of geologists.

ward the open Pacific. Through the sinuous point or middle wing (Fig. 1) between the positive and negative curves, which is located at the northeast point of Taiwan, a volcanic line passes from the inner side of the Ryûkyû *outcurve* to that of the Taiwan *incurve*.

ESSENTIAL  
CHARACTER-  
ISTIC OF THE  
RYÛKYÛ  
VOLCANIC  
CHAIN

c) It should, however, be borne in mind that the volcanic chain of cantalitic hornblende-andesite of Taiwan reappears, after an interruption of seven degrees, at Unzen and Tara-daké (*U* and *T* in Fig. 2), both near Nagasaki, and then proceeds through the heart of Kyûshû at Kibô-zan *B*, Kujû *K*, Tsurumi and Yufu-daké *Y*, and Futago-yama *F*, and finally passes over to the contracted end of Honshû along the shore of the Japan Sea (Fig. 1). *The Ryûkyû volcanic chain, characterized by augite-andesite or auganite, on the other hand, only starts from Aguni (A; in Fig. 1) off Okinawa, and, as is frequently mentioned, runs through the Togara group to southern Kyûshû.*

We have, therefore, to distinguish two volcanic chains quite different in the nature of magma, *viz.*, the cantalitic hornblende-andesite and the femic augite-andesite. To the latter group belongs the Ryûkyû volcanic chain; and Sakura-jima, which is the subject of the present paper, is one of the members of this chain.

*B) The Principal Formations and Main Geologic Structure of Southwest Japan.*—From a glance at the map of the southern portions (Figs. 1 and 2) of both Kyûshû and Shikoku—the two main islands of “Old Japan,” one can readily understand the fundamental geologic structure. The principal geologic formations appear in parallel zones, which cross them from the northeast to the southwest, and the two islands are the *horst*-blocks in the geological sense of the term, with the *rias* coast on the eastern and western shores.

a) The northernmost zone is built up of the oldest formations of **Gneiss** (*G* in Fig. 2), variously intruded and assimilated by granitic magna. The region is for a greater part occupied by the equatorial Inland Sea or Sôto-nchi, and the Kyûshû portion of it is now hidden under the superimposed volcanic masses.<sup>1)</sup>

b) The next in the order of age lies to the south of the first zone in a narrow contracting band; and in northern Kyûshû it reappears on the north side of the first zone. It is the green schistose **Sambagawa-Mikabu complex** (*Sc* in Fig. 2) of earlier Paleozoic age already referred to.<sup>2)</sup>

c) Small patches of **Cretaceous** bed *Cr* occupy a narrow space between *a* and *b* zones on the east; but on the west coast of Kyûshû it covers the submerged area of the Gneiss zone in the Anakusa islands at the south of Nagasaki.

d) Next comes on the south side a broad band of **Paleozoic** graywacke formation *Pa*, devoid of fossils.

e) The southernmost zone is the sandy slate formation *M* of probably **Mesozoic** age. It is this formation which covers the three provinces of

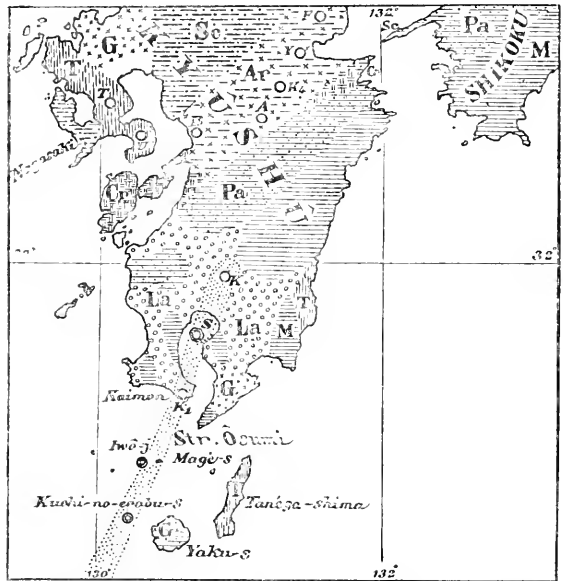

Fig. 2.—Geologic sketch-map of Southern Kyûshû  
scale 1 : 2,000,000

*Volcanoes:* *K*<sub>1</sub>-Kaimon, *S*-Sakura-jima, *K*-Kirishima, *A*-Aso, *K*<sub>j</sub>-Kujû-san, *Y*-Yufu and Tsurumi, *F*-Futago, *B*-Kibûzan near Kumamoto, *U*-Unzen, *T*-Tara-daké.

*Formations:* *G*-Granite, *Ar*-Archean, *Sc*-Sambagawa-Mikabu Schists, *Pa*-Paleozoic, *Cr*-Cretaceous, *M*-Mesozoic, *T*-Tertiary, *La*-Plateau Formation.

1) These surficial volcanic masses are left out in Fig. 2.

2) See page 6, footnote (3).

Hyûga, Ôsumi, and Satsuma, comprising an area of about one-third of whole Kyûshû (39,659 sq. *km.*). Poor seams of anthracite are intercalated in this complex.

Both the northerly lying Paleozoicum *Pa* and the southerly lying Mesozoicum *M* in Fig. 2—the two zones *d* and *e*—dip together toward the *northwest*, and on this account their geological relations are not at all clear to the writer. Topographically speaking, the boundary of both zones is the highest elevation (1,820 *m.*) and water-shed, traversing obliquely the whole breadth of Kyûshû. Granitic masses *G* occur within both terranes, one at the southernmost end of Kyûshû, the other at Yaku-shima *G*.

*f*) The **Tertiary** bed occupies only a small patch on the east coast; but it builds up the whole island of Tanéga-shima (*T* in Fig. 2). It is characterized by the presence of *Operculina*, just like the petroliferous Tertiary of central Taiwan.

In short, the three principal formations *a* (*Ar*), *d* (*Pa*) and *e* (*M*), counting from the north and in the order of age, traverse obliquely the geologic *horst* of the Kyûshû block (Fig. 2).

---

*g*) Having given an epitome of the principal formations and main geologic structure, the writer has still to mention a surficial bed on the Mesozoic (*M*) and Tertiary (*T*) terranes, which bed has a great bearing in deciphering the mode of formation of Kagoshima Bay.

The land surrounding the bay is a *plateau of lapilli and ash*, which attains an altitude of 230 *m.*, and which bounds the shore in sharp perpendicular cliffs, as if the bay were a sunken gigantic caldera, for which indeed it was taken by the late F. v. RICHTHOFEN. It is the **Plateau Formation** (*La*). The bed occupies a greater or lesser portion of the provinces of Satsuma, Ôsumi and Hyûga, comprising an area of 1,650 sq. *km.* From the terrene rise the Mesozoic slate formation *M* and granitic masses *G* in Fig. 2, and it is underlaid and in part *overlaid* by volcanic masses, one of the latter being the well-known volcano of Kirishima.



## § II. On the Formation of the Trench Bay of Kagoshima.

### A) General Geology of the Environs of Kagoshima Bay.—

As to the outstanding question about the foundation, on which the volcano Sakura-jima stands, it is first of all necessary to know the geology of the border land of the bay. As has just been stated, the extensive (1,650 sq. km.) and thick (100 m.), ash-grey and loose bed of lapilli and ash is a characteristic formation of the present area, forming a high flat of more than 230 m. This formation is underlaid by a complex of sandy slate of problematic Mesozoic age, and the Tertiary *Operculina*- and shell-bearing sandstones with coaly shale. Both are intruded at several places by the *ash-stone* which plays a great rôle in the geology of the region.

ASH-STONE,  
AN ASO  
LAVA      a) The ash-stone<sup>1)</sup> or *hai-ishi*—a hypersthene-trachyandesite (Pl. XVI. Fig. 1) is an ash-gray, friable and porous rock, so named on account of its having the appearance of hardened volcanic ash. It is extensively quarried for building materials, due chiefly to its being easily worked rather than to its intrinsic value.

The  $\alpha$  variety is dopatic, with phenocrysts of idiomorphic oligoclase and corroded sanidine. Femic minerals, such as hypersthene, augite, hornblende and biotite, are found only sparingly and often not discovered in a slide, the first component being, however, comparatively abundant. The main bulk of the rock is devitrified glass of various degrees of alteration, often spherulitic (Pl. XVI. Fig. 2) and sometimes silicified. The  $\beta$  variety is a black porphyritic obsidian, and semipatic with macrophenocrysts of feldspars, the black base being colorless glass swarming with streams of feldspar-microlites. It seems to correspond in a strict sense to the so-called *Aso lava*. (Pl. XVI. Fig. 3)

The light-grey  $\gamma$  (Pl. XVI. Fig. 2) modification makes shreds in the

---

1) It is a piperno-like eutaxitic rock, striped with black glass in pumiceous white mass. The stripes may be either *schlieren*-like patches detached by flows, or doughs of lava dropped in white ash mass. It is habitually called the 'Aso lava' by our geologists.

preceding, from which this one differs only in the groundmass, being mainly spherulitic, and gradually passing to spherulitefels. It frequently makes an independent mass. It is this ash-stone which seems to the writer to be the same effusive, named plagioliparite or rhyodacite, found in patches *all over Japan*, although here quartz is not typically developed. It is this rock which gave birth to the oft-mentioned *submarine bed of lapilli* that is usually misinterpreted as having been ejected from either Kirishima or Sakura-jima.

ASH-STONE  
AND LAPILLI  
BED IN THE  
ENVIRONS  
OF THE CITY  
OF KAGO-  
SHIMA

In order to make a close study of the geologic data given above, as well as to illustrate the mode of formation of the bay itself, the writer will select the environs of the city of Kagoshima for this scope.

The city lies opposite and west of the volcanic island of Sakura-jima, and is separated from it by a channel 3.7 *km.* wide and

25 fathoms deep. The old castle-hill of the Feudal Lord Shimazu stands in the city on the plateau-edge, 100 *m.* high. It is the *type of the lapilli plateau* of southern Kyûshû.

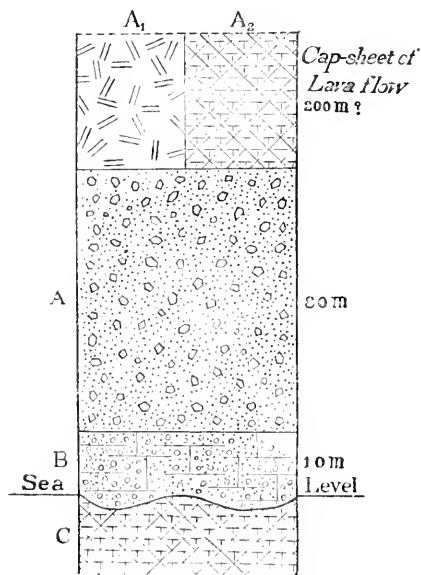

Fig. 3.—Section of Lapilli Plateau near Kagoshima.

*A.*—The upper massive, 80-meter bed is built up of an incoherent ash-grey mass of pumice and lapilli, loosely cemented with ash, underlain (at the entrance of the railway tunnel) by

*B.*—A light-brownish clay bed (Fig. 3). It consists mainly of comminuted pumice and a few clayey particles with some hypersthene

and hornblende crystals. The fossils found by the writer are *Dentalium* sp. and a univalve. This corresponds to the fossil horizon at Kaikata immediately to be referred to. The two beds *A* and *B* lie conformably with gradual transitions.

*C*.—The bottom exposed here is of a grey, soft and soaking mass of *hai-ishi* or hypersthene-trachyandesite, already briefly outlined (p. 13). This is a submarine lava-flow which gave birth to the lapilli. Pl. XVI. Fig. 1.

Following the railway from Kagoshima northward along the shore, the effusive *C* becomes spherulitic with pyroxenes at Jigami Station, *i.e.*, the  $\gamma$  type (p. 13). Pl. XVI. Fig. 2. At Shigétomi the lapilli plateau, 500 *m.* high, is capped with trachybasalt *A*<sub>1</sub>. Pl. XVI. Fig. 4. Farther northward, at the foot of Kirishima, the cap-rock is a hornblende-bearing pyroxene-andesite *A*<sub>2</sub>, which apparently attains a thickness of more than 200 *m.* (*see* Fig. 3).

The extensive bed of block-mud capped with hornblende-pyroxene-andesite in northern Kyûshû, especially in the Yabakei region in Prov. Bungo, seems to the writer to be the equivalent of our lapilli bed *A* and the cap-rock *A*<sub>2</sub>. The Yabakéi region is well known for its canyon scenery. The lapilli bed or its equivalent is, therefore, regional, and by no means confined to a corner of southern Kyûshû.

The stretch, 100 to 500 *m.* high, between Kagoshima and Shigétomi just referred to, and all the plateau-lands (400 *m.*) on the southern foot of Kirishima descend precipitously, *e.g.*, at Kokubu Station,<sup>1)</sup> to the shore-flat, or directly to the water's edge (Pl. IV. Fig. 1)—a special

1) After having finished the manuscript, the writer came across the passages in which the Ite v. Richthofen has not only given an exact written profile of hornblende-bearing pumiceous complex capped with *trachytic* rock, accompanied with petrographic details at the north of Kokubu, but also the canyon-like erosion valleys in the plateau land, which characterize the scenery of this region. ('Geomorphologische Studien', III, S. 16.) The writer was greatly surprised at the author's keen observation many decades ago, when that part of Japan was still entirely unknown; but his comparison of the Bay of Kagoshima and the Sakura-jima volcano with the Laguna de Taal in Luzon seems, however, not a fortunate one. The writer considers the bay as a rift valley and not a caldron depression; but it must be remembered that a partial nature of kettle depression is not yet fundamentally confuted.

clean-cut topography, which eloquently speaks for the depression of the whole complex to the bottom of 100 fathoms of Kagoshima Bay.

SETO  
REGION ON  
THE OP-  
POSITE COAST

The same geologic feature can be seen on the opposite coast near Séto Strait, now entirely buried and land-locked by lava-flows of the last eruption. The table-mountain of Sakkabira (Hô-zaki) (325 *m.*, Pl. IX. Figs. 2 and 3; Pl. X. Figs. 1 and 2; also Geologic Map), facing the strait, is again the ash-stone or piperno *U* (Fig. 3) of rather compact texture and light-gray tint, capped with a dark-gray trachybasalt *A*<sub>1</sub> in Fig. 3. In the former, *i.e.*, the ash-stone or hypersthene-trachyandesite, hornblende or biotite are occasionally found as accessories. The  $\beta$  and  $\gamma$  varieties (p. 13) are exposed on the shore near Obama, 1 *km.* south of the strait, *o* in Pl. XII. Fig. 1. Landward we find the Mesozoic slate, striking N.E. to S.W. with northwesterly dips, in contact with granite batholith. See Geologic Map.

Both are intruded by the ash-stone *U*, which was eroded later together with the slate and granite mass, resulting in the formation of flat-topped mountains, 300–700 *m.* high. They are flanked on the western shore by the 200-meter terrace of lapilli bed. (Pl. XII. Fig. 1)

At the fishery village Kaikata, south of the above-mentioned Obama, the ash-stone is overlain discordantly on the eroded edge by a gravel bed of slate, ash-stone and ash, which corresponds to the horizon *B* of Kagoshima (Fig. 3, p. 14). The writer made here a collection of a number of fossils which were sent to Prof. H. YABÉ for examination. The fossils determined are *Cardium muticum* Rwe., *U. retusum* L., *Dosinia troscheli* Lischke, *Tapes egyptus* Phil., *Bulla verrucosa* var. *ovula*?, *Cassia* sp. indet. YABÉ remarked that all are living species, No. 2 however, being rarely found as a fossil, and that the age of the bed *B* in question may be of either the **late Tertiary** or the **Diluvial**.

Another locality, made known by M. UYÉDA, is 0.2–0.3 *km.* inland from the shore of Tarumi, which lies to the south of the aforementioned Kaikata. The sandy fossil bed underlies the surface loam deposit, 1–1½ *m.* thick, and is probably of the same age as the Kaikata bed. The

bed is full of *Cardium* (*Lunlicardium*) *retusum* L. and *Phos senticosus* L., which are being used as raw materials for limekilns.

From the attitude of this bed toward the Tertiary *Operculina* sandstone in another region (near Miyazaki), the writer is disposed to consider with YABÉ the fossiliferous gravel bed to be of the *later Tertiary* or the *early Diluvial* age. The fossiliferous layer is seen at the above-mentioned Kaikata, often intercalating with the lapilli bed, 100 m. thick, which contains blocks of ash-stone. The lapilli and fossiliferous horizons (*A* and *B* in Fig. 3) are not separable and both are submarine deposits.

EARLY  
DILUVIAL  
AGE OF  
LAPILLI  
PLATEAU

We are, therefore, forced to the conclusion that the entire Plateau Formation, now elevated 200 m., must be of *later Tertiary*, or more probably *early Diluvial age*.<sup>1)</sup>

As the plateau edge, 100 m. high, forms cliffs all along the shore as on the Kagoshima side, we have again here the proof that *Kagoshima Bay is a hollow* in the lapilli formation, depressed during the Diluvial period. Considering the average elevation of the Plateau-land to be 230 m. and the bottom of the bay 200 m. or 100 fathoms, the *vertical relative displacement of the crust will therefore amount to 430 m.*—a considerable crustal displacement which occurred in a comparatively recent geological period in southern Kyûshû.

HOW KAGO-  
SHIMA BAY  
FORMED

that *Kagoshima Bay is a hollow* in the lapilli formation, depressed during the Diluvial period. Considering the average elevation of the Plateau-land to be 230 m. and the bottom of the bay 200 m. or 100 fathoms, the *vertical relative displacement of the crust will therefore amount to 430 m.*—a considerable crustal displacement which occurred in a comparatively recent geological period in southern Kyûshû.

Having dwelt upon the region of Kagoshima City, and of the defunct Seto Strait, the writer will now shortly touch on the third region of the lapilli land, where the crucial test can be advanced to the actual dislocation by which Kagoshima Bay was created.

GEOLOGY  
AND DIS-  
LOCATION OF  
THE KAIMON  
AREA

At the entrance of the Bay of Kagoshima stands the prominent konide (*see* Fig. 2) of Kaimon, from which the view (Pl. IV. Fig. 2) was taken northward to show

1) The Plateau Formation may perhaps represent both the late Tertiary and the early Diluvium without unconformity between them, on the supposition that the physiographic environment remained the same throughout the whole range of time.

the escarpment of dislocation on the left side. The region is likewise built up of ash-stone *C*, or hypersthene-trachyandesite apparently with some *quartz*, overlaid by block-mud *B*, and then lapilli deposit *A* (see Fig. 3). The rolling surface, 200 *m.* or more high, built up of these rocks, descends abruptly eastward, as in the figure, by faulting toward the lowland of Kaimon, on which at later times the konide of the same name and the gigantic crater-lake of Ikéda (Pl. IV. Fig. 2) with a diameter of 4 *km.* made their appearance, the one being the positive and the other the negative form of nearly equal size and volume.<sup>1)</sup> The remarkably regular escarpment of over 100 *m.*, so produced, runs with a trend to N.N.E. as in the figure. It is a part of the cliffs that bound the western shore of Kagoshima Bay.

CONCLUDING  
REMARKS ON  
THE FOR-  
MATION OF  
KAGOSHIMA  
BAY

What has already been stated will be sufficient for the present purpose in regard to the geology, and the way which led directly to the formation of Kagoshima Bay. The writer will now summarize the facts mentioned and the suggestions made before.

The bay is a slightly-bent trough at the south end of, geologically speaking, the oblique *horst* of Kyûshû, and at its northern blind recess rises the volcano island of Sakura-jîma. The bay is in average 20 *km.* wide, and 60 *km.* in its axial direction as the prolongation of the volcano chain of Ryûkû. That it is a topographic hollow was long since stated by v. RICHTHOFEN and STUËSS, from the morphological aspect which it presents. Conscious of this or not, our geologists hold the same view; and especially since the recent paroxysmal convulsion of Sakura-jîma, the super-

1) The diameters of the Lake Ikéda and the base of Kaimon are about 3.5 *km.*, and the volume of the lake also approximately coincides with that of the volcano, being about 4 cub. *km.*

abundant literature on the eruption by specialists as well as by laymen is diffused with phrases of the same tone. But so far as the writer's knowledge goes, no one has ever studied seriously the geology, the mode of formation and the age of tectonic movement in the bay. For this reason, the writer has indulged somewhat in detail on the above subjects.

EPITOME  
OF THE  
GEOLOGY

The geology of the region, briefly told, is this:

The region around Kagoshima Bay is built up of Mesozoic slate and batholithic granite. On the eroded surface of submerged land deposited locally the Tertiary formation, which was later partially upheaved and eroded. Then vulcanism was called into play in the shallow sea, when the ash-stone *C* (Fig. 3) poured out, catching fragments of slate, which solidified under water as soaking stone and spherulitefels. Then sands and gravel *B*, products of erosion, deposited with marine shells. Vulcanism was still in full force, ejecting submarine pumice and lapilli *A*, which were deposited to a great thickness of 100 *m.* or more.

Meanwhile the sea was sinking while deposition was going on. Finally, the land was upheaved to 230 *m.* forming a monotonous lapilli plateau which characterizes the region (Pl. IV. Fig. 1). The long interval of vulcanism corresponds to the *later Tertiary or early Diluvial time*, which we know by the evidence of fossils. Cotemporaneous with that upheaval, vertical displacement of 430 *m.* took place, thereby creating the trough-bay of Kagoshima. The whole coastline of Kyûshû was remodeled during this period.

It is contrary to an assertion often made recently that here volcanoes find their vents in the sunken bottom, as Sakura-jima and Kaimon, instead of the highland margin of the tectonic *graben*. The writer is inclined to think that volcanic vents find

their orifices only on the edge of a rift-valley, *when the depressed and compressed crust makes underthrust against the standing block, which in consequence rises and expands and also bursts open, thereby giving occasion to the escape of magma.*

In the present area, the undisturbed plateau simply sank down clear-cut in trench form, the bottom of which was, however, multifariously shattered into polygonal blocks, which appear above the water of the bay as the islets of Oko-shima, Hakamagoshi, Ko-jima, Kanzé, and Karasu-jima, the last being buried under the recent lava-flows. Simple fragmentation is directly opposed to the compacting of the wedged-in crust. This may afford some opportunity to the upward stoping and the eruption of active magma. Volcanoes make their appearance in a diffuse manner in such a pattern of great magnitude. In another aspect it seems to accord well with RECK's second case<sup>1)</sup> of the occurrence of eruptive vents, that is to say, within a trench valley the outbursts follow the fracture-line which bounds the table-horsts.

*In short, the plateau of Satsuma and Ôsumi is a table-block, while the table-fracture within the block created Kagoshima Bay, and the fragmentation of dropped block gave occasion for the escape of magma to the surface.*

B) The Outlying Ôsumi Group<sup>2)</sup>—The extensive plateau-land of lapilli is not confined to the above area. It occurs not only in detached patches in central-western Kyûshû, but also on the southern extension of Ôsumi and Satsuma in the form of *island groups*, where it occupies a total area more than that already mentioned. The writer adduced the facts of this unexpected dis-

1) Wolff, 'Der Vulkanismus,' I. S. 111.

2) See *ante*, p. 5.



covery from the keen stratigraphic observations made by I. Friedlaender, although he seems to be unconscious of the real extension of the lapilli plateau land. Through the effort of the German naturalist,<sup>1)</sup> some light is thrown on this vulcanologically little known group of Iwô-jima and Kuchino-Erabu.

He speaks of IWO-JIMA (Fig. 1, I; Fig. 2) as a high flat of 100-200 *m.*, being built up of vitroandesite overlaid by tufaceous

---

1) 'Ueber einige japanische Vulkane.' *Mitteil. Deutsch. Ges. f. Natur- u. Völkerkunde Ostasiens.* Bd. XII. Teil 2. Tôkyô, 1910.

For the sake of comparison and the cognate relation which they bear with Sakura-jima, a few notes will be appended chiefly from the work cited above, on the islands now under consideration (see Fig. 2).

a) The active IWO-JIMA ('Sulphur Island') lies 18 miles from Cape Kaimon, and has a circumference of 12 *km.*, the western half is a high flat, 200 *m.* in height, being built up of vitrodacite, tuff-sandstone and pumice, capped with lava-sheet. The eastern half is occupied by an active cone, 770 *m.* high, which rests upon the pumice terrace. The cone carries a top-crater having a diameter of 7-800 *m.* and a depth of 50. Fumaroles and solfataras are hissing from the bottom. The island is the well-known producer of sulphur and supports 900 inhabitants of whom one-third find their employment in working the sulphur deposits. We know of no historic record of any eruption. As it was colonized seven hundred years ago, old families must keep some records of activity, which may be found if search is made. At the beginning of April, 1914, it showed an unusual mood of vulcanism in throwing up smoke in sympathy with Sakura-jima (See p. 5).

b) The smaller TAKENO-SHIMA lies to the east of it. It is a flat island bounded on all sides by cliffs. The geological structure is exactly the same as the foundation of the preceding. Friedlaender imagines the island to be a part of a ruined cone whose center lies in the bottom of the southern coast. To the writer it seems more plausible to take the island for a patch of shattered lapilli land. We entirely miss petrographic details. Younger cones are not found on the island.

c) The westerly-lying KURO-SHIMA is a 'black' wooded conical island of the size of the preceding. It is said ('Geographic Scraps of Satsuma, Ôsumi, and Hyûga') that to reach the steep top (250 *m.*) is by no means easy, and there are cataracts within the thick forest on the way up to the crater which seems to be of recent origin. We know nothing about its rocks and eruptions.

d) KUCHINO-ERABU lies not far from Yaku (see p. 5). It is ill-defined, stretching 12 *km.* from N.N.W. to S.S.E. According to Friedlaender, it is likewise an elevated flat (150 *m.*) and cliff-bound, and has the same lithologic elements and structure as Iwô-jima and others. It carries upon the foundation the overlapping cones (665 *m.*), the north cone being older and craterless, the southern one still preserving a fresh solfataric crater. At the middle stands the latest-born giant with an apical crater, 500 *m.* in diameter and 50 *m.* in depth, where strong fumaroles are hissing and depositing sulphur. A hot spring gushes at the northeast coast. A violent eruption is said to have occurred in 1839, when many people were buried alive. At the end of March, 1914, it was rumored that it had thrown up thick smoke, which was observed from the easterly-lying Yaku-shima, in sympathy with Sakura-jima.

sandstone and a strong bed of pumice, capped with a sheet of lava-flow. The eastern sister island, TAKENO-SHIMA, has the same topography (100 *m.*) and the same lithologic elements. KURO-SHIMA, lying 17 miles west of the former, was seen by him, however, only from a distance, and we know nothing about its rocks and eruptions. Probably it is of the same type as the two preceding ones. KUCHINO-ERABU (Fig. 2; Fig. 1 *K*<sub>2</sub>) is also a cliff-bound flat island, 150 *m.* high, and geologically and topographically an exact copy of Iwô-jima, above referred to. These four islands were later crowned with recent volcanoes.

CONCLUSION From the similarity in the geology and topography of adjoining lands and the insular group in question, we can picture in our mind the region to have been once an extensive plateau-land, which was later shattered, contemporaneous with the creation of Kagoshima Bay, Ôshima Strait, and the intervening seas between the shattered islands. *If the writer is not mistaken in his suggestion, the whole group of the above-mentioned islands, together with Yaku, Tanéga-shima, Magé, and Kuchino-Erabu, must have once formed an integral part<sup>1)</sup> of ancient southern Kyûshû.*

(<sup>1</sup>) The Foundation of Sakura-jima.—The question as to the immediate foundation of any volcano cannot usually be easily answered. In a case like the present, which is that of an isolated insular

1) See the area dotted with islands in Sketch Map of southern Kyûshû in Fig. 2, and also the region enclosed by the 500-meter isobathe off southern Kyûshû including *K*<sub>2</sub> (Kuchino-Erabu Island) and *I* (Iwô-jima) in Fig. 1.

The conclusion arrived at here is also confirmed from the zoogeographic point. From the study of the Japanese termites, of which now twelve in number are known, Prof. S. Watasé says that the two islands of Yaku-shima and Tanéga-shima form the southwestern outpost of the Palearctic section of the Japanese Empire, while the island of Ôshima (Anami-Ôshima) marks off the extreme northeastern boundary of the Oriental Region. See Figs. 1 and 2. The southern border of the shattered region of southern Kyûshû, above referred to, is therefore an important faunastic divisional line of old geologic date from a termitologic point. See N. Holmgren, 'Die Termiten Japans.' *Annotations Zoologicae Japonenses*, Tôkyô, Vol. VIII. Part I., 1912, footnote p. 109.

volcano, we have first of all to consider the mainland that lies close to it, and this the writer believes to have done in the preceding pages (pp. 13-20) in connection with the discussion on the geology and the origin of Kagoshima Bay in which Sakura-jima is situated.

As already remarked, the bottom of the trench bay of Kagoshima was multifariously *shattered* (p. 20), leaving some polygonal blocks as if they were wedged out from the rest of the members. The tectonic movement was therefore similar in kind to that, by which plateaus are usually produced. These uplifted blocks are the low flat islets<sup>1)</sup> of Oko-jima (40 m.),<sup>2)</sup> Hakama-goshi (72 m.),<sup>3)</sup> the low Kanzé, the lava-drowned Karasu-jima,<sup>4)</sup> and Ko-jima,<sup>5)</sup> the last-named being at the north end of the bay. The bottom is 100 fathoms deep, and is a part of the continental shelf. The geology of these islets is interesting in many ways; firstly, they were never closely studied before, and secondly, they give some clues as to the nature of the foundation of Sakura-jima.

OKO-SHIMA 1) OKI-KOJIMA (spoken *Okoshima*) lies on the southwest coast of Sakura-jima (Geologic Map; Pl. III. Fig. 1), near Moyé-zaki (the 'burning cape')—the lava-end of the eruption in 1475-1476. It is only 400 m. long by 200 m. broad. It rises from the bottom 60 fathoms deep, and its flat top (40 m.) is 60 m. lower than that of the ancient citadel of Kagoshima. It is said<sup>6)</sup> to be a part of the lava-flow of 1476, which was later severed from the land by a depression of the intervening sea bottom; but this story is entirely unfounded (p. 42).

1) The new islands off the northeastern shore of Sakura-jima, formed during and after the eruption of 1779, will be dealt with elsewhere (p. 48), since these historic islands form a special group by themselves.

2) 沖小島 See Geologic Map. 3) 袴腰 or Shiro-yama (城山) 4) 烏島 5) 小島 It lies outside the limit of the annexed Geologic Map.

6) 'Compendium of Geography of Satsuma, Ōsumi and Hyūga,' Kagoshima. 薩隅日地理纂考

This gunboat-shaped islet<sup>1)</sup> (Fig. 4) presents the characteristic feature of the plateau land of Kagoshima, or a marine *butte*, and it is really a fragmentary block of the latter. Geologically, it is an exact copy of the Kagoshima environs (p. 14), the lower two-thirds being built up of the ash-stone or biotite-bearing hypersthene-

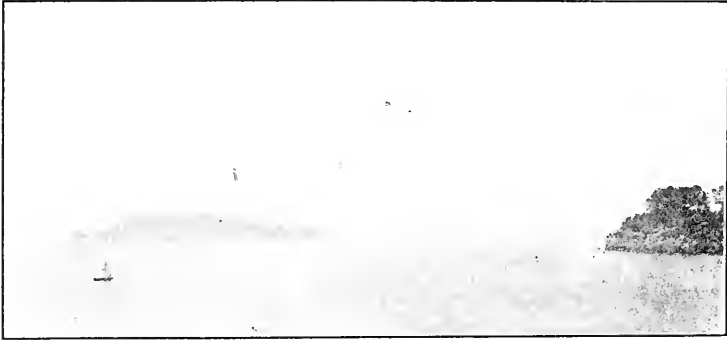

Fig. 4.—Oki-Kojima viewed southwestward from Sakura-jima.  
O.—Oki-Kojima, c.m.—Cape Moyé-zaki.

trachyandesite<sup>2)</sup> (Pl. XVI. Fig. 1) *C* in Fig. 3, overlaid discordantly by a thin horizontal, water-bearing bed of yellow sandy tuffite which corresponds to the fossil horizon *B*, and lastly, the lapilli bed *A* which makes up the upper one-third of the vertical section. One can readily recognize these beds even from a distance through differential erosion (Fig. 4). The andesite shows flowage-banding which dip at high angles in different directions. The normal trachyandesite is grey and light; the grey perlitic  $\beta$  type with hornblende (Pl. XVI. Fig. 3), and the black porphyritic obsidian type  $\gamma$  (Pl. XVI. Fig. 2) with pyroxenes (p. 13) also occur with pillow structure, indicating collectively that the ancient lavas are of submarine flows. At the north end of the islet a *dark-gray*

1) In 1861, it was fortified for defense against an English squadron which made an unsuccessful attempt of bombarding the city of Kagoshima.

2) Some contain a large quantity of corroded quartz, and in this case the rock may be appropriately called *dacite* or *plagioliparite*.

holocrystalline rock was seen, probably making dykes through the basal vitroandesite (trachyandesite) *C*. It contains abundantly medio-phenoerysts (4 mm.) of hypersthene and sporadic mino-phenoerysts of olivine, which we frequently fail to find in many slides. The rock closely resembles the **trachybasalt** *A*<sub>1</sub> of Fig. 3. The same rock makes up the flat-top of Sakkabira at the defunct Seto strait, and recurs at Karasu-jima. Pl. XVI. Fig. 4. Besides the abundancy of phenoerystic hypersthene, which is rare in the writer's experience, the hypersthene is intergrown with peripheral and lamellar (100) augite.

The light-colored trachyandesite *C* and the dark trachybasalt *A*<sub>1</sub> occur in close association, although the latter is decidedly of later origin. Both being widely distributed, it is an important petrographic problem in southern Kyûshû to make their relation clear.

In analogy with the neighboring plateau-land, the rock which builds up the islet is of early Diluvial or late Tertiary age.

<sup>HAKAMA-</sup><sub>GOSHI</sub>            2) HAKAMA-GOSHI. (Pl. III. Fig. 1 ; Pl. XII. Fig. 3)—  
The low rectangular table-hill of Hakama-goshi or Shiro-yama in Geologic Map is of the size, and the same geologic formation and structure as the preceding. It was originally an island rising from the bottom 20 fathoms deep, although it *now forms a western portion of Sakura-jima* and a landing place from the city by the accumulation of talus and outwash from that mountain-slope, which filled up the space between this islet and the former Sakura-jima. Small crafts are said to have plied here even in historic times. It was occupied by the village of Koiké, now entirely devastated and partially overflowed by the deluge of the recent lava-flow.

The lava-flow rushed down the western slope of Sakura-jima from the Yuno-hira vent to the sea, flooding over the villages

of Yokoyama and Akôbara, and touching the southern foot of Hakama-goshi on its forward movement. *See* Geologic Map, and Pl. XII. Fig. 3.

It is 72 *m.* high and consequently 30 *m.* lower than the city-castle, and rises from the sea-bottom 20 fathoms deep. It differs geologically from the island just described by the absence of the basal effusive *C* (p. 14); but the lower two-thirds are represented by the horizon *B* which is here barren in fossils, and built up likewise of sand mixed up with ash and pumice of the old hornblende-bearing hypersthene trachyandesite *C*. The upper one-third of the profile is again composed of lapilli beds *A*.<sup>1)</sup> The whole complex dips slightly southeast. The islet is, like Oki-kojima, a fragment of plateau-land.

<sup>KARASU-</sup>  
<sup>JIMA</sup> 3) THE LAVA-DROWNED KARASU-JIMA.<sup>2)</sup> — The small pointed island (22 *m.*), now drowned and hidden under the recent lava, lay to the south of Hakama-goshi, and from the geographic position it is probable that it was a relic of the Plateau Formation like the latter. S. KANAI, who frequently

1) There is a shell bed of doubtful stratigraphic position. It may be a member of the lapilli bed *A*, or simply scattered over the top or slope of the hill. It is not yet decided whether the find is a kitchen middens, or deposited in the sea prior to the upheaval of the island. The species, all living, were determined by T. Iwakawa, of the Female Normal School of Tôkyô, and they are as follows :

- |  |  |
|--|--|
| 1. Fasciolaria trapezium Linn.         | 2. Strombus succinctus septimus DuRoi. |
| 3. Strombus luhuanus Linn.             | 4. Conus quercinus Hwass.              |
| 5. Conus tessellatus Born.             | 6. Conus miles Linn. (?)               |
| 7. Area decussata Sowb.                | 8. Chama imbricata Brod.               |
| 9. Chama semipurpurata Lisch. (?)      | 10. Cypraea sp.                        |
| 11. Turbo (Macrostoma) coronatus Gmel. | 12. Maetra sulcotaria Desh.            |
| 13. Septifer nicobaricus Chemn.        | 14. Vola laqueta Sowb.                 |
| 15. Ostrea gigas (?) Thunb.            | 16. Chlorostoma rugatum Gould.         |
| 17. Gyrium grunifera Lam.              | 18. Phos senticosus Linn.              |
| 19. Columbella versicolor Sowb.        | 20. Nerita alficella Linn.             |
| 21. Pectunculus vestitus Dkr.          | 22. Trochus obeliscus Gmel.            |

Plant remains are also said to be found in Hakama-goshi.

2) Karasu-jima or the 'Crow Island,' named probably from the black color of the rock of the island.

landed on the spot prior to the recent eruption, informed the writer that the islet is built up of *trachybasalt* (Pl. XVI. Fig. 4), as is the southerly-lying Oki-kojima, representing an effusive ( $A_1$  in Fig. 3) of the Plateau Formation. The writer received later a few chips of an odd specimen from the buried islet through the kindness of Mr. M. UYÉDA, who collected it many years ago. It is a *dark-gray* crystalline trachybasalt of exactly the same type as that found in Oki-kojima, representing a certain horizon of the Plateau Formation, as the writer expected it to be (*see* page 25). It is incredible from a geological standpoint, that the islet welled out in one of the years 1475, 1476 or? 1756, as recorded in some old documents, which were accepted with blind faith by nearly all the recent writers on Sakura-jima, nor is it by any means a parasitic cone, as some assume it to be (*see* p. 42.)

KANZÉ 4) KANZE.<sup>1)</sup>—A low sandy hook (Pl. III. Fig. 1; Pl. XII. Fig. 3) in the channel between the city of Kagoshima and Sakura-jima, and lying to the south by southwest of the lava-drowned Karasu-jima. No solid rocks are exposed, and the origin of the islet remains unexplained. Float rocks scattered about are all brought from the neighborhood of the city. Lately, K. YAMAGUCHI informed the writer that a solid rock, which probably makes the foundation, was brought up from the sea bottom of the neighborhood, and the specimen is black in color, resembling that which was found in Karasu-jima. Pl. XVI. Fig. 4. From the proximity to the last-named and the similarity of the lithologic composition, Kanzé is in all probability of the same type and origin as Karasu-jima.

KO-JIMA OF KOKUBU 5) KO-JIMA OF KOKUBU.—A small group (Figs. 5-6) of islands, off the railway station of Kokubu, is composed of two

1) 神瀬

sharply-pointed wooded islets on the north (Heda-Kojima,<sup>1)</sup> 124 *m.*) and south (Oki-Kojima, 100 *m.*), both being built up of columnar ash-stone or piperno. A low patch (Benten,<sup>2)</sup> 40 *m.*) between the two is of the same jointed rock, silicified and pyritiferous, and colored brown through submarine decomposition, besides a cliff-rock (Ippai-jima) near the north island. The surrounding sea is 20 fathoms deep. The whole group, therefore, consists of

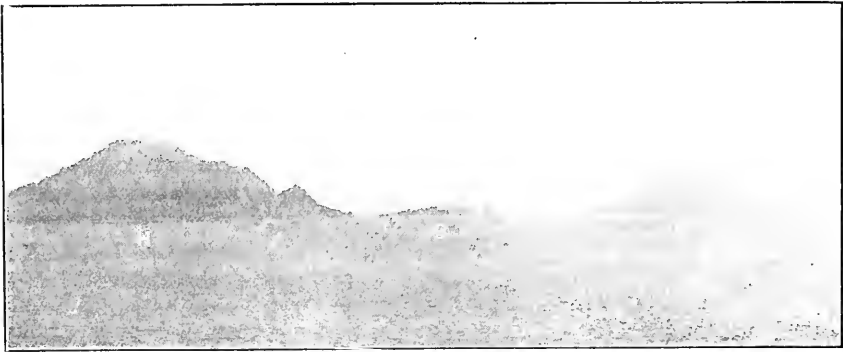

Fig. 5. - Western view of Kokubu-Kojima.

H.—Heda-Kojima. B.—Benten-jima. O.—Oki-Kojima.



Fig. 6. - Eastern view of Kokubu-Kojima.

1) 邊田小島

2) K. Yamaguchi (*Geogr. Jour. Tôkyô*, No. 2, 1915) lately visited the islets and found a patch of tuffite which is said to contain various diatoms. The same species recur in the Tertiary bed on the pass, east of the village of Kajiki on the opposite coast of the mainland. Diatoms and coral beds are also said to occur in the above-mentioned Heda-Kojima, but their stratigraphic positions are entirely unknown.



basal trachyandesite *C* (Fig. 3). Pl. XVI. Figs. 1, 2, and 3. The gray perlitic  $\beta$  type is to be seen in the south island. The upper, pyroclastic beds *A* and *B* of the Kagoshima type (Fig. 3) are not represented here. The same basal effusive recurs along the coast (Nagahama) at the north of Kajiki on the land, whence the view was taken (Fig. 5), and this group is simply a detached mass of the basal portion of the plateau-land of the mainland.

Since the last eruption, vulcanological literature has rapidly grown. An old book 'Zoku-Nihongi' says: "In the 8th year of the Tembiô-Hôji era (764 A.D.) an eruption occurred at the frontier of Ôsumi and Satsuma. In the sea off Shinné village (the present Shikiné?), three islands were formed of *sand*, *stone* and *lava*." In another book these are apparently referred to the present group. The identification of the above historic record with the islands in question<sup>1)</sup> was fully indorsed by recent writers on Sakura-jima. That this is, however, an erroneous interpretation will be clear by the statement made from a geological point, that the islands are simply detached blocks of an effusive Horizon *C* of the early Diluvial or late Tertiary age. (See p. 41).

In saying this, the writer does not deny the truth of the said record, yet he could not locate the point of that eruption in Kagoshima Bay.

In short, the islands of Oki-Kojima, Hakama-goshi, Karasu-jima, Kanzé and Ko-jima of Kokubu, dotting Kagoshima Bay, are not only the same in age, in rocks and in structure among themselves, but also exactly like those of the plateau land that encloses the bay (Pl. IV. Fig. 1 and Text-fig. 6). As has already been remarked, they are the wedged-up blocks of shattered bottom of

1) In the 'Explanatory Text to Sheet Kagoshima,' p. 53, it is said that the island is probably parts of a ruined crater. Nishio speaks of them as the foundation-stone of the later Sakura-jima. *Petermanns Mitteil.*, 1911, S. 132

the bay. They are buoyed up in different degrees or, in other words, depressed in altitude with reference to the neighboring plateau after the manner of the formation of a plateau. Volcanoes are said to appear in diffuse manner in such a geologic pattern of great magnitude (p. 20).

YENO-SHIMA 6) YENO-SHIMA<sup>1)</sup> (Pl. XII. Fig. 1, and Geologic Map).  
 —In passing, it is to be noted that the islet Yéno-shima, lying 3 km. to the south of the defunct strait of Seto, is built up of uniformly gray compact trachyandesite.<sup>2)</sup> Pl. XVI. Fig. 1. It is simply a detached erosion remnant of the basal effusive of the neighboring plateau formation, and in no way connected with any lavas of Sakura-jima.

SUBCRUST  
 OF SAKURA-  
 JIMA

We now approach the question as to the *foundation* of Sakura-jima. From what is said in the foregoing, the basement bed seems in all probability the same complex that makes up the four block-islands (1-5), and also the one that builds up the plateau-land of southern Kyūshū. As Sakura-jima is an island volcano, and is still young and not yet dissected, no opportunities are yet given to get insight into the inner structure of the volcano, and we have simply to conjecture the foundation in the realm of imagination.

A unique specimen of recent ejecta was given the writer by Assistant Professor KANAI, of Kagoshima. It is a fritted granite.<sup>3)</sup> As granite-batholiths intruding the Mesozoic slate formation appear in Prov. Ōsumi, both may occur underneath the foundation; but no slate has hitherto been discovered among recent ejecta except small fragments in trass.<sup>3)</sup> The members of

1) 江ノ島

2) It is composed of plagioclase, orthoclase and hypersthene in a crystalline groundmass of ragged prismoids of augite, plagioclase-laths and magnetite crystals, with trace of globulitic and sanidine-cement.

3) See 'Ejected Blocks of Biotite-granite' in Petrographical Part. See Pl. XXIII. Figs. 1 and 3.

the Plateau Formation (Fig. 3), which are supposed to make the foundation are not actually observed. The calcareous trass bombs among the ejecta, coated with black rind, may represent sandy tuffite *B.*<sup>1)</sup>

From the cores of many stumped mountains it is ascertained that the depth of the local reservoir or lava-macula may be estimated at 1,000 *m.*<sup>2)</sup> below the vents, and consequently, the thickness of the direct volcanic foundation may be assumed to be 1,000 *m.* Both the YUNO-HIRA and NABÉ-YAMA vents of the recent eruption are located at 300 *m.* above sea-level, and the bottom of Kagoshima Bay is 100 fathoms or approximately 200 *m.* deep. Setting apart 250–400 *m.* for the thickness of the Plateau Formation (Fig. 3), there still remains about 100 *m.* to make 1,000 *m.* for the subterranean location of the Mesozoic *slate*<sup>3)</sup> formation, which is, as already stated, often intruded by granite (Fig. 2).

It follows from the above that the lava reservoir of Sakura-jima probably lies within the terrane of the Mesozoic formation, for which the above-mentioned granitic projectile may be taken as a proof, and 500 *m.* below the bottom of the bay.

## Part II. The Volcano of Sakura-jima.<sup>4)</sup>

### § I. Morphogeography.

A) General.—The volcanic island of Sakura-jima is situated

1) See 'Ejecta of Trass' in Petrographical Part.

2) F. v. Wolf, 'Der Vulkanismus.' Bd. I., S. 334.

3) After a comparison of average compositions of igneous rocks and slate or shale, W.H. Hobbs arrived at the conclusion that lava, especially the Pacific type, originates through fusion of slate, the most easily-fusible of sedimentaries. It is to be remarked that the lava-macula of Sakura-jima is probably located in the slate formation. 'Some Considerations concerning the Place and Origin of Maculae.' *Beiträge zur Geophysik*, XII. Bd., 1913, S. 330.

4) a. K. Nakashima, 'Explanatory Text to Sheet Kagoshima.' *Geol. Surv. Japan*, 1897.

within the narrow rift bay of Kagoshima, opposite and east of the city of the same name, and separated from it by water 3.7 km. wide and more than 25 fathoms deep (the maximum being 38). On the southeast side of the island there was, before the recent eruption, the still narrower channel (500 m.) of Seto, 30–40 fathoms deep, where during the explosion of 1779 a floating sheet of pumice, 5 feet thick, covered the whole stretch, so that two terror-stricken islanders fled on foot to the opposite coast of Ôsumi, while the third, following the two pioneers, sunk to the bottom and was seen no more. This channel was completely choked up by the lava-flows on February 1st (some say on the 29th January), 1914.

The insular composite konide of Sakura-jima rises from a depth of 100 fathoms, having the equatorial and meridional diameters of 9.9 and 8.0 km. respectively.<sup>1)</sup> It has a circumference of 38.7 km., with an area of 75.6 sq. km., and a height of about 1,000 m.,<sup>2)</sup> with graceful piano slope below 1000 m. all round,

b. I. Friedlaender, 'Ueber einige japanische Vulkane.' *Mittel. d. D. Gesell. für Natur- und Völkerkunde Ostasiens*, Bd. XXII. Teil 2, S. 103, 1910. The author presents briefly the views and observations expressed by S. Watanabé.

c. Yamasaki-Satô, 'Geography of Japan,' Vol. VIII. p. 223, Tôkyô, 1909. (Japanese)

d. Uyêda, 'Sakura-jima before and after the Eruption of 1914.' *Jour. Geogr. Soc. Tôkyô*, 1914, p. 431 *et seq.* (Japanese)

1) These numbers refer to date prior to the eruption of Jan. 12th, 1914.

2) The area and volume calculated by stud. R. Oda after Simpson's formula:

a.	Area.....	75.59 sq. km.
		(71.90 „ „ after D. Satô)
b.	Height traced on Contour-line.	Volume above Sea-level.
	0 to 200 m. ....	9.04 cub. km.
	200 „ 400 .....	3.863
	400 „ 600 .....	1.683
	600 „ 800 .....	0.937
	800 „ 1,000 .....	0.390
	1,000 „ top .....	0.036

Total 15.919 cub. km.

It is nearly the same height as the volcano of Kaimon. The volume is one-sixty-fourth of Fuji-san, the latter being 1,025 cub. km. F. Ômori gives the figures 26.5 cub. km. for the volume of Sakura-jima.

excepting the western side; but seen from the north and south the mountain appears perfectly conical. See Text-fig. 10 *a*.

The coastal flat of talus and wash plain supports 19 village groups of 3,134 ménages, sustaining a farming and fishery population of 27,116. The sunny island produces oranges and gigantic radishes of half a metre in diameter. Horses, pigs and domestic fowls are raised on a large scale.<sup>1)</sup>

**B) The Building-up of the Volcano and Topography.**—Sakura-jima is apparently a simple konide sloping at  $5^{\circ}$  to  $30^{\circ}$ , and truncated on the top with a serrated wall (Pl. II. Figs. 1–3; Pl. III. Figs. 1–2); but the apical crater is really a triple one arranged in meridional direction. The volcano is also, geologically

---

1) *The vegetable zone of Mt. Sakura-jima.*—From a list of plants registered by the teaching staff of the Higher College of Dendrology, Kagoshima, we see there are no well-defined vegetable zones on the konide of Sakura-jima as there are on many other mountains, yet four zones can be recognized according to the predominant elements. See Fig. 7 on page 34.

I. The apical zone embracing the belt from the 900-metre contour-line upward to the top of 1,069 *m*. Among the scanty vegetation in the crateral area may be mentioned rushes and brush-wood—*Imperata arundinacea*, Cyr. (chigaki), *Miscanthus sinensis*, Anders. (suzuki), associated with *Panicum sanguinale*, L. (me-hijiwa) and *Eleusine coracana*, Gaertn. (shikoku-bie). On the east slope of the middle crater there is a localized forest of *Alnus firma*, SZ. (yasha-bushi).

II. The next one is the 500 to 900-metre zone, represented by a mixed forest of the preceding and the next following. Principal elements are *Hydrangea virens*, Sieb. (gaku-utsugi), *H. paniculata*, Sieb. (nori-utsugi), *Diercilla floribunda*, SZ. (nishi-utsugi), *Viburnum dilatatum*, Th. (gama-zumi), *Bx crenata*, Th. (inu-tsugé), and *Salix saïd-anu*, Seem. (yama-yanagi).

III. The zone of *Ficus Thunbergii*, Parl. (kuro-matsu), partly natural and partly planted, reaches the 500-metre contour above, while on the east it is already delimited at the 300-metre contour, due probably to its being on the lee of the prevailing winds which cause drought on this side. The lower boundary of the zone lies between 100 to 150 metres. The belt is also a mixed forest, associating with *Cryptomeria japonica*, Don. (sugi), *Ligustrum japonicum*, Th. (nezumi-mochi), *Thea japonica*, (L) Nois. (tsubaki), *Staurontia hexaphylla*, Dene. (nubé).

IV. The remainder of the area is the narrow coastal zone on the west and north and a small strip on the south, nearly all being under cultivation. The gardens and orchards are laid out in coarse volcanic soil on slopes. The staple products are *Citrullus vulgaris*, Schrad. (suika), *Saccharum officinarum*, L. (satô-kibi), *Ipomoea batatas*, Poir. var. *edulis*, Mak. (satsuma-imo), *Raphanus sativus*, L. (the well-known large radish), *Eriobotrya japonica*, Lindl. (biwa), *Prunus cocomanis*, Huds. (sumomo), and a number of oranges, viz., *Citrus aurantium*, L. var. *tachibana*, Mak.; var. *japonica*, Hook (kinkan); subsp. *sinensis*, Engle. (matsu-mikan); subsp. *nobilis*, Mak. (mikan), and a Japanese persimmon *Diospyros kaki*, L.

speaking, a single gigantic konide, having an altitude of 1,133.5 *m.*, and standing on an irregularly round base of 8 *km.* in diameter, which approximately coincides with the present dimension of the island. The main crater-cone is KITA-DAKÉ (*Mihachi*) or the north crater-cone (homate).

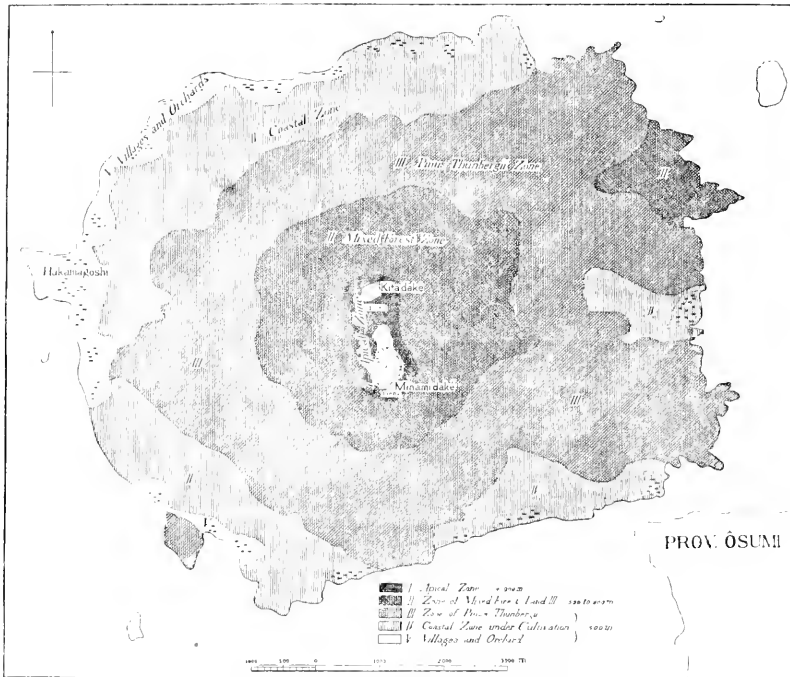

Fig. 7.—Sketch-map illustrating vegetable zones.

Later, the two other apical craters, the south and the middle, were created, the former being comparable in magnitude with the main; and the total morphological aspect of the mountain top presents that of a triple volcano, although the two later ones are really parasitic to the main, the north cone. The reason why they are so can be readily understood from the wide distribution (*see* Geologic Map) of the light-brownish *gray* lava (*Mihachi* lava), which characterizes the material of the main body of the volcano and the crater-wall of the north cone.

The fresh **South Cone** which rests upon the shoulder of the trunk, poured forth *black* lava (*Minami-daké* lava) sheeting the whole southern flank down to the shore. The **Middle Cone**, on the other hand, also sent down black lava (*Futanaka* lava) only to the (?) eastern slope. In short, the later two cones are adventive to the northern main.

In the following the writer will shortly characterize the three craters above-mentioned.

**KITA-DAKÉ**     *a)* The northern cone, *Kita-daké* or *Mihachi* (Pl. III. Fig. 2), has a rather deep bottom with a diameter of 500 to 600 *m.* (inner diameters 212-200 *m.*) and a depth of 100 *m.* (80 *m.*), and the precipitous wall 1,133 *m.* high which is the highest point of the volcanic island (Pl. II. Figs. 1-2). The pumiceous bottom is now clothed with mosses; and benches of lava are exposed to view on the inner cliff, which is a little ruptured on the *east* and west sides.

**NAKA-DAKÉ**     *b)* A little apart, southwards from the preceding, lies the shallow *Naka-daké* (*Futanaka* or *Futatsu-ai*) or the middle pit (Pl. III. Fig. 2; Pl. V. Fig. 1, *M*) with a N.-S. diameter of 400 *m.*, an E.-W. of 200 *m.*, and a depth of only 35 *m.*, the highest point of the wall being 1,000 *m.* It sits upon the cliff of the crater-bottom, 250 *m.* deep, of the South Cone or *Minami-daké*. The ash-covered bottom is clothed with mosses and shrubs. In ancient times it was full of water, and it was said to rise and fall with the tides. That it is comparatively a *new one* is testified by the presence of vents of solfataras, although they are now entirely extinct. The eruption of 1779 started in this venthole, or somewhere from its outer slope.<sup>1)</sup>

Watanabé<sup>2)</sup> says, this is the oldest of the three pits, while the late

1) It was commonly said at the time that the eruption began at *Futanaka* (兩中) or the crotch between the north and south craters. Some say at the southern one. We need not be very particular about the location of the first subaerial eruption; for, at that time the entire apical region or indeed the whole mountain was in a state of paroxysmal convulsion.

2) S. Watanabé, 'On the Volcano of Sakura-jima.' *Jour. Geogr. Tôkyô.* No. 289, 1913. (Japanese). Friedlaender is of the same view as Watanabé.

Nakashima<sup>1)</sup> (*l.c.*) was inclined to believe this one to be younger than Kita-daké. The writer considers the north pit to be the first-born, then comes the southern, and the middle pit to be the *youngest* of the



Fig. 8.—Showing the relation of the North, Middle and South Cones, viewed from the western slope. Photo. by Yamaguchi.

three, as we can see the middle pit *M* resting directly upon the shoulder of the southern pit craters on the cirque-like explosion (?) cliff near the top on the west, as in the above figure 8.

<sup>M</sup><sub>MINAMI-</sub><sub>DAKÉ</sub> c) The southernmost, elliptical *Minami-daké* (1,069.6 m.) is the lowest and the active one (Pl. III. Fig. 2; Pl. V. Fig. 1). Formerly it was called 'Shiro-mizu' or white water, but now people call it *Moyi-daké* or 'burning pit,' and it is the largest crater, having a

1) The writer fully endorses the view expressed by the late Nakashima from a petrographic standpoint, since the light colored salic hypersthene-andesite of the north cone greatly differs from the black femic sodipatic two-pyroxene andesites of the middle and south cones, which sometimes even contain an accessory of olivine. The only question left for future consideration is: Which has the precedence, the middle or the south cones, in their birth?

As may be seen in the photographic view taken from the top of the north cone (Pl. V. Fig. 1), the southern margin of the minor and shallow crater of Naka-daké is sharply cut off by the southern bottomless giant of Minami-daké, without being in the least *disfigured* by the grand explosion of its southern neighbor. On seeing the mutual relation of both pit-craters, the writer is rather inclined to believe that the middle *crater* is the younger of the two. K. Yamaguchi believes the middle pit to be simply a portion of the stemmed-up lava-flow of the south cone.



diameter of 650 *m.* by 450 *m.* and a depth of 250 *m.*,<sup>1)</sup> encircled with a sharp ridge of pitch-black andesite, sometimes rusty brown. It is bounded inside with precipitous cliffs, so that no one can reach the bottom, where twenty or thirty years ago a pond existed which is now entirely dry. On the southwest and north cliffs, built up of mud breccia mixed with pumice, capped with tabular or columnar solid lava, sulphurous fumes issue but not violently.

POISON  
GULCH

About 500 *m.* landward from the shore near Yunohama at the southern foot of Minami-daké, there is a spot where steam and carbonic acid mixed with sulphur dioxide issue from the bottom of a dry ravine. Insects and birds and even men were asphyxiated on approaching the aperture of the mofette. The place is called by the people Dokudani or 'poison gulch.'

POLYAXIAL  
CENTRAL  
TYPE

The form of the narrow lava-conduit of whole Sakura-jima is what F. v. Wolff styles the 'polyaxial central type.' The two apical adventive pit-craters, the middle and southern, are only accidentally formed by branchings of the principal canal, as may be surmised by an inspection of the annexed Geologic Map.

The linear compound volcano so formed has attained roughly a maximal height of 1,000 *m.*, which is, *the writer believes, the average height of modern volcanoes in Japan*, corresponding to the size of the kouide, the nature of the magma of intermediate acidity, and the amount of energy of the magma reservoir which is usually assumed to lie under 1,000 *m.* from the ventholes.

TOPO-  
GRAPHIC  
FEATURE

TOPOGRAPHIC FEATURES.—From the mode of formation as well as from the material which built up Sakura-jima, we are able to recognize the topographic form of

1) The maximum depth of the crater-bottom of other andesite-volcanoes of Japan seems to the writer to be 250 to 300 *m.*, without the danger of disruption of the body of a volcano.

the *mountain-top* on maps, or from the view either from west or east. From the city of Kagoshima (Pl. III. Fig. 2) we see a deep gulch beyond the round top (553 m.) of *Hikino-hira*.

PARASITIC CONES Parasitic cones will be briefly sketched elsewhere.<sup>1)</sup> Here the southern flank of the main (north) body was ruptured

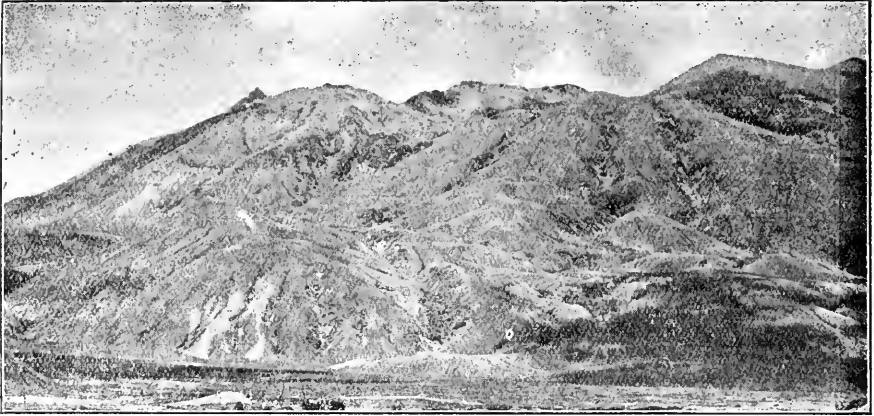

Fig. 9. Eastern view of the three cones.

before the building up of the south cone. The two possess topographically independent forms. A view from the east (Fig. 9) likewise presents a distinct line of demarcation between the main, north cone *N* and the middle parasitic one *M*.

After the piling up of the three apical cones, whereby the volcano attained its maximal height and perfection, new vents were opened a little below and outside the apical craters. They are the flank eruptions, when lavas poured down in pericentric flows (*see* Geologic Map). The time of their activity falls mostly in the historic period. The volcano of Sakura-jima has entered since then into the *destructive* phase and senile age, and its height

1) The parasitic cones of Nabé-yama and Yebino-tsuka on the east coast will be briefly touched under the heading: 'The Lavas of the Bummeri Eruption.'

The problematic parasitic cone of Hikino-hira (Hyoku-oka), having the appearance of a monalnock, will be spoken of in connection with the 'lavas of Kita-daké.'

will in future gradually decrease. Through repeated eruptions, which remarkably avoided the area of earlier flows, the former graceful form became irregular, the structure complicate, and the mount grew and will grow sideways. On the other hand, the relief and plan are in course of time being modified and simplified by subaërial and pluvial talus formations around the fringes of the volcanic island, especially on the north and west coasts.

The topography of the *mountain slope* or piano is therefore entirely governed by pericentric radial flows. They are geologically recent rocks not yet disintegrated, all being black slaggy block-lavas which can scarcely afford strong foothold to trees and shrubs. Only the inter-lavaless strips and the talus formation as well as the outwash plain near shore are available land for pasturage and horticulture, for which the island is tolerably well known (Text-fig. 7, Zones IV. and V.). Arable land is reduced to a minimum, owing to the poverty of soil and the scarcity of water.

C) Hydrography.—From the geologic structure and the topographic form as outlined above, we can well understand, that only the radial gullies on the slope serve as draining channels for meteoric water. On the west and north talus and torrential streams spread and deposit gravelly alluvial fans. As the ground is full of clefts, or of loose nature, the water is readily soaked in within a short distance. Consequently, there exist no permanent SPRINGS streams on the island. Copious *springs*,<sup>1)</sup> however, issue at some places on shore from the under gravel bed, or one can get plenty of ground water in shallow wells dug at the lower end of wash plains.

1) See 'Changes in the efflux of hot-springs,' p. 47, and 'Hot-springs,' pp. 56, 57, and lastly, 'Hot and cold springs,' p. 62.

Occasionally cloudbursts precipitate unusual rainfall, which runs down from the steep mountain slope in torrents, excavating narrow and deep channels and carrying all that is found on the way. The havoc brought about by high water frequently causes the people great distress. The calamity incurred from this cause after a great eruption is very heavy, owing to the suspension in the water of the light surface deposits of ash and pumice which were thrown out and spread about from the ventholes.

To cite an example, there occurred on November 20th, 1779, a great rush of mud flood on the north coast, which devastated the villages of Matsura and Futamata. It was two weeks after, but not at the time of, the great eruption of the An-ei era.

MUD FLOOD (YAMA-SHIWO) People call the mud flood *yama-shiwo*,<sup>1)</sup> or ‘mountain-tide,’ which is always a more dreadful calamity to the inhabitants than the terror of the actual eruption. Four deep dry ravines on the northern slope, well shown on the Geologic Map, are the indelible scars left by the excavation of that tremendous non-volcanic *yama-shiwo*. They are the Matsura-gawara and Futamata-gawara. There are many others not less notorious, on the northwest and southwest coasts, and always in densely populated quarters. The same unhappy events happened after the recent eruption even outside of the island, causing deluges of mud, and changing the course of streams.

Melioration-works with timber-bars, hurdle or tress-works, brushwood bundles or gabions are not used with the exception of dams of piled stones, as the torrent directly empties itself into the surrounding seas without inflicting much devastation to the low lying tract, which is here limited only to a small area on shore.

The geography of Sakura-jima is lacking in names for *rivers*,

1) 山汐 It is the *Jökullur* of Iceland. Iddings, ‘The Problems of Volcanism,’ p. 6.

RIVERLESS but instead the term 'kawabara' (spoken *kawabaru*) is of frequent occurrence, which signifies valley train or wash plain; for, in ordinary days not a drop of water is found in the percolating river-bottoms, *e.g.*, the 'kawabara' of Také, Akamizu and Nojiri, the latter two, however, are now overflowed by the recent lava-sheet from Yuno-hira on the west side.

## § II. The Eruptions at Sakura-jima prior to 1914.

A) The Eruption-periods I.-IV.—The building up of Sakura-jima is stated in various works to have taken place in the years 708 A.D. (1st year of Wadô era), 716 (2nd year of Reiki era), 717 (1st year of Yôrô era), and 718.

The island is said to have welled up and risen in a night.<sup>b)</sup>

ERUPTION-PERIOD II.  
761

'The frontier of Ôsumi and Satsuma was in the 8th year of the Tembiô-Hôji era enveloped in dark clouds in which the lightning darted about. After seven days it became clear. In the sea of Shimui-mura (present Shikiné?) three islands were formed of sand, stone and lava, the eruption being accompanied by flames. The islands so formed appear conjointly like an open shed. Sixty-two divisions of houses were destroyed and eighty people killed' (*Zoku-Nihongi*). Other books say that the islands referred to are Kamizukuri or Kojima, by which is meant the ruin-like Kojima group off Kokubu Station. In July-August, 766, they were visited by terrible earthquakes. That the whole story was an erroneous interpretation of ancient records is elucidated elsewhere (p. 29).

1) From 708 to 718 Kagoshima Bay seems to have been the seat of violent volcanic activity, constituting one eruptive period, having in common a hypocentre of activity. It is impossible for the writer to locate the exact points of vents, nor can he say whether they lie exclusively within the area of the present Sakura jima or not.

ERUPTION-  
PERIOD III.  
(THE  
BUMMEI  
ERUPTION)  
1468

For a long interval of seven centuries Sakura-jima remained apparently in quietude. The third period of activity began in 1468 (2nd year of Ônin era) with a moderate explosion on the southern top-crater. Another eruption

1471 occurred on October 25th, 1471 (3rd year of Bunmei era) near Kurokami on the east coast, ejecting stones, sands, and overflowing lavas, resulting in the formation of Cape Ômoyé-zaki.<sup>1)</sup>

1475 On September 15th, 1475 (7th year of Bunmei) a violent eruption took place above Nojiri on the southwest coast, inflicting great damage to the inhabitants and domestic cattle. Cape Moyé-zaki, which lies between Nojiri and Yuno,<sup>2)</sup> was then formed. Ash fell during five days, and Karasu-jima rose from the sea.<sup>3)</sup>

1476 An ash explosion of the same intensity occurred in 1476 (8th year of the same era). On September 29th it culminated in the greatest outburst. During five days before the event the land was incessantly shaken by weak and strong earthquakes. Eventually the top (which one?) was in flames and disrupted, throwing out rains of burning stones and ejecting ash and pumice for seven days, which enveloped Kagoshima and the neighboring districts, turning day into night. It was followed on October 6th by lava-flows, which caused an increase of land 8 km. in circumference on the southwest coast (Nojiri-Furusato and (?) adjoining land). Many people and animals were killed and wounded. Afterwards Oko-shima<sup>4)</sup> rose from the sea off the shore of Yuno.

*The eruption of 1476 seems to the writer to have been of the same type as that of the Anci era, shortly to be described, though it was on a somewhat smaller scale than the latter.*

1) It is the lava field of Urano-mayé. See Geologic Map.

2) The statements in old documents concerning the activity of 1475 and 1476 seem somewhat redundant and repetitive, and the succession of events is not entirely clear to the writer.

3) Geologically speaking, Karasu-jima is of Diluvial age (p. 26).

4) This traditional record is entirely unfounded (p. 23).

1478 The after-effects continued till 1478, when the mountain erupted again and the shore of Fukuyama on the opposite coast of Ôsumi was converted into a desert by rains of ash and pumice.

During the whole period the Kirishima group, the northern neighbor, kept a profound silence, or at least there is no record of its activity. In 1554 (23rd year of Tembun era) and 1556 (2nd year of Kôji era), Kirishima was, however, active. In 1615 (1st year of Genna era) Kaimon, this time the southern neighbor, made a great eruption. Thus, while Kirishima and Kaimon were displaying activity from 1554 to 1615, Sakura-jima was not in the least affected.

ERUPTION-  
PERIOD IV.  
1642

On April 1st, 1642 (19th year of Kwan-ei era), an eruption took place.

1678 On February 29th, 1678 (6th year of Em-pô era), an eruption took place.

1706 In January, 1706<sup>1)</sup> (2nd year of Hô-ei era), an eruption (?) took place.

1742 In April, 1742 (2nd year of Kwan-pô era), an eruption took place.

1749 *In September, 1749* (2nd year of Kwan-yen era), *Mt. Ôhira-yama*<sup>2)</sup> *erupted violently, spreading an apron of lava-flow just to the south of Hikino-hira* (Hiyoku-oka).

1756 On September 9th, 1756 (6th year of Hô-réki era), a *hot-spring* in *Yokoyama* gushed out, but has since disappeared.

1766 On May 21st, 1766 (3rd year of Mei-wa era), a great inundation by mud-flows took place from the top (which crater?).

1) In reading the phrase, "the mount 'burnt' or erupted," we must guard against falling into mistake. To cite an example, the writer found in the record of the same year the following clause: The Sakura-jima shrine located on the slope of the south crater about ninety-six feet from shore was burnt by accident from the tobacco pipe of a farmer of Akamizu.

2) The extent of this Ôhira lava-field is cartographically represented in Geologic Map.

## B) The Eruption-period V.—a) THE ERUPTION OF THE AN-EI

ERUPTION-PERIOD V. (1779-1799) ERA. The activity of the An-ei era<sup>1)</sup> was the most terrible one ever recorded of Sakura-jima, especially from 1779<sup>2)</sup> to 1781, though it was persistently turbulent for twenty years, gradually declining in intensity and finally coming to rest in 1799, having exhausted its volcanic energy.

1779 From November 7th, 1779, Kagoshima and the environs in a radius of about 40 km. were violently shaken, and people became very much excited with fear. From 10 A.M. to noon of the next day (8th) the water in all the wells of Sakura-



Fig. 10 a.—Southern view of the first phase of eruption at noon, on the 8th November, 1779, as seen from Tarumi, Prov. Ōsumi, the active center being at this moment the south crater-cone. Copy of a sketch by S. Izichi.

1) There are several works, both Japanese and foreign (Milne, Friedlaender etc.) on the eruption of An-ei, all telling the same story. The present version is chiefly based on *Chiri-sankô*, a 'Compendium of the Geography of Hyūga, Ōsumi, and Satsuma,' 1898, Kagoshima.

A full list of the literature is given in the 'Explanatory Text to the Sheet Kagoshima,' by the late K. Nakashima, and in the late Milne's 'The Volcanoes of Japan,' *Trans. Seis. Soc.*, IX, 1886.

2) From 1772 to 1880 the Kirishima group remained remarkably tranquil.



jima boiled up, spouting at several points, and the color of the sea became purple.

Soon after 2 P.M. a thread of white cloud rose from the south crater, and then black smoke was thrown out in cauliflower form<sup>1)</sup> from the slope between the middle and south top-craters, followed immediately by tremendous roaring and violent quaking. In the house one felt as if sitting on a rocking chair, and out of doors it was like being on the sea. When persons lay down they were rolled about, and when they stood up they were thrown down, and when they sat down they swung to and fro. Flames shot out from both (Figs. 10*b*, 10*c*) sides of the mountain ejecting pumice and sending down avalanches of mud,<sup>2)</sup> at first at Shirahama near the northern coast (see Geologic



Fig. 10*b*.—Sakura-jima in eruption in 1779, viewed from Kagoshima. Four active centers, the southernmost (on the right) being on the slope at Ancizanzan vent; the second at the crater of the south cone; the third and fourth (on the left) on the northeastern slope of the north cone (cf. Fig. 10*c*). The northern vents were very active on November 7, the southern on the next day. Copy of a sketch in possession of M. Hamasaki in Kagoshima.

1) According to A. Imamura, the height of the column of smoke-cloud was measured at that time by the compilers of an almanac in Kagoshima to be 12,029 m. (3 ri 2 cho 16 ken)—an altitude that is already in the windless and cloudless zone of constant temperature.

2) It seems highly probable that the ejection of mud-flow took place at the early phase of activity from one of the top-craters, either the middle or the south.

Map) and then at (?) Minami-daira. Soon the island was enveloped in dark smoke periodically illuminated with flashes of lightning and projectiles of red-hot stones like meteors with tails.

This threatening state lasted for five days, when the inten-

sity abated somewhat, though for a month every 3 or 4 hours, or every 2 or 3 days, it burnt and roared. The whole aspect of the mountain island was then entirely changed, elevations were engulfed and hollows filled up with ash (?) and later by lava-flows.

On this calamitous occasion 153 people were killed and many more wounded; 1,576 horses and 135 oxen were also killed, besides other domestic cattle and fowls. Two thousand islanders fled to Kagoshima, and on the other hand the citizens were thrown into confusion by an unfounded rumor of 'tsunami' or encroaching boisterous sea waves. Heavy damage resulted in Yuno and Arimura on the south, Kurokami on the east, and Kômen on the northeast coast. Headlands of *lava* were formed in Kômen and Kurokami (*see* Text-fig. 11), both bearing the



Fig. 10 c.

a—Lava ends of historic lavas prior to 1779.

v—Vents of the An-êi eruption, 1779.

Sketch-map by S. Izichi at the time of the An-êi activity.

same name. (?) Moyézaki or 'burning cape.' On the southern flank a lava stream crawled down to the shore from a large explosion-hollow of An-ci-Zan or *Shin-moyé* (see Geologic Map), forming Cape Tatsusaki. In Arimura a new *lava-island* rose but disappeared later.

CHANGES  
IN THE  
EFFLUX OF  
HOT-  
SPRINGS

A *hot-spring* ceased to flow in Arimura,<sup>b</sup> while two new ones began to gush forth on shore at the east and west ends of the lava-field between Furusato and Yuno-hama. They originated probably from meteoric water descending the slope, being warmed on the way by cooling lava and later mixed with sea water. The temperature and level were said to have changed with the phases of tides.

There is another hot-spring, 36 C., which is located at the bottom of what seems to have been once a small cove in Kurokami. The spring is of an old date and of saline nature with alkaline reaction. It once ceased to flow, but revived in 1779. This is also located at the margin of the An-ci flow on shore.

ASH-FALL

Ash fell in enormous quantities, especially on the Ôsumi side of Kagoshima Bay, *viz.*, the villages of Tarumi, Ushiné and Fukuyama, and a sheet of pumice covered the bay to a thickness of 5 or 6 feet, so that the terror-stricken people fled on foot, on November 9th, to the opposite Ôsumi coast over the narrow channel of Seto, and wild boars crossed to the Kagoshima side (the high flat of Yoshino, see Geologic Map) over the floating pumice. During the eruption the whole island of Kyûshû, the provinces of Isé, Shima, Owari, Mikawa, and farther east became dark and ashes fell there. On the 17th November ash fell in

1) The hot-spring revived during 1835-36. It is of saline nature with a weak acidic reaction and little content of carbonic acid, the temperature being 39°C. The two new ones have a temperature of 45°C., and saline character with alkaline reactions. See p. 56.

Tôkyô, a distance of 1,000 *km.* from the vent; in Ôsaka on the 9th. Patches of pumice were even seen floating on the shore of Inaba, Hôki, Tajima, and Tamba in the Japan Sea.

b) THE FIVE NEW ISLANDS.<sup>1)</sup> In consequence of the eruption of the An-ei era, many islands made their appearance within a year. During the eruption Sakura-jima was entirely enveloped in dust smoke and cloud. When the air cleared the island came into sight, five days after the ever-memorable outburst of the 1779 8th of November, 1779. After a few days (November 11th or 12th) from the bottom<sup>2)</sup> of the sea off the northeast shore of Sakura-jima unearthly sounds issued, like bellowing, accompanied with seething and broiling of the sea, ejecting of stones, pumice and mud (fine pumice splinters), resulting in the creation of shallow banks and small islands, which constantly changed their forms and positions. At first, fountains of yellowish mud rose to a height of 30 to 40 feet, which fell back and flooded<sup>3)</sup> villages on the shore of Sakura-jima and the adjoining lands of Kagoshima Bay. The islands so formed became finally fixed. They are the following (*see* Fig. 11):

INOKE-JIMA  
(Nos. 1 AND  
2) 1779

No. 1 was created on November 21st, 1779, near the shore, only 327 *m.* (3 *cho*) from the coast of the village Kômen (Mukômen).<sup>4)</sup> Its diameter was about 100 *m.*, but height only

1) As much doubt was cast upon the origin of the new-born islands, the writer in April, 1914, made a short visit to the islets and rocks in order to collect rock-specimens and also to study their structure.

2) Said to have been 70 fathoms deep in 1779, and this will by no means appear an exaggeration if anyone examines modern charts.

3) People call this *tsunami* or *shiro-ugé* (潮揚 波) signifying sea-wave or tidal wave.

4) It is to be remarked that the distances and directions mentioned in *Chiri-Sankô* are not entirely intelligible to the reader who takes up a modern map for reference. The writer thinks this is solely due to the fact that the once large village of Mukômen along the coastal plain perished under lava-flows. The buried part, as villagers told the writer, stretches between the present Urano-mayé and Kômen, which space is now covered with confused masses of block-lava, as indicated in figure 11.

3 *m.* This ephemeral lapilli island disappeared on August 1st, 1780.

No. 2 rose from the sea on November 22nd at a distance of 138 *m.* (1 *cho* 16 *ken*) eastwards from No. 1. This pumiceous-rocky mass (hypersthene-andesite) forms the present INOKO-JIMA<sup>1)</sup> which after the late eruption appears above water only at low tide. The islet or pointed rock off Ôseko-zaki in Text-fig. 12 is the one here referred to. A shoal, lying 200 *m.* south of Inoko-jima, may represent the ephemeral island No. 1.



Fig. 11.—An-ei lava-field and new islands to the northeast of Sakura-jima.

1) The writer identified the new islands on modern maps from circumstantial descriptions given in a book, 'Chiri-Sankō.' Recently, K. YAMAGUCHI (*Geogr. Jour. Tôkyô*, Jan. 1915) went over the same line of study as the writer, with a result which does not harmonize well with the one at which the writer arrived. He wishes to leave the judgment to others who may care to pursue the same course of historic interpretation.

IWÔ-JIMA  
(Nos. 3-4)  
1779-1780

Nos. 3 and 4. The former appeared on December 13th, 1779, at a distance of 1,600 *m.* (15 *cho*) eastward, and the latter near by (6 *cho*) on January 15th, 1780; both are rocky, and once emitted a sulphurous odor. The two afterwards coalesced into one. It is IWÔ-JIMA (Kuro-shima or Sé-jima)—the 'sulphur island.' This compound islet appears hook-shaped during low tide, as if it were a submerged rim of a small crater-wall. This is the only new islet built up of

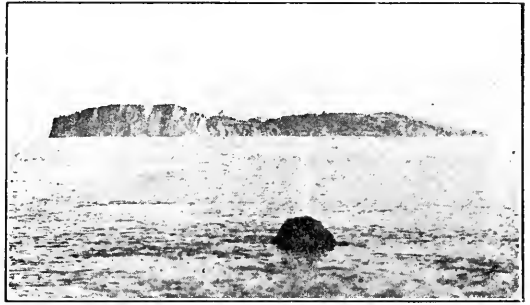

Fig 12.—The Inoko-jima rock in foreground and Shin-jima S in distance—the two new islets of 1779-1780. (After Yamaguchi.)

white-spotted black rock<sup>1)</sup> that the writer has seen among the new islets. See Fig. 13, I.

SHIN-JIMA  
(No. 5)  
1780

No. 5. Two islands welled out on May 11th, 1780, in the direction S.S.W. at a distance of about 1,500 *m.* (14 *cho*) from No. 4. On June 3rd, they amalgamated into one. This is gourd-shaped, pumiceous, and the largest island (700 by 450 *m.*), and received the name SHIN-JIMA (An-ei-jima or Moyé-jima). Many people went out daily in boats to see the remarkable spectacle displayed by submarine eruptions near the present west coast of the island, where on April 21, 1781, one of the vessels was hulled up by a paroxysmal outburst, killing twenty-three of the sight-seers. The island is a gourd-like island in plan as well as in relief, lying prostrate in meridional direction (Text-figs. 12 and 13, S). In the low central portion there is a group of fishermen's cottages. It is built up of a lapilli-ash bed (A) underlain

1) The black rock is dense and somewhat slaggy. Phenocrysts are of the same habits as in rocks of Sakura-jima. Brown glass is full of augite-microlites dusted with magnetite. A few elongated enstatite-augite (?) crystals with resolved terminations and skeletal forms are also occasionally found.

by loose sandy tuffite (B)—a complex which reminds<sup>1)</sup> us of the Diluvial lapilli bed of the Kagoshima environs (Text-fig. 3, p. 14). A slightly saline water seeps out from the junction of the two beds on the south shore, which induced five families from Akauizu of Sakura-jima to settle here twenty years after its formation. A pumiceous gray lava-flow covers

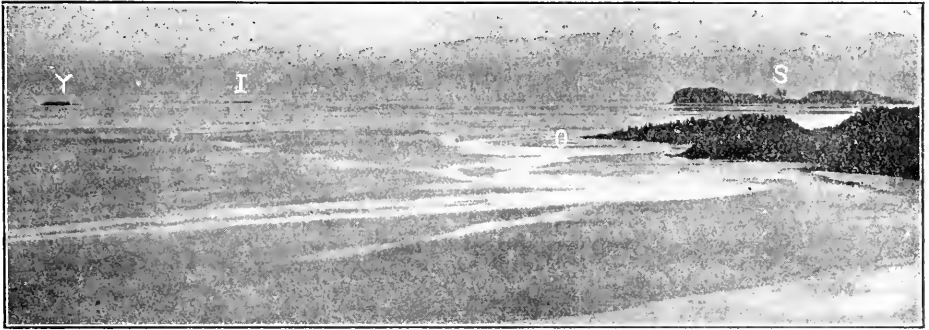

Fig. 13.—Three new islands, Shin-jima, Iwô-jima, and Yôbisu-jima, of 1779-1780. (After Yamaguchi.)

both edges of the central low stretch, which seems to the writer to be a ruined crater-bottom of a submarine vent. The cliffs which bound the island are solely due to marine abrasion. On August 9, 1786, a storm swept away the south-eastern headland leaving a shallow which was once occupied by land.

1) K. YAMAGUCHI (*loc. cit.*, footnote p. 49) is inclined to believe the island of Shin-jima to be of an old date in spite of frequent citations about its new creation during the An-ei eruptions in the literature of that period.

Sandy tuffite and lapilli beds, which YAMAGUCHI mentioned, build up a large portion of the island, and closely resemble the Diluvial Plateau Formation of Kagoshima; but if these beds are really identical with the latter, then the island must be considered to be a detached geologic block of the Plateau Formation, similar to Oki-Kojima and four other islands briefly outlined (p. 23-30). The writer, however, found no crystals of hornblende or biotite in shore sand in his collection, which are important constituents of the basal andesite from which the old tuffite and lapilli beds are derived elsewhere. Moreover, the pumiceous andesite, which intrudes and partially covers the underlying sedimentaries, is of the same kind as that of the An-ei lava—a fact indicating close genetic relation with the neighboring islets raised during the An-ei eruption.

A remarkable fact discovered by YAMAGUCHI, is, however, the presence of mollusc shells and diatoms entombed in the surface soil, 44 m. high, which, according to his interpretation, are not of recent origin.

In short, the question as to the origin of Shin-jima awaits further researches.

*No. 6* welled out on June 12th, 1780, at a distance of  
 YEBISU-JIMA  
 (Nos. 6, 7, 8) 1,500 *m.* (over 14 *cho*) in the direction E. 15° N. from No. 5.

*Nos. 7 and 8.* The first rose on September 29th in the direction S. 45° E. from No. 6, and the second (No. 8) near by on November 9th. Afterward Nos. 7 and 8 united, and later No. 6 also coalesced with them so that this compound island, resulting from amalgamation of the component islets Nos. 7, 8 and 6, is designated by the people No. 6. This is YEBISU-JIMA (Nakano-shima), and is like Iwô-jima built up of pumiceous andesite<sup>1)</sup> clods, thinly covered with pine, and fringed with a shell-mixed sandy shore. This is the only islet that looks white from the distance. A slight depression in the centre may be an indication of a defunct vent (*Y* in Text-fig. 13).

The islands Inoko-jima (Nos. 1-2), Iwô-jima (Nos. 3-4), Shin-jima (No. 5), and Yébisu-jima (Nos. 6-8) are called the New Five Islands, though in reality there are only four independent islets.<sup>2)</sup>

NII-BAMA In passing, the writer may mention the islet of HAMA-SHIMA<sup>3)</sup> (Nii-shima) off Kurokami village. See Geologic Map. It is a mere lapilli bank, elliptical in form. It is said to have been formed by submarine eruption during the An-ei activity. The old lapilli accumulation is commingled with recent ejecta, in which the writer picked up pieces of cordierite-bearing ones

1) The rock is dull-gray white-porphyrific porous hypersthene-andesite with porous ground-mass, built up of colorless glass with a felt-work of augite-microlite and a little skeletal plagioclase.

2) There is a shallow bank, 1 *km.* westward from Yébisu-jima (Nos. 6-8). The writer could not find any description that corresponds in position to this shallow. This *Doro-shima* ('mud island') or Kami-shima (Fig. 11) is a submarine pumice bank of yellowish-brown color, 436 *m.* (4 *cho*) in circumference, which appears above water only during low tide. This may be the phantom island, known only by tradition, which is said to have appeared in the Tembô-Hôji era (761 A.D.), and lately referred to as Ko-jima (pp. 29, 41). An old book says, according to Yamaguchi, that an island appeared on October 18, 1781 at the west of the new islands only for a few days. Again in June or July, 1786, another one rose at the west of the former and soon disappeared. The shallows to the south of Doro-shima are said to be the positions of these short-lived islands.

3) 濱島



(ceramicite) thrown out from the Nabé-yama vents during the first phase of the recent volcanic activity.

ORIGIN OF NEW ISLANDS      *Origin of the new islands.*—The foregoing pyrogenic islands made their appearance as the outcome of attendant submarine effusion of lava during and after the eruption in 1779. The following views as to their origin may be mentioned: *a)* They are sometimes spoken of simply as vents on the rupture line that traversed the body of Sakura-jima, as the Nabé-yama vents in the last eruption. *b)* It may also be suggested, although no one seems as yet to have given utterance to this view, that they are the loci of ventholes on the front of the gas-pent and cooling submarine lava that plunged into the sea down the mountain slope in a fiery stream from the twin vent, the east and west *higona* or ‘fire-holes’ near the northern top (Fig. 11). Neither view is applicable here as a working hypothesis, if the bathymetric condition of the surrounding sea be critically examined.

The new-born islands occur in diffuse manner and rise precipitously from the bottom 60 fathoms deep. Local depressions of the same depth intervene between the shore and the islands, so that there is no room for doubt that there exists no real connection of lava-flows between the insular masses and Sakura-jima (Text-fig. 11).

It seems to the writer that they represent the positions of ventholes of what Wolff<sup>1)</sup> styles the central eruption upon a local magma reservoir of satellitic injection fed through a narrow channel from the main macula under Sakura-jima, just as, according to Daly,<sup>2)</sup> Kilauea is fed by Mauna Loa in the Hawaiian islands. The

1) F. v. Wolff, ‘Der Vulkanismus.’ Bl. I.

2) ‘The Nature of Volcanic Action.’ *Proc. Am. Acad. Arts and Sciences*, Vol. 47, 1913

bottom, 60 fathoms deep, was under pressure and comparatively cool. The feeding channel from the main was closed by consolidation, and the accumulation of liberated gases in the cooling secondary reservoir under high tension corroded and ate away the roof, finally opening the way for the access of water to the small hot macula.

Soon subaqueous outbursts followed, ejecting mud (fine splinters of pumice) and lapilli in the shape of fountains, and disturbing the body of water which caused *tsunami* or sea-waves to the surrounding shores. The shallow bank, outlined with a 10-fathom line, rose from the bottom by accumulation of the submarine ejecta (Text-fig. 11), and likewise the lapilli-ash bed of Shin-jima (No. 5), 44 *m.* high, was deposited and raised at this time. As in normal development of submarine islands, a massive dome or tholoide rose through the aqueo-pyroclastic deposit in the final phase, which is typically represented in the form of Iwô-jima (Nos. 3-4).

One of the writer's motives in visiting these islands was to see the products of subaqueous consolidation of lava, the *modus operandi* of which is exactly known from authentic records.

In contrast to subaërial lavas, compact submetallie-clinking lavas were not found in the surface rocks in the whole region over which the writer rowed. The rocks are all more or less pumiceous and sometimes slightly slaggy, they have the appearance of a *dusky coke* from lignite and are also light. Under the microscope the intratelluric plagioclase-phenocrysts are compound crystals with brilliant birefringence, and the crystals are full of glass due to temporary regressive and corroding action of the magma during crystal-growth. Hypersthene and augite are as in terrigenous lavas. In the glassy groundmass one finds only slender pyroxene with stiff fibrous terminations in brown glass. The latter contains

abundant globulitic bodies, and is often locally decolorized, appearing macroscopically as light flecks. The pyroxene may be mostly enstatite-augite as in artificial slags. Magnetite and feldspar-microlites are wanting in the rocks from Inoko-jima, while in those of other islands magnetite-dust and skeletal plagioclase-microlites occur in moderate quantity. The rock is cloddy, due to contraction-fissures variously traversing the whole body, formed by a sudden quenching of the hot mass in water, the clefts so produced are afterwards lined with a limonitic substance, and filled with black dust which marks the direction of flaws.

Some of these characteristics differentiate the subaqueous from the lavas of subaërial consolidation.

WANING  
PHASE OF  
AN-EI  
ACTIVITY  
1781

The great paroxysmal eruption of the An-ei era (1779-'80) echoed for many years.

On April 11th, 1781 (10th year of An-ei, or 1st year of Temmei era), an eruption took place (where?), and the people in the island were greatly frightened. They made a vow to the God of the mountain, and refrained from fishing on the 18th (lunar calender) of every month. This day they still keep. While the writer was in Kagoshima last year, he heard people talking about this sacred 18th, which had lately not been strictly observed by the inhabitants, causing the wrath of the God Gongén whose shrine is located on a little elevation (400 *m.*) on the western slope, and the principal centre of the late eruption on the western flank was near the said shrine now entirely blown off with the hill.

1782 On January 18th, 1782 (2nd year of Temmei era), the mountain was active?

1783 On September 3rd, 1783, it sent out flames, and ash fell as far as Kyôto.

- 1785           On November 20th, 1785, it again erupted.
- 1790           On July 29th, 1790 (2nd year of Kwan-sei era), the top was much shaken and flames came out.
- 1791           On September 11th, 1791, it again burnt.
- 1792           On October 11th, 1792, it again burnt.
- 1794           It erupted.
- 1797           It sent out flames.
- 1799           On March 27th, 1799, it sent out flames.
- ERUPTION-PERIOD VI.  
1835-1836       During the year 1835-'36, a hot-spring in Arimura gushed (cf. 1779, p. 47).
- 1860           In February or March, 1860 (Ansei or Mannen era), the Yamano-yu hot-spring (?) in Takaguma, and another, a luke-warm sulphur spring in Tobi-oka on the north of Tarumizu, both in Prov. Ôsumi, gushed out. The south crater of Sakura-jima was rather active.
- 1876           In 1876 (9th of Meiji era), a hot-spring in Shinmidô (?) in Prov. Ôsumi gushed out (Milne).
- 1878-1879       At the end of the winter 1878, and in March, 1879, the south crater sent out flames (Friedlaender).

### § III. The Eruption of Sakura-jima in 1914.<sup>1)</sup>

(Eruption-period VII.)

- 1913           A) Premonitory Symptoms.—As early as the spring

1) The following are the chief works concerning the recent eruptions:

Nishio-Friedlaender, 'Der verheerende Ausbruch des Vulkans Sakura-jima im Süden der japanischen Insel Kiuschiu.' *Petermanns Geogr. Mitteil.*, 1911, S. 132. It is an extract from the 'Explanatory Text to Sheet Kagoshima.'

Ôseki, 'Der Vulkanausbruch auf Japan.' *Zeitschr. Gesell. f. Erdkunde zu Berlin*, 1914, S. 151.

Yamasaki, 'Der Ausbruch des Vulkans Sakurashima im Januar 1911.' *Zeitschr. Gesell. f. Erdkunde zu Berlin*, 1914.

F. A. Perret, 'Preliminary Report on the Grand Eruption of Volcano Sakurashima.' (Italian) *Zeitschr. f. Vulk.*, Bd. I. S. 113.

of 1913, Kagoshima and her environs showed many precursory and abnormal signs of subterranean convulsion. During the spring of 1913, the *hot-springs* of Kurokami on the eastern coast of Sakura-jima ceased to flow, so that the inn-keepers were obliged to give up their business. A little later, at Arimura and Yumo on the south, the alkaline hot-springs, all situated at the water's edge, became too hot for bathing during low, but cool during high tides through dilution with sea water. These incidents indicated that gases were already ascending from crevices, or heated waters seeping down from above. (*See* p. 47).

From the 19th to the 30th May, especially the 22nd and the 23rd, the atrio-like hollow of the Yoshimatsu area, 55 *km.* to the north of Kagoshima, with the epicentre near the above-named railway station at the northwestern foot of the Kirishima volcanoes quaked repeatedly, accompanied with detonations (*see* the Summary), causing anxiety to the inhabitants. On June 29 and 30, while the quakings of Yoshimatsu were attaining their climax, sympathetic earthquakes temporarily occurred near Kagoshima and the westerly lying punice

THE  
YOSHIMATSU  
EARTH-  
QUAKES

---

T. A. Jagger Jr., 'Letter from Sakura-jima.' *Weekly Bull. Hawaiian Volcano Observatory*, No. 13, 1914.

Ômori, 'The Sakura-jima Eruptions and Earthquakes.' I. and II. *Bull. Imp. Earthq. Invest. Com.*, Vol. VIII. Nos. 1-2, 1914-1916, Tôkyô.

Satô, 'Eruption of the Volcano of Sakurajima.' *Bull. Imp. Geol. Surv. Japan*, Vol. XXIV. No. 1, 1914, with an English resumé.

Azuma, 'The Great Eruption at Sakura-jima of 1914.' (大正三年櫻島大噴火記) Kagoshima, 1914, pp. 1-252. (Japanese)

'The True Account of the Great Explosion of Sakura-jima in 1914.' (大正三年櫻島大爆發實記) Published by *The Kyûshû Daily News*, Kumamoto, 1914, pp. 80. (Japanese)

'The Great Explosion and Earthquakes of Sakura-jima.' (櫻島大爆震記) Published by the Reportorial Staff of *The Kagoshima News*, Kagoshima, 1914, pp. 310. (Japanese)

'Sketches of the Great Eruption of Sakura-jima in 1914,' by the Meteorol. Observ. Kagoshima, 1915. 大正三年櫻島山大噴火實寫圖

Official Reports of the Kagoshima Meteorological Observatory on the recent eruptions are found in *Jour. Meteorol. Soc. Japan* for 1914.

region of Iziû-in, 15 *km.* west from the city, where clocks stopped and a few houses were badly damaged.

On November 8th and December 9th, 1913, and on the  
 1914 8th of January, 1914, Kirishima, lying 55 *km.* to the north from Sakura-jîma, made successive explosions, ejecting ash over the surrounding districts. A week before the great catastrophe of the 12th, a pond 3.6 *m.* square, just above Ari-mura in Sakura-jîma suddenly became dry, and the fishes in it all died, and some wells in the island dried up, or the water-table became considerably lower. These unusual phenomena were reported and the authorities replied that these were mere effects of the activity of Kirishima already referred to. These movements embracing the region within the radius of 61 *km.*<sup>1)</sup> from Sakura-jîma already pointed out the local origin of a subterranean disturbance of great volcanic energy. On January 8, thick snow fell in Kago-shima Bay, which has been rarely experienced in warm southern Kyûshû.

JAN. 10TH,  
 1914 We were now approaching the dreadful crisis, the energy concentrating in Sakura-jîma in its upward exertion for the egress of lava. From the morning of January 10th, precursory shocks were experienced in Kagoshima, throwing water out of basins every (?) 10 minutes. From 7 P.M. rapid tremors shook the island, accompanied with subterranean groaning. The magma was then apparently ascending. Some people observed already during this day shaken rocks falling from the western slope of the north cone of Sakura-jîma. The night was stormy with flashes of lightning followed by rain, then the weather became clear and warm.

1) G. K. Gilbert, 'Interpretation of Anomalies of Gravity.' Prof. Paper 85 C., *U. S. Geol. Surv.*, 1913.

JAN. 11TH,  
MORNING

On the 11th, 3.41 A.M.,<sup>1)</sup> a weak local earthquake (scale 1)<sup>2)</sup> was felt in Kagoshima, which inaugurated the subsequent convulsions.<sup>3)</sup> Henceforward, feeble shocks occurred four times an hour on an average till 9<sup>h</sup> 51' 45" A.M. when a strong one (scale 5) shook the city. The direction of the earthquake vibration was from S.S.E. to N.N.W., or S.E. to N.W., as recorded on a Gray-Milne-Ewing seismograph in the Meteorological Observatory in the city, situated on a hill-top (120 *m.*) of a pumice bed 90 *m.* thick. If the seismometer had been posted on solid rock in a region of flat topography the writer conjectures the direction of vibration would have been somewhat different from that actually recorded as above stated. Just at this time a boy at Nojiri in Sakura-jima was hurt on the head by flying stones (explosion?).

About four hours before the earthquake of 5.58 A.M. (scale 2), a slump<sup>4)</sup> of considerable magnitude happened at the doubly pointed 'scissor-rock' or *hasami* (Geologic Map) on the western crater-margin of Mt. Sakura-jima, which slid down toward the point where vents opened later. The slip caused mighty avalanches of debris and dust clouds which might have been easily mistaken for an explosion. The fresh rusty-

THE  
 AVALANCHE  
 OF THE  
 SCISSOR-  
 ROCK

1) The following is chiefly an extract from 'Report Meteor. Station Kagoshima.' *Jour. Soc. Meteor. Japan*, No. 2, Tôkyô, 1914. As to the numerical data refer to the original Report (see also Summary). My creditable informant is a fisherman who passed the restless night of the 11th with the villagers at Nojiri in Sakura-jima. He fled for his life at the explosion of the 12th at 10.5 A.M. on his boat to Tani-yama on the Kagoshima side. Then, rowing northwards along the city, met on the way homeward the great earthquake at 6.29 P.M. on a turbulent sea, and finally reached Fukuyama in safety the next morning. It is this resolute man who offered his services to guide the writer on his trip on the 18th January along the coast of Ôsumi as far as Fumoto near the lava end. He knows the details of the catastrophe from the very beginning to the end.

2) The scale is the one adopted by our seismologists and current in use among us.

3) This earthquake startled the whole population of the city from sound sleep; from then on they were kept awake throughout the early morning by the ever-increasing tremblings.

4) The dust-clouds formed from avalanches are not easily distinguishable from the ash-clouds of real explosions unless actually observed from proximity.

brown scar left by the slip can be distinctly seen from a distance, and the disappearance of pointed rocks deformed and lowered the topography of the western slope.

THE 11TH.  
AFTERNOON

An earthquake of the same intensity (scale 2) was experienced between noon and 1 P.M., and some people saw a light-bluish cloud rising on the western slope (the first sign of explosion on the *west?*). About 2 P.M. a man in Tarumizu saw light white clouds rising just above Ari-mura at about what corresponded later to the Sen-yemon venthole (No. 1 vent) on the southeastern slope of Mt. Sakura-jima (the sign of explosion on the *east?*). It may have been either condensation of steam below, or of vapor in the air by ionization. This fact indicated that the lava already ascended through the channel up to *within 300 m.* from the surface, as it has been experimentally proved that the liberation of gases begins with the pressure corresponding to that depth.

From noon, in fine weather, the frequency of the shocks was 10 in an hour till 8 P.M., whence it doubled, keeping this up till about 10 A.M. of the next day, the tragic 12th. The recorded shocks from the beginning down to this moment (12th, 10 A.M.) were 418.

THE 11TH,  
NIGHT

Shocks of the same degree (scale 2) occurred once between 5 and 6 P.M., and again between 7 and 8 P.M. At 7.15 P.M., cannonade-like sounds and tremblings occurred for the *first time*. A policeman at Yokoyama in *western* Sakura-jima reported at night to the authorities that high up in the back mountain he saw smoke rising and *red-hot stones flying about*. During the whole day the island was incessantly shaken, and roof tiles slipped from the eaves, showing the peculiar nature of the quaking. Apprehending the

THE FLYING  
OF RED-HOT  
STONES



coming dreadful event, a large proportion<sup>1)</sup> of the aged, infant and female population of the island fled to the nearest mainland from early day till late in the moon-lit night of the 11th.

The whole population around Kagoshima Bay spent a restless night, especially those who did not take to their heels from Sakura-jima passed the ever-trembling night in the cold open air. Clouds of gases were no doubt already issuing somewhere from the western slope during the night.

THE EAST      Of the *east* we knew very little, as the inhabitants had already deserted the island during the day, only a very few invalids and policemen<sup>2)</sup> stayed behind.

### B) Surface Manifestations of Activity at Sakura-jima.—

THE  
EVENTFUL  
DAY, JAN.  
12TH,  
MORNING

THE FIRST PHASE. Eventually the fateful day<sup>3)</sup> dawned; the weather was fine and calm; the low pressure had shifted its centre eastwards already on the 10th. The quakings abated a little between 1 and 3 A.M., suggesting that during these remarkably quiet hours fissures or spaces opened

1) 24,577 out of 27,116 of the inhabitants in the villages with which the island is dotted all round the coast.

2) The writer knows of one case, where sufferers at Kurokami were literally entombed under the pumice-lapilli burden (2 *m.* thick) and in their crushed houses for two days without food; at last they took courage to embark on a boat which was entrapped in the thick pumice sea (12 *cm.* thick). They were saved by some volunteering youths, who, noticing handkerchiefs waving from a distance, hastened to the spot and brought these poor people to their own homes at Fukuyama on the 11th.

3) A Japanese author said 137 years ago, when he wrote about the An-ei event at Sakura-jima, that eruptions habitually took place at New or Full Moon. That of An-ei was at New Moon—the first day of the 10th month, 1779, while this year it was near the Full Moon, *i.e.*, the 17th day of the 12th month of the lunar calendar. Jensen says that volcanic eruptions occur more frequently at Full Moon and New Moon than in the last quarter, and at the end of sunspot maxima. ‘The Geology of Sumoa and the Eruption in Sawaii.’ *Proc. Linnæan Soc. New South Wales*, 1906, Vol. XXXI, part 4, p. 665.

By the way, it is to be noted that P.J. Ricard, of Santa Clara College, Cal., lately observed a sunspot of great dimensions, twice the area of the earth, *i.e.*, 1/2785 of the sun. *Die Umschau*, January Number, 1914.

for a moment for the influx of magma into them. The earthquakes revived afterwards till noon; the climax, however, had already been reached during the night before. The insular population felt the strongest shock at about 5.30 A.M.

Then *surface activity was drawing closer*. At about 8 A.M., white filaments of misty clouds were seen to rise after an earthquake near the *Gongên shrine*<sup>1)</sup> at an elevation of 300 m. on the west slope facing Kagoshima, while at about the same time the HOT AND COLD SPRINGS saline hot-spring, and wells at Ari-mura on the southern foot spouted in fountains to a height of 1 m. It will be remembered that this village was afterwards buried under 'live' lava. The cold mineral spring at the water's edge in Saidô on the northern shore spouted at about 8.30 A.M. As the spot is known by the name of Yuno-saki or the 'hot-spring point,' it is likely that formerly the spring possessed a high temperature. The outgushes of this and other springs all round the island may not necessarily be attributable to subterranean pyrogenic origin; on the contrary, the writer is rather inclined to assign the cause to disturbances of drainage by the constant shaking and trembling high up in the body of the volcano.

At 9.10 A.M., a thread of white steam clouds (Text.-fig. 14 a) rose upright from the southern top-crater (Minami-daké) where two weak solfataric vents had been constantly emitting vapors from the inner cliff ever since the activity of 1879.<sup>2)</sup> It was a sure sign of surface activity, as the lava canal is directly connected with the crater. In the An-ei eruption of 1779, the same pioneer eruption happened in one of the three top-craters. (See Fig. 10 a, p. 44.)

About five minutes later, an earthquake (scale 3) happened associated with cannonading sounds and tremblings, and then the

1) Near No. 1 vent in Geologic Map.    2) See p. 56.

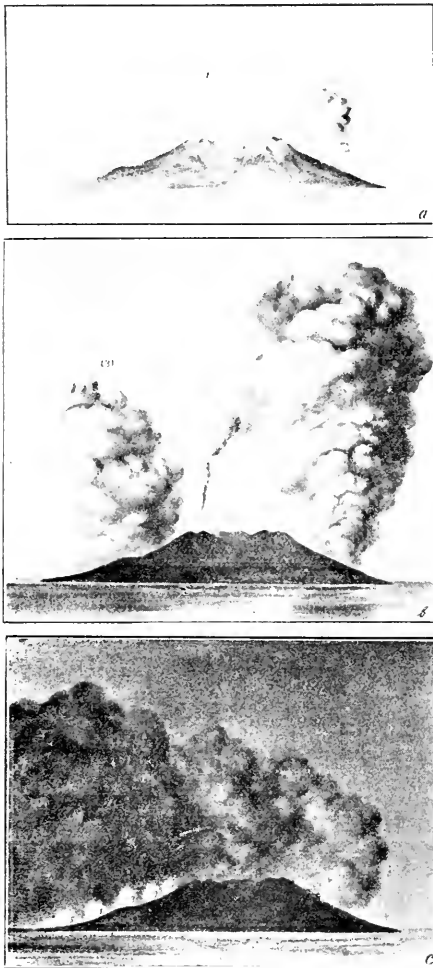

Fig. 14.—The first phase of eruption, viewed from Fukuyama.<sup>1)</sup>

*western* (Yuno-hira) vent in calm weather threw up black curdy smoke (ash cloud) high up into the air, which expanded in the upper horizon in cauliflower shape (Text-fig. 14 *a* (2), *b* on the right), meanwhile red glares and sparks were emitted from the vent, signaling the advent of fluent lava. The *eastern* (Nabé-yama) vent a little later sent forth clusters of black clouds (Text-fig. 14 *b* (3)) accompanied with terrible detonations. Thus, the general surface outbreak was inaugurated on both sides of Mt. Sakura-jima.<sup>2)</sup>

OUTBREAKS  
INAUGURATED

WEST SIDE THE ACTIVITIES ON THE WEST SIDE. Once the outbreak had started, it seemed to know no bounds. At 10.40 A.M., explosions and detonations were

1) Fig. 14 is copied from a hand-sketch by Doctor Ninomiya, of Fukuyama.

2) When at last (10. 10 A.M.) Mt. Sakura-jima was universally recognized as the real seat of the volcanic disturbance, those people who still remained on the island took flight on small craft still left on the coast, or were waiting half mad on shore for succor. All available steam-launches were speedily sent out from the city to all parts of the coast, and about 2,500 poor people were saved in these perilous expeditions.

Meanwhile the city of Kagoshima itself was the scene of great consternation with loud and bustling crowds. After the explosion at 2.30 P.M., ash began to fall on the city; and alarmed by an unfounded rumor of on-rushing scorching poisonous gases, the city population of 73,000 took flight in tumultuous disorder either on foot or on trains. Toward the evening Kagoshima was almost deserted, presenting the appearance of a dead city.

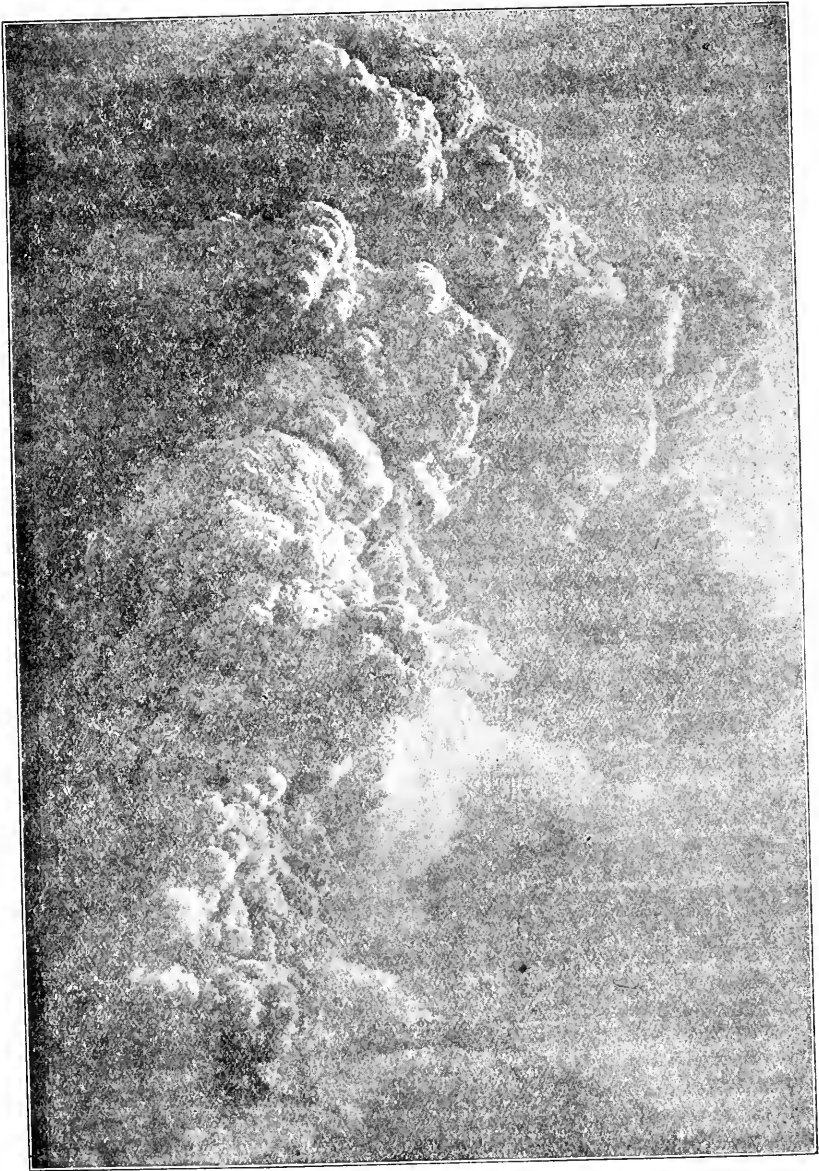

Fig. 15.—Sakura-jima at the first phase of eruption, as seen from Kagoshima. (Photo by Yamashita.)

steadily growing in strength, and the ventholes were increasing in number, to 4 or 5 one after another in a series toward the shore at Yokoyama. This indicated the widening and lengthening of

fissures toward the west. The writer is of opinion that each time the black clouds were forcibly thrown out and ash fell, it was a sure sign of a new fissure rent open somewhere. It is PERRET'S Vulcanian type. Meanwhile coarse ejectamenta and ash were thrown out from *vesiculated* magma (Strombolian type)

HEIGHT OF ASH-CLOUDS to a height of 18,181 *m.*<sup>1)</sup> during the first phase, *i.e.*, above the lower limit (11,000 *m.*) of the windless and cloudless zone of constant temperature (Frontispiece and Text-fig. 15).

Strong showers of projected incandescent stones, dragging behind them threads or tails of gray vapors, like meteors, are said to have fallen hot, abundantly and hissing into the sea to a distance of 3–3½ *km.* from the vent, which the writer measured on a map, so that it must have been dangerous to approach Yokoyama on shore in resening the terror-stricken inhabitants. It was now about 11.30 A.M. Old grayish-white and new blackish scorching stones fell all round the western shore, setting villages and forests

THE NUÉE ARDENTE on fire. The descending fiery wind-blast or the *nuée ardente*, as in Frontispiece, seems to have been instrumental in setting the villages and forests on fire. The outbreak was partly of the Vulcanian but predominantly of the Strombolian type, in the sense in which F. A. PERRET<sup>2)</sup> discriminates certain phases of volcanic manifestations.

1) It was measured by the Railway Station-master of Kagoshima. The height calculated from Kushino, far away west from the city was 7,272 *m.*; that estimated from the man-of-war "Toné" anchored near Taniyama being 8,181 *m.* T. Oguru, my assistant, got the value 3,560 *m.* from the writer's photo of January 15th, *i.e.*, four days after the first outbreak. This was, the writer presumes, the average height of clouds for a few days while displaying the Strombolian type of activity. In the *Report of Meteor. Observ. Kagoshima*, it is stated to be 3,000 *m.* The smoke column of the Krakatoa eruption was estimated as 27 *km.* (17 miles) high; in the Mauna eruption of 1914 it was 8000 ft. (2,464 *m.*)—Wood, *Bull. Seis. Soc. Am.*, Vol. V. In the An-çi eruption of Sakura-jima, the height calculated was 12,029 *m.* (see p. 45, footnote).

2) *Zeitschr. f. Vulkanologie*, Bd. I. 1914, S. 25.

HOLES IN  
GROUND

Numerous *holes* (Pl. V. Fig. 2), evidently caused by trajection of large disrupted blocks, were to be seen on the western shore, varying in size from 0.5 to 6 *m.* in diameter and 0.3 to 2 *m.* in depth. Shattered blocks with cordierite-bearing white inclusions are still to be seen in the bottom of pits made by them, or scattered about in the neighborhood by their rebound. Electric discharges seem to have had nothing to do with the making of the hollows. On the other hand, it seems not improbable that a thick pumice-ash deposit on the *wet* valley bottom might have been puffed up by *steam, generated by the advancing and overriding fluent lava*, and in this way some conical pits may be formed in the ground.

THE 12TH,  
AFTERNOON

From noon, the earthquakes remarkably abated owing to the releasing of pent-up gases, which opened a way for the lava to the surface; but 'air-quakes'<sup>1)</sup> or air-concussions and roarings continued, increasing both in frequency and force, constantly rattling the windows even of



Fig. 16.—Night view of Jan. 15, as seen from the quay in Kagoshima.

1) The air-quake or *quasi-earthquake* is accompanied with the 'detonation'—the *air-wave*, which in contrast to the pure sound-wave is said to be produced by slow oscillation of air. It does not affect the human ear as a sound in itself, but it causes audible sounds when it encounters some obstacle which can be easily disturbed, such as Japanese sliding doors. See S. Fujiwara, 'Abnormal Propagation of Sound-waves in the Atmosphere.' *Bull. Central Meteor. Observatory of Japan* Vol. II. No. 1, 1912. See also 'Morphological Summary of Japan and Korea.' III. Earthquakes. *Jour. Geol. Soc. Japan*, 1915, p. (26), footnote.

the city. Flashes of lightning (Fig. 16), which seem to have been mostly confounded with projectiles of red-hot rocks, were shooting in a girandole fashion within the column of emitting clouds.

At 2.30 p.m., black ash-smoke and white steam-gas clouds<sup>1)</sup> intermixed enveloped the whole island, accompanied by augmenting detonations; from 3.30 p.m., *real explosion* on a grand scale began with cannonading and tremblings. The fluent lava already began to crawl down slowly just before the great earthquake at

THE FIRST  
SIGN OF  
LAVA-FLOW      6.29 p.m. from the Yunohira vents. *Thus the explosive phase ended and the activity entered into the second phase—the true eruption.*<sup>2)</sup>

THE ACTIVITIES ON THE EAST SIDE      THE ACTIVITIES ON THE EAST SIDE. What the writer has just depicted refers to the activity on the front side—the *western*, the Yunohira ventholes, from morning to evening just before the *great earthquake at 6.29 p.m.* What took place during the same interval on the southeast coast of the island was very little known. Being on the further side of Mt. Sakura-jima from Kagoshima, these portions of the island scarcely attracted the attention of the general public, though not far from the coast of Ôsumi, which is dotted with impoverished villages on the fast soaking lapilli deposits of 1779, and probably also of 1476.

THE 12TH,  
MORNING      The spouting of wells in Ari-mura at 8 a.m. has been already referred to (p. 62). About 800 shocks

1) From the universality and abundance of salmiac and gypsum, especially the first, among incrustations and sublimates in the juvenile lavas and the ventholes in Sakura-jima, the writer is disposed to think that not a small portion of those curly white volcanic clouds is composed of snowy crystallites of the *salmiac fume*, which are formed in the medium of the atmosphere.

2) Some writers on the Sakura-jima eruption assign the first lava flow to an interval between 8.15 p.m. of the 12th to 8.30 a.m. of the 13th. In a photo (Pl. V. Fig. 3) taken on the 13th, 10.33 a.m., we see the lava flow already approaching the shore.

were counted from the 11th, 3 A.M., to the 12th noon. Most people fled the day before, as already stated, to the nearest mainland. The coastal inhabitants knew very little about the immediate danger that threatened them overhead from the top of the mountain. No sooner did they see, at 10.5 A.M., a thread of white clouds rising from the southern crater (Fig. 14a [1]) than they be-took themselves on small crafts and departed from the island. They and the few remaining people observed, at 10.10 A.M., black clouds, this time dead calm and silent on the west (Yunohira vent) followed soon after by the same black clouds on the east (Nabé-yama vent). See Fig. 14b (3).

A few minutes later masses of dense black clouds were thrown out, simultaneously with terrible detonations, projectiles of red-hot stones and sparks. The whole island was then enveloped in dark ash clouds. This horrible state continued till 1 P.M.<sup>1)</sup> with ever-increasing fury when the ash clouds attained the maximum height, which implied the climax of the ‘explosion.’

THE 12TH,  
AFTERNOON

RAIN OF  
PUMICE

About 2 P.M., the last men were rescued on steam-launches from the city. A solitary policeman of Kurokami came late in the afternoon to Séto through a hailstorm of pumice, took with him four invalids on some kind of raft, and rowed with difficulty through the sea of *floating pumice* to the opposite coast (p. 61(2)). As the pumice referred to was vesiculated young magma from the Nabé-yama ventholes, but not the fragments of old lavas, the writer may be justified in saying that the ‘live’ lava was already in contact with the atmosphere at about 2.30 P.M., as was the case from the Yunohira vents or bocche.

1) Ash and pumice eruptions began from this time and continued till noon of the 13th. The people on the Ôsumi coast say, the main ejections of lapilli and ash took place between the 12th, 10.35 A.M. and the 13th, 4 A.M. The main producers of lapilli were the eastern vents.



THE GREAT  
EARTH-  
QUAKE OF  
THE 12TH

At last, at 6.29 P.M., the violent destructive earthquake<sup>1)</sup> (scale 6) occurred, the strongest one in the last catastrophe, which demolished the hewed-stone walls of the city of Kagoshima, especially those running in N.-S. direction, while the walls and stone-buildings built in the east-west direction were simply fractured and twisted. The shocks seem to have come from S. 60° E. to N. 60° W., or the reverse, as may be conjectured from the position of the overturned tomb-stones in the city (*see* p. 59).

---

Some houses in the dark city were totally wrecked, and a large proportion of buildings of foreign style were more or less damaged (Text-fig. 17). The casualties on this occasion were 13 killed and 111 wounded.

Under the detonation by explosions, the sound of the alarm-bugling of the Forty-fifth Regiment and the fire-bells, the trembling and shaking of ground and houses, tumultuous crowds deserted the city, and the very last man left the telegraph office at 8 P.M. At about 9 P.M., a TSUNAMI baseless rumor of the inrush of *tsunami* or sea-wave again threw the refugees in open camps into indescribable confusion. An hour, or an hour and a half after the great earthquake a slight *tsunami*<sup>2)</sup> did come into the harbor quay of Kagoshima, caused probably through the deflection of disturbed waves in the crooked bay of Kagoshima.

The plateau of pumice-lapilli bed, 90 *m.* thick, was shaken at its

---

1) According to C. Davison (*Nature*, 1914, p. 716; *Geogr. Jour.* London, June number, 1914), a Galitzin seismograph at Laibach, Austria, recorded an earthquake at 9 h. 29 m. 27 s. A.M., Greenwich time, which corresponds to 6 h. 29 m. 2 s. P.M., Japan time. The coincidence is remarkable. He remarks that the earthquake had a possible connection with the eruption of Sakura-jima on the same day. Earthquakes connected with a volcanic eruption are usually of less intensity and confined to small areas, while the one in question being of strong shocks might have originated at some distance from the volcano. The latter clause does not fit well in the present case, as will be clear in the statement made in the Summary. It is to be noted here that the same earthquake was recorded at 6 h. 30 m. 21 s. P.M. at Tōkyō at a distance of about 1,000 *km.*

2) It is locally called 'shiuo-agé' (潮揚) or tide overflow, and this happened also in 1779, especially when the new islands (pp. 48-55) rose from the boisterous sea bottom through the eruptions of water and lava, though these 'shiuo-agé' differ in their origin.



FIG. 17.—Houses in Kagoshima damaged by the earthquake.  
(Photo taken on Jan. 16.)

cliff end near Ten-jin-ga-Séto at the west of the city, entombing a dozen people who were running from danger; another landslide occurred at Nikén-jaya under the same geologic condition, where the light railway line running southwards from the city to Tani-yama on the coast was buried under the fallen rubbish.

The third slide was at the basalt cliff of the Yoshino mesa (Geologic Map), 400 *m.* high,

along the coast between the city and Shigétomi, where the rails and telegraph posts were heavily damaged for a considerable distance by fallen blocks of one or more cubic metres. All communication with this out-of-the way city of Kagoshima was thereby cut off from the outer world, and this was the unfortunate cause of the rumor which spread all round the world, that the city with a population of 73,000 was totally annihilated and buried alive under the lava from Mt. Sakurajima, 8 *km.* distant beyond the sea from the nearest venthole!

JAN. 13TH.  
MORNING

From midnight to 1 (?4) A.M. of the 13th, smoke-clouds were in full force and the explosive activity attained its climax enforced with detonations, air-concussions and discharges of electricity, throwing out heated ruptured blocks.

THE NUÉE  
ARDENTE

During these hours a local *hurricane* raged, caused by a downward current, uprooting trees and wrecking houses on the western shore. It was a dark and heavy, scorching and expanding steam-cloud, laden with ejecta of preëxisting rocks of varying dimensions, which apparently crept down the slope westwards like the fiery wind of Mt. Pelée. (*See* Frontispiece and Text-fig. 15.) No one has ever described the scene, as the people



Fig. 18 *a*.—Prosperous villages of the western slope, looking down from the North cone—the theater of the recent eruption and devastation on the west side. (Photo by Mr. Uyêda.)

had already deserted this portion of the island. The marks left by the scorching blast are the bare trunks of trees and the thick deposits of blocks of various sizes, thinly mixed with ash, the latter being the characteristic volcanic conglomerate (Pl. V. Fig. 2)—the work of the *nuée ardente*, which every one

must have observed when walking on the western shore.

The early morning was dusky with a rain of ash blown by the southeasters over the city—the *first ash-fall in Kagoshima*.<sup>1)</sup> The boisterous activity, however, relaxed a little at about 10 A.M., while the 'live' lava was, it seemed to the writer, copiously pouring out from the vents.

THE NOON,  
LAVA-FLOW About noon, when the clouds cleared off a little, the lava was for the *first time* seen near the Yunohira vents, crawling in a yellow band down the slope toward Yokoyama on the shore. In a photo of the morning of the 13th, one can see, however, the lava already covering nearly half of the western lava-field (Pl. V. Fig. 3).

THE 13TH  
NIGHT, THE  
CLIMAX OF  
ERUPTION From 8 P.M. to 4 A.M. of the next morning the *real eruptions*<sup>2)</sup> accompanied with air-concussions and roarings (actual earthquakes being comparatively few) attained their climax from the Yunohira ventholes. The *eastern*,<sup>3)</sup> Nabéyama vents also seemed to rival the western. The *main outpouring*<sup>4)</sup> of fluent lava on the west was accomplished during these

1) The town Myazaki, 80 km. from the volcano, was enveloped in darkness at 1 P.M. caused by the ash-fall which already began at 1.45 A.M., so that people had recourse to candles and electric light. At Tadotsu in Shikoku, slight air-concussions were felt during the whole night on the 12th, and on the 13th the sky was misty, accompanied with ash-fall, and the wind was rather cold. On the next day, the 14th, ash fell in Tôkyô at a distance of 1,000 km. (Pl. XXIII. Fig. 8.)

2) Not the eruptions of ash and pumice. Most writers assign the *first* effusion of lava to have taken place from 7 to 8 P.M. of the 13th; but in reality it began to well out at least prior to the great earthquake at 6.29 P.M. of the 12th (see Frontispiece). See p. 67, footnote 2.

3) Ash and pumice, which were deposited on the Nabéyama side to a thickness of a metre, fell chiefly from the 12th, 2 P.M. to the 13th noon. These *explosive* ejectamenta were thrown out before the main eruption of the fluent magma, probably from higher vents.

4) Text-fig 18 b.—The consolidated lava margin hanging on the southern slope of the Yunohira hill, just below the Yunohira vent (the vent No. 2 in Fig. 19). The picture illustrates the case that fluent lava occupies a large volume, which when the lava consolidates diminishes in bulk, leaving the solidified crust in a hanging wall. The reduction of volume may also be caused by the slipping down of the still molten portion of magma in the interior of lava-mass whereby giving an opportunity to secondary lava-flows.

hours, especially at 8.14 P.M. The red-hot glare of lava, sparkling with discharges of electricity, appeared as if absorbing the whole mountain and turning it into a red mass.

About 11 P.M., the tumultuous outpourings a little subsided with a cloud-burst, which washed away the ash<sup>1)</sup> from the city, which had fallen during the 12th and 13th.

JAN. 14TH,  
MORNING

THE SECOND PHASE. *The first two days of prime outburst had now passed over.* The showers of the last night now cleared off; the morning was fine; the volcano was a little tranquil. The mountain top was for the first time in full view after having been enveloped in dark clouds since the 12th. About 5,000 people came back to the city little by little, but none

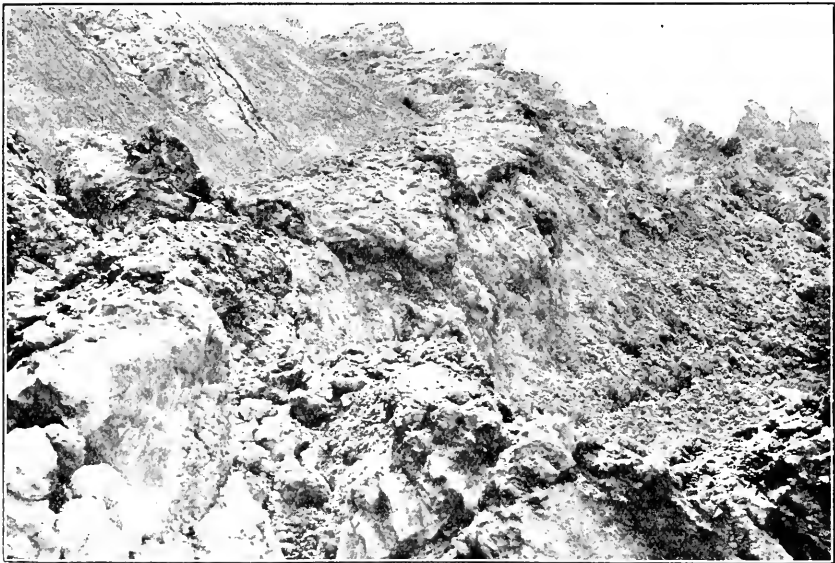

Fig. 18 b.

1) 118 grams per sq. m. The measurement of ash-fall does not strictly signify the scale of explosion, but depends greatly upon the direction of the wind. The number given is, moreover, from the observation taken in the city, 6 km. from the nearest vents, and 11.5 km. from the Nabé-yama vents.

to the island. All means of communication were then restored.

About 7 A.M., the yellow tongue of lava seen last night on the slope above Yokoyama on the west now approached the shore within a distance of 300 to 400 *m.* in a black ragged wall with a front, 2 *km.* wide, of fuming oxidized gases and sublimates of brown, yellow and white colors.

About 10.30 A.M., the activity renewed. A new vent, No. 3 (Text-fig. 19), made its appearance about  $\frac{1}{2}$  *km.* below the prime venthole of Yunohira (No. 2), displaying a more intense fury than the upper older vents. Later, two other minor ones, Nos. 4 and 5, were opened below the third, thereby adding fluent lavas to those already crawling down the slope in advance at the rate of 45 *m.* per hour during the earlier stage of the flow.

NEW VENT-  
HOLES

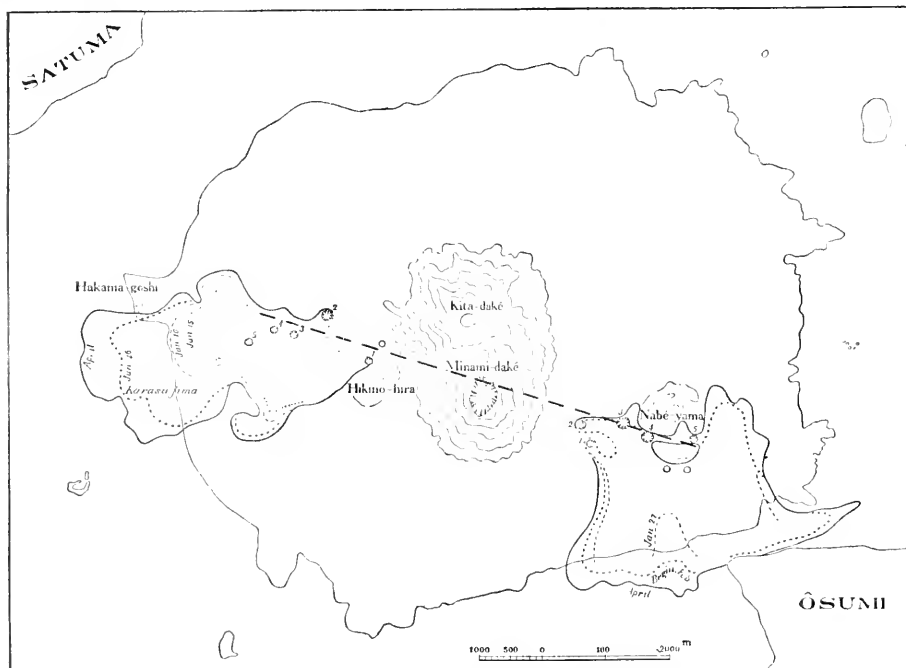

Fig. 19.—Lava-area and positions of bocche.  
(For Satuma read *Satsuna*.)

JAN. 14TH,  
NOON

Thus, the *vents were successively opened below the older ones along the comparatively shallow satellite injection-chamber*. Fear was again caused that other vents would open later below the bottom of the sea and also of the city. Throughout the whole day the cannonadings followed by air-concussions were constantly repeated simultaneously with the clinking of flowing lava. No information was at hand from the eastern side.

JAN. 15TH

The morning was calm, weather fine. Now and then a detonation followed by a sound like distant thunder recurred throughout the whole day. Each time this happened, brown dust-

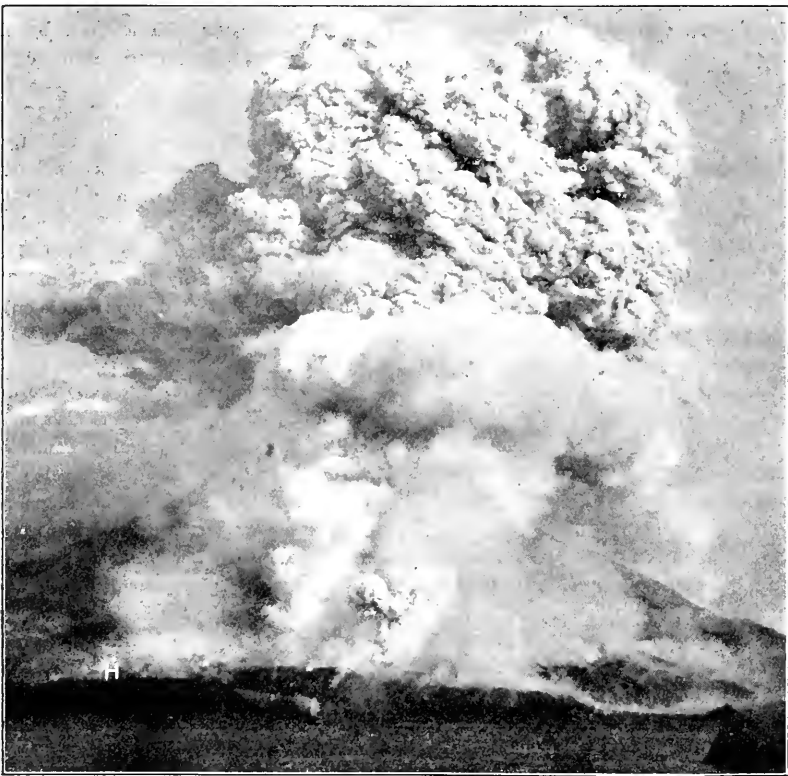

Fig. 20.—Lava-stream reaching the shore, on January 15th, as seen from the quay at Kagoshima. H—Hakamagoshi hill.

clouds were forcibly thrown out, and this act signified the pressing up of liquid magma from within through the ventholes. The night was rather quiet. This state of things had continued from the day before. Though *apparently tranquil* there occurred really *great eruptions* during all this time after the Hawaiian pattern, copiously pouring out liquid lava to the surface.

VELOCITY OF LAVA-STREAM      In the morning<sup>1)</sup> the viscous stream of lava already reached the flat shore (Pl. VI. Fig. 1), a distance of 3 *km.* from the vent, after three days, crawling at the rate of 3 *m.*<sup>2)</sup> per

1) The reports of the outbreak at Sakura-jima on January 12th were in the writer's hand in Tôkyô late in the evening of the 12th; the writer thought first that it was an ordinary sort of activity, as we frequently hear of late of Asama and Kirishima. Early on the next morning some details became known to the writer that the disturbance was of an extraordinary nature. Just a year before the writer had made a trip to southern Kyûshû with a work by I. Friedlaender (*loc. cit.*) in his hand, and spent a day in Sakura-jima, when he made some acquaintance with its geology, which encouraged him to hasten to the scene of activity.

Leaving Tôkyô on the 13th, the writer reached Kagoshima on the 15th at 11 A.M. The writer was the first geologist on the actual scene. The first sight that astonished him was the grand scale of the present volcanic activity, the second was the 'live'-lava actually flowing down the slope near Yokoyama beyond the sea at a distance of 4 *km.* Born in a volcanic land the writer saw the *fluent lava* for the first time in his life. The activities of modern volcanoes in Japan are exclusively of the *explosive* type, except a few instances of extensive flows of Myaké-jima in 1874, of Asama in 1783, and lastly, of Unzen in 1681-'83 (some say 1655-'57) and 1791-'92.

2) The writer measured this on a map (*cf.* Text-fig. 19.) The estimation was made on the lava flow, 2.5 *km.* from the main (No. 2) vent and 1.5 *km.* from the third, on a slope of low angles from the shore. Much weight cannot be attached to the calculation, for the velocity differs considerably according to the original land form and the distance from vents, due to the degree of cooling and consequently of viscosity. The chemical nature of the magma has also much to do with the velocity. Under the *sea* the rate must be considerably *greater* than on land. It should be remembered that basaltic lava is of thin fluid and consequently has greater velocity in its forward movement, while the lava of Sakura-jima is of an andesitic (auganitic) magma, and is of a rather viscous nature. Some say, the velocity of the Sakura-jima lava-flow to have been 45 *m.* (!) per hour during the 13th and the 14th, and 21 *m.* during the 16th and the 18th, and on the 22nd 1 foot an hour. Others calculated the rate of flow to have been 7 *m.*, the average velocity being 7 *m.* from the 16th to the 24th, or 19 *m.* from the 13th to the 23rd. See *postea*, p. 85.

For reference, the rate of flows in foreign volcanoes may here be inserted (Wolf, 'Der Vulkanismus,' Bd. I. S. 369). In Vesuvius and Etna it was 3.6-7.2 *km.* an hour near the vent. In the eruption of Etna in 1865, it was from 5 to 0.6 *km.*, while further away from the vent it still retained a velocity of 0.18 *km.* In the eruption of 1631, the rate of flow was 8 *km.* per hour; in 1906 1 *km.* In 1872, it was 0.433 *km.*; in 1895, 0.137 *km.*; averaging from 0.433-0.137 *km.* In Mauna Loa of 1850, it was 30 *km.* at the beginning, and later 0.276 *km.* In Teneriffe, a basaltic lava ran down with a velocity of 19 *m.* per hour. Sapper says, in the Sawaian eruption of 1905 it was 10-15 (5-7) *m.*



hour at this moment, burying a part of Yokoyama and Akamizu, leaving on the shore a margin of only about 200 *m.* (Text-fig. 19). The southern arm of the flow was then just on the top of the Atago shrine (see Geologic Map), 167 *m.* high, having an appearance as if another move would produce a cataract of fiery lava (Text-fig. 20).

THE 15TH,  
NIGHT

The scene during the night presented an interesting spectacle to the writer, as seen from the city on the opposite coast at a distance of 6 *km.* The lava stream from the Yunohira vent (Text-fig. 19, No. 2) appeared in a dark-red band; the two lower vents, Nos. 3 and 4, looked like orifices of glowing gigantic furnaces, and the main venthole of Yunohira was constantly throwing out dark smoke and red-hot splinters like sparks from a blacksmith's fire. Sounds not unlike waves on a stormy coast were periodically heard.

During the whole day and night, the active Kirishima, the northern neighbor, was in full view, and remained in perfect silence; not even a trace of cloud was observed.

EASTERN  
VENTS

Little was known of the back mountain—the Nabé-yama vents. At 3 A.M., they became quite active. The two upper vents, Nos. 2 and 3 in Text-fig. 19, were then in full force. The lava pouring forth from them ran down in two streams, the western branch buried Arimura and Waki, and the eastern the village of Séto (Geologic Map), leaving scarcely 10 *m.* of shore margin from the water. Concerning the *velocity* of the Nabé-yama flows we have no data to attempt a calculation; but they probably *moved faster* than the western on account of their being less viscous from their comparatively basic nature. The form of the eastern lava-field correspondingly deploys at the end, as in Text-fig. 19.

JAN. 16<sup>TH</sup> Early on the morning the writer was at the lookout of the Customhouse and saw the lava-front overriding the entire ash-covered village of Yokoyama, and a half of Akamizu. A photo taken (Pl. VI. Fig. 2, also Text-fig. 19) at 10 A.M. shows the very moment of a lava edge reaching the sea. From this moment the activity on the west side of Mt. Sakurajima entered into the *Sawaiian stage* in the eruption of Matavu of 1905. The scene was then beginning to change, white curdy clouds of *salt* fumes enveloped the entire lava-front (Pl. VI. Figs. 2, 3; Pl. VII. Fig. 1). For convenience sake, the writer hereafter employs the term 'Sawaiian type' for all the phenomena involved in the interaction of hot lava with sea water.

EASTERN  
VENTS The lava of the Séto branch from the Nabé-yama vents also seemed to have entered the sea, as plenty of *half-boiled fishes* shoaled about the coast of Futagawa in Ôsumi on this day. The vents in the rear were very active in contrast to those of the western, front sides, throwing out black ash clouds to a height of 2,000 m.

The writer was on board the 'Nishiki Maru,' which sailed along the northwest coast of Sakurajima rescuing cattle still left on the island, and on this occasion he was enabled to approach the 'live' lava, which was still in motion, and to have a nearer view of volcanic display periodically detonating and emitting black and white clouds from *spatter cones* in the still unconsolidated lava tunnel (Text-fig. 20, s). Cursory observers took these minor outbursts for the genuine eruptions from the vents newly opened in the body of the mountain.

The writer saw from on board threads of white fumes rising from fissures above the vent No. 1. (Geologic Map). Later on com-

ing back he saw while on deck that finally they exploded, at 5.15 P.M., with booming, throwing up intensely black ash-clouds. In anticipation of a greater outbreak, the writer rode back 14 miles northwards by train at 10 P.M. from the city to Kokubu Station.

JAN. 17TH About midnight and during the early morning, the writer heard strong detonations from a distance. Finally, at 4 A.M., there was an explosion on a grand scale at the new spot above mentioned on the western slope,<sup>1)</sup> and the dense ash clouds were blown by a southeast wind toward the city which became so dark, that, as stated in newspapers, it was necessary to use candles on the 17th forenoon. As pumice and triturated rocks are opaque bodies in the ordinary sense, the gloomy city enwrapped in ash clouds must have been to such a degree destitute of light that it is difficult to imagine. See Pl. VII. Fig. 2. It was the SECOND ASHFALL *second ashfall* in the city and the thickest one (883 grams per sq. m. and 7 cm. thick). The writer, having left the city, fortunately escaped from breathing in the rock dust, which was extremely irritant both to eyes and throat. During the night we saw from Kokubu Station the red glares of lava on both sides, the eastern being more prominent than the western (Text-fig. 14 c).

The writer started from Kokubu Station toward Fukuyama on the northeast shore<sup>2)</sup> of Kagoshima Bay with the intention of seeing the activity on the east side—the Nabé-yama ventholes, which was entirely neglected by the visitors of the Sakura-jima eruption, excepting those who had the special advantage of being on board the steam-launches of the Navy to get a cursory glance of the east side.

1) Probably the blast-hole *above* No. 1, (Text-fig. 19), and in Geologic Map.

2) All the country around was gray like a cement yard, and stems and branches of trees were bent by the weight of ash, of the 12th.

ASH            Ash was raining on the city and the distant view was just like an ink-black cloud-burst precipitating there. The weather was dull and rather cool, due perhaps to the absorption of the sun's rays by the warm ash cloud—a slight trace of the glacial period (Pl. VII. Fig. 2). The writer luckily escaped breathing the unhealthy ash which is, as the microscope reveals, nothing more than fragments of hypersthene and plagioclase crystals and minute splinters of brown glass (Pl. XXIII. Fig. 7). In the afternoon, the wind changed, blowing brownish wet ash-clouds toward us on the northeast coast, like *sleet*.<sup>1)</sup> An interesting fact was noticed by people, that, where the land was thickly covered with ash and dry, the sleet driven by the storm rolled over in grains and produced ash hailstone. It is the *endre granulée*<sup>2)</sup> or *pisolite*.<sup>3)</sup> The same rock occurs interstratified in the crater-wall of the volcano Mihara in Ôshima at the entrance of Tôkyô Bay. The writer was given a specimen by S. Nakamura, who made a collection of the rock, besides black Pele's Hair or *glass cotton*.

The status on the *city side* was not observed by anyone, as the whole island was wrapped in a thick ash cloud. The islet of Karasu-jima near Akamizu now became almost a portion of the

1) In all the works on volcanoes, and in the chapters on volcanoes in geological and geographical textbooks, *showers* are mentioned as one of the usual attendant phenomena during eruption by electric discharges in the steam-column that ascends from the crater. *Mud-flows* ('moya' or 'frane') are mainly attributed to this cause. The writer for a long time hesitated to admit the correctness of this statement. There were no showers at the moment of explosion of Bandai-san in 1888. During the present activity the weather was fine from January 10th to February 8th, excepting occasional mizzles, which were no doubt caused by ascending clouds. During this long interval all the phases of volcanicity were in full display, and there must have been many opportunities present for cloud-bursts, if they really occur as is usually stated in textbooks; but the writer never heard of, or saw any mud-flows excepting occasional ash-sleet, although the ash was abundantly deposited all round Kagoshima Bay.

2) Lacroix, 'La Montagne Pelée et ses éruptions.' Paris, 1904, p. 420.

3) I. Friedlaender, 'Ueber die Kleinformen der vulkanischen Producte.' Zeitschr. f. Vulkanologie, Bd. I. 1914, S. 37.

island owing to the advance of the encroaching lava (Pl. VI. Fig. 3), the temperature of the water at its proximity being  $37^{\circ}$  to  $40^{\circ}$  C. It was said that on the *east* the lava had drowned Arimura, leaving 300 *m.* of its western portion lava-free, and the front was already under the sea, boiling the water which was escaping in salt fumes. The Sêto branch of the Nabé-yama lava stream now advanced further seawards, and at 3 P.M., the Sêto Channel was reduced to only 18 *m.* in breadth.

Remarkable scenery was met with in Kagoshima Bay, which was turned into an extensive *buff desert of pumice*, which fell on the 12th (p. 68 and footnote), covering land and water all alike, and the boundary could only be detected by probing. Where the pumice was very thick, people said it could be walked<sup>1)</sup> on for a short distance. Boats could not, of course,

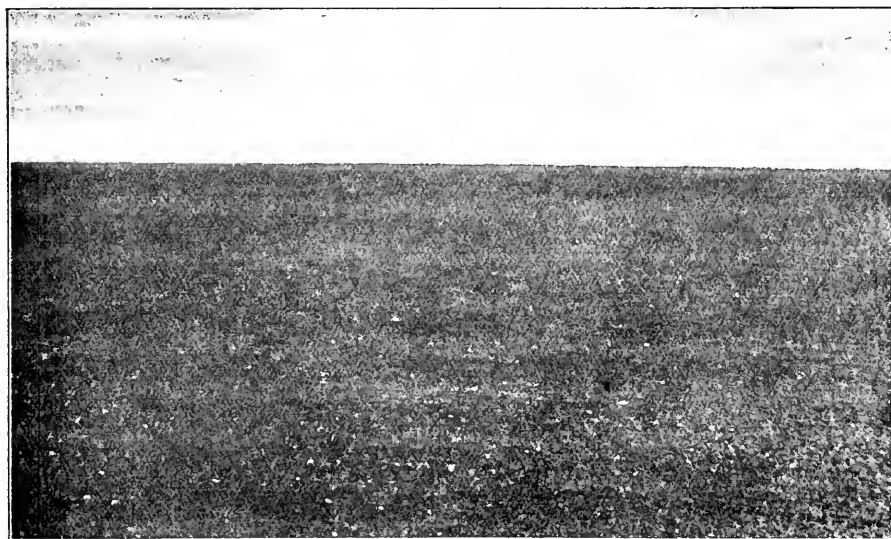

Fig. 21.—Floating pumice desert on the western shore of Sakura-jima.

1) The very same thing happened during the An-ei eruption (1779), when thick pumice choked the narrow channel of Sêto. Two terror-stricken people crossed on foot to Ôsumi, while the third sunk to the bottom to be seen no more, as the strong floating sheet of pumice did not allow him to emerge from it. See p. 47. The fishes, on the contrary, broke through and were leaping about on the pumice sheet. As they could not plunge again into the water, people were picking them easily with hand near the quay of Kagoshima.

go out offshore. A slight rattling sound was produced by wind and wave like that of flying desert sand on stormy days. The next morning, however, the wind cleared off the sheet of floating pumice toward the western shore where it aroused much interest.

From 10 A.M. onwards earthquakes were frequent. At night it drizzled a little in Kagoshima, probably from condensation of air by suspended ash particles, and the subterranean disturbance subsided. It rained also a little during the night at Fukuyama, which only moistened the eaves of houses, but hid the distant view of the glare of lava-flows (Text-fig. 14 *c*). The coastal population who fled to a distance were gradually coming home with an anxious air, being perhaps encouraged by the writer's visit to the region.

JAN. 18TH      The weather was fine in contrast to the day before and the island visible from the city, while on the leeward side WEST SIDE (east) it drizzled in early morning. The activity on the west rather abated from 5 A.M., but at night revived till 1 A.M., next morning. The lava buried the shore as far as Akôbara, touching the Hakamagoshi hill; and at 3 P.M., it came into contact with the north end of Karasu-jima (Pl. VI. Fig. 3), 550 *m.* distant from the shore of Akamizu, while on the south side of it the lava advanced a little further seawards. Saline fumes covered the entire front, the temperature of water near by being 23°–30° C.

EAST SIDE      The writer made a pioneer trip from Fukuyama to the lava end at the Sêto channel. Proceeding southwards along the ash-covered coast to Sakai (7 *km.*) where *pumice* began to appear (size 1.5 *cm.*), it became thicker at Futagawa (1.2 *m.* in the plain and 1.8 *m.* in wind shaded places). Further southwards pumice or rather *lapilli* became coarser (*see* Text-fig. 22) and thicker, so that the deposit *reached the eaves* (2 *m.*) of houses and the top of

fences. During the shower of lapilli some people were wounded and two were *buried alive* under the pumice, 8-9 feet thick, in their flight to a neighbouring height. There were no roads; rice-paddies, rivulets and houses, all were leveled to a plain; but the

walk on it was not troublesome, as the pumice bed was covered with fine ashes which smoothed the way and made the ground stable. Some people were digging passages to their



Fig. 22.—Ash-buried village of Fumoto.  
(Photo by S. Nakasu.)

buried houses to get into them. As the weather had been hitherto fine<sup>1)</sup> there was no great suffering; but from February 8th there were frequently storms, and the inrushes of floating pumice and ash-mud did more harm to the inhabitants than the dry subaërial ejectamenta, especially along the coast opposite to southeastern Sakura-jima (*see* also p. 40).

The Nabé-yama ventholes, 5 in number (Pl. XI. Figs. 1 and 2, Text-fig. 19), were and are still located on the fissure-line running E.S.E. for a distance of 2.2 km. from the steep slope of Mt. Sakura-jima to the foot along the southern shoulder of the pumice-built parasitic homate of Nabé-yama. The fissure is ap-

1) *Vide* footnote, p. 80 (1).

parently the eastern prolongation of the Yunohira vents on the city side.

Vent No. 3 or 4 was most active on the fine day of the writer's visit. There were a series of bocche, 5 or even 7 in number, which were mere orifices on the roof of the Nabé-yama satellitic chamber.

The mountain was rather active this day and strongly smoking on this (east) side. Periodic detonations and air-vibrations ushered in renewed outpourings and clinking flows of lava in the vent, either No. 3 or 4, which was sympathized later by all the rest, exhaling only white clouds, thus proving their subterranean connection. During the early phase the upper ones, Nos. 1 and 2, were in prime, but now the lower ones (3-5). This was due to the underground flow of magma and partial exhaustion, and lastly, to the differentiation of liquid and gaseous substances within the chamber. During the day it appeared like a wall of fumes, and at night, of flames. The scene was grand and indescribable at Fumoto, and the air warm. The writer was under a gale of dust clouds, though his position was 4 *km.* from the nearest vent (*see* Text-fig. 23).

TERMINUS  
OF LIVE-  
LAVA AT  
FUMOTO

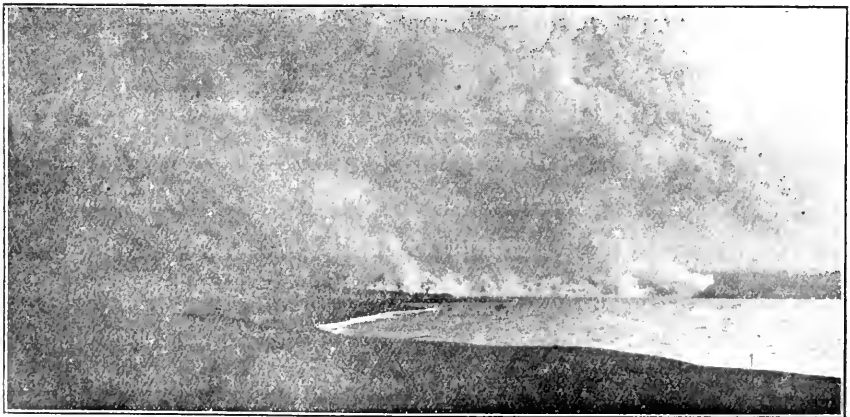

Fig. 23.—Lava end at the Sêto strait on Jan. 18, 1911.



The lava on this side crawled into the sea *already on the 16th*, and now almost choked up the straits of Sétô, exhaling a 'series of white saline vapors, as in the above picture, Fig. 23, from black heads of black lava above the level of yellowish water (36° C.). Arimura, Waki, and Sétô were all enveloped in vapors and smoke, and nothing was visible. The writer could not approach the lava end. See Pl. VII. Fig. 3.

JAN. 19TH Three ventholes were active on the *city-side*. Karasujima disappeared (Pl. VIII. Fig. 1), being entirely overrun by lava which was moving forwards into the sea, according to the writer's calculation at the rate of 5.6 *m.* per hour<sup>1)</sup> boiling at its front and exhaling now somewhat bluish vapors. Ash began to precipitate again on the city from 2.20 A.M., the fall attained its maximum at 6 A.M., and almost cleared off at 7 P.M. The ash deposit was 3 *mm.* thick and 97 *grams* per sq. *m.* The ejection of ash is, according to the writer's view, always an effect of either the opening of a new vent, or the falling in of the margin of a venthole in consequence of temporary exhaustion of a lava-reservoir. Where the explosion took place this time and what was the cause of it, was not known to the writer, as he was not close to any of the vents. The same was true for all the later explosions and ash-falls.

At Fukuyama (the *east side*) it was dusky from nightfall. The writer met with brownish misty ash-fall in rather dry and warm weather all the way from Fukuyama back to Kokubu on the northern shore of Kagoshima Bay. At Kokubu the writer heard strong cannonades and air-concussions at 1.8 P.M. and 1.21 P.M., and a rather sharp one at 2.50 P.M.

After three days' absence during a trip in Ôsumi, the writer

1) Footnote, p. 76. The rate of flow became now greater.

was again in the city, which was then restored to its former state, and was full of life in every way.

EAST SIDE Nothing was known of the details about the Nabé-yama vents.

The prime of the Sakura-jima eruption after having been active for nine days, was now near its end, especially with regard to the western vents.

JAN. 20<sup>TH</sup> The Yunohira lava was slowly pushing on with white fumes forwards into the sea, having already drowned Karasu-jima island (Pl. VIII. Fig. 1), while the vents were tranquil, roaring periodically, though the trembling ceased. The cliff of Atago-yama, 167 *m.* high, on the back of Akamizu was still free from lava; but its southern prolongation was already overflowed with melted rock. *See* Geologic Map.

EAST SIDE The writer took a small steamer to Tarumi in Ôsumi to get a sight of the Nabé-yama vents from the south to complete the round of Sakura-jima. The steamer steered heavily through the migrating pumice sheet (Text-fig. 21), which, as already referred to, the writer met with on the 17th on the northeast of the bay (p. 81).

MIGRATING  
PUMICE-  
SHEET

The whole stretch of coast from the west end of Arimura to Séto for a distance of 3 *km.* was entirely buried under a lava sheet and enveloped in impenetrably dense fumes and clouds. This side was very active in contrast to the west, constantly cannonading and vibrating both the ground and the air. Pl. X. Figs. 1-2.

It was somewhat astonishing to find that the south-west coast of the island between Yuno-hama and Nojiri remained intact. No damage to houses; no pumice on the ground. The ash covering was, however, universal. The region in question is the *land newly-built* by lava flows in historic periods. The *present eruptions and*

*lava flows carefully avoided this section of Sakura-jima.* Even the temperature of the hot-spring in Furusato was not greatly affected, being 45° C. which was only 2° C. higher than in former days (*see* p. 47).

JAN. 21ST      THE THIRD PHASE. The second phase of the eruption during the interval from the 14th to the 20th was now closed. The city side was quiet; lava still moving forwards into the sea. The writer took the train on the 21st for Tòkyô, so the diary for the following days is not from his personal observations. It is said that from 7.5 P.M., a strong explosion and roaring occurred, continuing throughout the whole night. The sea glared from the lava flow. Ash fell on the city. About a thousand people again fled to the west from the city.

Nothing was known of the east side. But it must have been more active than on the west side, throwing *pumice* and ash to the opposite coast of Ôsumi.

JAN. 22ND      The rain of ash on the city continued from last night (118 grams per sq. m, 2 mm. thick). Day<sup>1)</sup> and night there was constant roaring. Nothing particular was known from either side. The lateral lava margin was said to have been pushing forwards one foot<sup>2)</sup> an hour near Hakamagoshi on the west.

JAN. 23RD      From midnight it began to roar, giving a sound like a landslide. This was probably caused by the widening of pits on the east side. The citizens passed a restless night; the afternoon was misty, due to floating ash (21.5 grams per sq. m.); a strong earthquake occurred at 9 A.M., the day was rather quiet due to the outpouring of lava, but at night it again roared.

1) About the *spatter eruptions* observed on this day the reader is referred to the *Summary*.

2) *Vide ante*, p. 76, footnote 2.

The Nabé-yama lava was fast moving under water, but the heads of the lava-front rose up and formed a fuming series of equatorial islets parallel to the stream-line of the Séto channel. The *venthole* No. 4 (Text-fig. 19) seemed to have *grown in size*, this, the writer thinks, was due probably to the *ash ejections of the last three days*. The lava flow then received *abundant supplies* from the widened pit. It was on this day that the lava-free, cliffy Akashi Gongén hill (103 *m.*) between Waki and Séto became completely overflowed (Pl. IX. Figs. 2-3, Pl. X. Fig. 1, Geologic Map), and the lava tongue around Nabé-yama pushed considerably forwards toward Kurokami. By morning, the channel, which was formerly 400 *m.* wide and 8-9 fathoms deep, was open only about 24 *m.* The lava flow on this side was so rapid that on the next day the channel became almost land-locked. Ash fell here and stifling gases swept the opposite coast of Ôsumi. It was the *first time* that the writer heard of *suffocating gases* in the present eruption, indicative of the declining phase of activity.

JAN. 24TH The activity was gradually diminishing. During the morning it roared periodically and ash was still precipitating; only white fumes were seen on the city side; the lava moved little by little into the sea (29° C.) with saline fumes.

The east side was also rather quiet and exhausted, though enveloped in white clouds. The channel of Séto remained in the same condition, though becoming a little narrower. Pl. X. Fig. 1.

JAN. 25TH The activity became feeble, the Yunohira vent being apparently dead, and the lower ones were only making little *secondary* eruptions.

The east side was, however, still roaring and exhaling, and the whole area was entirely enveloped in vapor. Little ash fell, and *odious gases* swept down.

JAN. 26<sup>TH</sup> The activity was fast declining. It roared at 7 P.M., 11.42 P.M., 11.51 P.M., and at 0.15 A.M., 0.42 A.M., 1.23 A.M., 2.15 A.M., and 5.50 A.M. of the next day. The lava was moving a little under the sea. The east was active, throwing up smoke to a height of 2,000 *m*. The entire region was wrapped in white fumes. The Séto channel was still open (18 *m*.) though becoming narrower by 6 *m*. One could not row through the boiling strait (60° C.).

JAN. 27<sup>TH</sup> The *activity of the Yunohira ventholes passed away with this day, though that of the Nabé-yama craterlets still lingered on for 5 days.* Feebly active in the Yunohira area, with occasional minor secondary eruptions and 'trombe.' The entire field had a melancholy aspect (Pl. IX. Fig. 1) like that of the hot rubbish of a big town after a great fire. The lava-flow in the sea was now at a standstill before the city of Kagoshima, the new lava-field, 1.4 sq. *km.*, extended into the sea 950 *m*. from shore with a breadth of 1½ *km.* (Text-fig. 19).

The Séto channel on the *east* was agitated. It was now reduced to 9 *m*. in breadth, and 3.6 *m*. deep with a brown puniceous bottom, observed at 3 P.M. at low tide. The sea was hot, but only for the upper 90 *cm.*, while at lower depth the water was cold.

JAN. 28<sup>TH</sup> THE FOURTH PHASE. *The third phase of eruption extending from the 21st to the 27th was now closed, and the activity entered into the fourth phase.* Tremors occurred only at 5.49 P.M.; roarings were heard 16 times in the city from 4 P.M. till 10 A.M. of the 29th; glares of lava at night became weak and were seen in 5 spots. The lava of the Yunohira vents apparently moved no more. On the *east* side, the channel was still not yet closed by lava which was moving fast forwards, being 9 *m*. in height on the

APPARENT  
MOVEMENT  
OF WESTERN  
LAVA-FLOW  
CAME TO  
STANDSTILL

lava-front, and 7 *m.* deep at the passage at low tide. Three men crossed through it. Constant shocks were felt during the night at Fumoto near the strait, keeping the people awake.

JAN. 29<sup>TH</sup> The activity on the city side practically *subsided* with occasional roarings. Earthquakes were, however, recorded in the city at 6.43 A.M., 11.42 A.M. (scale 1), and 11.41 P.M. (scale 2). The *east* side was still *active*, constantly pouring out magma. When a party from the Fukuoka University approached the channel, they found it practically closed by the collapse of the 18 *m.* high lava-front, caused by a secondary explosion at 2 P.M.

JAN. 30<sup>TH</sup>-  
31<sup>ST</sup> Nothing particular happened on the 30th. On the 31st, 0.30 P.M., an explosion occurred on the *west*, by which the city was air-shaken. Strong smoke rose on the *east* side.

FEB. 1<sup>ST</sup> For four days the Yunohira ventholes remained quiet. On the other hand, at 5.43 A.M., an earthquake was recorded in the city (scale 1). At 2.17 P.M., 4.20 P.M., and 7.56 P.M., roarings were heard with sharp tremblings and ejections of strong smoke.

The Nabé-yama craterlets were still active and a new one was opened somewhere. Apparently a *new islet* appeared near Ari-mura, separated from it by a narrow water. This afterwards proved to be a *lava head* risen from the shore bottom. At the time of the earthquake at 4 P.M., a strong explosion occurred, the lava advanced, completely choking up, according to Mr. Schwartz, the strait of Sêto. *Thus the island of Sakura-jima became permanently a peninsula attached to the province of Ôsumi* (Pl. X. Figs. 2 and 3).

FEB. 2<sup>ND</sup> On the west, it strongly cannonaded and shook the city windows at 2.5 A.M., roared at 8.30 P.M., and 8.43 P.M.; lava glared 3 or 4 times during the night. The Nabé-yama side was

increasing in activity rather than declining; the smoke, however, became less in quantity, it roared strongly at 6.55 P.M., 7.15 P.M., and 10.56 P.M.

FEB.  
3RD-4TH

THE FIFTH PHASE. The fourth phase of activity, including the period from January 28th to February 2nd, was now closed, and the status entered into the fifth phase. This, the declining phase, still continued, manifesting the after-effects of the greatest volcanic activity we have seen since the An-ei eruption, 136 years ago, in volcanic Japan. The activity on the *east side* came to an *end* with the day immediately preceding, and at the same time the *main vulcanism of Sakura-jima*, the city side of it having been already at rest since the 27th. The minor manifestations were mere after-effects.

MAIN VUL-  
CANISM OF  
SAKURA-  
JIMA TERMINATED

Tranquil on the *west* during the day, only making minor explosions 2 or 3 times in an hour. There was a lava glare only once during the night and an explosion at 0.10 A.M. The *east* was still active, ejecting ash late at night and early next morning, which fell in the Kimotsuké and Sô districts in Ôsumi: a strong detonation occurred at 9.57 P.M. The lava-fronts were pushing seawards *little by little* in both arms.

FEB.  
5TH-6TH

From early morning posthumous smoke rather increased on the west, 4 or 5 times every hour. Of the east nothing was known except occasional air-concussions which shook the city.

On the 6th, 9 A.M. to 11 A.M., air-concussions from the east side rattled windows in the city at 7.55 P.M., a bright light was noticed with outpourings of lava. An earthquake (scale 1) occurred at 11.48 P.M.

FEB.  
7TH-8TH

At 4.40 A.M., it roared rather strongly and trem-

bled on the city-side while one or two small explosions occurred every hour. Ash fell in dusky weather on the city from 6.30 A.M., due to an explosion on the east (where?).

CLOUD-BURST AND MUD-FLOW On the morning of the 8th, a cloud-burst swept the coast of Ôsumi, causing a pumice and ash flood in Ushiné village submerging 400 houses. It is to be emphasized that the weather had been fine since January 10th, hitherto creating no *mud flows* (see Summary) in the ash-covered area during this rather long interval, excepting little local rainfalls. It is also to be observed that these precipitations, slight or strong, always happened after an ash day, but *not* simultaneously with the ascent of steam columns in the *main vents*.

FEB. 9TH-12TH The morning was fresh. The western side was calm and only smoked once at 3.25 P.M. The eastern was strongly smoking at 1 P.M. On the 10th, nothing was recorded. On the 11th, no smoke was witnessed on the west; the lava front was still emitting saline fumes in the sea. The east was yet strongly smoking and roared from 6.42 P.M., while the west was exhaling only faint smoke on the 12th.

FEB. 13TH-14TH The *east* roared at 7.20 A.M., 4 P.M., and 6.41 P.M., the last one was rather strong and rattled the city-windows. The *west* detonated strongly with smoke at 6.41 A.M., became bright at 11 P.M., and roared at 11.44 P.M. Earthquakes were frequently felt at 3.17 A.M., 8.52 A.M. (scale 1), 3.21 P.M., 3.34 P.M. (scales 2-3), and 6.30 P.M. (scale 1). On the whole the ground was by *no means tranquil*.

IWÔ-JIMA EARTH-QUAKES It was on this day, the 13th of February, that the active volcanic island of Iwô-jima (pp. 5, 21), the "Sulphur Island" (Fig. 1 i, Fig. 2), lying 100 *km.* southwards off the southern shore of the province of Satsuma, was strongly



shaken from 2 A.M. to 3 P.M.<sup>1)</sup>, causing anxiety among the inhabitants. It is an island 20 *km.* in circumference with a population of about 900, of which 300 are laborers on the sulphur mine. For twenty years the volcano had remained comparatively quiet. There is a single main cone, 770 *m.* high, besides 2 parasitic ones. Friedlaender<sup>2)</sup> says, that there are fumaroles and solfataras in the crater, 7–800 *m.* in diameter and 50 *m.* deep, as well as in a deep glen on the southern slope. It may not be unreasonable to conclude that the earthquakes, above referred to, were the manifestations of vulcanism<sup>3)</sup> in the zone to which this island and Sakura-jima as well as Kirishima are the appendants (*see* Text-fig. 2, p. 11).

On the 14th, only the eastern vents, as usual, strongly smoked and roared; red-hot lava at night glared at the vents.

FEB.  
15TH–16TH

The east boomed several times and ash was blown toward the city, turning it snow-white, and Sakura-jima was veiled in ash-mist. Again it rained from 3 P.M., which washed off the dust of the city. At Tarumi in Ôsumi a freshet of ash-mud broke dams and wrought havoc in the village. This was the second ash inundation (p. 92).

SECOND  
ASH-MUD  
DELUGE

On the 16th, the west was still faintly fuming. The east was, however, roaring, and an air-concussion at 10.58 P.M., rattled the city windows. Slight ash again fell from 4.40 P.M.

FEB.  
17TH–18TH

Smokes were low on the east, while the west temporarily woke and roared, and sent out flames at 1 28 A.M. and white clouds at 7.45 A.M. On the 18th, slight de-

1) Distant earthquakes were recorded in Kagoshima from the 13th, 3.34 A.M. to the 15th, 5.13 A.M., of which the first was the strongest.

2) See *ante*, page 21, footnote (a).

3) See page 98. This illustrates a case of 'sympathy of alternation' among the volcanoes belonging to the same *zone* (not the regions). See T. A. Jagger, Jr., 'Activity of Mauna Loa, 1914–15.' *Amer. Jour. Sci.*, Vol. XL, 1915, p. 639.

tonations at 6 A.M. and 9.30 P.M. on the east. It rained again from 9 A.M.

FEB.  
19<sup>TH</sup>-22<sup>ND</sup> Misty clouds covered the island. Air-vibrations from the east rattled the city. The west emitted smoke at 7.50 A.M., and also 11.30 A.M. On the 20th, the west roared at 7.30 A.M. Mists veiled the smokes of the east. On the 21st, 7.15 A.M., a great detonation from Sakura-jima, which was enveloped in rainy clouds, alarmed the city population. On the 22nd, the west roared at 10.5 P.M. and 10.43 P.M. For four days the island was hidden by mist.

FEB.  
23<sup>RD</sup>-24<sup>TH</sup> On the 23rd the east roared at 2 A.M. and 6.49 A.M., and on the west at 4.56 A.M. An earthquake was felt at 9.18 A.M. Slight ash fell during the whole day of the 24th; a rather strong booming was heard at 0.44 A.M., and 5 times from 10.54 A.M.

FEB.  
25<sup>TH</sup>-26<sup>TH</sup> At 2.41 A.M. loud roaring; the city windows rattled at 3.50 A.M. and 5.48 A.M. The west made minor explosions at 11.18 A.M. and 3.33 P.M., while on the east the feeble smoke in the morning suddenly changed to high curdy smoke in the afternoon; it roared from 7.10 P.M. to 8.40 P.M. Both sides were rather active to-day.

On the 26th, the west roared at 4.47 A.M. and made a small explosion at 10.17 P.M. The east was constantly throwing up smoke.

FEB. 27<sup>TH</sup>-  
MAR. 1<sup>ST</sup> The east sent up ash-clouds to a considerable height from morning till 4 P.M. and roared 5 times.

The weather was misty on the 28th. The east was constantly roaring. The west suddenly woke from a long slumber and rattled the city windows, exploded *violently* at 5.34 P.M. with a black column, and roared at 10.53 P.M.

Minor explosions at 6.25 A.M. and 6.51 P.M., and a strong roar at 8.39 P.M. on March 1st. Wet ash-mist covered the whole southern province of Satsuma. The east remained remarkably quiet during the last two days.

## (C) Economic and Social Statistics.

People killed....35 (6 in Sakura-jima) [in 1779-'80....161—according to some report ....9,600]	
„ wounded 127 (1 in Sakura-jima)	? ]
„ fate unknown...23.	? ]

Damage to property in the city of Kagoshima.....	¥ 1,100,470
„ „ „ „ Sakura-jima.....	„ 3,076,669
	¥ 4,177,139

## SAKURA-JIMA.

Horses killed.... 1,715 (800 saved) [in 1779-'80 .....1,576 killed]	
Oxen „ .... 203 (50-60 „ ) [ „ „ „ ..... 135 „ ]	
Pigs „ .... 612	? ]
Fowls lost ....10,311	? ]

The loss in domestic cattle and fowls amounts to ¥ 52,863

Houses (ménages) in Sêto, Waki, Ari-mura, all on the east side, buried under lava .....	510
„ „ „ Akamizu, Yokoyama, Koiké, all on the west side, buried under lava..	919
	1,429

Houses burnt and buried under lava.....	1,916
„ remaining which are, however, heavily covered with ash.....	1,186
	3,132

The insular population .....	27,116
Rescued by launches on Jan. 12th .....	2,493
„ „ „ „ 13th .....	5
„ „ „ „ 14th .....	35
„ „ „ „ 15th .....	6
	2,539

Fled to the nearest mainland before the catastrophe.....	24,577
--	--------

*D) Summary and Conclusion.*—The writer will now bring his *diary* on the eruption of Mt. Sakura-jima to a close. Its activity is imperceptibly diminishing in intensity, but it will be long<sup>1)</sup> in coming to final rest. In the Samoan eruption of 1905-'6, the basaltic lava was moving for a year and three months, so the present convulsion of the andesitic Sakura-jima will also be completely tranquillized in the near future, although it may last longer, considering the larger dimension of its vents and its greater magnitude of vulcanicity. The Yunohira or western ventholes started first (Text-fig. 14 *a* [2]), breathing only feeble fumes in April, 1914; while the late-born Nabé-yama or eastern vents (Text-fig. 14 *b* [3]) were still keeping on their detonations, though moderately, at the same time throwing up curdy black smoke. The vulcanism is greater in scale on the east than on the west side.

The following is a summary of what is already stated in the diary and the conclusions arrived at both from field observations and laboratory studies.

**i. Predisposing Causes.**—The eruption at Sakura-jima was not an accidental explosion of pent-up steam and gases near the old crater-pit of a slumbering volcano. On the contrary, the cause lay far and deep. In the earth's history, we find a series of long periods of epirogenic movement alternating with long periods of stability, responding to the varying conditions of stress-accumulation in the interior or to the gliding of the outer shell over the

---

1) The writer worked out the first part of the manuscript after the second trip in April, 1914. Complete records are not at hand on the declining and closing phase of the activity. In October 1915, i.e., after twenty-two months, one of the vents was said to have been still periodically exploding and throwing up the lava plug solidified within the venthole after the Vulcanian type. The subterranean condition has not yet come to rest. The tremors related in their origin to Sakura-jima and recorded by a seismometer at Kagoshima numbered 667 in January, 107 in February, and 397 in May, 1916.—*Note during Press.*

nucleus, from telluric or cosmic causes. Vulcanism is the straggling outcome of the processes of general deformation.

Since the *beginning of the present century* volcanoes distributed over *wide regions* have been displaying activity. In the South Seas there is a series of volcanoes on the inner side of the fore-deeps of Kermadec and Tonga. To begin from the south, Taupo in New Zealand was active in March 1886, one of the Kermadecs in 1902, Niuaufau in the Tonga islands in 1886, Topia in January 1906 and 1907, Fanna-lai in 1906, and lastly, Mt. Matav in Sawaii of the Samoa group in 1902, 1905 and 1906. In this volcanic chain the correctness of the old dogma is again proven, that the alignment of volcanoes is very intimately related to the tectonic structure of the region. Ambrym Island in the New Hebrides, not far from the above-mentioned chain, was the seat of activity from December 6th, 1913; Mt. Minnie collapsed on the 12th, and the burning lava welled out, overwhelming all the villages of the north coast.

Puna in Hawaii was active on September 21st, 1908; Korintji in Sumatra on June 3rd, 1909; Sangir in the Dutch Indies on March 14th, 1913. On June 6th, 1912, Katmai in Alaska burst out, throwing up ash-clouds to a height of 12 *km.*, causing an afterglow of the sun in America and Europe. The dust thrown up to the stratosphere was so dense that it had an influence on meteorological phenomena, on the atmospheric temperature; and many writers came to the conclusion that volcanic dust must have been a factor in the production of past climatic changes—the glacial age. Mt. Colima (1901, 1902 and March 24, 1903), Santa Maria (1902) in Central America were active, and Chirique near the Panama Canal a few years later.

In the Atlantic, the eruptions of Martinique and St. Vincent (1902) are well known. Teneriffe erupted in 1909. In the Medi-

terranean, Vesuvius manifested its activity in 1906 and 1913, and Stromboli in 1907 and 1910.

The beginning of the present century seems to mark a general awakening of vulcanism after a period of comparative tranquillity. In the Japanese islands, at the northwest corner of the Pacific, we find also a recurrence of vulcanism. Jensen in his Samoan paper says, that a volcanic island revives its activity after a cycle of sixty-years. In individual volcanoes like Asama, it is likewise after the completion of about 60 years; but the *regional* activity of deep origin revives after the *double length* of the sixty-year cycle. The following may illustrate the case :

Ôshima Is.	in Central Japan	erupted in 1777-'78	} 1777-1792
Sakura-jima	in Kyûshû	„ 1779	
Aoga-shima } Asama }	in Central Japan	„ 1780-'85	
		„ 1783	
Unzen	in Kyûshû	„ 1792	

The above table shows that one period of the regional activity was completed within 16 years, during which the centres of disturbance were regularly and alternately shifted to and fro from Kyûshû to Central Japan, or the reverse, thus illustrating the typical case of a 'sympathy of alternation between two regions.'<sup>1)</sup>

After a lapse of 120 to 135 years, or about the double length of the sixty-year cycle, the same regions are now being disturbed by vulcanism, viz., Asama, Yaké-daké, Ôshima, and the two volcanic islands of the Bonin group, *i.e.*, Iwô-jima and Tori-shima (Aug. 1902) in *Central Japan*; and the Tori-shima (May 4 [April 11], 1903) of the Ryûkyû chain,<sup>2)</sup> Kirishima (Jan. 8, 1914), the Iwô-jima<sup>3)</sup> or the 'sulphur island' (of Kagoshima Prefecture, Feb.

1) See page 93, and footnote 3.

2) See pages 4.

3) See pages 5, 21 and 92.

13. 1914), Suwanosé-jima (Mar. 21, 1914 to the beginning of July, 1915, cf. p. 4), and Kuchino-erabu in *southwest Japan*.

The An-ei eruption (1779) of Sakura-jima occurred 135 years before the eruption of the same volcano on January 12th, 1914. No one can offer a satisfactory explanation at the present stage of our knowledge about this recurrence.

**ii. Premonitory Symptoms.**—As premonitory symptoms of the paroxysmal eruption, the land at the north of Kagoshima Bay, especially near Yoshimatsu Station, 55 km. from the bay, had been frequently shaken during the eight months before the event. It may be of interest to give here a précis of the ‘Report’ by Y. Sataké, Chief of the Meteorological Observatory of Miyazaki Prefecture.

	Date, 1913-1914	Number of Earthquakes		
Period I. Strong earthq. 10.3%	(May 19th-30th (12 days).....	24	}39	
	(June 2nd-8th (7 days).....	4 strong....15		
Period II. (Climax) Strong earthq. 14%	a {	(June 25th-July 2nd (8 days).....	8 strong....31	}136
		Sympathetic Ijû-in earthq., June 29th-30th.		
	(July 9th-18th (10 days).....	6 strong....33		
	(July 23rd-30th (8 days).....	1 strong....11		
	b {	Aug. 4th-13th (10 days).....	— .... 7	
	Aug. 16th-23rd (8 days).....	1 strong....37		
	Aug. 27th-Sept. 1 (6 days).....	3 strong....17		
	No earthqs. from Sept. 2nd—Oct. 16th (45 days).			
Period III. (After-shocks) Strong earthq. 35%	(Oct. 17th—Nov. 16th (30 days).....	5 strong....11	}14	
	<i>The first eruption of Kirishima on Nov. 8th, 11 p.m.</i>			
	No earthqs. from Nov. 17th—Jan. 3rd, 1914 (48 days).			
	<i>The second eruption of Kirishima on Dec. 9th,</i> <i>4.15 a.m.</i>			
(Jan. 4th-14th, 1914 (11 days).....	— .... 3			
	<i>The third eruption of Kirishima on Jan. 8th,</i> <i>2.20 a.m., and lastly, the eruption of Sakura-jima</i> <i>on Jan. 12th, 10.5 a.m.</i>			

To summarize from the data given above, the local earthquakes at the northwestern foot of the volcano Kirishima began suddenly with moderate intensity which culminated at the second period *a*, when the sympathetic Ijû-in earthquake at the west of Kagoshima shook the ground violently. Even within the narrow seismic area of Yoshimatsu the epicentres shifted from west to east. The daily maximal frequency of earthquakes happened 2 hours later than the arrival of the daily maximal atmospheric pressure,<sup>1)</sup> the average daily maximum pressure of the atmosphere during the earthquake-swarm being 8–12 A.M. and especially 10–12 P.M.; thus *corroborating* the long-established rule that high pressure determines the precise moment of *quaking*, and also of *vulcanism*.

The salient feature noticeable in the above table is, that the volcanic vent burst open during the waning third period of the earthquake-swarm, when shocks became irregular and interrupted with *intensified* quaking (strong earthquakes 35%).

As to the volcanic activity of *Kirishima* with which the perimetric Yoshimatsu earthquakes had decidedly a close relation, the *first* eruption occurred on November 8th, 1913, 11 P.M., ejecting ashes and sending up flames, and shattering windows in the city of Kagoshima through air-concussions. The event happened after high atmospheric pressure. The *second* explosion of high intensity was on December 9th, 4.15 A.M., again after a maximal atmospheric pressure, with ashes and flames as usual. The volcano was treacherously silent till the very moment of outburst, as the writer has often experienced in the explosions of Asama. The *third* explosion took place on January 8th, 1914, 2.20 A.M., again after maximal atmospheric pressure. Since then Kirishima has remained

---

1) See the data appended in the said 'Report.'



silent and at last, four days later, the memorable eruption at Sakura-jima occurred.

The above conclusion concerning the maximal frequency of the earthquakes, which responded to the subterranean activity of Sakura-jima, namely that this frequency, prior to the great volcanic catastrophe, had some relation with the maximal period of the local atmospheric pressure, is verified by the following facts. According to the 'Report of the Meteorological Observatory in Kagoshima,' the daily frequency of shocks has been high between 8-9 A.M. and 8-9 P.M., corresponding to the pressure-maxima of 8-9, 9-10 A.M., and 8 9, 9-11 P.M. Sakura-jima also burst out on January 12th, 10.5 A.M. after the maximal period of local atmospheric pressure. The writer could not find any relation between the *direction* of pressure gradient and the occurrence of shocks.

iii. **The Phases of Eruptions.**—F. ÔMORI (*l.c.* p. 57) tabulated his tromometer observations, carried out under his direction in the city of Kagoshima and in Sakura-jima, the registration being started on the 16th, and the writer reproduces it here in order to explain various phases of activity recorded in his diary (pp. 56-95).

The *first phase* of the Sakura-jima eruptions passed away during Jan. 12th to 13th. The *second phase* (p. 73) was ushered in on the 14th, continuing till the 20th. On examining the second column, the eruptions of the first order were 60 in daily average from 16th to 20th, these numbers being decidedly the joint records of the eruptions of both the western and the eastern vents. From the 21st the western vents came to a standstill, while the macroscopic lava movement of the west came to rest only on the 27th.

From 21st to 27th—the interval of the *third phase* (p. 87), the daily average of outbursts was 30 and they were recorded from the eastern vents only, while the macroscopic lava-flowage

was observable till February 2nd during the *fourth* declining phase (p. 89) in the eastern lava-field, when the strait of Séto became completely barred. From the beginning of the fourth phase the decrease was very marked. The *fifth phase* (p. 91) began with February 3rd, the activity steadily and imperceptibly waning.

Date 1914		Outbursts		Volcanic earthqs. without eruptions	
		Strong, intratelluric, non-detonating	Weaker, superficial, detonating		
Second phase, 5 days including 14th & 15th	Jan. 16	Daily average 60	13	—	?
	17		67	1	11
	18		53	84	20
	19		74	39	3
	20		65	78	5
Third phase, 7 days	21	Daily average 30	37	77	7
	22		29	93	4
	23		34	82	2
	24		40	78	1
	25		36	63	5
	26		29	101	1
	27		35	136	4
Fourth phase, 6 days	28	Daily average 30	14	148	2
	29		17	147	8
	30		1	144	3
	31		5	130	3
	Feb. 1		6	117	9
Fifth phase	Lava ceased to flow on E. 2	Daily average 30	4	108	1
	3		2	60	2
	4		—	105	5
	5		—	82	0
	6		2	160	4
7	1	63	1		

According to ÔMORI, the stronger outbursts (**second column**) were non-detonating and intratelluric, with comparatively large earthquake motions, the double amplitude being 0.1 *mm.*, and they were followed by forcible ejections of ash clouds. The activity, unsuccessful attempts at complete explosion, must have been taking place deep in the channel.

The weaker outbursts (**third column**) were of a surface nature, accompanied by loud cannonading<sup>1)</sup> and echoes of sound, and producing air-concussions which shook windows at a distance. The earthquake motions were, however, feeble, being ten times less than the former. They were the result of the breaking open of the cooled crust of lava vents by pent-up gases. As the detonating velocity was very great, the works of the blasting which were achieved within a very short moment, were correspondingly of considerable magnitude. It is a noteworthy fact that the number of weaker outbursts, as ÔMORI says, is inversely proportional to that of the stronger till the end of the fourth phase.

The phenomena<sup>2)</sup> of eruptions, macroscopically observed daily by the writer on the field, were of two kinds, *viz.*, *a*) the cannonading with shocks and quaking of ground occurred at the time when a new or renewed fissure was opened, or a subterranean gush of lava was caused by gaseous pressure conditioned by sudden expansion at the orifices, and *b*) the thundering and roaring<sup>2)</sup> with

1) About the detonations see p. 66, footnote.

2) The writer carefully observed the night scene of the eastern vents at Fukuyama. Single booming was accompanied with shocks of the ground, emission of sparks and hurling of red-hot stones. Continuous roarings and clinkings, which immediately followed the preceding, signalized the outwelling of fluent lava and the subsequent down-rush of it from the margin of vents. The two did not necessarily follow one another, but occurred quite independently.

After his numerous observations in Stromboli, A. Sieberg found that strong explosions begin with weak momentary tremblings or oscillations of the ground, followed a few seconds later by either a dull long thundering or a sharp booming. At the same time fumarole steam rises accompanied with the trajectory of lava fragments.—'Einführung in die Erdbeben-und Vulkankunde Südtaliens,' Jena, 1914, S. 203.

little or no trembling (air-concussions), accompanied the breaking open of the cooled plug of the lava vent, followed by the cracking and clinking noise of the overflowing lava-stream.

The volcanic earthquakes without eruption (**fourth column**) showed a marked tendency of standing in opposition to the frequency of stronger outbursts (column II). To the writer the numbers of the fourth column seem to have been the movements to and fro of magma in a reservoir more than 1000 *m.* deep from the vents. Consequently, these 'endovolcanic earthquakes' have closer relation to the stronger outbursts as compared with the weaker surficial activity (column III), though the relations are remote with either.

**iv. Mass and Dimensions of Lava.**—The lava-effusing volcanoes are very rare in modern Japan, in contrast to surficial straggling explosive eruptions. The rocks are a basic type of andesites (auganites) of intermediate acidity. In Sakura-jima, lavas are poured out from the Yuno-hira vents on the western slope as well as from the eastern, Nabé-yama vents. Both have independent lava fields and both flowed directly into the sea, just like the recent Sawaiian flows.

In the following the writer gives the dimensions and the mass of lavas, which are necessarily of the nature of a first approximation to truth, besides he gives the numbers computed by his colleagues for comparison. We find a not inconsiderable discrepancy in the columns, owing to the estimation firstly, of thickness assumed by different writers after their personal judgment, and secondly, of the extension of submarine flows. The writer is favored with the data of the new soundings<sup>1)</sup> of Mr. Fujishiro's

1) The soundings were taken at the end of April, 1914, and the calculations given here are all based on the data at hand at that time. Since then, some changes were brought about especially on the eastern field (Text-fig. 24) by constant movements and secondary flows of the lava-front seawards. The marked changes occurred in regard to areal extent if a comparison is made between the area marked 'Marine Lava Field' from the survey of April, 1914, and that outlined with a heavy line, with the remark 'Sept. 1915,' the latter being the result of the renewed land-surveying done by the Prefectural office of Kagoshima.

party by Colonel Kanéko, of the Hydrographic Office of the Imperial Japanese Navy.

WESTERN  
LAVA-FIELD      The lava-front of the *western* lava-field (Text-fig. 19, p. 74) was before the recent event about 24.4 fathoms deep in average, which is equal to 44.6 *m.* As the bottom was gradually and uniformly slanting the mean depth would have been 22.3 *m.* Since the islet of Karasu-jima (22 *m.* high), located at the middle of the marine lava-field on the 10-fathom-line (18.3 *m.*), was now completely buried (January 19th) under lava, the thickness of the lava-sheet at this point must be not less than 40 *m.* The thickness of flow on land is also about 40 *m.* Therefore the average thickness of the entire western lava-field will be approximately 40 *m.*<sup>1)</sup> The writer is on this point in perfect accord with all his colleagues mentioned in the Table (p. 107). The field is 4 *km.* in axial direction and 2 *km.* in breadth at the front.

EASTERN  
LAVA-FIELD      A little more basic lava crawled down for a distance of 4 *km.* and spread in the same measure over the *eastern* slope, then finally plunged into the sea and choked up the narrow strait of Séto, 30 to 40 fathoms deep. The lava of this area makes a flat of 120 *m.* upon the buried slope originally 80 *m.* in altitude, and a hill top on shore, 103 *m.* high (Akashi Gongén, Pl. VIII. Figs. 2-3; Pl. IX. Figs. 2-3), was overflowed with a sheet of lava-flow. The thickness of lava on land may therefore be reckoned at 40 *m.*, as in the flow on the opposite side. The contiguous lava-field in the sea has, however, a thickness of 100 *m.*

---

1) From experience the writer is disposed to think that the average thickness of a single lava-flow of a femic andesitic magma on land amounts to from *thirty* to *fifty* metres, as we can often measure it at the lava-front, as well as in the benches within the steep crater-wall of the Japanese volcanoes. The limitation of the thickness mainly depends upon the viscosity inherent in the chemical nature of the modern Japanese lavas.

The southern main arm (Text-figs. 19 [p. 74] and 24) of the fluent lava pushed southwards under the sea with a thickness of

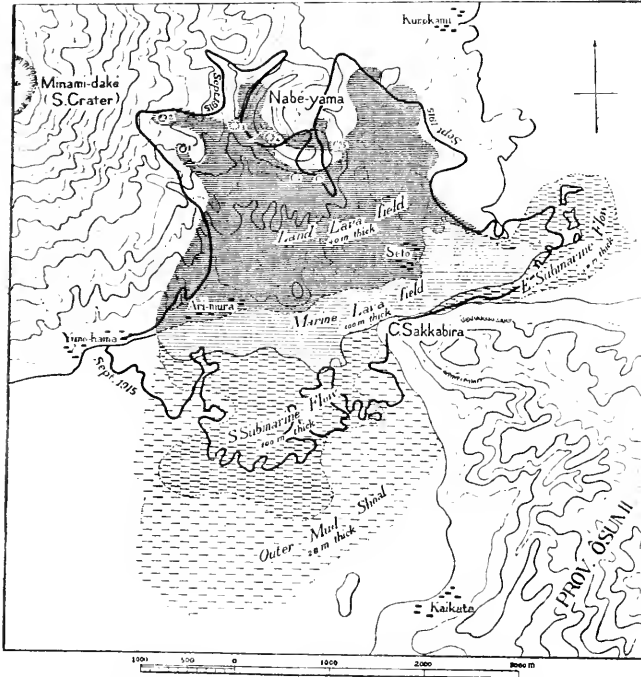

Fig. 24.—Distribution of the Nabé-yama lava-flows, land, marine and submarine. The heavy line, marked 'Sept. 1915,' shows the subterial extent of the lava-field by the recent survey (p. 104, footnote).

of forward movement and corresponding decrease of thickness to about half that of the southern.

As will be seen on the Sketch Map (Text-fig. 24), the southern arm of the submarine flow moved farther forwards pushing up the muddy bottom to an extent of 28 *m*. This outer muddy shoal is now 60 fathoms deep, while it was formerly 70–80 fathoms. As the soundings brought up nothing but samples of mud, the bottom of the shoal is evidently not sheeted with lava, and the writer deems it better to exempt it from the submarine lava area, although in the following calculations it is assumed as a lava mass.

100 *m*. where the bottom is now only 36 fathoms, while it was formerly 96 fathoms deep, giving a maximal difference of 60 fathoms which is equivalent to a vertical extent of over 100 *m*. of the submarine lava-sheet. The eastern submarine arm was deflected east-

wards by the head-land of Sakkabira with less intensity

## I. Western lava-field.—Dimensions of lava-streams from the Yunohira vents.

Author	Area	Thickness	Volume
Kotô	7.202 sq. km.	40 m.	0.2881 cub. km.
Ômori	8.330	40	0.3332
Satô	6.025	40	0.241
Yamasaki	5.23	40	0.2092

## II. Eastern lava-field.—Dimensions of lava-streams from the Nabé-yama vents.

Author	Area	Thickness	Volume
Kotô	5.40 sq. km. Lava-field on land	11.139 3.853	40 m. 0.2160 cub. km.)
	1.886 " " in sea		100 0.1886
	2.738 Submarine flow on S.		100 0.2738
	1.115 " " " E.		50 0.0558
	4.238 Outer mud shoal		28 0.1187
Ômori	5.25 Lava-field on land	15.41	40 0.21
	2.19 " " in sea above sea-level		100 0.219
	7.97 " " below "		100 0.797
Satô	6.2875	25	0.1572
Yamasaki	6.21	25	0.36445

Author	The entire lava-field	
	Area	Volume
Kotô	18.341 sq. km.	1.1410 cub. km.
Ômori	23.74	1.559
Satô	12.3125	0.3982
Yamasaki	11.44	0.57365

The whole mass 3,012,240 million Kilogrammes or 3,012 million tons.

From the Table given the area of the western lava-field is 7.202 *sq. km.* with a corresponding volume of 0.2881  *cub. km.* ; that of the eastern is 11.139 *sq. km.* inclusive of submarine flows, and the volume 0.8529  *cub. km.* As the density of the Nabé-yama lava is

<p>WHOLE MASS OF LAVA</p>	<p>2.64, the whole mass of lava poured out both from the eastern and western vents amounts to 3,012,240 million kilogrammes or 3,012 million tons. The volume of juvenile lava is equivalent to 1/14 of that of Sakura-jima, the latter being 15.949 <i> cub. km.</i> (p. 32). Assuming that recent and ancient lavas have the same density, the relative proportion of the mass of new lava to that of the preëxisting is also 1 : 14.</p>
-----------------------------------	---

On his trip to Sakura-jima in April 1915, F. ÔMORI took a remarkable photographic view of the lava-flow on the Nabé-yama side (Pl. XII. Figs. 1 and 2). This is a **secondary lava-stream** pressed up from below the still unconsolidated portion of the extensive lava-field of the preceding year. The still molten mass inside burst open through the outer hardened crust and crawled downwards from the middle of the field over its gray ash-coated solid sheet toward the lava-precipice. From this point or 'head' it rushed down anew into the sea (black fresh lower area in Fig. 1), taking a divergent course at its front.

The land so newly reclaimed pyrogenetically is, geomorphologically speaking, a kind of delta which may be likened to the 'bird-foot delta of the Mississippi.' See Pl. XII. Fig. 1. The digitiform field has ramifying axial channels (black lines in the picture), comparable with the diverging 'passes' of the great American river. While the upper and under portions had solidified and were creeping sluggishly onwards, the still molten portion was able to move faster and thus to leave empty spaces behind it. The steam



and gases in the picture are generated in such a tunnel, and gush out at the end. The channels which present the appearance of natural levees are really *collapsed tunnels* with broken-in roofs, the vault material being partially carried forwards with the flowing liquid rock. The event is said to have happened some time between the end of March and the beginning of April, 1915, *i.e.*, after a lapse of fourteen months after the great eruption.

Another feature, no less striking, is what the writer calls by the name of the *gas-blowing horn* at the largest tunnel's end, as may be seen in one white spot in the background of Pl. XII. Fig. 1 (*h*). An enlarged and nearer view of it is the lower picture (Fig. 2 (*h*)). This volcanic spouting horn is something like that often found in cliff-caves exposed to stormy coasts and like that it is generated in an analogous way, differing only in mode, which is here by a dry, not a wet process. Pent-up vapor and gases in the lava-tunnel forced their way out, causing this remarkable *volcanic blowing horn* at the water's edge. It is a special kind of *fumaroles*.

A relinquished lava-grotto is found near Cape Nagasaki (Geologic Map, *gr*) on the southeastern shore, where it opens at the termination of a lava-tunnel of an ancient flow at the water's edge. Here a cold "infernal" wind, so say the people, gently blows throughout the year from the deep interior. The **tromba** on land as well as in the sea (*postea*, p. 115) may be explained, according to the writer's opinion, on the same principle.

In the *western* field (p. 105) the lava flowed down from under a partially consolidated supercrust (on the front of Pl. XII. Fig. 3) toward the sea, where it deployed into two fan-shaped areas with an indentation between them, the head of which marks the position of the buried Karasu-jima. The back of the main front

describes a large ring, the edge of which is signalized by a series of fumes well seen from a distance. It is the remarkable example of a ring of *wet* fumaroles around the central arena where dry hot invisible ones exist which prevent the precipitation by the high tension of rising vapor. After rainy weather the fumaroles increase considerably in intensity<sup>1)</sup>—a fact which speaks for the atmospheric origin of the vapor. The arena of this amphitheater was formed by the settling<sup>2)</sup> of cooled crust in the unsupported subterranean channel which was made vacant probably through the escape underneath of uncooled magma outwards, and which was unable to bear the superincumbent weight of the crust.

Lava-deltas are by no means rare when fluent lava crawls down into the sea; but what the writer finds particularly remarkable is the wide circular depression, or 'foundered' arena, as in Fig. 3, Pl. XII., the formation of which must have caused many lava-tunnels in making way for the exit of fluent lava into the surrounding sea-bottom.

v. **The Temperature of Lavas.**—On the intratelluric temperature of the magma within the upper portion of the crust we have only scanty data on which to make even an approximate estimation. There seems, however, not much difference between the initial temperature<sup>3)</sup> at the vent and in the channel below 6–8 *km.* from the surface within the compression shell, as may be deduced

---

1) See page 116. See also Pl. IX, Fig. 1.

2) Pyrogenous settlings are technically called 'foundering' by Daly and other American writers.

3) J. P. Iddings also says, that the temperature of the earth's interior is not greater than the hottest volcanic lava, that is to say, it ranges from 1,000° to 1,500°C. The source of the hottest volcanic magma, according to this authority and to J. Milne, is located at a depth of 30 miles (48 *km.*), which is the base of the lithosphere at the boundary of the crystalline and amorphous zones, and the upper limit of the magma region, according to F. v. Wolff, is 30–40 *km.* Iddings, 'The Problem of Volcanism,' 1915, p. 156 *et seq.* Wolff, 'Der Vulkanismus,' 1914, Bl. I. S. 31.

from the contact phenomena in limestone which has been influenced by injected batholith of granite, and this temperature is assigned at about  $1,000^{\circ}$ – $1,200^{\circ}$ C. Wollastonite, a common mineral of contact limestone with granite, also crystallizes below  $1,200^{\circ}$ C.

The initial temperature of burning lava at the vent of Sakura-jima must lie above  $1130^{\circ}$ C. for reasons given below.

The melting or solidifying interval of a chemically decomposable body is rather long, as in the heterogeneous aggregate of minerals which constitute a rock mass. The melting point at the higher phase of the interval depends upon the acidity of the magma. The modern Japan proper lies within the petrographic province of andesites (Pacific branch)<sup>1)</sup>, or the rocks of intermediate acidity.

As the recent lavas of Sakura-jima have not yet been made the subject of special study, the writer has chosen for comparison the recent lava of Ôshima at the entrance of Tôkyô Bay. As the physical studies of Japanese lavas are not known in wide circles, and moreover, some results given below are made public for the first time, the writer may be justified in entering somewhat into details, although the lavas under consideration are *not those from Sakura-jima*.

THE  
MIHARA-  
YAMA  
LAVA

Messrs. FUJI and MIZOGUCHI<sup>2)</sup> undertook a melting point experiment of the lava welled out in October 1912 from the Mihara crater of Ôshima Island. The lava is a hypersthene-andesite of a rather basic nature with  $SiO_2$  51%,  $Al_2O_3$  22%,  $Fe_2O_3$  15%,  $CaO$  11%, and  $MgO$  2%. The lava in an electric oven began to be plastic from  $800^{\circ}$ – $860^{\circ}$ , ascertained through electric con-

1) Kotô, 'On the Volcanoes of Japan,' *Jour. Geol. Soc. Tokyo*, 1916, p. (73).

2) 'The Melting or Solidifying Range of Temperature of Lava by Electric Conductivity,' *Tôkyô Sug.-Bot. Kôzi*, Vol. VII, 1914.

ductivity, the melting point or the formation of complete melt being  $1130^{\circ}\text{C}$ . At  $1300^{\circ}$  a brisk effervescence or 'storm' of gases occurred, but not below.

With the aid of the optical pyrometer of Holborn-Kaulbaum they found in the field the temperature of the same lava, which in a red-hot state filled up fissures, to be from  $995^{\circ}$  to  $1048^{\circ}\text{C}$ . The crawling lava stream was examined with the same at night, and it was found that the bright (yellowish-red) proximal portion was  $995^{\circ}$ , the dull (red) terminal portion  $857^{\circ}$ , a temperature at which the rock becomes a little plastic.

The writer believes that the lava-streams of Sakura-jima behaved, and are still doing so, in the same fashion. Wolff ('Der Vulkanismus,' Bd. I. p. 43) says, that foreign andesites begin to be plastic at  $1095^{\circ}$  and melt completely at  $1100^{\circ}$ – $1125^{\circ}\text{C}$ .

Prof. K. TAWARA, of the Engineering College carried on, at the writer's request, a melting experiment at fixed temperatures and for definite lengths of time, the action being suddenly interrupted by quenching the samples in water at  $16^{\circ}$ . The high temperatures were determined with a thermoelement. The original rock-specimens were collected by Prof. F. ÔMORI from the second period flow of 1912 in the same crater of Ôshima island. The lava samples of hypersthene-andesite entrusted to the writer for microscopic analysis are slaggy and black, and dotted with bytownite-phenocrysts. They possess hyalo-crystalline texture with microphenocrysts of hypersthene. The groundmass is built up of feldspar microlites and augite grains, cemented by brown glass which contains dendritic skeletal magnetite.

The slides made of the quenched test samples were seen under the microscope with the following characteristics :

No. 1. Raised to  $900^{\circ}$  and kept at this temperature for 1 hour. Not much change from the original specimen.

No. 2.  $900^{\circ}$ , 2 hours. Dendritic magnetite is still to be seen. Augite in the groundmass is partially fused, forming black glass.

No. 3. 1000°, 1 hour. The groundmass-augite is reduced to grains, but minute magnetite crystals are newly formed.

No. 4. 1000°, 2 hours. Phenocrystic plagioclase is resorbed on edges and secondary black glass-inclusions become abundant. In the groundmass are seen the new augite prismoids and larger magnetite crystals in brown glass.

No. 5. 1050°, 1 hour. Phenocrystic hypersthene is rounded a little on edges. Newly formed are roundish rectangular augite and larger magnetite clumps, with colorless glass full of globulites.

No. 6. 1050°, 2 hours. Phenocrystic plagioclase is full of negative crystals filled with black glass. A few large grains of magnetite and abundant globulitic glass.

No. 7. 1100°, 1 hour. The groundmass becomes crystalline, being an admixture of subangular augite and magnetite crystals, with interstitial brown globulitic glass.

No. 8. 1100, 2 hours. Apparently like the original rock with dendritic skeletal magnetite in glassy groundmass.

The test chips are not sufficiently raised to 1130°, which is the complete melting point of the rock.

*To summarize the feature of changes:* the long-prismatic hypersthene (not amblystegite), which is the only phenocryst of the pyroxene group, remains almost unchanged. The bytownite is left nearly fresh, the only changes noticeable being the increase in size and quantity of black glass inclusions, showing that they are the products of temporary retrogressive *resorption* phenomena in bytownite rather than the progressive crystal development, as *they are usually supposed to be*. Feldspar microlites in the groundmass seem not to have suffered any changes. Feldspar phenocrysts and microlites are usually assumed to crystallize in several generations. To the writer it seems probable that they belong to the *same generation*, the difference in crystal development being simply due to *dissimilarity* in their chemical composition.

The chief changes noticeable within the range of temperature from 800° to 1100° are those of augite, magnetite and glass of the groundmass in their relative proportions and also in their development, corresponding to the varying consolidations of lava during the effusive period. The effects of sudden quenching of the test samples *under water* do not appear to be strongly marked, excepting the formation of *globulite* in interstitial base.

Very interesting features to be noted are the duration and the degree of temperature to which the tests are subjected. The longer in time and higher in the scale of temperature which the tests have to undergo, the more perfectly both the augite and magnetite crystallize from the melts. This possibly depends on the function of time of cooling and the relative proportion of volatile constituents.

In connection with the temperature of lava, a few words may be inserted on the formation of the 'block-lava' and the 'bread-crust bombs.' The diminution of pressure during the ascent of lava through the channel releases gaseous contents, and the exothermal heat from the reaction of gases counteracts the cooling by expansion and even can raise the temperature to a certain degree. In coming to the surface the body of the lava suddenly expands, thereby causing cooling, which is accelerated by the cooler atmosphere.

The manner of cooling from outside inward in such masses must result in much mechanical deformation during the forward movement. The projected masses turn to bread-crust bombs and the flowing streams to discrete blocks—the 'Aa' type of the roughest and most ragged outline.

Four months after the eruption the writer revisited the terminal cliff of the lava streams of the western

BLOCK-LAVA  
AND BREAD-  
CRUST  
BOMBS

SECONDARY  
EXHALATION

vents of Sakura-jima, when bluish white fumes of wet disagreeable odor were exhaling from the interstices of the loose pile of block lava (Pls. XIV. and XV.). They gave acid reactions with abundant  $H_2S$  and a little  $SO_2$ , showing thus the sulphureted-hydrogen *fumarolic*, or acid *solfataric* stage corresponding to a temperature of  $100^{\circ}$ – $200^{\circ}C$ . Sulphur was being deposited on the walls through the reaction of steam upon  $H_2S$ . Tests on  $HCl$  and  $SO_3$  gave negative results.

LAVA-FLOW  
IN SEA

The lava-streams flowed down on both sides directly into the sea, as in the late Sawaiian eruption, calmly generating saline vapor on contact with water, which was constantly driven landwards by convection current, and which enveloped the whole lava-field in dense white clouds (Pl. VI. Fig. 2, Pl. VII. Fig. 1). The lava margin was white with the bubbling up of water. The writer anticipated some damages in orchards and forests from *salt vapor*<sup>1)</sup> as in Samoa; but the effect was fortunately not pronounced.

People frequently spoke of and the writer also noticed that a few metres off the lava front an isolated spiral column of white steam ascended from the sea bottom almost vertically in a narrow thread to a considerable height. It is the whirlsteam or Perret's **tromba**<sup>2)</sup>, which was constantly changing its position. On land, the same whirlsteam was frequently seen in the unconsolidated lava-field, as in the lava-stream from the vent No. 5 of Nabéyama.

1) This saline steam or *Yushiro* (湯鹽), meaning hot saline bath, inflicted considerable damage upon crops on the northwestern shore of Kagoshima Bay during the An-ei eruption of 1779.

2) *Zeitschr. f. Vulkanologie*, Bd. I. S. 148, 1914. The writer conjectures the cause of this peculiar gaseous emission to be a forcible escape of compressed steam through a narrow orifice at the end of a lava-tunnel, local chamber or the like, perhaps mixed with mist of sea-water. See p. 109. Pl. XII. Fig. 2 (*b*).

In passing, it may be noted that white vapor arising from lava-fields both on land and sea (Pl. IX. Fig. 1) are especially dense after rain, owing to the evaporation of rain water and also to the condensation of saturated atmospheric moisture blown toward the dry and hot interior by convection current.<sup>1)</sup>

TEMPERATURE OF SEA-WATER      The temperatures<sup>2)</sup> of water on the west at the first phase of the lava immersion were reported to be 45° to 50° near the lava front, and 38° at a distance of 100 *m.* Temperature observations were carried out by a party of the Kyūshū University at the lava front near the shore at Arimura, on the east, at the end of January, 1914. From the surface to a depth of 5 *m.* thermometers read from 50°–60°, while at the bottom it ranged from 20.5° to 27°, the temperature of the air being constantly at 16°. The writer was on the same spot on April 18th, 1914, and could not approach the lava front within a reach of 100 *m.*, as it was too hot; but ten metres away from that limit, one could take a warm bath comfortably.

The sea water seems to have been heated by direct contact with lava as well as by radiation of subaërial hot lava, which action was confined within the narrow horizontal extent of about 100 *m.* (Pl. VII. Fig. 1) and the shallow layer of a little over 5 *m.* These ascertained data will be of some service in the study of oceanographic subjects.

BOILED FISHES      The writer heard from villagers at Futagawa on the Ôsumi coast that they saw shoals of flat lying fishes driven ashore on January 16th in a half boiled condition,

1) See page 110.

2) On January 28th, N. Yamasaki (see *ante*, p. 56, *l.c.* p. 6) observed at the lava front the surface temperature of water varying from 45.5° to 48°. At a distance of 200 *m.* it was 30° (a considerable decrease), at 300 *m.*, 21°, and at 600 to 1500 *m.*, 19.5°. From 2,000 *m.* it was normal. In the Hawaiian eruption of 1902, it is said, according to I. Friedländer, to have been from 50° to 60° C.



becoming half-cooked while emerging from the cool sea-bottom through the upper hot zone. The same thing happened in the Sawaiian eruption of 1902.

**vi. The Lapilli, Ash and Sand.**—The recent activity of Sakura-jima was manifested in two ways, beginning with explosions followed by lava effusions. During the first phase a prodigious amount of disrupted masses was thrown up to the sky, of various size and nature. The western vents were of excessive intensity, projecting blocks of 1 *m.* or more in diameter, which fell on shore near Yokoyama at a distance of two and a half kilometers from the orifices, and made conical holes in the ground (*see* p. 66 and Pl. V. Fig. 2). The blocks are of juvenile as well as resurgent origin, as will be seen described in the PETROGRAPHICAL PART. We are here mainly concerned with lapilli, sand and ash.

According to the usage of mining engineers and especially of agrogeologists various grades are established in the order of size in the skeletal portion of soil in mechanical analysis, viz.,

	Size expressed in diameter.	Name.
Minimum size	10 <i>cm.</i> .....	Boulder.
Varying between	10 <i>cm.</i> and 10 <i>mm.</i> .....	Pebble.
" "	10 <i>mm.</i> " 1 " .....	Gravel.
" "	1 " " 0.1 " .....	Sand.
" "	0.1 " " 0.01 " .....	Silt.
Less than	0.01 " .....	Mud.

Kanai,<sup>1)</sup> of the Kagoshima Higher Agricultural College, has treated the loose ejecta from Sakura-jima on the sieve method with the following results:

a) The ASH is composed of hypersthene (not amblystegite), plagioclases and comminuted colorless vesicular glass, of a size less than 0.25 *mm.*, which make up 70% to 95% of the whole mass. It is the size which approximately corresponds to that of

1) *Journ. Geol. Soc. Tôkyô*, July Number, 1914.

silt mixed with a little fine sand in the grade of the above category. The particles above 2 *mm.* are scanty.

A wash skeleton (Pl. XXIII. Figs. 6-7.) of the ash that fell on January 12th on the roof of a house (p. 122) at Kokubu Station, 19 *km.* away from the vent, was examined by the writer and seen to be composed of roughly-rectangular plagioclase, slender hypersthene and magnetite crystals, the first two being 0.45 *mm.* in longest extension, the last 0.2 *mm.* The skeletal portion may be taken for fine *crystal lapilli* or *crystal sand* in contrast to slag lapilli, as the components remarkably retain their idiomorphic shape. The light major portion consists of finely pulverized colorless splinters of strained pumiceous glass, mixed with small quantities of plagioclase powder, of a minimum size of 0.002 *mm.* As the locality is not far away from the orifices, the heavy crystal components are still found in large quantities among the ingredients of the ash.

The ash dust, carried away by storm for a distance of 1,000 *km.*, rained in Tôkyô on January 14th, two days after the eruption. It is light-gray and is uniform in size, being 0.007 to 0.008 *mm.* in diameter. It is composed of about 8% of plagioclase fragments, while the rest is glass splinters and textile fibers, with a single piece of hypersthene (Pl. XXIII. Fig. 8). The heavy components—magnetite with sp. gr. 5, hypersthene, 3.3-3.5, and a large portion of plagioclase, 2.5-2.75—were precipitated during the aërial voyage, and only particles of light friable colorless glass remained in suspension in the air. The glass contains drawn-out air pores, and is marked with striations produced by the stretching of the magma; thereby the substance became greatly strained and easily pulverulent.

It is no easy matter to decide whether the original rock is resurgent or juvenile. From the idiomorphism of the crystal com-

ponents it is highly probable that the ash materials were derived from trituration of pumice. It is therefore to be classed with *magma-glass* ash, but not lava ash.

A question naturally arises: Which vent—the western, Yunohira or the eastern, Nabé-yama vent—supplied the major portion of ash materials? To give a proper answer it is first of all necessary to know the date of any ashfall which should have been gathered in a special receptacle, but that precaution was unfortunately not carried out.

As will be immediately stated in speaking about lapilli, the main ash producers were the eastern vents (*see ante*, p. 68, footnote), for the reason that the magnetite found possesses well-defined crystal form and glass pure white, while the western vents hurled out only dirty glass particles and magnetite clumps.

b) The SAND (*moyézuma* or ‘burning sand’) varies in size from 1 to 2 *mm.*, corresponding to the gravel in the above scale, though the one with 3 *mm.* is tolerably abundant. Like lapilli, it is really rock particles, differing from them, however, in its compact texture, the color being usually black. Undoubtedly it must have precipitated in a large quantity at the very beginning of the eruption as a rain of sand of *old* lava, when vents first broke open through a preëxisting lava sheet of volcanic body. It has contributed in large measure to the darkness of the cauliflowers<sup>1)</sup> (Pl. I.) of dust clouds, which gave an awful impression to persons who happened to view the scene from far and near.

Towards the climax of paroxysm the sand became rarer.

---

1) The form produced is similar in principle to the smoke ring of tobacco-smokers. The puffed up vapor in the air from a volcanic vent expands in the horizontally rotating axis in shaping that curdy salmiacal ring, and the solid particles intermixed in smoke columns are sorted and fall leeward as a black rain of volcanic ash and sand. See A. Sieberg, ‘Einführung in die Erdbeben- und Vulkankunde Südtaliens,’ Jena, 1904, S. 203

At the later declining phase it again increased in proportion as the lava cooled and acquired viscosity, thereby affording great obstacles to outbursts which, when carried to effect, caused scattering and spreading of the rain of sand, by this time of *juvenile* lava. The writer met with such rain on his second trip. The sands and ashes are therefore of resurgent (*lava ash*) as well as of juvenile (*magma ash*) origin, so that chemical analysis made of them seems to be of restricted value, except for agricultural chemists. If samples are gathered at special periods the results attained are quite different.

c) The LAPILLI<sup>1)</sup> ('*karu-ishi*' or '*ga-ishi*') are fragments of gray pumiceous lava of a size of 2 to 4 *mm.*, making up from 7 to 37% of the mass. The rest varies in size from 2 to 4 *cm.* corresponding to the fine pebble in the above scale. They are no doubt of juvenile origin formed during the first phase in the Strombolian stage, and should be classed with the *slag lapilli* in contrast to the crystal lapilli.<sup>2)</sup>

The writer is able to discriminate the eastern, Nabé-yama, from the western, Yunohira, lapilli. The *eastern* are in appearance whitish and fine vesicular with roundish outline. Microscopically, we find idiomorphic olivine and hypersthene crystals, grouping themselves in local patches, and magnetite crystals as well as plagioclases are well crystallized in outline. Minute roundish air pores (0.07 *mm.*) are enclosed in the highly strained colorless pure glass. In short, the eastern lapilli are the froth of lava.

The *western* lapilli, on the other hand, are dirty brown and coarse with stretched air pores. They are characterized by the

---

1) See the heading 'Recent Lapilli' in *Petrographic Part*.

2) Idiomorphic anorthite crystals from Myaké-jima and the Volcano Tarumai are well-known examples.

absence of olivine and the anhedral form of magnetite. The glass base is full of dust or a little brownish, and contains a few microlites of both augite and plagioclase. The whole structure appears not unlike a spongy mass with skeletons, enclosing elongated pores of more than 0.3 *mm.* in diameter.

As regards quantity, the lapilli from the eastern vents are far more numerous than those from the western, chemically the former are rather basic, the reason of which is the presence of a basic mineral, *olivine*.

---

CHEMICAL  
COMPOSITION Among ejecta after a volcanic activity the product that has been usually subjected to chemical analyses is ash. So far as the writer is aware, no definite conclusions have yet been drawn from numerous chemical treatments, owing to the heterogeneous origin and composition as well as varying proportions of mineralogical ingredients dependent upon the distance from vents. In collecting samples fresh ash must be chosen with mention of date and locality, which is usually neglected.

A few specimens of analyses made of the recent Sakura-jima ash are given below :

	Ash which fell at the Normal School of Kagoshima city	Unknown locality	Ash which fell in Krakatoa, 1883
	Imp. Geol. Surv. Japan	Engineering College, Kyūshū Imp. Univ.	Winkler <sup>2)</sup>
<i>SiO</i> <sub>2</sub>	63.39 <sup>b)</sup>	60.38	61.36
<i>Al</i> <sub>2</sub> <i>O</i> <sub>3</sub>	16.75	18.10	17.77
<i>Fe</i> <sub>2</sub> <i>O</i> <sub>3</sub>	3.10	8.49	4.39
<i>FeO</i>	4.10	—	1.71
<i>MgO</i>	1.43	3.68	2.32
<i>CaO</i>	5.38	6.01	3.45
<i>Na</i> <sub>2</sub> <i>O</i>	3.50	0.56	4.98
<i>K</i> <sub>2</sub> <i>O</i>	1.32	0.46	2.51
<i>H</i> <sub>2</sub> <i>O</i>	0.63	—	—
<i>TiO</i> <sub>2</sub>	0.57	—	1.12
<i>P</i> <sub>2</sub> <i>O</i> <sub>5</sub>	0.20	0.14	—
<i>MnO</i>	0.03	—	0.41
<i>Cl</i>	—	0.07	—

All three samples of ash derived from hypersthene-andesite, fell near vents, and there exists general agreement among them. A soluble portion of ash that fell on January 12th at Kokubu Station (p. 118) was tested by Mr. Iimori under the direction of Prof. Ikeda, of the Tōkyō Imperial University, with the following results: *CaCl*<sub>2</sub> 0.049%, *NaCl* 0.015%, sulphates trace. It may be remarked that at the first phase the ashes contained chlorides while sulphates occurred only in trace. *NaCl* is of primary volcanic origin, as the writer took the sample before the inflow of the lava into the sea.

The acidity<sup>3)</sup> lessens with time as shown in the following, the numbers given being reduced to the standard after Dr. Daikuhara :

1) 15.75% of soluble silica.

2) 'Report of the Krakatoa Committee of the Royal Society.' London, 1888.

3) Daikuhara informed the writer, that the acidity exists in the soluble portion and is mainly due to the presence of *AlCl*<sub>3</sub>. It is Chloraluminite in the composition of *AlCl*<sub>3</sub>.*6H*<sub>2</sub>*O*, and crystallizes in hexagonal-rhombohedral. Wolff, 'Der Vulkanismus.' Bd. I.

Locality	Date, 1914			
	January 25	April 8	July 6	Middle July
West Kokubu, Aira district.	19.1	1.6	trace	—
Také in Futagawa, Kimotsuké district	18.2	2.1	„	—

The much talked-of injurious action of juvenile soil upon plantations will soon disappear after a few months, by rainfall, through the leaching of the soluble salts into the fast soaking bottom. Southern Kyûshû is a plateau of Diluvial pumice bed, more than 200 *m.* thick, formed by deposition of ejecta of ancient volcanoes. Recent deposits are exactly of the same kind as those of past geologic ages, they are all able to produce fertile soil and are well fitted for pasturage and certain kinds of subtropical plantations, as in the case of Central America. The only defect is the dearth of water and on this account the land could not well be brought under cultivation for rice paddies.

DEPOSITION  
OF EJECTA

The *mode of deposition* of ejecta is interesting and regular. It can be best seen at Kurokami at the foot

of Nabé-yama, where the maximum thickness attained 1.8 *m.*, burying houses even to the eaves (Text-figs. 22 and 25). Banks of a dry river nearby expose a good profile.

a) The basal deposit is an accumulation of coarse angular fragments of preëxist-



Fig. 25.—Ash-buried village of Kurokami on the eastern shore.

ing black compact lava mixed with juvenile lava, superimposed by *b*) a coarse admixture of lapilli and sand. Near the upper horizon the writer, to his surprise, picked up white porcelain-like splinter blocks, which under close examination were found to be the interesting cordierite-bearing ejecta to which special description will be given under the new name of **ceramicite**. It is remarkable that it constantly recurs in the same horizon elsewhere. *c*) The upper 13 *cm.* of the deposit is composed of ash mixed with little sand.

The above profile tells the order of volcanic ejections beginning with coarse and closing with fine materials. The lower portion of the (*a*) deposit is of projectiles during the explosive phase, while all the rest are the products of the eruptive period. The new deposit affords good ground and is pleasant to walk over, being a typically macadamized terrene covered with moist fine ash which coats hills, mountains and valleys alike.

What is said in the foregoing chiefly refers to the normal deposit. On the *west*, however, abnormal conditions prevailed. Here the first paroxysm seems to have been an extraordinary one, scattering rough blocks of 1.2 *m.* diameter, of old compact and new pumiceous lavas on the shore between Akamizu and Akôbara, at a distance of 2 *km.* from the vents. The loose pile of about 1.3 *m.* was coated with 1.3 *cm.* of ash sheet. The ground here is of roughest character and very unsteady (Pl. V. Fig. 2) in contrast to the east (Text-fig. 25).

DISPERSAL  
OF EJECTA

The *mode of dispersal of the ejecta* was mainly influenced by the direction of the wind, especially the coarser particles, which were under the direct control of varying local winds. A photographic picture taken a few minutes after the first eruption (Jan. 12th, 10.20 A.M.) unequivocally shows the wind veering at that time to northwest (Frontispiece and Text-fig.



15, p. 64), blowing coarse products as well as fine dust to the northwest, north and northeast, along the foot of the main volcanic cone, which locally deflected the course of projectiles to a northerly direction. Coarse ejecta are therefore remarkably absent on the southwestern coast of Sakura-jima.

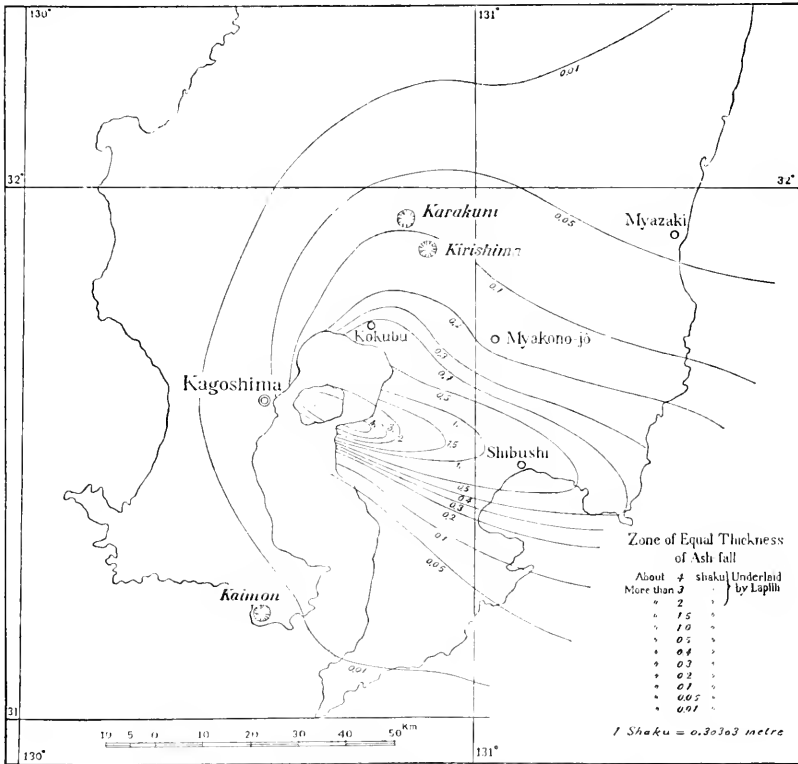

Fig. 26.—Distribution of ejecta in Southern Kyūshū.

Main volcanic ejections occurred from the first moment of subaerial activity till 4 A.M. of the next day, the 13th. Meanwhile the wind changed to W.N.W., driving the showers of lapilli to the province of Ōsumi (see Skotch-map, Text-fig. 26). The fine dust was thrown up to a height of 18 km., as was estimated by the Station-master of Kagoshima, though this stands far below that of the Krakatoa eruption, which was from 27 to 29 km. (see

p. 65), and the explosion gases ascended up to 70 to 80 *km.* As it was above the lower limit of the zone (11 *km.*) of windless constant temperature ( $-60^{\circ}\text{C}$ ), the Sakura-jima dust may have remained in suspension for a long time.

It is here to be remarked that the height calculated from Kushino, far away west of the city is 7,272 *m.*, that estimated from the war ship 'Toné' anchored near Taniyama is 8,181 *m.* The volcanic gases, which accompanied the eruption, must have ascended still higher and pressed up the zone of constant temperature to a cooler region, causing copious precipitations of rain. The writer has frequently asserted that the cloud-burst, however, did not occur with a rain of mud; on the contrary the first phase of eruption happened in fine weather. Possibly the recent eruption of Sakura-jima was more or less of the *anhydrous* character (*see* p. 92).

Major portions of fine ejecta floated in the higher atmosphere and were transported eastwards by the constant upper current of a westerly wind. Ash fell in the four provinces of Satsuma, Ôsumi, Hyûga and Iigo in southern Kyûshû. (Text-fig. 26). At Miyazaki (80 *km.*) in Hyûga it rained from 1.45 A.M. of the 13th. The whole Chûgoku region of Honshû was hazy on the same day. The island of Shikoku, especially the southern half, was the heavy precipitation area. In Ôsaka, dust fell slightly from noon of the 13th till the morning of the 14th. Thence eastwards it became thinner, and in Tôkyô, at a distance of 1,000 *km.* from Sakura-jima, it fell from the morning of the 14th. The same thing happened in the eruption of 1779. It is not surprising that dust fell in Tôkyô; for, the Icelandic eruption (Rudloff crater) of 1875 precipitated dust at Stockholm after 30 hours at a distance of 250 miles (1,900 *km.*), and the Krakatoa eruption at a distance of 2,500 *km.*

DUST IN  
UPPER  
ATMOS-  
PHERE

In the Bonin islands an afterglow of the sun, as in the Krakatoa eruption of 1883, was observed and dust began to rain from 5.30 A.M. of the 13th. It was transported thither with a velocity of 30 *m.* per second. Some doubts were entertained as to the source of the Bonin ashfall, as a new volcanic island rose on January 23rd from sea-level near South Iwô-jima, which lies to the south of the above-mentioned group.

The writer abstains from calculating the *amount of ejecta* from the Sakura-jima vents, because of the want of data for trustworthy estimation in such loose volcanic products of various dimensions.<sup>1)</sup> According to F. ÔMORI, the volume is 0.62 cub. *km.*, which is equivalent to 40% of that of new lava, and 1/25 of the volcano of Sakura-jima above sea-level. The ratio of the volume of ejecta to new solid lava is 8:5. In the Krakatoa eruption of 1883 (loc. cit., p. 122, footnote 2) the total volume of pumice and dust was estimated at 95% of the whole ejecta, there being no lava flows at that time.<sup>2)</sup> The fine pumice of that event was roughly calculated to be 3.5 times and the coarser sort 5.5 times lighter than the compact lava.

**vii. The Subsidence of the Sakura-jima Environs.**—After the catastrophe of Sakura-jima on January 12th, 1914, it was rumored that the neighborhood was gradually subsiding. Unequivocal signs were at hand: the overflow of bay waters into paddy fields and salt gardens over and through embankments on shore, thereby endangering both the rice culture and industry. Houses at Futamata and Shirahama standing on the northern shore of the volcano island became exposed to spray upon their windows, where they

1) In Kagoshima it was estimated that the dry ash occupying a sq. *m.* with a thickness of 2 *mm.* weighed 118 grammes.

2) In the Cotopaxi eruption of 1880, the quantity of ash was estimated as 2,000,000 tons; that of Katmai occupied 5 cub. miles.

were formerly outside the reach of rollers, and in April the writer frequently overheard people talking about the land settling 2 or 3 feet.

The same thing happened after the eruption of 1779. It is stated<sup>1)</sup> that the sea encroached upon the city of Kagoshima and its northern extension of shore by a subsidence of 5 or 6 and even 10 feet. The immersed land seems to the writer to have been later reclaimed, though some recent writers entertain the view that the lost land resumed its former altitude after a score of years. The bottom of the trench bay, or geologically speaking the *rift valley*, of Kagoshima is settling even at present, as will be immediately spoken of.

As to the recent positive movement of sea level, a popular view is that the current is now being deflected and stemmed to the opposite shore through the complete damming up of the strait of Séto by the new lava-flows (p. 90 and Text-fig. 19 in p. 74), while a few assign the cause to the increment of water temperature through the inflow of 'live' lava into the sea.

Thanks to the authority<sup>2)</sup> of the *Ordnance Department of The Headquarter Staff* of our Army, the writer was given all the available data of former and recent levelings undertaken with the express purpose of ascertaining the changes, if any, of levels in the neighborhood of the volcano after the paroxysmal activity. The resurvey resulted in the affirmative, and more than that, the local disturbance was found to be confined within a circular tract having a theoretical radius of 61 km., conforming to that post-

---

1) An episode in Mr. Nankei Tachibana's 'Seiyûki' or *a Journey through Southern Japan*, a news item in the *Kagoshima Daily*, of October 18th, 1914.

2) The result was later published in a pamphlet with the title, 'The Crust-shifting and Relief Changes in Kagoshima Prefecture after the Eruption of Sakura-jima,' May, 1915, Tôkyô. The writer received it only at the end of 1915.

ulated by G. K. Gilbert<sup>1)</sup> to show the quantitative relation between local variation of depth of compensation and the resulting variation of gravity. The nature of the disturbance in the present case is expressed in the relief through the concentric settling of terrene in a cauldron-shape with a centre off the northern shore of Sakura-jima (Pl. XIII.).

The subsidence of the present area involves a problem of isostasy, caused directly by a mass defect produced in the out-pouring of lava of 3,012,240 million kilogrammes or 3,012 million metric tons (p. 108), besides an indefinite quantity of ejecta hurled up from the vents and distributed within a distance of more than 1,200 *km.* (to the northeast of Tōkyō).

H. Nagaoka, of the International Geodetic Committee, has made known in a series of Annual Reports the anomalies of gravity at Ôita, Nobéoka, and Myazaki on the eastern coast, and at Shibushi, Kagoshima, and Hitoyoshi on the south, and in the interior of southern Kyūshū, the former 3 with negative and the latter 3 with positive values. These sets<sup>2)</sup> of values show that the region has been, in general, out of isostatic equilibrium, and this has been accentuated by the recent effusion of lava at Sakura-jima, which lies, so it seems to the writer, on the borderland of positive and negative anomalies. The borderland is as a general rule apt to be subject to unbalanced stress accumulation, as in Central Japan, where the great earthquake of 1891 devastated the stretch between the towns of negative Gifu and positive Nagoya.

Assuming that the zone of compensation lies below 122 or

1) 'Interpretation of Anomalies of Gravity.' Prof. Paper 85 C. U. S. *Geol. Surv.*, 1913.

2)	Ôita	$g''_o - \gamma'_o$	-0.032	} East coast		Shibushi	$g''_o - \gamma'_o$	+0.034	} South and inland
	Nobéoka	"	-0.008			Kagoshima	"	+0.045	
	Myazaki	"	-0.029			Hitoyoshi	"	+0.000	

\*Ergebnisse der relativen Schwerkraftmessungen in Japan in den Jahren 1909-1911 und 1912.'

113.7 *km.*, Gilbert attributes the cause of gravity anomaly to variations in the vertical distribution of density. A local, but not regional, anomaly of defect, with which we are now concerned, means a defect above and excess below, the sum of both being the same everywhere at 122 *km.* The inequality adjusts itself by undertow or underflow in the zone of relative mobility which can originate in liquefaction near the surface as a consequence of reduction of density through faulting, and the mobility of the intercrustal layer further causes vulcanism.<sup>1)</sup>

A regional anomaly defect of mass is, however, supposed to be adjusted by undertow above, below or within the zone of compensation. According to Barrell<sup>2)</sup> the undertow is only possible below the zone in the asthenosphere or the zone of weakness.

Having traced the relations among undertow, mobile zone, diastrophism and finally vulcanism, we now turn to our subject proper.

CURVES OF  
EQUAL  
SUBSIDENCE

In the annexed Sketch-map, Pl. XIII., the 'curves of equal subsidence' were drawn approximately through the points of equal settling of terrene.<sup>3)</sup> To each point are attached the figures in millimetres reduced to the level of Tôkyô, which express the differences between the levelings done during 1892 to 1900 and the resurvey during July and August of 1914.

The writer has drawn ten curves, *viz.*, of 800, 700, 600, 500, 400, 300, 200, 150, 100, and 0 *mm.* The curves describe roughly concentric circles which are at first closely packed together near Cape Ôsaki at the north of Kagoshima, and there lies a maximum

1) Volcanoes usually make their appearance in the region of *mass defect* rather than in the compacted area.

2) *Jour. Geol.* Chicago, 1914.

3) A similar attempt has already been made by F. Omori in his recent papers. See *Bull. Imp. Earthq. Com.*, Vol. VIII. No. 1, p. 29, and 'The Tôyô-gakugei-Zasshi' (*The Oriental Science*), No. 402, March, 1915.

land depression of 894 *mm.*, while outer circles distend considerably westwards. The region embraces the plateau of Yoshino, 500 *m.* high. On the opposite eastern shore of the Bay of Kagoshima the circles are nearly equidistant, though mostly of schematic nature.

The outermost extension of disturbance from an hypothetic centre lies at a distance of 52 *km.* on the east, where the settling of level sinks to minimum with a negative value of -11 *mm.* which is within the bounds of observational error due to refraction. Outside of the above border, the values are rather high from unknown causes, though they run below -20 *mm.* The corresponding western limit cannot be fixed owing to the want of data at disposal; but the line probably passes beyond the land. From the above, we see that the outer limit of disturbance is not far away from the postulated boundary of local gravity anomaly assigned by G. K. Gilbert, that is to say 61 *km.*

As already stated elsewhere (pp. 57 and 99), the premonitory indications of recent vulcanism were signalized nine months before in a swarm of earthquakes in the Yoshimatsu region (55 *km.* distant) and the unusual activity of the neighboring Kirishima volcanoes. The hypocentre was later shifted southwards to Ijû-in, and at last the subterranean commotion was satisfied in finding vents in Sakura-jima. All the recent local subterranean agitations confine themselves within a boundary of about the postulated 61 *km.* from an hypothetic centre of depression in the Bay of Kagoshima. See Pl. XIII.

MINO-OWARI  
EARTH-  
QUAKES OF  
1891

In this connection, a few words may be said of the great earthquake of Central Japan in 1891. The result of renewed levelings by The Headquarter Staff soon after the event showed the radius of disturbance in the Mino-Owari

plain to be 70 *km.*, while in the present area it is about 52 *km.*, the maximal positive and negative warpings in 1891 being 767 and 308 *mm.* respectively. Perhaps these values of radii indicate the limit of sustainment of local *competent structure* of the earth's supercrust.

Abnormal cases of the curves of equal subsidence in the present area are not rare. The flat-topped headland of Sakkabira, 325 *m.* high, facing the buried strait of Séto, is crowded with 3 curves (-700, -600, and -500 *mm.*) of high value (*see* Sketch-map, Pl. XIII.). The lapilli-laden top sunk down in step-fault toward the island of Sakura-jima. On the southwest slope of the island, the *bench marks* with -900, -800, and -800 *mm.* may be attributable to *slips of terrene* when the ground shook with intense successory motion.<sup>1)</sup> One point (bench mark No. 21) on the north-west slope is extraordinary in its being *raised* 2100 *mm.* from the former level, and this is the only point which made positive movement, and moreover of very high value.

The last and the greatest subsidence of 1,700 *mm.* occurred at Shira-hama on the northern shore of the island (*see* Sketch-map Pl. XIII.). On the island of Hêda-Kojima near the opposite shore, a negative value of 1,000 *mm.* was measured. Between the last two, and 3 *km.* off shore from Shira-hama, taken in conjunction

---

1) The tilting of a portion of volcanic cone during the activity seems to be not very rare, one instance being in Hawaii in 1868. Fault-slips along *peripheral* and *radial* fractures of a volcano happened during, or as a cause of the great Hawaiian earthquakes of 1868. Evidences collected by H. O. Wood seem to show that they were tectonic, rather than volcanic, earthquakes. That the disturbed area was about 375,000 sq. miles, points to the fact that the depth of origin must have been considerable, and that it gave rise to important oceanic sea waves. *Bull. Seis. Soc. America*, Vol. IV, 1914.

In passing, it may be mentioned that the destructive volcanic earthquakes of Sakura-jima on January 12th, 1914, were recorded in Tôkyô (1,000 *km.*), and in Laibach in Austria. *Nature*, 1914. The writer has been long since inclined to think that the volcanic and tectonic earthquakes are by no means easy to separate. We must now take into consideration the crypto-volcanic earthquakes which may eventually cause subaërial volcanic manifestations.



with the high negative value at Cape Ôsaki ( $-894$ ), there lies amidst the Bay of Kagoshima an hypothetical and geometrical centre (marked with a cross, x, in Pl. XIII.) around which the lines of equal subsidence describe concentric circles with a radius of  $52\text{ km}$ . The point is presumably the maximal locus of subsidence, which can only be proved by later soundings.

CAUSE OF  
SUBSIDENCE

The hot mobile layer or O. AMPFERER'S under-current<sup>1)</sup> was forced up under hydrostatic pressure through the vents in Sakura-jima in the form of 'live' lava, and *the cold heavy crust sunk down to compensate the mass defect*, which produced on the surface the effect in the form of a kettle-shaped depression.

That the negative movement of terrene has not yet come to a standstill, but is still progressing downwards, can be unequivocally proved by the differences of values from the *first* and the *second* recent levelings. The first was performed during July and August, 1914, and the second during February, 1915. From the values of the second levelings given on bench marks (*see* Pl. XIII.), we find where the high values obtained in the first are correspondingly high in the second. The maximum depression<sup>2)</sup> of bay shore at Cape Ôsaki with  $-894\text{ mm}$ . is now augmented by  $-055\text{ mm}$ . during an interval of 215 days, the hypothetic centre still remaining in the same locus.

Should the settling continue in the same fashion in the near

1) 'Ueber das Bewegungsbild von Faltengebirge.' *Jahrb. d. k. k. Geol. Reichsanstalt*, Vol. 56, 1906.

Modern views on the formation of mountains based on the Pratt-Hayford principle of isostasy are at present widely discussed in various scientific publications, and the general tendency on this line of study is concisely depicted in K. André's 'Ueber die Bedingungen der Gebirgsbildung,' Berlin, 1914.

2) For instance,  $-(055)$  expressed in the term of *mm*. affixed to the former value  $-894\text{ mm}$ . at Cape Ôsaki. See Pl. XIII.

future, the outstanding plateau of Yoshino will be *warped up and down* in consequence of the *overthrust* of the surface crust toward the ever sinking centre of depression.

So far we have been concerned with the *vertical elements* of crustal movement, we now turn to the *horizontal*. Comparisons of longitude and latitude measurement of bench marks disclose a considerable discrepancy in the values of earlier and recent dates. Assuming the triangulation base, Order II. A-G in Map, Pl. XIII. as permanent and unaltered, the new geographic positions of bench marks are calculated from actual observations in relation to the neighboring fixed triangulation base, as in Table.

No.	X	Y	Resultant	Direction of Shifting
1	+0.44	+0.42	0.61	N. 44° E.
2	+0.27	+0.48	0.55	N. 61° E.
3	+0.05	-0.02	0.05	N. 21° W.
4	+0.16	+0.63	0.65	N. 75° E.
5	+0.34	+0.89	0.95	N. 69° E.
6	+0.06	+0.36	0.36	N. 80° E.
7	-0.14	+0.79	0.80	S. 80° E.
8	-0.08	+0.27	0.28	S. 74° E.
9	-0.52	-0.09	0.53	S. 10° W.
10	-0.10	-0.09	0.13	S. 42° W.
11	+0.02	+0.01	0.02	N. 25° E.
12	+0.06	+0.12	0.13	N. 64° E.
13	+0.30	+0.15	0.33	N. 27° E.
14	-0.02	+0.14	0.14	S. 82° E.
15	+0.06	+0.32	0.32	N. 80° E.
16	+0.12	+0.18	0.21	N. 56° E.
17	-3.07	-0.08	3.07	S. 2° W.
18	-3.48	-0.97	3.62	S. 15° W.
19	-1.88	-0.80	2.03	S. 23° W.
20	+1.08	-0.06	1.08	N. 4° W.
21	+4.49	+0.56	<b>4.55</b>	N. 7° E.
22	+2.37	+1.11	2.61	N. 25° E.

The **X** signifies meridian direction, the **Y** that of parallels. Nos. 1-22, affixed on the upper left-hand of the triangles in Pl. XIII. mark the positions and the numbers of the bench marks.

From the new values of longitude and latitude, X and Y, the resultants are graphically estimated which express the directions and relative measure of horizontal shifting of ground on the position of bench marks, as shown with arrowheads on Map, Pl. XIII. An inspection of arrowheads shows that they also point at the hypothetic centre of subsidence within the Bay of Kagoshima, only Nos. 17, 18 and 19 on the southwest slope<sup>1)</sup> of Sakura-jima, however, point at the opposite direction, and those on the high flat of Sakkabira on the southeast are directed toward a secondary centre near the bench mark No. 12. The writer cannot give any adequate explanation on these apparent anomalies.

In *summarizing* what is stated above, our Headquarter Staff did good service in the cause of science in laboriously working out the actual occurrence of both the vertical negative movement of the crust and the horizontal shifting of geographic elements around and in Sakura-jima after its paroxysmal eruption.

A novel feature on vulcanology was brought to light in the concentric circle of equal subsidence and the horizontal shifting of ground toward a common centre in the bottom of the Bay of Kagoshima, where the maximum subsidence of the crust is to be expected. These movements may well be explained as a local disturbance of the lithosphere on the principle of isostasy. Gilbert (p. 129) postulated the radius of local disturbance of gravity anomalies to be 61 *km.*, and these anomalies arise from irregular vertical distribution of density with a defect above and excess below, all above the zone of compensation at 122 *km.* The inequality is adjusted by the undertow of a shallow layer made mobile

---

1) The abnormal shifting of bench marks seems to the writer to be due to the tilting and slipping of a portion of mountain mass through the shocks given by volcanic spasms. The same explanation can be applied to the bench mark No 21. See p. 132.

by reduction of density as a consequence of crustal dislocation. The undercurrent so started finally causes *vulcanism*.

The limit of the subsiding area in the present case is at a radial distance of 52 *km.*, while in the Mino-Owari plain at the time of the earthquake of 1891 it was 70 *km.*, approaching in both cases the postulated limit of local disturbance of gravity anomalies. The premonitory wandering earthquakes of Yoshimatsu and Ijû-in, and the unwonted activity of the Kirishima volcanoes for nine months prior to the Sakura-jima eruption all happened in the locally disturbed area within the prescribed radius. (*see Premonitory Symptoms*, p. 99).

A few points escaped the notice of the writers on the recent eruption, which ought not to be passed over without comment.

First of all, it is to be remarked that during the destructive earthquake on January 12th, 6,39 P.M., the first day of eruption, a solid basalt cliff, 400 *m.* high, collapsed near Cape Ôsaki (*see* Map, Pl. XIII.), where the railway track and telegraph posts were heavily damaged. All communication with the outer world was then cut off and caused a rumor to spread all round the globe that the city of Kagoshima was buried under lava (p. 70). It seems evident to the writer that the accident was not merely due to gravity, but the actual tossing of the subsiding ground induced the heavy slip of the cliff. As it will be remembered, Ôsaki is the spot of maximal subsidence on the land side, amounting to 894 *mm.*

Simultaneously with the landslump, the village Gamô, 12 *km.* northwest from Cape Ôsaki, was strongly shaken, causing collapse of bridges and cracking of house walls, besides gushing of groundwater from fissures many *cho* (1 *cho*=109 *m*) in length. Cape Ôsaki is an edge of the Yoshino plateau, and Gamô lies on the

northern foot of the latter. The region as a whole is unstable and settling at a rapid rate.

Lastly, Mr. Kazuno, the efficient director of the meteorological observatory of Kagoshima, warned people up to the very moment of eruption that the epicentre of the incessant earthquakes was in the above-mentioned flat of Yoshino (Geologic Map). This the seismometer indicated to him and he kept persistently and boldly to his assertion, though the public would not believe him. Finally, the excited people of the afflicted Kagoshima region spread malignant gossip about him without cause. As will be seen on the Geologic Map, the Yoshino plateau is an uncompensated area constantly sinking down to adjust local equilibrium. The crypto-volcanic earthquakes of the Sakura-jima eruption may have strongly agitated the Yoshino plateau, as his reliable seismometer led him to believe.

We are now enabled to approach a step further *in tracing the cause and effect of the local isostatic vulcanism*, displayed at Sakura-jima in the escape of gases and extravasation of lava of 3,012 million tons and an indefinite quantity of ejecta, in the geologic rift-valley bay of Kagoshima.

**viii. The Ventholes.**—All the scientists, home as well as foreign, who were in the field and studied the nature of the district, came to the inevitable conclusion that the lava effusion of 1779 on the southwestern and northeastern flanks of Sakura-jima occurred along the fracture that runs through from Kirishima to the volcanic chain of Ryūkyū, and the recent vents lie on a line which cuts the former at right-angles. (*See Geologic Map and Text-fig. 10 c.*) What is stated above well agrees with the current dogma that volcanoes sit upon the intersecting point of tectonic lines, as we are accustomed to find delineated on maps of Ischia, Krakatoa, and Hawaii.

The writer was probably the first amongst specialists, if he may be called so, who hurried to the scene and viewed the front or west side of the grand volcanic display, without being able to come to any definite idea as to the relation of vents and geologic structure; but on seeing the lineal arrangement (Text-fig. 19; Pl. XI. Figs. 1-2) of bocche on the rear, the Nabéyama side, the writer immediately conceived the existence of a mountain fracture extending on both flanks of the volcano.

During preliminary work to learn the distribution of the various lava flows, both ancient and historic, and also the history of the building-up of the volcano of Sakura-jima, the writer's view, however, became somewhat modified. Though apparently a simple overtowering konide, Sakura-jima is really a triple one, piled on the shoulder one after the other in a meridional direction in the order from the north top, then the south, and finally the middle (Text-fig. 8, and Pl. III. Fig. 2).

The constructive mature age of vulcanicity having passed away, the declining period of pericentric flank eruptions was ushered in in historic times, when lava poured forth around and outside of top-craters all round the slope after the fashion of the petals of a flower, firmly sheeting the old composite konide with a lava coat of mail.

There are, however, portions of the slope still remaining free of lava flows (Geologic Map), and these intervening gaps—*the positions of comparative weakness in the superstructure of the volcano—were selected for the effusion of hot magma in the recent eruption.* Moreover, the positions of vents lie at the overlapping junction-line of the north and the south cones which are the dominant topographic elements of the composite triple konide of Sakura-jima.

The preëxistence of a transverse fracture is universally ad-

mitted and cited on the fact of the presence of the parasitic volcanoes of the Nabé-yama homate on the east, and the Hikino-hira dome and the Hakama-goshi patch, besides the lava-drowned Karasu-jima on the west, on the supposed tectonic line (Text-fig. 19.)

This argument is *not at all convincing* to the writer, as the four masses differ in age and are heterogeneous in their origin. The writer admits the fact that the first is a true parasitic cone; but the nature of the second,—the Hikino-hira monadnock, is not yet thoroughly established beyond doubt. It may be a volcanic plug or a remnant of an edge of old disrupted slope, the rock being identical with that of the north cone. The third,—the Hakama-goshi patch, is a geologic block of sedimentary complex, dislodged from the plateau of Kagoshima (p. 25), and lastly, the fourth is a patch of ancient lava cap that covers the third (p. 26).

In short, the writer is not in full accord with the view expressed to the effect that the series of ventholes or bocche are located on a traverse tectonic line in the **fundamental** structure of the region.

---

There are a number of ventholes both in the front and the rear sides of Sakura-jima, of which some are only of ephemeral character (*see* p. 74, Text-fig. 19).

VENTHOLES  
ON THE  
WEST

We can count 5 lava vents on the *front* (west) side, and the one marked with a small circle is a mere epigonic blow-hole located on the edge of settling ground (Text-fig. 27, and a small cross, x. in fissured terraces in background of Pls. XIV–XV.) in consequence of the defect of mass which escaped in the form of fluent lava. No. 1 (Text-fig. 19) at the north of the roundheaded Hikino-hira is a comparatively insignificant lava orifice, 30 *m.* deep, which might have been very

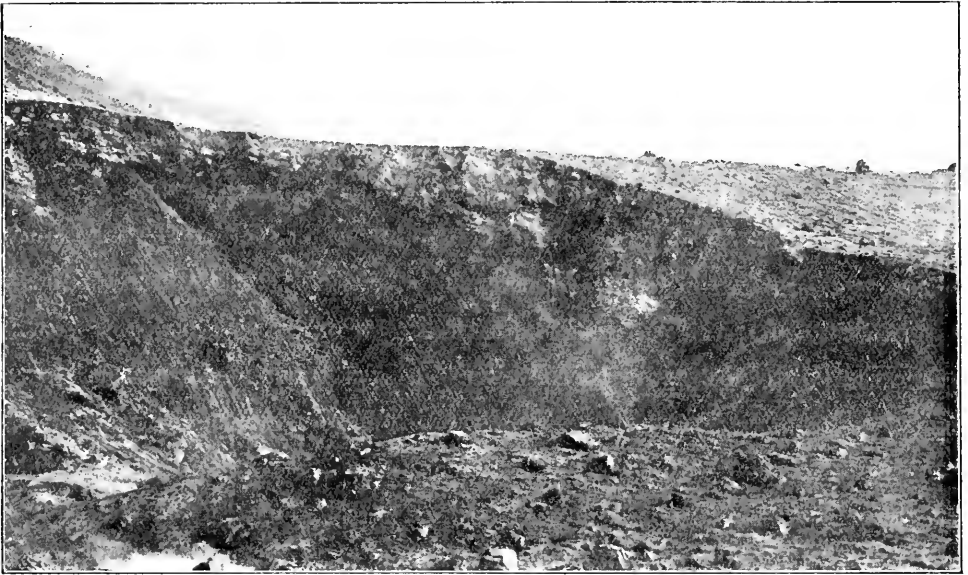

Fig. 27.—Blow-hole above No. 1 venthole in the western lava-field, marked with a cross in Pl. XV. (Photo by Mr. Yamaguchi.)

active during the first phase. It is Daubrée's diatreme hole from one end of which lava flowed downwards (Pl. XV. No. 1).

No. 2—the Yuno-hira vent—is the giant of orifice at an altitude of 300 *m.* and really entitled to the name of crater. It was formerly a hollow alongside the upper limit of a cultivated gentle slope below the western precipice of the north cone, as may be seen in various photographic views prior to the eruption. Already for a score of years, weak *jets of steam* have been issuing there from fissures in the ground. This time it engulfed a considerable hollow from which the lava shield rose (*see* Text-fig. 28) like a 'Schollendom'<sup>1)</sup> in Kilauea,<sup>2)</sup> and fluent lava broke through and forced its way down the slope (Pls. XIV.—XV.) pouring forth nearly the whole

1) The type of the eruption at Yuno-hira is exactly like that of Santorin in 1866 when a dome was there first formed, but the lava (hypersthene-andesite) finally burst out the side as a flow.—F. Fonqué, 'Santorin et ses eruption,' Paris, 1879.

2) F. A. Perret, 'Some Kilauean Formations.' *Amer. Jour. Sci.*, 1913, p. 154.





Fig. 28.—Lava-shield of the Yuno-hira vent, viewed southwestwards from the western slope of the North Cone.  
(Photo taken on Jan. 19th, 11 A.M., 1914.)

mass of the western lava stream, which deployed in its downward course like the finger of a hand and finally plunged into the sea (Pl. XII. Fig. 3).

Nos. 3 (?) and 5 (*see* p. 74, Text-fig. 19) are probably secondary spatter vents broken open from the undercurrent of lava stream under solidified shell. Whether No. 4 is a primary or secondary vent is not clear to the writer, the balance being in favor of the former, which is probably connected with No. 2 in its deep source.

Generally speaking, the western vents are rather irregularly

scattered and the paroxysmal activity was concentrated in No. 2—the Yuno-hira crater.

VENTHOLES  
ON THE  
EAST

The *rear*, eastern ventholes, in contrast to the irregular distribution of the western, are arranged in *straight* line (*see* Sketch-map, Text-fig. 19) irrespective of topography, from northwest by west to southeast by east. This distinct alignment of orifices marks the trend and location of fracture in the **superstructure** of the volcano, and apparently justifies the hypothesis on the existence of a tectonic line in that direction through the whole mountain. During the first phase, the sight of the glare at night observed by the writer was a splendid one. When one of the vents, either No. 3 or 4, made an outburst, the rest readily followed and sympathized with the forerunner together with minor vents, and the general awakening of fiery torches ensued one after another, finally fusing together in the form of a carmine-red wall<sup>1)</sup> of hellish blaze, as if hot lava was running along and underneath the fracture line (Text-fig. 14 [c]).

Comparing the position of orifices noted during two trips, one in January, 1914, the other in April of the same year, some changes had occurred (Text-fig. 19); No. 1 and those marked with small circles on the southern slope of Nabé-yama had been rather active during the first phase, though they later became dormant. The order of their birth according to the writer's opinion was as follows :

The activity started with the lava-flow at No. 1 (Text-fig. 19), the Sen-yemon recess popularly so called, which soon became exhausted, and then shifted to No. 2, and the one near by (not indicated in Text-fig. 19) was a contemporary. Nos. 3 (250 *m*) and 4 then followed, and displayed vulcanicity on a grand scale with

1) A continuous glare appeared before the outwelling of fluent lava.



Fig. 29.—Activity of No. 5 vent on the slope of Nabé-yama, as seen southwestwards from the Ebino-zuka hill. (Photo taken on May 17th, 1914.)

brotherly sympathy when the writer was there in April, 1915. On the second visit (in April, 1914), the writer saw, greatly to his surprise, a gaping fracture opened between Nos. 4 and 5 on the southern shoulder of the pumiceous Nabé-yama homate (Pl. XI. Figs. 1 and 2), and two tongues of lava ran down northwards. No. 5 was a peculiar epigonic lava venthole (Text-figs. 19 and 24), habitually standing in apathy to the others and remaining silent for long hours, spasmodically awaking with extraordinary violence and sharp detonations. During the writer's second trip, this bocca was active once a day, and was the most treacherous and dangerous one to approach (Text-fig. 29).

activity (p. 137); therefore he betakes himself to the realm of imagination. While in the field he was frequently reminded of the hypothesis of satellitic injection with which Daly<sup>1)</sup> explains the indifferent behavior of Kilauea and Loa.

In Sakura-jima it was, however, **bilateral satellitic injection** (Text-fig. 30). For the duration of a full twelve months before the event at Sakura-jima, subterranean agitations, expressed in the earthquakes and the unusual attitude of the volcano Kirishima, were felt in southern Kyūshū, to release the strain from an unstable isostatic equilibrium of the earth's supercrust. Lastly, a point of release was discovered in the old crater conduit of the south cone of Sakura-jima.

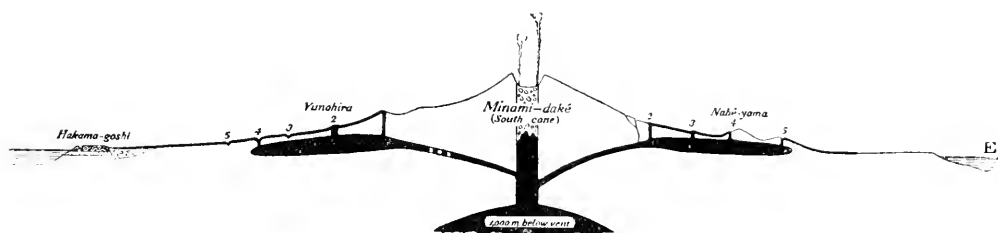

Fig. 30.—Bilateral injection-chamber in Sakura-jima.  
(Horizontal and vertical relief in natural scale).

Wolff (*loc. cit.*) says the local lava reservoir lies about 1,000 *m.* from vent (Text-fig. 30), and on this assumption the lava basin of Sakura-jima will be reached at 700 *m.* below sea level. Driven up by hydrostatic pressure in conjunction with the liberation of gases which would have increased internal pressure and consequently adiabatic heat, besides that of new chemical recombination, the lava ascended through channels up to half the height of the volcano by stoping, melting and gas-fluxing. Being unable to

1) 'The Nature of Volcanic Action.' *Proc. Am. Acad. of Arts and Sciences*, Vol. 47, July, 1911. His diagram is inserted in Wolff, 'Der Vulkanismus,' Bd. I, S. 336. In Daly's own later work, 'Igneous Rocks and Their Origin,' it is not reproduced.

overcome the burden of the higher part of the crater bottom, the magma sought easy and short ways of escape to the surface, where the mountain flanks remained yet uncovered with a lava coat of mail. The naked slopes on both sides, the only weak portions of the whole mountain side, gave opportunity for the sites of surface activity by means of two series of ventholes, one on the front, the other on the rear. *See* Text-fig. 30.

The ventholes were not in direct communication with the local main reservoir, but only indirectly, where lavas were injected sideways<sup>1)</sup> through narrow and long passages from the main conduit of the top-crater. It is the *satellitic injection chamber*, and there were two of them which fed one or a number of vents overlying them, and in turn were fed from the main channel. The vents were mere openings of secondary injection chambers through a thin skin of rock-crust which separated them.

That the satellitic chambers were supported with magma from the main channel is evident from the fact, that at the beginning of the activity threads of steam clouds ascended from the top-crater (Text-fig. 14 *a* [1]), which signalized the immediate explosion on the western flank [2] and ten minutes later on the eastern (Text-fig. 14 *b* [3]). While the lava made its way through melting up the crater conduit, partial gravitative differentiation took place, whereby the lower column of lava changed in its chemical nature to a heavy and basic one, and this lower column reinforced the satellitic chamber of Nabé-yama (Text-fig. 30). The fluent lava of the east therefore consolidated to an olivine-bearing heavy and basic rock, while that of the west solidified usually without the above-mentioned mineral component.

---

1) It is the *subnormal eruption* in the sense in which Perret understands such a mode of subterranean lateral flow of lava.

ix. **The Spatter Eruptions and the Formation of Domes.**—The writer will say a few words on what he calls the *spatter eruptions*, a sort of Strombolian type, at the main vent of Yuno-hira on the western slope (Text-fig. 19, No. 2)—a scene described by Azuma<sup>1)</sup> on January 22nd.<sup>2)</sup> It was the actual scene on the 11th day after the first eruption. The crater pit was wide open and choked up with black vesiculated crust. A rent suddenly opened at one spot, and no sooner did the red tongue appear therefrom than a tremendous cannonading took place. Then a black curdy smoke (dust cloud) ascended, throwing up black lustrous fragments of floating crust to a considerable height, which mostly fell again to the crater-bottom. The act was finished by emission of white (salmiac) fumes. After 3 or 4 minutes the same manifestation was repeated at another spot within the same crater.

These spatter eruptions explain all the phenomena, seen from a distance, of the volcanic display since the 13th of January, and the writer believes this is the *pattern of activity of the volcanoes of andesitic magma*.

The above-mentioned Yuno-hira vent<sup>3)</sup> also presents some remarkable features of uncommon interest. The venthole is of large dimensions, having really a claim to be named a crater. It is the main orifice which supplied nearly all the lavas of the

---

1) K. Azuma, 'The Great Eruptions at Sakura-jima in 1914,' Kagoshima, 1914, p. 92. (Japanese)

2) See p. 87.

3) The above is Azuma's account of an adventurous attempt in peeping into the interior of the new active crater-pit No. 2 in Geologic Map and also Sketch-map, Fig. 19. This is a valuable contribution to the present paper; for, what he has done is exactly that which the writer wished to have done. Azuma was the first who made such an undertaking, which is often attended with risk. One investigator was mortally wounded by falling hot blocks at the cracking lava-front, and two others by unexpected explosions, one of them being the well-known vulcanologist, F. A. Perret. We have a 'Report' from the pen of the American vulcanologist, 'Rapporto preliminare sulla grande eruption del vulcano Sakurashima.' *Zeitschr. f. Vulkanologie*, Bd. I. p. 133 *et. seq.*

western field occupying an area of 7.202 sq. *km.* with volume of 0.2881 cub. *km.* (p. 107). See Sketch-map, Text-fig. 19.

At the western slope of the North Cone between the knob of Hikino-hira and the parasitic cone of Furuhata, there was a cultivated talus slope at the upper limit, at about an altitude of 300 *m.*, and there are a few ancient vents, one of which being the Yuno-hira, as may be seen on Map and in all the pictures of the western side. The Hikino-hira and Furuhata lavas are scars left from old wounds and the spots mark the weak portions of the old volcanic body.

The slope between them is entirely changed in relief, a large cauldron having been formed with a margin of concentric terraces, each separated by gaping and fuming lines of fissures,<sup>1)</sup> as can be distinctly seen in the background of the pictures in Pls. XIV.–XV. Then from the engulfed and collapsed bottom rose a gigantic ‘live’ dome, not unlike those of Tarumai of Japan and Bogosloff of the Aleutian Islands. An excellent view of the smooth, bulging dome of lava from the north side in Text-fig. 28, taken 7 days after its birth, can tell the story better than words can depict. On seeing the successive slipping on the background of the figures in Pls. XIV.–XV. it soon suggested to the mind, that the solid ground was stoped and assimilated by ascending lava underneath, and the syntectic magma so formed contributed to the substance of the outwelled cupola.<sup>2)</sup>

1) In a verbal communication by Prof. F. Ômori, who visited the region in April, 1915, fifteen months after the spasm, he said that he had actually seen within one of the gaping fissures here cited, a still fresh *red-hot lava-tongue* about 15 feet below. His important observation gives weighty corroborative evidence in support of the writer's assertion that the lava in the local reservoir either stoped or assimilated the wall upwards, leaving only a thin margin of old surficial crust. Or, it may be assumed that the ramifying lava tongues simply ran into open fissures from a local reservoir by hydrostatic pressure.

2) It is not unlike Daly's "foundering" eruption. He says this type of eruption is conditioned by stoping and assimilation of batholithic magma, but in the present case we have before us the melting of the thin roof of a satellitic chamber.

The ephemeral dome was then ruptured on its southwest side through the expansion of lava and the pressure of the enclosed gases, leaving behind the hoof-shaped carcass of the dome, as may be seen in Plate XIV. on the left and the train of lava-flows from the ruptured side on the right in Plate XV. It was in the interior where Azuma observed the spattering eruption already referred to (p. 146). After the lapse of a year the feature of the Yuno-hira vent had entirely changed, the ephemeral dome had disappeared, as may be seen in the foreground of the picture in Pl. XII. Fig. 3.

---

In April, 1914, on his second trip the writer had a good opportunity of observing the process in detail from an isolated hill-top of Yebino-zuka near Kurokami on the east coast, when the vent No. 5 made a forcible outburst without warning but with tremendous detonation (Text-fig. 29), throwing up dark curdy smoke and grains of juvenile lava-crust. When the act was accomplished, the lava gushed out down the slope with clinking as if a viscous fluid was pumped out with one stroke, often from a *special lateral opening* a little below the main vent, as may be seen in some of the Nabé-yama vents.

The process seems to be as follows: The pent-up gases within the vent break open the plug or solidified skin of lava at the upper end of the conduit, resulting in the release of pressure in the column of lava. The occluded gases and steam then expand and cool the magma which in turn becomes viscous. The liberation of gaseous bodies in the magma in consequence of relief of pressure tends to let gases free from the viscous body, causing thereby an increase of the volume of foaming, puffing and spattering lava, and at the same time forcing up the upper lava column.



This is the cause of the outwelling of it from the orifice (Text-fig. 29). It is a *primary* lava-flow.

**x. Sublimation-products.**—The activity manifested by numerous volcanoes in Japan is usually of the explosive type, and we rarely have occasion to collect the manifold products of sublimation as in the case of the recent eruptions of Sakura-jima, when fluent lava copiously effused from a series of vents. In saying so, it does not seem to agree with the fact that fumaroles and solfataras are by no means rare in this country; but these mostly represent the last feeble stage of vulcanicity, and the sublimes deposited are of oxidized and decomposition-products of low temperatures, corresponding either to the sulphureted-hydrogen fumarolic or to the solfataric activity ( $100^{\circ}$ – $200^{\circ}$ C.), and consequently, meagre in variety.

During his second visit, in April, 1914, the writer was able to approach the margin and also the solidified but still very hot lava-flows at many points. The clefts in the ancient lava near the Yuno-hira venthole were seen richly incrustated, exclusively with needles of bright yellow sulphur—the direct *crateral* sublimate from the lava reservoir, while at the edge of the lava stream, away from the vent, the dominant deposits were variegated *lava-*  
LAVA  
SUBLIMATES sublimes incrustating the ragged holes of ‘block’ lava.

The latter are of special interest to us, as we could not yet approach the lava mass within the vent itself. The incrustation consists of (a) a loose aggregate of white salmiac crystals, superposed by (b) the yellow crystalline layer of another mineral on irregular prominences, and lastly, by (c) the deep orange-red crystal aggregate on tips, as in the first snow on mountain-tops in early autumn.

Unfortunately, a fine collection made on the spot has now

become useless for microscopic and chemical studies, as most of the sublimates are deliquescent, and intermixed with intricate aggregates.

(a) The main mass of the above incrustation is composed of salmiac,  $NH_4Cl$ , in the form of rhombic dodecahedrons, sometimes flattened on the face (110).<sup>1)</sup> The dodecahedrons were picked out, dissolved in water to remove solid impurities, and then evaporated to a white mass. This was analysed by Mr. Y. YOSHIMATSU and Assist. Professor Y. SHIBATA of our University, giving 99.60% of  $NH_4Cl$ , besides a slight trace of  $Fe$ . The writer dissolved the same dodecahedrons in water and allowed the solution to evaporate on an object glass. Under the microscope the preparation proved to be skeletal crystals of salmiac, besides a number of characteristic rhomboid tablets of gypsum crystals. The gypsum is a never-failing compound in volcanic exhalation.

(b) The yellow or orange-colored aggregate may be hexagonal molysite,  $FeCl_3$ ; or rhombic erythrosiderite,  $2KCl \cdot FeCl_3 \cdot H_2O$ .

(c) The ruby-red tip-aggregate may possibly be octahedral kremersite,  $KCl \cdot NH_4Cl \cdot FeCl_3 + H_2O$ .

---

Y. SHIBATA made qualitative tests on a specimen sent to the writer from Kagoshima. A mass of sublimates, found as incrustations on a slaggy lava, is a white crystalline aggregate of gypsum, as can be readily recognized under the microscope, with a yellow coating. The other compounds were found to be the following :

i. The solution extracted in water contains a small quantity of  $NH_4Cl$ , besides  $SO_2$  and a trace of  $Cl$ .

ii. Treated with hot aqua regia, the solution shows the presence of  $Ca$ ,  $Mg$ ,  $Fe$  (trace) and  $K_2SO_4$ .

---

1) M. MISAWA, *Jour. Geol. Soc. Tôkyô*, p. 96, 1916.

iii. The aqueous solution after fusion with an alkaline carbonate shows the presence of  $Al_2O_3$  and  $SiO_2$ , with a trace of  $Fe$  and  $Mn$ .

The sublimates are composed of, enumerated in the order of quantity, firstly,  $CaSO_4 + 2H_2O$ , then  $NH_4Cl$ ,  $MgSO_4$  and lastly, free  $SO_3$ .

The so-called rock salt with a saline taste, which thinly coats the block lava, was dissolved in water and evaporated. Abundant crystals of gypsum in flat rhomboid tablets and dirty cubes of (?) rock salt constitute the dry preparation.

M. KANAI found in a qualitative test made in fresh sublimation-products the following minerals with relative quantities in the order mentioned below: Salmiac,  $NH_4Cl$ ; kalinite,  $KAl(SO_4)_2 \cdot 12H_2O$ ; molysite,  $FeCl_3$ ; chloraluminite,  $AlCl_3 \cdot 6H_2O$ ; rock salt,  $NaCl$ ; iron-alum,  $FeSO_4 \cdot Al_2(SO_4)_3 \cdot 24H_2O$ .

SUMMARY To summarize what is stated on these scanty data, the most dominant elements of the products of volcanic exhalation are undoubtedly salmiac and primary gypsum,<sup>1)</sup> besides sulphur. The cauliflower-shaped so-called steam column ascending from the vents and also the white fumes emitted by fluent lava streams can be reasonably attributed to the presence of abundant salmiac fumes (p. 67, footnote).

1) Here it is meant that the gypsum is a direct product of exhalation.

### Part III. Petrography.<sup>1)</sup>

#### § I. The Lavas of the Pre-historic Cones.

##### A. The Lavas of Kita-daké.

a) **Topographic Features.**—As it has been stated already (p. 35), Kita-daké or the ‘north cone,’ which carries the apical crater of Mihachi, 1,037 *m.*, constitutes alone the main structure of Sakurajima, making up the highest cone and occupying nearly the whole base of the island. See Geologic Map. At later times several lateral flows and subaërial talus, together with pluvial fans, only slightly contributed to the peripheral expansion which is at present about 4 *km.* in basal diameters. That the *Kita-daké lava* is the principal building material can be confidently affirmed by tracing the occurrences of the same rock nearly through all parts of the island, although later flows hide and obscure exposures, especially on the eastern slope.

NORTHERN  
SLOPE *Northern Slope.*—A complete exposure (Geologic Map, *n*) from top to shore can be traced on the northern slope, terminating at the point of Wari-ishi-Saki. It is the *Uno-kami*<sup>2)</sup> flow. There is a lava-shelf or terrace at an altitude of from 200 to 300 *m.* on the slope, formed by stemming of subsequent flows of magma.

The adjacent eastern area is now under the lava sheet of 1779–’80, while the western is overlaid by the lava apron (*nk*) of Kabano.<sup>3)</sup> On the eastern skirt of the latter there are two narrow

1) The characterization of rocks under the present heading is merely of preliminary qualitative nature, detailed quantitative study being out of question at the present moment.

2) 宇ノ上

3) See *postea*, p. 158.

and dry channels through which torrents carrying pumice and ash once rushed down to the coastal villages. It is known as *Yama-shiwo* or mountain-tide of the Matsura gulch (Matsura-gawara on Geologic Map)—the scars left from excavation in 1779 (p. 40). The ravines lie petrographically in a weak line, being the margin of the Kabano lava; and one finds in the bottom of the channel good exposures of slag-agglomerate and cap-sheet of the Kabano lava (p. 158). There is still another double gulch of minor size, lying to the northeast of the former, known as the Futamata gulch (*see* Map).

WESTERN  
SLOPE

*Western Slope.*—The lava exposed on this side appears firstly in the form of a parasitic cone—the volcanello of Furuhata<sup>1)</sup> (Geologic Map, *n f*), and secondly, in a patch at Atago-yama (*n*), and thirdly, in a ravine of Ôgawara (*n*). The space between the first and the second is overflowed by the recent lava, while that of the second and the third by the Ôhira lava (*oh*) of 1749. In passing, it may be remarked that the pointed cliffs on the upper reach, called *hasami* or the ‘scissors,’ slid down in avalanche in the deep gulch of Hasé in the early morning of January 12th, the result of constant tremblings of the ground, and the slips were mistaken for the eruption, although the actual eruption began only about 10 A.M. of that day.

On the cliff that bounds the deep gulch of the above-mentioned Hasé valley (Mizu-otoshi in Geologic Map), strong *agglomerate* beds<sup>2)</sup>

1) 古畑 (三本頭) The volcanello of Furuhata is an ancient adventitious tholoide of the North Cone, to which it is genetically related in the nature of the magma. Once a wide open crater of the rheumatitic lava is still to be seen in the form of a fragment of wall, named Yunohira (Text-fig. 31, *r*), and a new low collapsed lava-dome (*r*) sits upon its western flank, which received the name of Furuhata. On the top (Sambongachi), there were three holes, constantly emitting lukewarm gases, only one of them still surviving after the recent paroxysm.

2) The cliff-profile shows the structure, beginning with  $\alpha$ ) the pumiceous ejecta and pumiceous lava, followed above by  $\beta$ ) the block bed with ashes, the whole being capped with  $\gamma$ ) the lava-sheet. The total thickness amounts to 300 *m.*, and the entire complex is built of the characteristic light-colored Kita-daké rock.

are, according to UYÉDA and YAMAGUCHI, found exposed from under the lava-sheet (100 *m.* thick) of the North Cone. From this important find it is evident, that the first phase of the activity of the Sakura-jima volcano was explosive, followed later by the outpourings of the rheumatitic material which built up the apparent tholoide (though really konide) of the present North Cone.

The above-mentioned Atago-yama of dubious origin is a geologic island left untouched by the recent lava-flows (Geologic Map). The patch (*n*) of the Ôgawara gulch is the inlier or *fenster* exposed through erosion from under the lava of the south cone. The recent ejecta of rock of this type (the north cone type) were found largely intermixed with the juvenile lavas on the western slope.

The *volcanic plug* (?) of *Iikino-hira* (Hyoku-oka).—A hornito-like boss elevates itself on the western slope to a considerable height (553 *m.*), though the northeast edge blends upwards with

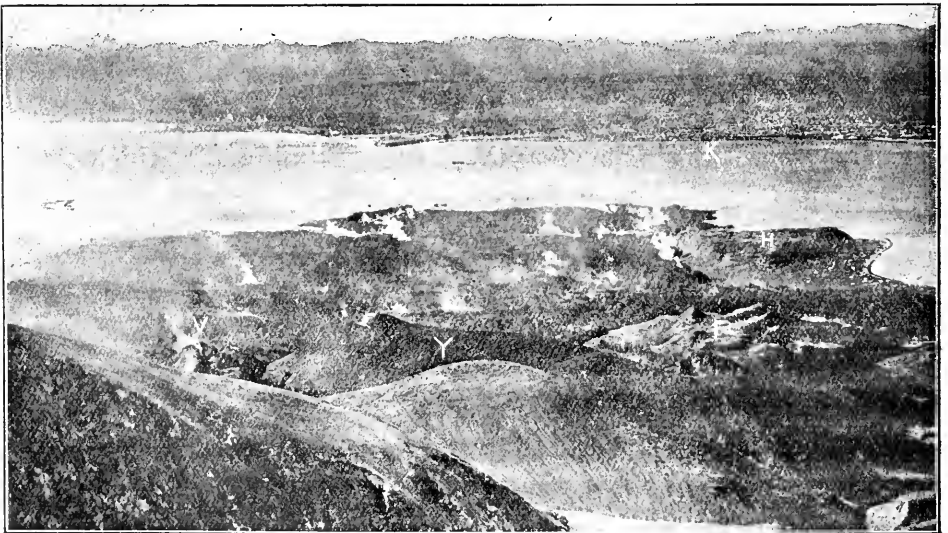

Fig. 31.—The volcanello Furihata on the western slope. (Photo by Mr. Yamaguchi.)  
 yv—Yuno-hira vent.                      y—Yuno-hira somma.                      F—Collapsed dome of Furihata.  
 n—Hakama-goshi.                      k<sub>t</sub>—Kanzé islet.                      k—Kagoshima.

the north cone. All the recent writers on Sakura-jima take it for a parasitic cone, simply from its outer form. It is built up of massive rock, which is of the *same kind* as that of the north cone. Until this monadnock-like mass is convincingly proved to be a real parasite, the writer will relegate Hikino-hira to a part of an ancient lava-flow, which was greatly disrupted by explosions of old date in the neighborhood, so as to give the outward look of a steep dome or tholoide.

*Southern Side.*—A small elevation, 103 *m.* high, near the defunct strait of Séto, raised its head on shore from below the ancient lava of the south cone or Moyé-daké. The writer passed over the edge of it and made a collection of the rock in January, 1913. This Akashi-Gongén hill and the whole adjacent tract are overflooded by the recent lava and no trace of this "103 *m.* hill" can be seen now on the surface, except a slight elevation in the middle of it, indicating by the petrified cataract of recent lava the site of this buried hill. About the origin of the hill, we find no clue as to whether it is a margin of the North Cone or one of its parasites. (Geologic Map, Pl. VIII. Figs. 2-3, Pl. IX. Figs. 2-3.)

*Eastern Side.*—A knob of Gongén-yama (340 *m.*) on the eastern slope and the Sono-yama (Maru-tsuka or the 'round mound,' 79 *m.*) on the northeastern shore are the geologic islands of the Kita-daké lava or its parasitic cones left uncovered by later flows.

*b) Petrographic Characters.*—The Kita-daké lava (Pl. XVI. Figs. 5 and 6) on the north side, a typical *hypersthene-andesite*,<sup>1)</sup> is the oldest and the most widely distributed rock of the island. It is a *light-colored*, *salic* type, which rather resembles the Diluvial

---

1) As it contains sanidine in the forms of phenocrysts and the rind around plagioclase, it may in future investigations turn out to be a *hypersthene-lalite* or *pyroxene-cantalite*.

and Tertiary effusives (Pl. XVI. Fig. 1) of southern Kyûshû than the *black* historic volcanics of the island. The slaggy hollows in the rock are often secondarily filled with calcite and primary tridymite aggregate. It is a slightly slaggy, dopatic rock of light color, in various shades of *gray*, which entirely depend upon different factors in the *groundmass*. The (*a*) brownish or purplish tinge is due to hematitization through fumarole action upon augite-needles and prismoids; the (*b*) ash-gray tinge, which is very common, is caused by *slight* admixture of the microlites of augite and the crystals of magnetite in the plexus of feldspar microlites; the (*c*) wet-grey comes from flocky aggregation of augite-anhedrons and magnetite dust; and lastly, the (*d*) lightest shade and dull lustre is attributable to the predominancy of feldspar microlites and residual colorless glass.

*Phenocrysts* of distinctly pleochroic pyroxenes, which are all of brownish green, are scarce and only represented by slender pleochroic hypersthene (*h*), but those of (*f*) labradorite (1–1.5 mm.) are fairly abundant. Simple anhedral feldspar, and idiomorphic polysynthetic-lamellar plagioclases as well, are usually zonal-structured. Glomeroporphyritic<sup>1)</sup> (*g*) secretory patches of micronorite (Text-fig. 32) play a part of phenocryst, being composd



Fig. 32.—Micronoritic segregation.

1) Flocked together probably during the crawling of lava-streams.



of an ophitic aggregate of plagioclase and pleochroic pyroxene; the brownish *hornblende*, which was only once seen in the Sakura-jima slides, occurs marginally<sup>1)</sup> intergrown with the pyroxene. Apatite was observed once or twice in slides. In the lavas of the southern slope augite is represented in *moderate* quantity.

The *texture* of the groundmass (Pl. XVI. Figs. 5 and 6) is pilotaxitic and hyalopilitic (if colorless glass is abundant) and fine, and appears dirty gray under weak powers (Fig. 5). As already stated, the color of the rock is solely influenced by different behaviors and a relative quantity of microlites of feldspar and augites besides magnetite and glassy base in the groundmass.

One exception to the general rule is the lava on the northern shore at the Point *Wari-ishi-Zaki* near Kômen. It is stuffed with light-colored, crystalline nodules of secretory origin; but the lava itself is blackish, being built up of *brown*, sometimes colorless, glass in which only resorbed and dusted augite prismoids are seen swimming. No feldspar was detected among microlites, owing perhaps to rapid cooling under *water*, which did not allow the crystallization of feldspars.

The *Atago-yama lava* is gray with brownish flecks. Microscopically, it is similar to that of *Wari-ishi-Zaki*, having networks of chilling cracks, appearing as if it were solidified lava under shore water. A noticeable feature is the colorless devitrified fibrous glassy base with corroded and fibrillated augite microlite, which is partially oxidized into hematite dust. Brownish flecks are solely due to this dust, which is also strewn through the oxidized margin of slaggy holes.

---

1) Bowen says in his experiment on the gravitative differentiation of melts, that olivine and pyroxene during their settling (olivine-nodule) cause crystallization of amphibole upon their cooling surface. *Amer. Jour. Sci.*, Vol. XXXIX. 1915, p. 175.

The lavas of *Furuhata-Sambongachi* (Pl. XVI. Fig. 7) and *Hikino-hira*.—They are all as the above with few hypersthènes and abundant plagioclases.

The groundmass is also light-gray under weak powers. Higher powers resolve its hyalopilitic texture approaching to that of pilotaxitic. Rectangular and lath-shaped twinned plagioclases make up the main bulk of groundmass, intermixed with a subordinate quantity of fine needles of augite, besides grains of magnetite which are found mostly attached to the augite.

### B. The Kabano Lava. (NORTH SIDE.)

Pl. XVI. Fig. 8 ; Pl. XVII. Fig. 1.

a) **Mode of Occurrence.**—An old lava descended the north-western slope to the 200-meter contour-line, from the interior of the (?) apical crater (terminal lava-flow). It hangs on the slope or piano in digital lobes and forms a characteristic shelf at its end by stemming and cooling of the viscous lava stream in its



Fig. 33.—North Cone (Kita-daké) viewed from near Shira-hama. Cf. Text-fig. 37 (p. 173).

1—Kabano lava-flow. 2—Erosion-gulch of Matsura-gawara. 3 and 4—East and west ventholes of the An-ei eruption.

downward course. The northwestern rim of the Kita-daké is built up of this black glassy lava. Geologic Map, and Text-figs. 33 (1) and 37 (1).

The relative age of this rather weak lava cannot be stated with certainty. It solely rests upon the Kita-daké lava, and is not in anyway related to other flows, so that it is still an open question whether its eruption happened soon after the building-up of Kita-daké, or later in historic periods. The writer puts it on record here merely from a geographic point.

As stated elsewhere (p. 153), the eruption began with the ejection of ash and pumice, followed by and covered with the later flow. Exposures are seen in the gullehes of Matsura-gawara. Text-fig. 33 (2). From a petrographic point the lava belongs rather to historic types. In contrast to the light-colored rock of the north cone, it is *black* and *vitreous*, dotted white with crystals of feldspar (from  $1\frac{1}{2}$  mm. downwards). The rock is hyalopilitic pyroxene (hyp>aug) andesite.

*b) Petrographic Characters.*—Under the microscope, this dohyaline and dopatic rock is seen to be largely made up of *colored* glass (often colorless), with shades of purplish-brown, dark-brown and red-brown, variously kneaded and streaked after a pattern of damask (Fig. 1). Abundant augite in the form of fibrous and also minute stiff needles in tufts and axiolites (Fig. 8), and relatively few skeletal plagioclase are present in the brown glassy base. Phenocrysts of zonal-structured plagioclase are abundant; but pyroxenes are few, of which the prismatic hypersthene (*h* in Fig. 8) predominates over anhedral augite (*h* in Fig. 1). Magnetite is present in small quantity. The lava is a black *vitrohypersthene-andesite* with augite-microlite or brown glass in the groundmass.

## C. The Minami-daké and Naka-daké Lavas.

(SOUTH AND EAST SIDES.) Pl. XVII. Figs. 2, 3, 4, 5.

a) **Mode of Occurrence.**<sup>1)</sup>—Although Minami-daké (the south cone) and Naka-daké (the middle cone) are really parasitic to the northern main, the first can match the northern in point of magnitude, and rides on its southern flank. At the first phase of the building-up of this brother giant to a lofty elevation of 1,070 *m.*, the southern shoulder of the old Sakura-jima volcano must have been already bodily blown off and destroyed when ejecta of preëxisting material and of juvenile substance were piled up around the vent of the south cone. Lavas alone without the contribution of breccia<sup>2)</sup> and tuffs cannot form *a priori* such an overtowering konide. The deep gulch on the west side seems to be the overlapping edge of both the north and south cones, where one expects to find their mutual relations and internal structure.

As may be seen on Geologic Map, the black Minami-daké lava makes up the entire apical region, while its skirt borders the *southern* shore on the point of Kannon-zaki between Yuno and Furusato, and further east at Yuno-hama, being interrupted midway by the lava stream of 1779. Besides, the *southwestern* slope is severally overlaid by the Biyôbu-hira<sup>3)</sup> lava of 1475-'76, and the Ôhira<sup>4)</sup> lava of 1749, and between the two is exposed the inlier or window of the old Kita-daké lava at the gulch of Ôgawara.<sup>5)</sup> These three periclinal lavas of flank eruptions complicate the topography and distribution of lavas, both in time and nature.

---

1) See *ante*, p. 35.

2) Strong clasmatic deposits are exposed along the southern and eastern slopes between the 200- and 400- meter contour lines.

3) 屏風平 See *postea*, p. 166.

4) 大平 (spoken U'hira) The *hira* means a flat.

5) See *ante*, p. 154. 大河原

NAKA-DAKÉ The *eastern* sleeve of the Minami-daké lava-field is sheeted with a flow from the central eruption of Naka-daké, which covers the eastern slope and marks also the coastal strip of Nagasaki-hana or headland. The already-mentioned excentric Nabé-yama and the minor Ebino-tsuka ringwall of 1471 sit upon this base, as may be seen on Geologic Map.

It should be remarked, that at the present state of the writer's knowledge it is doubtful, whether it is practicable to differentiate the Minami-daké and Naka-daké lavas or not. (*See* Text-fig. 9, M.) The top-region is so thickly coated with blocks, lapilli and ashes of historic and prehistoric eruptions that exposures of underlying rocks cannot be seen, except at the deep inaccessible radial gulches, which are few in number in this still undissected volcano.

On Geologic Map the hypothetic area of the Naka-daké lava is brought to cartographic expression in order to suggest a problem to be worked out in future researches. In passing, it is to be remarked that there may be another point of effusion of magma near Nabé-yama, adjacent to its northwest skirt at a knob of 340 *m.* It is Gongén-yama, and it may be a part of the Kita-daké or a volcanello belonging to it.

*b) Petrographic Characters.*—i. The specimens (Pl. XVII. Fig. 3) collected on the southeast slope between 300 and 800 *m.* are black, dopatic and compact *pyroxene-andesite*. Phenocrysts (1.0–1.5 *mm.*) of andesine plagioclase are abundant, but pyroxenes are as usual scarce, of which prismatic hypersthene predominates a little over anhedral augite. Phenocrystic *pyroxenes* are by no means easy to distinguish and show abnormal features. Hypersthene is mostly highly-birefringent, and augite is mostly pleochroic. Both have exactly the same brownish green color. Prismatic section with

eight-sided outline affords, however, a good diagnostic mark to hypersthene, while the tabular (100) with twinned basal section that of augite. Parallel intergrowth with peripheral augite was sometimes observed, but the reverse was only once noticed (S. E. slope). The statement on the relative quantity of the two pyroxenes should therefore not be taken in a strict sense, especially the phenocrysts are not found in large quantity, as in the lavas under question. Simple subhedral tabular (010) *feldspars* as well as polysynthetic-lamellar, long-rectangular plagioclase are zonal-structured.

The hyalopilitic groundmass is fine and built up mainly of minute augite needles and lesser and larger laths of feldspar in brownish glass base with magnetite crystals. Specimens from the neighborhood present textural varieties; some being brownish and slaggy, the other being fine in texture. But the mountain slope is thickly covered with all sorts of ejected blocks of several eruptions, so as to make a proper selection difficult in collecting specimens.

ii. The lavas in the Kannon-zaki area (Pl. XVII. Fig. 2) on the southern shore are likewise black and rather vitreous owing to the abundancy of glass in which the microlites are mostly represented by augite, besides a few larger feldspar-laths. *Olivine* was once noticed, and micronorite patches were also seen.

iii. The Naka-daké lavas, which cover the ( $\alpha$ ) top and eastern slope and the ( $\beta$ ) coastal strip of the Nagasaki headland, are rather slaggy and colored brown in vesicular spaces through oxidation of the pyroxenic components. The  $\alpha$  type is a *pitch-black* vitroandesite having a groundmass of abundant brown glass with augite needles only. It is a porphyritic obsidian (Pl. XVII. Fig. 4). The  $\beta$  type (Pl. XVII. Fig. 5) is hyalopilitic and *dull-black*

due to the predominancy of fine feldspathic microlites over those of augite in light-brown glassy base. Both types are found inter-mixed, a fact which seems to justify us in putting both together in one group.

## § II. The Lavas of the Historic Period.

### A. The Lavas of the Bummei Eruption,<sup>1)</sup> 1471-1476, Including the Nabé-yama and Ebino-tsuka Adventives.

#### a) The Urano-mayé Lava-field of 1471. (East Side.)

Pl. XVIII. Figs. 2 and 3.

a) **General.**—Taken in a broad sense, the grayish and salic, porous and light lava of Kita-daké, which constitutes the general foundation of the insular volcano of Sakura-jima, differs from all the later lavas, irrespective of historic or pre-historic, which are dark and basic, slaggy and heavy.

The femic *pre-historic* lavas already briefly outlined as the Kabano (?), Minami-daké and Naka-daké lavas welled out in streams, or built up mighty cones during the mature age of the volcano to a height of more than 1,000 *m.* Although dark in color, the three lavas are *dull-black*, owing to the predominance of feldspathic microlites in the groundmass, or else of light-brownish color of glassy base. *Among the pyroxenic phenocrysts, hypersthene usually predominates over augite, indicative of a rather salic nature of the magma, representing a transitional stage to more femic historic lavas to be considered immediately below.*

1) See *ante*, p. 42.

All the historic lavas, which are likewise dark in color, are fresh *pitch*-black, due to the presence of dark or violet-brown base, and they are the product of flank eruptions, in contrast to the central, showing that Sakura-jima has already passed in pre-historic times the prime of its volcanic age.

b) **Mode of Occurrence.**—It is stated<sup>1)</sup> that ‘on October 25th, 1471,<sup>2)</sup> the mountain was in flames above the village of Kurokami (on the east coast) projecting stones and raining ash. Lava piled up and formed a rocky hill called Ômoyé-zaki, the *great burning cape.*’ With this simple passage as a key, the writer has differentiated a lava field at the north of Kurokami from that of 1779, which encloses it on two sides, leaving a triangular uncovered patch of 2.4 sq. km. along the shore. See Geologic Map.

The field lies 1.2 km. north of Kurokami, and this triangular lava terrane has 3 depressions at the apex landward, while the projecting headland of Ômoyé-zaki forms another corner. The latter is the visible terminus and the former the vents from which lava poured forth seawards to the above-mentioned headland, and which people call the fire-holes or *higona* of Urano-mayé or Uran-mayé, the latter a solitary group of cottages in a cove.

The ventholes of the Urano-mayé lava-field are the fresh-looking depressions within a terrane of lava clods, the largest being elliptical with axes of 200 m. by 100, and bounded with steep cliffs 50 m. deep. The bottom of the pit is covered with talus, and old ashes. The black lava-field is craggy, affording foothold only to stunted trees and meagre grass. Topographically the writer is able to recognize this Urano-mayé lava-field of 1471

---

1) *Chiri-sankô* 地理纂考. Part XX. p. 12. ‘Geographic Scraps of the Provinces Hyûga, Ôsumi, and Satsuma,’ Kagoshima, 1898.

2) Some say it occurred in 1475?



from the enclosing one of 1779 in its being of low altitude and from the tradition of the people, especially the formation of Ômoyé-zaki or the 'burning headland' of which we have an authentic record.

c) **Petrographic Characters.**—The material of lava (Pl. XVIII. Figs. 2–3) is white-spotted (1–4 *mm.*), dopatic, slightly slaggy *pitch*-black rock which, when seen under the microscope, is exactly like the younger lavas of 1779, later to be described. It is a *pyroxene-andesite* with the groundmass of dark brown glass in which rather coarse microlites (0.06 *mm.*) of dusted augite and skeletal plagioclase swim in fluidal arrangement. The relative quantity of the two species of microlites is variable, although that of augite always predominates over the other. Pyroxene phenocrysts are scanty and both members are variably represented.

β) The Nabé-yama and Yébins-tsuka Homates. (East Side.)

a) **The Nabé-yama Homate.**—Contemporaneously with the activity and the outpouring of lava in 1471, Nabé-yama seems to have been also active. Mr. Ijichi in his oft-cited work: 'On the eruption of Sakura-jima in the An-ei era,' incidentally mentioned that the kettle (nabé)-shaped Nabé-yama is a relic of the eruption in 1471. He compared its position to the main Sakura-jima just as the parasitic knob of Hôyei-zan is related to Fuji-san. Particulars about its activity are not recorded in any work at the writer's disposal. (Geologic Map, *bn.*)

This model-like ringwall hill is located on the southeast slope and rises on a base of 1.3 *km.* in diameter 328 *m.* high. The outer slope of regular ringwall is tolerably steep, but the deep inside is still more precipitous, and the circular wall is only

opened on the east, from which one can see the pumiceous bottom through the densely grown shrub.

Nabé-yama is a unique, widely-opened kettle hill, entirely built up of stratiform loose lapilli and pumiceous mass. Therefore, it is in a strict sense a true homate. The loose covering of ejecta is in part no doubt of later origin. Hills like this both in form and substance are not unfrequently noticed in *submarine* volcanoes, the typical example being the new island near Iwô-jima on the south of the Bônin islands, which rose on January 23rd, 1914 and later disappeared.

The reservoir of magma must have been near the surface, not lower than 300 *m.*; the juvenile material being all lapilli and pumice, formed and ejected by gaseous evolution in the magma. Solid lavas have so far not been discovered, and a comparison with those of the same eruptive period in other quarters of Sakura-jima is impossible.

*b)* **The Yebino-tsuka Knob.**—A hillock (*see* Geologic Map, *b n*) which lies to the east of Nabé-yama is an exact copy of the latter both in form and material, differing only in size. The writer is inclined to consider this pumiceous bocca to be of the same age as its neighbor. This little hill, though half enclosed by the recent lava flow, is so favorably and safely situated that all the visitors landing on Kurokami went up and saw the recent terrific display of vulcanism from there (Text-fig. 29, p. 143).

### *B.* The Byôbu-hira Lava Field of 1475-'76.

(SOUTHWEST SIDE.)

Pl. XVII. Figs. 6, 7, 8 ; Pl. XVIII. Fig. 1.

*a)* **Mode of Occurrence.**—As the lava reservoir of the Bummei era seemed not yet to have been exhausted in 1471, activity revived

five years later, this time on the diametrically opposite southwest slope (*see ante*, p. 42). On September 15th, 1475, a violent explosion occurred above Yuno at an altitude of 400 *m*. Another version says that the fluent lava issued forth on October 6th, 1476.<sup>1)</sup> Lava welled out in streams, one branch spreading itself southeastwards on the mountain slope in an apron, while the southwestern arm started from the vent,<sup>2)</sup> No. 6 (*t*) of Geologic Map, ran down directly to the shore and pushed further into the sea, thereby creating the new point of Moyé-zaki (Text-fig. 4, *c.m.*) or the 'burning headland.' The area overflowed by block lava is a little greater than that of the earlier flow of Urano-mayé (p. 164). This Byôbu-hira field<sup>3)</sup> still leaves a series of six perfect vents or boccas (*boche*), which hitherto have been unknown to the outside world.

No. 1. The uppermost pit<sup>4)</sup> (Text-fig. 34 [1]) is the typical and the largest one, located at a height of 400 *m*. The inner diameter is 30 *m*. and the circumference 200 *m*. with a depth of 40, the northwest rim being a little lower. As it is a blow hole, the back side is clear-cut in the old ash-gray lava of Kita-daké, a continuation of the Ôgawara inlier (p. 154), and the fluent lava escaped only over the lower northwestern rim, as in No. 1 venthole of the western lava-field in the recent eruption (Text-fig. 27, p. 140).

On the cliff in the hollow (Text-fig. 34) a fresh slag-agglomerate

1) See page 42.

2) The vent No. 5 is named Takachiki (高築).

3) 屏風平焼野 A view of the Byôbu-hira lava field may be seen in Pl. XI, Fig. 3.

4) The four pits from Nos. 1-4, counting from above, received the names *Moyé-goua* (燃穴 or the 'burning bocca'), *Shituno-moyé-goua* (the 'lower bocca'), *Hebija-kubo* (蛇方窠 or the 'snake's hollow') and lastly, *Saribachino-kubo* (摺鉢ノ窠 or the 'mortar hollow') respectively. The road to the boccas leads up directly from Yuno, first entering into a block lava-field where there are two wind holes (the vents Nos. 4-5 in Geologic Map) in depressions. A cellar is especially built in each of the above-mentioned depressions for the storage of egg-papers of silk worms, as the cool and constant temperatures of 'blowing caves' are favorable in keeping back the untimely hatching of eggs. They seem to be terminal openings of lava-tunnels with which the above-mentioned two lower secondary ventholes (Nos. 3-4) had probably direct communication.

is seen to full advantage, overlaid by the sheet of the Kita-daké lava, that constitutes together with the underlying the main body of Sakura-jima. It is an excellent exposure to get a glimpse into the structure and rock-nature of old lava.

No. 2. The next circular bocca (Text-fig. 34 [2]), 64 *m.* distant from the first, is rather small with a



Fig. 34.—Vents Nos. 1-2 of the Byôbu-hira lava-field of 1175-1476. Cf. Geologic Map.

diameter of 130 *m.* and a depth of 40 *m.*, but is a typical deep clear-cut and impenetrable venthole, this time of new *black* lava, densely forested with *Cryptomeria japonica*. One cannot find the spot unless one stands on the very edge of the pit.

No. 3. The third pit in the series lies at about the same distance from No. 2, as the latter is separated from No. 1. It is a shallow basin (Text-fig. 35 [3]) filled with ejecta, which are also spread about over the neighborhood.

No. 4. The last and the lowest pit (Text-fig. 35 [4]) lies a little apart from the preceding No. 3 pit. In its form and forested condition it closely resembles No. 2., the only difference being the smallness in size and the deep bottom (100 *m.*).

These four ventholes are arranged in a series on the slope in

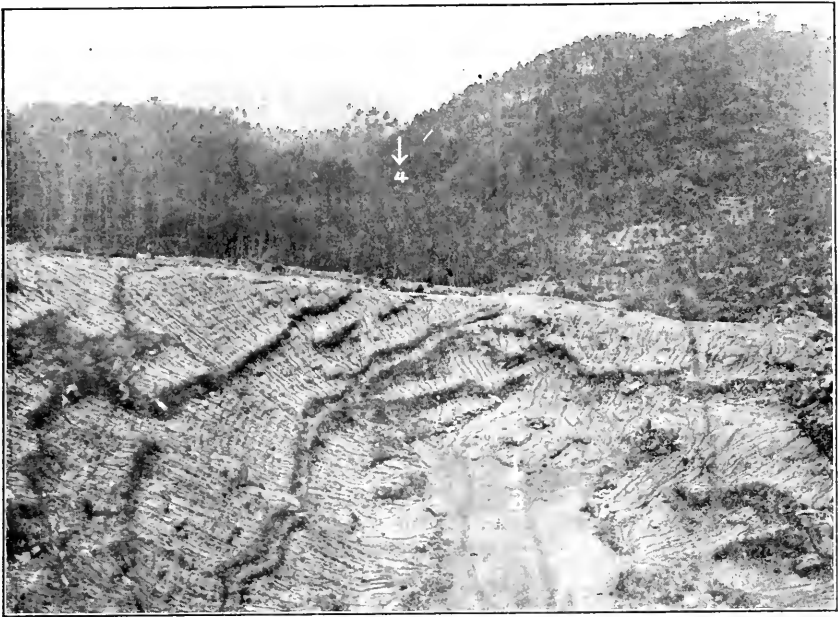

Fig. 35.—Vents No. 3 and 4 in the same lava-field as in Text-fig. 34.

the lava-field called Byôbu-hira or Shibano (*see* Geologic Map) in a south by southwestern direction. Though comparatively small in size, especially Nos. 2-4, these ventholes must have displayed tremendous phenomena in detonating and throwing up cloud dust, just as recent ones have done and are still doing on both flanks of Sakura-jima. We find no particulars of their activity on record. The writer is not certain whether all these represent the vents on the body of the mountain. Some may be secondary vents formed by the escape of accumulated gases within the fluent lava stream. A well-defined venthole lies between the 100- and 200-metre counter lines. It is the Takachiki vent (Geologic Map, No. 6, *t*), and it probably poured forth the fluent lava which ran down to the sea forming Cape Moyé-zaki.

*b*) **Petrographic Characters of Pyroxene-andesite.**—The lavas are identical with those of Urano-mayé (p. 165), although they occupy

areas on diametrically opposite shores, and in point of time both are only separated by an interval of five (?) years, during which no magmatic differentiation seems to have taken place in the lava reservoir, which is presumably common to the two lava-flows, as in the recent lavas.

The common feature of both the Urano-mayé and the Byôbuhira lavas is the development of varietal modifications in different parts of the lava streams. All the lavas are, however, dopatic or sempatic, dotted with abundant phenocrysts of plagioclase (1–3 mm.), while pyroxenes (hypersthene > augite) are only sparsely represented.

The *land* lavas (Pl. XVII. Figs. 6–7) are pitch-black and vitreous, while those at the water's edge (Pl. XVII. Fig. 8, Pl. XVIII. Fig. 1) are dull with shades of gray. The first is caused by the abundancy and chocolate-brown color of glass and also dusted augite-needles, while skeletal microlites are few. The *shore* lavas present the same feature as the land lavas in regard to phenocrysts; but the groundmass is rich in feldspar-microlites, which lend to the rock its *dullness* and *gray* tinge. Moreover, the shore rock is cloddy, owing to quenching fractures, and is stained with limonitic films. Under the microscope circular minute flecks are also seen, which are decolorized in its glassy base with the simultaneous separation of fibrous augite (enstatite-augite?) and globulitic substance. *These features are characteristic to shore lavas irrespective of age and chemical composition of the magma.*

### C. The Ôhira-yama Lava-flow of 1749 (WESTERN SLOPE).

Pl. XVIII. Figs. 4 and 5.

a) **Mode of Occurrence.**—As a precursor of the great eruption of the An-ei era (1779–1799), Mt. Ôhira-yama (spoken Uhira-yama)

above Nojiri erupted violently in the second year of Kwan-yen era (1749)' after remaining dormant for four centuries.<sup>1)</sup> On the southwestern slope just on the south of the mamelon-like knob (553 *m.*) of Hikino-hira (Hiyoku-oka),<sup>2)</sup> the writer found a doubtful bocca at an elevation of 500 *m.*, and another, but fresh and small one, at a spot 100 *m.* lower than the preceding. See Pl. XI. Fig. 3.

This lower nameless shallow vent, which here may be conveniently called the Hikino-taki (*cataract*) bocca, lies at the head of a lava stream which flowed down for a distance of 2.5 *km.* in a tongue-shaped strip without reaching the shore, and is partially overflowed in its northern skirt by the recent lava. See Geologic Map.

b) **Petrographic Characters of Pyroxene-andesite** (Pl. XVIII. Figs. 4-5).—The white-spotted (2-3 *mm.*) dopatic lava bears the stamp of historic type in its dark color; but it is rather compact, breaking

in conchoidal masses with cloddy texture. Moreover, the groundmass of this black rock has a *dull*, lustreless gray shade, due to the large amount of rectangular and lath-shaped feldspar swimming in a light-brown glass. Microscopic flecks in the groundmass are caused by local globulitization and decoloration of brown glass. Pyroxene pheno-

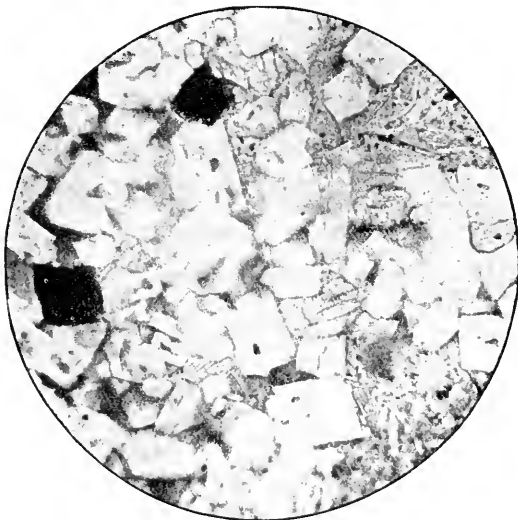

Fig. 36.—Miconoritic segregation in the Ôhira lava of 1749.

1) See page 43.

2) Hiyoku-oka 比翼岡, an old name of Hikino-hira 引ノ平.

crysts are as usual very scarce, but augite predominates over hypersthene. Excellent micronoritic segregations are typically developed in this lava, as in Text-fig. 36.

*D. The An-ei Lava of 1779 to 1781.*

(SOUTHWEST AND NORTHEAST SIDES.)

Pl. XVIII. Figs. 6–8, Pl. XIX. Figs. 1–2.

a) **Mode of Occurrence.**—After a lapse of thirty years from the slight eruption of Ôhira-yama in 1749,<sup>1)</sup> the most terrific paroxysm ever recorded of Sakura-jima happened in the An-ei era, especially from 1779 to 1781. This An-ei eruption has left a more dreadful impression than that of the Bummei era from 1471 to 1476.<sup>2)</sup>

Like the preceding activity, the An-ei eruption occurred also bilaterally in the same orientation, *i.e.*, on the southwest on one side and on the northeast on the other, as may be seen on Geologic Map. The vents of the former period lie at a comparatively *low elevation* of 400 *m.* in the Byôbu-hira area, while those on the opposite side at Urano-mayé are probably hidden by later flows, the vents exposed to view being only at about 200 *m.* above sea-level.

In contrast to the former, the vents of 1779 lie far up at an altitude of 700 *m.* on both sides, *corresponding to the greater amount of energy exerted in the volcanic manifestation than in that of the Bummei era.*

Although the eruptions were active on both slopes, as has been already stated, the lava emission on the south (the large vent of An-ei-San, Pl. XI. Fig. 3) is comparatively insignificant,

---

1) See page 170.

2) See page 163.



as compared with the vents of the northeast (the two<sup>1)</sup> ventholes of the Moyédashi fire holes, in Text-fig. 37 [3 and 4]) which not only sent down lava into the sea but also its submarine end rose to become the islet of Inoko-jima (a Rock off Ôsé-zaki in Text-figs. 11 and 12). A group of islands comprising Shin-jima, Iwô-jima, and Yébisu-jima represent, however, independent excentric submarine vents (Text-figs. 11, 13 [x, i, s]), which were undoubtedly connected with the same lava macula of Sakura-jima, and sympathetically burst open with the activity of the main conduit.

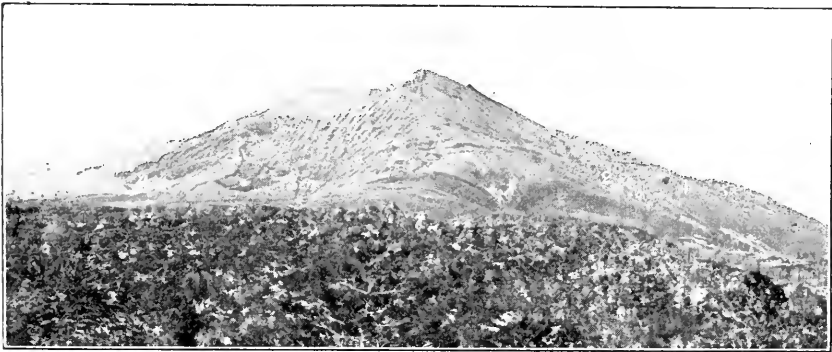

Fig. 37.—North Cone (Kita-daké, K) viewed from Kômen. Cf. Text-fig. 33, p. 158.  
(Photo by Mr. Yamaguchi.)

To speak more in detail, the *southern* lava issued from a single deep and open oval bowl, called An-ei-San, on the apical region of the south cone, running down in a narrow tongue to the shore, and forming the point of Tatsu-zaki between Furusato and Yuno-hama—a stretch of only a kilometer. The fresh craggy stream of block lava can be easily recognized even from a distance. See Geologic Map.

The *northeast* area, the Kômen<sup>2)</sup> lava-field, is ten times larger than the preceding. The lava welled out from the east and

1) There are altogether eight ventholes, primary as well as secondary, in the Moyédashi lava-field, marked in Geologic Map.

2) 高免

the west *higona* or fiery blast holes (Text-figs. 37 [3-4], 11), besides the third, which lies a little lower. The ventholes lie at about 700 *m.* above sea-level. Three other bocche, the fourth, the fifth, and the sixth,<sup>1)</sup>

are located between the 200- and 300-meter contours on the shelf formed by stemming of viscous lava-flows, and they are probably secondary vents, burst open by local accumulation of gases in a tunnel within the cooling

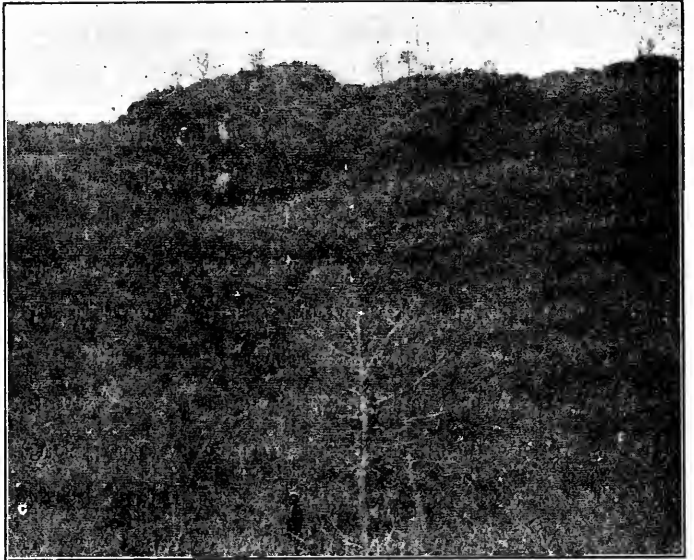

Fig. 38.—The sixth venthole in the northeast lava-field of 1779.  
See Text-figs. 10c, 11, 33, 37 and Geologic Map.

lava stream. The Kômen lava spread out into two branches overwhelming the once large village of Mukômen (*see* Text-fig. 11), and enclosing the triangular area of the old Urano-mayé lava-field<sup>2)</sup> of 1471.

*b)* **Petrographic Characters of Hypersthene-andesite.**—*a)* The lava of An-ei-San has the same black appearance as the other historic lavas, differing only slightly in lustre and in the sporadic occurrence of *olivine*—a component which is for the first time plainly observed in the lavas of Sakura-jima (Pl. XVIII, Fig. 6). The lavas are all of hypersthene-andesite.

1) The last lies on the roadside, Text-fig. 33.

2) See page 163.

The rock at the water's edge is weakly vitreous, dark-gray, somewhat slaggy and dopatic. As usual, the phenocrysts of andesine-plagioclase are abundant, while those of pyroxenes comparatively few, of which the prismatic hypersthene slightly predominates over anhedral augite. The hyalopilitic groundmass (Pl. XVIII. Fig. 7) is built up of dusted augite needles, mixed with a slightly smaller quantity of feldspar laths in a light-brownish glass. Microscopic flecks are seen, being caused, as usual in subaqueous lavas, by globulitization and decolorization of the base. The lighter shade of rock is caused by the *minuteness* of size but not the quantity of augite microlites in the groundmass.

The lava on the slope is of a grayish black type with slaggy semipatic fabric. The phenocrysts are likewise plagioclase and pyroxenes, the latter being comparatively abundant as compared with the other *historic* lavas. The dominant pyroxene is hypersthene. Anhedral olivine again occurs sporadically. The glass base is colorless, but if the brown glass partakes of the groundmass in appreciable amount, the rock becomes vitreous and black.

β) The lavas of the Kōmen area (the N.E. coast) are also divisible into those on land and shore. The former contains a comparatively large amount of hypersthene. The groundmass (Pl. XVIII. Fig. 8) is full of augite microlites, intermixed with a little larger feldspar in the chocolate-brown glass. The latter is characterized by minute texture (Pl. XIX. Fig. 1), of which there are two types, one variety being dark with a brown glassy base and augite microlite, the other being gray owing to very fine augite needles in the colorless glass. The common feature is the occasional appearance of anhedral olivine and the decided predominance of hypersthene over augite among phenocrysts.

;) The rocks of the new islets off the northeast shore (Text-fig. 11, p. 49) are already outlined elsewhere.<sup>1)</sup> The submarine lavas, of which they are built up, are gray or blackish gray, dull and pumiceous in color and texture, and not unlike an imperfectly coked brown coal. The groundmass is characterized by a frothy brown glass, in which fibrillated polysynthetic augite needles (clino-enstatite) and a few skeletal plagioclase laths are mixed with magnetite dust (Pl. XIX. Fig. 2). It is to be remarked that hitherto no olivine was detected, except in the lava from Iwô-jima.

---

The characteristics of the An-ei lavas are the sporadic appearance of anhedral *olivine* and the abundancy of pyroxene-phenocrysts, especially in the Kômen area, of which *hypersthene* abounds in preference to augite. These striking features distinguish the An-ei lavas from all the ancient lavas of Sakura-jima.

### § III. General Petrographic Characters of the Lavas of 1914.

#### A. Massive Lavas. Pl. XIX. Figs. 3-8, Pl. XX. 1-4.

a) **Land Lavas in General.**—The 'live' lavas, still hot when collected, are exclusively the so-called block lavas or of the 'a a' type, and petrographically belong to *hypersthene-andesite*, with olivine as an accessory. The writer can find scarcely any difference between the recent lavas and those of 1779. They are more or less slaggy, semipatic to dopatic, and mediophyric.

---

1) See p. 54.

Phenocrysts are tabular labradorite crystals (2 mm. or less), seriate and zonal structured with different extinction-directions, one variety being clear (Pl. XIX. Fig. 3), the other being full of glass inclosures (Fig. 4); some are corroded and rounded in outlines, and often internally ruptured. Microphenocrysts are pyroxenes, of which the prismatic pleochroic hypersthene (Pl. XIX. Figs. 6, 7, Pl. XX. Fig. 4), octagonal in basal section, usually dominates over anhedral augite,<sup>1)</sup> and both are often found in parallel intergrowth only in larger individuals. Grayish apatite occurs as an accessory. The other microphenocrysts are the light greenish-yellow olivine and occasionally magnetite

clumps, the olivine being never idiomorphic in these fluent lavas (Pl. XIX. Fig. 7, o; Pl. XX. Fig. 3).

The *olivine*<sup>2)</sup> habitually forms a nucleus of glomerophytic mass, o, the outer zone being a divergent mass of hypersthene prismoids (Text-fig. 39, n), and the amœboid iron ore constitutes a transitional zone. The whole appearance suggests the idea that the



Fig. 39.—Cracked olivine core with a rim of hypersthene crystals in the land-lava of the western field.

1) The crystal is tabular on the pinacoid (100), and the random sections usually met with are also the same pinacoidal plane with straight extinction, so that the estimation of the relative amount of both the straightly and obliquely extinguishing pyroxenes is only approximative. Pl. XIX. Fig. 8; Pl. XX. Figs. 1 and 3.

2) See *postea*, page 185.

intratelluric olivine was resolved<sup>1)</sup> into iron ore and hypersthene (Text-fig. 40), and, chemically speaking, olivine is equal to iron oxide plus hypersthene. At times pseudopodiform iron ore is simply left, forming the core of the hypersthene-aggregate (Text-fig. 40). On another occasion, feldspar laths enter into the composition, building up micronoritic patches (olivine-norite) and motex. Lastly, an isolated anhedron of olivine makes its appearance, and in this case it is not easy to discriminate this mineral from tabular hypersthene.



Fig. 40.—Resorbed olivine with pseudopodiform iron ore, encircled by hypersthene crystals in the marine lava of the eastern field.

The *groundmass* is always of minute fabric and hyalopilitic, being built up of prismoids or microlites of augite with a subordinate quantity of feldspar laths and magnetite grains in brownish glassy base. See Pl. XIX. Figs. 3, 4, 7 and 8. The *color of the lavas* is

1) According to Bowen and Andersen ('The Binary System  $MgO-SiO_2$ ', *Am. Jour. Sci.*, 1914, p. 499), olivine crystals may be resorbed during the normal course of crystallization as a simple result of cooling, and they inferred the formation of reaction-rims of enstatite around the crystal to the same cause. The change of forsterite to clino-enstatite is said to take place at about 1,557°C.

As the olivine sometimes appears associated with feldspar making micronoritic motex, as in the historic Sakura-jima lavas, any motion, whether upward or downward, of the crystals in magma can not be totally denied, as was demonstrated by Bowen ('Crystallization-Differentiation in Silicate Liquid,' *Item*, (1915), pp. 175 to 191).

In the present case, we have to do with a ferriferous complex system, and the remarkable pseudopodiform iron ore forms the transitional zone between the secondarily formed pleochroic hypersthene aggregate and the resorption-rest of an iron-rich olivine.

blackish, and the nature of the groundmass is responsible for various shades, being entirely dependent upon the presence and quantity of magnetite grains and globulites in the base. The dark gray arises from the presence of globulite, and the intensity of darkness is caused by the quantity of magnetite, just as in synthetic gems the intensity of colors of a substance depends upon the large size of the pigment. The bluish tinge indicates the presence of light violet-brown glass; the globulitic glass is never colored.

---

What is stated above, chiefly refers to the main mass of the western lavas. There are, however, accidental varieties of which the writer is able to differentiate *two* types. Both are found either at the lateral margin or on the terminal lava front, and characteristically free from olivine, owing probably to the fact that they are the salic precursors of lava effusions, and that the olivine sank down in the main magma by gravitative differentiation.

The  $\alpha$  type (Pl. XIX. Figs. 3-4) is outwardly characterized in being of grayish color with various shades, and of dominantly feldspathic nature. The groundmass is the pilotaxitic feltwork of feldspar microlites with a smaller amount of augite, which is equal in size with the former. The glassy base is colorless with much or no globulite. Microscopic flecks are the spots where globulites are specially accumulated.

The  $\beta$  type (Pl. XIX. Fig. 5) is a brown obsidian in the petrographic sense. This hyaloandesite is a variegated, dappled and streaked glass, variously kneaded in wavy bands marked with series of axiolites and flattened air-pores. Dark flecks are seen as in the  $\alpha$  type.

All the historic lavas of Sakura-jima, including the most recent ones, have the same appearance, structure and mineralogical

composition, with the only difference that in the lavas prior to 1779 olivine is wanting.

b) **Chemical Characters.**—An analysis was made of a very slaggy land lava of the Nabé-yama area by Mr. S. TANAKA, of our Geological Survey, with the result given in I., besides an incomplete analysis of an upper crust of the lava sheet in the western field in II.

	I.	II.
$SiO_2$	60.59	62.15
$Al_2O_3$	17.77	—
$Fe_2O_3$	1.23	—
$FeO$	5.59	4.69
$MgO$	2.39	2.17
$CaO$	6.34	6.05
$Na_2O$	3.04	2.72
$K_2O$	1.68	1.56
$H_2O$	0.59	0.63
$TiO_2$	0.71	0.65
$P_2O_5$	0.08	0.12
$SO_3$	0.23	—
$MnO$	0.24	0.17
	—	—
	100.48	

I. The Nabé-yama land-lava. Fusing point corresponds to No. 2 Segel cone =  $\pm 1,170^\circ C$ . Specific gravity at  $15^\circ C$ . is 2.64.

The present *olivine-bearing* hypersthene-andesite contains large amounts of  $CaO$ ,  $MgO$ ,  $Na_2O$ ,  $TiO_2$  and  $MnO$ , especially the first, but less of  $SiO_2$ , when compared with a typical hypersthene-andesite.



Norms :<sup>1)</sup>

Quartz .. .. .16.81	Q 16.81	} <i>Sol</i> 81.55
Orthoclase .. .. .9.95	} <i>F</i> 64.74	
Albite .. .. .24.16		
Anorthite .. .. .30.63		
Sod. sulphate .. .. .0.41		
Water .. .. .0.59		
Hypersthene .. .. 14.33	} <i>Fem</i> 17.87	
Diopside .. .. .0.28		
Apatite .. .. .0.12		
Magnetite .. .. .1.79		
Ilmenite .. .. .1.35		

$$\frac{Sol}{Fem} = \frac{81.55}{17.87} = 4.57 < \frac{7}{1} > \frac{5}{3} \quad \text{Class II.}$$

$$\frac{Q}{F} = \frac{16.81}{64.74} = 0.26 < \frac{3}{5} > \frac{1}{7} \quad \text{Order 4.}$$

$$\frac{K_2O' + Na_2O'}{CaO'} = \frac{669}{1132} = 0.59 < \frac{3}{5} > \frac{1}{7} \quad \text{Rang 4.}$$

$$\frac{K_2O'}{Na_2O'} = \frac{179}{490} = 0.36 < \frac{3}{5} > \frac{1}{7} \quad \text{Subrang 4, Bandose}$$

c) **Submarine Lava-flows** (Pl. XIX. Figs. 6, 7 ; Pl. XX. Figs. 2, 3 and 4).—The submarine lavas of the *western* field were taken out by a diver under the writer's supervision at three spots from depths of 10 to 40 fathoms at a distance of 20 to 80 *m.* from the edge of the seaward encroaching lava-flows. The writer therefore believes, that his specimens are not fragments which slid from the advancing front of subaërial lava. Contrary to our expectation of finding pillow-lavas,<sup>2)</sup> they form an arched-up dome-shaped solid sheet of lava, externally fractured and

1) Calculated by Ogura and Matsumoto.

2) Pillow-lavas are believed to be only formed from femic magmas. H. S. Washington, 'The Submarine Eruptions of 1831 and 1891 near Pantellaria.' *Am. Jour. Sci.*, XXVII. Feb., 1909.

much modified in appearance from the original smooth surface. The specimens were hammered off three and a half months after the extravasation, when the lava-field above sea surface was still fuming with the salmiac and other vapors, while the submarine portion was already partially covered with sea mosses and serpula worms.

The submarine lavas that were discharged from vents (*secche*) in the bottom, and those (*bocche*) from land consolidated in the subaqueous environment, differ greatly in their mineralogical development of magma; the former resemble an artificial slag, well exemplified in the rock of the new islets of the An-ei era (pp. 54, 176), while the latter are more like the normal rock, though both consolidated at the sea-bottom. The former are foamy brown glass, containing fibrillated augite microlites (clino-enstatite or enstatite-augite) mingling with only few or none of feldspar laths and magnetite grains (Pl. XIX. Figs. 6-7; Pl. XX. Figs. 2-4), but the latter, now under consideration, are more crystalline, as in the case of the new land rocks described above.

The rock is dull-grayish black and cavernous, dopatic to semipatic, dotted with the feldspar phenocrysts (2 mm., rarely 4 mm.); coccolithic or lumpy, due to chilling under water, resulting in the formation of regular, sometimes diverse networks (4 mm. in diameter) of clefts, lined with limonitic iron ores and dusts. The same structure also appears in subaërial flows, when it is drastically cooled at the lateral margin, *e.g.*, at Sambon-gachi on the western flow (p. 72, footnote 4, and Text-fig. 18*b*).

The phenocrystic plagioclase (labradorite) is full of brown glass due to temporary retrogressive corrosion, and is zonal-structured owing to rapid growth of the interior and also renewed growth in a later phase in another environment. Microphenocrysts of olivine are almost always present (Pl. XIX. Fig. 7; Pl. XX. Fig. 3)

although quantitatively insignificant. They never occur in euhedral form, as we usually find them in basalts, and frequently constitute nuclei of cumulophyric patches (Text-fig. 40, p. 178). Phenocrystic pyroxenes are scarce and seriate, and deeply corroded, of which subhedral hypersthene generally dominates over anhedral augite, although their proportions are sometimes reversed. Parallel growth is often observed in larger pyroxenes. Magnetite occurs sporadically in clumps and crystals. All the phenocrysts are affected by frequent shifting of the equilibrium of surroundings until the final consolidation of the lavas has taken place.

The groundmass of all specimens is very fine (Pl. XIX. Fig. 7, Pl. XX. Fig. 4), brownish and hyalopilitic, being mainly built up of dusted augite microlites mixed up with a subordinate quantity of skeletal feldspar laths in a light-brownish globulitic base.<sup>1)</sup>

The submarine lavas of the *eastern* field (Pl. XX. Figs. 2-4) were collected by the writer in April, 1914, at the lava-front at Séto, and 2 specimens by F. ÔMORI in April, 1915, the latter being from the raised heads of submarine flows now forming new rock-islets off-shore. The petrographic characters are the same as on the aforementioned western side, excepting the presence of large olivine (8 mm.) as in Pl. XX. Fig. 3. The external slaggy portion of the lava-sheet is, however, wanting in olivine owing to gravitative sinking of that mineral, and at the same time globulitic colorless glass makes its appearance in the groundmass.

In short, the submarine lavas also belong to the category of the olivine-bearing hypersthene-andesite, and are characterized firstly,

---

1) H. S. Washington says, that the groundmass of the Italian submarine lavas is a clear or sometimes brown glass thickly sprinkled with rusty brown or black dust, so much so as to be almost or quite opaque in places. 'The Submarine Eruption of 1831 and 1891 near Pantellaria.' *Am. Jour. Sci.*, XXVII. Feb., 1909. The globulitic or thickly dusted glass seems to be the universal characteristic of submarine lavas in the recent as well as in older ones in Sakura-jima.

by coccolithic structure, secondly, by comparative idiomorphy of plagioclase, thirdly, by the presence of large sporadic magnetite clumps, and lastly, by the dusted augite microlites in the light-brownish glass of the groundmass.<sup>1)</sup> The olivine and hypersthene have close paragenic relations; when the former appears in noticeable quantity the latter correspondingly increases in amount.

*d) Characteristics of the Western and Eastern Lavas.*—All the 'live' lavas of Sakura-jima have the same characters, not only macroscopically but also microscopically, in their black color, their mineralogical composition, and also in their texture. The same holds good generally for all the historic lavas of the island. As effusives are, in contrast to plutonics and hypabyssals, not easily susceptible to magmatic differentiation, they naturally consolidate into a uniform homogeneous mass. To find hidden, slight and constant differences among the recent lavas is, therefore, not an easy task.

In the preceding, the writer has characterized (*c*) the submarine lavas from both the terrigene-subaqueous and genuine submarine origin and (*a*) the main land flows. Slight deviations in habits and also in chemical constitution may perhaps be observed in the lava streams of distal and proximal ends from vents. As 'live' lavas, while crawling in their downward course, describe complicate comminglings and rotatory movements in a horizontal as well as in a vertical sense like streams and glaciers, specific differences, if any, in chemical and textural points cannot be easily recognized. In the following, some prominent features of the lavas from the *western* and *eastern* vents will be given in a brief form.

---

In the bilateral eruptions of Sakura-jima, the eastern vent at

---

1) See *ante*, 54 and 176.

an altitude of 300 *m.* burst out 10 minutes later than the western ones, located also at 300 *m.* (See Text-fig. 14 *b*, right west, left east). The outpouring of fluent lava, which began eight hours after the first outburst, must have been correspondingly later in the eastern vents, and the latter lavas should be assumed to be of younger birth. Consequently, it is not unreasonable to suppose that the eastern flows came from a *lower* horizon (see Text-fig. 30) of reservoir where, prior to the eruption after long quiescence, magmatic differentiation might have taken place either by selective crystallization or by gravitative concentration, or else in some other way.

The *eastern* lavas on this account are heavy, more basic and thin-fluid, flowing down farther seawards in submarine flows as compared with the western ones. (See Text-figs. 19 and 24.) Again the eastern lavas are less slaggy (comparatively compact), deeper in color and higher in specific gravity, the lustre being, however, variable in rocks on both sides ranging from pitch-black to vitreous and dull-gray.

A peculiar feature, which attracted the writer's attention, is the abundancy of lapilli on the eastern side.<sup>1)</sup> The sea was at that time thickly covered with floating pumice fragments only on the eastern water but not the western channel. The basic eastern lava, saturated with volatile constituents, seems to have been well adapted to the formation of spongy ejecta. It is superfluous to say that the west winds during the eruption blew suspending and projecting ejecta toward the east, thereby contributing a mass of subaërial fragmentary volcanics to the eastern side in no small measure.

PHENOCRYSTS.—*Olivine*,<sup>2)</sup> which is always anhedral, is universally

---

1) See *vide*, pp. 68 (footnote), 82.

2) See *vide*, page 177.

present in the eastern lavas, while in the western it appears only sporadically, especially in submarine lavas, where it is associated with amoeboid-shaped iron ore fringed with secondarily formed prismoids of hypersthene (Text-fig. 40). *Pyroxenes* are present in variable quantities on both sides, of which hypersthene decidedly prevails over augite in the east, while in the west both components appear almost in equal proportions. Parallel growths of pyroxenes are more frequent in the east. *Plagioclase*, being always zonal-structured, occurs very frequently in the east in segregation-patches in the form of either micronorite (plagioclase-hypersthene motex, Text-fig. 36)<sup>1)</sup> or microtinite (pure anorthite aggregate).<sup>2)</sup> Generally speaking, these enclaves of earlier segregation are characteristic to the 'live' lavas of Sakura-jima. *Magnetite* occurs in larger clumps in the east, as compared with its idiomorphic development in the west.

GROUNDMASS.—All are hyalopilitic; the glass base being either brownish or colorless in the east, while the latter prevails in the west. The relative proportion of glass, augite microlites and feldspar laths vary according to circumstances, on which entirely depend the lustre and shades of the color of the lava.

Augite microlites appear in two modifications, one being clear and euhedral, the other corroded and sprinkled with dust of magnetite. The second type is more frequently met with in the glass-rich variety mingled with only a few feldspar laths. Glassy rocks are abundant in the west. The brown glassy form of exceptional type is also met with in the west, which shows damascened texture, caused by complicated kneading of flattened air-pores and dust streams of magnetite (Pl. XIX. Fig. 5; Pl. XXIII. Fig. 4),

---

1) See pp. 193-194.

2) See p. 190.

What is stated in the preceding as the distinctive features of lavas on both sides of Sakura-jima is subject to rectification when additional slides can be examined, especially with regard to the statement on the groundmass.

### B. The Loose Ejecta.

Under this heading are embraced those loose volcanic ejectamenta which are of peculiar interest, and some of which are new to science, as may be learned from the following enumeration :

- |   |  |
|---|--|
| 1) Volcanic scum. <sup>1)</sup>               | 7) The porphyritic obsidian.               |
| 2) Gabbroids as ejecta.                       | 8) Pseudobombs of ancient lavas.           |
| 3) Ceramicites, natural porcelain<br>ejecta.  | 9) Ejecta of trass or ash-stone.           |
| 4) Solid ejected blocks of juvenile<br>lavas. | 10) The so-called sandstone.               |
| 5) Bread-crust bombs.                         | 11) Ejected blocks of biotite-<br>granite. |
| 6) Recent lapilli.                            | 12) Coal.                                  |

#### 1) **Volcanic Scum.**—By the term, volcanic or ‘lava scum’<sup>2)</sup>

1) On account of the presence of a large quantity of cordierite, the whole group of the scum or froth should be better consigned to that of **ceramicites**, which name the writer ventures here to propose.

2) It should not be confounded with the so-called ‘spongy thread-lace glass scoria,’ described by Dana in his “Characteristics of Volcanoes,” p. 163, and by I. Friedlaender in *Zeitschrift für Vulkanologie*, Bd. I. Tafel XXIII. Bilder 20 und 21. The genuine thread-lace scoria was, however, ejected from Asama in the eruption of October, 1914. The scoria is of large size, snow white, and light like soap-bubbles. Microscopically, it has a peculiar sponge-like structure with spicules regularly arranged forming a framework of the light mass. The same frothy scoria was blown up from the Yuno-hira vent during the first phase of the recent eruption. It is of large size, measuring up to half a metre in diameter.

The thread-lace scoria has recently been a subject of much discussion. F. A. Perret saw this Kilauean scoria lying upon the pahoehoe lava in a continuous stratum, indicating formation *in situ*, and therefore not to be included under the head of ejectamenta (‘Some Kilauean Ejectamenta.’ *Am. Jour. Sci.*, Vol. XXXVI. 1913, p. 617). S. Powers is of opinion that this scoria, a variety of basaltic pumice, is a kind of gaseous lava-froth blown out of craters and not formed *in situ* on the surface of the pahoehoe flows. Moreover, he defines the scoria as a gaseous pumice where the vesicles are separated only by slender threads instead of walls (‘Explosive Ejectamenta of Kilauea.’ *Am. Jour. Sci.*, No. 243, 1916, p. 240). The thread-lace scoria seems not to be exclusively a kind of basaltic pumice; for, the writer found it, as cited above, among the recent ejecta of Asama and Sakura-jima, which are built up of pyroxene-andesites.

the writer has in mind the whitish glassy substance, consisting of aggregation of bubbles, which are formed on the surface of magma when coming in contact with the air by violent agitation of liquid lava within the mouth of the vent. The lava-froth,<sup>1)</sup> which is a product of the Strombolian stage of activity and new to science, was projected into the atmosphere and fell on land and the surrounding sea. It is found on both sides of Sakura-jima, typical specimens are seen scattered abundantly on the *west* with its kindred 'spongy thread-lace glass scoria.'

The *forms* are variable (Text-fig. 41); some being roughly flat-conoidal, and sometimes pyramidal, but most of them are irregularly rounded and always flat; and the body is traversed

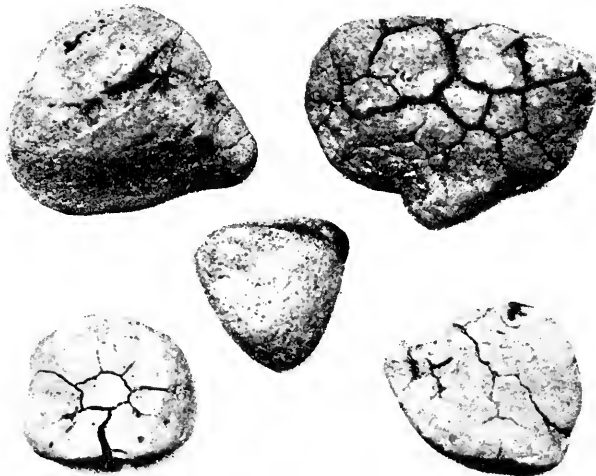

Fig. 41.—Various forms of lava scoria. Natural size.  
Loc.: Yokoyama.

1) A lava foam or froth, though different in kind, was noted in a recent paper by Jagger, Jr. (see *ante*, p. 93, footnote 3) as a product of 'gas-impelled and gas-heated fountains as the *initial manifestation* of a rising lava column.'



with contraction-cracks and finely textured on the periphery, while the inner part is coarse as in bread-crust bombs. Original shapes are greatly modified by frictional erosion while flying through the air. The size varies from 2 to 5 *cm.*, averaging 3 *cm.* There are 2 types in regard to *colors*.

*a)* *White Scum* (Pl. XX. Fig. 6).—This type is macroscopically a white, friable and saccharoidal mass, which under the microscope is speckled with polarizing particles of feldspar of 0.03 to 0.04 *mm.* in diameter, enclosed by elongated pores in colorless glass-film. Sometimes the feldspar particles form globular aggregates of 0.09 to 0.10 *mm.*, radially fringed with elongated pores (0.07 *mm.* in longer diameters) of glassy membrane. The feldspar polarizes with brown to bluish gray of the first order. The slightly brownish color of the scum is due to the yellowish iron globules attached inside the wall of the pores.

The coarser variety is purer in color and principally made up of glass-film, enclosing larger ellipsoidal pores (0.12 *mm.*). A few hypersthene<sup>1)</sup> and plagioclase crystals are present, being fringed with radially arranged and elongated pores, which are probably due to the liberation of heat during their crystallization.

*β)* *Gray Scum* (Pl. XX. Fig. 7).—Although macroscopically this type, of which the large bulk of the scums consists, differs from the preceding in color, being ashy or bluish gray, the microscopic appearance is the same in both, except the thin dispersal of finer particles of feldspar and the presence of aggregates of magnetite globules, and of very minute and round vacuoles (0.02 to 0.03 *mm.*). The vacuoles are responsible for producing that grayish

---

1) Sometimes it occurs in very fine euhedral needles, having an appearance of brownish rutile with totally reflected dark prismatic margin. Optically positive along prismatic axis, as in rutile.

effect of color by total reflection of penetrating rays of light. It is worth while to note that pores of the size of  $0.07\text{ mm.}$  have little effect on the microscopic appearance, while those of the minute size of  $0.02$  to  $0.03\text{ mm.}$  lend an allochromatic gray color to the scum. The minuteness of size, of course, contributes to the increment of vacuoles in a given space.

All the scums, including the white and gray types, contain bluish *cordierite* in moderate quantity, sometimes filled with globules of pyrrhotite, which habitually forms the centre of radiating air-pores (Pl. XX. Fig. 7, Pl. XXI. Fig. 1). They may, therefore, appropriately be called *cordieritiferous scums*, and their systematic position should be allotted to the *ceramicite group*.

2) **The Gabbroids as Ejecta** (Pl. XX. Fig. 8, Pl. XXI. Figs. 2–5, Pl. XXII. Fig. 1).—The projectiles of the gabbroids of segregate nature are found in 4 forms. The  $\alpha$  type is an elliptical bomb of about  $10\text{ cm.}$ , thinly coated with black slag. It is friable, easily to be crushed between the fingers, and its fractural surface has a white saccharoidal appearance with vitreous lustre. The  $\beta$  type is found in the form of flat discs. The  $\gamma$  type is met with in angular fragments in black compact andesite. It has a porcelain-like aspect (*ceramicite*) and resembles closely the well-known *cordierite-bearing ejecta* of the volcanoes of Asama and Iwaté. Microscopic patches—the  $\delta$  type with the composition and fabric of *norite*, are frequently noticed in the recent lavas from both the western and eastern vents. Lastly, the  $\epsilon$  type occurs in enclaves, having an eucritic composition, which deserves the *new name of microallivalite*.

The  $\alpha$  type—a *microtinite* (Pl. XX. Fig. 8, Pl. XXI. Fig. 2), is seen under the microscope to be composed of polygonal crystals of anorthite, closely fitted together as in contact texture, thereby

causing a macroscopically saccharoidal effects. It is an *anorthosite-equivalent in lava*. The anorthite shows no signs of plagioclase twinning, polarizes in brilliant colors with closely packed banding of spectrum colors on periphery, distinely seen in Figure 2 of Plate XXI. The size varies from 0.15 to 1.50 mm. The only other constituent is orthoclase(?) which fills, in patches (3 mm.), the interspaces left by the aggregates of anorthite (the black patches in Fig. 2, Pl. XXI. and the dirty field in Fig. 8, Pl. XX.). The grayish color of the orthoclase is solely due to the multitude of pores as in the quartz of mylonitized granite. Birefringence and refraction are lower than those of anorthite. Quartz, if present, is not easily distinguished from others by ordinary method. LACROIX mentioned the same blocks ejected from Martinique and Santorin.

This particular specimen of the enclave was qualitatively tested by KANAI, of the Higher Agricultural College of Kagoshima, and gave the following results:  $SiO_2$  very abundant,  $CaO$  and  $Al_2O_3$  abundant, alkalis ( $K_2O > Na_2O$ ) moderate,  $Fe$  little,  $MgO$  none. Presumably this white projectile is composed of anorthite mixed with a subordinate quantity of orthoclase, as is proved by microscopic analysis.

The  $\beta$  type (Pl. XXI. Fig. 5, Pl. XXII. Fig. 1) is a white disc of 10 cm. with black banding tinged slightly green (Text-fig. 42). It is rarely found and hitherto only in the east. It has a fine granular porcelain-like appearance on fractural surface, and the mineralogical composition of *diopside-gabbro* with aplitic texture. Basic plagioclase forms an equigranular aggregate of subhedrons and grains, some showing symmetric extinction at  $40^\circ$ , indicating that we have before us either bytownite or anorthite. Another granular component is anhedral diopside with augite-cleavage, zonally

colored light-green in centre, then bluish green, and lastly, brownish on margin. The last zone may be easily mistaken for a dioritic hornblende. The last but not least component are colorless elongated plates with high birefringence, positive character and a maximum extinction-angle of about  $26^\circ$ . It seems to be tre-

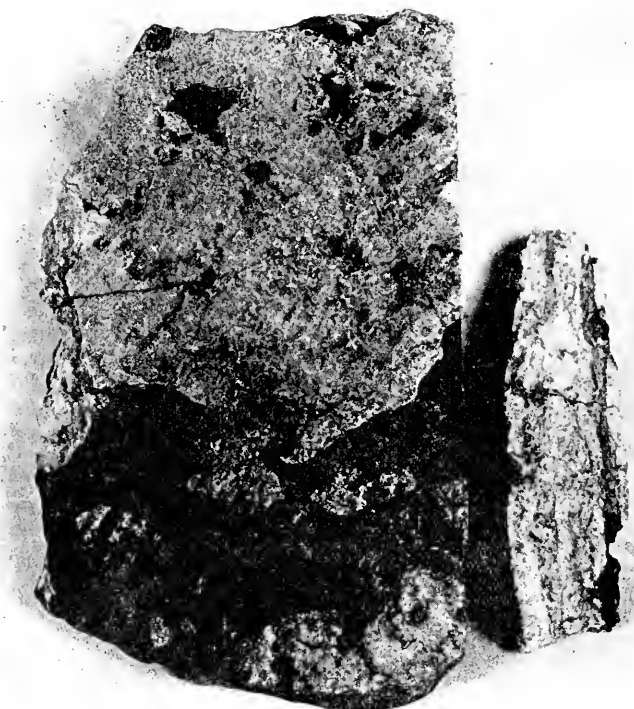

Fig. 42.—Ejecta of diopside-gabbro, a secretory product of angite-andesite. Right-hand figure is the cross section.

Loc. : Eastern slope of the Middle Cone.

$10\frac{1}{2} \times 8$  cm.

molite with amphibole cleavage.<sup>1)</sup> The whole is cemented by whitish or dirty residual glass.

The  $\gamma$  type—the lithoid microtinite, is, in contrast to the  $\alpha$  type, dull-white and slightly porous, and closely resembles the *third* type of *ceramicite* (p. 200). Microscopically, it is composed of anhedral microphenocrysts (0.4 mm.) of plagioclase imbedded in the groundmass of denticulated grains (0.040 to 0.015 mm.) of the same mineral. A few slender needles of diopside are intermixed

1) It looks very much like *wollastonite* in the nodule composed of anorthite and pyroxenes, which nodule is allotted to the category of the *polygenous endogene enclaves* in Lacroix's 'Montagne Pelée et ses éruptions,' p. 537.



Fig. 43.—White lithoidal microtinite in andesite-ejecta, found at Yokoyama.  $12 \times 8$  cm.

with the mass. The porous portion has mortar texture, the round plagioclase (? cordierite) grains being cemented with colorless glass full of vacuoles. Plagioclase<sup>9</sup>-phenocrysts are composed of an aggregate apparently forming trillings like those of cordierite, but their mineralogical nature is not yet definitely settled.

The writer considers this angular white enclave (Text-fig. 43) to be petrologically of diopside-gabbro.

*The  $\delta$  type*—a micronorite (Text-figs.

32 and 36). An enclave of noritic composition and motex has been known since the publication of LACROIX'S work on Montagne Pelée. In Japan the writer observed the same enclave, of a few centimetres in size, among the effusives of the volcanoes of Ontaké (Prov. Shinano) and Komaga-daké (in Hokkaidô). In the 'live' lavas of Sakura-jima, patches (1 mm.) of noritic segregation are of

1) Some of the plagioclase now under question may be a cordierite complicately multiple-twinning and penetrated after (110). Some are entirely composed of a cumulative aggregate of colorless rectangular and square-shaped embryo-crystals with *diagonal* extinction. They belong in all probability to cordierite.

quite common occurrence (pp. 156, 172, 186), although they are not usually recognized as such under the microscope. Hypersthene and basic plagioclase associate either with ophitic relation, or in hypidiomorphic granular aggregate. Olivine, if present, occupies the centre of patches peripherally corroded and fringed with vermiform magnetite. See Text-figs. 39 and 40.

*The  $\epsilon$  type* (Pl. XXI. Figs. 3-4). In April, 1915, F. ÔMORI found amongst ejecta a round reddish granitic body, 8 *cm.* in diameter, coated with black vitreous lava, between the second and third vent of the eastern side. On close examination it turned out to be a eucritic mass<sup>1)</sup> of probably segregate origin. A specimen of similar motex is in our Institute from the island of Nii-jima of the Izu group.

It is an hypidiomorphic aggregate of anorthite (0.8-1.5 *mm.*) and small pyroxenes (0.15 *mm.*), including hypersthene and augite in ophitic fabric. Anhedral olivine (0.15 *mm.* and less) is abundantly represented, being constantly enclosed in the feldspar (Text-fig. 44). Anorthite is of the same character as in the aforementioned gabbroids. This stone-meteorite-like ac-

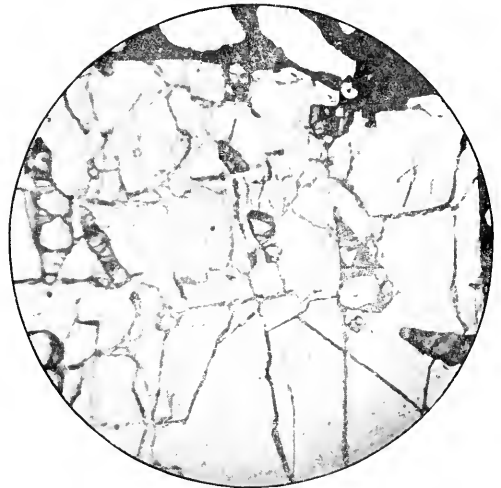

Fig. 44.—Feldspar-phenocryst in the eastern lava-field at Ycbino-tsuka.  $\times 18$ .

1) The rock closely resembles an aërolite called eucrite not only in its mineralogic composition, but also in its motex, being loose-granular, and the essential component, anorthite, also shows anomalous double-refraction and undulatory extinction. Being absolutely holocrystalline hypidiomorphic and partly poikilitic, we fail to find interstitial glass cement of a composition of feldspar called maskelynite in 'Meteoritenkunde.' Here the interstitial spaces, if any, are void and empty.

cessory mass of rock deserves the *new name of micro-allivalite*, since it is mainly composed of anorthite and olivine, corresponding to micronorite-patches in andesites first described and named by LACROIX in his well-known Martinique work.

A similar eucritic intergrowth or rather enclosure of anhedral olivines in a basic plagioclase is to be seen in the feldspar-phenocryst of the recent lava near Yébino-tsuka hill in the eastern lava-field, as in Text-fig. 44.

---

The whitish masses dealt with under the present heading are usually interpreted as formed under plutonic condition, and caught up by magma and brought to the surface. From the mortar texture with glass cement, pumiceous texture and pseudophenocrystic (cumuloporphyric) occurrences of masses, it seems they may not necessarily be formed in a deep horizon, and especially the noritic patches are likely formed even during subaërial flows.<sup>1)</sup> Anyway they are products of relatively early separation, and composed of minerals of high melting point among andesitic components. Selective crystallization and resistance toward resorption of the components caused magmatic differentiation, and concentrated the minerals in certain spots. The segregated portions were then conveyed through upward current to the surface. They are not, however, necessarily buoyed up in viscous magma from a deeper horizon, where the minerals gather owing to their comparatively high specific gravity.

It is to be noted that the enclaves of diopside-gabbro are

---

1) The macroscopic banding, *e.g.*, as in the  $\beta$  type (p. 191), is due to special aggregation of diopside and tremolite in one plane. To the writer this special texture seems to suggest the formation of the mass near the surface or on the surface of the lava-vent. Under plutonic conditions the same mass will crystallize in homogeneous mixture, or else the banding must be attributed to primary flow of segregation—a fact which is not observable in microscopic analysis in this granular aggregate.

found in large mass, while those of noritic composition are small and intimately mixed in lava-flows, as if forming an integral portion of rock components. Hypersthene as compared with diopside has lower melting point and density, and these seem to the writer to be the cause of the later origin and higher level of separation of noritic segregation.

Another lesson to be learned is, that basic diorite-schists and quartzless gabbros, both being usually considered to be plutonic, may be formed as accessory portions of modern effusives in a comparatively shallow horizon. The only difference observable in comparison with plutonic equivalents is the absence of garnet, which is the geologic barometer, occurring only in deep-seated rocks.

It is worth while to note in connection with microtinite that the normal chemical composition of the *base*, or *groundmass* of rocks of intermediate acidity like andesites, as observed by Teall,<sup>1)</sup> greatly resembles that of basic plagioclase. A slight addition of iron to the plagioclase-melt will result in the formation of chemical combinations of the enclaves which are mainly composed of glassy plagioclase or microtinite already referred to. From a chemical standpoint there is therefore no coercive ground in the way of explanation on the formation of the microtinite enclaves in our lavas from molten magma. Similar inclusions in sills have been already discussed by some British petrologists.<sup>2)</sup>

3) **The Ceramicites, Natural Porcelain Ejecta** (Pl. XXII. Fig. 2-8).—By the cordierite-bearing ejecta are here meant those porcelain-like projectiles from volcanoes, which contain cordierite as the charac-

---

1) 'British Petrography,' p. 42-43. See *postea*, p. 203.

2a) J. A. Smythe, 'On Some Inclusions in the Great Whin Sill of Northumberland.' *Geol. Mag.*, 1914, p. 214.

2b) Henslop and Smythe, 'The Dyke at Crooklone.' *Q.J.G.S.*, London, 1910, p. 7.



teristic component, the remaining ingredients being basic plagioclase and colorless glass, with a subordinate amount of hypersthene.<sup>1)</sup> There are gradual transitions from the preceding gabbroid ejecta (pp. 190–196) and lava scums (pp. 187–190) to the one under question, and a sharp line of demarcation cannot be drawn between them. The only difference is the presence of a characteristic, magnesian, orthorhombic mineral—the *cordierite*, which varies quantitatively within wide range. The more crystalline the mass, the less the amount of the cordierite, which sustains reciprocal proportion to basic plagioclase.<sup>2)</sup> If obsidian is a natural glass, the ejecta may fittingly be called *natural earthenware* or **ceramicite**<sup>3)</sup> with modifications corresponding to pottery, stoneware and porcelain. Ceramic wares are characterized by the presence of quartz and sillimanite, while the natural products contain cordierite and plagioclase in lieu of the two minerals.

The cordierite-bearing ejecta from Asama-yama are now well-known through the work of HUSSAK.<sup>4)</sup> Since then other occurrences were added to the list from Gōro-yama near the city of Nagano (Zenkōji),<sup>5)</sup> Ganju-san and Komaga-také near by, on the west of the city of Morioka,<sup>6)</sup> and the Komaga-také of Hokkaidō.<sup>7)</sup> Exactly the same ejecta were shown the writer by LACROIX,<sup>8)</sup> who gave a description of them. Mention may be made here of projectiles

1) Fine needles of this mineral often appear under the microscope like rutile. Cf. p. 189, footnote.

2) From the measurement of maximum symmetric extinction, oligoclase seems to be present among phenocrystic round crystals.

3) The writer ventures to give this *new name* to the multifarious cordierite-bearing ejecta. See *ante*, p. 187, footnote (1).

4) 'Ueber den Cordierit in vulkanischen Auswürflingen.' *Sitzungsber. d. K.K. Akad. d. Wiss. in Wien. Math.-Naturwiss. Klasse*, 1883, LXXXVII. S. 332.

5) N. Yamasaki, *Jour. Geol. Soc. Tôkyô*, Vol. II. p. 397. *Ibid.* Vol. IV. p. 35. (Japanese)

6) Found in the collection of the late Mr. Sakurai, deposited in our Museum.

7) Tak. Katô, 'Ueber die Cordieritführenden Einschlüsse in der Lava aus dem Vulkan Komaga-také auf Hokkaidô, Japan.' *Jour. Geol. Soc. Tôkyô*, Vol. XIX. p. 27.

8) 'La Montagne Pelée et ses éruptions.'

from the Laacher See.<sup>1)</sup> The garnet-bearing plagioliparitic effusives containing the same mineral are made known from Futakamiyama, Prov. Yamato,<sup>2)</sup> and Ôbora-yama,<sup>3)</sup> Prov. Isé, both being probably the same kind of rocks as those from Campiglia Maritima,<sup>4)</sup> Lipari,<sup>5)</sup> Cabo di Gata,<sup>6)</sup> and Tian-shan.<sup>7)</sup>

The ejecta from Sakura-jima may be divided into 5 types, according to granularity.

*The first type* (Pl. XXII. Fig. 2)—the saccharoidal modification—is pure white and saccharoidal with blue flecks (4 mm.) of short-prismatic cordierite and dark, irregular spots (1 mm.) of pyrrhotite. It crumbles easily between the fingers like the saccharoidal microtinite already mentioned (p. 190, the *a* type).

Microscopically, cordierite is porphyritic and anhedral or subhedral. It is peripherally resolved into subrectangular microcrystals arranged parallel to the *c*-axis of main crystals (Pl. XXII. Fig. 3), sometimes, however, being slightly divergent (Pl. XXII. Fig. 4) like digitate crystals or 'fingered aggregate' of andalusite in contact rocks, indicating that the larger cordierites were being formed during the turbulent state of the magma within the vent or in viscous lava. It is negative and bluish, parallel to *c*, and characteristically contains pores in the centre (Pl. XXII. Fig. 2, *c*). In other cases the cordierite is entirely built up of minute grains of the same mineral (Pl. XXII. Fig. 4). Irregular clumps of pyrrhotite of

1) R. Brauns, 'Die kristallinen Schiefer des Laacher Seegebietes und ihre Umbildung zu Sanidinit.'

2) M. Ôyû, 'Report on the Volcano Futakami-yama.' *Publications Imp. Earthq. Invest. Com.*, No. 27, Tôkyô. (Japanese)

3) Found during revising a student's slides.

4) *Zeitschr. d. deutsch. geol. Ges.*, 1861, S. 641; 1868, S. 327.

5) A. Bergeat, *N. J. Bbd.* XXX. and Bd. II. 1895.

6) A. Osann, *Z. d. deutsch. geol. Ges.*, XL. 1888.

7) In the Bogdo-Ola near Urumtsi, the femic diabase and salic keratophyres occur associated with the mediosilicic effusive of dacite besides Cordierite-liparite. G. Glunger, 'Die Gesteinswelt der Bogdo-Ola.' Inaugural Dissertation, München, 1912.

dull bronzy metallic lustre are intergrown with cordierite in approximately parallel arrangement in the direction of *c*-axis (Pl. XXII. Fig. 3).

The brilliantly polarizing simple grains of pure anorthite are partially enclosed or moulded upon dusty cordierite of gray color which is caused by the enclosures of superabundant minute vacuoles. A noteworthy feature is the isotropic colorless *glass ring* which surrounds the grain of anorthite (an) and which intervenes between the latter and the inclosing cordierite xenocryst (Pl. XXII. Fig. 2, c), as if the ring were the so-called contact rim.<sup>1)</sup> Patches of colorless glass fill up the interstices, which contains air pores in great abundance. In artificial earthenware such partial melts are frequently observed.

This type corresponds to artificial pottery in regard to its rough granularity although the color is marble-like. It grades into true microtinite, already referred to (p. 190).

*The second type* (Pl. XXII. Fig. 3)—the vesicular lithoidal modification—is a white vesicular body with compact stony ground and external chinks. There are 2 subgroups; the *one* with shining flecks of anorthite without visible blue cordierite, the *other* with abundant blue cordierite spots without plagioclase.

Microscopically, the highly birefringent phenocrysts (1 *mm.*) of simple anorthite are usually found in the more crystalline variety, the cordierite phenocrysts (0.4 *mm.*) in the finer modification. The cordierite is here composed of heterogeneous, polarizing grains with occasional pleochroic flakes, and the whole is rudely outlined by the homogeneous extinction by which one can discern the mineral from the general ground. Pyrrhotite clumps are enclosed in cor-

---

1) The substance of the rim or corona is probably akin to maskelynite, of the composition of a feldspar in aërolites.

dierite, and the tufts of *sillimanite* like those in porcelain are also found within the body of the same mineral.

The general mass is built up of polarizing crystalline grains (0.04 *mm.*) of plagioclase imbued with colorless glass which contains on the other hand superabundant vacuoles (Pl. XXII. Fig. 3). Empty hollows (0.2 *mm.*) are distributed through the mass, which cause vesicular texture. The ejecta are like stoneware burnt to about 1,300°C. just before the ebullition (so-called *storm*) of gases from a melt.

*The third type* (Pl. XXII. Fig. 4-5)—the compact lithoidal modification—is a porcelain-like projectile, occurring frequently in considerable size, often stained yellow or brown due to decomposition of pyrrhotite (Text-fig. 45). The ejecta are peripherally traversed with contraction-craeks, and break with conchoidal fracture having semitranslucent edges, while internally passing into the vesicular second type. This is the *normal type* (Pl. XXII. Fig. 4) of what we usually call the cordierite-bearing ejecta with violet spots of visible cordierite (Pl. XXI. Fig. 1).

Microscopically, it looks very much like the preceding second type, except the violet color of heterogeneous granulated cordierite and the scarcity of macroscopic pores.

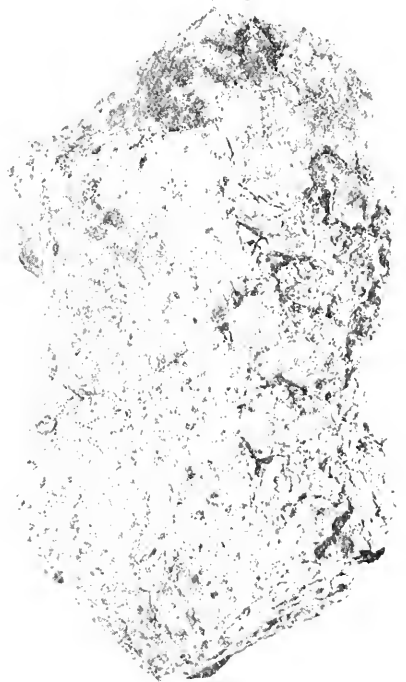

Fig. 45.—A lithoidal ceramicite.  
Loc.: Koiké. 16×9 *cm.*

An analysis of this type was kindly made for the writer by Mr. ÔHASHI, of our Geological Survey, with the following result: Sample taken was 1 gram.

<i>SiO</i> <sub>2</sub> . . . .	77.35	Norm : <sup>1)</sup>			
<i>Al</i> <sub>2</sub> <i>O</i> <sub>3</sub> . . . .	12.16	Quartz	<i>SiO</i> <sub>2</sub> . . . . .	46.47	Q 46.47
<i>Fe</i> <sub>2</sub> <i>O</i> <sub>3</sub> . . . .	0.81	Orthoclase	<i>K</i> <sub>2</sub> <i>O</i> · <i>Al</i> <sub>2</sub> <i>O</i> <sub>3</sub> ·6 <i>SiO</i> <sub>2</sub> . .	15.79	} <i>Sal</i> 87.30
<i>FeO</i> . . . .	1.09	Albite	<i>Na</i> <sub>2</sub> <i>O</i> · <i>Al</i> <sub>2</sub> <i>O</i> <sub>3</sub> ·6 <i>SiO</i> <sub>2</sub> . . . .	20.54	
<i>MgO</i> . . . .	1.26	Anorthite	<i>CaO</i> · <i>Al</i> <sub>2</sub> <i>O</i> <sub>3</sub> ·2 <i>SiO</i> <sub>2</sub> . .	3.98	
<i>MnO</i> . . . .	0.05	Corundum	<i>Al</i> <sub>2</sub> <i>O</i> <sub>3</sub> . . . . .	0.52	
<i>CaO</i> . . . .	0.90	Water	<i>H</i> <sub>2</sub> <i>O</i> . . . . .	0.37	} <i>Fem</i> 11.86
<i>Na</i> <sub>2</sub> <i>O</i> . . . .	2.43	Cordierite	2 <i>MgO</i> ·2 <i>Al</i> <sub>2</sub> <i>O</i> <sub>3</sub> ·5 <i>SiO</i> <sub>2</sub>	9.57	
<i>K</i> <sub>2</sub> <i>O</i> . . . .	2.67	Pyrrhotite	<i>Fe</i> <sub>3</sub> <i>S</i> <sub>5</sub> . . . . .	0.77	
<i>H</i> <sub>2</sub> <i>O</i> . . . .	0.52	Apatite	3 <i>CaO</i> · <i>P</i> <sub>2</sub> <i>O</i> <sub>5</sub> . . . . .	0.19	
<i>TiO</i> <sub>2</sub> . . . .	0.20	Magnetite	<i>FeO</i> · <i>Fe</i> <sub>2</sub> <i>O</i> <sub>3</sub> . . . . .	0.42	
<i>P</i> <sub>2</sub> <i>O</i> <sub>5</sub> . . . .	0.08	Hematite	<i>Fe</i> <sub>2</sub> <i>O</i> <sub>3</sub> . . . . .	0.53	
<i>S</i> . . . . .	0.30	Ilmenite	<i>FeO</i> · <i>TiO</i> <sub>2</sub> . . . . .	0.38	
	<u>99.82</u>				

From the norm, ratios are given as below :

Persalane	Columbare
$\frac{Sal}{Fem} = \frac{87.30}{11.86} = 7.36 > \frac{7}{1}$	$\frac{Q}{F} = \frac{46.47}{40.31} = 1.15 < \frac{5}{3} > \frac{3}{5}$
Alsbachase	Tehamose
$\frac{K_2O' + Na_2O'}{CaO'} = \frac{67}{14} = 4.79 < \frac{7}{1} > \frac{5}{3}$	$\frac{K_2O'}{Na_2O'} = \frac{28}{39} = 0.77 < \frac{5}{3} > \frac{3}{5}$

The ceramicite is a *salic* segregate of augite-andesite, and chemically speaking, it represents a series of biotite-granite, quartz-porphry, rhyolite and quartz-porphry schist.

The *fleckless* barren modification (Pl. XXII, Fig. 5, and Text-fig. 45) contains idiomorphic phenocrysts (1 mm.) of polysynthetic anorthite imbedded in the vacuole-rich glass ground, which contains a few corroded non-pleochroic cordierite (the rather large subangular

1) Calculated by T. Ogura.

white flecks in Fig. 5) and minute fragmentary plagioclase. The whole microscopic aspect presents that of a tuff cemented with glass. This feldspathic modification may be called the 'faience' of natural earthenware with fine semitranslucent texture.

*The fourth type* (Pl. XXII. Fig. 6).—It is marble-white and fine, light and friable. It shows banding, caused by alternation of a bluish compact zone (*a*) with a lustreless vesicular one (*b*). This projectile is astonishingly rich in ill-defined granulated cordierite (*c* in Fig. 6). The banding is, as seems to the writer, an indication that the ejected fragment in question is not segregated under plutonic conditions, nor a resorption-rest of an *exotic* fragment, as it is usually interpreted, but a primary segregation-product of lavas near the surface. To support the writer's case he has in his possession a bluish *pumice full of cordierite*, ejected from Asama on December 14th, 1912. See Pl. XXI. Fig. 1.

Microscopically, the (*a*) zone is exactly the same as the third, lithoidal type, while the (*b*) zone represents the lava scum.<sup>1)</sup> Again, we have here an indication that the ceramicite and lava-scum are genetically closely related. The banding points to being a result of circulation of lava in the intercrateral area.<sup>2)</sup>

*The fifth type* (Pl. XXII. Fig. 7).—The wet-gray, striped, resinous, porcelain-jaspilite variety, breaking with subconchoidal fracture.

The light colored stripe (*a*) is composed of subrectangular<sup>3)</sup> or roundish<sup>4)</sup> crystals of cordierite (0.025 mm.) besides a few larger ones, intermixed with prismoids of plagioclase and fine needles of hypersthene; the whole is imbedded in a colorless base, which encloses

1) Pl. XX. Fig. 6 shows the lava-scum zone (*b*) of the ejecta.

2) F. A. Perret; *Amer. Jour. Sci.*, 1913, p. 345.

3) See the photomicrograph, Pl. XXII. Fig. 7 (groundmass).

4) It is Lacroix's 'colloidal cordierite.' *Op. cit.*

vacuoles and brownish glass-drops, the former appearing black by total reflection. The dark-gray band (*b*) does not materially differ from the preceding (*a*), excepting the presence of larger patches of cordierite, irregularly distributed in glass full of vacuoles and brown amorphous enclosures, which both lend to the rock the grayish tinge.

---

In summarizing what is stated above, the cordierite-bearing porcelain-like ejecta, here called ceramicites, greatly resembles *earthenwares* with various modifications resulting chiefly from the difference of temperature at which the industrial products are artificially melted and manufactured. These volcanic ejecta compare well on one hand with the crystalline microtinite (p. 190) and on the other with the cryptocrystalline lava-scums (p. 187), already briefly mentioned; they are genetically related to one another and all three consolidated under comparatively low pressure, probably near the open vent, as in the recent pumice of Asamayama.

The *components* found in the ejecta are anorthite, sanidine, cordierite, pyrrhotite, magnetite, hypersthene and sillimanite, besides spongy glass; the first two scarcely to be distinguished on account of the absence of twinning structure. Noteworthy features are the absence of quartz, muscovite and even biotite, the latter being chemically akin to cordierite. The quartz is always mentioned by the writers on cordierite-bearing ejecta as making a large bulk—an error arising from misinterpretation of cordierite and feldspars. There is little probability for the presence of a large amount of quartz, the silica being represented in the colorless glass.

The pyrrhotite mentioned above is the characteristic component of ceramicite, by its presence alone the writer is able to recognize the ejecta from the rest of the projectiles. The colors

by reflected light can afford a clue in discriminating the sulphide from pyrite. Moreover, the presence of pyrrhotite is the sign of eruptivity, while pyrogenic pyrite is a product of post-volcanic activity. A rock similar in mineralogic composition to the well-known pyrrhotite-bearing *cordierite-gneiss* of plutonic origin found at Bodenmais, Bavaria, is, therefore, represented in the recent lava of Sakura-jima.

From the mode of the constant association of pyrrhotite and cordierite, the writer surmises a peculiar relation between them. In the grayish porcelaneous ejecta thrown up in a temporary eruption of Asama on the 13th of December, 1912, we find grayish blue stripes, which under the microscope (Pl. XXII. Fig. 8) are seen to consist of an aggregate of cordierite rectangles cemented by pyrrhotite—a mass serving for the matrix of the resorption-relic of the microphenocryst of a basic plagioclase (an). The cementing pyrrhotite sustains the same relation to the enclosed cordierite microcrystals, as the xenomorphic chalcopyrite to the idiomorphic ironpyrite of high crystallinity in ordinary orebodies. Both the pyrrhotite and cordierite are primary secretory products of a basic andesite magma, and any explanation on the close association of iron and copper pyrites will help in the elucidation of the genetic relation of the two minerals in our ceramicites.

The neovolcanic *cordierite* is associated with andesites and liparites, but not with basalt, so far as the writer is aware of. The cordierite-bearing ejecta are direct offsprings of the former, while in the latter (plagioliparite) they occur as cognate xenoliths (HARKER).

Exhaustive study of cordierite is out of place here. The writer can only say that idiomorphic crystals, save those rectangular microcrystals, are not observed. Trillings, whose formation is sup-



posed to be attributable to high temperature (A. von LASAULX), are frequently seen. Optically positive, and pleochroic only in larger individuals;  $c > b = a$ .

A characteristic feature is the accumulation of variously orientated grains (Lacroix's colloidal cordierite), of which the whole interior of the cordierite is built up (Pl. XXII. Figs. 4 and 6), and such composite crystals appear macroscopically dark-blue. When clear crystals are seen, minute pores are characteristically found in the central part, thereby coloring allochromatically grayish-blue,<sup>1)</sup> and the vacuoles are probably, originally, open spaces left between granules, as in porcelain pores.

Larger cordierite is habitually resolved peripherally into grains (colloidal cordierite), or microcrystals rudely arranged parallel to the *c*-axis (Pl. XXII. Fig. 3). Both the external and internal granulations seem to have risen from regressive resorption rather than from imperfect growth. Where roundish clear plagioclase is enclosed poikilitically within the vacuole-rich cordierite, the former is fringed with isotropic substance, as if it were a reactional rim (the corona of French authors), which sometimes contains gas pores (Pl. XXII. Fig. 2). It may arise from remelting through a temporary rise of temperature.

*Glass* makes up the colorless groundmass in variable quantity, in which an excess of  $SiO_2$ , found in the analysis, is likely to be contained. It is always full of pores. When the vacuoles sink to 0.02 to 0.03 *mm.*, the glass appears macroscopically gray on account of total reflection of light; otherwise it looks dull-white.

---

As to the *mode of formation of ceramicites* or cordieritiferous ejecta, the petrologists are not in accord in their opinions, but

1) The writer conjectures that the characteristic bluish colors and pleochroism of cordierite are attributable to the same cause.

they are right in special cases, as the ejecta may not be of a single origin. LACROIX and BRAUNS (*loc. cit.*) have already given a summary of views on the modes of formation, which may be grouped into the following headings:

- i. Intratelluric concrétion of a trachytic or syenitic magma (HUSSAK).
- ii. Contact-metamorphic product of the caught-up schists or sedimentaries (BRUHNS and YAMASAKI).
- iii. Crystallized mass from syntectic magma under plutonic conditions (TAK. KATÔ).
- iv. Imperfectly resorbed ancient rocks (LACROIX and BRAUNS).

LACROIX<sup>1)</sup> made a close study of the ejecta from Pelée and La Soufrière, which are akin to those of Sakura-jima. He is inclined to believe the cordierite to be mostly of secondary nature, formed either in andesites or dacite magma, and recognized three possible cases of its formation.

- a) Resorption-relic of a rock-fragment, e.g., granite.
- b) A mineral newly crystallized from the melt of cordierite-bearing rock-fragment.
- c) Newly crystallized in a cordierite-free rock, which suffered chemical reaction of new magma in coming in contact with it.

Around the two volcanoes, Montagne Pelée and La Soufrière, there are, according to LACROIX, diverse cordieritiferous blocks derived from preëxisting unknown rocks, *viz.*,

- a) Blocks composed of zonal feldspar (oligoelase-anorthite), hypersthene, biotite, cemented with grains of quartz and some glass. Miarolitic spaces are filled with cordierite.

---

1) 'La cordierite dans les produits éruptifs de la Montagne Pelée et de la Soufrière de Saint-Vincent.' *Compt. rend.* **137**, p. 115-117, 1903.

- β) White porcelain-like masses flecked with cordierite, being a breccia of an old andesite. Cordierite is formed by the reaction of constituents of new andesitic magma upon a metasilicate of the preëxisting one.
- γ) Fragments of breccia cemented with opal-like matter, the fragments themselves being aggregates of cordierite crystals.

Taking into consideration what has been actually observed of the ejecta and what others have said of similar projectiles, the writer is forced to the following conclusions from the data given below :

- 1) The cordieritiferous ejecta or ceramicites greatly resemble ceramic wares.
- 2) They contain primary glass-enclosures and air-pores.<sup>1)</sup>
- 3) There are no biotite nor amphibole (with the exception of tremolite), both only crystallize under intratelluric environment, the cordierite being the vicariate of biotite.
- 4) Quartz, so frequently spoken of as making a large bulk, seems to be for a greater part due to misinterpretation of either cordierite, feldspar or some other colorless minerals.
- 5) The small, grayish, dough-shaped *lava-foams*, in which cordierite and feldspars are frequently found, make gradual transitions to the solid ejecta or ceramicites.
- 6) The minerals composing the ceramicites are of light chemical elements, and colorless, excepting a subordinate quantity of ferriferous minerals, viz., hypersthene and diopside.

All in all, the writer is disposed to think that the cordieritiferous ejecta of Sakura-jima are of primary leucolithic consolida-

1) The presence of gas-bubbles is the sign of melts at low pressure, and the gas contained may be the one originally caught up between subcrystals, or occluded from air.

tion and local collection of crystals from melts under low pressure at or near the surface within the vent, where the temperature is lower than the interior, that is to say, a subaërial product, during the Strombolian activity (PERRET); for this reason we have lava-scum and cordierite-bearing pumice. Chemically speaking, they seem to correspond to the groundmass (p. 196)<sup>1)</sup> of andesite, the phenocrysts of early crystallization sink down to a lower horizon, thereby producing the total effect of selective crystallization-differentiation. The crystalline ejecta, e.g., ordinary ceramicites, on the other hand, are the assemblage or secretion of chemically light crystals in a rather lower horizon, buoyed up through the magma to the surface, assisted by the ascent of gas and the circulation of liquid lava within the vent.<sup>2)</sup> It is difficult to say anything about the origin of the magma, whether primary or syntectic, although the former is for the greater part highly probable.

The ceramicites are consolidated leucocrates of andesitic magma, formed close to the wall of the vent at a shallow horizon. The volcanic scums (p. 187), the gabbroid ejecta (p. 190) and the ceramicites all seem genetically of the same origin, differing only specifically. They probably correspond to LACROIX'S enclaves homœgènes or HARKER'S cognate xenoliths.

#### 4) **Solid Ejected Blocks of Juvenile Lava.**—The 'live' lava makes

1) Within the exogenous contact zone of the oligoclase-granite in the Orijärvi region, Pentti Eskola mentions a greater number of cordierite-gneisses, skarns and ores, which are said to be formed by pneumatolytic metamorphism under plutonic condition. It will, however, appear at first sight paradoxical to find their analogous products among the juvenile recent ejecta of Sakura-jima.

It is worthy of note here, that he often speaks of the *conversion of plagioclases into cordierite*, which is expressed in the term of chemical formulas. The present writer is also convinced of the fact, that there exists an intimate relation between feldspars and cordierite, the latter often poikilitically enclosing the former with the corona of glass between them. See Pl. XXII, Fig. 2. 'On the Petrology of the Orijärvi Region in Southwestern Finland.' *Bull. Com. Géol. de Finlande*, No. 40, 1914, pp. 167-262.

2) Perret, 'The Circulation System in Halemaumau in Lava Lake during the Summer of 1911.' *Amer. Jour. Sci.*, 1913, p. 345.

up undoubtedly a large portion of ejecta, besides gray lapilli, and the size differs within wide limits from 2 *m.* to 2 *cm.*, depending on the distance from vents and the fury of eruptions, those of later phases being smaller in size and compact. They are all black and porphyritic with plagioclase phenocrysts. Textures vary from compact to vesicular and even slaggy, lustres also from pitch-black to dull. Petrographic characters are the same as the main flows, of which qualitative microscopic analyses and descriptions were already given (pp. 176–181, 184–187).

As has been pointed out already, the lavas of the acidic, western, and the basic, eastern flow differ only in slight degrees. The ejecta of the *east* side are, however, rich in basic plagioclase (labradorite, symmetric extinction  $30^{\circ}$ – $33^{\circ}$ ), and in hypersthene, augite being present only in subordinate quantity, and the glass of the groundmass white.

Those of the *western* side contain a large quantity of highly birefringent non-pleochroic augite. The nature of plagioclase is apparently the same. The prevailing type of the groundmass contains brown glass and augite microlites in large quantities, in contrast to the eastern flows.

5) **Bread-crust Bombs.**<sup>1)</sup>—The bread-crust bombs or turtle-back bombs are the characteristic projectiles of the west, varying in size from 10 *cm.* to 1 *m.*, and always angular in form. They are a common type all over the globe, frequently depicted and described among the projectiles of recent volcanoes. Larger ones make hollows in dashing against the ground, whereby the projectiles themselves break open, exposing the gray spongy interior, the color being solely caused by fine inclusions of gas. The exterior is black and compact, passing by degrees to the brown and gray

---

1) On the formation of bread-crust bombs see p. 114.

interior, and traversed with cracks which usually radiate from deeper clefts of the interior. They are the juvenile lava half consolidated within the vents, where they burst open and were thrown up into the sky.

There the outer portion is farther cooled down, while the interior is vesiculated and expanded by relief of pressure, thereby creating cracks in the glassy skin. The lapilli, abundantly scattered about, seem to be mainly *fragments of the inner portion*, rent open through mutual collision of the bombs while flying in the air. Their petrographic nature is hypersthene-andesite with hyalopilitic texture. The brown glass of the groundmass swarms with equal quantities of augite and feldspar microlites.

Microscopically, the rock is exactly the same as that of the lapilli, except the texture, it is therefore not necessary to restate here a petrographic description (p. 211). The following points are, however, worthy of note:

- a) The flowage texture of dopatic hyalopilitic groundmass has no relation to the surface of bombs.
- b) Quantitative relation and the distribution of phenocrysts are uniform throughout the mass.
- c) Microlithic bodies are quantitatively uniformly distributed in different portions, contrary to expectation.
- d) All the petrographic elements were already there during the aerial journey, the crystallinity of bombs having already been attained during their intercrater stage.
- e) The only special aspect to be noted is the vesiculation of the groundmass, which causes macroscopic differences in color, texture and lustre.
- f) Vesiculæ during their formation shifted microlites away sideways.

- g) Vesiculæ are less in number around larger vesicles.
- h) Around the hollows, microlites are tangentially arranged parallel to the margin, indicating that the lava still remained in a semifluid state during the gaseous expansion.
- i) The sudden relief of pressure is solely responsible for the evolution and coalescence of gas pores.

6) **Recent Lapilli ('little stones').**—a) Lapilli or pumiceous blocks making a large bulk of ejecta around the *western* vents are externally rusty brown and internally fresh and ash-gray, dotted with plagioclase crystals (2–3 mm.). The feldspar shows a *gray* fractural surface streaked with polysynthetic lamellar sutures, and the gray color is due to both brown glass- and granular enclosures. Pleochroic hypersthene and deep greenish-brown augite (hypersthene > augite) are mafic phenocrysts. Micronoritic patches of hypersthene and bytownite, and gabbroic ones were noticed. The pumiceous hyalopilitic groundmass is of *brownish* glass, in which are scattered fibrillated augite-needles, like spicules in sponges.<sup>1)</sup> A subordinate quantity of feldspar-laths is intermixed with augite. The brownish outer portion of lapilli contains a globulitic body in the vesiculæ through oxidation in contact with air.

β) In contrast to the lapilli of western Sakura-jima mentioned above, those which fell in the Ushiné coast of Ôsumi Province, which were thrown up from the *eastern* vents, are of lighter shade (Pl. XXIII, Fig. 5). The microscope reveals not a few distinctive features. Augite is apparently lacking, and hypersthene represents the whole pyroxene.<sup>2)</sup> Plagioclase is more basic, highly birefringent and more distinctly zonal-structured. Brownish an-

1) It is analogous to the structure of the thread-lace scoria (p. 187, footnote 2).

2) Pl. XXIII, Fig. 6. Isolated by washing after crushing of the lapilli that fell on Tabé in the Ushiné coast near the defunct strait of Sêto.

hedral *olivine* is accessorially found. The dominant groundmass is *colorless* pure glass, and pumiceous.

In short, the eastern lapilli are of comparatively basic nature, corresponding to the massive lava-flows, as has been already emphasized elsewhere (p. 184).

7) **Porphyritic Obsidian** (Pl. XXIII. Fig. 4).—The single specimen of porphyritic obsidian found was picked up from among the ejecta on the east side at an altitude of 400 *m*. It is a compact pitch-black vitreous glass dotted with grayish lustreless specks of plagioclase. Slides show abundant and seriate phenocrysts of plagioclase and a subordinate amount of pyroxenes (augite > hypersthene), besides magnetite clumps in a brownish damascened glass,—a texture resulting from kneaded and compressed air-pores as in the figure. In a certain homogeneous portion of brown glass, brownish axiolites and colorless crystallites are found in fluidal arrangement. A substance similar in texture to obsidian occurs as coating of trass (Pl. XXIII. Fig. 3, and Text-fig. 46, p. 215) and other projectiles.

8) **Pseudobombs of Ancient Lavas**.—There are ejecta, though quantitatively insignificant, of ancient lavas of various shape and size, more or less rounded through subaërial mutual abrasion, which may appropriately be called *pseudobombs*. Their common feature is the ash-gray color; but the texture varies from compact and tabular to somewhat scoriaceous.

*a*) One kind consists of *hypersthene-andesites*, and their petrographic character is the same as the Kita-daké type, to which the reader is referred for details (pp. 155–158). Specimens were only picked up on the western slope. During the earlier explosive phase vents were rent through the rock of which the western slope is built, and the ruptured resurgent fragments were thrown up among the juvenile lavas.



β) Among the gray ancient rocks, there is a light-gray rough trachyte-looking ejecta. Under the microscope, weakly pleochroic, old-looking hypersthene is enclosed by a peripheral zone of brownish 'hornblende.' Gray apatite and tridymite were also observed. This *hornblende-hypersthene andesite* might represent the mesa sheet above the lapilli bed of the Plateau Formation (Younger Tertiary or Early Diluvium) of southern Kyûshû ( $A_2$  in Text-fig. 3, p. 14). If the writer's supposition proves to be right, the foundation of the volcano must be assumed to be the Plateau Formation, especially in taking into account the associated lapilli, which have been described as the 'ejecta of trass.' See page 214.

γ) Among the ejecta of the western slope, an angular grayish enclave of secretory origin was collected, which was caught up in a mass of the Furuhata lava or the North Cone type. This 'homogenous' inclusion (Pl. XX, Fig. 5) has microlithic texture, being built up of microlites of feldspar (1 mm. in length), divergently arranged with polygonal spaces left between them, as if residual glass leached out through a net-work of feldspar-skeletons. The microscope reveals that augite crystallized optically with feldspar-microlites, and the thin membrane of colorless glass stretches between microlithic webs. This is called the 'structure enchevêtrée' (halter strap structure) by Lacroix.<sup>1)</sup>

δ) There are some round blocks with black coating. They are the disrupted fragments (Kita-daké type) of the mountain body, that fell within the caldron of broiling lava and were again thrown out in the proximity of the ventholes. The effect produced in

1) 'La Montagne Pelée et ses éruptions.' Pl. XXX, Fig. 6. From Dr. Sidney Powers, the writer received a specimen of olivine gabbro, taken from the walls of Kilauea, described by R. A. Daly as a wehrlitic intrusive arching up ash bed after the manner of laccolith.—'Igneous Rocks and Their Origin,' p. 76. On seeing a slide of it under the microscope, it shows the structure enchevêtrée as in our *secretionary* patches, although olivine is wanting in the Sakura-jima rock.

the lava bath is simply caustic and slight, showing that the temperature in the vents was far below 900°C. Augite-microlites, as well as phenocrysts, are hematitized rusty brown, and the colorless glass has become granular. The alterations occur patchwise near the contact.

9) **Ejecta of Trass or Ash-stone (*Hai-ishi*).** Pl. XXIII. Fig. 3.—There are peculiar ejecta, though quantitatively insignificant, among the projectiles in western Sakura-jima. They grade in color from brick-red to brown and finally to gray, and are trass-like poly-mictic in composition, being built up of fragments (4 *mm.* to 1 *cm.*) of the black Mesozoic slate and black porphyritic augite-andesite, whitish pumice and grayish hornblende-biotite-hypersthene andesite. The agglomeratic mass is sometimes coated with a black rind of recent lavas (Text-fig. 46). The ejecta may be grouped into two forms :

*α*) Grayish *balls* of more than 6 *cm.* in diameter, without any coating of black rind. The form is the result of frictional abrasion of friable projectiles while flying in the air. The balls or pseudo-bombs effervesce with acids.

*β*) *Angular fragments* of various sizes, sometime attaining the considerable dimension of 1 *m.*, and in one or two instances making hollows in the ground by projectile impact. The fragments, or rather blocks, are always coated partially with black rind as in Text-fig. 46, and non-effervescent with acids. The core in contact with the rind is colored brick-red through oxidation, gradually changing into brown and then gray.

Under the microscope, the black vitreous white-spotted *rind*, 5 *cm.* thick, proves to be a vitro-pyroxene andesite (porphyritic obsidian) with the phenocrysts of plagioclase, hypersthene prisms and augite grains (hypersthene > augite). The bulk of the rind is made up of brown glass, which is crowded with skeletal microlites



Fig. 46.—Trass, a magma-soaked lapilli aggregate, partially coated with obsidian rind. Loc. : Koiké.

of plagioclase mixed with a subordinate quantity of those of augite. It may perhaps have consolidated from partially resorbed magma from trass mass, *i.e.*, chemically speaking, syntectic.

The *trass core* contains fragments of the underlying Mesozoic slate. The second component is dark brown augite-andesite. The third is gray, hornblende-bearing biotite-hypersthene andesite or ash-stone (*hai-ishi*). The grass-green hornblende and weakly pleochroic prismatic light-colored hypersthene are the mafic elements, besides accessory biotite and diopsidic augite and abundant plagioclase (andesine) phenocrysts. The groundmass is highly feldspathic and full of feldspar microlites in colorless glass. The component rock is an ancient piperno andesite that built up the base of the volcano. The fourth and the last component is the pumice derived from the preceding, and the pumiceous hollows are entirely filled with *calcite*. The third and fourth together make up a large bulk of the trass.

The piperno<sup>1)</sup> andesite and pumice, as already stated, built up the extensive plateau of southern Kyûshû,<sup>2)</sup> and constitute the

1) See page 13 and footnote on *hai-ishi*.

2) See page 19.

foundation of the volcano. They were burst and thrown out from the vent, commingled with other ejecta. That they are ancient ultra-Sakura-jima andesite is proved by the presence of *hornblende* and *biotite* in fragments. The volcanics of above characters are entirely wanting in the indigenous lavas that compose the body of Sakura-jima. The infilling of calcite in pumiceous space is worthy of note, and it is not found in the trass with lava rind, as calcite dissociates at 900°C. under normal pressure. The calcite is at times vicariated by a brownish isotropic irregularly-split 'opal'-like substance, which greatly resembles imperfectly fused feldspar grains in pottery.

10) **The so-called Sandstone.** Pl. XXIII. Fig. 2.—Among the western ejecta, the rock-collectors find grayish banded fragments called sandstone in Sakura-jima. On the banding plane glimmering white flecks of biotite are seen looking like muscovite-sandstone. The fracture at right-angles to the former shows wet-gray resinous lustre. It is the pumiceous hypersthene trachyandesite bearing hornblende and biotite (*ho* in Fig.), and constitutes the foundation of southern Kyûshû and also the base of the insular volcano. The two minerals are well seen in the photomicrograph, the hornblende being darkened (*ho*) through the caustic action of recent magma.

Under the microscope, the resinous lustre is seen to be caused by infilling of dirty amorphous silicate in the pumiceous hollows. This glass-soaked rock was rent and thrown up like the preceding trass to the surface, intermixed with polygenous projectiles.

11) **Ejected Blocks of Biotite-granite.** Pl. XXIII. Fig. 1.—There is a unique projectile among the ejecta collected by KANAI on the margin of the main western crater, and this is a block of granite. The rock *in situ* can only be found at a distance of 15 km.

southeast on the mainland in Prov. Ōsumi, where the so-called Mesozoic slate occurs, intruded by a granite boss which bears a low grade copper ore-deposit. As stated elsewhere, Kagoshima Bay can be best explained by an assumption of meridional fault-block depression (pp. 18–20), and the basement upon which Sakurajima rests should be identical in geologic composition to the neighboring plateau-land. The Plateau Formation (p. 14) is composed of a *lapilli* bed underlaid by marine *tuffite* and trachyandesite, which in turn lies upon eroded edges of Mesozoics intruded by granite.

The first and second are represented among the ejecta by the 'ejecta of trass' (p. 214), and the first also by the so-called sandstone (p. 216). In addition to these, our new find of granite among the recent ejecta is of great significance in deciphering the composition of the foundation of the volcano. Anyway the fragment was disrupted from the bottom at least 1,000 *m.* below, and without being assimilated in the lava bath, was conveyed to the surface.

The granite block, 10 *cm.* in size, is rounded on the edges by corrosion, and colored slightly brown. It is dull white and friable through fritting by hot magma, and has an impaired and faded aspect. See Pl. XXIII. Fig. 1. The *feldspars* have lost their lustre and the biotite is changed into a brick-red mass. The microscope shows the *biotite* to be impregnated along the cleavage plane with yellow crystals of sulphide ore (pyrrhotite), and newly formed minute muscovite-like flakes take the place of the original biotite, sometimes arranged divergently, intermixed with hematite, the fresh substance being no more seen, and appearing black in Fig. 1.

The *quartz* is milky-white. It is minutely cracked, as if quenched, and filled with muscovite(?) flakes. Some portion is

remarkably changed into an aggregate of confused straightly extinguishing fibres, which may be an allotropic quartz, and the normal portion is swarmed with liquid inclosures, which are arranged without relation to cracks. The *orthoclase* is entirely altered into an aggregate of doubly refracting pseudophlitic substance presenting a blurred aspect in the figure. In short, the changes which the granite suffered, are of a caustic nature and the result of intense baking.

Continuous regular long cracks in quartz intersecting at obtuse angles may be traceable to the rhombohedral cleavage. The sericitization of orthoclase started from twinning sutures and also from externally-bounding faces, and this alteration seems to have taken place not in a *low* temperature, as it is usually assumed. We find no tridymite which may be thought to have originated from  $\beta$ -quartz. It is stated<sup>1)</sup> that above 870°C  $\beta$ -quartz inverts to tridymite; but unless a flux is present this change does not occur until a temperature of 1,400°C is attained. Our granite-block must have been dropped into a bath of andesite-magma having a temperature of above 1,130°C (p. 112), and yet tridymite was not formed.

The friability of the granite ejecta may be attributable to the molecular (cleavage and twinning) and physical (expansion) changes which promote disintegration through great heat.<sup>2)</sup>

1) W. A. Tarr, 'Study of Heating-Test.' *Eco. Geol.*, 1915, p. 348.

2) During the field work in the volcanic district of Kaimon at the entrance of Kagoshima Bay in 1915, M. Nagabuchi made an interesting find of dull white subangular blocks of granite about 10 cm. in diameter. The granite is turtle-backed, much cleft and friable, and easily crumbles by hammering. It is found scattered about between the northern slope of the Konide of Kaimon and the northerly lying Lake of Ikéda, a caldron-shaped eratical depression of volcanic origin, nearly equal in dimensions and mass to the volcano of Kaimon. No granitic rocks are exposed on the surface within a distance of 19 km. (in Prov. Ôsumi). Therefore, it is not unreasonable to conjecture that our fritted granite blocks were torn away and thrown out from the subcrust by an intense volcanic explosion, as in the case of ejecta of Sakura-jima. Here we have again the proof, that explosions of pent-up gases play a more important rôle in volcanic eruptions than we have hitherto imagined.

12) **Coal.**—A fragment of coal was also collected by KANA near the western vent at an altitude of 300 *m*. It is a bituminous black coal which, however, shows submetallic lustre on the cleavage plane with a slight tarnish. One may be skeptical on this occurrence near vents where we could scarcely expect to find it. There is no probability of coal having been carried up this barren mountain-slope by man before the eruption. As similar fragments have been picked up recently by other collectors, they may have been ejected during the first phase of the eruption from the bottom of ventholes, possibly from a lignite seam of the tuffite bed. Poor kinds of coal were reported to occur in the Plateau Formation of Tertiary age (?) from the neighboring provinces of Hyûga and Satsuma.

13) **Summary on the Loose Ejecta.**—In summarizing what is said about the loose ejecta, we unexpectedly find a large number of them, both ancient and modern, and many present new features which must have uncommon interest for petrologists, especially ceramicites and gabbroids, the acid and basic pole of augite-andesites respectively. Both are leucolithic, and represent Vogt's anchi-monomineralic, extreme-differentiates of the andesite-magma.

More particularly, the projectiles of ancient heterogeneous origin are represented firstly, by pseudobombs of the ash-gray Kita-daké rock (pp. 212–214), and secondly, by trass composed of piperno andesite and its pumice of *A* and *C* zones (p. 14), besides the *Mesozoic slate*, and thirdly, by the so-called sandstone, being a glass-soaked pumiceous trachyandesite (pp. 15, 216). The second and third are, so to say, the volcanic relicts of the different members of the Plateau Formation of southern Kyûshû. The fourth and the last one is the fritted *granite* of (?) *Mesozoic* age. The ejecta of preëxisting rocks are exclusively thrown out during the earlier phases of activity.

On the whole, it is remarkable and quite astonishing to find among ejecta all the lithologic members of the subcrust on which stands the volcano Sakura-jima. So far as the writer's knowledge goes, none of the substrata are omitted, and all are faithfully represented in the recent projectiles, so that we can read in them the geologic history of the underground of the region concerned. Lastly, the only one exception is the find of coal (p. 219) which is, however, of dubious origin.

---

In closing the present treatise, the writer becomes aware of the fact that he has perhaps laid *too much stress* on melting, stoping and gas-fluxing in contrast to hydrostatic pressure as to the mode of the ascension of the magma (p. 144). On seeing the multiplicity of the ejecta of subcrustal origin, the eruption seems to have started at first with a new rupture backed by gaseous explosion, partly outside of the old conduit, whereby all the lithologic members of the foundation of the volcano were blown up through the virgin vents.



# CONTENTS.

	PAGE
INTRODUCTION . . . . .	1
 PART I. General Outline of the Geologic Structure of South- west Japan . . . . .	 2
§ I. GEOGRAPHIC AND GEOLOGIC SITUATION OF SOUTHWEST JAPAN.	2
<i>A. The Peri-Tunghai tectonic line and the genesis of the Ryû-     kyû arc . . . . .</i>	 5
<i>a) East coast of Korea . . . . .</i>	6
<i>b) Faulting of the axis of South Japan . . . . .</i>	6
<i>c) Monoclinal Ryû-kyû arc . . . . .</i>	7
<i>d) Taiwan as a prolongation of the Ryû-kyû arc . . . . .</i>	9
<i>e) Essential characteristics of the Ryû-kyû volcanic chain.</i>	10
<i>B. The principal formations and main geologic structure of South-     west Japan . . . . .</i>	 10
The zones of <i>a) Gneiss, 11—b) Sambagawa-Mikabu         Series, 11—c) Cretaceous, 11—d) Paleozoic graywacke,         11—e) Mesozoic sandy slate, 11—f) Tertiary, 12—         g) The lapilli plateau, i.e., Plateau Formation . . . . .</i>	      12
§ II. ON THE FORMATION OF THE TRENCH BAY OF KAGOSHIMA.	13
<i>A. General geology of the environs of Kagoshima Bay . . . . .</i>	13
<i>a) Ash-stone (an Aso lava) . . . . .</i>	13
<i>b) Origin of lapilli . . . . .</i>	14
<i>c) Ash-stone and lapilli bed in the environs of the city         of Kagoshima . . . . .</i>	 14
<i>d) The Sêto region on the opposite coast . . . . .</i>	16
<i>e) Early Diluvial age of the 'lapilli plateau' . . . . .</i>	17
<i>f) How Kagoshima Bay was formed . . . . .</i>	17
<i>g) The geology and dislocation of the Kaimon area . . . . .</i>	17
<i>h) Concluding remarks on the formation of Kagoshima         Bay . . . . .</i>	 18

	PAGE
<i>i</i> ) An epitome of the geologic history of the neighborhood of Sakura-jima .. .. .	19
<i>B.</i> <i>The outlying Ōsumi group</i> .. .. .	20
Conclusion .. .. .	22
<i>C.</i> <i>The foundation of Sakura-jima</i> .. .. .	22
<i>a</i> ) The six block islands: 1) Oko-shima, 23—2) Hakama- goshi, 25—3) The lava-drowned Karasu-jima, 26—4) Kanzé, 27—5) Kojima of Kokubu and its erroneous historic interpretation, 27—6) Yeno-shima .. .. .	30
<i>b</i> ) The suberust of Sakura-jima .. .. .	30
PART II. The Volcano Sakura-jima .. .. .	30
§ I. MORPHOGRAPHY .. .. .	31
<i>A.</i> <i>General</i> .. .. .	31
<i>B.</i> <i>The building up of the volcano and topography</i> .. .. .	33
(Appendix.—The vegetable zones of Mt. Sakura-jima)	
<i>a</i> ) Kita-daké or the main, North Cone .. .. .	35
<i>b</i> ) Naka-daké or the Middle Cone .. .. .	35
<i>c</i> ) Minami-daké or the South Cone .. .. .	36
<i>d</i> ) Poison Gulch, a mofette .. .. .	37
<i>e</i> ) Polyaxial central type of conduit .. .. .	37
<i>f</i> ) Topographic feature .. .. .	38
<i>g</i> ) Parasitic cones .. .. .	38
<i>C.</i> <i>Hydrography</i> .. .. .	39
<i>a</i> ) Springs .. .. .	39
<i>b</i> ) Mud-flood or <i>Yama-shiro</i> .. .. .	40
<i>c</i> ) Streamless .. .. .	41
§ II. THE ERUPTIONS OF SAKURA-JIMA PRIOR TO 1914. . . . .	41
<i>A.</i> <i>The eruption-periods I.—IV. (708-1766)</i> .. .. .	41
<i>a</i> ) The eruption-period I. (708 A. D.-718) .. .. .	41
<i>b</i> ) The eruption-period II. (764-766(?)) .. .. .	41
<i>c</i> ) The eruption-period III. The BUMMEI eruption (1468- 1478) .. .. .	42

	PAGE
<i>d</i> ) The eruption-period IV. (1642-1766) . . . . .	43
<i>B.</i> <i>The eruption-period V. (1779-1799)</i> . . . . .	44
<i>a</i> ) The eruption of the AN-EI era (1779-1780) . . . . .	44
<i>b</i> ) Changes in the efflux of hot springs . . . . .	47
<i>c</i> ) Ash-fall . . . . .	47
<i>d</i> ) The five new islands, 48—Inoko-jima, 48—Iwô-jima, 50—Shin-jima, 50—Yebisu-jima, 52—Hama-shima . . . . .	52
<i>e</i> ) Origin of the new islands . . . . .	53
<i>f</i> ) Waning phase of the An-ei activity . . . . .	55
<i>C.</i> <i>The eruption-period VI. (1835-1879)</i> . . . . .	56
§ III. THE ERUPTION OF SAKURA-JIMA IN 1914 . . . . .	56
(Eruption-period VII.)	
<i>A.</i> <i>Premonitory Symptoms</i> . . . . .	56
<i>a</i> ) Hot springs . . . . .	57
<i>b</i> ) The Yoshimatsu earthquakes . . . . .	57
<i>c</i> ) Activity of Kirishima on Jan. 8th . . . . .	58
<i>d</i> ) The Kagoshima earthquakes on Jan. 10th and 11th . . . . .	58
<i>e</i> ) The avalanche of the Scissor Rock . . . . .	59
<i>f</i> ) The flying of red-hot stones in western Sakura-jima . . . . .	60
<i>B.</i> <i>Surface manifestation of activity at Sakura-jima</i> . . . . .	61
<i>a</i> ) THE FIRST PHASE (Jan. 12-13th), 61—The eventful day, Jan. 12th, 61—Hot and cold springs, 62—Outbreaks inaugurated . . . . . 63 The activity on the <i>west</i> side, 63—Height of the ash- cloud, 65—The <i>nuée ardente</i> , 65—Holes in the ground, 66—The first sign of lava-flow . . . . . 67 The activity on the <i>east</i> (Nabé-yama) side, 67—The 12th, morning, 67—The rain of pumice in Séto, 68— The great earthquake of the 12th, 6. 29 P.M., 69— The <i>tsunami</i> . . . . . 69	
<i>b</i> ) Jan. 13th, morning, 71—The <i>nuée ardente</i> , 71—The first ash-fall in Kagoshima, 72—The lava already	

	PAGE
covered the western slope at noon, 72—The 13th, night, the climax of eruption . . . . .	72
c) THE SECOND PHASE (Jan. 14-20th), 73—The 14th, morning, 73—New ventholes appeared successively on the <i>west</i> , 74—Velocity of lava, 45 <i>km.</i> per hour . . . . .	74
d) Jan. 15th, morning, 75—Velocity of lava-stream, 76—The 15th, night, 77—The eastern vents and the velocity of lava . . . . .	77
e) Jan. 16th, 78—The western lava stream reached the sea, 78—The Nabé-yama (eastern) vents and boiled fishes, 78—Spatter cones . . . . .	78
f) Jan. 17th, 79—The second ash-fall in Kagoshima turning the city to night, 79—Slight glacial period, 79—Ash-pisolite, 80—Lava reached Karasu-jima, 80—Lava filled the Séto channel reducing it to 18 <i>m.</i> , 81—Ash-mud flood denied (footnote) . . . . .	81
g) Jan. 18th, 82—The writer's pioneer trip to the east coast, 82—Lapilli buried houses on the Ôsumi coast, 82—Men buried alive, 82—Pumice-ash flood, 83—Terminus of 'live' lava at Fumoto . . . . .	84
h) Jan. 19th, 85—Karasu-jima disappeared, 85—Ash-fall, 85—Peace was restored in Kagoshima . . . . .	85
i) Jan. 20th, 86—Migrating pumice-sheet in the west, 86—Southwest Sakura-jima suffered little by the catastrophe . . . . .	86
j) THE THIRD PHASE (Jan. 21-27th), 87—Jan. 21st, 87—Rain of pumice on the east . . . . .	87
k) Jan. 22nd, 87—Ash-fall in the city . . . . .	87
l) Jan. 23rd, 87—Nabé-yama vent No. 4 grown in size and great lava-flows, 87—Suffocating gases on the Ôsumi coast . . . . .	88
m) Jan. 24th, 88—The 25th, 88—Odious gases again, 88—The 26th, 89—Explosion on the east . . . . .	89

	PAGE
n) Jan. 27th, 89—Apparent movement of the western lava-flow came to a standstill . . . . .	89
o) THE FOURTH PHASE (Jan. 28—Feb. 1st), 89—Jan. 28th, 89—The 29th, 90—The 30th to 31st, 90—February 1st, 90—A new islet formed, 90—Eventually Sakura-jima became a peninsula of Ôsumi, 90—Feb. 2nd . . .	90
p) THE FIFTH PHASE (Feb. 3—Mar. 1st), 91—Feb. 3rd to 4th, 91—The main vulcanism of Sakura-jima terminated, 91—Feb. 5th to 6th, 91—Feb. 7th to 8th, 92—The cloud-burst and mud-flood, 92—Feb. 9th to 12th, 92—Feb. 13th to 14th, 92—Iwô-jima off Satsuma quaked, 92—Feb. 15th to 16th, 93—The second ash-mud deluge in Ôsumi, 93—Feb. 17th to 18th, 93—Feb. 19th-22nd, 94—Feb. 23rd to 24th, 94—Feb. 25th to 26th, 94—Feb. 27th to March 1st . . . . .	94
C. <i>Economic and social statistics</i> . . . . .	95
D. <i>Summary and conclusions</i> . . . . .	96
i. PREDISPOSING CAUSES . . . . .	96
Recurrence of vulcanicity in general, 97—Recurrence in Japan . . . . .	98
ii. Premonitory symptoms . . . . .	99
Earthquake-swarms of Yoshimatsu, 99—Earthquakes and volcanic outbursts after maximal period of local atmospheric pressure . . . . .	100
iii. The phases of eruptions . . . . .	101
First phase, Jan. 12th to 13th, 101—Second phase, Jan. 14th to 20th, 101—Third phase, Jan. 21st to 27th, 101—Fourth and fifth phase . . . . .	102
iv. The mass and dimensions of lava . . . . .	103
The western lava-field, 105—The eastern lava-field, 105—The whole mass of lava, 108—Lava-delta and steam-spouting horn 108—The ring of wet fumaroles. 110	110
v. The temperature of lavas . . . . .	110

	PAGE
Melting range of the Mihara-yama lava by Fuji and Mizoguchi, 111—Melting experiments of the same by Tawara, 112—Summary on melting experiments, 113—Block-lava and bread-crust bombs, 114—Secondary exhalations, 114—Fumaroles, 115—Lava-flows in sea, 115—The tromba, 115—Temperature of sea-water, 116—Boiled fishes. . . . .	116
vi. Lapilli, ashes and sands . . . . .	117
The ashes, 117—Crystal-lapilli, 118—Magma-glass ashes, 119—The sands, 119—Cauliflower-shape of dust-clouds, 119—Resurgent and juvenile sands and ashes, 120—The lapilli, 120—Slag-lapilli, 120—Characters of eastern and western lapilli, 120—Chemical composition of ash, 121—Acidity of ashes, 122—Deposition of ejecta, 123—Dispersal of ejecta, 124—Dust in the upper stratosphere, 126—Amount of ejecta . . . . .	127
vii. Subsidence of the Sakura-jima environs. . . . .	127
Relevings of the Ordnance Department, 128—Curves of equal subsidence, 130—The Mino-Owari earthquakes of 1891, 131—Cause of the subsidence, 133—Summary, 135—Local isostatic vulcanism. . . . .	137
viii. Ventholes . . . . .	137
A view that the series of vents located on mere surficial fissure of the crust, 139—Western ventholes, 139—Eastern ventholes, 142—Mechanism of the recent Sakura-jima eruptions, 143—Satellitic injection-chamber . . . . .	145
ix. The spatter eruption and the formation of a dome . .	146
The Yuno-hira dome, 147—Mode of eruption of No. 5 vent of Nabé-yama . . . . .	148
x. Sublimation-products. . . . .	149
Lava-sublimates, 149—Salmiac, the principal subli-	

	PAGE
mate, 150—Summary .. .. .	151
PART III. Petrography .. .. .	152
§ I. THE LAVAS OF THE PRE-HISTORIC CONES .. .. .	152
A. <i>The lavas of Kita-daké</i> .. .. .	152
a) Topographic features, 152—Northern slope, 152— Western slope, 153—The volcanello of Furu-hata, 153— The agglomerate bed that underlies the North Cone, 153—Atago-yama of dubious origin, 154—The volcanic plug of Hikino-hira, 154—Southern side, 155—The Akashi-Gongén hill, 155—Gongén-yama and Sono-yama on the eastern side .. .. .	155
b) Petrographic characters .. .. .	155
B. <i>The Kabano lava (northern side)</i> .. .. .	158
a) Mode of occurrence, 158—The age doubtful .. .. .	159
b) Petrographic characters .. .. .	159
C. <i>The Minami-daké and Naka-daké lavas</i> .. .. .	160
a) Mode of occurrence, 160—The Naka-daké flow .. .. .	161
b) Petrographic characters, 161—(i.) The Minami-daké lava, 161—(ii.) The Kammon-zaki lava, 162—(iii.) The Naka-daké and the Nagasaki headland area .. .. .	162
§ II. THE LAVAS OF THE HISTORIC PERIOD .. .. .	163
A. <i>The lavas of the Bunnei eruption, 1471-1476, including the         Nabé-yama and Yebino-tsuka adventures</i> .. .. .	163
a. <i>The Urano-mayé lava-field of 1471 (eastern side.)</i> .. .. .	163
a) General .. .. .	163
b) Mode of occurrence .. .. .	164
c) Petrographic characters .. .. .	165
β. <i>The Nabé-yama and Yebino-tsuka homates</i> .. .. .	165
a) The Nabé-yama homate .. .. .	165
b) The Yebino-tsuka knob .. .. .	166
B. <i>The Byōbu-hira lava-field of 1475-1476</i> .. .. .	166

	PAGE
a) Mode of occurrence, 166—The four pits, Nos. 1-4, 167 to 168—The vent No. 6 (the Taka-chiki vent) ..	169
b) Petrographic characters of pyroxene-andesite, 269—The land and shore lavas .. .. .	169
C. <i>The Ohira-yama lava field of 1749</i> .. .. .	170
a) Mode of occurrence .. .. .	170
b) Petrographic characters of pyroxene-andesite .. .. .	171
D. <i>The An-ci lava of 1779-1781</i> .. .. .	172
a) Mode of occurrence, 172—An-ci-San, 172—The Kōmen lava-field .. .. .	172
b) Petrographic characters of hypersthene-andesite, 174— <i>a</i> ) The An-ci-San lava, 174— <i>β</i> ) The Kōmen lava, 175— <i>γ</i> ) The rocks of the An-ci islands .. .. .	176
§ III. GENERAL PETROGRAPHIC CHARACTERS OF THE LAVAS OF 1914 .. .. . 176	
A. <i>Massive lavas</i> .. .. .	176
a) Land lavas in general, 176—Hypersthene-andesite, 176—The colors of lavas, 178—The <i>a</i> and <i>β</i> types .. .. .	180
b) Chemical characters .. .. .	180
c) Submarine lava-flows, 181—The lavas of the western field, 181—The lavas of the eastern field .. .. .	183
d) Characteristics of the <i>western</i> and <i>eastern</i> lavas, 184—Phenocrysts, 185—The groundmass .. .. .	186
B. <i>The loose ejecta</i> .. .. .	187
1) VOLCANIC SCUMS, 187—Spongy thread-lace glass scoria, 187—CERAMICITES, a new group name, 187— <i>a</i> ) White scums, 189— <i>β</i> ) Gray scums .. .. .	187
2) THE GABBROIDS AS EJECTA, 190—The <i>a</i> type, <i>Microtinite</i> , 190—The <i>β</i> type, <i>diopside-gabbro</i> , 191—The <i>γ</i> type, <i>lithoidal microtinite</i> , 192—The <i>δ</i> type, <i>micronorite</i> , 193—The <i>ε</i> type, <i>micro-allivalite</i> , 194—General explanation .. .. .	195



	PAGE
3) THE CERAMICITES, natural porcelain ejecta, 196—The first type, a saccharoidal modification, 198—The second type, a vesicular lithoidal modification, 199—The third (normal) type, a compact lithoidal, porcelain-like modification, 200—Chemical composition, 201—The fourth type, 202—The fifth type, a gray jaspilite-like modification, 202—Origin of ceramicites . . . . .	203-308
4) SOLID EJECTED BLOCKS OF JUVENILE LAVA. . . . .	209
5) BREAD-CRUST BOMBS. . . . .	209
6) RECENT LAPILLI (western and eastern). . . . .	211
7) PORPHYRITIC OBSIDIAN . . . . .	212
8) PSEUDOBOMBS OF ANCIENT LAVAS ( $\alpha$ , $\beta$ , $\gamma$ and $\varepsilon$ types) 212	212
9) EJECTA OF TRASS or ash-stone, ( $a$ ) balls, ( $b$ ) fragments. 214	214
10) THE SO-CALLED SANDSTONES (glass soaked lapilli.) . .	216
11) EJECTED BLOCKS OF BIOTITE-GRANITE . . . . .	218
12) COAL . . . . .	218
13) SUMMARY on the LOOSE EJECTA . . . . .	219

---



# INDEX.

<p><b>Æ</b>gean Sea of Japan .. .. . 6</p> <p>Aërolite .. .. . 194</p> <p>Agglomerate bed of Mizu-otoshi .. 153</p> <p>Air-quake (<i>quasi</i>-earthquake) .. . 66</p> <p>Alaska (Katmai) .. .. . 97</p> <p>Amblystegite .. .. . 113</p> <p>Ambrym in New Hebrides.. .. . 97</p> <p>Ampferer, O., .. .. . 133</p> <p>Andersen, O., .. .. . 178</p> <p>Andree, K., .. .. . 133</p> <p>An-ei-jima (Moyé-jima, Shin-shima) .. 50</p> <p>An-ei-San (Zan) .. .. . 47, 172, 173</p> <p>Anhydrous eruption .. .. . 126</p> <p>Anorthite of Myaké-jima and Tarumai 126</p> <p>Anorthosite-equivalent.. .. . 191</p> <p>Aoga-shima .. .. . 98</p> <p>Arimura .. .. . 46</p> <p>Asama .. .. . 98</p> <p>Ash .. .. . 117</p> <p>Ash, chemical composition of, .. . 122</p> <p>Ash, lava— .. .. . 119</p> <p>Ash, magma-glass— .. .. . 119</p> <p>Ash-cloud, height of, .. .. . 65</p> <p>Ash-fall .. .. . 47</p> <p>Ash-fall, first in Kagoshima .. . 72</p> <p>Ash-fall in Tôkyô.. .. . 118</p> <p>Ash-fall, second, .. .. . 79</p> <p>Ash-mud deluge in Ôsumi .. .. . 93</p> <p>Ash-stone, a hypersthene-trachyandesite .. .. . 15</p> <p>Ash-stone (<i>hai-ishi</i>) .. .. . 13, 14, 214</p> <p>Asiatic bank .. .. . 7</p> <p>Aso, the volcano of, .. .. . 4</p> <p>Atago-yama lava .. .. . 157</p> <p>Avalanche of Scissor Rock, <i>hasami</i> .. 59</p> <p>Azuma, K., .. .. . 57, 146</p> <p><b>B</b>arrell, J., .. .. . 130</p> <p>Benten Rock of Oki-Kojima .. .. . 28</p> <p>Bergeat, A., .. .. . 198</p> <p>Biotite-granite.. .. . 187</p> <p>Black rind of lava .. .. . 211</p>	<p>Boeca, <i>pl. bocche</i> .. .. . 182</p> <p>Bonin islands, afterglow and ash-fall .. .. . 127</p> <p>Bowen, N. L., .. .. . 178</p> <p>Brauns, R., .. .. . 198, 205</p> <p>Bread-crust bomb .. .. . 114, 187, 200</p> <p>Brown, C., .. .. . 2</p> <p>Bruhns .. .. . 205</p> <p><i>Bulla vernicosa var. ovula</i> .. .. . 16</p> <p>Byôbu-hira (Shibano) .. .. . 169</p> <p>Byôbu-hira lava, a pyroxene-andesite.. 169</p> <p>Byôbu-hira lava of 1475-1476 ..160, 166, 167</p> <p><b>C</b>abo di Gata.. .. . 198</p> <p>Campiglia Maritima .. .. . 198</p> <p><i>Cardium muticum</i> Rwe. .. .. . 16</p> <p><i>Cardium retusum</i> L. .. .. . 16</p> <p><i>Cassia</i> sp. .. .. . 16</p> <p>Cendre granulée (pisolite) .. .. . 80</p> <p>Ceramicite .. .. . 187</p> <p>Ceramicite, chemical composition of, 201</p> <p>Ceramicite, its formation, .. .. . 205</p> <p>Ceramicite, lithoidal .. .. . 200</p> <p>Ceramicite, natural earthenware.. .. 197</p> <p>Ceramicite, porcelain-like ejecta.. .. 203</p> <p>Characteristics of the eastern lavas .. 184</p> <p>Characteristics of the western lavas.. 184</p> <p>Chloraluminite .. .. . 151</p> <p>Chirique .. .. . 97</p> <p>Climo-enstatite .. .. . 182</p> <p>Coal .. .. . 187, 218</p> <p>Cognate xenolith .. .. . 204</p> <p>Colima .. .. . 79</p> <p>Cordierite.. .. . 193, 202, 204</p> <p>Cordierite, neovolcanic, .. .. . 204</p> <p>Cordierite-liparite .. .. . 198</p> <p>Corona (rim) .. .. . 199</p> <p>Cretaceous .. .. . 11</p> <p>Crystal lapilli (crystal sand) .. .. 118</p> <p>Cupola .. .. . 147</p> <p><b>D</b>aly, A., .. .. . 53, 110, 114, 147, 213</p> <p>Daikuhara, G., .. .. . 122</p>
--	--

- Damage to property .. .. . 95  
 Davison, C., .. .. . 69  
 Detonations .. .. . 103  
 Diluvial .. .. . 16, 29  
 Diluvial (early) .. .. . 17, 19  
 Diopside-gabbro .. .. . 191, 192  
 Domes, formation of, .. .. . 146  
 Doro-shima (Kani-shima) .. .. . 52  
*Dosinia troscheli*, Lischke .. .. . 16  
 Dust-cloud (not ash-cloud) .. .. . 59  
 Dust in the upper atmosphere .. .. . 126  
**E**arthquakes in Ijū-in.. .. . 58, 100  
 Earthquakes in Iwō-jima .. .. . 92  
 Earthquakes in Yoshimatsu.. .. . 57, 100  
 Earthquakes, the greatest, .. .. . 67, 69  
 Economics .. .. . 95  
 Ejecta, deposition of, .. .. . 123  
 Ejecta, dispersal of, .. .. . 124  
 Ejecta of biotite-granite .. .. . 216  
 Ejecta of biotite-granite of Kaimon .. 218  
 Enclave of diopside-gabbro.. .. . 195  
 Enclave of diorite-schist and gabbro.. 196  
 Eruption, anhydrous .. .. . 126  
 Eruption of Bummei (1468-1471) .. .. 42  
 Eruption of Cotopaxi of 1880 .. .. . 127  
 Eruption, Icelandic, of 1875, .. .. . 126  
 Eruption of Krakaton .. .. . 127  
 Eruption of Sawai.. .. . 116  
 Eruption of the An-ei era .. .. . 44, 172  
 Eruption of the Ansei or Manen era .. 56  
 Eruption of the Empō era.. .. . 43  
 Eruption of the Genna era.. .. . 43  
 Eruption of the Hō-ei era .. .. . 43  
 Eruption of the Hō-rōki era .. .. . 43  
 Eruption of the Kōji era .. .. . 43  
 Eruption of the Kwam-pō era .. .. . 43  
 Eruption of the Kwan-sei era .. .. . 56  
 Eruption of the Kwan-yei era .. .. . 43  
 Eruption of the Kwan-yen era .. .. . 43  
 Eruption of the Meiji era .. .. . 56  
 Eruption of the Mei-wa era .. .. . 43  
 Eruption of the Reiki era .. .. . 41  
 Eruption of the Tembiō-Hōji era .. .. 41  
 Eruption of the Temban era .. .. . 41  
 Eruption of the Temmei era .. .. . 55  
 Eruption of the Yōrō era .. .. . 41  
 Eruption, phases of, .. .. . 107  
 Eruption, real, .. .. . 72  
 Eruption, subnormal .. .. . 145  
 Eruption-period I. (703-718) .. .. . 41  
 Eruption-period II. (764) .. .. . 41  
 Eruption-period III. .. .. . 42  
 Eruption-period IV. .. .. . 42  
 Eruption-period V. .. .. . 44  
 Eruptive type .. .. . 149  
 Erythrosiderite .. .. . 150  
 Eskola, Pentti, .. .. . 208  
 Eucritic mass.. .. . 194  
 Explosive type .. .. . 149  
**F**aience .. .. . 202  
 Faulting of South Japan axis .. .. . 6  
 Fifth phase .. .. . 91  
 First phase of eruption .. .. . 61  
 Fishes, boiled, .. .. . 78, 116  
 Five New Islands .. .. . 48  
 Flank eruption .. .. . 38  
 Fo-kien, inclined tableland of, .. .. . 9  
 Foundered arena .. .. . 110  
 Foundering eruption .. .. . 147  
 Fouqué, F., .. .. . 140  
 Fourth phase .. .. . 89  
 Framed folding (*Rhamenfaltung*) .. .. 8  
 Friedlaender, I., .. 21, 32, 44, 56, 116, 187  
 Fuji, N., .. .. . 111  
 Fujishiro .. .. . 104  
 Fujiwhara, S., .. .. . 66  
 Furohata lava .. .. . 147  
 Furohata volcanello .. .. . 153  
 Furusato .. .. . 47  
 Futakami-yama, Prov. Yamato .. .. . 198  
 Futamata gulch .. .. . 153  
**G**abbroids .. .. . 187, 190  
 Gamō village .. .. . 136  
 Gases, odious, .. .. . 88  
 Gases, suffocating, .. .. . 88  
 Gas-blowing horn .. .. . 109  
 Gas-fluxing .. .. . 220  
 Gifu .. .. . 129  
 Gilbert, G. K., .. .. . 58, 129, 130, 135  
 Glacial period.. .. . 80  
 Glass cotton (Pele's hair) .. .. . 80  
 Glomeroporphyritic .. .. . 156  
 Glunger, G., .. .. . 198  
 Gneiss .. .. . 11  
 Gongōn-yama .. .. . 155  
 Gōrō-yama, Prov. Shinano .. .. . 197  
 Granite, fritted, .. .. . 30  
 Gravity, regional anomaly of, .. .. . 130

- Gray scums .. .. . 189  
 Groundmass, chemical composition of, 196  
 Gypsum .. .. . 150  
 Gypsum, primary, .. .. . 151  
**H**akama-goshi (Shiro-yama) 20, 23, 29, 125  
 Hakama-goshi, shell bed of, .. .. . 26  
 Hama-shima (Nii-shima) .. .. . 52  
 Harker, A., .. .. . 204  
 Harker's cognate xenolith .. .. . 208  
 Hawaii (Puna) .. .. . 97  
 Hébiga-kubo, 'snake's hollow,' .. .. . 169  
 Héda-Kojima .. .. . 28  
 Heights of ash-cloud .. .. . 65  
 Henslop and Smythe .. .. . 196  
 Higona (fire-hole) .. .. . 53  
 Hikino-hira (Hyoku-oka) .. .. . 38, 155  
 Hikino-taki bocca .. .. . 171  
 Hobbs, W. H., .. .. . 31  
 Holes in the ground .. .. . 66  
 Holmgren, N., .. .. . 22  
 Hornblende .. .. . 157  
 Horses killed .. .. . 95  
 Horst, relaxed, .. .. . 7  
 Hot spring .. .. . 47, 57, 87  
 Hot spring of Arimura .. .. . 47  
 Houses buried .. .. . 95  
 Hurricane, volcanic, .. .. . 71  
 Hussak, E., .. .. . 197  
 Hydrographic Office .. .. . 105  
 Hydrography .. .. . 39  
 Hypersthene-trachyandesite .. .. . 24  
**I**ddings, J. P., .. .. . 110  
 Imori .. .. . 122  
 Ikéda, crater-lake of, .. .. . 18, 218  
 Imamura, A., .. .. . 45  
 Inland Sea (*Seto-uchi*) .. .. . 6  
 Inoko-jima .. .. . 48  
 Inoko-jima Rock .. .. . 173  
 International Geodetic Committee .. .. . 129  
 Ippai-jima (of Kokubu Kojima) .. .. . 28  
 Iwakawa, T., .. .. . 26  
 Iwô-jima (Sé-jima, Kuro-shima) .. 21, 50, 173  
 Izichi, S., .. .. . 46  
**J**agger, T. A. F., .. .. . 57, 98, 188  
 Jensen .. .. . 61  
**K**abano lava, age unknown .. .. . 159  
 Kabano lava, vitrohypersthene-  
   andesite .. .. . 159  
 Kagoshima Bay .. .. . 4, 8, 13, 18  
 Kagoshima Bay (100 fathoms) .. .. . 16  
 Kagoshima Bay, a hollow .. .. . 17  
 Kagoshima, trench bay of, .. .. . 13  
 Kaimon .. .. . 4, 5  
 Kaimon, lowland of, .. .. . 18  
 Kalinite .. .. . 151  
 Kanai, M., 1, 26, 30, 117, 151, 191, 213, 216  
 Kani-shima (Doro-shima) .. .. . 52  
 Kanzé .. .. . 20, 23, 27, 29  
 Karasu-jima .. .. . 20, 23, 26, 29  
 Katmai (Alaska) .. .. . 97  
 Katô, Tak., .. .. . 197  
 Kawabé Seven Islands .. .. . 4  
 Kazuno .. .. . 137  
 Kermadec group .. .. . 97  
 Kilauea .. .. . 53  
 Kilauea and Loa .. .. . 144  
 Kita-daké (*Mihuchi*) .. .. . 34, 35  
 Kita-daké hypersthene-andesite .. .. . 155  
 Koiké .. .. . 25  
 Ko-jima (of Kokubu) .. .. . 23, 27, 29, 41  
 Komaga-daké in Hokkaidô .. .. . 193, 197  
 Komaga-daké, west of Morioka .. .. . 197  
 Kômen .. .. . 46  
 Kômen area .. .. . 175  
 Korea, east coast of, .. .. . 6  
 Korintji (Sumatra) .. .. . 197  
 Kotô, B., .. .. . 6, 111  
 Kremersite .. .. . 150  
 Kuchino-Erabu .. .. . 21, 22  
 Kuro-shima of the An-ei islands .. .. . 21, 22  
 Kuro-shima (Iwô-jima, Sé-jima) .. .. . 50  
 Kyûshû, horst of, .. .. . 18  
**L**â Soufrière .. .. . 206  
 Lacroix, A., 191, 193, 195, 197, 202, 913, 206  
 Lacroix, A., enclave homogènes .. .. . 208  
 Lapilli (*karu-ishi* or *gaishi*) .. .. . 117, 120  
 Lapilli buried houses .. .. . 83  
 Lapilli, magma-soaked, .. .. . 215  
 Lapilli, origin of, .. .. . 14  
 Lapilli plateau .. .. . 14  
 Lapilli, recent, .. .. . 187  
 Lasaulx, A. v., .. .. . 205  
 Lava, block— .. .. . 114  
 Lava, Furu-hata — .. .. . 147  
 Lava, temperature of, .. .. . 110  
 Lava-ash (resurgent) .. .. . 120  
 Lava-delta .. .. . 108  
 Lava-flows, area of, .. .. . 109

- Lava-flows, dimensions of, . . . . . 104, 107  
 Lava-flows, first sign of, . . . . . 67  
 Lava-flows, submarine, . . . . . 181  
 Lava-flows, the great flow in Nabé-  
   yama . . . . . 88  
 Lava-flows, thickness of, . . . . . 105, 107  
 Lavas of 1914 . . . . . 176  
 Lavas of Kabano . . . . . 152  
 Lavas of Kita-daké . . . . . 152, 155  
 Lavas of Mihara-yama . . . . . 111  
 Lavas of pre-historic cones . . . . . 152  
 Lava-sublimate . . . . . 149  
 Lava-tunnel . . . . . 109, 110  
 Lesser Antilles . . . . . 1  
 Levelings . . . . . 131  
 Linschoten Is. (Cecilia Is.) . . . . . 4  
 'Live' lava . . . . . 76  
 Loose ejecta . . . . . 187  
 Loose ejecta, Summary on, . . . . . 219  
 Luzon, Taal . . . . . 15  
**M**achatschek . . . . . 8  
 Magé-shima . . . . . 22  
 Magma ash (juvenile) . . . . . 120  
 Magma-glass ash . . . . . 119  
 Main vulcanism terminated . . . . . 91  
 Martinique . . . . . 1, 97  
 Maskelynite . . . . . 194  
 Mass of lava . . . . . 104  
 Matav (in Samoa) . . . . . 97  
 Matsura-gawara (gulch) . . . . . 153, 158  
 Mauna Loa . . . . . 53  
 Mechanical analysis . . . . . 117  
 Mechanism of the Sakura-jima erup-  
   tion . . . . . 143  
 Melting experiment . . . . . 112  
 Melting interval . . . . . 111  
 Mesozoic . . . . . 11  
 Mesozoic slate . . . . . 31  
 Meteorological Observatory of Kago-  
   shima . . . . . 4  
 Micro-allivalite . . . . . 195  
 Miconorite . . . . . 156, 195, 211  
 Miconoritic segregation . . . . . 171  
 Microtinite . . . . . 186, 190  
 Middle Cone (Naka-daké) . . . . . 35  
 Milne, J. . . . . 44  
 Misawa, M., . . . . . 150  
 Minami-daké lava . . . . . 160  
 Minami-daké lava, a pyroxene-andesite . . . . . 161  
 Mino-Owari earthquake of 1891 . . . . . 131  
 Mizoguchi . . . . . 111  
 Molysite . . . . . 150  
 Montagne Pelée . . . . . 206  
 Moya (mud-flow) . . . . . 80  
 Moyédashi lava-field . . . . . 173  
 Moyé-gona ('burning bocca') . . . . . 167  
 Moyé-jima (Shin-jima, An-ei-jima) . . . . . 50  
 Moyé-saki . . . . . 23, 42, 47  
 Mud-flow (moya) . . . . . 80, 29  
 Mukōmen . . . . . 174  
 Miyazaki . . . . . 72  
**N**abé-yama . . . . . 31  
 Nabé-yama, great lava-flow of, . . . . . 88  
 Nabé-yama homate . . . . . 165  
 Nabé-yama lava, chemical composition  
   of, . . . . . 180  
 Nagabuchi, M., . . . . . 28  
 Nagoka, H., . . . . . 129  
 Nagasaki-hana headland . . . . . 161  
 Nagoya . . . . . 129  
 Naka-daké lava . . . . . 160  
 Nakano-shima (Yebisu-jima) . . . . . 52, 73  
 Nakano-shima lava . . . . . 52  
 Nakashima, K., . . . . . 31, 36, 44  
 New Hebrides (Ambrym) . . . . . 97  
 New Islands, origin of, . . . . . 53  
 Ninomiya, Doctor . . . . . 63  
 Nishio, K., . . . . . 29  
 Nōjiri lava . . . . . 171  
 Nishio and Friedlaender . . . . . 56  
*Nuvé ardente* . . . . . 65, 71  
 Nummulite (*Pellastispira*) of Motobu . . . . . 7  
**Ô**hora-yama, Prov. Isé . . . . . 198  
 Obsidian, porphyritic, . . . . . 187, 212  
 Oda, R., . . . . . 32  
 Ôgawara ravine . . . . . 153  
 Ogura and Matsumoto . . . . . 181, 201  
 Ôhashi, R., . . . . . 201  
 Ôhira lava . . . . . 153, 160  
 Ôhira-yama lava-flow . . . . . 43, 170  
 Oki-kojima (Oko-jima) . . . . . 20, 23, 24, 26, 29  
 Oko-shima (Oki-kojima) . . . . . 20, 23, 24, 26, 29  
 Olivine . . . . . 185, 177  
 Olivine, resorbed, . . . . . 178  
 Omori, F., . . . . .  
   . . . . . 57, 101, 103, 106, 112, 127, 147, 183, 194  
 Ômoyé-zaki . . . . . 164  
 Ontaké of Shinano . . . . . 193

- Operculina* (Tertiary) . . . . . 13, 17  
 Ordnance Department . . . . . 128  
 Osann, A., . . . . . 198  
 Ôshima of Izu . . . . . 98  
 Ôshima (Anami-Ôshima) of Ryûkyû . . . . . 22  
 Ôseki, K., . . . . . 56  
 Ôsumi, the strait (Van Diemens Strait),  
   of, . . . . . 5  
 Outbreak inaugurated . . . . . 63  
 Oxen killed . . . . . 95  
 Ôyu, M., . . . . . 198  
**P**aleozoic . . . . . 11  
 Parasitic cone . . . . . 38  
 Pelée, Mt. . . . . 71  
 Pele's hair (glass cotton) . . . . . 80  
 Peninsula, Sakurajima became, of  
   Ôsumi . . . . . 90  
 People killed . . . . . 95  
 People rescued . . . . . 95  
 People wounded . . . . . 95  
 Peri-Tunghai . . . . . 7  
 Peri-Tunghai tectonic line . . . . . 5, 6  
 Perret, F. A., . . . . . 56, 65, 115, 140, 146, 187, 202, 208  
 Petrographic province of andesite . . . . . 111  
 Petrography . . . . . 152  
 Philippine Bay (South Japan Sea,  
   Mariana Sea) . . . . . 3  
*Phos santicosus* L. . . . . 17  
 Pigs killed . . . . . 95  
 Pillow lavas . . . . . 181  
*Pinus Thunbergii* Parl. . . . . 33  
 Piperno . . . . . 13, 215  
 Pisolite (cendre granulée) . . . . . 80  
 Plagioliparite (rhyodacite) . . . . . 14  
 Plateau Formation . . . . . 12, 17, 27, 31  
 Poison gulch (Doku-dani) . . . . . 37  
 Polyaxial central type . . . . . 37  
 Population of Sakurajima . . . . . 95  
 Powers, S., . . . . . 213  
 Predisposing causes . . . . . 96  
 Premonitory symptoms . . . . . 99  
 Pseudobombs . . . . . 187, 212  
 Pumice, floating, . . . . . 68  
 Pumice, rain of, . . . . . 68  
 Pumice-ash flood (yamashiro) . . . . . 83  
 Pumice-desert on sea . . . . . 81  
 Pumice-lapilli . . . . . 61  
 Pumice-sheet, migrating, . . . . . 86  
 Pyrrhotite . . . . . 198, 199, 204  
**Q**uasi-earthquake (air-quake) . . . . . 66  
**R**ecent Lapilli (little stone) . . . . . 211  
 Reck, H., . . . . . 20  
 Regional anomaly of gravity . . . . . 130  
 Resorbed olivine . . . . . 178  
 Rhamenfaltung (framed folding) . . . . . 8  
 Rhyodacite (plagioliparite) . . . . . 14  
 Riechthofen, F. v., . . . . . 6, 9, 12, 15, 18  
 Riverless . . . . . 41  
 Rock sult . . . . . 151  
 Ryûkyû arc . . . . . 2, 4  
 Ryûkyû arc, monoclinial, . . . . . 7  
 Ryûkyû, cordillera of, . . . . . 3  
 Ryûkyû fore-deep . . . . . 1, 8  
 Ryûkyû, genesis of . . . . . 5  
 Ryûkyû *Graben* . . . . . 7  
 Ryûkyû outcurve . . . . . 9, 10  
 Ryûkyû, volcanic chain of, . . . . . 3, 4, 6, 7  
**S**akkabira (Hô-zaki) . . . . . 16  
 Sakurajima, now a peninsula . . . . . 90  
 Sakurajima, vegetable zone of, . . . . . 33  
 Sakurai, the late Mr. H., . . . . . 197  
 Salmiac . . . . . 146, 151, 182  
 Salmiac fume . . . . . 67  
 Salmiac, principal sublimate . . . . . 150  
 Salt vapor (*yushiteo*) . . . . . 115  
 Sambagawa-Mikabu series . . . . . 6, 11  
 Samoa (Mt. Matav) . . . . . 97  
 Sand (*moyézuna*) . . . . . 117, 119  
 Sandstone, so-called . . . . . 187, 216  
 Sataké, Y., . . . . . 99  
 Sattelle injection, bilateral, . . . . . 144, 145  
 Santa Maria . . . . . 97  
 Satô, D., . . . . . 32, 57  
 Sawaiian type . . . . . 78  
 Scums . . . . . 187, 189  
 Secca . . . . . 182  
 Secondary lava stream . . . . . 108  
 Second phase . . . . . 73  
 Seismograph of Gray-Milne-Ewing . . . . . 59  
 Se-jima (Iwô-jima, Kuro-shima) . . . . . 50  
 Sêto Strait . . . . . 16  
 Shibano (Byôbu-hira) . . . . . 169  
 Shibata, Y., . . . . . 150  
 Shin-shima (An-ei-jima, Moyé-jima) . . . . . 50, 173  
 Shitano-moyégona (lower bocca) . . . . . 167  
 Shiwo-agé (tidal overflow) . . . . . 69  
 Sieberg, A., . . . . . 103, 119

- Slips of terrene .. .. . 132  
 Smythe and Henslop .. .. . 196  
 Smythe, I. A., .. .. . 196  
 Social statistics .. .. . 95  
 South Cone (Minami-daké).. .. . 62  
 South Cone (*Minami-daké*, *Moyé-daké*) 35, 36  
 Southwest Japan .. .. . 10  
 Spatter cones .. .. . 78  
 Spatter eruption .. .. . 146  
 Spongy thread-lace glass scoria.. .. 187  
 Springs .. .. . 39, 47, 56, 57, 62  
 Springs, cold, .. .. . 62  
 Springs, hot, .. .. . 62  
 Standstill of lava-flow .. .. . 89  
 Stopping .. .. . 220  
 Stromboli .. .. . 89  
 Strombolian type .. .. . 65  
 Structure enchevêtrée .. .. . 213  
 St. Vincent .. .. . 4, 97  
 Suberust of Sakura-jima .. .. . 30  
 Sublimate, crateral, .. .. . 149  
 Sublimation-products .. .. . 149  
 Submarine lava-flows .. .. . 181  
 Subsidence curves.. .. . 130  
 Subsidence of the Sakura-jima en-  
 viron .. .. . 127  
 Subsidence, causes of, .. .. . 133  
 Suess, E., .. .. . 8, 18  
 Sumatra (Korintji) .. .. . 97  
 Supercrust of volcano .. .. . 138  
 Surface manifestation of eruption .. 61  
 Suribachino-kubo (mortar-hollow) .. 167  
 Suwanosé-jima .. .. . 4, 5  
**T**achibana, N., .. .. . 128  
 Tadotsu .. .. . 72  
 Taiwan .. .. . 2, 7  
 Taiwan incurve .. .. . 9, 19  
 Takachiki vent .. .. . 167  
 Takeno-shima .. .. . 21, 22  
 Tanaka, S., .. .. . 189  
 Tanéga-shima .. .. . 22  
*Tapes egyptus* Phil. .. .. . 16  
 Tarr, W. A., .. .. . 218  
 Tawara, K., .. .. . 112  
 Teall, J. J. H., .. .. . 196  
 Tembiô-Hôji era (761) .. .. . 41  
 Temperature of lava .. .. . 110  
 Temperature of water .. .. . 116  
 Teneriffe .. .. . 97  
 Tenjinga-séto .. .. . 70  
 Tertiary .. .. . 12, 19  
 Tertiary, late, .. .. . 16, 17, 19  
 Tertiary, pre-Lepidocyclina .. .. . 7  
 Thickness of lava-flows .. .. . 105, 107  
 Third phase .. .. . 87  
 Thread-lace scoria.. .. . 187  
 Tian-shan .. .. . 198  
 Tidal overflow (*shûwo-agé*) .. .. . 69  
 Togara chain .. .. . 4  
 Tôkyô .. .. . 48  
 Tonga group .. .. . 79  
 Torishima (of the Ryûkyû volcanic  
 chain) .. .. . 4  
 Trachyandesite .. .. . 30  
 Trachybasalt .. .. . 25, 27  
 Trass .. .. . 30, 187  
 Trass, ejecta of, .. .. . 217, 214  
 Tromba .. .. . 115  
 Tsunami (sea-wave, *shûwo-agé*) .. 48, 54, 69  
**U**nzen .. .. . 98  
 Urano-mayé lava, pyroxene-andesite 163  
 Urano-mayé lava-field .. .. . 174, 163  
 Uyeda, M., .. .. . 2, 16, 27, 32, 71  
**V**egetable zone of Sakura-jima.. .. 33  
 Velocity of lava flow .. .. . 76, 77  
 Ventholes.. .. . 137  
 Ventholes on the east .. .. . 142  
 Ventholes on the west.. .. . 139  
 Vesuvius .. .. . 98  
 Vogt's anchi-monominerale differen-  
 tiate .. .. . 219  
 Volcanic conglomerate .. .. . 71  
 Volcanic reocets .. .. . 219  
 Volcanic scums (froth).. .. . 187  
 Volz .. .. . 8  
 Vulcanian type .. .. . 65  
**W**ashington, H. S., .. .. . 32, 183  
 Watasé, S., .. .. . 22, 35  
 Water, temperature of, .. .. . 116  
 White scums .. .. . 189  
 Winkler .. .. . 122  
 Wolf, F. v., .. 20, 31, 53, 110, 112, 122, 144  
 Wollastonite .. .. . 111, 192  
**Y**abé, H., .. .. . 7, 16, 17  
 Yaku-shima .. .. . 22  
 Yamaguchi, K., .. 1, 27, 28, 36, 49, 50, 51  
 Yamasaki, N., .. .. . 32, 56, 116, 197, 206  
 Yamashiwo (pumice-ash flood) .. .. 83



Yamashita, photo by, .. .. .	64	Yoshimatsu, Y., .. .. .	150
Yebino-tsuka homate .. .. .	165	Yoshino flat .. .. .	47
Yebisu-jima (Nakano-shima) .. ..	52, 173	Yuno-hama .. .. .	47
Yeno-shima .. .. .	30	Yuno-hira .. .. .	31
Yokoyama .. .. .	64, 65	Yuno-hira vent .. .. .	25

---

Published December 25th, 1916.

---



B. KOTÔ:  
THE GREAT ERUPTION OF SAKURA-JIMA IN 1914.

PLATE I.

## PLATE I.

Sakura-jima at the first phase of eruption, as seen from the premises of the Terukuni Shrine in the city (Figs. 1-4), and from the top of the castle hill (Fig. 5), on January 12th, 1914. Photo by Mr. Sugimoto.

Fig. 1.—View taken at 10<sup>h</sup> 15<sup>m</sup> A. M., i.e., ten minutes after the first outburst.

Fig. 2.—At 10<sup>h</sup> 20<sup>m</sup> A. M.

Fig. 3.—At 10<sup>h</sup> 25<sup>m</sup> A. M.

Fig. 4.—At 10<sup>h</sup> 30<sup>m</sup> A. M.

Fig. 5.—At 10<sup>h</sup> 50<sup>m</sup> A. M. After a few minutes of the scene represented in the figure, the whole mountain was enveloped with the awe-inspiring dense ash-cloud, so that nothing was known afterwards on the status of activity, except the terrible cannonading and air-concussions.

The scene on the frontispiece represents the stage between the figures 4 and 5.



Fig. 1. 100 200 ym.



Fig. 2. 100 200 ym.



Fig. 3. 100 200 ym.



Fig. 4. 100 200 ym.



Fig. 5. 100 200 ym.

Sakurajima at the first eruption, January 12th, 1914. (Photographed by S. K. Shima.)

Kobe. The Eruption of Sakurajima.



B. KOTÔ:  
THE GREAT ERUPTION OF SAKURA-JIMA IN 1914.

PLATE II.

## PLATE II.

Western views of the volcano Sakura-jima prior to the great eruption in 1914, as seen beyond the channel, 5.4 *km.* wide, from Kagoshima.

Fig. 1.—Photo by Mr. Sugimoto, taken on January 8th, 1913. See pages 33, 35.

Fig. 2.—Photo by Mr. Yamashita, taken six years before the recent eruption. See pages 33, 35.

Fig. 3.—View from the castle-hill of Kagoshima. Photo by Mr. Yamaguchi. See page 33.





Fig. 1



Fig. 2



Fig. 3

Yamaguchi and Sugimoto photo.

Kotō : The Eruption of Sakura-jima.



B. KOTÔ:  
THE GREAT ERUPTION OF SAKURA-JIMA IN 1914.

PLATE III.

### PLATE III.

Panoramic views of western Sakura-jima before and after the recent eruption.

Fig. 1.—Snow-mantled Sakura-jima before the eruption, as seen from the castle-hill of Kagoshima. Photo by Mr. Hidaka. See pages 23, 25, 27, 33.

Fig. 2.—Nearer view of Sakura-jima after the eruption from the low flat islet of Kanzé. Photo by Mr. K. Yamaguchi in May, 1914, i.e., four months after the catastrophe. The lava-flows, which encroached upon the sea in the foreground, was then still in an unconsolidated and fumarolic state, as may be seen in the picture. See pages 33, 35, 36, 138.

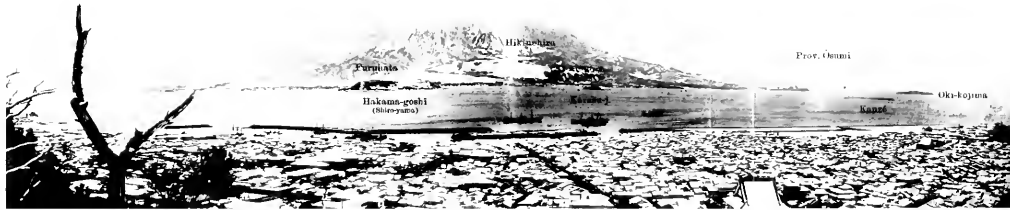

Fig. 1



Fig. 2

Koto: The Eruption of Sakurajima.



B. KOTÔ:

THE GREAT ERUPTION OF SAKURA-JIMA IN 1914.

PLATE IV.

## PLATE IV.

Fig. 1.—View of the characteristic land-feature of the ‘lapilli plateau formation’ from Kokubu Railway Station, looking northwards toward the volcanic group of Kirishima, which is faintly seen at a distance. See pages 15, 19, 29.

Fig. 2.—View of the Kaimon lowland, as seen from the northern slope of the volcano of Kaimon. On the left is the fault-scarp of the Benzaiten Gold Mine, whose northern continuation marks the western border of the trench bay of Kagoshima. The right half beyond the Kaimon lowland in the foreground shows the large walled crater-lake of Ikéda, which is equal in size and volume to the Volcano Kaimon. The lake-surface is seen in the space left by a breach in the crater-wall. See page 17.



Fig. 1



Fig. 2

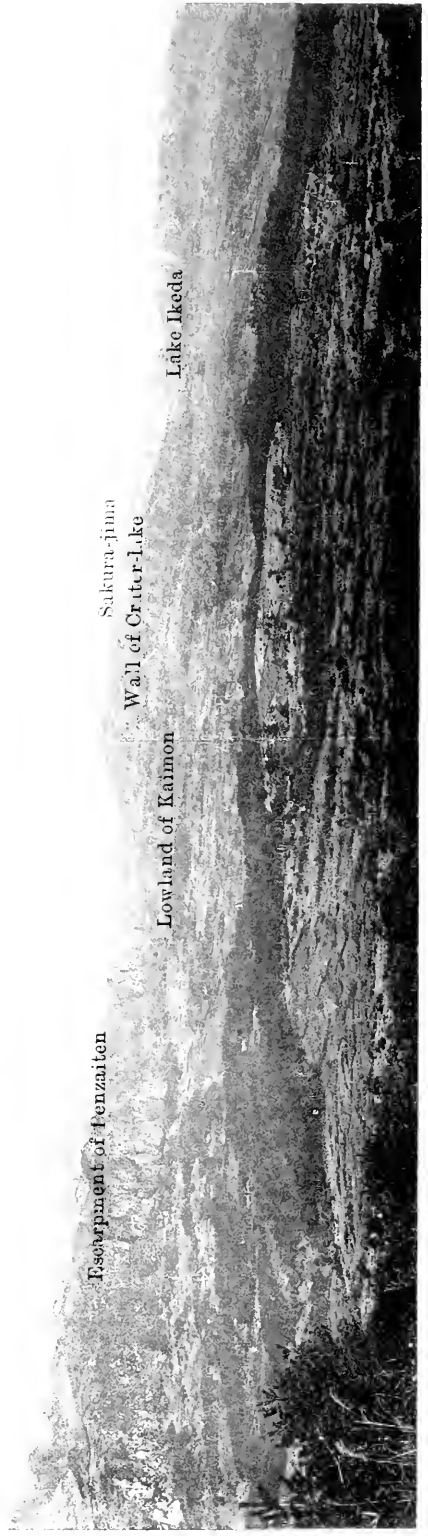

Author photo.

Koto: The Eruption of Sakura-jima.



B. KOTO:  
THE GREAT ERUPTION OF SAKURA-JIMA IN 1914.

PLATE V.

## PLATE V.

Fig. 1.—View of the ash-mantled shallow crater-basin or rather sunken top of the Middle Cone in foreground, and the large engulfed solfataric crater of the South Cone beyond, as seen southwards from the top of the North Cone or Kita-daké. Photo by Mr. Yamaguchi on January 4th, 1915. See pages 35, 36.

Fig. 2.—Scene of the deserted Akôbara village at the lava-front. The ground is thickly sheeted with the so-called *volcanic conglomerate*—a mass of angular blocks of various sizes that rained contemporaneously with the raging fiery wind, *nuée ardente*, which outrooted and barked trees. The hollows seen in the foreground were made by the impact of large block projectiles at the first phase of eruption. The 'live' lava later flowed down and overrid the bewildered ground. Photo by the writer in May, 1914. See pages 66, 71, 117.

Fig. 3.—View taken on January 13th, 10<sup>h</sup> 33<sup>m</sup> A. M., 1914, showing the lava-stream approaching the shore near the Hakama-goshi hill on the western shore. Note the rising vapor-cloud in the middle, s, from a spatter vent in the flowing lava. Photo bought in Kagoshima on January 15th, 1914. See pages 67, 72.

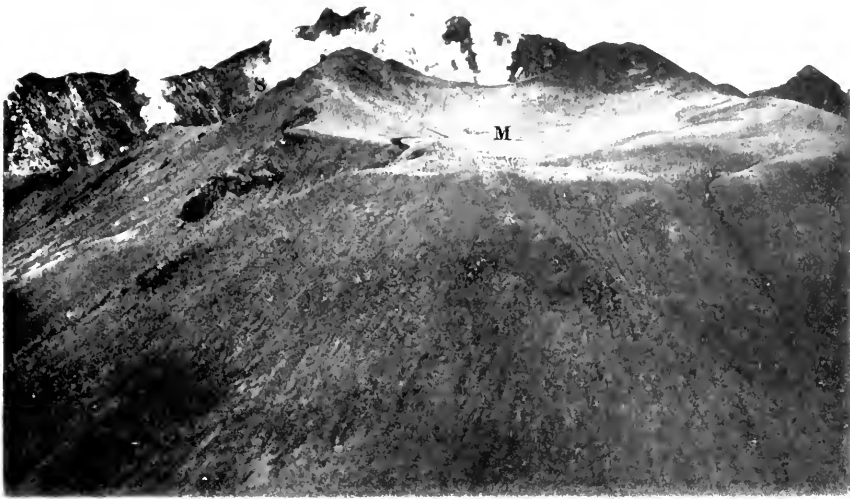

Fig. 1



Fig. 2



Fig. 3

Author and Yamaguchi photo.



B. KOTÔ:  
THE GREAT ERUPTION OF SAKURA-JIMA IN 1914.

PLATE VI.

## PLATE VI.

- Fig. 1.—The 'live' lava from the western vent was approaching the Akamizu shore, leaving a margin of only 200 *m.*, on the morning of January 15th, 1914. The text-figure 20 (p. 75) is the same view taken in the afternoon of the same day. Photo by the writer. See pages 15, 76.
- Fig. 2.—The same fluent lava reached the water's edge on January 16th, 1914, and caused the saline vapor to rise in dense curdy shape at the western lava-front on coming in contact with the water. Photo by Mr. S. Nakasa. See pages 77, 78, 81, 82, 115.
- Fig. 3.—The same lava advanced into the sea, and the islet of Karasu-jima now became a portion of the land on January 17th, 1914. Photo bought at Kagoshima. See pages 78, 81, 82.





Fig. 1



Fig. 2



Fig. 3

Author and Nakano photo.



B. KOTÔ:  
THE GREAT ERUPTION OF SAKURA-JIMA IN 1914.

PLATE VII.

## PLATE VII.

Fig. 1.—View of the lava-front in the sea, being enveloped by white curdy clouds of saline fumes, thus representing the Sawaiian stage in the eruption of Matav in 1905. Photo by Mr. S. Nakasa at 1 P.M., on January 18th, 1914, looking southwards from the top of the Hakamagoshi hill (in the opposite direction to that in Pl. VI. Fig. 2). See pages 78, 115, 116.

Fig. 2.—Snowing of the thick ash-dust in Kagoshima on January 17th, 1914. A few people were walking in rain-coats with umbrellas, and a dozen soldiers were patrolling the streets in the same fashion to safeguard against fire and theft, as most of the houses were left vacant by the inmates who fled to the country. Photo bought in Kagoshima. See pages 79, 80.

Fig. 3.—View of eastern vent in eruption, a gale of dust stream was coursing eastwards toward the writer who felt the air quite warm. A series of white saline fumes was rising from black heads of the submarine lava which was flowing toward the opposite shore of the strait of Sêto. Photo by the writer on January 18th, 1914, at Fumoto in Prov. Ôsumi. See page 85.



Fig. 1



Fig. 2



Fig. 3

Nakaseki and author's photo.

Koto: The Eruption of Sakura-jima.



B. KOTÔ:  
THE GREAT ERUPTION OF SAKURA-JIMA IN 1914.

PLATE VIII.

### PLATE VIII.

Fig. 1.—The western lava-flow drowned the islet of K̄arasu-jima on January 20th, 1914. Compare Fig. 3, Pl. V. and Figs. 1 and 3, Pl. VI. Photo by the writer. See pages 85, 86.

Fig. 2.\*—Western view of the strait of S̄eto prior to the eruption, now entirely blocked up by the Nabé-yama lava-flows, so that Sakura-jima became a peninsula of Prov. Ôsumi. In the middle is seen the round-topped Akashi-Gongén (103 *m.*), and on the left is the hot spring of Ari-mura, now lava-drowned. Photo bought in Kagoshima. See pages 88, 105, 155.

Fig. 3.\*—The same view of the now defunct strait of S̄eto, as seen from S̄eto village in Sakura-jima toward the Ôsumi shore. Photo bought in Kagoshima. See pages 88, 105, 155.

---

\* Cf. Plate IX. Figs. 2 and 3.



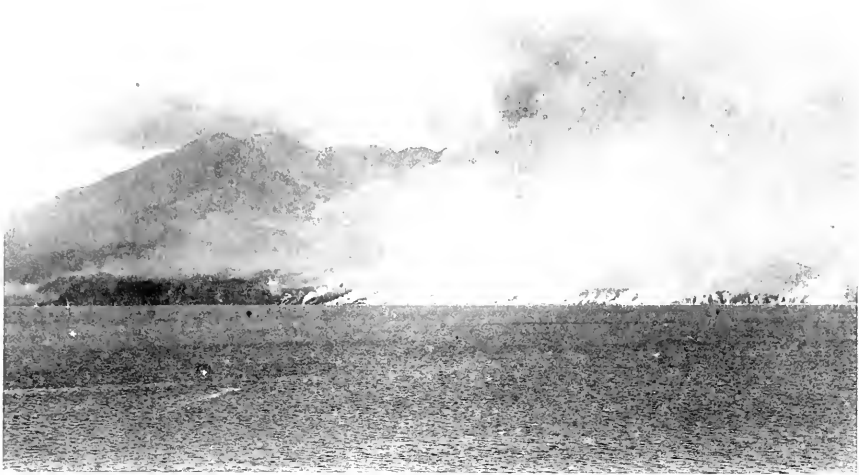

Fig. 1



Fig. 2



Fig. 3



**B. KOTÔ:**  
THE GREAT ERUPTION OF SAKURA-JIMA IN 1914.

PLATE IX.

## PLATE IX.

- Fig. 1.—View of the western lava-streams, both on land and in sea, from the Meteorological Observatory hill in Kagoshima. The lava-flows then came to a standstill and yet remained unconsolidated, the ‘foundered’ marine lava-field is encircled with a series of white fumes, as may be seen in the picture. Photo by Mr. S. Nakasa, taken on April 4th, 1914. See page 89, 110, 116.
- Fig. 2.—View of the strait of Séto prior to the recent catastrophe, looking eastwards from Cape Tatsuzaki. On the left is the round Akashi-Gongén hill (103 *m.*) and the thriving little hot spring of Ari-mura. On the right is the butte-like isolated hill of Sakkabira on the Ôsumi side. It is a detached geologic block of the basal Lapilli Plateau Formation, left isolated during the formation of the Bay of Kagoshima. The same geologic body constitutes the foundation of Sakura-jima. Compare Figs. 2 and 3, Pl. VIII. Photo bought in Kagoshima. See page 16, 88, 105, 155.
- Fig. 3.—Nearer view of the preceding (Fig. 2). Ari-mura in the foreground, the thriving hot spring and most prosperous village in Sakura-jima, now entirely disappeared owing to the overflowing by the recent lava. Photo bought in Kagoshima. See pages 16, 88, 105, 155.

Fig. 1



Fig. 2



Fig. 3



Nakano's photo.

Kotô : The Eruption of Sakura-jima.



B. KOTÔ:

THE GREAT ERUPTION OF SAKURA-JIMA IN 1914.

PLATE X.

## PLATE X.

- Fig. 1.—Lava-stream moving southwards into the sea with curdy saline fumes at its front, the lava creeping along the bottom being far in advance in comparison with that visible above sea-level, as may be conjectured from the veil of vapor on the surface of the water. Photo by Mr. Uyeda, taken on January 24th, 1914, from a steamer off Yu-mura on the southern coast. See pages 16, 86, 88.
- Fig. 2.—The same view as above (Fig. 1). Photo by Mr. Ôhashi, taken on February 7th, 1914. See pages 86, 90.
- Fig. 3.—View of the strait of Sêto looking westwards. The strait is now entirely blocked up by fluent lava-streams which abut against the shore-cliff of Sakkabira in Prov. Ôsumi. Photo by the writer taken on April 9th, 1914. See page 90.





Fig. 1

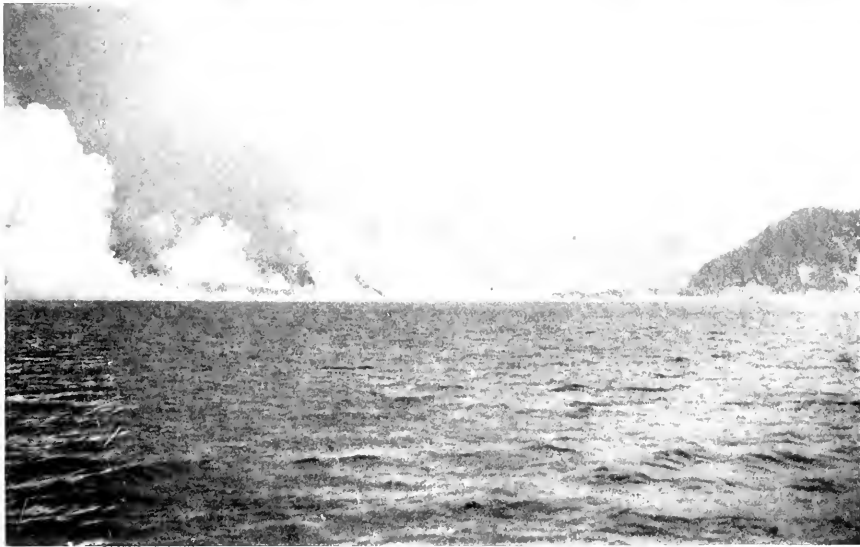

Fig. 2



Fig. 3

Uyeda, Ohno-hi, and author photo.

Notes: The Eruption of Sakura-jima.



B. KOTO :  
THE GREAT ERUPTION OF SAKURA-JIMA IN 1914.

PLATE XI.

## PLATE XI.

- Fig. 1.—View of the serial ventholes on the Nabé-yama side on the eastern slope of the South Cone, s, looking westwards from Fumoto in Prov. Ôsumi. m and n are the Middle and North Cone, respectively. Photo bought in Kagoshima. See pages 83, 138, 143.
- Fig. 2.—View of the same serial ventholes, Nos. 2-5, the picture being taken from the opposite direction to that of the preceding (Fig. 1). Photo by Mr. Yamaguchi, taken on March 22nd, 1914. See pages 83, 138, 143.
- Fig. 3.—Southwestern Sakura-jima from Oko-shima, showing the lava-field of Byôbu-hira of the Bunmei eruptions (1475-1476) and the Ôhira (Uhira) lava-field of the Kwan-yen activity (1749). Photo by the writer. See pages 167, 170, 172.



Fig. 1



Fig. 2

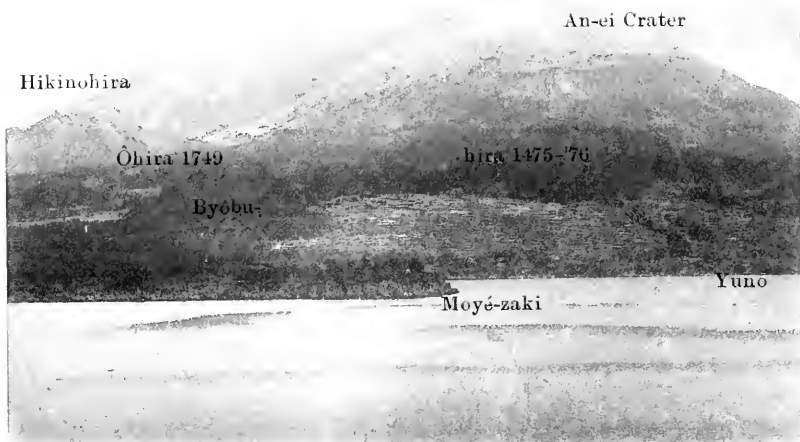

Fig. 3

Author and Yamaguchi photo.

Kotô: The Eruption of Sakura-jima.



B. KOTÔ:

THE GREAT ERUPTION OF SAKURA-JIMA IN 1914.

PLATE XII.

## PLATE XII.

- Fig. 1.—The ‘*lava-delta*’ of a secondary lava-flow in the *eastern* field after the pattern of the ‘bird-foot delta of the Mississippi.’ The digitiform area has ramifying axial canals whose seaward extremities each terminate at the ‘gas-spouting horn,’ *h*. Photo by Prof. Ômori, taken on April 24th, 1915. (One ‘h’ in the picture is to be deleted.) See pages 16, 16, 30, 108, 109.
- Fig. 2.—Nearer view of a ‘gas-spouting horn,’ *h*, of the preceding (Fig. 1, *h*). Photo by Prof. Ômori. See pages 108, 109.
- Fig. 3.—The lobate marine lava-field in the *western* field with the *founded* central arena encircled by a row of fumaroles. Cf. Pl. IX. Fig. 1. Photo by Mr. Yamaguchi, taken on January 4th, 1915. See pages 25, 26, 27, 109, 110, 141, 148.



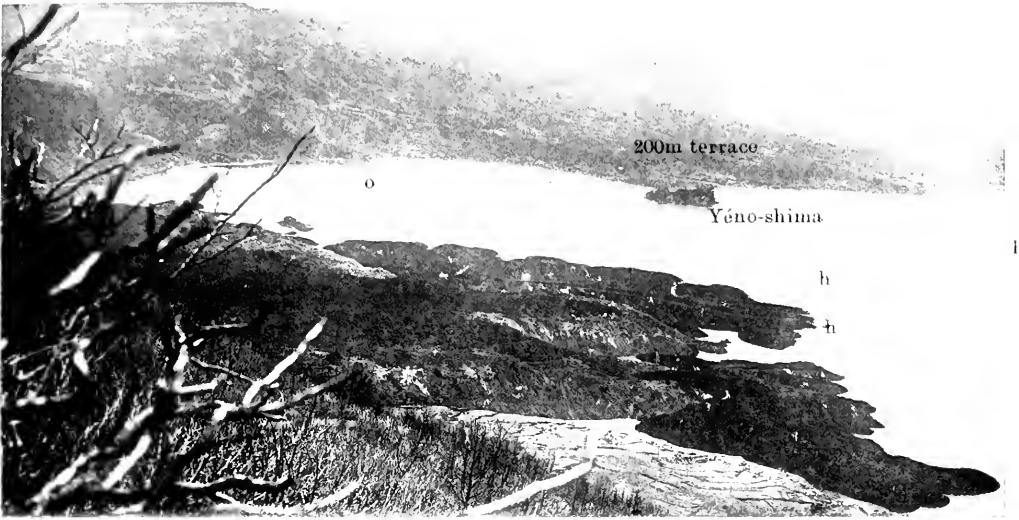

Fig. 1



Fig. 2

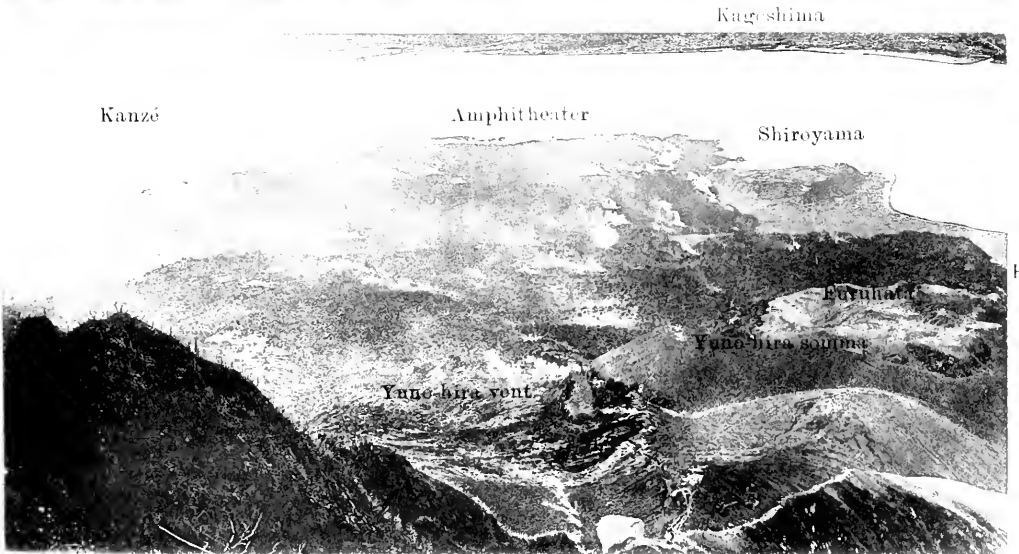

Fig. 3

Omori and Yamazuchi photo.



B. KOTÔ:  
THE GREAT ERUPTION OF SAKURA-JIMA IN 1914.

PLATE XIII.

### PLATE XIII.

Map showing the subsidence area of Sakura-jima and its neighborhood, constructed by the writer on the data of levelings by the General Staff of our Army before and after the eruption of the volcano in 1914. The values with the minus sign prefixed, e.g.,  $-894\text{ mm.}$  near Cape Ôsaki, indicate the differences or lowering of the bench marks expressed in millimeters between the first levelings of 1892-1900 and the relevelings of July-August of 1914, i.e., after the catastrophe of January. Those values enclosed by parentheses prefixed with the minus sign, e.g.,  $-(055\text{ mm.})$  show the subsequent progressive subsidence of the local crust after 215 days ascertained by the third levelings. The lines connecting equal values describe concentric circles with the hypothetical maximum depression marked with a cross, x, as the centre at the north of Sakura-jima. See pages 129, 130, 132, 133, 135, 136.

# MAP OF THE SUBSIDENCE AREA OF KAGOSHIMA AFTER THE WORKS OF THE HEADQUARTER STAFF

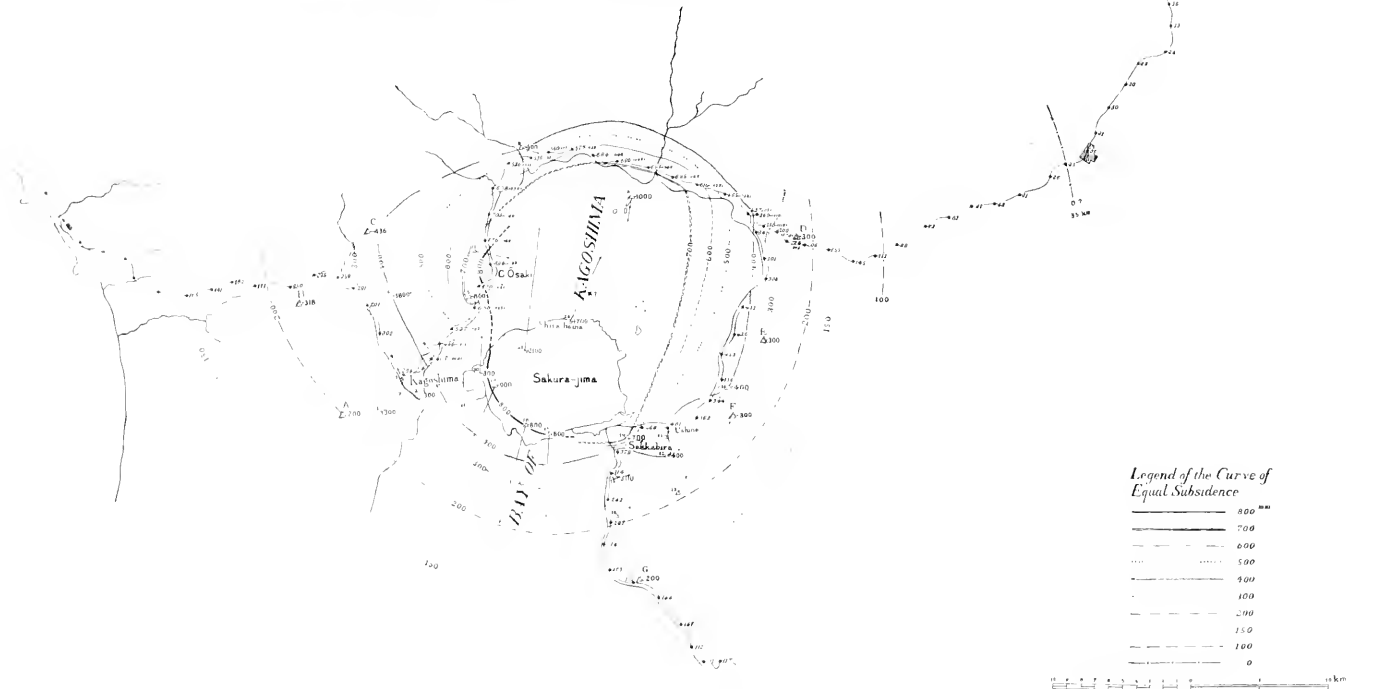

Koto: The Eruption of Sakura-jima.



B. KOTÔ:  
THE GREAT ERUPTION OF SAKURA-JIMA IN 1914.

PLATE XIV.

## PLATE XIV.

View of the western vent, No. 2, the Yuno-hira venthole, as seen from the westerly lying Yuno-hira crater-wall. The Hikino-hira dome and the northerly lying slope is terraced by successive depressions with fuming and gaping fissures at each step. In consequence of the depression, a 'schollen-dome' in the foreground rose up from the bottom, which became afterwards disrupted at No. 2 and supplied nearly the whole fluent lava to the western lava-field. Photo by the writer in April, 1914. See pages 139, 340, 147, 148.



Hikino-hira

No. 2



Author photo.



B. KOTÔ:  
THE GREAT ERUPTION OF SAKURA-JIMA IN 1914.

PLATE XV.

## PLATE XV.

The southwestern continuation of the view of the Yuno-hira venthole, shown in Plate XIV. No. 1 venthole on the western terraced slope of Hikino-hira (marked No. 1) was active at the very first phase of the eruption pouring down lava-streams to the west, its crater-wall being of preëxisting Hikino-hira rock. A vent in a higher position, marked with a cross, is a mere blow-hole.

The lava in the foreground crawled down the western slope seawards from No. 2, the Yuno-hira crater. The ragged mass in the foreground is the 'welded flow-breccia,' i.e., the lava before complete consolidation was partially plastic igneous magma shattered by rapid movement and cemented by the same magma. Photo by the writer in April, 1914. See pages 139, 140, 147, 148.

Hikino-jima

X

No. 1

No. 2

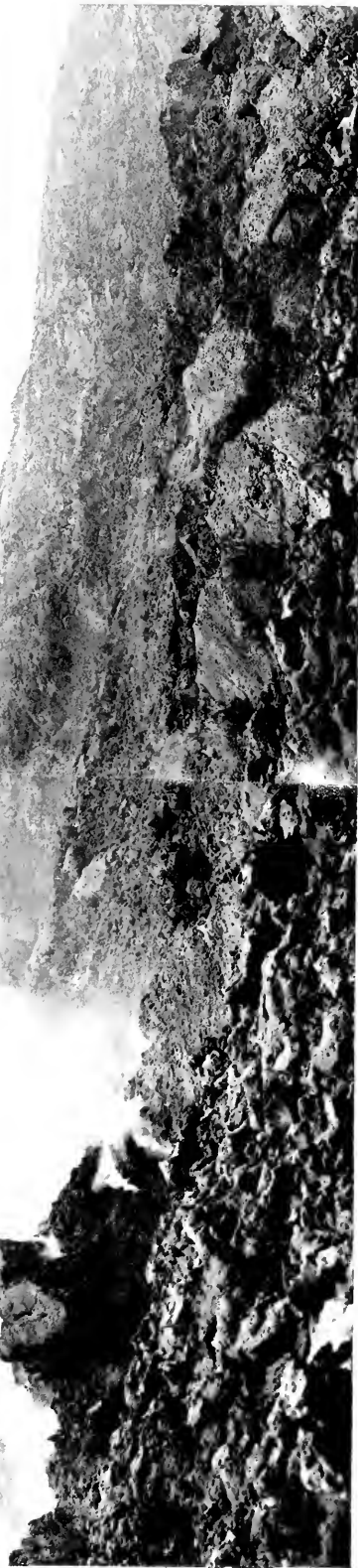

Author photo.

Koto : The Eruption of Sakura-jima.



B. KOTÔ:  
THE GREAT ERUPTION OF SAKURA-JIMA IN 1914.

PLATE XVI.

## PLATE XVI.

Microscopic textures of the older effusives of the basal formation and the Kita-daké (North Cone) lavas.

Fig. 1.—Biotite-vitrodacite or quartz-bearing biotite-hypersthene **trachyandesite**, type  $\alpha$ , from Oki-kojima. See pages 13, 15, 24, 29, 30, 156.

Fig. 2.—Spherulitic hornblende-hypersthene **trachyandesite**, type  $\gamma$ , from Obama in Prov. Ôsumi. See pages 13, 15, 24, 29.

Fig. 3.—Spherulitic and perlitic hornblende-bearing obsidian of the hypersthene-**trachyandesite**, type  $\beta$ , from Oki-kojima. See pages 13, 15, 24, 29.

Fig. 4.—Holo-crystalline **trachybasalt** ( $A_1$  in Text-fig. 3, p. 14) from the lava-drowned islet of Karasu-jima. Fresh olivine as well as resorption-rests are seen in the figure, the latter being represented by aggregates of magnetite which looks very much like rhönite. See pages 25, 27.

Figs. 1-4 are the pre-Sakura-jima effusives of the Lapilli Plateau Formation.

---

Fig. 5.—**Hypersthene-andesite** with the phenocrysts of hypersthene and plagioclase, and microritic patches from the crater-margin of the top of Kita-daké, the North Cone. See pages 155, 157.

Fig. 6.—Magnified texture of the **same** from another locality on the top-crater of Kita-daké, showing mono-mineralic feldspar-microlites in the ground-mass. See pages 155, 157.

Fig. 7.—**Hypersthene-andesite** of the Kita-daké rock-type from the parasitic dome of Furuhata on the western slope of Kita-daké. See page 158.

---

Fig. 8.—Black **vitrohypersthene-andesite** with plexus of augite-microlites in the groundmass, representing the Kabano lava-flows on the northwestern slope of Kita-daké. See pages 158, 159.



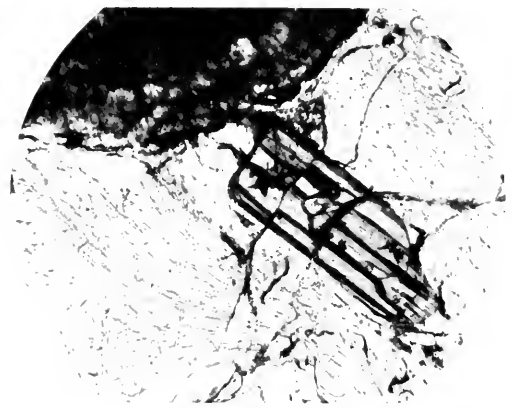
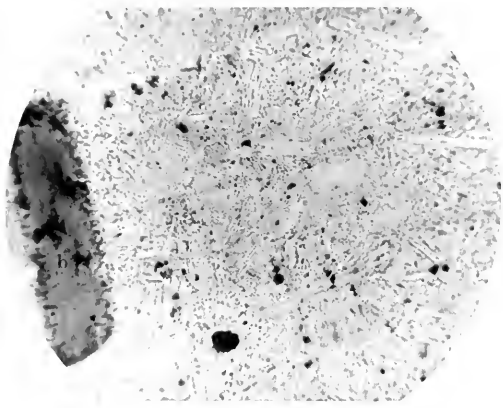

Fig. 2  
×64

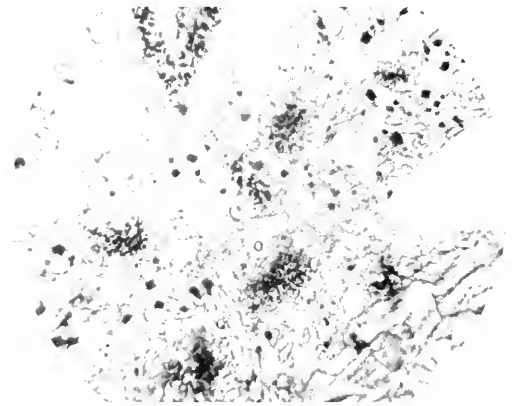

Fig. 1  
×135

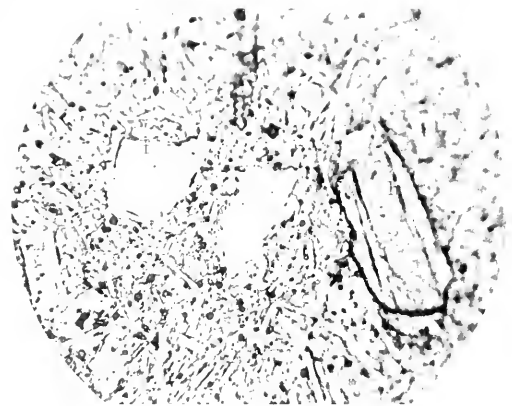

Fig. 6  
×135

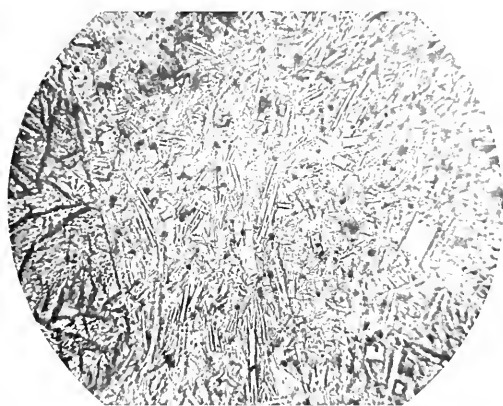

Fig. 8  
×131

Phot.



B. KOTÔ:  
THE GREAT ERUPTION OF SAKURA-JIMA IN 1914.

PLATE XVII.

## PLATE XVII.

Microscopic textures of the lavas of the Kabano lava-field, the South and Middle Cones, and the Bummei eruption of 1471-1476.

Fig. 1.—Black **vitrohypersthene-andesite** of Kabano, the same lava type as Pl. XVI. Fig. 8, from which this differs in its glassy base which is characteristically damascened in texture. See pages 158, 159.

---

Fig. 2.—**Pyroxene-andesite** (hyp. > aug.) of the South Cone from Cape Kannou-zaki. Olivine was once observed (not in slide). See pages 160, 161, 162.

Fig. 3.—**Pyroxene-andesite** of the same type collected on the southeast slope of the South Cone between 300-800 *m.* contour-line. It is the normal type with abundant brown glass base. See pages 160, 161.

Fig. 4.—**Pyroxene-andesite** of the same type as the preceding, collected on the top of the Middle Cone. See pages 160, 161, 162.

Fig. 5.—**Pyroxene-andesite** of the Middle Cone, type  $\beta$ , from the Nagasaki headland. See pages 160, 161, 162.

---

Fig. 6.—**Pyroxene-andesite** lava of the *Bummei* eruption. A specimen from the Byôbu-hira lava-field, vent No. 1, on the southwestern shore. See pages 166, 170.

Fig. 7.—**Pyroxene-andesite** lava of the same era from Cape Moyé-zaki at the lava-end of the Byôbu-hira flow. See pages 166, 170.

Fig. 8.—**Pyroxene-andesite** at the water's edge from the same locality as the preceding. See pages 166, 170.

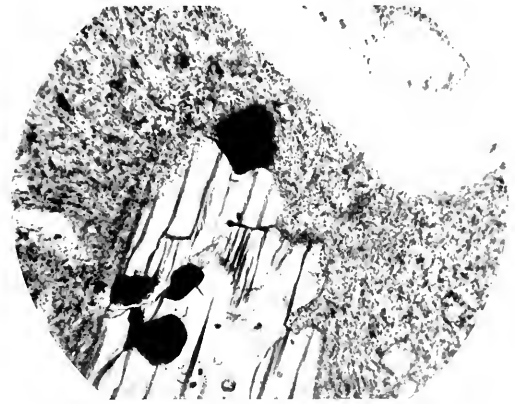
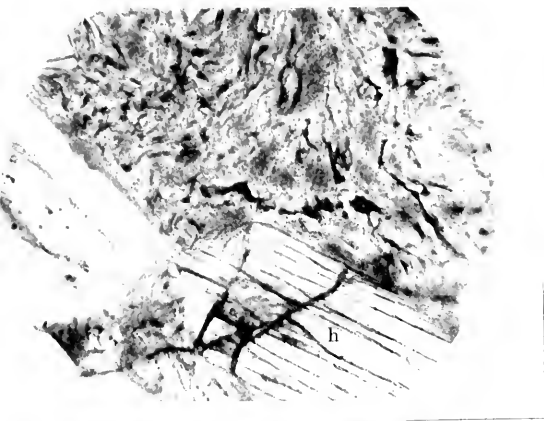

Fig. 2  
×60

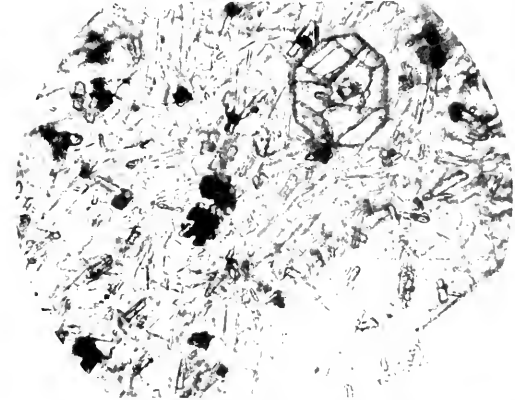
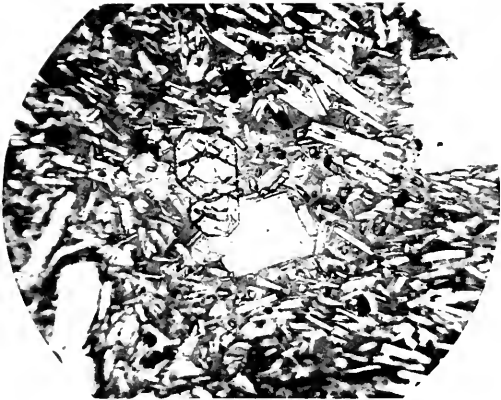

Fig. 4  
×135

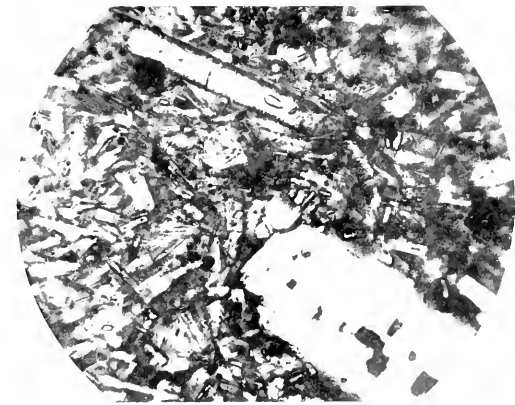
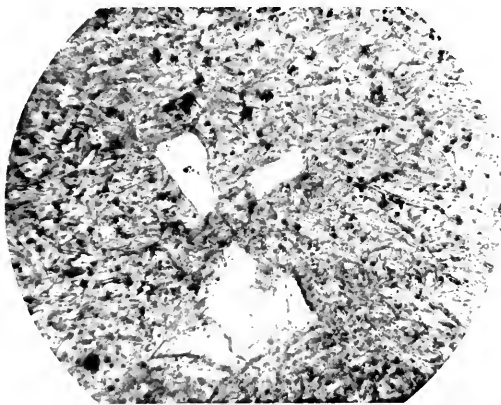

Fig. 6  
×135

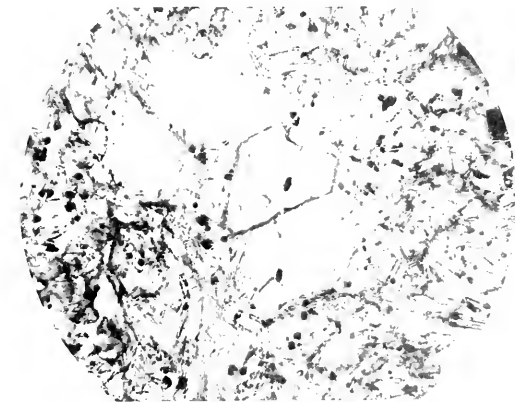
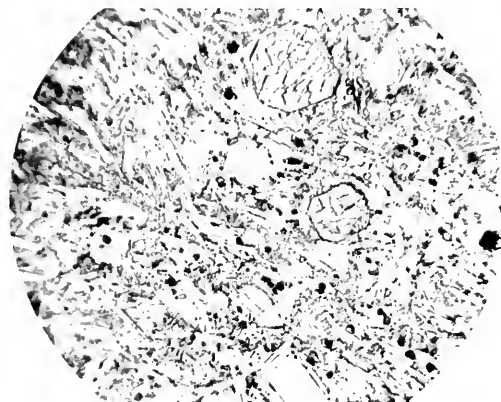

Fig. 8  
×135

photo.



B. KOTÔ :

THE GREAT ERUPTION OF SAKURA-JIMA IN 1914.

PLATE XVIII.

## PLATE XVIII.

Microscopic textures of lavas of the Bummei eruption of 1471-1476, the Kwan-yen eruption (Ôhira-lava) of 1749 and the An-ei eruption of 1779-1781.

Fig. 1.—**Pyroxene-andesite** (the gray type) from under water at Cape Moyé-zaki, the locality being the same as the *Bummei* lava in Pl. XVII. Fig. 8. See pages 166, 170.

Fig. 2.—**Pyroxene-andesite** of the same era from a craterlet in Urano-mayé on the northeastern coast. See pages 163, 165.

Fig. 3.—**Micronoritic localization** in the Bummei lava from under water at Cape Ômoyé-zaki, the lava being the same as the preceding. See pages 163, 165.

---

Fig. 4.—**Pyroxene-andesite** (aug. > hyp.) of the Ôhira-yama lava of 1749 on the western slope of the South Cone. See pages 170, 171.

Fig. 5.—The **same** magnified 120 diameters. See page 170.

---

Fig. 6.—**Olivine-hypersthene-andesite** at the lava terminus at Cape Tatsu-zaki, flowed down from An-ei-zan(?) on the southern slope of the South Cone. See pages 172, 174.

Fig. 7.—**Hypersthene-andesite** of the An-ei era at the water's edge at Furu-sato, being a part of the preceding flow (p. 175). Olivine is not observed in this rock, but is characterized by abundant augite microlite in the brown glass. See pages 172, 173, 175.

Fig. 8.—**Hypersthene-andesite** of the An-ei eruption at Kômen on the northeastern coast. See pages 172, 175.



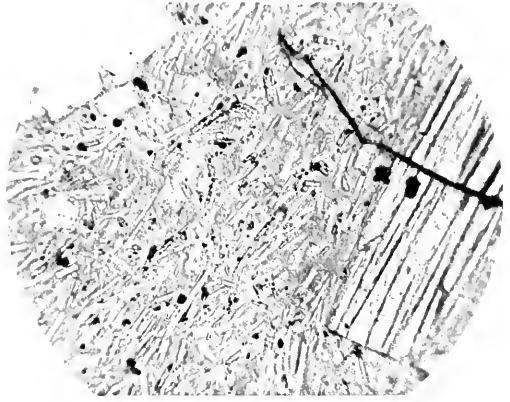

Fig. 2  
X135



Fig. 3  
X135

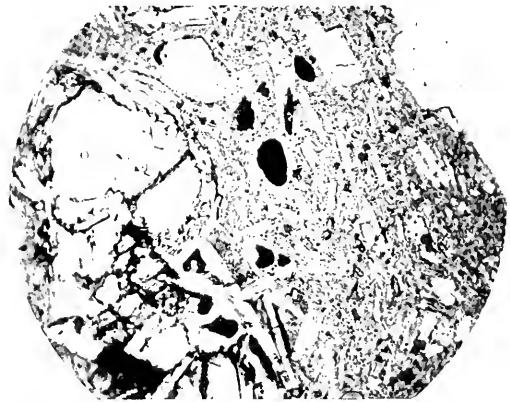
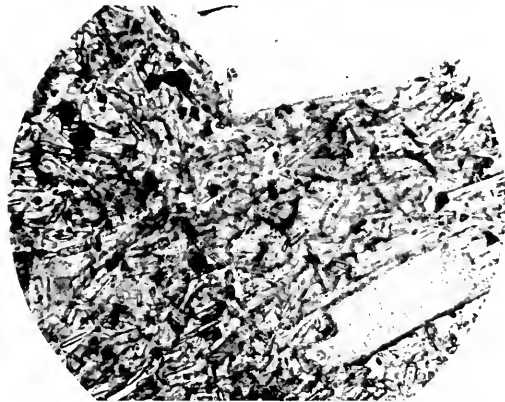

Fig. 6  
X177

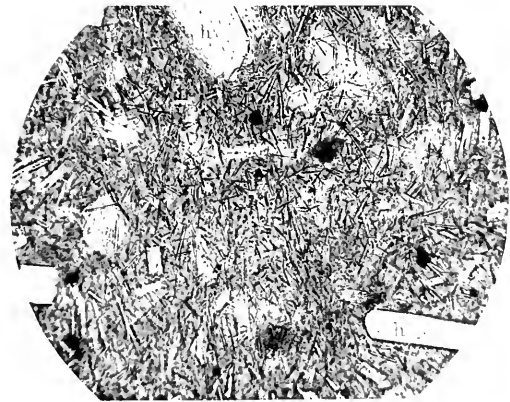
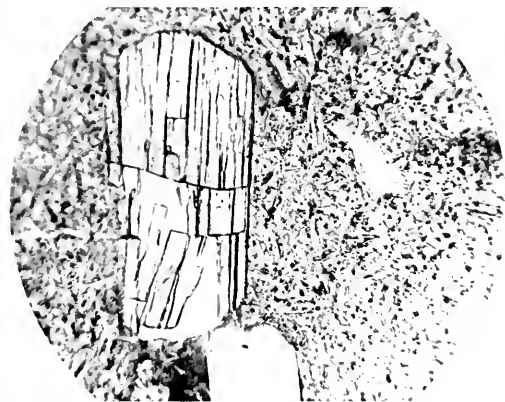

Fig. 8  
X150

or photo.



B. KOTÔ:

THE GREAT ERUPTION OF SAKURA-JIMA IN 1914.

PLATE XIX.

## PLATE XIX.

Microscopic textures of lavas of the An-ei eruption of 1779-1781, and the recent eruption of 1914.

Fig. 1.—**Hypersthene-andesite** of the An-ei eruption at the water's edge at Cape Hirabana on the northeastern shore. See pages 172, 175.

Fig. 2.—**Hypersthene-andesite** from Iwô-jima, one of the new islets that rose from the sea during the An-ei activity. See pages 172, 176.

---

Fig. 3.— **Hypersthene-andesite** of the recent eruption (1914), taken from the lower portion of the lava-front of the western lava-field at Akôbara. See pages 176, 177, 178, 179.

Fig. 4.—**Hypersthene-andesite** from the same lava-field on its southern margin at Akamizu. See pages 176, 177, 178, 179.

Fig. 5.—**Hypersthene-vitroandesite** with the damascened brown glassy ground-mass, ejected from a western vent, fell and made hollows in the ground at Akôbara. The ejected block represents the hyaline type of lava, it encloses angular enclaves of whitish ceramicite, and makes veinlets in it. See pages 176, 179, 186.

Fig. 6.—**Olivine-bearing hypersthene-andesite** brought out from the bottom at 10 fathoms at the lava-front on the Yokoyama side. The olivine is not seen in the figure. See pages 176, 177, 181, 182.

Fig. 7.—The **same** as the preceding, from the bottom at 10 fathoms on the Akamizu side. A resorption-rest of olivine is seen in the figure. See pages 176, 177, 178, 181, 182, 183.

(Figs. 3-7 are the photomicrographs of lavas from the western (front) lava-field.)

---

Fig. 8.—**Hypersthene-andesite** at Yuno-hama in the eastern lava-field. See pages 176, 177, 178.

Fig. 1  
×158

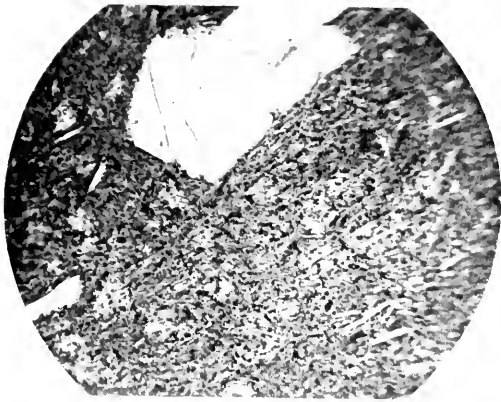

Fig. 2  
×158

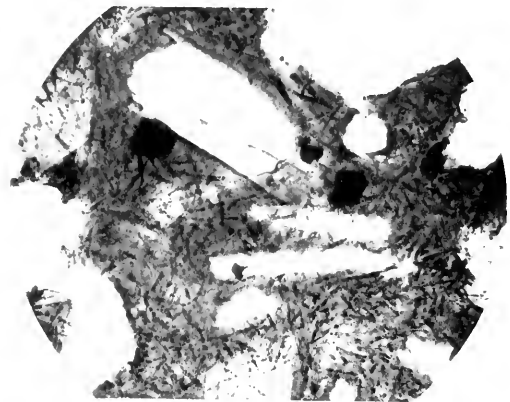

Fig. 3  
×173

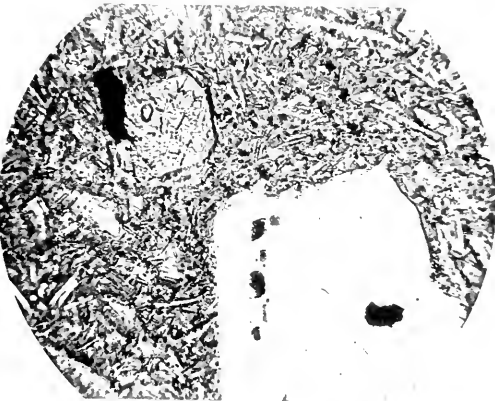

Fig. 4  
×165

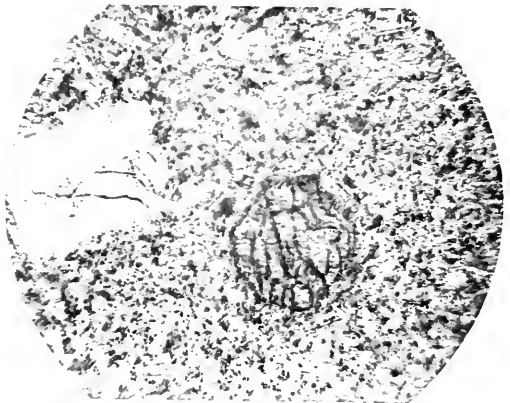

Fig. 5  
×170

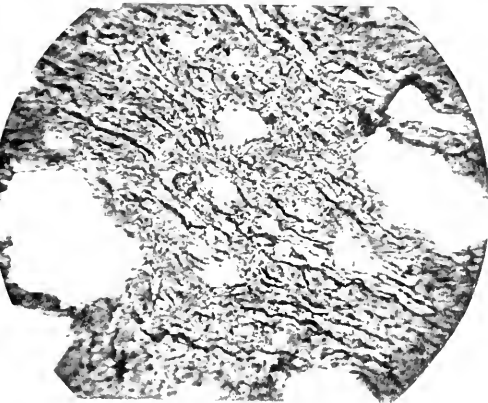

Fig. 6  
×155

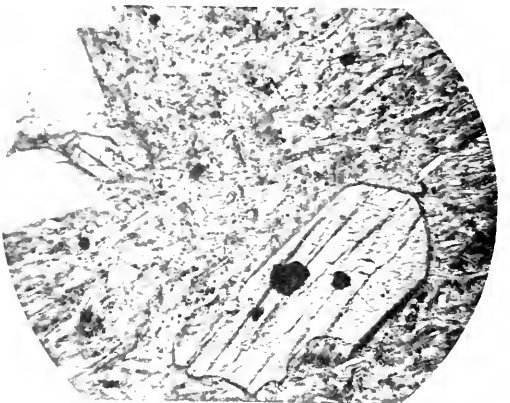

Fig. 7  
×140

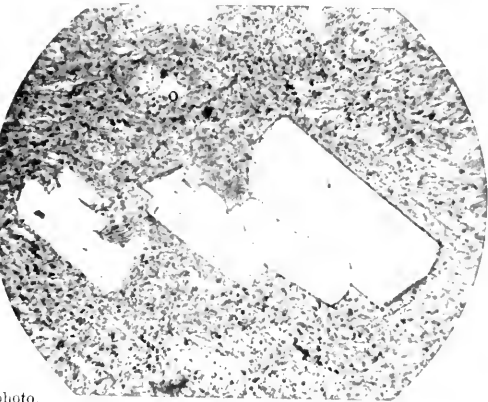
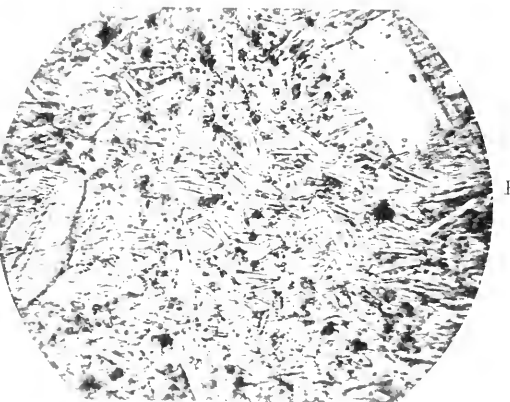

Fig. 8  
×140



Author photo.



B. KOTÔ:

THE GREAT ERUPTION OF SAKURA-JIMA IN 1914.

PLATE XX.

## PLATE XX.

Microscopic textures of the lavas of the Nabé-yama (eastern) field, effluxed in the recent eruption of 1914, and of the ejecta in the western field in the same eruption.

Fig. 1.—**Hypersthene-andesite** forming the lower portion of the land-lava at the lava-drowned watering-place of Ari-mura. No olivine was detected, but augite is fairly abundant among phenocrysts. See pages 176, 177.

Fig. 2.—**Olivine-hypersthene-andesite** from a lava head within the sea near Ari-mura. On account of high magnification, unfortunately no phenocrysts of olivine, hypersthene nor plagioclase are seen in the microscopic field. See pages 176, 181, 182, 183.

Fig. 3.—**Olivine-hypersthene-andesite** of submarine origin like the preceding, forming an islet off shore of Ari-mura. See pages 176, 177, 181, 182, 183.

Fig. 4.—**Olivine-hypersthene-andesite** from the lava-front at the water's edge at the defunct strait of Séto. See pages 176, 177, 181, 183.

(Figs. 1-4 are the photomicrographs of lavas of the eastern (Nabé-yama) lava-field.)

---

Fig. 5.—A **secretionary patch** in the gray hornblende-andesite of Furukata, a volcanello adventive to the North Cone. It occurs scattered about in Akôbara as ejecta or pseudobombs, having spindle-shape due to subaërial abrasion. It shows the *structure enchevêtrée*. See page 213.

Fig. 6.—**White scum** from the western coast with pores greater than 0.03 *mm.* in diameter. See pages 118, 189, 202.

Fig. 7.—**Gray scum** from the same region as the preceding with pores less than 0.03 *mm.* in diameter. See pages 118, 189, 190.

Fig. 8.—**Microtinite** ejecta on the western lava-field coated black with lava films. It is built up of clear anorthite polygons cemented with grayish patches of (?) orthoclase full of air pores. See pages 190, 191.



Fig. 1  
×148

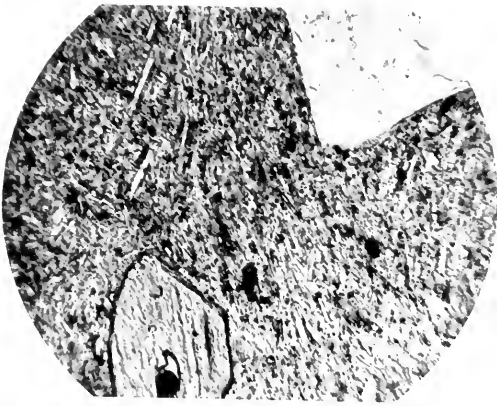

Fig. 2  
×150

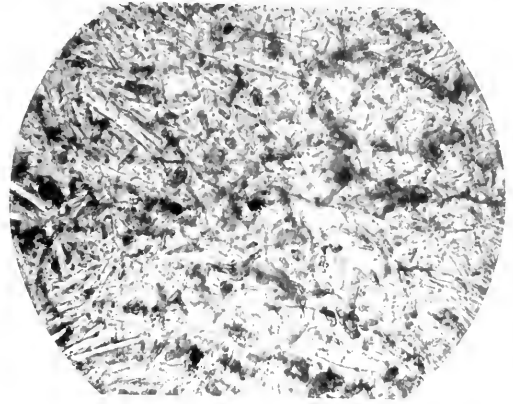

Fig. 3  
×132

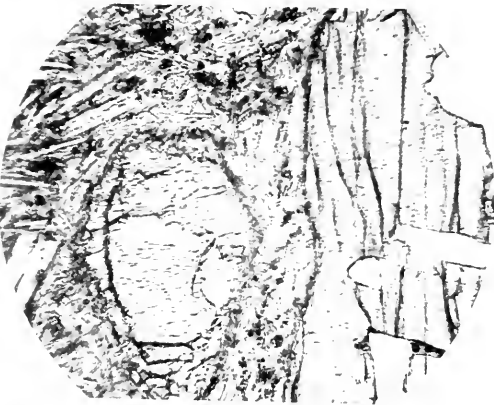

Fig. 4  
×112

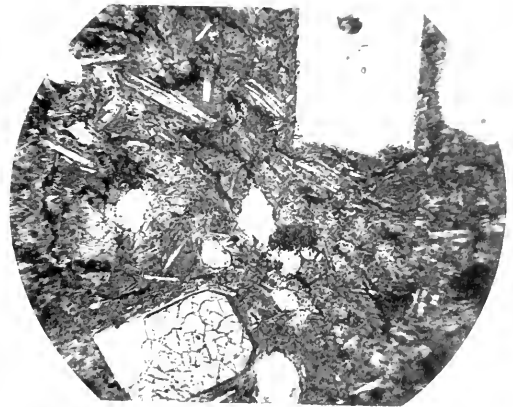

Fig. 5  
×30



Fig. 6  
×30

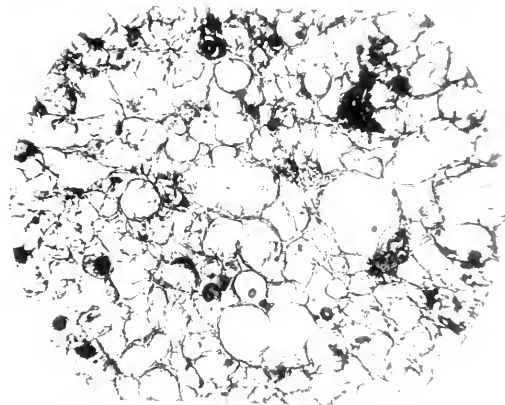

Fig. 7  
×30

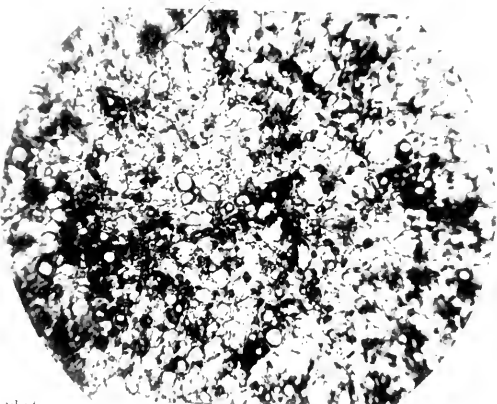
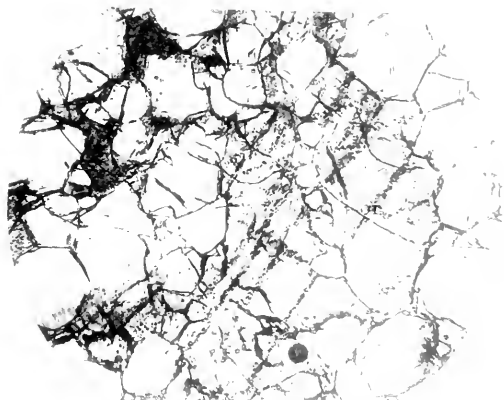
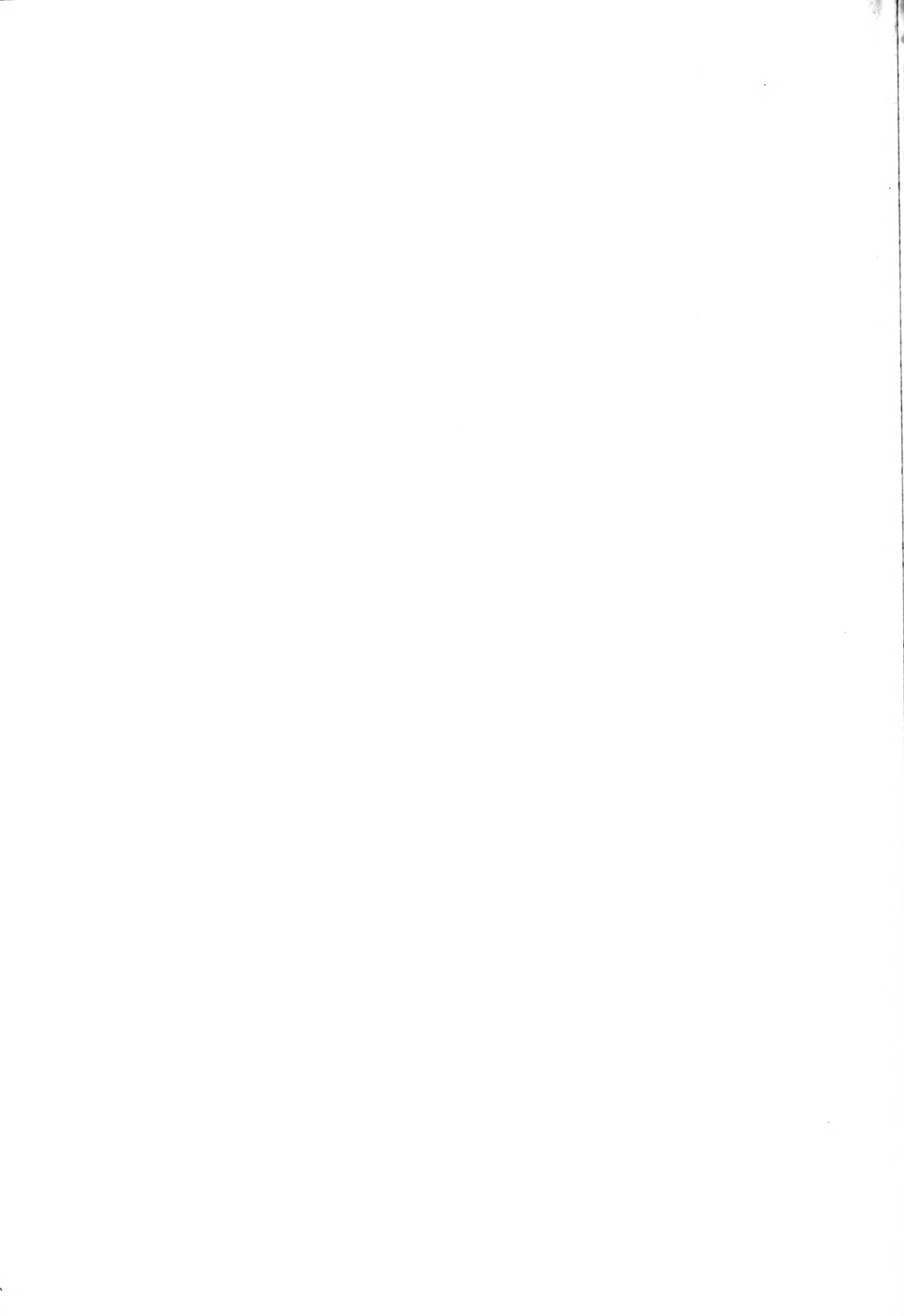

Fig. 8  
×17



Author photo.



B. KOTÔ:  
THE GREAT ERUPTION OF SAKURA-JIMA IN 1914.

PLATE XXI.

## PLATE XXI.

Microscopic textures of various ejecta, namely; scums, microtinites, microallivalites and gabbroids, ejected during the eruption of 1914.

Fig. 1.—**Cordieritiferous scum** or ceramicite-pumice from the western shore, showing cordierite aggregate filled with globules of pyrrhotite, the whole being enclosed by a fringe of bladed air-pores. It is a unique specimen of *pumice with cordierite*. Photo by Asist. Professor M. Ôyu. See pages 190, 200, 202.

Fig. 2.—**Microtinite**, being the same as in Pl. XX. Fig. 8, seen under crossed nicols. See pages 190, 191.

Fig. 3.—**Micro-allivalite**, which occurs as a round body coated with lava-film, and is found as blocks on the margin of eastern vents during the late phase of activity. See pages 190, 194.

Fig. 4.—The **same** under crossed nicols. See pages 190, 194.

Fig. 5.—**Gabbroid ejecta** from the eastern slope of the South Cone. See pages 190, 191.

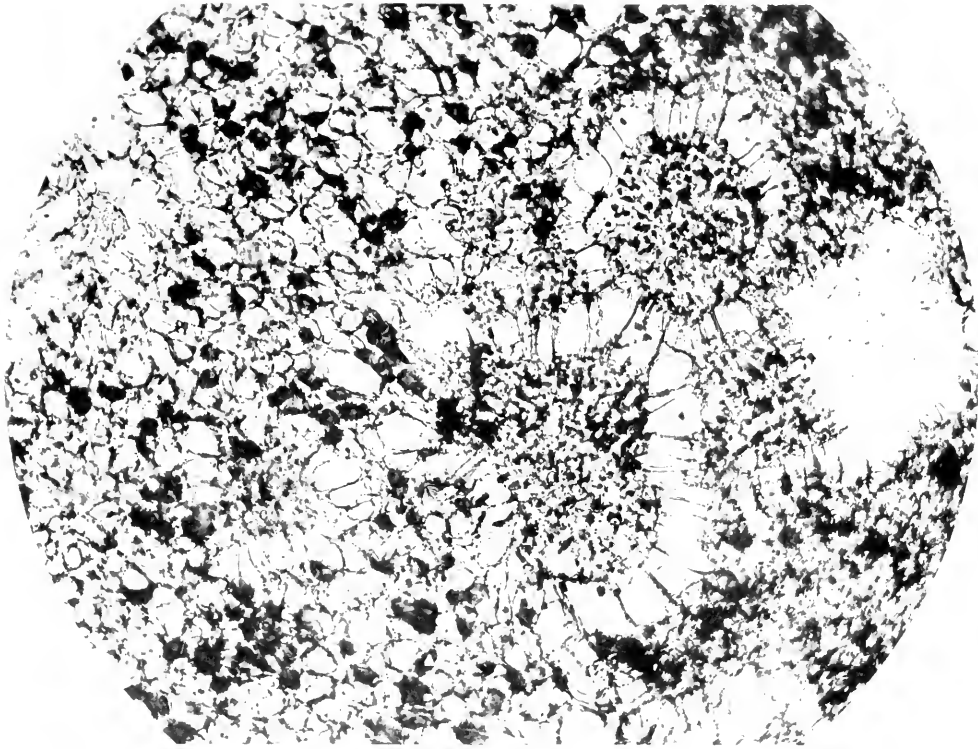

Fig. 1  
×65

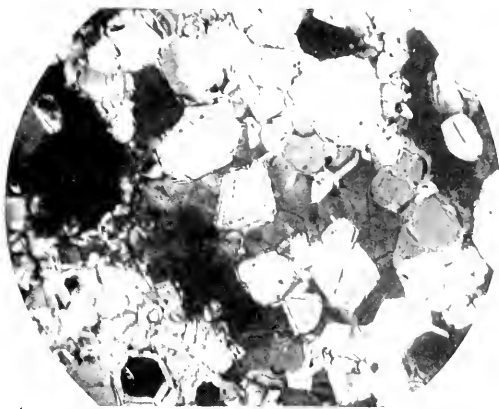

Fig. 2  
×17

+Nicols

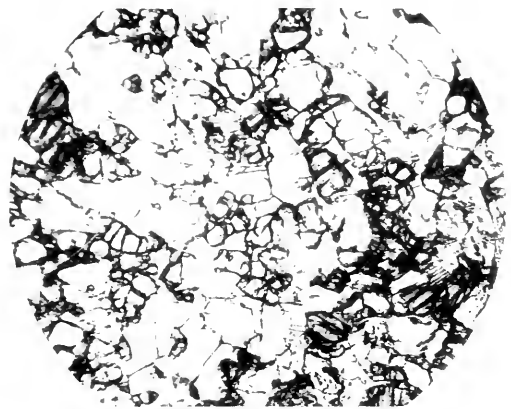

Fig. 3  
×17

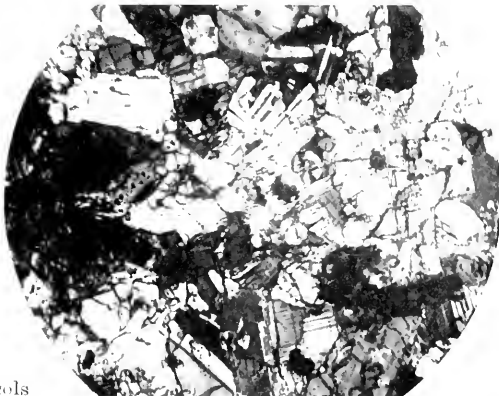

Fig. 4  
×17

+Nicols

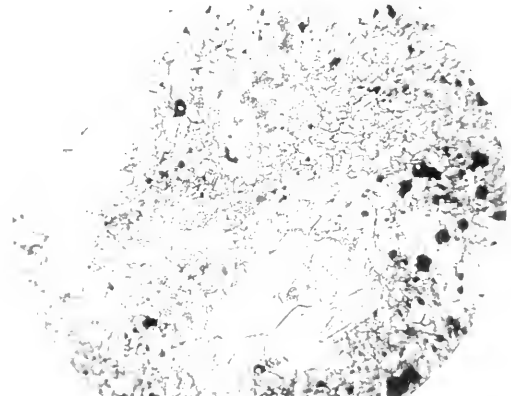
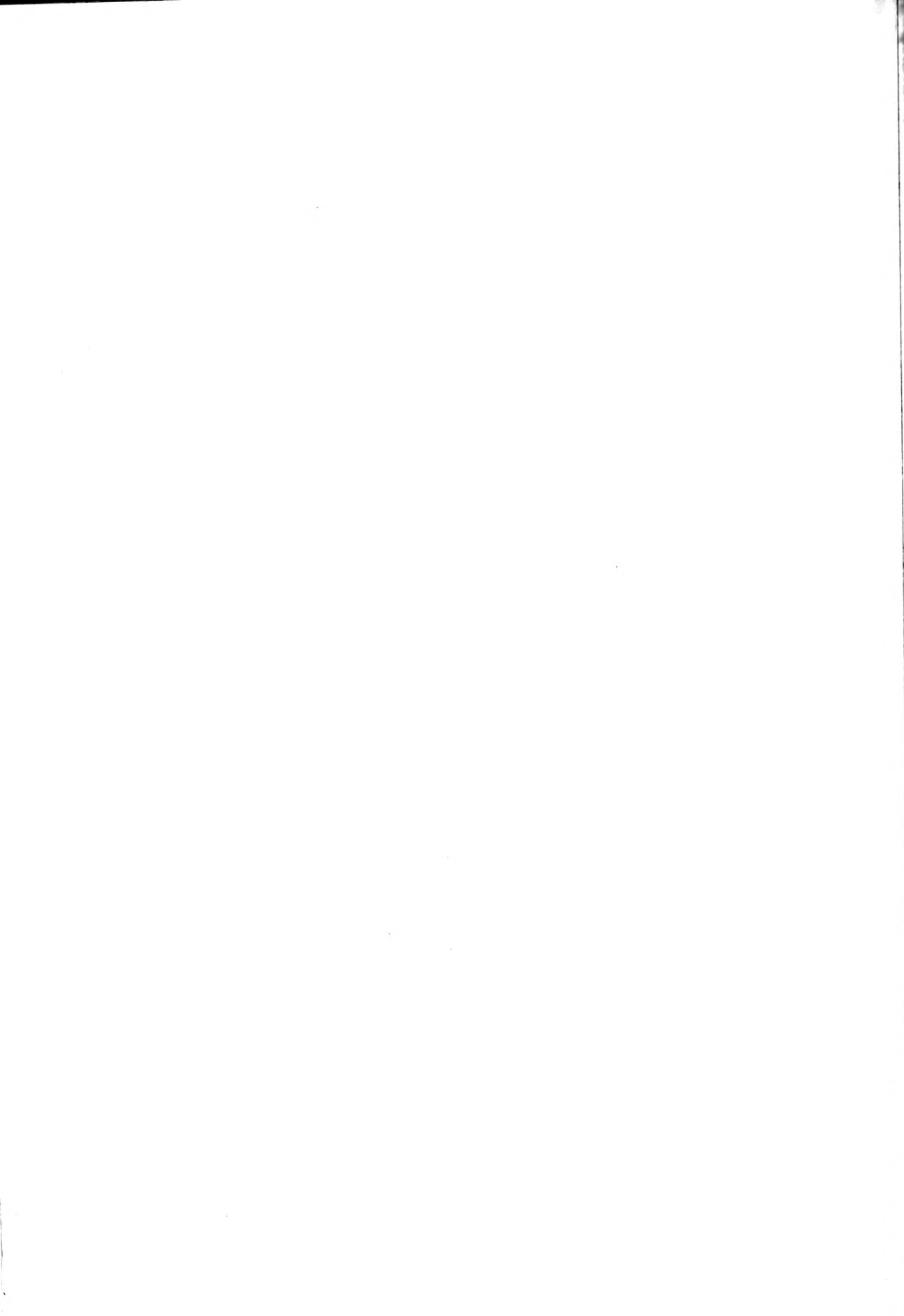

Fig. 5  
×25

Author photo.



**B. KOTÔ:**  
THE GREAT ERUPTION OF SAKURA-JIMA IN 1914.

PLATE XXII.

## PLATE XXII.

Microscopic textures of ejecta of the gabbroids, and the cordierite-bearing secretory products or ceramicites erupted in 1914, except Fig. 8, which is an Asama ceramicite of 1913.

Fig. 1.—**Gabbroid** magnified 79 diameters. The same ejecta as Pl. XXI. Fig. 5. See pages 190, 191.

Fig. 2.—**Ceramicite** or cordierite-bearing ejecta, type I., found at Koiké. The corroded anorthite with a clear glassy rim enclosed in large cordierite plates full of minute air-pores. See pages 196, 198, 199, 205.

Fig. 3.—**Ceramicite**, type II., under crossed nicols, from Kurokami on the eastern shore. A cordierite crystal in the centre is built up of heterogeneous grains of the same with homogeneous extinction of light, and pyrrhotite serves as the infilling matter. See pages 196, 198, 199, 200, 205.

Fig. 4.—**Ceramicite**, type III., from the same locality as above. A large crystal of cordierite is for the greater part built up of similarly orientated rectangles of the same mineral. See pages 196, 198, 200, 205.

Fig. 5.—**Ceramicite**, type III., with porphyritic polysynthetic anorthite, seen under crossed nicols, from the same locality as the two preceding. See pages 196, 200, 201.

Fig. 6.—**Ceramicite**, type IV., from spongy and banded ejecta near the Yunohira vent on the western side. See pages 196, 202, 205.

Fig. 7.—**Ceramicite**, type V., from the same locality as above. It is a complex of minute rectangles of cordierite mixed with prismoids of plagioclase and hypersthene. See pages 196, 202.

Fig. 8.—**Ceramicite**, from the volcano Asama, showing corroded anorthite in the ground which is composed of rectangles of cordierite cemented with pyrrhotite, showing characteristically the so-called *sideronitic* texture. Cordierite and pyrrhotite here seem to have crystallized nearly at the same time. See pages 196, 204.



Fig. 1  
×79

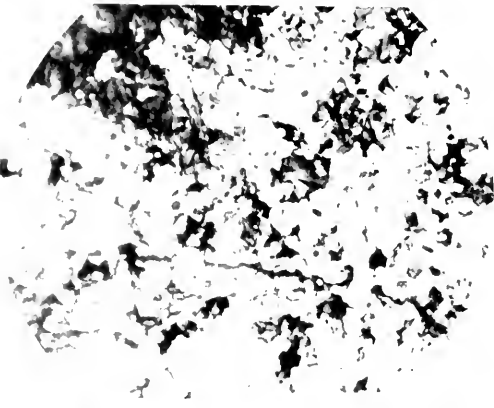

Fig. 2  
×79

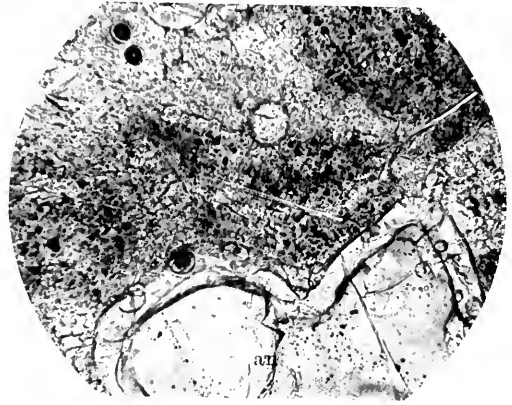

Fig. 3  
×16

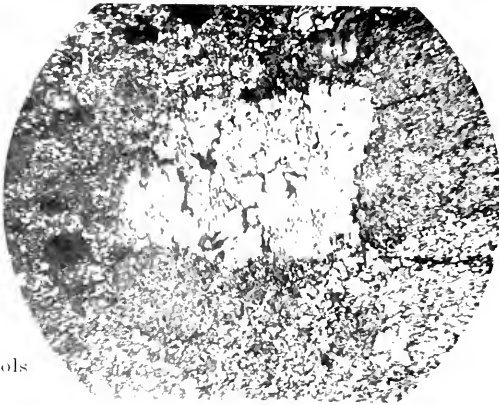
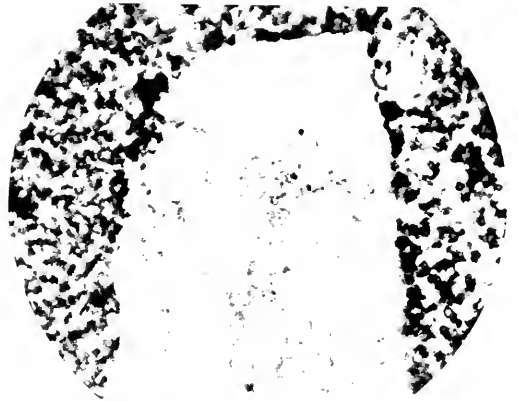

Fig. 4  
×79



+Nicols

Fig. 5  
×16

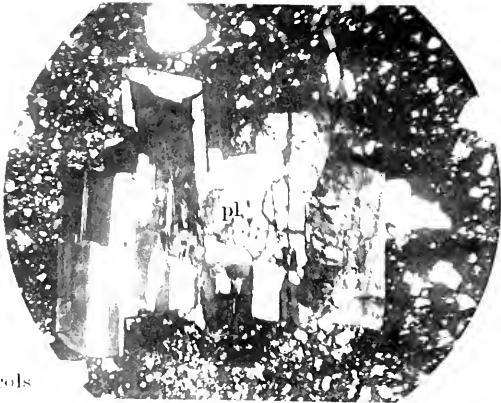
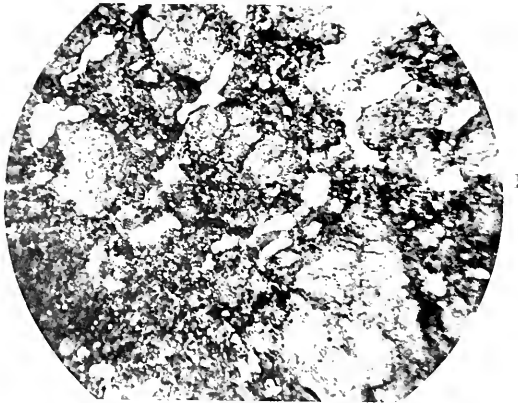

Fig. 6  
×17



+Nicols

Fig. 7  
140

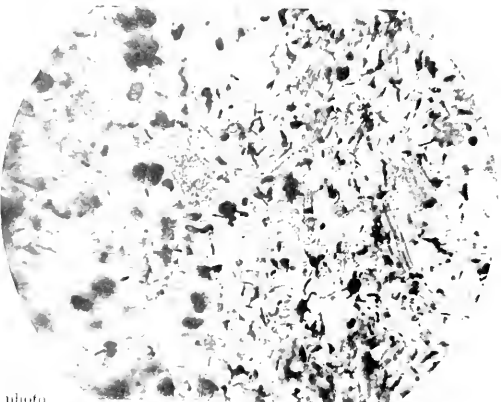
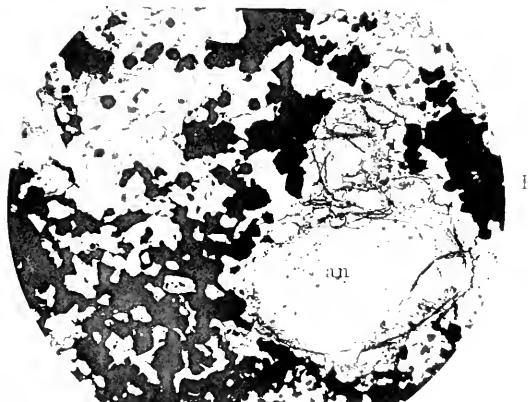

Fig. 8  
×30



Author photo.



B. KOTÔ :  
THE GREAT ERUPTION OF SAKURA-JIMA IN 1914.

PLATE XXIII.

## PLATE XXIII.

Microscopic textures of various ejectamenta thrown out during the eruption of 1914.

Fig. 1.—Fritted friable **granite**-block, under crossed nicols, ejected from the hidden foundation of the volcano. Quartz is cracked, orthoclase pseudo-phitized and biotite impregnated with pyrrhotite along cleavage plane. See pages 30, 216.

Fig. 2.—The so-called **sandstone**, which is really a glass-soaked pumice layer of the Plateau Formation of southern Kyûshû. Biotite is fresh (not found in the photomicrograph), but the rhomb-shaped hornblende is opacitized. See page 216.

Fig. 3.—**Trass** or a loose aggregate of heterogeneous constitution, mainly built up of lapilli of biotite-hornblende andesite soaked with opal-like isotropic substance. See 30, 212, 214.

Fig. 4.—Porphyritic **obsidian** of hypersthene-andesite, found as blocks at an altitude of 400 *m.* above the coastal village of Ari-mura. The brown glass in the groundmass shows the characteristic kneaded and damascened texture. See pages 186, 212.

Fig. 5.—Pumiceous **lapilli** with hypersthene that rained at the Experimental Station of the Kagoshima Agricultural College, at a distance of 11 *km.* from the Nabé-yama vents. See page 211.

Fig. 6.—Crystals of hypersthene, plagioclase and clumps of magnetite from pressed **lapilli** that thickly cover the coast of Prov. Ôsumi (Tabé). See pages 118, 211.

Fig. 7.—Wash-skeleton of **ash** that fell at Kokubu Station during the first phase of activity, at a distance of 20 *km.* Minerals found are idiomorphic hypersthene, allotriomorphic plagioclase and a subordinate quantity of magnetite clumps. See page 118.

Fig. 8.—**Ash** that fell in Tôkyô, at a distance of 1,000 *km.* from Sakura-jima, being mainly composed of minute splinters of colorless strained glass full of air-pores. It is the lightest portion of comminuted lapilli. See pages 72, 118.

Fig. 1  
×25

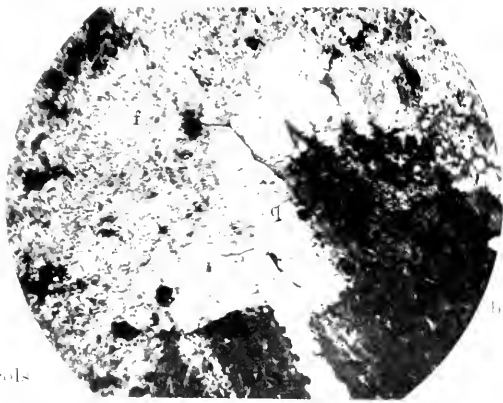

+Nuclei

Fig. 2  
×35

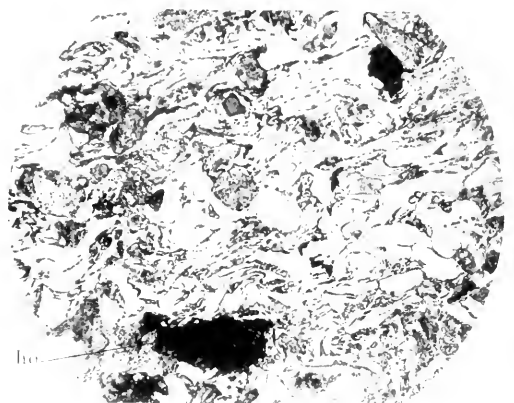

Fig. 3  
×17



Fig. 4  
×179

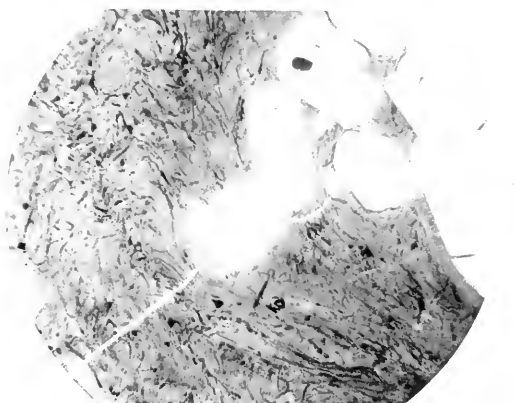

Fig. 5  
×18

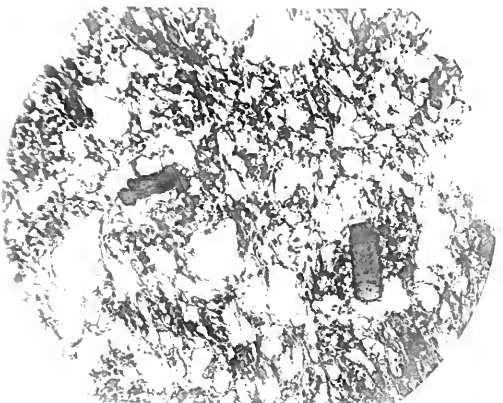

Fig. 6  
×18



Fig. 7  
×25

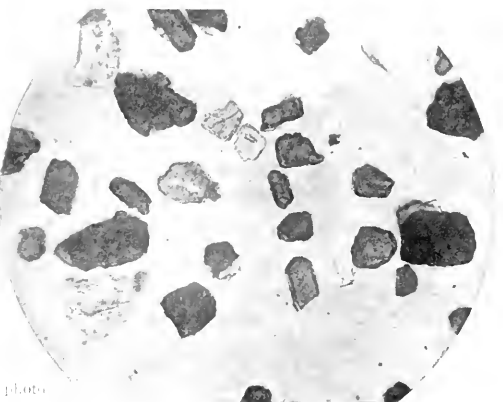
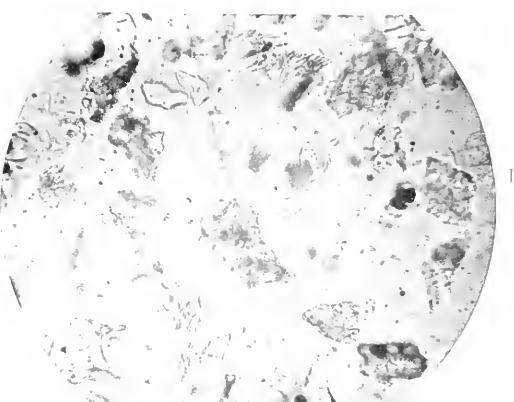

Fig. 8  
×179



Author photo



# GEOLOGIC MAP OF VOLCANO SAKURAJIMA

BY B. KOTO, PH. D.

1911

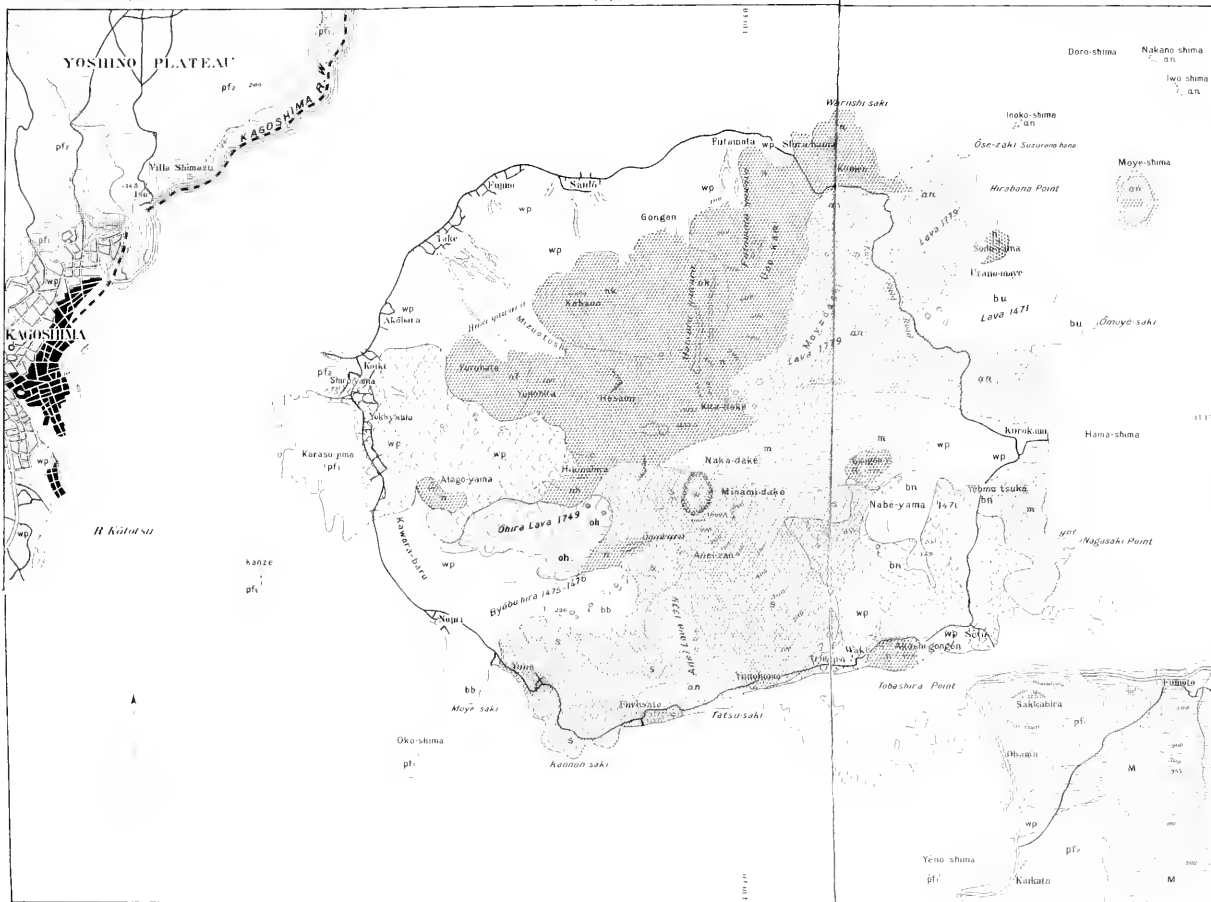

## LEGEND

- M**  
Mesozoic Slate
- Basal Plateau Formation**
- Platform Formation**
- Basal Formation**
- Wash Plain**
- Premittic Lavas**
- North cone lava**  
*(Ohira Lava 1749, Nabe-yama Lava 1747, Yabu-bira Lava 1475-1476)*
- Multiple lava**
- South cone lava**
- Historic Lavas**
- Ohira Lava**
- Yabu-bira Lava**  
*(Ohira Lava 1749, Nabe-yama Lava 1747, Yabu-bira Lava 1475-1476)*
- Recent**
- New Land Lava**
- New Marine Lava**

Scale 1:50,000

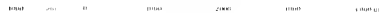





**Contributiones novae ad Floram Bryophyton  
Japonicam.**

PARS SECUNDA.

Elaboravit

**Shūtai Okamura**, *Rigakuhakushi*.

(Institutione Botanico Universitatis Imperialis Tōkyōensis).

---

*Cum 42 figuris.*

---

**I. HEPATICAE.**

**MARCHANTIACEAE.**

*Reboulia haemisphaerica* (L.) RADDI.

Formosa : Prov. Taihoku-chō, Urai [烏來] (Leg. JUKICHI SHIRAGA!  
VII, 1911.); in monte Arisan (Leg. BUNZŌ HAYATA! 6. IV. 1914.).

Species nova ad floram formosanam.

*Marchantia tosana* STEPH.

Formosa : Prov. Taihoku-chō, Urai [烏來] (Leg. JUKICHI SHIRAGA!  
VII, 1911.); in monte Arisan (Leg. BUNZŌ HAYATA! 6. IV. 1914.).

Species nova ad floram formosanam.

## JUNGERMANIACEAE AKROGYAE.

*Plagiochila fruticosa* MITT.

Formosa: In monte Arisan (Leg. BUNZŌ HAYATA! 6. IV. 1914.)

Species nova ad floram formosanam.

*Chiloscyphus rivularis* (SCHRAD.) LOESKE. Abh. Bot. Ver.

Prob. Brand. pp. 172-174 (1904).

Syn. *Chiloscyphus polyanthus* (L.) CORDA. var. *rivularis* (SCHRAD.) NEES. Eur. Lab. II. p. 374. (1836).

Habitat in solio lacus c. 2m. profundo.

Hondo: Prov. Kōduke, in Lacu Marunuma [丸沼] (Leg. HARAİKAWA! VII. 1914.).

Species nova ad floram japonicam.

*Bazzania spinosa* SH. OKAMURA. Sp. nov.

*Plantae* robustae, caespitosae, lutescenti-fuscescentes, haud nitidae, rigidiuseulae. *Caulis* repens, usque ad 5 cm. longus, cum foliis c.

3 mm. latus, dichotome ramosus, hic illic flagellaris, flagelliis usque ad 3 cm. longis, microphyllinis, per totam longitudinem dense fasciculatim fere hyalino-radiculis. *Folia* dense imbricata, oblique-patentia, e basi semi-cordata ovalia, apice rotundato-truncata, con-

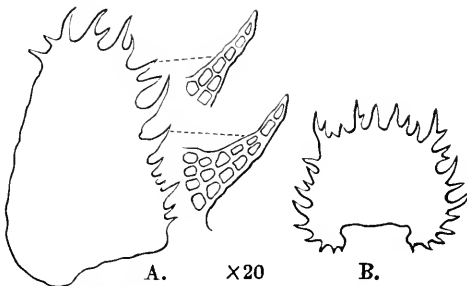

Fig. 1. *Bazzania spinosa*.

A. folium. ( $\times 20$ ). B. Amphigastrium. ( $\times 20$ ).

cava, c. 1.6 mm. longa, basi c. 1.0 mm. et apice c. 0.6 mm. lata, marginibus anticis subplanis integris, posticis incurvis e basi ad apicem densiuscule (10-16) spinosis, spinis c. 80-250  $\mu$  longis, e seriebus cellularum basi 2-3 ad apicem 1 compositis, cuticula

spinorum incrassata; cellulis basilaribus rectangularibus c. 35–42  $\mu$  longis et c. 15–20  $\mu$  latis, in medio et apice folii plerumque quadratis, c. 20–35  $\mu$  magnis, marginalibus quadratis c. 14–20  $\mu$  magnis, omnino laevissimis valde chlorophyllosis incrassatiusculis, trigonis parvis vel nullis. *Amphigastria* magna, dense imbricata, transverse inserta, decurrentia, cordato-quadrata, valde recurvo-concava, c. 0.8–0.9 mm. magna, marginibus recurvis, ubique crebre spinosis.

Formosa: in monte Arisan (Leg. BUNZŌ HAYATA! 4. IV. 1914.).

Nomen speciei ab spinis marginis folii.

*Trichocolea tomentella* (HUDS.) LINDB.

Kyūshū: in insula Yakushima (Leg. TAKANORI IWAKI! 21. IX. 1914.).

*Radula complanata* (L.) DUM.

Formosa: Prov. Taihoku-chō, Urai (Leg. JUKICHI SHIRAGA! VII. 1914.).

Species nova ad floram formosanam.

*Madotheca Perottetiana* MONT.

Formosa: Prov. Taihoku-chō, Urai (Leg. JUKICHI SHIRAGA! VII. 1914.).

Species nova ad floram formosanam.

*Erullania moniliata* NEES.

Formosa: Prov. Taihoku-chō, Urai (Leg. JUKICHI SHIRAGA! VII. 1914.).

Species nova ad floram formosanam.

---

## II. MUSCI.

## SPHAGNACEAE.

*Sphagnum acutifolium* EHRH.

Sachalin : Sicca [數香] (Leg. JŪSUKU SUSUKI! 1. V. 1913); Ochiai (Leg. HARUZŌ KOMATSU! VIII. 1914.). Korea : Prov. Kankyō-Nandō, Sanyō [山羊] (Leg. TAKENOSHIN NAKAI! 22, VII. 1914.); in monte Hōtaizan [胞胎山] (Leg. TAKENOSHIN NAKAI! 6. VIII. 1914.); in monte Rohō [鷲峰] (Leg. TAKENOSHIN NAKAI! 10. VII. 1914.).

Species nova ad floram koreanam.

*Sphagnum Gîrgensohnii* Russ.

Sachalin : Sicca (Leg. JŪSUKU SUSUKI! 1. V. 1913.); Ochiai (Leg. HARUZŌ KOMATSU! VIII. 1914.). Korea : in monte Rohō (Leg. TAKENOSHIN NAKAI! 10. VII. 1914.); in monte Hōtaizan (Leg. TAKENOSHIN NAKAI! 6. VIII. 1914.); in monte Hakutōzan [白頭山] (Leg. TAKENOSHIN NAKAI! 10. VIII. 1914.).

Species nova ad floram koreanam.

*Sphagnum japonicum* WARNST.

Sachalin : Sicca (Leg. JŪSUKU SUSUKI! 1. V. 1913.).

Species nova ad floram sachalinam.

*Sphagnum papillosum* LINDB.

Sachalin : Sicca (Leg. JŪSUKU SUSUKI! 1. V. 1913.).

Species nova ad floram sachalinam.

*Sphagnum squarrosus* PERS.

Korea : Prov. Kankyō-Nandō, Shindōrei [新道嶺]. Chōshin-gum (Leg.

TAKENOSHIN NAKAI! 13, VII. 1914.); in monte Rohō (Leg. TAKENOSHIN NAKAI! 10. VII. 1914.).

Species nova ad floram koreanam.

## DICRANACEAE.

### *Trematodon drepanellus* BESCH.

Formosa: Taihoku (Leg. HISAHIKO SASAOKA! 7. III. 1912. et YAICHI SHIMADA! IV. 1913.).

### *Trematodon longicollis* MICHX.

Formosa: in monte Arisan (Leg. BUNZŌ HAYATA! 6. IV. 1914.).

Species nova ad floram formosanam.

### *Ceratodon purpureus* (L.) BRID.

Korea: Prov. Heian-Hokudō, Hiraihō [飛來峯] (Leg. TAKENOSHIN NAKAI! 10. VI. 1914.).

Species nova ad floram koreanam.

### *Dicranella heteromalla* (DILL., L.) SCHIMP.

Formosa: Prov. Taihoku-chō, Shabosan [沙帽山] (Leg. YAICHI SHIMADA! 31. XII. 1913.).

Species nova ad floram formosanam.

### *Dicranum Bergeri* BLANDOW.

Syn. *D. Schraderi* SCHWGR.

Sachalin: Sicca (Leg. JŪSUKU SUSUKI! 1. V. 1913.).

Species nova ad floram japonicam.

### *Dicranum majus* TURN.

Sachalin: Sicca (Leg. JŪSUKU SUSUKI! 1. V. 1913.). Korea: in monte

Rohō (Leg. TAKENOSHIN NAKAI! 11. VII. 1914.).

Species nova ad floram koreanam.

*Dicranum scoparium* (L.) HEDW.

Korea: Prov. Heian-Hokudō, Hokujōmen, Kōkai-gun (Leg. TAKENOSHIN NAKAI! 1. VII. 1914.); in monte Rohō (Leg. TAKENOSHIN NAKAI! 11. VII. 1914.).

Species nova ad floram koreanam.

FISSIDENTACEAE.

*Fissidens japonicus* DOZ. et MOLK.

Formosa: Taihoku (Leg. YAICHI SHIMADA! 20. VI. 1914); Urai (Leg. JUKICHI SHIRAGA! VII. 1911.).

Species nova ad floram formosanam.

*Fissidens lateralioides* SH. OKAMURA, sp. nov.

Habitat in terra irrorata. *Plantae* tenellae, laxae caespitosae, laete virides, haud nitidae, molliusculae. *Caulis* adscendens, c. 7–10 mm. longus et c. 0.16 mm. diam., cum foliis c. 2.5–3.0 mm. latus, infima basi fusco-radiculosus, simplex, densiuscule foliosus, obtusus. *Folia* sicca leviter crispata, madida erecto-patentia, c. 10–15-juga, infima c. 4-juga minuta, caetera majora, haud decurrentia, lineari-lanceolata, apice acuta, c. 2.0–2.3 mm. longa et c. 0.5–0.56 mm. lata, integerrima autem summo apice minutissime serrulata, lamina vera usque ad medium folii producta, oblique truncata, lamina dorsali ad basin nervi enata, limbo ad apicem producto, hyalino, dorsali inferne latiore c. 30–35  $\mu$  lato e seriebus c. 5–7, superne sensim angustiore e seriebus duabus cellularum elongatarum composito, ventrali inferne e seriebus 2–3, superne e seriebus duabus composito; nervo concolore vel saepe fusciscenti, superne

stricto breviter excedente; cellulis valde chlorophyllosis, laevibus, pellucidis, hexagonis, in medio folii c.  $9-14\mu$  magnis, superioribus minoribus c.  $7\mu$  magnis, basilaribus ad nervum rectangulis vel fere rhomboideis c.  $20-25\mu$  longis. *Inflorescentia* autoica; flores masculi geminiformes; antheridia c. 10. *Ramulus perichaetialis* fusco-radiculosus. *Bractee perichaetii* in-

timae basi alte vaginantae lineares, apice breviter attenuatae, c.  $1.2-1.4$  mm. longae et c.  $0.12$  mm. latae, marginibus basi late superne anguste ex unica serie cellularum formato limbatis, e medio ad apicem remote crenulatis; nervo valido, infra summum apicem evanido; cellulis hexagonis c.  $10\mu$  magnis, basilaribus linearibus, infimis rectangulis. *Vaginula* anguste oblongo-cylindrica, c.  $0.3$  mm. alta, fusca. *Seta* lateralis c.  $1.3-1.6$

mm. alta, strictiuscula vel inferne arcuata, lutescenti-rubra, laevis. *Theca* crecta, oblongo-cylindrica, symmetrica, brevicollis, c.  $0.5-0.72$  mm. longa et c.  $0.32$  mm. crassa, laevis; cellulis exothecii rectangulis, c.  $30-35\mu$  longis et c.  $15\mu$  latis, parietibus incrassiusculis, ad orificium in seriebus c. 5 minutis hexagonis; stomatibus nullis. *Annulus* nullis. *Peristomii* dentes subulati, basi connati, ad  $\frac{3}{4}$  profunde bifidi, c.  $0.32$  mm. longi et basi c.  $35\mu$  lati, rufescentes, basi dense trabeculati minutissime papilloso, intus dense et alte lamellosi, cruribus duobus, filiformibus, dense spiralter incrassatis. *Sporae* c.  $7-9\mu$  magnae, virides vel ferruginei, laeves. *Operculum* e basi conica longe rostratum, c.  $0.35-0.4$  mm. longum et basi c.

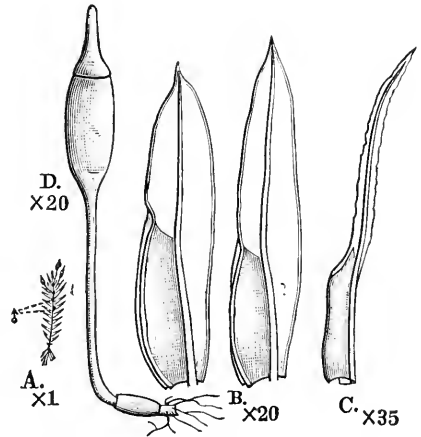

**Fig. 2.** *Fissidens lateralioides*

- A. Planta fertilis ( $\times 1$ ); B. Folia ( $\times 20$ );  
 C. Bractea perichaetialis intima ( $\times 35$ ).  
 D. Sporangia cum seta et vaginula ( $\times 20$ ).

0.25 mm. diam., rufescens, rostro stricto vel curvatulo. apice obtuso. *Calyptra* cucullata, c. 0.56 mm. longa, viridescens vel pallida apice fusca. laevis.

Hondo: Prov. Etehū, Kamidaki-mura, Kamishinkawa-gun (Leg. HISAHIKO SASAOKA! 12. XI. 1914.).

Habitus, statura, faciesque omnino *F. laterali* BROTH., foliis autem e cellulis majoribus, limbo latiore, inflorescentia autoica, seta brevior, theca oblongo-cylindrica diversa.

Nomen speciei ab facie ut *F. lateralis* BROTH.

***Fissidens nagasakinus* BESCH.**

Formosa: Taihoku et Mubikō [無尾港] (Leg. HISAHIKO SASAOKA! 30. X. 1912.).

***Fissidens zippelianus* BR. JAV.**

Formosa: Prov. Shinchiku-chō, Chikunan-ippo [竹南一堡] (Leg. HISAHIKO SASAOKA! 21. X. 1912.).

**POTTIACEAE.**

***Weisia viridula* (L.) HEDW.**

Formosa: Prov. Shinchiku-chō, Chikunan-ippo (Leg. HISAHIKO SASAOKA! 21. III. 1912.); Prov. Taihoku-chō, Mubikō (Leg. HISAHIKO SASAOKA! 3. XI. 1912.).

***Barbula orientalis* (WILS.) BROTH.**

Formosa: Taihoku (Leg. HISAHIKO SASAOKA! 1. XI. 1912.).

***Tortula emarginata* (DOZ. et MOLK.) MITT.**

Formosa: Prov. Shinchiku-chō, Chikunan-ippo (Leg. HISAHIKO SASAOKA! 13. VI. 1912.).



## GRIMMIACEAE.

*Glyphomitrium angustifolium* SH. OKAMURA. sp. nov.

Habitat in saxis. *Plantae* robustae, compacte pulvinatae, superne laete virides, inferne nigrescentes, in statu sicco nitidiusculae, nigrescenti-virides, rigidiusculae. *Caulis* erectus vel adscendens, usque ad 1.5 cm. altus, basi rubiginoso-radiculosus, simplex vel 1-3-ramosus, sectione teres, c. 0.24-0.28 mm. diam., fasciculo centrali c. 40  $\mu$  magno pluricellulari, reti intermedio fusciscenti, cellulis hexagonis vel oblongo-hexagonis, c. 15-20  $\mu$  magnis tenellis, cellulis periphericis in seriatis 1-3 minoribus c. 7  $\mu$  magnis incrassiusculis fuscis; ramis erectis, c. 5-8 mm. altis, strictis, simplicibus; caulibus ramisque dense foliosis teretibus. *Folia* sicca circinato-incurva, madida erecto-patentia, carinato-concava, lanceolata vel subulato-lanceolata, apice obtusiuscule acuta, c. 4.0-4.5 mm. longa et c. 0.64-0.72 mm. lata, marginibus integerrimis, undulatis; nervo valido, apice evanido, in sectione transversali plano-convexo, dorso valde prominenti, basi c. 0.12 mm. lato et c. 0.06 mm. crasso, cellulis ventralibus c. 11-12 majoribus, ducibus medianis c. 7, stereideis numerosis, cellulis dorsalibus c. 17 distinctis minoribus; cellulis laminalibus incrassiusculis, valde chlorophyllosis, obscuriusculis, ad apicem rotundato-hexagonis, c. 12-14  $\mu$  magnis, ad basin quadratis vel breve rectangularibus, basilaribus infimis rectangularibus, c. 30-40  $\mu$  longis et c. 12-17  $\mu$  latis. *Inflorescentia* autoica; flores masculi ad basin perichaeti

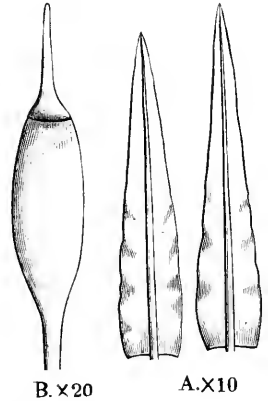

**Fig. 3.** *Glyphomitrium angustifolium*.  
A. Folia ( $\times 10$ ); B. Sporangia ( $\times 20$ ).

geminiformes. *Bracteeae perichaetii* foliis similes, sed breviores, c. 1.3–1.6 mm. longae. *Vaginula* cylindrica, c. 0.8 mm. alta, fusca. *Seta* 7–9 mm. alta, erecta, basi rubescens apice lutescens, laevis, stricta, sicca leviter torta. *Theca* libera, erecta, oblongo-cylindrica, c. 1.2–1.36 mm. longa et c. 0.5–0.56 mm. crassa, pallide fusca, laevis, collo obconico lutescenti c. 0.32 mm. longo; cellulis exotheeii oblongis oblongo-hexagonis vel rectangulis, c. 25–35  $\mu$  longis et c. 9–12  $\mu$  latis, ad orificium in seriebus c. 3–4 minutis quadratis; stomatibus nullis. *Annulus* c. 54  $\mu$  altus, duplex, hyalinus. *Peristomii* dentes anguste subulato-lanceolati, c. 0.2 mm. longi et basi c. 28  $\mu$  lati, fere ad basin divisi, dense papilloso, intus humile et laxe lamellosi, cruribus lineari-subulatis. *Sporae* c. 15–18  $\mu$  magnae, fusciscenti-virides, minutissime papillosae. *Operculum* e basi conica longe rostratum, c. 0.65–0.8 mm. longum et basi 0.28–0.34 mm. diam., rostro erecto crassiusculo, apice obtuso. *Calyptra* campanulato-mitriformis, c. 2.1–2.3 mm. longa, thecam totam obtgens, longitudinaliter plicata, lutea apice fusca, laevis.

Hondo: Prov. Sagami, Yamakita (Leg. KIYOTAKA HISAUCHI! 21. II. 1915.).

Habitus statura faciesque *G. sinensi* MITT. simillima, sed foliorum forma longe diversa.

Nomen speciei ab foliis angustioribus.

***Grimmia Hisauchii* SH. OKAMURA. sp. nov.**

Habitat in saxis. *Plantae* tenellae, pulvinatae, superne virides, inferne sordide luridae, in statu sicco atro-virides apice albescentes, rigidae, nitidiusculae. *Caulis* erectus adscendens vel decumbens, usque ad 2.5 em. longus, inferne parce rubiginoso-radiculosus, semel-ter dichotome ramosus, sectione teres, c. 0.16–0.2 mm. diam., fasciculo centrali nullo, reti centrali fusciscenti vel lutescenti, cel-

lulis hexagonis c.  $15-20\ \mu$  magnis tenellis, cellulis periphericis c. 3-seriatis minoribus c.  $7-10\ \mu$  magnis paulum incrassatis fuscis; ramis strictis vel arcuatis, dense foliosis, obtusis. *Folia* sicca valde adpressa stricta, madida erecto-patentia, e basi rotundato-ovalia subulato-attenuata, carinata, apice nervo excurrente longe pilifera (pilo hyalino usque ad 1.2 mm. longo, paulum papilloso, margine minute serrulato), c. 2.8–3.2 mm. longa et basi c. 0.7 mm. lata, marginibus integerrimis, basi revolutis inde uno vel utroque lateralis leviter revolutis; nervo valido, superne canaliculato, in sectione transversali concavo-convexo, dorso prominenti, basi c.  $80\ \mu$  lato et c.  $30-40\ \mu$  crasso, ducibus ventralibus 2–3, cellulis dorsalibus c. 10, fasciculo stereidearum e stratis 2–3 cellularum composito; cellulis laminalibus basilaribus uni-stratis, luteis vel fuscis, juxta costam linearibus c.  $25-40\ \mu$  longis et c.  $7\ \mu$  latis, margines versus quadratis vel breviter rectangulis c.  $15-20 \times 15\ \mu$  magnis, parietibus haud incrassatis non sinuosis nec porosis, caeteris quadratis c.  $9-10\ \mu$  magnis sublaevibus, in dimidio superiore bi-stratis, ad margina 4-stratis subopacis. *Caetera* desunt.

Hondo: Prov. Sagami, Ikego [池子], Dushi (Leg. KIYOTAKA HISAUCHI! 12. XII. 1914.).

Species *G. pilifera* habitu faciesque subsimilis, sed foliorum forma, pilo humile papilloso, cellulis basilaribus haud sinuosis longe diversa.

Nomen speciei in honorem Leg. Dom. KIYOTAKA HISAUCHI.

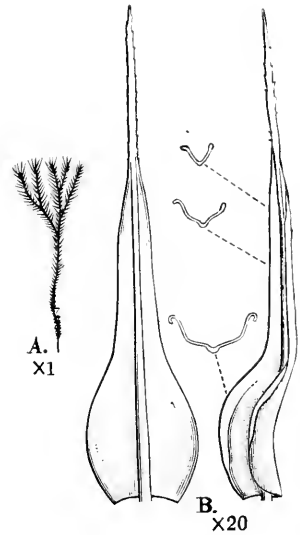

Fig. 4. *Grimmia Hisauchi*.

A. Planta ( $\times 1$ ); B. Folia ( $\times 20$ ).

*Grimmia Kiyoshii* SH. OKAMURA. sp. nov.

Habitat in saxis. *Plantae* tenellae, pulvinatae vel saespitosae, superne lutescenti-virides inferne fuscae, haud nitidae, rigidiuseulae. *Caulis* erectus vel adscendens, usque ad 2.5 cm. longus, inferne

densiuscule fusco-radiculosus, irregulariter et fasciculatim ramosus, sectione teres, c. 0.24 mm. diam., fasciculo centrali nullo, reti centrali fuscescenti, cellulis hexagonis c. 20  $\mu$  magnis, parietibus incrassiusculis, cellulis periphericis c. 4-5-seriatis minoribus c. 10-15  $\mu$  magnis valde incrassatis fuscis; caulibus ramisque densiuscule foliosis obtusis. *Folia* sicca adpressa vix crispata, madida erecto-patentia, basi breviter decurrentia, ovato-lanceolata, in acumen subulatum carinatum attenuata, summo apice obtusa vel acuta, epilosa, basi concava apice carinata, c. 2.0-2.4 mm. longa et c. 0.5-0.7 mm. lata, marginibus e basi ultra medium revolutis, in parte subulae obsolete denticulatis, utique

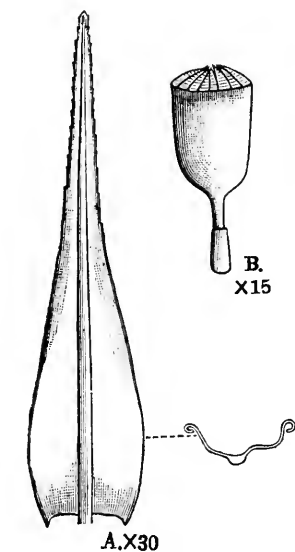

**Fig. 5.** *Grimmia Kiyoshii*.

A. Folium ( $\times 30$ );

B. Sporangia ( $\times 15$ ).

summo apice serralatis; nervo valido, apice evanido, dorso e medio ad apicem bi-seriate denticulato, in sectione transversali plano-convexo, dorso prominenti, basi c. 60  $\mu$  lato et c. 40  $\mu$  crasso, ducibus ventralibus 2, cellulis dorsalibus c. 10, fasciculo streidearum e stratis 2 cellularum composito; cellulis laminalibus laevibus, basilaribus anguste linearibus c. 30-40  $\mu$  longis et c. 7-9  $\mu$  latis, margines versus quadratis vel rectangulis, parietibus incrassiusculis haud porosis, caeteris quadratis vel breve rectangulis incrassiusculis paulum sinuosis c. 7-9  $\mu$  magnis laevis, in parte subulae et ad margina 2-stratis subopacis.

*Inflorescentia* autoica. *Bracteae perichaetii* intimae erectae, paulum vaginatae, oblongo-lanceolatae, apice acutae vel obtusae, c. 2.7–2.8 mm. longae et 0.8 mm. latae, caetera foliis similes. *Seta* erecta, 0.32 mm. longa, fusca, laevis. *Theca* immersa, erecta, oblonga, symmetrica, deoperculata latistoma, c. 0.8–1.0 mm. longa et c. 0.7 mm. diam., fusca, laevis; cellulis exothecii hexagonis, c. 30  $\mu$  magnis, ad orificium in seriebus c. 10 brevissime hexagonis; stomatibus ad basin thecae numerosis. *Annulus* ignotus. *Peristomii* dentes dorso dense trabeculati, dense et minutissime papilloso, fusci. *Sporae* c. 10–11  $\mu$  magnae, fuscae, minute papillosae. *Caetera* ignota.

Hondo: Prov. Idu, in monte Amagi (Leg. KIYOSHI FUJII! 18. VIII. 1914.).

Species *G. apocarpa* var. *gracili* affinis, sed foliis ovato-lanceolatis apice subulato-attenuatis semper epilosis, cellulis paulum sinuosis dignoscenda.

Nomen speciei in honorem Leg. DOM. KIYOSHI FUJII.

***Racomitrium canescens* (WEIS., TIMM.) BRID.**

Korea: in monte Hakutōzan (Leg. TAKENOSHIN NAKAI! 10. VIII. 1914.).  
Species nova ad floram koreanam.

***Racomitrium fasciculare* (SCHRAD.) BRID.**

Korea: in monte Rohō (Leg. TAKENOSHIN NAKAI! 11. VII. 1914.).  
Species nova ad floram koreanam.

***Racomitrium hypnoides* (L.) LINDB.**

Korea: in monte Rohō (Leg. TAKENOSHIN NAKAI! 11. VII. 1914.).  
Species nova ad floram koreanam.

***Racomitrium Iwasakii* SH. OKAMURA. sp. nov.**

Habitat in terra. *Plantae* robustiusculae, caespitosae, caespi-

tibus lutescenti-viridibus vel atro-viridibus inferne postea furginosis, haud nitidis, rigidiusculis, densis. *Caulis* erectus vel decumbens, usque ad 4 cm. altus, dichotome ramosus, fere ad apicem fusco-radiculosus, sectione teres, c. 0.4–0.5 mm. crassus, fasciculo centrali nullo, reti centrali lutescenti, cellulis hexagonis c. 20–28  $\mu$  magnis incrassiusculis, cellulis periphericis c. 4–5-seriatis minoribus luteo-fuscis incrassioribus, superficiali tenuis subhyalinis; ramis dense foliosis, obtusis, non breve ramulosis. *Folia* sicca adpressa et leviter crispata, humida erecto-patentia vel patentia, haud homomalla, lanceolato-elliptica, in acumen breve hyalinum papillosum serratum subcuspidum contracta, c. 2.0–2.4 mm. longa et c. 0.8 mm. lata (acuminibus hyalinis c. 0.12–0.32 mm. longis.), valde concava et ad apicem carinato-concava, marginibus e strato uni-cellularum ubique hortiter revolutis; nervo valido, infra summum apicem evanido, fusco-luteo, dorso superne papilloso, in sectione transversali plano-convexo, basi c. 85  $\mu$  lato et c. 40  $\mu$  crasso, e 5-stratis cellularum composito, ducibus medianis 4, cellulis ventralibus c. 5, dorsalibus c. 12; cellulis laminalibus valde papillois, linearibus, c.

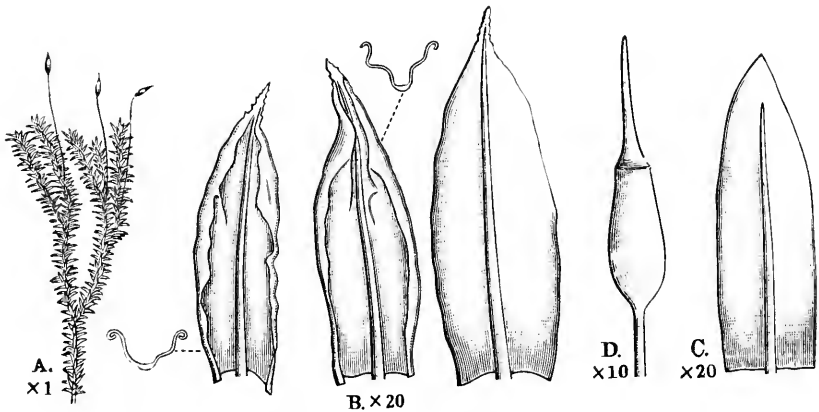

**Fig. 6.** *Rhacomitrium Iwasakii*.

A. Planta ( $\times 1$ ); B. Folia ( $\times 20$ ); C. Bractea perichaetialia intima ( $\times 20$ );  
D. Sporangia ( $\times 10$ ).

40–60  $\mu$  longis et c. 7–8  $\mu$  latis, superne quadratis vel subquadratis c. 10–12  $\mu$  magnis, basilaribus inter sese porosis fere laevibus, angularibus laevissimis quadratis vel oblongo-rectangulis c. 25–45  $\mu$  longis et c. 14–18  $\mu$  latis, externis oblongis et turgidacis. *Inflor-entia* dioica. *Ramulus perichaetialis* fusco-radiculosus. *Bractea perichaetii* intimae erectae, oblongo-lanceolatae, apice breve et late acutae, hyaline muticae, c. 1.6–2.0 mm. longae et c. 0.5–0.56 mm. latae, superne carinato-concavae, marginibus subplanis, integerrimis; nervo tenui, infra summum apicem evanido, dorso fere laevi; cellulis linearibus, superne rhomboideis et brevioribus, omnino laevibus vel parce papillois. *Vaginula* oblongo-cylindrica, c. 1 mm. alta, fusca apice nigrescens. *Seta* c. 12–18 mm. longa, erecta, fusca superne luteo-fusca vel lutea, sicca torta. *Theca* erecta, symmetrica, oblongo-cylindrica, c. 1.8 mm. longa et c. 0.72 mm. crassa, fusca, laevis, sicca subirregulariter plicata; cellulis exothecii rectangularibus, c. 28–56  $\mu$  longis et c. 14–22  $\mu$  latis, superioribus angustioribus c. 9  $\mu$  latis, ad orificium in seriebus 3–4 quadratis vel hexagonis c. 9–14  $\mu$  magnis. *Annulus* c. 50  $\mu$  altus, triplex, luteo-fuscus, deciduus. *Peristomii* dentes basi connati, c. 1.5 mm. longi et basi c. 50–56  $\mu$  lati, fere ad basin filiformiter bifidi, e basi ad medium densiuscule articulati, haud trabeculati, rufescentes superne lutei, dense papillois, intus laeves. *Sporae* c. 7–9  $\mu$  magnae, lutescenti-fuscae, laeves. *Operculum* e basi conica sensim longe subulate attenuatum, c. 1.8–2.0 mm. longum et basi c. 0.4 mm. diam., luteo-fuscum. *Calyptra* mitriformis apice sensim subulate attenuata, basi multifida, haud plicata, lutescenti-viridescens apice fusca, superne scabra.

Hokkaido (Yezo): Prov. Ishikari, Nopporo-mura (Leg. NIZŌ IWASAKI! 3. V. 1914.): Prov. Shiribeshi, Otaru (Leg. NIZŌ IWASAKI! 10. V. 1915.).

Species *R. aciculari* (L.) BRID. similis, sed foliis apice subcuspidate contractis hyalinis papillosis longe diversa.

Nomen speciei in honorem Leg. Dom. NIZŌ IWASAKI.

### ORTHOTRICHACEAE.

#### *Amphidium lapponicum* (HEDW.) SCHIMP.

Hondo: Prov. Mutsu, in monte Hakkōdasan (Leg. ĒJIRŌ UEMATSU ! 30. VII. 1907.). Hokkaido: Prov. Ishikari, in monte Teineyama, Sapporo (Leg. NIZŌ IWASAKI ! 25. IX. 1914.)

Species nova ad foloram japonicam.

#### *Aulacomitrium minutissimum* SH. OKAMURA. sp. nov.

Habitat in truncis. *Plantae* minutissimae, caespitosae, caespitibus viridibus vel fusco-viridibus, haud nitidis, densiusculis. *Caulis* repens, brevis, usque ad 3–4 mm. longus, densissime fusco-radiculosus, parce (1–3) ramosus, sectione teres, c. 0.12–0.15 mm. diam., fasciculo centrali c. 30–35  $\mu$  magno, reti ceterum incrassiore, areolis ubique fere ejusdem magnitudinis, cellulis hexagonis c. 15  $\mu$  magnis fuscis c. 3–4-seriatis; ramis brevibus, vix ultra 2 mm. longis, erectis, simplicibus vel innovando-ramulosis, dense foliosis. *Folia* sicca plus minus inflexo-adpressa, madida patentia, carinato-concava, lineari-lanceolata, breviter acuminata, c. 1.1–1.4 mm. longa et c. 0.24–0.28 mm. lata, marginibus usque ad medium revolutis, integerrimis; nervo crassiusculo, apice evanido, in sectione transversali plano-convexo, dorso paulum prominenti, basi c. 42  $\mu$  lato et c. 20  $\mu$  crasso, e stratis 2–3 cellularum uniformium composito; cellulis laminalibus majoribus, minutissime papillosis, haud opacis, rotundato-hexagonis, c. 14–17  $\mu$  magnis, parietibus crassiusculis, in medio folii utrobique e nervo ad margina c. 7–8-seriatis,



basilaribus utrobique c. 8–10-seriatis, ad nervum rectangulis c. 30–35  $\mu$  longis et c. 14  $\mu$  latis, ad angulos quadratis c. 14–15  $\mu$  magnis saepe fuscis. *Inflorescentia* autoica; flores masculi axillares; folia perigonia intima minuta, ovata, apice acuta; antheridia c. 5. *Bractae perichaetii* intimae longissimae, apice breviter acuminatae, c. 1.3–1.5 mm. longae; nervo tenui, ad 1/2 evanido; cellulis anguste rectangularibus, c. 20–35  $\mu$  longis et c. 7–8  $\mu$  latis, basilaribus longioribus, superioribus brevioribus c. 14–20  $\mu$  longis et c. 7–10  $\mu$  latis, omnibus laevibus.

*Vaginula* cylindrica, c. 0.32 mm. alta. *Seta* c. 1.1–1.3 mm. alta, erecta, tenuis, lutescentifuscens vel fuscens, laevis. *Theca* erecta, ovalis, c. 0.4–0.5 mm, longa et c. 0.32–0.4 mm. crassa, deoperculata trugide ovalis, fusca, laevis; cellulis exothecii valde incrassatis, ad orificium in seriebus c. 5–6 transverse rectangularibus valde incrassatis fuscis. *Peristomii* dentes per paria approximati, lanceolati, c. 0.16 mm. longi et basi c. 50–56  $\mu$  lati, densiuscule articulati, minutissime papilloso vel fere laeves, fusci. *Sporae* c. 30  $\mu$  magnae, fuscae, papillosoe. *Opercurum* e basi conica rostratum, c. 0.32 mm. longum, rostro erecto apice obtuso. *Calyptra* campanulata, thecam totam obtegens, c. 0.96 mm. longa, luteo-fusca, pluries (c. 10) plicata, nuda.

Hondo: Prov. Sagami, in monte Hakone (Leg. KIYOTAKA HISAUCHI! 3. I. 1915.).

Species distinctissima, a congeneribus statura minore, foliis angustis, cellulis folii majoribus facillime dignoscenda.

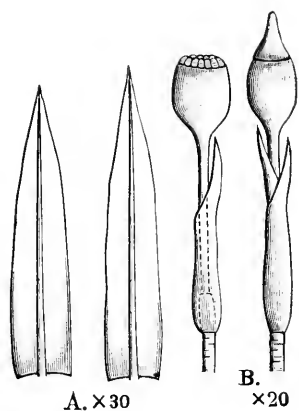

Fig. 7. *Aulacomitrium minutissimum*.

A. Folia ( $\times 30$ ); B. Theca cum Bracteis perichaetii intimis ( $\times 20$ ).

Nomen speciei ab statura minutissima plantae.

*Macromitrium incurvum* (LINDB.) PAR.

Formosa: Prov. Taihoku-chō, Sōzanshō [草山莊] (Leg. YAICHI SHIMADA! 1. I. 1914.); Taihoku (Leg. YAICHI SHIMADA! 2. VI. 1914.); Mentenzan [面天山] (Leg. YAICHI SHIMADA! 31. X. 1914.).

FUNARIACEAE.

*Physcomitrium eurystomum* (NEES.) SENDT.

Formosa: Taihoku (Leg. HISAHIKO SASAOKA! 29. II. 1912.).  
Species nova ad floram formosanam.

*Physcomitrium subeurystomum* CARD.

Formosa: Taihoku (Leg. YAICHI SHIMADA! 20. VI. 1914.).

*Funaria hygrometrica* (L.) SIBTH.

Formosa: Prov. Shinchiku-chō, Naroyama (Leg. HISAHIKO SASAOKA! 1. XII. 1912.). Korea: in monte Rohō (Leg. TAKENOSHIN NAKAI! 10. VII. 1914.).

Species nova ad floram formosanam et koreanam.

BRYACEAE.

*Bryum argenteum* L.

Formosa: Prov. Shinchiku-chō, Naroyama (Leg. HISAHIKO SASAOKA! 1. XII. 1912.).

*Rhodobryum Wichurae* (BROTH.) BROTH.

Formosa: Prov. Taihoku-chō, Mentenzan (Leg. YAICHI SHIMADA! 31. X. 1914.).

Species nova ad floram formosanam.

## MNIACEAE.

*Mnium Kiyoshii* SH. OKAMURA. sp. nov.

Habitat in saxis irroratis. *Plantae* robustiores, caespitosae, caespitibus late extentis, viridibus, in statu sicco molliusculis nitidis. *Caulis* repens, usque ad 20 cm. longus, densissime fusco-radiculosus, irregulariter parce ramosus, densiuscule foliosus complanatus, sectione teres, c. 0.56–0.64 mm. diam., fasciculo centrali c. 56  $\mu$  diam. paucicellulari luteo vel luteo-fusco, reti intermedio hyalino vel lutescenti, cellulis hexagonis vel oblongo-hexagonis c. 40–56  $\mu$  magnis, parietibus tenellis lutescenti-fuscis, cellulis periphericis c. 3–4-seriatis sensim minoribus c. 10–18  $\mu$  magnis paulum incrassatis fuscis; ramis prostratis, c. 5 cm. longis, apice flageriformiter productis, simplicibus, densiuscule foliosis complanatis. *Folia* sicca leviter crispata, madida horizontalia et quasidisticha, haud decurrentia, e basi valde angusta brevissima subito subcordato-saepe ovato-oblonga, apice rotundato-obtusa, emarginata vel haud emarginata, nervo excurrente breviter apiculata, c. 5–9 mm. longa et c. 3.5–4.5 mm. lata, subplana, marginibus paulum undulatis, ubique limbatis, limbo lato lutescenti, inferne e seriebus 4–5, superiore 2–3 cellularum elongatum formato, fere e basi ad apicem dense et minute simplici-subserulatis, serrulis obtusis ex unica serie saepe

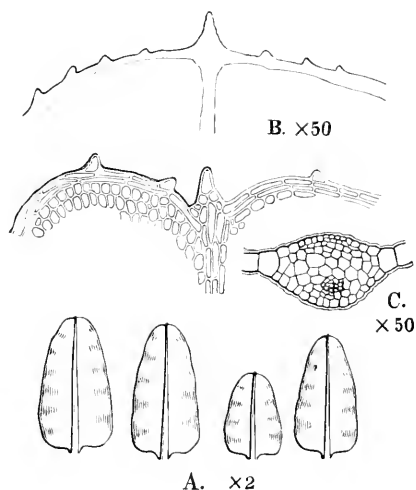

Fig. 8. *Mnium Kiyoshii*.

A. Folia ( $\times 2$ ); B. Apex folii ( $\times 50$ );  
C. Sectio transversalis nervi ( $\times 50$ ).

duabus seriebus cellularum vesiciformium compositis; nervo valido, apice tenuiore, in sectione transversali biconvexo, dorso prominentiore, basi c. 0.32–0.36 mm. lato et c. 0.20–0.24 mm. crasso, cellulis ventralibus in medio 2–3-stratis minoribus incrassiusculis, duabus medianis numerosis laxioribus, fasciculo comitum indistincto ducibus contiguo, fasciculo stereidarum valde minore paucicellulari (c. 6–8) luteo-fusco, cellulis dorsalibus c. 16 laxioribus; cellulis laminalibus valde chlorophyllosis, laevibus, in seriebus obliquis dispositis, ad nervum oblongo-hexagonis, c. 70–100  $\mu$  longis et c. 35–50  $\mu$  latis, ad limbum marginalem et apicem minoribus hexagonis, basilaribus infimis paulum elongatis subrectangulis. *Caetera* ignota.

Hondo: Prov. Izu, in monte Amagi (Leg. KIYOSHI FUJII! 18. VIII. 1914.).

Species *M. vesicato* BESCH. valde affinis, sed statura robustiore, foliis subcordato- vel ovato-oblongis, apice latioribus plerumque emarginatis facilliter dignoscenda.

Nomen speciei in honorem Leg. Dom. KIYOSHI FUJII.

*Mnium ligulifolium* CARD.

Korea: in monte Hōtaizan [胞胎山] (Leg. TAKENOSHIN NAKAI! 6. VIII. 1914.).

Species nova ad floram koreanam.

Distr. Hondo.

*Mnium punctatum* (L.) HEDW.

Kyūshū: Prov. Ōsumi, in insula Yakushima (Leg. TAKANORI IWAKI! 23. IX. 1914.).

*Mnium subglobosum* BR. EUR.

Korea: in monte Gatokirei [牙得嶺] (Leg. TAKENOSHIN NAKAI! 5.

VII. 1914.); in monte Rohō (Leg. TAKENOSHIN NAKAI ! II. VII. 1914.).  
Species nova ad floram koreanam.

*Mnium trichomanes* MITT.

Formosa: Prov. Taihoku-chō, Hakkoshō [八甲庄] (Leg. YAICHI SHIMADA ! 20. VI. 1914.).

Species nova ad floram formosanam.

RHIZOGONIACEAE.

*Rhizogonium spiniforme* (L.) BRUCH.

Formosa: Prov. Taihoku-chō, Shabōsan [沙帽山] (Leg. YAICHI SHIMADA ! 31. XII. 1913.).

Species nova ad floram formosanam.

AULACOMNIACEAE.

*Aulacomnium turgidum* (WAHLENB.) SCHWAEG.

Korea; in monte Rohō (Leg. TAKENOSHIN NAKAI ! 10. VII. 1914.).

Species nova ad floram koreanam.

BARTRAMIACEAE.

*Philonotis palustris* MITT.

Formosa: Urai (Leg. JUKICHI SHIRAGA ! VII. 1911.).

POLYTRICHACEAE.

*Pogonatum arisanense* SH. OKAMURA, sp. nov.

Habitat in terra. *Plantae* robustissimae, ferrugineo-virides sed sicca nigrescentes, haud nitidae, rigidiores. *Caulis* erectus, c. 12-

15 cm. longus, cum foliis c. 1.5-2.5 cm. crassus, strictus vel leviter flexuosus, rubiginosus, basi dense fuscescenti-radiculosus, simplex, dense foliosus, obtusus. *Folia* infima minuta, dein sensim majora, sicca adpressa crispata et circinato-involuta vel -convoluta et spiraliter hic illie torta, humida arcuate erecto-patentia vel patentia, e basi brevi (c. 2 mm. longo) semivaginate late ovali fuscescenti et pellucido sensim lineari-lanceolata, apice breviter acuminata, c. 14-17 mm. longa, basi c. 2.0-2.5 mm. in medio c. 1.2 mm. lata, marginibus planis vel subplanis, e basi ad apicem dense (c. 80) serratis, serraturis basilares angustioribus lutescenti-fuscis ex unica serie 1-3 cellularum formatis, in laminae parte infima minoribus autem ad apicem majoribus rubiginosis vulgo uni-cellula formatis; nervo valido, in medio folii c. 0.16 mm. lato, cum apicem evanido, dorso e medio ad apicem dense 2-4-seriate spinoso-serrato; lamellae latitudinem folii totam occupantes, densissimae, sat numerosae (c. 70-80), humillimae c. 25-28  $\mu$  altae, in sectione transversali ab uno strato cellularum (2-3 rarius 4) constructae, rarius in basi vel medio duarum cellulae connatae, cellulis subaequalibus rarius ad marginem majoribus, cellula marginali laevi haud incrassata quadrato-rotundata hemirotundata vel fere rotundata; cellulis vaginalibus folii inferioribus elongate rectangulis c. 50-70  $\mu$  longis et c. 15  $\mu$  latis, laminalibus minutis paulum incrassatis quadratis anguste quadratis vel subhexagonis c. 10-15  $\mu$  magnis, marginalibus quadratis c. 10  $\mu$  magnis. *Inflorescentia* dioica; planta mascula ignota. *Ramulus perichaetialis* caulis innovatione pseudolateralis. *Bractae perichaetii* externae erecto-patentiae, intimae suberectae, e basi longe (c. 3-4 mm.) semivaginate elliptica abrupte lineari-subulatae, apice attenuatae subcarinatae, c. 13-16 mm. longae, basi c. 1.6-2.0 mm. medio c. 0.56-0.70 mm. latae, marginibus fere e basi ad apicem dense serratis; nervo valido, dorso superne 2-seriate spinoso-

serrato. *Vaginula* 6 mm. alta, longe cylindrico-conica, fusca, longe et hyaline pilosa. *Seta* suberecta, c. 3 cm. longa, rubra, fere stricta vel leviter flexuosula, sicca superne torta. *Theca* erecta, e collo indistincto oblonga, c. 5 mm. longa et c. 2 mm. crassa, in sectione transversali fere rotundata, leviter 8-plicata, fusca, sicca deoperculata sub ore paulum contracta; cellulis exothecii hexagonis quadrato-hexagonis vel rectangulis c. 30–60  $\mu$  longis et c. 20–30  $\mu$  latis, medio alte et recte papilliformi-prominentibus; stomatibus nullis. *Peristomii* dentes 32, c. 0.4 mm. longi, e membrana basilari humili (c. 0.08 mm.) lineari-oblongi, apice rotundato-obtusi, brunnei margine hyalini. *Sporae* minutissimae, c. 9–10  $\mu$  magnae, lutescentes vel olivaceae, laevissimae. *Operculum* et *Calyptra* mihi desunt.

Formosa: in monte Arisan (Leg. BUNZŌ HAYATA! 6. IV. 1914.).

Species cum *P. contorto* et *P. atrovirenti* praecipue *P. erythrodontio* comparanda, sed lamellis folii numerosis (c. 2.5–4.0 plo.)

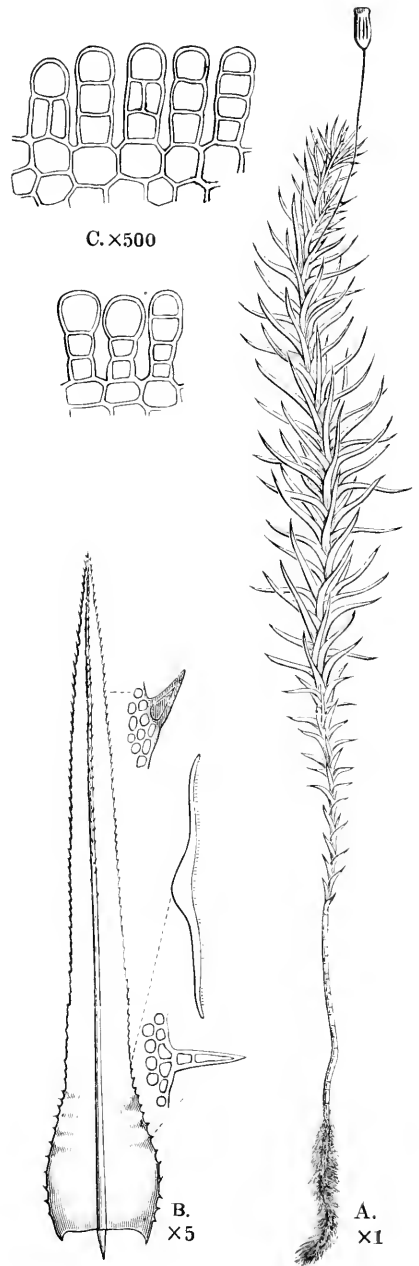

**Fig. 9.** *Pogonatum arisanense*.  
A. Planta fertilis ( $\times 1$ ); B. Folium ( $\times 5$ );  
C. Sectio transversalis lamellae folii ( $\times 500$ ).

facillime dignoscenda.

*Pogonatum grandifolium* (LINDB.) JAEG.

Korea: Prov. Heian-Hokudō, Hokujömen [北上面], Kōkai-gun (Leg. TAKENOSHIN NAKAI! 1. VII. 1914.).

Species nova ad floram koreanam.

*Pogonatum inflexum* LINDB.

Formosa: Prov. Taihoku-chō, Chikushiko [竹仔湖] (Leg. YAICHI SHIMADA! 3. I. 1914.); Prov. Taihoku-chō, Mentenzan [面天山] (Leg. YAICHI SHIMADA! 31. X. 1914.); in monte Arisau (Leg. BUNZŌ HAYATA! 6. IV. 1914.).

*Pogonatum urnigerum* SCHIMP.

Korea: Prov. Kankyo-Nandō, Daikori [大興里], Chōshin-gun (Leg. TAKENOSHIN NAKAI! 18. VII. 1914.).

Species nova ad floram koreanam.

*Polytrichum alpinum* L.

Korea: in monte Rohō (Leg. TAKENOSHIN NAKAI! 11. VII. 1914.).

Species nova ad floram koreanam.

*Polytrichum commune* L.

Sachalin: Sicca (Leg. JŪSUKI SUSUKI! 1. V. 1913.). Korea: Prov. Kankyo-Nandō, Hakutokurei [白徳嶺], Kōsan-gun [甲山郡] (Leg. TAKENOSHIN NAKAI! 10. VII. 1914.); in monte Rohō (Leg. TAKENOSHIN NAKAI! 4. VIII. 1914.).

Species nova ad floram koreanam.



## HEDWIGIACEAE.

*Hedwigia albicans* (WEB.) LINDB.

Korea: Prov. Heian-Hokudō, in monte Hiraihō [飛來峰] (Leg. TAKENOSHIN NAKAI! 9. VI. 1914.).

## CLIMACIACEAE.

*Climacium japonicum* LINDB.

Korea: Prov. Heian-Hokudō, in monte Hiraihō (Leg. TAKENOSHIN NAKAI! 9. VI. 1914.).

*Pleuroziopsis ruthenica* (WEINM.) KINDB.

Korea: in monte Gatokurei (Leg. TAKENOSHIN NAKAI! 5. VII. 1914.);  
in monte Rohō (Leg. TAKENOSHIN NAKAI! 11. VII. 1914.).

Species nova ad floram koreanam.

## CRYPHAEACEAE.

*Pilotrichopsis dentata* (MITT.) BESCH.

Formosa: Prov. Shinchiku-chō; Ritōsan [李棟山] (Leg. HISAHIKO SASAKA! 2. XII. 1912.).

## LEUCODONTACEAE.

*Leucodon perdependens* SH. OKAMURA. sp. nov.

Habitat in ramis arborum (Picea ajanensis et Abies nephrolepis etc.) sylvaticarum in alpinis. *Plantae* graciles, caespitosae, caespitibus viridibus vel fuscescenti-viridibus, nitidiusculis, rigidiusculis,

densiusculis. *Caulis* primarius repens, filiformis; secundarius longe dependens, substrictus, usque ad 10–20 cm. longus, irregulariter et laxe subpinnatim ramosus, sectione ellipticus, c.  $0.24-0.28 \times 0.16-0.2$  mm. magnus, fasciculo centrali nullo, reti centrali hyalino, cellulis hexagonis c.  $15-20 \mu$  magnis, tenellis, cellulis periphericis c. 3–4-seriatis minoribus rubiginosis valde incrassatis; ramis pendulis, c. 1–6 cm. longis, apice longe vel breve attenuatis, simplicibus vel parce (1–5) ramulosis; ramulis c. 1 cm. longis, patentibus, apice

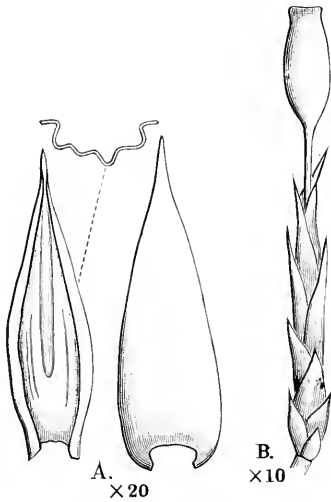

**Fig. 10.** *Leucodon perdependens*.

A. Folia ( $\times 20$ ); B. Sporangia ( $\times 10$ ).

attenuatis vel obtusis; ramis ramulisque sicca apice substrictis arcuatis vel hamulosis sed haud circinato-incurvis; caulibus secundariis ramis ramulisque densiuscule foliosis teretibus; caulis secundarius floriferous saepe brevis, simplex vel parce ramosus. *Folia* sicca adpressa argute longitudinaliter plicata, madida erecto-patentia, valde concava, profunde plicata, basi breviter decurrentia, oblongo-lanceolata apice breviter attenuata vel acuta, summo apice canaliculata, c. 1.2–1.9 mm. longa et c. 0.5–0.8 mm. lata, marginibus late planis, apice minute serrulatis; nervo nullo;

cellulis laevissimis, valde chlorophyllosis, linearibus, c.  $30-56 \mu$  longis et c.  $3-4 \mu$  latis, marginalibus basilaribus pluriseriatis (c. 12) quadratis incrassatis c.  $9-12 \mu$  magnis, basilaribus infimis per totam latitudinem folii lutescenti-fuscis. *Inflorescentia* dioica, utriusque sexus in cauligenis vel ramuligenis; flores masculi geminiformes; folia perigonia concava, ovali-oblonga, apice cuspidata, enervia; antheridia c. 10, paraphysibus numerosis. *Bractee perichaetii*

longitudine fere setae, intimae e basi alte vaginante breviter acuminatae, erectae apice, erecto-patentiae, integerrimae, enerves, c. 3.6 mm. longae, haud plicatae; cellulis linearibus, valde incrassatis, marginalibus basilaribus rectangulis. *Vaginula* cylindrica, c. 1.2 mm. alta, fuliginosa. *Seta* erecta, stricta, c. 3 mm. longa, basi rubiginosa dein lutea, laevis, sicca leviter torta. *Theca* erecta, symmetrica, oblonga vel elliptico-oblonga, c. 1.2 mm. longa et c. 0.56 mm. crassa, sicca deoperculata sub ore paulum contracta, lutea vel luteo-fusca, laevis, brevicollis; cellulis exothecii irregulariter quadratis hexagonis vel rectangulis, haud incrassatis, ad orificium in seriebus 4-5 minutis anguste quadratis; stomatibus nullis. *Anulus* duplex, c. 40  $\mu$  altus, basi luteus apice hyalinus, deciduus. *Exostomii* dentes lineari-lanceolati, basi connanti, c. 0.28 mm. longi et basi c. 40  $\mu$  lati, linea media flexuosula sed indistincta haud perforata, strato dorsali lutescenti basi laevi dein dense et grosse papilloso, ventrali dense (c. 15) et humile lamelloso; endostomium flavidulum, grosse papillosum; corona basilaris c. 70  $\mu$  alta; processus nulli. *Sporae* c. 15  $\mu$  magnae, ochraceae, laeves. *Operculum* ignotum. *Calyptra* cucullata, c. 2.2 mm. longa, lutescenti-viridescens apice brunnea, laevis.

Korea: Prov. Heian-Hokudō, in monte Aibutsusan [愛物山] (1320 m.) (Leg. TAKENOSHIN NAKAI! I. VII. 1914.).

Species *L. pendulo* LINDB. comparanda, sed seta laevis, exostomii dentes basi leavi dien grosse papilloso longe diversa.

Nomen speciei ab caule secundario perpendenti.

## NECKERACEAE.

*Pterobryopsis cucullatifolia* SH. OKAMURA. sp. nov.

Habitat in truncis arborum. *Plantae* robustiusculae, lutescenti-

viridescentes, nitidiusculae, molliusculae. *Caulis* primarius repens, hic illic fasciculatim fusco-radiculosus; secundarius erectus, c. 3–4 cm. longus, simplex vel parce ramosus, sectione teres, c. 0.3–0.35 mm. crassus, fasciculo centrali nullo, reti centrali luteo, cellulis hexagonis vel oblongo-hexagonis, incrassiusculis c. 15–20  $\mu$  magnis, cellulis inde ad superficiem paulum minoribus incrassationibus rubiginosis; ramis erecto-patentibus, c. 1–2 cm. longis, obtusis vel subflagelliformiter attenuatis; caulibus secundariis ramisque dense et

turgide foliosis teretibus. *Folia* sicca subimbricata, madida erecto-patentia, haud decurrentia, cymbiformi-concava, ovato-oblonga, raptim in acumen angustum strictum vel leviter recurvum plus minus longum (c. 0.4–0.5 mm.) subulatum constricta, c. 2.4–2.6 mm. longa et c. 1.1–1.3–1.5 mm. lata, marginibus superne valde inflexis, in subula minute serrulatis, caeterum integerrimis; nervo sim-

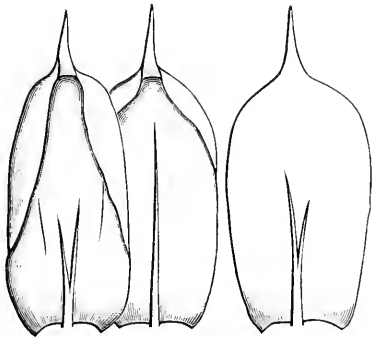

A.  $\times 15$   
**Fig. 11.** *Pterobryopsis*  
*cucullatifolia*.

A. *Folia.* ( $\times 15$ ).

plici, tenui, c. 0.7–1.6 mm. longo, saepe furcato; cellulis chlorophyllous, linearibus, parietibus incrassatis et plus minus porosis, in medio folii paulum porosis c. 70–100  $\mu$  longis et c. 7  $\mu$  latis, superioribus argute porosis c. 40–60  $\mu$  longis et c. 7  $\mu$  latis, basilari-bus infimis fuscis valde incrassatis brevioribus latioribus c. 15  $\mu$  latis inter sese valde porosis, alaribus distinctis fuscis oblongis inter sese valde porosis c. 20–40  $\mu$  longis et c. 15–18  $\mu$  latis. *Cetera* ignota.

Formosa: Prov. Sinehiku-chō, Naroyama (Leg. HISAHIKO SASAOKA! 1. XII. 1912.).

Species cum *P. crassicauli* (C. MÜLL.) FLEISCH. et *P. crassiusculo*

(CARD.) BROTH. comparanda, ab hic statura minore, foliis in acumen  $1/3$  longis, ab illia foliorum forma dignoscenda.

*Aërobryopsis Parisii* (CARD.) BROTH. ENGL. und PRANT. nat. Pflanzenf. p. 820. (1906). [nomen solum comb. nov.].

Syn. *Aërobryum Ferriei* BROTH. in Bull. de l'Herb. Boissier. 2<sup>me</sup> Sér. II. p. 926. (1902). [nomen solum!].

Syn. *Meteorium Parisii* CARD. Reih. Bot. Centralblatt. Band. XIX. Abt. II. Heft. 1. p. 121. (1905). [Ster.!).

Habitat in truncis arborum. *Plantae* robustiusculae, caespitosae, caespitibus lutescentibus vel lutescenti-viridibus, nitidiusculis, mollibus. *Caulis* primarius elongatus repens, hic illic fasciculatim fuscescenti-radiculosus; secundarius irregulariter pinnatus, longe dependens, substrictus vel leviter flexuosus, usque ad 10–20 cm. longus, laxè inordinate pinnatim ramosus, sectione teres vel saepe oblongus, c.  $0.28-0.36 \times 0.24-0.28$  mm. magnus, fasciculo centrali nullo, reti centrali hyalino vel lutescenti, cellulis hexagonis c. 15–20  $\mu$  magnis, parietibus incrassiusculis, cellulis periphericis c. 5–6-seriatis minoribus valde incrassatis luteis vel fuscis; ramis patulis vel patentibus, c. 1–3 cm. longis, strictis vel leviter flexuosis, plerumque simplicibus rarius parce ramulosis, obtusis vel acutis; caulibus ramis ramulisque dense foliosis subcomplanatis. *Folia* sicca laxè adpressa rugulosa mollia, madida patentia vel erecto-patentia, valde concava, ovata vel oblonga, in acumen elongatum undulatum flexuosum sensim attenuata apice capillare sat subito constricta, c. 2.0–3.2–3.5 mm. longa et c. 0.7–1.2 mm. lata, marginibus planis vel subplanis, superne undulatis, ubique minutissime serrulatis; nervo tenui, ad basin acuminis evanido, in sectione transversali plane biconvexo, basi c. 42  $\mu$  lato et c. 15  $\mu$  crasso, e 3-stratis cellularum incrassatarum uniformium composito; cellulis

chlorophyllosis, parietibus omnibus incrassatis, in medio folii rhombis vel sublineari-rhomboideis, dorso papilla singula medio notatis,

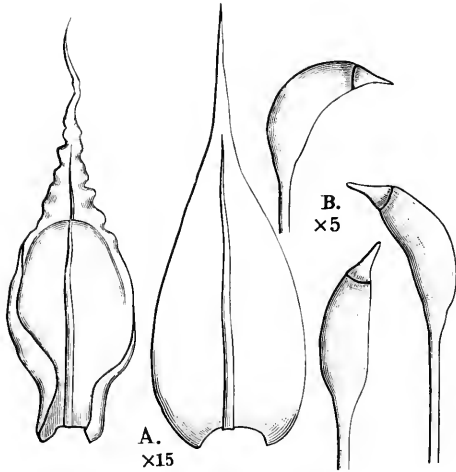

Fig. 12. *Aërobryopsis Parisii*.

A. Folia ( $\times 15$ ); B. Theca ( $\times 5$ ).

c.  $20-40 \mu$  longis et c.  $7 \mu$  latis, basilaribus linearibus c.  $40-56 \mu$  longis et c.  $7 \mu$  latis, infimis latioribus c.  $7-9 \mu$  sinuatis inter sese porosis laevibus, alaribus numerosis brevioribus oblongis rectangulis ovatisque c.  $20-30 \mu$  longis et c.  $15 \mu$  latis lutescentibus laevibus, superioribus sublineari-rhomboideis c.  $20-40 \mu$  longis et c.  $5-7 \mu$  latis laevibus. *Inflorescentia* dioica; flores masculi

ignota; flores feminei in caule vel ramis. *Ramulus perichaetialis* haud radiculosus. *Bractae perichaetii* intimae basi haud vaginatae oblongae concavae, in acumen recurvum vel erectum elongatum filiforme minute serrulatum subito attenuatae, c.  $2.4-2.8$  mm. longae et basi c.  $0.45$  mm. latae; nervo tenui, infra apicem evanido; cellulis linearibus, inter sese porosis, basilaribus laxioribus, omnibus laevissimis. *Vaginula* cylindrica, c.  $1.6-1.8$  mm. longa, lutescenti-viridescens apice fusca. *Seta* saepe gemella, c.  $10-15-20$  mm. longa, stricta vel leviter flexuosula, rubra, inferne laevis superne scabra, sicca haud torta. *Theca* suberecta vel arcuata, asymmetrica, leviter gibbosa, e collo distincto conico cylindrica, ad orificium paulum angusta, sicca deoperculata sub ore paulum contracta, haud plicata, c.  $2.5-3.0$  mm. longa (collo c.  $0.4$  mm.) et c.  $0.8$  mm. crassa, fusca, laevis; cellulis exothecii quadratis vel rectangulis c.  $25-56 \mu$  longis et c.  $20-25 \mu$  latis, parietibus incrassiusculis, ad

orificium in seriebus c. 5 minoribus quadratis c. 15–20  $\mu$  magnis; stomatibus in collo numerosis phaneroporis. *Annulus* duplex, c. 30–35  $\mu$  altus, ex unica vel duplici serie cellularum, fuscus, deciduus. *Exostomii* dentes basi connati, lineari-subulati, c. 0.56 mm. longi et basi c. 56  $\mu$  lati, albescens, dorso minute papilloso, ventre altiuscule c. 25-lamellosi; endostomium albicans vel lutescens; corona basilaris c. 100–110  $\mu$  alta, minutissime papillosa vel fere laevis; processus dentium longitudinis, lineari, dense et minute papilloso, haud carinati, rimoso-perforati; cilia nulla. *Sporae* c. 14–16  $\mu$  magnae, luteae, paulum scabrae. *Operculum* e basi conica sensim attenuate rostratum, c. 1.0–1.2 mm. longum et basi 0.48–0.56 mm. diam., rostro paulum curvato. *Calyptra* ignota.

Formosa: Kushak et Tamusui (Leg. FAURIE! 1903. ster.); Prov. Taihoku-chō, Urai (Leg. JUKICHI SHIRAGA! VII. 1911. ster.); Prov. Shinchiku-chō, Naroyama (Leg. HISAHIKO SASAOKA! I. XII. 1912. fr.).

Distr. Kyūshū: Prov. Ōsumi; Amami-Ōshima (Leg. FAURIE! VI. 1900. ster.).

*Aërobryopsis assimilis* (CARD.) PAR.

Formosa: Prov. Shinchiku-chō, Naroyama (Leg. HISAHIKO SASAOKA! I. XII. 1912.).

*Aërobryopsis subdivergens* (BROTH.) BROTH.

Formosa: Prov. Taihoku-chō, Mentenzan (Leg. YAICHI SHIMADA! 31. X. 1914.).

*Meteoriopsis ancistroides* (REN. et CARD.) BROTH. ENGL. und PRANT. nat. Pflanzenf. p. 826. (1906).

Syn. *Meteorium ancistroides* REN. et CARD. in Bull. Soc. roy. Belg. I. p. 72. (1895); *Meteorium himalayense* PAR. Ind. Br. Editio secunda Vol. III. p. 229. (1905).

Habitat in truncis arborum. *Plantae* robustiusculae, caespitosae, caespitibus lutescenti-viridescentibus, nitidiusculis, molliusculis. *Caulis* primarius elongatus, repens, divisus, hic illic fasciculatim fuscescenti-radiculosus; secundarius longe dependens, leviter flexuosus, c. 8–20 cm. longus, dense pinnatim ramosus, sectione teres, c. 0.32 mm. diam., fasciculo centrali nullo, reti centrali hyalino, cellulis hexagonis tenellis c.  $14\ \mu$  magnis, cellulis periphericis c. 5–8-seriatis sensim minoribus valde incrassatis luteis vel fuscescentibus; ramis patentibus vel horizontalis, c. 6–30 mm. longis, strictis leviter curvatis vel paulum flexuosis, haud hamulosis, simplicibus saepe parce (1–4) ramulosis, obtusis; caulibus ramis ramulisque dense squarrose foliosis teretibus. *Folia* sicca imbricata vel leviter crispata, e basi breviter decurrente suberecta semiamplexicauli late ovata vel rotundato-ovata, apice sensim breve vel longe subulato-attenuata, subula subcanaliculata recurvo-squarrosa, c. 1.6–2.0 mm. longa et c. 0.8–1.0 mm. lata, concava, haud plicata, marginibus ubique praecipue ad apicem argute serratis vel serrulatis, apice saepe undulatis; nervo tenui, infra apicem folii evanido, in sectione transversali plano-convexo, dorso paulum prominenti, basi c.  $40\ \mu$  lato et c.  $20\ \mu$  crasso, e 3-stratis cellularum incrassatarum uniformium composito; cellulis chlorophyllosis, incrassatis, utrobique facie papilla singula medio notatis sed haud opacis, longe rhomboideis vel breviter linearibus, c.  $28\text{--}40\ \mu$  longis et c.  $3\text{--}4\ \mu$  latis, basilaribus longioribus latioribus c.  $40\text{--}60\ \mu$  longis et c.  $7\text{--}10\ \mu$  latis laevibus inter sese porosis, in alis saepe paulum concavis distinctis (rarius indistinctis) numerosis (c. 20–40) quadratis vel oblongis c.  $14\text{--}28\ \mu$  longis et c.  $10\text{--}15\ \mu$  latis haud porosis vel parce porosis hyalinis vel fuscescentibus. *Inflorescentia* dioica; flores masculi ignoti; flores feminei in ramis vel caule. *Ramulus perichaetialis* haud radiculosus. *Bractae perichaetii* intimae deltoideo-



oblongae, in acumen subito erectum saepe flexuosum elongatum angustum subpiliforme sensim attenuatae, c. 1.6–1.8 mm. longae et basi c. 0.56–0.7 mm. latae, marginibus in acumen argute serratis; nervo saepe indistincto, medium evanido; cellulis laevibus, linearibus, c. 40–80  $\mu$  longis et c. 7–10  $\mu$  latis. *Vaginula* cylindrica, c. 1.2 mm. longa et c. 0.48 mm. crassa, lutescens apice fusca,

valde pilosa. *Seta* c. 1.2–1.8 mm. alta et c. 0.16–0.24 mm. crassa, apice crassiore, erecta, fusca, laevis. *Theca* e perichaetio exserta, erecta, symmetrica, ovato-oblonga, sicca deoperculata sub ore paulum contracta, haud plicata, cum collo c. 2.5–2.7 mm. longa (collo c. 0.5 mm.) et c. 1.1–1.2 mm. crassa, fusca, laevis; cellulis exotheci hexagonis vel oblongo-hexagonis, c. 35–50  $\mu$  longis et c. 20–30  $\mu$  latis, ad orificium in seriebus c. 5 minoribus hexagonis c. 15  $\mu$  magnis; stomatibus nullis. *Exostomii* dentes basi paulum remoti, lineari-lanceolati, c. 0.64 mm. longi et basi c. 0.084 mm. lati, strato dorsali lutescenti, e basi ad medium transversim striatulo inde laevi, linea media flexuosula, strato ventrali latiore, densissime (c. 35–40) et alte lamelloso; endostomium hyalinum vel fuscescens, minute papillosum; corona basilaris c. 0.13 mm. alta, horride plicata; processus c. 0.48 mm. alti, carinati in carina anguste perforati, minute papilloso; cilia nulla. *Sporae* c. 30–35  $\mu$  magnae, ferrugineae, laeves. *Operculum* e basi conica rostratum, c. 0.9

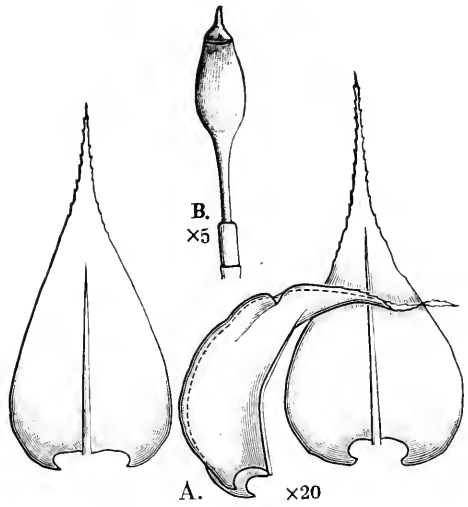

**Fig. 13.** *Meteoriopsis ancistroides*.

A. Folia ( $\times 20$ ); B. Sporangia ( $\times 5$ ).

mm. longum et c. 0.7 mm. diam., rostro longiusculo recto. *Calyptra* ignota.

Formosa: Prov. Shinchiku-chō, Naroyama (Leg. HISAHIKO SASAOKA! 1. XII. 1912.).

Distr. Sikkim-Himalaya; Bhotan.

*Meteoriella cuspidata* SH. OKAMURA. sp. nov.

Habitat in truncis arborum. *Plantae* robustae, caespitosae, caespitibus lutescenti-viridescentibus, nitidiusculis, rigidiusculis. *Caulis* primarius elongatus, repens, divisus, hic illic dense fasciculatim fusco-radiculosus; secundarius longe dependens, leviter flexuosus, c. 6–28 cm. longus, apice obtusus rarius flagelliformiter attenuatus, dense vel saepe laxe regulariter pinnatim ramosus, sectione ellipticus, c. 0.36–0.48–0.72 × 0.24–0.32–0.45 mm. magnus, fasciculo centrali nullo, reti centrali hyalino vel lutescenti-rubiginoso, cellulis hexagonis vel oblongo-hexagonis c. 15–20–30 μ magnis, parietibus tenellis vel incrassiusculis, cellulis periphericis c. 5–7-seriatis sensim minoribus valde incrassatis rubiginosis; ramis

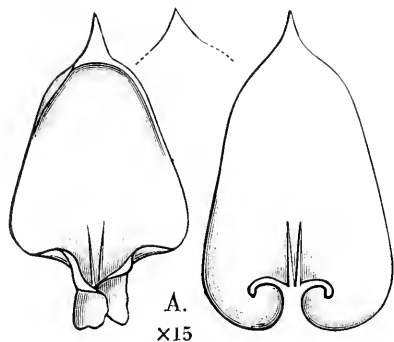

Fig. 14. *Meteoriella cuspidata*.

A. Folia (×15.)

1–3 cm. saepe 7 cm. longis, patentibus horizontalis vel pendulis, strictis curvatis vel leviter flexuosis haud hamulosis, obtusis rarius flagelliformiter attenuatis, simplicibus vel dense vel laxe pinnatim ramulosis; ramulis c. 5–10 mm. longis, obtusis rarius flagelliformiter attenuatis; caulibus secundariis ramis ramulisque dense et turgide foliosis, tereti-

bus vel leviter complanatis, cum foliis c. 2.5–3.0 mm. crassis. *Folia* sicca vix mutata, e basi cordata erecta auriculata (auriculis parce

circinatis caulem amplexis) late ovato-oblonga, apice breviter cuspidata (cuspidate erecto vel leviter recurvo), valde concava, c. 2.4–2.6 mm. longa et c. 1.5–1.6 mm. lata, marginibus ubique integerrimis vel paulum crenulatis, ad basin acuminis inflexis; nervis binis, aequalibus vel inaequalibus (saepe nervus unus indistinctus), c. 0.32–0.8 mm. longis, in sectione transversali basi c. 40–56  $\mu$  latis et c. 20  $\mu$  crassis, e 2-stratis cellularum incrassatarum compositis; cellulis linearibus, laevibus, parietibus ubique incrassatis minute porosis, in medio et apice c. 30–50  $\mu$  longis et c. 7  $\mu$  latis, basilaribus c. 56–75  $\mu$  longis et c. 7  $\mu$  latis, infimis brevioribus et latioribus rectangulis c. 30–35  $\mu$  longis et c. 10–14  $\mu$  latis fuscis vel rubiginosis, alaribus nullis. *Caetera* ignota.

Formosa: Prov. Shinchiku-chō, Naroyama (Leg. HISAHIKO SASAOKA! 1. XII. 1912.); Prov. Taihoku-chō, Urai (Leg. JUKICHI SHIRAGA! VII. 1911.).

Species distinctissima, a congeneribus foliis apice breviter cuspidatis, margine integerrimis vel subintegerimis faciliter dignoscenda.

Nomen speciei ab apice cuspidato folii.

*Meteoriella soluta* (MITT.) SH. OKAMURA. JOUR. Coll. Sci. Imper. Univ. Tokyo. Vol. XXXVI. Art. 7. p. 18. (1915.)

Syn. *Meteorium solutum* MITT. Musci Ind. orient. [JOUR. the proce. Lin. Soc. Supp. Bot. Vol. I. p. 88. (1859)].

Habitat in rupibus *Plantae* robustae, fusco-nigrescentes apice lutescenti-virides, rigidiusculae, nitidiusculae, caespitosae. *Caulis* primarius repens, elongatus, usque ad 13 cm. longus, hic illic fasciculatim fusco-radiculosus, divisus; secundarius pendulus, usque ad 5 cm. longus, strictus vel leviter flexuosus, densiuscule et regulariter pinnatim ramosus, sectione ellipticus, c. 0.28–0.32  $\times$  0.20–0.24 mm. magnus, fasciculo centrali nullo, reti centrali subrubigi-

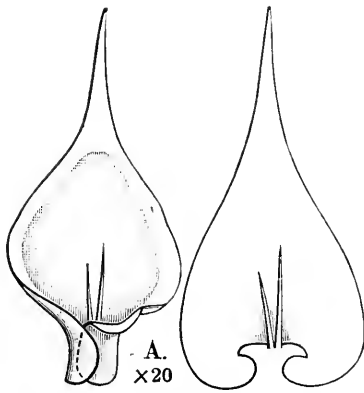

Fig. 15. *Meteoriella soluta*.

A. Folia ( $\times 20$ ).

noso, cellulis oblongo-hexagonis paulum incrassatis c.  $20-28 \times 15-20 \mu$  magnis, cellulis periphericis c. 3-4-seriatis minoribus hexagonis vel oblongo-hexagonis c.  $7-10 \mu$  magnis valde incrassatis rubiginosis; ramis c. 1-2.5 cm. longis, patulis, densiuscule foliosis teretibus, apice obtusis vel breviter attenuatis, simplicibus vel 1-3-ramulosis; ramulis usque ad 5 mm. longis. *Folia* sicca vix mutata, e basi cordata erecta auriculata (auriculis parce circinatis caulem amplexis) ovata elliptica vel subrotundata, apice subulato-acuminata divaricata vel recurvo-squarrosa, c. 2.0-2.4 mm. longa et c. 1.0-1.1 mm. lata, valde concava, marginibus subintegerrimis vel minutissime serrulatis; nervis binis, inaequalibus, usque ad medium folii evanidis, in sectione transversali basi e 2-stratis cellularum uniformium incrassatarum compositis; cellulis laevissimis, linearibus, parietibus incrassatis minute porosis, c.  $42-56 \mu$  longis et c.  $7 \mu$  latis, superioribus c.  $28-40 \mu$  longis et c.  $4-5 \mu$  latis, basilaribus abbreviatis latioribus c.  $15-20 \mu$  longis et c.  $15 \mu$  latis fuscis.

Hondo: Prov. Ise, in monte Gozaisho, Mie-gun (Leg. KICHITARO MURATA! 17. X. 1914.).

Species nova ad floram japonicam.

Distr. Sikkim.

*Meteoriella Kutōi* (SH. OKAMURA) SH. OKAMURA. *Com. nov.*

Syn. *Meteoriella soluta* (MITT.) SH. OKAMURA. var. *Kutōi* SH. OKAMURA. *Jour. Coll. Sci. Imper. Univ. Tokyo. Vol. XXXVI. Art. 7. p. 18, (1915).*

**Conspectus Specierum Meteorieellarum.**

- |    |   |   |                       |
|----|---|---|-----------------------|
| 1. | { | Folia apice cuspidata leviter recurva vel erecta, plantae robustae. |                       |
|    |   | .....   | <i>M. cuspidata</i> . |
|    |   | Folia apice subulato-attenuata recurvo-squarrosa. ....              | <i>L.</i>             |
|    |   | Plantae robustae, folia apice integerrima vel minutissime serrulata |                       |
|    |   | .....   | <i>M. soluta</i> .    |
|    |   | Plantae tenellae, folia apice majore dentata vel retro-serrata. . . | <i>M. Kutōi</i> .     |

***Trachypus humilis* LINDB.**

Formosa: Prov. Taihoku-chō, Urai (Leg. JUKICHI SHIRAGA! VII. 1911.).  
Species nova ad floram formosanam.

***Himantocladium loriforme* (BR. JAV.) FLEISCH.**

Habitat in truncis arborum. *Plantae* robustae, caespitosae, caespitibus lutescenti-viridibus, nitidiusculis, molliusculis, *Caulis* primarius repens, elongatus, hic illic dense et fasciculatim fusco-radiculosus, saepe stoloniferus; secundarius remotus (c. 7–10 mm. remotus), dependens, strictus, c. 6–12 cm. longus, apice longe attenuatus saepe flagellaris, basi stipitatus inde dense regulariter pinnatim ramosus, stipite c. 1–3 cm. longo, e stipite flagella parvifolia et fasciculatim radiculosa emittentes, sectione teres vel oblongus, c. 0.45–0.64 × 0.35–0.56 mm. magnus, fasciculo centrali nullo, reti centrali hyalino, cellulis hexagonis vel oblongo-hexagonis c. 20–30 μ magnis tenellis, cellulis periphericis c. 5–9-seriatis sensim minoribus crassioribus lutescentibus vel fuscis; ramis c. 2–3 cm. longis, patentibus, apice obtusis vel longe attenuatis saepe flagellaribus, plerumque regulariter pinnatim ramulosis; ramulis c. 5–10 mm. longis, apice obtusis vel longe attenuatis saepe flagelliformibus; caulibus secundariis ramis ramulisque densiuscule foliosis, valde

complanatis, cum foliis c. 2-3-4 mm. latis. *Paraphyllia* nulla. *Folia* unimorpha, octosticha, sicca vix mutata transverse rugulosa, dorsalia subimbricata, lateralia erecto-patentia, paulum asymmetrica, breviter decurrentia, e basi cordato-ovata longe lingulata, apice latiora et acuta vel cuspidato-acuta, concaviuscula, haud longitudinaliter plicata, c. 2.4-2.8-3.0 mm. longa et basi c. 1.0-1.2 mm. in medio c. 0.64 mm. lata, marginibus basi uno latere late inflexo, inferne minute serrulatis, apice grosse serratis; nervo valido, infra summum apicem folii evanido, in sectione transversali plano-convexo, dorso paulum prominenti, basi c. 40-50  $\mu$  lato et c. 25  $\mu$  crasso, e 3-stratis cellularum incrassatarum uniformium composito; cellulis chlorophyllosis, laevissimis, pellucidis, parietibus omnino incrassatulis c. 1.0-1.5  $\mu$  latis, luminibus e medio ad apicem folii 4-6-angulato-rotundatis vel ovalis c. 7-10-15  $\mu$  magnis, marginalibus e medio ad infra apicem usque ad 5-seriatis elongatis rhomboideis

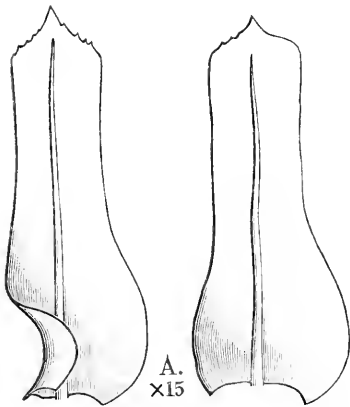

Fig. 16. *Hymantocladium*  
loriforme.

A. Folia ( $\times 15$ ).

vel breviter linearibus c. 20-40  $\mu$  longis sed unica serie externa plerumque brevior, basilaribus basin versus sensim longioribus late rhomboideis inde linearibus c. 30-70  $\mu$  longis et c. 7-9  $\mu$  latis inter sese porosis, angularibus indistinctis sed saepe quadratis vel breviter rectangulis minoribus; folia ramea et ramulia minora c. 1.6-1.8 mm. longa, basi c. 0.8-0.9 mm. in medio folii c. 0.50-0.64 mm. lata. *Cactera* ignota.

Formosa: Prov. Taihoku-chō, Urai (Leg. JUKICHI SHIRAGA! VII. 1911.).

Species nova ad floram japonicam.

Distr. Celebes, ins. Ceram, Banca, Java, ins. Fidji, Samoa, Borneo, New Guinea, Philippines etc.

*Neckeropsis pseudonitidula* SH. OKAMURA. sp. nov.

Habitat in truncis arborum. *Plantae* valde graciles, caespitosae, caespitibus lutescentibus vel lutescenti-viridibus, nitidiuseulis, molliuseulis. *Caulis* primarius repens, elongatus, filiformis, c. 4–6 cm. longus, hic illic dense et fasciculatim fusco-radiculosus; secundarius densiuseculus, dependens, strictus vel fere strictus, c. 2–7 cm. longus, apice flagelliformis, simplex vel laxiuscule vel densiusecule et irregulariter pinnatim ramosus, sectione teres vel oblongus, c.  $0.12\text{--}0.24 \times 0.12$  mm. magnus, fasciculo centrali nullo, reti centrali hyalino, cellulis oblongo-hexagonis vel hexagonis c.  $10\text{--}15 \mu$  magnis, parietibus tenellis vel incrassiuseulis, cellulis periphericis c. 4–6-seriatis c.  $10\text{--}15 \mu$  magnis valde incrassatis lutescentibus vel aureis; ramis c. 7–25 mm. longis, patentibus vel dependentibus, fere strictis, apice obtusis vel longe attenuatis et saepe flagelliformiter productis, simplicibus rarius parce (1–2) breviter ramulosis; caulibus secundariis ramisque densiusecule foliosis, valde complanatis, cum foliis c. 1.0–1.3 mm. latis, saepe flagelliferis, flagellis elongatis microphyllinis. *Paraphyllia* nulla. *Folia* sicca immutata, haud rugulosa, quadristicha sed ut videntur distiche complanata, erecto-patentia vel divaricato-patentia, asymmetrica, breviter decurrentia, obovata vel

rotundato-obovata, apice rotundato-obtusa, c. 0.64–0.8–0.9 mm. longa et c. 0.48–0.58–0.64 mm. lata, subplana, marginibus e basi ad

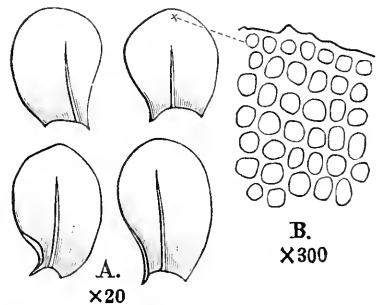

**Fig. 17.** *Neckeropsis pseudonitidula*.

A. folia ( $\times 20$ ); B. Cellulae e parte apicis folii ( $\times 300$ ).

medium uno latere anguste inflexo, basi crenulatis, apice crenulatis vel minute serrulatis, haud limbatis; nervo validiusculo, ad 5/10–7/10 evanido (c. 0.4–0.64 mm. longo.), in sectione transversali fere plano, basi c. 30  $\mu$  lato et c. 15  $\mu$  crasso, e 2-stratis cellularum subincrassatarum uniformium composito; cellulis chlorophyllosis, laevissimis, parietibus omnino incrassiusculis c. 2–3  $\mu$  latis, luminibus superioribus rotundatis quadrato-rotundatis vel breviter oblongis, c. 7–9–15  $\mu$  longis, e medio folii basin versus sensim longioribus, late ovalis rhombeis vel breviter rhomboideis, c. 15–20  $\mu$  longis et c. 7–9  $\mu$  latis, basilaribus ad nervum linearibus c. 18–30  $\mu$  longis et c. 5–7  $\mu$  latis haud porosis, marginalibus quadratis breviter rectangulis vel ovalis, angularibus indistinctis. *Cactera ignota.*

Formosa: Prov. Taihoku-chō, Urai (Leg. JUKICHI SHIRAGA! VII. 1911.).

Species *N. nitidula* MRR. valde proxima, sed statura graciliore, foliis apice rotundato-obtusis haud acutis, marginibus minute serrulatis, nervo longiore et crassiore, cellulis superioribus luminibus plerumque rotundatis vel rotundato-quadratis jam abunde diversa.

Nomen speciei ab facie ut *N. nitidula* MRR.

*Neckera idumoana* SH. OKAMURA. sp. nov.

Habitat in truncis arborum. *Plantae* robustiusculae, saespitosae, caespitibus laete viridibus inferne stramineis, nitidiusculis, molliusculis. *Caulis* primarius elongatus, repens, hic illic fasciculatim fusco-radiculosus; secundarius dependens, strictus, c. 4–8 cm. longus, dense pinnatim ramosus, apice obtusus, sectione oblongus, c. 0.20–0.30  $\times$  0.16  $\times$  0.2 mm. magnus, fasciculo centrali nullo, reti centrali hyalino, cellulis hexagonis c. 10–15  $\mu$  magnis, parietibus paulum incrassatis, cellulis periphericis c. 3–6-seriatis minoribus incrassatis luteo-fuscis; ramis c. 5–25 mm. longis,



simplicibus vel pinnatim ramulosis, patentibus, strictis; ramulis e. 5–7 mm. longis, apice obtusis saepe flagelliformiter productis; caulibus secundariis ramisque dense foliosis, plus minus complanatis, cum foliis e. 2.5–3.0 mm. latis. *Paraphyllia* nulla. *Folia* sicca immutata, haud transverse rugulosa, dorsalia imbricata, symmetrica, apice obtuse acuta, lateralia erecto-patentia vel patentia, paulum asymmetrica, breviter decurrentia, ovato-vel late ovato-oblonga, apice breviter et anguste vel latiuscule acuta, e. 1.6–1.8 mm. longa et e. 0.7–0.96 mm. lata, concava, haud plicata, marginibus e basi ad medium uno latere anguste inflexo, e medio ad apicem serrulatis vel fere integerrimis; nervo tenui, medium vel ultra medium folii evanido, in sectione transversali plano-convexo. dorso paulum prominenti, basi e.  $56\mu$  lato et e.  $25\mu$  crasso, e 3-stratis cellularum incrassatarum uniformium composito; cellulis valde chlorophyllis, laevibus, parietibus incrassatis, superioribus rhombeis vel oblongis e. 10–15–20  $\mu$  longis et e. 7–8  $\mu$  latis, basilaribus lineari-rhomboides vel linearibus e. 25–50  $\mu$  longis et e. 7  $\mu$  latis parce porosis, marginalibus brevioribus, in alis concaviusculis oblongis vel rectangulis e. 15–28  $\mu$  longis et e. 9–11  $\mu$  latis parce porosis luteo-fuscis. *Inflorescentia* dioica (floribus masculis haud visis dioica videtur); flores feminei numerosi in caulibus secundariis vel ramis. *Ramulus perichaetialis* haud radiculosus. *Bractea perichaetii* intimae basi alte vaginatae et oblongo-lanceolatae, apice anguste attenuatae, e.

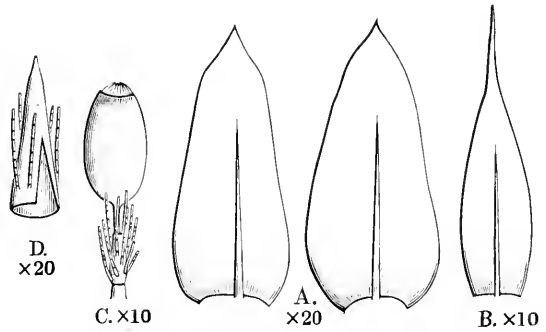

Fig. 18. *Neckera idumoana*.

A. Folia ( $\times 20$ ); B. Bractea perichaetialis intima ( $\times 10$ );  
C. Sporangia ( $\times 10$ ); D. Calyptra ( $\times 20$ ).

*Inflorescentia* dioica (floribus masculis haud visis dioica videtur); flores feminei numerosi in caulibus secundariis vel ramis. *Ramulus perichaetialis* haud radiculosus. *Bractea perichaetii* intimae basi alte vaginatae et oblongo-lanceolatae, apice anguste attenuatae, e.

3.2–3.7 mm. longae et c. 0.8 mm. latae, e medio ad apicem minute serrulatae; nervo medium evanido; cellulis linearibus c. 30–70  $\mu$  longis et c. 7  $\mu$  latis, basilaribus rectangulis c. 25–50  $\mu$  longis et c. 12  $\mu$  latis, angularibus 4–6-gonis. *Vaginula* cylindrica, c. 0.8 mm. longa, fusca; paraphysibus numerosis hyalinis. *Seta* c. 0.4–0.5 mm. longa et c. 0.18–0.2 mm. crassa, erecta, fusca, laevis. *Theca* immersa, oblonga, symmetrica, erecta, c. 1.2–1.6 mm. longa et c. 0.95 mm. crassa, fusca, laevis; cellulis exothecii hexagonis vel rectanguli-hexagonis plus minus irregularibus, ad orificium minutis hexagonis c. 15–20  $\mu$  longis et c. 10–15  $\mu$  latis; stomatibus nullis. *Exostomii* dentes lineari-subulati, basi paulum connati, c. 0.32 mm. longi et basi c. 42  $\mu$  lati, dorso basi fusciscenti dein lutescenti laeves, linea media saepe anguste et longe perforata, ventre humile c. 15–18-lamellosi; endostomium? *Sporae* c. 20–25  $\mu$  magnae, fuscae, paulum scabrae. *Calyptra* cucullata, c. 1 mm. longa, lutescenti-viridescens apice fusca, parce (c. 6) pilosa, pilis lutescentibus erectis c. 0.4–0.5 mm. longis.

Hondo: Prov. Idumo, Kiyomidudera (Leg. MASAYOSHI NAKAJI! 21. IX. 1913. et 11. I. 1914.).

Species *N. humili* MITT. proxima, sed statura robustiore, foliis sicca haud rugulosis oculo nudo jam raptim cognoscenda.

Nomen speciei ab Prov. Idumo.

*Neckera kamakurana* SH. OKAMURA. sp. nov.

Habitat in truncis arborum. *Plantae* robustiusculae, caespitosae, caespitibus superne laete viridibus inferne lurido-viridibus, molliusculis, nitidiusculis, late extentis. *Caulis* primarius elongatus, repens, divisus, hic illic fasciculatim fusco-radiculosus; secundarius deflexus vel dependens, strictus vel fere strictus, c. 1–5 cm. longus, apice obtusus, simplex vel laxiuscule pinnatim ramosus,

sectione oblongus, c.  $0.24-0.32 \times 0.16-0.24$  mm. magnus, fasciculo centrali nullo, reti centrali hyalino, cellulis hexagonis c.  $15-20 \mu$  magnis, parietibus paulum incrassatis, cellulis periphericis c. 4-5-seriatis minoribus c.  $9-10 \mu$  magnis incrassatis luteis vel fuscis; ramis c. 1.0-1.5 cm. longis, patentibus vel horizontalis, strictis, apice obtusis, simplicibus vel parce (1-3) ramulosis; ramulis obtusis; caulibus secundariis ramis ramulisque dense foliosis complanatis, cum foliis c. 3-4 mm. latis, haud flagelliformibus. *Para-*

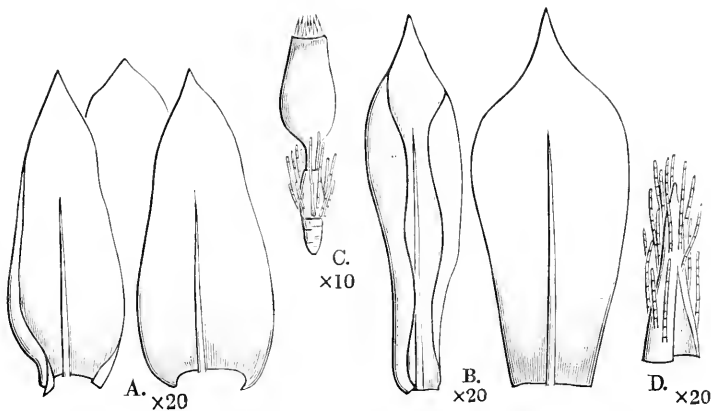

**Fig. 19.** *Neckera kamakurana*. A. Folia ( $\times 20$ ); B. Bractea perichaetii intimae ( $\times 20$ ); C. Sporangia ( $\times 10$ ); D. Calyptra ( $\times 20$ ).

*phylia* nulla. *Folia* sicca immutata, superne paulum transverse rugulosa, dorsalia imbricata symmetrica, lateralia erecto-patentia vel divaricato-patentia, asymmetrica, breviter decurrentia, ovato-vel late ovato-oblonga, apice breviter et anguste vel latiore acuta, c. 2.1-2.4 mm. longa et 0.96-1.2 mm. lata, concava, haud plicata, marginibus e basi ad ultra medium uno latere anguste inflexo, infimis autem utroque anguste recurvis, superne minute serrulatis vel integerrimis; nervo tenui, ultra medium evanido, in sectione transversali plano-convexo, dorso paulum prominenti, basi c.  $40-45 \mu$  lato et c.  $15-20 \mu$  crasso, e 3-stratis cellularum subincrassarum

uniformium composito; cellulis chlorophyllosis, laevibus, parietibus incrassatis, superioribus rhombeis vel rhomboideis, c.  $15-30 \mu$  longis et c.  $7-8 \mu$  latis, in medio folii breviter linearibus c.  $25-40 \mu$  longis et c.  $5-7 \mu$  latis, basilaribus c.  $40-60 \mu$  longis et c.  $7-8 \mu$  latis, infimis brevioribus c.  $30-40 \mu$  longis et c.  $9-10 \mu$  latis inter sese porosis saepe luteis, angularibus infimis rectangulis c.  $15-20 \mu$  longis et c.  $9 \mu$  latis, angularibus supernis minutis quadratis c.  $7-9 \mu$  magnis luteis. *Inflorescentia* autoica; flores utriusque sexus geminiformes, in caulibus secundariis vel ramis; folia perigonia intima obovato-oblonga, apice subito in acumen breve subulato-acutum contracta, c.  $0.75$  mm. longa et c.  $0.36$  mm. lata, enervia; antheridia c.  $7$ , c.  $0.4$  mm. longa, paraphysibus paucis hyalinis. *Ramulus perichaetialis* haud radiculosus. *Bractae perichaetii* intimae basi alte vaginatae et obovato-oblongae, subito in acumen breviter et latiore subcuspidatum constrictae, c.  $2.5-3.0$  mm. longae et c.  $1.0-1.1$  mm. latae, margine ad apicem crenulatae vel integerrimae; nervo tenui, ultra medium evanido; cellulis superioribus late rhombeis vel rhomboideis, c.  $15-20 \mu$  longis et c.  $7-9 \mu$  latis, ceteroquin linearibus c.  $30-100 \mu$  longis et c.  $7 \mu$  latis. *Vaginula* oblongo-cylindrica, c.  $0.48-0.60$  mm. alta et c.  $0.24$  mm. crassa, fusca; paraphysibus numerosis, hyalinis. *Seta* c.  $0.4-0.5$  mm. longa et c.  $0.12-0.16$  mm. crassa, erecta, fusca, laevis. *Theca* immersa ovato-oblonga, symmetrica, erecta, c.  $1.2-1.4$  mm. longa et c.  $0.64-0.75$  mm. crassa, fusca, laevis; cellulis exothecii rectangulis c.  $30-56 \mu$  longis et c.  $15-20 \mu$  latis, ad orificium c.  $3-4$  seriebus minutis plane hexagonis; stomatibus nullis. *Exostomi* dentes basi connati, lineari-lanceolati, c.  $0.35-0.4$  mm. longi et basi c.  $42 \mu$  lati, strato dorsali laevi, inferne lutescenti-fuscescenti apice hyalino, linea media fere stricta et saepe hic illic paulum perforata, strato ventrali hyalino laxo (c.  $20-25$ ) et humile lamelloso; endo-

stomium hyalinum papillosum vel fere laeve; corona basilaris haud producta; processus ignoti. *Sporae* c. 15–20  $\mu$  magnae, virides, laeves. *Calyptra* cucullata, c. 1.2 mm. longa, lutea apice fusca, densiuscule pilosa, pilis lutescentibus, erectis, c. 0.4–0.5 mm. longis.

Hondo: Prov. Sagami, Shūbusan [鷺峰山], Kamakura (Leg. KIYOTAKA HISAUCHI! 5. VI. 1915.).

Species *N. humili* MITT. affinis, sed bracteis perichaetii intimis obovato-oblongis, apice subito in acumen breviter subcuspidatum constrictis, calyptra densiuscule pilosis jam abunde diversa.

Nomen speciei ab loc. Kamakura.

*Pinnatera formosana* SH. OKAMURA. sp. nov.

Habitat in truncis arborum. *Plantae* robustiusculae, caespitosae, caespitibus luteo-viridescens, haud nitidis, molliusculis. *Caulis* primarius elongatus, c. 5–8 cm. longus, densiuscule fasciculatim fusco-radiculosus; secundarius densus, strictus sed in statu sicco saepe curvatus, c. 1.5–5.0 cm. longus, inferne simplex stipitiformis (stipite brevi c. 1–1.5 mm. vel longiore usque ad 10 mm. longo), dein dense regulariter pinnatim ramosus, in lineamentio oblongus vel oblongo-lanceolatus, cum ramis c. 7–20 mm. latus, superne saepe flagelliferous, sectione oblongus, c. 0.32–0.40  $\times$  0.24–0.32 mm. magnus, fasciculo centrali nullo, reti centrali hyalino, cellulis hexagonis vel oblongo-hexagonis c. 15–20  $\mu$  magnis, parietibus incrassiusculis, cellulis periphericis c. 4–6-seriatis paulum minoribus valde incrassatis luteis vel fuscis; ramis c. 7–13 mm. longis, erecto-patentibus, strictis, apice obtusis vel acutis, simplicibus vel irregulariter vel regulariter pinnatim ramulosis, saepe flagelliferis; ramulis c. 5–7 mm. longis, obtusis vel acutis; caulibus secundariis ramis ramulisque dense foliosis teretibus. *Paraphyllia* nulla. *Folia* sicca laxè approximata longitudinaliter triplicata, madida erecto-patentia; folia

caulina e basi decurrentia et cordato-ovata lanceolato-lingulata, apice acuta vel breviter acuminata, c. 1.6–2.0 mm. longa et basi c. 0.9–0.95 mm. lata, concava, basi saepe leviter bi-plicata, marginibus e basi ad medium planis, integerrimis crenulatis vel apice minute serrulatis, haud limbatis; nervo valido, infra summum apicem folii evanido, luteo, in sectione transversali plano-convexo, dorso prominenti, basi c. 70–80  $\mu$  lato et c. 40  $\mu$  crasso, e 3–4-stratis cellularum

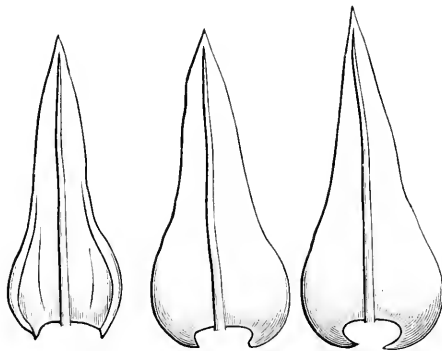
A.  $\times 20$ **Fig. 20.** *Pinnatella formosana*.A. Folia ( $\times 20$ ).

valde incrassatarum uniformium composito; cellulis laevissimis, omnino incrassatiusculis, luminibus in medio folii 4–6-angulose rotundatis ovalis vel ellipticis c. 9–20  $\mu$  longis et c. 7  $\mu$  latis, superioribus rhombis vel rhomboideis c. 20–30  $\mu$  longis, basilaribus breviter linearibus c. 15–30  $\mu$  longis et c. 4–6  $\mu$  latis, infimis luteis parce porosis, alari-

bus indistinctis, marginalibus e basi ad medium c. 4–7-seriatis minoribus plerumque quadratis c. 6–7  $\mu$  magnis; folia ramea minora, c. 1.2–1.3 mm. longa et c. 0.6–0.64 mm. lata, ceteroquin ut folia caulina; folia ramulina c. 0.8–0.9 mm. longa et c. 0.4–0.5 mm. lata, ceteroquin ut folia caulina. *Cetera* ignota.

Formosa: Prov. Sinchiku-chō, Senseki [尖石] (Leg. HISAHIKO SASAKA! 1. XII. 1912.).

Species *P. Makinoi* BROTH. similis, sed e cellulis superioribus et basilaribus foliorum fasiliter dignoscenda.

Nomen speciei ab loc. Formosa.

*Thamnum Fauriei* BROTH. et PAR.

Formosa : Prov. Shinchiku-chō, Senseki (Leg. HISAHIKO SASAOKA ! I. XII. 1912.).

Species nova ad floram formosanam.

## LEMBOPHYLLACEAE.

*Dolichomitra cymbifolia* (LINDB.) BROTH. var.*subintegerrima* SH. OKAMURA. var. nov.

Habitat in saxis. *Plantae* valde robustae, caespitosae, caepitibus viridibus vel lutescenti-viridibus seniores lutescenti-fuscis vel fuliginosis, densiusculis, rigidiusculis. *Caulis* primarius repens, elongatus, fusco-radiculosus; caulis secundarius arboriformis, erectus, c. 5–8 cm. altus, inferne stipitatus, superne dendroideam ramosus, stipite c. 1–3 cm. longo, e stipite flagella dependentia parvifolia fasciculatim fusco- vel rubiginoso-radiculosa emittentes, sectione teres, c. 0.4 mm. diam., fasciculo centrali nullo, reti centrali hyalino, cellulis hexagonis c. 20  $\mu$  magnis tenellis, cellulis periphericis c. 5–6-seriatis minoribus valde incrassatis fuscis; ramis c. 3–4 cm. longis, curvatis, ramulosis; ramulis c. 1–2 cm. longis, curvatis; ramis ramulisque dense et tumide foliosis, teretibus, apice obtusis. *Folia* sicca vix mutata, madida tumide imbricata vel patula, e, basi angusta elliptica vel subrotundato-elliptica, apice rotundato-obtusa vel brevissime apiculata, c. 1.2–1.8 mm. longa et c. 0.9–1.0 mm. lata, maxime cymbiformi-concava, apiculo haud recurvo potius leviter vel fortiter incurvo, marginibus basi recurvis, superne fere integris minute serrulatis vel parce minute duplicato-serrulatis; nervo valido, infra apicem evanido, saepe furcato vel 1–2-nervuloso; cellulis laevissimis, anguste rhomboideis vel rhomboideo-linearibus, c. 28–40  $\mu$  longis et c. 4–7  $\mu$  latis, superioribus brevioribus

c. 14–20  $\mu$  longis, basilaribus linearibus c. 40–70  $\mu$  longis et c. 5–7  $\mu$  latis inter sese vix porosis, alaribus paucis quadratis vel rectangulis c. 14  $\mu$  magnis fuscis. *Cactera* ignota.

Hondo: Prov. Ise, in monte Gozaishodake, Mie-gum (Leg. KICHTARO MURATA! 15. VIII. 1914.).

A typo foliis apice haud recurvis potius incurvis, marginibus superne fere integerrimis vel minute et parce serrulatis dignoscenda.

Nomen varietatis ab foliis subintegerrimis.

### ENTODONTACEAE.

#### *Entodon arenosus* SH. OKAMURA, sp. nov.

Habitat in arena fossae. *Plantae* robustiusculae, caespitosae, caespitibus viridibus, nitidiusculis, mollibus, late extentis. *Caulis* elongatus, prostratus, usque ad 12 cm. longus, hic illic fasciculatim fusco-radiculosus, densiuscule pinnatim ramosus, sectione teres, c. 0.25 mm. diam., fasciculo centrali arto c. 20  $\mu$  magno pauci-cellulari (c. 6), reti intermedio hyalino, cellulis hexagonis tenellis c. 15–20  $\mu$  magnis, cellulis periphericis c. 3–4-seriatis minoribus c. 10  $\mu$  magnis parce incrassatis chlorophyllosis sed postea fuscis; ramis prostratis, elongatis, usque ad 5 cm. longis, hic illic fasciculatim fusco-radiculosus, simplicibus vel parce pinnatim ramulosis; caulibus ramis ra-

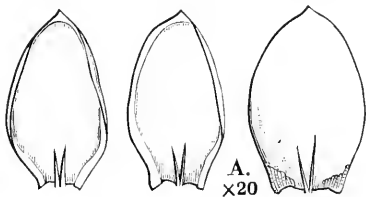

Fig. 21. *Entodon arenosus*.

A. Folia ( $\times 20$ ).

mulisque laxe foliosis, valde complanatis, obtusis, cum foliis c. 2.5 mm. latis. *Paraphyllia* nulla. *Folia* octosticha, uniformia, symmetrica, sicca paulum mutata, madida folia dorsalia et ventralia laxe adpressa, lateralialia patentia, valde concava, vix decur-

rentia, e basi angusta late ovalio-elliptica, apice late et brevissime



cuspidata, c. 1.1–1.2 mm. longa et c. 0.8 mm. lata, marginibus basi recurvis, saepe e medio ad basin cuspidis uno latere recurvo, superne serrulatis, alis haud concavis; nervis binis, tenellis, brevibus, c. 0.3–0.4 mm. longis; cellulis valde chlorophyllosis, leavissimis; linearibus, c. 70–110  $\mu$  longis et c. 7  $\mu$  latis, superioribus brevioribus rhomboideis c. 20  $\mu$  longis, basilaribus brevioribus inter sese haud porosis, alaribus numerosis quadratis c. 20  $\mu$  magnis vel breviter rectangulis c. 25–30  $\mu$  longis et c. 20  $\mu$  latis chlorophyllosis. *Caetera* ignota.

Shikoku: Prov. Iyo, Uguisudani, Tamatsu-mura, Nii-gun (Leg. TSUNETARO OTA! 19. XII. 1914.).

Species *E. Andoi* SH. OKAMURA. valde affinis, sed foliis late ovali-ellipticis basi latioribus, fasciculo centrali caulis pauci-cellulari dignoscenda.

Nomen speciei ab vita in arena fossae.

***Entodon dolichocucullatus*** SH. OKAMURA. sp. nov.

Habitat in truncis arborum. *Plantae* robustiusculae, dense depresso-caespitosae, lutescenti-virides, nitidiusculae. *Caulis* prostratus, elongatus, c. 5–8 cm. longus, hic illic fasciculatim fusco-radiculosus, dense et irregulariter pinnatim ramosus, sectione plerumque oblongus, c. 0.4–0.5  $\times$  0.28–0.32 mm. magnus, fasciculo centrali nullo, reti centrali hyalino, cellulis hexagonis vel oblongo-hexagonis c. 15–28  $\mu$  magnis tenellis, cellulis periphericis c. 3–4-seriatis minoribus c. 7–15  $\mu$  magnis hexagonis incrassatis lutescentibus; ramis prostratis, c. 1.0–2.5 cm. longis, strictis, apice aliquando leviter curvatis, simplicibus rarius parce vel pinnatim ramulosis, obtusis acutis vel attenuatis; ramis ramulisque dense foliosis, valde complanatis, cum foliis c. 2.5–3.0 mm. latis. *Folia* sicca vix mutata, dorsalia laxè imbricata, lateralia erecto-patentia, valde concava, e basi angusta ovato- vel

oblongo-lanceolata, apice late vel anguste acuta, c. 1.9–2.1 mm. longa, basi c. 0.64–0.8 mm. et infime c. 0.48–0.56 mm. lata, marginibus basi leviter recurvis, apice minute serrulatis; nervis binis, c. 0.32–0.4–0.5 mm. longis, in sectione transversali fere planis, c.  $15\ \mu$  crassis, e 2-stratis cellularum incrassatarum uniformium compositis; cellulis laevissimis, anguste linearibus, c. 90–140  $\mu$  longis

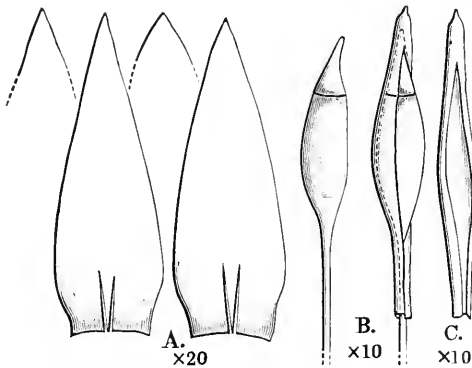

Fig. 22. *Entodon dolichocucullata*.

A. Folia ( $\times 20$ ); B. Theca ( $\times 10$ );

C. Calyptra ( $\times 10$ ).

et c. 6–8  $\mu$  latis, superioribus c. 50–70  $\mu$  longis, basilariibus infimis laxioribus c. 30–50  $\mu$  longis et c. 13–16  $\mu$  latis parce porosis, alaribus numerosis quadratis subquadratis vel breviter rectangularibus c. 20–40  $\times$  15–20  $\mu$  magnis hyalinis. *Inflorescentia* autoica; flores utriusque sexus geminiformes in caule

vel ramis; folia perigonia intima obovata, apice subito attenuata, c. 0.64–0.8 mm. longa et c. 0.32 mm. lata, concava, enervia; antheridia c. 6, c. 0.32 mm. longa, paraphysibus paucis, c. 0.32 mm. longis hyalinis. *Ramulus perichaetialis* haud radiculosus. *Bractee perichaetii* intimae basi semivaginatae lanceolatae apice sensim longe et anguste attenuatae, erectae, c. 2.1–2.4 mm. longae et c. 0.56–0.64 mm. latae, margine e basi ultra medium late recurvae, enerves vel indistincte binerves; cellulis foliis similis. *Vaginula* cylindrica, c. 1.2–1.4 mm. longa et c. 0.3 mm. crassa, pallida apice fusca; paraphysibus paucis, hyalinis. *Seta* solitaria, c. 8–9 rarius 11 mm. longa, erecta vel leviter flexuosula, lutescens, laevis, sicca leviter torta. *Theca* erecta, e collo obconico oblongo-cylindrica, symmetrica vel paulum asymmetrica, c. 1.4–1.6 mm. longa (collo

c. 0.4 mm. longo) et c. 0.56–0.6–0.8 mm. crassa, sicca deoperculata fere cylindrica et sub ore rarius paulum contracta, rubiginosa, laevis; cellulis exothecii quadrato-hexagonis oblongo-hexagonis rectangularisque, c.  $20\text{--}70 \times 20\text{--}35 \mu$  magnis, ad orificium in seriebus 5 minoribus quadratis hexagonis vel oblongo-hexagonis et transverse dilatatis; stomatibus in collo paucis. *Annulus* nullus. *Exostomii* dentes subulato-lanceolati, basi connati, c. 0.32 mm. longi et basi c.  $60\text{--}70 \mu$  lati, dorso basi (c.  $70 \mu$  longi) dense transverse saepe oblique vel longitudinaliter striatuli, dein dense papilloso, apice longitudinaliter striatuli, basi fusci dein luteo-fusci, saepe in linea media anguste perforati, ventre basi densiuscule dein remote et humile c. 10-lamellosi, hyalini, grosse papilloso; endostomium luteo-fuscum; corona basilaris paulum (c.  $40 \mu$  alta) producta, papillosa; processus dentium fere longitudinis, lineares, carinati, papilloso, rarius basi longitudinaliter striatuli. *Sporae* c.  $9\text{--}10 \mu$  rarius  $14 \mu$  magnae ochraceae, minutissime papillosoae. *Opercurum* e basi anguste conica rostratum, c. 0.8–0.9 mm. longum et c. 0.48–0.56 mm. diam., rubiginosum, rostro crasso stricto vel paulum curvato apice obtuso. *Calyptra* cucullata, c. 3.4–4.0 mm. longa, infra thecam dependens ibidemque apicem setae (usque ad c. 1.2–1.6 mm. longa) amplectens, pallida apice fuscescens, laevissima.

Formosa: Prov. Taihoku-chō, Sōzansho [草山庄] (Leg. YAICHI SHIMADA! I. I. 1914.).

Species *E. Drummondii* (BR. EUR.) JÆG. subsimilis, sed foliis latioribus, apice anguste acutis, seta brevior, calyptra valde longissima, nec non peristomii structura ex quo jam abunde diversa.

Nomen speciei ab calyptra longissima.

*Pyloisia laeto-viridis* SH. OKAMURA. sp. nov.

Habitat in truncis. *Plantae* glaucilae, dense depresso-caespito-

sae, caespitibus late extentis, lacte viridibus, sericeis, molliusculis. *Caulis* repens, usque ad 4 cm. longus, hic illic dense fasciculatim fusco-radiculosus, dense et regulariter pinnatim ramosus, sectione teres, c. 0.2–0.24 mm. diam., fasciculo centrali valde arto paucicellulari, reti intermedio hyalino, cellulis hexagonis vel oblongo-hexagonis c. 15–20  $\mu$  magnis tenellis, cellulis periphericis c. 3-seriatis minoribus c. 7–15  $\mu$  lutescenti-fuscescentibus incrassatis; ramis prostratis, c. 5–7 mm. rarius c. 10 mm. longis, strictis vel curvatis, simplicibus rarius parce (1–3) ramulosis, dense foliosis subcomplanatis. *Folia* sicca laxa adpressa, plerumque homomalla, madida patentia, saepe homomalla, haud decurrentia, e basi angusta late vel anguste ovato-oblonga, apice acuto-attenuata vel sensim attenuata, c. 1.3–1.5 mm. longa et c. 0.48–0.64 mm. lata, valde concava, marginibus e basi ad basin acuminis leviter recurvis, integerrimis rarius apice indistincte crenulatis; nervis binis, tenellis, c. 0.24–0.4 mm. longis; cellulis valde chlorophyllosis, laevissimis, pro-

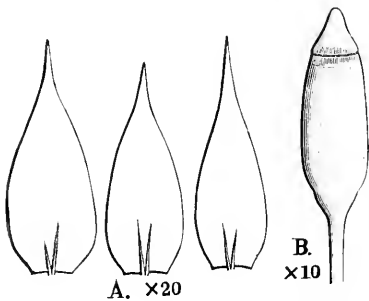

**Fig. 23.** *Pylaisia laeto-viridis*.  
A. Folia ( $\times 20$ ); B. Theca ( $\times 10$ ).

senchymaticis, in medio folii c. 40–50  $\mu$  longis et c. 4–5  $\mu$  latis, superioribus c. 28–40  $\mu$  longis et c. 4–5  $\mu$  latis, basilaribus c. 50–70  $\mu$  longis et c. 4–7  $\mu$  latis, infimis brevioribus c. 25–40  $\mu$  longis, alaribus numerosis quadratis c. 15–20  $\mu$  magnis valde chlorophyllosis.

*Inflorescentia* autoica; flores feminei in caule et ramis; flores masculi in caule; folia perigonia intima ovata, apice acuta, c. 0.48 mm. longa et c. 0.24 mm. lata, encervia; antheridia c. 5, c. 0.2 mm. longa, paraphysibus numerosis, hyalinis, c. 0.24–0.32 mm. longis. *Ramulus perichaetialis* parce fusco-radiculosus. *Bractae perichaetii* intimae basi semivaginatae et lanceolatae apice sensim attenuatae, erectae.

c. 2.0–2.4 mm. longae et c. 0.4–0.56 mm. latae, integerrimae; nervis binis indistinctis vel nullis; cellulis ut in foliis, sed longioribus angustioribus, basilaribus laxioribus anguste rectangulis c. 15–18  $\mu$  latis. *Vaginula* cylindrica, c. 1 mm. longa et c. 0.3–0.4 mm, crassa, lutescenti-fuscescens; paraphysibus numerosis hyalinis. *Seta* c. 6–7 mm. longa, leviter curvata, rubra, laevis, sicca torta. *Theca* erecta, e collo distincto oblongo-cylindrica vel cylindrica, symmetrica, c. 1.6–2.0 mm. longa (collo c. 0.4 mm. longo.) et c. 0.7–0.9 mm. crassa, fusca, laevis; cellulis exothecii quadratis vel rectangulis saepe irregulariformis, c. 30–56  $\mu$  longis et c. 20–40  $\mu$  latis, ad orificium in seriebus c. 4 minoribus hexagonis transverse dilatatis; stomatibus in collo numerosis. *Annulus* triplex, c. 56  $\mu$  altus, basi fuscescens apice hyalinus, deciduus. *Exostomii* dentes lineari-lanceolati, basi connati, c. 0.3 mm. longi et basi c. 50  $\mu$  lati, lutescenti vel fere hyalini, dense papilloso, saepe subopaci, intus laeves c. 20 humile lamellosi; endostomium hyalinum, dense et grosse papillosum, haud opacum; corona basilaris c. 70  $\mu$  alta, fere plana; processus dentium longitudinis, lineari-subulati, divisi, ad tertiam partem solitari dein ad apicem dentibus adhaerentes, hyalini, grosse papilloso; cilia nulla. *Sporae* c. 20–30  $\mu$  magnae, virides, postea ferruginea, dense papillosae. *Operculum* e basi conica brevissime rostratum, c. 0.6 mm. longum et basi c. 0.56 mm. diam., rostro apice obtuso. *Calyptra* cucullata, c. 1.6–1.7 mm. longa, pallida, laevis.

Hondo: Prov. Sagami, Kakuenji in Kamakura (Leg. KIYOTAKA HISAUCHI! 5. VI. 1915.).

Species a congeneribus exostomii dentes papilloso, processus divisi, ad tertiam partem solitari dein ad apicem dentibus adhaerentes faciliter dignoscenda.

Nomen speciei ab colore ea.

## FABRONIACEAE.

*Schwetschkea Matsumurae* BESCH.

Formosa : Taihoku (Leg. YAICHI SHIMADA ! 2. VI. 1914.) ; Prov. Shin-chiku-chō, Chikunan-ippo [竹甯一堡] (Leg. HISAHIKO SASAOKA ! 13. VI. 1912.).

Species nova ad floram formosanam.

## HOOKERIACEAE.

*Hookeria nipponensis* (BESCH.) BROTH.

Kyūshū : Prov. Ōsumi, in insula Yaku-shima (Leg. TAKANORI IWAKI ! 23. IX. 1914.).

## RHACOPILACEAE.

*Rhacopilum aristatum* MITT.

Formosa : Prov. Taihoku-chō, Urai (Leg. JUKICHI SHIRAGA ! VII. 1911.).

## LESKEACEAE.

*Haplohymenium biforme* BROTH.

Kyūshū : Prov. Ōsumi, in insula Yaku-shima (Leg. TAKANORI IWAKI ! 23. IX. 1914.).

*Herpetineuron attenuatus* SH. OKAMURA. sp. nov.

Habitat in truncis vel saxis. *Plantae* graciles, caespitosae, caespitibus densiusculis, lutescenti- vel fuscescenti-viridibus, haud nitidis. *Caulis* primarius elongatus, repens, stoloniformis, divisus, hic illic fasciculatim fusco-radiculosus ; secundarius c. 7–12 mm.

longus, erectus siccitate apice circinatim involutus vel arcuatus, humidis apice plerumque arcuatus, dense foliosus teres, apice obtusus vel breviter acutus saepe longiuscule (c. 5–7 mm.) flagelliformis, simplex vel parce (1–3) ramosus, sectione teres vel ellipticus, c.  $0.24-0.3 \times 0.16-0.20$  mm. magnus, fasciculo centrali arto, reti intermedio hyalino, cellulis hexagonis c.  $14-20 \mu$  magnis tenellis, cellulis peripheris c. 5–7-seriatis minoribus c.  $5-10 \mu$  magnis valde incrassatis lutescentibus vel luteo-fuscis; ramis c. 2–5 mm. rarius c. 8 mm. longis, apice obtusis vel breviter acutis, plerumque arcuatis. *Folia* sicca adpressa, madida erecto-patentia, breviter decurrentia, oblongo-lanceolata, apice longe attenuata vel longiore acuta, c. 1.2–2.0 mm. longa et c. 0.4–0.6 mm. lata, basi bi-plicata, marginibus planis, apice serratis; nervo crasso, lutescenti vel luteo-fusco, superne flexuoso, infra summum apicem folii evanido, in sectione transversali plano-convexo, dorso valde prominenti, basi c.  $84 \mu$

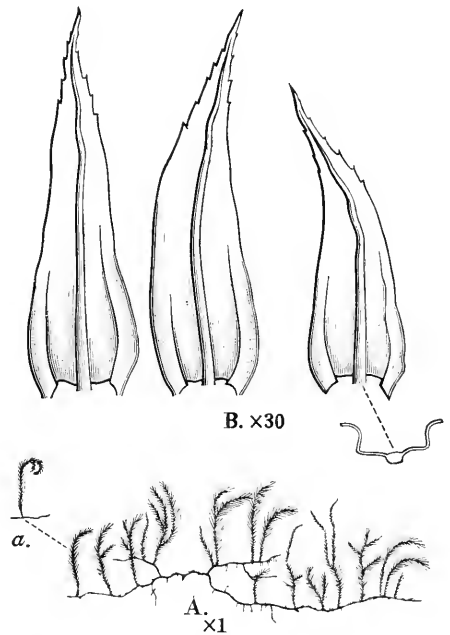

**Fig. 24.** *Herpetineuron attenuatus*.

A. Planta, a. in statu sicco ( $\times 1$ );

B. Folia ( $\times 30$ ).

lati et c.  $50 \mu$  crasso, e c. 5–6-stratis cellularum uniformium valde incrassatarum composito, cellulis ventralibus c. 8, dorsalibus c. 15–17 minoribus; cellulis laminalibus valde chlorophyllosis, in seriebus obliquis dispositis, subquadratis vel subrhombeis, c. 5–7  $\mu$  magnis, parietibus incrassiusculis, luminibus quadratis ellipticis vel oblongis, omnino levibus et pellucidis. *Caetera* ignota.

Hondo: Prov. Sagami, Kamakura (Leg. KIYOTAKA HISAUCHI! 1. III. 1914.).

Species distinctissima, a congeneribus foliorum forma facilliter dignoscenda.

Nomen speciei ab foliorum formis.

*Leskea pusilla* MITT. in Trans. Linn. Soc. London. 2nd. Ser. Bot. Vol. III. part 3. p. 188 (1891); Icones Plant. Koisikavenses. Vol. III. No. 1. p. 17. Taf. 154. (1915).

Habitat in truncis arborum defectrum. *Plantae* tenellae, caespitosae, caespitibus fusciscenti-viridibus, haud nitidis, molliusculis, late extensis. *Caulis* repens, usque ad 3 cm. longus, hic illic fasciculatim fusco-radiculosus, dense et subirregulariter pinnatim ramosus, sectione teres, c. 0.12–0.16 mm. diam., fasciculo centrali

nullo, reti centrali hyalino, cellulis hexagonis c.  $14\mu$  magnis, cellulis periphericis c. 2–3-seriatis paulum minoribus incrassatis lutescentibus; ramis prostratis vel ascendentibus, simplicibus rarius 1–2-ramulosis, strictis vel curvatulis, apice obtusis vel acutis, usque ad 6 mm. longis, sicca arcuatis vel flexuosis, plerumque apice hamulosis, densiuscule foliosis subcomplanatis. *Paraphyllia* nulla. *Folia* sicca adpressa vix crispata, madida erecto-

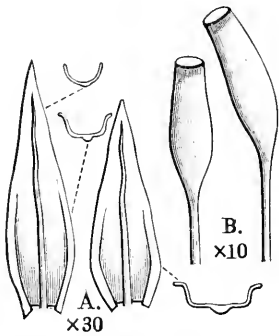

Fig. 25. *Leskea pusilla*.  
A. Folia ( $\times 30$ ); B. Theca ( $\times 10$ ).

patentia, vix decurrentia, valde concava, stricta vel curvatula, e basi contracta ovato-lanceolata vel oblongo-lanceolata, apice breviter attenuata saepe leviter incurva vel recurva, summo apice acuta vel subobtusa, c. 0.8–1.2 mm. longa et c. 0.3–0.4 mm. lata, marginibus basi leviter recurvis, apice suberectis, integerrimis



vel apice crenulatis; nervo valido, infra summum apicem folii evanido, e medio ad apicem leviter flexuoso, lutescenti, in sectione transversali plano-convexo, dorso valde prominenti, basi c.  $42\ \mu$  lato et c.  $28\ \mu$  crasso, e 3-4-stratis cellularum uniformium incrassatarum composito, cellulis dorsalibus c. 8, ventralibus c. 4; cellulis laminalibus in medio folii quadratis subquadratis ovali-quadratis vel rectangulis, c. 7-9-14  $\mu$  longis et c. 7-9  $\mu$  latis, superioribus ovalis vel oblongis, basilaribus quadratis vel rectangulis c. 7-10-18  $\mu$  longis et c. 7-10  $\mu$  latis, angularibus quadratis, omnino laevibus vel parce humile papillosis haud opacis. *Inflorescentia* autoica; flores masculi in caule vel ramis geminiformes; folia perigonialia 5-8, intima quadrato-obovata, apice subito acuto-attenuata vel cuspidata, c. 0.32 mm. longa et c. 0.24 mm. lata, concava, enervia; antheridia 5-8, paraphysibus perpauca, hyalinis vel fusciscentibus; flores feminei in caule. *Ramulus perichaetialis* valde radiculosus. *Bractea perichaetii* intimae basi semivaginatae oblongo-lanceolatae apice subito lanceolato-subulate attenuatae, c. 1.6-2.0 mm. longae, integerrimae; nervo valido, infra summum apicem evanido, lutescenti-fusco; cellulis prosenchymaticis, basilari-bus rectangularibus laxioribus, laevibus. *Vaginula* cylindrica, c. 0.9-1.0 mm. alta et c. 0.25-0.30 mm. crassa, fusciscentis. *Seta* c. 10-15 mm. longa, stricta curvatula vel flexuosula, sicca per totam longitudinem torta, inferne rubra, superne fusciscentis, laevis. *Theca* symmetrica vel paulum asymmetrica, oblongo-cylindrica, c. 1.6-2.5 mm. longa et c. 0.4-0.56 mm. crassa, stricta vel curvatula, fusca, laevis, brevicollis (collo obconico c. 0.24 mm. longo), sicca de-operculata sub ore paulum contracta; cellulis exothecii rectangulis quadratis vel oblongo-quadratis, ad orificium in seriebus c. 5 minutis hexagonis; stomatibus in collo sat numerosis, phaneroporis. *Peristomium* duplex; exostomii dentes lineari-subulati, basi connati, c.

0.56 mm. longi et basi c. 0.07 mm. lati, strato dorsali luteo, basi (usque ad c. 0.14 mm. alto.) transversim striolato inde ad apicem minutissime papilloso, aliquando superne pertuso, linea media flexuosula, strato ventrali paulum latiore dense (c. 35.) et alte lamelloso; endostomium luteum, minutissime papillosum; corona basilaris usque ad 0.1 mm. alta, leviter plicata; processus dentium longitudinis, anguste lineari-subulati, carinati in carina perforati, ventre c. 15-trabeculati; cilia nulla. *Sporae* c.  $15\ \mu$  magnae, fuscescenti-virides, minutissime papillosae. *Caetera* desiderantur.

Hondo: Prov. Etchū, Tsukioka-mura, Kamishinkawa-gun (Leg. HISAHIKO SASAOKA! 30. IX. 1913.). Prov. Musashi; Ōmori, Kasuga-jinsha (Leg. SHŪTAI OKAMURA! 2. II. 1913.).

Distr. endemica.

*Haplocladium capillatum* (MITT.) BROTH.

Formosa: Prov. Shinchiku-chō, Chikunan-ippo (Leg. HISAHIKO SASAOKA! 14. V. 1912.).

Species nova ad floram formosanam.

*Haplocladium latifolium* (LAC.) BROTH.

Formosa: Prov. Taihoku-chō, Taihoku (Leg. HISAHIKO SASAOKA! 31. X. 1912.).

*Thuidium japonicum* DOZ. et MOLK.

Formosa: Prov. Shinchiku-chō, Naroyama (Leg. HISAHIKO SASAOKA! 1. XII. 1912.). Kyūshū: Prov. Ōsumi, in insula Yaku-shima (Leg. TAKANORI IWAKI! 21. IX. 1914.).

## HYPNACEAE.

*Drepanocladus uncinatus* (HEDW.) WARNST.

Korea: Prov. Kankyo-Nandō, Chōdadō [長蛇洞], Sansui-gun [三水郡] (Leg. TAKENOSHIN NAKAI! 24. VII. 1914.); in monte Rohō (Leg. TAKENOSHIN NAKAI! 11. VII. 1914.).

Species nova ad floram koreanam.

*Hygrohypnum ochraceum* (TRUX.) BROTH.

Hondo: Prov. Iwashiro, Kamanumahara (Leg. GENICHI KOIDZUMI! VIII. 1913.).

Species nova ad floram japonicam.

*Rhytidiadelphus calvescens* (WILS.) BROTH.

Korea: in monte Rohō (Leg. TAKENOSHIN NAKAI! 11. VII. 1914.).

Species nova ad floram koreanam.

*Rhytidiadelphus squarrosus* (L.) WARNST.

Korea: in monte Rohō (Leg. TAKENOSHIN NAKAI! 10. VII. 1914.).

Species nova ad floram koreanam.

*Rhytidiadelphus triquetrum* (L.) WARNST.

Korea: in monte Rohō (Leg. TAKENOSHIN NAKAI! 11. VII. 1914.).

Species nova ad floram koreanam.

*Rhytidium rugosum* (EHRH.) KINDB.

Korea: in monte Rohō (Leg. TAKENOSHIN NAKAI! 11. VII. 1914.); in monte Hakutōsan [白頭山] (Leg. TAKENOSHIN NAKAI! 10. VIII. 1914.).

Species nova ad floram koreanam.

*Hylocomium pyrenaicum* (SPRUC.) LINDB.

Korea : in monte Rohō (Leg. TAKENOSHIN NAKAI ! 11. VII. 1914.).  
Species nova ad floram koreanam.

*Hylocomium splendens* (HEDW.) SCHIMP.

Korea : in monte Rohō (Leg. TAKENOSHIN NAKAI ! 11. VII. 1914.).  
Species nova ad floram koreanam.

*Hypnum Schreberi* WILD.

Sachalin : Sicca (Leg. JŪSUKI SUSUKI ! 1. V. 1913). Korea : in monte  
Rohō (Leg. TAKENOSHIN NAKAI ! 10. VII. 1914.).  
Species nova ad floram sachalinam et koreanam.

*Ectropothecium Shiragae* SH. OKAMURA. sp. nov.

Habitat in truncis arborum. *Plantae* graciles, caespitosae, caespitibus lutescenti-viridibus, nitidiusculis, molliusculis, densissimis, late depresso-extentis. *Caulis* elongatus, repens, c. 5–7 cm. longus, per totam longitudinem fasciculatim fusco-radiculosus, divisus, dense et regulariter pinnatim ramosus, sectione oblongus, c. 0.24–0.32 × 0.16–0.24 mm. magnus, fasciculo centrali arto pauci-cellulari, reti intermedio hyalino, cellulis hexagonis vel oblongo-hexagonis c. 15–30 μ magnis tenellis, cellulis periphericis c. 3-seriatis minoribus incrassatis lutescentibus vel fuscis ; ramis c. 3–5–7 mm. longis, transverse patentibus et prostratis vel patulis et adscendentibus, strictis, simplicibus rarius parce vel regulariter pinnatim ramulosis apice obtusis, dense foliosis complanatis, cum foliis c. 1.2 mm. latis. *Paraphyllia* nulla. *Folia* quasidisticha, haud homomalla, sicca laevia, ovato-lanceolata, apice subulato-acuminata, c. 0.9–1.2 mm. longa et c. 0.28–0.32 mm. lata, concava, haud plicata, marginibus basi leviter recurvis, inferne integerrimis, e medio ad apicem argute serra-

tis; nervis binis, c. 0.24–0.32 mm. longis, in sectione transversali fere planis, basi c. 15–20  $\mu$  latis, e 2-stratis cellularum incrassatarum uniformium compositis; cellulis laevissimis, anguste linearibus, c. 30–56  $\mu$  longis et c. 3  $\mu$  latis, marginalibus non difformibus, basilaribus c. 4  $\mu$  latis, infimis laxioribus rectangulis c. 20–30  $\mu$  longis et c. 7–9  $\mu$  latis hyalinis, alaribus 1 rarius 2 magnis oblongis c. 30–40  $\mu$  longis et c. 15–20  $\mu$  latis subvesiculaeformibus hyalinis, supraalaribus paucis quadratis vel breviter rectangulis minori-

bus c. 15  $\mu$  magnis hyalinis. *Inflorescentia* autoica; flores utriusque sexus geminiformes in caule; folia perigonialia intima rotundato-ovata, apice subulato-attenuata, c. 0.5 mm. longa et c. 0.28 mm. lata, concava, enervia; antheridia numerosa (c. 15), c. 0.2 mm. longa, paraphysibus paucis, c. 0.24 mm. longis, hyalinis. *Ramusulus perichaetialis* parce radiculosus. *Bracteae perichaetii* intimae basi longe semivaginatae lanceolatae in acumen sensim elongatum pili-forme falcatum serratum attenuatae, c. 2 mm. longae et c. 0.4 mm. latae, haud plicatae, margine e basi ad ultra medium late recurvae, enerves vel obsolete binerves; cellulis linearibus, c. 40–70  $\mu$  longis et c. 5–6  $\mu$  latis, basilaribus infimis laxioribus rectangulis c. 30–45  $\mu$  longis et c. 10–15  $\mu$  latis. *Vaginula* cylindrica, c. 0.8 mm. alta et c. 0.3 mm. crassa, pallida; paraphysibus numerosis hyalinis. *Seta* c. 8 mm. longa, tenuis, c. 0.08 mm. crassa, substricta, rubra, laevis, sicca paulum torta. *Theca* nutans, e collo obconico distincto ovalis, symmetrica, c. 0.8–0.9 mm. longa (collo c. 0.16 mm. longo.) et c. 0.56 mm. crassa, fusca, superne paulum mamilliosa, sicca deoperculata sub ore valde contracta haud curvata, leavis; cellulis exo-

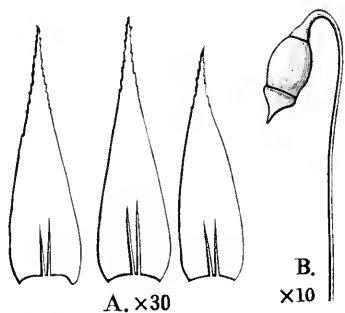

**Fig. 26.** *Ectropothecium Shiragae.*

A. Folia ( $\times 30$ ); B. Theca ( $\times 10$ ).

thecii rotundato-quadratis paulum collenchymaticis, c. 20–35  $\mu$  magnis, ad orificium in seriebus c. 4–5 minoribus hexagonis c. 10–15  $\mu$  magnis; stomatibus nullis. *Annulus* duplex, c. 45  $\mu$  altus, basi fuscescens inde hyalinus, deciduus. *Exostomii* dentes subulato-lanceolati, basi connati, c. 0.32 mm. longi et basi c. 70  $\mu$  lati, dorso basi lutei transversim striatuli, superne hyalini grosse papilloso, ventre hyalini dense (c. 35) et alte lamellosi; endostomium corona basilaris c. 140  $\mu$  alta, ochracea, laevis; processus dentium fere longitudinis, ochracei, papilloso, carinati in carina anguste perforati; cilia bina, bene evoluta, hyalina, papillosa, nodulosa. *Sporae* c. 7–8  $\mu$  magnae, ochraceae, minutissime papillosae. *Operculum* e basi conica mamillosa rostratum, c. 0.5 mm. longum et basi c. 0.5 mm. diam., rostro brevi c. 0.2 mm. longo erecto laevi. *Calyptra* cucullata, c. 1.5–1.6 mm. longa, pallida, laevis.

Formosa: Prov. Taihoku-chō, Urai (Leg. JUKICHI SHIRAGA! VII. 1911.).

Species *E. planulo* CARD. proxima, sed foliis subulato-acuminatis, cellulis angustioribus, seta brevioribus diversa.

Nomen speciei in honorem Coll. DOM. JUKICHI SHIRAGA.

*Stereodon cymbifolius* SH. OKAMURA. sp. nov.

Habitat in saxis. *Plantae* subgraciles, dense caespitosae, caespitibus late extentis, viridibus seniores fusco-viridibus, sericeis, mollioribus. *Caulis* elongatus, repens, usque ad 5 cm. longus, hic illic fasciculatim fusco-radiculosus, dense et subirregulariter pinnatim ramosus, sectione teres, c. 0.16–0.24 mm. diam., fasciculo centrali nullo, reti centrali luteo, cellulis hexagonis vel oblongo-hexagonis tenellis c. 20–25  $\mu$  magnis, cellulis periphericis c. 2–3-seriatis minoribus c. 15  $\mu$  magnis incrassatis fuscis, externis luteis et membrana externa tenella; ramis 8–15 mm. rarius usque ad 25 mm. longis, simplicibus vel irregulariter pinnatim ramulosis, adscendenti-

bus vel fere erectis aliquando prostratis, strictis vel curvatulis, apice obtusis sed sicca acutis, dense foliosis complanatis, cum foliis 1.2–1.6 mm. latis. *Paraphyllia* nulla. *Folia* sicca laxe adpressa haud homomalla nec falcata, madida erecto-patentia, e basi angusta late oblonga vel obovato-oblonga, subito in acumen saepe semitortum plus minus elongatum subulatum sensim attenuatum constricta, c. 0.8–1.2 mm. longa et c. 0.4–0.56 mm. lata, cymbiforme concava, non plicata, marginibus basi leviter recurvis dein late incurvis, superne argute serratis; nervis binis, tenellis, c. 0.16–0.3 mm. longis; cellulis laevissimis, anguste prosenchymaticis, c. 80–120  $\mu$  longis et c. 4–6  $\mu$  latis, superioribus brevioribus c. 40  $\mu$  longis, basilaribus infimis abbreviatis et laxioribus c. 35–40  $\mu$  longis et 7–10  $\mu$  latis aureis, alaribus 3 magnis oblongis vesiculiformibus c. 30–50  $\mu$  longis et c. 20–35  $\mu$  latis, lutescentibus vel fere hyalinis, supraalaribus perpaucis c. 4–5 quadratis vel rectangularibus lutescentibus vel fere hyalinis. *Inflorescentia* dioica; flores feminei in caule et ramis; flores masculi in ramis geminiformes, minores, c. 0.2–0.24 mm. longi; folia perigonia intima ovata, apice acuta, concava, enervia, c. 0.18–0.24 mm. longa et c. 0.08–0.1 mm. lata; antheridia pauca (c. 2–3), c. 0.14 mm. longa, paraphysibus perpaucis, c. 0.1 mm. longis, hyalinis. *Ramus perichaetialis* valde fusco-radiculosus. *Bractae perichaetii* intimae lanceolatae, apice sensim elongate attenuatae, erectae vel recurvae, c. 1.2–1.4 mm. longae et c. 0.3–0.4 mm. latae, concavae, leviter plicatae, superne argute serratae; nervis binis, c. 0.4–0.5 mm. longis, saepe in-

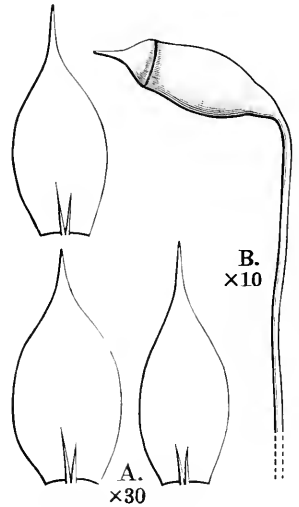

Fig. 27. *Stereodon cymbifolius*.

A. Folia ( $\times 30$ ); B. Sporangia ( $\times 10$ ).

distinctis; cellulis linearibus, basilaribus laxioribus, fere rectangulis aureis. *Vaginula* cylindrica, c. 1.1–1.3 mm. longa et c. 0.3 mm. crassa, brunnea; paraphysibus perpaucis. *Seta* c. 10–15 mm. longa, stricta vel leviter flexuosula, rubiginosa, laevis, sicca torta. *Theca* obliqua vel horizontalis, e collo obconico anguste ovato-oblonga, deoperculata fere cylindrica, c. 1.6–1.8 mm. longa (collo c. 0.3 mm. longo.) et c. 0.8–0.85 mm. crassa, paulum asymmetrica, sicca deoperculata leviter curvata, sub ore paulum contracta, laevis, castanea; cellulis exothecii rectangulis, c. 40–56  $\mu$  longis et c. 20–30  $\mu$  latis, parietibus incrassatis c. 10–14  $\mu$  crassis, ad orificium in seriebus tribus minutis quadratis vel hexagonis c. 20  $\mu$  magnis; stomatibus in collo paucis. *Annulus* duplex, c. 40  $\mu$  altus, rubiginosus, deciduus. *Exostomii* dentes subulato-lanceolati, basi connati, c. 0.44 mm. longi et basi c. 60–70  $\mu$  lati, dorso luteofusci, dense transversim striatuli, apice papilloso, linea media flexuosula, ventre dense (c. 35) et altissime lamellosi; endostomium luteum, minute papillosum; corona basilaris c. 0.15 mm. alta; processus dentium longitudinis, carinati in carina anguste perforati; cilia bina, bene evoluta, nodulosa, papillosa. *Sporae* c. 20–25  $\mu$  magnae, virides, laevissimae. *Operculum* e basi conica longe rostratum, c. 0.9 mm. longum et basi c. 0.6 mm. diam., rostro stricto, c. 0.64 mm. longo. *Calyptra* cucullata, c. 1.4–1.6 mm. longa, basi lutea superne fuscescens, laevis.

Hondo: Prov. Etchū, in monte Kurobe-yama, Shimoshinkawa-gun (Leg. HISAHIKO SASAOKA! 3. VIII. 1915.).

Species *S. Henoni* (DUBY.) MRR. affinis, sed statura paulum graciliore, seta brevior praecipue foliorum forma longe diversa.

Nomen speciei ab foliis cymbiforme concavis.



*Stereodon fertilis* (SENDTN.) LENDE.

Korea : in monte Gatokurei (Leg. TAKENOSHIN NAKAI ! 5. VII. 1914.);  
in monte Hakutōsan (Leg. TAKENOSHIN NAKAI ! 10. VIII. 1914.).

Species nova ad floram koreanam.

*Stereodon plumaeformis* (WILS.) MITT.

Formosa : Prov. Taihokuchō ; in monte Mentenzan [面天山] (Leg. YAICHI SHIMADA ! 31. X. 1914.); Taihoku (Leg. HISAHIKO SASAOKA ! 2. XI. 1912.).

*Isopterygium expallescens* LEVIER.

Formosa : Prov. Taihoku-chō ; Urai (Leg. JUKICHI SHIRAGA ! VII. 1911.).  
Species nova ad floram formosanam.

*Isopterygium Giraldii* (C. MÜLL.) PAR.

Formosa : Taihoku (Leg. YAICHI SHIMADA ! 20. VI. 1914.).

*Isopterygium Hisauchii* SH. OKAMURA. sp. nov.

Habitat in truncis arborum defectrum. *Plantae* graciles, caespitosae, caespitibus laete viridibus, late extentis, mollibus, nitidis. *Caulis* repens, usque ad 4 cm. longus densiuscule rubiginoso-radiculosus, laxe et irregulariter pinnatim ramosus, sectione teres. c. 0.16 mm. diam., fasciculo centrali nullo, reti centrali hyalino, cellulis tenellis hexagonis c. 15–20  $\mu$  magnis. cellulis periphericis c. 2–3-seriatis minoribus c. 7–9  $\mu$  magnis haud incrassatis lutescenti-virescentibus vel lutescenti-fuscis ; ramis prostratis, usque ad 1.5 cm. longis, simplicibus, densiuscule foliosis valde complanatis, apice obtusis vel breviter attenuatis. *Folia* sicca patentia leviter plicata, madida patentia non plicata, haud decurrentia, symmetrica, e basi ovata lanceolata, in acumen elongatum angustum subulatum sensim

attenuata, c. 1.9–2.4 mm. longa et c. 0.5–0.64 mm. lata, concava, marginibus basi erectis, ubique praecipue ad apicem argute serratis ;

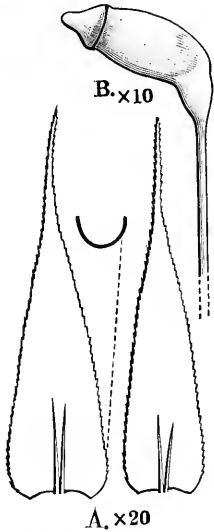

**Fig. 28.** *Isopterygium Hisauchii*.

A. Folia ( $\times 20$ );  
B. Sporangia ( $\times 10$ ).

nervis binis, tenuis, brevibus c. 0.64 mm. longis, viridibus ; cellulis valde chlorophyllosis, laevissimis, linearibus, c. 60–90  $\mu$  longis et c. 7–8  $\mu$  latis, basilaribus infimis haud porosis rectangularis c. 25–35  $\mu$  longis et c. 10  $\mu$  latis chlorophyllosis saepe fuscis vel hyalinis, alaribus inconspicuis.

*Inflorescentia* autoica ; flores utriusque sexus in caule geminiformes ; folia perigonialia intima ovata apice sensim attenuata, c. 0.48–0.72 mm. longa et c. 0.30–0.36 mm. lata, concava, enervia, margine crenulata ; antheridia c. 8, paraphysibus paucis brevibus. *Ramulus perichaetialis* valde fusco-radiculosus. *Bractea perichaetii* intimae e basi semi-vaginate sensim anguste subulatae, c. 1.7–2.0 mm. longae et c. 0.4–0.5

mm. latae, subula erecta vel recurva, marginibus e medio ad apicem argute serrulatis ; nervo nullo ; cellulis linearibus, chlorophyllosis, saepe apice dorso prominente papillosis, basilaribus rectangularis fuscis. *Vaginula* cylindrica, c. 0.8 mm. longa, lutescenti-viridescens apice fusca. *Seta* c. 1.0–1.5 cm. longa, tenuis, stricta, basi rubra superne lutescenti-rubescens, laevissima, sicca torta. *Theca* inclinata vel horizontalis, e collo distincto conico oblonga, asymmetrica, leviter gibbosa, sicca deoperculata sub ore valde contracta haud plicata, c. 1.4–1.9 mm. longa (collo c. 0.4–0.5 mm. longo.) et c. 0.6–0.8 mm. crassa, fusca, leavis ; cellulis exothecii quadratis vel rectangularis, c. 25–50  $\mu$  longis et c. 20–30  $\mu$  latis, ad orificium in seriebus 3–5 minutis subquadratis ; stomatibus in collo numerosis. *Annulus* duplex, c. 50–56  $\mu$  altus, e duplici serie

cellularum, deciduus. *Exostomii* dentes basi connati, subulato-lanceolati, c. 0.36 mm. longi et basi c. 70  $\mu$  lati, dorso lutei, basi transversim striatuli, superne papilloso, ventre dense (c. 30) et alte lamellosi; endostomium hyalinum, minutissime papillosum; corona basilaris ad medium dentium producta; processus dentium fere longitudinis, carinati in earina vix perforati; cilia terna rarius bina, bene evoluta, nodulosa, breviter appendiculata, *Sporae* c. 9–12  $\mu$  magnae, luteo-virides, minutissime papillosae. *Operculum* e basi conica breviter rostratum, c. 0.56 mm. longum et basi c. 0.56 mm. diam., rostro crassiusculo recto obtuso. *Calyptra* cucullata, c. 2.8 mm. longa, inferne lutescenti-viridescens superne fuliginosa, laevis.

Hondo: Prov. Sagami; Sagiyama, Yokohama (Leg. KIYOTAKA HISAUCHI! 27. V. 1915.)

Habitus statura faciesque omnino *I. taxirameum* (MITT.) JAEG., foliis autem apice anguste attenuatis, inflorescentia autoica, operculo brevioro rostrato longe diversis.

Nomen speciei in honorem Coll. DOM. KIYOTAKA HISAUCHI.

*Isopterygium taxirameum* (MITT.) JAEG.

Formosa: Prov. Sinchiku-chō; Chikumau-ippo (Leg. HISAHIKO SASAOKA! 5. XII. 1912.).

*Vesicularia Sasaokae* SH. OKAMURA. sp. nov.

Habitat in rupibus. *Plantae* tenellae, dense depresso-caespitosae, lutescenti-virides, molles, nitidiusculae. *Caulis* repens, c. 4–6 cm. longus, hic illic dense fasciculatim rubiginoso-radiculosus, dense et regulariter pinnatim ramosus, sectione teres vel ellipticus, c. 0.24–0.32 mm. diam., fasciculo centrali nullo, reti centrali hyalino, cellulis tenellis hexagonis c. 15–28  $\mu$  magnis, cellulis periphericis c. 2–3-seriatis minoribus c. 10–15  $\mu$  magnis incrassiusculis luteis vel

fusciscentibus; ramis plerumque 4–6 mm. rarius usque ad 8 mm. longis, patulis vel horizontalis, strictis, obtusis, cum foliis c. 1.5–2.0 mm. latis, simplicibus aliquando parce (1–2) ramulosis; caulibus ramisque dense foliosis complanatis. *Folia* sicca vix mutata apice

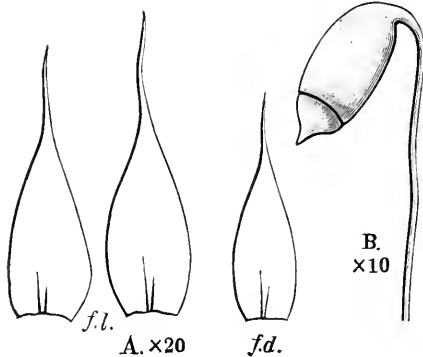

Fig. 29. *Vesicularia Sasaokae*.

A. Folia: f.d. folia dorsalia; f.l. folia lateralia ( $\times 20$ ); B. Sporangia ( $\times 10$ ).

flexuosula leviter recurva vel stricta, madida erecto-patentia, haud homomalla, concava; folia lateralia paulum asymmetrica, ovato-oblonga, sensim in acumen elongatum filiforme strictum vel leviter flexuosum attenuata, c. 1.5–1.8–2.0 mm. longa et c. 0.56–0.64 mm. lata, marginibus in acumen minute serrulatis vel integerrimis; folia dorsalia fere symmetrica, oblongo-lanceolata,

apice breviter attenuata, c. 1.4–1.6 mm. longa et c. 0.5 mm. lata; nervis binis, brevibus, tenellis, c. 0.32–0.4 mm. longis; cellulis chlorophyllosis, laevissimis, parietibus incrassiusculis, utriculo primordiali distincto, in medio folii late rhomboideis, c. 40–56  $\mu$  longis et c. 15–18  $\mu$  latis, in acumen linearibus c. 110–140  $\mu$  longis et c. 7  $\mu$  latis, basilaribus lineari-rhomboideis c. 80  $\mu$  longis et c. 15–18  $\mu$  latis, infimis fere rectangularibus vel oblongis c. 40–50  $\mu$  longis et c. 20–28  $\mu$  latis, alaribus indistinctis. *Inflorescentia* autoica; flores utriusque sexus geminiformes in caule; folia perigonia intima rotundato-ovata, apice subito breviter attenuata, c. 0.48 mm. longa et c. 0.25 mm. lata, concava, enervia; antheridia c. 10, c. 0.25 mm. longa, paraphysis paucis hyalinis brevibus. *Ramulus perichaetialis* valde rubiginoso-radiculosus. *Bractee perichaetii* intimae oblongo-lanceolatae, in acumen sensim elongatum piliforme erectum vel leviter recurvum integerrimum vel minute serrulatum

attenuatae, c. 2.2 mm. longae et basi c. 0.64–0.7 mm. latae; nervis binis, indistinctis, brevibus, c. 0.4 mm. longis; cellulis ut in foliis. *Vaginula* cylindrica, c. 0.8 mm. longa et c. 0.4 mm. crassa, fusca; paraphysibus paucis, hyalinis, brevibus, c. 0.5 mm. longis. *Seta* c. 10–15 mm. longa, paulum flexuosa, rubra apice lutescenti-rubra, laevis, sicca leviter torta. *Theca* pendula vel nutans, oblonga, c. 1.4–1.5 mm. longa et c. 0.9 mm. crassa, brevicollis, fusca, laevis, sicca deoperculata sub ore contracta; cellulis exothecii quadratis rectangulis vel hexagonis, c. 25–56  $\mu$  longis et c. 25–40  $\mu$  latis, ad orificium in seriebus c. 3–4 minoribus quadratis vel hexagonis c. 15  $\mu$  magnis; stomatibus nullis. *Annulus* duplex, c. 56  $\mu$  altus, hyalinus, deciduus. *Exostomii* dentes subulato-lanceolati, basi connati, c. 0.48 mm. longi et basi c. 84  $\mu$  lati, dorso e basi ad medium luteo-fusci et dense transversim striatuli, dein hyalini laxe et grosse papilloso, linea media flexuosula, ventre dense (c. 40) et alte lamellosi; endostomium luteum, minute papillosum; corona basilaris c. 0.16 mm. alta; processus dentium longitudinis, carinati in carina anguste perforati, grosse papilloso, apice hyalini; cilia bina, bene evoluta, hyalina, papillosa. *Sporae* c. 7–9  $\mu$  magnae, fusciscentes, laeves. *Operculum* e basi convexo-conica acute apiculatum, c. 0.7 mm. longum et c. 0.7 mm. diam. *Calyptra* cucullata, c. 2 mm. longa, lutescens, laevis.

Formosa: Prov. Taihoku-chō, Eifukusan [永福山] (Leg. HISAHIKO SASAOKA! 24. II. 1912.).

Species *V. reticulata* (Doz. et Molk.) Broth. valde affinis. sed foliis longiore acuminatis faciliter dignoscenda.

Nomen speciei in honorem Coll. Dom. HISAHIKO SASAOKA.

*Vesicularia Shimadae* SH. OKAMURA. sp. nov.

Habitat in rupibus. *Plantae* robustiusculae, dense depresso-

caespitosae, luteo-fuscescentes, nitidiusculae, rigidiusculae. *Caulis* repens, elongatus, c. 4–7 cm. longus, per totam longitudinem fasciculatim fusco-radiculosus, divisus, dense et regulariter pinnatim ramosus, sectione teres vel oblongus, c. 0.40–0.48 × 0.25–0.32 mm. magnus, fasciculo centrali nullo, reti centrali hyalino, cellulis tenellis hexagonis vel oblongo-hexagonis c. 25–40  $\mu$  magnis, cellulis periphericis c. 2–3-seriatis minoribus c. 14  $\mu$  magnis paulum incrassatis lutescentibus vel fuscescentibus; ramis c. 5–6 mm. rarius c. 7 mm. longis, patulis vel horizontalis, strictis, obtusis, cum foliis c. 1.6–2.0 mm. latis, simplicibus aliquando parce (1–3) ramulosis; caulibus ramisque dense foliosis complanatis. *Folia* sicca vix mutata, madida erecto-patentia vel divaricata, haud homomalla; folia dorsalia concava, obovata apice abrupte acuto-attenuata, c. 1.1–1.4 mm. longa et c. 0.6–0.72 mm. lata, asymmetrica; folia lateralia valde concava, ovato-lanceolata, sensim in acumen angustum subulatum strictum vel leviter curvatum attenuata, c. 1.6–1.8 mm. longa et c. 0.72 mm. lata, asymmetrica vel fere symmetrica; folia ventralia anguste ovato-lanceolata, apice sensim anguste attenuata, c. 1.4 mm. longa et c. 0.48 mm. lata; marginibus ubique integerrimis; nervis binis, tenuis, brevibus. c. 0.32–0.4–0.5 mm. longis; cellulis foliorum lateralium chlorophyllosis, laevissimis, parietibus incrassiusculis, utriculo primordiali distincto, longe rhomboideis, c. 70–100  $\mu$  longis et c. 14–16  $\mu$  latis (5–6 : 1), basilaribus infimis oblongis, c. 40  $\mu$  longis et c. 18  $\mu$  latis, marginalibus uniseriatis linearibus, alaribus indistinctis; cellulis foliorum dorsalium superioribus late rhombeis, c. 30–40  $\mu$  longis et c. 18–20  $\mu$  latis. *Inflorescentia* autoica; flores utriusque sexus geminiformes in caule; folia perigonialia intima ovata, apice acuta, c. 0.4 mm. longa et c. 0.24 mm. lata, enervia; antheridia c. 10, c. 0.2–0.24 mm. longa; paraphysibus perpauca. *Ramus perichaetialis* valde rubiginoso-radiculosus. *Bra-*

*ctae perichaetii* intimae basi semivaginatae oblongo-lanceolatae in acumen sensim elongatum piliforme erectum vel curvatum integerrimum attenuatae, c. 2.0–2.3 mm. longae et basi c. 0.48–0.56 mm. latae; nervis binis, indistinctis, c. 0.48–0.56 mm. longis; cellulis ut in foliis.

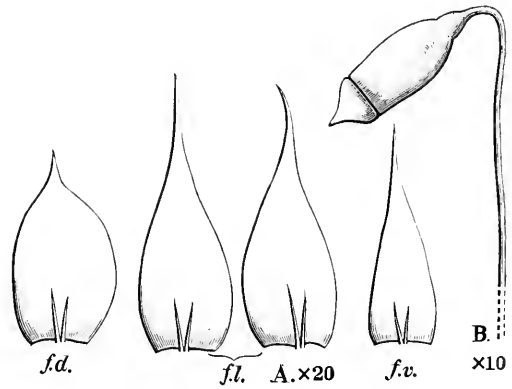

**Fig. 30. Vesicularia Shimadae.**

A. Folia: f.d. folia dorsalia; f.l. folia lateralialia; f.v. folia ventralialia ( $\times 20$ ); B. Sporangia ( $\times 10$ ).

*Vaginula cylindrica*, c. 0.8–

0.96 mm. longa et c. 0.4 mm. crassa, lutescens apice fusca; paraphysibus paucis, hyalinis. *Seta* c. 13–20 mm. longa, paulum flexuosa, rubra, laevis, sicca leviter torta. *Theca* pendula vel nutans, e collo obconico distincto oblongo-cylindrica, symmetrica, c. 1.68–1.76 mm. longa (collo c. 0.32 mm. longo) et c. 0.72–0.8 mm. crassa, fusca, laevis vel paulum mamillosa, sicca deoperculata sub ore haud contracta; cellulis exothecii hexagonis vel oblongo-hexagonis. c.  $30\text{--}56 \times 30\text{--}40 \mu$  magnis, ad orificium in seriebus c. 2–3 minoribus c.  $15 \mu$  magnis hexagonis; stomatibus nullis. *Annulus* duplex, c.  $70 \mu$  altus, basi luteus superne hyalinus, deciduus. *Exostomii* dentes subulato-lanceolati, basi paulum remoti, c. 0.48 mm. longi et basi c. 0.1 mm. lati, hyaline limbati, dorso basi lutei et dense transversim striatuli dein lutei et minute papilloso, apice hyalini, fere leves vel paulum papilloso, linea media flexuosa, ventre hyalini dense (c. 45) et alte lamellosi; endostomium corona basilaris lutea, minutissime papillosa, c. 0.16 mm. alta; processus dentium fere longitudinis, carinati in carina anguste perforati, papilloso, luteo-fusci, apice hyalini; cilia terna, bene evoluta, fere hyalina, papillosa,

nodulosa. *Sporae* c. 9–12  $\mu$  magnae, fusciscentes, laeves vel leviter scabridae. *Opercurum* e basi conica acute apiculatum, c. 0.64 mm. longum et c. 0.56–0.72 mm. diam. *Calyptra* cucullata, c. 2.–2.3 mm. longa, pallida apice fusca, laevis.

Formosa: Prov. Taihoku-chō, Honkeirai [磺溪内], Shabōsan [沙帽山] (Leg. YAICHI SHIMADA! 2. I. 1914.).

Nomen speciei in honorem Coll. Dom. YAICHI SHIMADA.

### SEMATOPHYLLACEAE.

#### *Rhaphidostegium argutum* SH. OKAMURA. sp. nov.

Habitat in truncis. *Plantae* robustiusculae, caespitosae, lutescenti-virides, sericeae, rigidiusculae. *Caulis* elongatus, repens, c. 2–4 cm. longus, hic illic fasciculatim fusco-radiculosus, densiuscule subirregulariter pinnatim ramosus, sectione oblongus, c. 0.2  $\times$  0.16 mm. magnus, fasciculo centrali nullo, reti centrali aureo, cellulis tenellis rotundato-hexagonis c. 20–30  $\mu$  magnis, cellulis periphericis c. 3–4-seriatis c. 10  $\mu$  magnis fusco-aureis; ramis patulis, brevibus c. 3–5–7 mm. longis simplicibus vel rarius c. 10 mm. longis et parce ramulosis, apice obtusis; caulibus ramis ramulisque densiuscule foliosis complanatis, cum foliis c. 1.5–2.0 mm. latis. *Folia* sicca vix mutata, madida patula, haud homomalla, valde concava, oblongo-lanceolata, in acumen subcanaliculatum saepe leviter flexuosum attenata, c. 1.1–1.4–1.6 mm. longa et c. 0.35–0.56 mm. lata, marginibus ultra medium revolutis, e medio ad apicem grosse serratis; nervis nullis vel subnullis; cellulis anguste prosenchymaticis c. 80–140  $\mu$  longis et c. 5–7  $\mu$  latis, superioribus brevioribus c. 50–70  $\mu$  longis, basilaribus infimis abbreviatis c. 30–40  $\mu$  longis aureis, alaribus aureis 3–4 magnis rectangularibus subvesiculososis c. 50–80  $\mu$  longis et c. 20–25  $\mu$  latis, supraalaribus quadratis c. 25  $\mu$



magnis, omnibus laevissimis. *Inflorescentia* dioica; flores masculi ignoti. *Ramulus perichaetialis* valde fusco-radiculosus. *Bracteae perichaetii* intimae oblongo-lanceolatae, apice sensim anguste acuminatae, c. 24 mm. longae et c. 0.4 mm. latae, marginibus e medio ad apicem grosse serratis; cellulis basilaribus infimis aureis. *Vaginula* cylindrica, c. 1.2 mm. alta, aurea apice nigrescens; paraphysibus numerosis, hyalinis. *Seta* c. 1–2 cm. longa, rubra, tenuis, laevissima, sicca torta. *Theca* inclinata, asymmetrica, leviter curvata, oblonga, sicca deopereculata sub ore paulum contracta, c. 1.8–2.0 mm.

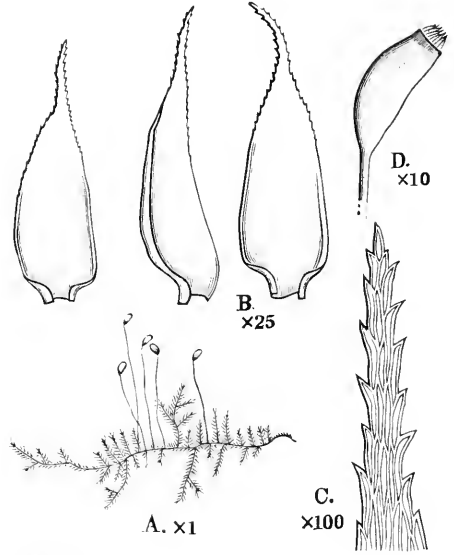

**Fig. 31.** *Rhabdostegium argutum*.  
A. Planta ( $\times 1$ ); B. Folia ( $\times 25$ ); C. Apex folii ( $\times 100$ ); D. Sporangia ( $\times 10$ ).

longa et c. 0.6–0.7 mm. crassa, pallido-fusca, collo brevi; cellulis exothecii quadratis vel rectangulis c.  $28\text{--}56 \times 20\text{--}28 \mu$  magnis, ad orificium in seriebus 1–2 transverse rectangulis c.  $14 \times 20 \mu$  magnis; stomatibus in collo paucis. *Exostomii* dentes lineari-lanceolati, c. 0.4 mm. longi et basi c. 0.08 mm. lati, hyaline limbati, dorso lutei et transversim striatuli, apice lutescenti dense et grosse papilloso, ventre dense (c. 35) et alte lamellosi; endostomium luteum; corona basilaris c. 0.16 mm. alta, minutissime papillosa; processus dentium longitudinis, carinati in carina anguste perforati, papilloso; cilia unica, bene evoluta, nodulosa, hyalina, papillosa. *Sporae* c.  $14 \mu$  magnae, virides, minutissime et parce papillosoe. *Caetera* ignota.

Hondo: Prov. Yamashiro; Kamigamo, Otagi-gun (Leg. D. Imoto! II. 1914.).

Species *R. japonico* BROTH. subaffinis, sed marginibus foliorum e medio ad apicem grosse argutis, inflorescentia dioica, seta longiore, endostomium cilia unica faciliter dignoscenda.

Nome speciei ab foliis apice argutis.

*Rhaphidostegium demissum* (WILS.) DE NOT.

Formosa: Prov. Taihoku-chō, Shabōsan (Leg. YAICHI SHIMADA! 31. XII. 1913.).

Species nova ad floram formosanam.

*Rhaphidostegium japonicum* BROTH. Hedwigia Band XXXVIII. p. 230 (1899).

Habitat in truncis vel rupibus. *Plantae* graciles, caespitosae, caespitibus lutescenti-viridibus, sericeis, rigidiusculis, densis, late extentis. *Caulis* repens, c. 3–4 cm. longus, hic illic dense fasciculatim fusco-radiculosus, densiuscule subirregulariter pinnatim ramosus, sectione teres vel oblongus, c. 0.12–0.16 mm. magnus, fasciculo centrali nullo, reti centrali luteo, cellulis tenellis hexagonis vel oblongo-hexagonis c. 10–20  $\mu$  magnis, cellulis periphericis 1–2-seriatis minoribus c. 10  $\mu$  magnis, valde incrassatis, fuscis; ramis c. 6–10 mm. longis, patulis, apice obtusis, simplicibus vel parce ramulosis, dense foliosis paulum complanatis. *Folia* sicca adpressa rarius ad apicem rami indistincte homomalla, madida erecto-patentia, concava, e basi oblonga lanceolata, apice sensim piliformiter attenuata, c. 1.3–1.6 mm. longa et c. 0.4–0.45 mm. lata, marginibus e basi ultra medium leviter revolutis, integerrimis; nervis nullis vel indistincte binis; cellulis omnibus laevissimis, anguste linearibus, c. 70–80  $\mu$  longis et c. 4  $\mu$  latis, superioribus brevibus c. 35–50  $\mu$  longis et c. 4–6  $\mu$  latis, basilaribus infimis brevioribus c. 40  $\mu$  longis aureis, alaribus 3–5 magnis oblongis subvesiculosus c. 35–56  $\mu$  longis et c.

20–25  $\mu$  latis aureis, supraalaribus quadratis vel breviter rectangulis minoribus lutescentibus vel hyalinis. *Inflorescentia* autoica; flores utriusque sexus geminiformes in caule vel ramis; folia perigonia interna ovata, apice breviter acuminata, c. 0.4 mm. longa et c. 0.24 mm. lata, concava, enervia; antheridia c. 5–7, c. 0.16 mm. longa, paraphysibus perpauca, hyalinis. *Ramulus perichaetialis* valde fusco-radiculosus.

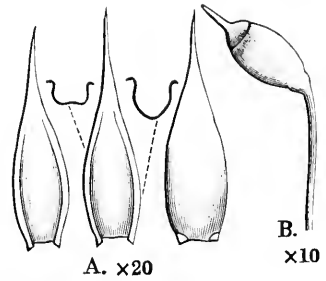

**Fig. 32.** *Rhabdostegium japonicum*.

A. Folia ( $\times 20$ ); B. Sporangia ( $\times 10$ ).

*Bractea perichaetii* intimae oblongo-lanceolatae, apice sensim anguste attenuatae, c. 0.9–1.0 mm. longae et c. 0.24 mm. latae, subintegerrimae; nervis binis, indistinctis; cellulis ut in foliis. *Vaginula* clavellato-cylindrica, c. 0.8 mm. longa, fusca; paraphysibus perpauca. *Seta* c. 8–9 mm. longa, paulum flexuosa, rubra, laevis, sicca torta. *Theca* inclinata vel subrecta, ovalis, c. 1 mm. longa et c. 0.64 mm. crassa, brevicollis, fusca, sicca deoperculata sub ore paulum contracta; cellulis exothecii collenchymaticis, quadratis vel breviter rectangulis, c. 30–40  $\mu$  longis et c. 20–30  $\mu$  latis, ad orificium in seriebus duabus vel tribus minutis hexagonis c. 15–20  $\mu$  magnis; stomatibus nullis. *Annulus* nullus. *Exostomii* dentes basi connati, subulato-lanceolati, c. 0.32 mm. longi et c. 70  $\mu$  lati, hyaline limbati, dorso e basi ad medium fusci et transversim striatuli, apice hyalini et papilloso, ventre dense (c. 35) et alte lamellosi; endostomium luteum, minutissime papillosum; corona basilaris c. 0.1 mm. alta; processus dentium longitudinis, carinati in carina anguste perforati; cilia bina vel unica, bene evoluta, nodulosa, hyalina, papillosa. *Sporae* c. 15  $\mu$  magnae, fusciscentes, minutissime papillosoe. *Operculum* e basi convexo-conica rostratum, c. 0.64–0.7 mm. longum et c. 0.4 mm. diam., rostro c. 0.4–0.5 mm.

longo, stricto vel curvato. *Calyptra* c. 1.4 mm. longa, lutescens apice fuscescens.

Formosa: Prov. Taihoku-chō; Eifukusan [永福山] (Leg. HISAHIKO SASAOKA! 24. II. 1913.); Shabōsan [沙帽山] (Leg. YAICHI SHIMADA! 30. XII. 1914.).

Species nova ad floram formosanam.

Distr. endemica japonica.

### BRACHYTHECIACEAE.

#### *Okamuraea brevipes* BROTH.

Habitat in arborum truncis. *Plantae* graciles, caespitosae, caespitibus densiusculis, rigidiusculis, lutescenti-viridibus, nitidiusculis. *Caulis* elongatus, repens, c. 5–6 cm. longus, divisus, subirregulariter pinnatim ramosus, hic illic fasciculatim fusco-radiculosus, sectione teres, c. 0.24–0.32 mm. diam., fasciculo centrali c. 30  $\mu$  magno paucicellulari, reti intermedio hyalino, cellulis hexagonis vel oblongo-hexagonis tenellis c. 15  $\mu$  magnis, cellulis periphericis c. 5–6-seriatis sensim minoribus luteo-fuscis vel fuscis incrassatis; ramis erectis, strictis vel substrictis, plerumque brevibus, c. 5–8 mm. longis simplicibus, rarius 13 mm. longis subpinnatim vel subfasciculatim ramulosis, omnino dense foliosis teretibus, apice obtusis vel subacutis. *Folia* caulina et ramea sicca imbricato-adpressa leviter plicata, madida erecto-patentia, concava, breviter decurrentia, ovato-oblonga, apice acuta, in summo acumen sensim elongatum subulatum angustum attenuata, c. 1.7–2.0 mm. (rarius c. 2.4 mm.) longa et c. 0.64–0.85 mm. lata, basi tri-plicata, marginibus basi late recurvis, ad apicem subplanis, integerrimis vel minutissime serrulatis; nervo valido, ultra medium folii evanido, in sectione transversali plano-convexo, basi c. 50  $\mu$  lato et c. 35  $\mu$

crasso, e 4-stratis cellularum uniformium composito; cellulis laevissimis, plus minus incrassatis, rhombeis vel rhomboideis, c. 20–35  $\mu$  longis et c. 6–9  $\mu$  latis, superioribus longioribus angustioribus, basilaribus quadratis breviter rec-

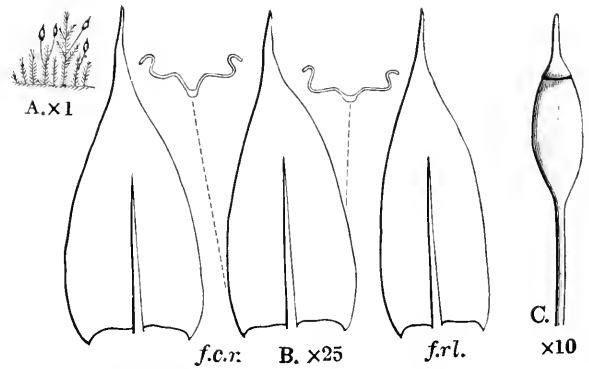

**Fig. 33.** *Okamuraea brevipes*.

A. Planta ( $\times 1$ ); B. Folia: f.c.r. folia caulina et ramea; f.rl. folia ramulina ( $\times 25$ ); C. Sporangia ( $\times 10$ ).

tangulis breviter linearibus vel oblongo-hexagonis c. 20–25  $\mu$  longis et c. 9–14  $\mu$  latis, alaribus numerosis quadratis breviter rectangularibus c. 9–14  $\mu$  longis et c. 7  $\mu$  latis; folia ramulina angustiora, anguste oblongo-lanceolata, apice sensim attenuata. *Inflorescentia* autoica; flores utriusque sexus geminiformes in caule vel ramis; folia perigonialia intima ovata apice acuto-attenuata, c. 0.64 mm. longa et c. 0.32 mm. lata, nervo tenui, ad medium evanido; antheridia c. 5–6, c. 0.4 mm. longa, paraphysibus numerosis, hyalinis. *Ramulus perichaetialis* haud radiculosus. *Bractea perichaetii* intimae e basi vaginante sensim anguste subulatae, subula erecta integerrima, c. 1.9 mm. longae et c. 0.56 mm. latae; nervo tenui, medium evanido; cellulis linearibus. *Vaginula* cylindrica, c. 0.8 mm. longa, lutescens apice fusca: paraphysibus sat numerosis lutescentibus vel hyalinis. *Seta* c. 3–5 mm. longa, stricta curvatula vel leviter flexuosula, rubra, laevissima. *Theca* erecta, symmetrica, oblonga, c. 1.2–1.4 mm. longa et c. 0.7 mm. crassa, brevicollis (collo obconico, c. 0.3 mm. longo), castanea, laevissima; cellulis exothecii quadratis rectangularibus vel hexagonis, c. 20–45  $\mu$  longis et c. 20–30  $\mu$  latis, ad orificium in seriebus c. 4–6 minutis hexagonis;

stomatibus in collo numerosis, phaneroporis. *Annulus* duplex, c.  $20\ \mu$  altus, fuscus, deciduus. *Exostomii* dentes basi connati, lineari-lanceolati, c. 0.28 mm. alti et basi c.  $50\ \mu$  lati, linea media flexuostula, marginibus dense cristatis, strato dorsali luteo minutissime papilloso, strato ventrali lato albido vel lutescenti densissime (c. 40) et alte lamelloso; endostomium hyalinum, minutissime papillosum vel laeve; corona basilaris humilis, c.  $50\ \mu$  alta; processus nulli; cilia nulla. *Sporae* c.  $15\ \mu$  magnae, lutescenti-virides, subscabridae. *Operculum* e basi conica longe rostratum, c. 0.9–1.0 mm. longum et c. 0.4 mm. diam., rostro longiusculo, recto, apice obtuso. *Calyptra* ignota.

Hondo: Prov. Echigo; in monte Oginojō-yama [越ノ城山] (Leg. MASAO NAKAMURA! 15. V. 1908.).

*Okamuraea cristata* BROTH. in Öfvers. Finsca Vet.-Soc. Förh. XLIX. No. 10. p. 2. (1905/06); Bot. Magaz. Tōkyō. Vol. XXII. No. 254. pp. 41–43 (1908); ENGLER und PRANT. nat. Pflanzf. p. 1132. (1908).

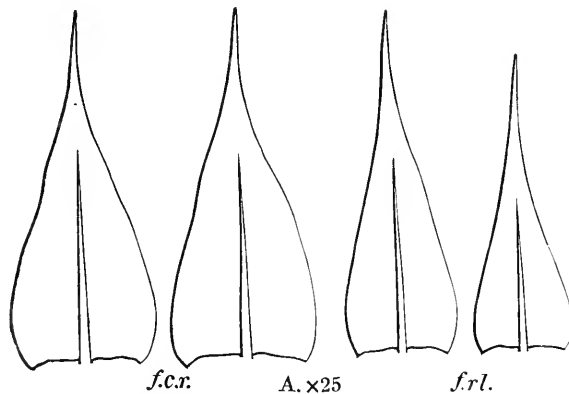

Fig. 34. *Okamuraea cristata*.

A. Folia: f.c.r. folia caulina et ramea; f.r.l. folia ramulina ( $\times 25$ ).

Shikoku: Prov. Tōsa; in monte Tsuetate-tōge (Leg. SHŪTAI OKAMURA! 6. IV. 1906. et 29. XII. 1906); in monte Yokogura (Leg. SHŪTAI OKAMURA! 26. V. 1907.); in monte Iradu (Leg. SHŪTAI OKAMURA! 1. I. 1908.). Hondo: Prov. Tango; Nariaisan (Leg. ICHIRO SONO! 28. XI. 1907.). Prov. Rikuzen; Kinkwazan (Leg. EJIRO UEMATSU! 31. III. 1908.). Prov. Shinano; in monte Tateshina (Leg. ZENRYŌ ŌHINATA! 12. VI. 1910.): in monte Asama (Leg. ZENRYŌ ŌHINATA! 20. IV. 1912.).

*Okamuraea cristata* BROTH. var. *gracilis* BROTH.

Habitat in truncis arborum. *Plantae* graciles, caespitosae, caespitibus late extentis, densis, rigidiusculis, lutescenti-viridibus, nitidiusculis. *Caulis* elongatus, repens, usque ad 4 cm. longus, divisus, subpinnatim ramosus, hic illic fasciculatim fusco-radiculosus, sectione teres, c. 0.16–0.2 mm. diam., fasciculo centrali c. 28  $\mu$  magno pauci-cellulari, reti intermedio hyalino, cellulis hexagonis vel oblongo-hexagonis tenellis c. 9–14  $\mu$  magnis, cellulis periphericis c. 3–4-seriatis sensim minoribus lutescenti-fuscescentibus incrassatis; ramis erectis, strictis vel curvatulis, plerumque brevibus, c. 5–12 mm. longis, simplicibus vel subpinnatim vel subfasciculatim ramulosis, dense foliosis teretibus, apice obtusis vel breviter attenuatis. *Folia* caulina et ramea sicca adpressa, madida erecto-

patentia, concava, basi tri-plicata, breviter decurrentia, late ovato-lanceolata, apice sensim elongate subulate attenuata, c. 1.2 mm. longa et c. 0.56 mm. lata, marginibus basi late recurvis dein ad apicem subplanis, integerrimis vel minutissime serrulatis; nervo valido, ultra medium folii evanido, in sectione transversali plano-

convexo, basi c. 42  $\mu$  lato et c. 28  $\mu$  crasso, e 4-stratis cellularum incrassatarum uniformium composito; cellulis laevissimis plus minusve incrassatis, in medio folii rhombis vel oblongis, c. 15–17  $\mu$  longis et c. 7–8  $\mu$  latis, superioribus longioribus rhomboideis vel sublinearibus c. 20–30  $\mu$  longis et c. 6–7  $\mu$  latis, basilaribus quadratis oblongis vel breviter rectangularibus c. 10–20  $\mu$  longis et c. 7–10  $\mu$

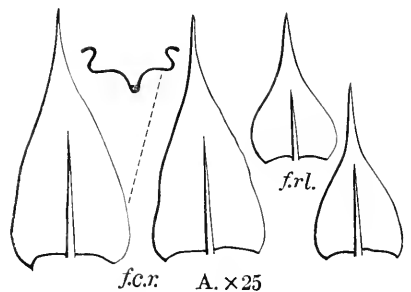

**Fig. 35.** *Okamuraea cristata* var. *gracilis*.

A. Folia; f.c.r. folia caulina et ramea;  
f.r.l. folia ramulina ( $\times 25$ ).

latis, alaribus numerosis quadratis c. 7–10  $\mu$  magnis; folia ramulina late ovata apice subito subulato-attenuata.

Hondo: Prov. Ise; Tsū-shi (Leg. HISAHIKO SASAOKA! 13. VI. 1913).

A typo statura graciliore, foliis minoribus, apice brevioribus differt.

*Okamuraea hakoniensis* (MITT.) BROTH. ENGLER und PRANTL nat. Pflanzenf. p. 1133. (1908).

Syn. *Hypnum hakoniense* MITT. Trans. Linn. Soc. Lond. 2nd Ser. Bot. Vol. III. Part 3. p. 185. (1891.).

Habitat in arborum truncis. *Plantae* graciles, caespitosae, caespitibus late extentis, densiusculis, rigidiusculis, lutescenti-viridibus, nitidiusculis. *Caulis* elongatus, repens, usque ad 5 cm. longus, irregulariter pinnatim ramosus, hic illic fasciculatim fusco-radiculosus, sectione teres, c. 0.24 mm. diam., fasciculo centrali pauci-cellulari, reti intermedio hyalino, cellulis hexagonis vel

oblongo-hexagonis tenellis c. 14 $\mu$  magnis, cellulis periphericis c. 5–6-seriatis minoribus lutescentibus vel fuscis valde incrassatis; ramis erectis, strictis vel curvatulis, c. 2 cm. longis, subpinnatim vel subfasciculatim ramulosis vel simplicibus, dense foliosis teretibus, apice attenuatis saepe flagelliformiter productis; ramulis attenuatis. *Folia* caulina et ramea sicca adpressa, madida

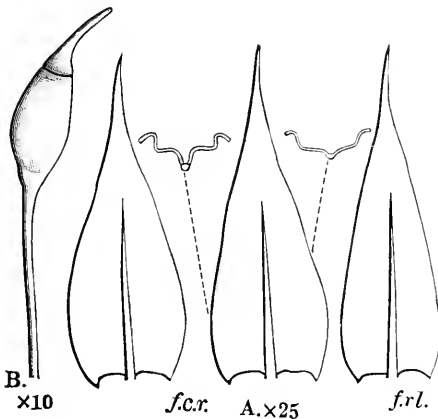

**Fig. 36.** *Okamuraea hakoniensis*.

A. Folia: f.c.r. folia caulina et ramea f.r.l. folia ramulina ( $\times 25$ ); B. Sporangium ( $\times 10$ ).

erecto-patentia, concava, vix decurrentia, ovato-oblonga, in acumen sensim elongatum subulatum attenuata, c. 1.6–1.8 cm. longa et c.



0.5–0.64 mm. lata, basi tri-plicata, marginibus basi late recurvis dein ad medium subplanis, integerrimis vel minutissime serrulatis; nervo valido, ultra medium folii evanido, in sectione transversali plano-convexo, basi c.  $42\ \mu$  lato et c.  $30\ \mu$  crasso, e 3-stratis cellulalium incrassatarum uniformium composito; cellulis laevissimis, plus minusve incrassatis, rhombeis vel rhomboideis, c. 20–35  $\mu$  longis et c. 7–9  $\mu$  latis, superioribus longioribus angustioribus, basilaribus late rhomboideis rectangulis vel breviter linearibus, alaribus numerosis minoribus quadratis vel breviter rectangulis (lumine saepe ovalibus) vel oblongis c. 7–9  $\mu$  magnis; folia ramulina angustiora, oblongo-lanceolata, apice anguste attenuata. *Inflorescentia* dioica? floribus masculis haud visis dioica videtur. *Ramulus perichaetialis* haud radiculosus. *Bractee perichaetii* intimae e basi vaginante sensim anguste subulatae, subula erecta vel leviter curvata, integerrimae, c. 1.6–2.0 mm. longae et c. 0.4 mm. latae; nervo tenui, medium evanido; cellulis linearibus, basilaribus rectangulis. *Vaginula* cylindrica, c. 0.8–1.0 mm. longa, lutescenti-viridescens apice fusca; paraphysibus sat numerosis, lutescentibus vel hyalinis. *Seta* c. 7–9 mm. longa, stricta curvatula vel leviter flexuosula, rubra, laevissima, sicca torta. *Theca* erecta vel inclinata, breviter oblonga vel ovalis, symmetrica vel paulum gibbosa, c. 1.2–1.5 mm. longa et c. 0.64–0.72 mm. crassa, castanea, laevissima, nitidiuscula, brevicollis, collo obconico c. 0.24–0.3 mm. longo; cellulis exothecii quadratis hexagonis vel rectangulis, c. 30–50  $\mu$  longis et c. 20–35  $\mu$  latis, ad orificium in seriebus c. 4–5 minutis hexagonis c. 20  $\mu$  magnis; stomatibus in collo numerosis, phaneroporis. *Annulus* duplex, c. 28–30  $\mu$  altus, ex unica serie cellularum, fuscescens, deciduus. *Exostomii* dentes basi connati, lineari-lanceolati, c. 0.32–0.36 mm. alti et basi c. 56  $\mu$  lati, linea media flexuosula, marginibus dense cristatis, strato dorsali luteo minutissime pa-

piloso, strato ventrali angustiore luteo densissime (c. 35–40) et alte lamelloso; endostomium hyalinum, minutissime papillosum; corona basilaris c. 0.1 mm. alta; processus nulli; cilia nulla. *Sporae* c. 28–35  $\mu$  magnae, virides, subscabridae. *Operculum* e basi conica longe rostratum, c. 1.0–1.2 mm. longum, rostro longo, subulato, curvatulo, apice obtuso. *Calyptra* cucullata, c. 1.7 mm. longa, lutescens apice fusca, parce pilosa, pilis hyalinis.

Shikoku: Prov. Tosa; in monte Yanaze (Leg. SHŪTAI OKAMURA! 20. VIII. 1905.). Hondo: Prov. Shinano; in monte Yatsuga-dake (Leg. ĒJIRO UEMATSU! 24. VIII. 1908.). Prov. Idu; in monte Amagi (Leg. KIYOSHI FUJII! 18. VIII. 1914.). Prov. Suruga; Gotenba (Leg. KIYOTAKA HISAUCHI! 11. IV. 1915).

*Okamuraea imbricata* BROTH.

Habitat in truncis arborum. *Plantae* graciles, caespitosae, caespitibus late extensis, densiusculis, rigidiusculis lutescenti-viridibus, nitidiusculis. *Caulis* elongatus, repens, usque ad 7 cm. longus, divisus, irregulariter pinnatim ramosus, hic illic fasciculatim fusco-

radiculosus, sectione teres, c. 0.28 mm. diam., fasciculo centrali paucicellulari, reti intermedio hyalino vel lutescenti, cellulis hexagonis tenellis c. 15  $\mu$  magnis, cellulis periphericis c. 5–6-seriatis minoribus fuscis valde incrassatis; ramis erectis, strictis vel curvatulis, usque ad 2 cm. longis, subpinnatim vel subfasciculatim ramulosis vel simplicibus, dense foliosis teretibus,

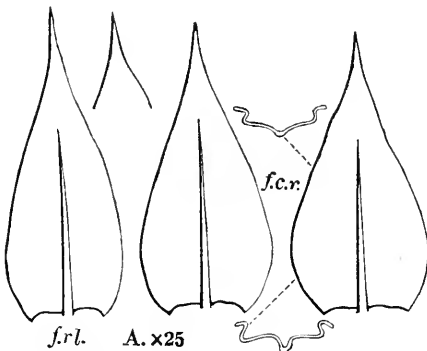

Fig. 37. *Okamuraea imbricata*.

A. Folia: f.c.r. folia caulina et ramea; f.r. folia ramulina ( $\times 25$ ).

apice obtusis vel attenuatis. *Folia* caulina et ramea sicca imbricato-

adpressa, madida erecto-patentia, concava, breviter decurrentia, ovato-lanceolata, in acumen sensim subulatum attenuata, c. 1.36–1.6 mm. longa et c. 0.64–0.72 mm. lata, basi tri-plicata, marginibus basi late recurvis dein ad medium subplanis, integerrimis vel minutissime serrulatis; nervo valido, infra apicem folii evanido, in sectione transversali plano-convexo, basi c.  $35\mu$  lato et c.  $20\mu$  crasso, e 3–4-stratis cellularum incrassatarum uniformium composito; cellulis laevissimis, plus minusve incrassatis, rhombeis vel rhomboideis, c. 20–30  $\mu$  longis et c. 6–8  $\mu$  latis, superioribus longioribus angustioribus, basilaribus rhomboideis rectangularibus vel breviter linearibus, alaribus numerosis minoribus quadratis (lumine saepe ovalibus) c. 7  $\mu$  magnis; folia ramulina angustiora, ovato-oblonga, apice attenuata. *Cetera* ignota.

Hondo: Prov. Mutsu; in monte Hakkoda (Leg. ĒJIRŌ UEMATSU! 31. VII. 1907.). Prov. Rikuzen; Ourabayashi, Sendai (Leg. ĒJIRŌ UEMATSU! 27. IX. 1907.).

***Okamuraea ussuriensis*** (BROTH.) BROTH. ENGLER und PRANT. nat. Pflanzenf. p. 1133. (1908).

Syn. *Brylania ussuriensis* BROTH. Frag. flor. bryolog. Asiae orient. cong. II. pp. 8-9. (1906).

Habitat in saxis. *Plantae* robustiusculae, caespitosae, caespitibus lutescenti-viridibus, nitidiuseulis, rigidiuseulis, densis, late extensis. *Caulis* elongatus, repens, usque ad 4 cm. longus, irregulariter pinnatim ramosus, rarius fusco-radiculosus, sectione teres, c. 0.24 mm. diam., fasciculo centrali valde arto pauci-cellulari, reti intermedio hyalino, cellulis hexagonis tenellis c. 10–15  $\mu$  magnis, cellulis periphericis c. 3–4-seriatis minoribus lutescenti-fuscescentibus incrassatis; ramis prostratis vel ascendentibus, usque ad 2.5 cm. longis, irregulariter ramulosis; ramis ramulisque dense foliosis, api-

ce obtusis acutis vel attenuatis. *Paraphyllia* nulla. *Folia* caulina et ramea sicca adpressa, madida erecto-patentia, concava, breviter decurrentia, late cordato-ovata, apice acuta inde subito in summo acumen elongatum angustum subulatum attenuata, c. 1.9 mm. longa et c. 0.9 mm. lata, basi tri-plicata, marginibus late recurvis, integerrimis vel minutissime serrulatis; nervo valido, infra apicem folii evanido, in sectione transversali plano-convexo, basi c.  $56\mu$  lato et c.  $35\mu$  crasso, e 4-stratis cellularum incrassatarum uniformium composito; cellulis laevissimis, plus minusve incrassatis,

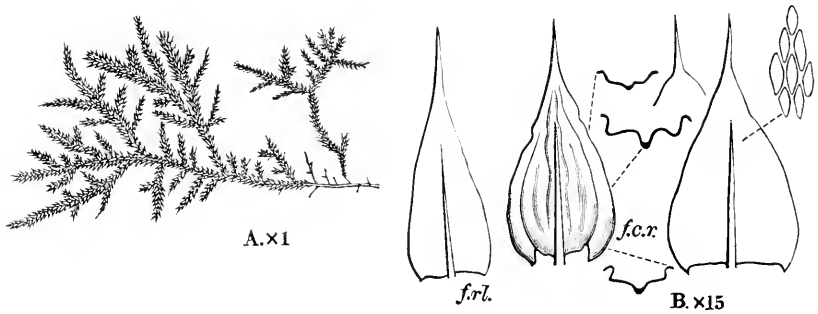

**Fig. 38.** *Okamuraea ussuriensis*.

A. Planta ( $\times 1$ ): B. Folia: f.c.r. folia caulina et ramea;  
f.r.l. folia ramulina ( $\times 15$ ).

rhombeis vel rhomboideis, c.  $15-20\mu$  longis et c.  $5-8\mu$  latis, superioribus longioribus, basilaribus quadratis c.  $7-10\mu$  magnis vel rectangulis vel rhombeis c.  $20\mu$  longis et c.  $4\mu$  latis, alaribus numerosis minoribus quadratis rectangulis vel rhombeis; folia ramulina angustiora, oblongo-lanceolata, apice sensim attenuata. *Caetera* ignota.

Korea: Prov. Heian-Hokudō; in monte Hiraihō [飛來峰] (Leg. TAKE-NOSHIN NAKAI! 9. VI. 1914.).

Species nova ad floram koreanam.

Distr. Ussuri et China.

**Conspectus specierum et varietatum Okamuraearum.**

1. { Folia caulina et ramea apice subito elongate attenuata. . . . . 1.  
 { Folia caulina et ramea apice sensim breviter vel longe attenuata.  
 { . . . . . 2.  
 { Folia caulina et ramea ovato-oblonga, apice subrotundato-acuta inde subito in summo acumen elongatum subpiliforme attenuata.  
 { . . . . . *O. plicata*.  
 { Folia caulina et ramea late cordato-ovata, apice acuta inde subito in summo acumen elongatum angustum subulatum attenuata. . . . .  
 { . . . . . *O. ussuriensis*.
2. { Folia caulina et ramea late ovato-lanceolata, apice breviter subulato-attenuata. . . . . *O. imbricata*.  
 { Folia caulina et ramea apice longe attenuata. . . . . 3.
3. { Folia caulina et ramea late ovato-oblonga, apice subulato-attenuata; seta c. 3-5 mm. longa. . . . . *O. brevipes*.  
 { Folia caulina et ramea ovato-lanceolata, apice elongate et subulate attenuata; seta c. 7-15 mm. longa. . . . . 4.
4. { Folia caulina et ramea anguste ovato-lanceolata; seta c. 7-9 mm. longa; theca breviter oblonga vel ovalis, c. 1.2-1.5 mm. longa.  
 { . . . . . *O. hakoniensis*.  
 { Folia caulina et ramea late ovato-lanceolata; seta c. 15 mm. longa; theca oblonga c. 2 mm. longa. . . . . *O. cristata*.  
 { Ramis ramulisque longissime multi-flagelliferis; caetera ut in typo.  
 { . . . . . *O. crist. var. multiflagellifera*.  
 { Ramis plerumque brevibus haud flagelliferis; folis minoribus, apice brevioribus; planta graciliore. . . . . *O. crist. var. gracilis*.

*Ishibaea japonica* BROTH. et SH. OKAMURA. Bot. Magaz. Tôkyo. Vol. XXIX. No. 346. pp. 186-188. Tab. VIII. (1915).

Habitat in truncis arborum. *Plantae* tenellae, caespitosae, caespitibus lutescenti-viridibus, nitidiusculis, rigidiusculis. *Caulis* repens, usque ad 6 cm. longus, hic illic fasciculatim rubiginoso-

radiculosus, densiuscule et irregulariter ramosus, sectione teres, c. 0.2–0.24 mm. diam., fasciculo centrali nullo, reti centrali hyalino, cellulis irregulariter hexagonis (parietibus flexuosis) c.  $20\mu$  magnis, cellulis periphericis lutescentibus vel fuscis c. 2–3-seriatis minoribus incrassatis; ramis prostratis vel paulum ascendentibus, simplicibus vel parce (1–3) ramulosis, strictis vel leviter curvatis, apice obtusis vel acutis, usque ad 1 cm. longis, dense foliosis et teretibus. *Paraphyllia* nulla. *Folia* sicca adpresssa, madida erecto-patentia, valde concava, ovato-lanceolata, in acumen sensim subulatum attenuata, c. 1.2–1.3 mm. longa et c. 0.28–0.32 mm. lata, marginibus usque ad basin acuminis revolutis, apice serrulatis vel subintegerrimis; nervo infra summum apicem folii evanido, in sectione transversali plano-convexo, dorso valde prominenti, basi c.  $42\mu$  lato et c.  $30\mu$  crasso, c. 4-stratis cellularum uniformium incrassarum composito, cellulis ventralibus 4–5 majoribus, dorsalibus c. 9 minoribus; cellulis laminalibus prosenchymaticis, laevibus, valde chlorophyllosis, c.  $30\text{--}56\mu$  longis et c.  $3\text{--}5\mu$  latis, superioribus brevioribus, basilaribus laxioribus, angularibus sat numerosis quadratis c.  $9\mu$  magnis, chlorophyllosis. *Inflorescentia* autoica; flores masculi in caule geminiformes; folia perigonialia externa obovato-oblonga, apice longe attenuata, intima obovato-oblonga, apice acuta, c. 0.64 mm. longa et c. 0.24 mm. lata, concava, enervia; antheridia c. 6, paraphysibus paucis, c. 0.24 mm. longis, hyalinis; flores feminei in ramis rarius in caule positi. *Ramulus perichaetialis* parce radiculosus. *Bracteae perichaetii* intimae basi semivaginatae oblongo-lanceolatae, subito in acumen elongatum subulatum attenuatae, c. 1.6 mm. longae, apice minutissime serrulatae; nervo infra summum apicem evanido; cellulis linearibus, basilaribus longe rectangulis. *Vaginula* cylindrica, c. 0.8–0.9 mm. longa, albicantifuscescens, c. 1.2–1.5 mm. alta. *Seta* stricta vel leviter flexuosula,

rubra, laevis, sicca superne torta. *Theca* erecta, oblonga vel oblongo-cylindrica, symmetrica, c. 1.2–1.6 mm. longa et c. 0.56–0.72 mm. crassa, luteo-rubra, laevis, collo conico brevi; cellulis exothecii irregulariter rectangulis vel quadratis, ad orificium in seriebus c. 6 minoribus hexagonis; stomatibus in collo paucis phaneroporis. *Annulus* nullis. *Peristomium* duplex; exostomii dentes subulato-lanceolati, basi connati, c. 0.2–0.24 mm. longi et basi c. 42–56  $\mu$  lati, strato dorsali luteo vel lutescenti-fusco, basi transversim striolato dein ad apicem laevissimo, linea media flexuosula, strato ventrali luteo angustiore c. 18–20 lamelloso; endostomium flavescens, laeve; corona basilaris c. 40  $\mu$  alta; processus dentium  $\frac{4}{5}$  longitudinis, leviter carinati, in carina perforati, sed plerumque divisi et fragosi, fragmentis dentibus adhaerentibus; cilia nulla. *Sporae* c. 15  $\mu$  magnae, fuscescenti-virides, laeves. *Operculum* conicum, apice obtusum, c. 0.32 mm. longum et c. 0.32 mm. diam. *Calyptra* cucullata, c. 1.9 mm. longa, lutescenti-viridescens apice fusca, laevis.

Hondo: Prov. Shinano; Sironmajiri (Leg. ĒKICHI ĪSHIBA! 17. VIII. 1909.); Sakai-mura, Shimotakai-gun (Leg. SHINZŌ ĪTŌ! 28. X. 1913.).

Genus *Homalothecio* BR, EUR. affine, sed inflorescentia, teneritate omnium partium, foliis haud plicatis nec non peristomii structura exquo longe diversum.

Genus clar. ĒKICHI ĪSHIBA, florae bryologicae Japoniae scrutatori meritissimo dedicatum.

***Ptychodium perattenuatum*** SH. OKAMURA, sp. nov.

Habitat in truncis arborum. *Plantae* robustiusculae, dense caespitosae, late extentae, lutescenti-virides, nitidae, rigidiusculae. *Caulis* repens, elongatus, usque ad 10 cm. longus, hic illic dense fasciculatim fusco-radiculosus, dense et regulariter vel subregulariter

pinnatim ramosus, sectione oblongus, c.  $0.28-0.32 \times 0.2-0.24$  mm. magnus, fasciculo centrali nullo, reti centrali hyalino, cellulis hexagonis tenellis c.  $15 \mu$  magnis, cellulis periphericis c. 4-5-seriatis minoribus incrassatis lutescentibus vel fusciscentibus; ramis ascendentibus, c. 5-15 mm. longis, strictis vel curvatis, simplicibus vel parce (1-4) fasciculatim rarius pinnatim ramulosis, apice obtusis acutis vel attenuatis, aliquando flagelliformibus, dense foliosis, teretibus. *Paraphyllia* nulla. *Folia* sicca laxè adpressa plicata haud homomalla, madida erecto-patentia, concava, subcarinata, longitudinaliter plicata (c. 5), basi breviter decurrentia, late ovato-vel subcordato-deltaidea subito in acumen elongatum angustum subulatum summo apice subloriforme attenuata, c.

2.7-2.9 mm. longa et c. 1.0-1.2 mm. lata, marginibus basi revolutis dein subplanis, e basi ad apicem minute saepe in acumen grosse serratis; nervo validiusculo, infra summum apicem folii evanido vel fere percurrente, in sectione transversali planoconvexo, dorso prominenti, basi c.  $50 \mu$  lato et c.  $20 \mu$  crasso, e 4-seriatis cellularum incrassatarum uniformium composito; cellulis laevibus, parietibus incrassiusculis, linearibus, c.  $30-40 \mu$  longis et c.  $5-6 \mu$  latis,

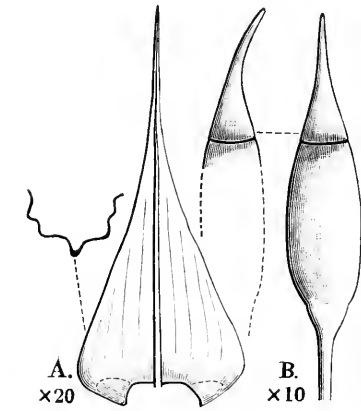

Fig. 39. *Ptychodium perattenuatum*.

A. Folium ( $\times 20$ ); B. Theca ( $\times 10$ ).

basilaribus c.  $40-70 \mu$  longis et c.  $6-7 \mu$  latis, infimis brevioribus et latioribus c.  $9 \mu$  latis parce porosis, alaribus numerosis breviter rectangulis c.  $20-35 \times 9-15 \mu$  magnis hyalinis, supraalaribus numerosis quadratis c.  $15 \mu$  magnis vel oblongis c.  $20 \mu$  longis hyalinis. *Inflorescentia* dioica; flores utriusque sexus geminiformes in caule et



ramis ; folia perigonialia intima ovata, apice subito subulate attenuata, c. 0.8 mm. longa et c. 0.35 mm. lata, nervo tenui, infra apicem evanido ; antheridia c. 12, c. 0.4 mm. longa, paraphysisibus numerosis, hyalinis, c. 0.4 mm. longis. *Ramulus perichaetialis* parce radiculosus. *Bractee perichaetii* intimae e basi alte semivaginate subito in acumen elongatum angustum loriforme attenuatae, apice recurvae serratae, c. 2.8–3.2 mm. longae et c. 0.64–0.72 mm. latae ; nervo tenui, infra summum apicem evanido ; cellulis ut in foliis, sed basilaribus laxioribus fere anguste rectangulis. *Vaginula* cylindrica, c. 1.4–1.6 mm. alta et c. 0.3 mm. crassa, pallida ; paraphysisibus numerosis, hyalinis vel lutescentibus. *Seta* c. 13–15 mm. longa, stricta vel leviter flexuosa, rubra, laevissima, sicca torta. *Theca* erecta, oblonga vel oblongo-cylindrica, symmetrica, c. 2.0–2.4 mm. longa (collo c. 0.32–0.4 mm. longo) et c. 0.8–0.96 mm. crassa, fusca, laevis ; cellulis exothecii hexagonis oblongo-hexagonis vel rectangulis, c. 20–50 × 20–25  $\mu$  magnis, ad orificium in seriebus c. 2–3 minoribus c. 15  $\mu$  magnis quadratis vel hexagonis ; stomatibus in collo sat numerosis. *Annulus* duplex, c. 40  $\mu$  altus, fuscescens. *Exostomii* dentes lineari-subulati, basi connati, c. 0.4 mm. longi et basi c. 50–56  $\mu$  lati, dorso lutei, basi dense transversim striatuli, superne hyalini minute papilloso, linea media flexuosa, ventre dense (c. 30) et altiusecule lamellosi ; endostomium corona basilaris c. 0.1 mm. alta, lutea, minute papillosa ; processus dentium fere longitudinis, carinati in carina haud vel angustissime perforati, lutei, minute papilloso ; cilia unica, brevia vel rudimentaria. *Sporae* c. 9–11  $\mu$  magnae, luteae, laeves. *Operculum* e basi anguste conica longe rostratum, c. 1.2–1.6 mm. longum et basi c. 0.56–0.7 mm. diam., rostro recto vel leviter curvato, apice obtuso. *Calyptra* cucullata, c. 2.4–2.8 mm. longa, pallida apice lutea, laevis.

Formosa : Prov. Taihoku-chō ; Shabōsan [沙帽山] (Leg. YAICHI SHIMADA ! 30. XII. 1914.).

Species *P. plicatulo* CARD. valde affinis, sed foliis longioribus, apice subito elongate et anguste attenuatis diversa.

Nomen speciei ab foliis perattenuatis.

*Brachytheceium plumosum* (SW.) BR. EUR.

Formosa : Prov. Taihoku-chō ; Shabōsan (Leg. YAICHI SHIMADA ! 2. I. 1913.).

*Myuroclada concinna* (WILS.) BESCH.

Korea : Prov. Kankyō-nando ; Shōshinzan [松眞山] (Leg. TAKENOSHIN NAKAI ! 27. VIII. 1914.).

*Oxyrrhynchium Schottmülleri* (BROTH.) BROTH.

Hondo : Prov. Kōduke ; Maru-numa (Leg. HARAOKAWA ! VII. 1914).

Habitat in solio lacus c. 2 m. profundo.

*Oxyrrhynchium Schottmülleri* (BROTH.) BROTH. var.  
*perlongicladum* SH. OKAMURA. var. nov.

Habitat in rivulorum saxis irroratis. *Plantae* robustae, caespitosae, caespitibus late extentis, lutescenti-viridibus, nitidiusculis, rigidiusculis. *Caulis* repens, valde elongatus, c. 25 cm. longus, basi nudus, haud radiculosus, densiuscule ramosus, sectione subangulato-teres, c. 0.5 mm. diam., fasciculo centrali c. 40  $\mu$  magno paucicellulari, reti intermedio hyalino, cellulis hexagonis c. 25–30  $\mu$  magnis, cellulis periphericis c. 5-seriatis minoribus lutescentifuscis subincrassatis ; ramis repentibus, perelongatis, usque ad 18 cm. longis, subflexuosis, laxiuscule foliosis haud complanatis et hic illic nudis, apice obtusis vel breviter attenuatis, vage ramulosis ;

ramulis patulis, 1–3 cm. longis, laxiuscule foliosis, haud complanatis. *Folia* sicca patula vel laxe adpressa et paulum mutata, madida erecto-patentia, concaviuscula, breviter decurrentia, e basi angusta late ovata vel ovato-ovalia, apice obtusa vel obtusiuscula, c. 1.4–1.9 mm. longa et c. 1.3–1.6 mm. lata, marginibus basi revolutis dein planis, fere ubique serrulatis; nervo longe ultra medium evanido; cellulis linearibus, laevissimis, valde chlorophyllosis, c. 70–112  $\mu$  longis et c. 8–9  $\mu$  latis, superioribus brevioribus rhomboideis c. 20–28  $\mu$  longis et c. 8–10  $\mu$  latis, basilaribus infimis brevioribus laxioribus c. 12–14  $\mu$  latis, alaribus rectangularibus c. 30–60  $\mu$  longis et c. 15–20  $\mu$  latis fuscis vel chlorophyllosis. *Bracteae perichaetii* e basi deltoideo-ovata sensim acuminatae, acumine canaliculatae, c. 1.4–1.6 mm. longae et c. 0.56–0.64 mm. latae, concavae, marginibus e medio ad apicem serratis; nervo tenui, infra apicem evanido. *Seta* c. 10–12 mm. longa, flexuosula, tenuis, rubra, laevissima, leviter torta. *Theca* inclinata, oblongo-cylindrica, symmetrica, c. 2 mm. longa et c. 0.8 mm. crassa, fusca, laevis. *Sporae* virides, c. 15–17  $\mu$  magnae, laeves. *Caetera* ignota.

Hondo: Prov. Musashi, Kobotoke-tōge (Leg. KIYOTAKA HISAUCHI! 20. IV. 1914.).

A tipo ramis perelongatis, haud complanatis differt.

Nomen varietatis ab ramis perelongatis.

### *Eurhynchium Arbuscula* BROTH.

Kyūshū: Prov. Ōsumi, in insula Yakushima (Leg. TAKANORI IWAKI! 21. IX. 1914.).

### *Eurhynchium yezoanum* SH. OKAMURA sp. nov.

Habitat in terra. *Plantae* graciles, caespitosae, caespitibus viridibus vel fusco- vel luteo-viridibus, nitidiusculis, rigidiusculis, late

extentis, densis. *Caulis* repens, elongatus, usque ad 4 cm. longus, dense fasciculatim fusco-radiculosus, densissime et regulariter pinnatim ramosus, sectione teres vel oblongus, c. 0.3–0.4 mm. diam., fasciculo centrali arto paucicellulari, reti intermedio hyalino, cellulis hexagonis c. 14–20  $\mu$  magnis, cellulis periphericis c. 4–5-seriatis minoribus c. 7–10  $\mu$  magnis paulum incrassatis lutescentibus; ramis erectis suberectis vel ascendentibus, c. 5–10 mm. longis, inferne simplicibus stipitiformibus dense fasciculatim fusco-radiculis, superne dense pinnatim ramulosis, apice obtusis; ramulis erectis, c. 2–4 mm. longis, apice obtusis; ramis ramulisque dense foliosis teretibus. *Paraphyllia* nulla. *Folia* sicca laxe adpressa, madida erecto-patentia, dimorpha; *folia caulina* breviter decurrentia, e

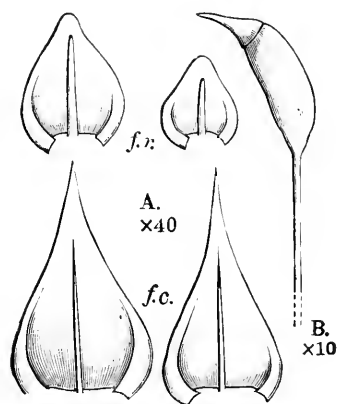

**Fig. 40.** *Eurrhynchium yezoanum*.

A. Folia: f.c. folia caulina, f.r. folia ramea ( $\times 40$ ); B. Sporangia ( $\times 10$ ).

basi cordata vel deltoideo-cordata breviter lanceolato-attenuata, apice saepe recurva, c. 0.48–0.65–0.8 mm. longa et c. 0.4–0.45–0.48 mm. lata, marginibus basi late recurvis, ubique serrulatis; nervo tenui, infra apicem folii evanido, superne sensim tenuiore; cellulis valde chlorophyllosis laevibus, linearibus, c. 28–50  $\mu$  longis et c. 3–4  $\mu$  latis, superioribus angustioribus, basilaribus brevioribus et laxioribus c. 14–20  $\mu$  longis et c. 7  $\mu$  latis, alaribus numerosis quadratis vel rectangulis c. 10–14  $\mu$  longis et c. 10  $\mu$  latis; *folia ramea* valde concava, vix decurrentia, cordata vel ovato-cordata, apice breviter acuta obtusa vel rotundato-obtusa, c. 0.32–0.4 mm. longa et c. 0.28–0.32 mm. lata, marginibus basi late recurvis, ubique serratis; nervo valido, infra summum apicem folii evanido, apice

haud tenuiore et extremitate dorso denticulo instructo, in sectione transversali plano-convexo, dorso valde prominenti, basi c.  $45\ \mu$  crasso, e 5-stratis cellularum incrassatarum uniformium composito; cellulis chlorophyllosis, laevibus, linearibus, c.  $25\text{--}35\ \mu$  longis et c.  $3\text{--}4\ \mu$  latis, superioribus brevioribus c.  $18\text{--}20\ \mu$  longis basilaribus brevioribus et laxioribus c.  $14\text{--}20\ \mu$  longis et c.  $5\text{--}7\ \mu$  latis, alaribus quadratis vel rectangulis c.  $8\text{--}14\ \mu$  longis et c.  $6\text{--}8\ \mu$  latis concoloribus. *Inflorescentia* dioica? (floribus masculis haud visis dioica videtur). *Ramulus perichaetialis* radiculosus. *Bractee perichaetii* intimae basi semivaginatae ellipticae, subito in acumen sensim elongatum angustum lineari-subulatum attenuatae, c.  $1.4\text{--}1.8$  mm. longae et c.  $0.4\text{--}0.5$  mm. latae, acumine fere erectae, remote serrulatae; nervo nullo; cellulis linearibus c.  $80\text{--}90\ \mu$  longis et c.  $4\text{--}5\ \mu$  latis, basilaribus brevioribus et laxioribus c.  $40\text{--}70\ \mu$  longis et c.  $9\text{--}14\ \mu$  latis. *Vaginula* cylindrica, c.  $10$  mm. alta, albescenti-lutescens apice fusca; archeogonia numerosa; paraphysibus numerosis, hyalinis. *Seta* c.  $6\text{--}8$  mm. alta, erecta vel leviter curvata, rubra, laevissima, sicca haud torta. *Theca* inclinata, e collo brevi oblongo-cylindrica, asymmetrica, paulum gibbosa, sicca deoperculata sub ore contracta, c.  $1.2\text{--}1.6$  mm. longa et c.  $0.6\text{--}0.7$  mm. crassa, lutescenti-rubra; cellulis exothecii quadratis hexagonis vel rectangulis c.  $28\text{--}40 \times 14\text{--}20\ \mu$  magnis, ad orificium minoribus rotundato-hexagonis c.  $10\text{--}14\ \mu$  magnis; stomatibus in collo sat numerosis, phaneroporis. *Annulus* c.  $30\text{--}35\ \mu$  altus, simplex, e 1 vel 2 seriebus cellularum, lutescenti-ruber, deciduus. *Pristomium* duplex; exostomii dentes subulato-lanceolati, basi connati, c.  $0.4\text{--}0.48$  mm. longi et basi c.  $70\ \mu$  lati, strato dorsali basi luteo vel fusciscenti-luteo et transversim striatulo, e medio ad apicem lutescenti et papilloso, strato ventrali angustiore dense (c. 30) et alte lamelloso; endostomium luteum; corona basilaris c.  $0.18$  mm. alta, fere laevis;

processus dentium fere longitudinis, carinati in carina angustissime perforati vel haud perforati; cilia unica, brevia, fere laevia, nodulosa, latiora, aliquando bina et angustiora. *Sporae* e. 12–17 mm. magnae, luteo-virides laeves. *Operculum* e basi conica longe et paulum curvate rostratum, e. 0.8–1.0 mm. longum et e. 0.48 mm. diam., lutescenti-rubrum, rostro apice obtuso laevi. *Calyptra* cucullata, luteo-viridescens, nuda, laevis.

Yezo (Hokkaido): Prov. Ishikali, Yamahana-mura, Sapporo (Leg. NIZŌ IWASAKI! 21. IV. 1914.).

Species cum *E. strigoso* (HOFFM.) BR. EUR. et *E. diversifolio* (SCHLEICH) BR. EUR. comparanda, ab hic nervo folii caulini extremitate dorso haud denticulo instructo, foliis rami acutis et rotundato-obtuso, ab illa nervo folii ramei valido et extremitate dorso denticulo instructo, theca angustiore, operculo breve rostrato dignoscenda.

*Rhynchostegium ovalifolium* SH. OKAMURA. sp. nov.

Habitat in terra irrorata. *Plantae* robustae, depresso-caespitosae, caespitibus densiusculis, viridibus, in statu sicco lutescenti-viridibus vel stramineis, sericeo-nitidiusculis, mollibus. *Caulis* repens, usque ad 4 cm. longus, densiuscule fuscescenti-radiculosus, densiuscule et irregulariter pinnatim ramosus, sectione teres e. 0.3–0.4 mm. diam., fasciulo centrali e. 30–40  $\mu$  magno, reti intermedio hyalino, cellulis hexagonis tenellis e. 28–35  $\mu$  magnis, cellulis periphericis e. 2–3-seriatis minoribus e. 9–12  $\mu$  magnis incrassatis lutescentibus; ramis prostratis, usque ad 3 cm. longis, simplicibus vel 1–3 ramulosis, dense et imbricato-foliosis complanatis, apice breviter attenuatis vel obtusis, cum foliis e. 3.5–4.0 mm. latis. *Folia* sicca paulum longitudinaliter rugosa, madida patentia, vix decurrentia, concava, haud plicata, e basi angusta late ovata in

acumen subito elongatum subulatum semitorum attenuata, c. 2.1–2.4 mm. longa et c. 1.2–1.4 mm. lata, marginibus ubique serrulatis; nervo infra apicem folii evanido, in sectione transversali plano-convexo, dorso valde prominenti, basi c.  $50\mu$  lato et c.  $40\mu$  crasso, e 4-stratis cellularum uniformium composito, cellulis ventralibus c. 4–5 majoribus, dorsalibus c. 8; cellulis laminalibus laevissimis, valde chlorophyllous, prosenchymaticis, c.  $70\text{--}130\mu$  longis et c.  $7\text{--}8\mu$  latis, basilaribus brevioribus laxioribus c.  $50\text{--}60\mu$  longis et c.  $10\text{--}15\mu$  latis, in angulis concavis rectangulis numerosis (c. 20). *Inflorescentia* autoica; flores masculi in foliorum axillis

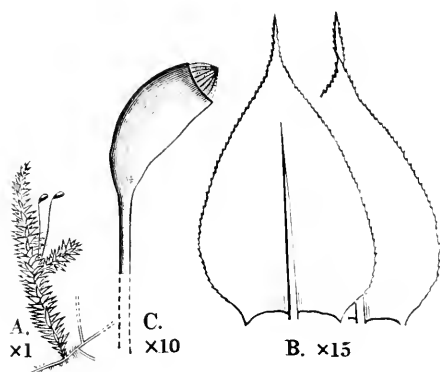

**Fig. 41.** *Rhynchosstegium ovalifolium*.

A. Planta ( $\times 1$ ); B. Folia ( $\times 15$ ); C. Sporangia ( $\times 10$ ).

ramorum; folia perigonia intima ovalia, apice acuta, integerrima, enervia, c. 0.6 mm. longa et c. 0.35 mm. lata; antheridia c. 10; flores feminei in ramis. *Ramulus perichaetialis* valde radiculosus. *Bractea perichaetii* intimae e basi alte vaginante sensim anguste subulatae, subula recurva minute serrulata vel subintegerrima; nervo tenui, medio evanido; cellulis basilaribus laxioribus. *Seta* c. 7–10 mm. longa, erecta, rubra, laevis, sicca torta. *Theca* inclinata, oblonga, asymmetrica, gibbosa, cum collo c. 1.5–1.6 mm. longa et c. 0.64–0.72 mm. crassa, fusca, laevis, collo obconico; cellulis exothecii hexagonis oblongo-hexagonis, ad orificium in seriebus duabus minutis; stomatibus in collo numerosis. *Exostomii* dentes lineari-lanceolati, luteo-fusci, hyaline limbati, basi transversim striatuli, apice hyalini et minute papilloso, intus dense et alte lamellosi; endostomium luteum; corona basilaris plicata, laevis; processus dentium fere

longitudinis, carinati in carina anguste perforati, minutissime papilloso; cilia bina, bene evoluta, nodulosa, minutissime papillosa. *Sporae* c.  $14\ \mu$  magnae, virides, laeves. *Cactera* ignota.

Hondo: Prov. Ise, Unomori-jinsha, Yokkaichi-shi (Leg. KITITARŌ MURATA! 28. XII. 1914.).

Statura faciesque omnino *R. pallidifolio* (MITT.) JAEG; foliis autem ovalibus apice brevioribus, seta breviorc, theca minore jam abunde diversa.

***Rhynchostegium spiralifolium* SH. OKAMURA. sp. nov.**

Habtat in solio lacus c. 2 m. profundo. *Plantae* robustae, valde depresso-caespitosae, caespitibus late extentis, lutescenti-fusciscentibus, in statu sicco nitidiusculis, rigidiusculis. *Caulis* repens c. 6–20 cm. longus, hic illic fasciculatim fusco-radiculosus, densiuscule et regulariter pinnatim ramosus, sectione oblongus, c.  $0.24\text{--}0.28 \times 0.16\text{--}0.2$  mm. magnus, fasciculo centrali nullo, reti centrali

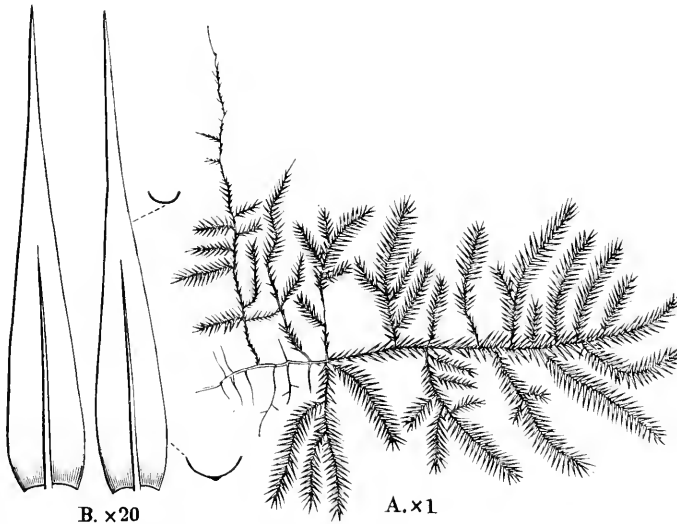

**Fig. 42.**—*Rhynchostegium spiralifolium*.

A. Planta ( $\times 1$ ); B. Folia ( $\times 20$ ).



hyalino, cellulis hexagonis tenellis c.  $15\mu$  magnis cellulis periphericis c. 6-seriatis valde incrassatis lutescentibus vel fuscis; ramis prostratis, c. 2–2.5 cm. longis, strictis, simplicibus vel parce pinnatis ramulosis; caulibus ramisque densiuscule foliosis valde complanatis, cum foliis 4–5 mm. latis, apice obtusis. *Folia* ut videtur disticha, sicca paulum rugulosa apice spiraliter torta, madida patentia, haud decurrentia, anguste oblongo-lanceolata, in acumen elongatum subulatum haud tortum sensim attenuata, c. 2.4–2.8–3.4 mm. longa et c. 0.4–0.5–0.64 mm. lata, concaviuscula, marginibus ubique integerimis; nervo valido, medium folii evanido, luteo, in sectione transversali plano-convexo, dorso prominenti, basi c.  $60\mu$  lati et c.  $35\mu$  crasso, e stratis 3 cellularum uniformium composito, cellulis ventralibus c. 6, dorsalibus c. 10; cellulis laminalibus laevissimis, prosenchymaticis, c. 70–120  $\mu$  longis et c. 7  $\mu$  latis, superioribus brevioribus c. 80  $\mu$  longis, basilaribus brevioribus, ad insertionem oblongis 1–3-seriatim dispositis c. 40–50  $\mu$  longis et c. 12–14  $\mu$  latis parietibus incrassiusculis haud porosis, in angulis haud concavis paucis breviter rectangulis vel quadratis saepe inconspicuis. *Cetera* ignota.

Hondo: Prov. Kōdake, in Lacu Marumma [丸沼] (Leg. HARAIKAWA! VII. 1914.); Prov. Bizen, in Stagno in Tatsunokuchiyama, Mitsu-gum (Leg. Usūo Uno! 5. X. 1915.).

Nomen speciei ab foliis in statu sicco apice spiraliter tortis.

## INDEX.

	PAGE.		PAGE.
<b>A</b> ërobryopsis assimilis (CARD.) BROTH. . . . .	31	Eurhynchium Arbuscula BROTH. . . . .	91
A. Parisii (CARD.) BROTH. . . . .	29	E. yezoanum SH. OKAMURA. . . . .	91
A. subdivergens (BROTH.) BROTH. . . . .	31	<b>F</b> abroniaceae . . . . .	54
Aërobryum Ferriei BROTH. . . . .	29	Fissidens japonicus DOZ. et MOLK. . . . .	6
Amphidium lapponicum (HEDW.) SCHIMP. . . . .	16	F. lateralioides SH. OKAMURA. . . . .	6
Aulacomitrium minutissimum SH. OKAMURA. . . . .	16	F. nagasakius BESCH. . . . .	8
Aulacomniaceae . . . . .	21	F. zippeliius BR. JAV. . . . .	8
Aulacomnium turgidum (WAHLENB.) SCHWÆGG. . . . .	21	Fissidentaceae . . . . .	6
<b>B</b> arbula orientalis (WILS.) BROTH. . . . .	8	Frullania moniliata NEES. . . . .	3
Bartramiaceae . . . . .	21	Funaria hygrometrica (L.) SIBTH. . . . .	18
Bazzania spinosa SH. OKAMURA. . . . .	2	Funariaceae . . . . .	18
Brachytheciaceae . . . . .	76	<b>G</b> lyphomitrium angustifolium SH. OKAMURA. . . . .	9
Brachythecium plumosum (SW.) BR. EUR. . . . .	90	Grimmia Hisauchiï SH. OKAMURA. . . . .	10
Bryhnia ussuriensis BROTH. . . . .	83	G. Kiyoshii SH. OKAMURA. . . . .	12
Bryaceae . . . . .	18	Grimmiaceae . . . . .	9
Bryum argenteum L. . . . .	18	<b>H</b> aplocladium capillatum (MITT.) BROTH. . . . .	58
<b>C</b> eratodon purpureus (L.) BRID. . . . .	5	H. latifolium (LAC.) BROTH. . . . .	58
Chiloscyphus polyanthus (L.) CRUDA. var. rivularis (SCHRAD.) NEES. . . . .	2	Haplohypnum bifforme BROTH. . . . .	54
C. rivularis (SCHRAD.) LOESK. . . . .	2	Hedwigia albicans (WEB.) LINDB. . . . .	25
Climaciaceae . . . . .	25	Hedwigiaceae . . . . .	25
Climacium japonicum LINDB. . . . .	25	Herpetineuron attenuatus SH. OKAMURA. . . . .	54
Cryptaceae . . . . .	25	Himantocladium loriforme (BR. JAV.) FLEISCH. . . . .	37
<b>D</b> icranaceae . . . . .	5	Hookeria nipponensis (BESCH.) BROTH. . . . .	54
Dicranella heteromalla (DILL, L.) SCHIMP. . . . .	5	Hookeriaceae . . . . .	54
Dicranum Bergeri BLANDOW. . . . .	5	Hypohypnum ochraceum (TRUN.) BROTH. . . . .	59
D. majus TURN. . . . .	5	Hylacomium pyrenaicum (SPRUC.) LINDB. . . . .	60
D. Schraderi SCHWÆG. . . . .	5	H. splendens (HEDW.) SCHIMP. . . . .	60
D. scoparium (L.) HEDW. . . . .	6	Hypnum hakoniense MITT. . . . .	80
Dolichomitria cymbifolia (LINDB.) BROTH. var. subintegerrima SH. OKAMURA. . . . .	47	H. Schreberi WILD. . . . .	60
Drepanocladus uncinatus (HEDW.) WARNST. . . . .	59	Hypnaceae . . . . .	59
<b>E</b> tropothecium Shiragae SH. OKAMURA. . . . .	60	<b>I</b> shibaea japonica BROTH. et SH. OKAMURA. . . . .	85
Entodon arenosus SH. OKAMURA. . . . .	48	Isopterygium expallescens LEVIER. . . . .	65
E. dolichocaulatus SH. OKAMURA. . . . .	49	I. Giraldii (C. MÜLL.) PAR. . . . .	65
Entodontaceae . . . . .	18	I. Hisauchiï SH. OKAMURA. . . . .	65
		I. taxirameum (MITT.) JAEG. . . . .	67

	PAGE.
<b>J</b> ungermaniaceae akrogyae . . . . .	2
<b>L</b> embophyllaceae . . . . .	47
<i>Leskea pusilla</i> MITT. . . . .	56
Leskeaceae . . . . .	54
<i>Leucodon perlependens</i> SH. OKAMURA. . . . .	25
Leucodontaceae . . . . .	25
<b>M</b> acromitrium incurvum (LINDB.) PALIS. . . . .	18
<i>Madotheca Perottetiana</i> MONT. . . . .	3
<i>Marchantia tosalna</i> STEPH. . . . .	1
Marchantiaceae . . . . .	1
<i>Meteoriella cuspidata</i> SH. OKAMURA. . . . .	34, 37
<i>M. Kutōi</i> SH. OKAMURA. . . . .	36, 37
<i>M. soluta</i> (MITT.) SH. OKAMURA. . . . .	35, 37
<i>Meteoriopsis ancistroides</i> (REN. et CARD.) BROTH. . . . .	31
<i>Meteorium ancistroides</i> REN. et CARD. . . . .	31
<i>M. himalayense</i> PAR. . . . .	31
<i>M. Parisii</i> CARD. . . . .	29
<i>M. solutum</i> MITT. . . . .	35
Mniaceae . . . . .	19
<i>Mnium Kiyoshii</i> SH. OKAMURA. . . . .	19
<i>M. ligulifolium</i> CARD. . . . .	20
<i>M. punctatum</i> (L.) HEDW. . . . .	20
<i>M. subglobosum</i> BR. EUR. . . . .	20
<i>M. trichomanes</i> MITT. . . . .	21
<i>Myuroclada concinna</i> (WILS.) BESCH. . . . .	90
<b>N</b> eckera idiomorpha SH. OKAMURA. . . . .	40
<i>N. kamakurana</i> SH. OKAMURA. . . . .	42
Neckeraceae . . . . .	27
<i>Neckeropsis pseudonitidula</i> SH. OKAMURA. . . . .	39
<b>O</b> kamuraea brevipes BROTH. . . . .	76, 85
<i>O. cristata</i> BROTH. . . . .	78, 85
<i>O. cristata</i> BROTH. var. <i>gracilis</i> BROTH. 79, 85	
<i>O. cristata</i> BROTH. var. <i>multiflagellifera</i> SH. OKAMURA. . . . .	85
<i>O. hakoniensis</i> (MITT.) BROTH. . . . .	80, 85
<i>O. imbricata</i> BROTH. . . . .	82, 85
<i>O. plicata</i> CARD. . . . .	85
<i>O. ussuriensis</i> (BROTH.) BROTH. . . . .	83, 85
Orthotrichaceae . . . . .	16
<i>Oxyrrhynchium Schottmülleri</i> (BROTH.) BROTH. . . . .	90
<i>O. Schottmülleri</i> (BROTH.) BROTH. var. <i>perlongicladum</i> SH. OKAMURA. . . . .	90
<b>P</b> hilonotis palustris MITT. . . . .	21
<i>Physcomitrium curystomum</i> (NEES.) SENDT. . . . .	18
<i>P. subeurystromum</i> CARD. . . . .	18
<i>Pilotrichopsis dentata</i> (MITT.) BESCH. . . . .	25

	PAGE.
<i>Pinnatera formosana</i> SH. OKAMURA. . . . .	45
<i>Plagiochila fruticosa</i> MITT. . . . .	2
<i>Pleuroziopsis ruthenica</i> (WEINM.) KINDB. . . . .	25
<i>Pogonatum arisanense</i> SH. OKAMURA. . . . .	21
<i>P. grandifolium</i> (LINDB.) JAGE . . . . .	24
<i>P. inflexum</i> LINDB. . . . .	24
<i>P. unguigerum</i> SCHIMP. . . . .	24
Polytrichaceae . . . . .	21
<i>Polytrichum alpinum</i> L. . . . .	24
<i>P. commune</i> L. . . . .	24
Pottiaceae . . . . .	8
<i>Pterobryopsis cucullatifolia</i> SH. OKAMURA. . . . .	27
<i>Ptychodium perattenuatum</i> SH. OKAMURA. . . . .	87
<i>Pylaisia lacto-viridis</i> SH. OKAMURA. . . . .	51
<b>R</b> adula complanata (L.) DUM. . . . .	3
<i>Reboulia haemisphaerica</i> (L.) RADDI . . . . .	1
<i>Rhacomitrium canescens</i> (WEIS., TIMM) BRID. . . . .	13
<i>R. fasciculare</i> (SCHRAD.) BRID. . . . .	13
<i>R. hypnoides</i> (L.) LINDB. . . . .	13
<i>R. Iwasakii</i> SH. OKAMURA. . . . .	13
Rhacopilaceae . . . . .	54
<i>Rhacopilum aristatum</i> MITT. . . . .	54
<i>Rhaphidostegium argutum</i> SH. OKAMURA. . . . .	72
<i>R. demissum</i> (WILS.) DE NOT. . . . .	74
<i>R. japonicum</i> BROTH. . . . .	74
Rhizogoniaceae . . . . .	21
<i>Rhizogonium spiniforme</i> (L.) BRUCH. . . . .	21
<i>Rhodobryum Wichurae</i> (BROTH.) BROTH. . . . .	18
<i>Rhynchostegium ovalifolium</i> SH. OKAMURA. . . . .	94
<i>R. spiralfolium</i> SH. OKAMURA. . . . .	96
<i>Rhytidadelphus calvescens</i> (WILS.) BROTH. . . . .	59
<i>R. squarrosus</i> (L.) WERNST. . . . .	59
<i>R. triquetrum</i> (L.) WERNST. . . . .	59
<i>Rhytidium rugosum</i> (EHRH.) KINDB. . . . .	59
<b>S</b> chwetschkea Matsumurae BESCH. . . . .	54
Sematophyllaceae . . . . .	72
Sphagnaceae . . . . .	4
<i>Sphagnum acutifolium</i> EHRH. . . . .	4
<i>S. Gignensolmii</i> RUSS. . . . .	4
<i>S. japonicum</i> WERNST. . . . .	4
<i>S. papillosum</i> LINDB. . . . .	4
<i>S. squarrosum</i> PEER. . . . .	4
<i>Stereodon cymbifolius</i> SH. OKAMURA. . . . .	62
<i>S. fertilis</i> (SENDTN.) LINDB. . . . .	65
<i>S. plumaeformis</i> (WILS.) MITT. . . . .	65
<b>T</b> harmium Fauriei BROTH. et PAR. . . . .	47
<i>Thuidium japonicum</i> DOZ. et MOLL. . . . .	58

	PAGE.		PAGE.
Tortula emarginata (Doz. et MOLK.) MITT.	8	Trichocolea tomentella (HUDS.) LINDB.	.. 3
Trachypus humilis LINDB. . . . .	37	<b>V</b> esicularia Sasaokae SH. OKAMURA. . . . .	.. 67
Trematodon drepanellus BESCH. . . . .	5	V. Shimadae SH. OKAMURA. . . . .	.. 69
T. longicollis MICHX. . . . .	5	<b>W</b> eisia viridula (L.) HEDW. . . . .	.. 8

## On some Japanese Calcareous Sponges belonging to the Family Heteropiidæ.

By

**Sanji Hōzawa**, *Rigakushi*.

Zoological Institute, Science College, Tokyo Imperial University.

---

*With 2 plates.*

---

In the collection of calcareous sponges collected by Professor IJIMA and preserved in the Zoological Institute of the Science College, there exist seven species belonging to the family Heteropiidæ. Six of them seem to be new to science. In the present paper I propose to give descriptions of all the species in the following order :

1. *Grantessa shimeji*, n. sp.
2. ,, *sagamiana*, n. sp.
3. ,, *intusarticulata* (CARTER).
4. ,, *basipapillata*, n. sp.
5. ,, *mitsukurii*, n. sp.
6. *Heteropia striata*, n. sp.
7. *Amphiute ijimai*, n. sp.

Here let be fulfilled my pleasant duty of expressing my hearty thanks to Professor IJIMA, who has not only kindly placed at my disposal the valuable fruits of his long years' collecting, but has

also rendered me many a courteous help during the course of my investigation.

Family **HETEROPIIDÆ** DENDY.

Genus **Grantessa** von LENDENFELD (emend.).

1. *Grantessa shimeji*, n. sp.

(Pl. I., figs. 1, 2; Pl. II., figs. 10, 11; textfig. 1).

This new species is represented in the collection by five specimens. They differ more or less from one another in certain minor points of external feature, but are practically identical in the finer structure.

The first specimen (Sci. Coll. Spec. No. 1; Pl. I., figs. 1, 2), which is taken for the type, was obtained by K. AOKI in the immediate neighbourhood of the Misaki Marine Biological Station. The sponge forms an irregular hemispherical colony with a height of 45 mm. and maximum diameter of about 85 mm. In the superficial parts, the colony is seen to consist of numerous sub-cylindrical, erect and on the whole radially directed tubes, each of which somewhat tapers distally and terminates with an osculum. The tubes may be 6–10 mm. long, and  $1\frac{1}{2}$  mm. broad in the lower parts, where the wall presents a thickness of 0.35–0.6 mm. The wall gradually diminishes in thickness towards the oscular margin. The osculum is approximately circular with a diameter of  $\frac{1}{2}$ – $1\frac{1}{2}$  mm. An oscular fringe of oxea is present, but is scarcely visible to the naked eye. The dermal surface is rough, owing to the presence of oxea in scattered tufts projecting almost vertically from it. The gastral surface is also rough on account

of the projecting apical rays of gastral quadriradiates. Several of the tubes are seen to bear diverticulum of varying length, the blind end of which is outwardly directed and may sometimes show a perforation representing osculum at an early stage of breaking through. The deeper parts of the colony give quite a different view from the peripheral. The inner continuations of the radial tubes branch and anastomose with one another and thus form a complicated network of tubes which constitutes the greater part of the mass of the colony. Here the diameter of the tubes and the thickness of wall are somewhat greater than in more peripheral parts of the colony. The sponge is colourless in alcohol, its texture rather firm and compact.

The second specimen (Sci. Coll. Spec. No. 2) was also obtained by K. AOKI at the same locality. It is an irregularly shaped mass, 80 mm. high, and 40 mm. in maximum diameter. The oscular tubes are on the whole of a larger calibre than those of the type-specimen. They reach 14 mm. in length and 5 mm. in width in the widest part, where the wall is nearly  $\frac{1}{2}$  mm. thick. The dermal surface is relatively smooth, the tufts of oxea being not so strongly developed as in the type-specimen.

The third specimen (Sci. Coll. Spec. No. 3) was obtained by Prof. IJIMA at the same locality. It is a small colony, provided with about 30 oscular tubes. In external characters it agrees fairly well with the type-specimen.

The fourth specimen (Sci. Coll. Spec. No. 4) was collected by Mr. K. YENDŌ at Ōshima, in the Province of Shima. It is a little smaller than the type-specimen. Height, 30 mm. Maximum diameter, 65 mm. Minimum diameter, 40 mm.

The fifth specimen (Sci. Coll. Spec. No. 5) hails from the same locality as the preceding. It represents an irregularly

roundish mass, measuring about 15 mm. in height and 30 mm. in maximum diameter. On the whole, the oscular tubes are much smaller than those of any other specimen. The largest tube measures only 5 mm. long and 2 mm. broad in the widest part, where the wall is nearly 0.45 mm. thick. The osculum is irregularly circular, measuring about 0.45 mm. in diameter; oscular fringe of oxea not visible with the naked eye.

The following description of canal system and spicules is based on studies of the type-specimen.

#### Canal system (Pl. II., figs. 10, 11).

The canal system is typically syconoid. Dermal pores, 40–100  $\mu$  in diameter, are scattered irregularly over the sponge surface. The dermal cortex is rather weakly developed with a small quantity of mesoglaea. The flagellate chambers are straight, cylindrical and usually not branched; they are radially arranged around the gastral cavity, extending from gastral to dermal cortex. Each chamber is provided with a number of small prosopyles of 10–40  $\mu$  diameter, and with a single apopyle at the inner end. The position of nucleus in collar cells is apical. The gastral cortex is nearly as thick as the dermal and is perforated by short but rather wide exhalant canals, which usually arise each from a single chamber and sometimes from two or three chambers. A weakly developed diaphragm occurs at the apopyle. Diameter of exhalant pores 70–150  $\mu$ .

#### Skeleton (Pl. II., figs. 10, 11).

The dermal skeleton is composed of the following elements: 1) triradiates, which are tangentially arranged in several layers without definite orientation; 2) the paired rays of subdermal



pseudosagittal triradiates; and 3) oxea which project nearly vertically from dermal surface and which are grouped in small tufts standing in no definite relation to radial chambers.

The tubar skeleton near the osculum is of the inarticulate type, consisting of the basal rays of subdermal pseudosagittal and subgastral sagittal triradiates (Pl. II., fig. 11). In the remaining parts of the sponge, where the wall is thicker and the chambers are more elongate, the tubar skeleton receives an addition of some rows of sagittal triradiates with outwardly directed basal rays and is thus of the articulate type (Pl. II., fig. 10).

The gastral skeleton is made up of tangentially placed triradiates, of the paired rays of subgastral triradiates and of the facial rays of gastral quadriradiates, of which the apical rays project into the gastral cavity.

The skeleton of the oscular margin is composed of oxea and triradiates. The oxea run longitudinally and parallel with one another as well as with the downwardly directed basal rays of the triradiates.

#### Spicules.

Dermal triradiates (textfig. 1, *a, b*).—Slightly sagittal. Basal ray smooth, straight, ending in a sharp point, about  $80 \mu$  long and  $8 \mu$  thick. Paired rays longer and slightly thicker than basal ray, not quite smooth, almost straight but sometimes slightly crooked, gradually tapering and sharply pointed, about  $120 \mu$  long and  $10 \mu$  thick.

Subdermal triradiates (textfig. 1, *c, d, e*).—Pseudosagittal. All rays equally thick, lying nearly in the same plane. Basal ray longer than paired rays, straight excepting slight curvature near base, sometimes very slightly crooked, gradually tapering, sharp-

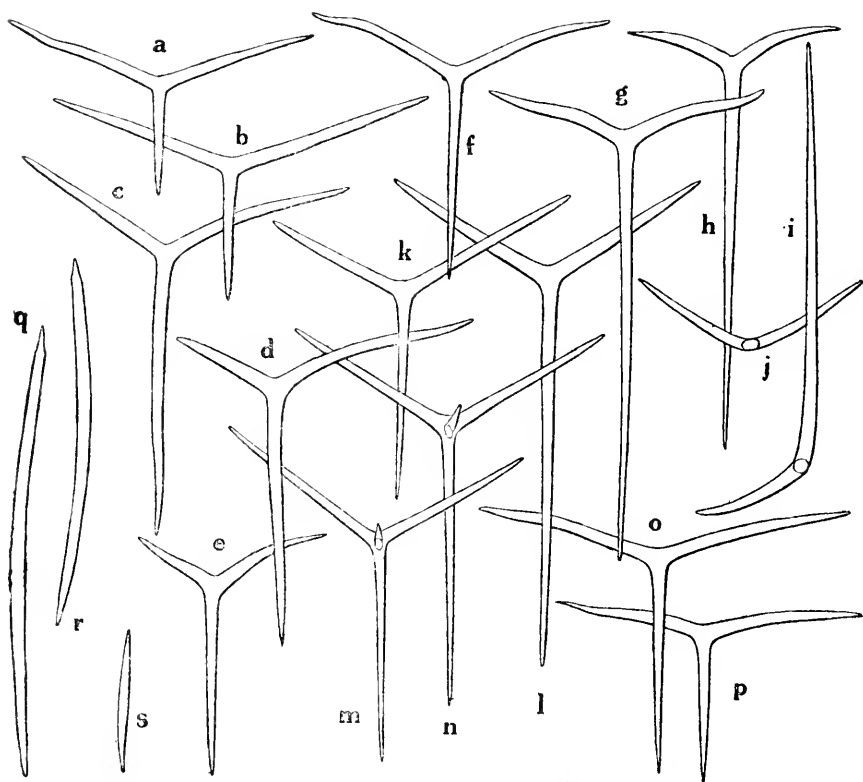
Textfig. 1. *Grantessa shimeji*.

- a, b, Dermal triradiates.  
 c, d, e, Subdermal triradiates.  
 f, g, Tubar triradiates.  
 h, i, j, Subgastral triradiates.  
 k, l, Gastral triradiates.  
 m, n, Gastral quadriradiates.  
 o, p, Triradiates of oscular margin.  
 q, r, s, Oxea of oscular margin.  
 (All figs. 200×).

pointed, 120–180  $\mu$  long and 10  $\mu$  thick. Paired rays unequal in length and shape; the longer ray sometimes nearly as long as the shorter, curved, 90–140  $\mu$  long and 10  $\mu$  thick. The shorter ray almost straight, 60–110  $\mu$  long and 10  $\mu$  thick.

Tubar triradiates (textfig. 1, *f. g*).—Sagittal. Basal ray long, almost straight, gradually tapering and sharply pointed, 120–270  $\mu$

long and  $10\ \mu$  thick. Paired rays nearly equal, curved, gradually tapering and sharply pointed,  $70\text{--}100\ \mu$  long and  $10\ \mu$  thick.

Subgastral triradiates (textfig. 1, *h, i, j*).—Sagittal. Basal ray long, straight, gradually tapering, sharp-pointed, about  $250\ \mu$  long and  $10\ \mu$  thick. Paired rays nearly equal, widely diverging, lying not in the same plane as the basal ray, slightly curved, gradually tapering to a point, about  $80\ \mu$  long and  $12\ \mu$  thick.

Gastral triradiates (textfig. 1, *k, l*).—Sagittal. Basal ray much longer than paired rays, quite straight, tapering from base to the sharp point,  $140\text{--}270\ \mu$  long and  $8\text{--}10\ \mu$  thick. Paired rays straight, almost equal or slightly differentiated in length, somewhat thicker than the basal ray, gradually tapering, sharply pointed,  $90\text{--}120\ \mu$  long and  $10\text{--}12\ \mu$  thick.

Gastral quadriradiates (textfig. 1, *m, n*).—Almost like gastral triradiates with addition of a short apical ray. Basal ray much longer than paired rays, quite straight, gradually tapering, sharp-pointed,  $150\text{--}200\ \mu$  long and  $8\text{--}10\ \mu$  thick. Paired rays almost straight, subequal in length, slightly thicker than the basal ray, gradually tapering, sharply pointed,  $100\text{--}120\ \mu$  long and  $10\text{--}12\ \mu$  thick. Apical ray much shorter and slender than facial rays, ending sharply, slightly curved and directed upwards,  $30\text{--}50\ \mu$  long and  $8\text{--}10\ \mu$  thick. The quadriradiates situated near the osculum have the paired rays curved and more widely diverging than in those of other parts.

Triradiates of oscular margin (textfig. 1, *o, p*).—Basal ray smooth and straight, gradually tapering, sharp-pointed, slightly longer than paired rays,  $100\text{--}150\ \mu$  and  $10\ \mu$  thick. Paired rays stouter than the basal, widely diverging, almost at right angles to the basal ray, curved, not quite smooth, sharply or bluntly pointed at end,  $100\text{--}130\ \mu$  long and  $12\ \mu$  thick.

Oxea.—Usually slightly curved, nearly uniformly thick throughout their length and sharply pointed at both ends, of which the free end is sometimes provided with a more or less distinct nodiform ring. They occur in tufts projecting from the dermal surface and with the inner  $\frac{1}{3}$ – $\frac{1}{2}$  of their length imbedded in the chamber layer.

Oxea of oscular margin (textfig. 1, *q*, *r*, *s*).—Similar to those just described, but on the whole longer, being 100–320  $\mu$  long and 6–8  $\mu$  thick.

Note.—The above described species can not be identified with any previously described. The specific name “Shimeji” is given to it on account of its resemblance in form to certain fungus known in Japan by that name. This sponge is common in the neighbourhood of the Misaki Marine Biological Station. It occurs in especial in abundance in the spring, attached on perpendicular or overhanging faces of rocks below low tide-mark.

Localities.—Misaki; Ōshima, Province of Shima.

## 2. *Grantessa saganiana*, n. sp.

(Pl. I., fig. 3; Pl. II., fig. 12; textfig. 2).

The type-specimen of this new species (Sci. Coll. Spec. No. 20) was collected from a depth of 429–572 m. at Okinose, Sagami Sea.

Sponge consists of a solitary person; elongate, cylindrical, slightly laterally compressed and bent at base, with an indistinct oscular fringe; surface slightly hispid, due to large oxea and trihexa projecting here and there. The body is about 45 mm. long and 9 mm. in greatest breadth. It narrows towards both ends. The sponge wall is about 1 mm. thick in the middle parts of body; nearer the osculum the thinner it becomes. The osculum

is elliptical, 6 mm. by 3 mm. wide, and leads into the wide and deep gastral cavity. The colour in alcohol is greyish white; the texture is fairly firm and elastic.

A second specimen (Sci. Coll. Spec. No. 21) was obtained by Prof. IJIMA in the Sagami Sea, off Cape Sunosaki, from a depth of 429 m. It was attached to the spine of *Goniocidaris mikado* (DÖDERLEIN). The specimen is much smaller than the type, measuring 22 mm. in length, 5 mm. in greatest breadth and about 0.8 mm. in thickness of wall. The surface is more strongly hispid than in the type. The osculum is elliptical,  $3\frac{1}{2}$  mm. by 2 mm. wide; it is in part provided with a distinctly developed oscular fringe.

The third specimen (Sci. Coll. Spec. No. 22; Pl. 1., fig. 3) was obtained by K. AOKI at the entrance to Enoura, Suruga Bay, from a depth of 380 m. It was found attached at base on a coral together with a polyzoan colony. It represents an elongate, slightly curved and laterally compressed tube, with the surface thickly beset with projecting oxea. Total length 30 mm. Greatest breadth 7 mm. Wall not thicker than 1 mm. The osculum is circular with a diameter of 3 mm. Oscular fringe is rather distinct.

The following account refers to the type-specimen.

#### Canal system (Pl. II., fig. 12).

The canal system is syconoid. Dermal pores small, circular or oval with a diameter of 40–150  $\mu$ , thickly distributed all over the surface of sponge; the pores lead singly, or more frequently several together in groups, into wide inhalant canals through the thin dermal cortex. The inhalant canals extend inwards, around and between the distal ends of flagellate chambers.

Flagellate chambers are arranged radially with regard to the

central gastral cavity, extending nearly through the entire thickness of the sponge wall. They are broad in the proximal parts and become markedly narrower in the distal parts. Sometimes they are seen to be united with one another in the proximal parts and also to divide distally into branches. The nucleus of collar cells occupies an apical position.

The gastral cortex is very thin with a small quantity of mesogloea; it is pierced by very short exhalant canals, arising from either a single or from 2–4 flagellated chambers. A well-developed diaphragm exists at the apopyle. The exhalant canals open into the gastral cavity through small angular meshes, measuring 200–400  $\mu$  across and formed by intercrossing rays of gastral tri- and quadri-radiates.

#### Skeleton (Pl. II., fig. 12).

The dermal skeleton is made up of: 1) triradiates tangentially disposed in a few layers, with basal ray generally directed downwards; 2) the paired rays of subdermal pseudosagittal triradiates; 3) large oxea, which occur here and there in vertical disposition in the sponge wall and which usually project outwards on the dermal side only but may sometimes do so also on the gastral side; 4) trichoxea which are but rarely found.

The tubar skeleton is composed of: 1) the centripetal basal rays of subdermal pseudosagittal triradiates; 2) the centrifugal basal rays of subgastral triradiates; and 3) one or two intermediate rows of triradiates which have their basal ray directed outwards. The above refers to the thick-walled middle parts of the sponge. In the parts close to osculum where the wall is thin, the tubar skeleton consists only of the basal rays of subdermal and subgastral triradiates.

The gastral skeleton consists of the paired rays of subgastral sagittal triradiates, of triradiates, and of the facial rays of quadriradiates. Of the last, the short apical rays project into the gastral cavity. Triradiates and quadriradiates are disposed tangentially, otherwise in no definite orientation. The former are always less numerous than the latter.

The skeleton of the oscular margin consists in a close interlacement of fine longitudinal trichoxea and of triradiates and quadriradiates, both which have strongly divergent paired rays and downwardly directed basal ray. To the above there may be added a number of large oxea which run longitudinally and parallel with trichoxea.

#### Spicules.

Dermal triradiates (textfig. 2, *a, b*).—Slightly sagittal. All rays straight, smooth and gradually sharp-pointed. Basal ray slightly longer than paired rays, equally thick or a little thicker than these, 240–370  $\mu$  long and 20–28  $\mu$  thick. Paired rays of nearly equal length, 200–270  $\mu$  long and 20  $\mu$  thick.

Subdermal triradiates (textfig. 2, *c, d, e*).—Pseudosagittal, irregular. All rays of nearly same thickness but of different length and shape. Basal ray much longer than paired rays, sharp-pointed, its basal parts slightly curved and for the rest straight or nearly so, 200–490  $\mu$  long and 16–20  $\mu$  thick. Paired rays are of different length and shape, lying not in the same plane with basal ray. The longer of them gradually tapers to a sharp point, is bent near base and is sometimes more or less crooked in the remaining parts, 100–160  $\mu$  long and 12–16  $\mu$  thick. The shorter ray is sharp-pointed and strongly curved in the middle parts, 90–110  $\mu$  long and 16–20  $\mu$  thick.

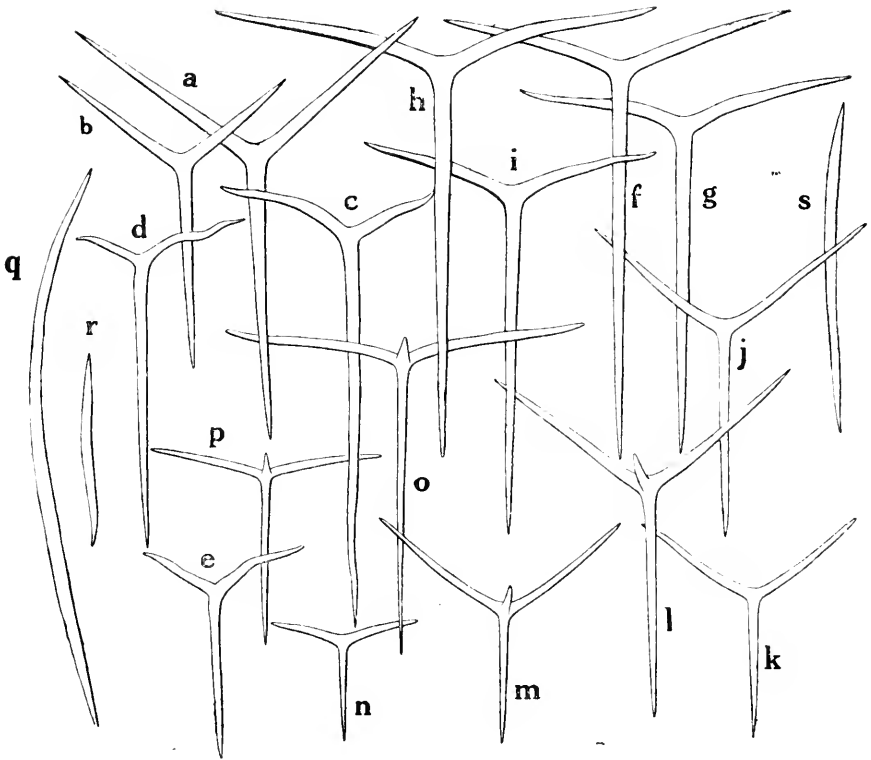
Textfig. 2. *Grantessa sagamiensis*.

- |          |                                   |
|----------|-----------------------------------|
| a, b,    | Dermal triradiates.               |
| c, d, e, | Subdermal triradiates.            |
| f, g,    | Tubar triradiates.                |
| h, i,    | Subgastral triradiates.           |
| j, k,    | Gastral triradiates.              |
| l, m,    | Gastral quadriradiates            |
| n,       | Triradiate of oscular margin.     |
| o, p,    | Quadriradiates of oscular margin. |
| q, r, s. | Oxea.                             |

(a-p, 100×; q-s, 40×).

Tubar triradiates (textfig. 2, *f, g*).—Sagittal. All rays of subequal thickness. Basal ray straight, tapering in the entire length, 160–480  $\mu$  long and 12–24  $\mu$  thick. Paired rays equal in length, more or less curved, tapering throughout their whole length, 80–210  $\mu$  long and 12–20  $\mu$  thick.



Subgastral triradiates (textfig. 2, *h, i*).—Strongly sagittal, nearly similar to tubar triradiates but with oral angles wider in varying degrees. Basal ray straight, smooth, gradually sharp-pointed, 420–480  $\mu$  long and 20–24  $\mu$  thick. Paired rays lying not in the same plane with basal ray, equally long, slightly curved, gradually sharp-pointed, 180–250  $\mu$  long and 16–24  $\mu$  thick.

Gastral triradiates (textfig. 2, *j, k*).—Slightly sagittal. All rays equally thick. Basal ray quite straight, smooth, tapering from base to the sharp point, 180–270  $\mu$  long and 16–20  $\mu$  thick. Paired rays equal in length, almost straight excepting a slight curvature near base, gradually sharp-pointed, 170–210  $\mu$  long and 16  $\mu$  thick.

Gastral quadriradiates (textfig. 2, *l, m*).—Facial rays exactly similar to gastral triradiates. Basal ray 170–280  $\mu$  long and 16–20  $\mu$  thick. Paired rays 200–210  $\mu$  long and 16–20  $\mu$  thick. Apical ray curved, sharp-pointed, nearly as thick as the facial rays but much shorter, 50–70  $\mu$  long 16  $\mu$  thick.

Triradiates of oscular margin (textfig. 2, *n*).—Basal ray quite straight, sharply pointed, 140–280  $\mu$  long and 8–12  $\mu$  thick. Paired rays slightly curved, standing nearly at right angles to basal ray, thicker and shorter than the latter, 100–170  $\mu$  long and 12–16  $\mu$  thick.

Quadriradiates of oscular margin (textfig. 2, *o, p*).—Facial rays exactly similar to triradiates of the oscular margin. Apical ray very short, slightly curved. Basal ray 200–350  $\mu$  long and 12  $\mu$  thick. Paired rays 150–220  $\mu$  long and 12–16  $\mu$  thick.

Large oxea (textfig. 2, *q, r, s*).—More or less curved, of varying lengths, nearly uniformly thick in the greater part of their length but tapering at both ends which are sharply pointed, 0.6–1.8 mm. long and 30–50  $\mu$  thick.

Trichoxea of oscular margin.—Slender, quite straight, sharply pointed at inner end, generally broken off at outer end. A large example with broken outer end measured  $590\ \mu$  in length and  $4\ \mu$  in thickness.

Trichoxea of dermal cortex.—Slender, hair-like, generally much thinner than those of the oscular margin, measuring about  $2\ \mu$  in thickness.

Note.—This form seems to be quite distinct from any of the hitherto known species. *Grantessa lanceolata* (BREITFUSS)<sup>b</sup> may be looked upon as its nearest ally, though showing some marked differences in spiculation.

Localities.—Okinose ; off Sunosaki ; Entrance of Enoura, Suruga Bay.

### 3. *Grantessa intusarticulata* (CARTER).

(Pl. I., figs. 4, 5 ; Pl. II., fig. 13 ; textfig. 3).

*Hypograntia intusarticulata*, CARTER, 1885-1886 (1), p. 45.

„ *medioarticulata*, CARTER, 1885-1886 (1), p. 46.

*Grantessa intusarticulata*, DENDY, 1892 (1), p. 108 ; 1893 (2), pp. 181, 201, Pl. XIII., fig. 18.

*Grantia intusarticulata*, BREITFUSS, 1897 (2), p. 219.

Sixteen specimens of this species have come under my observation. Thirteen of them (Sci. Coll. Spec. Nos. 6-17, 29) were collected by K. AOKI at Dōketsba in the Sagami Sea from depths varying from 185 to 214 meters ; one (Sci. Coll. Spec. No. 30) came from Jōgashima (Misaki), while the remaining two (Sci. Coll. Spec. Nos. 31, 32) were obtained by Prof. IJIMA from the shallow bottom in the neighbourhood of the Misaki Marine Biological Station.

All specimens in the first group are solitary tubular individuals attached by the narrowed base. They are provided with an

1). *Ebnerella lanceolata* BREITFUSS, 1893 (3), p. 28, Taf. I., Fig. 3-5 ; Taf. IV., Fig. 24, 25.

oval or circular osculum, surrounded by a more or less distinctly developed fringe of oxea. The specimen from Jōgashima is a fragment of oscular tube with base. The last two specimens represent a colony of several small and tubular individuals joined together at their base (Pl. I., fig. 5),

To base further description on I have selected one of the Dōketsba specimens (Sci. Coll. Spec. No. 6 ; Pl. I., fig. 4). It measures about 60 mm. in total length and 11 mm. in greatest width. The wall reaches about 1 mm. in thickness. The osculum is oval, measuring  $2\frac{1}{2}$  by 5 mm. It leads into a wide and deep gastral cavity. The sponge is bent in the basal parts, where it presents a somewhat irregular contour and also gives rise to some tubercular processes for attachment. The dermal surface looks very smooth, while the gastral is somewhat rough owing to projecting apical rays of gastral quadriradiates. Colour in alcohol greyish white. Texture firm, but elastic.

#### Canal system (Pl. II., fig. 13).

The canal system is typically syconoid. The inhalant canals open on the dermal surface by means of small irregularly roundish, mesh-like pores of 70–100  $\mu$  diameter. The canals, after traversing the dermal cortex, unite into larger trunks which lead into the interstices between flagellate chambers. The dermal cortex, which appears finely hispid on account of vertically disposed microxea, is rather thin, being about 100  $\mu$  thick ; it directly overlies the distal ends of flagellate chambers. The flagellate chambers are elongate and radially arranged in the chamber layer. They are usually simple, but are sometimes divided into two or three parallel and distally narrowing branches. The chambers communicate either singly or several together with exhalant canals, which

are short but relatively wide. Diaphragm is present at each apopyle. The nucleus of collar cells occupies an apical position.

The gastral cortex is almost as thick as the dermal; it is perforated in a mesh-like manner by irregularly quadrate, pentagonal or hexagonal openings (150–250  $\mu$  across) of exhalant canals. The epithelium lining the gastral cavity and exhalant canals is very conspicuous, the component cells being relatively large. The apical rays of gastral quadriradiates, as they stand out into the gastral cavity, seem to be covered all over by the epithelium.

#### Skeleton (Pl. II, fig. 13).

The dermal skeleton consists of triradiates, microxea and the paired rays of subdermal pseudosagittal triradiates. The triradiates lie parallel to the dermal surface with the basal rays in most cases directed towards the sponge base. The microxea are very small, numerous and thickly set. They lie in the dermal cortex at varying angles to the external surface, beyond which the outer ends freely project to a certain extent.

In the middle parts of the sponge the tubar skeleton is formed by the centripetal basal rays of subdermal pseudosagittal triradiates, by the centrifugal basal rays of subgastral sagittal triradiates, and by several intermediate rows of sagittal triradiates, of which the basal rays are centrifugally directed.

The gastral skeleton is chiefly made up of triradiates tangentially placed without definite orientation and arranged in several layers. It also contains the paired rays of subgastral triradiates as well as large quadriradiates, the apical rays of which project into the gastral cavity, pointing towards the osculum.

The oscular margin is composed of trichoxea of varying thickness running longitudinally and parallel with one another, and of

very closely set triradiates, which have very strongly diverging paired rays.

### Spicules.

Dermal triradiates (textfig. 3, *a, b*).—Slightly sagittal. Basal ray straight, smooth, gradually and sharply pointed, 120–250  $\mu$  long and 16–20  $\mu$  thick. Paired rays very slightly curved and gradually sharp-pointed. They are nearly as thick as the basal ray, but shorter, being 80–190  $\mu$  long and 12–16  $\mu$  thick.

Subdermal triradiates (textfig. 3, *c, d*).—Pseudosagittal, irregular. Basal ray considerably longer than the paired rays, slightly bent near base, and gradually sharp-pointed, 280–360  $\mu$  long and 16–20  $\mu$  thick. Paired rays equally thick but differing in length and shape. The longer ray gently curved and gradually sharp-pointed, 80–130  $\mu$  long and 12–16  $\mu$  thick. The shorter ray more or less angularly curved in the middle, gradually and sharply pointed, 50–120  $\mu$  long and 12–16  $\mu$  thick.

Tubar triradiates (textfig. 3, *e, f, g, h*).—Sagittal. Basal ray straight, gradually sharp-pointed, much longer and slightly thicker than the paired rays, 120–380  $\mu$  long and 12–16  $\mu$  thick. Paired rays are of equal or slightly differentiated length, gradually sharp-pointed, straight or slightly bent, 60–120  $\mu$  long and 8–12  $\mu$  thick.

Subgastral triradiates (textfig. 3, *i*).—Sagittal. Similar to tubar triradiates, but the paired rays are more strongly divergent. All rays lie in the same plane. Basal ray straight, much longer and slightly thicker than the paired rays, 250–330  $\mu$  long and 16–20  $\mu$  thick. Paired rays slightly curved, gradually and sharply pointed, 100–160  $\mu$  long and 12–16  $\mu$  thick.

Gastral triradiates (textfig. 3, *j, k, l*).—Regular or very slightly sagittal. All rays gradually and sharply pointed, generally

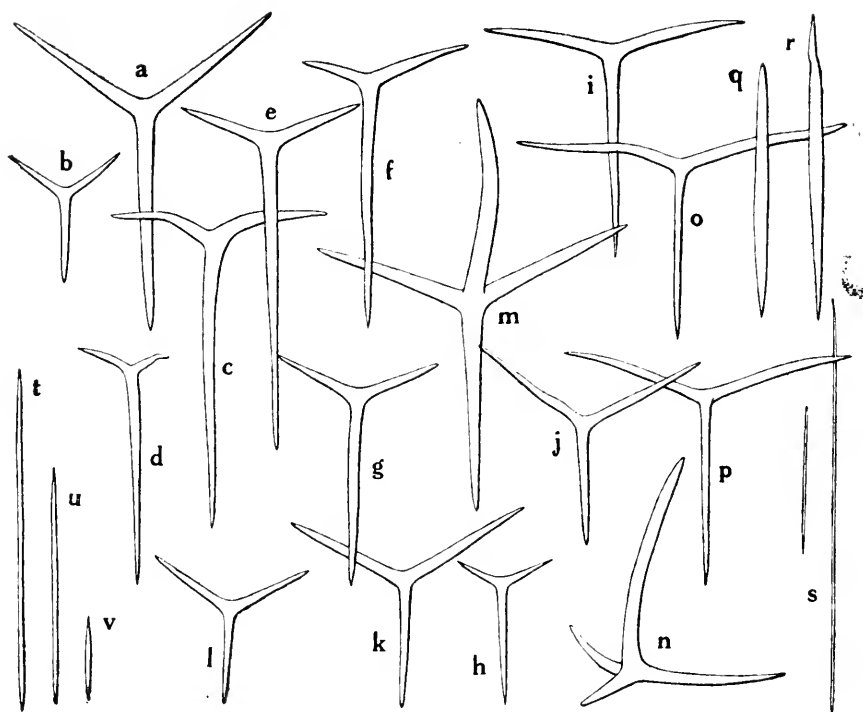
Textfig. 3. *Grantessa intusarticulata*.

- |             |                                |
|-------------|--------------------------------|
| a, b,       | Dermal triradiates.            |
| c, d,       | Subdermal triradiates.         |
| e, f, g, h, | Tubar triradiates.             |
| i,          | Subgastral triradiate.         |
| j, k, l,    | Gastral triradiates.           |
| m, n,       | Gastral quadriradiates.        |
| o, p,       | Triradiates of oscular margin. |
| q, r,       | Microxea.                      |
| s,          | Trichoxea of oscular margin.   |
| t, u, v,    | Oxea of oscular margin.        |
- (a—p, s—v, 100 × ; q, r, 400 ×).

straight, but sometimes slightly crooked, 100–160  $\mu$  long and 12  $\mu$  thick.

Gastral quadriradiates (textfig. 3, *m, n*).—Large and very stout, with gradually and sharply pointed facial rays which are equal or slightly differentiated sagittally, and with very strongly developed apical ray, curved and pointed only at the end. In

typical cases, the facial rays are 180–230  $\mu$  long and 24  $\mu$  thick; the apical ray about 280  $\mu$  long and 24  $\mu$  thick.

Triradiates of oscular margin (textfig. 3, *o, p*).—Very strongly sagittal. Basal ray longer and more slender than the paired rays, straight, gradually and sharply pointed, 230–310  $\mu$  long and 8  $\mu$  thick. Paired rays strongly diverging, slightly curved, either gradually sharp-pointed or broadened in the middle and narrowed towards both the base and the pointed end. The oral angles are rather variable.

Microxea (textfig. 3, *q, r*).—Nearly straight, symmetrically sharp-pointed at both ends, sometimes with a hastate point at one end, 76–92  $\mu$  long and 4  $\mu$  thick.

Trichoxea of oscular margin (textfig. 3, *s*).—Very slender, straight, 210–550  $\mu$  long and 2  $\mu$  thick.

Oxea of oscular margin (textfig. 3, *t, u, v*).—These resemble trichoxea, but are thicker, straight, almost uniformly thick throughout their length; the ends sharply pointed, 110–450  $\mu$  long and 6  $\mu$  thick.

Note.—The specimens seem to agree very well in all essential characters with the Australian species first described by CARTER under the names of *Hypograntia intusarticulata* and *H. medioarticulata* and later referred to *Grantessa* by DENDY. I am therefore strongly inclined to identify the Japanese form with that species.

Localities.—Near Port Philip Heads (CARTER); Watson's Bay, Port Jackson (DENDY); Dōketsba and Misaki, Sagami Sea.

#### 4. *Grantessa basipapillata*, n. sp.

(Pl. I., fig. 6; Pl. II., fig. 14; textfig. 4).

This species is based on a single specimen (Sci. Coll. Spec.

No. 23), which was obtained by K. AOKI at Dōketsba, Sagami Sea. It represents in the main an irregularly cylindrical sycon person broken off at one end and which has budded out near the damaged end a second, much smaller person. The mother person is slightly laterally compressed and exhibits several small nipple-shaped protuberances on the sides. It measures about 80 mm. long by 10 mm. broad at the widest part, where the wall is about 1 mm. thick. The osculum is circular with a diameter of  $3\frac{1}{2}$  mm.; its margin is very thin and plain without fringe. The second person is cylindrical, circular in cross section, about 20 mm. long, 5 mm. broad, and 0.7 mm. in thickness of wall. It shows at the end a small osculum of only  $\frac{1}{2}$  mm. diameter. The dermal surface is quite smooth without any projecting spicules. The gastral surface is lined with quadriradiates, of which the short apical rays project inwards. The gastral cavity is very wide and extends through the entire length of the specimen. The colour of the sponge in alcohol is greyish white. Texture is firm but rather brittle.

#### Canal system (Pl. II., fig. 14).

The canal system is typically syconoid. The dermal cortex is fairly thick. The dermal pores, measuring 40–100  $\mu$  across, are thickly distributed over the dermal surface. They lead, either singly or two or three together, into prolonged inhalant canals extending deep into the chamber layer.

The flagellate chambers are arranged radially with regularity. They are nearly straight, circular in transverse section, distally more or less narrowed, and usually, though not always, undivided. Their distal ends are all in about the same plane, just beneath the dermal cortex. The position of nucleus in collar cells is apical.



The gastral cortex is thinner than the dermal and the exhalant canals are short. These spring each from a single or more flagellate chambers. Diaphragm present at apopyle. Gastral openings of exhalant canals are angular mesh-like gaps, measuring about 0.2 mm. across on an average.

#### Skeleton (Pl. II., fig. 14).

The dermal skeleton is fairly well-developed, being composed of densely intercrossing rays of tangentially placed sagittal triradiates and of the paired rays of subdermal pseudosagittal triradiates.

There is little regularity in the orientation of the dermal triradiates, save in the tendency of their basal rays to take ab-oscular direction.

The tubar skeleton is typically inarticulate, being composed of the centripetal basal rays of subdermal pseudosagittal triradiates and of the centrifugal basal rays of subgastral sagittal triradiates.

The gastral skeleton is more weakly developed than the dermal. It is made up of slender triradiates and quadriradiates, both tangentially placed but otherwise without definite orientation, and of the strongly developed paired rays of subgastral sagittal triradiates.

Around the osculum are small oxea which are placed longitudinally and parallel with one another.

#### Spicules.

Dermal triradiates (textfig. 4, *a, b, c*).—Slightly sagittal. Basal ray is, as usual, slightly longer and thicker than paired rays; quite straight, tapering from base gradually to a sharp point, 130–460  $\mu$  long and 20–48  $\mu$  thick. Paired rays nearly equally long, slightly

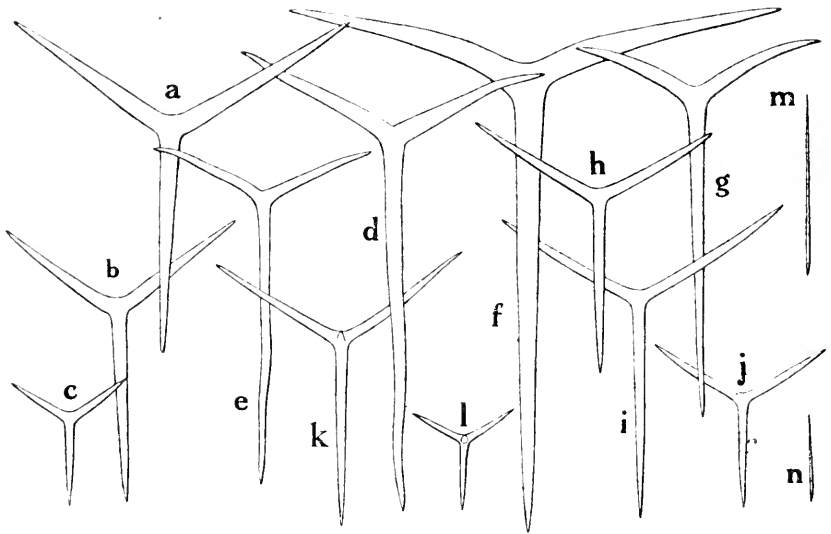
Textfig. 4. *Grantessa basipepillata*.

- |          |  |
|----------|--|
| a, b, c, | Dermal triradiates.                      |
| d, e,    | Subdermal triradiates.                   |
| f, g,    | Subgastral triradiates.                  |
| h, i, j, | Gastral triradiates.                     |
| k, l,    | Gastral quadriradiates.                  |
| m, n,    | Oxea of oscular margin.                  |
|          | (a—c, 66 $\times$ ; d—n, 100 $\times$ ). |

curved at base and tapering throughout their entire length, 150–400  $\mu$  long and 16–36  $\mu$  thick.

Subdermal triradiates (textfig. 4, *d, e*).—Pseudosagittal, irregular. All rays are of nearly same thickness but of different length and shape. Basal ray nearly straight, sometimes slightly crooked, with sharp point, 360–480  $\mu$  long and 20–28  $\mu$  thick. The longer paired ray slightly curved and crooked, gradually tapering, sharp-pointed, 140–200  $\mu$  long and 16–24  $\mu$  thick. The shorter paired ray more straight than the longer, gradually and sharply pointed, 130–170  $\mu$  long and 20–28  $\mu$  thick.

Subgastral triradiates (textfig. 4, *f, g*).—Strongly sagittal, strongly developed. Basal ray quite straight, tapering from base to a sharp point, slightly thicker than the paired rays, 400–550  $\mu$  long

and 28–40  $\mu$  thick. Paired rays strongly diverging, almost of equal length, gradually tapering, sharply pointed, curved, lying in a plane different from that of basal ray, 140–300  $\mu$  long and 24–30  $\mu$  thick.

Gastral triradiates (textfig. 4, *h, i, j*).—All rays are of nearly equal thickness. Basal ray quite straight, tapering throughout their entire length, sharply pointed, 140–280  $\mu$  long and 12–16  $\mu$  thick. Paired rays nearly equal in length, either straight or slightly curved, gradually and sharply pointed, 130–200  $\mu$  long and 12–16  $\mu$  thick.

Gastral quadriradiates (textfig. 4, *k, l*).—Facial rays are exactly similar to gastral triradiates. Apical ray poorly developed. Basal ray 90–250  $\mu$  long and 12–16  $\mu$  thick. Paired rays 70–200  $\mu$  long and 8–12  $\mu$  thick. Apical ray smooth, slightly curved, sharply pointed, 20–30  $\mu$  long and 12  $\mu$  thick.

Oxea of oscular margin (textfig. 4, *m, n*).—Quite straight, spindle-shaped, usually thickest nearer proximal than distal end, tapering towards both sharply pointed ends. The free projecting ends usually broken off. Some complete examples measured 110–240  $\mu$  long and 3–4  $\mu$  thick.

Locality.—Döketsba, Sagami Sea.

##### 5. *Grantessa mitsukurii*, n. sp.

(Pl. I., fig. 7; Pl. II., fig. 15; textfig. 5).

The single specimen (Sci. Coll. Spec. No. 24), representing this new species, is a small colony of irregularly anastomosing tubes, the individuality of which is indicated only by the oscula numbering six in all. Each osculum is surrounded by a very feebly developed fringe of oxea. The specimen was collected by the late

Prof. MITSUKURI at Koajiro, close to the Misaki Marine Biological Station. The tubes measure 3–5 mm. in breadth, and the wall 1 mm. in thickness. The size of oscula is various, ranging from  $\frac{1}{2}$ –2 mm. in diameter. They lead into the common gastral cavity of a habitus corresponding to that of the entire specimen. The colour in alcohol is greyish white. The texture is rigid.

#### Canal system (Pl. II., fig. 15).

The canal system is syconoid, though not in a very typical way. The dermal cortex is very strongly developed. The dermal pores are circular and small, measuring about  $60\ \mu$  across on an average.

The flagellate chambers, which are radially arranged around the gastral cavity, extend through the greater part of the thickness of wall. They are rather narrow, not quite straight, but more or less crooked; most of them branch once or twice in the distal parts. The position of nucleus in collar cells is apical.

The gastral cortex is much thinner than the dermal. It forms a continuous lacework, the angular meshes ( $150$ – $300\ \mu$  across) of which are visible to the naked eye. The meshes referred to constitute the openings of exhalant canals into the gastral cavity. The exhalant canals, arising from a single or more flagellate chambers, are short.

#### Skeleton (Pl. II., fig. 15).

The fairly thick dermal skeleton is made up of: 1) sub-regular or slightly sagittal triradiates, lying tangentially in several layers in a rather confuse arrangement; 2) the paired rays of subdermal pseudosagittal triradiates; and 3) small oxea grouped into small tufts which project from the sponge surface.

The tubar skeleton is of the inarticulate type, being composed of the strong basal rays of subdermal pseudosagittal triradiates as well as of subgastral sagittal triradiates of varying sizes, respectively directed centripetally and centrifugally.

The gastral skeleton is thinner than the dermal. It is composed of the strong paired rays of subgastral sagittal triradiates, and of sagittal triradiates which are similar to those of the dermal skeleton except in being slightly smaller and rather more regularly arranged.

The skeleton of the oscular margin is composed of oxea and triradiates, both placed densely together. The former run longitudinally and parallel with one another, the latter have strongly divergent paired rays.

#### Spicules.

Dermal triradiates (textfig. 5, *a, b*).—Subregular or slightly sagittal, varying in size. All rays conical, nearly straight, often slightly irregularly contoured, tapering from base to sharply pointed end, 130–410  $\mu$  long and 20–50  $\mu$  thick. Towards the osculum the triradiates become distinctly sagittally differentiated.

Subdermal triradiates (textfig. 5, *c, d*).—Pseudosagittal, irregular, strongly developed. All the rays differing in length, somewhat irregular in contour. Basal ray almost straight, tapering from base to sharp point, occasionally slightly thicker than paired rays, 320–630  $\mu$  long and 30–60  $\mu$  thick. Paired rays are equal in thickness, but unequal in length and shape. The longer ray usually curved, sometimes crooked, gradually tapering, 160–430  $\mu$  long and 30–50  $\mu$  thick. The shorter ray less curved than the longer, gradually pointed, 120–330  $\mu$  long and 30–50  $\mu$  thick.

Subgastral triradiates (textfig. 5, *e, f*).—Strongly sagittal. On

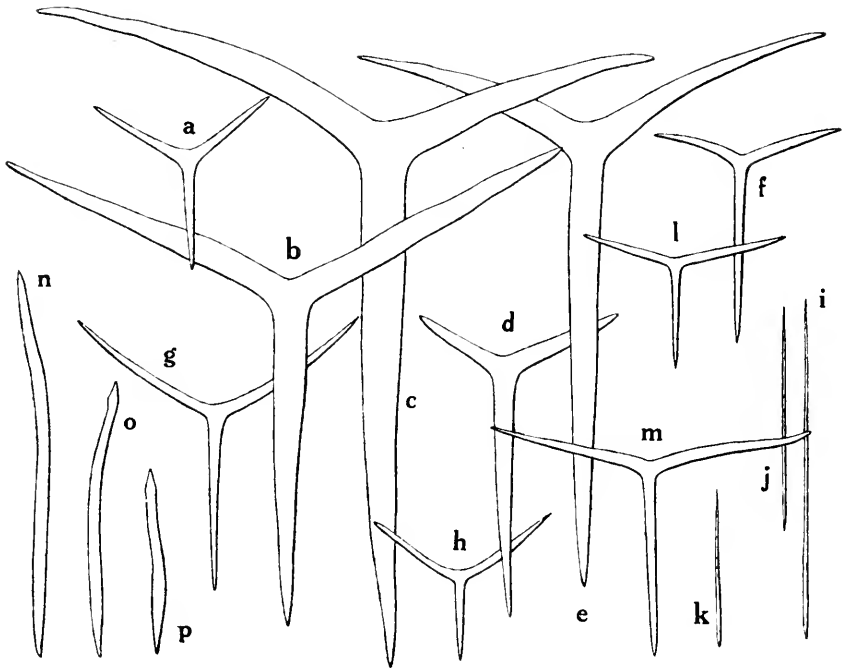
Textfig. 5. *Gradessa mitsukurii*.

- |          |                                |
|----------|--------------------------------|
| a, b,    | Dermal triradiates.            |
| c, d,    | Subdermal triradiates.         |
| e, f,    | Subgastral triradiates.        |
| g, h,    | Gastral triradiates.           |
| i, j, k, | Oxea.                          |
| l, m,    | Triradiates of oscular margin. |
| n, o, p. | Oxea of oscular margin.        |
- (All figs. 100 ×).

the whole, they are about equally well developed as subdermal pseudosagittal triradiates. Basal ray almost straight, gradually sharp-pointed, slightly thicker than paired rays, 240–580  $\mu$  long and 20–50  $\mu$  thick. Paired rays almost equally long, tapering from base to sharp point, 130–310  $\mu$  long and 16–50  $\mu$  thick.

Gastral triradiates (textfig. 5, *g, h*).—Slender. Basal ray quite straight, tapering in their entire length, sharply pointed, 120–220  $\mu$  long and 16–24  $\mu$  thick. Paired rays curved at base, gradually

sharp-pointed, nearly as long as basal ray, 160–200  $\mu$  long and 16–24  $\mu$  thick.

Oxea (textfig. 5, *i, j, k*).—Very small, slender, straight, broadest nearer one end than the other, tapering towards both pointed ends. One example measured was 130  $\mu$  long and 4  $\mu$  in the thickest part.

Triradiates of oscular margin (textfig. 5, *l, m*).—Basal ray quite straight, gradually tapering, sharp-pointed, 130–250  $\mu$  long and 12–16  $\mu$  thick. Paired rays stouter and shorter than basal ray, nearly at right angles to the latter; straight or slightly curved, 120–220  $\mu$  long and 16–20  $\mu$  thick.

Oxea of oscular margin.—There exist two kinds of oxea. The thicker kind is irregularly curved and rather bluntly pointed at ends; sometimes provided with a nodiform ring at the free end, 250–470  $\mu$  long and 16–20  $\mu$  thick (textfig. 5, *n, o, p*). The thinner kind resembles oxea of dermal cortex, but is longer; broadest near the inner end, 300–460  $\mu$  or more long and 4–6  $\mu$  thick.

Note.—This interesting species seems to be closely related to *Grantessa sycilloides* (SCHUFFNER)<sup>1)</sup> of the Indian Ocean, but can be distinguished from it chiefly by the external appearance, by the presence of thin dermal oxea, by the flagellate chambers being laterally not fused with one another, and by the basal rays of subgastral sagittal triradiates being equally developed as in those of subdermal. The species is named after the late Professor MITSUKURI, the collector of the type-specimen.

Locality.—Koajiro Misaki.

---

1) *Sycortis sycilloides* SCHUFFNER, 1887 (1), p. 420, Taf. XXV, Fig. 10.

Genus **Heteropia** CARTER (emend.).

6. *Heteropia striata*, n. sp.

(Pl. I., fig. 8; Pl. II., fig. 16; textfig. 6).

This new species is based on three specimens in the Science College. Two of them were obtained by the late Professor MITSUKURI at Koajiro, near the Misaki Marine Biological Station. A third specimen was collected by myself at Aburatsubo, also close to the Misaki Marine Biological Station. It was found attached to the under side of a floating log.

The first specimen (Sci. Coll. Spec. No. 25; Pl. I., fig. 8), which is herewith made the type of the species, is a small colony of about eighteen tubular individuals, united together at their base and most of which are bent in the same direction. They are broadest at base and taper distally. The larger individuals are provided with terminal osculum fringed with very feebly developed trichoxea; the smaller individuals show neither osculum nor the fringe. The largest individual measures 8 mm. in total length and 3 mm. in greatest breadth, the wall reaching about 0.7 mm. in thickness. The osculum is circular with a diameter of about 0.6 mm. The surface shows longitudinal striation due to the presence of large oxea in dermal cortex, and is hispid on account of vertically projecting hair-like oxea. Colour in alcohol is white; texture rigid.

The second specimen (Sci. Coll. Spec. No. 26) closely resembles the first in both external appearance and microscopical structure.

The third specimen (Sci. Coll. Spec. No. 27) is the largest of all. The colony is composed of numerous branching and anastomosing tubes of varying calibre. Most of the tubes are provid-



ed at their free end with a circular osculum of  $\frac{1}{2}$ – $1\frac{1}{2}$  mm. diameter; the marginal fringe is scarcely visible to the naked eye. The tubes attain a breadth of about 5 mm.; thickness of wall about 1 mm. The colour of the sponge in the preserved state is brownish white.

The following description is based on the type-specimen.

#### Canal system (Pl. II., fig. 16).

The canal system of this species is not of the true syconoid type, unlike others of the genus. It is rather of an intermediate type between the sylleibid and the leuconoid.

The flagellate chambers vary much in shape and size, from those of spherical shape measuring 50–100  $\mu$  diameter to others of an elongate sac-like configuration, say, 200  $\mu$  by 80  $\mu$  in dimension. They are closely set in the chamber layer, showing a somewhat radial—though not quite strictly radial—arrangement around wide and long, sometimes slightly branched exhalant canals. The position of nucleus in the collar cells is apical.

The exhalant canals perforate the thin gastral cortex and open into the gastral cavity by angular mesh-like pores of various sizes, up to 150–250  $\mu$  in length.

#### Skeleton (Pl. II., fig. 16).

The fairly thick dermal skeleton consists of: 1) small sagittal triradiates, lying tangentially in several layers, with their basal rays generally directed towards sponge base; 2) large oxea running longitudinally; and 3) the paired rays of subdermal pseudo-sagittal triradiates. Besides these, there may occur slender hair-like oxea, very sparsely distributed and projecting on the dermal surface.

The tubar skeleton may be said to be on the whole of the inarticulate type. It is chiefly composed of the basal rays of subdermal pseudosagittal and subgastral sagittal triradiates. The oppositely directed rays in question lie side by side almost in their entire length. Usually the subdermal triradiates are less developed than the subgastral.

The gastral skeleton is much thinner than the dermal. It is made up of the paired rays of subgastral sagittal triradiates, of sagittal triradiates placed tangentially and with their basal rays pointing towards sponge base, and of a few quadriradiates which have their short apical ray projecting into the gastral cavity.

The skeleton of oscular margin is, in full-grown individuals, composed of oxea and of triradiates, both closely set. The former are of two kinds: the one is similar to that found in dermal cortex, while the other is very thin and hair-like. The oscular triradiates, which are apparently differentiated from the gastral triradiates, have very slender basal ray and the stouter paired rays standing nearly at right angles to it.

#### Spicules.

Dermal triradiates (textfig. 6, *a*, *b*).—Slightly sagittal. All rays of equal thickness, tapering from base to sharp point. Basal ray quite straight, 80–170  $\mu$  long and 8–12  $\mu$  thick. Paired rays of about the same length, almost straight, 60–100  $\mu$  long and 8–12  $\mu$  thick.

Subdermal triradiates (textfig. 6, *c*, *d*).—Pseudosagittal, stout, all rays of different length but of nearly the same thickness, not quite smooth. Basal ray generally curved near base, gradually and sharply pointed. Paired rays of different length and shape. The longer ray is slightly shorter than the basal ray, almost

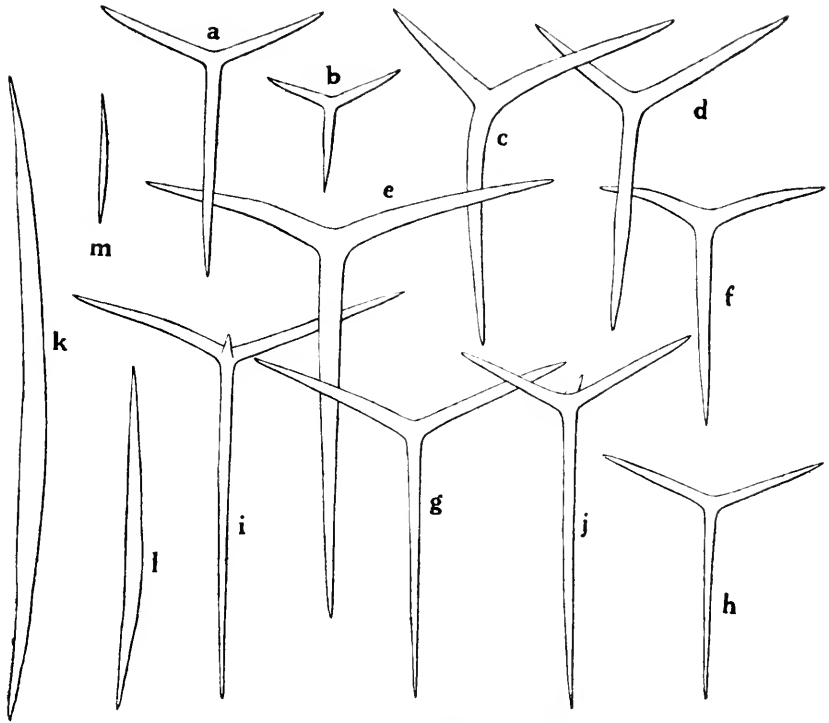
Textfig. 6. *Heteropia striata*.

- |          |                         |
|----------|-------------------------|
| a, b,    | Dermal triradiates.     |
| c, d,    | Subdermal triradiates.  |
| e, f,    | Subgastral triradiates. |
| g, h,    | Gastral triradiates.    |
| i, j,    | Gastral quadriradiates. |
| k, l, m, | Dermal oxea.            |
- (a—j, 150×; k—m, 40×).

straight excepting the slight curvature near base, gradually tapering to a sharp point. The shorter ray almost straight, tapering from base to sharp point. In a typical case, the basal ray is  $190\ \mu$  long; the longer paired ray  $130\ \mu$  long; and the shorter paired ray  $110\ \mu$  long; all  $16\ \mu$  thick.

Subgastral triradiates (textfig. 6, *e, f*).—Sagittal, with sharply pointed rays of nearly equal thickness. Basal ray straight, tapering from base to sharp point,  $150\text{--}300\ \mu$  long and  $16\text{--}20\ \mu$  thick.

Paired rays much diverging, almost of equal length, slightly curved, 90–170  $\mu$  long and 16–20  $\mu$  thick.

Gastral triradiates (textfig. 6, *g, h*).—Sagittal. Basal ray usually much longer and slightly thinner than paired rays, quite straight, tapering gradually from base to sharp point, 170–230  $\mu$  long and 8–12  $\mu$  thick. Paired rays almost of equal length, straight or slightly curved, gradually and sharply pointed, 90–150  $\mu$  long and 12–16  $\mu$  thick. The spicules closely resemble dermal triradiates but may be distinguished from these by the larger size, by the basal ray being thinner than paired rays, and by their more regular arrangement.

Gastral quadriradiates (textfig. 6, *i, j*).—Similar to gastral triradiates, except in the presence of apical ray. Apical ray very short, thinner than either of the basal or paired rays, slightly curved and gradually sharp-pointed, 40–60  $\mu$  long and 6–8  $\mu$  thick.

Large dermal oxea (textfig. 6, *l, l, m*).—Strongly developed, spindle-shaped, a little irregular in outline, generally broadest at a point nearer proximal than distal end and tapering towards both sharply pointed ends. They are more or less curved, and are of very variable length, 0.49–2 mm. long and 30–90  $\mu$  thick.

Trichoxea of dermal cortex.—Hair-like, straight or slightly curved, generally with the free end broken off, 2–4  $\mu$  thick. A large example measured 700  $\mu$  in length and 2  $\mu$  in thickness.

Trichoxea of oscular margin.—Nearly like those of dermal cortex. Here again, the free end is usually found broken off. An example, incomplete at one end, measured 240  $\mu$  in length and 4  $\mu$  in thickness.

Note.—I have referred this new species to the genus *Heteropia*, chiefly because of the presence in dermal cortex of the large oxea running nearly parallel with the surface. Remarkable is the non

syconoid type of its canal system, in which respect it differs from all other members of the genus. It is evidently a species closely related to *Heteropia glomerosa*.<sup>1)</sup>

Localities.—Kojiro and Aburatsbo, near the Misaki Marine Biological Station.

### Genus **Amphiute** HANITSCH.

#### 7. *Amphiute ijimai*, n. sp.

(Pl. I., fig. 9; Pl. II., fig. 17; textfig. 7).

This new species is represented in the collection by three specimens, all obtained at Dōketsba, Sagami Sea, from a depth of 215–257 m.

The first specimen (Sci. Coll. Spec. No. 18), which I make the type of the species, is a single person of a somewhat curved and laterally compressed, elongate cylindrical form, broadest at a part a little above the middle. The total length is about 60 mm. and the greatest breadth 12 mm. The osculum is in part damaged, besides being in a collapsed state. It shows neither an oscular fringe nor a collar. The gastral cavity is deep and extends throughout the entire length of the sponge. The lower part of the sponge is drawn out in a stalk-like manner, the body in this region being narrowed to a breadth of 5 mm. The dermal surface of the sponge, except in the lower parts, is smooth and shows fine longitudinal striation due to the presence of large oxea in dermal cortex. Thickness of the wall, as measured in the broadest part of the sponge, is about 1 mm. The

---

1) *Leucomia glomerosa* BOWERBANK, Proc. Zool. Soc. London, 1873, pp. 17–19, Pl. IV, Figs. 1–6; *Heteropia glomerosa*, DENDY, 1915 (4), pp. 83–86, Pl. I, Figs. 3, 3a, 3b; Pl. II, Figs. 8a–8g.

colour in alcohol is greyish white. The texture is rather soft and not very compact.

The second specimen (Sci. Coll. Spec. No. 19) consists of a single cylindrical person with the lower parts torn off. It is 37 mm. long and 10 mm. broad in the broadest part, where the thickness of wall is less than 2 mm. The osculum, turned towards one side, is irregular in shape and measures about 3 mm. across in a way. Its margin is very thin and without an obvious fringe or collar. The colour in alcohol is greyish white; the texture is firm and elastic.

The third specimen (Sci. Coll. Spec. No. 28; Pl. I., fig. 9) is rather spindle-shaped and slightly laterally compressed. It measures 80 mm. in total length, 12 mm. in greatest breadth, and about  $1\frac{1}{2}$  mm. in maximum thickness of wall. The osculum at the upper truncate end is almost naked, with thin irregularly undulating margin. It leads into a wide and deep gastral cavity. The narrowed stalk-like base of the sponge is provided with a number of small irregular processes for attachment. The colour in alcohol is white and the texture is fairly firm and elastic.

The following description is based on the type (first) specimen.

#### Canal system (Pl. II., fig. 17).

The canal system stands somewhat intermediate between syllebid and leuconoid types, approaching more nearly the latter than the former. The dermal pores, measuring 80–150  $\mu$  in diameter, are closely distributed all over the surface. Canals starting from several pores join together to form very wide inhalant canals which run deep into the wall. The exhalant canals are also very wide and extend through the greater part of the wall thickness.

They open into the gastral cavity by apertures of 150–250  $\mu$  diameter, separated by interspaces of 50–250  $\mu$ .

The flagellate chambers, densely arranged between inhalant and exhalant canals, are generally of an oval shape, about 80–150  $\mu$  in the shorter diameter. Some of them, especially those in the periphery of the sponge, may be of a more or less elongate shape and are arranged radially around the exhalant canal, thus suggesting the sylleibid condition.

#### Skeleton (Pl. II., fig. 17).

The dermal skeleton is composed of microxea, triradiates, large oxea and the paired rays of subdermal pseudosagittal triradiates. Nearly all the microxea stand vertically to the dermal surface. Those at the oscular margin stand out parallel with the long axis of the sponge. The triradiates are placed tangentially in a few layers, with the basal ray pointing more or less downwards. The large oxea generally run longitudinally, covering all over the sponge surface.

The tubar skeleton is of the inarticulate type, being composed of the centripetal rays of subdermal pseudosagittal triradiates and of the centrifugal rays of subgastral sagittal triradiates. The ends of the rays mentioned usually reach beyond the middle of the wall, and there exist between them no intermediate spicules indicative of an articulate skeleton.

The gastral skeleton is thinner than the dermal and contains the paired rays of subgastral triradiates as well as large oxea and quadriradiates. The oxea nearly resemble those of the dermal cortex, but are much less numerous and somewhat more irregularly placed. The quadriradiates are slender-rayed and fairly large in

number. Their basal rays point downwards, while the apical rays project into the gastral cavity.

### Spicules.

Dermal triradiates (textfig. 7, *a, b*).—Typically slightly sagittal. Basal ray straight, gradually tapering and sharply pointed, either slightly longer or shorter and a little more slender than the paired rays, 80–190  $\mu$  long and 8–12  $\mu$  thick. The paired rays subequal in length, generally straight excepting a slight curvature near base, sometimes a little crooked, gradually tapering, sharp-pointed, 80–180  $\mu$  long and 12–14  $\mu$  thick.

Subdermal triradiates (textfig. 7, *c, d, e*).—Pseudosagittal. All rays of different length and shape. Basal ray longer than the paired rays, straight except being slightly bent near base, gradually sharp-pointed, 280–600  $\mu$  long and 14–16  $\mu$  thick. The shorter of the paired rays is nearly straight, gradually tapering and sharply pointed, 80–170  $\mu$  long and 12  $\mu$  thick. The longer of the paired rays slightly bent near base, sometimes crooked farther out, gradually and sharply pointed; they are as thick as the basal ray and in most cases thicker than the shorter of the paired rays, 150–280  $\mu$  long and 14–16  $\mu$  thick.

Subgastral triradiates (textfig. 7, *f, g*).—Strongly sagittal, with the paired rays very strongly divergent. Basal ray quite straight, and gradually sharp-pointed, 380–880  $\mu$  long and 12  $\mu$  thick. Paired rays almost as thick as the basal ray, equal or slightly differentiated in length, gently curved or crooked, gradually tapering and sharply pointed, 170–220  $\mu$  long and 12  $\mu$  thick.

Gastral quadriradiates (textfig. 7, *h, i*).—Slender; facial rays sagittal in most cases. Basal ray generally the longest, quite straight, distinctly tapering in the basal parts but less so in the

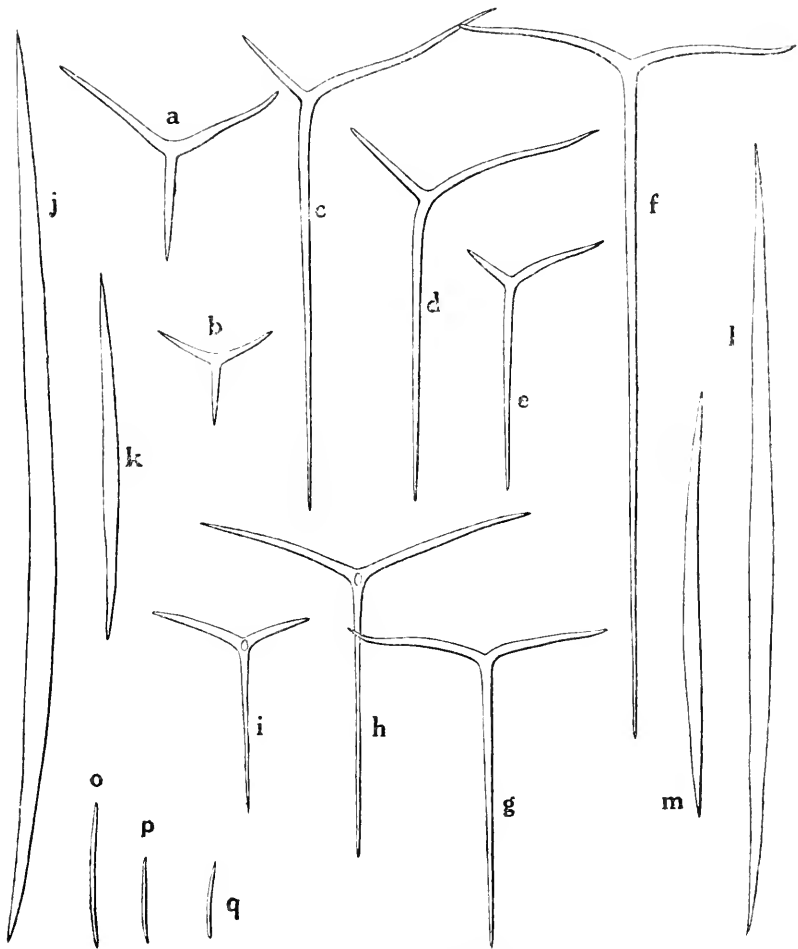

Textfig. 7. *Amphite ijimai*.

- |          |                         |
|----------|-------------------------|
| a, b,    | Dermal triradiates.     |
| c, d, e, | Subdermal triradiates.  |
| f, g,    | Subgastral triradiates. |
| h, i,    | Gastral quadriradiates. |
| j, k,    | Large dermal oxea.      |
| l, m,    | Large gastral oxea.     |
| o, p, q, | Microxea.               |
- (a-i, o-q 100×; j-m, 40×).

remaining greater parts, 230-360  $\mu$  long and 8  $\mu$  thick. Paired rays slightly curved, a little thicker than the basal, with a wide oral angle, generally equally long but sometimes differentiated

in length, nearly uniformly thick in the greater parts of their length, pointed at end, 90–230  $\mu$  long 12  $\mu$  thick. Apical ray almost straight, sometimes slightly crooked in the apical parts, gradually sharp-pointed, under 150  $\mu$  length and 8  $\mu$  thickness.

Large oxea of dermal cortex (textfig. 7, *j, k*).—Usually large, straight or slightly curved, thickest at about the middle, gradually tapering towards sharp-pointed ends, 1.2–3 mm. long and 50–80  $\mu$  thick.

Large oxea of gastral cortex (textfig. 7, *l, m*).—Nearly similar to those of dermal cortex, being differentiated from these only in the fewer number and in the less regular arrangement.

Microxea (textfig. 7, *o, p, q*).—Generally slightly curved, nearly uniformly thick throughout their length, and pointed at both ends, 110–210  $\mu$  long and 6–8  $\mu$  thick.

Note.—This species appears to be referable to *Amphiute* HANITSCH, by the presence of subdermal pseudosagittal and subgastral triradiates and of the large longitudinal oxea in both dermal and gastral cortices. But it differs in several respects from the only other known species of the genus *Amphiute paulini*, which was first described by HANITSCH (1, 2) and afterwards also by BREITFUSS (4) from the west coast of Portugal. The difference consists chiefly in the present form being solitary, in the osculum being destitute of a distinct and conspicuous fringe, and in the dimensions and other details of the characters of most spicules.

I take pleasure in naming this interesting species after Professor IJIMA.

Locality.—Dōketsba, Sagami Sea.

---

## List of References.

- Arnesen, E.** (1) (1901). Spongier fra den norske kyst. I. Calcarea. Systemmatisk katalog med bemerkinger og bestemmelsestabel. Bergens Mus. Aarbog, 1900 (1901), No. 5.
- Bowerbank, J. S.** (1) (1872-1876). Contributions to a General History of the Spongiadae. Proc. Zool. Soc. London, 1872, pp. 115-129, 196-202, 626-634, Pl. V, VI, X, XI, XLVI-XLIX; 1873, pp. 3-25, 319-333, Pl. I-IV, XXVIII-XXXI; 1874, pp. 298-305, Pl. XLVI, XLVII; 1875, pp. 281-296; 1876, pp. 768-775, Pl. LXXVIII-LXXXI.
- Breitfuss, L.** (1) (1896). Kalkschwämme der Bremer-Expedition nach Ost-Spitzbergen im Jahre 1889 (Prof. W. KÜKENTHAL und Dr. A. WALTER). Zool. Anzeiger, Bd. XIX, No. 514, pp. 426-432.
- (2) (1897). Catalog der Calcarea der zoologischen Sammlung des königlichen Museums für Naturkunde zu Berlin. Arch. für Naturgesch., Jahrgang LXIII, Bd. 1, pp. 205-226.
- (3) (1898). Kalkschwammfauna des weissen Meeres und Eismeerküsten des europäischen Russlands mit Berücksichtigung und Aufstellung der Kalkschwammfauna der arktischen Region. Memoires de l'Acad. Imperiales Sciences, St. Petersbourg, (Ser. 8), Vol. VI, No. 2, Taf. I-IV.
- (4) (1898). Kalkschwammfauna der Westküste Portugals. Zool. Jahrb. Syst. Abt. Bd. XI, pp. 89-102, Taf. XI.
- (5) (1898). Kalkschwammfauna von Spitzbergen. Nach dem Sammlung der Bremer-Expedition nach Ost-Spitzbergen im Jahre 1889 (Prof. W. KÜKENTHAL und Dr. A. WALTER). Zool. Jahrb. Syst. Abt. Bd. XI, pp. 103-120, Taf. XII, XIII.
- Carter, H. J.** (1) (1885-1886). Descriptions of Sponges from the Neighbourhood of Port Phillip Heads, South Australia. Ann. Mag. Nat. Hist., (Ser. 5), Vol. XVII, pp. 431-441, 502-516; Vol. XVIII, pp. 34-55, 126-149.

- Carter, H. J.** (2) (1886). Description of a new species (*Aphroceras ramosa*). (in HIGGIN, T., Report on the Porifera of the L.M.B.C. district). Proc. Lit. Phil. Soc. Liverpool, Vol. XL. Appendix.
- Dendy, A.** (1) (1892). Synopsis of the Australian Calcareous Heterocoela; with a proposed Classification of the Group and Descriptions of some New Genera and Species. Proc. Roy. Soc. Victoria, (n.s.), Vol. V, pp. 69-116.
- (2) (1893). Studies on the Comparative Anatomy of Sponges. V. Observations on the Structure and Classification of the Calcareous Heterocoela. Quart. Journ. Microsc. Sci., (n.s.), Vol. XXXV, pp. 159-257, Pl. X-XIV.
- (3) (1913). Report on the Calcareous Sponges collected by H.M.S. "Sealark" in the Indian Ocean. Trans. Linnean Soc. London, Zool. Vol. XVI. Part. I, pp. 1-29, Pl. I-V.
- (4) (1915). Report on the Calcareous Sponges collected by Mr. JAMES HORNELL at Okhamandal in Kattiawar in 1905-6. Report to the Government of Baroda on the Marine Zoology of Okhamandal in Kattiawar, Part II, 1915.
- Dendy, A. and Row, W. H.** (1) (1913). The Classification and phylogeny of the Calcareous Sponges, with a Reference List of all the described Species, systematically arranged. Proc. Zool. Soc. London, 1913, pp. 704-813.
- Haeckel, E.** (1) (1872). Die Kalkschwämme, eine Monographie. Berlin, 1872.
- Hanitsch, R.** (1) (1894). Amphite, eine neue Gattung heteroceler Kalkschwämme. Zool. Anzeiger, Vol. XVII, p. 433.
- (2) (1895). Notes on a Collection of Sponges from the west coast of Portugal. Trans. Liverpool Biol. Soc., Vol. IX, pp. 205-219, Pl. XII, XIII.
- Jenkin, C. F.** (1) (1908). The Marine Fauna of Zanzibar and British East Africa, from Collections made by CYRIL CROSSLAND, M. A., in the Years 1901 and 1902. The Calcareous Sponges. Proc. Zool. Soc. London, 1908, pp. 434-456.

- Lambe, L. M.** (1) (1900). Sponges from the Coast of North-eastern Canada and Greenland. *Trans. Roy. Soc. Canada, (Ser. 2), Vol. VI, Sect. 4*, pp. 19-49, Pl. 1-VI.
- Lendenfeld, R. von.** (1) (1885). A Monograph of the Australian Sponges. Part III. The Calcispongiæ. *Proc. Linn. Soc. New South Wales, Vol. IX*, pp. 1083-1150, Pl. LIX-LXVII.
- Polejaeff, N.** (1) (1883). The Calcarea. Report on the Scientific Results of the Voyage of H.M.S. Challenger, *Zoology, Vol. VIII*.
- Preiwisch, J.** (1) (1904). Kalkschwämme aus dem Pacific. Ergebnisse einer Reise nach dem Pacific, Schauinsland 1896-1897. *Zool. Jahrb. Syst. Abt., Bd. XIX*, pp. 9-26, Taf. II-IV.
- Ridley, S. O.** (1) (1881). Spongida, Account of the Zoological Collections made during the Survey of H.M.S. Alert in the Straits of Magellan and on the Coast of Patagonia. *Proc. Zool. Soc. London, 1881*, pp. 107-137, Pl. X, XI.
- Row, W. H.** (1) (1909). Report on the Sponges Collected by Mr. CYRIL CROSSLAND in 1904-5. Part I. Calcarea. *Journ. Linn. Soc. London, Zoology, Vol. XXXI*, pp. 182-214, Pl. XIX, XX.
- Schuffner, O.** (1) (1877). Beschreibung einiger neuer Kalkschwämme. *Jenaische Zeitschr. Vol. XI*, pp. 403-433, Pl. XXIV-XXVI.



S. HOZAWA:  
ON SOME JAPANESE CALCAREOUS SPONGES.

PLATE I.

### Plate I.

- Fig. 1. *Grantessa slimeji*, n. sp.; natural size.
- Fig. 2. *Grantessa slimeji*, n. sp.; natural size.
- Fig. 3. *Grantessa sayamiana*, n. sp.; natural size.
- Fig. 4. *Grantessa intusarticulata* (CARTER); natural size.
- Fig. 5. *Grantessa intusarticulata* (CARTER); natural size.
- Fig. 6. *Grantessa basipapillata*, n. sp.; natural size.
- Fig. 7. *Grantessa mitsukurii*, n. sp.; natural size.
- Fig. 8. *Heteropia striata*, n. sp.; natural size.
- Fig. 9. *Amphiute ijimai*, n. sp.; natural size.



*Fig. 3*

*Fig. 1*

*Fig. 4*

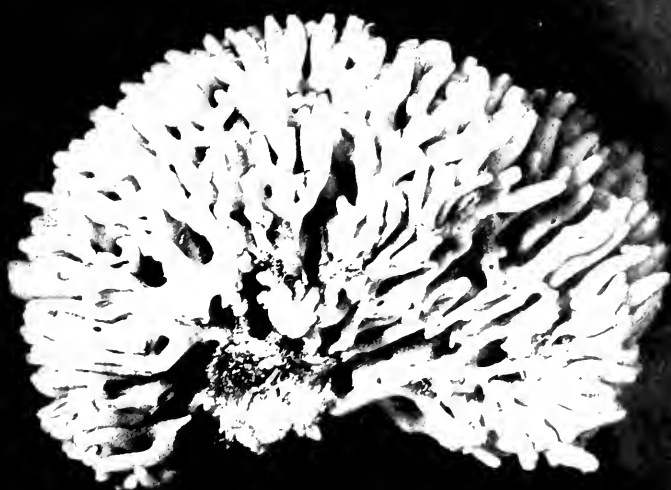

*Fig. 5*



*Fig. 7*



*Fig. 2*

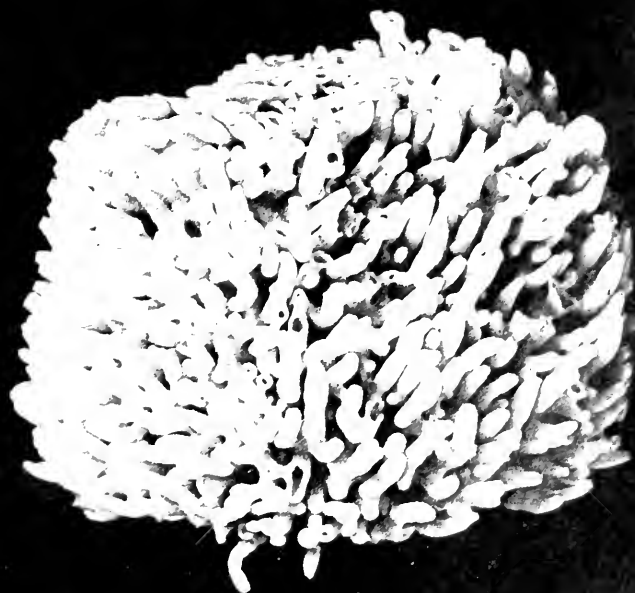

*Fig. 6*



*Fig. 9*



*Fig. 8*





S. HŌZAWA :  
ON SOME JAPANESE CALCAREOUS SPONGES.

PLATE II.

## Plate II.

- Fig. 10. *Grantessa shineji*, n. sp.  
Part of a horizontal section ; 150 × .
- Fig. 11. *Grantessa shineji*, n. sp.  
Part of a horizontal section ; 150 × .
- Fig. 12. *Grantessa sagamiana*, n. sp.  
Part of a horizontal section ; 100 × .
- Fig. 13. *Grantessa intusarticulata* (CARTER).  
Part of a horizontal section ; 100 × .
- Fig. 14. *Grantessa basipapillata*, n. sp.  
Part of a horizontal section ; 100 × .
- Fig. 15. *Grantessa mitsukurii*, n. sp.  
Part of a horizontal section ; 100 × .
- Fig. 16. *Heteropia striata*, n. sp.  
Part of a horizontal section ; 150 × .
- Fig. 17. *Amphiute ijimai*, n. sp.  
Part of a horizontal section ; 100 × .

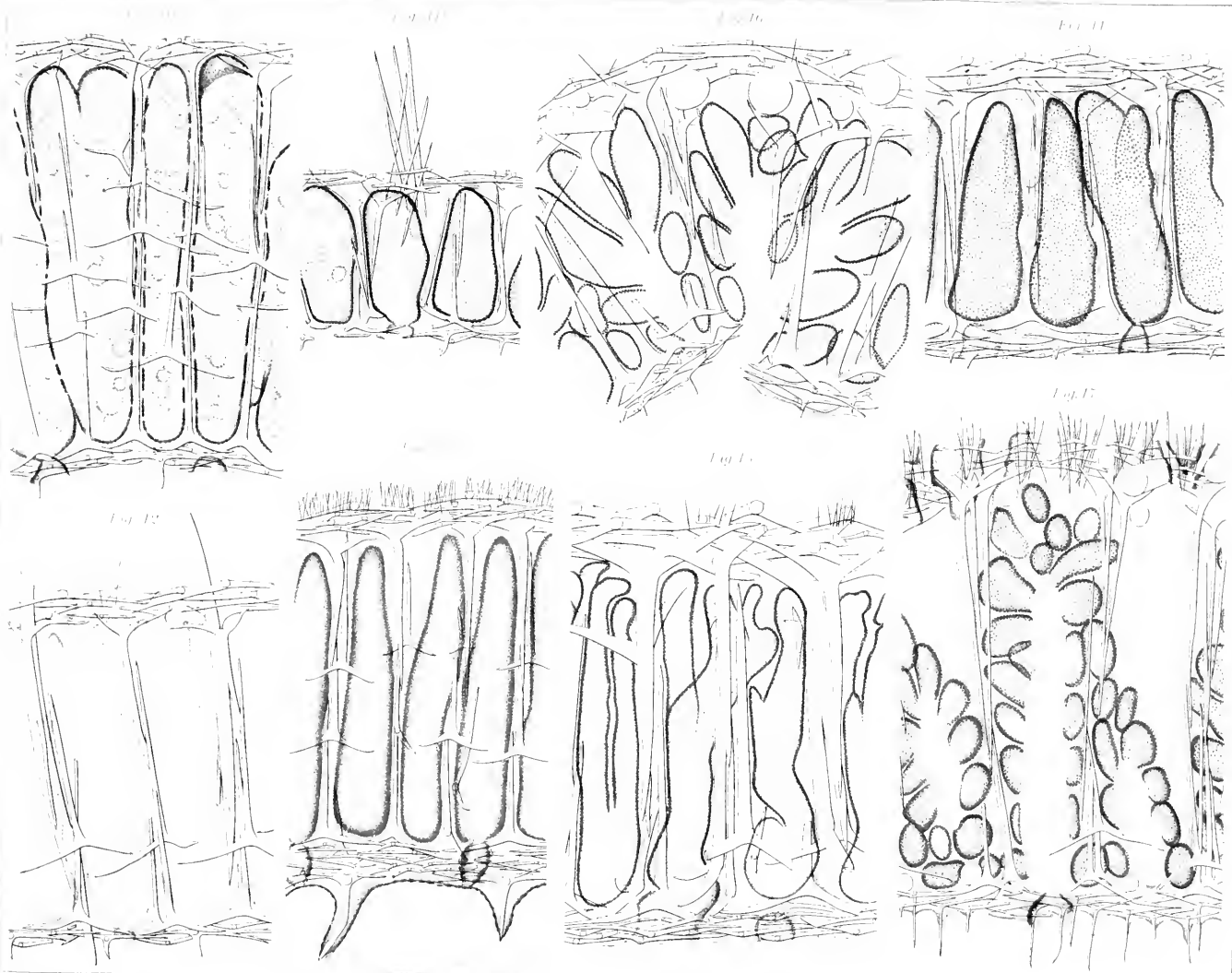

S. II. *Fig. 1-10.* Japanese Calcareous Sponges.



## Injection Experiments on Plants.

By

**Yasutaro YENDO**, *Rijakushi, Nōgakushi.*

---

*With two Plates.*

---

### I. Introduction.

The first experiments of injections into the plant body were made by ERHART (1) and REICHARD. They experimented with 8 species of plants, employing various solutions, and showed the possibility of introducing by injection extraneous substances into the sap of the plant body although the effects varied according to the material employed.

Some experiments have recently been made for particular purposes, in which the injection method was used. WEBER (2) succeeded, for example, in influencing the unfolding of winter buds by means of a water-injection, JESENKO (3) made similar researches, employing certain chemical substances. On the whole, the investigations which hitherto have been made on this subject are scanty, but interesting in the results.

As Prof. MIYOSHI (4) has remarked, the organisation of plants differs from that of animals in respect to the imperfectness of the circulating system and the higher grade of individuality of several parts, so that we cannot expect to apply the injection

method to a plant so effectively as is done with animals. If we should succeed, however, in making particular chemical substances circulate in a certain measure through the body of plants, it might be possible to stimulate their development or to cure them of diseases, and moreover, to render them immune by the injection of certain substances.

The scope of the present study is to answer the following questions :—

1) Is it possible that a certain amount of a substance injected into a certain part of the plant body, is conducted through the entire plant? In other words, how far and to what part is an injected solution conducted during a definite time?

2) How does the effect of injection differ according to the kinds of plants, organs and tissues?

The present investigation was carried out at the suggestion and under the guidance of Prof. M. MIYOSHI, during the academic year of 1911–12 in the Botanical Institute of the College of Science, Imperial University of Tokyo. I beg here to express my gratitude to him for his generous assistance and advice.

## II. Method of injection.

A medical syringe, provided with measured shaft and 1.5 c.cm. in volume, was employed. Usually the injection was made by inserting the cannula into the plant body deeply and obliquely, until it touched a vascular bundle; in the case of injecting into a hard tissue of a plant, a slit was made with a knife and then the syringe was applied.

We have to ascertain into what parts the injected solution penetrates and how far the fluid reaches. On injecting a coloured solution I observed that it enters the air-containing intercellular



spaces and the lumen of vascular bundles more easily than the interior of the cells.

The range attainable by the injected solution may differ in accordance with the structure, size and nature of the plant, the direction of the injecting needle applied, the intensity of the pressure of injection, the amount of the solution injected, etc. I found by my experiments that the injected solution, 0.03 c.cm.—0.15 c.cm. in volume, does not extend far from the point of injection, but is arrested within a few centimeters.

### III. Experiments with various injection solutions.

The following aqueous solutions were used in my experiments :—

- |                     |                |
|---------------------|----------------|
| 1) Lithium nitrate, | 1% ; 5% ; 10%. |
| 2) Copper sulphate, | 1% ; 5%.       |
| 3) Eosin,           | 0.5%.          |
| 4) Aniline violet,  | 0.2%.          |

Lithium is a metal which is not usually found in the plant body, but there are some plants containing it normally (TSCHEK 5), hence in experimenting with a lithium salt solution, we must take care to choose a plant which is free from it.

Lithium salts act poisonously on several plants (GAUNERSDORFER, 6) even in small quantities, but as its toxicity is not so intense as that of  $\text{SO}_4\text{Cu}$  or eosin, and moreover, as it is quickly carried through the plant body, it may most suitably be used for our purpose. A minute amount of lithium is readily detectable spectroscopically and we can roughly determine its amount from the intensity and duration of the red lithion line (TRUCHOT, 7). Observation has shown that it is sometimes obscured by the presence of too many other metal-lines appearing in the spectrum.

Though I mainly used solutions of lithium nitrate, those of  $\text{SO}_4\text{Cu}$ , eosin and aniline violet were also employed for the purpose of tracing microscopically the path through which they are conducted, and to compare the modes of conduction.

#### IV. Injection experiments on several plant-organs.

Organ injected	Plant name	No. of exp.	Remarks
Root	<i>Rhaphanus sativus</i>	67, 71	conical, fleshy.
"	<i>Taraxacum officinale</i>	10	contains milky juice.
Rhizome	<i>Carex pumila</i>	25	jointed.
"	<i>Menianthes trifoliata</i>	28	lacunose.
"	<i>Calystegia soldanella</i>	13	contains milky juice.
"	<i>Equisetum arvense</i>	42	
"	<i>Nuphar japonicum</i>	32	submerged.
Bulb	<i>Narcissus papyraceus</i>	22	coated.
"	<i>Solanum tuberosum</i>	11	a tuber.
Stem	<i>Cornus controversa</i>	5	woody.
"	<i>Canna lutea</i>	18	
"	<i>Setaria sp.</i>	19	a culm.
"	<i>Ricinus communis</i>	6	jointed, provided with a medullary hole.
"	<i>Cosmos bipinnatus</i>	5	
"	<i>Trichosanthes cucumeroides</i>	15	succulent, climbing.
"	<i>Pueraria Thunbergiana</i>	17	hard, climbing.
"	<i>Lycopodium clavatum</i>	41	creeping.
"	<i>Potamogeton polygonifolius</i>	37	slender, submerged.
"	<i>Myriophyllum spicatum</i>	34, 35	do.
"	<i>Cercus serpentinus</i>	61	fleshy.
Cotyledon	<i>Vicia Faba</i>	12	fleshy.
Petiole	<i>Magnolia hypoleuca</i>	4	
"	<i>Aspidium lacinum</i>	39	

Petiole	<i>Trachycarpus excelsa</i>	60	
Leaf	<i>Allium fistulosum</i>	62, 69, 72	
"	<i>Rhoco discolor</i>	20, 21	
"	<i>Narcissus papyraceus</i>	23	
"	<i>Cotyledon malacophylla</i>	9	succulent.
"	<i>Typha japonica</i>	36	lacunose.
Inflo- rescence	<i>Fatsia japonica</i>	1	
"	<i>Narcissus papyraceus</i>	24	
"	<i>Nuphar japonicum</i>	30	
Fruit	<i>Citrus nobilis</i>	3	a hespidium.

### V. Injection into parenchymatous tissue.

(Compare exp. 77-83.)

For these experiments, we must choose plants with thick parenchymatous tissue, so that the injection may be performed with ease. When injecting into the cortical parenchymatous tissue, the needle was inserted as little as possible, nearly parallel to the surface of that part, and then the solution was gently injected. Injection into the medullary parenchymatous tissue often proves difficult as it is necessary to expose a part of the pith by cutting out some parts of the outer tissues (cortical tissues and vascular bundles) with a sharp knife. The needle must be introduced deeply into the pith and brought as nearly parallel as possible to the axis of this; then the injection should take place gently and with great care, so as to avoid over-injection into other parts. For a plant having a wide medullary cavity (e.g. *Vicia Faba*), there may be no need of cutting off the outer tissues, since the medullary air-space readily takes up the solution injected. In this case, insert the tip of the cannula into the medullary cavity, piercing the body

wall of the plant, and then inject the solution very slowly so as to avoid excess.

I experimented with *Vicia Faba* (exp. 79), applying the aniline violet solution, and observed that the solution injected into the medullary cavity was at first absorbed by the innermost layer of pith-cells and was then carried by degrees through the pith-cells toward the vascular bundles, so that it penetrated almost all the pith and xylem parts. The walls of the xylem elements were especially well tinged by it (see Pl. II, Fig. 2), while the outer tissues (i.e. cambium, phloëm and primary cortex) remained entirely free of it. This proves that the dye is carried to a distance only through the xylem elements.

In the case of lithium solutions applied, I invariably observed that lithium was conducted through the cortical and medullary parenchymatous tissues, but it is certain that the longitudinal conduction is accomplished by the vascular bundles. We may affirm from these facts that the parenchymatous cell is capable of conducting certain injected substances, but its power of conduction is feeble in comparison with that of conducting tissues proper.

## VI. Experiments in the moist chamber.

I made some injection experiments in the moist chamber with *Vicia Faba*. The results (see exp. 48A, 49) agreed in all cases; namely, the injected substance was carried not only upwards but also downwards from the stem into which it was introduced, and penetrated the branches attached to the stem at tolerable distances below the point of injection. Lithium was detected, in this case, in the petioles and midribs of most of the leaves, but never in the blades (small veins and mesophyll). In the control plant (exp. 48B), however, it was present especially in the

blade, with the exception of young terminal leaves, and the downward conduction did not occur conspicuously as a rule. This marked difference must be due to the absence of transpiration.

### **VII. Experiments on some deciduous trees in winter and early spring.**

(See exp. 50-58.)

In order to observe the mode of conduction in deciduous trees in winter and early spring, some injection experiments were performed. From these experiments it was found that lithium was carried upwards to a considerable distance from the injected point, but downwards only to a comparatively short distance; the conduction in these plants, however, is feebler than that in leafy plants.

I observed in *Cornus controversa* that the conduction of lithium gradually increased in early spring; in the leafless plant in winter (exp. 53-55) lithium was not carried far, even after a considerable lapse of time; when the plant was at the bleeding period in early spring and the buds had unfolded a little, an increase in the rate of conduction was observed (exp. 56), but lithium did not yet reach the buds (Pl. II, Fig. 5. A). Only when the young leaves attained about 3 cm. in length, (Pl. II, Fig. 5. B) it was found in them for the first time (exp. 57). We may infer from these experiments that transpiration plays the most important rôle in the conduction of the injected substance, although osmotic action of cells and the root-pressure etc. have more or less influence.

### **VIII. Experiments on some Thallophytes.**

As will be seen in the experimental data (43, 44), certain fungi distinctly showed the conduction of lithium through their

body. In *Cortinellus edodes* (exp. 45) I observed that the upward conduction was more extensive to the downward one and that the transverse conduction occurred within a certain limit. In *Usnea barbata* v. *scabrosa* (exp. 46), no conduction of lithium was observed. As regards algæ (OLTMANN'S, 15), most of them are too compactly structured and their cells filled with slimy or watery contents, so that there exists in them no space to receive injections, making them unsuited for injection experiments. *Eisenia* and *Ecklonia* were employed in my experiments, since they have rather loosely constructed medulla.

The algae were examined immediately after the injection, and I have found that hyphae, siebhyphae as well as the slimy substance, were well tinged in the injected part of the medulla; and in the case of eosin injection the contents in the siebhyphae were especially deeply coloured.

The algae which were subjected to injection were kept in a sea-water reservoir at the sea-shore during the experiment.

The results indicated that the injected pigment gradually discoloured in the course of time, and after a few days it was found very slightly in the injected parts, the hyphae as well as the slimy substances were almost entirely gone, but frequently a few inner rows of the cortical cells were found slightly tinged. In using  $\text{SO}_4\text{Cu}$  (exp. 63) and  $\text{LiNO}_3$  as injection material, similar results were obtained.

*Bryopsis pulmosa*, a unicellular plant, may be worth investigation, to observe the conduction of injected substances. The injected colouring matter was visible through its transparent cell-wall; the arrangement of the contents was disturbed and well permeated by the injected solution. The injected plants were kept under sea-water, and observations were made at intervals.

The result showed that conduction of the injected substances could not be seen, and they discoloured in the course of time (exp. 64, 70, 73).

The lithium injection was also performed with this plant, but no conspicuous transportation was observable (exp. 64).

In short, we conclude from these experiments, that no conduction of the injected substance occurs, but merely diffusion, and some parts of the injected solution gradually pass out of the injected wound into the sea-water.

## IX. Discussion of the results.

### 1. RELATION BETWEEN TRANSPIRATION AND CONDUCTION OF INJECTED SOLUTION.

The experimental data given below show that an injection solution, especially lithium, when injected into a stem is always carried toward the transpiring organs, the leaves; but not so much to other organs, e.g. inflorescences (exp. 6, *Ricinus communis*, Pl. I, Fig. 5), buds and young organs, e.g. young leaves, terminal buds, young shoots; moreover, lithium when injected into a cotyledon, rhizome, bulb and root is carried toward the shoot. In the case of transpiration having been retarded, the conduction of the injected solutions always diminishes. For instance, *Vicia Faba* (exp. 48, 49) cultured in the moist chamber, as above mentioned, showed certain differences from the control plants. The experiments on deciduous trees in winter indicated that the conduction of lithium is feeble than that in leafy plants. It is manifest from these facts that transpiration plays an important rôle in conducting the injected solution.

In the experiment with the inflorescence of *Fatsia japonica*

(exp. 1. Pl. I, Fig. 1), I distinctly found lithium in flowers which were just opening, but never in flower-buds and fruits. In *Narcissus papyraceus* (exp. 24), lithium was found in the uppermost opened flower, but scarcely in lower flower-buds which were covered with a broad bract. In these instances, we see that the injected substance is apt to be carried to the most transpiring part.

I will now describe the results of the experiment on water-plants. When the terminal portion of *Myriophyllum* (exp. 35, Pl. I, Fig. 7) emerged from the water, lithium when injected in the submerged part of the stem, was detected abundantly in the aerial parts, more especially in the leaves, whilst it was almost absent in the submerged ones. A little lithium was also found in the emerged inflorescence of *Potamogeton crispus*, but it was not detectable in the submerged leaves (exp. 38).

Submerged plants, having no transpiring parts, also indicated conduction (THODAY, SKYKES, SNELL, 12, 13) of injected lithium; in these plants, however, lithium was usually not detectable in the lamina even in the case of its evident presence in the petiole and midrib, for example, in submerged forms of *Nuphar japonicum* (exp. 29, 32). In the case of slender submerged forms, as *Myriophyllum spicatum*, I could not detect lithium throughout the body (exp. 34), and after a few days lithium was not found even in the injected part.

I wished to ascertain whether these submerged forms, which were employed in my experiment, are capable of conducting lithium, or not. Some *myriophyllum* plants, firmly fixed by means of cotton wool, were inserted into a hole bored in the cork of a small glass-vessel which was filled with 2.5%  $\text{LiNO}_3$  solution, and kept under water during the experiment. I examined them on



the following day, and confirmed that lithium was present throughout the long stem, but less in the leaves.

We may infer from this demonstration, that in the case of injection, lithium can be more or less conducted through the body of the submerged water-plant, but the quantity of lithium conducted is so minute, that I could not detect it spectroscopically. As to the fact, that lithium, being conducted, was not stored up in the submerged body, but was lost from the injected part in course of time, we may imagine that lithium in part exudes out of the water-pores of the leaf or other parts into the surrounding water, and in part diffuses into the water from the wound made by the injecting needle.

## 2. UPWARD CONDUCTION AND DOWNWARD CONDUCTION.

We should not leave the fact unnoticed that the injected solution was conducted not only in an upward direction but also more or less downward, which we see in almost all of the experimental data. The upward conduction, as a rule, was observed most conspicuously, especially in the case of transpiring organs. I observed that lithium travelled up to a distance of 337 cm. in *Trichosanthes cucumeroides* (exp. 15) and 203 cm. in *Cornus controversa* (exp. 5). Here I may tabulate the comparison of upward and downward conduction, taking examples obtained in my experiments, as follows.

Plant name	No. of exp.	Upward conduction in cm.	Downward conduction in cm.
<i>Fatsia japonica</i>		34.5	2
<i>Cornus controversa</i>	5	203	—
<i>Canna lutea</i>	18	57	68.5
<i>Setaria sp.</i>	19	133	2
<i>Allium fistulosum</i>		20	8
<i>Rhoco discolor</i>	20	9.5	2.5
” ”	21	10	1.5
<i>Celosia cristata</i>		44	5
<i>Euphorbia heterophylla</i>		57	2
<i>Carex macrocephala</i>	26	49	12
<i>Cosmos bipinnatus</i>	7	89	80
<i>Asclepias curassavica</i>		22	10
<i>Tetragonia expansa</i>	8	21	19 plus.
<i>Cotyledon malacophylla</i>	9	11	1.3
<i>Platanus orientalis</i>		35	5
<i>Rhaphanus sativus</i>		5	2.5
<i>Vicia Faba</i>		8	6
<i>Calystegia soldanella</i>	13	21	37
<i>Trichosanthes cucumeroides</i>	15	337	10
<i>Pueraria Thumbergiana</i>	17	197	7
<i>Jussiaea repens</i>		30.5	16
<i>Cereus serpentinus</i>	61	31	7
<i>Lycopodium cerinum</i>	40	9.5	1.5
<i>Lycopodium claratum</i>	41	2	25
<i>Equisetum arvense</i>	42	18	7
<i>Cortinellus edodes</i>	45	6.5	1

As we see in the above table, upward conduction exceeds the downward in many instances, but sometimes a vigorous downward conduction<sup>1)</sup> occurs. In *Canna lutea* (exp. 18), I observed that the injected lithium not only descended through the stem down to its base but was also conducted into all leaves which attach to every node.

A marked downward conduction also occurred when injection was made in the leaf, flower-stalk, fruit, etc.

SO<sub>4</sub>Cu was injected into the leaf-sheath of *Allium fistulosum* and penetrated down to the rhizome (exp. 62). In *Narcissus papyraceus* (exp. 23, 24), lithium, when injected into the leaf or scape, was found in the rhizome and most coats of the bulb, moreover it was also conducted up to other leaves and the scape. In *Citrus nobilis* (exp. 3, Pl. I, Fig. 2), lithium, when injected into the fruit, was conducted backwards through the fruit-stalk and branch and into 4 leaves.

When injection was made into a long rhizome or stolon, I often observed conduction in both directions, forwards and backwards, (exp. 13, *Calystegia soidanella*; exp. 14, *Lactuca repens*; exp. 36, *Carex macrocephala*; exp. 42, *Equisetum arvense*).

Indeed, I observed in *Carex pumila* (exp. 25) that lithium travelled through the rhizome fore and backwards, passing through the erect shoots one by one.

In the experiments with leafless deciduous trees in winter or early spring I could also confirm that both conductions occurred, the upward being more vigorous than the downward one.

---

1) SCHECHNER (16) mentioned that a vigorous downward current is due to the inversion of the osmotic ratio and according to BOEHM'S (17) view it occurs when the earth is relatively dry and the sap-conducting vessels filled with water.

Plant name	No. of exp.	Upward conduction in cm.	Downward conduction in cm.
<i>Hamamelis japonica</i>	50	30	20
<i>Cornus officinalis</i>		44	17
<i>Fagus sylvatica</i>	51	15	9 plus.
<i>Calycanthus praecox</i>	52	6	2
<i>Cornus controversa</i>	53	32	15
„	54	67	24
„	55	74	10
„	56	19	3
„	57	57	25
<i>Prunus mutabilis</i>	58	32	1.5

### 3. TRANSVERSE CONDUCTION.

The injected solution was conducted not only longitudinally but also more or less transversely (GAUNERSDORFER, 6). In *Cornus controversa* (exp. 54, 55) lithium was found in the wood of the injected side of the stem considerably wider and deeper than the dimension of the wound in which the injection was made, but did not spread so much as to reach the opposite side.

In the case of a smaller stem, lithium was present throughout, but the amount of lithium in the injected side always exceeded that in the other parts.

We learn roughly from these facts that transverse conduction takes place moderately through the lignified wood. I also observed less transverse conduction in plants whose vascular bundles are arranged separately, being interjected by soft parenchymatous cells.

An apparent transverse conduction often occurred in plants which have transverse connections among the longitudinal vascular

bundles; in this case, the transverse connections may effect that conduction, for example, in the parallel-veined leaf of *Rhoco discolor*, provided with many delicate transverse connections among the longitudinal veins, I observed that lithium was conducted transversely to the margin (exp. 20, 21, Pl. I, Fig. 4. A, B).

### 3. SPEED OF CONDUCTION OF THE INJECTED SOLUTION.

A rough idea about the rapidity of movement of the injected substance was arrived at in my experiments. It was ascertained that the speed varied according to the substance employed; lithium was carried most rapidly, but  $\text{SO}_4\text{Cu}$  and eosin less rapidly, and aniline dyes the least. Indeed, aniline violet was conducted so slowly that it was left just as it was in the injected part, even for some hours, but was then slowly conducted upwards and at last so far that the extension was no longer detectable.

After some comparative experiments, I confirmed that the rate of conduction of several aniline dyes (OVERTON, 8), varies according to their kind, i.e. a basic aniline dye (for example dahlia-violet), was less conductible than an acid one (for example congo-red or indigocarmine).

The relative rapidity of movement, however, depends on the concentration of the substance employed, because the proportion of osmosis and diffusion may be altered by varied concentration of a solution (GAUNERSDORFER, 6). To ascertain this fact, I demonstrated with the leaf of *Plusia japonica*, applying  $\text{LiNO}_3$  (10%, 5%, 1%) solutions. After a certain time, the leaves were removed from the stem, several deep incisions were made with a knife along the petiole, in order to break the continuity of conduction, then examined spectroscopically.

0.03 c. cm. of the solutions was injected in each case.

Date of injection and remarks	Duration of exp.	% of Li NO <sub>3</sub>		
		1%	5%	10%
Nov. 30. A.M. 10° 37 <sup>m</sup> -43 <sup>m</sup> . Fine weather, somewhat windy Humid. = 48°-42° Temp. = 14°-15°	1 <sup>hour</sup>	1.8 <sub>cm.</sub>	2.0 <sub>cm.</sub>	2.3 <sub>cm.</sub>
Dec. 1. A.M. 9° 20 <sup>m</sup> -30 <sup>m</sup> . Fine weather Humid. = 61°-63° Temp. = 11°-12°	7 <sup>hs</sup> 20 <sup>ms</sup>	3.6 <sub>cm.</sub>	5.4 <sub>cm.</sub>	9.0 <sub>cm.</sub>
Dec. 6. A.M. 10° 20 <sup>m</sup> -24 <sup>m</sup> . Fine weather Humid. = 75°-55° Temp. = 14°-18°	5 <sup>hs</sup> 40 <sup>ms</sup>	2.8 <sub>cm.</sub>	4.5 <sub>cm.</sub>	6.0 <sub>cm.</sub>
The distances are those of upward con- duction.				

The above table shows that a 10% solution has been conducted to the farthest distance, while a 5% solution was not so conspicuous, and a 1% solution the least.

##### 5. CONDUCTING PATH OF INJECTED SOLUTIONS.

Applying the aniline violet solution to *Vicia Faba*, I observed that the dye was conducted only through the xylem portion, i.e. the lignified walls of the xylem elements were deeply coloured and contents of the xylem parenchyma cells more or less coloured (Pl. II, Fig. 2). In the rhizome of *Menianthes trifoliata*, I also observed that eosin was conducted most easily through xylem portions, especially vessels (Pl. II, Fig. 3). However, in most cases, phloëm elements as well as parenchymatous tissues were penetrated in various degrees by injected substances. I observed in the ex-

periments on *Cereus serpentinus* (exp. 61) and *Trachycarpus excelsa* (exp. 60, Pl. II, Fig. 4), that  $\text{SO}_4\text{Cu}$  was more abundantly present in the phloëm than in the xylem. In *Lycopodium cernuum* the central cylinder, more especially the xylem parenchyma cells which enclose the vessel, contained much  $\text{SO}_4\text{Cu}$ , and the cortical sclerotic cells more or less of it.

In the experiments with  $\text{LiNO}_3$  solutions I ascertained that lithium was chiefly found not only in the wood, but also more or less in the bark and pith.

In short, we may infer from these facts that the injected solution is conducted most easily through the xylem elements, but also penetrates the phloëm parts and other tissues in some degree. The rate of penetration of course varies according to the substance.

#### 6. INJECTION METHOD AS A MEANS FOR TRACING THE COURSE OF A VASCULAR BUNDLE

Many physiologists have investigated the course of the transpiration-current by placing cut branches in the solution of a colouring matter (PFEFFER, 11) or by means of precipitates (DIXON, JULY, 20). As I had opportunity to observe this phenomenon, some instances may be mentioned.

A small quantity (0.03–0.15 c.cm.) of 5%  $\text{SO}_4\text{Cu}$  solution was injected into the petiole of *Fatsia japonica* on the upper side and examined after a certain time. Tracing the vascular bundle which contains  $\text{SO}_4\text{Cu}$  (Pl. II, Fig. 1, C), I found that it divides into some veinlets (*b'*) at the basal part of the blade, and they assemble as if forming a plexus (*e'*) with veinlets of other vascular bundles, but again separate from one another (*d'*) and then run into the blade as palmate veins, some grouping together where they arrange themselves in horse-shoe shape (*e'*) as seen in cross section. It is

interesting that the bundles containing  $\text{SO}_4\text{Cu}$  are regularly situated on the upper side of the horse-shoe shaped vascular bundle groups in all the palmate veins. Many veinlets are given off from the palmate veins and terminate in the parenchymatic mesophyll, forming a network which is often blackened, due to the action of  $\text{SO}_4\text{Cu}$  (Pl. II, Fig. 1, D).

The lithium injection was made into the pulvinus of a leaf of *Magnolia hypoleuca* (exp. 4, Pl. I, Fig. 3). The point of injection was situated on one side of the pulvinus. The result obtained was that lithium was found in only one half of the blade. This shows that a vascular bundle in the pulvinus runs through the midrib and branches off as veins and veinlets only on one side of the blade, but not on the other. A similar case occurred in the experiment with the pinnate leaf of *Aspidium lacerum* (exp. 39, Pl. I, Fig. 6), whose vascular bundles are separated one from another by the interjacent ground tissue of the petiole. I observed also in the experiments on woody plants that lithium was detectable only in the branches belonging to the injected side, but not at all in those of the opposite side.

Thus, by the above means, the course of vascular bundles can be determined.

### X. Summary.

1. The rate of conduction of an injection varies according to the nature of the substance; among the substances used in my experiments, lithium nitrate is most easily conducted,  $\text{SO}_4\text{Cu}$  and eosin less easily, aniline violet the least.

2. The injected substances are mostly carried to that part where the transpiration is going on most actively.

a. Lithium, when injected into the stem, is found more in



leaves than in inflorescences and young parts.

b. Lithium, when injected into a part of the cotyledon, rhizome, bulb or root, is carried up to the shoot.

c. In some water plants, e.g. *Myriophyllum*, injected lithium, is found abundantly in the arial parts, but very little or none at all in the submerged parts where the injection was made.

3. The injection experiments performed with plants cultivated in the moist chamber show a very feeble conduction of the substance injected.

4. Conduction of lithium injected into deciduous trees during winter is more or less perceptible, but is much less manifest than in leafy plants.

5. Upward conduction is always conspicuous; downward conduction generally less so, though sometimes very manifest; while transverse conduction is very feeble.

6. Injection solutions are conducted mainly through the xylem elements, and also through the phloëm parts, though other tissues permit conduction in some degree.

7. The speed of conduction of an injected solution varies according to its concentration.

8. Certain fungi (*Omphalia* sp., *Caprinus* sp., *C. tinellus edodes*) indicate conduction of injected lithium.

9. Algae (*Sargassum Horneri*, *Ecklonia cava*, *Bryopsis pulmosa*, etc.) scarcely conduct injected substances, but mere diffusion of these may occur, and an injected solution passes out of the injection wound some time after into the sea-water.

10. Vascular bundles are traceable by means of the injection method.

**XI. Experimental data.<sup>1)</sup>**

Experiments with  $\text{LiNO}_3$  solutions.

## (A) Vascular plants

## Land-plants

Dicotyledons .....Exp. 1-17.

Monocotyledons .....Exp. 18-26.

Pteridophytes .....Exp. 39-42.

## Water-and Marsh-plants

Dicotyledons .....Exp. 27-35.

Monocotyledons .....Exp. 36-38.

## (B) Thallophytes .....Exp. 43-47.

Experiments in moist chamber. ....Exp. 48-49.

Experiments on some deciduous trees in winter and

early spring .....Exp. 50-58.

Experiments with  $\text{SO}_4\text{Cu}$  solutions .....Exp. 59-64.

Experiments with colouring matter solutions .....Exp. 65-76.

Injection into parenchymatous tissue.....Exp. 77-82.

---

1) Though I experimented with 73 species belonging to 49 families of vascular plants and 9 species of thallophytes, I have described here only about one third of my experiments, selecting the more significant cases.

NO. of exp.	Plant name and family name	Date of injection	Duration of experiment	Quantity injected	Part injected	Parts examined after injection	Upwards		Downwards
							Dimension, number, position, etc.	Results	
1)	<i>Pidsea japonica</i> DcNE et PLANC. (Araliac.)	Nov. 30th P.M. 1 <sup>o</sup> 46m	20-25 <sup>hs</sup>	10% LiNO <sub>3</sub> 0.06c.cm.	infloresc.	riachis	34 5 <sub>cm.</sub> high	Li. was present up to the extremity, in the wood, pith and primary cortex of the inj. side.	Li. was present down to 2 <sub>cm.</sub> in the inj. side.
2	<i>Citrus nobilis</i> Lort. v. <i>microcarpa</i> HASSK. (Rutac.)	Dec. 12th	10 <sup>ds</sup>	10% LiNO <sub>3</sub>	branch	branch	8 <sub>cm.</sub> long	Li. was present throughout.	Li. was present downwards to 2 <sub>cm.</sub>
		P.M. 2 <sup>o</sup> 25 <sup>m</sup>	20-23 <sup>hs</sup>	LiNO <sub>3</sub> 0.03c.cm.	leaf	leaf	7 in number	Li. was present abundantly in all of them.	
					fruit	fruit	3 in number	Li. was present in the peels, a little in seeds, absent in succulent vesicles.	
3)	<i>Citrus nobilis</i> Lort. (Rutac.)	Dec. 12th P.M. 2 <sup>o</sup> 30 <sup>m</sup>	10 <sup>ds</sup> 17-20 <sup>hs</sup>	10% LiNO <sub>3</sub> 0.09c.cm.	fruit	fruit	The surface of the fruit became dark coloured and soft.	Li. was absent in the epicarp, present abundantly in the mesocarp, almost absent in vesicles and seeds.	Li. was present to 20 <sub>cm.</sub> down and in 4 leaves.

1) Compare Pl. I, Fig. 2.      2) Compare Pl. I, Fig. 1.      3) Compare Pl. I, Fig. 3.      hs=hours.    ds=days.

NO. of exp.	Plant name and family name	Date of injection	Duration of experiment	Quantity injected	Part injected	Parts examined after injection	Upwards		Downwards
							Dimension, number, position, etc.	Results	
4 <sup>1)</sup>	<i>Magnolia hypoleuca</i> Sieb. et Zucc. (Magnoliac.)	Oct. 13 <sup>th</sup> P.M. 5 <sup>o</sup> .10 <sup>m</sup>	6 <sup>ds</sup> 17-20 <sup>hs</sup>	10% LiNO <sub>3</sub> 0.03 <sub>g</sub> .cm	pulvinus of leaf	petiole midrib blade	3.5 <sub>cm</sub> . long 35.5 <sub>cm</sub> . long 19 pairs of side-nerves	Li. was present. Li. was present up to 34 <sub>cm</sub> . Li. was present in all side nerves on one leaf side of the blade, but absent in small veins and mesophyll.	Li. was present in the petiole absent in the stem.
5	<i>Cornus controversa</i> Hems. (Cornac.)	Dec. 1 <sup>st</sup> A.M. 10 <sup>o</sup> .30 <sup>m</sup>	5 <sup>ds</sup> 20-23 <sup>hs</sup>	10% LiNO <sub>3</sub> 0.15 <sub>g</sub> .cm.	branch 1.8 <sub>cm</sub> . in diam.	branch leaf	203 <sub>cm</sub> . long with many branches and branchlets.	Li. was present abundantly in all branches and branchlets which attached on the inj. side, absent in those on the opposite side. Li. was present in 214 leaves, abundant in the petiole and blade.	
6 <sup>2)</sup>	<i>Ficus communis</i> L. (Euphorbiac.)	Sept. 26 <sup>th</sup> P.M. 2 <sup>o</sup> .25 <sup>m</sup>	5 <sup>ds</sup> 23-27 <sup>hs</sup>	10% LiNO <sub>3</sub> 0.5 <sub>g</sub> .cm.	stem	stem leaf axillary shoot infloresc.	11 <sub>cm</sub> high. 3 nodes. 3 in number at each node. attaches to the 1st and 2nd node. 8.5 <sub>cm</sub> . high, just blooming.	Li. was present up to the top and continued to an inflorescence. Li. was present in the petiole as well as the blade Li. was present in the axis, absent in terminal young leaves and buds. Li. was present a little up to the middle part of the rachis, absent in all flowers.	Li. was present down to 3 <sub>cm</sub> . Li. was present in the basal part of petiole of a leaf which attached to the 1st node below the inj. point.

1) Compare Pl. I, Fig. 3.

2) Compare Pl. I, Fig. 5.

7	<i>Cosmos bipinnatus</i> , Cav. (COMPOSIT.)	Oct. 16th P.M. 3 <sup>o</sup> .40m	8ds 1-4hs	5% LiNO <sub>3</sub> 0.09c.cm.	stem  infloresc.	stem	89cm.; 8 nodes.	Li. was present throughout it and in all leaves.  Li. was present in the stalks and in both inner and outer involucres, but absent in ray flowers as well as tube flowers.	87cm. giving off 6 branches at its lower part. Li. was present down to 80cm. in the main stem and more or less in all branches.
8	<i>Tetragonia sparsosa</i> Arr. (AIZOAC.)	Oct. 16th P.M. 1 <sup>o</sup> .30m	3ds 21-24hs	5% LiNO <sub>3</sub> 0.09c.cm.	stem  leaf  terminal bud	stem	21cm. long; 14 nodes, attaches to the main stem and axillary shoots.	Li. was present throughout.  Li. was present abundantly in all leaves; in nerves as well as mesophyll.  Li. was present a little.	Li. was present down to over 19cm  Li. was present in one leaf, absent in other leaves and young shoots.
9	<i>Colylection madagascariensis</i> PALL. V. <i>japonica</i> FR. ET SAV. (CRASSULAC.)	Oct. 20th A.M. 9 <sup>o</sup> .30m	11ds 1-4hs	5% LiNO <sub>3</sub> 0.03c.cm.	blade  leaf  flower	blade	11cm. high including the height of a spike.  many on the spike.	Li. was present up to the termination in the inj. site.  Li. was present in all leaves and bracts which attached to the inj. side of the stem.  Li. was present in the calyx, absent in petals, stamens, pistils.	11cm. high. Li. was present down to 1.3cm. in the inj. side and in 3 leaves.
10	<i>Taraxacum officinale</i> WIGG. (COMPOSIT.)	April 8th A.M. 10 <sup>o</sup> .30m	1d 21-24hs	5% LiNO <sub>3</sub> 0.03c.cm.	root  leaves  infloresc.	root	9cm. long  (α) flowering one.  (β) unflowering one.	Li. was present throughout the inj. side, and abundantly in the central cylinder.  Li. was present in several leaves, but little in its blade.  Li. was present a little in the scape, absent in the involucre and flowers.  Li. was absent.	forks at a distance of 3.5cm. below the inj. pt. Li. was present down to 3cm.

No. of exp.	Plant name and family name	Date of injection	Duration of experiment	Quantity injected	Part injected	Parts examined after injection	Upwards		Downwards.
							Dimension, number, position, etc.	Results	
11	<i>Solanum tuberosum</i> L. (Solanac.)	June 11 <sup>th</sup> P.M. 3 <sup>o</sup> .30 <sup>m</sup>	1 <sup>d</sup> 19-23 <sup>hs</sup>	5% LiNO <sub>3</sub> 0.09 <sub>c</sub> .cm.	bulb	bulb shoot	Li was present within a distance of about 2.5cm. around the inj. pt. Li. was present in all parts except the young leaves and buds. Li. was absent in all parts. do.	Li. was present to 6cm. below the cotyledon, absent in all side-roots.	Dimension, number, position and results
12	<i>Vicia Faba</i> , <i>V. ervilia</i> Pers. (Leguminosac.)	June 18 <sup>th</sup> P.M. 3 <sup>o</sup> .35 <sup>m</sup>	1 <sup>d</sup> 20-21 <sup>hs</sup>	5% LiNO <sub>3</sub> 0.06 <sub>c</sub> .cm.	cotyledon	cotyledon stem leaf root	Li. was present abundantly. Li. was present throughout. Li. was present in the stipules, petioles, and blades of all leaves, absent in the apical bud. Li. was present throughout. Li. was present in the stem, abundant in leaves, absent in a flower-bud. Li. was absent.	Li. was present back to 3.5cm. 27cm. long, stands at a distance 2.5cm. from the inj. pt. on the rhizome. Li. was present throughout the stem, abundant in all leaves and a little in the calyx of several flowers but absent in the corolla.	
13	<i>Calyptroglia soidanella</i> R. Br. (Convolvulac.)	June 18 <sup>th</sup> P.M. 0 <sup>o</sup> .40 <sup>m</sup>	2 <sup>ds</sup> 1-3 <sup>ds</sup>	5% LiNO <sub>3</sub> 0.12 <sub>c</sub> .cm.	rhizome	rhizome shoot root	Li. was present throughout. Li. was present in the stem, abundant in leaves, absent in a flower-bud. Li. was absent.	Li. was present back to 3.5cm. 27cm. long, stands at a distance 2.5cm. from the inj. pt. on the rhizome. Li. was present throughout the stem, abundant in all leaves and a little in the calyx of several flowers but absent in the corolla.	

14	<i>Lactuca repens</i> MAXIM. (Composit.)	June 18 <sup>th</sup> P.M. 2 <sup>o</sup> .35 <sup>m</sup>	1 <sup>st</sup> 19-22 <sup>ns</sup>	5% LiNO <sub>3</sub> 0.09 <sup>c</sup> .cm.	rhizome	rhizome	forks at a distance of 16 <sup>cm</sup> . from the inj. pt. ( <i>α</i> ) 68 <sup>cm</sup> . long, with 8 leaves and many young underground shoots. ( <i>β</i> ) 31 <sup>cm</sup> . long, with 6 leaves and many underground shoots.	Li. was present in the vicinity of the inj. pt.  Li. was present in all leaves, but absent in the rhizome and shoots.  do.	Li. was present back to 2 <sup>cm</sup> .
15	<i>Trichosanthes cucumeroides</i> MAXIM. (Cucurb.)	Oct. 9 <sup>th</sup> P.M. 2 <sup>o</sup>	2 <sup>ds</sup> 21-25 <sup>ns</sup>	10% LiNO <sub>3</sub> 0.06 <sup>c</sup> .cm.	stem	stem leaf tendrill	383 <sup>cm</sup> . long.  58 in number with a terminal bud.	Li. was present up to 337 <sup>cm</sup> . Li. was present in the petioles and blades of 45 leaves.  Li. was present, except the upper ones.	90 <sup>cm</sup> . long; Li. was present down to 10 <sup>cm</sup> .
16	<i>Dioscorea Tokoro</i> MAXIMO. (Dioscoreace.)	Oct. 20 <sup>th</sup> A.M. 9 <sup>o</sup> .30 <sup>m</sup>	4 <sup>ds</sup> 7-10 <sup>ns</sup>	5% LiNO <sub>3</sub> 0.015 <sup>c</sup> .cm.	stem	stem leaf infloresc.	98 <sup>cm</sup> . long; 16 nodes.  a leaf attaches to the 1 <sup>st</sup> node. 4 leaves on the branch at the 2 <sup>nd</sup> node.	Li. was present up to 11 <sup>cm</sup> . in it and continued to a branch (10 <sup>cm</sup> . long) bearing many inflorescences.  Li. was present in the petioles and midribs of all leaves.  Li. was absent even on the branch which attached at the 2 <sup>nd</sup> node.	Li. was present down to 4 <sup>cm</sup> .

No. of exp.	Plant name and family name	Date of injection	Duration of experiment	Quantity injected	Part injected	Parts examined after injection	Upwards		Downwards
							Dimension, number, position, etc.	Results	
17	<i>Pueraria Thunbergiana</i> BENTH. (Legumin.)	Nov. 10th A.M. 10 <sup>o</sup> .30m	11ds 4-7hs	10% LiNO <sub>3</sub> 0.30c.cm.	stem	stem	It was the leaf-fall period, some leaves were lost during the experiment.	Li. was present up to 197cm.	Li. was present down to 7cm.
					stem	leaf	9 in number changed somewhat yellow.	Li. was present in the petiole and main veins of lower 6 leaves, absent in smaller veins and mesophyll.	
					stem	stem	57cm. high; 5 nodes	Li. was present throughout.	68.5cm high, 4 nodes: Li. was present throughout.
18	<i>Canna lutea</i> MILL. (Cannac.)	Oct. 16th P.M. 4 <sup>o</sup> .30m	4ds 20-24hs	5% LiNO <sub>3</sub> 0.15c.cm.	stem	stem		Li. was present in all parts.	Li. was present in all parts.
					leaf	leaf	(a) 38cm. long at the 1st node.	do.	(a) 58.5cm. long. Li. was present in all parts.
							(b) a scaly leaf at the 2nd node.	do.	(b) 77cm. long. do.
							(c) do. at the 3rd node.	do.	(c) 84cm. long. do.
							(d) do. at the 4th node.	do.	(d) 70cm. long. do.
		(e) do. at the 5th node.	do.	(e) 72cm. long. do.					
		infloresc. 18.5cm. high, with 3 flowers.				Li. was present up to the tip through the rachis, present also in the scales and ovaries, a little in the perianth, and much less in styles and stamens of those flowers.			



19	<i>Sedaria</i> sp. (Gramin.)	Oct. 6th A.M. 10 <sup>o</sup> .50m	1 <sup>st</sup> 2-5 <sup>th</sup> s	5% LiNO <sub>3</sub> 0.09 <sub>c</sub> .cm.	stem leaf	12 <sub>cm</sub> . 5 nodes. (a) 58 <sub>cm</sub> . long. (b) 49 <sub>cm</sub> . long. (c) 35.5 <sub>cm</sub> . long. (d) 29 <sub>cm</sub> . long. (e) 21 <sub>cm</sub> . long.	Li. was present throughout. Li. was abundant up to the tip. do. do. do. do. Li. was present in leaves which attached to all branches. Li. was absent.	Li. was present down to 1 <sub>cm</sub>
20 <sup>1)</sup>	<i>Rhoeo discolor</i> Hce. (Commelin.)	Feb. 23rd P.M. 3 <sup>o</sup> .35 <sup>m</sup>	2 <sup>ds</sup> 17-13 <sup>hs</sup>	5% LiNO <sub>3</sub> 0.06 <sub>c</sub> .cm.	midrib of leaf	darkening and crisping occurred at the inj. part. 9.5 <sub>cm</sub> . long.	Li. was present up to the tip, and transversely to both the margins.	16 <sub>cm</sub> . long. Li. was present down to 2.5 <sub>cm</sub> .
21 <sup>2)</sup>	<i>Rhoeo discolor</i> Hce. (Com- melin.)	Feb. 26th P.M. 1 <sup>o</sup> .30 <sup>m</sup>	2 <sup>ds</sup> 19-21 <sup>hs</sup>	5% LiNO <sub>3</sub> 0.06 <sub>c</sub> .cm.	blade of leaf	14.5 <sub>cm</sub> . long.	Li. was present up to 10 <sub>cm</sub> in the injected side of the blade and not at all in the other side.	10 <sub>cm</sub> . long. Li. was present down to 1.5 <sub>cm</sub> in the injected side.
22	<i>Narcissus papillaceus</i> Ker. (Amaryll.)	March 23rd P.M. 1 <sup>o</sup> .30 <sup>m</sup>	1 <sup>st</sup> 18-21 <sup>hs</sup>	10% LiNO <sub>3</sub> 0.06 <sub>c</sub> .cm.	bulb leaf infloresc. rhizome root	4 in number. 47 <sub>cm</sub> . long.	Li. was present almost in all scales. Li. was present in all leaves, except in their terminal parts. Li. was present in the scape, absent in flowers and a bract.	Li. was present. Li. was present a little.

1) Compare Pl. I, Fig. 4 A.

2) Compare Pl. I, Fig. 4 B.

No. of exp.	Plant name and family name	Date of injection	Duration of experiment	Quantity injected	Part injected	Parts examined after injection	Upwards		Downwards
							Dimension, number, position, etc.	Results	
23	<i>Narcissus papyraceus</i> KER. (Amaryl.)	March 23 <sup>rd</sup> P.M. 1 <sup>o</sup> .32 <sup>m</sup>	1 <sup>d</sup> 21-23 <sup>hs</sup>	10% LiNO <sub>3</sub> 0.06 <sub>100</sub> .cm.	leaf	leaf	Li. was abundantly present with the exception of the terminal part.	30 <sub>100</sub> .cm. long. Li. was present abundantly in the leaf.	Li. was present.
					rhizome				
					root				
					bulb				
24	<i>Narcissus papyraceus</i> KER. (Amaryl.)	March 23 <sup>rd</sup> P.M. 1 <sup>o</sup> .36 <sup>m</sup>	2 <sup>hs</sup> 1-3 <sup>hs</sup>	10% LiNO <sub>3</sub> 0.06 <sub>100</sub> .cm.	scape	scape	Li. was present throughout the scape, also present in the perianth, ovary, style of upper opened flower, and the lower part of the perianth of lower younger ones; present in the bract.	22 <sub>100</sub> .cm. long. Li. was present abundantly.	Li. was present.
					rhizome				
					root				
					bulb				
						leaf			Li. was present in almost all the scales.

25	<i>Carex panamii</i> Tuckerm. (Cyperac.)	June 18th P.M. 10.10am	21s 20-22hs	5% LiNO <sub>3</sub> 0.09c.cm.	rhizome shoot	rhizome shoot	73 <sub>cm</sub> long, bears two shoots. (a) stands at a dist. of 7 <sub>cm</sub> from the inj. pt. (β) stands at the end of the rhizome.	Li. was present forwards to 7 <sub>cm</sub> , and continued to a shoot. Li. was present, especially in leaves. Li. was absent.	Li. was present down to 28 <sub>cm</sub> in the rhizome. (a) 2 shoots are standing at a dist. of 13 <sub>cm</sub> from the inj. pt. Li. was present in these shoots. (β) 1 shoot stands at a dist. of 28 <sub>cm</sub> from the inj. pt. Li. was present in it.
26	<i>Carex microcephala</i> Willd. (Cyperac.)	June 18th P.M. 10.30am	1d 20-23hs	5% LiNO <sub>3</sub> 0.09c.cm.	rhizome	rhizome	forks at a distance of 2 <sub>cm</sub> from the inj. pt. (a) 16 <sub>cm</sub> long, gives off 3 shoots at its extremity. (β) 16 <sub>cm</sub> long, gives off a shoot at its extremity.	Li. was present in the rhizome and one shoot; present also in some leaves and bracts on the spike of the shoot. Li. was absent in the rhizome as well as the shoot.	10 <sub>cm</sub> to the first node, Li. was present just to the node.
27	<i>Menisaulas trifoliata</i> L. (Gentian.)	March 30th A.M. 110.50am	9ds 1-2hs	5% LiNO <sub>3</sub> 0.06c.cm.	petiole blade	petiole blade	3 <sub>cm</sub> long. 3 in number.	Li. was present abundantly. Browning occurred at the margin. Li. was present in all parts of the leaves.	7.5 <sub>cm</sub> long. Li. was present abundantly down to the base.
28	<i>Menisaulas trifoliata</i> L. (Gentian.)	March 30th A.M. 110.50am	9ds 4-6hs	5% LiNO <sub>3</sub> 0.06c.cm.	rhizome root	rhizome root	a shoot is growing at its extremity. attaches to several nodes.	Li. was present up to 6 <sub>cm</sub> in the inj. side. Li. was present in some of them.	Li. was present to 2 <sub>cm</sub> .

No. of exp.	Plants name and family name	Date of injection	Duration of experiment	Quantity injected	Part injected	Parts examined after injection	Upwards		Downwards
							Dimension, number, position, etc.	Results	
29	<i>Nyctaginia japonicum</i> DC. (Nymph.)	Oct. 19 <sup>th</sup> P.M. 4 <sup>o</sup> 40 <sup>m</sup>	7 <sup>ds</sup> 21-24 <sup>hs</sup>	10% LiNO <sub>3</sub> 0.06c.cm.	petiole of submergical leaf	petiole	14cm. long.	Li. was present throughout.	Li. was present down to 4cm.
30	<i>Nyctaginia japonicum</i> DC.	Oct. 19 <sup>th</sup> P.M. 4 <sup>o</sup> 12 <sup>m</sup>	8 <sup>ds</sup> 19-22 <sup>hs</sup>	10% LiNO <sub>3</sub> 0.09c.cm.	peduncle of flower	peduncle	48cm. long.	Li. was present throughout. Li. was present in the receptacle and ovary, absent in the perianth and stamen.	Li. was present to 4cm.
31	<i>Nyctaginia japonicum</i> DC.	Oct. 19 <sup>th</sup> P.M. 4 <sup>o</sup> 41 <sup>m</sup>	8 <sup>ds</sup> 20-22 <sup>hs</sup>	10% LiNO <sub>3</sub> 0.09c.cm.	petiole of aerial leaf	petiole	46cm. long.	Li. was present abundantly throughout.	Li. was present to 10cm.
32	<i>Nyctaginia japonicum</i> DC. A sub-merged form.	June 13 <sup>th</sup> P.M. 3 <sup>o</sup>	1 <sup>d</sup> 19-20 <sup>hs</sup>	5% LiNO <sub>3</sub> 0.75c.cm.	rhizome	rhizome	7cm. to the extremity.	Li. was present up to the extremity and continued to leaves. Li. was present in the petioles and midribs of 2 full-grown leaves, absent in their blades and present in the petiole of one blade-wanting leaf, absent in all younger leaves.	Li. was present back to 12cm. in the inj. side. Li. was absent.

33	<i>Jussiaea repens</i> L. (Onogr.)	Nov. 7 <sup>th</sup> P.M. 1 <sup>o</sup> .25 <sup>m</sup>	7 <sup>ds</sup> 1-4 <sup>hs</sup>	10% LiNO <sub>3</sub> 0.06 <sub>c.cm.</sub>	stem leaf fruit flower	19 <sub>cm.</sub> high. 18 in number and terminal young leaves and bud. attaches to several lower nodes.	Li. was present abundantly. Li. was present in all leaves except the young ones and bud. Li. was present in the fruit-wall, a little in seeds. Li. was present in the peduncle, sepal, ovary, a little in the petal of all flowers and flower-buds.	Li. was present down to 6 <sub>cm.</sub>  attaches to the node which is 1 <sub>cm.</sub> below the inj. pt. Li. was present in its wall.
34	<i>Myriophyllum</i> sp. (Halorrhagid.)	Oct. 10 <sup>th</sup> P.M. 2 <sup>o</sup>	1 <sup>d</sup> 20-22 <sup>hs</sup>	5% LiNO <sub>3</sub> 0.15 <sub>c.cm.</sub>	stem submerged	105 <sub>cm.</sub> long, with 3 branches.	Li. was present within 4 <sub>cm</sub> (2 nodes), absent in leaves.	Li. was present down to 3 <sub>cm.</sub> but absent in leaves.
35)	<i>Myriophyllum</i> sp. emersed.	Oct. 26 <sup>th</sup> P.M. 4 <sup>o</sup>	4 <sup>ds</sup> 20-22 <sup>hs</sup>	10% LiNO <sub>3</sub> 0.03 <sub>c.cm.</sub>	stem submerged	submerged part 5 <sub>cm.</sub> aerial part 6.5 <sub>cm.</sub>	Li. was present very little. Li. was present abundantly, especially in the leaf.	Li. was present down to 2 <sub>cm.</sub>
36	<i>Typha japonica</i> Miq. (Typhac.)	Oct. 20 <sup>th</sup> P.M. 1 <sup>o</sup> .30 <sup>m</sup>	19 <sup>ds</sup> 1-3 <sup>hs</sup>	5% LiNO <sub>3</sub> 0.15 <sub>c.cm.</sub>	leaf	173 <sub>cm.</sub> long.	Li. was present abundantly up to the extremity, not only in the inner soft part, also in the outer hard wall.	

1) Compare Pl. I, Fig. 7.

No. of exp.	Plants name and family name	Date of injection	Duration of experiment	Quantity injected	Part injected	Parts examined after injection	Upwards		Downwards
							Dimension, number, position, etc.	Results	
37	<i>Potamogeton polydromifolius</i> Potemk. (Potamoeg.)	Nov. 15 <sup>h</sup> A.M. 11 <sup>o</sup> .30 <sup>m</sup>	2 <sup>ds</sup> 21-21 <sup>ds</sup>	10% LiNO <sub>3</sub> 0.06 <sub>c</sub> .cm.	stem	stem leaf	7 <sub>c</sub> m. long, 5 nodes. 3 in number.	Li. was present throughout. Li. was present a little in the petioles, and the blade of the lower 1 leaf, absent in the blade of 2 upper leaves.	Li. was present only in the inj. nodes.
38	<i>Potamogeton crispus</i> L. (Potamoeg.)	April 29 <sup>th</sup> P.M. 1 <sup>o</sup> .40 <sup>m</sup>	2 <sup>ds</sup> 21-22 <sup>ds</sup>	5% LiNO <sub>3</sub> 0.09 <sub>c</sub> .cm.	stem	stem	20 <sub>c</sub> m. long; 8 inter-nodes with many leaves and axillary shoots.	Li. was present very little in the stem and absent in all leaves.	Li. was present within 1 node.
39b	<i>Aspidium lacinum</i> Sw. (Polypod.)	Oct. 6 <sup>th</sup> P.M. 2 <sup>o</sup>	2 <sup>ds</sup> 19-22 <sup>ds</sup>	5% LiNO <sub>3</sub> 0.15 <sub>c</sub> .cm.	petiole	rachis pinna sorus	62.5 <sub>c</sub> m. long. about 25 leaflets on one side.	Li. was present throughout the inj. side. Li. was present abundantly in all leaflets on one side, absent in those of the other side except some terminal leaflets.	6 <sub>c</sub> m. long. Li. was present down to 2 <sub>c</sub> m.

1) Compare Pl. I, Fig. 6.

40	<i>Lycopodium complanatum</i> L. (Lycopod.)	Nov. 4th P.M. 8 <sup>o</sup> .37m	2ds 15-18hs	10% LiNO <sub>3</sub> 0.03c.cm.	stem	stem	(a) creeping stem, 19cm. long. (b) erect stem, 8.5cm long, stands at a distance of 1cm. from the inj. pt. bearing fertile spikes.	Li. was present.  Li. was present in all parts of the stem as well as in leaves and spikes.	Li. was present down to 1.5cm.
41	<i>Lycopodium clavatum</i> L. (Lycopod.)	Jan. 29th P.M. 2 <sup>o</sup>	11ds 21-24hs	10% LiNO <sub>3</sub> 0.03c.cm.	stem	stem  branch	70cm. long, gives off many branches.	Li. was present in the stem and leaves up to 2cm.	Li. was present in the main stem down to 12cm. (a) 10cm. long, is given off at a distance of 3cm. from the inj. pt. Li. was present in it. (β) 18cm. long. 7cm. from the inj pt. Li. was present in it.
42	<i>Equisetum arvense</i> L. (Equiset.)	March 27th A.M. 11 <sup>o</sup> .35m	3ds 2-4hs	5% LiNO <sub>3</sub> 0.03c.cm.	rhizome	rhizome  stem  root	13.5cm. long, fertile, 5.5cm. high including the cone.	Li. was present abundantly. Li. was present in the stem, absent in the cone and leaves.	Li. was present back to 7cm.
43	<i>Omphalia</i> sp. (Fungi)	Oct. 10th P.M. 3 <sup>o</sup> .5m	22-24hs	5% LiNO <sub>3</sub> 0.03c.cm.	stipe	stipe pileus	2cm. long. 2cm in diam.	Li. was present. Li. was present in all sides of the margin.	2.5cm Li. was present down to 1.5cm.
44	<i>Caprius</i> sp. (Fungi)	Oct. 10th P.M. 3 <sup>o</sup>	18-20hs	5% LiNO <sub>3</sub> 0.03c.cm.	stipe	stipe pileus	5cm. high. 3cm. in radius.	Li. was abundant. A ripped slit appeared at the inj. pt. Li. was present more or less in all parts.	1.5cm long. Li. was present.

No. of exp.	Plant name and family name	Date of injection	Duration of experiment	Quantity injected	Part injected	Parts examined after injection	Upwards		Downwards
							Dimension, number, position, etc.	Results	
45)	<i>Cortinellus edodes</i> HEM. H. (Fungi)	Oct. 16 <sup>th</sup> A.M. 10 <sup>o</sup>	1d 20-25hs	5% LiNO <sub>3</sub> 0.09c.cm.	stipe	stipe	8.5cm high.	Li. was present up to 6.5cm. transversely in a tolerable wide area in the cross section, through the inj. pt., but limited in a narrow area at a further distance.	4.5cm. high. Li. was present down to 1cm.
46	<i>Usnea barbata</i> V. <i>scabrosa</i> ACH. (Lichens)	Nov. 7 <sup>th</sup> P.M. 2 <sup>o</sup> 40 <sup>m</sup>	2ds 1-2hs	5% LiNO <sub>3</sub> 0.01c.cm.	stalk	stalk		Li. was present only in the inj. part, absent in all other parts.	
47	<i>Bryopsis palmosa</i> Kütz. (Algae)	March 11 <sup>th</sup> P.M. 2 <sup>o</sup> 15 <sup>m</sup>	2ds 20-23hs <sup>2</sup>	5% LiNO <sub>3</sub> 0.06c.cm.	stalk	stalk pinna basal part	14-19cm. long.	Li. was present within 6-11cm. in all, above and below the inj. pt. Li. was absent. Li. was absent.	
48A	<i>Vicia</i> <i>Faba</i> L. V. <i>equina</i> Pers. (Legumin.) cultured in the moist chamber.	Oct. 9 <sup>th</sup> P.M. 3 <sup>o</sup>	20-25hs	5% LiNO <sub>3</sub> 0.03c.cm.	stem	stem leaf apical bud	5 nodes.	Li. was present throughout. Li. was present in the mid-ribs and petioles of all leaves, absent in their blades and stipules. Li. was absent.	Li. was present down to 2cm., absent in the root.

1) This sample was obtained from a grocer and kept standing on moist sand during the experiment, but its growth was so slow that the plants did not open even after 2 days.

2) The plants were taken out of sea water on 12th at 10 A.M.



48B	<i>Vicia Faba</i> L. v. equina Pears control plant	Oct. 16th P.M. 2 <sup>o</sup>	24 <sup>ds</sup> 1-4 <sup>ds</sup>	10% LiNO <sub>3</sub> 0.06c.cm.	stem stem	5 nodes. 2cm. 2 nodes, with a terminal bud.	Li. was present throughout. Li. was abundant in the blade and all other parts. Li. was absent. Li. was present, except the bud. Li. was absent in the blade and stipule, present in the midrib and petiole.	Li. was present down to 3cm.
49	<i>Vicia Faba</i> L. v. <i>apivina</i> Pears cultured in the moist chamber.1)				stem leaf branch			15.5cm. 6 nodes. Li. was present throughout. 4 in number. Li. was present in the pet- iole and midrib, absent in the blade. (α) 25cm. high with 5 nodes, attaches to the lowest node. Li. was present up to 15cm., absent in leaves. (β) 8cm. high with 2 nodes, attaches to the next node. Li. was present up to 6cm. absent in leaves. Li. was present a little in the uppermost part.
50	<i>Hamamelis japonica</i> S. et Z. (Hamame- lit.)	Feb. 16th P.M. 2 <sup>o</sup>	24 <sup>ds</sup> 20-24 <sup>ds</sup>	5% LiNO <sub>3</sub> 0.03c.cm.	branch branch 7mm. in diam.	77cm. with many branchlets.	Li. was present in bark as well as wood up to 30cm. in the longest branch, and also to some distance in 4 lateral branchlets. Li. was absent in the rachis and flowers. Li. was absent.	Li. was present down to 20cm. absent in the lateral branches.

1) In the course of the experiment the lower 2 lateral branches developed very abnormally, but the main stem did not lengthen so much.

No. of exp.	Plant name and family name	Date of injection	Duration of experiment	Quantity injected	Part injected	Parts examined after injection	Upwards		Downwards
							Dimension, number, position, etc.	Results	
51	<i>Paspis sylvatica</i> L. V. Sieboldi. MAXIM. (Fagac.)	Feb. 20th P.M. 10.15 <sup>00</sup>	2 <sup>ds</sup> 22-22 <sup>30</sup> <sup>ds</sup>	5% LiNO <sub>3</sub> 0.03 c.cm.	branch	branch bud	60 cm. long, bears many branchlets.	Li. was present up to 15 cm.  Li. was absent.	Li. was present over 9 cm.
52	<i>Calycanthus praecox</i> L. (Calycanth.)	Feb. 20th P.M. 06.5 <sup>m</sup>	1 <sup>d</sup> 1-2 <sup>ds</sup>	5% LiNO <sub>3</sub> 0.02 c.cm.	branch 4 mm. in diam.	branch flower	24 cm. long, bears 5 branchlets.  just flowering.	Li. was present up to 6 cm. in the main branch, absent in all other branchlets.  Li. was absent in all parts.	Li. was present down to 2 cm.
53	<i>Cornus controversa</i> HEMS. (Cornac.)	Jan. 29th Noon	22 <sup>ds</sup> 3-6 <sup>ths</sup>	10% LiNO <sub>3</sub> 0.06 c.cm.	branch 9 mm. in diam.	branch bud	91 cm. long, gives off many branches.	Li. was present up to 32 cm. and also present in several branches which attached to the inj. side, but never in small branchlets.  Li. was absent.	Li. was present down to 15 cm.
54	<i>Cornus controversa</i> HEMS.	Feb. 5th A.M. 9.30 <sup>m</sup>	15 <sup>ds</sup> 1-7 <sup>ths</sup>	10% LiNO <sub>3</sub> 0.21 c.cm.	stem <sup>1)</sup> 2.9 cm. in diam.	stem bud	216 cm. high, bears 7 lateral branches.	Li. was present up to 67 cm in the main stem, more in detail present in the wood, bark, and pith on the inj. side, wider and deeper than the dimension of the inj. wound.	180 cm high, bears two small branches. Li. was present down to 24 cm., in the wood, bark, and a part of pith on the inj. side.

1) Dimension of the injection wound was 0.7 cm. in depth, 1.7 cm. in length, 0.4 cm. in max. width.

55	<i>Cornus confertiflora</i> Hems.	March 15 <sup>th</sup> P.M. 2.0-2.20 <sup>m</sup>	6 <sup>ds</sup> 19-27 <sup>hs</sup>	10% LiNO <sub>3</sub> 0.15c.cm.	stem 2.4 <sup>m</sup> in diam.	stem branch	divides into 6 branch- es at a height of 57 <sup>cm</sup> . (a) 128 <sup>cm</sup> . long. (b) 178 <sup>cm</sup> . long. (c) 160 <sup>cm</sup> . long. (d) 168 <sup>cm</sup> . long. (e) 128 <sup>cm</sup> . long. (f) 117 <sup>cm</sup> . long.	Li. was present in the wood and bark of the injected side, up to its extremity, and continued to branches. Li. was present up to 17 <sup>cm</sup> Li. was absent. do. do. do. Li. was present a little in the lower part.	85 <sup>cm</sup> . high, bears 2 branches. Li. was present down to 10 <sup>cm</sup> . in the wood and bark on the inj. side.
56	<i>Cornus confertiflora</i> Hems.	March 23 <sup>th</sup> Noon	3 <sup>ds</sup> 1-3 <sup>ds</sup>	10% LiNO <sub>3</sub> 0.03c.cm.	branch	branch bud <sup>1</sup>	60 <sup>cm</sup> long, bears many branchlets. new leaves coming out.	Li. was present up to 19 <sup>cm</sup> in the branch, absent in all branchlets. Li. was absent.	Li. was present down to 7 <sup>cm</sup> .
57	<i>Cornus confertiflora</i> Hems.	March 22 <sup>nd</sup> Noon	2 <sup>ds</sup> 21-24 <sup>hs</sup>	10% LiNO <sub>3</sub> 0.03c.cm.	branch 0.5 <sup>cm</sup> . in diam.	branch leaf <sup>2</sup> scale	57 <sup>cm</sup> . long with many branchlets. attaches at the basal part of new un- folding leaves.	Li. was present even in the branchlets. Li was present in the petiole and midrib of most larger leaves, absent in younger ones. Li. was present a little.	bears a 10 <sup>cm</sup> long branch at a dis- tance of 11 <sup>cm</sup> be- low the inj. pt. Li. was present down to 25 <sup>cm</sup> and in the branch, but not at all in the leaves attaching to it.

1) See Pl. II. Fig. 5A.      2) See Pl. II. Fig. 5B.

No. of exp.	Plant name and family name	Date of injection	Duration of experiment	Quantity injected	Part injected	Parts examined after injection	Upwards		Downwards
							Dimension, number, position, etc.	Results	
58	<i>Trapa serradilla</i> LINDL. (Rosac.) a garden-variety.	April 1st P.M. 3.30pm	22-25hs	5% LiNO <sub>3</sub> 0.09c.cm.	branch 8mm in diam.	branch	60 <sub>m</sub> long, sends out 2 branches. (α) 23 <sub>m</sub> long, attaches at a distance of 3cm (β) 39 <sub>m</sub> long, attaches at a distance of 2cm on the opposite side of the inj. pt. just flowering.	Li. was present up to 35cm. Li. was present throughout. Li. was absent.	Li. was present down to 1.5cm.
59)	<i>Fatsia japonica</i> DCSE. ET PRANC. (Araliac.)	Sept. 20th A.M. 10 <sup>o</sup>	23-25hs	5% SO <sub>4</sub> Cu 0.65c.cm.	petiole	petiole	10 <sub>cm</sub> long, the inj. pt. changed black. 22.5 <sub>cm</sub> long, spotted black along vascular net-works.	SO <sub>4</sub> Cu was present in a few vascular bundles throughout. SO <sub>4</sub> Cu was present more or less in all segments.	SO <sub>4</sub> Cu was present down to 8cm.
60	<i>Trachycarpus excelsa</i> WENDL. (Palmae.)	Feb. 24th P.M. 11 <sup>o</sup> 50m	4hs 2-5hs	5% SO <sub>4</sub> Cu 0.03c.cm.	petiole	petiole		SO <sub>4</sub> Cu was present up to 20 <sub>cm</sub> , abundantly in phloem parts <sup>2)</sup> , but less in xylem parts of some vascular bundles.	SO <sub>4</sub> Cu was present down to 15cm.
61	<i>Cereus serpentinus</i> LAG. (Cactac.)	Jan. 29th P.M. 2.5m	13hs 1-4hs	5% SO <sub>4</sub> Cu 0.06c.cm.	stem	stem	33 <sub>cm</sub> long.	SO <sub>4</sub> Cu was present up to 31 <sub>cm</sub> much in phloem parts, but also fairly much in xylem parts and parenchyma tissues near the vascular bundles.	SO <sub>4</sub> Cu was present down to 7cm.

1) Compare Pl. II, Fig. 1.

2) Compare Pl. II, Fig. 4.

62	<i>Allium fistulosum</i> L. (Liliac.)	Feb. 10 <sup>th</sup> A.M. 10 <sup>o</sup> 30 <sup>m</sup>	1 <sup>d</sup> 21-23 <sup>hs</sup>	5% SO <sub>4</sub> Cu 0.15 <sub>c</sub> cm.	leaf- sheath	leaf rhizome	3 in number, 48 <sub>cm</sub> . long.	SO <sub>4</sub> Cu was present abundantly in parenchyma around the inj. part. SO <sub>4</sub> Cu was present up to 20 <sub>cm</sub> . in one leaf.	SO <sub>4</sub> Cu was present down to the base (7 <sub>cm</sub> .) 6 <sub>mm</sub> . in thickness. SO <sub>4</sub> Cu was present in all tissues, especially in vascular bundles, down to 5 <sub>mm</sub> . absent in the roots.
63	<i>Ecklonia crux</i> KJELLM. (Algae)	March 5 <sup>th</sup> P.M. 5 <sup>o</sup>	1 <sup>d</sup> 20-23 <sup>hs</sup>	5% SO <sub>4</sub> Cu 0.06 <sub>c</sub> cm	Pith of stalk 1.5 <sub>cm</sub> . in diam.	pith cortex		SO <sub>4</sub> Cu was present very little within 1 <sub>cm</sub> about the inj. part in the hyphae, sieveplasm, as well as slime. SO <sub>4</sub> Cu was present in some inner layers of cortical cells around the injected pith.	
64	<i>Bruggopsis palmosa</i> KÜTZ. (Algae)	March 11 <sup>th</sup> P.M. 2 <sup>o</sup> 20 <sup>m</sup>	1 <sup>d</sup> 27 <sup>hs</sup>	5% SO <sub>4</sub> Cu 0.03 <sub>c</sub> cm	stalk	stalk	10-19 <sub>mm</sub> . long.	SO <sub>4</sub> Cu was present a little in the inj. part, cell-contents were disturbed in their arrangements.	
65	<i>Tetragonia capensis</i> AET. (Aizoac.)	Oct. 26 <sup>th</sup> A.M. 11 <sup>o</sup>	5 <sup>ds</sup> 22-23 <sup>hs</sup>	0.5% Eosin 0.09 <sub>c</sub> cm.	stem	stem leaf		Eosin was present up to 6 <sub>cm</sub> . throughout the inj. side of stem and then continued to a leaf. Eosin was transmitted not only to xylem parts of the inj. side, but also to some parts of phloem, pericycle and parenchyma. Most parts of these tissues having imbibed eosin were destroyed. Eosin was present in the petiole and midrib of one leaf.	Eosin was present down to 6 <sub>cm</sub> .

No. of exp.	Plant name and family name	Date of injection	Duration of experiment	Quantity injected	Part injected	Parts examined after injection	Upwards		Downwards
							Dimension, number, position, etc.	Results	
66	<i>Vicia faba</i> L. var. <i>equina</i> Pers. (Legumin.)	Dec. 7 <sup>th</sup> P.M. 4 <sup>o</sup> .	7 <sup>hs</sup> 20-24 <sup>hs</sup>	0.5% Eosin 0.09 c.cm.	stem  leaf	stem  leaf	Dimension, number, position and results	9 cm. high. Eosin was present down to 3 cm.	
67	<i>Iphegios solitans</i> L. (Crucifer.)	April 12 <sup>th</sup> P.M. 4 <sup>o</sup> .	2 <sup>ds</sup> 19-25 <sup>hs</sup>	0.5% Eosin 0.09 c.cm.	root 6 cm. in diam.	root  inflores. leaf	10.5 cm.  just flowering.	Eosin was present up to the end in some vascular bundles of the inj side and continued to an inflorescence. Eosin was present up to 7 cm. Eosin was almost absent.	
68	<i>Nymphar japonicum</i> DC. (Nymph.)	Sept 14 <sup>th</sup> A.M. 11 <sup>o</sup> :30 <sup>m</sup>	2 <sup>ds</sup> 1-3 <sup>hs</sup>	0.5% Eosin 0.75 c.cm.	petiole	petiole	a longitudinal grip occurred along the inj. side. 2 cm. long.	40 cm. long. Eosin was present throughout the inj. side, and a little in the rhizome.	
69	<i>Allium fistulosum</i> L. (Liliac.)	Feb. 10 <sup>th</sup> A.M. 10 <sup>o</sup> :30 <sup>m</sup>	2 <sup>ds</sup> 4-7 <sup>hs</sup>	0.5% Eosin 0.15 c.cm.	leaf-sheath	leaf  rhizome	14 cm. long  3 in number 4.3 cm. to the end of the longest one.	Eosin was present in the midrib, but less in side veins. Much eosin was left in the inj. part. Eosin was present up to 40 cm.	

70	<i>Bryopsis paludosa</i> Kütz. (Algae)	March 11 <sup>th</sup> P.M. 2 <sup>o</sup> .40 <sup>m</sup>	19-21hs	0.5% Eosin 0.03 <sub>c</sub> .cm.	stalk	stalk	Eosin was slightly present about the inj. part and contents of that part were disturbed in their arrangement.	
71	<i>Leptanthus salivus</i> L. (Crucifer.)	Oct 24 <sup>th</sup> A.M. 11 <sup>o</sup> .5 <sup>m</sup>	6ds 3-5hs	0.2% Aniline violet 0.06 <sub>c</sub> .cm.	root	root	Aniline violet was present in all tissues about the inj. part, but did not attain far; the wall of vessels was well tinged.	
72	<i>Allium fistulosum</i> L. (Liliac.)	Feb. 10 <sup>th</sup> A.M. 10 <sup>o</sup> .35 <sup>m</sup>	2 <sup>ds</sup> 4-6 <sup>hs</sup>	0.2% Aniline violet 0.15 <sub>c</sub> .cm.	leaf- sheath	leaf- sheath	Aniline violet was present up to 2 <sup>cm</sup> . in the parenchyma and vascular bundles; epidermal cells were well tinged without any appearance of injury, especially protoplasm, nucleus, nucleolus etc. were distinctly tinged.	Aniline violet was present down to 2 <sup>cm</sup> .
73	<i>Bryopsis paludosa</i> Kütz. (Algae)	March 11 <sup>th</sup> P.M. 2 <sup>o</sup> .25 <sup>m</sup>	1 <sup>o</sup> 1-3 <sup>hs</sup>	0.2% Aniline violet 0.03 <sub>c</sub> .cm.	stalk	stalk	Aniline violet was much decolorized and only slightly visible. In the inj. part, chlorophyll-grains, and other contents were tinged and disturbed in their arrangement, the cell wall near the inj. pt. also slightly tinged.	
74	<i>Dahlia japonica</i> DCNE. ET PLANC. (Araliac.)	June 2 <sup>nd</sup> P.M. 3 <sup>o</sup> .15 <sup>m</sup>	3 <sup>ds</sup> 12-13 <sup>hs</sup>	0.1% Dahlia Violet 0.15 <sub>c</sub> .cm.	petiole	petiole	Dahlia violet was detectable up to 4 <sup>cm</sup> . Several tissues were tinged at the inj. part.	It was present down to 3 <sup>cm</sup> .

No. of exp.	Plant name and family name	Date of injection	Duration of experiment	Quantity injected	Part injected	Parts examined after injection	Upwards		Downwards
							Dimension, number, position, etc.	Results	
75	<i>Fatsia japonica</i> .	June 2nd P.M. 3 <sup>o</sup> 6m	3ds 10-12hs	0.1% Indigo-carmin 0.15c.cm.	petiole	petiole	Indigo-carmin was detectable slightly in several tissues about the inj. part, some elements of the bast fiber thinly coloured.		
76	<i>Fatsia japonica</i> .	June 2nd P.M. 3 <sup>o</sup>	3ds 19-20hs	0.1% Congo-red 0.15c.cm.	petiole	petiole	Congo-red was present up to 12cm. in the xylem of a few vascular bundles.	It was present down to 3cm.	
77	<i>Tetragonia expansa</i> Arr. (Aizoac.)	Oct. 26th A.M. 10 <sup>o</sup>	2ds 3-5hs	10% LiNO <sub>3</sub> 0.01c.cm.	pith of stem	stem	Li. was present up to 1cm.	It was present down to 1cm.	
78	<i>Jussiaea repens</i> L. (Onag)	Nov. 28th Noon	4ds 1-4hs	10% LiNO <sub>3</sub> 0.03c.cm.	pith of stem	stem	Li. was present up to 8cm. in the main stem, not at all in other organs.	Li. was present down to 14cm.	
79	<i>Vicia Faba</i> L. var. <i>equina</i> Pers. (Legumin.)	Dec. 7th P.M. 4 <sup>o</sup>	4ds 21-25hs	0.2% Aniline violet 0.09c.cm.	medullary hole of stem	stem	Aniline violet was present up to 6cm. in the section through the stem at the inj. pt. The dye was found in most parts of pith and xylem portions, but not at all in the outer tissues. In the section 1-2cm. above the inj. pt. the dye was found in most xylem portions, but absent in the pith. In the section at 5cm. above the inj. pt. it was found only in few xylem portions.	Aniline violet was present down to 1.5cm.	



80	<i>Kervia javanica</i> DC. (Rosac.)	April 15 <sup>th</sup> P.M. 4 <sup>o</sup>	6hs 20-23hs	5% LiNO <sub>3</sub> 0.06c.cm.	pith of stem	stem branch leaf	120cm. long with 20 side branches.	Li. was present up to 26cm.  Li. was present in 4 branches. Li. was present in full grown leaves which attached to the above 4 branches.	Li. was present down to 4cm.
81	<i>Tetragonia epipassa</i> AIT. (Aizoac)	Oct. 26 <sup>th</sup> A.M. 10 <sup>o</sup> 10m	2hs 1-3hs	10% LiNO <sub>3</sub> 0.01c.cm.	cortex of stem	stem leaf	attaches on the inj. side at 2cm above.	Li. was present up to 2cm in the inj. side and con- tinned to a leaf.  Li. was present in the leaf- stalks, absent in the blade.	Li. was present down to 1cm.
82	<i>Jussiaea repens</i> L. (Onag.)	Nov. 21 <sup>st</sup> P.M. 3 <sup>o</sup> 5m	5hs 21-4hs	10% LiNO <sub>3</sub> 0.3hs.cm.	cortex of stem	stem leaf	2cm. long.	Li. was present throughout the length.  Li. was present in all parts of lower leaves, absent in the blade of upper ones.	Li. was present down to 4cm.

## Literature.

1. ERHART, G., Über subcutane Injection bei Pflanzen. (Archiv der Pharmacie. III. R. II. p. 408. 1873.)
2. WEBER, F., Über die Abkürzung der Ruheperiode der Holzgewächse durch Verletzung der Knospen, beziehungsweise Injection derselben mit Wasser. (Sitzungsb. d. k. k. Akad. d. Wiss. in Wien. CXX. März. 1911.)
3. JESENKO, Fr., Einige neue Verfahren die Ruheperiode der Holzgewächse abzukürzen. (Berichte d. Deut. Bot. Gesellsch. XXIX. p. 273. 1911.)
4. MIYOSHI, M., Lectures on General Botany. (Japanese edition) II. p. 253-4. 1905.
5. TSCHERMAK, E., Über die Verbreitung des Lithiums im Pflanzenreiche. (Zeitschrift f. d. landwirtschaftl. Versuchswesen in Oesterreich. p. 562. 1899. Ref. Bot. Centralb. LXXXII. p. 87. 1900.)
6. GAUNERSDORFER, JOH., Das Verhalten der Pflanzen bei Vergiftungen, speciell durch Lithiumsalz. (Die landwirtschaftl. Versuchsstation, herausgegeben von Nobbe. XXXIV. p. 171. 1887. Ref. Bot. Centralb. XXXII. p. 262. 1887.)
7. TRUCHOT, P., Bestimmung des Lithiums mittelst des Spektroskops. (Archiv der Pharmacie. p. 561. 1874.)
8. OVERTON, E., Studien über die Aufnahme der Anilinfarben durch die lebende Zelle. (Jahrb. f. Wiss. Bot. XXXIV. p. 669-701. 1900.)
9. JOST, L., Plant Physiology. (English translation p. 20 and 61. 1907.)
10. STRASBURGER, E., Botanisches Practicum. IV. Aufl. p. 113 u. 125. 1902.
11. PFEFFER, W., Pflanzenphysiologie. II. Aufl. p. 79. 194 u. 200. 1904.
12. THODAY, D., and SYKES, M. G., Preliminary Observations on the Transpiration Current in Submerged Water-plants. (Annals of Bot. XXIII. p. 635. 1909.)
13. SNELL, K., Untersuchungen über die Nahrungsaufnahme der Wasserpflanzen. (Flora. XCVIII. p. 213-49. 1907.)

14. OKAMURA, K., On the Comparative Anatomy of Water-plants. 1889. (Manuscript!)
  15. OLTMANN, F., Morphologie und Biologie der Algen. I. p. 445 u. 524, 1905.
  16. SCHECHNER, K., Zur Kenntnis des absteigenden Wasserstromes. (Anz. Kais. Akad. Wiss. Wien. XLVI. p. 272. 1909.)
  17. BOEHM, J., Umkehrung des aufsteigenden Saftstromes. (Berichte d. Deutsch. Botan. Gesellsch. VIII. p. 311-3. 1890.)
  18. WIESNER, J., Der absteigende Wasserstrom und dessen physiologische Bedeutung. (Botan. Zeitung. No. 1. u. 2. 1889.)
  19. WIESNER, J., Über den absteigenden Transpirationsstrom. (Bot. Centralb. XLIII. p. 171. 1890.)
  20. DIXON, H. H. and Joly, J., The Path of the Transpiration-current. (Annals of Bot. IX. p. 403. 1895.)
-

## CONTENTS.

	PAGE
I. Introduction. . . . .	1
II. Method of injection. . . . .	2
III. Experiments with several injection solutions. . . . .	3
IV. Injection experiments with several plant organs. . . . .	4
V. Injection into parenchymatous tissue. . . . .	5
VI. Experiments in moist chamber. . . . .	6
VII. Experiments on some deciduous trees in winter and early spring. . . . .	7
VIII. Experiments on some thallophytes . . . . .	7
IX. Discussion of the results. . . . .	9
1. Relation between transpiration and conduction of injected solution. . . . .	9
2. Upward conduction and downward conduction. . . . .	11
3. Transverse conduction. . . . .	14
4. Speed of conduction of injected solutions. . . . .	15
5. Conducting path of injected solutions. . . . .	16
6. Injection method as a means for tracing the course of a vascular bundle. . . . .	17
X. Summary. . . . .	18
XI. Experimental data. . . . .	20
Literature. . . . .	44

Y. YENDO.  
INJECTION EXPERIMENTS ON PLANTS.

PLATE I.

## Explanation of the figures.

### Pl. I.

Illustrations to show the course of conduction of the injected lithium.

The red shaded parts represent where lithium was detected after the injection. I.p= injection point.

- Fig. 1. Inflorescence of *Fatsia japonica*  $\left(\times \frac{1}{3}\right)$ . (Compare exp. 1).
- Fig. 2. Portion of a branch of *Citrus nobilis* with fruit  $\left(\times \frac{2}{5}\right)$ .  
(Compare exp. 3).
- Fig. 3. Leaf of *Magnolia hypoleuca*  $\left(\times \frac{1}{5.5}\right)$ . (Compare exp. 4).
- Fig. 4. Two leaves of *Rhoeo discolor* with different injection points  $\left(\times \frac{1}{3}\right)$ .  
(Compare exp. 20, 21).
- Fig. 5. Portion of *Ricinus communis*  $\left(\times \frac{1}{4}\right)$ . (Compare exp. 6).
- Fig. 6. Leaf of *Aspidium lacerum*  $\left(\times \frac{1}{7.3}\right)$ . (Compare exp. 39).
- Fig. 7. Portion of *Myriophyllum*  $\left(\times \frac{1}{2}\right)$ . The line (*l*) represents the water level (Compare exp. 35).

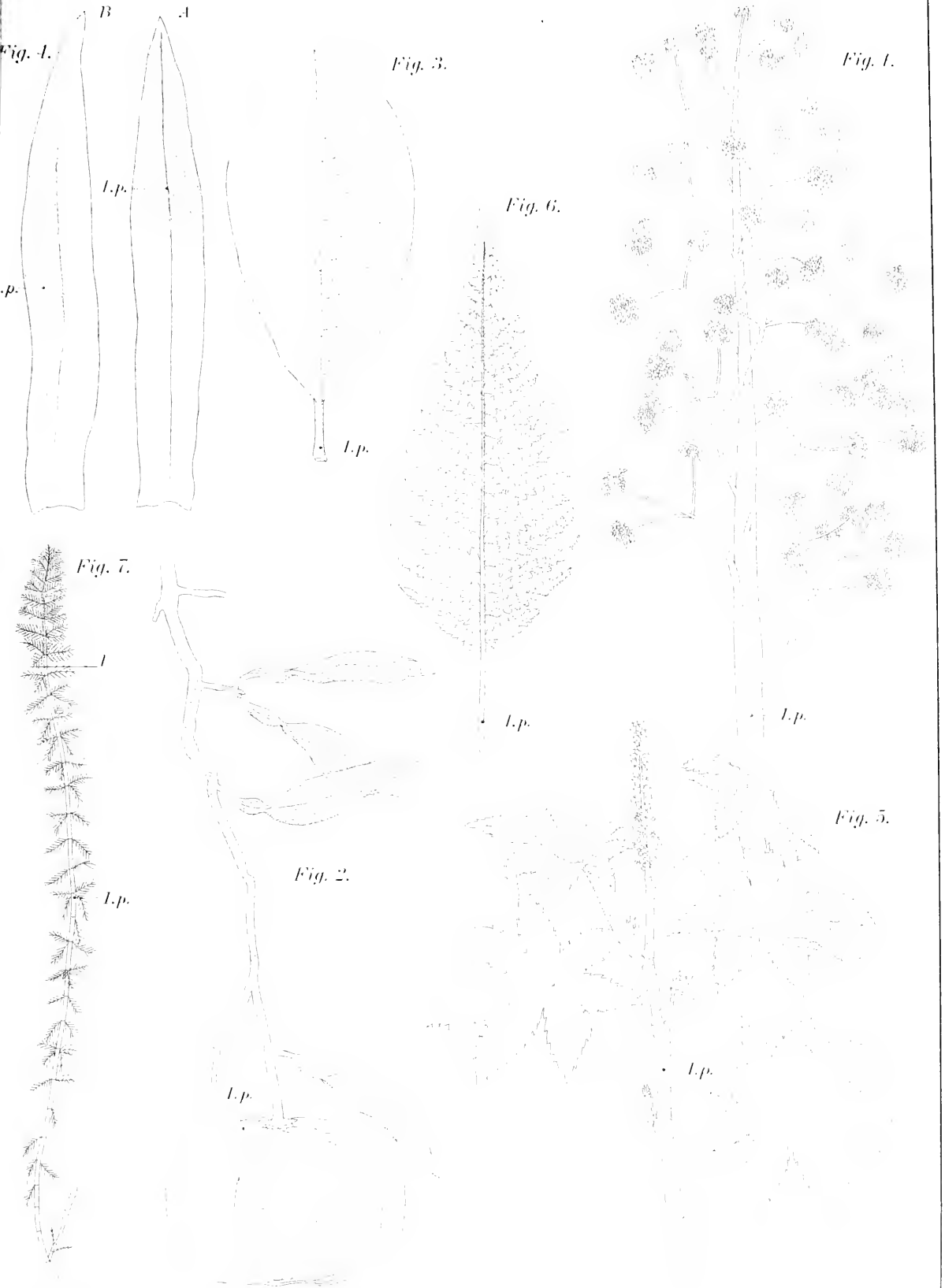





Y. YENDO.

INJECTION EXPERIMENTS ON PLANTS.

PLATE II.

## Explanation of the figures.

### Pl. II.

Fig. 1. *Fatsia japonica*.

- A. Basal part of palmate veins. Through the dotted lines *a*, *b*, *c*, *d*, *e* the sections *a'*, *b'*, *c'*, *d'*, *e'* in C were taken respectively (nat. size).
- B. Median longitudinal section of the same, showing the course of vascular bundles; the coloured bundles represent those stained by the injected  $\text{SO}_4\text{Cu}$ . The dotted lines *a*, *b*, *c*, *d*, *e* are like in A (diagrammatic).
- C. Cross sections of the same; *a'*, *b'*, *c'*, *d'*, *e'* are the sections through *a*, *b*, *c*, *d*, *e* in A and B respectively, the coloured bundles are like in B (diagrammatic).
- D. Surface view of a portion of the leaf, showing the termination of vascular bundles being affected by the  $\text{SO}_4\text{Cu}$  injection (nat. size).

Fig. 2. Cross section of a vascular bundle of the stem of *Vicia Faba* to show xylem elements which contain aniline violet in consequence of the injection ( $\times 200$ ).

Fig. 3. Cross section through the rhizome of *Menianthes trifoliata* to show xylem elements which contain eosin in consequence of the injection ( $\times 70$ ).

Fig. 4. Cross section of a vascular bundle of the petiole of *Trachycarpus excelsa* to show that much  $\text{SO}_4\text{Cu}$  is contained in phloem elements in consequence of the injection ( $\times 200$ ).

Fig. 5. 2 stages of the unfolding bud of *Cornus controversa* (nat. size). In the A stage, lithium which has been injected into the stem is not detectable in the young leaves, while in the B stage it is first found in the larger leaves. (Compare exp. 56, 57.)

Fig. 1.

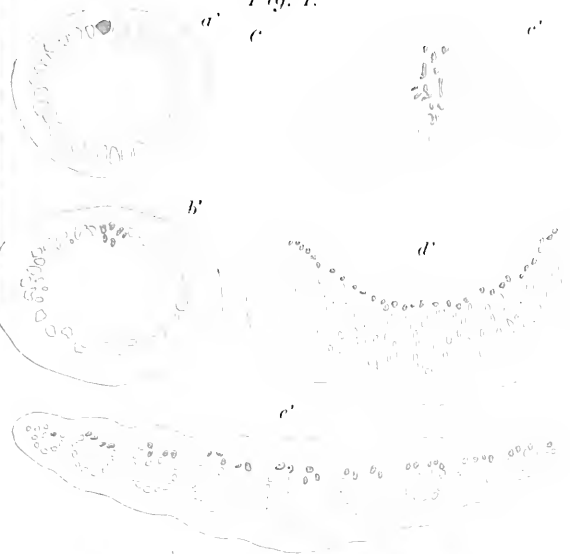

Fig. 2.

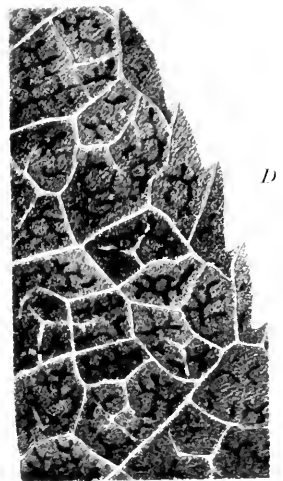
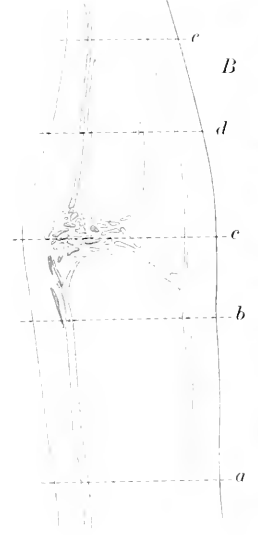
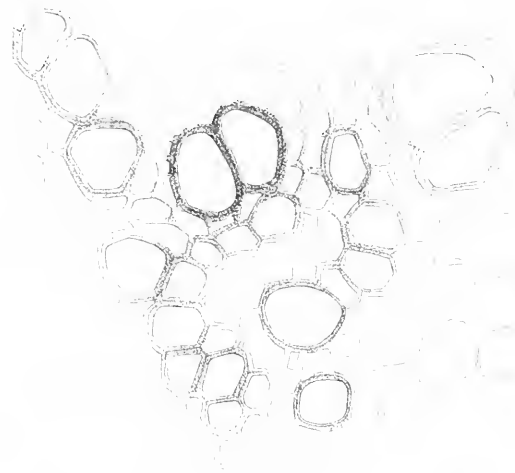

Fig. 1.

Fig. 3.

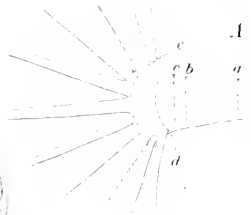
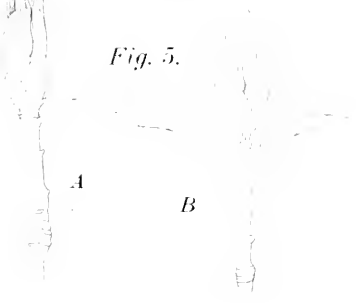

Fig. 5.









MRI WHOI LIBRARY



WH 19KY R

