







THE JOURNAL  
OF  
COMPARATIVE NEUROLOGY  
AND PSYCHOLOGY

---

EDITORIAL BOARD

HENRY H. DONALDSON  
The Wistar Institute

C. JUDSON HERRICK  
University of Chicago

HERBERT S. JENNINGS  
Johns Hopkins University

J. B. JOHNSTON  
University of Minnesota

ADOLPH MEYER  
Pathological Institute, New York

OLIVER S. STRONG  
Columbia University

JOHN B. WATSON  
Johns Hopkins University

ROBERT M. YERKES  
Harvard University

---

VOLUME XIX

1909

---

PHILADELPHIA, PA.

THE WISTAR INSTITUTE OF ANATOMY AND BIOLOGY

E157(1)

10

1107

# The Journal of Comparative Neurology and Psychology

## CONTENTS OF VOL. XIX, 1909.

### Number 1, April, 1909.

	PAGE.
Some Experiments Bearing upon Color Vision in Monkeys. By JOHN B. WATSON. ( <i>From the Psychological Laboratory of the University of Chicago.</i> ) With Five Figures .....	1
The Expressions of Emotion in the Pigeons. I. The Blond Ring-dove. ( <i>Turtur Risorius</i> ). By WALLACE CRAIG. ( <i>From the Department of Zoology of the University of Chicago.</i> ) With One Plate .....	29
The Reaction to Tactile Stimuli and the Development of the Swimming Movement in Embryos of <i>Diemyctylus Torosus</i> , Eschscholtz. By G. E. COGHILL. ( <i>Studies from the Neurological Laboratory of Denison University. No. XXII.</i> ) With Six Figures .....	83
Sensations Following Nerve Division. By SHEPHERD IVORY FRANZ. ( <i>From the Laboratory of the Government Hospital for the Insane, Washington, D. C.</i> ) I. Pressure-like Sensations. With Five Figures ....	107
Alterations in the Spinal Ganglion Cells Following Neurotomy. By S. WALTER RANSON. ( <i>From the Anatomical Laboratory of the University of Chicago.</i> ) Introduction. With Six Figures .....	125

### Number 2, May, 1909.

On the Relation of the Body Length to the Body Weight and to the Weight of the Brain and of the Spinal Cord in the Albino Rat ( <i>Mus Norvegicus</i> var. <i>Albus</i> ). By HENRY H. DONALDSON. ( <i>Professor of Neurology at the Wistar Institute.</i> ) With Three Figures .....	155
Note on the Formulas Used for Calculating the Weight of the Brain in the Albino Rats. By SHINKISHI HATAL. ( <i>From the Wistar Institute.</i> )	169
The Nervus Terminalis (Nerve of Pinkus) in the Frog. By C. JUDSON HERRICK. ( <i>From the Anatomical Laboratory of the University of Chicato.</i> ) With Ten Figures .....	175
The Nervus Terminalis in the Carp. By R. E. SHELDON. ( <i>From the Anatomical Laboratory of the University of Chicago.</i> ) With Seven Figures.	191
The Criteria of Homology in the Peripheral Nervous System. By C. JUDSON HERRICK. ( <i>From the Anatomical Laboratory of the University of Chicago.</i> ) .....	203
Literary Notices .....	211

<b>Number 3, June, 1909.</b>		PAGE.
On Sensations Following Nerve Division. By SHEPHERD IVORY FRANZ. ( <i>From the Laboratories of the Government Hospital for the Insane, Washington, D. C.</i> ) II. The Sensibility of the Hairs. With Seven Figures .....		215
Modifiability of Behavior in its Relations to the Age and Sex of the Danc- ing Mouse. By ROBERT M. YERKES. ( <i>From the Harvard Psychological Laboratory.</i> ) With Four Figures .....		237
The Reactions of the Dogfish to Chemical Stimuli. By RALPH E. SHELDON. ( <i>Contribution from the Woods Hole Laboratory of the United States Bureau of Fisheries.</i> ) With Three Figures .....		273
The Work of J. von Uexkuell on the Physiology of Movements and Be- havior. By H. S. JENNINGS .....		313
 <b>Number 4, July, 1909.</b> 		
Imitation in Monkeys. By M. E. HAGGERTY. ( <i>From the Harvard Psycho- logical Laboratory.</i> ) With Thirteen Figures .....		337
 <b>Number 5, November, 1909.</b> 		
The Morphology of the Forebrain Vesicle in Vertebrates. By J. B. JOHN- STON. ( <i>University of Minnesota.</i> ) With Forty-five Figures.....		457
Some Experiments upon the Behavior of Squirrels. By C. S. YOAKUM. ( <i>From the Psychological Laboratory of the University of Chicago.</i> ) With Five Figures .....		541
Tropic and Shock Reactions in Perichæta and Lumbricus. By E. H. HARPER. ( <i>From the Zoological Laboratory of Northwestern Univer- sity.</i> ) With Two Figures .....		569
Literary Notices .....		589
 <b>Number 6, December, 1909.</b> 		
The Radix Mesencephalica Trigemini. By J. B. JOHNSTON. ( <i>University of Minnesota.</i> ) With Thirty-two Figures .....		593
A New Association Fiber Tract in the Cerebrum with Remarks on the Fiber Tract Dissection Method of Studying the Brain. By E. J. CURRAN. ( <i>Harvard Medical School.</i> ) With Three Plates .....		645
Visual Discrimination in Raccoons. By L. W. COLE and F. M. LONG. With One Figure .....		657
A Statistical Study of the Medullated Nerve Fibers Innervating the Legs of the Leopard Frog ( <i>Rana Pipiens</i> ) after Unilateral section of the Ventral Roots. By ELIZABETH H. DUNN. ( <i>From the Anatomical Laboratory of the University of Chicago.</i> ) With One Figure .....		685
Factors Determining the Reactions of the Larva of <i>Tenebrio Molitor</i> . By MAX MORSE. With Two Figures .....		721



# SUBJECT AND AUTHOR INDEX.

## VOLUME XIX.

- A**LTERATIONS in the spinal ganglion cells following neurotomy, 125.
- B**EHAVIOR, modifiability of, in its relations to the age and sex of the dancing mouse, 237.  
Of squirrels, some experiments upon, 541.
- Body length, relation of, to body weight and to the weight of the brain and of the spinal cord in the albino rat, 155.
- Body weight, relation of body weight to, and to the weight of the brain and of the spinal cord in the albino rat, 155.
- C**ARP, the nervus terminalis in, 191.  
Cerebrum, a new association fiber tract in the, 645.
- COGHILL, G. E. The reaction to tactile stimuli and the development of the swimming movement in embryos of *Diemycylus torosus*, Eschscholtz, 83.
- COLE, L. W., and F. M. LONG. Visual discrimination in raccoons, 657.
- Color vision in monkeys, some experiments bearing upon, 1.
- CRAIG, WALLACE. The expressions of emotion in the pigeons. The blond ring-dove, 29.
- CURRAN, E. J. A new association fiber tract in the cerebrum, 645.
- D**OGFISH, the reactions of, to chemical stimuli, 273.
- DONALDSON, HENRY H. On the relation of the body length to the body weight and to the weight of the brain and of the spinal cord in the albino rat, 155.
- DUNN, E. H. A statistical study of the medullated nerve fibers innervating the legs of the leopard frog after unilateral section of the ventral roots, 685.
- E**MOTION in the pigeons, the expressions of. I. The blond ring-dove, 29.
- F**IBER tract in the cerebrum, a new association, 645.
- Forebrain vesicle in vertebrates, the morphology of, 457.
- Formulas used for calculating weight of the brain in albino rats, 169.
- FRANZ, SHEPHERD IVORY. Sensations following nerve division. I. The pressure-like sensations, 107. II. The sensibility of the hairs, 215.
- Frog, the nervus terminalis in the, 175.
- G**ANGLION cells, alterations in the spinal, following neurotomy, 125.
- H**AGGERTY, M. E. Imitation in monkeys, 337.
- HARPER, E. H. Tropic and shock reactions in *Perichæta* and *Lumbricus*, 569.
- HATAI, SHINKISHI. Note on the formulas used for calculating the weight of the brain in albino rats, 169.
- HERRICK, C. JUDSON. The nervus terminalis in the frog, 175.  
The criteria of homology in the peripheral nervous system, 203.  
Homology in the peripheral nervous system, the criteria of, 203.
- I**MITATION in monkeys, 337.
- J**ENNINGS, H. S. The work of J. von Uexkuell on the physiology of movements and behavior, 313.
- JOHNSTON, J. B. The morphology of the forebrain vesicle in vertebrates, 457.  
The radix mesencephalica trigemini, 593.
- L**ONG, F. M., and L. W. COLE. Visual discrimination in raccoons, 657.  
*Lumbricus*, *Perichæta* and, tropic and shock reaction in, 569.

- M**EDULLATED nerve fibers innervating the legs of the leopard frog after unilateral section of the ventral roots, a statistical study of, 685.
- Modifiability of behavior in its relations to the age and sex of the dancing mouse, 237.
- Monkeys, imitation in, 337.  
Some experiments bearing upon color vision in, 1.
- Morphology of the forebrain vesicle in vertebrates, 457.
- MORSE, MAX. Factors determining the reactions of the larva of *Tenebrio molitor*, 721.
- Mouse, modifiability of behavior in its relations to the age and sex of the dancing, 237.
- N**ERVE division, sensations following. I. The pressure-like sensations, 107.  
II. The sensibility of the hairs, 215.
- Nervous system, the criteria of homology in the peripheral, 203.
- Nervus terminalis in the carp, the, 191.  
In the frog, 175.
- Neurotomy, alterations in the spinal ganglion cells following, 125.
- P**ERICHAETA and *Lumbricus*, tropic and shock reactions in, 569.  
Physiology of movements and behavior, the work of J. von Uexkuell on the, 313.
- Pigeons, the expressions of emotion in the, I. Blond ringdove, 29.
- Pinkus, nerve of, in the frog, 175.
- R**ACCOONS, visual discrimination in, 657.  
Radix mesencephalica trigemini, the, 593.
- Rana pipiens*, a statistical study of the medullated nerve fibers innervating the legs of the leopard frog, after unilateral section of the ventral roots, 685.
- RANSON, S. WALTER. Alterations in the spinal ganglion cells following neurotomy, 125.
- Rat, relation of the body length to the body weight and to the weight of the brain and of the spinal cord in the albino, 155.  
Weight of the brain in albino, note on the formulas used for calculating, 169.
- Reactions in perichæta and *lumbricus*, tropic and shock, 569.  
Of the larva of *Tenebrio molitor*, factors determining the, 721.
- S**ENSATIONS following nerve divisions. I. The pressure-like sensations, 107.  
II. The sensibility of the hairs, 215.
- SHELDON, R. E. The nervus terminalis in the carp, 191.  
The reactions of the dogfish to chemical stimuli, 273.
- Spinal cord in the albino rat, relation of the body length to the body weight and to the weight of the brain and of the, 155
- Spinal ganglion cells, alterations in the, following neurotomy, 125.
- Squirrels, some experiments upon the behavior of, 541.
- Stimuli, the reactions of the dogfish to, 273.  
The reaction to tactile, and the development of the swimming movement in embryo of *Diemctylus torosus*, Eschscholtz, 83.
- Swimming movement in embryos of *Diemctylus torosus*, Eschscholtz, the reaction to tactile stimuli and the development of, 83.
- T**HE stimuli, the reaction to, and the development of the swimming movement in embryos of *Diemctylus torosus*, Eschscholtz, 83.
- Tenebrio molitor*, factors determining the reactions of the larva of, 721.
- Trigemini, the radix mesencephalica, 593.
- U**EXKUELL, J. VON, the work of, on the physiology of movements and behavior, 313.
- V**ISUAL discrimination in raccoons, 657.
- W**ASHBURN, M. F. Review of *La naissance de l'intelligence*, George Bohn, 589.  
Review of the animal mind. Second volume of the *Animal Behavior* series, edited by R. M. Yerkes, 211.
- WATSON, JOHN B. Some experiments bearing upon color vision in monkeys, 1.
- Weight of brain and of the spinal cord in the albino rat, relation of the body length to the body weight and to, 155.
- Weight of the brain in the albino rats, note on formulas used for calculating the, 169.
- Y**ERKES, ROBERT M. Modifiability of behavior in its relation to the age and sex of the dancing mouse, 237.
- YOAKUM, C. S. Some experiments upon the behavior of squirrels, 541.

# The Journal of Comparative Neurology and Psychology

---

VOLUME XIX

APRIL, 1909

NUMBER I

---

## SOME EXPERIMENTS BEARING UPON COLOR VISION IN MONKEYS.

BY

JOHN B. WATSON.

*From the Psychological Laboratory of the University of Chicago.*

WITH FIVE FIGURES.

For over a year, the writer has been experimenting with apparatus for obtaining large bands of spectral light suitable for use as stimuli in testing the color vision of animals by means of the discrimination method. In the process of constructing the apparatus finally adopted, the writer has availed himself liberally of the assistance of Professors Gale and Milliken of the physics department of the University of Chicago, and of Professor R. W. Wood of the physics department of the Johns Hopkins University. He is also under deep obligation to Professors Angell and Carr for many valuable suggestions.

The actual accumulation of the data bearing upon color vision in monkeys began March 12th and ended August 20, 1908. Two rhesus monkeys (J. and B.) and one cebus (H.), all gentle and accustomed to experimentation, were the subjects used in the investigation. The report is given in its present incomplete form, because of the fact that the writer's work could not be continued at the University of Chicago. The apparatus used there, however, has been duplicated in the Hopkins laboratory and the investigation will be continued in the latter place both upon two of the monkeys,

J. and B., which served as subjects in the present work and upon other monkeys. In addition to continuing the tests upon color vision, steps are being taken thoroughly to test the delicacy of the white-light vision of the monkeys and their sensitivity to differences in the size and form of visual stimuli.

In view of these further tests, which are concerned with the nature and delicacy of the visual reactions as a whole of this animal, it would seem to be premature in this preliminary report to enter into any general discussion of color vision in animals or to take up the related structural facts which bear upon color vision. The color vision of several different species of animals is being tested in the various laboratories and for this additional reason the writer will confine his statements on the historical side strictly to the work of Kinnaman, which, so far as the writer is aware, is the only study of the color vision of this animal which can lay any claim to scientific accuracy.

Kinnaman's<sup>1</sup> work was certainly as careful and as exact as his method would permit. His stimuli were obtained by means of light reflected from pigmented papers. The method was roughly as follows: A board, 1 inch by 7 inches, and 5 feet long contained six holes pierced at regular distances. Each hole was large enough to admit the bottom of a cylindrical glass. The convex surface of each glass was covered with colored papers or with different grays. Food was kept with one of the colored glasses, the position of which could be varied at will after each test. The discriminations were made rapidly. "In order to determine whether brightness or color was the basis for discrimination four control tests were made. In three of these, I attempted to determine whether the monkeys could discriminate greys and colors varying by the same degree of brightness equally well. If blue and red, for example, with a difference in brightness of  $15^{\circ}$  (determined by the flicker method) were differentiated perfectly, and two grays differing by  $15^{\circ}$  very imperfectly, then color very probably was the basis of the discrimination in our first series of tests." Both original tests and control tests were

<sup>1</sup>American Journal of Psychology, Vol. 13, p. 98.

carefully made and so satisfactory were the results obtained from them that we find the author expressing himself somewhat extravagantly as follows:

"1. There can be no doubt that monkeys perceive colors.

"2. Two grays having a given degree of difference in brightness are not discriminated as well as two colors having an equal difference in brightness.

"3. For accurate discrimination of difference in brightness a difference of about 35 degrees or 9 per cent of the white constituent of the gray is necessary.

"4. The monkeys are able to distinguish colors from grays though the brightnesses are the same.

"5. The male appears to have a preference for bright colors, but blue seems to be discriminated against.<sup>2</sup>

"6. In two instances there were indications of at least a low form of general notion."

For detailed reasons, which can not be entered into here, the assertion is ventured that the use of colored papers can never give us a satisfactory test of color vision in animals.<sup>3</sup> Certainly, the writer has room for "doubt" both in Kinnaman's work and in his own. The fact that there is a high percentage of correct choices of the positive color in both investigations cannot be doubted, but that the correct choices were made upon basis of 'hue' and not that of 'brightness' cannot be decided so easily as Kinnaman supposes. It would not be at all ridiculous for one, skeptical of the possibility of testing the color vision of animals, to assert that every discrimination which has been made between two colored papers by an animal could have been made if it had been totally color-blind.

As a reason for such scepticism, a few of the defects of this method as a whole may be mentioned now:

1. The surfaces of the papers differ greatly, owing to accidents

<sup>2</sup>Blue certainly was not discriminated against by the animals used by the writer. See Table VI.

<sup>3</sup>The committee appointed by the American Psychological Association at the 1907 meeting to report upon methods and apparatus for testing vision in animals will take up in its report the defects and advantages of the various methods of testing color vision.

in manufacture, dyeing, ironing, etc. In addition, it is extremely difficult to bend colored papers around glasses or to paste them upon doors so accurately that slight differences in form, size and depth do not appear. To sum up these defects under 1, we may say that colored papers afford numerous secondary criteria.

2. They do not reflect monochromatic bands, but overlapping bands. This is especially true of those reflecting the shorter wave lengths.

3. *The range of intensity obtainable in them is so limited, that if any given region of the spectrum should offer to the animal a different order of intensity from that which the same region offers to our own eyes, the slight change which we could introduce in the brightness of a given stimulus, by substituting a paper of the same color only lighter or darker (to our own eyes) might not at all reverse for the animal the intensity relation originally existing between the colors.*

Yerkes,<sup>4</sup> in his work on the dancing mouse, mentions most of these objections and shows by experiment that for that animal the red end of the spectrum is probably extremely weak in intensity. Whether or not the different parts of the spectrum possess the same intensity for the eye of the monkey, as they do for our own, is a question which we have at present no data for deciding, but certainly in the present state of our knowledge we cannot assume such to be the case.

Believing that many problems in the study of color vision in animals cannot be solved without the aid of a continuous spectrum, and being more or less disheartened by the failure of colored papers and filters (as they have heretofore been used) to furnish suitable stimuli for testing even the more elementary questions at issue, the writer began work upon a spectral light apparatus which it is hoped will make possible an experimental treatment of the following problems:

1. Has the animal the power to discriminate between any given color and any other selected color with equal ease, when the relative

<sup>4</sup>Yerkes, R. M. *The Dancing Mouse.* The Macmillan Company, 1908.

intensity of either color, and the absolute intensity of both may be altered at will? In investigating this problem, we ought to be able to find totally color blind animals, red-green blind animals, animals with normal color vision, if such differences in sensitivity exist. After the problem has been solved, color theories based upon the phylogenetic development of a photo-chemical molecule will or will not have bases in fact.

2. How nearly identical in wave length may any two colors be and still afford a basis for the animal to discriminate between them (the qualitative 'difference limen', D.L.)?<sup>5</sup>

3. How nearly identical in intensity may two bands of the same wave length be and still afford a basis for discrimination (the D.L. for intensity)?

4. Do the different parts of the spectrum possess different threshold values (stimulus limen, R.L.)?

5. Is the spectrum of a given animal wider or narrower than the average width of the spectrum of man?

#### DESCRIPTION OF APPARATUS.

As Figs. 1 and 2 show, the light apparatus is made upon the principle of a spectrometer. Fig. 1 shows, in order, the arc,  $A$ , the condensing lens,  $L_1$ , the slit,  $S_1$ , the collimating lens,  $L_2$ , the prism,  $P$ , the mirror,  $M_1$ , and the lens,  $L_3$ , (all are enclosed in a system of dark boxes).

The arc is an ordinary hand-feed arc. The direct 220 v. current supplying the arc is furnished by the university power-house. This current is very steady and uniform. The positive (cored) carbon is placed horizontally and in the axis of the optical system. The arc is so arranged that it can be adjusted by the experimenter in the adjoining room at  $K$  (Fig. 2). Two long rods,  $RR$ , extending from the arc into the experimental room permit this.  $AC$  in Fig. 1 shows the gearing system by means of which the long rods are brought into connection with the short feeding rods of the arc. After practice the experimenter can control the arc at  $K$  through

<sup>5</sup>In the apparatus to be described, a double image prism would afford the conditions for this test.

long periods of time without allowing sensible alteration in its intensity. Since the arc is not in the dark-room where the animals react, the noise made by it is not a source of disturbance. When burning well, this arc rarely makes a noise which is noticeable even near at hand, after the heavy wooden box (metal lined) has been closed.

The lens used as a condenser is an ordinary 4" biconvex reading glass with 8" focus. This lens gives a clearly defined image of the crater of the positive carbon at its focus.

The slit,  $S_1$ , which is placed at the focus of  $L_1$ , is a common optical slit with knife edge opening. Its width was adjusted once for all to give a spectrum of high intensity and was never thereafter changed.

The collimating lens,  $L_2$ , is a heavy 3½" achromatic lens with a focal distance of 18". The slit,  $S_1$ , is in the focus of this lens, consequently the face of the 65 mm. heavy flint glass prism,  $P$ , is filled with parallel light admitted by it. The now refracted beam falls upon the mirror,  $M_1$  (the use of this mirror is necessitated by the narrowness of the room) which is silvered upon its anterior surface. This mirror reflects the beam through the achromatic lens,  $L_3$ , (similar in all respects to  $L_2$  except that  $L_3$ 's focal distance is 24").

The lens,  $L_3$ , brings the refracted beam to a focus upon the double slit,  $S_2$ , (not shown in Figs. 1 and 2, but shown separately in Fig. 3) in a series of colored images of  $S_1$ . The solar lines are plainly visible and serve as a guide in the selection of particular wave lengths. The apparatus can be so arranged (by revolving  $M_1$  upon its axis) that these lines shall coincide with definite mm. divisions of the slit.<sup>6</sup>

In order that this double slit may be more easily understood, the following description is given: Fig. 3 shows the slit horizontally. The sharply outlined spectrum falls upon the polished surface of the slit between 0 on the  $SC$  scale, and 0 on the  $SC_1$  scale. Two selected portions of the spectrum pass out between the knife edge

<sup>6</sup>For example, the Na line can be made to fall upon 3 of the scale  $SC$ , etc.



openings,  $J-J_1$ , and  $J_2-J_3$ . The width of these openings is controlled by means of the micrometer screw system  $Cal, ES, K, B$ , the mechanism of which is well known (i. e., turning  $Cal$ , e. g., forces the nut,  $K$ , backwards or forwards as the case may be and consequently the edge of the jaw at  $J$  advances or recedes from  $J_1$ ).

The two small jaws,  $J_1$  and  $J_2$ , must be moved by hand. They are held in place (i. e.; in the grooved track of the slit) by means of a small bowed spring. Since they are cut accurately to fit the track in which  $J$  and  $J_3$  slide, they are held firmly in vertical position by means of the spring. If it is desired to have the opening,  $J-J_1$ , admit some other part of the spectrum, the apparatus easily permits it. Suppose we desire to have the opening at 6 instead of at 3.65, as it stands in the diagram (see relation of scale  $SC$  to index  $I$ ). We turn the screw,  $Cal$ , until  $I$  falls at 6. The small jaw,  $J_1$ , is then pushed up flush against  $J$ .  $J$  is then pushed forward, carrying  $J_1$  with it for whatever width of slit is desired;  $J$  is then backed again to 6. This leaves the opening,  $J-J_1$ , in its new position optically perfect. By means of the micrometer screw head this distance is made accurate to 1/1000 mm. This would leave a much wider space at 0 than before. This variable opening at 0 is closed with a strip of black cardboard. Four tiny points,  $p, p_1, p_2, p_3$ , on the jaws,  $J_1$  and  $J_2$ , facilitate this.<sup>7</sup>

The position of this slit in the system can be inferred from an examination of Fig. 2:  $L_3$  of Fig. 1 is shown on the right in Fig. 2;  $S_2$  is at the focus of this lens, 24" distant. The two small vertical mirrors,  $M_2$  and  $M_3$ , placed at an angle of  $45^\circ$  so as to form a horizontal V (with apex directed towards  $S_2$  and midway between the two openings) serve to catch the two selected beams (e. g., red and green) issuing from the openings,  $J-J_1$  and  $J_2-J_3$  of  $S_2$  and to reflect them to the mirrors,  $M_4$  and  $M_5$  respectively. These latter two mirrors in turn reflect the two beams in a parallel way down the room to the SCREEN. The width between these two mirrors can be adjusted to any desired distance. Since the rays as they issue from the openings of  $S_2$  are diverging, we have a broad, diffuse,

<sup>7</sup>The slots,  $Sl$  and  $Sl_1$ , serve to admit bolts for attaching slit as a whole permanently in its vertical position.

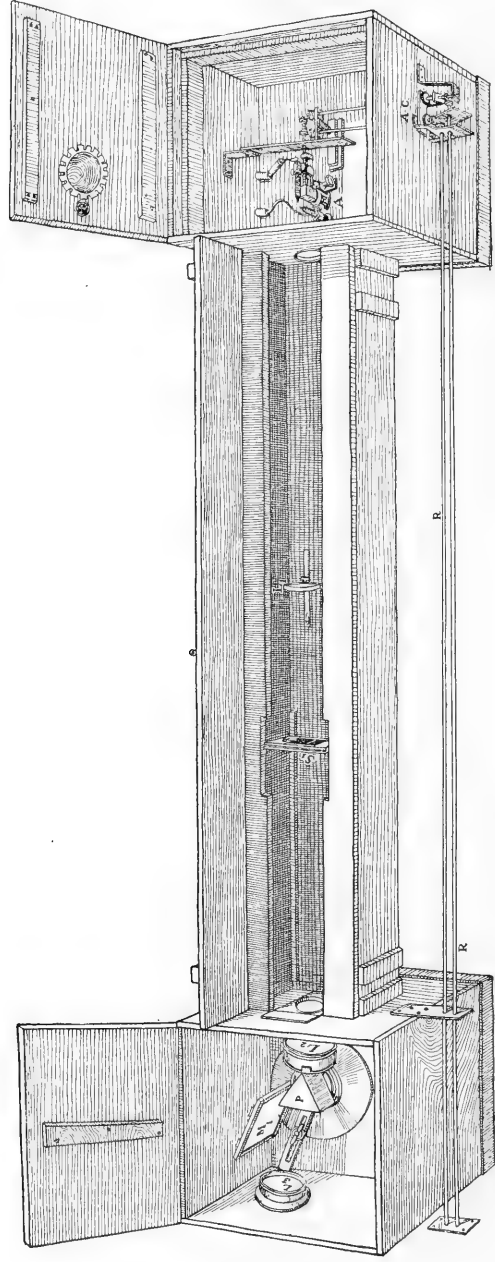

FIG. 1.









4444

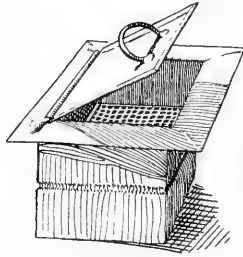

FIG. 4.

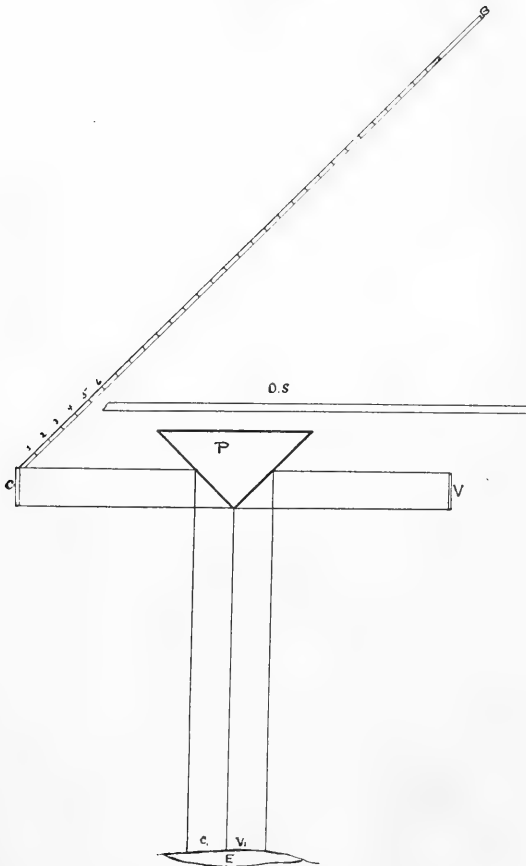

FIG. 5.

faint band of red and of green light on the screen. In order to intensify and sharply define the bands on the screen, two small achromatic lenses,  $L_4$  and  $L_5$ , are interposed in the pathways of the two beams,  $R$  and  $G$  respectively. These two lenses are of short focal length (6"). They project sharply defined and enlarged images of the two openings of  $S_2$  upon the screen (marked RED and GREEN in the diagram). These images are about 7" in height and  $1\frac{1}{8}$ " in width.

Four reversing mirrors,  $RM$ , are used in order to reverse the right and left positions of the two beams. These mirrors revolve in a vertical plane. They are mounted in bearings in such a way that the small weights,  $Wgt$ , pull them back to the  $45^\circ$  position whenever the cords,  $CRM$ , are slackened, as in the diagram. These cords are jointly fastened to a rod at  $X$ . A single forward pull upon this rod brings all four mirrors to the  $180^\circ$  position, in which position they no longer intercept the two beams.

A glance at the apparatus will show that when, e. g., the red is on the left, the reversing mirrors have to intercept the beam; when it is on the right, they no longer intercept it and the beam is reflected directly from the mirror,  $M_4$ , to the screen. It is clear from this that the absolute intensity of the two bands is slightly less in the "reversed position" than in the normal. But this reduction occurs in both bands equally.<sup>8</sup> In order to compensate for this reduction, a vertical sliding bar,  $SB$ , is placed in the pathway of the beams. 1" x 2" windows are cut in this bar at the points where the beams impinge upon it. One half of each window is

<sup>8</sup>All the mirrors in the system are silvered on the anterior surface. They are kept highly polished by the use of "jewelers' rouge." When not in use, they are kept covered with silk handkerchiefs. The absorption of the light consequently is kept constant and at a minimum.

[Since the mirrors used in the apparatus are a source of a great deal of trouble and care and since their use causes a certain variation in the absolute intensity of the light, effort was made to find a substitute for them. After some experimentation it was found that total reflection prisms could be made to separate the beams, to space them properly, and finally to reverse them. In addition the dark room at Hopkins is large enough to accommodate the apparatus without the use of the mirror,  $M_1$ , behind the large prism. The whole apparatus is now "self-maintaining" and completely constant so far as the absorption of the light is concerned.]



left open, the other half is covered with a sufficient number of strips of plate glass to compensate for the absorption of the reversing mirrors. To one end of this bar a spring is attached. When this spring operates alone, the bar is held in such position that the beams of light have to pass through the open halves of the windows. A cord, *CSB*, runs from the opposite end of the bar around to the rod at *X*, which controls the mirrors. Pulling upon this cord brings the sliding bar forward to such a position that the beams have to fall upon the halves of the openings which are covered by the plate glass. This bar is made to work synchronously with the mirrors in such a way that when the reversing mirrors are "out" the plate glass windows are "in" and *vice versa*. A simple forward pull or a release of the rod at *X* adjusts both mirrors and bar. This compensatory device was used in certain of the control tests described below (all of the red-green), but since many trials showed that the reactions of the animals were not altered by its insertion or removal, its use was discontinued.<sup>9</sup>

Behind the opaque screen, there is a vertically placed 12" x 24" pane of acid ground glass (acid ground is less granular than common ground glass; milk glass would have been used, could it have been obtained). The moment the screen is raised by pulling upon *H*, the two bright-colored bands (surfaces) appear. Immediately behind each of these bands (they are 8" apart)<sup>10</sup> a hole is cut in the platform to admit the food-boxes shown in Fig. 4. A glass partition, *GP*, set in a low wooden base serves to keep the animal from opening both food-boxes at once. It also serves to force the animal to go clearly to the right or to the left and to keep a position habit from forming.<sup>11</sup>

<sup>9</sup>However, if one were working with two colors approximately equal in intensity to the animal, it might very well happen that this change in absolute intensity would, owing to possible onset of the Purkinje phenomenon, alter the intensity relation for the animal.

<sup>10</sup>This distance depends upon the distance of  $M_4$  from  $M_5$ .

<sup>11</sup>Before this partition was at hand, one monkey, whose records are not given, went always to the right, then down the screen of ground glass to the left until he came to the box which contained the food.

## METHOD OF CONTROLLING THE INTENSITY OF THE TWO LIGHTS.

The diagrams (Figs. 1 and 2) show that the absolute intensity of the entire spectrum may be changed by opening or closing the slit  $S_1$ . Since the present tests are not concerned with faint or weak spectra (as such), the width of this slit, as has been stated, was kept constant and as wide as was possible still to permit a sharply defined spectrum at  $S_2$ . The intensity of the two selected bands can be altered separately in two ways: By attaching an iris diaphragm (or better, possibly, an Aubert) to each of the two projecting lenses,  $L_4$  and  $L_5$ , or by the use of an episcotister.

In the experiments here reported, the intensity of the red and of the green was controlled by the use of the iris diaphragm, while that of the blue and of the yellow was controlled by the episcotister. The chief objection to the diaphragm lies in the fact that the width of the band changes slightly when the diaphragm is opened or closed. By an oversight, the spectroscopic reading was taken only when the diaphragm was completely open. It was my intention to return to the red-green discrimination during the summer months when it was possible to obtain sunlight, and to use both the diaphragm and the episcotister, but I found that the time at my disposal did not permit this. Accordingly, all the red-green tests reported below were made with the arc as a source; and all changes in intensity of the two bands were made by means of the diaphragm (in table of constants, e. g., "red maximum" was obtained by a wide open diaphragm, "red minimum" by a fixed pinhole opening in the diaphragm). On the other hand, all changes in intensity in the blue-yellow tests were made by means of the episcotister. In the present state of color photometry, it is desirable to have some check upon photometric readings. The episcotister furnishes such a check by allowing us to increase or decrease in a constant way the angular opening through which the beam is allowed to pass. In the present work, the episcotister proved eminently satisfactory. In the table of constants given below, the maximum yellow, e. g., was the normal intensity of the beam as it came from  $S_2$ ; the minimum yellow was the intensity of the beam after it had been interrupted by the episcotister, set with a  $30^\circ$  opening ( $15^\circ$  on each side). The angle

of  $30^\circ$  was chosen as the minimum after several preliminary trials. It was desirable to keep the minimum intensity of any beam always well over the human threshold. Any smaller angle did not permit this, with sunlight as the source. That this minimum was also well above the animal's (reaction) threshold was tested in the following way: The episotister, set at the minimum ( $30^\circ$ ), was allowed to interrupt the blue; the yellow was cut out at  $S_2$  and the animal tested at  $X$  in the ordinary way. When the screen was raised, only the blue band appeared. As a result, it was found in every case that the animal followed the light regardless of its right or left position. The blue was then cut out at  $S_2$  and the yellow interrupted, with similar results. There is the possibility, however, that the minimum intensity was over the 'brightness limen' but not over the 'color limen.' This objection cannot be met until extended threshold tests have been made.

In conducting such experiments in the future, the following procedure will be adopted: first, during the formation of the association, an episotister opened to the maximum ( $320^\circ$ ) will interrupt each beam continuously during all tests;<sup>12</sup> second, after the association has been established, the control tests will be made with the two episotisters set at any desired angle; third, the iris diaphragm will be used as an additional control.<sup>13</sup>

The episotister was run at a very high rate of speed. As a test as to whether the beams were uniform for the animal, the screen

<sup>12</sup>In duplicating the apparatus at Hopkins, the motor and the two episotisters were mounted upon a small revolving table. This table is so arranged that a pull on a cord (at  $X$ , Fig. 2, where the experimenter sits) will interchange the positions of the two episotisters, thus making it possible to have the animal on the one trial react, *e. g.*, to "minimum red," "maximum green," and on the next to "maximum red," "minimum green."

<sup>13</sup>It will be remembered that there are three common ways in which intensity in the physiological sense can be altered: (1) by decreasing the amplitude of the ether waves of the beam which falls upon a given retinal area (increasing distance of source); (2) by lessening density of beam (use of diaphragms, etc.); (3) by interrupting beam (episotister). In order to test whether the physiological effect, *e. g.*, of distancing the source of the beam is the same as interrupting it, it is desirable to make changes in intensity by employing all three methods. The desirability of the use of the episotister and diaphragm has been assumed in the present work.

was sometimes raised before the episcotister had gained full speed. The flickering light never failed to frighten the animals. *They would never leave my shoulder to make a choice until the lights appeared perfectly steady to my own eyes.*

METHOD OF DETERMINING INTENSITY OF ILLUMINATION OF  
MONOCHROMATIC BANDS.

After vainly trying to obtain a photometric reading of the minimal intensity of the monochromatic bands,<sup>14</sup> with a photometer based upon the Joly principle, I finally, on the advice of Professor Milliken, abandoned the photometer and had resort to the simple apparatus, the ground plan of which is shown in Fig. 5. In the diagram, *V* is a band of monochromatic light visible upon the ground glass surface. *C* is a white surface (bristol-board; plaster-paris is preferable) equal in width to *V*, which reflects light to the prism, *P*, from a source the intensity, and distance from *C* of which, is known. *P* is a 90° prism silvered on the two surfaces which reflect the images of *V* and *C* into the eye at *E*. The distances from *V* to *P* and from *C* to *P* are equal, 15.5 cm. The distance from *P* to *E* is 20 cm. The total distance from *E* to *V* approximately equals the distance of the color from the eye of the monkey when he reaches the partition *GP* in Fig. 2 and makes his choice as evidenced by his going to the right or to the left of the partition (the monkey B. often stopped at this point and turned his head first to the right, then to the left, etc., before finally making his choice).

The photometric determinations were made in a dark-room under conditions as nearly as possible like those under which the animal reacts. The eye was dark-adapted (15 to 30 minutes). A comfortable position was taken with the eye at *E* so that a clear reflected image of *V* appeared. An assistant then lighted a standard electric light which was screened from the observer's eye by the opaque screen, *OS*, and mounted it upon the board, *B*, which was graduated in cm. The distance of this light was varied until the observer at *E* judged the two lights to be equal. The judgments made under

<sup>14</sup>They are not really sources in the technical sense, but surfaces.

these conditions are introspectively similar to those made with an ordinary photometer. The images of *V* and *C* appear side by side, with no dividing surface between. Six judgments for each change in the intensity of the band were made, three ascending and three descending, and the results averaged.

The units in which the results below are given are "hefner-meters." In other words, the apparatus measures the "intensity of illumination" of the variable surface, *V*, in terms of *C*, the "intensity of illumination" of which can be calculated from the formula:

$$I = \frac{\text{Cos } \theta}{r^2}$$

( $\theta = 45^\circ$  in all cases; *r* is read directly from the scale of *B*).<sup>15</sup>

The following table of constants gives the wave lengths of the four bands used in the present work and their "intensity of illumination" under the various conditions.

TABLE OF CONSTANTS.

Designation of Variable Light.				Standard White Light.	Average Distance from C.	Hefner-Meters.
1.	Max.	Sun.	Yellow	16 c. p.	49.8 ± 2.8 cm.	56.33
2.	Min.	"	"	Hefner	29.4 ± 1.8 "	8.18
3.	Max.	"	Blue	16 c. p.	84.6 ± 3.4 "	19.51
4.	Min.	"	"	Hefner	46.8 ± 2.5 "	3.23
5.	Max.	Arc	Yellow	5 c. p.	81.0 ± 4.0 "	6.65
6.	"	"	Blue	5 c. p.	128.0 ± 2.8 "	2.665
7.	"	"	Green	5 c. p.	86.0 ± 5.2 "	5.90
8.	"	"	Red	5 c. p.	72.0 ± 4.0 "	8.42
9.	Min.	"	Green	Hefner	130.0 ± 3.6 "	.418
10.	Min.	"	Red	"	69.0 ± 2.8 "	1.485

WIDTH OF MONOCHROMATIC BANDS.<sup>16</sup>

Red =  $\lambda$  6485 — 5790.

Yellow =  $\lambda$  5750 — 5600.

Green =  $\lambda$  5250 — 4825.

Blue =  $\lambda$  4800 — 4650.

<sup>15</sup>The angle  $\theta$  refers to the angle at which the light from the source falls upon the cardboard C.

<sup>16</sup>These are broad spectral bands, mutually exclusive, but not "monochromatic" in the sense in which the physicists use that term.

## METHOD OF PRESENTING THE STIMULI.

The animals were carried from their living room to the dark-room, and allowed to remain there for two or three minutes. A malaga grape was then placed in the food-box at the base of the colored band selected as the positive color. The animal was next permitted to climb to my shoulder. The screen was then raised and the animal allowed to walk towards the lights (for a distance of three feet) and make his choice, i. e., open either of the two boxes. If the red box were opened, the grape could be obtained; if the green, the animal was pulled back to my shoulder. After the choice had been made, the screen was again dropped over the lights and the animal allowed to finish eating the grape.

At first, the stimulations were given at intervals of three minutes, but the animals became so eager and restless during the long wait, that the tests were finally given as rapidly as the apparatus could be arranged. The animal was always permitted to finish eating the food obtained at the previous trial before the next test was given.

Differences between the olfactory values of the two boxes were eliminated in a variety of ways: The boxes were frequently interchanged; other similar boxes were used occasionally; food was placed in both boxes, but the conditions were so arranged that the animals could get food only in the one box. Fig. 4 shows one of the boxes. A horizontal wire partition runs across the box, 1" from the top. When the grape was placed below this, the monkey never made the slightest effort to get it. The most important control test was made after the association had been firmly established by allowing one or two grapes to lie very near the box kept with the green, or with the yellow as the case might be (the color to which the animal was not reacting positively). In no case were these grapes ever disturbed—even if the animal made an occasional error and opened the wrong box, he never seemed to notice that the grapes were nearby. In the hundreds of cases where he had obtained the grapes, he had found them in the top compartment of the box after he had pulled open the lid. While these tests do not appear in the tabulated report, they were made exhaustive. In addition to controlling the factor of smell, such tests tend to show conclusively that possible

small differences in the visual characteristics of the boxes did not serve as secondary criteria to which the animal might have reacted.

In presenting the lights, care was taken in the successive tests to vary the height to which the screen was raised. In order to keep this factor variable, I purposely left off a stop which would allow the screen to go a certain height and no higher. The screen could be raised from 0"-7", the full height of the band. The animals would, e. g., on one test have to react with the two bands only  $\frac{1}{2}$ " high, while on the next the bands would be 7" high. This procedure tended to eliminate the possibility of their reacting to slight differences in form. A few of the tests where the vertical and horizontal forms of the two bands were changed independently are included in the report.

In the early part of the work, only six trials per day were given. Gradually, as the animal became more accustomed to his work, fifteen to twenty were given. The animals were always eager for the grapes, and so long as they were unafraid, the tests could be repeated again and again until the experimenter became fatigued.

The positive color was presented very irregularly as regards left and right positions. In the early stages of the association, the position of the two bands was interchanged regularly. After the first three or four days, however, irregularity was introduced. The positive color would be presented first on the right on a given day, while on the succeeding day it would be presented first on the left. In order to give an idea of the variations introduced in the order of the presentation of the stimulus, I offer the following notes taken from J's reactions to red-green:

April 23.

Red on left to begin:

Red and green alternated for the first three trials.

Red given three times on right.

Red given three times on left.

April 24.

Red on right to begin:

Red and green alternated for three trials.

Red given three times on right.

Red given three times on left.

Red given three times on right.

Red given three times on left.

On April 22, in the nine trials given, the position of the red and green was alternated.

#### THE RESULTS OF THE EXPERIMENTS.

The tables given below show, separately for each animal, the daily set of conditions to which he was reacting, and the results of the test. The date of the experiments is given first in the tables, then, in order, the number of choices of the positive color (i. e., color with food), the number of choices of the negative color, the percentage of correct choices, the source from which the spectrum was obtained, the relative and absolute intensity of the two bands (refer for photometric statements to table of constants, p. 15), and the remarks.

A reference to the tables shows that they are divided into two parts: *A*, with stimulus constant, and *B*, with stimulus variable. The first part of division *A*, shows in all cases the gradual rise of discrimination, while the second part gives the animal's maximum of steadiness under an unchanging set of conditions. When a maximum of steadiness had apparently been obtained, changes in the relative brightness of the two bands and changes in their form and surfaces were introduced. Division *B* of each table shows clearly just what changes were made and the effect of such changes upon the percentage of correct choices.

#### DISCUSSION OF RESULTS.

1. The surprising result of the early part of the test on the red-green is seen to be the *failure of the animals to react to the red*. This was noticeable in all of the animals tested, see especially Tables I and II. The early records of monkey B. are not given in Table III. His failure to react to red on the early trials was as pronounced



as in J's case. The same is true of the early records of another monkey (S). My notes are full of such comments as the following: "Animal apparently is not stimulated by red," "apparently can not see in red light," etc. While I can give no explanation of the results, it is worth while to mention that they are suggestive either of a 'preference' for green, or possibly, in the light of Yerkes' experiments on the dancer, of the low stimulating effect of red. I am inclined to favor the first of the two possibilities, if any, for the reason that after the habit of reacting to the red was perfected, the discrimination could still be made when the absolute intensity of the two bands was enormously lessened (I had abundant incidental opportunity to make many such tests on occasions when the arc momentarily, for one reason or another, failed to give an intense spectrum).

2. In the case of all three animals the blue-yellow discrimination arose more rapidly than the red-green. Indeed, in the case of B., the habit of reacting to blue was formed with extraordinary rapidity. The question arises as to whether blue was not a 'preferred' color. Again, however, there are no unequivocal data at hand to aid us in reaching a decision for two reasons: 1st, the general question raised above, but not answered, as to whether the whole red end of the spectrum does not have a low stimulating effect upon the photo-chemical substances in the retina of these animals. If the blue were more intense, the animal might from the beginning tend to react to the blue and to neglect the yellow; 2d, the effect of practice. It must not be forgotten that when the animals began upon the blue-yellow test, they had previously had training in the red-green. For this latter reason, no conclusion can be drawn from the present work bearing upon the views sometimes expressed that the yellow-blue photo-chemical process is phylogenetically older than the red-green.

3a. The onset of position habits in the case of both H. and B. in the red-green test, and in that of J. in the blue-yellow and the constant struggle of the experimenter to keep such position habits from forming are significant. Although these animals had been obtaining food for several days with a given color stimulus, we find instead of a steady and rapid increase in the ability to associate

the color with the food, a total break in the process, and a resort, on their part, to the use of a sensory process genetically lower than the visual, namely, the kinæsthetic. Such behavior is suggestive of the relatively unimportant rôle which color vision plays in the life of this animal.

3b. The onset of the position error in such a crucial place in J's series (see p. 26) is especially unfortunate. His percentage of correct choices increased normally during the formation of the association. This percentage remained high for the several days, during which the various changes were being made in the negative color, then all at once we find the habit disintegrating. On the whole, in this case, it seems best to reserve judgment as to whether the animal was reacting to blue on the basis of its possibly greater intensity, and to await further tests upon him.

4. *If one were to draw the general conclusion that the wave length of a given monochromatic light stimulus is, or might be, under suitable conditions, a factor in the adjustment of the animal to that stimulus, one apparently would find abundant support for the position in the above tables.* The writer for the present, however, prefers to allow the experimental data to stand as such without drawing any conclusions from them. The reason for this position becomes apparent when we consider the following points:

Did the changes which were made in the relative intensities of any two bands really reverse the intensity relation for the animal (a glance at the table of constants will show the enormous changes which were made)? The answer to this question must come from experiments. In order to answer it we would need to know for each species of animal, 1st, the relative stimulating effect upon it of the different parts of the spectrum, that is, we would need to have a curve for the animal corresponding to the curves which have been constructed for similar reasons for the human eye in its normal and abnormal states. The first step in constructing such a curve might come through obtaining the animal's reaction thresholds (stimulus limen, R. L.) for the separate spectral bands, e. g., the red, yellow, green and blue; 2d, beginning with these values (expressed in photometric and in radiometric terms) as the lowest points in the

intensity scale of each of the above named monochromatic light stimuli, we might next lay off a series of steps, the reaction D. L.'s. (difference limen) along the scale of each of the four bands. In order to illustrate the foregoing method, let us suppose that we are testing the ability of an animal to make a discrimination between red and green. We have found previously a reaction threshold value (R. L.) for green, say X, and a similar threshold for red, say, 20 X (that is, red is lower in its stimulating effect than the green). The next step in the experiment would be to confront the animal in the usual way with these two stimuli at the intensity of 20 X for red and X for green. If the discrimination arose, we would have to assume that the animal was discriminating between the two colors by reason of the difference in their wave length. Absence of discrimination at this level of intensity, however, would be no proof of the lack of 'color vision' (*stating the situation in conscious terms for the sake of convenience*) for the reason that the values X and 20 X might represent the 'brightness thresholds' at these places in the spectrum and not the 'color thresholds.' In the absence of color discrimination at the level of the thresholds (R. L.), we should have to carry our experiment further and test the possibility of the discrimination arising when the intensities of the two stimuli are raised respectively to the level of their previously determined first D. L. (with red, e. g., at the intensity 20 X + c, where c represents whatever constant the Weber-Fechner Law requires, and green at X + c<sub>1</sub>). If discrimination failed also at this point, at intermediate points and at points high up on the intensity scale, we would have just grounds for denying color vision in the animal; or if discrimination were possible, for affirming it.<sup>17</sup> That many difficulties are in the way of the successful carrying out of this experiment, the writer is painfully aware. The chief difficulty in the way of such an investigation will be found to lie in our present crude methods of color photometry. With conditions as they are, therefore, I felt that the safest method to use was the one adopted in the present paper, namely, to alter the relative intensity of the two bands by enormous steps, hoping that when tests on stimulus and

<sup>17</sup> Provided, as is not the case, there were no other factors to consider.

difference limens shall have been made, the results will show that the relative differences in intensity with which I worked were far in excess of those needed to reverse for the animal the intensity relation of any given pair of colors.

The second question to be raised is concerned with the differences in the energy of the different parts of the spectrum. Might not the animal after all (apart from the intensity relations) be reacting to secondary energy criteria of one form or another? The writer is not able at present to enter profitably into a discussion of this phase of the subject. That there are problems lying here which must be solved, but which can be coped with in no easy manner, no one acquainted with the facts can doubt.

With such questions raised (and they are not raised here for the first time) is it any wonder that we find it impossible to accept the uncritical results which have been obtained by the use of filters, colored papers, etc., as evidence for the presence of color vision in animals?

TABLE I.  
J'S REACTIONS TO RED-GREEN.  
A—With Stimulus Constant.

Date.	Red.	Green.	Per Cent. Correct.	Source.	Intensity.		Remarks.
					Red.	Green.	
3-12	0	3	0	Arc	Max.	Max.	
3-13	1	5	16.6	"	"	"	
3-14	0	6	0	"	"	"	
3-15	1	5	16.6	"	"	"	
3-16	0	5	0	"	"	"	
3-17	1	4	20	"	"	"	
3-18	2	4	33.3	"	"	"	
3-19	0	5	0	"	"	"	
3-20	5	1	83	"	"	"	
3-21	3	4	43	"	"	"	
3-22	2	4	33.3	"	"	"	
3-23	6	0	100	"	"	"	
3-24	3	3	50	"	"	"	
3-25	4	2	66.6	"	"	"	
3-26	5	1	83	"	"	"	
3-27	6	0	100	"	"	"	
3-28	6	0	100	"	"	"	
3-29	6	0	100	"	"	"	
3-30	6	0	100	"	"	"	
3-31	5	1	83	"	"	"	
4- 1	5	0	100	"	"	"	
4- 2	5	1	83	"	"	"	
4- 5	5	1	83	"	"	"	
4- 6	6	0	100	"	"	"	
4- 7	5	1	83	"	"	"	

## B—With Stimulus Variable.

4- 8	6	0	100	Arc	Min.	Max.	
4- 9	9	3	75	"	Max.	"	
4-10	12	3	80	"	Min.	"	
4-11	8	1	89	"	"	"	
4-12	14	2	87.5	"	"	"	
4-13	12	4	75	"	"	"	Animal very hungry.
4-14	9	1	90	"	Max.	Min.	
4-16	8	4	66.6	"	"	"	Fed too much.
4-17	9	1	90	"	"	"	
4-19	5	1	83	"	"	"	
4-19	6	0	100	"	Min.	Max.	Change in intensity made in middle of series.
4-20	14	0	100	"	E*	"	
4-22	9	1	90	"	"	"	
4-23	7	2	77	"	Max.	Min.	
4-26	13	0	100	"	E	Max.	
4-27	12	1	92	"	Max.	Min.	Only lower half of red exposed.

\*E designates subjective quality.

The above tests were continued from April 27th to May 28th. An average of from 85-90 per cent of correct choices was maintained throughout the whole period. In these last tests, all variations in the presentation of the stimuli which could be thought of were introduced, such as presenting the red on the right and left alternately, red twice on right, once on left, then three times on right and three on left, etc. On account of the position error entering into B's reactions, he was fully one month behind J. Since it was desirable to keep J in practice, he was put through all the control tests with B.

TABLE II.  
H'S REACTIONS TO RED-GREEN  
A—With Stimulus Constant.

Date.	Red.	Green.	Per Cent. Correct.	Source	Intensity.		Remarks.
					Red.	Green.	
3-18	0	4	0	Arc	Max.	Max.	
3-19	1	3	25	"	"	"	
3-20	2	4	33.3	"	"	"	
3-21	0	6	0	"	"	"	
3-22	4	2	66.6	"	"	"	
3-23	1	5	16.6	"	"	"	
3-24	4	2	66.6	"	"	"	
3-25	3	3	50	"	"	"	
3-26	4	2	66.6	"	"	"	
3-27	4	2	66.6	"	"	"	
3-28	3	3	50	"	"	"	
3-29	5	1	83	"	"	"	
3-30	3	3	50	"	"	"	
3-31	6	0	100	"	"	"	Disturbance in general physical condition of animal for several days. Position error became noticeable when tests were again started with animal, 5 days later, animal going always to left. This error persisted until May 4. In the interim 6-10 trials per day were given. The introduction of a partition broke up error.
5- 4	8	1	89	"	"	"	
5- 5	8	1	89	"	"	"	

## B—With Stimulus Variable.

5- 6	6	0	100	Arc	Max.	Min.	
5- 8	8	2	80	"	"	"	
5- 9	8	2	80	"	"	"	
5-10	8	2	80	"	"	"	
5-11	10	1	90	"	"	"	
5-12	8	2	80	"	"	"	
5-13	10	2	83	"	"	"	
5-14	9	1	90	"	"	"	
5-15	9	1	90	"	"	"	
5-17	13	1	93	"	"	"	
5-18	6	1	86	"	"	"	Change in intensity made in middle of series.
5-18	7	0	100	"	E.	Max. }	
5-19	11	0	100	"	"	"	
5-20	7	5	58.3	"	"	"	Animal too hungry; all 5 errors made in succession.
5-21	11	1	91	"	"	"	
5-22	14	2	87	"	Min.	"	
5-23	9	1	90	"	"	"	
5-24	9	1	90	"	"	"	
5-25	16	0	100	"	Max.	Min.	
5-26	15	2	88	"	"	"	Only lower half of red exposed.
5-27	12	4	75	"	E.	"	Red $\frac{1}{2}$ as wide as green.
5-28	12	0	100	"	Min.	"	

TABLE III.

## B's REACTIONS TO RED-GREEN.

B was given test for test with J (see J's record) with similar averages up to March 25th. Noticeable position error began to appear which grew steadily worse. This error, as in H's case, was finally eliminated by the introduction of the glass partition. The error persisted for fifty-one days. Ten to twelve trials were given per day during this entire period.

## A—With Stimulus Constant.

Date.	Red.	Green.	Per Cent. Correct.	Source	Intensity.		Remarks.
					Red Max.	Green Max.	
5-15—5-20		Held av'age	90	Arc			This average will serve as basis for comparison with those in B.

## B—With Stimulus Variable.

5-21	13	1	93	Arc	E.	Max.	
5-22	14	2	87	"	"	"	
5-23	13	1	93	"	Min.	"	
5-25	15	1	94	"	Max.	Min.	
5-26	15	2	88	"	"	"	Only lower half of red exposed. Half vertical strip of red shown. Animal frightened.
5-27	12	2	85	"	"	"	

TABLE IV.  
J'S REACTIONS TO BLUE-YELLOW.  
A—With Stimulus Constant.

Date.	Blue.	Yellow	Per Cent. Correct.	Source	Intensity.		Remarks.
					Blue. Max.	Yellow Max.	
7-14	4	4	50	Arc	..	..	
7-15	6	4	60	..	..	..	
7-16	8	3	72.7	..	..	..	
7-17	9	4	70	..	..	..	
7-18	12	5	71	..	..	..	
7-19	10	5	66.6	..	..	..	
7-20	17	8	68	..	..	..	
7-21	12	1	92	..	..	..	
7-22	12	2	86	..	..	..	
7-23	13	2	86	..	..	..	
7-24	11	0	100	..	..	..	
7-26	16	6	73	..	..	..	Disturbing noise.
7-27	18	5	78	Sun- light.	..	..	
7-28	14	1	93	Arc	..	..	
7-29	15	4	79	Sun- light.	..	..	
7-30	17	4	81	Arc	..	..	
7-31	14	3	82	Sun- light.	..	..	
8- 1	15	3	83	..	..	..	
8- 4	13	1	93	..	..	..	
8- 5	13	3	81	..	..	..	
8- 6	13	1	93	..	..	..	
8- 7	18	2	90	..	..	..	

## B—With Stimulus Variable.

8- 8	12	1	92	Sun- light.	Max.	Min.	
8-10	18	2	90	..	..	..	
8-12	17	6	74	Arc	..	Max.	
8-13	15	1	94	Sun- light.	..	..	
8-15	8	4	66.6	..	..	..	Monkey growing very careless. I pulled him back vigorously so as to punish when errors were made, hoping thereby to obtain a more careful choice.

8-16 Min. blue was thrown in for the first time. Monkey was entirely confused. After jerking him back vigorously for several trials, he began to go always over to left, out of range of beam; then, after remaining still for a moment, he would suddenly thrust out his paw to open left-hand box regardless of color exposed there. I tried in many ways to overcome this position error, even to the extent of allowing him to react as in the beginning, to max. yellow and blue with no changes, but the error was not overcome in the time at my disposal.



TABLE V.  
H'S REACTIONS TO BLUE-YELLOW.  
A—With Stimulus Constant.

Date.	Blue.	Yellow	Per Cent. Correct.	Source	Intensity.		Remarks.
					Blue.	Yellow	
7-14	3	2	60	Arc	Max.	Max.	
7-15	4	5	44	"	"	"	
7-16	4	8	33.3	"	"	"	
7-17	10	10	50	"	"	"	
7-18	8	3	73	"	"	"	
7-19	4	4	50	"	"	"	
7-20	7	5	58	"	"	"	
7-21	8	6	57	"	"	"	
7-22	11	5	69	"	"	"	
7-23	11	6	65	"	"	"	
7-24	12	3	80	"	"	"	
7-26	12	3	80	"	"	"	
7-27	18	5	78	"	"	"	
7-28	9	6	60	Sun-light, Arc	"	"	
7-29	15	4	79	Sun-light, Arc	"	"	
7-30	14	2	87.5	Sun-light, Arc	"	"	
7-31	14	4	78	Sun-light, Arc	"	"	First 3 choices wrong.
8- 1	12	1	92	"	"	"	
8- 2	17	2	90	"	"	"	
8- 3	11	5	69	"	"	"	Made very angry by being jerked back on errors.
8- 5	13	2	86	"	"	"	
8- 6	17	3	85	"	"	"	
8- 7	10	0	100	"	"	"	

B—With Stimulus Variable.

8- 8	11	0	100	Sun-light.	Max.	Min.	
8-10	14	0	100	"	"	"	
8-12	10	0	100	Arc	"	Max.	
8-13	15	0	100	Sun-light.	"	"	
8-14	10	1	90	"	"	"	
8-16	21	5*	81	"	Min.	"	Changes in intensity made in midst of series.
8-16	8	0	100	"	Max.	Min.	
8-16	8	1	89	"	"	Max.	
8-17	12	2	86	"	"	"	Changes in intensity made in midst of series.
8-17	13	2	86	"	Min.	"	
8-18	8	0	100	"	Max.	"	Half vertical strip of blue shown.
8-18	8	0	100	"	"	"	Lower half of blue shown.
8-19	10	0	100	"	"	"	
8-20	15	0	100	"	"	"	Surface value of colors altered by pasting tissue paper over glass.

\*Two of the five errors were made when the sun was overcast.

TABLE VI.  
B'S REACTIONS TO BLUE-YELLOW.  
A—With Stimulus Constant.

Date.	Blue.	Yellow	Per Cent Correct.	Source	Intensity.		Remarks.
					Blue.	Yellow	
7-14	2	3	40	Arc	Max.	Max.	
7-15	6	4	60	"	"	"	
7-16	7	3	70	"	"	"	
7-17	8	4	66.6	"	"	"	
7-18	16	2	89	"	"	"	
7-19	12	0	100	"	"	"	
7-20	18	2	90	"	"	"	
7-21	14	1	93	"	"	"	
7-22	12	1	92	"	"	"	
7-23	12	1	92	"	"	"	
7-24	13	0	100	"	"	"	
7-26	12	2	87	"	"	"	
7-27	18	2	90	"	"	"	
7-28	17	5	77	Sun-light. Arc	"	"	Change to fainter spectrum seemed to be noticed.
7-29	15	2	88	Sun-light. Arc	"	"	
7-30	14	0	100	Sun-light. Arc	"	"	
7-31	14	0	100	Sun-light. Arc	"	"	
8- 1	9	0	100	"	"	"	
8- 4	13	1	93	"	"	"	
8- 7	17	0	100	"	"	"	

B—With Stimulus Variable.

8- 8	14	0	100	Sun-light.	Max.	Min.	
8-10	16	1	94	"	"	"	
8-12	13	0	100	"	"	"	
8-13	15	0	100	Arc	"	Max.	
8-15	10	0	100	Sun-light.	"	"	
8-15	13	3	81	"	Min.	"	By mistake on this day the episcotister, set in the tests on the other animals usually with a 30° opening, was closed to 10°. The animal dashed to the yellow on his first two trials, then became steady and made only one more error in the series. Film clouds were passing over the sun and at times the blue was barely over my own threshold.
8-16	17	1	94	"	"	"	
8-16	8	0	100	"	Max.	"	Changes in intensity made in midst of series.
8-16	5	0	100	"	Min.	"	
8-16	8	0	100	"	Max.	Min.	Changes in intensity made in midst of series.
8-17	17	0	100	"	Min.	Max.	
8-17	17	0	100	"	Max.	Min.	
8-17	14	0	100	"	"	Max.	Half vertical strip of yellow shown. Half vertical strip of blue shown.
8-18	8	0	100	"	"	"	
8-18	8	0	100	"	"	"	Surface value altered by pasting tissue paper over surface of ground glass.
8-19	10	0	100	"	"	"	
8-20	15	0	100	"	"	"	

THE EXPRESSIONS OF EMOTION IN THE PIGEONS.  
 I. THE BLOND RING-DOVE (*Turtur risorius*).

BY

WALLACE CRAIG,

*From the Department of Zoölogy of the University of Chicago.*

WITH ONE PLATE.

CONTENTS.

	PAGE
Introduction—Purposes of this study—Acknowledgements.....	30
Description of sounds made by the blond ring-dove, and accompanying movements .....	31
Prefatory remarks .....	31
1. Silence .....	33
2. Fear .....	34
3. Alarm .....	35
4. Cry intermediate between the alarm and the kah.....	37
5. The kah .....	38
(I) The ordinary-kah .....	39
(II) The kah-of-excitement .....	40
(III) The copulation note .....	42
6. The charge .....	42
7. Parent's call when ready to feed the young.....	43
8. Cry intermediate between the kah and the coo.....	44
9. The coo .....	44
(1) The perch-coo, or the song.....	47
(II) The bowing-coo .....	48
(III) The nest-call .....	51
Life-history of the blond ring-dove.....	53
A.' Beginning of the life cycle .....	54
Development of the young.....	54
First appearance of the cries of the adult: the alarm-note and the kah .....	59
The change of voice.....	60
First appearance of the coo.....	62
Influence of old birds.....	64
The charge .....	65
Summary of development .....	66
B.' Beginning of the annual cycle.....	66
Wooing and mating.....	67
C.' Beginning of the brood cycle.....	69
Copulation, nest-building, and egg-laying.....	69
D. The daily cycle .....	70
Changing places on the nest.....	72
C." The brood cycle, continued.....	74
Incubation, brooding, and preparation for a new brood.....	75

B." The seasonal cycle, continued.....	78
The lapse of brooding and loss of voice at the end of the breeding season .....	78
A" The life cycle, continued.....	78
The prime of life, and old age .....	78
Summary of the life-history .....	79

## INTRODUCTION.

This study of the behavior of pigeons was undertaken seven years ago with intention—*first*, to describe the various sounds produced by one type species of pigeon, and the bodily movements which invariably accompany the utterance of the sounds; *second*, to compare these with the sounds and movements of all the species in Professor Whitman's large collection of living pigeons; *third*, to throw light upon any problems which seemed naturally to connect with the study as it progressed. The present paper is drawn up to fulfill the first of these intentions. It is a descriptive account of the vocal and bodily expressions of emotion in one species chosen as a type. It may make this first paper more valuable if I indicate briefly the nature of the work by which it is to be followed. The following is a brief outline of the whole.

1. *Description* of the vocal and bodily expressions of emotion in the blond ring-dove. Life-history of this species, in so far as it concerns the use of voice and accompanying gesture (present paper).

2. *Comparison* of the sounds and gestures of different species; showing specific characteristics, homologies, and the possibility of voice and gesture throwing light on problems of phylogeny.

3. *Inheritance*. The forms of expression in pigeons are strictly hereditary. They are not learned by imitation (copying). In hybrids the voice is intermediate, except when it is imperfectly developed.

4. *Variation*. Comparative study shows that the vocal utterances vary from group to group in a manner indicating determinate or orthogenetic variation.

5. *Selection*. Pigeons are subject to sexual selection of a kind more or less like that described by Häcker.<sup>1</sup> But the theory of

<sup>1</sup>Häcker, Valentin. Der Gesang der Vögel. Jena, 1900. Häcker's statement is an improvement upon that of Groos, in his "Die Spiele der Thiere," Jena, 1896.

sexual selection takes account of only a fragment of the great utility of the voice. Voice and gesture are of prime importance through all the cycles of the life-history. This is shown, but not at all fully explained, in the present paper. It is somewhat further shown in the following (No. 6).

6. *Sociology.* A preliminary account of the sociologic interpretation of pigeon behavior has already been published.<sup>2</sup>

7. *Psychology.* The psychologic conclusions are so numerous and so intimately connected with the details of description, that it is impracticable to summarize them in this place.

My indebtedness to Professor Whitman is so evident from beginning to end of the paper that there is no need to speak of its details. I wish, however, to acknowledge in gratitude the two chief debts I owe to him. In the first place, Professor Whitman knows the emotions, the voices, and the gestures of the pigeons very much better than I do; he has told me a great many facts about the birds which my more limited experience has not afforded; and he has always given helpful answers to my questions as to what a bird is thinking about when it does a certain act. In the second place, more important than the facts, I owe much to Professor Whitman for the influence of his spirit of research. Enthusiasm and steadiness of labor, sympathetic insight into the animal mind, patience with details, yet a constant reference to general problems, I hope I have learned to some degree. I wish to express grateful obligations also to the University of Chicago and to the Marine Biological Laboratory at Woods Hole, especially for that freedom which allows a student to develop his own ideas.

#### DESCRIPTION OF SOUNDS AND ACCOMPANYING MOVEMENTS.

##### PREFATORY REMARKS.

There is among scientists a widespread impression that bird-songs are not susceptible of accurate description. But this impression is

<sup>2</sup>The voices of pigeons regarded as a means of social control. *The American Journal of Sociology*, Vol. 14, 1908, pp. 86-100.

certainly erroneous, at least so far as the utterances of pigeons are concerned. It may be granted that the qualities (timbres) and the intensities of sounds cannot be accurately determined outside of the physical laboratory; but in this respect the qualities and intensities of sounds are not very different from shades of color, feeling to the fingers, and many such vague impressions which are used in so-called accurate description. Those features of sounds which have to do with pitch and with time, on the other hand, are as susceptible of accurate description as are the forms and dimensions of visible organs.

It must be remembered, too, that for the purpose of comparative study, a description need not go minutely into every detail. This study is to include a comparison of each utterance of the ring-dove with other utterances of the same bird, and with corresponding utterances of the opposite sex, of the young, and of different species. For all of these comparisons it suffices to have a general knowledge of each utterance as regards timbre and intensity and an accurate knowledge of each as regards pitch and time.

For the study of expression, on the contrary, it is desirable that intensity and timbre, in addition to the other two sets of characteristics, be measured with extreme accuracy. Such a work of measurement, for one species of pigeon alone, would involve years of labor; indeed, such work is just beginning to be done, and its methods are just beginning to be developed, even for the human voice.<sup>3</sup> Hence we must be content for the present to describe the changes of expression in the dove's voice by means of non-quantitative musical signs and popular language; and though these means of description are broad and indefinite, they are full of meaning, and may convey a good idea of expression.

There is only one point in which I have found it necessary to depart in any way from the regular musical notation. That point concerns the glide, or portamento. Pigeons' notes very commonly glide with absolute continuity from one pitch to another. I have not been able to find any convenient musical sign which indicates such a glide, as distinct from a mere legato; hence, I have adopted the

<sup>3</sup>E. W. Scripture. *The Elements of Experimental Phonetics*. New York, 1902, pp. xvi + 627, Pl. xxvi.

double slur, thus,



which must always be understood to mean a perfect glide, or portamento.

### 1. SILENCE.

Many birds, especially among the Oscines, are uttering some sound continually, being silent only when they are asleep. For example, the various species of American blackbird (as, *Quiscalus*, *Agelaius*) repeat their "chuck" so frequently, both while flying and while perching, that the presence of a flock is always made known to the ear at a considerable distance. The Fringillidæ, similarly, are ever repeating a short "chip" or "chirrup." But the ring-dove has no such incessantly repeated note. The dove's notes are voiced only when prompted by some form of excitement. When engaged in any non-social occupation, such as eating, drinking, preening its feathers, or merely resting, the ring-dove is silent. And when on the wing, even in the midst of excitement, the blond ring-dove never utters any sound, except on rare occasions (only one occasion within my experience) an apparently involuntary grunt. Some other forms of birds even prostitute their most useful notes to purposes of play. The blue jay (*Cyanocitta cristata*), for example, often gives alarming cries when no danger is near, and seems to enjoy, so far as the limits of avian intelligence will allow, the consternation which it can thus produce among its feathered neighbors. But the pigeons, perhaps on account of their lower grade of intelligence, are incapable of carrying play to such a point; they never use the alarm-note except when really alarmed. Certain of the dove's calls are given at times in a manner which might be styled half-serious, half-playful; but of the utterances of the adult ring-dove, there is only one (the song, p. 47) which ever appears to be given and enjoyed purely for its own sake.

## 2. FEAR.

In the case of any object threatening or frightening a ring-dove, the bird being, for one reason or another, disinclined to turn tail and flee, it exhibits attitudes and movements of terror and anger which we may call, for the sake of brevity, the expression of fear. The reasons why the bird may be disinclined to turn tail are numerous: it may be young and unable to fly; sick or wounded and hence unable to effect a speedy retreat; it may be defending its nest or its mate; or it may be simply quarreling with a neighbor on equal terms. In all such cases the dove shows the expression of fear, which is now to be described; these cases are to be distinguished from those in which the dove uses its energies merely to escape and fly away, for then it shows a very different expression which we call alarm and which will be described later.

The expression of fear in the ring-dove is not at all peculiar to the species; it is essentially the same as the expression of fear in all birds, and very similar to the expression of fear in reptiles and mammals. It consists chiefly in the erection of appendages—bristling the feathers, spreading the tail, lifting the wings—and in the emission of threatening sounds. It should be noticed that in the expression of this emotion all the feathers are raised to the utmost degree; in sudden fright the tail also is widely spread. The wing nearest to the feared object is raised and is used to strike with, dealing blows of great power and of such swiftness that, if a man allows his hand to be struck at, the hand feels the blow before the eye can see it. In some cases the near wing alone is raised, but in many cases the two wings are raised symmetrically. The head is drawn in close to the body, but is always turned toward the object of fear, ready to deal blows with the beak. The eye assumes a ferocious glare, utterly different from its ordinary mild look. This great change in the eye is caused largely by the following conditions. The eyelids are drawn back so as to open the eye to the widest limit; such wide-openness gives a staring appearance to the eye of any creature, and gives to the eye of the dove an especial glare, by exposing the maximum of the fiery red iris. The black pupil of the eye also remains large, not contracting to a pin-point as in the case of some of the other emo-



tions. Since the feathers of the head are slightly raised, they swell out around the eye and give somewhat the effect of a frown. Whether these changes are sufficient to account for the total change in expression of the eye, I do not know. The important point, in any case, is, that the change in expression of this one important feature is just as marked as the change in appearance of the bird as a whole.

The sounds emitted under the influence of fear are various. Those ordinarily given in these circumstances are a hiss and a snapping of the bill. Both of these, however, are so feeble that they appear to be but impotent relics of a once powerful snap and hiss. They are so feeble, indeed, that an observer recognizes them by seeing a puffing movement and seeing the bill close, rather than by hearing either the hiss or the snap. A dove in extreme terror (especially when acting with tense exertion, as when a wild one is struggling in the hand, may utter powerful grunts or even a sort of scream. But in ordinary cases the frightened dove expresses all its emotion in the attitude and the movements of defense, not in any effort to make sounds. It appeals strongly to the eye but not at all to the ear.

### 3. ALARM.

Fear is the emotion shown by doves toward an enemy at close quarters; alarm is the emotion shown toward an enemy, or a possible enemy, in the distance. The alarm-note is heard many times every day, for the doves are always on the lookout for dangerous-appearing objects, especially for the appearance of a hawk in the sky.

The bodily changes in the expression of alarm (Plate I, Fig. 1) evidently serve two purposes:—first, to prevent the enemy, so far as possible, from seeing the dove; second, to allow the dove, on the other hand, to see the enemy. The first purpose is served by changes which reduce the apparent size of the body to a minimum: the contour feathers are all appressed until they lie as close as possible, the tail and wings are closed, and the wings pressed tight against the sides. The second purpose is served by the bird standing high on the legs and stretching the neck in a manner which shows that a great strain accompanies the concentration of attention upon the alarming object.

This stretching to full length, combined with the reduction in girth due to appression of the feathers, makes the bird look ghastly thin. The stretching is usually upward and forward, but not always so; for when intervening objects partly obstruct the view, the dove may stretch its neck backward or somewhat to one side. This goes to show that the emotion of alarm depends, not upon the assumption of one specific position, but upon *stretching* in general.

The expression of alarm includes the utterance of a very distinct cry, a cry of great utility, because it communicates the alarm to all pigeons within hearing. This cry of alarm is a single, short, emphatic note. Its chief characteristic is its emphasis, and it becomes more and more emphatic with greater degrees of the emotion. Its emphasis depends upon the fact that it is evidently made with effort. If the birds are much startled, and not sitting on the nest (which would have the effect of making them more quiet), they give a loud sound which reaches a high key, thus:

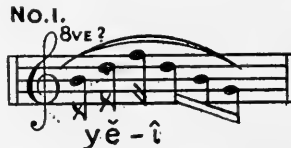

Short and vehement; abrupt rise and abrupt fall. Timber: chest-tone.



Rate: 4 crotchets per second. A clarinet tone. Beginning abrupt, loud, explosive. Fall in pitch abrupt.

With a less-alarming stimulus, the note is less loud, and lower in pitch, with less rise and fall, thus:



When the birds are on the nest they are seclusive in their actions, and, accordingly, disinclined to make a noise. Hence, the alarm-note sounded by a bird on the nest is always less loud, even though the emotion be extreme, as shown by the tension displayed in the bird's attitude and movements. But notwithstanding the lower intensity and pitch, the quality of effort is shown in this alarm as clearly as in the louder ones. Just what it is that gives evidence of effort, it is not always easy to say. But, for one thing, the note usually begins and ends abruptly; and such abrupt beginning and ending is an equivalent, so far as expressiveness is concerned, of the abrupt rise and abrupt fall of the notes represented above. For another thing, this note, when intense, has a hoarse sound, a sort of "stage whisper" effect, like that produced when one contracts the chest strongly but obstructs the breath in the vocal organs; and this is no doubt what occurs in the bird, for one can see the hard breathing movement of the body when the note is sounded. This subdued alarm is given by either the male or the female, when sitting on the nest, or when near the nest containing the eggs or young.



Timbre: approaching that of an electric buzzer.

Intensity: So low that sometimes, I judge, it was inaudible at 2 yards distance.

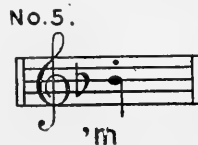

A pure, resonant chest-tone. Not loud.

#### 4. CRY INTERMEDIATE BETWEEN THE ALARM AND THE KAH.

The specific cry of the ring-dove to be described next, which I have named the kah, resembles the alarm-note in tone but differs

from it in inflection and in being divided into a series of separate sounds. The kah, being generally a social call, is widely different from the alarm-note in meaning. But on rare occasions, on one occasion in particular, I have heard a ring-dove give a note which seemed to be an intermediate between the kah and the alarm. On the particular occasion referred to, when the bird heard other doves fighting in a neighboring cage (being unable to see them), it appeared to be moved both by alarm and by a social attraction toward the other doves; and it gave, several times, a sound which was intermediate between the alarm and the kah; thus:

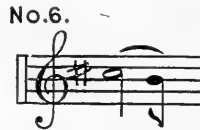

The second note may be distinct, or may be, as it were, merely the declining end of the first note.

The fact that the dove can give an intermediate between two sounds which usually are so distinct, shows that the bird has more freedom in the use of its voice than might at first be supposed.

##### 5. THE KAH.

The kah is a note which, in speaking familiarly about the doves, we often designate as the "laugh," because it resembles the laugh of a young child so closely as to suggest that sound to anyone who hears the kah for the first time. But I have avoided calling it the "laugh" in this paper, because, though the cry sounds like a laugh, I must guard against leading the reader to think of it as a laugh in any other sense. The kah consists of from three to ten notes, like "kah kah kah kah kah," in an uninterrupted series, all the notes being, as a rule, closely alike. The timbre is a chest-tone, with a sort of nasal twang, suggestive of the harder notes of a clarinet. The various forms of the kah may be imitated with much accuracy by the human voice.

This cry is an exceedingly variable one, for it differs greatly as

given by different individuals, and in the case of each individual it varies according to the circumstances under which it is given, I shall describe three types: (I) the ordinary-kah; (II) the kah-of-excitement; (III) the copulation-note. The first two of these, however, are not two specific cries; they are but two types chosen to represent a perplexing multiformity of sounds which might, perhaps, be as well represented by a greater number of types.

(I) *The ordinary-kah.*—In order to give a general statement which will include all the uses of this utterance, one may say that it is a greeting. If translated into English it would be "hallo," with varying intonation. It is given by a dove upon rejoining the flock, or upon alighting on a perch where another ring-dove is sitting, or upon seeing a friend after a short period of separation, or upon going to the nest where the mate is sitting, especially when the intention is to exchange places with that bird upon the nest, or upon going to the mate with intent to caress it, as by preening its head. Conversely, a dove may give this call when it is approached and caressed by the mate; when, sitting upon the nest, it is approached by the mate with intent of taking its turn in sitting; and so with the reciprocals of the other situations mentioned. These uses are all obviously social. The cry is given also at certain conjunctures which do not necessarily involve other birds: thus, the kah is often given by a dove when it alights on a perch, even if there be no other birds near; or it is given when the dove goes to its nest and eggs, even if the mate be not near. But the use of the kah at these conjunctures is evidently an outgrowth from the social usage; and, moreover, even in any one of these situations the probability of its use is much greater when other birds are present. The dove sometimes voices this sound when, seeing food put into its cup, it comes to eat; in this case the cry probably has some social reference to the man who has brought the food. For this cry of greeting is very often used toward the dove's human acquaintances; and a dove that has been long isolated from its kind will give a kah of greeting to any human being who comes near.

The sound of the ordinary-kah is distinguished from that of the kah-of-excitement by being light, free, and careless in expression.

The ordinary-kah is less loud than the other. It is shorter and quicker, more brisk, consisting of only 4 to 6 notes, rarely only 3, and these notes typically staccato. The pitch is in some cases sustained without alteration through all the notes; when there is any change in pitch it is not of the wailing, chromatic type which characterizes the kah-of-excitement, but it is of a bright and cheery sort. Here are some typical examples of the music of the ordinary-kah.

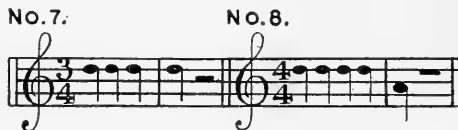

(II) *The kah-of-excitement.*—The ordinary-kah passes by all possible gradations and by numerous variations into that general type which I have named the kah-of-excitement. The kah-of-excitement, or an approach to it, is given in sundry situations of which I shall try to give a general description in three groups (a), (b), (c). (a) The kah-of-excitement is given at the same conjunctures as is the ordinary-kah, if only there be more excitement than common, due either to outward circumstances or to the bird's own inward state. An instance of outward circumstances occasioning excitement, may be found in some cases of a bird going to relieve its mate of duty on the nest. At this conjuncture, in ordinary cases, the bird gives the ordinary-kah; but if it finds the mate unwilling to leave the nest and stubbornly opposing the change, it may give a more excited kah. As to causes of excitement within the bird itself, in general it may be said that the ordinary-kah is given more by the female, the kah-of-excitement by the male; the ordinary utterance in winter, the excited utterance in the breeding-season; and, within the breeding-season, the ordinary form on days when the birds are quietly incubating or brooding, the excited form on days when they are pairing, or preparing for a new brood, or when, though incubating or brooding, they are disturbed by the presence of other birds. (b) The kah-of-excitement is used under the same circumstances with the charge, which is to be described presently. The cry may be given before,

during, or after the charge, or it may be given independently of the movement. It is sounded both in charging an enemy and in charging the female. (c) The kah-of-excitement often serves as a prelude to the bowing-coo. In some cases, this use is not to be distinguished from (b), the bowing-coo being preceded not only by the kah, but also by the charge. But in other cases, when the bowing-coo is not connected with a fight or a chase, but arises from a sudden inward impulse to express the feelings, it may be preceded by a kah-of-excitement unaccompanied by the charge, the apparent use of the kah being merely to introduce the bowing-coo.

The sound of the kah-of-excitement is far different from the gentle tone of the ordinary-kah; it is a strain expressive of high emotion and tense effort. The excited utterance differs from the ordinary in much the same way that the whining tone of an angry child differs from the child's ordinary speech. The details of the change causing this heightened expression are not always the same, but I shall describe what seems to be most characteristic in the cases of the individuals that I have studied. The kah-of-excitement is nearly always of longer duration than the ordinary sound; it consists commonly of 5 or 6 notes, sometimes as many as 10, and the notes are, in some individuals, long drawn out. The effect is usually legato, in contrast with the staccato of the ordinary-kah. The sound is louder than the ordinary-kah, and the pitch higher, the loudness and pitch rising with each rise in excitement. The strain always descends in pitch toward the close; it generally rises at the beginning, culminates somewhat before the middle, and then descends; but in some cases it begins with the highest pitch, maintains it for two or three notes, and then descends. The changes in pitch are usually chromatic, the interval from one note to the next being a semitone or even a fraction of a semitone; this is one of the chief causes of the emotional, wailing expression.

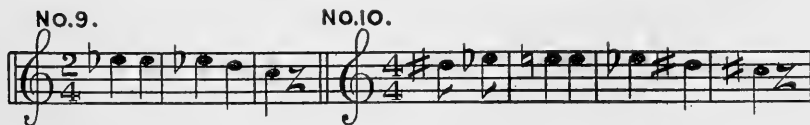

NO. 11.



NO. 12.



Time: 3 crotchets per second.

(III) *The copulation-note.*—In all species of pigeons which I have studied, the act of copulation is immediately followed, on the part of both male and female, by the assumption of a singular attitude and the emission of a copulation-note. In some pigeons this note is perfectly distinct from any other utterance of the species. In the blond ring-dove the copulation-note very much resembles the kah uttered on other occasions. Comparing it with the ordinary-kah and the kah-of-excitement, I should say that it more closely resembles the former.

NO. 13.



NO. 14.

Time:  $3\frac{1}{2}$  crotchets per second.

#### 6. THE CHARGE.

It has already been stated that the kah-of-excitement, whether uttered to an enemy or to the female, is often accompanied by the charge. In charging (Plate I, Fig. 2), the male raises his body high above the ground, by extending the legs and standing on tip-toe. The body, thus elevated, is directed horizontally, with the head pointing straight before, and the tail straight behind, as if to cleave the air with the least resistance. The feathers of the rump and the lower back are raised and held stiffly erect, and the feathers of the wing (both quills and coverts) are slightly spread out. The feathers on the fore part of the body, in contrast, especially those on the head, are smoothly appressed. The reason for this contrast, I think we can explain as follows. The bristling feathers on the back and wings have the same effect as in the case of the expression of fear; they make the apparent size greater and the aspect more terrible. On the other hand, the smooth outline of the head and neck gives a more pointed appearance to the oncoming charger; gives more free play to the neck and head in pecking or in avoiding the pecks of the



adversary; and also allows the flashing eye to produce its most powerful effect. For the bright red iris, during the charge, expands to a maximum, reducing the black pupil to a pin-point; and the eye, thus transformed to a fiery red orb, is a focal point in the appearance of the charging cock-bird.

Having assumed this striking aspect, the dove charges at his utmost speed upon the bird which has roused his passion, uttering at intervals the long, loud kah-of-excitement. If confined within a cage and thus separated from the bird which has excited him, he charges up and down the cage, back and forth in all directions, now stopping to stand and glare, for a few moments, at the other bird, now starting again on his mad career. Though on all ordinary occasions the dove's gait is a walk, during the charge he often progresses by long leaps; the leaping might be accounted for as being a necessity at the great speed at which the bird charges, but the great bounds are useful also in that this uncommon mode of locomotion contributes to the expression of irresistible energy and reckless determination.

The charge, as the reader may have gathered from what has already been said, is an activity of the male bird especially. It is used in attacking or driving away rivals or enemies. It is used also in driving the female; sometimes, as an expression of jealousy, in driving the female away from other males; but in other cases in driving the female to no apparent purpose except to express the male's inherent quality of maleness and his mastery over the female.

Though this behavior is rarely seen in the female, she may be observed to charge in some cases, especially in either of the two following circumstances. First, when the safety of her nest and eggs (or young) is jeopardized by the approach of strange birds; secondly, when a female has been kept long in isolation, in which case her behavior comes to resemble that of the male not only in this but in many other aspects (cf. p. 46).

#### 7. PARENT'S CALL WHEN READY TO FEED THE YOUNG.

Each species of pigeon has a call by which the parent signifies to the young, his (or her) readiness to feed them. This call is always more or less distinct from the other calls of the species. The signal

is of use to birds kept free or in a large pen, where parents and young are liable to be at a distance from one another, when the former are fed by their master; but the same signal is not often observed in caged birds, on account of the young being always at the parents' side and ready to feed, not needing to be called. On this account I have had but few opportunities of studying the call to the young to feed; but I have heard the note in a few cases, in each of which I noticed that it bore a general resemblance to the kah, and in one case I was able to study it in some detail. In this case the call was given in the same tone of voice as the kah, but was usually a single note, long-drawn-out and very plaintive; it was given by the father bird, and was repeated by him even in the intervals between retchings in feeding the young. Each time the father began to give this note, one of the young, being more energetic than the other, ran at once to the parent and received the lion's share of food.

#### 8. CRY INTERMEDIATE BETWEEN THE KAH AND THE COO.

Occasionally the male gives a cry which has precisely the character of the kah except for the timbre, which is a head-tone precisely like the tone of the coo. I should name this cry, were it not for the strange sound of the appellation, the coo-toned kah. It is heard not uncommonly when a male gives first the kah-of-excitement and then the bowing-coo, this intermediate sound forming a transition from the former to the latter. It is heard also, though more rarely, unconnected with the bowing-coo. This intermediate cry, like the intermediate between the alarm and the kah, is of interest as showing that the vocal reactions of the ring-dove are not so definite and invariable as one might suppose.

#### 9. THE COO.

The coo is, in several respects, more musical than any of the sounds previously described. For, first, the coo is more deliberate, the other notes being more hurried; secondly, the coo is more formal, more fixed, more definite in pitch and in pitch-intervals; thirdly, the coo is in a head-tone, which is more musical than the chest-tone of the alarm-note and the kah.

Each coo consists of three syllables, which may be represented as *cook coorr roo* (or in German, which has the advantage of a definite pronunciation, *kuhk kuhrr ruh*). The first and the last syllable are the emphatic syllables, the middle one sounding like a connective between the other two. The emphasis of the first and the last syllable is usually accompanied by a heightened pitch, there being a fall in pitch, usually somewhat abrupt, from the first syllable to the second, and a rise, usually a gradual one, from the second syllable to the third. The sound represented by the letter r has nothing in common with the r as pronounced in most parts of the United States; it is a distinctly rolling sound; yet it is not even like the r as rolled by the tongue, but like the rolling sound produced by the uvula. The rolling produced by the dove seems to be merely a rapid repetition of the k sound which is heard singly at three points in the coo (thus, *kook koorr roo*) and heard singly also in the kah. If this is true, then the single k sound and the rolling must be produced in one and the same organ; what organ that is it would not be easy to say, though it is probably the syrinx. In imitating the ring-dove's cooing, then, it is most precise to make the rolling sound with the uvula; persons who cannot roll the uvula will produce the next approximation by rolling the r with the tongue. The ring-dove's cooing may be imitated very closely by the human voice, in the soprano register. Any reader of this paper who can read music can produce for himself a sufficiently accurate imitation of the dove's cooing by singing the syllables to the music given, remembering the one peculiarity of notation already mentioned (p. 32). One who cannot read music can have a sufficiently accurate imitation produced for him by any musician, capable of singing soprano, who will read the syllables and the notation given on the following pages.

The three clear syllables constituting the coo proper are followed generally, though not invariably, by two guttural syllables which seem to have something to do with drawing in or regulating the breath, though what is their precise function I have never been able to observe. Gutturals similarly closing the strain are heard in the case of many other birds which are accustomed to pour forth the song with one continuous, tense effort; for example, such a sound is

heard after the coo of the common pigeon, after the crow of the domestic cock, after the cry of the whippoor-will (*Antrostomus vociferus*), and sometimes at the close of the song of the meadow-lark (*Sturnella magna* and *S. neglecta*). The guttural sounds following the coo of the ring-dove are usually a distinct enunciation of the syllables "go o." These gutturals, however, show extreme individual differences in quality, intensity and duration, in some cases the two syllables being reduced even to a single sound. This extreme individual difference, conforming to no law or system, is one of the facts which indicate that the gutturals merely have to do with regulating the breath, and should be regarded as involuntary after-effects of the coo proper.

The coo of the female is always less powerful than that of the male. Not only is the intensity less and the pitch in many cases lower, but the notes are much shorter, thus destroying the richness of the strain. Often, too, the inflection is lacking, or is hurried and slurred in such a manner as to produce a travesty of the coo of the male. If a female be kept long in isolation, with no chance to satisfy her sexual and social desires, she becomes so self-assertive, bold, and boisterous, that she is scarcely to be distinguished from a male, either by her cooing or by any other form of behavior (cf. p. 43). But when a female is quietly pursuing the normal activities of the breeding-season, her voice is so different from that of the male that her coo alone is usually sufficient to determine beyond a doubt the fact of her sex.

Aside from these variations in the case of the female, the coo is, as has already been mentioned (p. 15), a pretty constant sound, much less variable than the kah. In different individuals the coo is slightly different in pitch, inflection, and duration. But the melody, in its main outlines, and the syllabication are, so far as I know, invariable.

The general description just given applies to all the coos of this species, but these coos are divisible into three types which are kept perfectly distinct, there being no gradations between them. The chief means of distinguishing these three types of coo is the difference between the bodily attitudes and movements accompanying each.

Yet the sounds themselves are sufficiently different for a person familiar with the birds to tell, usually, by the ear alone, which of the three coos is being given. Professor Whitman has named the three types respectively, the perch-coo (or song), the bowing-coo, and the nest-call.

(I) *The perch-coo, or song.* The perch-coo of the ring-dove is its song, properly so-called. While singing, in almost every instance, the bird sits on the perch, hence the name perch-coo. Less commonly the bird sings on the ground, and rarely in the nest. No special concurrence of outward circumstances is needed to move the bird to sing, for the perch-coo seems to express, in many cases, simply a feeling of good spirits; in this, the song differs somewhat from the other two forms of coo, which are usually reserved for special occasions or particular situations. The perch-coo is the only utterance of the adult ring-dove that ever appears to be given and enjoyed purely for its own sake (cf. p. 33); in this sense it may properly be regarded as "play." Of course the feeling of good spirits which is expressed in this coo is favored by outward circumstances which are comfortable or stimulating. Singing is most frequent in spring time, when the birds are in the fullest vigor and vitality; it diminishes during the summer as vitality is lowered by the exhausting labors of the breeding-season; it is least indulged in during the autumn, at which time the molt renders the bird somewhat unwell. But in the spring time, the season of lusty singing, the perch-coo may be repeated at intervals from dawn till sunset, irrespective of what passes during the day. The only circumstance which, to my knowledge, acts as an immediate excitant of the perch-coo, is the sound of another bird singing in the distance. There are occasions when the birds answer and re-answer one another for considerable periods, and the perch-coo is invariably used in such cases of simply calling-and-answering. It is thus seen that even this case, the only case in which the perch-coo is directly related to the environment, partakes of the nature of play.

No highly specialized attitude or movement accompanies the utterance of the perch-coo, no movement save what facilitates vocalization. The bird simply stands in the normal perching position. (Plate I,

Fig. 3), braces its muscles for the effort, and draws a deep breath; then, during the expulsion of the breath, the expelled air fills the crop, causing a great round swelling of the fore neck, extending to the sides of the neck, the throat, and the upper breast. In the interval between coos, the swelled crop subsides somewhat, and during each coo it is again blown out to the fullest extent.

The music of the perch-coo is as described for the coos in general. The perch-coo may be taken as a mean, from which the bowing-coo departs in one direction, the nest-call in another. The perch-coo is often given singly, but usually in series. The number of coos in a series, recorded throughout the early morning of a certain summer day, varied from 3 to 9, averaging 6. During the evening of a similar day, the number in a series varied from 2 to 5, averaging 4. The following are typical examples of the perch-coo of the male.



The perch-coo of the female differs from that of the male, as has already been stated for the coos of the female in general (p. 46), in being less loud, and poorer in both quality and expression. With regard to the perch-coo in particular, it must be added that the female often omits the guttural "go o" at the end, and even when she does give the guttural it is usually reduced to one syllab'e, sounding like "wah."

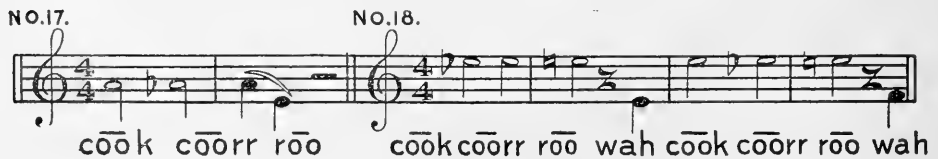

(II) *The bowing-coo.* The bowing-coo is given on the same occasions with the kah-of-excitement and the charge. These three

modes of expression commonly follow one another, or alternate with one another, in quick succession. Indeed the bowing-coo, instead of being named thus, might well be called the coo-of-excitement. It differs from the perch-coo, in regard to its use, in much the same way as the kah-of-excitement differs from the ordinary-kah. The perch-coo expresses moderate emotion; the bowing-coo, excessive emotion. The perch-coo, though heard more frequently from the male, is given commonly by both sexes; the bowing-coo, under normal circumstances, is given almost exclusively by the male. The perch-coo is never directly aimed at another bird; the bowing-coo is always so aimed. The other bird at which the bowing-coo is aimed may be another male, whom the cooing bird wishes to fight or drive away; or it may be a female, in which case the cooing bird may be wooing, or expressing affection, or driving the female away from other males, or (apparently) merely asserting his mastery over the female. It is thus seen that the bowing-coo, like the other expressions of excitement, does not attach to any one emotion nor to any one type of the situation, but is used in case of great excitement due to any cause whatever.

As the name implies, the bowing-coo is accompanied by a bowing movement; the bird bending, at the beginning of each repetition of the coo, to a perfectly prone position (Plate I, Fig. 6), and rising, at the end of each, to an extremely erect position (Plate I, Fig. 5). To speak more precisely, the downward movement is made with suddenness at the beginning of the first syllable of the "*cook coor roo, goo o;*" the prone position is maintained inflexibly during the first two syllables; the upward movement is made, somewhat less abruptly than the downward movement, at the beginning of the last syllable, "*roo,*" the erect position is stiffly maintained during the last syllable of the coo and the guttural "*goo o.*" While in the erect posture, the dove lifts its feet, right and left alternately, high above the ground, as if marking time. Its crop, during the whole performance, is swelled out as in the perch-coo, or even more so. The feathers on the head, neck, and breast, are smoothly appressed; but the feathers on the back are stiffly erected. This arrangement of the feathers reminds one of the feather arrangement of the charge.

The sound of the bowing-coo differs from that of the perch-coo in

such a way as to convey a feeling of intense excitement. The expression of excitement is due to the entire character of the coo and cannot be completely analyzed. However, it may be said that the sound is, for one thing, louder than that of the perch-coo. It is usually higher in pitch, with the changes in pitch greater. Haste, as if the bird were in a great hurry to express all its excitement, invariably characterizes this coo, notwithstanding the fact that the total duration of the coo may be no less than that of the perch-coo. The series of bowing-coos are somewhat longer than those of perch-coos; on a certain summer's morning, the series varied from 4 to 10 coos each, averaging 6 and a fraction; and, whereas the perch-coo may be given singly, or only two or three times in succession, I have no record of the bowing-coo being given less than four times in succession save in case of the bird being disturbed when in full operation.

The following are good examples of the bowing-coo. The guttural "go o" at the end is conspicuous, and in extreme cases it is quite loud, this being highly characteristic of the bowing-coo.

NO. 19.



Time: 3 crotchets per second.

NO. 20.

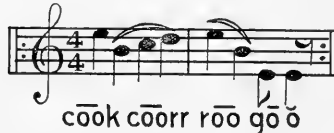

Time: about 4 crotchets per second. (The whole lasts 2 seconds +). Accompanied by a more perfect bow than the preceding.

These two coos were given by a bird with an unusually clear, re-sounding voice, a bird who cooed deliberately and musically. But in many individuals the voice, instead of sounding such a deep rich



tone, breaks into a higher, more shrill sound. In some cases only part of the notes break into the higher pitch. In other cases, the whole strain is in a high, shrill voice, as in the following example.



Time: 6 crotchets per second.

Timbre: Falsetto.

The female characteristically does not give the bowing-coo. When an adult female has been kept long in isolation, and has in consequence acquired almost identically the masculine bearing and behavior (p. 16), then she gives the bowing-coo like a male. But under any other circumstances, the bowing-coo is heard from her very, very rarely, and when heard it is of a comparatively feeble and perfunctory type.

(III) *The nest-call.* The nest-call, as the name implies, is a coo which is given typically in the nest, by either male or female, and serves to call the mate to the nest. Before the nest has been built, when the pair are hunting a nesting-site, the nest-call is used by either bird which has found a likely site, to call the other bird to the spot. On some other occasions, this call may be given by a bird which is not in the nest. But in all cases the calling bird places itself in a corner of the cage, or in the corner formed where a perch joins the side of the cage, or in some such partly inclosed space; one male that Professor Whitman made very tame would crouch in the hollow hands of his master and nest-call lustily; it is evident that such hollow places have, for the ring-dove, somewhat the same suggestive power as a nest.

The nest-call is characterized by a distinct attitude (Plate I, Fig. 4), which the bird invariably assumes in giving this sound. The body is tilted forward until in many instances the tail points almost vertically upward, and the head is as low as the feet, or lower; if the bird is standing on the floor, the tip of the bill and also the swelling crop touch the floor; if on a perch, the head may be held so

low that the eye gazes at one from under the perch; if in the nest, the position usually is less perpendicular, the tendency being to sink not only the head but the whole body into the nest. When the nest-call is given in a corner, the bird's face is turned towards the wall. The eye is partly closed, and may be entirely closed in moments of ecstasy. The feathers of the whole body are comfortably appressed. During the time this attitude is held, there is always a gentle flipping of the wings. This gentle wing-flip, considered merely as a movement, is usually quite different from the wing flutter of the young bird begging for food; for the strokes of the wings are made singly, at as slow a rate sometimes as two per second, and the movement is chiefly confined to the tip of the wing. But, considered psychologically, the nest-calling wing-flip bears an unmistakable resemblance to the begging expression, for it is given with reference to another bird, with a supplicatory significance; this is more evident in the female than in the male, and is seen especially when she is anxious for sexual union; in such case her wing movement may become a true flutter, and she may flutter separately that wing which is next to her mate, thus exhibiting clearly the similarity between her wing-flip and that of the begging young. But, whereas the fluttering of the hungry youngster is notable for its violence, the wing flutter of the amorous adult is notable always for its gentleness.

The nest-call is always given singly. Though the bird may continue nest-calling for many minutes together, there is invariably a considerable interval between each call and the next. These intervals of silence give opportunity for the vocalist to look about and watch the bird to which it is calling, and also to express its feelings by the wing-flip just described; for, during the effort of uttering the coo, the dove must hold its body rigid, the head square to the front, and the wings tight against the sides; only in the intervals between coos can it give the delicate flipping movement of the wings.

The sound of the nest-call differs in several respects from that of the other coos. The nest call is less loud than the others; the guttural at the close is usually omitted altogether. But this is the most protracted of all the coos, its individual notes, especially the last two out of the three, being of long duration; this protraction

seems to be connected naturally with the fact that the coo is given always singly. Further, the notes of the nest-call show greater and more precise changes of pitch than do the notes of other types of coo; they rise and fall between tones which are distinctly marked and sustained; they do not, typically, fade into those vanishing tones which make the other types of coo somewhat less musical than this.



A break (yodel) between the last two notes. Sometimes the musical intervals exact, even the "go o."



Time: about 2 seconds for the 3 syllables. There is a "go o" at the end, but it is almost inaudible.

The guttural *go o* is usually omitted in the nest-call.

#### LIFE-HISTORY.

The life-history of the ring-dove falls in cycles of four orders, one cycle within another. These are: (A) the life cycle; (B) the annual cycle; (C) the brood cycle; (D) the daily cycle.

(A) The most comprehensive of the cycles, since it comprehends all the others, is the life cycle; which consists of a period of immaturity, beginning with the egg and extending through several months of growth and development, and a period of maturity extending through several years. (B) The period of maturity is divided into annual cycles, each consisting of a winter period during which the birds show little or no reproductive activity; and a summer period, or breeding season, during which the birds are continuously active in the processes connected with reproduction. (C) The breeding

season, since it is occupied with the rearing of several successive broods, is divided into as many brood cycles, each consisting of several days of love-making and nest-building, fourteen days of sitting on the eggs, and at least as many days of caring for the young. (D) At the time of brooding, the birds' activities fall into a very definite round, repeated daily, constituting the daily cycle. Of course the dove's whole life is divided into daily cycles of a sort, because the birds invariably roost through the night and do all their work in the day time. But the most specialized daily program, the one which will therefore be described in this paper as a type, is the daily program at the time of brooding.

These four cycles will best be treated in the order in which they come and go in the dove's life. Accordingly, the order of the treatment will be as follows:—

- A'. Beginning of the life cycle.
- B'. Beginning of the annual cycle.
- C'. Beginning of the brood cycle.
- D. The daily cycle.
- C". The brood cycle, continued.
- B". The annual cycle, continued.
- A". The life cycle, continued.

#### A'. BEGINNING OF THE LIFE CYCLE.

*The day of hatching.*—When hatched, the pigeon is a little blind and naked body, able to slightly raise a shaking and swaying head and open its bill to receive the food regurgitated by the parent, and just able to drag itself slowly, by using the feet, from one position to another in the nest. When a parent wishes to feed a young one, she (or he) puts her bill down to the young one and gently touches its head, or takes hold of its bill. Then the young one raises its head in its shaky and indefinite way and after a number of random movements gets its bill into that of the parent and is fed. It seems as if sometimes the mere movement of the mother in raising her body from the young is sufficient to cause it to raise its head for food. If the young be touched by the hand at this time their response is either

to raise the head for food or to give a few little jerks of the head which have no apparent significance. They show no sign of fear. To speak of the converse relation, of young to parent—a movement of the young under the mother seems to be a gentle stimulus to her which may cause her to feed it.

Within half a day from the time of hatching, the young may be heard to give a very faint "peep," so faint, in fact, that it is inaudible at a distance of three or four feet; a very brief note, also, for it lasts but a small fraction of a second. By the second day the voice is a little stronger; it may sometimes be heard at a couple of yards' distance. It is a rather musical, sibilant sound, easily imitated by whistling the letter S very gently through the teeth. There is a gentle rise in pitch at the beginning and a sudden slight fall at the end; the pitch of the sustained part of the note is about b," but is variable. It may be asked if the voice is of any use at this time, or if it is merely undergoing development for the latter period of strength and usefulness. In answer, it may be said that even the young on the day of hatching squeaks when it is hungry and is silent when satisfied, and that even its microphonic voice is useful as a stimulus to the parent birds, including them to feed.

*The small nestling.*—The little bird grows with wonderful rapidity, and its development keeps pace with its growth. On the third day the eyelids begin to become detached from one another, but the eyes are kept closed almost all the time, and the young bird is several days old before the eyes seem to be of real utility. When the eyes begin to function, and not before, the young bird begins to show signs of fear. At first, the body is depressed and the head lowered to a hardly appreciable extent. Then, as these signs become more marked, the little pin-feathers begin to be raised slightly from the skin, and the bill is just barely opened and closed again, this movement being the first beginning of the puff or hiss. Each of these signs becomes gradually more marked, till finally they develop in the fledgling into a most extravagant expression of fear.

The voice alters very little for several days after hatching, though growing in some cases slightly stronger.

*The large nestling.*—About the ninth day the parents begin to

leave the young uncovered part of the time; at first they leave them uncovered only when they themselves come off to feed, then leaving them for a greater and greater part of the day till finally they cease to cover them at all. This last occurs on the tenth or eleventh or twelfth day. It is not surprising that the parent leaves the nest at this time, for the young bird has grown so large that the parent cannot quite cover it, not to speak of covering two such big youngsters. When there are two young in the nest, the parents leave sooner, I think, than when there happens to be only one. The nestlings have been as rapid in development as they have been in growth. The feathers on the wings and back have grown sufficiently to hide the skin. The eyes are wide open, and the birds are looking about most of the time; they are more active altogether, their activity being evidently in preparation for activity after leaving the nest. For days before venturing from the nest the young may stand and stretch themselves in the fashion of the adult, first raising both wings above the back, and then stretching each wing in turn together with the corresponding legs. The day before leaving, too, I have seen a young one stand in the nest and flap its wings as if practicing for flight.

The expression of fear has at this time reached a maximum. If a hand be brought near, the young bird squats down in the hollow of the nest, making itself remarkably flat, erects all the feathers, draws its head down while at the same time pointing its bill toward the intruding hand, and repeatedly shuts the bill with a sounding snap. The flattening of the body is very characteristic of the nestling, for it is absent, in its typical form, in adults, beginning to decline just before the young leaves the nest. The expression of fear thus reaches a maximum development before any other, indeed it gradually disappears, to a great extent, as the young becomes older; the snap of the bill, especially, becomes weaker after the bird has learned to fly, and degenerates in the adult into that rudiment of a snap which, though it can be seen, can hardly be heard. The age at which the young bird learns to fly is, pretty definitely, the age at which it gives up the expression of fear. When able to fly, the bird shows a'arm instead of fear, in the presence of dangerous objects; it is impelled to flee rather than to remain and make a show of resist-

ance. In the adult, the attitude of fear is not assumed unless some special circumstances prevent flight, as when the bird is sick, or brooding.

The voice in these large nestlings is still weak and seldom heard, and generally undifferentiated (except that the alarm-note may be given a day before the first trip from the nest). Begging for food is just beginning to be accompanied by a slight shaking of the wings, although the bird's power of coordination is still so undeveloped that it cannot direct its bill with any definiteness toward the mouth of the parent.

*The fledgling.*—The time of leaving the nest is very variable. The first trip on the floor of the cage may take place at any age from nine to fourteen days. When the young birds first leave the nest, they always return to it to spend the night, and in many cases they return to it long before night comes. After a few days, however, they fly up on a perch and settle there for the night, huddling as close as possible to each other, or, if there be only one young, huddling thus close to the father. This first night out of the nest comes ordinarily at the age of fifteen to seventeen days; it is more definitely fixed, I should say, than the first trip from the nest, probably because it is determined by the growth of the wing feathers and the resulting ability to fly.

As soon as the young birds leave the nest they begin to pick up bits of gravel or other small objects from the floor. It takes generally more than one day for them to learn to eat out of the seed cup, and when they do first accomplish this they eat very slowly, as if they had to think about each seed taken. When the young one is well able to feed itself, the parents feed it gradually less and less; the amount of their feeding depends largely, it would seem, on the clamorousness of the young, which, in turn, varies inversely to the young bird's ability to obtain food by its own efforts; in this way the amount of food given by the feeders is adjusted to the necessities of the fed. As may be surmised, the time of weaning is very indefinite. I had one young one which learned to eat very quickly and received only a small part of its nourishment from the parents after the fifteenth or sixteenth day (although the father continued to feed it occasion-

ally until the twenty-fourth day). Another young one, in contrast, was only learning to eat on the twenty-third day, begging very hard from its parents, who were by this time unwilling to feed it, and it was still fed in a spurious fashion by the father on the thirtieth day.

Now, as to the sound which forms an important part of the begging expression. About the time the young bird first leaves the nest the voice makes a sudden growth; the little peep which has been made in begging for food grows much stronger and becomes somewhat squeaky in tone. It continues to grow louder almost as long as the begging note is used, that is, almost until the parents quit feeding. It is at that time a sibilant squeak beginning soft and low, becoming rapidly higher and louder, and then ending abruptly. It may be imitated by whistling the letter S through the teeth, loudly, with the inflection just described. This (No. 25 of the musical notations) is the emphatic note, given when the bird is begging hard from the parent. But when its enthusiasm dies down, its note becomes lower, softer,



and shorter, until it may become a gentle "st" like No. 28. The pitch, as can be seen, varies through a great range. While it ranges very much lower than that of the young nestling, I think it may also extend as high as the highest notes of the nestling.

A slight shaking of the wings when begging for food is noticed, as was mentioned above, before the young have left the nest. This shaking of the wings becomes more ample as the voice becomes stronger, until, in a pair of three-week-old birds, it makes a lively scene. Each young one stands in front of its father (or mother), sticking its bill into his face and trying to push it into his mouth, squeaking without intermission, with its wings half spread and flapping strongly, following the father wherever he goes, and running around him if he attempts to turn away, every movement being made to an exaggerated degree. If parent and young happen to stand side by side, as they are compelled to do when on a perch, for example,



then the wing farthest from the parent is shaken very little or not at all, but the nearer wing is shaken strongly, in many cases being spread across the parent's back, slapping him vigorously. Now the question arises: Why should the three-weeks-young need to beg so hard for food, while the new-hatched get it without begging? The answer, I think, is not so far to seek. The parents' mouths have become sore from the frequent distension and friction caused by the insertion of the young ones' bulky beaks. Besides, the parents give a great deal more food to the large young than to the newly-hatched, and they work harder to bring it up from the crop. They are tired of feeding, and will quit, if not importuned by the young. The less a young one begs at this stage, the less it will receive.

*First appearance of the cries of the adult: the alarm-note and the kah.*—The first utterance to become differentiated from the begging squeak is the alarm-note. This is first given on the twelfth to the fourteenth day. At that time it has the same pitch and timbre as the squeak of hunger, but differs from the latter in being very short, abrupt, emphatic. It has a quick fall in pitch at the end, and in some cases it seems to have a slight rise at the beginning, though in other cases it appears to be at its highest from the very beginning; its inflection is thus exactly like that of the adults' alarm-note, although its tone is that of the baby voice. As the inflection is precisely like that of the adult, so is the attitude struck during alarm, the little fellow standing with neck stretched out, looking at the object, whatever it may be, that has excited the emotion. It must be said, however, that at first the attitude struck is only a slight one, the head being only very moderately raised; and the alarm-note as first given is not nearly so emphatic as in the adult, not so loud in proportion, so to speak. The pitch of this sound, as given in my notes, varies from d' to c."

As regards the economy of alarm, parents and young are in agreement from a very early stage. The young give the signal upon hearing it from the adults, and the parents likewise may catch the infection from the young, and in all cases the alarm leads to preparation for avoiding danger either by flight or by hiding (squatting low in the nest, depressing the feathers, and keeping very still).

The next utterance to be differentiated is the kah, and its origin resembles that of the alarm-note in that at first it is given in the sibilant baby voice yet with the rhythm and inflection of the adult cry, under the same circumstances as the adult cry, and apparently with the same meaning. Two young birds, of different broods, began to give this call on the twenty-seventh day. Another brood of two birds began, apparently, at exactly the same age, for I find in my notes that on the twenty-seventh day they "have an intermittent call. It is in the same tone as the ordinary squeak of the young and hence resembles the contented chirrup of a chicken. It seems to be given when the birds are moving about and sociab'le." This call is given in nearly all the many circumstances in which the adult kah is given, but it is not so commonly uttered upon merely alighting on a perch. It is heard in general, as quoted above, "when the birds are moving about and sociable," and it is heard particularly when the bird charges upon another one, in which case the kah is often followed by the bowing-coo. Like all other utterances given in the baby voice, this kah may be imitated by whistling the letter S loudly through the teeth; the following notations will furnish a guide in such imitation.

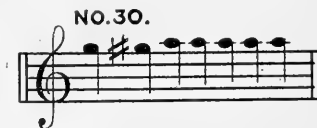
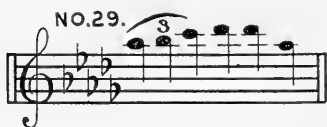

Time: 5 crotchets per second.

*The change of voice.*—By the term "change of voice" is meant the change from the high-pitched sibilant voice of the young to the more grave and sonorous tones of the adult. It seems well to introduce this topic here because, while the change of voice affects not only the alarm and the kah but also the coo, which will not be treated until later, yet in the coo it is complicated by the simultaneous occurrence of great changes in modulation, whereas in the alarm and the kah the change in pitch is the only change which occurs.

The change in pitch does not occur by a gradual deepening of the baby voice; the voice "breaks," just as it does in a thirteen or four-

teen-year-old boy. The first change observed is that the sibilant notes of the young have become impure in tone. The impurity increases until a decided harshness is produced, due to the admixture of low tones with the high ones, making evident the analogy to the breaking of the voice in a youth. The low tones become more and more prominent and the high ones dwindle until, after many weeks, the high tones have disappeared altogether, leaving the voice with purely the adult sound.

As to the age at which the change of voice occurs, there is an intimation of the change, perhaps, as early as the age of four weeks, for at that time the pure sibilant has changed to a squeaky tone, less pure than the first, and louder. But the earliest distinct break in the voice occurs at about six weeks. The following notation is to represent the combination of high and low sounds which characterizes the voice at this time.



Kah on alighting on perch.

Pitch of the "s" not definitely determined. The "a" is a hard chest-tone, impure.

Each note begins with the sibilant sound but drops suddenly into the lower pitch. As the bird grows older the sibilant is reduced more and more, but many weeks elapse before it has entirely disappeared. I have observed a slight trace of it in the alarm-note, for example, at the age of seventeen weeks.

The change of voice is due, no doubt, merely to the development of the vocal organs, just as it is in the adolescent man. This puts it on a different plane from the other developmental changes in expression. The inception of the fear reaction, of the alarm-note, of the kah, or of the coo, and the changes in the form of the coo, must be due to the coming into play of fresh tracts and centers in the nervous system. But the deepening of the voice must be due to

changes in the syrinx. Observation of the birds leads me to believe that they have no control whatever over the breaking of the voice; it is purely mechanical!

*First appearance of the coo.*—The first attempts at cooing usually appear much later than the alarm and the kah. Only in one case, in a bird which showed other signs of precocity, did the song originate on the same day as the kah, the twenty-seventh day. In the nest-mate of this bird the coo was not heard until the fortieth day; in another bird not until the forty-seventh day, and not decisively until the fiftieth day. The first coo is thus very variable in the time of its appearance. And it is equally variable in its character. The variable character of the early cooing is shown in this quotation from my notes. The young bird “takes few hasty steps toward mother on perch, head directed toward her, giving kah in squeaky voice. He repeats this about three times, then stands up straight and stiff (in attitude of male in the up phase of the bowing-coo), then he bows, down and up several times, making not a sound. He goes through much the same performance two or three times. Little later he gives coo in a purely squeaky voice (pitch a”) without bowing.” In this case, then, the perch-coo and the bowing-coo apparently developed at the same time; but, while the perch-coo was audible, the bowing-coo, if sounding at all, had not passed the threshold of audibility. In many cases, however, I think that the bowing-coo precedes the perch-coo by a day at least. This was true of the nest-mate of the bird just referred to: “After giving the kah in its squeaky voice, bird went through bowing motion, roughly, making just a single short note now and then, pitch g’, sometimes two notes, with time-interval between, and second higher than first by one tone or less.” In another case the first coo was a “perfectly nondescript sound. Much resembled its attempts at kah, but notes more irregular, some of them more prolonged.” All these accounts go to show that the coo at its first appearance is not only variable but extremely imperfect. While the alarm-note springs into being perfectly formed, as it were, and the kah, at its inception, is almost as perfect, the coo, at first, is an insignificant fragment which does not in the least suggest the sound it is ultimately to assume. It seems that in those

individuals in which the coo appears very late, it is correspondingly well developed when it does appear.

*Development of rhythm and melody.*—The modulation of the alarm-note and of the kah being practically of the adult type from the very beginning, these utterances exhibit no development in rhythm or inflection. The coos are the only utterances which go through a long course of development in modulation.

By the third month, the coo has been extended considerably. There is a greater number of notes, and the notes are, on an average, of longer duration. But even at this time the rhythm is so imperfectly developed, so irregular, that it often bears little resemblance to that in the adult song. Moreover, the rhythm varies so much, even in a single series of coos, that one must conclude it is largely accidental. The following are examples.

NO. 32.

kukuku' kuku u uu

♀ 56th day. Nest-call coo.

Time: 3 crotchets per second. Attitude: nest-call. Tune very variable. In fact, no constant tune at all.

No. 33 A      No. 33 B.

ka u kur      ku ku ku ka u

No. 33 C.

ka u kur ka u ku

♂ 82nd day.

Though the coo is so formless at first, it very soon begins to show the general form of the adult coo. It comes to consist uniformly

of three notes, and gradually this trisyllable comes to have exactly the accent, the tone-quality, and the melody of the adult coo. But even after attaining the trisyllabic form the early coo has three definite differences from the adult utterance, as follows:

First. The different notes of the coo are separated more in the young than in the adult, often allowing a considerable rest between. This fact, together with the general character of the utterance, gives the impression that the young bird coos with difficulty and at the expense of considerable effort.

Second. The rolling sound, represented by the letter *r*, is absent from the earliest coos, and develops rather slowly, for even when it does first appear it is a perfunctory performance.

Third. The appendix to the coo, represented by the syllables "go o," is not given until the age of three or four months, and when it is first given it is only a monosyllable.

In addition to the three features enumerated, the juvenile coo is characterized by poverty in the quality of sound and a hurriedness and lack of all beauty in the inflection. As the bird grows older, the coo becomes loud, voluminous, and mellow, and acquires a graceful, gliding inflection, which, without changing the general form of the melody, gives it an entirely new and improved character.

The perch-coo and the bowing-coo develop at an equal rate and become practically of the adult form at the age of about seventeen weeks. But at this age the nest-call coo is still decidedly imperfect (at least in the male). All through the development of voice the nest-call lags behind the other coos. This is perhaps because the nest-call is purely a sexual expression, whereas the other two forms of coo are used to express emotions which may be developed before sexual maturity, such as combativeness, or simple good-spirits.

*Influence of old birds.*—Pigeons, young and old, are extremely sensitive to suggestion. The young ones often give a certain note when they hear the parents give it; this is noticed as soon as the first of the adult cries appears, i. e., the alarm-note. The more the young hear other birds, the more they call. Thus the calling of other birds may lead the young to give a certain sound earlier than they would give it if left alone. But the young do not imitate the adults, in

the sense of copying them, or learning new sounds. The forms of utterance (herein the pigeons differ from many other birds) are strictly hereditary.

*The charge.*—The charge is associated in its development with the kah, as has already been stated (page 40), and thus appears at an early age, even at the age of twenty-seven days. The charging activity in the young, as in the adult, includes chasing another bird, pecking her (or him), assuming the peculiar horizontal attitude, progressing by leaps as well as by steps, and uttering the kah (kah-of-excitement). But each of these acts is at first of a weak and gentle sort. The charging activity, like the vocal activities, passes through a prolonged and gradual development before it reaches the form seen in the adult.

*Development of certain other instincts.*—Since the first attempts at cooing appear at an age of from twenty-seven to forty-seven days, it might seem that they are too early to have any sexual significance whatever. Yet some activities connected with sex begin at an equally early age,—sitting on eggs, for example. In one instance, on the twenty-first day, a fresh egg having been laid by the mother, the young one entered the nest, observed the egg intently, and carefully sat on it. At fifty-one days, a young one entered the nest, settled very carefully on the pair of eggs, sat for several minutes, and when the father tried to drive it off persisted for a considerable time in holding its position. This sitting on the eggs is not an accident, for the little fellow is very careful to have the eggs under him, and if there are two eggs he takes a great deal of pains in trying to get them both under, finally settling down upon them with that side-wise rocking movement always seen in the case of the adult.

A young female showed the courting propensities of her sex, practising the art upon her father, at a very early age. It is difficult to say at just what age this began, because it is impossible to draw a sharp line between filial and amorous attentions. At fifty-six days this young female responded to the cooing of the father and some other pigeons by assuming the nest-call attitude, head down and wings shaking, and making an attempt at the nest-call coo. At seventy-four days she showed the typical courting behavior, for in the

evening by lamp-light she huddled close to the father and preened his breast and neck, sometimes preening her own feathers in that spasmodic manner which is a sign of eros, and sometimes interrupting these proceedings to give the nest-call coo. From this day forth she did not cease to show her readiness and anxiety to mate.

## SUMMARY OF DEVELOPMENT.

Development and decline of the voice and habits of the nestling.	Development of cries and habits of the adult.	The change of voice.
1st day. Voice just audible. Voice a stimulus to parent. Young and parent communicate also by touch. No fear.		
3d day. Eyes begin to open.		
About 6th day. Slight expression of fear.		
10th to 12th day. Young are left uncovered by parents all day. Expression of fear reaches a maximum.		
9th to 14th day. Young first leave the nest. Begin to pick up food. Begging begins to be accompanied by shaking of wings. Expression of fear begins to decline.	12th to 14th day. Expression of alarm. Alarm-note.	
15th to 17th day. First night out of nest.	21st day and later. Sit on eggs.	
15th to 24th day and later. Weaning. Maximum development of baby voice and of begging behavior.	27th day. The kah.	
	27th to 38th day. The charge.	
	27th to 47th day. The coo.	4 weeks. First impurity in baby voice (?).
	56th to 119th day. The nest-call coo.	6th week. Distinct break in baby voice.
	74th day. Female shows courting behavior.	3 months. Alarm and kah nearly as in adult.
	4 to 6 months. Coos all differentiated and perfected.	17 weeks. Still a trace, in some cases, of the sibilant.
	4 months and later. Begin to breed.	

## B'. BEGINNING OF THE ANNUAL CYCLE.

The age at which a ring-dove begins to breed depends upon the season, for the tendency is in all cases to begin breeding in the spring. Birds maturing in the autumn are delayed by the tendency



to sexual inactivity in winter; and birds maturing in the spring are accelerated, in comparison, by the tendency to begin breeding in spring.

The autumn and the early winter are marked not only by inactivity in breeding but also by disuse of the voice; at least a disuse as compared with its copious use at other seasons.

But as winter advances, long before warm weather has definitely set in, a change toward the musical life is noticeable. The voice is used more and more, and it gradually regains the volume of sound and perfection of form which characterize it in spring and summer. Whether the preliminary exercise of the voice aids at all in its development, it would be difficult to say. The fact is that the perfection of the voice and the tendency to use it arise gradually and coincidentally; and it seems probable that each aids the other. Yet there are reasons for believing that practice has very little effect in developing the voice of the dove.

As the birds begin to coo, they naturally begin to coo to each other; and while the whole pigeonry bombards the ear with an abundance of sounds, each pen presents to the eye an abundant spectacle of bowing and charging, wooing and fighting, love and jealousy. This may continue a long time before each bird secures a mate. But, to notice in detail the formation of a union between two birds, it is more convenient to study the case of two ring-doves isolated in cages.

If a cage containing an unmated male ring-dove be suddenly brought alongside another cage containing another ring-dove, of unknown sex, the male becomes highly excited at once, and gives vent to his excitement in all possible ways. First he bows and coos with all his might, and he continues to do so for a long time. Then he charges about the cage, assuming the attitude peculiar to the charge, and frequently repeating the loud kah-of-excitement. At intervals he stops to glare at the strange bird and sometimes to peek at it through the bars, but soon he starts again to bow-and-coo and charge. After more or less of this display of aggressive impulse, he begins to show eros, by a certain spasmodic preening of the inside of the wing (a movement which invariably accompanies erotic activity), and by assuming the nest-calling attitude and sounding the nest-call.

If left beside the stranger's cage for some hours, the male must sometimes rest and be silent; but even the intervals of rest and silence are broken frequently by series of perch-coos. This behavior on the part of the male is useful in that it stimulates the strange bird to respond, and, in responding, to reveal its sex.

If the strange bird be a male, it shows similar excitement and aggressiveness. And the two males are sure to fight if they can reach one another.

But if the strange bird be a female, she acts far otherwise. She is at first very indifferent, unless she is particularly anxious to mate. And after some days, when she begins to show an interest in the male, she does not give the bowing-coo, nor charge up and down the cage, nor show other signs of pugnacity and aggressiveness. So far from tending to aggress upon the male, her conduct is rather an expression of submission to him. She shows a certain excitement; for instance when she utters the kah it is a kah expressive of gentle excitement. But she spends the greater part of her time in alluring the male by means of the nest-calling performance—the nest-calling attitude, seductive cooing, and gentle flip of the wings. She often tries to get through the bars of her cage to the male; and, failing to do so, she sometimes lies down with one side pressed against the bars. She shows eros by the usual method of preening inside the wing; she may even take the copulation position while the male is cooing and bowing to her.

When the male sees the strange bird behaving in this submissive and seductive manner, he loses the intensity of his pugnacity; though he always continues to be masterful. He spends less time now in the bowing-coo and more time in nest-calling and in trying to get to the female. If the doors are now opened and the birds allowed to come together, they become mated. The time it takes the doves to become mated varies greatly. In case of some old, experienced birds that are ready and anxious to mate, two or three days in contiguous cages may make them acquainted, and then as soon as the doors are opened and they come together, they are ready to copulate. In other cases, especially in cases of inexperienced birds, the male is so cruel to the female at first that it is not safe to leave her with him until after a

long period—even weeks—of acquaintanceship. But once the birds have had their attention concentrated on each other and have become affectionate, the business of breeding proceeds smoothly and rapidly.

#### C'. BEGINNING OF THE BROOD CYCLE.

In the preparation for a brood of young, whether it be the first brood of the season or a later brood, there is always *first* a period such as has been described, in which the male by means of the kah-of-excitement, the bowing-coo, charging upon the female and even pecking her severely, gains a mastery over the female that draws her attention to himself to the exclusion of all other males which may come in sight or which may be surviving in the female's memory. The female on her part submits herself to the male and draws his attention to her. And both birds become worked up to a state of tense sexual excitement. This period is always followed by a *second* period in which the excitement, venting itself in copulation and in work upon the nest, becomes less violent, though perhaps not less powerful. The charge and the kah-of-excitement fall to a very low ebb, and even the bowing-coo is used much less than at first; but the perch-coo and the nest-call are in frequent requisition.

Copulation is repeated a great number of times, there being many repetitions per day and continuance for a number of days. It is continued until near the time when the first egg is laid; and sometimes even after the first egg is laid. The number of days of copulation seems to be ordinarily four or five; but there is at hand as I write, a pair of birds still continuing a series which they began fifteen days ago. The number of copulations or attempts at copulation in one day, I have never determined under normal conditions. In certain abnormal experimental conditions, devised for another purpose, I counted on several different days from twelve to fifteen attempts per day. I should think that even in normal cage conditions the number of attempts might be equally great.

The first day of copulation is a day of high excitement, and the divers expressions of this excitement may be divided into two classes; namely, those that occur through a great part of the day in general,

and those that occur immediately before each act of copulation. Throughout the greater part of the day, the male frequently gives the bowing-coo, the nest-call, or the perch-coo, the female gives the nest-call, and both birds kah frequently and loudly. Preening of the feathers in a spasmodic manner, especially the preening of the wing on the inner side, and the preening of the head of the mate as the two birds sit side by side, are equally characteristic activities of the day. Immediately before copulation there is usually a special cooing and a special show of eros by preening inside the wing, and there is invariably the act of billing, the female putting her bill into the mouth of the male, and he disgorging a little of the contents of his crop for her to take. This is the signal, as it were, which is immediately followed by copulation.

The search for a nesting-site and the building of a nest, which have been going on at the same time with the operations already described, are accompanied by a great deal of vocal performance, especially nest-calling. Both birds engage in the search for a nesting-site. When either bird has found a likely place, it sits there and nest-calls by the hour. The mate, hearing this call, is drawn to the spot, and then both sit together and nest-call, gently flip their wings, and preen each other's heads for a long period. The construction of the nest is carried on by one bird, usually the female, sitting in the nest and building in the materials which are brought by its mate. Each time the male brings a straw the female receives it with the gentle flip of the wings and the nest-call.

When the eggs have been laid, the male and the female take turns most regularly in sitting on them. This fact gives to the daily program during incubation a complexity and definiteness which are not equalled at any other time in the dove's life. The present point in the life-history is therefore a good place at which to insert a description of the daily cycle.

#### D. THE DAILY CYCLE.

The daily cycle of activities reaches its maximum complexity and its greatest definiteness at the time of incubation. At any other time it is indeed noticeable that the birds follow a daily program:

they always wake with the sun; they begin to coo before leaving the roost; they are most active in the early morning, fighting and love-making, cooing and calling and running about; they rest, or even sleep, in the hottest part of the day; in the evening they are again active and musical; they go to roost as soon as the light has begun to fade; they frequently coo after going to roost; and, finally, while strictly diurnal in their habits, and helpless at night as are most diurnal birds, yet they may often be set cooing at night by the lighting of a lamp, by a bright moon, by the cooing of other birds, or perhaps by their own inward inclination.

In order to obtain a more complete record of the daily cycle during incubation, I have more than once watched the birds continuously for half a day at a time, noting every movement and every utterance, now from before dawn until noon, and again from noon until night.

Thus on July 2d I entered the room at 3.50 A. M. The birds were still in their nocturnal positions, female on the nest, and male on the perch. At 3.54, although there was not yet light enough to read by, the male cooed four times; the female in answer cooed four times; he cooed once at the end of her song. Then he preened his feathers. Cooing and dressing the feathers always occupy the first part of the day. The coos given were mainly of the perch-coo type, varied at intervals by series of bowing-coos; but at 5.09 A. M. the male turned on his perch so as to get his head in a corner; and gave the nest-call, continuing until he had repeated it twenty-four times. Not until 5.36, or one hour and forty minutes after I first heard him coo, did the male come down from his perch to feed. The female greeted him with gently fluttering wings, and as he flew up on the perch and down again, she again gave this sign of feminine affection. Thus matters continued, with but little interruption, until at 8.19 A. M. the male took his place on the nest. In these four and a half hours from the time of waking to that of taking his place on the nest, the male repeated his coo 487 times! He gave about 70 bowing-coos, 386 perch-coos, and 24 nest-calls. The bowing and perch-coos were given in 95 separate series, each series consisting of from one to ten coos. The female during all this time cooed only once; this once was when, in answer to the male's song of four coos at dawn she

gave a similar series of four coos. After that she often fluttered her wings when the male happened near the nest, but she never cooed. The male's 487 coos were pretty evenly distributed over the whole time. But they began at the hour of dawn with a somewhat slower rate than the average, rose to a maximum just after the bird had left his roost and breakfasted, and then declined somewhat until the time of taking the nest.

The male takes the nest at 8.30 A. M. and keeps it until 4.45 P. M., when he yields it again to the female, who sits steadily until 8.30 the next morning. Of course the birds are not punctual to a single minute, but their regularity during early incubation, if nothing occurs to disturb them, is remarkable. Towards the close of incubation, and after hatching, they are much less regular. And at any time, the presence of other birds or of alarming objects is likely to throw them out of the regular order. Thus on the 2d of July which I have been describing, the female left the nest at 8.15 A. M., being alarmed by the barking of a dog, and the male entered the empty nest at 8.19, which was probably a few minutes earlier than he would otherwise have done. The most potent disturbing factor, however, is the presence of other birds, which arouses the jealousy of the male.

*Changing places on the nest.*—When the male comes, at his due time, to relieve the sitting female, or when the female comes similarly to relieve the sitting male, there is always a little communication or ceremony. There is little difference in behavior between the male and the female on this occasion. There is much variation in the ceremony, but the usual procedure is about as follows. The bird that is out, comes to the nest, giving the kah as it arrives; it jumps on the edge of the nest-box, kahs again, flips its wings and tickles the head of its sitting mate. The sitting bird responds by fluttering its wings and showing evident satisfaction with its mate's attention. This exchange of greeting is usually sufficient; after a few caresses, and sometimes cooings, on the part of each bird, the sitting bird gently rises and steps forward, and the other steps in behind and settles upon the eggs. It sometimes happens that the sitting bird leaves before the other comes, as in the case mentioned above when the sound of a dog's bark caused the female to leave a little before

her time. On the other hand, it is not uncommon for the sitting bird to be unwilling to leave, and for the bird that is due on the nest to paw the sitting bird's back, probe with its bill all around the sitting bird, feeling for the eggs, and finally enter the nest and squeeze the former occupant until at last, slowly and deliberately, it leaves the nest. This happens especially when the eggs have just hatched, for the feeling of the young birds under the breast apparently is a greater attraction than the feeling of mere eggs; and so it often happens that both birds sit at once on the young, crowding each other, and each trying to cover as much as possible of the coveted nestlings.

That the touch of the eggs or young and of the nest itself give pleasure and satisfaction to the sitting bird, is evident from many highly expressive acts; such as the manner in which the bird arranges the eggs with its bill, touching them again and again, arranging and re-arranging many times; from the complacency with which it finally settles down upon them; and from the absorbed interest it shows in arranging the straws and gently picking at anything about the nest (cf. p. 75.)

When the male has taken the nest, all is quiet. The sitting bird always makes itself as inconspicuous as possible. Though this useful instinct has lapsed to some extent in the long-domesticated ring-dove, yet even the male of this house-bird rarely coos when on the nest. On this day on which the male cooed 487 times before taking the nest, he did not coo after that for three hours, and then he gave only one series of six coos. The female, after leaving the nest, goes first to breakfast at the seed-cup, after which she flies about the cage, preens her feathers, and busies herself with such small matters. Most of her activities have little interest for the present discussion, but it is worthy of note that she often alights on the edge of the nest-box, and on doing so she often sounds the kah. The female, it would seem, is always somewhat more attached to the nest than is the male. Although the female often uses the kah, she goes but little at any time; during the four hours I watched this female after her leaving the nest, she sang only once, a series of four coos.

In the middle of the day, no matter at what stage of the brood

cycle, the birds always sleep, or rest. The sitting male thus sleeps through the hottest hours. But the first and last hours of his brooding are spent in alert, though quiet, wakefulness.

When the male is again free from the nest in the evening, he indulges in another period of cooing, though a much less noisy period than that of the morning. When first relieved by the female, having had a long fast, he goes at once to feed; then he usually performs an elaborate toilet; and only gradually does he rise to the evening musical performance. This performance, indeed, as has been mentioned, is much less than that of the morning: for example, to compare with that morning's performance of July 2d which has already been described, I made a similarly complete observation on an afternoon just four days previous, with the result that, during the whole time between leaving the nest and going to roost, i. e.  $3\frac{1}{2}$  hours (as against  $4\frac{1}{2}$  hours for the morning), the male sang only 16 times (as against 95), making 65 coos (as against 487); moreover, while 70 of the morning's repetitions were accompanied by bowing and 24 were of the suppliant type known as the nest-call, the evening performance was entirely of that less emotional and less elaborate type known as the perch-coo. The cooing generally reaches a maximum just before the bird goes to roost. After taking the roost, the male usually coos a number of times, but his songs become rapidly less frequent till all is silent. And this silence ensues while daylight is still much brighter than that by which the bird first begins to coo in the morning; which again makes the songster's evening performance inferior to that of the morning.

#### C". THE BROOD CYCLE, CONTINUED.

After the laying of the eggs, pigeons in general spend their days in comparative quiet. This is not always very evident in the common ring-dove, as may be gathered from the foregoing pages; but in some of the wild species the change is sudden and almost complete. The birds go about with a haunted look, with a perpetual expression of alarm, as it were. The male sings only at sunrise and at sunset, and when singing he goes away from the nest as far as possible.



Even when it is necessary to sound the alarm-note while on the nest, the bird subdues its voice into something very like a whisper. The quietness of the brooding time is thus a forced quiet, an active silence, caused by inhibition. In fact, in the tame ring-dove, which has so far lost its fear as to be at ease even during brooding, the inhibition is largely removed, and the birds are far more noisy during incubation than are any of the wild species. Strong attachment of the mates to one another is shown throughout the brood cycle by tame and wild species alike. The notion that the comparative quietness of the birds during brooding is due to lack of conjugal feeling, is a mistake.

Quietness and retirement form only one phase of a great alteration of disposition during brooding; another phase is a sudden defensive bravery and irascibility. The sitting bird, whether male or female, defends the nest as valiantly as a brooding hen. And even when off duty from incubation each bird is now more bold than ever in attacking and driving away enemies.

The eggs hatch in 14 days; that is to say, on the 14th day after the laying of the second egg. The hatching of the eggs, the arrival of the young, gives again a stimulus of the same sort with the first appearance of the eggs, and makes the parents again still more quiet, more jealous, and more devoted to their parental duties. It has already been shown (page 73) that the movement of the young under the breast of the parent is a stimulus to the latter. Professor Whitman has found that when he needed a foster-parent for some valuable young pigeon, he could take a ring-dove whose eggs were not yet ready to hatch, and, by stroking her breast gently with his fingers in imitation of the movements of the young, he could induce her to commence feeding. Thus we see that the feeling of the movements of the young is a stimulus not only to the feeding impulse but at the same time to the secretion of "pigeon's milk" in the crop. That the young are a greater attraction than are the eggs to the sitting bird, is evidenced by the frequency with which the parents sit both together on the little birds, often crowding each other to get a larger share of the coveted nestlings. That the hatching-out of the young gives an additional stimulus to maternal jealousy, is shown by the

fact that if, on the day of hatching, there are fledglings still in the cage from a former brood, the mother now ceases to tolerate the presence of those fledglings; her eye begins to glare and her feathers to bristle, and soon she attacks her fledged offspring with such fury that the owner is obliged, for humanity's sake, to take them out of her cage.

Within a few days after the hatching of the eggs, the birds begin to become irregular in their brooding hours. The young are still kept covered, to be sure, but the occasional desire of the parents to sit both at the same time, and the frequent necessity of their coming to feed their young, gradually breaks up the regularity of the sitting exchanges. Brooding ceases entirely, at least if the birds are kept indoors, in a period of 10 to 12 days.

But while brooding has thus been gradually given over, the business of feeding has become rapidly more and more arduous, as a result of the rapid increase in size of the young and the enormous development of their begging powers. There may even be added a new note to the parents' vocabulary at this time, a call to the young to feed. But as soon as the young have reached their maximum importunity they begin to pick some food from the ground, and the parents, tired and sore-mouthed from the feeding of youngsters almost as large as themselves, are ready to quit feeding; thus the young are gradually weaned, at an age ranging from about 15 to 25 days. The mother quits feeding before the father, for she is always more devoted to the next pair of eggs and young, while the father feeds the fledglings in the day-time and roosts beside them at night.

A succeeding pair of eggs and young has already been mentioned. Preparation for such begins very early, in that the parents, while feeding young, commence another round of cooing and love-making and mating; the cycle of one brood is not finished before the cycle of the next is begun. Just how early the new cycle will be begun, depends upon the season and upon all the circumstances. As to season: In the spring and early summer the succession of broods is more rapid than at any other time of year. As to other circumstances: For example, the destruction of eggs or young at any stage sets the parents at once to cooing and love-making. Professor

Whitman, on removing the eggs from a nest, has observed the birds to begin fondling one another within half an hour afterwards. When only one egg hatches, so that the labor of feeding is only half what it usually is, the birds have more energy and come more quickly to the preparation for a new brood. The shortest interval I have observed between hatching and laying is, when only one bird is reared, 13 days; when two birds are reared, 14 days.

In the normal course of events the inauguration of a new brood cycle is gradual, being a repetition, perhaps somewhat abbreviated, of the performance by which the birds first become mated. There is first a period of bowing and cooing by the male and a gradual rise of excitement in both birds; then a period of copulation, nest-calling, and nest-building, with a gradual decline in the excitement, followed by the laying of the eggs and the birds' devotion again to incubation. Thus (even before the old brood cycle is finished) is a new brood cycle begun.

It has been said that after the birds have begun a new round of mating they still foster the young of the last brood, but there is a limit to this fostering of the old fledglings; there comes a time when the parents not only refuse to feed them but cease to tolerate their presence. This desertion of the former brood happens much earlier with the female parent; so soon as the mother has taken to sitting again, she begins to acquire a hostile attitude towards her nearly grown-up-children; so far from feeding them, she pecks at them when they try to share the seed-cup with her; and so far from brooding them, she keeps them always at a little distance from her body. Affairs generally continue in this smoldering condition for several days; but a day comes—and according to my observation it is almost invariably the day on which the new eggs hatch—when the fire of this maternal jealousy bursts forth and the mother persecutes the fledglings with such fury that if they were not taken from the cage they would perhaps even be killed. The male, though not nearly so aggressive in this matter, has become more or less completely indifferent to the old fledglings, and shows no regret at their departure. Thus ends the brood cycle.

## B". THE SEASONAL CYCLE, CONTINUED.

Renewed efforts, as shown in cooing, kaking, nest-building, and a host of other activities, are necessary to initiate each brood cycle. If the birds be disinclined to effort, from any cause, such disinclination will delay or prevent the commencement of another brood cycle. This is what happens in the molting season, beginning in the latter part of August. There may be a decrease of breeding power, especially in some pigeons, even before the molt; but most of the domestic ring-doves retain ample breeding powers up to the time when the molt begins to diminish their general vitality. The breeding powers lost at this time are not regained, by the wild species, until the following spring; and though the domestic ring-dove may be bred all through the autumn and winter, yet the frequency of repetitions of the brood cycle is lessened, the health of the birds may suffer, and it is evident that this extension of the breeding season is unnatural. Coincident with the lapse of breeding propensity, in all species of pigeons, is a loss of voice, a loss especially of the more emotional, more musical notes. The loss of voice is not so conspicuous in the domesticated and unnatural ring-dove. The loss of song is not complete even in most of the wild species, for their coos may be heard at irregular intervals through the months of September and October at least; but the coo at this time is in some cases notably different from that of the breeding-season. And though the songs may be given thus sporadically, their sum total is exceedingly small. The comparative silence which reigns in the pigeonry is gloomy; the hushing of the birds in August is an annual surprise, a change so sudden and so great that one does not become accustomed to it.

## A". THE LIFE CYCLE, CONTINUED.

Though ring-doves begin to breed at a very early age, even at four months, and thereafter continue to pass through the regular succession of brood cycles and annual cycles, Professor Whitman has found that they do not reach their maximum breeding powers until the age of about three years. After that age, the breeding powers remain at the maximum for some years.

Professor Whitman has kept blond ring-doves till they were about ten years old. In one such case he knew pretty definitely that the bird's death was due to causes other than old age. Yet he thinks that he has observed somewhat of a decline in the breeding powers in a bird about ten years old.

#### SUMMARY OF THE LIFE-HISTORY.

##### *A'. Beginning of the life cycle.*

The voice of the young ring-dove is heard the first day, and is useful to induce the parents to commence feeding (page 55).

The voice of the growing young is useful to cause the parents to give a sufficient amount of food, and to continue feeding until the young one is able to feed itself (page 57).

Fear begins to be shown as soon as the young have the full use of their eyes (page 55).

Alarm develops somewhat later, 12th to 14th day (page 59).

The kah appears often on the 27th day (page 60).

The charge appears on the 27th day or later (page 65).

The coo appears from the 27th to the 47th day (page 62). It is at first very imperfect, and develops very slowly to the adult form.

Development of the voice is of two sorts which may be referred to two causes; namely, development of the syrinx or vocal apparatus, and development of the nervous system (page 61).

The young often give cries at the suggestion of the parents, but they do not imitate the cries of the parents (page 64).

##### *B'. Beginning of the annual cycle.*

The elaborate cooing and other performances of the spring season serve to proclaim the sex of each bird (there being no markings distinctive of sex), to bring the birds together in pairs, and to unite each pair by a firm bond (pages 66-69).

##### *C'. Beginning of the brood cycle.*

The male and the female, by mutual stimulation and self-stimulation, work up a pitch of excitement sufficient to start them on the arduous, month-long labors of the brood cycle (page 69).

After days of copulation and nest-building, all of which are controlled by cooing and other ceremonies, two eggs are laid and the birds enter upon fourteen days of brooding.

D. *The daily cycle.*

The male and the female take turns very regularly in sitting on the eggs. Each time when one bird relieves the other, there is a ceremonial communication between them.

C". *The brooding cycle, continued.*

After the eggs are laid, the birds are guardedly quiet when near the nest, but there is no diminution of conjugal affection (page 74).

The hatching of the eggs, and the movements of the young under the breast, are strong stimuli to the parents (page 73).

The parents may even add at this time a new call to their vocabulary; a call to the young to feed (pages 43, 44, 76).

The parents, while still feeding the young, gradually work up, by cooing and other performances, to that pitch of excitement which is needed to start a new brood cycle (page 76).

B". *The annual cycle, continued.*

At the end of the summer, especially when the molt begins, the birds have not sufficient energy to work up to the beginning of a new brood cycle. Thus brooding stops.

A". *The life cycle, continued.*

Pigeons do not reach their maximum breeding powers until an age of about three years.

The length of life is not definitely known.



#### EXPLANATION OF PLATE.

FIG. 1.—The alarm (page 35). Both are in the attitude of alarm; but the more extreme in attitude is the adult bird, distinguished by the black half-ring on the neck.

FIG. 2.—The charge (page 42). Male.

FIG. 3. The perch coo (page 47). The bird that is cooing is an adult male. The other bird is a young one.

FIG. 4. —The nest-call (page 51). The bird with its head down in the nest is a male, nest-calling to the other bird, which is a female.

FIGS. 5 and 6.—The bowing-coo (page 48). Fig. 5 and Fig. 6 both show the same bird (an adult male) in a phase of the bowing-coo, Fig. 5 showing the up phase, and Fig. 6 the down phase. The bird is bowing-and-cooing to his own image in a large mirror which was placed close against the end of the cage for the purpose of getting these photographs.



EXPRESSIONS OF EMOTION IN PIGEONS.

WALLACE CRAIG.

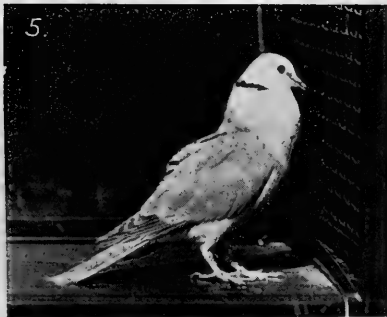
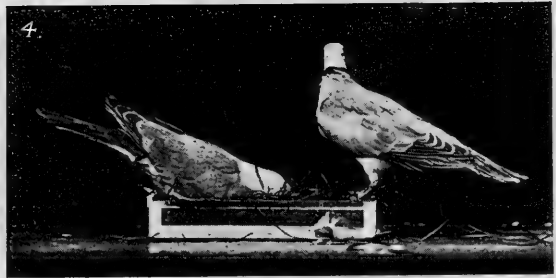
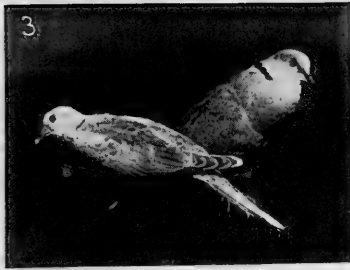



THE REACTION TO TACTILE STIMULI AND THE  
DEVELOPMENT OF THE SWIMMING MOVE-  
MENT IN EMBRYOS OF DIEMYCTYLUS  
TOROSUS, ESCHSCHOLTZ.

BY

G. E. COGHILL.

*Studies from the Neurological Laboratory of Denison University, No. XXII.*

WITH SIX FIGURES.

In 1906 I began a series of experiments upon embryos of *Rana* and *Amblystoma* with a view to determining whether there is any regularity in the earliest neuro-muscular responses to tactile stimuli in the amphibian embryo. During the season of 1907 these experiments were continued upon embryos of *Diemyctylus torosus*, Eschscholtz (*Triton torosus*). Although the work of the first year gave interesting results and convinced me that the field of investigation was a fruitful one, it was less exhaustive and critical in its methods than the later work has been, and there is no occasion to give an account of it in this connection. It will, therefore, receive no further treatment here and all the data and discussions of this paper will relate exclusively to *Diemyctylus torosus*.

These experiments were originally planned for correlated anatomical and physiological studies. As an introduction to such work upon *Amphibia* they form the basis for the anatomical part, since they reveal distinct phases in the development of neuro-muscular response to the most primitive system of cutaneous receptors. But, apart from this significance to pure anatomy and physiology, they are, of themselves, an interesting contribution to the science of animal behavior, for they deal with a most important phase of behavior, namely, its very beginning in the embryo. If, for instance, there is any such thing as a "simple reflex," such as Sherring-

ton suggests,<sup>1</sup> it must be found in the earliest reflexes of the embryo as observed in these experiments, and if it is possible to trace the development of a "simple reflex" into a form of acknowledged instinctive behavior, this link in the development of behavior would seem to appear in the development of the swimming movement as described in the following pages.

In view of this bearing of the experiments upon the subject of animal behavior certain results of the experimental part of my investigations are here made known before the anatomical phase of the work has been completed.

#### METHODS.

The embryos were removed from the egg membranes at various stages in development, ordinarily before they showed any sign of irritability to tactile stimuli. They were then placed in shallow Petri dishes, a single specimen in a dish, and tested from time to time for reactions. Usually an experiment continued until the animal began to swim.

The stimulus employed was a touch with the end of a rather fine human hair, mounted in such a way as to render the touch very gentle. The extreme sensitiveness of some very young embryos is remarkable. Even the touch of a fine piece of lint will at times evoke a vigorous response, as if it were a violent irritant.

Without critical consideration the tactile nature of this mode of stimulation might be held in doubt. The touch of a hair such as was used in these investigations might easily cause a considerable pressure, so that there might be a question whether the responses were to a strictly tactile stimulus or to a mechanical stimulus upon the muscles or central nervous system. Indeed, in the very early phase of development, when the irritability was for some reason unusually low, some of the reactions, I believe, may have been to direct pressure upon the muscles or central nervous system. But such instances, if they occurred at all, in these investigations, were,

<sup>1</sup>Sherrington, Charles S. "The Integrative Action of the Nervous System," p. 8.

I believe, relatively rare. For instance, when the stimulus is applied to the under side of the head as the animal lies on its side, and the response is a movement of the head away from the side touched, it is inconceivable that this response is to a direct pressure upon the muscles effecting the movement, and it seems altogether improbable that such a stimulus could be brought to bear upon the central nervous system directly in such a manner as to give rise to a constant form of response. Or, in case the stimulus is applied to the margin of the dorsal or ventral caudal fin and a movement of the head only results, as regularly occurs in certain phases of development, it is absolutely impossible for such a reaction to be given in response to pressure either upon the acting muscles or upon the central nervous system. As reactions of this sort occur here and there throughout nearly every one of my experiments, it seems to me certain that the stimulus employed was, with possibly rare exceptions, purely tactile, and that, so far as the mode of stimulation is concerned, my conclusions are valid.

Ordinarily the stimulus was applied to the upper side of the specimen as it lay on its side on the bottom of the dish. Frequently, however, it was applied to the under side of the specimen from beneath, in order to determine whether contact with the dish had any influence on the mode of reaction, but it was impossible to detect any factor of this kind in the responses. Some embryos, also, were suspended in an upright position and tested for the same purpose, and with the same result.

An individual record in detail was kept of each embryo from the time it was removed from the egg membranes till the end of the experiment. In the record of each trial, or application of the stimulus, the following factors were noted particularly: the region and side touched, the form of the response and the time of the trial. Tabulated schemes for rapid recording were tried in my first experiments of 1906, but it soon became apparent that such forms could not be adhered to, for they were necessarily based upon presumptions of some sort and were, therefore, a hindrance rather than a help to alert observation. These methods were wholly abandoned and have no part in the records from which this paper is written.

## REACTION TO TACTILE STIMULI.

A. *Response to Stimulation on the Head.*

According to their reaction to a touch on the side of the head; in the region innervated by n. trigeminus or n. vagus, embryos of *Diemyctylus torosus* may be grouped according to three types, as follows:

Type I. Embryos which from the beginning and during a considerable period, respond regularly or almost regularly with a movement of the head directed away from the side touched.

Type II. Embryos which for a relatively short period at first respond irregularly with movements of the head toward or away from the side touched, and then enter upon a relatively long period of response like that of Type I.

Type III. Embryos which are at first asymmetrical in response, that is to say, they move their head in one direction only, regardless of the side touched, and then enter upon a short period of irregularity like the first period of Type II, and finally upon a relatively long period of response like that of Type I. Or individuals of this type may pass directly from the period of asymmetry to the regular form of Type I. The accompanying charts illustrate the behavior of typical specimens from each of these three types. The first column on the left in these charts records the serial number of the trials made, and the record of each trial is represented in the corresponding horizontal line to the right. The figures in the second column from the left record the time in hours and minutes that elapsed since the last preceding trial in each case. The diagrams in the third column from the left represent the form of reaction in the various trials. Where there is more than one diagram in a space these are to be read from left to right, and each represents a distinct phase in a series of movements. The arrow occasionally placed in these spaces indicates that a cephalo-caudal progression of the movement was distinctly observed. Where an "S" occurs the specimen swam, and the following diagram in the same space indicates the composition of the swimming movement. It should be noted that these diagrams of the movements are simply free-hand representa-

tions of the reaction according to written descriptions made at the time of trial. They can not be considered as absolutely accurate in every detail, but they do represent truthfully the general order of the development of trunk movements in these animals.

The curves of the charts represent the side touched and the direction of the initial movement in the reaction relative to the side touched. The solid line records the direction of the movement of the head; divergence to the left from the vertical records a movement toward the side touched; divergence towards the right, away from the side touched; coincidence with the vertical, undetermined. The broken line records the side touched; divergence to the left signifies a touch on the left side of the head; divergence to the right, a touch on the right side; a blank, no record. Obviously, where the two curves are parallel the movement recorded was to the left; where they diverge or converge the recorded movement was towards the right.

The apparent incompleteness in the serial numbers of the trials in the first column of some charts is due to the fact that in these experiments alternate or occasional trials were being made with reference to touch on the tail bud. The charts represent perfect series of trials with reference to touch on the side of the head.

The charts presented here are selected from a series which, with descriptions, has been deposited with the Wistar Institute of Anatomy and Biology, for the advantage of students who may be interested in a more exhaustive report of my experiments than this paper affords.

The accompanying table presents schematically some of the data upon which this classification into three types is based. It is the tabulation of the records of 36 specimens which have been selected solely upon the basis of completeness of the record and duration of the experiment. Owing to the difficulties in the manipulation of the work and unavoidable hindrances many experiments were not carried continuously through the entire period which is here under consideration, and, although contributing materially to the evidence on the problem as a whole, can not, on that account, be included in a comparative study of this kind.

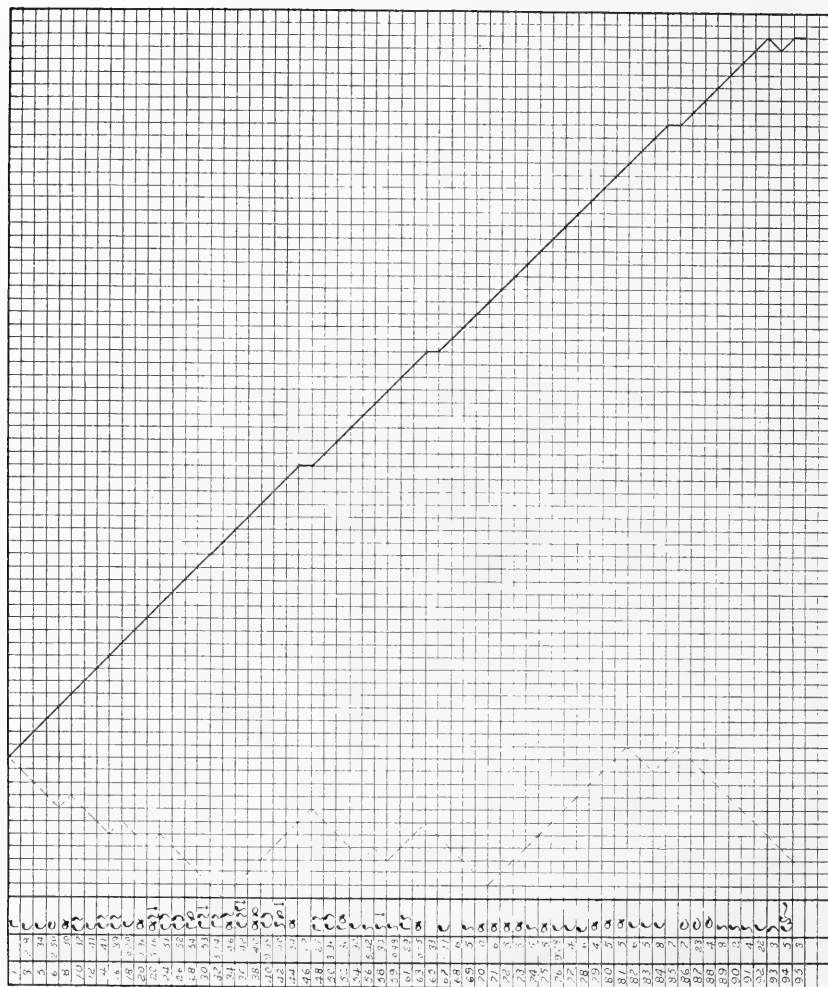

FIG. 1.—Experiment 156, illustrating Type I. The embryo from which this record was made was the most regular of my series in response away from the side touched.



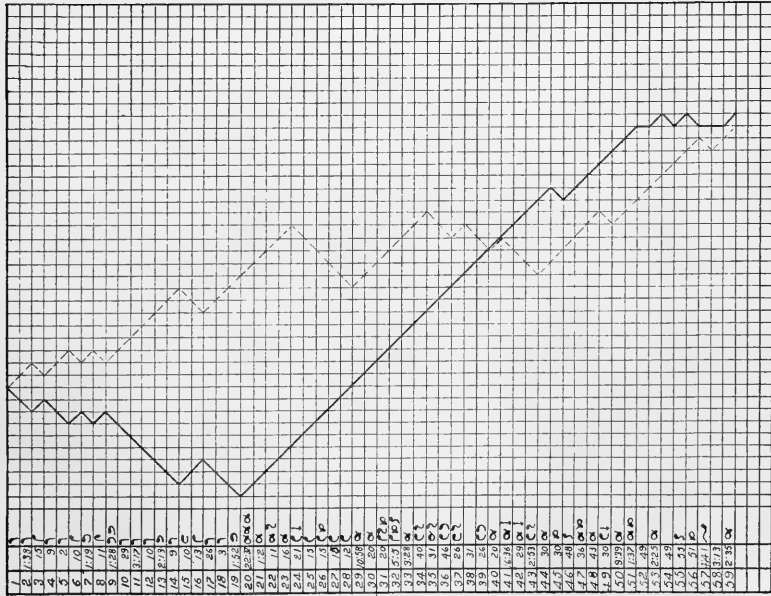

FIG. 3.—Experiment 136, illustrating Type III, in a case where the asymmetry passes over directly into regular response away from the side touched, but with a long interval.

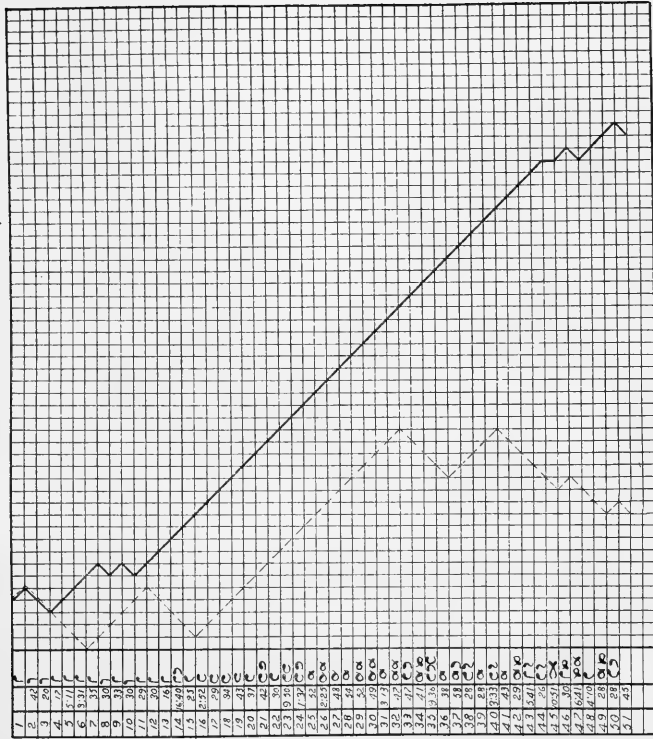

FIG. 2.—Experiment 151, illustrating Type II.

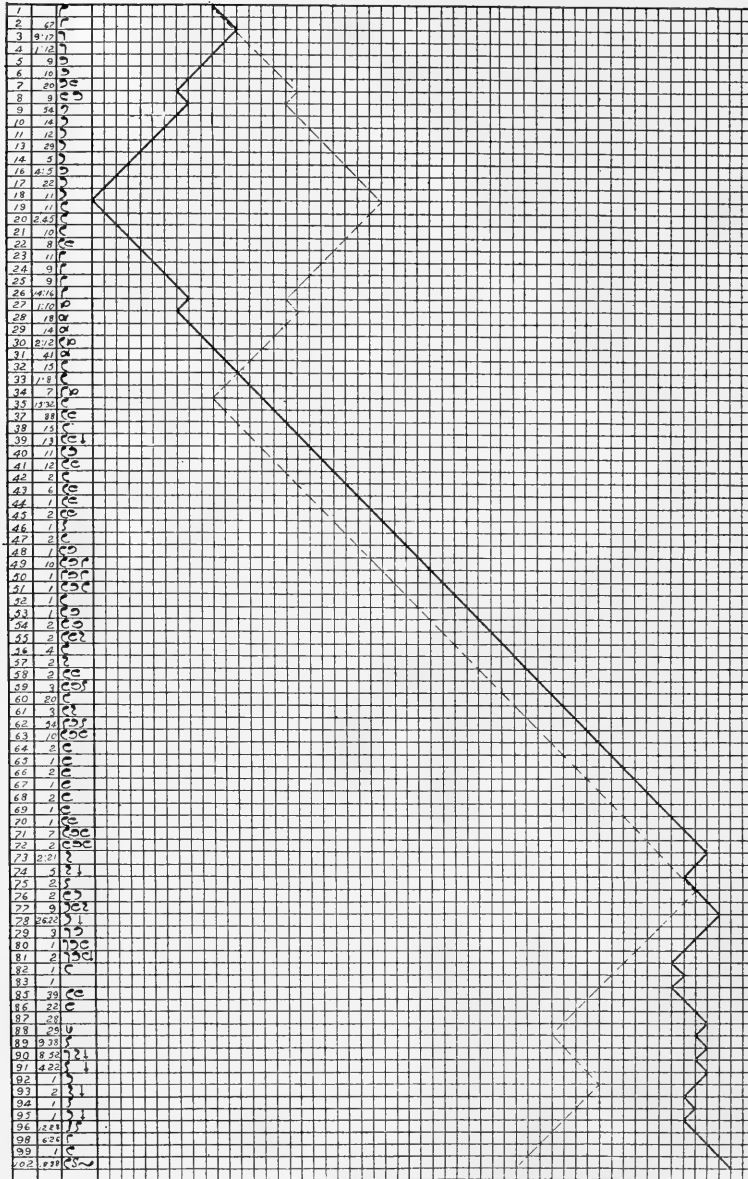

FIG. 4.—Experiment 37, illustrating Type III, in a case where asymmetry in response passes abruptly into regularity, and the asymmetry is preceded by two movements at variance with it.

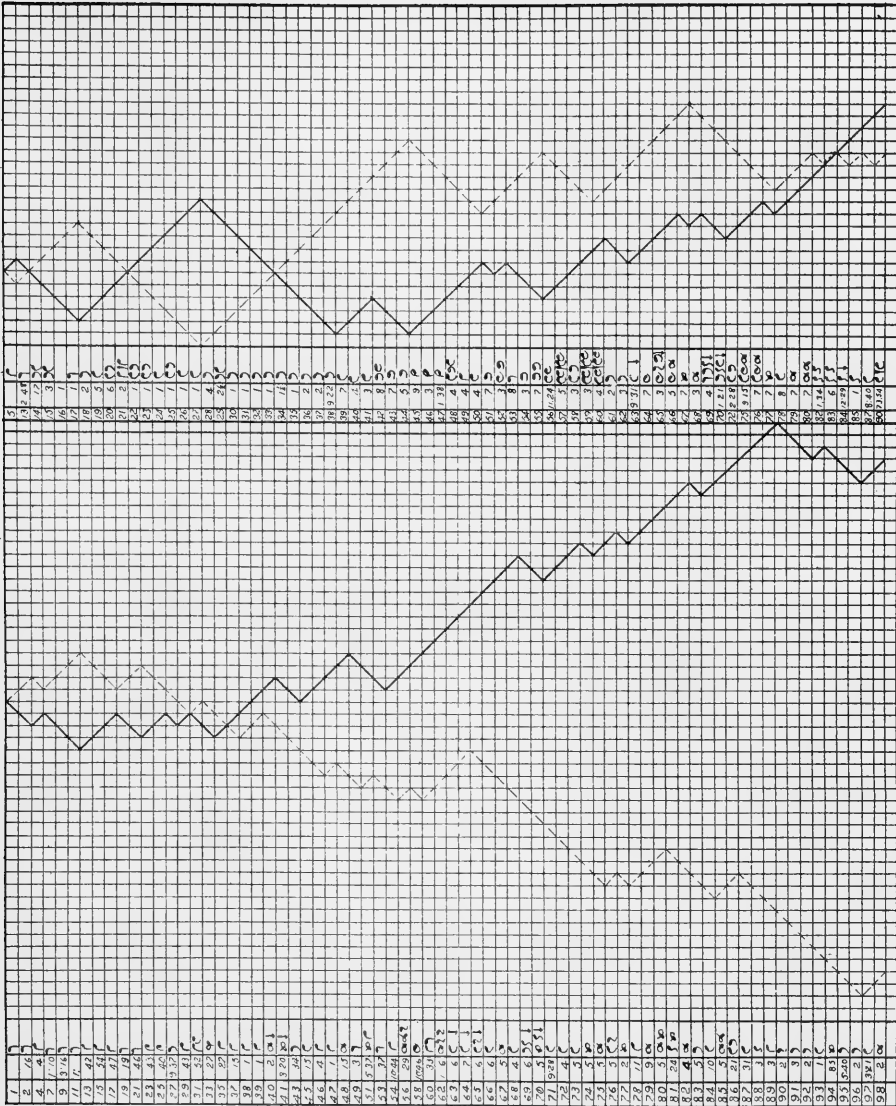

FIG. 5. (Upper figure).—Experiment 48, illustrating Type III, in a case where the period of irregularity is influenced, apparently, by the preceding asymmetry. It should be observed that the reactions were taken rapidly during the period of asymmetry and irregularity.

FIG. 6. (Lower figure).—Experiment 162. The embryo from which this record was made was, on the whole, the most irregular specimen of my series. Still, after the period of asymmetry there is a marked general tendency to move the head away from the side touched.

For further data see Table, p. 92.

A	B	C	D	E	F	G	H	I	
45	?	.....	.....	.....	.....	64:36	31	96.7	TYPE I.
32	?	.....	.....	.....	.....	52:07	53	94.3 <sup>1</sup>	
146	24:00	.....	.....	.....	.....	72:00	40	100.0	
150	24:00	.....	.....	.....	.....	96:14	49	95.9	
145	24:00	.....	.....	.....	.....	73:34	40	95.	
144	20:22	.....	.....	.....	.....	67:52	35	97.1 <sup>2</sup>	
156	13:30	.....	.....	.....	.....	96:43	57	100.	
Average...	21:10	.....	.....	.....	.....	74:43	305	97.4	
151	:20	.....	.....	12:19	:19	70:49	34	100.	TYPE II.
143	20:00	.....	.....	6:42	:19	48:09	25	96.	
147	5:45	.....	.....	2:27	11:00	71:09	35	91.4 <sup>3</sup>	
148	5:18	.....	.....	2:04	:14	64:41	24	100.	
149	?	.....	.....	1:35	:17	81:37	37	97.2 <sup>4</sup>	
34	3:53	.....	.....	1:52	9:29	49:02	37	100.	
142	20:00	.....	.....	6:29	:12	47:58	27	100.	
155	1:30	.....	.....	4:36	:27	59:04	23	100.	
158	24:00	.....	.....	11:49	:39	47:51	23	95.6 <sup>5</sup>	
161	?	.....	.....	:26	1:23	59:15	25	92.	
163	:41	.....	.....	5:10	:42	64:57	38	94.7 <sup>6</sup>	
154	1:30	.....	.....	6:18	17:24	47:17	27	92.5	
140	1:30	.....	.....	8:34	:10	93:31	41	87.8	
141	14:00	.....	.....	33:21	:11	32:39	31	93.5	
36	?	.....	.....	26:47	14:01	37:34	19	94.7	
Average...	8:12	.....	.....	8:41	3:47	58:22	446	95.	
136	?	14:51	.....	.....	22:27	64:51	33	96.9 <sup>7</sup>	TYPE III.
152	5:20	7:12	.....	.....	:58	58:04	22	100.	
159	2:54	8:26	.....	.....	10:22	69:13	24	91.6	
153	5:25	5:26	.....	.....	:43	66:10	32	96.8	
37	24:00	32:26	.....	.....	15:32	32:36	53	98.1	
39	?	:38	.....	.....	15:52	50:22	26	100.	
157	:14	7:31	.....	.....	2:39	72:53	30	96.6	
162	12:00	12:35	9:37	2:32	:27	45:08	46	78.2	
164	:40	23:48	5:38	11:59	:29	34:49	20	95. <sup>8</sup>	
139	1:28	10:04	:22	2:26	22:45	68:12	39	97.4	
137	9:00	16:38	:07	6:26	22:44	62:25	33	93.3	
126	20:00	5:38	18:48	4:01	:09	98:48	60	98.3	
160	12:00	12:18	:43	:41	:41	58:36	37	89.1	
38	24:00	4:13	3:44	4:26	14:16	115:58	30	80. <sup>9</sup>	
Average...	9:45	11:33	5:34	4:30	9:17	64:08	489	93.	

<sup>1</sup>The first 30 responses, distributed through 23 hours and 13 minutes, were all directed away from the side touched.

<sup>2</sup>During one period of 41 hours and 30 minutes there were 30 consecutive responses away from the side touched.

<sup>3</sup>During one period of 46 hours and 13 minutes there were 22 consecutive responses directed away from the side touched.

<sup>4</sup>During one period of 57 hours and 36 minutes there were 25 successive responses directed away from the side touched.

<sup>5</sup>During one period of 36 hours and 50 minutes there were 18 successive reactions directed away from the side touched.

<sup>6</sup>During one period of 41 hours and 32 minutes there were 19 successive responses directed away from the side touched.

<sup>7</sup>During one period of 47 hours and 6 minutes there were 25 successive reactions directed away from the side touched.

<sup>8</sup>During one period of 22 hours and 59 minutes there were 17 successive movements directed away from the side touched.

<sup>9</sup>There were in all 52 responses, distributed through a period of 137 hours and 33 minutes. Of these responses, 40 were directed away from the side touched, a percentage of 76.9.

The several columns in this tabulation have significance as follows:

Column A. The number of the experiment, the data of which read to the right.

Column B. The time that elapsed between the last trial which gave no response and the first to which response occurred.

Column C. The time during which the embryo was asymmetrical in response.

Column D. The interval or time that elapsed between the last observed response that accorded with asymmetry and the first response that accorded with irregularity.

Column E. This is the second phase in the development of embryos of Type III, and the first phase of embryos of Type II. It is described above as the period of irregularity in response.

Column F. The interval or time that elapsed between the last observed reaction that accorded with irregularity and the first that accorded with the regular form of response as described above for Type I.

Column G. The time during which the embryo is considered as moving its head regularly away from the side touched.

Column H. The number of responses given during the period represented by Column G.

Column I. The percentage of the responses indicated in Column H that were away from the side touched.

The time is recorded in each instance in hours and minutes, excepting in a few instances in Column B where the time was not determined. Averages are given in the several columns for each of the three types, excepting in Column H where the corresponding numbers represent totals.

With reference to the side touched in each trial my records are complete, but, inasmuch as the records in Column G clearly have no references to the side touched as determining factor, this element of the question is omitted from the table.

A comparison of the averages in Column B of the table might be interpreted to mean that the specimens of the second and third type came under observation relatively earlier in the period of development than did the specimens of the first type. But it should be

noted that the figures in Column B represent the maximum possible time of irritability before the observation of it began. On the other hand, a comparison of the averages in Column G shows a clear distinction between Type I, on the one hand, and Types II and III, on the other. There is a difference of, say, 10 to 15 hours in the length of the period of regularity in moving the head away from the side touched. Furthermore, if the average of Column G for Type I be compared with the corresponding average for Type II plus the averages of Column E and F of this type, it will be seen that the embryos of Type I were longer in passing through the one period of regularity than were the embryos of Type II in passing through the periods of both regularity and irregularity, including the interval. It would seem, therefore, that a period of irregularity has not been passed over unobserved in Type I, and that the distinction between these two types is not based on the relative age of the individuals when they came under observations.

A similar comparison of the corresponding figures for Type III with those of Type I shows that the time represented by Columns E, F and G for Type III approximately equal that of Column G for Type I. But for the excessively long period of No. 38 in Column G, the comparison would result about the same as that with Type II. But when the period of asymmetry and the following interval is taken into account it is clear that the specimens of Type III were a much longer time in passing through the periods represented by Columns C, D, E, F and G than were the specimens of Type I in passing through the period of Column G alone. This would seem to indicate that the condition of asymmetry is due to a precocious development of one side of the neuro-muscular system rather than to a retarded development of the other side. At any rate the sum of the averages in Columns C and D for Type III is greater than the average in Column B for Type II. It would seem altogether improbable, therefore, that a period of asymmetry like that of Type III has been passed over unobserved in Type II.

While I do not place any great dependence upon this comparison of the averages in the table, I believe they do tend to show that the difference between the different types of reaction as observed in these

and numerous other embryos is not based upon relative age but upon the relative development, and probably the variable physiological condition, of the various constituent elements of the neuro-muscular system. When a period of asymmetry occurs, it appears before the period of irregularity or regularity, and never follows either of the latter, excepting in rare cases when one or two movements right at the beginning of the experiment are at variance with the asymmetry (Figs. 3, 4, 5, 6). The asymmetry clearly influences the irregular reaction in some cases, so that the movements towards the side touched appear to be determined by a partial persistence of asymmetry (Fig. 5). But this is not always the case. The period of regularity persists, ordinarily, till near the time of swimming. The actual length of the period varies greatly in different specimens, but a comparative study of numerous specimens convinces me that the regularity in response is purest for a period of about 48 hours.

The structural basis for a regular asymmetry in response must be in the ascendancy of the effector system of one side over that of the other, rather than in structural difference in the receptor systems of the two sides. Two facts particularly support this interpretation: (1) All spontaneous movements (somatic) that have been observed in embryos which conform to a given asymmetry are in accordance with the asymmetry in each case, towards the right in dextrally asymmetrical specimens and towards the left in sinistrally asymmetrical specimens. (2) In any given asymmetrical embryo the asymmetry is the same with reference to stimulation on the tail bud as it is with reference to stimulation on the head, and specimens that are asymmetrical in one respect are so also in the other.

The structural basis for a regular movement of the head away from the side touched must obviously lie in the ascendancy of the descending tracts which decussate in the cephalic part of the central nervous system over the uncrossed long tracts which descend into the cord. In comparing this condition with the response to stimulation on the tail bud, it should be remembered that the path from n. trigeminus or n. vagus to the opposite musculature of the cephalic part of the trunk is through the descending axones of these nerves within the central system, while the path from the caudal nerves to

the same musculature is through the ascending axones of the afferent nerves. This factor will be best considered in connection with the account of reaction to touch on the tail bud.

The most difficult phase of the problem to deal with by way of anatomical inference or in the framing of a working hypothesis from the point of view of anatomy is the occasional response directed towards the side touched and the period of irregularity in response that precedes the period of regular movement away from the side touched. It is possible that, in such cases, the impulse passes directly to the centers of synapse with the effectors of the opposite side and, in case these centers are inactive, returns by a commissural path to the corresponding effectors of the same side; or it might be that the connection with the effectors of the same side is through collaterals of axones which themselves pass directly to the opposite side, and that, in case the opposite effectors are inactive, the impulse may flow over into the collaterals and effect a connection with the effectors of the same side. Two observations may be cited in favor of the latter hypothesis: (1) There is a perceptibly lower degree of irritability during the periods of irregularity and asymmetry in response. My experiments are not exhaustive on this point, but they afford a considerable evidence to this effect, and none to the contrary. (2) The irritability of an embryo may vary perceptibly within a comparatively short period of time. This factor has not been definitely correlated with irregularity in response, but it may be the explanation of the occasional movement towards the side touched during the long period of predominant regularity. Also the very rare irregular movement occurring before a period of asymmetry, as observed above, may have its basis in this variable irritability at some point in the neuro-muscular system.

In some such manner as indicated above my experiments permit of a provisional hypothesis to explain the occurrence of the early periods of asymmetry and irregularity in response of some embryos and the occasional movement towards the side touched, and warrant the conclusion that, for a period of about 48 hours, or more, following the first movements in response to a tactile stimulus, the response of a symmetrically developed, normal embryo of *Dicmyctylus torosus*



is regularly away from the side touched when the stimulation is applied to the fields of the n. trigeminus and n. vagus.

### B. *Response to Stimulation of the Tail Bud.*

There is no marked regularity in the responses to touches on the tail bud. There is a slight general tendency in some specimens towards movement of the head toward the side touched, but no definite significance can yet be attributed to this tendency. It is clear, however, that specimens that are asymmetrical with reference to stimulation on the head are similarly asymmetrical with reference to stimulation of the tail bud, and that ordinarily the asymmetry with reference to the two points of stimulation extends over approximately the same period.

One other fact concerning the reaction to stimulation on the tail bud is established beyond question by my experiments. The first response to such a stimulus in the very young embryo is a head movement, and as the embryo advances in age this movement still begins in the head region and progresses caudad. Ontogenetically, then, the most primitive conduction paths of the medulla spinalis are longitudinal and afferent, and the crossed paths are secondary, excepting possibly in the most cephalic part where the medulla spinalis may be involved in the crossed paths between the n. trigeminus or n. vagus and the opposite musculature of the trunk. The two halves of the medulla spinalis, therefore, seem to be physiologically distinct during this phase of development. This fact of development reveals from a new source the fundamental nature of the longitudinal divisions of the cerebro-spinal system, at least of the somatic components, as they have been conceived by Herrick,<sup>3</sup> Johnston<sup>4</sup> and others on purely morphological and physiological grounds. It also suggests that in their direct connection with the cephalic part of the nervous system the special cutaneous systems of fishes and amphibians accord essentially with the primary plan of the general cutaneous system.

<sup>3</sup>"The Cranial and First Spinal Nerves of Menidia," *Archives of Neurology and Psychology*, Vol. II, and *The Journal of Comparative Neurology*, Vol. IX; also numerous later papers, mostly in this Journal.

<sup>4</sup>"The Brain of Acipenser," *Zool. Jahrb.*, 1901; "The Nervous System of Vertebrates," Philadelphia, 1906; and other papers in this Journal.

It would be a difficult thing ordinarily to demonstrate that the receptive fields and afferent conductors become functional in an embryo before the effectors do, for through the effectors alone is the functioning of the receptor and conductor demonstrable. But if the skin of a given somite in the tail bud of an amphibian embryo of suitable age be touched there will be no perceptible response in the effectors of that segment, while response will occur in the older somites farther cephalad. Into this given caudal somite, then, impulses are pouring from the external world through the receptors and conductors before the effectors of that segment are capable of making any perceptible response whatever. If this is true of the more caudal somites, it may be assumed to be true of the head segments also, and the embryo may be regarded as existing under a storm of impulses of the receptive system for a considerable period before it has the ability to give expression through its effectors. How widely this order of development of the receptor and effector may be applicable, as a law, and what its significance may be are questions of interest. It is possible that the summation of subliminal stimuli in neuro-muscular reflexes rests upon this as a fundamental principle of functional development. It is possible, also, that Kappers<sup>5</sup> might correlate this precocity of the afferent system with his theory of neurobiotaxis, in which he assumes that the afferent conductors have influence over the effector centers to cause them to migrate, phylogenetically at least, in the direction of the maximal amount of stimulation.

#### THE SWIMMING MOVEMENT.

The movements of *Diemyctylus* embryos are of two main types; (1) the flexure, which is a bending of the body in one direction

"Phylogenetische Verlagerungen der motorischen Oblongatakerne, ihre Ursache und Bedeutung." *Neurol. Centralbl.*, No. 18, 1907.

"Weitere Mitteilungen bezüglich der phylogenetischen Verlagerung der motorischen Hirnnervenkerne. Der Bau des autonomen Systemes." *Folia Neuro-Biologica*, B. 1, Nr. 2, Jan., 1908.

"Weitere Mitteilungen über Neurobiotaxis." *Folia Neuro-Biologica*, B. 1, Nr. 4, 1908.

"The Structure of the Autonomic Nervous System compared with its Functional Activity." *Journal of Physiology*, Vol. XXXVII, No. 2, 1908.

only; (2) the "S" movement or reaction, which is a bending of the more cephalic and the more caudal parts of the body in opposite directions, giving the form of the letter S.

The flexure may occur in several varieties. It may be a "head flexure," which effects a movement of the head only; a "pectoral flexure," which affects slightly more of the trunk than the head flexure does; a "mid-trunk flexure," which is effected by the muscles of the middle portion of the trunk only; a "general flexure," which involves the bending of the whole trunk. In the mid-trunk or pectoral flexure the parts cephalad and caudad of the flexed part may assume positions parallel to each other, in the form of the letter U. This may be designated as the "U" reaction. The general flexure may be extended till the body assumes more or less a coiled condition. This movement may be termed the "coiled reaction."

The various forms of the flexure are not to be considered as essentially distinct, for, with possibly the exception of the U reaction, they develop gradually one into the other in the order mentioned. Nevertheless, the distinctions are useful for descriptive purposes.

The first member of this series to appear in the course of development of the embryo is the head flexure; the next is the pectoral flexure, and, as the embryo advances in age, the flexure extends farther caudad until it involves the entire trunk in a general flexure, and, finally, in a coiled reaction. In ontogeny, then, the flexure develops cephalo-caudad. This is true for responses to stimulation on the tail bud as well as for responses to stimulation on the head.

In the development of any particular flexure, pectoral, general or coiled, the same progression cephalo-caudad is observed. If the n. trigeminus or n. vagus is stimulated by a touch, the normal reaction is a head flexure, and, if the embryo is sufficiently advanced in age, this flexure progresses caudad until the whole trunk is involved. In like manner, if the touch is upon the tail bud, the response begins in the head region and progresses caudad. The physiological development of a flexure, then, is correlated with its ontogenetic development.

Now, so far as my observations go, the S reaction never appears until the embryo is capable of executing an extended general flexure,

and rarely until it has actually executed a coiled reaction. Furthermore the S reaction is ordinarily first performed by a reversal of the head from an extended general flexure or a coiled reaction before the original flexure is completed in the caudal part of the trunk. This reversed movement of the head, in early stage of the embryo, may simply progress caudal till it reverses completely the original flexure; but when the movement attains its typical form it is a relatively short, quick movement, and, when performed in series, it becomes the normal swimming movement.

The occurrence of the S reaction in series has its origin, evidently, in a mode of response which appears very early in the course of development. It may be designated as the "secondary reaction." This secondary reaction is a movement that is made during the phase of relaxation from a direct response to an external stimulus. It is caused, probably, by a rhythmic process in the motor cells, or, possibly, by stimuli from the proprioceptive field. It may be of greater or less extent than the original flexure. It may, for instance, advance a general flexure into a coiled reaction. It is a conspicuous feature in the behavior up to the time when the S reaction appears.

Now, it is obvious that when the head is once reversed from a flexure into an S reaction, the secondary reaction would explain the second reversal, which is simply repetition of the initial movement. The successive reversals of the head may, then, be initiated as secondary reactions and the progression of the successive flexures caudad, in the form of S reactions, propels the animal forward.

Locomotion, therefore, in the amphibian embryo is dependent upon the progression of the flexure cephalo-caudad, and the cephalo-caudal progression of the individual movement is further correlated with a similar progression in the ontogenetic development of the reaction. Furthermore, it is clear that this order of development of function is correlated with the order of structural development of the central nervous system, as illustrated, for instance, in the order of closure of the neural tube. These correlations naturally suggest, further, that the necessity of locomotion may have been an important phylogenetic factor in determining the order of development of the parts of the nervous system in vertebrates.

Emphasis, properly, has been placed, by authorities generally, upon the principle of cephalization as correlated with the organs of special sense; but these early movements of the embryo show that, so far as functional development is concerned, the most primitive centralization of the nervous system, ontogenetically, is in direct response to the demands of the motor system in its relation to locomotion, while the sensory system involved is not the special sensory but the most primitive, diffuse, exteroceptive field. It remains to locate exactly this primitive center of the cerebro-spinal system by correlated anatomical and experimental studies; but from the experiments alone, this center would seem to be in close relation to the cephalic musculature of the trunk. This is inferred particularly from the fact that a flexure in response to a touch on the tail bud begins in the head region and progresses caudad and is the same in form (without reference to the initial direction of the movement) as the flexure that follows stimulation of the head. All movements, then, regardless of the point of stimulation, must emanate from the same center: Into this center all impulses would seem to flow in order to be directed in such a way upon the musculature of the trunk as to give rise to locomotion. Clearly the development of an eye or ear as such in its earliest functional condition has no part in determining this region of centralization. The controlling factor in this centralization is the motor system: a cephalization in response to the prepotency of the requirements of effectors and not in response to the demands of the cephalic receptive fields.

Phylogenetically, then, the most primitive cephalization of the nervous system may have occurred, also, in response to the demands for locomotion and have given rise to a center of control in the region corresponding to the lower portion of the myelencephalon or the upper portion of the medulla spinalis. Quite in harmony with this suggestion is the convincing evidence that Johnston<sup>6</sup> presents for the migration caudad of the afferent roots of the cranial nerves. Such a change in their course would lead them more directly into this primitive locomotor center. Upon this hypothesis, also, the economy

<sup>6</sup>"The Nervous System of Vertebrates," Chapter III.

of the arrangement of the special cutaneous nerves of fishes and amphibians is obvious. It is not to be supposed that the cephalization of the locomotor effectors is, in any respect, a direct cause of the cephalo-caudal migration of the special cutaneous receptors and conductors, but such a cephalization would certainly favor the development of such systems, for, as already suggested, their peripheral conductors hold essentially the same relation to the cephalic part of the central system as do the most primitive central conductors from the trunk.

It should be noted here that a certain amount of locomotion may be acquired by an amphibian embryo by other movements than the S reaction as described above. The body may be flexed, for instance, and straightened by a series of secondary, vibratory movements. Such a reaction propels the animal on its side in a circle or spiral path. Also, a rapid succession of reversed flexures, in which no S reaction can be detected, may give swimming in a zigzag, erratic course. But normal, upright swimming in a direct course is, according to my observations, attained only through the perfecting of the S reaction and its performance in series.

As already suggested, this development of the swimming movement is of interest from the point of view of animal behavior. We now see that swimming, which may be regarded as instinctive in these forms, arises as the elaboration of the simplest known reflex in the embryo, the contraction of the most cephalic trunk muscles. Certain forms of the flexure, such as the U reaction and the coiled reaction, do not seem to be in the direct line of the development of the swimming movement, being simply intensive or tetanic forms of the ordinary flexures. On the other hand, the other types of flexure develop in a regular order and in a remarkably constant manner into the movements of locomotion. Now none of these simple flexures can be regarded as having any value as trials, since the *Diemyctylus* swims perfectly upon leaving the egg membranes in the normal course of development, and within them it can gain no practical experience for swimming out of movements of any sort. Instinctive swimming, therefore, and the simplest reflex alike, are inherent in the neuro-muscular system of the embryo, and while the former de-

velops in a regular order out of the latter, the movements themselves, which conform to this order, can have no selective value. The question naturally follows whether in forms which do not admit of such early experiments, such as birds, many quadrupeds and primates, the various forms of locomotion, as well as other forms of behavior, which, in a greater or less degree, appear to develop out of a series of trials, may not conform to the same law. It seems altogether possible that in such cases, also, the so-called erratic movements may have only a trophic value. As such they would be essential to the perfecting of movements, but would have no directive value in the development of responses.

If, moreover, this hypothesis is valid for the ontogenetic origin and development of instinctive behavior it would seem plausible, also, as a theory of phylogenetic development. Its application to phylogenesis, though, would clearly be in opposition to the idea, which is accepted by various psychologists, that instinctive behavior has somehow been reflected back into the race from the intelligent type,—or psychologically expressed, that instinct is a phylogenetic derivative of intelligence. For the latter hypothesis, I am not aware that there is any direct, experimental proof, while we do see, in such vertebrates as Amphibia which admit of early experimentation, instinctive behavior (locomotion) developing directly out of the simplest known reflex. However, while we seem to have a definite conception of the psychic parallel of the former (instinct), the concept of the psychic parallel of the latter is much less definite, and largely disregarded by psychologists. Yet it would seem that in the ontogenetic developments of the psychic life of *Diemyctylus* there must be quite as definite a reflex-psychosis concomitant with the earliest and simplest reflex as there is an instinct-psychosis with the later instinctive behavior in the form, for example, of locomotion; for, although the neuroses of the simple reflex are evidently not as elaborate as are those of locomotion, they are quite as definite in form. But, however this hypothesis of the relation of the instinct to the reflex may appeal to the psychologist, an adequate knowledge of the behavior of *Diemyctylus* must take into account the origin and development of locomotion from the simple reflex; for this reflex

represents the simplest known physiological unit of the somatic neuro-muscular system, or of the somatic "action system." The relation of this unit to any of the more complex neuro-muscular processes is certainly an essential factor in the problem of behavior, or of physiology in the broadest sense.

In presenting the mode of locomotion of the amphibian embryo it is not my intention to antagonize the current explanation of the propelling factors of the swimming movement of fishes, ordinarily described as being, in effect, the same as that of a sculling oar. The latter explanation, so far as I am aware, is offered with reference to the adult fish, and it might not apply to an embryonic or very young fish. Quite conceivably, the swimming movement might become modified during growth, in response to changes in body form, modes of feeding and other factors of behavior; and it is still quite possible that in the adult fish there is a cephalo-caudal progression of movement which is obscured by other factors of special adaptation.

This contribution should not be submitted without reference to the splendid work of Paton<sup>7</sup> on the reaction of vertebrate embryos. This is the only paper accessible to me that bears in any respect immediately upon the work in hand. Paton's contribution, however, is chiefly upon the development of fishes, with merely a reference to *Rana* and *Amblystoma*, and is particularly devoted to the spontaneous movements. Such movements would seem to be much more common in embryos of fishes than in embryos of *Diemyctylus*. The latter, during the early phases of irritability to touch, may be under observation for hours without making a perceptible spontaneous movement of the trunk, cardiac and branchial movements not being taken into account in my work.

My approach to the problem of physiologico-anatomical correlations in the development of the neuro-muscular system of vertebrates differs materially from that of Paton's method. Paton undertakes "to determine in a general, but not in a specific way" how far the reactions are dependent upon "the functional activity of a nervous

<sup>7</sup>"The Reaction of the Vertebrate Embryo and the Associated Changes in the Nervous System." *Mitteilungen a. d. zoologischen Station zu Neapel*, Bd. 18, Heft 2 u. 3, 1907.



system" and dismisses the study of specific reactions as impracticable, on account of the "apparently conflicting" data; but my work clearly demonstrates that, in response to the stimulus employed in my experiments, embryos of *Diemyctylus* have a very definite and regular mode of response, during certain phases of development. In fact I have yet to find the first individual that, through any considerable period, reacts contrary to the mode described in this paper, that is to say, no embryo has yet come under my observation that regularly moves its head toward the side touched when the stimulation is on the head. Nor have I found a single embryo that, observed for a considerable period, has not fallen under one of the three types which I have here described.



# SENSATIONS FOLLOWING NERVE DIVISION.

BY

SHEPHERD IVORY FRANZ.

*From the Laboratories of the Government Hospital for the Insane,  
Washington, D. C.*

WITH FIVE FIGURES.

## I.—THE PRESSURE-LIKE SENSATIONS.

Since the confirmation and elaboration by Goldscheider, by von Frey and by others, of the discovery of Blix that there are points or areas on the skin sensitive only to certain forms of stimulation, physiologists have assumed a form of punctate sensibility in the skin. The work of these investigators has been taken to show that in the skin special nerves subserve the following sensations: heat, cold, pain and pressure (touch). On the other hand, the recent work of Head and his co-workers has not only cast considerable doubt on the validity of the broad generalization of punctate sensibility, but it is also plain that the earlier hypothesis is not in accord with the results obtained on man after injury or section of peripheral nerves.

Head, it will be remembered, investigated the sensibility to light touch, to different degrees of temperature, to pressure, to dual stimuli, to pain, to size and to movement in patients following injury or section of peripheral nerves and he carried his inquiries up to the point of recovery for all forms of sensation. The criticism of the older hypothesis, which was made possible because of these recent pathological studies, may well be summed up in the words of Head: "When the median nerve is divided, sensation is entirely lost over a considerable part of both index and middle fingers. Over the palm, within the area said by anatomists to be supplied by this nerve, sensation is usually diminished and not completely abolished.

In a similar manner, division of the ulnar nerve produces complete insensibility of the little finger, and of a variable part of the palm and the ulnar half of the ring finger. Such is the usual statement of surgeons and anatomists. . . . The most careful examination of the hand fails to show the slightest diminution in sensation over the median half of the palm in consequence of division of the ulnar nerve. What has always been called the diminished sensibility produced by the division of a nerve is really a condition in which some kinds of sensibility are lost and others retained.”<sup>1</sup>

The results of careful examinations of about eighty patients, in whom the nerves of arm or leg had been divided or injured, led to the following conclusions: “The sensory mechanism in the peripheral nerves is found to consist of three systems:

“(A) *Deep sensibility*, capable of answering to pressure and to the movement of parts, and even capable of producing pain under the influence of excessive pressure, or when the joint is injured. The fibers subserving this form of sensation run mainly with the motor nerves, and are not destroyed by division of all the sensory nerves to the skin.

“(B) *Protopathic sensibility*, capable of responding to painful cutaneous stimuli, and to the extremes of heat and cold. This is the great reflex system, producing a rapid widely diffused response, unaccompanied by any definite appreciation of the locality of the spot stimulated.

“(C) *Epicritic sensibility*, by which we gain the power of cutaneous localization, of the discrimination of two points, and of the finer grades of temperature, called cool and warm.”<sup>2</sup>

The separate sensation elements in each of the three forms of sensibility may be tabulated as follows:

“Loss of *epicritic sensibility* abolishes: recognition of light touch over hairless parts or parts that have been shaved; cutaneous localization; discrimination of compass points; appreciation of difference in size, including the accurate discrimination of the head from the

<sup>1</sup>Head, Rivers and Sherren: The Afferent Nervous System from a New Aspect. *Brain*, 1905, Vol. 28, p. 100.

<sup>2</sup>*Ibid.*, p. 111.

point of a pin apart from the pain of the prick (acuesthesia); discrimination of intermediate degrees of temperature, from about 25° C. to about 40° C.

“Loss of *protopathic sensibility* abolishes: cutaneous pain, especially that produced by pricking, burning, or freezing, together with that of stimulation with the painful interrupted current; over hair-clad parts, plucking the hairs ceases to be painful; sensations of heat from temperature above 45° C.; sensations of cold from temperatures below 20° C.

“After destruction of all cutaneous afferent fibers the part is still endowed with *deep sensibility*, pressure can be recognized, and its gradual increases appreciated; pain is produced by excessive pressure (measured by the algometer); movements of muscles can be recognized; the point of application of pressure can be localized; the patient can recognize the extent and direction of movement produced passively in all joints within the affected area.”<sup>3</sup>

It will be seen, therefore, that the examination of patients in whom nerves have been injured or cut reveals many different degrees or qualities of sensation in addition to the four which, from the examination of normal individuals alone, have been supposed to be the only sensory elements. The main points of difference between the old and the new view—so far as the enumeration of sensations is concerned—are as follows: There is apparently a difference between the sensations of hot and warm, and between those of cold and cool; touch is different from pressure; there are different kinds of pain.

When, for example, the ulnar nerve has been cut, examination of the skin with various stimulating objects shows that over the hairless portions of the fourth and ring fingers light touches with a wisp of cotton wood or with a fine camel’s-hair brush are not felt; the hair-clad parts may or may not react to such stimuli, depending upon the location of the lesion; parts of these fingers will not be sensitive to temperature stimuli, and perhaps not to pressure; there may, or may not, be sensations from pricks of a pin; and if the

<sup>3</sup>Head and Thompson: The Grouping of Afferent Impulses within the Spinal Cord. *Brain*, 1906, Vol. 29, p. 551.

fingers can not be moved voluntarily there will be a loss of sensibility to movement passively produced. Some of these effects may be found over a variable extent of the palm and the back of the hand. In Fig. 1 is given the condition found in a man following an operation in which part of the ulnar nerve was excised. The area insensitive to light touch and to the intermediate degrees of temperatures included all the little finger, about three-quarters of the ring finger, and about two-fifths of the palm and back of the hand. Part of

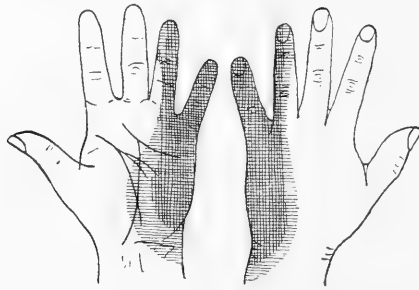

FIG. 1.—The extent of loss of sensation following the division of the ulnar nerve at the elbow. The part marked with horizontal lines was insensitive to light touches, and to intermediate degrees of temperatures. The vertical line area (cross-hatched on account of its being included within the area insensitive to touch), was, in addition, insensitive to pressures and to pain. Adapted from Head and Sherren.

this area was insensitive to deep touch and no sensation was got from the vibrations of a tuning fork. This area was also analgesic.

In this and other cases in which losses of sensibility were found, the ability to appreciate touch was tested with a wisp of cotton wool lightly brushed over the parts. When such a piece of cotton wool is carried over the skin of a normal individual, there is a distinct feeling of touch, which is magnified, perhaps altered, wherever the hairs are touched. The cotton wool should be very lightly grouped in a bundle, not tied, and I have found that on the hand a piece of cotton wool, weighing 55.5 mg., with a bending pressure of from 200 to 300 mg. will be accurately appreciated over the parts

which are not calloused.<sup>4</sup> On the lips and parts of the face, a wisp of cotton wool weighing 20 mg. and bending at 200 to 250 mg., was just sufficient to produce a sensation. At times it is more convenient to use a camel's-hair brush, although Head has objected to the use of this instrument. I find it to be a more constant stimulus, in that it remains the same in bending strength for long periods. With cotton wool it is difficult, if not impossible, to select for each day's series of experiments an amount equal to that used on previous days, and if the same piece be used on successive days, it soon loses its original strength. In the experimental results that follow, I have used both cotton wool and a camel's-hair brush. I selected a long haired brush from which I cut off most of the outside hairs, leaving a brush 24 mm. long from the end of the hairs to the insertion, with about 125 hairs. As thus modified, the bending strength of the brush was 100 mg. for very slight bending, and about 200 mg. for more extensive bending. These figures are to be compared with the bending strength of the wisps of cotton wool mentioned above. I have found that the same results follow the use of the brush as the use of the cotton wool, and since, as mentioned above, it is more constant, it can be used for many patients as well as the same patient at different times.

For further tests I have employed the touch instrument of Bloch, which is illustrated in the accompanying figure. To a piece of wood was attached a spring steel wire A which was bent at a right angle B; the long part of this wire A measured six inches. The area of cross section was about 0.1 square mm. A scale E attached to the instrument enabled the experimenter to determine the pressure made by the wire in bending. The right-angled piece of wire was pressed against the subject's skin, care being taken to keep it vertical all the time, and when the patient reported that the pressure was perceived, the reading was taken from the scale and recorded. Two instruments of this character were constructed, one of which was

<sup>4</sup>Head and Sherren do not give any figures regarding these matters. In some later work, Head used a series of von Frey hairs with bending pressures of 830, 360, 230 and 100 mg., respectively. The use of these, however, more nearly approaches the use of the esthesiometer which will be described later.

approximately twice as strong as the other, in reality one division on instrument A equaled 0.6 division on instrument B. The instrument A enabled me to stimulate with tensions from 0 to 2000 mg., while instrument B enabled me to stimulate with tensions from 0 to 4000 mg. Each instrument was divided into arbitrary divisions, circular degrees, and since I was dealing with relative differences I did not translate the figures into terms of tension. All the figures that are included in the following tables are, however, directly comparable.<sup>5</sup>

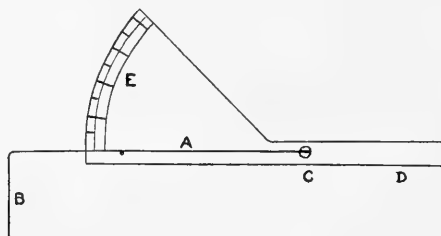

FIG. 2.—Esthesiometer of Bloch. The figure is about one-third the size of the instrument.

The presence or absence of pressure sensations was determined by stimulating the parts with the pointed, but not sharp, end of a pencil. On normal parts this stimulus was immediately appreciated. Pain from pressure was determined by an algometer. The surface

<sup>5</sup>The value of such an instrument for determining differences in touch sensations was well brought out in some experiments, not yet published, on the touch thresholds in different parts of the body. One subject whom I examined carefully showed an increase in threshold values in the lower leg and foot on the left, although no similar difference was found to exist in other parts of the body. This leg was also smaller than the right, in circumference. When asked to explain the latter difference the subject replied that both knee and ankle of this leg had been injured at two different times and that for a period of six months six years previously she had this leg bound up and almost immovable. Another subject, a case of traumatic epilepsy, showed an increase in threshold values for touch on the right upper arm and shoulder, on the back over the scapula and over the chest above the breast, although otherwise both sides were the same. This was the only sensory or motor change that I found in this woman, and this persisted after the operation that was undertaken for her relief. In neither case did the testing with cotton show the least difference between the two corresponding segments of the body.



applied to the skin was circular, 3 mm. in diameter. This instrument was used instead of the usual algometer of Cattell, because it was necessary to make determinations on skin areas so close together that the large stimulating surface of the Cattell instrument would have been impracticable; and since the object of the work was to determine relative amounts of pressure causing pain, the smaller instrument was the more advisable.

The subject of the experiments is H., male nurse in the Government Hospital for the Insane, age 38, of good education, and interested not only in getting well, but also in the results of the experiments. For these reasons he was excellent in co-operation and the results were to be depended upon more than those from most patients, who may fear that the knowledge of their condition will be a hin-

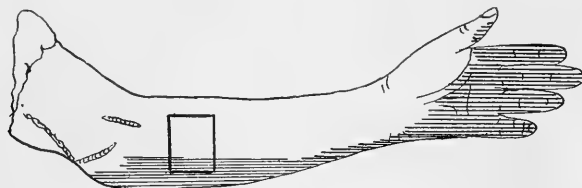

FIG. 3.—Arm and hand of subject copied from photograph. Area insensitive to light touch marked with horizontal lines.

drance to their obtaining employment. His training in the examination of the insane was a benefit to him in noting his own condition, and his answers showed that his use of terms to describe his sensations was more accurate than that of similar untrained individuals, and the results are to be depended upon more than in those cases in which subjects have not been accustomed to note and to analyze mental symptoms. On June 20th, an inmate of the Hospital during a period of confusion attacked H. with a large pen knife and cut him in the left arm above the elbow, the wound extending 12 cm. from the dorsal side across the triceps muscle to the inner bend of the elbow. The lower part of the wound is to be seen in Fig. 3.

Immediately following the accident the patient was taken to the operating room. The triceps was found to be almost completely severed, and this was stitched together after the wound was thor-

oroughly irrigated. No attempt at this time was made to discover nerve lesions. The wound healed by first intention. The day following the accident I saw the patient. So far as he could tell the thumb felt "dead" on the volar side, but there was no loss of sensation in the forefinger. The second, ring and little fingers also felt "dead". The area of anaesthesia to light touch, which was discovered at this time was over the ulnar part of the hand, back and front, and included the three fingers mentioned. I did not make careful notes of the condition at the time, and the accurate comparison of the anesthetic area at this time with what was found later can not be made. Following the accident the feeling in the thumb improved, but the sensation ability of the forefinger decreased. On August 12th, an exploratory operation was performed by Dr. G. T. Vaughan. The ulnar nerve was found divided near the olecranon; the median nerve was nicked, and there were excrescences or clubbed swellings on both edges of the nick. The ulnar nerve was brought together with sutures, the swellings on the median nerve were cut away and pieces of fascia were placed around the nerves to prevent the ingrowth of any scar tissue from neighboring parts. The results of my later examinations show that, in all probability, the medial antibrachial nerve was severed. This was not examined at the time of the operation. Immediately following the operation there was further improvement in the condition of the thumb, but the patient thinks this improvement was not marked. I did not examine the patient again until October 6th.

At the time of the first careful examination, I found the following condition: The little and ring fingers were totally anesthetic to all forms of stimuli, heat and cold, light touch and pressures. The middle and forefingers were anesthetic for all forms of stimuli over the two distal joints, both on the back and palmar parts. The palmar area corresponding to these two fingers was insensitive to light touch, but pressures could be appreciated and well localized. Pricks of a pin were painful. Up to this time there had appeared from time to time painful sensations following movements of the arm at the elbow, localized poorly, but apparently over the knuckles of the middle, ring and little fingers and over the palm at the place

where these fingers join the palm. Longitudinally the pains seemed to extend about three quarters of an inch, but, as said above, no very accurate localization can be made. In addition, heat (test tube with water heated to  $45^{\circ}$  C.) did not produce a sensation over the area insensitive to light touch and over half of the palmar part of

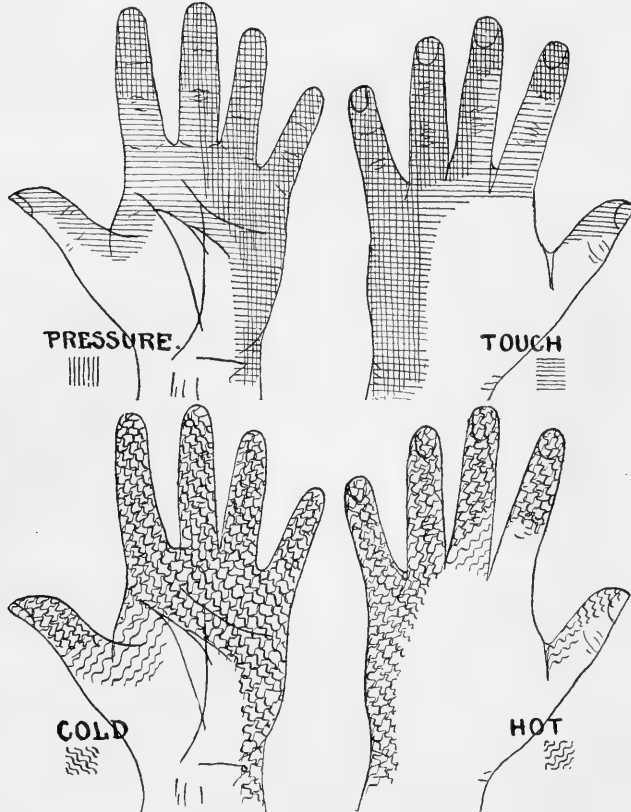

FIG. 4.—Hand showing areas insensitive to pressure, to light touch and to temperatures.

the thumb. Cold was not appreciated over the same area, although the test tube was cooled to  $0^{\circ}$  C., but there seemed to be a dissociation of the areas concerned with hot and cold sensations, for on the thumb, with the exception of the tip, no hot sensations were evoked, although cold was properly appreciated over the thumb with the exception of the first joint. Fig. 4 illustrates this condition.

Movement sensations were tested as follows: The eyes of the patient were closed or turned away so that he did not see what was being done. The left wrist was moved in the four possible directions and he properly duplicated these movements with his right wrist. Similar experiments on flexion and extension were made with the thumb, forefinger and second finger and similar results obtained. When, however, the ring and little finger were moved the patient gave no indication of the movement of these parts. Moreover, when the thumb and fingers were moved together so as to make a fist, the patient moved only the thumb and the first and middle fingers of the right hand. It was evident, therefore, that the patient had no sensations of movement from the little and ring fingers. Voluntary movement of the fingers of the left hand were poorly executed. The thumb could be moved only slightly, and this principally in flexion. The forefinger and middle finger also could be slightly flexed, while the third and fourth fingers could not be moved to the slightest degrees. No voluntary power to flex or to extend the wrist could be found. During the next ten days at times poorly localized, rather radiating, pains were felt over the ring and little fingers and on the back and outer aspect of the hand. No pain was felt on pressure of the fingers, nor on movement of the individual fingers. Pain, but slight, was felt on passive extensor movements of the wrist, but none on adduction and abduction. Pain at elbow on extension. During this period the subject complained of tingling sensations extending from the hand to the elbow, at times this pain was so severe that it prevented sleep. The flexion at the wrist was about  $45^{\circ}$ , extension about  $20^{\circ}$ . Flexion at elbow almost to the limit, extension about  $150^{\circ}$ . Very slight voluntary flexion of the first, second, and third fingers, but none of the fourth finger. A week later movement of the first and second fingers and thumb were properly sensed, movements of ring finger were sensed as movements, but patient could not tell which finger was being moved. No sensations from movements of the fourth finger. Side to side movements of the middle finger were sensed, but in attempting to duplicate them on the right side they were always made in the opposite direction, although the similar movements of the first finger and thumb

were properly expressed with the corresponding members of the uninjured hand. These results indicate clearly, I believe, that the motor sensations from the little finger were entirely unappreciated, those of the thumb and forefinger were appreciated in a normal manner or degree, while there was a change in appreciation of the movement sensations from the middle and ring fingers. The fact that the movements of the ring finger were sensed as movements does not necessarily imply that movement could be appreciated. Such movement sensations may have been due to the movement of the skin covering other fingers and palm, which gave more normal sensations, or they may have been due to movement of tendons or other tissues in the palm or back of the hand. It appears probable to me, however, that some movement sensation persisted in this finger, or, rather, we should say that the nerves conveying the impulses for movement sensations had sufficiently regenerated to enable a sensation to be produced. The results with the middle finger, especially the sideways movements, are extremely suggestive of an improvement in this part of the hand.

During the days that experiments were carried out, many times the patient reported that light touches, touches with cotton wool or a brush, over hairy parts were different in character than those over other normal parts. The way this was always expressed was that the sensations were stronger, or clearer. From the reports of Head's work, one may understand that there is a rather sharply defined line of separation of the parts sensible to cotton wool from those insensible to the same sort of stimulation. That this is not always so, was shown in my experiments. The patient would often feel the stimulus, and then again miss it in certain places, while in neighboring regions the stimulus often failed, but occasionally did produce a sensation. That there is no sharp line dividing the 'epieritic' and 'protopathic' areas is shown also by the results of a different sort of stimulation. If, instead of cotton wool or the light brush, we use an instrument that will enable us to give different degrees of stimulation, we find the area insensitive to cotton wool does not give a sensation on stimulation, even with considerable amounts of stimulation. Neighboring areas in which there can be

no doubt of the presence of both epicritic and protopathic sensibilities do not show a normal amount of sensibility to this form of stimulation. There is a gradual decrease in the loss or in the dullness of sensibility from the area of epicritic loss, we may say from area of complete sensibility loss, to the area in which no sensory change, according to Head's methods, can be demonstrated. The accompanying figure illustrates the conditions found on the hand.

The area tested was carefully examined for hairs, and wherever hairs were found, the part was carefully shaved. The part of the area insensitive to cotton wool was mapped out and recorded on the

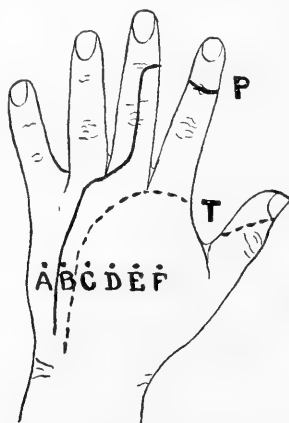

FIG. 5.—To illustrate the sensibility of the hand determined by Bloch's instrument, compared with the loss of pressure and light touch sensations.

hand with red ink. The sensibility to pressure and to forms of stimuli denoting the presence or absence of protopathic sensibility was also tested and the areas of loss were marked on the part. Points were then selected separate from each other by 1 cm. These were also marked with red ink so that the stimuli could be given at approximately the same spots each time. These points were then examined with the help of Bloch's instrument illustrated above. Five experiments were made on each point and on corresponding points on the right hand. Table I gives the results of this form of examination. The letters indicate the corresponding areas on the left (nerve cut) and right hands. The figures give the averages of

five determinations of the just perceptible determined by one of the Bloch instruments.

TABLE I.  
TOUCH THRESHOLDS ON HAND. BLOCH INSTRUMENT.

Points.	Left hand.	Right hand.
A	...	6.0
B	...	8.6
C	62.*	6.6
D	29.8	10.6
E	27.8	14.8
F	13.4	7.4

\*Approximate, since instrument reads only to 60.

The point A on the left hand was within the area in which pressure (pencil) was not felt. B was within the area in which pressures were felt, but no sensations accompanied stimulation of cotton wool or a camel's-hair brush. C, D, E, and F, were areas in which the epicritic sensibility was found intact. It will be noticed from the table that the amount of stimulus to produce a sensation at point C was twice the amount of that necessary on the other areas, D, E, and F, and that it was greatly in excess of that required on the normal hand. The points D, E, and F, supposedly normal, showed an increase in the threshold value—approximately double the normal. On the fingers similar results were found. On the parts in which pressure of the pencil was immediately perceived, but no sensibility to cotton wool, the limit of stimulation with the Bloch instrument was not felt, and in the areas in which epicritic sensibility was retained there was an abnormally great threshold value. Only in those parts where cotton wool could be felt was it possible to make any determination with the Bloch instrument, and when the results in these experiments were compared with the results of the right hand, the difference between the apparently normal area of this left hand with the known normal area of the right, are as strikingly marked as those in the table just given, and those in the table mentioned below. On apparently normal points of the thumb of the left hand, sixteen experiments with instrument A gave

a threshold average of 29, while a similar number of corresponding points of the right thumb gave an average of 8.7. On the ball and on the back of the third joint of the thumb eleven experiments on the left hand averaged 42.1, and on the right, 20.5.

On the upper part of the forearm, a section including the area in which different forms of sensibility were altered, was carefully crossmarked in centimeter square divisions. This section of the area was carefully shaved so that these experiments could be carried out. Each of the thirty-five squares was then carefully tested five times. The averages were calculated and the results of these examinations are given in Table II.

TABLE II.  
TOUCH THRESHOLDS ON VOLAR SIDE OF FOREARM. BLOCH INSTRUMENT B.

Points.	A	B	C	D	E	F	G
Aver. threshold .....	19.9	25.5	34.9	54.1*	46.*	51.*	....

\*Approximate.

The results for the five horizontal centimeter squares are grouped in this table. Below G the arm did not respond to temperature stimuli, nor to the stimulation of the hairs. Areas A, B and C reacted to all forms of temperature stimuli with sensations of hotness, warmth, coolness and cold, while area D responded to only some of these. These areas also gave results to brushing and pulling the hairs, while plucking the hairs in areas E, F and G gave no sensations. A full account of the results on the hair and temperature sensations in these areas will be found in a subsequent article. It is sufficient for the present to know that areas E, F and G were clearly devoid of epicritic sensibility, when areas A, B and C were, in accordance with Head's methods of examination, clearly normal.

In G and F the stimulus was perceived only once, although the instrument was pressed to its highest point. Twice in area E stimuli were perceived, seven times in area D, and always in areas C, B and A, when the pressure of the tension of the instrument became sufficient. A comparison of these results with the results of a similar examination of the right arm show that the stimulus necessary to



cause a sensation in the area A is normal, while the threshold values in B and C are greater than normal. This gradual change from no sensation to a normal sensibility threshold is striking. The results show that there is no sharp line separating the areas of protopathic and epicritic sensibilities, and it appears that the changes in the nervous system are more widespread than has hitherto been supposed. On the hand and arm the line separating the area in which the epicritic sensibility was lost from that in which it was retained, is sharply defined by cotton wool or by camel's hair pressure, but in view of the more quantitative experiments with the touch instrument of Bloch this line must be considered a very rough approximation, for the experiments show that the sensibility disturbance extends much beyond this line. For the distance of two centimeters beyond the line of epicritic sensibility loss, normal sensibility threshold as measured by the esthesiometer was not found.

These results may be explained in a number of different ways. At first sight they appear to confirm the hypothesis which has been advanced to explain all the results of Head and Sherren, namely, that we are dealing with differences in threshold value when we speak of epicritic and protopathic sensibility. The results which have been obtained on the sensibility to temperature and the result on the sensibility of the hairs are not in accord with such a hypothesis. It appears to me more likely that the gradual approach from the area of deep sensibility loss to the perfectly normal area, especially the gradual lowering of the threshold along the area in which the epicritic sensibility is present, indicates that there is an overlapping of the nerves as the anatomists used to teach, and which Head assumes is disproven by his discovery of the various forms of deep, protopathic and epicritic sensibilities. According to the accounts and conclusions published by Head and his co-workers, it would appear that there is no overlapping of these nerves, but a critical analysis of the cases published by Head and Sherren shows that they always found such an overlapping. For example, if we consider carefully the diagrams published by Head of the distribution of the median, ulnar and superior radial nerves of the hand, we find on the palm, the ulnar nerve is supposed to innervate that part of the palm which is on

the ulnar side from a line drawn through the middle of the ring finger; the superior radial nerves presumably the radial side to a line drawn through the middle of the thumb; while the remainder of the palmar part of the hand is innervated by the median nerve. All of these areas must have, according to Head, deep, protopathic and epicritic sensibilities. But Head's work shows that we seldom find areas of these different forms of sensibility occupying the same position on the hand. For the median, for example, there may be a loss of deep sensibility in the first and second fingers; but the rest of the area which is assigned to the median retains its deep sensibility. The retention of this sensibility must be due to fibers in other nerves. So also we find there is an overlapping of the epicritic sensibility, and it seems to me the results on II, as well as the results obtained by Head, clearly show such an overlapping effect. On the arm, the areas A, B and C, Fig. 3, were supposed to retain all their epicritic sensibility, whereas it is evident that areas B and C are not nearly so sensitive as area A.

The tests for threshold of pain sensations brought out no new facts. The areas which were carefully examined for touch thresholds, and which gave the results recorded above, were examined, but, with perhaps a slight increase in threshold over the whole lower arm on the left, there was nothing distinct. The measurements made with the algometer described above showed that in the area near the elbow (rectangle in Fig. 3) for each horizontal centimeter above the line of loss of deep sensibility there was no difference. The averages of three experiments in each longitudinal area are as follows: 978, 905, 779, 820, 970, and 923 grams. Similarly on the hand there were no sufficiently noticeable differences between the threshold in area B (Fig. 5) from that in area F.

The pains on movement of fingers, wrist and elbow are of a different character from those produced by pressure, and they have been mentioned in an early part of the article. They were not located at the place where the movements occurred, but were always referred to the fingers or hand. It seems likely that these were due to pressure on the nerve trunks, but this is purely speculative and is supported by only a few observations as follows: At times

the patient reported pain sensations produced by drawing his shirt sleeve up above the elbow; when the arm was pressed, and especially when pressure was exerted along the course of the nerve trunks, the subject felt pains in the fingers and palm, of a radiating character and apparently widespread.

The results of this study may be summarized as follows: There is a widespread disturbance in touch sensations following injury to the peripheral nerves, not only in the loss of certain forms of sensation but also in the increase of threshold values in much larger areas of the body segment than those in which there is sensation loss. This decrease in sensibility is marked for touch sensations, but is also apparent for the sensations that arise from stimulating the hairs and for the temperature sensations. The hair and temperature sensations will be more fully discussed in a subsequent article. With the exception of the areas in which no pain from pressure was felt, the pain thresholds are not altered, at least not in the same way as those for touch.

NOTE:—The results of the careful examinations of Dr. H. Head's arm in which the radial nerve was cut for the purpose of testing the sensibility have just been received (Rivers and Head: *A Human Experiment in Nerve Division.* *Brain*, 1908, Vol. 31, pp. 323-450). Owing to the recent appearance of this work, a note of the main features of difference cannot be added to the present article, but will be included as part of the second article of the series.

[Received for publication, December 5, 1908.]



# ALTERATIONS IN THE SPINAL GANGLION CELLS FOLLOWING NEUROTOMY.

BY

S. WALTER RANSON.

*From the Anatomical Laboratory of the University of Chicago.*

WITH SIX FIGURES.

## INTRODUCTION.

The work of Nissl, Lugaro, and a considerable number of other investigators has placed us in possession of the essential facts concerning the finer structure of the spinal ganglion cells both under normal and pathological conditions. It is not the purpose of this paper to supplement in any way the excellent cytological studies of these earlier investigators, but rather to answer certain questions suggested by an investigation recently published from this laboratory under the title of "Retrograde Degeneration in the Spinal Nerves" (Ranson '06).

It was shown that two months after the section of the second cervical nerve in young rats 52 per cent of the nerve cells had disappeared from the corresponding ganglion. The average loss was 4412 nerve cells, the average normal ganglion containing 8451 such cells. Since there were only 1500 medullated fibers in the nerve at the time of the operation on 12-day-old rats, it is remarkable that its division should have caused the destruction of so large a number of cells.

Still more difficult to explain is the fact that the degeneration of 52 per cent of the ganglion cells was accompanied by a loss of only 17 per cent of the dorsal root fibers. In the hope of finding an explanation for these results, the literature dealing with the architectural relations of the afferent elements entering into the formation of the spinal nerves, has been carefully reviewed in another paper (Ranson '08).

From a study of the literature, it is evident that the cells of the

spinal ganglion should be divided into two types represented by the large and the small cells which differ both anatomically and physiologically from each other. The large cells, which in the second cervical ganglion of the white rat constitute a third of the total number, are connected with medullated fibers. The remaining two-thirds are small cells and these are associated with non-medullated fibers which divide into central and peripheral fibers after the manner of a T or Y. These non-medullated fibers can be traced into the dorsal root and toward the periphery as far as the junction point of the afferent and efferent fibers.\*

It is believed that these facts, together with the observations in the present paper, make it possible to explain the conflicting results presented in the paper on "Retrograde Degeneration." At the time that paper was written there were certain technical difficulties in the way of deciding whether any particular type of cell was chiefly affected by the destructive process. This question had

\*After this paper had gone to the press the important book of Dogiel, "Der Bau der Spinalganglien," came to hand. He finds eleven types of spinal ganglion cells according to the character of their processes, with the greatest conceivable wealth of collaterals and dendrites. Nevertheless in seven out of the eleven types the fundamental character of the spinal ganglion cell is maintained in that the axons divide after the manner of a T or Y into central and peripheral fibers. Our belief that the vast majority of the fibers arising in the spinal ganglion divide after this manner is thus confirmed, although a hurried examination of the book might lead to the opposite conclusion.

In the four remaining types (III, IV, VIII and XI) he was unable to demonstrate this division and the destination of these axons remains hypothetical. For the purposes of the present paper these types take the place of his old Type II which he has abandoned. He thinks it probable that these cells are not connected with fibers in the peripheral nerve. In this paper we have attempted to show that there are cells in the ganglion which because of their failure to react to lesions of the peripheral nerve can have no axon in the nerve. These non-reacting cells would correspond as well to his new Types III, IV, VIII and XI as to his old Type II.

He still maintains that the small cells give rise to non-medullated fibers and the large ones to medullated fibers. On page 33 he states that the axon "after its exit from the capsule becomes covered with a sheath of myelin or in the case of the small cells and fine fibers it remains non-medullated even to its bifurcation." In Type III, which consists of large cells, all the axons are medullated, and in Type X, which consists of small cells, all the axons are non-medullated.

to be answered, however, before any solution of the problems, already mentioned, could be reached; and, accordingly, the prime purpose of the present investigation is to follow the various stages of axonal reaction in sections, prepared for that purpose, in order to determine whether it is chiefly the large or the small cells which undergo complete disintegration.

Naturally, there were also other problems which engaged the attention as the investigation progressed. The more important of these can be stated briefly as follows:

1. Can the cells of Dogiel's Type II, or his new types III, IV, VIII, and XI, which send no axon into the nerve, be identified by their failure to show chromatolysis after the section of the peripheral nerve?

2. What proportion of the spinal ganglion cells react to the section of the nerve? When it is remembered that there are on the average three spinal ganglion cells for each medullated afferent fiber in the nerve, and that most observers have found nearly all the cells showing the axonal reaction, this question becomes a very pertinent one.

3. If all the cells react, is there any indication that the reaction in some is secondary to that in others? That is to say, do the small cells, which do not have medullated axons in the nerve, react so much later than the large cells that one might interpret their alterations as due to a purely intra-ganglionic disturbance?

4. What is the nature of the degenerative processes which, as has been shown, lead to the disappearance of about half the cells?

5. Is there any special locality in the ganglion where the cell destruction is most marked, or any part which remains intact?

6. Can the cells which survive be followed through the stages of repair until they are again of normal appearance? If so what type of cell is most likely to undergo repair?

#### TECHNIQUE.

The second cervical nerve of the right side was cut under aseptic precautions in white rats 12 days old. The technique of the operation was the same as that described in the paper on "Retrograde

Degeneration." The operated ganglia, along with the control ganglia of the opposite side, were removed after varying periods and fixed in Hatai's fluid (Hatai '01). After penetration with paraffin, they were cut in serial sections 6 microns thick and stained with toluidin-blue. The 18 rats were allowed to survive the operation for different lengths of time, which were as follows: 5, 6, 7, 8, 9, 10, 12, 16, 17, 20, 25, 27, 31, 34, 37, 41, 44, and 57 days.

#### TYPES OF CELLS.

A most exhaustive account of the cytology of the spinal ganglion cells and of the axonal reaction, resulting from the lesion of their peripherally directed processes, is to be found in the publications of Lugaro. His contributions to this subject, which have appeared from time to time during the past ten years, have been summarized by David Orr ('04) from whose excellent review the following citation has been taken. According to Lugaro, there are five cell types in the spinal ganglia of mammals: (1) Large clear cells, with granuliform chromophile elements scattered almost equally throughout the protoplasm with a slight increase toward the cell periphery. The nucleus is large and clear and there is a definite perinuclear and peripheral clear zone. (2) Large and medium sized cells with very fine chromophile elements, which are larger, however, at the periphery of the cell. Other characteristics as in Type 1. (3) Small dark cells with very fine chromophile elements, which are larger around the nucleus with which they are in contact. The fundamental substance and the nucleus are diffusely colored. (4) Small and medium sized clear cells with chromophile elements somewhat large and few in number. The nucleus is clear and separated from the chromophile substance by an achromatic zone. (5) Large clear cells with elongated chromophile elements lying concentrically around the nucleus in parallel planes. The nucleus is always excentric.

There can be no doubt but that cells corresponding to all these types can be seen in the spinal ganglia of various animals; but the number of transitional forms is so great that any such elaborate



classification, however valuable it may be as an aid to description, must be more or less artificial.

A simpler classification has been given by Cox ('98) who makes size the basis of differentiation; the large and the small cells form his two main groups. The large cells fall into two types. The cells of Type I present granules of irregular size and shape, which only in the periphery of the cell have an elongated form. There is no concentric arrangement of the granules, and the nuclei are approximately centric. Type II comprises cells with large elongated granules which have a tendency to arrange themselves in rows. The nucleus is excentric. The small cells resemble, so far as the character of their chromatic substance is concerned, the large cells of Type I. Hatai (1901) has also emphasized the importance of size as a basis of classification of the spinal ganglion cells.

Warrington and Griffith ('04) have adopted a classification which is, in the main, very satisfactory and which really differs but little from that of Cox. These authors merge Lugaro's Types I and II into one and call them the "clear cells." These correspond to Cox's large cells of Type I. Lugaro's Type III is accepted and comprises the "obscure cells." These correspond to Cox's small cells. Lugaro's Type IV is divided into two groups. The larger ones, which are all of medium diameter, are called the "coarsely granular cells" and correspond in all probability to Cox's large cells of Type II. The small cells of Lugaro's Type IV are called the "smallest clear cells." They are rare, but differ markedly from the other small cells in that the protoplasm is not diffusely colored. These cells are not given a place in Cox's classification.

According to Warrington and Griffith, the large, clear cells represent about 25 per cent of the total number; they vary in size from 35 to 100 microns. The coarsely granular cells are much less numerous, representing about 4 per cent; they are of a rather uniform diameter of 35 to 50 microns. The obscure cells varying in size from 10 to 56 microns constitute 68 per cent or about two-thirds of all of the cells. In the following table are given the size and relative number of the various types of cells as Warrington and Griffith found them in the second cervical ganglion of the cat. The corresponding types in the classification of Lugaro and Cox are also indicated.

It should be stated that, while Lugaro used a variety of mammals, Cox confined his studies to the ganglia of the rabbit and Warrington and Griffith used only the cat. It is very probable that this is in part responsible for the fact that there is not perfect agreement in results.

TABLE I.  
TYPES OF CELLS IN THE SECOND CERVICAL GANGLIA OF THE CAT.

Warrington and Griffith.	Lugaro.	Cox.	Size.	Relative Number.
Clear cells .....	Types I & II	Type I	35-100	25.%
Obscure cells .....	Type III	Small cells	10-56	68.1%
Coarsely granular cells ....	Type IV	Type II (?)	35-50	4.3%
Smallest clear cells.....	Type IV	.....	10-25	1.9%

In considering such a classification the question arises as to just what significance is to be attached to the grouping adopted. Do the cells belonging to such a group retain permanently their special characteristics; or may a cell pass from one type into another as physiological conditions change? In other words, does a type represent a group of cells anatomically distinct or only a set of cells which happen to be at the moment of fixation in the same physiological phase? Lugaro is of the opinion that his five types of cells must be considered as specifically distinct from an anatomical point of view. But the study of the reparative changes in the ganglion after section of the nerve has led me to regard it as extremely probable that the arrangement of the Nissl granules is quite as much an expression of the functional phase of the cell as of its anatomical type. Thus, in the repair following chromatolysis the cells can be followed as they pass in the course of a few days from one well-marked type of finely granular cells into another well-marked type of coarsely granular cells. The contrast between these two states of the same cell is much greater than that between the cells of Lugaro's Types I and II.

We shall, therefore, not attempt to classify the spinal ganglion cells according to the arrangement of the tigroid substance alone,

but, accepting Dogiel's classification based on the external morphology of the neurones, attempt to fix upon the arrangement of the chromatic bodies characteristic for each of his type of cells. This leads us to a classification which is almost identical with that of Cox and which agrees in all essential points with that of Warrington and Griffith. We distinguish the following groups of cells:

1. Small cells.
2. Large cells.
  - (a) Medium sized coarsely granular cells.
  - (b) All other large cells.

There can be little doubt as to the justification for making size the prime criterion for the separation of the spinal ganglion cells, since this classification is supported by a variety of other observations. We find that the large and small cells differ from each other in their reaction to the protoplasmic dyes; the small cells are associated with non-medullated fibers, the large cells with medullated fibers (Dogiel); and while the latter react to electrical stimulation of the nerve, the former do not (Hodge). It will also be shown that they differ in their reaction to section of the nerve. All the facts justify us in regarding the large and small cells as fundamentally different from one another. It should not be supposed, however, that any particular diameter of cell body can be fixed upon as a dividing line between the two types. There are medium sized cells which in all other respects resemble the large cells, and others of the same size which present all the characteristics of the small cells.

1. *The Small Cells.* The characteristics of the small darkly staining cells have been sufficiently described in the citations already given. Their relatively large nucleus and scanty cytoplasm, staining deeply with the acid dyes, separate them quite sharply from the large cells. The arrangement of the Nissl granules presents nothing peculiar. Their tigroid substance is most often in the form of very fine granules, but is sometimes aggregated into masses of medium size which may be most abundant either near the nucleus or at the periphery of the cell. The small clear cells described by Warrington and Griffith are not present in any considerable number in the spinal

ganglion of the white rat. The small cells constitute about two-thirds of all the cells in the ganglion. They correspond to those described by Dogiel, and according to him possess non-medullated fibers. A full consideration of the small cells will be found in a previously published paper (Ranson '08).

2. *The Large Cells.* The large clear cells are characterized by their clear protoplasm. The size, shape, and arrangement of the chromatic granules presents such an infinite variety that any attempt at classification based on these alone would be largely artificial. We know, however, that among the large cells are some—called by Dogiel cells of Type II, or his new types III, IV, VIII and XI,—which do not send any axon into the peripheral nerve; and, since these would not show axonal reaction after division of the nerve, it should be possible to identify them by their normal appearance in a ganglion in which all the other large cells show chromatolysis. Suggestive observations have been made in this connection by Cox, and Warrington and Griffith. The two latter investigators found that after section of the nerve at a point just distal to the spinal ganglion all the cells in the ganglion with the exception of the coarsely granular medium sized cells and the very smallest cells in the ganglion showed chromatolysis. No lesion of the peripheral nerve would produce any alteration in these coarsely granular cells. In the cat these cells present a rather constant diameter of from 35 to 50 microns. Similar observations were made by Cox upon the rabbit, but the non-reactive cells which he found differed from those of Warrington and Griffith in the concentric arrangement of the elongated tigroid masses and in the excentric position of the nucleus. In short, they were the cells which constitute his Type II. Cox regards his Type II as identical with Dogiel's Type II, since the component cells are few in number and do not give evidence of any injury to their axon after section of the peripheral nerve close to the ganglion. Warrington and Griffith suggest the same possibility for their coarsely granular cells.

It seems probable to the writer that these two types are really the same and that in some animals the tendency to concentric arrangement is more marked than in others. This is borne out by the fact

that the cells with elongated concentric granules are not present in the cat, where Warrington and Griffith find the non-reactive cells to be of the coarsely granular form.

In the white rat, according to my own observations, the concentric type is very rare, only two or three typical instances have been found. On the other hand, a number of the medium sized coarsely granular cells show a sufficient elongation of the granules to suggest somewhat the other type. These cells in the spinal ganglion of the white rat, therefore, resemble closely the non-reactive coarsely granular cells described by Warrington and Griffith in the cat, but also show some affinity with the cells of Cox's Type II; and it is of considerable interest to note that, like these cells of the other investigators, they also fail to react to lesion of the nerve.

Since in my experiments only the dorsal ramus of the second cervical nerve was cut and about 13 per cent of the total number of afferent fibers running in the ventral ramus escaped lesion, there are a few cells of all types which fail to react. While this tends somewhat to obscure the picture, it is possible to determine that the unaltered coarsely granular cells are present in nearly as great numbers as in the normal ganglia (Fig. 3) and it is clear that few if any of the cells of this type have suffered alteration as the result of the section of the nerve. These non-reactive cells in the spinal ganglion of the white rat are all of medium size and present a clear protoplasm with large chromatic granules which in some cases show a tendency toward a concentric arrangement. These cells are not very numerous, constituting only a small percentage of the total number of cells.

It is, therefore, clear that among the large cells of the ganglion there are a few cells of a fairly definite type which fail to react to a lesion of the nerve. These cells vary slightly according to the animal used in the experiment. I believe that these are varieties of a single type of cell and am inclined to accept the suggestion, made by Cox, and Warrington and Griffith, that they represent the cells of Dogiel's Type II (new types III, IV, VIII, XI).

There does not seem to be any adequate reason for a further classification of the large cells so far as the arrangement of the

chromatic granules is concerned. The descriptions of Lugaro give an idea of some of the various pictures that may be presented.

#### CHROMATOLYSIS.

A general review of the literature on chromatolysis would have but little value for us. The observations of the previous investigators will be discussed in connection with the particular problems as these are taken up. It will, however, be necessary to present at this point the procedure adopted in the more important investigations, as a basis for the comparison of results in the subsequent pages. Lugaro ('96) cut the sciatic nerve in dogs at the level of the hip joint, and also resected the brachial plexus in both dogs and rabbits. The animals were allowed to live for periods varying from 2 to 240 days. Cox ('98) resected the brachial plexus in rabbits and allowed them to live for a period varying from one day to a year. Cassirer ('99) removed a piece of the sciatic nerve at the point of its exit from the pelvis, in rabbits which he killed 5 to 63 days after the operation. Köster ('03) also resected the sciatic nerve immediately after its exit from the pelvis in cats, dogs, and rabbits. The animals lived from a few days to a year after the operation. All these investigators prepared the spinal ganglia associated with the injured nerves by some modification of Nissl's method, most often staining with toluidin-blue. By the study of ganglia removed at different periods after the operation they have been able to follow the changes in the ganglion cells through the various phases of chromatolysis. The following general statement concerning these various phases is necessary as a preface to a discussion of the problems which each presents.

Somewhere from 1 to 4 days after a nerve has been divided changes become noticeable in the cells of the associated spinal ganglion. There occurs a progressive solution of the tigroid substance beginning either near the nucleus or at a point intermediate between the nucleus and the periphery of the cell. The cell becomes swollen and the nucleus more or less displaced toward the periphery. These changes characterize what will be called the phase of reaction. After a time which varies within wide limits according to the con-

ditions of the experiment the secondary or consecutive alterations make their appearance. These are of three kinds: (1) repair, which occurs in a considerable proportion of the cells and consists of a restoration of the Nissl bodies and a return of the nucleus to the center of the cell; (2) atrophy, which occurs in nearly all the cells that undergo repair and results in a very considerable shrinkage of the cell body and its nucleus; (3) progressive degeneration leading to the complete destruction of all those cells which fail to undergo repair.

The phase of reaction has been most carefully studied and all the essential features of the intra-cellular changes have been described many times. Accordingly, we shall have chiefly to consider at this time the relative susceptibility of the different types of cells, and pay but little attention to the finer details of chromatolysis. The measurements of Lugaro and Fleming supply us with satisfactory data as to the atrophy taking place in the cells; but the observations on the phases of repair and degeneration are of the meagerest sort. It is with regard to these two late phases that the present investigation has given the most suggestive results.

*The Phase of Reaction.* Due in part, perhaps, to the peculiarities of the type of animal but more to the immaturity of the individuals used for the experiments, chromatolysis occurs very early in the second cervical ganglion of the young white rat. Five days after an operation performed on a rat 12 days old chromatolysis is already far advanced and is, in fact, at its highest point. Even in the largest cells there remains but a narrow peripheral ring of undissolved Nissl-granules. The tumefaction of the cells and the peripheral dislocation of the nuclei are as pronounced on the fifth day as at any subsequent time (Fig. 3).

All authors, Lugaro, Fleming, Cox, Cassirer, Köster, and Warrington and Griffith, agree that the vast majority of the cells in the spinal ganglion react to a lesion of the peripheral nerve. There is some difference of opinion as to the exact proportion; while Köster asserts that all the cells react, the remaining authors make an exception of the very smallest cells in the ganglion, and Cox, Warrington and Griffith also find a small percentage of the large cells that do

not react. Making allowance for these differences, we may say that it is a fact, accepted by all who have studied this question, that somewhere from 85 to 100 per cent of the spinal ganglion cells show chromatolysis after the section of the peripheral nerve close to the ganglion. The preparations of the ganglia of the rat also show the greater number of cells in the various stages of reaction. The extensive chromatolysis, which seems to be established beyond any possibility of doubt, is very difficult to harmonize with the results obtained by the numerical investigation of the architecture of the ganglia, results which are also beyond cavil.

It has been clearly demonstrated by many observers, Hodge, Bühler, Lewin, Hardesty, Hatai, and Ranson, that there are several times as many cells in the spinal ganglion as there are medullated afferent fibers. This well established fact has been discussed in detail in a previous paper and we do not need to consider it here. It is very interesting, however, to note that we have here two well established facts which seem contradictory to each other. Whereas at least 85 per cent of the cells show what has been interpreted by all observers as a typical axonal reaction after section of the peripheral nerve, the numerical results show that on the average only 33 per cent of the cells are connected with the medullated fibers in the nerve. In what way are we to explain the axonal reaction in the other 52 per cent of the cells? Lugaro and Köster, who had not themselves worked with the numerical method, felt justified in doubting the correctness of the numerical results, because they conflicted with facts that they knew to be correct. But having worked with both methods and being convinced of the correctness of both sets of results, I cannot so lightly set aside either in order to avoid the dilemma. There seem to be but two alternatives: either the reaction in this 52 per cent of the cells is not an axonal reaction at all but is secondary to some intra-ganglionic disturbance, or there must be a very large number of non-medullated fibers in the nerve. It has been shown (Ranson '08) that the histology of the ganglion would not exclude the possibility of the first alternative. "The spinal ganglion is not to be regarded as an aggregation of more or less spherical cells each independent of the others, and



connected only with its central and peripheral processes; but is in reality a complicated mass containing the ramifications of dendrites and axis cylinders, forming exceedingly intricate intercellular meshworks and pericellular baskets, the cells in this way being brought into close functional relation with each other." We will now study the reaction in the different types of cells to see if there is any evidence that the reaction in some cells is secondary to that in others.

It has been shown in a previous paper that the evidence points to the small cells as those not associated with medullated fibers, and it is, therefore, in these cells that we would expect to find evidence of the secondary nature of the chromatolysis. Nevertheless, the evidence shows that the small cells are the ones most susceptible to a lesion of the nerve. According to all observers who have made any statement in this connection, the small cells are the first cells in the ganglion to react. This fact is entirely at variance with the idea that their reaction is secondary to an axonal reaction in the large cells.

According to Lugaro the small dark cells are rapidly altered, the reaction reaching its height by the fourth day, while the reaction in the other cells does not reach its maximum until the fifteenth day. The cytoplasm of the small cells is pale, especially at the center, and the nucleus has been displaced to the periphery. Cox found that the small cells showed alterations as early as twenty-four hours after the operation and by the end of the fourth day most of them were very much altered, while the large cells were just beginning to show chromatolysis. All the other observers agree that the small dark cells show chromatolysis but do not say at what time the reaction occurs. There can, therefore, be no doubt that most of the small dark cells react to the injury of the nerve and do so earlier than the large cells. It must be borne in mind, however, that not all of the small cells react in this way. As will be remembered, a few of the smallest cells do not present a dark cytoplasm, but are clear cells with a few large chromatic granules. Lugaro, Warrington and Griffith agree that these cells never show chromatolysis. According to the last two observers there are also a few of the

smallest dark cells that fail to react. In the cat no cells under 25 microns, dark or clear, showed chromatolysis. They estimate these non-reactive cells as constituting from 7 to 13 per cent of all the cells, according to the ganglion studied.

In my preparations from the rat, which came to autopsy five days after the operation, the chromatolysis is at its highest point and the majority of the cells are greatly altered. It is therefore not possible to determine whether the large or small cells were first altered. It is in the small cells, however, that the most extreme alterations are found. Fig. 3 illustrates some of these changes. The nucleus is strikingly excentric, in most of the cases it causes a distinct bulging of the cell-outlines, and in many it appears to be indenting the cell from without. The chromatic substance is completely dissolved except for a dense ring which persists at the periphery of the cell and a small clump sometimes found near the nucleus. Even at this stage, five days after the operation, it is clear that some of these small dark cells have disintegrated, but of this more will be said in connection with the phase of degeneration.

From what has been said it will be obvious that the changes which appear in the small cells are characteristic of axonal reaction, and there is nothing in the finer details of the chromatolysis to indicate that it is due to any other cause than a lesion of the axons of these cells. If we are to continue to place any confidence in the conclusions based on Nissl's axon-reaction, we are forced from these facts to admit that the majority of the small cells possess axons in the peripheral nerve, the numerical results to the contrary notwithstanding.

Concerning the phase of reaction in the large cells there is very little to add to that which has been described by previous observers. We have already mentioned the facts concerning the non-reacting coarsely granular cells. There is but one other point of interest in the chromatolysis of the large cells, namely, the absence of any trace of clumping of the tigroid masses about the nucleus in the preparations of the reacting ganglia of the rat. Fleming, Cox, and Kleist have each seen and described this phenomenon; and there

can be little doubt about the correctness of these earlier observations, since the figures and descriptions given by these authors are very clear, and agree in all essential points with each other. In some of the illustrations it seems as if almost the entire quantity of chromatic substance is accumulated in one solid mass which more or less completely encircles the nucleus. Why this appearance was not to be found in a single cell in my preparations is hard to understand. It may be due to the fact that my animals were of a different kind, but more probably is to be explained on the basis of the rapidity with which the reaction occurred in my specimens. It seems probable that the chromatolysis was so rapid that there was no time for the clumping of the granules to occur before they were dissolved. Or it may be that clumping occurred in the earlier stages but gave place before the fifth day to complete chromatolysis.

*The Phase of Degeneration.* Very little attention has been paid to the degenerative changes which lead to the ultimate disappearance of the cells. Lugaro found that scattered cells underwent complete degeneration and became surrounded and penetrated by capsular nuclei. This occurred from 15 to 40 days after the injury. Vacuolar degeneration seemed to him to play a small part in the cell destruction. Fleming speaks of a "disintegration of the protoplasm" that occurred in many cells 6 to 18 weeks after the operation. Cox gives an excellent description of the degeneration by vacuolation. According to him the vacuoles are sometimes small, sometimes large and multiple and in the latter case the Nissl-bodies have almost entirely disappeared from the cell. If the vacuoles are very large the nucleus vanishes, so that the cavity which represents the remains of the earlier cell contains only the membranous partitions between the vacuoles. These membranes are impregnated with little granules. In addition to this form of degeneration Kleist mentions another, namely the gradual progressive atrophy of the cell resulting at last in its complete disappearance. Köster is of the opinion that the vacuolation is not the result of a pathological process but is due to an error in technique. The cell destruction according to him does not occur until late, mostly after the 284th day. One sees then violet-stained protoplasmic remains which contain only

degenerate nuclei or none at all, and which are surrounded by proliferating connective tissue cells of the capsule.

It is quite remarkable, considering how large a number of cells disappear from the ganglion (52 per cent according to counts on the second cervical ganglion of the white rat), that the strictly degenerative changes are not more obvious in sections of the reacting ganglia. One reason why my preparations have not given altogether satisfactory data on this point is that most of them were not counterstained. While this gives the best material for study of chromatolysis, it does not bring out the protoplasmic changes which indicate the disintegration of the cell. In the preparations of ganglia removed seven and eight days after the operation, which were counterstained, a small percentage of the cells can be seen undergoing definite disintegrative changes. Two well-marked types of disintegration can be recognized. By far the most frequent and important is that in which the cell becomes penetrated by proliferating fibroblasts from the capsule which form nests of vesicular nuclei suggestive of the intracapsular proliferation in rabies. The early stages in such a process are shown in Fig. 5. The small dark capsular nuclei have given place to large vesicular ones. These are seen grouped about the cell. Five have penetrated into the cell. There is no trace of the Nissl-bodies, the nucleus presents an indefinite crenated border and contains the outlines of a barely recognizable nucleolus. A further increase in the number of the fibroblasts gives rise to the formation of nests of such cells in which one can just recognize the outlines of the original spinal ganglion cell. Such nests are relatively frequent after the seventh day. By the transformation of these into adult connective tissue with the consequent shrinkage, the spaces formerly occupied by the ganglion cells are obliterated so that the ganglion cells that survive are brought to lie almost as close together as in the normal ganglion. The amount of intervening connective tissue is surprisingly little after two months.

The other form of degeneration, vacuolation, is more rare but seems to play a certain part in the cell destruction. It may go on to such an extent that the cell is converted into a single large vacuole, surrounded by a thin ring of protoplasm (see Fig. 6). It is true

that one sometimes meets with vacuolation in the cells from normal ganglia; but the process does not reach the same extent nor is it nearly as frequent as in the "operated" ganglia.

While this is all that can be said positively concerning the disintegrative processes, it seems probable that many of the small cells become so much swollen that the nucleus is extruded, after which the cell rapidly disintegrates. Such a process as this cannot of course be observed, but it may be supposed to occur, because of the extreme peripheral position of the nucleus in the cells (see Fig. 3). The nuclei often are so placed that they appear half outside the cell, and in some more marked cases as if the nucleus were a separate structure indenting the cell-body from without.

In connection with the degenerative changes two other problems demand attention. Is there any special part of the ganglion in which the cells seem particularly susceptible to degeneration after section of the peripheral nerve? Is there any particular type of cell which is more likely to disappear than the others? The first question is suggested by observations of Bumm, who worked with the second cervical nerve of the cat, and of Kleist working with the same nerve in cats and rabbits, both of whom found after section of the dorsal root a region on the posterior aspect of the proximal part of the ganglion in which the degenerative changes were much more marked than in the rest of the ganglion. Both Bumm and Kleist believe that there are situated here cells which are associated with a fiber in the dorsal root but not with one in the nerve. They consider these as relay neurones inserted between the sympathetic and the central nervous system. It is to be borne in mind, however, that these authors base their conclusion purely on the effect of cutting the dorsal roots, and that they did not attempt to determine whether these supposed cells could be demonstrated by their failure to react when the peripheral nerve was cut. The descriptions and illustrations given in their papers indicate that the destruction in this dorso-proximal quarter of the ganglion involves a large part of the cells and give the impression that these cells must be quite numerous. Now if the idea that these cells possess no fiber in the peripheral nerve is correct, they should not react to a section of the nerve and

one would be justified in expecting to find a considerable number of unaltered cells in this region of the ganglion. It does not seem probable that such a condition could have been overlooked by all those who have studied chromatolysis in the spinal ganglion after section of the peripheral nerve; and, having Bumm's observation in mind, I have again gone carefully through my preparations, but have been unable to see that this dorso-proximal region of the ganglion showed any greater number of unaltered cells than are to be found in any other part of the ganglion. This fact argues strongly against the assumption of Bumm and Kleist that the dorso-proximal part of the ganglion is the locus of cells which send a fiber into the dorsal root but none into the nerve. Just why the cells in the dorso-proximal part of the ganglion should be more susceptible to a lesion of the dorsal roots than the other cells of the ganglion is hard to say. It should, however, be borne in mind that it is just this portion of the ganglion that would be most exposed to direct trauma in an operation on the dorsal roots, and that it would also be most affected by any anæmia produced by the division of the arteriole accompanying the dorsal root. It is not probable, however, that these are determining factors, and the observations of Bumm and Kleist may still have an important but as yet undetermined significance.

It has been shown that there is no special area which is most affected, but there still remains the question whether any particular type of cell is more susceptible than another. One of the clearest observations that can be made on the material from the white rat, is that the cells which disappear belong for the most part to the small cell type. It is true that it is very difficult to follow the different steps in the disintegration of these cells, and it would be impossible to reach this conclusion by direct observation of the process of degeneration. The only hint in this direction which such a study gives is the fact that the nuclei of these cells are much more excentric than those of the large cells, so much so that the nucleus often appears as a second sphere attached to one side of the cell body. It is clear, however, that as the length of the post-operative period increases, the number of cells diminishes, spaces are left filled with

very loose cellular connective tissue, and the cells which remain are predominantly large cells. As time goes on the connective tissue contracts, the spaces are obliterated, and the large cells, no longer separated by so many small cells, come to lie much closer together than in the normal ganglion. This condition is very obvious by the 20th day, at which time the degeneration is almost complete and the majority of the surviving cells have returned to their normal appearance. Figs. 1 and 2 are representative areas from the control and "operated" ganglia of a rat which survived 20 days. The large cells have undergone some atrophy. The disappearance of the small cells and the approximation of the large ones is obvious, yet the contrast is less marked in the illustration than that which one finds in following through a series of sections of these two ganglia.

Perhaps a more satisfactory method of showing this relation is by means of a differential count. A difficulty in the way of such a count is that size is not the only point of differentiation between the two types of cells. For, as has been said, there are cells of medium size which because of other characteristics belong with the large cells, and other medium sized cells which belong with the small ones. On this account it is not possible to make an altogether satisfactory differential count on the basis of size alone. Nevertheless, it is only by the use of such a rigid objective criterion that one can rule out all possibility of personal bias. Accordingly, in making the count a mean diameter of 20 microns was accepted as an arbitrary dividing line between the two types. The majority of the large cells have a greater diameter than this, the majority of the small cells less. In making this count use was made of an ocular net micrometer ruled in squares in such a way that with the combination of the Zeiss oil-immersion lens and 12 eye-piece the sides of these squares corresponded to the chosen diameter. In this way it was possible rapidly to measure each cell and determine to which class it belonged. Two counting machines were used, the large cells being registered on one, the small cells on the other. Four sections from each ganglion were thus subjected to a differential count. These sections were taken at random from different parts of the ganglia.

Table II shows that the decrease in the number of cells is due chiefly to the loss of cells under 20 microns in diameter. There is also no doubt a slight loss of cells of the larger size, but this is compensated by the fact that the remaining large cells lie closer together, so that a single section shows about the same number as there are in a similar section of a normal ganglion. But the point to be emphasized is that the cell destruction affects chiefly the smaller cells. That this fact escaped the attention of all the previous investigators is probably due to the slow repair of the large cells in their specimens, which permitted a considerable amount of atrophy to occur before the cells again became of normal appearance.

TABLE II.

Showing the proportion of large and small cells in the normal and "operated" second cervical ganglion of the white rat 20 days after section of the ramus posterior of the corresponding nerve.

NORMAL		OPERATED	
Large cells	Small cells	Large cells	Small cells
32	48	28	16
32	35	36	24
26	47	21	18
28	38	31	20
Sum. . . . 118	168	116	78
Average. 29.5	42	29	19.5

It is necessary in making such a differential count to make it at just the proper period after the operation. The careful measurements of Lugaro and Fleming have shown that there is during the phase of active chromatolysis a considerable swelling of the cells, and that repair is accompanied by marked atrophy which continues to progress for some time and leaves the cells very much reduced in size. It is clear that either swelling or atrophy would tend to obscure the relations brought out in Table II. In making the counts it was necessary to select a period when the repair of the cells was just complete and their œdematous condition had subsided, but before they had begun to show marked atrophy. For this purpose the preparations from the rat killed 20 days after the operation



were very well suited. At the end of two months so much atrophy has occurred that the relations given in Table II can no longer be made out.

These observations bear out the conclusion reached in a previous paragraph that the reaction in the small cells is not secondary to that in the large. If it were, it would be difficult to see why the large ones should survive and the small ones disintegrate. These small cells which do not have medullated axons in the nerve are the first to react, show a typical axonal reaction, resulting in very extensive cell destruction. These facts are very important for a proper understanding of the architecture of the spinal ganglion, but their bearing on that subject can best be discussed in another place.

*The Phase of Repair.* We come now to the study of the reparative processes by which the surviving ganglion cells regain their normal appearance. For this study the preparations from the young rats proved especially fitted. Because of the rapidity with which the ganglia passed through the various phases, the repair came very much earlier in these specimens than in any previously described. Repair began on the eighth or ninth day and was almost complete in 20 days. During this interval specimens were taken every two or three days and a complete series representing the reparative changes was thus obtained. In the preparations of other investigators taken from the ganglia of other, and older, animals the repair occurred late when the specimens of the series were taken weeks apart.

Nine days after the operation the nuclei of the large cells begin to recede from their peripheral position and come more and more in the course of the next few days to occupy the center of the cells. There is little change as yet in the character of the chromatic granules. In most of the cells the stainable substance forms only a narrow ring about the periphery of the cell; the remainder of the cytoplasm stains a diffuse light blue. Twelve days after the operation only a few of the large cells show peripheral nuclei and there is a very noticeable augmentation in the quantity of the tigroid masses. As this accumulates in the cell it disposes itself in two ways. A part of it goes to increase the breadth and

density of the peripheral ring that has resisted solution during the earlier phases of chromatolysis. The larger part, however, is distributed in the form of very fine granules through the remainder of the protoplasm. At this stage the majority of the large cells correspond quite well to Lugaro's description of the cells of his second type. They are large and medium-sized clear cells with very fine tigroid masses which are larger at the periphery of the cell. They do not, however, long conform to this type, since the chromatic substance is rapidly increasing in quantity and is laid down in the form of large granules scattered uniformly throughout the protoplasm. By the seventeenth day the central portions of the cells contain Nissl-bodies of considerable size, and by the twentieth day the distinction between the coarsely granular peripheral ring and the rest of the cell has disappeared. The cells present a uniformly coarsely granular appearance. In this way we are able to trace the large cells from the height of chromatolysis through the stages of gradually increasing chromatic substance, until they present the pyknomorphous appearance characteristic of the large cells 20 days after the operation (Figs. 2 and 4).

The importance of thus following the transformation is two-fold. In the first place, it shows that the large cells undergo repair; and in the second place it shows that the large cells present in the 20-day preparations and counted as such in the enumerations given in Table II are in reality the same large cells as were originally present in the ganglion, and cannot be regarded as hypertrophied small cells. In this way we can be sure that the conclusions derived from Table II are not misleading, namely, that it is the small rather than the large cells which undergo complete degeneration.

#### CONCLUSIONS.

The more important results of the investigation may be summarized in the form of answers to the problems suggested in the introduction.

1. It is probable that the medium sized coarsely granular cells which fail to react to a lesion of the nerve close to the dorsal root ganglion, belong to neurones which send no axon into the nerve (Dogiel's Type II, or new types III, IV, VIII and XI).

2. While only a part of the cells (52 per cent) undergo complete degeneration, nearly all of the cells (at least 85 per cent) show chromatolysis after an operation severing all branches of the nerve; and this occurs in spite of the fact that not more than 33 per cent of the spinal ganglion cells are associated with medullated fibers that would be injured in cutting the nerve.

3. There is no indication that the reaction in the small cells is secondary to some intra-ganglionic disturbance; it possesses all the characteristics of a true axonal reaction and occurs at least as early, and according to Cox and Lugaro somewhat earlier, than the reaction in the large cells.

4. The process of degeneration varies in different cells. In some cases the invasion of the degenerating ganglion cells by proliferating fibroblasts is the most striking feature, in others vacuolation appears to be the cause of the cell disintegration. In the small cells it is probable that the extremely excentric nuclei may, as the turgescence increases, be finally extruded.

5. There does not seem to be any part in which the reaction is more marked than in the rest of the ganglion, and the dorso-proximal portion shows as many altered cells as are to be found elsewhere. This fact may be taken as an argument against the assumption of Bumm that this portion of the ganglion is the locus of cells which do not possess a fiber in the peripheral nerve.

6. The large cells of the ganglion can be followed through the various stages of repair until they again present central nuclei and are filled with a very large amount of coarsely granular chromatic substance.

7. It has been shown, moreover, that it is the small neurones which are most seriously injured, since it is from among this group of elements that the loss of cells chiefly occurs. Since the small cells show typical axonal reaction and degenerate in by far the greatest number, we are forced to conclude that they possess axons in the peripheral nerves, and that their non-medullated processes traced by Dogiel as far as the junction of the ventral and dorsal root, extend beyond that point into the nerve.

This conclusion has recently been confirmed by the demonstration

of very large numbers of non-medullated fibers in the spinal nerves of the rabbit by the method of Cajal. These non-medullated fibers, an account of which will appear in another paper, allow us to explain with ease the following otherwise inexplicable facts:

1. The axonal reaction in the small cells which are not connected with medullated fibers in the nerve.

2. The results of Lugaro, Fleming, Cox, Cassirer, Köster, Warrington and Griffith, and myself which show that the vast majority of all the cells in the spinal ganglion react to a lesion of the peripheral nerve although only a small part of these cells are connected with medullated fibers in the nerve.

3. The degeneration of 4412 ganglion cells after the section of a nerve containing 1500 medullated fibers. These 4412 cells were chiefly small cells and were associated with non-medullated fibers in the nerve.

4. The intact condition or only slight degeneration of the dorsal roots after the degeneration of 52 per cent of ganglion cells, the average loss in the dorsal root being 17 per cent. This is easily understood when it is remembered that the large cells which alone are associated with medullated fibers in the dorsal root pass rapidly through the phases of reaction and repair to complete restitution.

#### BIBLIOGRAPHY.

BUMM, A.

- '03. Die experimentelle Durchtrennung der vordern und hintern Wurzel des zweiten Halsnerven bei der Katze und ihre Atrophiewirkung auf das zweite spinale Halsganglion. *Sitz. Ber. Ges. Morph. Physiol.*, München, B. 18, p. 65.

COX, W. H.

- '98. Der feinere Bau der Spinalganglienzellen des Kaninchens. *Anat. Hefte*, Abth. 1, Bd. 10, Heft 31, p. 73.
- '98a. Beiträge zur pathologischen Histologie und Physiologie der Ganglienzellen. *Internat. Monatsschr. für Anat. und Phys.*, Bd. 15, p. 241.

CASSIRER, R.

- '99. Ueber Veränderungen der Spinalganglienzellen und ihrer centralen Fortsätze nach Durchschneidung der zugehörigen peripheren Nerven. *Deutsche Zeitschr. für Nervenheilk.*, Bd. 14, p. 151.

FLEMING, R.

- '97. The effect of ascending degeneration on the nerve cells of the ganglia, and the posterior nerve roots, and the anterior cornua of the cord. *Edinburgh Med. Jour.*, vol. 43, p. 279.

HATAI, S.

- '00. The finer structure of the spinal ganglion cells in the white rat. *Jour. Comp. Neur.*, vol. 11, p. 1.

KLEIST, K.

- '04. Experimentell-anatomische Untersuchungen über die Beziehungen der hinteren Rückenmarkswurzeln zu den Spinalganglien. *Virchow's Archiv*, Bd. 175, p. 381.
- '03. Die Veränderung der Spinalganglienzellen nach der Durchschneidung des peripherischen Nerven und der hinteren Wurzel. *Virchow's Archiv*, Bd. 173, p. 466.

KÖSTER, G.

- '03. Ueber die verschiedene biologische Werthigkeit der hinteren Wurzel und des sensiblen peripheren Nerven. *Neurol. Centralbl.*, Bd. 22, p. 1093.

LUGARDO, E.

- '04. On the pathology of the cells of the sensory ganglia. *Riv. di Patol. nerv. e ment.*, vol. 5, nos. 4, 6, 9; vol. 6, no. 10; vol. 7, no. 3; vol. 8, no. 11; *Ref. Rev. of Neurol. and Psych.*, vol. 2, p. 228.

WARRINGTON, W. B., and GRIFFITH, F.

- '04. On the cells of the spinal ganglia and on the relationship of their histological structure to the axonal distribution. *Brain*, vol. 27, p. 297.

RANSON, S. W.

- '06. Retrograde degeneration in the spinal nerves. *Jour. Comp. Neur. and Psych.*, vol. 16.
- '08. The architectural relation of the afferent elements entering into the formation of the spinal nerves. *Jour. Comp. Neur. and Psych.*, vol. 18.

FIG. 1. *Zeiss, Ocular 4, Objective 8.*—Drawing traced from photo-micrograph of a transverse section through the control second cervical ganglion of a young white rat twenty days after the operation, showing the characteristics of the normal ganglion. In the center is a clear area representing the dorsal root fibers. Note the size of the large cells, also the large number of small cells.

FIG. 2. *Zeiss, Ocular 4, Objective 8.*—Drawing traced from a photo-micrograph of a transverse section through the "operated" second cervical ganglion of a young rat twenty days after the operation. This section illustrates the alterations which have occurred in the ganglion as a result of division of the nerve. It can be readily seen by comparing Figs. 1 and 2 that there have occurred both an atrophy of the ganglion as a whole and a decrease in the number of the cells. It is apparent at a glance that the cells in the operated ganglion are predominately of the medium size. None are as large as the largest cells seen in the normal ganglion, due to the fact that the cells have already begun to show some atrophy. The most striking feature is the loss of the small cells.

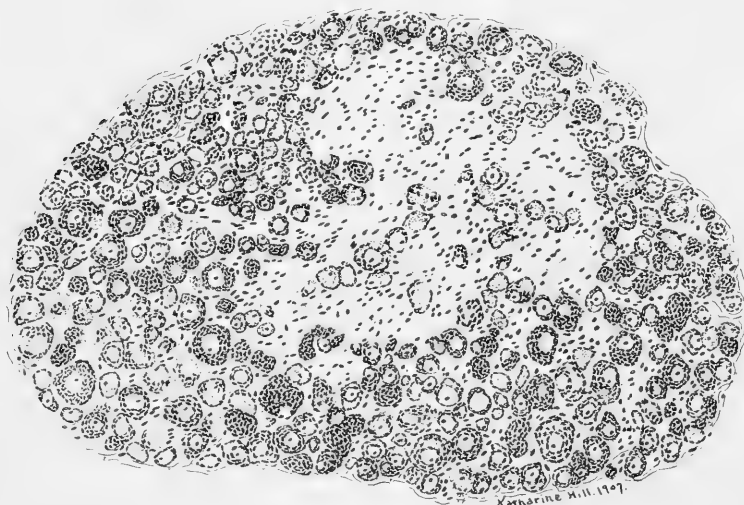

FIG. 1.

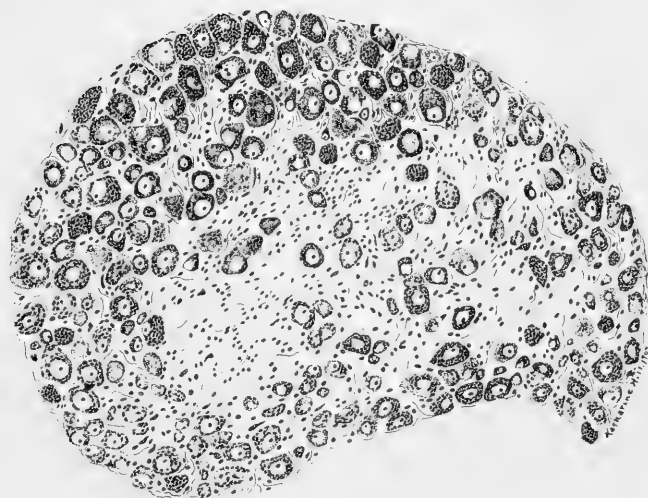

FIG. 2.

FIG. 3. *Zeiss, Ocular 4, Objective 1/12*.—Drawing of a small area from a transverse section through the "operated" second cervical ganglion of a young white rat five days after the operation. With the exception of one medium-sized cell, all of the cells show more or less extensive chromatolysis. The medium sized non-reacting cell is distinctively of the coarsely granular type. The usual features of chromatolysis can be seen in the reacting cells. Notice the extreme peripheral position of the nuclei of the small cells.

FIG. 4. *Zeiss, Ocular 4, Objective 1/12*.—Drawings of a small area of a section through the same ganglion as that represented in Fig. 2. It represents the condition in the ganglion twenty days after the section of the nerve. The most striking feature is that the large cells have almost regained their normal appearance. The nuclei are centric and there is a large amount of chromatic granules distributed in the normal manner throughout the protoplasm.

FIG. 5.—Showing a degenerated cell penetrated by proliferating cells from the capsule, from the second cervical ganglion of a rat eight days after the operation.

FIG. 6.—Showing a cell distended by a large vacuole, from the second cervical ganglion of a rat seven days after the operation.



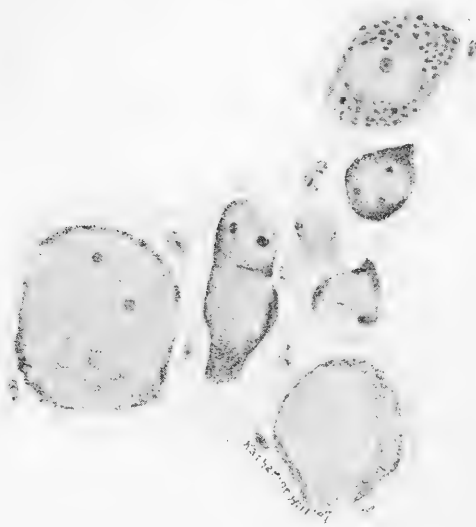

FIG. 3.



FIG. 4.

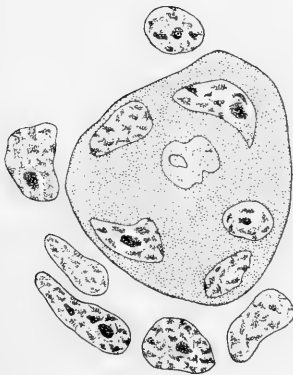

FIG. 5.

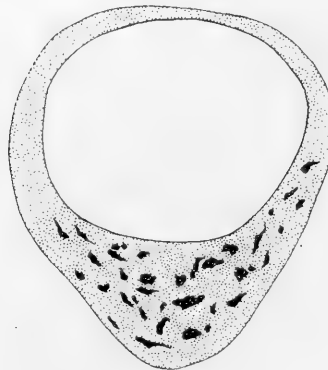

FIG. 6.



# The Journal of Comparative Neurology and Psychology

---

VOLUME XIX

MAY, 1909

NUMBER 2

---

## ON THE RELATION OF THE BODY LENGTH TO THE BODY WEIGHT AND TO THE WEIGHT OF THE BRAIN AND OF THE SPINAL CORD IN THE ALBINO RAT (*MUS NORVEGICUS* VAR. *ALBUS*).

BY

HENRY H. DONALDSON.

*Professor of Neurology at The Wistar Institute.*

WITH THREE FIGURES.

In a recent paper (Donaldson, '08) the relations of the body weight to the weight of the brain and of the spinal cord in the albino rat have been described.

In addition to the determination of the body weight it was stated in the paper just cited (pp. 346-7) that measurements had also been made on the body length (trunk and head) of some of the rats, but to avoid confusion the discussion of this character and its relations was reserved for the present paper.

The reasons for making a series of linear measurements on the albino rat were briefly the following:—

1. To obtain a second general measure of the body growth of the albino rat in terms other than those of weight.
2. To gather data by which to determine the body weight and body length ratio for the variety measured.

This ratio is valuable because it gives a notion of the general shape of the animal and also enables us to state whether there are

differences in this relation according to sex, as well as to make comparisons with other forms.

It also permits the determination of the influence of dwarfing and other modifying conditions on the weight-length relation.

3. Both the weight of the brain and of the spinal cord can be related to the body length, and the measurement on body length thus made to furnish an additional datum from which the weights of the brain and of the spinal cord can be inferred. As we shall see, this datum is a much better one than body weight, especially in those cases where, for one reason or another, the animal has become emaciated.

4. If we consider the body length of the rat to correspond in a general way with the sitting height in man, we have one more means of comparing the growth changes in the two forms.

In the following pages we shall discuss these points, so far as they have been worked out. For the mathematical treatment of the results I am indebted to my colleague, Dr. Hatai, who is publishing at this same time some notes on the formulas previously used by both of us (Hatai, '08; Donaldson, '08), as well as giving a new and more general formula for determining the weight of the brain from the body weight (Hatai, '09).

The technique of weighing and measuring was that described in the earlier paper (Donaldson, '08). A number of complete records on the albino rat have been added to those on hand at that time. Moreover, for the relation of body weight to the body length alone, additional records have been obtained by weighing and measuring animals which had been anaesthetized lightly.

It was my first intention to print the full series of individual records (233 males, 173 females) in a general table at the end of this paper. I have, however, decided not to do so for the following reasons:—

*First.*—Printing such a general table would involve repeating a number of the records already published in a former paper (Donaldson, '08), and would in turn need to be again repeated in a forthcoming paper on the change in the percentage of water during the growth of the nervous system.

HENRY H. DONALDSON.

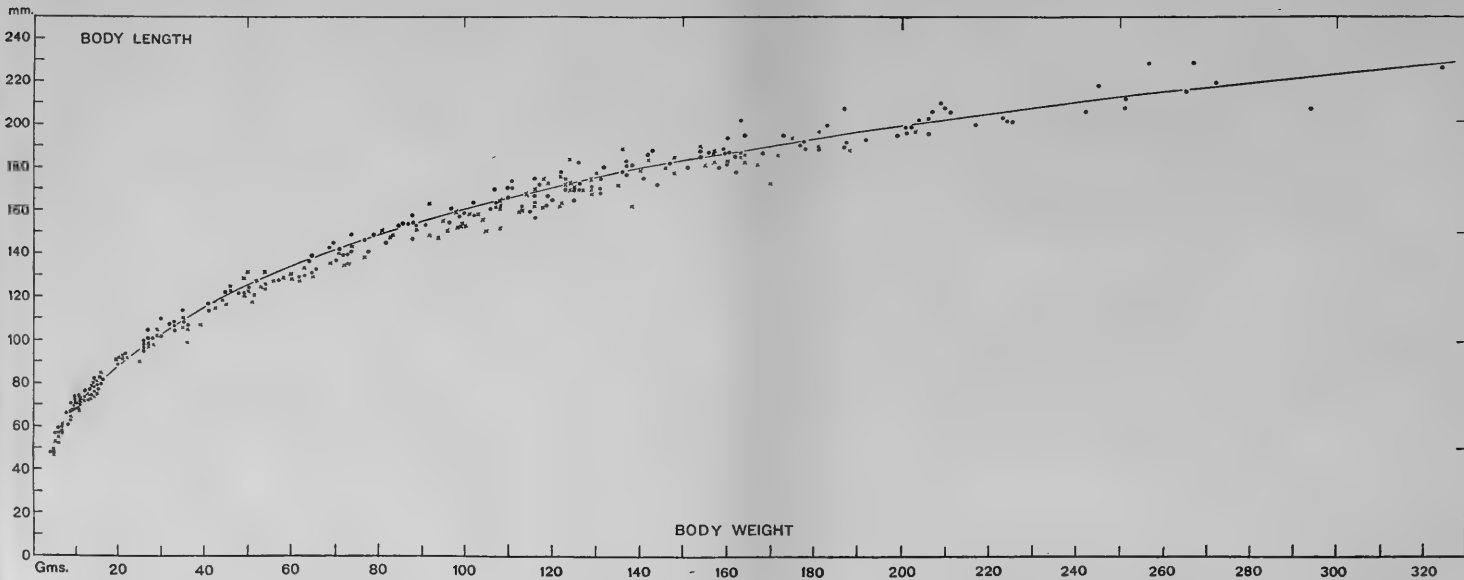

To show in the abino rat, the body length in millimeters according to body weight in grams. Records for 170 males ●, and 148 females X. The theoretic curve for the sexes combined is based on formula (4).



*Second.*—The individual records have been tabulated and are on file at the Institute. They are therefore available for use by other investigators, and may be had by application to the Director of The Wistar Institute.

*Third.*—It is hoped that this condition will be only temporary, and that when this group of investigations is completed, the entire series of individual records employed for them can be printed in the form of tables in a special brochure, thus making them generally available. At this time only the mean values of the observation are tabulated.

We turn at once, therefore, to the consideration of the special questions:—

1. The body length of the albino rat according to body weight.

On Chart I, so far as is possible without confusion, the individual records for body length (170 males and 148 females) are entered according to the body weight. The continuous line on the chart shows the theoretical curve. As can be seen, the distribution of the records is such as to fit a theoretical curve that rises with diminishing rapidity, and so far as it can be plotted, is still bending towards the horizontal. A distinction between the sexes in the relation of body length to body weight, though present, is hardly to be seen on Chart I. The mean values for the body lengths are given in Table 2. Making use of these data, the weight length ratios have been determined for the series in hand.

Table 1 gives the numerical expression of the relations obtained by dividing the calculated body length (for both sexes combined, see Table 2) by the body weight.

The ratios thus obtained are given in Table 1, and these show that the albino rat becomes relatively shorter as its weight increases.

By means of a correlation table based on groups differing by 10 grams in body weight and 10 mm. in body length, the mean statures for given body weights have been calculated. This has been done for each sex separately, as well as for both sexes taken together, and the final values obtained are given in Table 2.

When the means for the males are compared with those for the

females (see Chart II, based on 179 males and 160 females) it will be observed that the latter run slightly below the former. The difference, though small, has significance, as we shall show later. However, for the general discussion at this time the results are not separated according to sex, but are treated together.

TABLE 1.  
THE RATIOS OBTAINED BY DIVIDING THE BODY LENGTH BY THE WEIGHT IN  
THE CASE OF MUS NORVEGICUS VAR. ALBUS.

Body weight gms.	Body length mm. Both sexes combined (See Table 2.)	Ratios.
5	51.9	10.38
15	77.6	5.17
25	94.8	3.78
35	109.1	3.11
45	120.5	2.67
55	130.6	2.37
65	137.7	2.11
75	144.9	1.93
85	152.0	1.78
95	157.7	1.66
105	163.4	1.55
115	167.7	1.45
125	173.5	1.38
135	177.7	1.31
145	180.6	1.24
155	184.9	1.19
165	189.2	1.14
175	192.0	1.09
185	194.9	1.05
195	197.8	1.01
205	200.6	.97
215	203.5	.94
225	206.3	.91
235	209.2	.89
245	210.6	.85
255	213.5	.83
265	216.4	.81
275	217.8	.79
285	220.6	.77
295	222.1	.75
305	224.9	.73
315	226.4	.71
325	227.8	.70

The theoretical curve which most closely represents the change in body length with increasing body weight, is given by the formula (4)

$$y = 143 \log (x + 15) - 134$$

where  $y$  represents the body length and  $x$  the body weight.

This is a formula of the same type as those used for determining the weight of the brain and of the spinal cord in relation to the



HENRY H. DONALDSON.

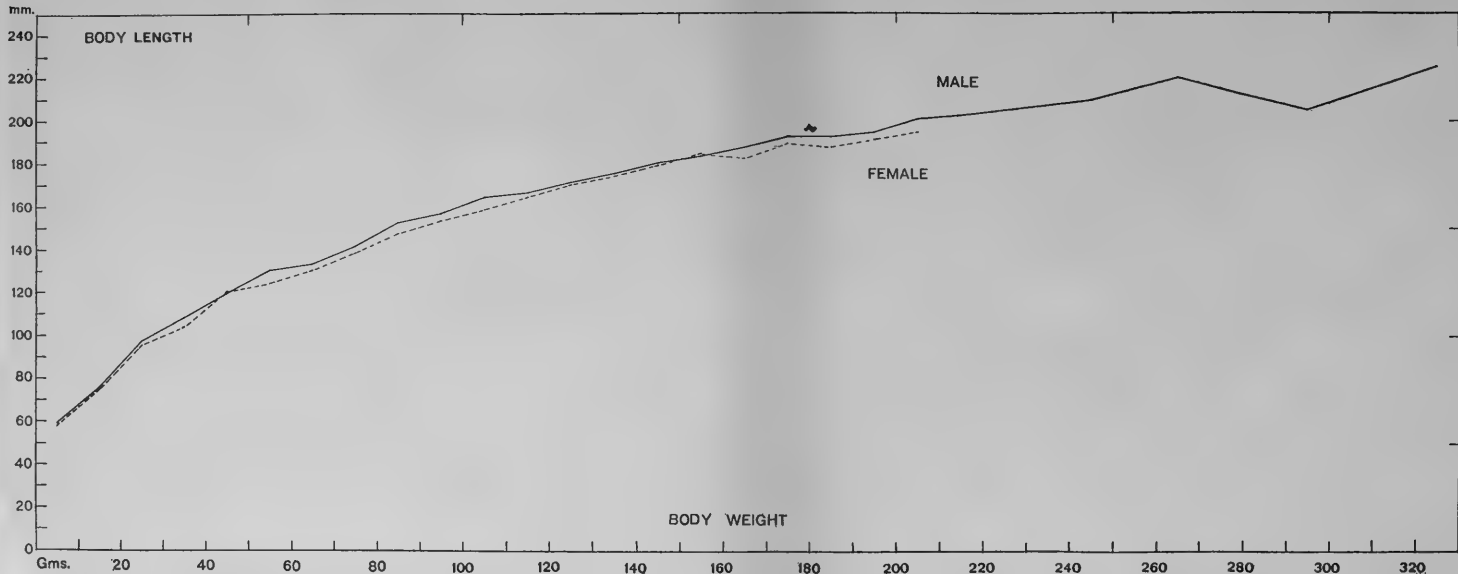

To show in the albino rat, the mean values for the body length according to body weight, sexes separated; — males, ..... females. The theoretic curve is not drawn, as it would confuse the other lines.



weight of the body, and the type has been already discussed in a previous paper (Donaldson, '08, p. 350).

In this connection, however, there are some points to be corrected and further discussed. The consideration of these points is taken up in a paper by Dr. Hatai which appears at this time.

TABLE 2.

Mean body length according to body weight in *Mus norvegicus* var. *albus*. The body length as given in the last column has been calculated by the formula (4),  $y = 143 \log (x + 15) - 134$ .

Body Weight Gms.	BODY LENGTH OBSERVED.						Body length in mm. calculated by formula (4)
	Frequen- cies. M.	Mean mm. M.	Frequen- cies. F.	Mean mm. F.	Frequen- cies. M.+F.	Mean mm. M.+F.	
5	12	59.2	12	58.3	24	58.8	51.9
15	15	76.3	24	75.4	39	75.9	77.6
25	11	97.7	8	96.3	19	97.0	94.8
35	8	108.8	8	105.0	16	106.9	109.1
45	5	121.0	11	121.4	16	121.2	120.5
55	7	130.7	13	125.0	20	127.9	130.6
65	9	134.0	5	131.0	14	132.5	137.7
75	9	141.6	5	139.0	14	140.3	144.9
85	8	152.5	4	147.5	12	150.0	152.0
95	6	156.6	10	154.0	16	155.3	157.7
105	6	165.0	9	159.4	15	162.2	163.4
115	12	166.7	9	165.0	21	165.8	167.7
125	7	172.1	15	171.0	22	171.6	173.5
135	9	176.1	4	175.0	13	175.6	177.7
145	5	181.0	4	180.0	9	180.5	180.6
155	9	184.0	6	185.0	15	184.5	184.9
165	7	188.0	6	183.3	13	185.7	189.2
175	4	192.5	2	190.0	6	191.3	192.0
185	5	193.0	3	188.3	8	190.7	194.9
195	2	195.0	0		2	195.0	197.8
205	7	200.7	2	195.0	9	197.9	200.6
215	4	202.5			4	202.5	203.5
225	2	205.0			2	205.0	206.3
235	0				0		209.2
245	2	210.0			2	210.0	210.6
255	3	215.0			3	215.0	213.5
265	2	220.0			2	220.0	216.4
275	1	215.0			1	215.0	217.8
285	0				0		220.6
295	1	205.0			1	205.0	222.1
305	0				0		224.9
315	0				0		226.4
325	1	225.0			1	225.0	227.8

The co-efficient of correlation between the body weight and body length, the records being grouped as stated above, is found to be .90.

It is possible, therefore, to infer the body weight from the stature, and *vice versa*, provided the body weight is normal.

At the same time it is evident that body weight is much more open to fluctuations than is the body length, and therefore the body length is the better standard.

2. The relation of the weight of the brain and of the spinal cord to the body length.

We shall consider each division of the central nervous system separately.

(a) The relation of the weight of the brain to the body length.

When the data on brain weight are plotted according to the body length, we obtain the distribution of individual entries (196 males,

TABLE 3.  
CALCULATED BRAIN WEIGHTS AND SPINAL CORD WEIGHTS ACCORDING TO BODY LENGTH IN *MUS NORVEGICUS* VAR. *ALBUS*.  
DATA FOR BOTH SEXES COMBINED.

Body length mm.	Body weight gms. Calculated by Formula (4).	Brain weight gms. Calculated by Formula (8).	Spinal cord weight gms. Calculated by Formula (3).
50	4.5*	.204*	.031*
55	6.6	.409	.047
60	7.8	.522	.059
65	9.7	.660	.077
70	11.7	.827	.088
75	13.9	.962	.106
80	16.6	1.065	.129
90	21.8	1.191	.159
100	28.2	1.288	.194
110	36.6	1.379	.235
120	44.7	1.442	.270
130	55.1	1.504	.305
140	67.4	1.561	.346
150	81.6	1.612	.381
160	102.4	1.675	.428
170	118.7	1.714	.463
180	142.0	1.760	.498
190	169.5	1.811	.539
200	201.3	1.851	.580
210	239.1	1.897	.621
220	283.6	1.942	.656
225	324.0	1.977	.691

\*Since the formulas do not allow of extrapolation toward the lower end of the curve, the averages of the observed values are here employed.

137 females as shown on Chart III. The difference between the two sexes is slight, and in this instance therefore the data for both sexes will be treated together.

The theoretic curve which fits the means most closely has been obtained in the following manner:—

For the body lengths given in Table 3, the body weights were calculated by formula (4) transposed as follows:—

HENRY H. DONALDSON.

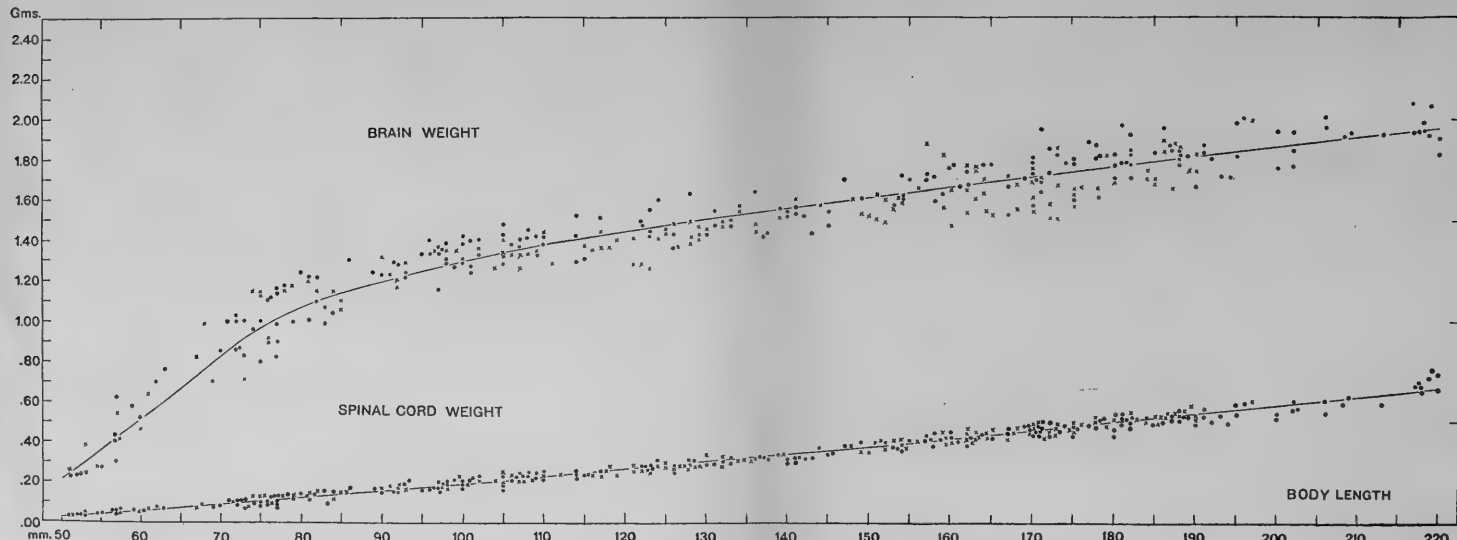

To show in the albino rat, the brain weight and spinal cord weight according to body length. (1) Upper entries, brain. Individual records, 196 males ●, 137 females X. The theoretic curve is based on formula (8). (2) Lower entries, spinal cord, 189 males ●, 137 females X. The theoretic curve is based on formula (3).



$$x = 10 \frac{y + 134}{143} - 15 \dots \dots \dots (4)$$

where  $x$  represents the body weight and  $y$  the body length.

On the basis of the body weights thus determined the weight of the brain can be calculated by the revised formula (8)

$$y = \frac{\log x^{1.56} (x - 8.7)^{.569} - 0.316}{2} + \sum_0^{\infty} \left( \log \frac{x^{1.56}}{(x - 8.7)^{.569}} + 1.424 \right) \left[ \frac{1}{1 + (\log x)^n} - \frac{1}{1 + (\log x)^{n-1}} \right] \dots \dots \dots (8)$$

as given by Hatai, '09, in this number of this journal, in which  $y$  represents the weight of the brain and  $x$  the body weight.

The computation is simpler, however, if we use

$$y = .554 + .569 \log (x - 8.7) \dots (1) \quad (\text{Donaldson, '08})$$

when  $x > 10$ , and a special formula

$$y = 1.56 \log (x) - .87 \dots (7) \quad (\text{Hatai, '09})$$

when  $x < 10$ .

The results obtained from these two formulas are identical with those from formula (8), and are given in the third column of Table 3. The corresponding curve is shown by the continuous line on Chart III.

When the means are determined by the aid of a correlation table, in which the records are arranged in groups differing by 10 mm. in body length and 0.1 gms. in brain weight, the co-efficient of correlation between body length and brain weight is found to be .86, which is high.

(b) The relation of the weight of the spinal cord to the body length.

When the individual records for the weight of the spinal cord are plotted in relation to the body length, we obtain results which are surprisingly regular. See Table 3 and Chart III (189 males, 137 females).

As in the case of the determination of the brain weights, the

body weights used were those calculated by formula (4), and then the theoretical curve which fits these results most closely has been obtained by the use of the formula (3). (Donaldson, '08.)

$$y = .585 \log (x + 21) - 0.795 \quad (3)$$

where y represents the weight of the spinal cord and x the weight of the body.

This curve apparently forms a straight line, though in reality it is a trifle convex towards the base line.

From the correlation table based on groups differing by 10 mm. in body length and .04 gms. in spinal cord weight, we obtain a coefficient of correlation which is .99, being almost perfect.

It will be seen from the foregoing that the weight of the spinal cord can be inferred from the body length with a high degree of accuracy.

In this connection an application of the foregoing data can be made at once. It was noted in a previous paper (Donaldson, '08, p. 360) that for rats of the same body weight, but of different sex, the central nervous system in the male was slightly heavier than in the female. The question naturally arises, therefore, whether there is any somatic character with which this difference in the weight of the central nervous system according to sex can be connected. I shall endeavor to show that in the sex difference in body length we find such a character.

It has been pointed out in the present paper (p. 158) that for the same body weight the males have a slightly greater body length than the females. It will be of interest, therefore, to determine whether this difference in body length is sufficient to account for the difference in the weight of the central nervous system.

It is to be remembered in this connection that when males and females of like body weights are compared, the brain in the male is absolutely heavier, but the spinal cord is absolutely lighter. (Donaldson, '08.)

The relative difference is slightly greater in the case of the spinal cord, but the absolute mass of the brain is so much greater than that of the cord that as a final result the entire central nervous system is found to be heavier in the male.



If we turn now to the preceding Table 2, we find the percentage difference between the body lengths for the two sexes (as determined from the average of the percentage differences between the five pairs ranging from 155 to 205 gms. in body weight) to be 1.74 per cent. in favor of the male. That is, on the average, mature males of a given body weight exceed by 1.74 per cent. in body length females of a like body weight.

If now we select the body length of 193 mm., which is that for the male having a body weight of 185 grams (see Table 2), and consider that this body length is 101.74 per cent. of the corresponding female body length, we find by calculation that the body length of the latter is 189.7 mm., thus giving an absolute difference of 3.3 mm. in favor of the male. In order to determine what difference in the weight of the central nervous system would correspond to this difference in body length, we may refer to the preceding Table 3, where the weight of the nervous system (both sexes combined) is given according to the body lengths. From this table it is possible to determine how much increase in the weight of the nervous system corresponds to an increase of 1 mm. in body length. Taking the entries from the body lengths of 180 to 210 mm., we obtain the following:—

From	Increase in body length	Average increase in the weight of the central nervous system
180-190	1 mm.	.0092
191-200	1 mm.	.0081
201-210	1 mm.	.0087

Average .....	—————	.0087 gms.
---------------	-------	------------

If the average difference in weight for 1 mm., as shown by the table, is .0087 gms., 3.3 mm. would imply an absolute difference of .02871 grams. This amount is 1.20 per cent. of the weight of the nervous system for a rat 195 mm. in body length (this is the mid-value between 180 mm. and 210 mm., the limits taken in the foregoing table). In Table 6, of the previous paper, Donaldson, '08, it appears as an average of all the groups taken in pairs, that for rats of like body weight, but different sex, the entire central

nervous system in the male exceeds that in the female by 1.13 per cent.<sup>1</sup>

It will be seen from the foregoing that the increase in the weight of the nervous system in the female, when the body length is made equal to that of the male, is 1.20 per cent, and the anticipated difference is 1.13 per cent. It follows that the difference according to sex in specimens of like body weight is accounted for by the difference in stature, the female having the smaller central nervous system because the stature of the female is less than that of the male.

When, therefore, the influence of body weight and of stature is taken into account, the weight of the entire central nervous system in the two sexes is similar. It still remains true, however, that there is a characteristic division of this total weight according to sex, whereby the male has a slightly heavier brain, but a lighter spinal cord. These results are in accord with the more recent observations on the human nervous system. (Brain: Blakeman, '05; Lapicque, '08. Spinal cord: Mies, '93; Pfister, '03, and Donaldson, '08.)

#### COMPARISON OF THE BODY LENGTH OF THE ALBINO RAT WITH THE SITTING HEIGHT OF MAN.

The objection is often made that the length measurements on the lower mammals cannot be compared with the measurements of stature in man because of the differences in the relation of the head to the trunk, and of the trunk to the legs.

As a matter of fact, however, the body length (trunk + head) which we have taken in the rat involves measurements of the pelvis, vertebral column and the skull quite comparable with those made in determining the sitting height in man. The chief difference is in the case of the skull which is measured from base to vertex in man, while in the rat the measurement is along the fronto-occipital axis, and so includes the nasal bones. These latter grow a trifle more rapidly than the cranium, especially in the male (Hatai, '07), but

<sup>1</sup>The value of 8 per cent given in Donaldson, '08, page 360, ninth line, is an error. The correct value is 1.13 per cent as given above.

the difference becomes insignificant in comparison with the other parts of the skeleton which contribute so much more to the total result.

We, therefore, conclude that a comparison between the body length of the albino rat and the sitting height of man may be properly made.

The purpose of making such a comparison is to determine whether the rat is similar to man in the way in which this character changes with age.

It is not a character which at the time needs to be studied in detail and so only very general statements are necessary.

In his study on the growth of school children at Worcester, Mass., West ('92) made records for the sitting height in both sexes between the ages of 5 years and 21 years. The results are charted in his Fig. 1 (p. 32) and given in his Table 1 (p. 35).

If we take the average values of the sitting height in man for the two sexes, first at 19 years of age and again at 5 years of age, we find the following:—

Sitting height at 19 years.....	873 mm.
Sitting height at 5 years.....	595 mm.
	—
Difference .....	278 mm.
Percentage gain, 47 per cent.	

For comparison it is necessary to determine the increase in body length in the albino rat during the corresponding interval.

Computing from birth as the zero age, and taking the time unit for the rat on one-thirtieth of that for man (see Donaldson, '06), we obtain the following:—

Nineteen years of human age correspond with 220 days of rat age.

Five years of human age correspond with 60 days of rat age.

Table 9, in Donaldson, '08, shows that 220 days correspond with an average body weight of 234 grams, and of 60 days, with 78 grams. The corresponding body lengths in the rat, as shown in Table 2, are for

234 grams .....	209 mm.
78 grams .....	147 mm.

---

Difference ..... 62 mm.

Percentage gain, 42 per cent.

It appears, therefore, that while the sitting height in man increased 47 per cent during the greater portion of the active growing period, the body length in the rat increased 42 per cent during the corresponding period.

Though not exactly alike, these figures represent changes of the same order, and this is all that we desire to show at the present time. The value of this determination, so far as it can be foreseen, is to indicate that the spinal cord during growth is subject to approximately the same relative amount of passive lengthening in both man and the albino rat.

#### CONCLUSIONS.

1. In the albino rat the ratio obtained by dividing the body weight by the body length diminishes as the body weight increases.

2. Among rats of the same body weight, the males have a slightly greater body length than the females.

3. The correlation between body weight and body length is high, being .90.

4. The correlation between body length and brain weight is high, being .86.

5. The correlation between body length and the weight of the spinal cord is nearly perfect, being .99.

6. The greater weight of the central nervous system in male, as compared with female rats of like body weight, is completely explained by the greater body length of the males. This result agrees with the more recent observations on man.

7. The relative increase in the body length of the rat during active growth is similar to the increase in the sitting height of man during the corresponding period. Hence, in both forms, the

spinal cord is subject to a corresponding amount of passive lengthening.

8. The body length is a better datum than the body weight from which to infer the weight of the brain or of the spinal cord. This is especially true when there is any reason to suspect emaciation of the body.

9. A mean of the two determinations of the weight of the brain or of the spinal cord (1) from the body weight (when normal) and (2) the body length, will give better approximations than the determination based on either datum alone.

#### BIBLIOGRAPHY.

BLAKEMAN, J.

1905. A study of the biometric constants of English brain-weights, and their relationships to external physical measurements. *Biometrika*, vol. 4, pp. 124-160.

DONALDSON, H. II.

1906. A comparison of the white rat with man in respect to the growth of the entire body. *Boas Memorial Volume*, pp. 5-6.
1908. A comparison of the albino rat with man in respect to the growth of the brain and of the spinal cord. *Journ. Comp. Neurol.*, vol. 18, no. 4, pp. 345-392.

HATAI, S.

1907. Studies on the variation and correlation of skull measurements in both sexes of mature albino rats (*Mus norvegicus* var. *albus*). *Amer. Journ. Anat.*, vol. 7, no. 4, pp. 423-441.
1908. Preliminary note on the size and condition of the central nervous system in albino rats experimentally stunted. *Journ. Comp. Neurol.*, vol. 18, no. 2, pp. 151-155.
1909. Note on the formulas used for calculating the weight of the brain in the albino rats. *Journ. Comp. Neurol.*, vol. 19, no. 2.

MIES, J.

1893. Ueber das Gewicht des Rückenmarkes. *Centralbl. f. Nervenheilkunde u. Psychiatric*, S. 1-4.

PFISTER, H.,

1903. Zur Anthropologie des Rückenmarks. *Neurol. Centralbl.*, Bd. 22, S. 757 und 819.

WEST, G. M.

1892. Anthropometrische Untersuchungen über die Schulkinder in Worcester, Mass., Amerika. *Archiv f. Anthropologie*, vol. 22, pp. 13-48.



NOTE ON THE FORMULAS USED FOR CALCULATING  
THE WEIGHT OF THE BRAIN IN THE  
ALBINO RATS.

BY

SHINKISHI HATAI.

*Associate in Neurology at The Wistar Institute.*

In previous papers (Hatai, '08; Donaldson, '08) the formulas for calculating the weight of the brain and of the spinal cord in relation to the body weight were determined on the assumption that the amount of increment to the weight of these parts is proportional to the reciprocal of the body weight plus a constant or

$$\frac{dy}{dx} = h \frac{1}{(x + a)} \dots\dots\dots (1)$$

where  $y$  is the weight of the brain or spinal cord in grams and  $x$  the weight of the body in grams.

Integration of (1) gives at once the value of  $y$ .

Thus:

$$y = h \int \frac{1}{(x + a)} dx = h \log (x + a) + c$$

or in our previous notation (Donaldson, '08):

$$y = A + C \log (x + \beta) \dots\dots\dots (2)$$

This type of logarithmic formula has been used by the present writer ('08) and Donaldson ('08) and was found to be very satisfactory for representing the relation between the body weight and the weight of the brain or spinal cord.

This type was further employed by Donaldson ('09) to represent the relation between the body weight and body length and was proved by him to be satisfactory.

The formula in each case was as follows:

Brain weight or  $y = .569 \log (x - 8.7) + 0.554 \dots \dots \dots (3)$

Spinal cord weight or  $y = .585 \log (x + 21) - 0.795 \dots \dots \dots (4)$

Body length or  $y = 143 \log (x + 15) - 134 \dots \dots \dots (5)$

Although the formulas (4) and (5) are entirely free from theoretical objections within the interval  $x = (5 \text{ grams, } 325 \text{ grams})$ , the formula (3), however, has two defects when we apply it to the case of  $x < 8.7$ . The first defect, which appears when  $x$ , the body weight, is less than 8.7 grams, is due to the fact that the resulting value of  $(x - 8.7)$  becomes a negative quantity and the logarithm of such a quantity is necessarily imaginary. The difficulty thus presented is, however, merely a theoretical one, since for the purpose of computation the following method may be employed.

Let us consider the two cases when  $x$  is greater than  $a$  and when  $x$  is less than  $a$  then we have

(A)  $\frac{dy}{dx} = \frac{h}{(x-a)}$  when  $x > a$

(B)  $\frac{dy}{dx} = \frac{h}{(a-x)}$  when  $x < a$

Then integration of (A) leads to the formula (3) which we have already obtained, that is

$$y = A + C \log (x - B) = .554 + .569 \log (x - 8.7)$$

while the integration of (B) becomes

(C)  $y = A - C \log (\beta - x) = .554 - .569 \log (8.7 - x)$

The formula (C) thus obtained gives results identical with those obtained when we compute the value of  $y$  from the formula

(D)  $y = .554 + .569 \log (-C)$

In this case, of course, with an understanding that  $\log (-C)$  should be treated as equivalent to  $-\log C$ .

As long as the results obtained by the formula (C) agree with those obtained by the formula (D), the following procedure is justified.



In the formula (3), when the variable  $x$  is less than a constant  $C$ , or in this case 8.7, we can take the logarithm of the real positive number ( $C$ ) and put a negative sign before it, *i. e.*,  $.569 \log(-C) = -.569 \log C$  where  $-C = (x - 8.7)$ .

With the foregoing understanding, the formula can thus be applied even in the case of a rat, the body weight of which is less than 8.7 grams.

There remains, however, a second defect in this formula (3) which cannot be overcome.

When the value of  $x$  lies between 7.7 and 9.7 grams, the formula fails to represent the observed values on account of sudden change in the course of the resulting curve. Although this interval is very small when we consider the whole extent of the curve, yet it prevents the general application of the formula.

In Chart I, Plate II, in the paper by Donaldson, '08, the curve representing the change in the brain weight between the body weights of 5 and 10 grams was completed by simply joining the two points, both of which had been carefully calculated by the formula (3), and it was not until we came to consider the formula in another connection that we appreciated the impossibility of applying it to this interval.

I have now obtained a revised formula which is free from the foregoing objections. At the same time it should be stated that the values obtained by this new formula do not differ from the values so far as computed by the previous formula (3), or as given by the ideal line by which the curve was previously completed.

I shall present first the theoretical considerations touching the revised formula. Let us consider the series

$$S = \frac{\psi(z) + \phi(z)}{2} + \sum_0^{\infty} [\psi(z) - \phi(z)] \left[ \frac{1}{1+z^n} - \frac{1}{1+z^{n-1}} \right] \dots \dots \dots (6)$$

where  $\psi(z)$  and  $\phi(z)$  are (some) functions of  $z$ . The sum of the first  $n$  terms of  $S$  becomes obviously

$$S_n = \phi(z) + \frac{\psi(z) - \phi(z)}{1+z^n}$$

When  $(z) < 1$ , the limit of  $z^n$  is zero for  $n = \infty$  and consequently  $s = \psi(z)$ .

On the other hand, where  $(z) > 1$ ,  $z^n$  tends to  $\infty$  and therefore in this case  $S = \phi(z)$ . (See Jordan "Course d'analyse," Tome I, p. 320.)

We have shown already that the brain weights in rats in which the body weights are greater than 10 grams, can be calculated by the formula

$$y = .569 \log (x - 8.7) + 0.554 \dots \dots \dots (3)$$

Later we found that the brain weights in rats in which the body weight lay between 5-10 grams may be calculated by a special formula for this portion of the curve, namely:

$$y = 1.56 \log (x) - .87 \dots \dots \dots (7)$$

and therefore in the two formulas (3) and (7)  $y$  can be considered as the function of  $\log x$ .

The values calculated by the latter formula (7) agree perfectly with the ideal line which completes the brain-weight curve between 5 and 10 grams of body weight.

As has been shown already, the formula (6) is perfectly general in its application when two conditions are satisfied; namely, when  $|z| > 1$  in one case and  $|z| < 1$  in the other.

We also found that not only are the two formulas (3) and (7) functions of  $\log x$ , but that (1) is applicable to rats in which the body weights are more than 10 grams or  $|\log x| > 1$ , while formula (7) is applicable to rats in which the body weight is less than 10 grams or  $|\log x| < 1$ . This satisfies all the necessary conditions.

Thus a combination of the two formulas (3) and (7) will enable us to calculate the brain weight for any given body weight from 5 grams to 320 grams. (Extrapolation may be used towards the upper end of the curve).

The final formula is represented by the following:—

$$y = \frac{\log x \cdot \frac{1.56}{2} (x - 8.7) - 0.316}{2} + \sum_0^{\infty} \left( \log \frac{x^{1.56}}{(x - 8.7)^{.569}} + 1.424 \right) \left[ \frac{1}{1 + (\log x)^n} - \frac{1}{1 + (\log x)^{n-1}} \right] \dots \dots \dots (8)$$

in which  $y$  represents the brain weight and  $x$  the body weight.

As to the actual use of the above formula, I may add the following remarks.

As was mentioned already, the series reduces to

$$\phi(\log x) = .569 \log(x - 8.7) + 0.554$$

when  $(\log x)$  is greater than 1; while, on the other hand, the series reduces to

$$\psi(\log x) = 1.56 \log x - .87$$

when  $(\log x)$  is less than 1. Therefore it is only necessary to note whether we are treating rats in which the body weights are greater or less than 10 grams.

If the body weight is greater than 10 grams, we can simply use

$$\phi(\log x) \text{ or } y = .569 \log(x - 8.7) + 0.554$$

and if it is less than 10 grams, the other formula

$$\psi(\log x) \text{ or } y = 1.56 \log x - .87$$

Of course, one can determine the brain weight directly from the formula (8) after some laborious calculation; nevertheless such a procedure has no advantage over the simpler process described above.

The present formula (8) is desirable simply, first, because it is free from the theoretical objections; and, second, because by it we can express the complicated relations existing between the body and brain under a single generalized form.

#### BIBLIOGRAPHY.

DONALDSON, H. H.

1908. A comparison of the albino rat with man in respect to the growth of the brain and of the spinal cord. *J. of Comp. Neurol.*, vol. 18, no. 4.

1909. On the relation of the body length to the body weight and to the weight of the brain and of the spinal cord in the albino rat (*Mus norvegicus* var. *albus*). *J. of Comp. Neurol.*, vol. 19, no. 2.

HATAI, S.

1908. Preliminary note on the size and condition of the central nervous system in albino rats experimentally stunted. *J. of Comp. Neurol.*, vol. 18, no. 2.



# THE NERVUS TERMINALIS (NERVE OF PINKUS) IN THE FROG.

BY

C. JUDSON HERRICK.

*From the Anatomical Laboratory of the University of Chicago.*

WITH TEN FIGURES.

A ganglionated nerve connected with the forebrain and intimately associated with the nervus olfactorius has been described in nearly all groups of fishes. The first clear description of such a nerve is that of Pinkus ('94) for Protopterus. It was termed the *nervus terminalis* by Loey, in 1905, and accurately described in twenty genera (27 species) of selachians, and it was mentioned by Allis ('97) as occurring in *Amia*. Brookover ('08) has described it more fully in *Amia* and *Lepidosteus* and at the meeting of the Association of American Anatomists in Baltimore, December, 1908, Brookover and Sheldon reported the presence of a similar nerve in the teleosts. Further literature on the subject is cited by the authors mentioned.

Ernst de Vries ('05) described a transitory ganglion on the vomeronasal nerve of mammals and suggested that the nerve of the organon vomeronasale (Jacobson's organ) of higher vertebrates is homologous with the nervus terminalis of fishes. Since, however, the organon vomeronasale of mammals is lined with sensory epithelium of the same type as the undoubted olfactory parts of the nose and gives rise to nerve fibers indistinguishable from other fila olfactoria (Read, '08), it is probable that its innervation does not differ from that of the other parts of the olfactory organ. In this case it is difficult to see how the nerve of the organon vomeronasale can be compared with the nervus terminalis of fishes, for the latter fibers are not known to connect with the specific cells of

the olfactory mucous membrane, they bear a ganglion on their course and centrally, in most if not in all cases, they do not connect with the olfactory bulbs but with the brain farther caudad in the vicinity of the recessus preopticus or lamina terminalis. It may, therefore, be concluded that, while the nervus terminalis occurs in fishes generally, its presence has not hitherto been demonstrated in the adults of any forms above the fishes.

In examining preparations of the brain of the frog prepared by the Golgi method I found an impregnation of nerve fibers which conform so closely to the central course of the nervus terminalis of selachians and dipnoans that I have no hesitation in considering them homologous. In the first series of sections in which this nerve was seen its fibers were completely impregnated on both right and left sides from a position rostrad of the olfactory bulbs to their decussation in the lamina terminalis; and, since the olfactory nerves and tracts were for the most part unimpregnated, the course of the nervus terminalis could be followed with precision. These findings were subsequently verified in several series of adult and larval frogs, as follows:

Transverse sections of adult *Rana pipiens* by the Golgi method (the series referred to above, Figs. 1 to 7).

Sagittal sections of adult *Rana pipiens* by the Golgi method.

Transverse sections of the adult *Rana pipiens* by the Weigert method. In this series the process of decolorization of the sections was incompletely carried out, leaving considerable color in the background, so that, though the intra-cerebral course of the nervus terminalis is unmedullated, the course of the tract could nevertheless be followed with precision. Other series of Weigert sections permitted the nerve to be identified where it enters the brain, but not through the brain substance, on account of the complete decolorization of its fibers.

Transverse sections of a half-grown frog tadpole by the Golgi method, illustrating the whole central course of the nerve and its free terminal arborizations in the lamina terminalis (Figs. 9 and 10).

Horizontal sections of an old larva of *Rana catesbiana* 30 mm.

long, stained with Delafield's hæmatoxylin and erythrosin (Fig. 8).

In these five specimens all, or nearly all, of the intra-cerebral course of this nerve was followed on both the right and the left sides. In several other specimens, both larval and adult, smaller portions of the nerve were also seen. For all of the sections on which this work is based I am indebted to the skill of my assistant, Mr. P. S. McKibben. The findings are briefly these.

In the series of transverse sections made by the Golgi method through the brain of the adult frog first referred to, at the level of the olfactory bulbs (Figs. 3 and 4), there is impregnated a compact fascicle of a few (probably less than 40) unmyelinated nerve fibers on each side, lying between the meninges and the ventral surfaces of the olfactory bulbs. This is the *nervus terminalis*. When followed caudad the nerves of the right and left sides are found to be similar; but rostrad they exhibit slight differences.

On the left side at the extreme rostral end of the olfactory bulb the *nervus terminalis* has separated from the meninges and joined one of the small fascicles of *fila olfactoria* on the ventral border of the *nervus olfactorius* (Fig. 2). None of the *fila olfactoria* of this fascicle are impregnated, so that it is easy to follow the *nervus terminalis* separately on this side. Scattered *fila olfactoria* are impregnated in other parts of the *nervus olfactorius* and these are indistinguishable in appearance from the fibers of the *nervus terminalis*. Less than 1 mm. rostrad of the olfactory bulb (Fig. 1) the *nervus terminalis* passes from the ventral to the medial aspect of the *nervus olfactorius*, still embedded in its marginal layer, and here it disappears from view. At about this level the impregnated *fila olfactoria* also lose their stain, so that it is probable that the *nervus terminalis* continues farther rostrad in the *nervus olfactorius*, though its fibers are not farther impregnated in my preparations.

On the right side the relations are essentially the same, but not so clearly demonstrable on account of the fact that impregnated *fila olfactoria* mingle in some places with the fibers of the *nervus terminalis* and the latter is not so compact a fascicle. Its fibers

lie somewhat more deeply embedded in the nervus olfactorius than those of the left nerve. They curve dorsad and mesad before disappearing, as on the other side.

Passing caudad, the fila olfactoria enter the bulbus olfactorius, but the fibers of the nervus terminalis separate from them ventrally and constitute a small compact bundle of fibers lying in the meninges ventrally of the olfactory bulbs (Figs. 3 and 4). This position is maintained until they have passed caudad of all of the formatio bulbaris (glomerular formation) of the olfactory bulbs, where they turn abruptly dorso-mesad and enter the substance of the cerebral hemisphere at its ventro-medial border. The point of entrance of these fibers varies somewhat in different specimens. It is in the adult always farther caudad than any of the formatio bulbaris of the ventral and medial aspects of the olfactory bulbs, and in all but one of the observed cases farther caudad than the formatio bulbaris of the bulbus accessorius on the lateral aspect of the olfactory bulb.

Having entered the brain, the nervus terminalis passes caudad (Fig. 5), turning slightly dorsad and laterad in its course, embedded in the ventral part of the hemisphere about midway between the ventral border of the lateral ventricle and the medial wall of the hemisphere. The fibers of the tractus olfactorius medialis lie ventrally and medially of it and those of the median forebrain bundle dorsally of it. Upon reaching the lamina terminalis (Fig. 6), it ascends more rapidly between the lateral forebrain bundle and the crossed portion of the medial forebrain bundle to enter the middle part of the anterior commissure complex dorsally of the pre-optic recess, where it decussates (Fig. 7). The fibers can be clearly traced across the meson in a compact bundle, but their exact place of termination has not been determined. These relations were confirmed in every detail in the transverse Weigert series, and in everything except the decussation in the anterior commissure in the sagittal Golgi series.

In one of my series of transverse sections through the brain of the adult *R. pipiens* prepared by the method of Cajal the nervus terminalis can be followed in its course through the cerebral hemi-



sphere on one side. Neither the fila olfactoria nor the fibers of the nervus terminalis are stained, and therefore the peripheral relations cannot be determined. The nervus terminalis (unstained) is seen to detach itself from the olfactory nerve under the olfactory bulb and to pass back to the lamina terminalis exactly as already described. Within the brain it is surrounded by a dense mass of deeply stained fibers belonging to the secondary olfactory and other systems, so that it can easily be followed back to its decussation as a clear yellow area surrounded by a dark field of impregnated fibers.

Professor J. B. Johnston informs me that in 1905 he observed a similar nerve in Golgi sections of the adult frog brain; but since he had no control of this single observation, it was not published.

In the Golgi sections of the young larva (Figs. 9 and 10) the nervus terminalis is seen to enter the lamina terminalis and there its fibers arborize, some of the free termini crossing the meson and some remaining uncrossed. Other histological preparations of the larva show that the cells in the region of these arborizations are much crowded, forming the nucleus medianus septi. It is probable that in the adult also the nerve ends in the nucleus medianus septi, either wholly crossed or partly crossed and partly direct, as in the tadpole.

In the horizontal series of sections through the brain of an old larva of *Rana catesbiana* stained with hæmatoxylin and erythrosin very nearly the whole intra-cerebral course of the nervus terminalis is shown in four consecutive sections, as seen in Fig. 8. The nucleus medianus septi does not appear here. It lies immediately dorsally of the plane figured as a dense mass of cells which crosses the median plane in the lamina terminalis directly ventrally of the foramen of Monro.

The relations of the nervus terminalis of the larva are essentially similar, so far as observed, to those of the adult frog, save that the nerve enters the brain relatively farther rostrad and farther laterad in the larva. Fig. 8 shows it penetrating the formatio bulbaris rostrad of the bulbulus accessorius. It seems probable to me that the point of entrance of the nervus terminalis remains relatively

fixed, the changed relations of the adult being due to a farther growth of the olfactory bulbs rostrad rather than to a recession of the nervus terminalis caudad. In the adult the olfactory capsules lie far rostrad of the olfactory bulbs, while in the larva they lie in about the same transverse plane, the olfactory nerves passing out to them almost laterally.

In none of my preparations have I been able to trace the fibers of the nervus terminalis distally more than about 1 mm. beyond the olfactory bulbs. I have not examined the peripheral relations of the olfactory nerve and nasal capsules in the adult frog. In several preparations of frog tadpoles (probably *R. pipiens*) I have found cells scattered along the peripheral course of the nervus olfactorius which differ from the sheath cells of the fila olfactoria. The clearest case observed is a large tadpole taken just before the metamorphosis, which was prepared by the method of Cajal and cut into horizontal sections. Scattered along the ventral surface of the olfactory nerve in the middle part of its course are more than 100 nuclei which differ conspicuously from the sheath nuclei among which they lie, being round or broadly oval and twice as wide as the narrowly oblong sheath nuclei. They are scattered along the olfactory nerve from its foramen through the skull to the point where it breaks up to spread over the olfactory mucous membrane. From the similarity of these nuclei to those found by Brookover on the nervus terminalis of ganoids and teleosts I incline to regard them as belonging to ganglion cells of the nervus terminalis of the frog, though I have not been able to demonstrate their fibrous connections.

The exact central connection of the nervus terminalis also demands further investigation. The single impregnation of the terminal arborizations in the lamina terminalis of the young larva is not altogether conclusive and this observation must be verified and extended before much weight can be given to it. One is, however, struck by the similarity between this observation and the descriptions of Loey of the central relations of the nervus terminalis in the selachians.

In conclusion, it seems clear that the nerve here described in

the frog is morphologically similar to the nervus terminalis of fishes, so far as our information extends.

## LITERATURE CITED.

- ALLIS, E. P.  
1897. The cranial muscles and cranial and first spinal nerves in *Amia calva*. *Journ. Morph.*, vol. 12, no. 3.
- BROOKOVER, C.  
1908. Pinkus's nerve in *Amia* and *Lepidosteus* (Abstract.) *Science*, N. S., vol. 27, no. 702, p. 913.
- LOCY, W. A.  
1905. On a newly-recognized nerve connected with the forebrain of selachians. *Anat. Anz.*, vol. 26, nos. 2 and 3.
- PINKUS, F.  
1894. Ueber einen noch nicht beschriebenen Hirnnerven des *Protopterus annectens*. *Anat. Anz.*, vol. 9, no. 18, pp. 562-566.
- READ, EFFIE, A.  
1908. A contribution to the knowledge of the olfactory apparatus in dog, cat and man. *Am. Journ. of Anat.*, vol. 8, no. 1.
- DE VRIES, E.  
1905. Note on the ganglion vomeronasale. *Proc. of the Section of Science, kon. Akad. van Wetenschappen, Amsterdam*, vol. 7, part 2.

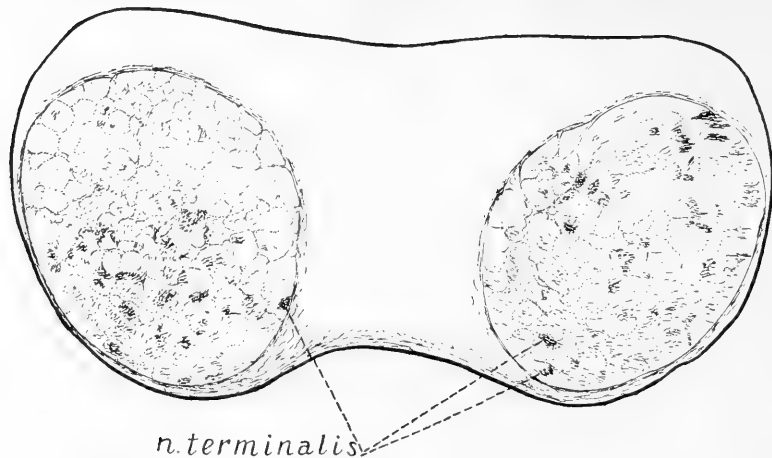

FIGS. 1 TO 7. A series of transverse sections through the brain of adult *Rana pipiens* prepared by the Golgi method, to illustrate the central course of the nervus terminalis. All except Fig. 1 are drawn to the same scale.

FIG. 1. Through the olfactory nerves about 1 mm. rostrad of the olfactory bulbs.  $\times 60$ .

Each olfactory nerve is broken up into numerous fasciculi, some of the larger of which are indicated by the dotted outlines. A small proportion of the fibers of the olfactory nerve (fila olfactoria) are impregnated, some of these fibers being scattered singly among the fasciculi of the nerve, others aggregated into more or less definite bundles. The fascicle marked *n. terminalis* on the left side is unmixed with fila olfactoria; on the right side the two fascicles so designated are probably of mixed character.

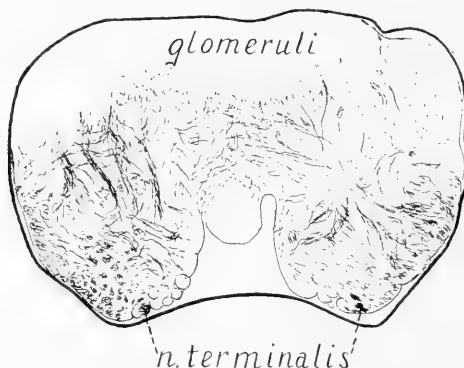

FIG. 2. Through the olfactory nerves just at their entrance into the olfactory bulbs.  $\times 30$ .

The most rostrally placed glomeruli occupy the dorsal part of the section. The fila olfactoria occupy the middle and ventral parts of the section and only a few of them are impregnated. The nervus terminalis is embedded in the most ventral part of each olfactory nerve and all of its fibers are impregnated.

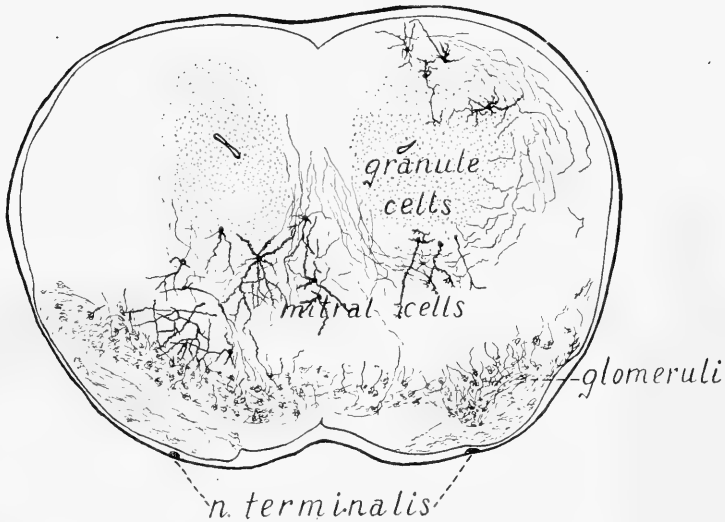

FIG. 3. Through the olfactory bulbs at the level of the rostral ends of the rhinocœles.  $\times 30$ .

The stippled area surrounding each rhinocœle indicates the extent of the layer of granule cells, most of which are not impregnated in the preparation. A few impregnated granules are drawn on the right side. Several typical neurones of the mitral cell layer are drawn on the left side. Fibers of the tractus olfactorius pass dorsad from all parts of the mitral cell layer. The glomerular layer lies farther ventrally, while the layer of fila olfactoria occupies the extreme ventral part of each bulb. The nervus terminalis has separated from the fila olfactoria on each side and lies between the latter and the meninges.

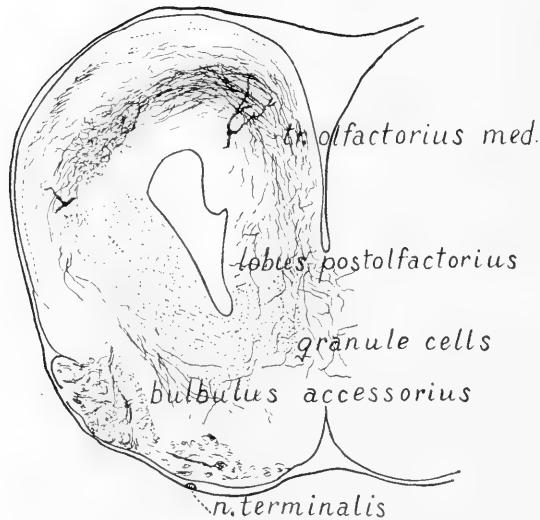

FIG. 4. Through the olfactory bulbs at the level of the rostral end of the bulbulus accessorius.  $\times 30$ .

The layer of granule cells is indicated by the stippled area, ventrally of which is the layer of mitral cells (unimpregnated). The dorsal half of the section is occupied by secondary olfactory cells, two of which are imperfectly impregnated. The fibers of the lateral secondary olfactory tracts are not impregnated. They lie chiefly along the dorso-lateral border of the section external to the dotted line. The olfactory glomeruli are limited to the extreme ventral part of the section. The nervus terminalis lies still farther ventrally close to the meninges.

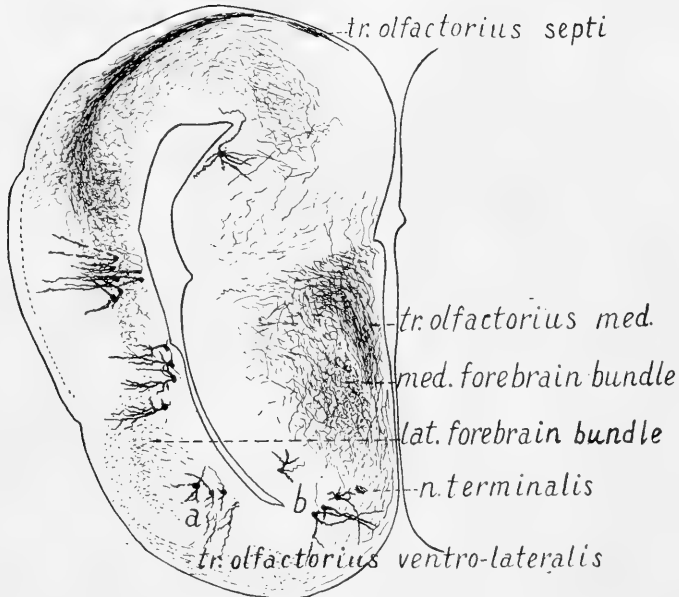

FIG. 5. Through the cerebral hemisphere between the olfactory bulb and the lamina terminalis.  $\times 30$ .

The lateral and medial basal forebrain bundles are impregnated and the neurones marked *a* and *b* send their axones into these two bundles respectively. The tract marked *tr. olfactorius medialis* contains also other elements, particularly olfactory fibers of the third order for the nucleus medianus septi. The ventral fibers of the lateral secondary olfactory tract are impregnated, but not the dorsal fibers of this tract. The nervus terminalis lies ventrally of the median forebrain bundle and laterally of the *tr. olfactorius medialis*.

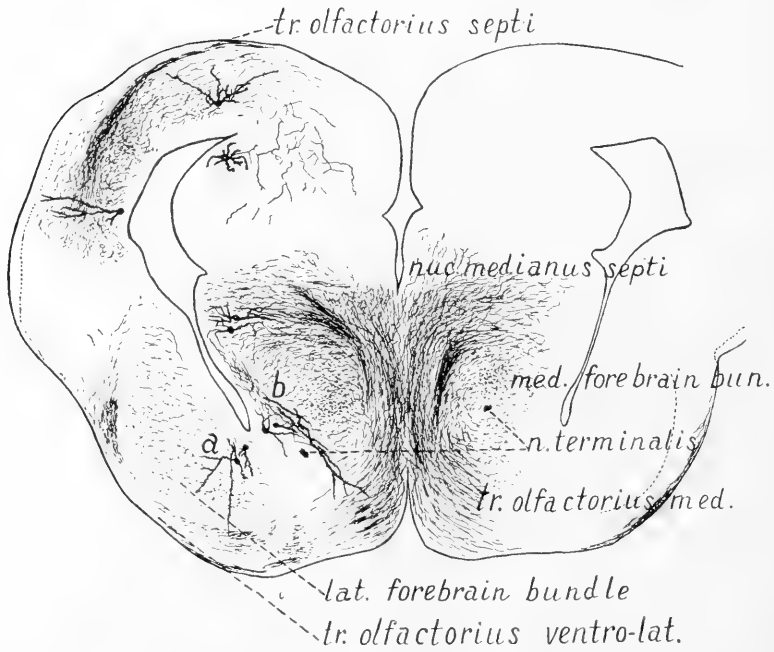

FIG. 6. Through the most rostral part of the lamina terminalis.  $\times 30$ .

The tract marked *medial forebrain bundle* on the right side is composed chiefly of the crossed portion of this tract (cf. fig. 7). Fibers of the uncrossed portion of this tract arise from the cells marked *b* on the left side. As in fig. 5, the tract marked *tr. olfactorius medialis* contains also tertiary olfactory fibers for the nucleus medianus septi.



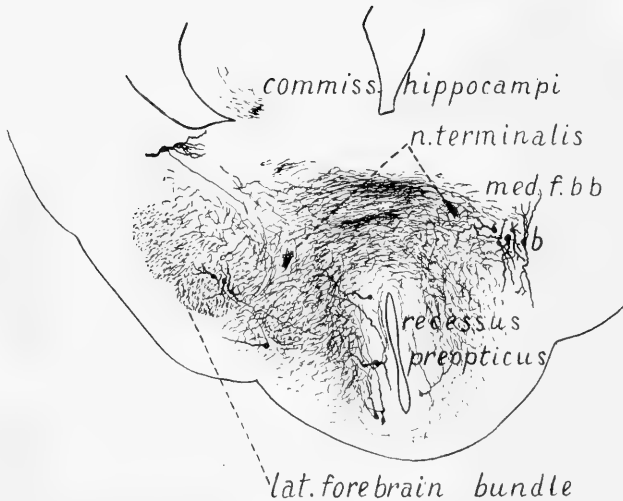

FIG. 7. Section immediately rostral to the decussation of the nervus terminalis in the lamina terminalis.  $\times 30$ .

The decussation of the medial forebrain bundle (*med. f. b. b.*) occupies the ventral part of the lamina terminalis. The commissura hippocampi (dorsal commissure) is approaching the lamina terminalis from the dorsal side. The other elements of the anterior commissure complex lie farther caudad.

FIG. 8. Composite drawing of horizontal sections through the brain of a tadpole of *Rana catesbiana* about 30 mm. long, to show the central course of the nervus terminalis.  $\times 50$ .

The specimen was beginning the metamorphosis when preserved, having the hind leg buds about 6 mm. long. Sections were cut in the horizontal plane 30 microns thick and stained with Delafield's hæmatoxylin followed by erythrosin. In these sections the nuclei of the cells are clearly stained and some of the forebrain tracts. Among the latter is the nervus terminalis on both sides. Distally this nerve can be followed only a very short distance after leaving the brain, its fibers being mingled with fila olfactoria and indistinguishable from them, both being unmyelinated. Centrally the nerve can be followed back to the lamina terminalis, where it plainly decussates in the anterior commissure.

All of the details of this figure are taken from section 19 of the series, except parts of the nervus terminalis which are taken from the neighboring sections whose numbers they bear. Section 19 shows the nerve at its point of entrance into the rostral end of the hemisphere and also its decussation in the lamina terminalis. With the aid of the camera lucida I have projected upon the outline of this section the remainder of the intra-cerebral course of the nerve, which is all included within the three sections lying next ventrad (sections 20, 21 and 22). Three elements of the anterior commissure complex are shown, the decussation of the nervus terminalis, the decussation of the lateral forebrain bundle and the commissure of the corpora striata. The decussation of the medial forebrain bundle lies in the plane of the section, but it is not stained in the preparation; cf. fig. 7.

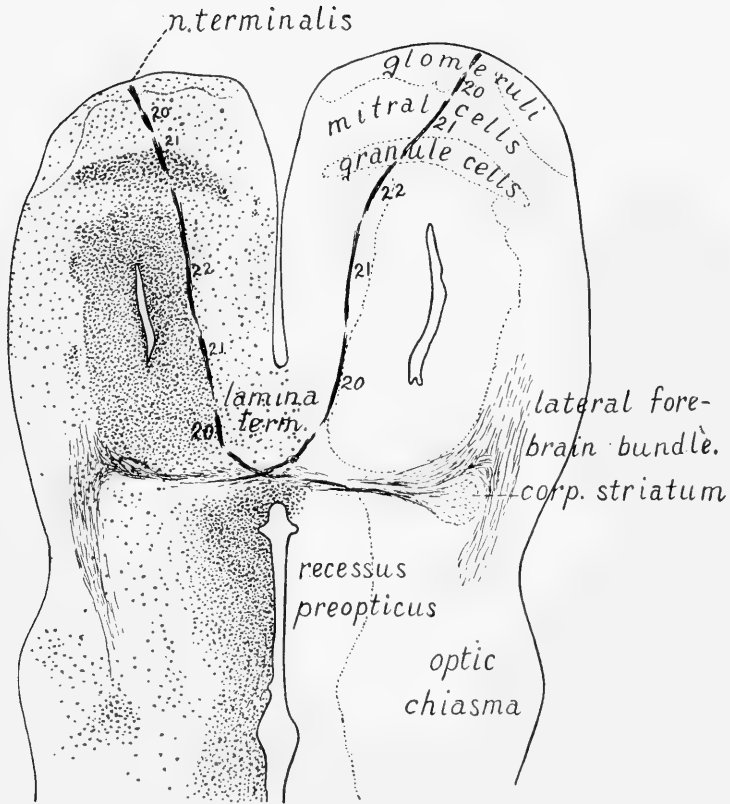



FIG. 9. A transverse section through the brain of a half-grown frog tadpole, taken just behind the olfactory bulbs. Golgi method.  $\times 70$ .

The nervus terminalis is shown immediately after its entrance into the cerebral hemisphere. A few fibers of the tractus olfactorius are impregnated ventrally of it.

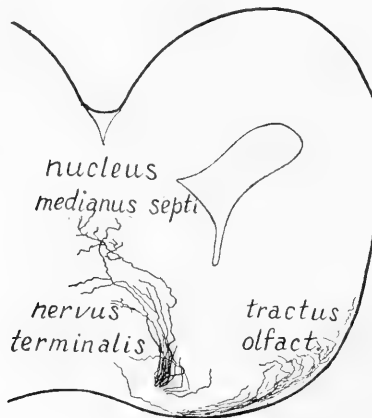

FIG. 10. The section following immediately caudad of the one shown in fig. 9.  $\times 70$ .

The section is very thick and shows almost the whole central course of the nervus terminalis and its ending by free arborizations in the nucleus medianus septi. The tractus olfactorius lateralis is also impregnated.

## THE NERVUS TERMINALIS IN THE CARP.

BY

R. E. SHELDON.

*From the Anatomical Laboratory of the University of Chicago.*

WITH SEVEN FIGURES.

Fritsch figured in 1878 the stump of a nerve arising mesad of the olfactory from the rostral aspect of the brain of *Galeus canis*. This he called an "überzähliger Nerv." Our present knowledge concerning it is, however, due almost entirely to the work of the last few years, during which its existence has been demonstrated in group after group among the lower vertebrates. Pinkus, '94, '95, in *Protopterus* was the first to trace and describe the entire course of the nerve which he called simply, "ein neuer Nerv." Allis, '97, found the nerve in *Amia* but added nothing concerning its structure and connections, naming it, however, the nerve of Pinkus. Loey, '99, in *Acanthias* described a nerve, closely associated with the olfactory, as in the cases previously reported, but ganglionated. Pinkus had found cells in connection with the nerve in *Protopterus*, but hesitated to call them a ganglion. In 1902 Sewertzoff described in *Ceratodus* embryos a similar ganglionic nerve which he named the *nervus preopticus* owing to the fact that it appears to arise near the preoptic recess in Dipnoans. Later, Burekhardt, in 1905, found the same nerve in adult *Ceratodus*. Loey in several papers, '03, '05a, '05b, takes up in detail its occurrence in different groups of selachians, its peripheral and central connections and its embryonic history. He pointed out its homology with the nerve of Pinkus in *Protopterus* and *Amia* and the *nervus preopticus* of *Ceratodus*, proposing for it the name of *nervus terminalis*. Brookover, '08, demonstrated a ganglion for the nerve in *Amia* and *Lepidosteus*, adding also to our knowledge of its peripheral connections.

Until very recently, however, its presence in forms other than the selachians, ganoids and dipnoans has not been demonstrated. At the Baltimore meeting of the Association of American Anatomists, in a joint paper, Brookover and I reported its existence in teleosts, describing its ganglion, and peripheral and central connections. At the same time Herrick showed that it is also present in both the larval and adult frog.

This paper takes up in detail the central course of the nerve in the carp, *Cyprinus carpio*. It consists entirely of a tract of unmedullated fibers which was traced by means of the following methods and material.

1. Weigert method.

(a) Four transverse series of the entire olfactory crura, bulbs and nasal capsules of adult individuals about 50 cm. in length.

(b) Two longitudinal series through the olfactory bulbs and capsules of similar adults.

(c) Two transverse series through the cerebral hemispheres of adults.

(d) One transverse series through the entire head of a young carp about 2 cm. in length.

These were stained by a modification of the straight Weigert method which left the unmedullated fibers a reddish brown. This method was particularly valuable, as the tract is, for most of its extent, surrounded by medullated fibers from which it stands out quite distinctly.

2. Vom Rath method.

One transverse and one longitudinal series through the olfactory crura, bulbs and capsules of an adult about 30 cm. in length. This method also gave good results, as the unmedullated fibers appear lighter in color than the medullated.

3. Cajal method.

Two transverse series through the cerebral hemispheres of an adult about 35 cm. long. In my preparations the *nervus terminalis* is an orange yellow, while the medullated fibers surrounding it are nearly black. These series were of especial value in showing the decussation of the nerve in the anterior commissure.

4. Toluidin blue and thionin methods.

(a) Two transverse series through the bulbs and capsules in an individual of 35 cm. length.

(b) One longitudinal series through the bulbs and capsules of a fish 30 cm. long.

(c) One transverse series through the hemispheres of an individual 40 cm. in length.

By these two methods one can easily demonstrate the peripheral ganglion and the nucleus in which the fibers end centrally.

As noted in the paper reported before the Association of American Anatomists, numerous scattered ganglionic cells are found on the ventro-median side of the olfactory nerve about half way between the formatio bulbaris and the olfactory capsule. Cells of the same type are also found caudad to the glomerular region and rostrad to the nasal capsules, diminishing rapidly in numbers, however, as one passes caudad or rostrad from the main group of cells. It was also noted that Cajal preparations show coarse fibers which can be traced from these cells rostrad to the olfactory mucous membrane, where they are distributed to the epithelium with the olfactory nerve fibers.

The tract which forms the central course of the nerve is easily distinguished about half way between the caudal and cephalic ends of the olfactory bulb on its ventro-median side. Here it is surrounded by the medullated fibers of the tractus olfacto-lobaris medialis as shown in Fig. 1. Rostrad of this point, however, it is soon lost, as the medullated fibers either end or seek a new position, leaving the nerve surrounded only by the unmedullated fibers of the olfactory nerve. Scattered among these fibers in this region are the cells of the peripheral ganglion. As the tract passes caudad from the bulb it continues to hold its position on the ventro-median aspect but migrates peripherally until it lies next the meninges, surrounded on three sides, however, by the tractus olfacto-lobaris medialis (Fig. 2). This relation holds throughout the length of the olfactory crus (see Fig. 3). On reaching the cerebral hemispheres the tract turns dorso-laterad through the tractus olfacto-lobaris medialis to lie, for a time, between the latter and the radix olfactoria medialis propria (Fig. 4). It holds this position for some

distance lying partly enclosed by the tractus olfacto-lobaris medialis. When the anterior commissure is reached, however, it turns abruptly mesad (Fig. 5) and largely decussates in the mid-line (Fig. 6) in the most rostral part of the commissure. Part of the fibers apparently do not cross but end on the same side. The exact termination of the fibers could not be demonstrated. It is certain, however, that they end close to the mid-line, without doubt in the dense nucleus of small cells shown in Fig. 7.

As was stated in the earlier report, it should be noted that the connection between the central tract and the peripheral ganglion with its fibers has not been established and cannot be except by fortunate Golgi or Cajal preparations. There can be little doubt, however, that this is the nervus terminalis for the following reasons. The ganglion and peripheral distribution of the fibres are identical with the condition found by Brookover in *Amia* and *Lepidosteus* in connection with what is undoubtedly the nervus terminalis. It is also similar to that described for *Protopterus* by Pinkus, for *Ceratodus* by Sewertzoff and for selachians by Loey. The course of the central tract corresponds to that shown for the nervus terminalis of selachians by Loey, who worked out the central termination in some detail. Still stronger support comes from the findings of Herrick in the frog. In this form the nerve takes the same course through the brain, including the decussation. Peripherally, however, the nerve leaves the brain to run in the meninges rostrad past the formatio bulbaris so there can be no question as to its character.

Summarizing: there is little doubt that there exists in the carp a nerve comparable morphologically to the nerve of Pinkus or the nervus terminalis of other fishes and the frog.



## LITERATURE CITED.

## ALLIS, E. P.

1897. The cranial muscles and cranial and first spinal nerves in *Amia calva*. *Jour. Morph.*, vol. 12, no. 3, March, 1897, pp. 487-808, pls. XX-XXXVIII.

## BING, ROBERT AND BURCKHARDT, RUDOLF.

1905. Das Centralnervensystem von *Ceratodus forsteri*. *Semon, Zoölog. Forschungsreisen in Austral. u. d. Malay. Arch.*, pp. 513-584, Taf. XLII, 35 Fig. in Text.

## BROOKOVER, CHAS.

1908. Pinkus's nerve in *Amia* and *Lepidosteus*. *Science*, N. S., vol. 27, no. 702, June 12, 1908, pp. 913-914.

## FRITSCH, G.

1878. Untersuchungen über den feineren Bau des Fischgehirns. *Berlin*, 1878, pp. 1-94, i-xy, 13 pls.

## HERRICK, C. JUDSON.

1909. The nervus terminalis (nerve of Pinkus) in the frog. *Report at Baltimore meeting, Assoc. Amer. Anat.*, 1909; and *Journ. Comp. Neurol. and Psych.*, vol. 19, no. 2.

## LOCY, W. A.

1899. New facts regarding the development of the olfactory nerve. *Anat. Anz.*, Bd. 16, no. 12, pp. 273-290, Fig. 1-14.
1903. A new cranial nerve in selachians. *Mark Anniversary Vol.*, article III, pp. 39-55, pls. V-VI, 1903.
- 1905a. A footnote to the ancestral history of the vertebrate brain. *Science*, N. S., vol. 22, no. 554, Aug. 11, 1905, pp. 180-183, 5 figs.
- 1905b. On a newly recognized nerve connected with the forebrain of selachians. With 32 figs. *Anat. Anz.*, Bd. 26, pp. 33-63, 111-123, 1905.

## PINKUS, FELIX.

1894. Ueber einen noch nicht beschriebenen Hirnnerven des Protopterus annectens. *Anat. Anz.*, Bd. 9, no. 18, pp. 562-566, 4 Abb., 1894.
1895. Die Hirnnerven des Protopterus annectens. *Morph. Arb.*, Bd. 4, zw. Hft., pp. 275-346, Taf. XIII-XIX.

## SEWERTZOFF, A. N.

1902. Zur Entwicklungsgeschichte des *Ceratodus forsteri*. *Anat. Anz.*, Bd. 21, no. 21, Aug. 1902, pp. 593-608, 5 Abb.

## SHELDON, R. E., AND BROOKOVER, CHAS.

1909. The nervus terminalis in teleosts. *Report at Baltimore meeting, Assoc. Amer. Anat.*, 1909.

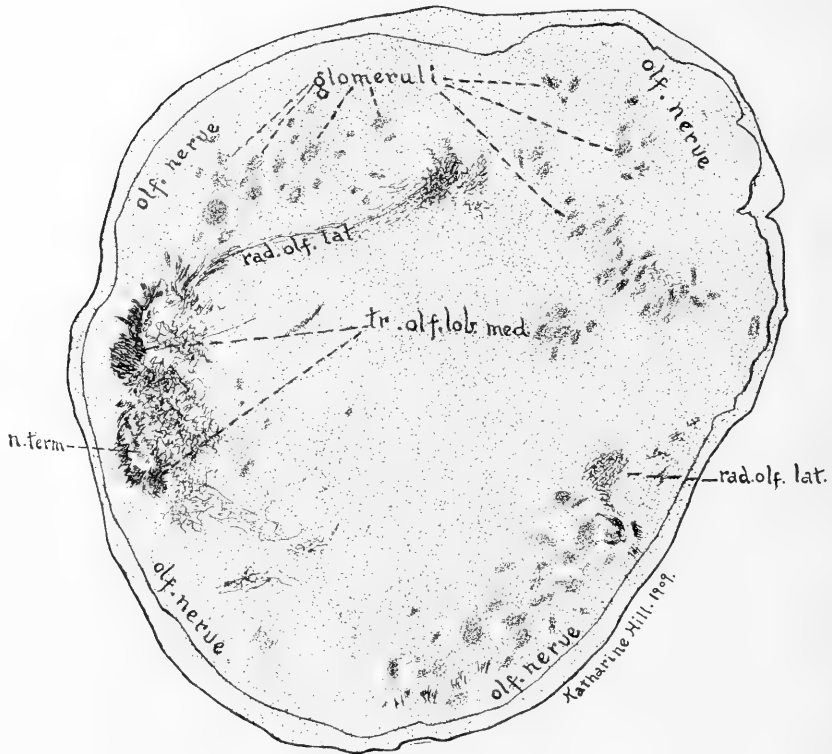

Fig. 1.

FIG. 1. Transection through the middle of the right olfactory bulb of a carp 50 cm. in length. Weigert method.  $\times 41$  (Zeiss oc. 2, obj. AA, reduced to two-thirds). Shows the nervus terminalis imbedded among the fibers of the tractus olfacto-lobaris medialis. Most of the stippled periphery is filled with the unmyelinated fibers of the olfactory nerve which are ending in glomeruli in this region. An especially prominent mass of such fibers appears dorso-laterally forming a protuberance. The nervus terminalis is lost a short distance rostrad of this level among the fibers of the olfactory nerve; *n. term.*, nervus terminalis; *olf. nerve*, olfactory nerve, fibers of which are scattered about the periphery at the points noted; *rad. olf. lat.*, radix olfactoria lateralis; *tr. olf. lob. med.*, tractus olfacto-lobaris medialis.

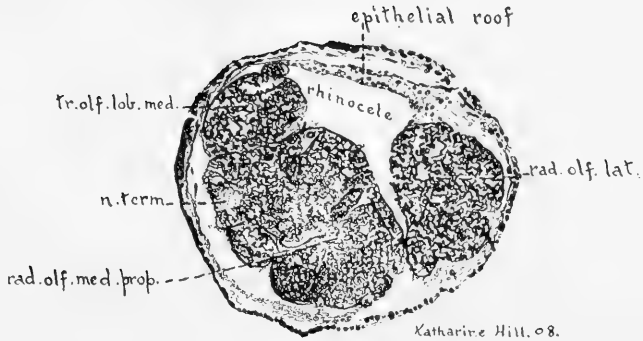

Fig. 2.

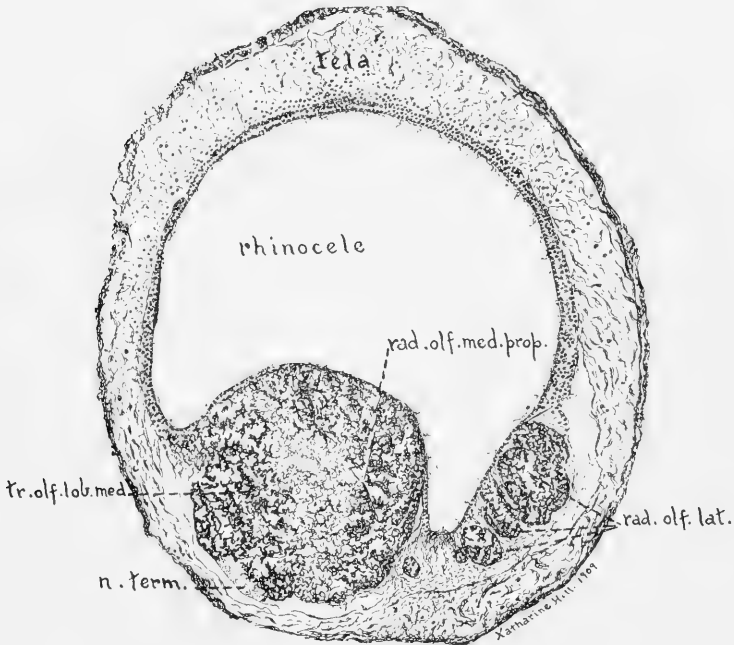

Fig. 3.

FIG. 2. Transection through the middle of the right olfactory crus of a 50 cm. carp. Weigert method.  $\times 21$  (Zeiss comp. oc. 8, obj.  $\Lambda^*$  reduced to two-thirds), *n. term.*, nervus terminalis; *rad. olf. lat.*, radix olfactoria lateralis; *rad. olf. med. prop.*, radix olfactoria medialis propria; *tr. olf. lob. med.*, tractus olfacto-lobaris medialis.

FIG. 3. Transection through the caudal part of the right olfactory crus of a carp 50 cm. in length. Weigert method.  $\times 64$  (Zeiss comp. oc. 6, obj. AA, reduced to two-thirds). This is a section immediately rostrad of the cerebral hemispheres and shows essentially the same features as Fig. 2.

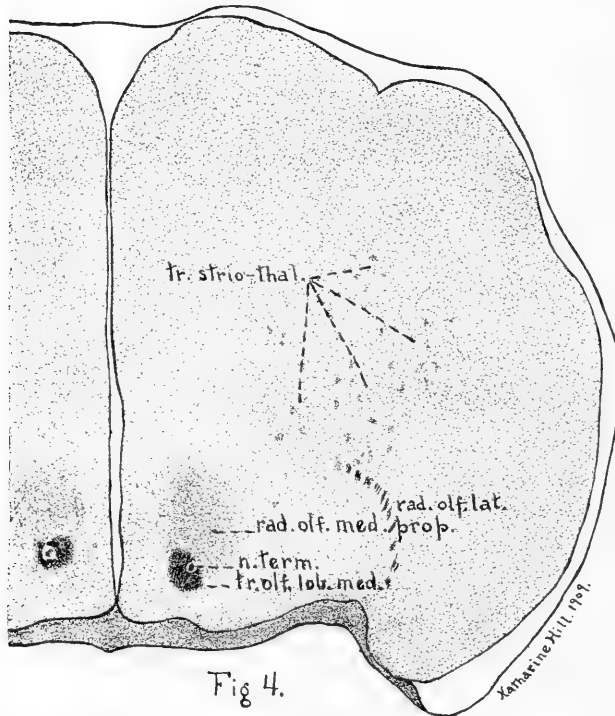

FIG. 4. Transection through the rostral part of the cerebral hemispheres of a 50 cm. carp. Weigert method.  $\times 21$  (Zeiss comp. oc. S, obj. A\* with the pointer at 10. Reduced to three-fifths). Shows the nervus terminalis partly imbedded in the tractus olfacto-lobaris medialis which it has passed through dorso-laterad. Compare its location in Fig. 3. Note that the n. term. now lies between the tr. olf. lob. med. and the rad. olf. med. prop.; n. term., nervus terminalis; rad. olf. lat., radix olfactoria lateralis; rad. olf. med. prop., radix olfactoria medialis propria; tr. olf. lob. med., tractus olfacto-lobaris medialis; tr. strio-thal., tractus strio-thalamicus.

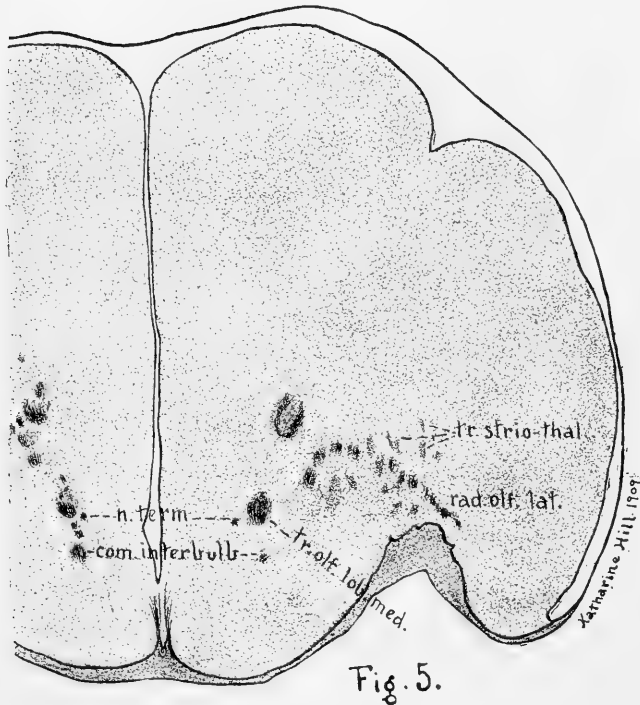

Fig. 5.

FIG. 5. Transection through the hemispheres of a carp 50 cm. long, immediately rostrad of the anterior commissure. Weigert method.  $\times 21$  (Zeiss comp. oc. 8, obj. A\*, with the pointer at 10. Reduced to three-fifths). Shows the nervus terminalis separated from the tractus olfacto-lobaris medialis preparatory to its decussation. *com. interbulb.*, commissura interbulbaris; *n. term.*, nervus terminalis; *rad. olf. lat.*, radix olfactoria lateralis; *tr. olf. lob. med.*, tractus olfacto-lobaris medialis; *tr. strio-thal.*, tractus strio-thalamicus.

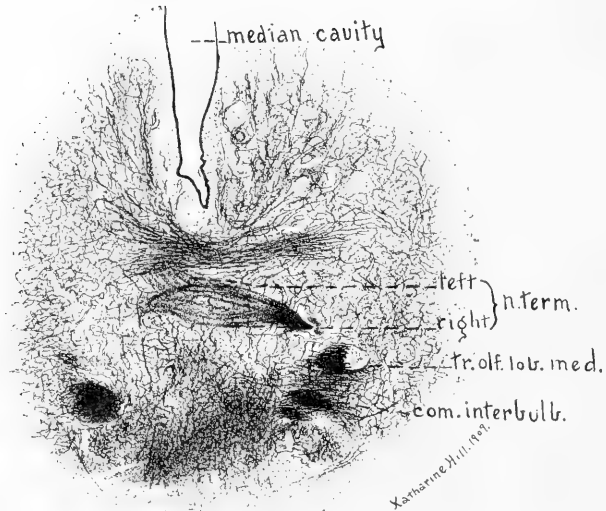

Fig. 6

FIG. 6. Transection through the rostral part of the anterior commissure of a carp about 35 cm. in length. Ramón y Cajal method.  $\times 156$  (Zeiss comp. oc. 6, obj. 8 mm. Reduced to two-thirds). Shows the entire decussation of the nervus terminalis of the right side and part of that of the left. The cells of the nucleus of termination are not shown. *com. interbulb.*, commissura interbulbaris; *n. term.*, nervus terminalis; *tr. olf. lob. med.*, tractus olfacto-lobaris medialis.

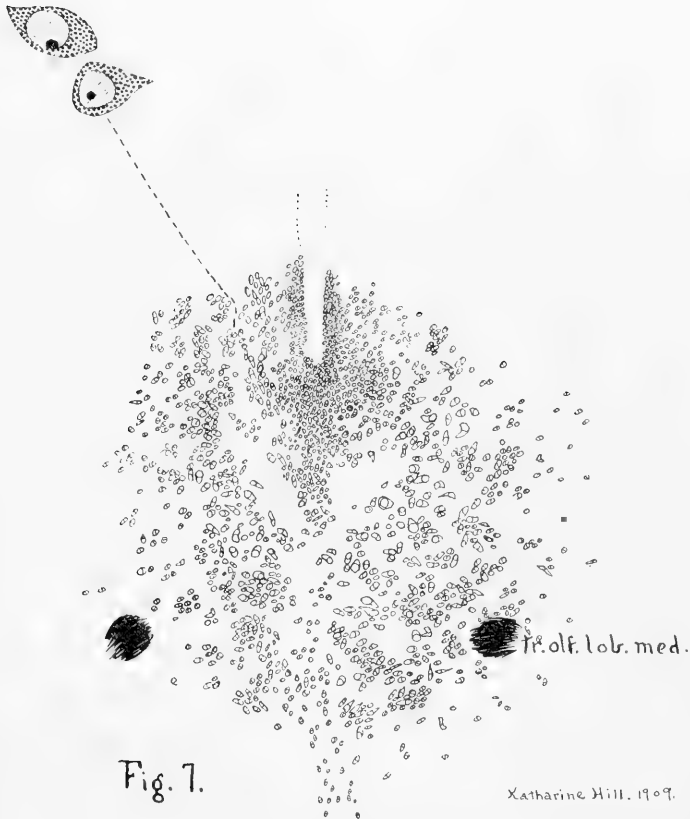

Fig. 7.

Katharine Hill, 1909.

FIG. 7. Transection through the rostral part of the anterior commissure of a carp about 40 cm. in length. Toluidin blue method.  $\times 156$  (Zeiss comp. oc. 6, obj. 8 mm. Reduced to two-thirds). Detail cells.  $\times 766$  (Zeiss comp. oc. 18, obj. 4 mm. Reduced to two-thirds). All drawings made with a camera lucida at level of stage. This section is through the same region as Fig. 6 and shows the numerous small cells of the nucleus of termination of the nervus terminalis. Two of the cells are drawn at a higher magnification. The two tr. olf. lob. med. appear almost colorless in the preparation, but are here colored black in order to orient the group of cells with reference to Fig. 6.





# THE CRITERIA OF HOMOLOGY IN THE PERIPHERAL NERVOUS SYSTEM.

BY

C. JUDSON HERRICK.

*From the Anatomical Laboratory of the University of Chicago.*

Even a cursory survey of the literature of comparative neurology reveals a confusion of usage among different authors who have described the same organ under different names or applied the same name to different organs. This confusion in some cases is so great that it is necessary to add to the name of the part the name of the author whose usage is followed, in much the same way that zoölogists add the name of the authority after the name of every species.

The confusion in many cases rests upon an imperfect knowledge of the facts; but in others it arises from differences in the interpretation of commonly accepted anatomical and physiological data. In so far as the latter is the case it suggests the necessity for an analysis of the factors upon which homology rests and an attempt on the part of working anatomists to come to an agreement as to the relative value of these factors.

It will, I think, be generally agreed that true homology always rests, in the last analysis, upon genetic relationship of the parts homologized. In the case of serial homology, or homodynamy, too, I doubt not that the principles of homology of organs from species to species will be found to apply with but small change in the meristic comparison of organs from segment to segment in a metameric body. This cardinal principle of homology requires that the parts so homologized must have had a common origin phylogenetically, or in the case of meristic organs have sprung from a common segmental type. No functional or structural similarity, however close, which has been brought about by convergence from diverse ancestral

conditions due to the action of similar environmental agencies or any other cause can be regarded as having weight in determining homology. The question then narrows itself down to the problem of the recognition and evaluation of evidences of genetic relationship among organs.

There is theoretically no limit to the diversity of the forms which homologous parts may show in their transformation from type to type in the course of phylogenetic history. So long as the sequence can be traced in unbroken series with no admixture of foreign elements into the organ complex the homology remains perfect. Practically, however, such ideal relations seldom prevail, for most organs are complexes of diverse tissue elements, some of which may disappear in the course of a long phylogenetic history to be replaced perhaps by others originally foreign to this organ. How far this process of substitution may be carried and leave the individuality of the organ unimpaired is certainly a debatable point.

A peripheral nerve, for instance, may show extreme variation in its distribution without change in its functional composition and present no difficulties to the morphologist so far as its homologies are concerned. But a nerve whose composition varies from species to species may be incapable of any simple morphological treatment and homology, even though its area of peripheral distribution is practically constant through the whole animal series. This would be the case if some functional systems represented in the nerve in the higher members of the series can be shown not to have been developed out of those of the lower members, but to have entered the nerve as alien structures.

Thus, the *ramus lateralis vagi* is a nerve of simple composition which is present throughout the Ichthyopsida, but with the widest possible variation in the details of its distribution. Its homology throughout the entire series is free from uncertainty in all but a very few cases. When, however, we find that the *ramus lateralis accessorius* of the facial nerve, which when present in teleosts typically runs an entirely separate course into the body, in some cyprinoid fishes is joined by an intra-cranial anastomosis to the *ramus lateralis vagi* and that the two nerves pass into the body fused

in a single trunk, the homology is immediately disturbed. For, not only does the foreign admixture come from a different cerebral segment, but it is of totally different functional composition, connecting with a different type of sense organ peripherally and with a different cerebral coördination system.

A survey of the phylogenetic history of the facialis nerve presents constantly recurring phases of the problem. This nerve was in primitive vertebrates a branchiomic nerve, supplying a gill-bearing segment and containing at least four components. The stages in its metamorphosis into a nerve supplying chiefly the superficial mimetic facial musculature of man can be clearly read by the comparative anatomist.

In the course of this phylogeny some new components are added, some are totally lost and the survivors experience manifold changes of function and rearrangement of rami. Though the identity of the nerve as a segmental unit is never lost, yet its perfect homology throughout the series is certainly open to discussion; and the morphological position of some of the rami whose composition varies from type to type by reason of peripheral anastomoses with other segmental nerves, such as the trigeminus and glossopharyngeus, is still more ambiguous.

I would suggest as a basis for further discussion the following rules for the fixing of homologies in the peripheral nervous system of vertebrates:

(1) If a nerve is a member of a meristic series (cranial or spinal), the preservation of its individuality in the comparative series of animals requires that its roots must come from the same segment or segments throughout the phylogenetic series. If there has been a shifting of one or more roots to another segment the homology is thereby to that extent impaired.

(2) But if the nerve in question is a composite of roots from several segments (like the hypoglossus), the individuality of the nerve is not necessarily destroyed by a shifting of the whole series forward or backward, or by the inclusion of more or less segments of the same kind in the complex, provided the relations to adjacent segmental nerves are not fundamentally altered. Neverthe-

less such variations of this nerve cannot be regarded as *perfectly* homologous with each other.

(3) *Perfect* meristic or serial homology (homodynamy) requires that the members of the series shall repeat the same pattern, both in the components represented in the roots and in the peripheral distribution. Typical illustrations of this serial homology are seen in some of the segmental nerves of annelid worms and in some of the spinal nerves of lower vertebrates. The human body probably presents few such exact repetitions of a segmental pattern except in some peripheral rami of a part of the spinal nerves.

(4) In general, homology requires that the nerves concerned shall have similar segmental relations, similar components and similar distribution.

(5) If, however, in the course of the phylogeny a new component is differentiated within a given segmental nerve from a more ancient unspecialized element, this nerve does not thereby lose its homology with the primordial unspecialized nerve; for the genetic relationship remains unbroken. Accordingly, if it should prove (as seems probable) that the gustatory component of the facial nerve was in the early phylogeny differentiated from the preëxistent unspecialized visceral system of that segment, no disturbance of the homologies would result.

(6) Peripheral rami which are defined primarily with reference to other peripheral non-nervous organs, like the sciatic nerve, may be regarded as homologous in different animals so long as they possess the same functional components and maintain essentially the same relations to the organs with reference to which they are defined, even though the segmental relations of the roots and plexuses from which they are derived may vary.

(7) But if any peripheral nerve is a ramus by definition of a definite segmental nerve (such as the r. hyoideus facialis), its homology is not perfect unless in the types compared it is composed wholly of fibers derived only from its own segment. Any admixture of fibers from another segmental nerve to that extent destroys the homology, no matter how perfectly the mixed nerve may follow the same course as the unmixed nerve. For instance,

in primitive vertebrates there is in front of the trigeminus a general cutaneous nerve belonging to a different segment, the profundus nerve. The profundus nerve is rarely preserved in the adult, though vestiges of it can be recognized in several selachians and ganoids, where there is evidence that the profundus nerve has fused with the ophthalmic rami of the trigeminus. These rami, therefore, are to be regarded as trigeminus plus profundus nerves in all cases where it can be shown that the profundus elements are preserved. Similarly, in fishes branches of the lateral line and gustatory roots of the facialis often anastomose peripherally with trigeminal branches. It is evident that the mixed ramus thus constituted has no longer the same individuality as before. It cannot be classed simply with the trigeminus or facialis; it is both. It should be given both names, or an entirely new name, or else some arbitrary rule should be laid down regarding the selection of a single name already current. The past usage in such cases has been most varied and confusing, and the confusion has, in many cases, been worse confounded by ignorance of the fact that there was any difference in the composition of the anastomosing rami, or by indifference to this fact even when recognized. The result is that to-day the synonymy of the rami of the cranial nerves of lower vertebrates, where such anastomoses are frequently and very diversely developed, is in worse confusion than that of the pre-Linnæan herbals.

(8) A given ramus of a segmental nerve which contains more than one component is not perfectly homologous with a ramus of the same nerve in a different species which has a similar peripheral distribution, but lacks one or more of the components or has an additional component, even though the added component comes from the same segmental nerve. Thus, the hyomandibular trunk of the cod is not perfectly homologous with this nerve in *Menidia*; for the cod lacks the visceral sensory component of this nerve which is present in *Menidia*, though the other relations are practically identical.

(9) From the preceding considerations it follows that the composition of every nerve and ramus must be accurately known before its homologies can be understood. Dissimilar and unrelated func-

tional systems must never be homologized either in a phylogenetic or meristic series.

(10) When the composition of a segmental nerve is fully known each root and its ganglion (in case of the sensory roots) should have a separate name and be treated as a functional and morphological unit. In determining the homologies of such a unit regard must be had primarily for the function which it performs, as determined by its terminal relations, *i. e.*, the type of peripheral end organ and the location within the central nervous system of the primary nuclei of origin or termination of its fibers. These considerations take precedence over all others in doubtful cases.

(11) The peripheral relations of nerves to other organs along their courses are also important in determining their homologies; but resemblances in such relations must not outweigh differences in functional composition, where these two factors are in conflict.

(12) No inflexible rules can at present be laid down for the nomenclature of peripheral rami of mixed or variable composition. In the selection of names for peripheral nerves or rami priority should rule among competing terms, other things being equal. But if the prior term implies a false morphology, or is unnecessarily cumbersome or otherwise objectionable, or if it has been long obsolete, it may be discarded in favor of a better one or one better known. Peripheral rami of mixed composition can often be analyzed into an ancient or primary branch of one nerve and cenogenetic additions by peripheral anastomosis from a different segmental nerve. In such cases the ramus may be named as a branch of the nerve with which its palingnetic connection is made, even though it is not exactly homologous with the nerve so named in other species which lack the peripheral anastomotic addition. Thus the *r. mandibularis trigemini* is typically composed of general cutaneous and motor fibers. In some vertebrates gustatory fibers enter it by peripheral anastomosis from the geniculate ganglion of the *facialis*. The mixed nerve so formed may for convenience still be termed the *ramus mandibularis trigemini*, even though it is morphologically partly *facialis*, provided the imperfection of the homology is explicitly recognized. In the same way the lingual nerve of man may be assigned to the *trigeminus*,

in spite of the admixture of facialis fibers through the chorda tympani, provided the trigeminal element can be shown to be phylogenetically the older.

The principles outlined above for guidance in determining homologies in the peripheral nervous system can be applied, *mutatis mutandis*, to tracts within the central nervous system. It will not be necessary to make the application here in detail. The treatment of the grey nuclei and correlation centers will also be controlled by similar rules, the aim being to homologize only such structures as are genetically related and to use functional connections wherever possible as guides to homology.





## LITERARY NOTICES.

Margaret Floy Washburn. *The Animal Mind*. New York, The Macmillan Co., 1908. Pp. x+333. \$1.60. (Second volume of the Animal Behavior Series, edited by R. M. YERKES.)

During the past few years the problems of animal behavior have attracted the attention of numerous zoölogists and psychologists. The older "anecdotal" school has finally given place to a school of strictly experimental investigators. The result of a decade of experimentation is an accumulation of data which seems destined to provide a secure foundation for a science of comparative psychology; but as yet these data are, in many instances at least, so fragmentary and so ill-organized that writers wholly fail to agree upon their interpretation. Several obstacles are encountered by the reader who attempts to keep in touch with the work which is being done in this field. The investigations have been concerned, in the main, with circumscribed and isolated problems; and no thorough-going attempt has ever been made to correlate the various groups of experimental findings, or to present a systematic *résumé* and interpretation. Then, too, the data are scattered through a great number of psychological and biological periodicals which are not readily accessible. Moreover, with the advance of scientific achievement in this field there has been developed a refinement of technic and of method which must, of course, be mastered before one can hope to evaluate the results or discover their significance. And, it may be added, the literature is replete with controversial clashes between opposing factions, who advocate a more mechanical or a more anthropomorphic interpretation of observations upon animal behavior.

This, in brief, is the situation which confronted Professor Washburn when she undertook to prepare a volume on "The Animal Mind." In her attempt to clear up the situation she summarizes numerous investigations, evaluates their results in the light of the experimental methods employed, and she discusses the bearing of these results upon the general question: What must be the characteristics of the animal mind,—granting that such a mind exists." The magnitude of the author's task may be inferred from the fact that she cites 476 references from the literature; and her presentation of the results of other investigators is but a small fraction of this exceedingly valuable contribution to the science of comparative psychology.

After an introductory discussion dealing with the difficulties and the methods of comparative psychology (pp. 1-26), and with the evidences of mind (pp. 27-36), she proceeds to the specific question of the protozoan mind (pp. 37-57). The author's attitude toward her problem is illustrated by the following quotation (pp. 36-7): "We know not where consciousness begins in the animal world. We know where it surely resides—in ourselves; we know where it exists beyond a reasonable doubt—in those animals of structure resembling ours which readily adapt themselves to the lessons of experience. Beyond this point, for all we know, it may exist in simpler and simpler forms until we

reach the very lowest of living beings. \* \* \* No one can prove the absence of consciousness in even the simplest forms of living beings. It is therefore perfectly allowable to speculate as to what may be the nature of such consciousness, provided that the primitive organisms concerned possess it." She does not present the arguments which may be advanced for and against the ascription of mental processes to the lower animals; nor does she indicate how probable or how plausible is her assumption that the lower animals possess a consciousness. This may or may not be a serious omission,—probably many readers who have followed the discussions will agree that it is not. But it does seem paradoxical enough that an author should devote whole chapters to the description of something which, in the opinion of many reputable scientists, does not exist; and whose existence the author herself is not willing to vouch for.

An examination of the motor reactions of ameba and paramecium is believed to warrant the inference that the hypothetical protozoan mind differs from the human mind in certain essential and clearly definable features. The mental stock-in-trade of the protozoon probably amounts to not more than three or four qualitatively different sensations; there is an utter absence of mental imagery (or revived sensations), and of anything correlate with attention. (This inference, however, does not seem to be justified, in the case of stentor, by Jennings' observations.) The mental life of the protozoa cannot therefore be a continuous "stream of consciousness," but only a succession of discrete and isolated experiences of the most primitive sort. From this humble beginning of mind, the author sketches in broad outline the developing consciousness through the entire animal series. "The reactions of animals to stimulation show, as we review the various animal forms from the lowest to the highest, increasing adaptation to the qualitative differences and to the spatial characteristics of the stimuli acting upon them. It is therefore possible to suppose that the animal mind shows increasing variety in its sensation contents, and increasing complexity in its spatial (and other) perceptions. But besides this advance in the methods of responding to present stimulation, the higher animals show in a growing degree the influence of past stimulation."

The author presents a detailed description of this increasing complexity in animal response to stimulation. Three chapters on sensory discrimination trace the development of sensory equipment (pp. 58-147). This is followed by a discussion of spatially determined reactions and space perception (pp. 148-204). Here are considered the question of the adaptation of animal reactions to the spatial relations of stimuli (light, gravitation, and the like), and the question of animal perception of space. It is inferred that orientation in the lower animals is probably due to an experience of unpleasantness or uneasiness,—and that no spatial perception need be assumed to account for the reaction. But certain responses to genuine visual stimuli (*i. e.*, where eyes are present) may be due to a consciousness of spatial relations.

Chapters on "The Modifications of Conscious Processes by Individual Experience" (pp. 205-269) describe the various labyrinth and puzzle-box experiments, and discuss the elimination of useless movements in the acquisition

of motor habits. Here, and in the succeeding chapter on the "memory idea" (pp. 270-284), the author reports that an examination of the learning process in animals fails to discover any conclusive evidence for the presence of "ideas" (excepting perhaps in the case of monkeys). "The behavior of the lower forms of animal life, at least, can be fully explained without supposing that the animals concerned ever consciously recall the effects of a previously experienced stimulus in the entire absence of the stimulus itself." The closing chapter (pp. 285-294) deals with the biological significance of attention.

Professor Washburn's book is the pioneer in its field. It will unquestionably prove to be a time-saver to the student of animal behavior, and will be a welcome adjunct to the work of the class-room. Many of its discussions are carried through with a thoroughness and an insight which render them of paramount value. This is particularly true of the learning process. The treatment of spatially determined reactions and spatial perception and of tropisms is, however, in the opinion of the reviewer, too vague and too inconclusive to be of value to the student.

It is suggested that future editions could be improved by the addition of a more inclusive index. To cite but a few omissions, such important topics as memory, mental image, and experience are not mentioned in the author's index. The bibliography might be extended to include Wundt (writings since 1892), Sanford, Brehm, Jourdan, and Ribot, and a complete list of the work done in this field by Darwin, Mœbius, Wasmann and Watson.

J. W. BAIRD.

University of Illinois.



# The Journal of Comparative Neurology and Psychology

VOLUME XIX

JUNE, 1909

NUMBER 3

## ON SENSATIONS FOLLOWING NERVE DIVISION.

BY

SHEPHERD IVORY FRANZ.

*From the Laboratories of the Government Hospital for the Insane,  
Washington, D. C.*

WITH SEVEN FIGURES.

### II. THE SENSIBILITY OF THE HAIRS.

Examinations of the sensibility of the skin from the standpoint of punctate sensibility indicate that the hairs are closely associated with those points that are stimulated by pressures and that react by giving a sensation of pressure or touch. The hairs are assumed to have a form of sensibility allied to or the same as that of neighboring parts sensitive to touches or pressures, although on this point most authors are silent.<sup>1</sup> The experiments carried out by Head and Sherren indicate, however, that the hairs are independently sensitive to stimuli and that they react in a different manner than do the so-called pressure points. Numerous observations in cases of nerve lesions show that the sensations evoked by stroking or pulling the hairs differ from those of pressure and touch of the skin. For example, in an individual whose radial nerve has been cut the parts

<sup>1</sup>That this is probably not so is indicated by recent studies of the nerve endings (presumably sensory) in or near the hair bulbs of "touch" hairs in animals. The structures which have been found are different to those on hairless parts endowed with sensibility to touch and pressure.

which remain endowed with motor nerves are sensitive to pressures and jarrings of the skin, but in his own case Head found that in this region "when the hairs are pulled the elevation of the skin produced no effect upon consciousness," and also, that "pressures which had previously caused a sensation were no longer appreciated when applied to the skin lifted from the subcutaneous structures to form a ridge."<sup>2</sup> It is evident, therefore, that the sensations produced by stimulation of the hairs are not pressures and do not belong to the class of "deep sensibility." On the other hand, Head and Sherren found that with the return of protopathic sensibility—the ability to appreciate prick as such and to respond to ice and to water at about 50° C.—"the hairs began to react to cotton wool, and this stimulus evoked a curious radiating sensation with a characteristic quality. True localization was impossible and the skin over the same parts became, when shaved, entirely insensitive to cotton wool."<sup>3</sup> In another place we are told "under certain conditions the hairs may regain a peculiar form of sensibility at the time when the affected parts are sensitive only to prick and to the extremes of heat and cold. Plucking a normal hair, will, in most cases, cause pain, and it is this sensibility to pain that returns to the hairs when they react in this manner to stimulation with cotton wool."<sup>4</sup> These facts indicate that the sensations from the hairs are to be grouped not with the epicritic, although they react to cotton wool, but among the protopathic forms of sensation.

The subject of my experiments is an individual in whose arm the median and ulnar nerves had been cut about four months previous to the examinations.<sup>5</sup> To assist in the definition of the area in which protopathic sensibility remained and from which the epicritic sensibility had departed, I carefully examined the hairy parts of

<sup>2</sup>H. Head, W. H. R. Rivers and J. Sherren. The Afferent Nervous System from a new Aspect. *Brain*, 1905, vol. 28, p. 103.

<sup>3</sup>H. Head and J. Sherren. The Consequences of Injury to the Peripheral Nerves in Man. *Brain*, 1905, vol. 28, p. 241.

<sup>4</sup>Head and Sherren. *Op. cit.*, p. 242.

<sup>5</sup>For an account of the lesions and general sensibility changes see my article in *Jour. Comp. Neurol. and Psychol.*, 1909, vol. 19, pp. 107-124.

the forearm and hand, plucking individual hairs, and also brushing the hairs with cotton wool or with the light camel's hair brush. The results obtained on this patient are sufficiently different from Head's reports to warrant a rather full description of the sensibility of the hairs.

Over the parts of the hand and forearm which are quite normal, immediately a hair is touched there is felt a sensation, apparently similar to that when the skin is lightly touched with a blunt instrument, such as a pencil. This sensation results, I find, from the movement of the hair, and it is emphasized when more than one hair is moved or when more than one hair is grasped with forceps. After a hair has been firmly grasped with forceps and slight traction is exerted upon it, the sensation becomes clearer, or more intensive, and when sufficient traction is exerted a distinct feeling or sensation of pain supervenes. The pain appears to differ in character from that produced by extremes of pressure, as for example that produced by an algometer, for it is rather burning in character. Observations such as these were made by H. (the subject of the experiments to be reported here) and by me, and confirmed by repeated experiments at various sittings.

On the other hand, as may be expected from the results of Head's experiments, over parts which are not normal the hairs react in a totally different fashion. On the volar side of H's forearm, near the bend of the elbow, I marked off an area which included subareas in which the different forms of sensibility were altered. First I examined carefully the sensibility of the hairs to traction. I went over the whole forearm and hand wherever hairs were found, and marked in red ink a line between the area which was sensitive and that which was insensitive to such stimulation. The hand and arm were then photographed and from the photograph was traced Fig. 1, which is here reproduced. The area in which traction on the hairs was not accompanied by a pressure-like or by a pain sensation is that marked with vertical lines. The upper part of the arm, beyond the elbow, I did not carefully investigate, for it seemed that some of the change to be found there might be, and probably was, due to the cutting of superficial skin nerves both at the time of the accident

and at the subsequent operation. The extent of this area is much larger than the area of loss of protopathic sensibility as determined by the methods of Head, and the extensive character of the change led me to a more careful examination of parts of the area. Since time did not permit the careful mapping of the whole area, I selected for more careful work two areas, one on the volar side of the forearm near the bend of the elbow, the other on the dorsal-ular side of the arm near the wrist.

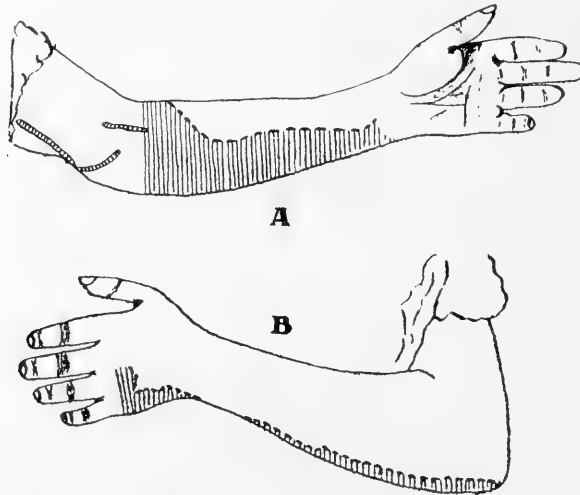

FIG. 1.

FIG. 1.—Diagram of hand and forearm of subject in whom ulnar and median nerves were cut at elbow. Scars of original accident and of operation shown above elbow. Area marked with vertical lines represents area in which hairs are insensitive to plucking. The diagram was made from a tracing of a photograph, and the distortion of the hand is due to the peculiar position in which the patient holds the fingers.

An illustration of the upper of these two areas as it was marked in red ink on the arm of the subject is given in Fig. 2. The line separating the area of pain-on-pulling-hairs from that of no-pain-on-pulling-hairs is approximately that between areas D and E. In general contour, however, it is more irregular and more nearly approaches the shape of the lowest line on the figure. The extent of this area in which pulling the hairs did not result in a sensation of



pain or in a pressure-like sensation was determined as accurately as possible. Once the general line was found, I went carefully over all the hairs within a centimeter of the line and mapped out the exact area in which plucking did not result in pressure-like or in pain sensations. Within the areas F and G, I found none of the hairs to be sensitive to plucking. Throughout this area and below G, the usual pressure-like and pain sensations were not produced by pulling the hairs, even when two or more hairs were pulled out with their roots. In area E the plucking of only a very few hairs on the upper

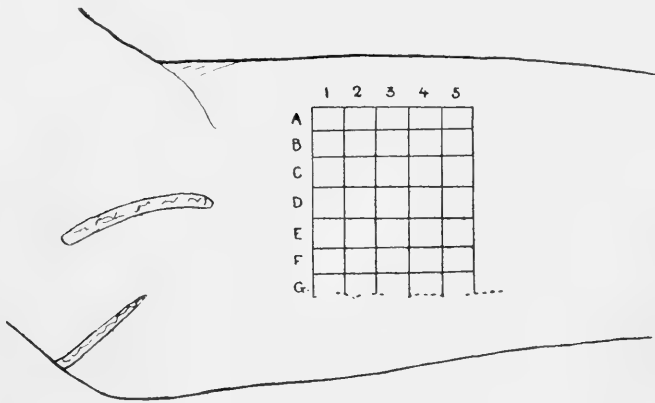

FIG. 2.

FIG. 2.—Diagram of upper inner part of forearm. Horizontal areas G, F, and E were insensitive to plucking of hairs. Below G pressures were not felt, likewise traction and brushing of hairs. Horizontal areas A, B, and C had all forms of sensibility intact. Areas E, F, and G were sensitive to brushing of hairs.

border of some of the squares resulted in sensations, while stimulation of some of the hairs at the lower border of area D was not accompanied by the proper kind of sensation. The extent of the lack of proper sensations in the hairs may then be said to be in the horizontal areas E, F and G. Although the plucking of hairs in area E was not accompanied by a normal sensation of pain and the pressure-like sensation, such as are produced by plucking the hairs over normal parts, when several, say five or six, were pulled at one time a feeling of an indefinable (to the patient) character was obtained. The subject

could not make any good comparison with any other known kinds of sensation, for it was different from pressure and was not like the sensations obtained by brushing or plucking the hairs over normal parts. The feeling (or sensation) could not be localized beyond the general (upper or lower) part of the arm. From numerous stimulations and repeated experiments the feeling or sensation was found to depend upon the movement of the skin in neighboring regions. When great care was taken not to move the skin in near-by regions, this unusual and ill-defined sensation did not result. Throughout the series of experiments the patient reported that, although he perceived the plucking of the hairs, it should be understood that at no time within the area of the diagram did the sensations have the same quality or character as that produced by plucking the hairs on the right arm. How much of this curious sensation difference was due to suggestion and how much to an actual change can not be determined, but it is fair to assume that the patient was ordinarily trustworthy.

After locating as accurately as possible the area in which the hairs were insensitive to traction, I mapped out the area in which the hairs were sensitive to stimulation with cotton wool. When, on normal parts, the hairs were lightly brushed with cotton wool, the sensation was immediately perceived, and an accurate localization was made of the place where the stimulus was given. When the hairs are stimulated as they lie, we find that many hairs from widely separated regions may be stimulated. This is particularly so if the hairs happen to be long and overlap each other to any extent. To determine with some precision the presence or absence of this form of sensibility, I carefully lifted the hairs overlapping any special part and stimulated only those which were immediately beneath those that had been lifted. In carrying on the experiment in this way it was possible to locate quite accurately the extent of this kind of hair sensibility and the error of determining the line of division between sensitive and non-sensitive parts was not more than a few millimeters.

The results of this careful examination were quite unusual and wholly unexpected. I found the hairs to be sensitive to stimulation of cotton wool or of the light camel's hair brush in all the areas

above the lowest line on the diagram, Fig. 2. It will be noticed, therefore, that the fifteen square centimeters embraced in the horizontal areas E, F and G were sensitive to this form of stimulation but not sensitive to the stimulation of traction.

When this large area was shaved, it was found that stimulation of the skin with cotton wool or with a camel's hair brush was accompanied by sensation only in the horizontal subareas A, B and C. In these same areas other forms of epicritic sensibility, e. g., the appreciation of two-ness, were also present.

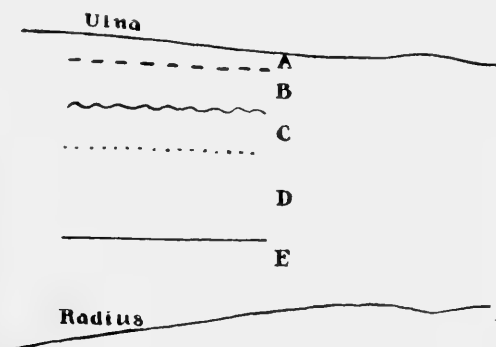

FIG. 3.

FIG. 3.—Back of forearm near wrist. Horizontal area A, loss of all forms of sensibility. Area B, hairs do not respond to cotton wool or to traction. Area C, hairs react to cotton wool, not to traction with pain sensation, but with only pressurelike feeling. Areas D and E, hairs react to cotton wool and to traction. Area E, brushing hairs and traction on them felt more plainly than in any other areas. Area D and radialwards, area in which epicritic sensibility retained.

This unexpected result on the upper part of the arm led me to a further examination of another section of the arm ten days later. The second area was on the outer and ulnar side of the forearm beginning about 8 cm. from the fold of the wrist and extending up the arm a distance of 5 cm. This part of the arm is shown in Fig. 3. Area A in the figure is the area insensitive to pressures. Area B is separated for convenience, but experimentally not sharply to be distinguished, from area A and is that part of the arm in which pressures usually, but not always, were felt. The wavy line separates

the areas in which the hairs do (C) and do not (B) respond to stimulation with cotton wool. The dotted line separates the areas in which plucking the hairs produced pain and no pain. Areas D and E are areas in which the hairs reacted both to cotton wool and to traction. Area C is the area in which plucking the hairs produced a sensation similar to that of pressure or to that of brushing the hairs, but in this area no pain was felt even when the hairs were pulled out with their roots. In area B plucking of the hairs was accompanied by no pain and the hairs did not appear to be sensitive to any form of stimulation. At times in this area, as happened with the area near the elbow, when more than three or four hairs were pulled simultaneously a sensation was obtained. This was poorly localized, but appeared to be in neighboring more normal areas. Here also it was found that the movement of the neighboring parts appeared to be the determining factor in the production of the sensation. The sensation from this form of stimulation was described as similar to that of moving the hairs with cotton wool or with the camel's hair brush, and also partly like that of lightly touching the part with a blunt instrument.

When this part of the arm was shaved it was found that cotton wool could be appreciated in areas D and E. In these areas different degrees of temperature could also be appreciated and the subject reported marked sensation differences between cool and cold, and between warm and hot stimuli.<sup>6</sup>

The above facts may be summarized as follows: When the ulnar and median nerves are cut, over parts of the hand and arm it is found that the hairs are not sensitive to plucking at a time when lightly brushing the hairs on the same areas is appreciated as a stimulus. The parts in which there is insensibility to plucking the hairs are within the area that, in accordance with Head's differential signs, may be described as possessing protopathic sensibility, but in which the epicritic sensibility has been abolished.

It appears, therefore, that we have in the hairs two forms of sensibility, one for traction and the other for light pressures or

<sup>6</sup>A full report of the temperature findings in this portion of the arm will be found in Section III of this article, beyond.

movements. The results, I believe, cannot be explained, as von Frey has attempted to explain all of Head's results,<sup>7</sup> as a difference in threshold values; for in traction we deal with amounts of stimuli much greater (or at least on normal parts they appear much greater) than that of brushing the hairs with cotton wool. Such a two-fold function in the hairs is in accord with the findings of a two-fold nerve supply to the hairs,<sup>8</sup> although the results on animals have not been confirmed for the common (bodily) hairs of man. So far as I am aware, the only results to be compared with these on the hair sensibility are those on temperature sensations to be reported in the next section and the few results by Head and Sherren on temperature sensations. In one or two cases these authors, it will be remembered, found parts of the skin not sensitive to hot (above 45° C.) and to cold (below 10° C.) objects, but found the same parts when stimulated with temperatures of moderate degree to be sensitive and to give appropriate warm and cool sensations.

### III. TEMPERATURE SENSATIONS.

From examinations of normal individuals it appears that there are special points on the skin that react to stimuli by giving a sensation of heat or cold, but that in the small areas between these temperature points no sensations of hotness or coldness can be evoked by stimuli. On the other hand, when we stimulate the skin with areas of heated or cooled objects rather than with points the sensations of warmth or coolness result. The areal sensations appear to differ from those in which separate spots are stimulated in that only one sensation is obtained, and there is not an apparent mixture of heat and cold from the spots that may be stimulated in the area. For the understanding of these differences in sensation no explanation has been offered that meets with universal approval, but the analogy of the rods and cones in the retina has been made. It is

<sup>7</sup>von Frey. The Distribution of Afferent Nerves in the Skin. *Jour. Amer. Med. Assn.*, 1906, vol. 47, pp. 645-648.

<sup>8</sup>F. Tello. Terminaciones sensitivas en pelos y otros organos. *Trab. del. lab. de Invest. Biol. de la Univ. de Madrid* (S. Ramón y Cajal), 1906, tomo 4, pp. 49-77.

said that if the area of the skin which is stimulated has a few spots that ordinarily give an intense sensation of coolness or warmth, the areal stimulation takes this character and that the spots which normally give a weaker sensation help to fill up and to make the areal stimulation continuous. In other words, it is assumed that when more than one spot is stimulated, the general character of the resultant sensation depends upon the sensation that is most intense in the spots stimulated.<sup>9</sup>

It will be remembered that in their examinations of sensations following nerve injury, Head and his collaborators found certain sensation losses that appear not to conform with the hypothesis of special nerve endings for warmth and coolness alone. Certain of their results appear unaccountable on the supposition of loss of certain numbers of the fibers that supply the end organs concerned with the sensations of warmth and cold,—supposedly Ruffini's cylinders and Krause's end bulbs, respectively. Their work has cast considerable doubt on the singularity of the sensations of warmth and coolness and it appears from their examination of cases in which nerves have been injured or cut that there are two sets of nerves, four different fibers, which convey temperature sensations. The two sets belong respectively to the epicritic and protopathic systems, the former being concerned with medium temperatures, which are appreciated as warmth and coolness, while the latter mediates the sensations which may be spoken of as hotness and coldness.<sup>10</sup>

The results of temperature experiments made by me on a patient (H.) in whose arm the median and ulnar nerves were cut confirm, in a general way, those reported by Head.<sup>11</sup> In some particulars, however, differences were found.

Over parts which were insensitive to pressures no sensations of temperature were obtained, even from those temperatures which caused a burning of the skin. H. at one time placed his hand

<sup>9</sup>On this see Titchener. *Experimental Psychology*, vol. 1, part 2, pp. 87-91.

<sup>10</sup>Head and Sherren. *The Consequences of Injury to the Peripheral Nerves in Man*. *Brain*, 1905, vol. 28, pp. 224-228.

<sup>11</sup>For an account of the patient and for other sensation differences, see Franz: *this Journal*, vol. 19, pp. 107-124.

against a steam radiator and produced a burn about 1 cm. in diameter, without appreciating that his hand was in contact with a hot surface. This burn did not heal, as Head has noted in similar cases, as rapidly as burns on normal parts, and it was over ten weeks before this area of the side of the hand took on a healthy appearance. During this time no pain or feeling of temperature could be obtained from this part of the hand. Temperatures as high as I dared use in the experiments, without causing a burn, were not felt. In the same way low temperatures were not appreciated on this part of the arm and hand. A test tube, the temperature of which had been lowered to  $-5^{\circ}$  C. was not felt and during cold weather the patient had to depend upon the sensations from the thumb and the radial part of the arm to determine when the hand should be covered.

In the areas of the hand and arm in which protopathic sensibility remained, the extremes of temperature were easily appreciated, although the medium temperatures did not call forth a sensation. In the area retaining also the epicritic sense, however, both extreme and medium temperatures were readily appreciated.

In the experiments with my subject, I used heated or cooled test tubes, 12.5 mm. in diameter with hemispherical bottoms. These were filled with water and in each tube a thermometer was inserted so that the temperature could be read directly after or before stimulating any part of the skin. The tubes were placed on the skin and pressed only with their own weight. It was found that at no place of stimulation did an area more than 8 mm. in diameter rest upon the skin. For cold sensations the test tubes were cooled by being placed in a mixture of ice and salt, and for the lowest temperature the tubes were cooled to  $-5^{\circ}$  C. For lesser degrees of cold, for temperatures of about  $20^{\circ}$  C. the tubes were immersed in cooled water. For testing for sensations of warmth and hotness the tubes were immersed in a water bath that almost completely covered the test tubes. Irregular orders were followed in determining the temperature sensations, and no indication was given the subject what the next kind of stimulation was to be. Moreover, the same square centimeter was never tested twice by the same stimulus in succession. The tubes were allowed to rest on the skin for only one or two sec-

onds. Immediately before the test tube was placed on the skin, the signal word "Now" was given and after the test tube had been lifted, the subject reported whether or not he had felt anything and also the quality of the stimulation. The usual procedure of requesting judgments when no stimulus or when an indifferent stimulus was given was tried to see whether or not the subject guessed. After some preliminary trials, the subject used exclusively the terms "hot," "warm," "cool," "cold," "pressure," and "do not feel anything." The subject also often voluntarily compared the temperature sensations of two or more stimuli in order and these reports gave a clue to certain differences that will be reported later. Throughout the test it was impossible to keep from the subject the knowledge that he was being tested for temperature sensations, and whenever he reported that the stimulus was accompanied by a sensation of pressure only, he was asked to try to determine the character of the temperature. At these times he was able to make a judgment only when a stimulus was repeated, and after the test tube had been left on the skin from 10 to 60 seconds, until in all probability there had been time for radiation of the heat or transmission of the stimulus to more nearly normal parts.

A series of early experiments on the hand showed certain deviations from the results of Head and Sherren, and for this reason, two areas were selected for careful examination, those which had been previously used for the determination of the hair sensibility on the upper part of the forearm near the bend of the elbow, and on the lower part of the forearm near the wrist.<sup>12</sup>

In the area near the bend of the elbow, each square centimeter was tested separately, but in irregular order that no suggestion might be given or obtained of the extent of the loss of temperature sensation, and each area was carefully gone over three times with each form of stimulation. The resultant sensations that were reported were, with two exceptions to be mentioned, the same in all three tests, and the uniformity is a striking evidence of the accuracy of the observations. In experiments in this area, no attempt was made

<sup>12</sup>Figures 2 and 3, pp. 219 and 221, illustrate the areas which were carefully tested.



to keep the temperature of the test tubes constant beyond that of having them cold, cool, warm or hot to corresponding parts of a normal individual, but temperature degrees were always noted and records made at the time. In Fig. 4 is shown the area on the upper

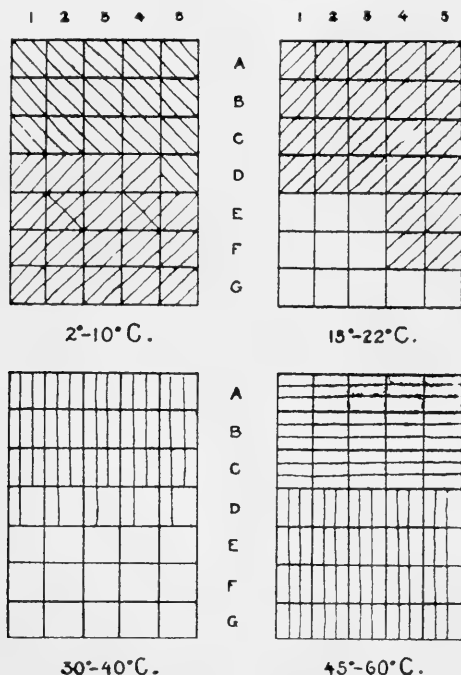

FIG. 4.

FIG. 4.—Illustrating the sensations accompanying temperature stimuli on the upper volar part of the forearm. Each of the four parts of the figure represents the same area of skin. The lowest line is the extent of the loss of pressure sensations. The line above area D separates, but not so sharply on the skin, the area of epicritic sensibility (A, B and C), from that of propathic sensibility (D, E, F and G). Vertical lines, sensations of warmth. Horizontal lines, sensations of hotness. Diagonal lines running from top to the right, sensations of coldness. Diagonal lines running from the top to the left, sensations of coolness.

part of the forearm divided into its component square centimeters with the results from each kind of temperature stimulation.

In only two cases, with very cold stimuli,  $2^{\circ}$ - $10^{\circ}$  C., did the three answers differ and in both cases, once each in the two

squares E4 and E5, the stimulus was perceived as cold. The four parts of the figure represent the sensations from the stimuli which normally would be called cold ( $2^{\circ}$ - $10^{\circ}$  C.), cool ( $15^{\circ}$ - $22^{\circ}$  C.), warm ( $30^{\circ}$ - $40^{\circ}$  C.) and hot ( $45^{\circ}$ - $60^{\circ}$  C.). The lines running downward from the left indicate sensation 'cold,' the lines running downward from the right indicate the sensation 'cool,' the vertical lines indicate the sensation 'warm,' and the horizontal lines indicate the sensation 'hot.'

With the lowest temperatures all the areas responded with some form of sensation. The areas A, B and C reacted uniformly with the sensation cold, and the square centimeter D5 also reacted in the same manner. Once each, as has previously been mentioned, E2 and E4 gave a feeling of cold, while in each of these squares two other similar stimuli were reported to feel cool. With the next grade of stimulus, cool, there was a wider distribution of cool feeling than there was of cold feeling with the lowest temperatures, the areas comprising A, B, C and D, and of E and F the square centimeters marked 4 and 5.

The feeling of warmth was obtained over areas A, B and C uniformly with temperatures from  $30^{\circ}$ - $40^{\circ}$  C., and in D the subject reported a similar feeling but "only slightly warm." With stimuli from  $45^{\circ}$ - $60^{\circ}$  C., areas A, B and C reacted always to the stimulus as "hot," while areas D, E, F and G gave the feeling of warmth.

Areas A, B and C are areas in which hot is distinguished from warm and cold is distinguished from cool. Areas E, F and G are areas in which only hot or cold stimuli are invariably distinguished, although area D5 reacted to cold, areas E2 and E4 reacted once to cold, D1-5 and also E4, E5, F4 and F5 reacted to cool stimuli. Area D reacted to warm stimuli with an appropriate reaction, but the intensity of the stimulus appeared to be less than in the neighboring area C. With the hot stimulus areas A, B and C reacted in a normal manner, while the other areas reacted to the same stimulus with the sensation of warmth. It will be noted that in the area in which the epicritic sensibility remained intact, coolness and coldness and warmth and hotness were always distinguished. This comprised the horizontal sections, A, B and C.

The area near the wrist gave similar results, although in the experiments of this region I did not map out the area according to squares and have to offer only the general results on the horizontal areas. In this case, however, I was careful to keep the temperature of stimulation constant for each area, and each time the stimulus was applied it was of the intensity noted on the diagram. The results of these experiments are shown in Fig. 5. Five dif-

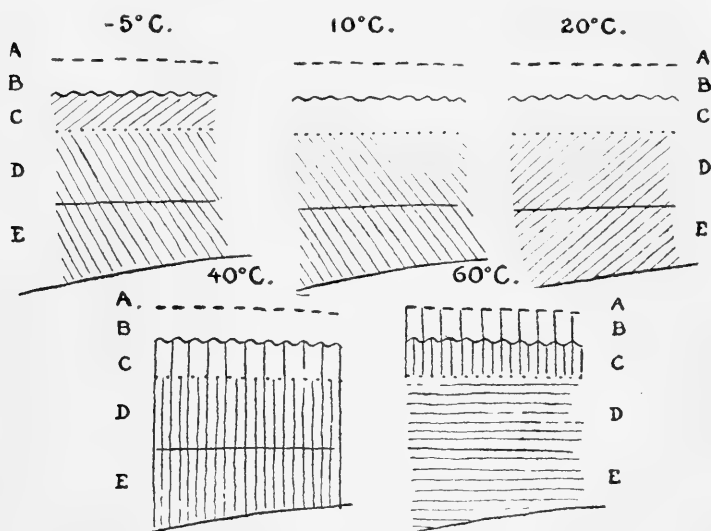

FIG. 5.

FIG. 5.—Skin area on ulnar aspect of forearm near wrist. Area A, no pressure sensations felt. Areas B and C pressures felt and protopathic sensibility retained. Areas D and E, pressures and touch appreciated and epicritic sensibility intact. For explanations of sensations of temperature, see legend to Fig. 4.

ferent degrees of the stimulus were chosen,  $-5^{\circ}$ ,  $10^{\circ}$ ,  $20^{\circ}$ ,  $40^{\circ}$  and  $60^{\circ}$  C. The coldest stimulus felt cold in areas D and E, cool in area C. A temperature of  $10^{\circ}$  C. felt cold in areas D and E, but did not call forth a sensation of temperature when placed on area C.  $20^{\circ}$  C. was reported cool in areas D and E, but was indifferent in the other areas. Stimuli of  $40^{\circ}$  C. were felt warm in areas C, D and E, but indifferent in areas A and B. In area C the subject

noted that this temperature was "just warm," "only slightly warm," etc., not so warm a sensation as that given by the stimulus in the areas D and E. Likewise with a stimulus of 60° C. The area in which warm sensations were obtained were B and C, but the sensations from area B were not so intensive as those in area C. This temperature was felt in areas D and E always as hot.

The parts of the arm which did not retain their ability to appreciate pressures, area below G in Fig. 4, and area A in Fig. 5, did not respond at any time to any temperature stimulus. Areas G, F, E and D in Fig. 4 and area B and C in Fig. 5 may be said to have retained the protopathic sensibility in addition to the deep sensibility, and in these areas hot stimuli were felt to be only warm, while cold stimuli were felt to be only cool. In the upper forearm area D-G there was no response, as a rule, to the intermediate degrees of temperature. The remainder of the area A-C responded accurately to all degrees of temperature stimuli. In the area near the wrist, only D and E reacted well to all degrees of temperature, and showed the presence of epicritic sensibility. Areas B and C failed to respond to medium degrees of temperature and their response to the extremes was not well marked.

At different times during the examination of these two arm areas, the following experiment was tried: The test tube, instead of being placed with its end on the skin, was placed so that three to four centimeters of its length extended over the horizontal areas which gave such widely different results. In these experiments the subject described the sensations which were produced and the accounts are in accord with the observations made when the small horizontal areas were stimulated by the end of the test tube. Near the wrist when cold,  $-5^{\circ}$  C., was used, the subject reported that toward the radius the sensation was of extreme cold, but near the axis of the arm the sensation was only cool. In a similar way the sensation from 60° C. was described as hot near the radius and warm near the axis of the wrist. The places from which respectively cool and warm sensations were obtained when cold and hot stimuli were given were pointed to by the subject and they correspond closely to the area C. This area it will be remembered was found by the previous

experiments to give these sorts of sensations with the extremes of temperature. On the upper part of the forearm similar results were obtained. In this case the subject was permitted to keep his eyes open and to mark with his other hand the places where the stimuli changed in quality. The marking of the division between the areas was not clear and distinct, but between two points, about two centimeters apart, the difference in the sensations was reported to be marked. These results are in accord, therefore, with those of stimulation of the individual square centimeters and they strengthen the impression that the sensation difference that was reported in the first series was not due to radiation or conduction. These results are quite unlike the results in normal individuals, for in the latter

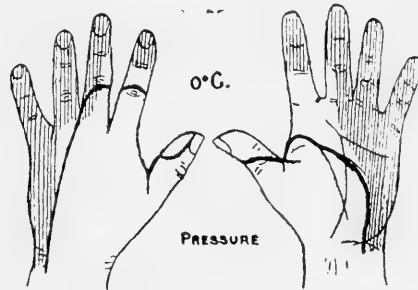

FIG. 6.

FIG. 6.—Area insensitive to cold stimuli, compared with the loss of pressure sensations. Area insensitive to cold inclosed within heavy line. Area marked with vertical lines insensitive to pressures.

we find the most intense sensations at the places where the warm or cool object leaves the skin, and the intermediate area appears to be stimulated uniformly with the same temperature.

On the hand, experiments similar to those on the arm were made, but with not so many different temperatures. The results of these experiments are given in Figs. 6 and 7. In Fig. 6 is shown the area of the hand insensitive to cold stimulation. This included the ulnar quarters of the palm and the back of the hand, the whole of the fourth and ring fingers, the first two joints of the second and index fingers and about half of the thumb. For comparison, the area insensitive to pressure with a pencil is illustrated on the same diagram

by the use of vertical lines. In only a small portion of the third finger does the area of insensitivity to pressure go beyond that of insensitivity to cold. Fig. 7 gives in a similar way the area insensitive to hot stimuli. For comparison, with the areal loss of cold and hot sensations, the area insensitive to light touch is drawn. On the back of the hand and on the index finger the area of insensitivity to light touch is greater than that to heat, while on the thumb the area for hot sensation loss is greater than for light touch. With the exception of a very slight portion of the thumb the area insensitive to cold is included within that insensitive to light touch.

In a general way, therefore, these results, as has already been

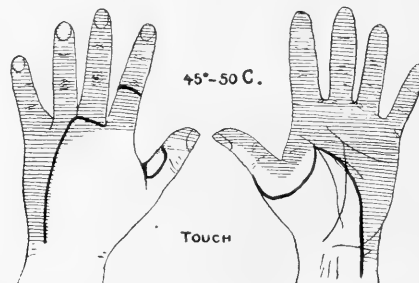

FIG. 7.

FIG. 7.—Area insensitive to hot stimuli, compared with loss of sensations to light touch. Area insensitive to hot stimuli inclosed within heavy lines. Area marked with horizontal lines insensitive to light touches (cotton wool and camel hair brush).

said, confirm the observations of Head. The facts that do not agree with those of Head are: There are different extents of areas responding to different degrees of temperature; the area for the appreciation of hot stimuli, for example, not being the same as that for the appreciation of cold stimuli as such; temperatures of extreme degree are felt like medium temperatures or call forth sensations of warmth or coolness on areas which do not respond to the medium temperatures with a corresponding sensation of warmth or coolness.

The results obtained from the arm may be taken to mean that whenever a cold or hot stimulus was given there was a radiation of effect from the stimulated area to the neighboring areas. This

explanation would also account for the less widely felt sensations from the medium degrees of temperature when the individual square centimeters were separately stimulated. Such an explanation would not account, it seems to me, for the results which were obtained when an extended line was stimulated rather than a small area. It appears more probable that, as Head contends, for temperature sensations we have two sets of nerves, one of which responds to the extremes of temperatures and the other to the medium temperatures. These two sets of nerves correspond to the forms of sensibility that are called respectively protopathic and epicritic, but in a different way than that described by Head and his co-workers. The results from my subject show that, although hot and cold stimuli produce sensations in areas endowed with the protopathic form of sensibility, the sensations correspond to those produced in normal areas by stimulation with medium temperatures. This at first sight looks as if we were dealing solely with differences in threshold values, but this hypothesis does not account for another apparently anomalous condition which was found by Head and Sherren, viz., the loss of the ability to sense the extremes of temperatures with the retention of the ability to sense medium temperatures.

It seems to me that the temperature results, taken in connection with those which have been described in my articles on the 'Pressure-like' and 'Hair Sensibilities,' show there is an overlapping of the nerves, or rather there is an overlapping of nerve supply, and that the sensation differences which were found in this case are to be explained as due to the presence or absence of certain nerve endings or of nerve fibers. It is possible that the *sensations* of coolness and warmth are protopathic, while those of coldness and hotness are epicritic. This, it will be observed, is contrary to Head's belief.

Received for publication December 7, 1908.

NOTE.—Since the articles on sensations following nerve division were written I received the number of *Brain* in which Rivers and Head give the results of careful examinations made on Head's arm in which the radial nerve was divided near the elbow (W. H. R. Rivers and Henry Head. A Human Experiment in Nerve Division. *Brain*, 1908, vol. 31, Part 123, pp. 323-450). Some of the new observations reported by Rivers and Head indicate a condition on Head's arm similar to that found by me on H., but some of these

anomalies are not sufficiently discussed. A full account of this recent work, with criticisms of special parts of it, will be found in a forthcoming number of the *Journal of Philosophy, Psychology and Scientific Methods*. In this review I shall make a careful comparison of the present work with that of Rivers and Head, and with that of Trotter and Davies (*Journal of Physiology*, London, 1909, vol. 38, pp. 134-246), which has also appeared since my articles have been in type. At present I wish to call attention to only a few matters reported in these two recent articles.

The recovery of sensibility to light touch is considered by Rivers and Head to be dependent upon the regeneration of the so-called touch spots. These touch spots are, according to these authors, grouped about the hairs and much, if not all, of the sensibility of the hairs depends upon the presence of the nerve endings which make up these touch spots. They say, for example, "Over hair-clad parts these touch spots are strictly associated with the roots of the hairs, they express the sensibility to mechanical stimuli to that part of the hair which lies beneath the surface of the skin. Almost every hair is a delicate tactile sense-organ; any movement of its tip is transmitted to its root with the increasing power of a lever, setting up tactile impulses." We find, however, they report in one part of their paper that tactile sensations (sensations to light touch) could be evoked only after a period of 365 days following the operation, but in another place we are informed that "No sensations were obtained from the hairs until 86 days after the operation, when there were found four hairs that gave a sensation when they were plucked." It is also noted that 161 days following the operation the hairs on the arm were sensitive to the stimulation of brushing with cotton wool, although the sensibility to light touch did not return for 365 days. Surface indications are that Rivers and Head were dealing with the same form of dissociation of the hair sensibility which has been described by me in the foregoing papers, but that they did not carefully investigate this matter. At any rate, from their account of the sensibility of the hairs we are justified in assuming that the hair sensibility was found by them to be independent of the presence of distinct touch spots and that their observations upon the sensibility of the hairs, casually reported, support the view expressed in the foregoing paper.

According to Rivers and Head all temperature sensations also depend upon sensation spots, and the differences in temperature sensations described by Head and Sherren in a former paper are now reported to be due to the presence of a greater or less number of cold or hot spots in the epicritic and protopathic areas respectively. Head still holds the view that in an area in which there is no epicritic sensibility only the extremes of temperature will be appreciated, while in the area endowed with epicritic sense there is the ability to appreciate the intermediate degrees of temperature. It is not clear that Head had sensations similar to those of my subject, but we read "It would seem that the number of spots stimulated is of greater importance than the intensity of cold by which the sensation is evoked." In experiments in which his arm was tested by cold areas of different size Head reported a cool large area to feel colder than an ice cold small area, in the former case there being a number of spots stimulated and in the latter only one.



On account of the fewness of the spots in the protopathic area it is difficult to see how the protopathic skin would give the *hot* and *cold* sensations even from the stimulation of comparatively large areas and how the sensations could be of the same intensity as those from normal parts. Head's observations on the temperature sensations are at variance with those reported by me, but it should be remarked that Trotter and Davies were not only unable to confirm Head's observations, but that, in fact, they obtained results similar to those reported here.

The matter of the sensibility to light touch needs hold our attention for only a brief time. The gradual increase in sensitivity from the anesthetic area outwards has also been demonstrated by Trotter and Davies in even a more convincing manner than that given by me. They have shown that the sensibility of individual touch spots differs at different times during the period of recovery, and it is very plain that the sensory disturbances following the section of a nerve are more widespread than Head and his collaborators admit. It is of some interest to note that a criticism of the cotton wool method of testing light touch has also been made by Trotter and Davies and that for similar tests they used a brush.

April 26, 1909.



# MODIFIABILITY OF BEHAVIOR IN ITS RELATIONS TO THE AGE AND SEX OF THE DANCING MOUSE.

BY

ROBERT M. YERKES.

*From the Harvard Psychological Laboratory.*

WITH FOUR FIGURES.

## CONTENTS.

	PAGE
I. Introductory statements: the dancer as material for the investigation of problems of behavior.....	237
II. Relation of age and sex to rapidity of acquisition of a visual discrimination habit .....	238
III. Sensitiveness to electric stimulus, in its relation to age and sex....	249
IV. Strength of electric stimulus, in its relation to rapidity of habit-formation .....	252
V. Relation of difficultness of discrimination to rapidity of habit-formation at different ages.....	255
1. Experiments with cardboards in discrimination box.....	255
2. Experiments with discrimination box in dark-room.....	259
3. Experiments with one side of discrimination box covered in varying degrees.....	263
VI. Relation of age to rapidity of acquisition of labyrinth habits.....	265
VII. Conclusions and summary .....	267

## I. INTRODUCTORY STATEMENTS: THE DANCER AS MATERIAL FOR THE INVESTIGATION OF PROBLEMS OF BEHAVIOR.

The dancing mouse is well adapted, by its abundant and in certain respects peculiar activity, to experiments on behavior. Taking advantage of this fact, I have used it extensively as material for the development of methods and the revelation of problems, both physiological and psychological. That the results which have been obtained are typically mammalian I am not prepared to assert. This, however, is, for my immediate purposes, secondary in importance to the methodological values of the work. Animal psychology is urgently in need of exact methods of research. It is an appreciation

of this fact that has shaped my experimental work during the past five years, and that now leads me to offer the following results of my study of the dancer primarily as a contribution to the evolution of method and as an aid to the profitable formulation of problems.

This paper is a direct continuation of the studies in the behavior of the dancer which are described in my book, "The Dancing Mouse."<sup>1</sup> Although I have attempted so to write the paper that both methods and results shall be intelligible to those readers who are not familiar with the details of previous publications,<sup>2</sup> it has been necessary—in order to keep my account within reasonable space limits—for me to omit everything except the chief points, in connection with methods which I have previously described, and a concise statement of new results. In other words, I have been forced to assume much more knowledge on the part of the reader than I should if this were my first publication on the subject.

Certain problems concerning the relation of age and sex to habit-formation which were proposed in my book, and either left unsolved or only partially solved, are brought nearer to satisfactory solution by the results herein reported, and a multitude of new problems are revealed. To me, however, the investigation presents itself simply as another step toward a realization of the complexity of the phenomena of behavior and of the need for accurate analytic methods.

## II. RELATION OF AGE AND SEX TO RAPIDITY OF ACQUISITION OF A VISUAL DISCRIMINATION HABIT.

Can the dancer acquire a given habit with the same rapidity at different ages? This question was the starting point of a study of plasticity which has already been reported in part.<sup>3</sup> Before presenting the results of my experiments I shall very briefly, with the help of figures which are reproduced from an earlier paper, describe the method of work.

<sup>1</sup>Yerkes, Robert M. *The Dancing Mouse: a study in animal behavior.* New York, The Macmillan Company, 1907. xxi + 290.

<sup>2</sup>Yerkes, Robert M. and Dodson, John D. *The Relation of Strength of Stimulus to Rapidity of Habit-formation.* *Jour. of Comp. Neur. and Psy.*, vol. 18, p. 459-482, 1908.

<sup>3</sup>The Dancing Mouse, pp. 270-275.

The habit whose formation was studied quantitatively, in the case of groups of dancers consisting of five pairs each, for the ages of one month, four months, seven months, and ten months, may be called the white-black discrimination habit. It involved the discrimination

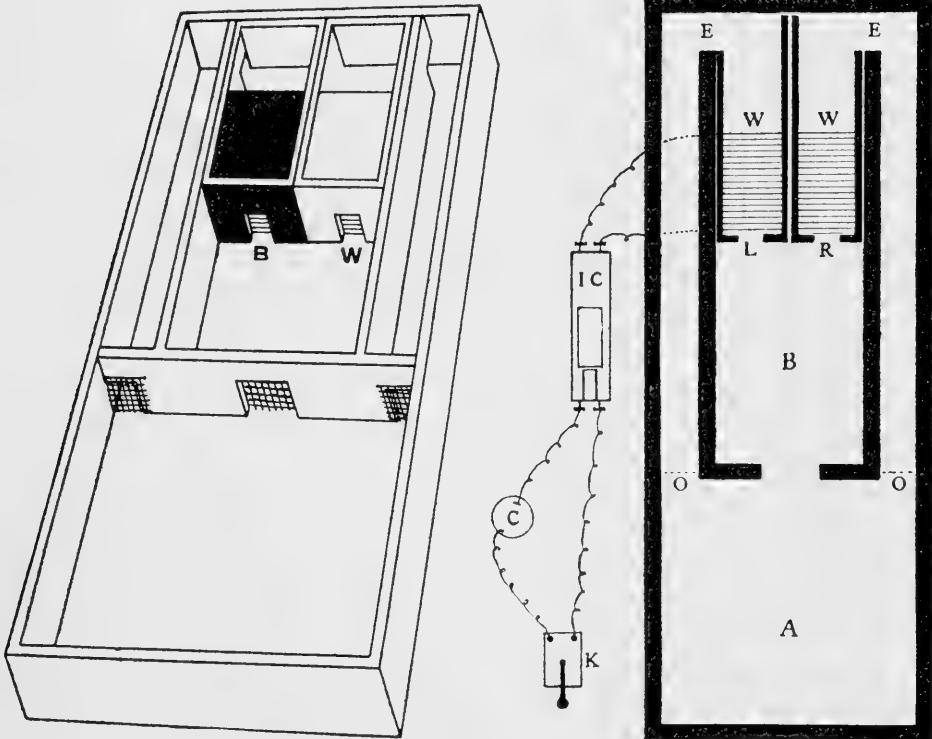

FIG. 1.

FIG. 2.

FIG. 1.—Discrimination box. *W*, electric box with white cardboards; *B*, electric box with black cardboards.

FIG. 2.—Ground plan of discrimination box. *A*, nest-box; *B*, entrance chamber; *W W*, electric boxes; *L*, doorway of left electric box; *R*, doorway from right electric box to alley; *O*, swinging door between alley and *A*; *IC*, induction apparatus; *C*, electric battery; *K*, key in circuit.

of the entrances to two boxes, one of which was white and the other black, and the entering of the white box. Any attempt to enter the black box was punished by an electric shock.

Figures 1 and 2 show the experiment box in perspective and in

ground plan, respectively. The subject, after being placed in the nest box, A, by the experimenter, was permitted to pass into the entrance chamber, B. Then a piece of cardboard, which was placed between the animal and the opening into A, was slowly moved toward L, R, of Figure 2. Thus the dancer was brought face to face with the two entrances, L and R, of this figure (B and W, *i. e.*, black and white of Figure 1). One of these it would soon attempt to enter in order to escape to the nest box, and thus find space for dancing. If it started to enter the black box (and this might be either the box on the left, L, or the box on the right, R, for the white and black cardboards, which were at the entrances and within the boxes, could be transferred readily by the experimenter) it was immediately given a weak electric shock by the closing of the key, K. This usually caused it to retreat from the box and to try the other entrance. In case it entered the black box in spite of the shock, it was not permitted to escape by way of E and O to the nest box, but instead was forced to return to B and again make choice of an entrance. This was continued until the white box was chosen, then the animal was allowed to return to A. After an interval of one or two minutes it was given another opportunity to select the right entrance. This was continued until the white box had been chosen ten times. Such a group of ten trials constitutes what we shall refer to as a series. One series was given each individual daily from the beginning of experimentation until the acquisition of a perfect habit of discrimination and choice.

The positions of the white and black cardboards were changed in precisely the same way for each individual according to an order which has already been described.<sup>4</sup> These shifts in the position of the white box were made in order to prevent the mouse from acquiring the habit of going regularly to the entrance at the left or at the right.

An experiment (test or trial) was recorded as yielding an error of choice if the mouse entered the wrong box far enough to get a shock; as yielding a correct choice if, without first entering the black box,

<sup>4</sup>*Jour. of Comp. Neur. and Psy.*, vol. 18, p. 461, 1908.

it entered the white one and passed through to the nest box. In the tables appear the number of errors per series made day after day by the various individuals. At the outset of the experiments each mouse was given two series of what may be called "preference tests." In connection with these tests no electric shock was given and the mouse was permitted to enter and pass through either the white or the black box, for it was the sole purpose of the experimenter to discover, by means of these series, any initial preference that the subject might have for either the white or the black box.

A habit of discriminating between the boxes, and of uniformly choosing to enter the white one, was considered perfect when the mouse made no errors in three successive daily series. As a measure of the rapidity of habit-formation we may use the number of tests between the beginning of the first training series (following preference series B) and the end of the series which preceded the three perfect series. This measure of rapidity of learning, which I have named the index of plasticity, proves to be extremely useful for purposes of comparison.

To ascertain age differences in rapidity of white-black habit formation I used groups of individuals which, so far as I could tell, differed from one another constantly only in age. Five males and five females constituted each group, and four such groups were used. During their lives all of the animals were kept under the same conditions. They were paired at the age of twenty-five days, and thereafter a male and a female were kept in a separate cage and were placed in the experiment box for their daily training at the same time and given their tests alternately.

We may now examine the results of the experiments. Table 1 contains records of the number of errors of choice made by each of the individuals of the one-month-old group in each daily series. The numbers at the top of the columns refer to the mice. *Even numbers always designate males; odd numbers, females.* The two preference series are indicated by the letters A and B. No. 210, it will be noted, made six erroneous choices in each of the preference series and also in the first training series; that is, he attempted to enter the black box instead of the white box six times in ten. In subsequent training se-





ries the number of errors made by this individual rapidly decreased until in the seventh series only one was made. Then followed three perfect series. For this individual, since he acquired a perfect habit as the result of seventy training tests, the index of plasticity is 70.

The tables contain, in addition to the individual results, the average number of errors per series for the males and for the females.

TABLE 3.  
RELATION OF AGE TO MODIFIABILITY OF BEHAVIOR  
WHITE-BLACK DISCRIMINATION HABIT  
*Results for dancers seven months old*

Series.	MALES.					Average.	FEMALES.					Average.
	92	96	98	116	120		91	93	99	101	109	
A	5	6	5	7	6	5.8	4	4	7	6	6	5.4
B	7	4	7	3	5	5.2	6	6	7	5	7	6.2
1	4	3	5	7	5	4.8	5	6	7	3	8	5.8
2	4	5	6	5	8	5.6	2	3	7	6	2	4.0
3	4	3	4	3	5	3.8	4	4	4	4	6	4.4
4	7	5	4	5	3	4.8	4	3	3	6	4	4.0
5	3	4	5	4	7	4.6	5	3	5	2	3	3.6
6	3	5	2	4	4	3.6	5	2	4	2	2	3.0
7	3	1	1	4	4	2.6	1	4	4	3	2	2.8
8	6	2	3	2	4	3.4	2	4	2	2	3	2.6
9	2	1	3	5	5	3.2	1	5	1	1	1	1.8
10	5	1	3	4	5	3.6	0	2	2	0	3	1.4
11	1	1	1	3	1	1.4	0	1	1	1	1	0.8
12	2	2	1	4	1	2.0	1	1	2	1	2	1.4
13	2	0	1	3	2	1.6	2	3	1	0	0	1.2
14	4	2	1	3	2	2.4	1	1	0	0	0	0.4
15	2	1	0	1	0	0.8	1	1	0	1	0	0.6
16	1	0	0	0	2	0.6	0	0	0	1	0	0.2
17	1	0	0	0	2	0.6	1	0	0	0	0	0.2
18	1	0		1	0	0.4	0	0		0		0
19	0			0	1	0.2	0			0		0
20	0			1	1	0.4						0
21	1			0	1	0.4						0
22	0			0	1	0.2						0
23	1			0	0	0.2						0
24	0				1	0.2						0
25	0				0	0						0
26	0				0	0						0
27	0				0	0						0

Any one who compares this account of my investigation of the relation of age to rapidity of learning with my earlier account will discover that only two pairs of dancers of one month of age for which results were given previously<sup>5</sup> have place in the group under discussion. This is due to the fact that I felt it highly desirable to repeat the experiments with one-month individuals in order to make

<sup>5</sup>The Dancing Mouse, pp. 243, 273.

sure that in the interval which had elapsed between the beginning of this portion of my work and its completion no important changes in the plasticity of the race had occurred.<sup>6</sup> As a matter of fact this precaution proved unnecessary, for no important differences appeared as the result of the interruption of the investigation.

The condensed results for the four-month individuals appear simi-

TABLE 4.  
RELATION OF AGE TO MODIFIABILITY OF BEHAVIOR  
WHITE-BLACK DISCRIMINATION HABIT  
*Results for dancers ten and twelve months old*

Series.	MALES.						FEMALES.					
	90	112*	142	144	196	Average.	97*	113*	119	123	141	Average.
A	6	6	5	5	6	5.6	5	8	7	5	4	5.8
B	5	5	6	6	5	5.4	5	7	6	5	4	5.6
1	4	4	7	4	5	4.8	7	6	5	6	4	5.6
2	6	4	5	4	3	4.4	4	3	7	4	5	4.6
3	7	3	5	7	4	5.2	4	6	8	7	3	5.6
4	3	4	5	5	5	4.4	7	3	5	5	3	4.6
5	5	4	5	4	1	3.8	4	2	3	2	6	3.4
6	3	4	1	7	3	3.6	2	2	1	1	5	2.2
7	3	5	3	3	4	3.6	2	3	1	0	7	2.6
8	3	2	2	5	4	3.2	2	1	2	1	5	2.2
9	4	3	2	4	1	2.8	1	1	1	1	4	1.6
10	3	4	1	1	0	1.8	1	1	0	1	1	0.8
11	1	1	1	1	0	0.8	1	0	0	1	2	0.8
12	1	2	1	1	0	1.0	2	0	1	0	2	1.0
13	2	1	0	1		0.8	0	0	0	1	0	0.2
14	0	3	1	1		1.0	0		1	0	1	0.4
15	1	1	1	0		0.6	0		1	0	0	0.2
16	0	1	0	1		0.4			0	0	1	0.2
17	0	0	1	1		0.4			0		1	0.2
18	0	0	0	1		0.2			0		0	0
19		1	0	1		0.4					0	0
20		0	0	1		0.2					0	0
21		0		0		0						
22		0		0		0						
23				0		0						

\*Twelve months old.

larly in Table 2, and those for the seven-month individuals in Table 3. In the ten-month group (Table 4) I have included the results for three mice which were twelve months old. Although it is not wholly satisfactory to do this, it seemed better than to deal with the three individuals separately. At any rate nothing is concealed by averaging the results for the ten mice, for the individual results are available.

To make comparisons easier, I have brought together in Table 5

<sup>6</sup>An epidemic which destroyed almost all of my mice caused a delay of over a year.

the averages for the males and females of each group. This table presents also the general averages for each sex. Inspection of these results reveals the following significant facts.

(1) The females exhibit a stronger initial preference for the black box than do the males. Both, however, choose the black box more frequently than the white box, in the preference series. Since

TABLE 5.

GENERAL RESULTS OF THE STUDY OF THE RELATION OF AGE TO MODIFIABILITY OF BEHAVIOR.

*Each result in the table is either the average number of errors in ten tests for five individuals, or the general average for twenty individuals.*

Series.	MALES.					FEMALES.				
	1 mo.	4 mo.	7 mo.	10 mo.	Gen. Av.	1 mo.	4 mo.	7 mo.	10 mo.	Gen. Av.
A	5.4	5.6	5.8	5.6	5.60	6.2	6.2	5.4	5.8	5.90
B	5.0	6.4	5.2	5.4	5.50	6.0	5.4	6.2	5.6	5.80
1	5.0	5.6	4.8	4.8	5.05	5.6	5.2	5.8	5.6	5.50
2	3.0	5.2	5.6	4.4	4.55	3.2	2.8	4.0	4.6	3.65
3	3.2	4.6	3.8	5.2	4.20	3.0	3.2	4.4	5.6	4.05
4	3.2	3.6	4.8	4.4	4.00	2.6	2.6	4.0	4.6	3.45
5	2.6	3.4	4.6	3.8	3.60	2.2	2.2	3.6	3.4	2.85
6	1.8	2.4	3.6	3.6	2.85	1.6	1.8	3.0	2.2	2.15
7	1.2	2.4	2.6	3.6	2.45	1.4	2.2	2.8	2.6	2.25
8	0.4	2.8	3.4	3.2	2.45	1.0	0.6	2.6	2.2	1.60
9	0.4	2.0	3.2	2.8	2.10	1.2	1.2	1.8	1.6	1.45
10	0.2	1.0	3.6	1.8	1.65	0.2	0.6	1.4	0.8	0.75
11	0	1.6	1.4	0.8	0.95	0.4	0.6	0.8	0.8	0.65
12	0	0.6	2.0	1.0	0.90	0.4	0.2	1.4	1.0	0.75
13	0	0.4	1.6	0.8	0.70	0.2	0.4	1.2	0.2	0.50
14		0	2.4	1.0	0.85	0	0	0.4	0.4	0.20
15		0.2	0.8	0.6	0.40	0	0	0.6	0.2	0.20
16		0	0.6	0.4	0.25	0	0	0.2	0.2	0.10
17		0	0.6	0.4	0.25			0.2	0.2	0.10
18		0	0.4	0.2	0.15			0	0	0
19			0.2	0.4	0.15			0	0	0
20			0.4	0.2	0.15			0	0	0
21			0.4	0	0.10					
22			0.2	0	0.05					
23			0.2	0	0.05					
24			0.2		0.05					
25			0		0					
26			0		0					
27			0		0					

entire lack of preference would be indicated by an equal distribution of the choices—five for the white and five for the black in each series—the preference for the black, in the case of the males, is .6 in series A and .5 in series B, and in the case of the females it is .9 in series A and .8 in series B.

(2) The females make more errors than the males in the first

training series, but thereafter they make fewer errors and their training is completed with fewer series than that of the males. In other words, the general averages of Table 5 indicate that a group of twenty female dancers, ranging in age from one month to twelve months, acquired the habit of discriminating between two boxes, whose only considerable difference was in amount of illumination, and of choosing the white box much more quickly than did a comparable group of twenty male dancers. This is especially interesting in view of the fact next to be noted.

(3) The one-month males exhibit a considerably less strong preference for the black box than do the one-month females and, at the same time, they acquire the habit much the more quickly. The reverse is true of the four-month groups: the males exhibit the

TABLE 6.  
INDICES OF PLASTICITY FOR DANCERS OF DIFFERENT AGES.

Age of Individuals.	MALES.		FEMALES.		BOTH SEXES.	
	First correct series.	Total no. of training tests.	First correct series.	Total no. of training tests.	First correct series.	Total no. of training tests.
1 month.....	74	82	76	106	75	94
4 months.....	92	128	78	106	85	117
7 months.....	146	192	106	146	126	169
10 months*.....	128	160	98	134	113	147

\* One male and two females whose ages were twelve months are included.

stronger preference for the black to begin with and learn somewhat less rapidly.

(4) The males acquire the white-black habit more quickly at the age of one month than at the ages of four, seven, or ten months. And the females likewise acquire the habit most readily at one month of age.

Several of the above facts are clearer in the light of the results of Table 6, in which are arranged the indices of plasticity for the several groups of dancers, and the number of trials which, in the case of each group, preceded the first correct series of choices. The indices are given in the columns headed "total number of training tests." Judging by these indices we may say that the plasticity of the male dancer, as measured by the particular habit under consideration,

diminishes from the age of one month to between the seventh and the tenth months. It seems then to increase slightly. Whereas 82 is the index for the one-month individuals, that for the four-month males is 128, and that for the seven-month males 192. For the ten-month group the index 160 indicates increasing instead of diminishing plasticity.

The results indicate that the plasticity of the females does not change greatly between the first and the fourth months; that thereafter it decreases for a few months, and then again increases slightly. The indices for the several ages, as they appear in Table 6, are 106, 106, 146, and 134. All of these except the first, indicate a degree of plasticity higher than that of the males.

Figures 3 and 4 represent graphically the principal results of the experiments which have just been described. Figure 3 is based upon the general averages of Table 5. The irregularly broken line is the curve of the learning for the males of the dancer race; the regularly broken line, for the females of the race. The superiority of the females in the acquisition of this particular white-black discrimination habit is apparent. Figure 4 is based upon the data of the third, fifth, and seventh columns of Table 6. The irregularly broken line may be termed the plasticity curve of the male dancer (for a particular habit) between the ages of one month and ten months. The regularly broken line may similarly be termed the plasticity curve of the female dancer between the same age limits. The solid line, the plasticity curve of the race.

And now we are confronted by the question, Why the age differences in plasticity which are exhibited by our results? In reply we might say that preference determines rapidity of learning. For we note that the females, apparently because of their strong preference for the black box, make more errors of choice in the first training series than do the males (general averages of Table 5), and that subsequently they very rapidly learn to avoid the black box. It would appear, then, that initial preference for the black box is a favorable condition for habit-formation because it leads to a large number of errors in the early training series and thus gives the animal that experience which enables it to adjust itself to the situation. This

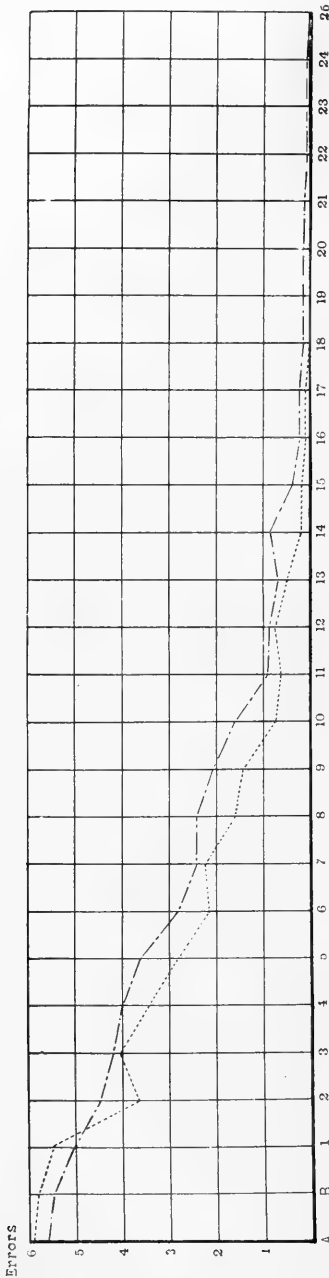

FIG. 3.

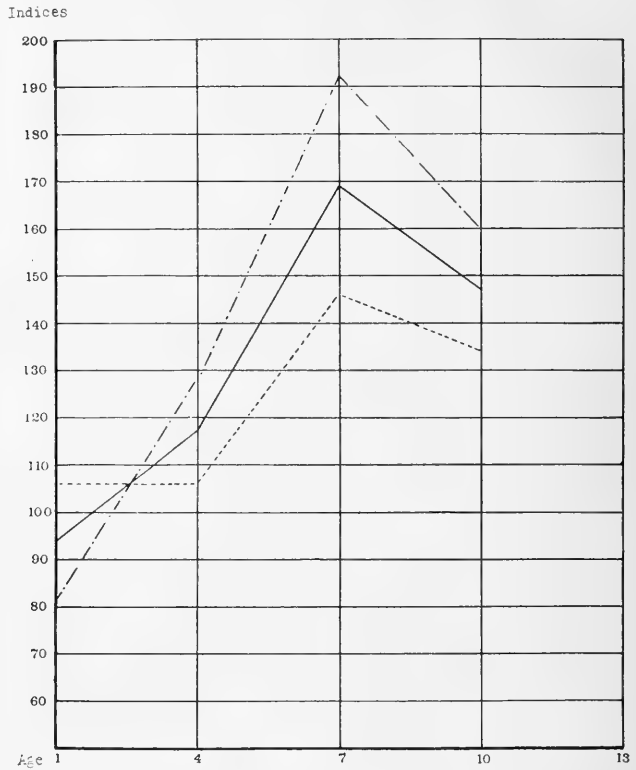

FIG. 4.

FIG. 3.—Curves of learning (error curves) for twenty male and twenty female dancers in white-black visual discrimination habit. Ordinates represent number of errors of choice in series of ten tests (per day). Abscissæ represent daily series of tests, beginning with two preference series, A and B, and continuing to the completion of the training. Curve for males ----- ; Curve for females .....

FIG. 4.—Plasticity curves for twenty male, and twenty female dancers, and for the race, in white-black discrimination habit. Ordinates represent indices of plasticity or modifiability (*i. e.*, the number of tests up to the point at which no errors of choice were made in three successive series of ten tests each). Abscissæ represent ages in months. Curve for males ----- ; Curve for females ..... ; Curve for race —.

interpretation of the facts, however, is contradicted by the following results which comparison of the data of Tables 6 and 7 reveals. The one-month males, although they showed only a slight initial preference (0.2) for the black box, acquired the white-black habit more quickly than did any other group of dancers. On the other hand, the four-month males, while exhibiting a strong initial preference (1.0) for the black box, acquired the habit much less quickly than did the one-month individuals. In view of these facts it is impossible to conclude that preference plays an all-important role as a condition for white-black habit-formation. Evidently we must look elsewhere for the factor or factors upon which the results of the plasticity experiments depend.

TABLE 7.

GENERAL RESULTS OF WHITE-BLACK PREFERENCE TESTS FOR INDIVIDUALS WHICH WERE USED IN THE STUDY OF THE RELATION OF AGE TO MODIFIABILITY OF BEHAVIOR.

The figures in the table represent the number of choices of the black in preference to the white in series of ten tests each.

Age of Individuals.	MALES.			FEMALES.		
	Series A.	Series B.	Average.	Series A.	Series B.	Average.
1 month.....	5.4	5.0	5.2	6.2	6.0	6.1
4 months.....	5.6	6.4	6.0	6.2	5.4	5.8
7 months.....	5.8	5.2	5.5	5.4	6.2	5.8
10 months*.....	5.6	5.4	5.5	5.8	5.6	5.7

\* One male and two females whose ages were twelve months are included.

It is quite conceivable that age or sex differences in the value of the electrical stimulus may be responsible for the differences in rate of habit-formation which appear. This possibility was tested experimentally by an examination of (1) the relation of electric sensitiveness to age and sex, and (2) the relation of strength of stimulus to rapidity of habit-formation. Before attempting further to analyze or interpret the results presented in the tables we shall examine the experimental data which enable us to answer the questions, Does the sensitiveness of the dancer to electric stimuli depend upon age and sex, and, Does the strength of the electric stimulus influence the rapidity of habit-formation?

## III. SENSITIVENESS TO ELECTRIC STIMULUS, IN ITS RELATIONS TO AGE AND SEX.

The measurements of sensitiveness to electrical stimulation which are now to be presented were made in connection with the study of the relation of age to rate of habit-formation, for the special purpose of throwing light upon the interpretation of the data which have just been considered. Had the experimenter's aim been to make a thorough-going investigation of the limits of sensitiveness in the dancer, other and more accurate methods would have been employed. But as matters stood, it seemed desirable to use for these tests of sensitiveness the method of applying the stimulus that had been used in the plasticity experiments themselves.

In its especially adapted form, this method exhibited the following points of importance. A current from a storage cell was used, in connection with a calibrated Hasler inductorium,<sup>7</sup> as stimulus. The strength of the induced current was regulated by moving the secondary coil. By means of an interrupted circuit device similar to that previously described<sup>8</sup> the mouse was permitted to receive this current through its fore feet. While one observer manipulated the keys of the circuits and regulated the strength of the current, another placed the mouse in position and observed its behavior when it received the shock. Determination was made, by repeated trials, of the lowest stimulus strength to which a definite motor response was given, and of the strength to which only an uncertain response was given. The average of these two results was accepted as *the threshold value for the individual*.

Twenty male and twenty female dancers were tested on two different days. The results in terms of the position of the secondary coil, as they appear in Table 8, indicate: (1) That the males are somewhat more sensitive than the females. This difference, which, according to the calibration curve of the inductorium, is nearly ten per cent., was not evident to the experimenter as he worked with the dancers from day to day in the training tests. (2) There is no indication of change of sensitiveness with increase in age.

<sup>7</sup>For the use of this inductorium I am indebted to Dr. E. G. Martin.

<sup>8</sup>The Dancing Mouse, p. 94.



As it happens the averages for the age groups are precisely the same for both the males and the females. This is a surprising result which we could not expect to obtain by the repetition of so small a number of tests. (3) Individual differences in sensitiveness are much more marked, and in all likelihood more important, than either sex or possible age differences.

As there is no reason to suppose, in the light of these rough determinations, that possible changes in sensitiveness which accompany ageing account for any of the results of the plasticity experiments, we may ask whether it is at all likely that the sex

TABLE 8.  
MEASUREMENTS OF SENSITIVENESS TO ELECTRICAL STIMULUS.

SEX DIFFERENCES.				
	Males (averages for 20).		Females (averages for 20).	
Position of secondary coil, First Day.....	17.88+	cm.	17.41	cm.
Position, Second Day.....	17.72-		17.25	
Average Position.....	17.80*		17.33	
Extremes { Least sensitive.....	15.75		16.67	
{ Most sensitive.....	19.25		18.00	

AGE DIFFERENCES.				
	MALES.		FEMALES.	
	Not over four months.	Over four months.	Not over four months.	Over four months.
Number of dancers tested.....	13	7	12	8
Average age.....	2.5 mos.	8.3 mos.	2.4 mos.	8 mos.
Position of secondary coil, First Day.....	17.73 cm.	18.17 cm.	17.35 cm.	17.50 cm.
Position, Second Day.....	17.87	17.44	17.30	17.17
Average Position.....	17.80	17.80	17.33	17.33

\* Difference in favor of males .47 cm., or about 10% of the value of the current.

and individual differences in sensitiveness furnish the basis for such differences in rapidity of habit-formation as the tables indicate.

Before this question can be answered satisfactorily, we must know what relation strength of electric stimulus bears to rapidity of learning. Does increase in the strength of the stimulus from the threshold value—or, what for our present purposes amounts to the same thing, increase in sensitiveness—facilitate or retard the process

of habit formation? As an answer to this question, I offer a summary statement of the results of a special investigation of the relation of strength of stimulus to rapidity of learning in which I was ably assisted by Mr. John D. Dodson. This study, unlike that of sensitiveness, was a thoroughgoing quantitative investigation of the significance of the factor under consideration, and we present our results with confidence that their accuracy, despite many technical difficulties, renders the generalizations which they indicate of importance not only in connection with our present experiments, but for all work on animal behavior.

#### IV. STRENGTH OF ELECTRIC STIMULUS, IN ITS RELATION TO RAPIDITY OF HABIT-FORMATION.

Precisely how does increasing or decreasing the strength of the electric stimulus, which the dancer is learning to avoid by associating it with the darker of two boxes, influence the process of learning? The answer which results obtained with forty dancers enable us to give to this question is exceedingly important in its several aspects.<sup>9</sup>

(1) We have demonstrated that the influence of the stimulus varies with the difficultness of the visual discrimination which is demanded of the mouse, and that condition of discrimination must be taken into consideration from the first in formulating our answer to the above question.

(2) That when visual discrimination is easy, rapidity of habit-formation increases as strength of stimulus is increased from the threshold to the point of injurious stimulation. In our experiments, the strongest stimulus employed was decidedly disagreeable to the experimenters and caused violent reactions in the mouse. Whether beyond this intensity of stimulation the rate of learning increases, we cannot say from the results of experimentation, but we may say with assurance that it cannot possibly increase very much, inasmuch as the stimulus would soon become positively harmful.

<sup>9</sup>Yerkes, R. M., and Dodson, J. D. The Relation of Strength of Stimulus to Rapidity of Habit-formation. *Jour. Comp. Neur. and Psy.*, vol. 18, pp. 459-482, 1908.

(3) That when visual discrimination is moderately difficult, rapidity of habit-formation increases as strength of stimulus is increased up to a certain point, and with further increase in the stimulus it rapidly decreases. A moderate strength of stimulus is most favorable for habit-formation under this condition of discrimination.

(4) That when visual discrimination is very difficult, rapidity of habit-formation increases as strength of stimulus is increased for a time, but not nearly so long as in the case of the medium condition of discrimination, and then with further increase in the stimulus it rapidly decreases. A low intensity of stimulus is most favorable for habit-formation under this condition of discrimination.

The law which is indicated by these facts may be formulated thus. *As difficultness of visual discrimination increases that strength of electrical stimulus which is most favorable to habit-formation approaches the threshold. The easier the habit the stronger that stimulus which most quickly forces its acquisition; the more difficult the habit the weaker that stimulus which most quickly forces its acquisition.*

From these facts it is evident that the value of a given strength of electric stimulus, for the training of a dancer whose sensitiveness is accurately known, can be stated only if the degree of difficultness of discrimination for the individual also be known. A degree of difference between the white and the black boxes which renders discrimination moderately easy for one dancer may render it extremely easy for another. Male and female, or old and young, or even two individuals of the same sex and age, may differ, both in discriminating ability and in sensitiveness.

This consideration makes apparent the incomparability of the results of the plasticity experiments. Instead of uniformity and simplicity of conditions, we have variability and complexity. It is evident that before a given individual can be used to advantage in any such training experiments as these, or rather before we can interpret the results, we must know accurately the relations of the conditions of experimentation to the individual.

Intensity of the electric stimulus is, then, important in connection with rapidity of habit-formation. Since, however, no difference in sensitiveness appears to be correlated with age differences we may assume, until we know otherwise, that the age differences in rapidity of learning are not due to the influence of the electric stimulus. But, at the same time, since the males appear to be more sensitive than the females, it may be that the sex differences in rapidity of learning are in part at least due to the influence of the stimulus. Possibly the particular combination of condition of discrimination and strength of stimulus was more favorable for the one-month males than for the comparable group of females, and possibly also for the females, as a whole, the combination of conditions was more favorable than for the males.

The significance of this suggestion will be clearer in the light of the results of the next section of this paper, for in that we shall have to examine data, which, if I could have foreseen them at the beginning of my work with the dancer, would have altered almost all of my experiments. I do not wish to give the reader the impression that I regard the results of the plasticity experiments as valueless or that I consider this investigation of mine exceptional in comparison with the work of any or all other investigators in this field. On the contrary, I have great respect for both the experimental procedure and the results which it yielded, but I am especially interested in pointing out the complexity of conditions which the investigation has revealed.

Before turning to the topic of the next section, I wish to call attention to the probable significance of the law of habit-formation which I have tentatively formulated above. As I have stated it, this law may not hold for other conditions of habit-formation, or for other animals. Only further investigation along lines which Mr. Dodson and I have followed can decide these questions. Meanwhile, it is evident that the subject is of great importance, for much of our experimental work in animal psychology rests upon the assumption that the stronger the stimulus which conditions a particular act the sooner the animal will learn to perform that act. In the light of our results concerning the relation of strength

of electric stimulus to rapidity of habit-formation it becomes pertinent to inquire, Is utter hunger as favorable a condition for the discovering of a certain method of obtaining food as moderate hunger? Is extreme eagerness to escape from confinement as favorable as a moderate desire? What we really should know before we undertake to study the intelligence of a particular animal is the value for it of the several factors which constitute the chief experimentally controlled conditions of activity. So long as we continue to use external conditions as incentives to habit-formation, without definite knowledge of their values for the individual, we shall work blindly. Food supply—the internal aspect of which is hunger—as a condition of habit-formation, may be studied experimentally; and the same is true of every other so-called motive upon which the experimenter depends. It is high time that we made serious efforts to discover the values of our stimuli instead of slothfully assuming that they will answer our purposes.

That there are a number of important laws of habit-formation to be discovered no student of animal behavior can doubt. These laws, of which the one offered above may serve as an example, should rapidly replace what is too much talked of as “the law of habit-formation.”

#### V. RELATION OF DIFFICULTNESS OF DISCRIMINATION TO RAPIDITY OF HABIT-FORMATION AT DIFFERENT AGES.

Among the important results of the investigation of relation of strength of stimulus to rapidity of learning was the demonstration of the fact that differences in plasticity depend upon the condition of visual discrimination as well as upon the strength of the electric stimulus. What holds with respect to rapidity of acquisition of the white-black discrimination habit in young and old dancers, under conditions which render discrimination difficult, does not necessarily hold under conditions of easy discrimination. This I have demonstrated, and thrown further light upon, by three different methods, the results of which will now be presented in turn.

##### 1. *Experiments with cardboards in discrimination box* furnished

the first indication of the great importance of condition of discrimination. With other points of method the same as in the plasticity experiments, I so arranged the black and white cardboards of the discrimination box that the amount by which the white box differed in illumination from the black box was very much greater than it had been in the earlier experiments. Whereas, formerly, discrimination had been rather difficult, it was now made

TABLE 9.

RELATION OF AGE TO RAPIDITY OF HABIT-FORMATION UNDER CONDITIONS OF DIFFICULT AND OF EASY DISCRIMINATION  
WHITE-BLACK DISCRIMINATION

Series.	DANCERS 8 OR 12 MONTHS OLD.				DANCERS 1 MONTH OLD.			
	Difficult Discrimination.		Easy Discrimination.		Difficult Discrimination.		Easy Discrimination.	
	No. 112	No. 113	No. 204	No. 121	No. 292	No. 291	No. 430	No. 432
A	6	8	5	4	7	7	7	8
B	5	7	4	5	5	6	8	8
1	4	6	6	7	7	8	7	6
2	4	3	4	1	3	6	5	3
3	3	6	4	0	1	3	2	1
4	4	3	1	1	4	2	2	1
5	4	2	0	0	0	0	1	2
6	4	2	0	0	1	1	0	0
7	5	3	0	0	0	1	0	0
8	2	1	0*	0*	0	1	0	0
9	3	1	2	0	0	0	0*	0*
10	4	1	0	0	0	0	1	0
11	1	0	2	0	0	0	0	1
12	2	0	1	0	0	0	0	1
13	1	0	0	0	0	0	0	0
14	3	0	0	0	0	0	0	0
15	1	0	0	0	0	0	0	0
16	1	0	0	0	0	0	0	0
17	0	0	0	0	0	0	0	0
18	0	0	0	0	0	0	0	0
19	0	0	0	0	0	0	0	0

\* At this point condition of discrimination was changed from "easy" to "difficult."

easy. The plasticity experiments, it is to be remembered, showed that the young dancers acquired the habit much more rapidly than the old individuals. Just the reverse proved to be true under the conditions of easy discrimination: the old mice learned more quickly than the young individuals.

In order to make the results perfectly conclusive, I carried out series of training experiments at the same time with a pair of

dancers one month old and a pair twelve months old under the conditions of discrimination used in the plasticity investigation, and similarly with two pairs of dancers one of which was one month old and the other eight months, under the conditions which I have just characterized as easy. The results of these experiments, as they are presented in condensed form in Table 9, are striking indeed. As was the case in my first experiments, the old dancers<sup>10</sup> acquired their habit, under conditions of difficult discrimination, much less rapidly than did the young individuals. The index of plasticity for the twelve-month mice, Nos. 112 and 113 of the table, is 130; that for the one-month mice, Nos. 292 and 291, is 70. The latter acquired the habit with few more than half as many training tests as were necessary for the former.

When we turn to the results of the experiments made under conditions of easy discrimination, we find that the eight-month mice, Nos. 204 and 121, learned with only 40 tests; whereas, the one-month individuals, Numbers 430 and 432, required 50 tests.

In Table 10 are presented the results of additional experiments like those just described. Two eight-month dancers, Nos. 136 and 166, acquired the habit on the basis of 40 and 20 tests, respectively. Their index of plasticity is, therefore, 30. The index for two four-month mice, which were subjected to the same training, was 80, and that for two eight-month individuals, 75.

The importance of the relation of age to difficultness of visual discrimination is clearly exhibited by the indices of plasticity for young and old dancers under conditions of easy and difficult discrimination in Table 11.

Comparison of the data of Tables 9, 10 and 11 with those of Tables 1 to 6 proves conclusively that the direction of the age differences in plasticity which was revealed by the experiments described early in this paper was determined, in part at least, by the condition of visual discrimination which happened to be chosen for the

<sup>10</sup>I shall use the terms of old and young in contrasting two groups of dancers which differed in age by several months. As a matter of fact a dancer at the age of eight, ten, or even twelve months is not, as a rule, obviously senile.

experiments. Had the tests been made with a condition of greater difference in the illumination of the two boxes the results probably would have indicated a slight increase in plasticity with age, instead of a decrease. If then under one condition of training plasticity diminishes as the dancer grows older, and under another condition in connection with the same habit it increases, it is clear that the

TABLE 10.

RELATION OF AGE TO RAPIDITY OF HABIT-FORMATION UNDER CONDITIONS OF EASY AND OF DIFFICULT DISCRIMINATION. WHITE-BLACK DISCRIMINATION.

*Discrimination at first easy and later difficult.*

Series.	DANCERS 8 MONTHS OLD.		DANCERS 4 MONTHS OLD.		DANCERS 1 MONTH OLD.	
	No. 136	No. 166	No. 408	No. 185	No. 416	No. 105
A	5	6	4	4	8	8
B	7	4	4	3	6	3
1	6	4	6	5	7	3
2	5	1	5	3	4	4
3	0	0	3	3	5	6
4	1	0	3	1	4	3
5	0	0	2	3	7	2
6	0	2*	1	2	2	1
7	0	2	0	1	0	1
8	1*	4	0	0	0	1
9	1	3	1	0	0	1
10	0	2	0	0	3*	0
11	2	2	0	0*	4	0
12	0	3	0	1	6	0
13	0	1	1*	0	2	1*
14	0	0	1	0	3	0
15		0	0	0	1	0
16		2	1	0	1	0
17		0	0	0	2	
18		0	0	0	0	
19		1	0	0	1	
20		1			0	
21		1			0	
22		2			0	
23		0				
24		0				
25		0				

\*At this point condition of discrimination was changed from "easy" to "difficult."

relation of age to rapidity of habit-formation is more complex than certain statements made by students of animal behavior would lead one to suppose.

My experiments reveal the presence and importance of a number of variable factors in the white-black discrimination habit; and until we know accurately the values and relations of these several



factors it would be rash indeed to make general statements concerning the relation of age to plasticity. We must limit ourselves carefully to particular statements, for what holds of one condition of training may not hold at all of what appears to be a very similar condition.

TABLE 11.

INDICES OF PLASTICITY FOR DANCERS OF DIFFERENT AGES, TRAINED UNDER CONDITIONS OF DIFFICULT OR OF EASY VISUAL DISCRIMINATION.

No. of dancer.	CONDITION OF DISCRIMINATION.			
	DIFFICULT.		EASY.	
	Young dancers- 1 month old.	Old dancers- 12 months old	Young dancers- 1 month old.	Old dancers- 8 months old.
112		160		
113		100		
204				40
121				40
292	60			
291	80			
430			50	
432			50	
136				40
166				20
416			60	
105			90	
Averages.	70	130	62.5	35.0

2. *Experiments with discrimination box in dark-room.* The results of the experiments which have just been described suggested to me the idea that ability to acquire the white-black visual discrimination habit depends largely upon two factors: capacity for visual discrimination and associative memory. The facts of plasticity thus far revealed might be accounted for, it would seem, by the assumption that in the young dancer capacity for visual discrimination was either greater at the outset or more readily developed than in the case of old individuals, whereas associative memory is more highly developed in the old than in the young mice. This hypothesis I immediately attempted to test experimentally. If it be correct, young mice should develop the capacity to discriminate slight differences in luminosity more quickly than old mice. To test this matter I planned a series of training experiments with the apparatus which I have previously described<sup>11</sup> as the Weber's

<sup>11</sup>The Dancing Mouse, p. 118.

law apparatus. It is a discrimination box in which the two boxes which have heretofore been referred to as white and black are illuminated by standardized incandescent lamps. There are no cardboards and difference in illumination, as desired, is obtained by shifting the position of the source of light for one of the boxes. This apparatus permits easy and fairly accurate measurements of the absolute and relative illumination of the two boxes, and in this respect it is more satisfactory than the cardboard method. Its chief disadvantage is that it compels experimentation in a dark-room or at least with artificial illumination of the boxes.

In the Weber's law apparatus two pairs of dancers were trained systematically until they had been given almost a thousand tests. The individuals represent the age limits of the plasticity experiments. The old ones, Nos. 170 and 95, were ten and twelve months, respectively; the young ones, Nos. 294 and 293, were one month old. Instead of a single series of ten tests per day, all these individuals were given two such series each day.

To start with, all the mice possessed perfectly formed habits of choosing the white box, in the old white-black discrimination apparatus. Experiments in the Weber's law apparatus were begun with the two boxes illuminated the one by 80 hefners, the other by 20 hefners. The difference in luminosity in this case may be stated as three-fourths, since the latter value is only one-fourth the former. I have found it convenient to keep one of these values constant throughout a training experiment and to vary the latter as need dictated. The fixed value, which may then be known as the *standard*, is indicated in the table by the abbreviation S. The other value, which may be known as the *variable*, is indicated by the abbreviation V.

A habit was considered perfect in this experiment when a dancer succeeded in choosing without error in two successive series. As soon as ability to discriminate a certain degree of difference in luminosity had been acquired, the amount of the difference was reduced and the training continued under the more difficult condition of discrimination. We may now examine the results of this experiment as they appear in Table 12.

At the outset the condition of discrimination was fairly easy and the old dancers learned to choose correctly with 110 tests, the young

TABLE 12.  
RELATION OF DISCRIMINATING ABILITY TO AGE.  
EXPERIMENTS WITH WEBER'S LAW APPARATUS.

DANCERS 10-12 Mo.			DANCERS 1 Mo. OLD.			DANCERS 10-12 Mo.			DANCERS 1 Mo. OLD.		
Series	No. 170	No. 95	Series	No. 294	No. 293	Series	No. 170	No. 95	Series	No. 294	No. 293
S. 80 h.V. 20 h. Difference three-fourths.						S. 80 h.V. 60 h. Difference one-fourth.					
1	6	8	1	9	6	44	3	3	41	4	3
2	4	5	2	8	5	45	1	5	42	2	4
3	7	6	3	3	4	46	4	3	43	4	3
4	5	3	4	6	4	47	3	4	44	3	7
5	4	3	5	4	1	48	6	3	45	8	6
6	1	3	6	5	0	49	3	4	46	3	7
7	1	3	7	1	0	50	1	2	47	2	6
8	1	2	8	5	0	51	4	4	48	3	4
9	1	0	9	3	1	52	4	5	49	2	5
10	0	0	10	3	0	53	3	4	50	3	6
11	0	2	11	1	0	54	3	2	51	2	3
12	2	0	12	2	0	55	3	3	52	2	3
13	0	1	13	1	..	56	2	2	53	4	4
14	0	0	14	1	..	57	1	4	54	3	4
15	0	0	15	0	0	58	3	5	55	4	3
16	0	0	16	0	0	59	2	5	56	4	2
						60	2	6	57	4	5
						61	4	5	58	3	5
						62	2	4	59	2	3
						63	2	4	60	3	5
						64	2	6	61	6	7
						65	2	5	62	3	5
						66	5	6	63	3	4
						67	3	4	64	3	7
						68	2	3	65	2	3
						69	2	4	66	1	2
						70	2	4	67	0	4
						71	3	4	68	4	3
						72	3	5	69	2	3
						73	3	2	70	4	0
						74	2	4	71	5	2
						75	2	3	72	2	3
						76	1	2	73	3	4
						77	1	2	74	2	5
						S. 80 h. V. 26.66 L.			Difference one-third.		
						78	2	4	75	2	0
						79	1	3	76	2	2
						80	1	5	77	2	3
						81	2	6	78	1	2
						82	1	1	79	0	1
						83	4	5	80	0	1
						84	2	5	81		3
						85	1	3	82		0
						86	1	2	83		4
						87	4	2	84		2
						88	2	3	85		3
						89	3	5	86		3
						S. 80 h.V. 32 h.			Difference two-fifths.		
						90	1	1	87		1
						91	1	3	88		3

ones, with 95. In view of the results of the previous section we might have expected the young individuals to learn more slowly than

the old ones. But we must remember that the conditions of this experiment are markedly different from those in which cardboards were used to render the two boxes visually distinguishable.

Next the amount of difference in luminosity was reduced to one-half, and the experiment continued. Again the young individuals acquired the habit more quickly than the old ones. The index of plasticity for the old is 250, for the young it is 165.

With a difference in luminosity of only one-fourth, the training was now continued for several days, but as no one of the four mice succeeded in acquiring a perfect habit it was changed finally to one-third. It is noteworthy that in the thirty-four series (340 tests) that were given to the mice with the difference one-fourth, the old individuals did not succeed in making a correct series, whereas both of the young mice did. With the difference one-third, No. 294 quickly acquired a perfect habit, and No. 293 came very near to doing so, but failed in twelve series. At the conclusion of the twelfth series, neither of the old individuals had learned to choose correctly, with the difference one-third.

Although the results of this experiment are not as convincing as they might be, they do indicate that young dancers can acquire the ability to discriminate slight differences in luminosity more readily than can old individuals. It is conceivable, then, although by no means demonstrated as true, that the young individuals in the plasticity experiments acquired the white-black habit more quickly than the old individuals did because they could discriminate better or acquired discriminating ability more rapidly and not because they acquired an association more readily. In this event, our experiment measures differences in visual discrimination, and in changes which it undergoes with training instead of associative plasticity.

I have already shown<sup>12</sup> that the dancer is capable, as the result of prolonged training, of developing the power to discriminate between boxes which differ from one another in illumination by less than one-tenth. This fact becomes important at this point, for

<sup>12</sup>The Dancing Mouse, pp. 127, 128.

we are forced to ask, Do the plasticity experiments reveal anything except age differences with respect to what might be termed the educability of light vision? With the hope of getting further light on this problem, I carried out additional experiments, with the individuals used in the Weber's law apparatus, by a method whose form and results will now be described.

3. *Experiments with one side of discrimination box covered in varying degrees.* For this work the cardboards were removed from the discrimination box which had served for the plasticity experiments, and difference in the illumination of the two boxes was obtained by covering, with a piece of black cardboard, the whole or a part of the top of one of the two small boxes. The total inside length of the boxes was 29 cm. I have described the condition of the darker box by giving in terms of a fraction the amount of the top which was covered. Thus 18/29 means that the cardboard covered 18 of the 29 cm., beginning at the entrance and extending toward the rear of the box. Shifting the lighter box (the one to be chosen) from side to side involved merely the moving of the black cardboard from the top of one box to the top of the other.

After the experiments just reported had been completed, mice Nos. 170, 95, 294, and 293 were given training tests in the discrimination box under the above conditions. Table 13 presents the condition of discrimination as well as the results of the various series of tests. When, as at the outset, the whole of one box was covered, discrimination was extremely easy, because the boxes differed greatly in illumination.

From the first, as the data of Table 13 indicate, the young animals learned more rapidly than did the old ones. We have in these results, therefore, additional support for the belief that discriminating ability is more readily gained by the young dancer.

It may not be out of place to remark here that the simple form of the lighter-darker discrimination apparatus which served for this series of experiments is precisely what should have been used throughout this investigation. It has taken me years to learn that it is not only possible, but also perfectly easy, to devise a condition of experimentation which should be readily and accurately

describable as to the difference of brightness of the two boxes and satisfactory in its results. I cannot too strongly urge, from my present point of view, the avoidance of cardboards as means of testing visual discrimination. The conditions of many of my experiments are practically indescribable so far as absolute value of illumination is concerned, yet, as I now see it, they might perfectly well have been describable with a fair degree of accuracy.

TABLE 13.

RELATION OF AGE TO ABILITY TO DISCRIMINATE ON THE BASIS OF DIFFERENCE IN ILLUMINATION, AND TO THE CAPACITY FOR IMPROVEMENT OF VISUAL DISCRIMINATION.

Series.	DANCERS 10-12 MONTHS OLD.			DANCERS 1 MONTH OLD.		
	Portion of darker box covered by card.	No. 170.	No. 95.	Portion of darker box covered by card.	No. 294.	No. 293.
1	Whole.	5	5	Whole.	5	3
2		2	6		4	4
3		2	1		0	1
4		1	0		0	0
5		0	0		0	0
6		0	0	$\frac{1}{2}$	0	0
7		0	0	$\frac{1}{2}$	1	1
8	$\frac{1}{2}$	2	1	$\frac{1}{2}$	0	0
9	$\frac{1}{2}$	3	0	$\frac{1}{2}$	0	0
10	$\frac{1}{2}$	3	0	$\frac{1}{2}$	5	2
11	$\frac{1}{2}$	0	1	$\frac{1}{2}$	3	1
12	$\frac{1}{2}$	2	2	$\frac{1}{2}$	4	2
13	$\frac{1}{2}$	2	0	$\frac{1}{2}$	2	1
14	$\frac{1}{2}$	5	0	$\frac{1}{2}$	4	2
15	$\frac{1}{2}$	5	2	$\frac{1}{2}$	2	1
16	$\frac{1}{2}$	2	2	$\frac{1}{2}$	1	3
17	$\frac{1}{2}$	4	1	$\frac{1}{2}$	0	1
18	$\frac{1}{2}$	4	1	$\frac{1}{2}$	2	2
19	$\frac{1}{2}$	4	2	$\frac{1}{2}$	1	0
20	$\frac{1}{2}$	4	1			
21	$\frac{1}{2}$	2	3			

Having now tested the first of the two important factors in the the acquisition of the white-black discrimination habit, namely, ability to gain visual discriminating power (the educability of white-light vision), we must turn to the second factor and inquire whether associative memory changes with age.

It occurred to me that since the labyrinth habit, as conclusively proved by Professor Watson<sup>13</sup> for the white rat, depends more

<sup>13</sup>Watson, J. B. Kinæsthetic and Organic Sensations: Their Role in the Reactions of the White Rat to the Maze. *Psychol. Rev. Mon. Supp.*, vol. 8, no. 2, 1907. vi + 100 pp.

largely upon kinæsthetic sense data than upon vision or any other special sense, it might serve well to reveal age differences in associative ability. In this connection we may ask, therefore, Do old dancers learn labyrinth paths more readily than young ones?

#### VI. RELATION OF AGE TO RAPIDITY OF ACQUISITION OF LABYRINTH HABITS.

For the labyrinth experiments I selected two mazes which I had previously used for the study of educability in the dancer: they are designated as D and C in my book.<sup>14</sup> D is what I have described as the regular type of maze, and C as the irregular. Training in labyrinth D was given first to each of ten dancers of from one to two months of age, and likewise to the same number of about ten months of age. About a month after the completion of the training in labyrinth D, the same individuals were trained in labyrinth C.

In all cases the experiments were conducted as follows. Two mice, a male and a female from the same cage, were placed in the nest box of the labyrinth together. One at a time they were given first a preliminary test in which they were permitted to find their way from the entrance to the exit of the labyrinth without being disturbed, and then training tests in which they received a slight electric shock each time they made an error in the choice of a path. The tests were continued without interruption, first one individual then the other being tested, until each had perfectly learned the path. A habit was considered as perfect when an individual succeeded in traversing the maze twice in succession without a mistake. Records were kept of the number of errors in choice of a path and of the time consumed in finding the way from entrance to exit.

As typical series of results I present in Table 14 the time and error records in labyrinth D of No. 416, a six-week dancer, and No. 166, a nine-month individual. The young mouse was slower than the old one in most of the tests, but he acquired a perfect habit

<sup>14</sup>The Dancing Mouse, pp. 219, 222.

no less quickly. I need scarcely state that the time records have little value for our present purposes, and are therefore omitted, except in the case of Table 14.

TABLE 14.

RELATION OF AGE TO RAPIDITY OF ACQUISITION OF LABYRINTH HABITS. TYPICAL SERIES OF RESULTS GIVEN BY TWO MALES IN LABYRINTH D.

Number of trial.	DANCER 6 WEEKS OLD. No. 416.		DANCER 9 MONTHS OLD. No. 166.	
	Time in seconds.	Number of errors.	Time in seconds.	Number of errors.
Preliminary.	280	31	161	19
1	240	60	56	6
2	134	24	25	4
3	53	6	62	8
4	22	0	143	17
5	141	3	62	8
6	15	0	57	6
7	22	1	31	3
8	14	0	15	0
9	63	6	46	3
10	58	2	29	2
11	15	0	20	0
12	12	0	13	0

TABLE 15.

RELATION OF AGE TO RAPIDITY OF ACQUISITION OF LABYRINTH HABITS.

Results in the table indicate the number of trials up to the point at which no errors occurred for at least two consecutive trials.

DANCERS 1-2 MONTHS OLD.			DANCERS 10 MONTHS OLD.		
Number of animal.	Results for Labyrinth D.	Results for Labyrinth C.	Number of animal.	Results for Labyrinth D.	Results for Labyrinth C.
256	5	27	92	15	22
258	8	22	96	6	6
396	15	26	98	6	19
398	16	14	120	9	12
418	13	7	166	10	—
Av. for Males.	11.4	19.2	Av. for Males.	9.2	14.7+
179	4	16	91	19	8
181	19	9	93	15	13
255	10	18	97	6	11
263	6	7	99	8	19
395	13	—	109	10	7
Av. for Females.	10.4	12.5	Av. for Females.	11.6	11.6
Gen. Av.	10.9	16.2	Gen. Av.	10.4	13.0

The general results of the labyrinth experiments appear in Table 15. Averages are given for the sexes separately, inasmuch as so



often heretofore we have discovered sex differences to be of importance for the interpretation of our results. Comparing the young dancers with the old, we note that the males of one to two months of age acquire both the labyrinth D and the labyrinth C habits considerably less quickly, as measured by the number of tests, than the ten-month individuals. In the case of the two groups of females there is practically no difference in rapidity of learning. The general averages likewise show that the old dancers are somewhat superior to the young in ability to learn these labyrinth paths.

What evidence we have, favors the conclusion that the associative memory of the dancer improves somewhat during the first year of life. Possibly change in the "appereceptive mass" is responsible. It is only fair to admit, in concluding the presentation of experimental data, that I consider this problem unsolved, for I have presented insufficient evidence to convince the critical observer that associative memory improves with age.

#### VII. CONCLUSIONS AND SUMMARY.

This attempt to discover the relation of age and sex of the dancing mouse to plasticity, or rapidity of habit formation, makes possible interesting and important, albeit not altogether favorable, comments upon the methods of the investigation. As the work progressed it became increasingly clear that the use of cardboards as means of producing different degrees of illumination of the two boxes between which the mouse was forced to discriminate was unsatisfactory. Chief among the objections to this method may be mentioned the practical impossibility of keeping the difference in illumination constant throughout even a single series; the impossibility of determining accurately, except by very elaborate and time-consuming methods, either the relative or the absolute illumination of the white and black boxes;<sup>15</sup> the impossibility of chang-

<sup>15</sup>Photometric determinations of the amount of light reflected by the white and the black cardboards which were used throughout these experiments indicate that the white cardboard reflected about 10.5 times as much light as the black cardboard. For a careful measurement of these values of the cardboards I am indebted to Professor J. W. Baird.

ing the amount of difference in the illumination of the boxes with ease and accuracy. These are only a few of the objections to white, grey, and black cardboards or papers that experience enables me to raise. Naturally I shall neither use them nor recommend their use hereafter in investigations of the visual powers of animals. Later, in connection with a report on "Methods of studying vision in animals" which is to be made by the committee on standardization of tests of the American Psychological Association, I shall propose a substitute method.

The investigation has shown, I believe, the great importance of choosing conditions of experimentation which may be readily and accurately measured and controlled, and of determining, as a preliminary to any experimental study of habit-formation, the value for the individual animal of the several important factors in the experimental situation. It has further shown that we should work with *individuals*, and with relatively simple and perfectly analyzable situations; and that no treatment of our results is so likely to hide their real significance as the averaging of groups of observations for different individuals. Evidently the best preparation for an experiment is a thoroughgoing study of the characteristics of each animal to be used in the investigation; and the best result which an experiment can yield is evidence of the relation of experimentally controlled conditions to the particular traits of an individual animal. Averages are important, but we should not sacrifice individual facts for the purpose of presenting them.

The primary aim of the investigation, it will be remembered, was the discovery of the relation of plasticity to age and sex. The data prove that dancers at the age of one month acquire the white-black habit more rapidly than do older individuals, and that the females, on the average, acquire the habit more rapidly than do the males. Of great importance is the fact (represented by the curves of Fig. 3) that whereas the females make more mistakes of choice at first than do the males they very soon begin to choose with a higher degree of accuracy, and ultimately acquire a perfect habit with considerably fewer training tests than the males.

That these age and sex differences in the form of the habit-

formation curves are not necessarily indicative of general differences in plasticity is rendered evident by the results of the sections on sensitiveness, strength of stimulus, and difficultness of discrimination. For in the light of these results we are able to name as two important, and to a certain extent independently variable, conditions upon which the acquisition of the visual habit depends, (a) ability to sense the difference in illumination of the two boxes and (b) ability to associate the darker box with the electric shock. Evidently an individual which possesses highly developed white light vision and is capable of distinguishing very slight differences in illumination may, at the same time, possess little ability to associate stimuli. The data of section V indicate that what we have called age and sex differences in plasticity are in all probability, to be referred to differences in visual discriminating ability and in "associative memory." Admitting that the results of the experiments justify only tentative conclusions, we may say that the young dancer seems to be somewhat superior to the old individual in ability to discriminate on the basis of difference in illumination, whereas the old individual seems to associate stimuli somewhat more rapidly, if anything, than the young dancer.

This suggestion, for it is scarcely more than that, of the way in which a habit may break up into two relatively independent factors is one of the most interesting results of the investigation. It strongly emphasizes the importance of studying the various sense factors separately and of attempting to discover upon what external and internal conditions "associative memory" depends.

To sum up the results of the investigation point by point, it appears that—

1. The dancer at one month of age acquires a particular white-black visual discrimination habit more rapidly than do older individuals. From the first until the seventh month there is a steady and marked decrease in rapidity of habit-formation; from the seventh to the tenth month the direction of change is reversed. These statements hold for both sexes.

2. Young males acquire the habit more quickly than young females, but between the ages of four and ten months (at least) the females acquire the habit the more quickly.

3. Curves of learning for the sexes indicate that the female makes more mistakes early in the training tests than does the male, but that this condition soon gives place to greater accuracy of choice on the part of the female.

4. Initial preference for the white or the black box does not seem to be a very important determinant of the rate of habit-formation.

5. Tests of sensitiveness indicate that the male dancer is somewhat more sensitive to electric stimuli than the female. There are no evidences of changes in sensitiveness with change in age.

6. The strength of the electric stimulus which is used as an incentive for habit-formation is extremely important as a determinant of rate of habit-formation. For a given animal and condition of visual discrimination there is a certain strength of stimulus which is most favorable for the acquisition of the habit (the optimal stimulus).

7. It is extremely important that experimenters discover the optimal stimulus for habit-formation.

8. For the dancer the following law appears to hold in connection with the particular habit under consideration and for the electric stimulus. *As difficultness of visual discrimination increases that strength of electric stimulus which is most favorable (the optimal) to habit-formation approaches the threshold.* The easier the habit the stronger that stimulus which most quickly forces its acquisition; the more difficult the habit the weaker the stimulus which most quickly forces its acquisition.

9. A given difference in the illumination of the boxes which are to be discriminated cannot be detected with equal ease by old and young dancers. When the difference in illumination is slight the young individuals detect it more readily than the old mice; when the difference is great, the old individuals apparently detect it as readily as do the young mice.

10. The capacity for "associative memory" is greater, if anything, in the dancer of ten months of age than in the one-month individual. This is indicated by certain results of the visual discrimination experiments and by the results of labyrinth tests.

11. The results of this investigation indicate, then, that the acquisition of a visual discrimination habit depends upon two independently variable (within limits) capacities in the dancer: (1) the power to detect differences in illumination or to gain this power (educability of white-light vision), and (2) the power to associate the darker box with the electric shock (associative memory). The former of these capacities seems to be greater in the young than in the old dancer; the latter seems to be somewhat greater in the old than in the young individual.

12. Should the statements just made hold true for animals generally, it is evidently important that the senses be trained early in life and that the development of associative memory be furthered later. Investigation of the problems suggested by our results should yield important practical data for the science of education.



# THE REACTIONS OF THE DOGFISH TO CHEMICAL STIMULI.

BY

RALPH EDWARD SHELDON.

*Contribution from the Woods Hole Laboratory of the United States  
Bureau of Fisheries.\**

WITH THREE FIGURES.

## TABLE OF CONTENTS.

	PAGE
Introductory .....	273
Conditions of experimentation .....	276
Reactions obtained .....	278
Sensitiveness to chemical stimuli.	
Experimental results .....	281
Analysis of results .....	281
Operations.	
Destruction of the spinal cord .....	288
Trausection of the spinal cord .....	289
Innervation and reactions of the nostrils .....	291
Chemical sensation as a sense quality.....	294
Conclusions .....	294
Summary .....	297
Bibliography .....	299
Figures .....	308

## INTRODUCTORY.

The smooth dogfish, *Mustelus canis* (Mitchell), was the subject of experiment in an endeavor to find out the sensitiveness of the general body surface to chemical stimuli and the extent to which the nerves of general sensation share in the reactions called forth through stimulation of the mouth and nostrils. In the investigation of these problems certain accessory points, such as the spinal animal and the innervation of the olfactory capsules, are taken up. The substances

\*Published by permission of George M. Bowers, U. S. Commissioner of Fisheries.

used as stimuli were those known to affect the gustatory, and to a less extent the olfactory sense, in higher forms.

The work was carried out at the laboratory of the U. S. Bureau of Fisheries at Woods Hole. I wish to express to the Director, Dr. F. B. Sumner, my appreciation of his assistance in furnishing me with every facility necessary for the successful prosecution of the work. The subject was originally taken up in 1907 under the direction of Dr. G. H. Parker in the Zoological Laboratory at Harvard University. I desire to tender to him my thanks for many helpful suggestions made both at that time and at the Woods Hole laboratory.

During the last few years much has been done, particularly among the invertebrates, on the reactions of animals to different kinds of stimuli. Part of this work has been concerned with chemical stimulation, the character of which is shown by the work of Pearl ('03), Bell ('06) and Jennings ('04 and '06). So far as the vertebrates are concerned, work on chemical stimulation has dealt almost exclusively with their two chief organs of chemical sense, smell and taste. A serious attempt has been made, however, to determine for the organs and their functions a physico-chemical basis. Haycraft ('87) was one of the first to attempt seriously to deal with taste from a strictly chemical standpoint. He was followed shortly by Corin ('88). The most important work of this character appeared about a decade ago from several sources simultaneously. Overton ('97) considered osmosis, while Kahlenberg ('98, '00), Richards ('98, '00), Kastle ('98) and Höber and Kiesow ('98) have taken up critically the physical and chemical characters of substances which stimulate the gustatory apparatus in man, together with the chemistry of taste itself. Still more recently Herlitzka ('07) and particularly Sternberg, in a series of papers published from 1898 to 1906, have made a detailed study of the chemical basis of sweet, sour, salty, bitter, metallic, electrical and alkaline tastes.

Many other writers have made a physiological study of the action of this same series of chemical substances on the gustatory apparatus of man. This includes the work of Kiesow ('94b), Hayeroft ('00a), Hänig ('01), Nagel ('05) and Lemberger ('08), together with numerous others, practically all of whom, however, consider in this con-



nection only the taste buds and associated nerves. Other authors have argued that, in addition to these structures, the nerves of general sensation take part in the sense of taste in man. Such a view is supported by the work of Camerer ('70), von Vintschgau ('79b), von Anrep ('80), Adduico and Mosso ('86), Hooper ('87), Berthold ('88), Oehrwall ('91), Shore ('92), Kiesow ('94a), Vinci ('97, '99), Fontane ('02), Ferrari ('04) and Herlitzka ('07).

Extensive work has also been done on the sense of smell in man from the physiological, and to a less extent the chemical viewpoint, as may be seen by consulting bibliographies such as that given by Zwaardemaker ('95) and Bawden ('01). There will be no general consideration of the subject here, as it does not bear directly on the problem at hand. It is to be noted, however, that in connection with the olfactory organ as well as the gustatory, the free nerve endings take part in the reactions secured. Physiological evidence is noted by Haycraft ('00b), while the presence of such terminations has been demonstrated by a number of writers from Grassi and Castronovo in 1889 to Read (1908).

In spite of the evidence presented by these authors, outside the single work of Grützner ('94), little has been done on mammals toward a study of the reactions of the free nerve termini generally to chemical stimuli. This has been due partly to preconceived ideas on chemical sense and partly to the feeling that nothing is to be gained by a general study of the chemical sense among the vertebrates,—even to the extent of including smell and taste under the same category. Such is the view of Zwaardemaker, who says ('03), "Bei den Wirbelthieren jedoch sind Geruchs- und Geschmackssinn in vieler Hinsicht so grundverschieden, dass es meines Erachtens keine Empfehlung verdient, sie zusammen zu behandeln."

On the chemical senses of the lower vertebrates little has been done. Bateson ('90a, '90b) discussed the senses of smell, taste, and touch in several fishes. The work is of little value in the present connection. In 1894 Nagel published his great monograph on smell and taste. Nagel repeatedly uses the term chemical sense, always meaning, however, the combined organs of taste and smell and not a general chemical sense. He stimulated selachians, teleosts, and am-

phibia by means of solutions of different chemicals. The selachians were very sensitive to weak stimuli, reacting to dilute solutions of vanillin all over the body, but to quinine only about the head. Barbus failed to react to salty, sweet, bitter, or sour substances on the general body surface, while *Gasterosteus* reacted to quinine only about the head. With *Cobitus* and *Gobius* he obtained reactions with meat juice and sugar solutions. *Lophius* was sensitive to chemical stimuli over the entire skin. Triton, the only amphibian tested, reacted on stimulation of the head only. It is evident from later work, particularly that of Herrick ('02, '03c) and Parker ('07, '08a, '08b), that Nagel's results did not permit the drawing of sound conclusions, partly because of the substances used as stimuli, and partly because he failed to differentiate between fishes with taste buds on the outer surface and those lacking such structures with their visceral sensory innervation. Herrick ('02) was concerned almost exclusively with the sense of taste, in a narrow sense, that is, the reactions to sapid solutions through stimulation of the taste buds. He performed a few experiments of a general chemical nature, insufficient, however, to permit any conclusions. Almost the only work on vertebrates which takes up the reactions of the nerves of general sensation to chemical stimuli is that of Parker ('07, '08a, '08) on *Amphioxus* and *Ameiurus*. His results will be reviewed later.

Considering that a general chemical sense is probably more primitive in phylogeny than taste and smell and that a careful study of such a general sense may do much to make clearer the development of these two senses, as well as their physiology, it is strange that so little has been done on this topic. This is especially true in the lower vertebrates, where, in many cases, it is difficult to separate the reactions due to stimulation of the organs of taste and smell from those due to the nerves of general sensation.

#### CONDITIONS OF EXPERIMENTATION.

The substances used in this work were hydrochloric, nitric, and sulphuric acids for acid stimuli; sodium, ammonium, and lithium chlorides for saline stimuli; sodium hydroxide for alkaline; cane sugar, dextrose, saccharine, and its carbonate for sweet; and quinine

hydrochloride, picric acid, ammonium and sodium picrates for bitter. All were made up in distilled water on the basis of the gram-molecular solution. The inorganic acids were prepared as normal solutions, titrated against an alkali of known strength for accuracy. The other solutions were made up by weight, the concentration first used as a test depending partly on the solubility of the chemical used. The chlorides were prepared as 5*n* solutions, the sugars 3*n*, sodium hydroxide as *n*, saccharine *n*/6, quinine hydrochloride *n*/10, picric acid and its salts *n*/15. In the experimental work all of these solutions were gradually diluted until the limit of reaction was reached. Sufficient time was given between tests at different degrees of concentration and with different substances to eliminate after-effect.

A large number of dogfishes were used in the experiments in order to rule out individual variation. Most of the normal fishes used were those caught in the fish traps and placed shortly in tanks about a meter and a half long, two-thirds of a meter wide and a third of a meter deep. A current of sea water was kept constantly running through the tanks. After a few days in these tanks the fishes could be handled with little difficulty. For most of the work, individual adult dogfishes were removed and placed in a smaller trough about eighty cm. long, thirty cm. wide and fifteen cm. deep, through which a strong current of sea water was flowing. After a little handling the animals would lie quietly in this trough either on the dorsum or venter, submitting to a certain amount of manipulation. In cases where it was necessary to have part of the animal out of water or where the fish was very unruly it was fastened to a frame.

*Application of the Stimulus.*—The solutions were applied by means of a pipette and were, in most cases, ejected slowly with the tip of the pipette about two millimeters from the skin of the fish. In such cases the fish was completely covered with water. Where it was essential that the region stimulated should be out of water absorbent cotton saturated with the solution was usually applied. Occasionally, however, the solution was ejected directly against the skin and the time of the tactile reaction taken, after which the slower chemical reaction could usually be identified. In stimulation of the mouth or nasal capsules a metal guard, closely fitted to the snout, was placed

between the two sets of apertures preventing diffusion of the stimulus from one set to the other.

*Regions Tested.*—With each solution used, approximately fifty places on the body were tested at each concentration used, and the time of reaction always recorded with a stop watch. These regions included the mouth, nostrils, spiracles, anus, claspers, and selected places on the fins, dorsal, lateral, and ventral surfaces of the fish. For the location of these points see figures 1 and 2.

#### REACTIONS OBTAINED.

The reactions obtained varied according to the part of the body stimulated, as follows: Stimulation of the mouth or spiracles is followed by one or more violent gulps, accompanied, of course, by a quick ejection of water through the branchial openings. A more rapid respiration for a greater or less length of time, depending on the stimulus, follows this. This is the only reaction secured by chemical stimulation of the mouth and spiracles, and it is secured by stimulus of no other region. When the nostrils are stimulated by any of the substances used, the reaction is likewise very characteristic. It consists essentially of a very quick jerk of the head. This reaction is likewise secured by stimulation of no other region. In the case of the paired fins the characteristic reaction is a quick movement of the fins, usually of a vibratory type. Often, particularly if the stimulus is weak, the first reaction is a turning or movement of the whole fin toward the stimulus, occasionally away from it, followed usually by vibration of the fin. With the median fins the reactions are very similar. The more usual reaction, however, begins with the movement of the fin toward the stimulus. Often the small caudal finlets of the median dorsals and the anal fin will react by a rapid vibration, even though that part of the fin is not stimulated. If this reaction occurs, it usually begins by a quick movement of the finlet toward the stimulus, more rarely away from it. When the finlet of either the anal or second dorsal fin takes part in the reaction, the other does also, so that the action of the two is simultaneous and in the same direction. When the caudal fin is stimulated, the reaction consists in a rather slow sidewise movement of the tail either toward, or away from, the

stimulus. This is evidently the beginning of a swimming movement. Stimulation of the anus results usually in bending over ventrad of the pelvic fins. Occasionally the fins react alternately in an attempt to turn the body over. If the stimulus is strong or long continued, these reactions are followed by a lateral squirming of this part of the fish culminating in the swimming away of the animal. Stimulation of the claspers results in a quick lateral movement and vibration of the structures. The head responds by a rather slow movement away from the solution. In general, stimulation of the dorsal, lateral, and ventral surfaces, other than those already mentioned, results in a movement of the fish which is very evidently a part of the general swimming movement. In fact, stimulus of almost any region of the fins or body, if persisted in, will transfer the local reaction to one which forms part of the swimming movement of the animal. This is shown especially in the case of stimulation of the fins or lateral surfaces. If the caudal, second dorsal, or anal fin is stimulated and the reaction is toward the stimulus, for instance, there will often be a movement of the first dorsal fin but in the opposite direction. The same relation holds true if the first dorsal fin is stimulated. Often a reaction of all the fins is secured. For example, there will be a movement toward the stimulus by the caudal, anal, and second dorsal fins, a movement away from the stimulated side by the first dorsal fin, an upward movement of the paired fins on the side stimulated and a downward movement on the opposite side. This reaction was first pointed out to me by Dr. Parker as a response secured by tactile stimulation of the same regions. Such reactions are unquestionably part of the general swimming movements of the fish, as may be seen by observing the animal in an aquarium. As caused by chemical stimuli, they are evidently of a kind to preserve the fish from injury, enabling it to remove itself from an injurious environment. Very similar reactions are secured by stimulation of the sides of the body and tail. In general it can be said that a slight stimulus calls forth a local response, while a stronger or longer-continued stimulus almost invariably results either in a new reaction which is part of the swimming movement, or else in a gradual change of the local reaction into such a part of the swimming movement. The former occurs where

the local reaction differs decidedly from the swimming movements, as in the case of stimulation of the mouth, while the latter holds in cases where the two are similar, as in the reactions due to stimulation of the fins. Certain interesting special cases are to be noted. If the dorsum or side of the fish near the small finlets of the dorsal or anal fins be stimulated, a quick movement of the finlets toward the side stimulated, usually followed by vibration of the finlet, occurs. This may be a reaction to remove an irritant, as is noted in the case of the frog when a drop of acetic acid is placed on the skin, or it may be part of the swimming movement, as seems more probable. Evidence against the former interpretation is offered by results which Parker obtained by tactile stimulation. He found that tactile stimulation of the dorsum near the finlet of the second dorsal fin caused this reaction; but he also found that if he now stimulated a point between the finlet and the mid-dorsal line on the same side the finlet continued to wipe the skin, but ventrad of the point now stimulated. It would, therefore, appear that the reaction is called forth by stimulation of any part of the side in this region and is not a local response to remove an irritant. It might be argued, however, that the power of localization is not well developed in this form. The strongest evidence in favor of the second interpretation is that when the skin beside both dorsal finlets is stimulated on the same side at the same time one turns to one side and one to another, as is the case when the animal is swimming. This reaction of the finlets was one of the most delicate found. Reactions could be secured by stimulation of the skin beside the second dorsal finlet when all the remainder of the body was insensitive.

If the claspers are turned to one side and the venter underneath stimulated, a quick vibration of the claspers over this point follows. This is probably part of the general swimming movement also, although its constancy and accuracy suggest the wiping reaction. In the case of the pectorals, however, when the ventral surface between them is stimulated there follows a quick scissors-like action of the two fins over the point stimulated. If one fin is held, the reaction takes place with the other alone. This reaction is not a part of the general swimming movement, is very consistent and accurate, and apparently is of the same character as the wiping reaction of the frog. It is

probably purposeful only in the sense that such a reaction is of a general preservative character such as is discussed by Sherrington ('06). This reaction often occurs, also, when the pectoral itself is stimulated, particularly on its median margin.

#### SENSITIVENESS TO CHEMICAL STIMULI.

*Experimental Results.*—The least stimulus which will cause a reaction, the comparative sensitiveness of different parts of the body, and the time of reaction for the different substances used are shown in the tables. The data were obtained under the following conditions. Several animals were always used for the tests and the figures given are based on results obtained from two or more individuals. From three to five tests were made at each point stimulated, with each solution used, and at each different degree of concentration of that solution. When individuals were used as controls, however, fewer tests were made if these demonstrated that the reactions were in conformity with those first obtained. Before the solutions were applied, both distilled and sea water were used to make certain that no reaction would result from their use, exclusive of the test solution. So much variation in the reaction time between different individuals was noted that both upper and lower limit in seconds are stated for each point tested. These limits differ considerably in many cases, yet it is easy to see that there is a general difference in the reaction time for different regions of the body and for different degrees of concentration of the solutions. For all tests on the dorsal or lateral surfaces, the fish lay on the venter; while for experiments on the ventral surface, it lay on the dorsal or dorso-lateral aspect. About ten of the points stimulated are omitted from the tables.

*Analysis of Results.*—It will be noted that the same reactions are secured by the use of any of the inorganic acids used as stimuli, that is, the reactions are due to the hydrogen ions. The reactions to the acids in the more concentrated solutions are very strong and definite. In nearly every part of the body they take place as quickly as mechanical conditions will permit, that is to say, almost instantaneously. With the decrease in concentration the reaction time becomes a trifle longer. Practically the entire body is sensitive to n/20 acid, the head









## SIGNS AND ABBREVIATIONS USED IN THE TABLES.

Numbers at the heads of columns refer to the points stimulated as shown on Figs. 1 and 2. Other numbers indicate the reaction time in seconds.

— is equivalent to the word to.

\* signifies that a reaction was secured with the region stimulated out of water, according to some of the methods already described. The reaction time in such cases was rarely taken. The exceptions are indicated by the replacement of — by \*.

‡ refers to cases in which the reaction was secured with the region tested under water, the reaction time not being taken. This sign usually signifies that the reaction was very weak and incomplete.

x is used in one case where the reaction was very strong and definite, but where the reaction time was not taken.

0 indicates that no reaction could be secured with the fish, either under or out of water. When used after another number it signifies that no reactions were secured in two or three of the five tests made.

Where blank spaces occur no tests were made.

*Am. and Sod. pier.*, ammonium and sodium picrates; *Betw.*, between; *Cane sug. and dext.*, cane sugar and dextrose; *Carb. of Sacch.*, the carbonate of benzyisulphonic amide formed by the neutralization of saccharine by sodium carbonate; *Caud.*, caudal or caudad; *Ceph.*, cephalad; *cl.*, claspers; *conc.*, concentration; *Dors.*, dorsal or dorsals; *finl.*, finlet, caudal prolongation of anal and dorsal fins; *margin.*, margin; *Mth.*, mouth; *Nostr.*, nostrils; *pect.*, pectorals; *Pier. acid.*, picric acid, trinitrophenol; *Quin. h.c.h.l.*, quinine hydrochloride; *Spir.*, spiracle; *Subs.*, substances used as stimuli; *Vent.*, ventral or ventrad; *1D.*, first dorsal fin; *2D.*, second dorsal fin.

being the only part at all insensitive. At n/40 the body surface generally reacts, although the reactions are less definite, particularly on stimulation of much of the dorsal surface. At n/50 the mouth, spiracle, anus, nostrils, fins, claspers, and side are still sensitive, as is also the dorsal surface beside the finlets. Stimulation of the mouth, spiracle, claspers and skin beside the finlets by n/75 still calls forth a reaction. At n/100 no reaction could be obtained, although the fish in many cases seemed to perceive the stimulus. In all this work many observations were made which indicate that the dogfish actually feels stimuli to which it does not react to an appreciable extent. One probably comes to a point in decreasing the concentration of the solutions where the stimulus is perceived yet not sufficiently strong to cause action of any kind on the part of the animal. All of the reactions secured at n/40 or less were weak, although usually definite. The reactions to acids in general are characterized by their quickness

and definiteness. There are rarely premonitory symptoms of any kind before the reaction takes place, even though the reaction time is long. In summary, it is evident that the dogfish is sensitive to acids of a solution of  $n/75$ , both in the mouth and spiracle in which are found taste buds, and also on the outer body surface when no such structures are found.

NaOH is the only hydroxide given in the table, although experiments were made with KOH which indicate that essentially similar reactions would be secured by its use. To NaOH the dogfish reacts quickly and definitely in the stronger solutions, although not quite so quickly as to acids. It will be noted likewise that the animal is not sensitive generally to so dilute solutions. Reactions are secured from the general body surface, however, to a solution of  $n/70$ . It is of special importance to note that the mouth and spiracle are almost insensitive to alkalis except in very strong concentration. Some slight chemical reactions take place between the hydroxide and the sea water, as was the case with the acids used also. This probably renders the solutions less powerful than they would otherwise be.

To salts the reactions are slower than to acids and alkalis. The responses to both lithium and ammonium chlorides are practically the same. No reactions to sodium chloride could, however, be obtained. This is due, doubtless, to its presence in such quantities in the sea water. The reactions to the chlorides are usually preceded by premonitory symptoms a few seconds before the definite reaction occurs. These consist of a local or general uneasiness. The reactions are also often prolonged, continuing for a few seconds after the stimulus is removed. It will be noted here, as in the case of the alkali, that the general body surface is more sensitive than the mouth. Definite reactions are secured from the former to a  $2n$  solution, while the fish shows a sensitiveness to a normal solution. The mouth and spiracle, however, react very weakly to solutions as strong as  $5n$ , and almost never to a lesser degree of concentration. The general lack of effect of the solutions of a weaker grade than normal is probably due to the fact that the salts of the sea water make it about a  $5/8$  normal solution. This interpretation is supported by the results when NaCl was used and also by the tests made by Parker ('08b) on the fresh

water catfish (*Ameiurus*), which is quite sensitive to salts. The reactions secured by the use of salts are not due to osmosis, as sugar solutions of equal osmotic strength have no effect.

Reactions to quinine hydrochloride take place only in the mouth and spiracles, that is, reactions to quinine take place only on stimulation of surfaces bearing taste buds, as Parker found for the catfish. The dogfish is extremely sensitive to picric acid. In strong solution it is extremely distasteful and the animal responds vigorously. The response is slow, however, and there are usually premonitory symptoms before the reaction, as noted for salts. Reactions are also often prolonged after the stimulus is removed. The mouth and body surface are sensitive to n/60 unquestionably, while an apparent uneasiness of the fish seems to indicate that it feels in the mouth, spiracles and nostrils a still greater degree of dilution. Picric acid was used by Parker ('07, '08b) as a bitter stimulus. It was with this idea in mind that the substance was used on the dogfish. It might be argued, nevertheless, that inasmuch as aquatic forms are very sensitive to acid stimuli, the reaction in this case is due to the acid radical in the trinitrophenol rather than to the base which gives to us the bitter taste of picric acid. To test this point neutral ammonium and sodium picrates were used. Both of these are as bitter to the human taste as is picric acid. From the tables it will be seen that the fish is by no means as sensitive to these as it is to the picric acid, although weak reactions can be secured by the use of strong solutions. The results show that it can not be assumed that the stimulus of picric acid rests entirely or even largely with the base, but that the acid radical is probably responsible almost entirely for its influence on fishes. It is evident, however, that the base does possess a stimulating power, as slight reactions were secured to the neutral picrates. It can be stated, therefore, that the dogfish reacts to substances which give us a bitter taste. To stimuli of this character the mouth is more sensitive than is the remainder of the body. On the whole, the fish seems less sensitive to bitter substances than to the other kinds of stimuli used. Outside of picric acid the animal showed little distaste for the solutions used, even though reactions were secured.

No reaction at all could be obtained to sugars. This holds true

for all aquatic vertebrates, due probably to the fact that sweet substances are substantially unknown to aquatic life. To saccharine or benzylsulphonic amide very quick and definite reactions were always secured. Thinking that this reaction was probably due to the acid radical, the saccharine was neutralized by sodium carbonate, the resulting product being as sweet to man as is the saccharine. No reactions at all were then secured, proving that those first obtained were due to the acid radical.

Comparing different regions of the body as to sensitiveness, it will be noted that the head is least sensitive, while the mouth, nostrils, paired fins, particularly the pelvic, the anal and dorsal, especially the second dorsal, are more sensitive. Areas of skin closely associated with the dorsal and anal finlets are included with these fins.

#### OPERATIONS.

Some operations were next performed to find out what part of the nervous system takes part in these responses. After operations no fishes were subjected to experimentation until at least twenty-four hours had elapsed. Narcotization was accomplished by a mixture of ether and water from the effects of which the animals did not appear to suffer in any way.

*Destruction of the Spinal Cord.*—In this experiment the tail was cut off, the caudal artery and vein plugged with cotton and the cord entirely destroyed as far cephalad as the cephalic margin of the first dorsal fin by means of a small steel wire. This method was suggested to me by Dr. Parker, who had used it with much success. By this operation the peripheral innervation of all of the caudal part and middle of the body is destroyed, except that from the lateral line nerve. The individuals subjected to this operation lie in the water perfectly motionless so far as the caudal part of the body is concerned, occasionally trying feebly to swim by means of the pectoral fins. The skin caudally gradually turned white as is the case with dead dogfish. Such fishes lived, however, for some weeks. As was to be expected, no reactions could be obtained chemically either by stimulation of the general body surface or the lateral line. Parker ('05) showed that the function of the lateral line is to respond to slow mass movements

of water. The head is sensitive to chemical stimuli after the operation as before.

*Section of the Spinal Cord.*—The cut was made about two centimeters cephalad of the first dorsal fin. After the operation the fishes lived for weeks, differing from the normal individuals in their ordinary actions only in the fact that the caudal part of the body kept up a constant swimming. The fish would be propelled to the side of the tank, where it would remain for hours keeping up a vigorous swimming movement of all the body caudad of the cut. This was never observed to cease until the death of the animal. Bethe ('99) noted this same swimming after section of the cord in the dogfish, but found that there were intervals of cessation. When this fish was tested with the solutions used on the normal fish, it was found that the caudal part of the body was more sensitive than before. The reactions take place from a fraction of a second to a few seconds quicker than before, the reactions seemed more positive and definite and some of the fishes studied reacted to slightly weaker solution. The reactions of the head were practically normal. After most of the operations many of the fishes failed to react to quite so weak a solution as before, due, probably, to the shock of the operation or to diminished vitality. The reactions of the spinal fish are almost never long continued after stimulation with salts or picric acid, contrary to the condition in the normal animal.

Several points are involved in these experiments. These are, how does the spinal fish differ from the normal and why? Is the observed difference due to a lack of inhibition by the brain, the use of the new paths for the reflexes, or stimulation of the cut ends at the cephalic end of the cord? Taking up the first: Danilewski ('92) on *Amphioxus* found that "voluntary" movements ceased with removal of the rostral part, the only action recorded taking place in response to definite stimuli. He concluded that the centers for movement lie in the rostral part of the animal. Steiner ('88) worked on the lamprey, selachians, ganoids, and teleosts. In the lamprey he found no voluntary movement of the caudal part after section, while the other fishes acted about as usual after section of the cord except for the dead weight of the head. Steiner believed that the centers for equilibrium

and voluntary motion lie in the cord. Loeb ('91) found that a dogfish with the cord cut was no longer able to orient itself, even though it could swim off readily. Bethe ('99) observed no difficulty in the swimming movements of the spinal dogfish. Pflüger ('53) and Bickel ('97) took up the study of the spinal eel. The former found that the eel had no difficulty in maintaining its equilibrium and could swim readily, while the latter says that the spinal eel is incapable of remaining in the normal position and can swim only forward. The normal individual can swim in both directions. The spinal frog has been studied with great care. Pflüger ('53) found that the spinal frog still retained its muscle tonus and could spring; Mendelssohn ('82, '83, '85) found the reflexes good after section of the cord; Steiner ('85) observed no change in the reactions; Schrader ('87) obtained similar results. Moore and Oertel ('99) found, however, that the reflexes were increased, although fatigue occurred quickly. Babák ('03, '05, '07) found that section of the cord in the larval frog resulted in no loss of power in the spinal part. In regard to mammals, particularly man, there is a mass of experimental and clinical evidence on the results of the separation of the spinal cord from the brain. This is presented mainly by Rosenthal ('73, '84); Bastian ('90); Burns ('93, '96); Rosenthal and Mendelssohn ('97); Senator ('98); Brauer ('99); Moore and Oertel ('99); Walton ('02); Walton and Paul ('06), Sherrington ('97, '00b, '05, '06a, '06b); and Sherrington and Laslett ('03). In mammals, as observed by most investigators, the loss of reflex power is very great, often practically total after a break in the functional continuity of the cord and brain. It is evident, therefore, as is emphasized by Sherrington, Walton, and Walton and Paul, that in the ascent of the animal scale the cord loses its power as an automatic center and becomes less and less capable of responding to stimuli.

In the fishes under observation in these experiments no lack of the power of equilibrium was observed. This may easily be due to the fact that the innervation of the pectoral fins was left intact. This probably accounts for the different results obtained by Loeb and Bickel.

The greater activity and sensitiveness of the caudal part of the



fish after section of the cord are due, in all probability, to a removal of inhibition from the higher centers, by the use of shorter paths, or to both. Pike ('08) believes that the second is the true explanation. He considers that normally the long paths by way of the brain are made use of. After section, pathways through the cord must serve, giving a shorter arc which requires less time for the transmission of the impulses. This is supported by the conclusions of Moore and Oertel who suggest, however, that the higher centers may have a regulatory rather than an inhibitory influence over the cord. Walton and Paul think that the cord is particularly for active, instantaneous and violent reflexes. It is probable that use of shorter paths by the reflexes has much to do with the result secured, but the evidence presented in the literature is strong in support of the view that the brain possesses an influence over the cord of a regulatory type, at least.

Wiping movements of the fins and finlets occur as in the normal animal. This is in line with the results in the spinal frog and can not, in either case, be considered purposeful, as Howell ('05) and Sherrington ('06b) clearly show. Such movements in a spinal animal are simply such as are of a general protective nature for the normal animal or else form a part of the habitual action of the organism.

No spinal shock was observed. This is as would be expected. Steiner, Loeb, Bickel, and Bethe do not mention it for fishes. Moore and Oertel show that it is slight in the frog and passes off quickly. In mammals, as is well known from the work of Bastion ('99), Burns ('93), Sherrington ('97, '00b), Senator ('98), Babák ('07) and Pike ('08) the influence of shock is greatest. These citations fall in line with the statement made above to the effect that the power of the cord as an automatic center decreases as one ascends the animal scale. Probably in the dogfish many of the reactions of the caudal part of the animal take place normally through the cord, so that section of it brings about little change.

*The Innervation and Reactions of the Nostrils.*—It will be noted from the chart that the nostrils are very sensitive to the solutions used as stimuli. The reactions obtained were also very decided. The question arises as to whether these are due to the olfactory nerves or the nerves of general sensation. Accordingly, different nerves were

cut in order to clear up this point. The only nerve hitherto known to supply the nasal mucosa in the dogfish is the olfactory. It has long been known that the trigeminus nerve supplies this region of the head for tactile sensation, but none of its fibers have been traced to the olfactory capsule.

Aichel ('95) found trigeminal fibers in the olfactory mucous membrane of embryonic teleosts, but was uncertain as to their derivation. Jagodowski ('01) observed the same fibers. Later, Sheldon ('08) demonstrated the existence of fibers, derived from the trigeminal nerve, in the mucous membrane of the adult carp. Retzius ('92) in the frog and Rubaschin ('03) in the chick obtained similar results. In the lower mammals and man such an innervation has been demonstrated by Grassi and Castronovo ('89), Ramón y Cajal ('89, '93), van Gehuchten ('90), von Brunn ('92), von Lenhossék ('92), Retzius ('92), Disse ('94) and Read ('08).

In the dogfish the trigeminal nerve is divided into four rami. These are the ophthalmicus superficialis to the dorsum of the snout, closely associated with the ophthalmicus superficialis facialis of the lateralis system; the ophthalmicus profundus to the side of the head and snout; the maxillaris to the upper jaw and the mandibularis to the lower. These latter two are bound together for some distance from the brain in close association also with the buccalis. All of these trigeminal rami are general sensory with the exception of the mandibularis which is combined general sensory and motor (Strong, '03). The relations of all these rami except the ophthalmicus superficialis are shown in fig. 3.

The olfactory crura were first cut in an endeavor to destroy the sense of smell. At first the section was made from the dorsum, but this operation was usually fatal. Such fishes would either die inside of twenty-four hours or else react very feebly. Finally the method of Lyon ('00) was adopted. The fish was etherized, the mouth pried open as far as possible and the olfactory crura reached by means of an incision in the roof of the mouth. The maxillaris and mandibularis were also reached in the same way (see fig. 3). Before the cut was made the mucosa was reflected as shown in the figure, then a piece of cartilage was removed, care being taken not to cut any of the

blood vessels of the roof of the mouth, as this leads to serious bleeding. The location of the vessels to be avoided is shown in the dissection. The fishes seemed to suffer no ill effect from this operation and would live for some weeks thereafter. The profundus and superficialis nerves were cut by means of an incision into the orbit at the caudal margin of the eye ball.

After section of the olfactory crura, stimulation of the nostrils causes the same reactions as were obtained for normal fishes. It is, therefore, evident that these reactions are not due to stimulation of the olfactory nerve. When the four rami of the trigeminal are cut and the olfactory left intact, no reactions are secured. This shows clearly that the reactions obtained are due to the nerves of general sensation. The associated nerves of the lateralis system have been proved to be insensitive to chemical stimulation. The following nerves were next cut without destroying the reactions; the ophthalmicus superficialis, the ophthalmicus profundus and the oph. sup. and oph. prof. together. When the maxillaris-mandibularis trunk is cut, however, all reactions cease. When normal fishes are taken, this trunk cut on one side and not on the other, stimulation of the nostril on the operated side calls forth no responses, while the nostril on the normal side is as sensitive as before. As the mandibularis nerve goes to the lower jaw exclusively, it is evident that the sensitiveness of the nostrils to the chemical stimuli used is due to the maxillaris nerve. These experiments also show that the nostrils in selachians are innervated by the trigeminal nerve, as is the case in most other vertebrates.

Some odorous substances were also used in the nostrils although without results so far as the sense of smell is concerned. The substances used were the oils of cloves, pennyroyal, thyme and aniline oil. A few cc. of the oil were placed in a 200 cc. flask of distilled water and shaken violently. After a day or so most of the oil would collect while the remainder remained in suspension in the water in the form of small drops. This water was drawn off and called a saturated solution. Normal fishes reacted very quickly when this solution is applied to the nostrils. When the olfactory crura are cut the nostrils remain as sensitive as before. To clove oil, for instance, both normal and operated fishes are sensitive to a solution of about 1/100

saturated. These results show that here as in man the trigeminal nerve shares in what we usually call the sense of smell.

#### CHEMICAL SENSATION AS A SENSE QUALITY.

Experiments were next performed to ascertain if these reactions to chemicals are due to the stimulation of nerve endings distinct from those excited by tactile stimuli. First a given region of the body was fatigued for tactile response. One method used was to keep a steady stream of water from a pipette playing on some sensitive portion of the skin. After five minutes, or such a matter, the fish will no longer respond. Chemical reactions can always be secured thereafter in a little more than the ordinary length of time. When the experiment was reversed, however, the results differ. A given region may be fatigued in from five to ten minutes for any kind of chemical stimulus, acids, for example. It will then react to salts, for instance, but not to tactile stimuli for some minutes, if care is taken not to get outside the area fatigued. A blunt point was often used also to fatigue the tactile organs, with the same result. Parker ('08b) found in *Amphioxus* that when the animal was fatigued for mechanical stimuli it still reacted to chemical stimuli, and *vice versa*.

Further a 2 per cent. solution of cocaine on absorbent cotton was applied to the skin and the region stimulated every few minutes for both tactile and chemical purposes. Under these conditions tactile response disappears in from ten to twenty minutes. Responses to chemical stimuli can be obtained thereafter, although the reaction is slower than usual. Finally, response to chemicals disappears, the first to cease being that to bitter substances, as is the case in mammals in the mouth, after Adduceo and Mosso ('96) and Fontane ('02).

#### CONCLUSIONS.

The results obtained show that the reactions of the dogfish to substances which we call sour, alkaline, salty, and bitter are obtained by stimulation of the nerves of general sensation. One is not justified in saying that the taste buds and taste nerves (the facialis, glossopharyngeus and vagus) do not take part in these reactions in the mouth. It is certain, however, that such nerves do not

share in the responses secured by stimulation of the nostrils and body surface generally. It has been shown above that the reactions secured from the former are due to the nerves of general sensation. No gustatory nerves, such as Herrick ('01, '03b, '03c) described for the silurids, innervate the trunk of the dogfish and there is no evidence that visceral sensory nerves such as Herrick ('99) found in *Menidia* reach the skin of the trunk in this form. It can be said, therefore, that in the dogfish the reactions secured from all parts of the body, excepting the mouth and probably largely from that, are due to stimulation of the nerves of general sensation. It is apparent, however, that the taste buds and nerves are concerned with the responses to bitter substances. These conclusions are supported by Parker's work on *Ameiurus*, where he secured reactions to this same series of chemical stimuli after section of the recurrent branch of the *facialis*. His work shows that in the catfish the free nerve-termini react to chemical stimuli, even of a very weak character.

Grützner ('94) found that the nerves of general sensation in man are very sensitive to chemical stimuli, experimenting on himself and the frog with acid, alkaline, salty solutions, etc. This is the only work dealing with this chemical sense in man. Haycraft ('00b) comments on the well-known fact that the sensitiveness of the nasal mucous membrane of man to ammonia and chlorine is due to these same nerves. Camerer ('70) obtained taste reactions from papilla-free regions of the mouth. A little later von Vintschgau ('79b) stated that the nerves of general sensation take part in the sense of taste in man. Shore ('92) followed with the argument that salty and sour tastes are largely due to the general sensory nerves. This is based mainly on the fact that by the use of gymnemic acid he rendered the tongue insensitive to bitter and sweet substances without the loss of acid, salty, or tactile sensation.

He also found that the perception of acids goes fairly well in hand with tactile sensation. In view of the results following the use of picric acid and saccharine on the dogfish, it is interesting to note that Shore obtained no reactions to these substances in man after the use of gymnema. This shows that in man picric acid

and saccharine stimulate only through their bitter and sweet properties and not, as is largely the case in the dogfish, by means of the acid radical. Kiesow ('94a) found that he could separate the tactile from the gustatory sense in the reactions to acids and salts. In 1903a he added that some tastes are mixed with pressure. Herlitzka in 1907 insisted that metallic taste is partly tactile, while in 1908 he concluded that it is entirely due to smell and touch. These citations show that even in man the nerves of general sensation possess the power of reacting to chemical stimuli to a far greater extent than is usually considered to be the case. In addition to the special sensitiveness of certain portions of the outer skin to chemical stimuli the nerves share in what we are accustomed to call the sense of smell and play a large part in the sense of taste. They probably have much to do with the reactions to acid, alkaline, and salty substances, at least, although such work as that of Kiesow ('98) shows that the taste buds and nerves certainly take some part in these responses. Kiesow found that individual papillæ react to acid and salty tastes. The work on the dogfish is in line with such an interpretation, as here the body surface, innervated by the nerves of general sensation, is especially sensitive to acid, alkaline, and salty substances, while bitter stimuli affect chiefly the mouth.

We now come to the question as to whether or not these chemical reactions are due to a sense quality distinct from the general tactile sense. It is generally assumed that there are several distinct tastes: sour, salty, bitter and sweet, at least. The work of Kiesow ('98) on the different papillæ of the tongue, and that of von Anrep ('80), Hooper ('87), Berthold ('88), Oehrwall ('91), Kiesow ('94a); and Vinci ('97, '99) with cocaine, gymnema and allied substances support the view that the different taste qualities can be separated from one another. Practically all authorities are agreed in believing that there are likewise in man several cutaneous sense qualities. It is not essential for the point at issue whether one follow the dicta of the Blix, Goldscheider, von Frey school or arrive at the conclusions expressed by Nagel ('05); or, on the other hand, assent to views of Head, Rivers, Sherren and

Thompson in their recent work. So far as the lower vertebrates are concerned little work has been done on the subject. Von Anrep ('80) found that tactile reflexes disappeared before chemical, following the use of cocaine on the skin of the frog, while Parker in his work on *Amphioxus* and *Ameiurus* showed that such a view is fully supported by the results obtained. It may, therefore, be said that workers are agreed in assigning to the gustatory and general cutaneous senses several sense qualities and that this work falls in line in stating that, in the dogfish, the results secured by the use of cocaine and by fatigue suggest that a separate mechanism exists for the reactions to chemical as distinguished from general tactile stimuli.

From the evidence given we may say, with little hesitation, that there exists a general chemical sense from the protozoa to man. This general sense is the only chemical sense present in the lower invertebrates; as we ascend in phylogeny, however, there are probably developed from it, as Herrick ('08) suggests, smell and taste. The undifferentiated sense remains as the sensitiveness to chemical stimuli exhibited by the nerves of general sensation in the lower vertebrates and man.

The association of chemical sensibility with the nerves of general sensation need not in the least militate against the functional analysis of the nervous system as elaborated by Herrick ('03a) and Johnston ('02, '06), as it has never been assumed by them that sensitiveness to chemical stimuli must be confined to the nerves and organs of smell and taste.

#### SUMMARY.

1. The smooth dogfish, *Mustelus canis* (Mitch.), is sensitive to chemical stimuli over the entire body surface, mouth and nostrils, responding by reactions which are characteristic for the different regions stimulated.

2. All parts of the body are very sensitive to acids and alkalis in very dilute solution, less sensitive to salts and bitter substances, and do not react at all to sugars.

3. Certain parts of the general body surface are more sensitive

than is the mouth to salts and alkalis. The outer skin and the mouth are equally sensitive to acids, while the mouth is more sensitive to bitter substances.

4. The most sensitive portions of the body are the mouth, nostrils, anus and fins, while the head is the least sensitive to chemical stimuli.

5. When the spinal cord is destroyed, no reactions are obtained from the caudal part of the body, showing that the lateral line nerves have nothing to do with chemical sensation.

6. When the cord is severed from the brain, the caudal part of the animal is more sensitive to chemical stimuli than before. There is no spinal shock.

7. Section of the olfactory crura and different rami of the trigeminal nerve show that the extreme sensitiveness of the nostrils to the stimuli used is due to the ramus maxillaris trigemini, a nerve of general sensation, rather than to the olfactory nerve.

8. Parts of the body fatigued for tactile response always react to chemical stimuli, but when any given region is fatigued for a given chemical it rarely responds to tactile stimuli, although it usually reacts to other kinds of chemical stimuli.

9. When cocaine is applied to the skin, tactile response disappears before chemical. Among the different chemical sense qualities, the sensitiveness to bitter disappears first.

10. This sensitiveness to chemical stimuli is due almost exclusively to the nerves of general sensation, not at all to the olfactory and very little to the gustatory nerves.

11. Evidence presented suggests that this sense is a true sense quality, with a nervous mechanism distinct from that serving general tactile sensation.

12. A true chemical sense is found not only in the invertebrates, but also in all vertebrate groups from the lancelet to man.

HULL LABORATORY OF ANATOMY.

The University of Chicago.

Feb. 4, 1909.



## LITERATURE CITED.

All papers cited have been consulted excepting those marked with an asterisk (\*). The subject matter of articles so indicated was ascertained through reviews.

## \*ADDUCCO AND MOSSO.

1886. Ricerche sopra lo fisiol del gusto. *Giorn della R. Accad. de Med.*, No. 1-2.

## MICHEL, OTTO.

1895. Kurze Mittheilung über den histologischen Bau der Riechschleimhaut embryonaler Teleostier. *Sitzungsber. d. Gesellsch. f. Morphol. u. Physiol in München*, Bd. 11, Hft. 2 u. 3, 19 Nov., S. 73-78.

## ANREP, B. VON.

1880. Ueber die physiologische Wirkung des Cocain. *Pflüger's Arch. f. Physiol.*, Bd. 21, S. 38-77.

## BARAK, EDWARD.

1903. Ueber die Entwicklung der locomotorischen Coordinationsthätigkeit im Rückenmarke des Frosches. *Pflüger's Arch. f. Physiol.*, Bd. 93, S. 134-162.
1905. Ueber die Beziehung des centralen Nervensystems zu den Gestaltungsvorgängen der Metamorphose des Frosches. *Pflüger's Arch. f. Physiol.*, Bd. 109, S. 78-82.
1907. Ueber die Shockwirkungen nach den Durchtrennungen des Zentralnervensystems und ihre Beziehung zur ontogenetischen Entwicklung. *Centbl. f. Physiol.*, Bd. 21, Nr. 1, S. 9-11.

## BARKER, LEWELLYS F.

1896. A case of circumscribed unilateral, and elective sensory paralysis. *Jour. Exp. Med.*, vol. 1, pp. 348-360.

## BASTION, H. C.

1890. On the symptomatology of total transverse lesions of the spinal cord, with special reference to the condition of the various reflexes. *Brit. Med. Jour.*, vol. 1, Mar. 1, pp. 480-481.

## BATESON, W.

- 1890a. The sense organs and perceptions of fishes, with remarks on the supply of bait. *Jour. Marine Biol. Assoc.*, London, N. S., vol. 1, pp. 225-256, pl. 20.
- 1890b. The sense of touch in the rockling. *Ibid.*, p. 214.

## BAWDEN, H. H.

1901. A bibliography of the literature on the organ and sense of smell. *Jour. Comp. Neur.*, vol. 2, pp. i-xi.

## BELL, JAMES C.

1906. The reactions of crayfish to chemical stimuli. *Jour. of Comp. Neurol. and Psychol.*, No. 4, vol. 16, pp. 299-326.

\*BERTHOLD, B.

1888. Rev. *Centrab. f. d. med. Wiss.*, S. 460-461.

BETHE, ALBRECHT.

1899. Die Locomotion des Haifisches (*Scyllium*) und ihre Beziehungen zu den einzelnen Gehirntheilen und zum Labyrinth. *Pflüger's Arch. f. Physiol.*, Bd. 76, S. 470-493, Text Fig. 2.

BICKEL, ADOLF.

1897. Beiträge zur Rückenmarksphysiologie des Aales. *Pflüger's Arch. f. Physiol.*, Bd. 68, S. 110-119.

BLIX, MAGNUS.

1884. Experimentelle Beiträge zur Lösung der Frage über die spezifische Energie der Hautnerven. *Zeitschr. f. Biol.*, Bd. 20, S. 141-156. Taf. 1.

1885. Experimentelle Beiträge zur Lösung der Frage über die spezifische Energie der Hautnerven. *Ibid.*, Bd. 21, S. 145-160, Taf. 2.

BRAUER, L.

1899. Die Beziehungen der Rückenmarksquerläsion zu den unterhalb derselben sich abwickelnden Sehnenreflexen. *Müncb. Med. Wochenschr.*, Jahrg. 46, Hft. 1, Nr. 2, 10 Jan., S. 41-42.

BRUNN, A. VON.

1892. Beiträge zur mikroskopischen Anatomie der menschlichen Nasenhöhle. *Schultze's Arch. f. mikr. Anat.*, Bd. 39, S. 632-652, Taf. 29-30, Fig. 10-11.

BRUNS, L.

1893. Ueber einen Fall totaler traumatischer Zerstörung des Rückenmarkes an der Grenze zwischen Hals- und Dorsalmark. Ein Beitrag zur Frage vom Verhalten der Lähmung und der Reflexe speciell der Patellarreflexe bei hochsitzenden totalen Querschnittsläsionen des Rückenmarkes. *Arch. f. Psychiatric*, Bd. 25, S. 759-830, Taf. 15-16.

1896. Klinische und pathologisch-anatomische Beiträge zur Chirurgie der Rückenmarkstumoren. *Ibid.*, Bd. 28, S. 96-168, Taf. 4-5.

CAMERER, W.

1870. Ueber die Abhängigkeit des Geschmackssinnes von der gereizten Stelle der Mundhöhle. *Zeitschr. f. Biol.*, Bd. 6, S. 440-452.

CORIN, JOSEPH.

1888. Action des acides sur le goût. *Arch. de biol.*, T. 8, pp. 121-138.

DANILEWSKI, B.

1892. Zur Physiologie des Centralnervensystems von Amphioxus. *Pflüger's Arch. f. Physiol.*, Bd. 52, S. 393-400.

\*DISSE, J.

1894. Ueber Epithelknospen in der Regio olfactoria der Säuger. *Nachricht. der k. Gesellsch. d. Wiss. zu Göttingen.*

- FANO, G.  
1903. Contribution a l'étude des réflexes spinaux. *Arch. Ital. de Biol.*, Tom. 39, pp. 85-128, 1 pl.
- FERRARI, P.  
1904. Comment se modifie la sensibilité gustative pour les très petite doses des anesthésiques locaux. *Arch. Ital. de Biol.*, Tom. 42, pp. 411-420.
- FONTANE, ARTHUR.  
1902. Ueber die Wirkung des Eucain B auf die Geschmacksorgane. *Zeitschr. f. Psychol. u. Physiol. d. Sinn.*, Bd. 28, S. 253-260.
- FREY, M. VON.  
1894. Beiträge zur Physiologie des Schmerzsinns. *Ber. über die Verhandl. der kgl. Sächs. Gesellsch. der Wissensch. zu Leipzig. Math. physische Classe*, Bd. 46, S. 185-196.  
1894. Beiträge zur Physiologie des Schmerzsinns. *Zweite Mitth. Ibid.*, S. 283-296.  
1895. Beiträge zur Sinnesphysiologie der Haut. *Dritte Mitth. Ibid.*, Bd. 47, S. 166-184.
- GOLDSCHLEIDER, ALFRED.  
1885. Ueber Wärme-, Kälte-, und Druckpunkte. *Arch. f. Anat. u. Physiol., Physiol. Abth.*, S. 340-345.
- GRASSI, BATTISTA AND CASTRONOVO, A.  
1889. Beiträge zur Kenntnis des Geruchsorgans des Hundes. *Schultze's Arch. f. mikr. Anat.*, Bd. 34, S. 385-390. Taf. 21.
- GRÜTZNER, P.  
1894. Ueber die chemische Reizung sensibler Nerven. *Pflüger's Arch. f. Physiol.*, Bd. 58, S. 69-104, Taf. 1.
- HÄNIG, D. P.  
1901. Zur Psychophysik des Geschmacksinnes. *Wundt's Philos. Studien*, Bd. 17, S. 576-623, 7 Fig. im Text.
- HAYCRAFT, JOHN B.  
1887. The nature of the objective cause of sensation. Pt. 2, taste. *Brain*, vol 10, pp. 145-163.  
1900a. The sense of taste. *Schäfer's Text-book of Physiol.*, vol. 2, pp. 1237-1245.  
1900b. The sense of smell. *Ibid.*, pp. 1246-1258.
- HEAD, HENRY; RIVERS, W. H. R., AND SIERRREN, JAMES.  
1905. The afferent nervous system from a new aspect. *Brain*, vol. 28, pp. 99-115, pl. 1.
- HEAD, HENRY, AND SIERRREN, JAMES.  
1905. The consequences of injury to the peripheral nerves in man. *Ibid.*, pp. 116-338, Figs. 44.
- HEAD, HENRY, AND THOMPSON, THEODORE.  
1906. The grouping of afferent impulses within the spinal cord. *Ibid.*, vol. 29, pp. 537-742, figs. 83, pls. 1-3.

## HERLITZKA, A.

1907. Ueber den "metallischen Geschmack" und den Geschmack der metallischen Ionen. VII Internat. Kongress zu Heidelberg. *Rev. Zentralbl. f. Phys.*, Bd. 21, S, 504-505.
1908. Sul "sapore metallico," sulla sensazione astringente e sul sapore dei sali. *Arch. di Fisiol.*, T. 4, Fasc. 2, pp. 217.

## HERRICK, C. JUDSON.

1899. The cranial and first spinal nerves of Menidia; a contribution upon the nerve components of the bony fishes. *Jour. Comp. Neur.*, vol. 9, nos. 3 and 4, pp. 153-455, pls. 14-20.
1901. The cranial nerves and cutaneous sense organs of the North American siluroid fishes. *Ibid.*, vol. 11, no. 3, pp. 177-249, pls. 14-17.
1902. The organ and sense of taste in fishes. *Bull. of the U. S. Fish Commission for 1902*; also *Bull. of the Scientific Lab. of Denison Univ.*, vol. 12, 1903, article 6, pp. 39-96.
- 1903a. The doctrine of nerve components and some of its applications. *Jour. of Comp. Neur.*, vol. 13, no. 4, pp. 301-312.
- 1903b. On the morphological and physiological classification of the cutaneous sense organs of fishes. *Am. Nat.*, vol. 37, no. 437, pp. 313-318.
- 1903c. On the phylogeny and morphological position of the terminal buds of fishes. *Jour. Comp. Neur.*, vol. 13, no. 2, pp. 121-138.
1908. On the phylogenetic differentiation of the organs of smell and taste. *Jour. Comp. Neurol. and Psychol.*, vol. 18, no. 2, pp. 157-166.

## HÖBER, RUDOLF, AND KIESOW, F.

1898. Ueber den Geschmack von Salzen und Laugen. *Zeitschr. f. Physik. Chemie*, Bd. 27, S. 601-616.

## HOOPER, DAVID.

1887. Examination of the leaves of the *Gymnema sylvestre*. *Nature*, vol. 35, pp. 565-567.

## HOWELL, W. H.

1905. A text-book of physiology. *Philadelphia, W. B. Saunders and Co.*, 1905.

## JAGODOWSKI, K. P.

1901. Zur Frage nach der Endigung des Geruchsnerven bei den Knochenfischen. *Anat. Anz.*, Bd. 19, S. 257-267, 10 Ab.

## JENNINGS, H. S.

1904. Contributions to the study of the behavior of lower organisms. *Pub. 16, Carnegie Inst. of Washington*.
1906. Behavior of lower organisms. 14 + 2 + 366 pp., *New York*, 1906.

## JOHNSTON, J. B.

1902. An attempt to define the primitive functional divisions of the central nervous system. *Jour. Comp. Neurol.*, vol. 12, pp. 87-106, pls. 1-4.
1906. The nervous system of vertebrates. *Philadelphia*, 1906.

## KAHLENBERG, L.

1898. The actions of solutions on the sense of taste. *Bull. Univ. of Wis., Science series*, vol. 2, no. 1, pp. 1-31.
- 1900a. The relation of the taste of acid salts to their degree of dissociation. *Jour. Phys. Chem.*, vol. 4, pp. 33-37.
- 1900b. The relation of the taste of acid salts to their degree of dissociation II. *Ibid.*, pp. 533-537.

## KASTLE, J. II.

1898. On the taste and affinity of acids. *Am. Chem. Jour.*, vol. 20, pp. 466-471.

## KIESOW, FRIEDRICH.

- 1894a. Ueber die Wirkung des Cocain und der Gymnemasäure auf die Schleimhaut der Zunge und des Mundraums. *Wundt's Philos. Stud.*, Bd. 9, S. 510-527.
- 1894b. Beiträge zur physiologischen Psychologie des Geschmackssinnes. *Ibid.*, Bd. 10, S. 329-368, 523-561.
1896. Beiträge zur physiologischen Psychologie des Geschmackssinnes. IV. *Ibid.*, Bd. 12, S. 464-473.
1898. Expériences gustatives sur diverses papilles isolément excitées. *Arch. Ital. de Biol.*, T. 30, pp. 399-425.
- 1903a. Ein Beitrag zur Frage nach den Reaktionszeiten der Geschmacksempfindungen. *Zeitschr. f. Psychol. u. Physiol. der Sinn.*, Bd. 33, S. 453-461.
- 1903b. Zur Psychophysologie der Mundhöhle nebst Beobachtungen über Funktionen des Tast- und Schmerzapparates und einigen Bemerkungen über die wahrscheinlichen Tastorgane der Zungenspitze und des Lippenrots. *Ibid.*, S. 424-443. 1. Fig.

## KIESOW, F., AND HAHN, R.

1901. Beobachtungen über die Empfindlichkeit der hinteren Teile des Mundraumes für Tast-, Schmerz-, Temp., und Geschmacksreize. *Ibid.*, Bd. 26, S. 383-417.

## LEMBERGER, FRIEDA.

1908. Psychophysische Untersuchungen über den Geschmack von Zucker und Saccharin (Saccharose und Kristallose). *Pflüger's Arch. f. Physiol.*, Bd. 123, S. 293-311, 1 text fig.

## LENHOSSÉK, M. VON.

1892. Die Nervenursprünge und -Endigungen im Jacobson'schen Organ des Kaninchens. *Anat. Anz.*, Bd. 7, Nr. 19 u. 20, S. 628-635. Mit 1 Ab.

## LOEB, JACQUES.

1891. Ueber Geotropismus bei Thieren. *Pflüger's Arch. f. Physiol.*, Bd. 49, S. 175-189, 1 Holzsch.

## LYON, E. P.

1900. Compensatory motions in fishes. *Am. Jour. of Physiol.*, vol. 4, no. 2, pp. 77-82.

## MENDELSSOHN, MORITZ.

1882. Untersuchungen über Reflexe. *Sitz. ber. d. kgl. preuss. Akad. d. Wissensch. z. Berlin.* Halbbd. 2, S. 897-900.
1883. Untersuchungen über Reflexe. Zweite Mitth. *Ibid.*, Halbbd. 1, S. 123-125.
1885. Untersuchungen über Reflexe. Dritte Mitth. *Ibid.*, Halbbd. 1, S. 107-111.

## MOORE, BENJAMIN, AND OERTEL, HORST.

1899. A comparative study of reflex action after complete section of the spinal cord in the cervical or upper dorsal region. *Am. Jour. Physiol.*, vol. 3, no. 1, pp. 45-52.

## MÜLLER, J.

1842. Elements of physiology. Trans. by W. Baly, vol. 11, 1842.

## NAGEL, WILHELM A.

1894. Vergleichend physiologische und anatomische Untersuchungen über den Geruchs- und Geschmackssinn und ihre Organe, mit einleitenden Betrachtungen aus der allgemeinen vergleichenden Sinnesphysiologie. *Bibliotheca Zoologica*, Bd. 7, Hft. 18, S. vii, 207, 7 Taf.
1896. Ueber die Wirkung des Chlorsauren Kali auf den Geschmackssinn. *Zeitschr. f. Psychol. u. Physiol. d. Sinn.*, Bd. 10, S. 235-239.
- 1905a. Der Geschmackssinn. Nagel. *Handbuch der Physiologie des Menschen.* Bd. III, Physiologie der Sinne, S. 621-646.
- 1905b. Die Lehre von den spezifischen Sinnesenergien. *Ibid.*, S. 1-15.

## OEHRWALL, HJALMAR.

1891. Untersuchungen über den Geschmackssinn. *Skand. Arch. f. Physiol.*, Bd. 2, S. 1-69. Taf. 1.
1901. Die Modalitäts- und Qualitätsbegriffe in der Sinnesphysiologie und deren Bedeutung. *Ibid.*, Bd. 11, S. 245-272.

## \*OVERTON, ERNST.

1897. Ueber die osmotischen Eigenschaften der Zelle in ihrer Bedeutung für die Toxikologie und Pharmakologie mit besonderer Berücksichtigung der Ammoniak- und Alkaloide. *Zeitschr. f. physik. Chem.*, Bd. 22, S. 189.

## PARKER, G. H.

1905. The function of the lateral line organ in fishes. *Bull. of the U. S. Bureau of Fisheries*, vol. 24, 1904, pp. 183-207.
1907. The interrelation of sensory stimulations in Amphioxus. *Science*, N. S., vol. 25, no. 645, pp. 724-725.

## PARKER, G. H.

1908a. The sense of taste in fishes. *Ibid.*, vol. 27, no. 690, pp. 453.

1908b. The sensory reactions of *Amphioxus*. *Proc. of Amer. Acad. of Arts and Sciences*, vol. 43, no. 16, pp. 413-455.

## PEARL, RAYMOND.

1903. The movements and reactions of fresh water Planarians. A study in animal behavior. *Quart. Jour. of Micr. Sc.*, N. S., vol. 46, pt. 4, pp. 509-714.

## \*PFLÜGER, W.

1853. Die sensor. Functionen d. Rückenm. *Berlin*, 1853.

## PIKE, F. H.

1908. Spinal shock; a preliminary note. *Science*, N. S., vol. 28, no. 727, pp. 808-809.

## \*RAMÓN Y CAJAL.

1889. Nuevas aplicaciones del metodo de coloration de Golgi. *Term. del nervio olfat. en la mucosa nasal. Barcelona.*

1893. Nuevo concepto de la histologia de los centros nerviosos. 1893. *Virchow's Arch.*, 1896.

## READ, EFFIE A.

1908. A contribution to the knowledge of the olfactory apparatus in dog, cat and man. *Am. Jour. of Anat.*, vol. 8, no. 1, pp. 17-47, pls. 17, Fig. 1.

## RETZIUS, GUSTAF.

1892. Kleinere Mittheilungen von dem Gebiete der Nervenhistologie. III. Zur Kenntniss der Nervenendigungen in der Riechschleimhaut. *Biol. Untersuchungen*, Bd. 4, Neue Folge, S. 62-64, Taf. 18.

## RICHARDS, T. W.

1898. The relation of the taste of acids to their degree of dissociation. *Am. Chem. Jour.*, vol. 20, pp. 121-126.

1900. The relation of the tastes of acids to their degree of dissociation. II. *Jour. of Phys. Chem.*, vol. 4, pp. 207-211.

## ROLLET, ALEXANDER.

1899. Beiträge zur Physiologie des Geruchs, des Geschmacks, der Hautsinne und der Sinne im allgemeinen. *Pflüger's Arch. f. Physiol.*, Bd. 74, pp. 383-465, 1 Text-fig.

## ROSENTHAL, J.

1873. Studien über Reflexe. *Monatsber. der kgl. preuss. Akad. d. Wissensch. zu Berlin*, S. 104-107.

1884. Ueber Reflexe. *Biol. Centralbl.*, Bd. 4, S. 247-256.

## ROSENTHAL, J., AND MENDELSSOHN, M.

1897. Ueber die Leitungsbahnen der Reflexe im Rückenmark und den Ort der Reflexübertragung. *Neurol. Centralbl.*, Jahrg. 16, S. 978-985.

RUBASCHKIN, W.

1903. Ueber die Beziehungen des Nervus trigeminus zur Riechschleimhaut. *Anat. Anz.*, Bd. 22, S. 407-415, 4 Ab.

SCHRADER, MAX E. G.

1887. Zur Physiologie des Froschgehirns. (Vorläufige Mittheilung.) *Pflüger's Arch. f. Physiol.*, Bd. 41, S. 75-90.

SENATOR, H.

1898. Zwei Fälle von Querschnittserkrankung des Halsmarkes. *Zeitschr. f. klinische Medicin*, Bd. 35, S. 1-35, Taf. 1-3.

SHELDON, R. E.

1908. The participation of medullated fibers in the innervation of the olfactory mucous membrane of fishes. *Science*, N. S., vol. 27, no. 702, pp. 915-916.

SHERREN, JAMES.

1908. Injuries of nerves and their treatment. *New York*, 1908, pp. 1-130, pls. 20, Figs. 25.

SHERRINGTON, CHARLES S.

1897. Experiments in examination of the peripheral distribution of the fibers of the posterior roots of some spinal nerves. Pt. 2. *Phil. Trans. of Roy. Soc. of London*, Series B, vol. 190, pp. 45-186, pls. 3-6.
- 1900a. Cutaneous sensations. *Schäfer's Text-book of Physiology*, vol. 2, pp. 920-1001.
- 1900b. The spinal cord. *Ibid.*, pp. 783-883.
1904. Qualitative difference of spinal reflex corresponding with qualitative difference of cutaneous stimulus. *Jour. of Physiol.*, vol. 30, pp. 39-46.
1905. Ueber das Zusammenwirken der Rückenmarksreflexe und das Prinzip der gemeinsamen Strecke. *Ergebnisse der Physiol.*, 4 S. 797-850, ab. 1 u. 2.
- 1906a. The integrative action of the nervous system. *New York*, 1906.
- 1906b. Observations on the scratch reflex in the spinal dog. *Jour. of Physiol.*, vol. 34, pp. 1-50, 27 figs.

SHERRINGTON, C. S., AND LASLETT, E. E.

1903. Observations on some spinal reflexes and the interconnection of spinal segments. *Ibid.*, vol. 29, pp. 58-96, 45 figs.

SHORE, L. E.

1892. Contribution to our knowledge of taste sensations. *Ibid.*, vol. 13, pp. 191-217.

STEINACH, EUGEN.

1896. Ueber die electromotorischen Erscheinungen an Hautsinnesnerven bei adäquater Reizung. *Pflüger's Arch. f. Physiol.*, Bd. 63, S. 495-520.



## STEINER, J.

1885. Die Functionen des Centralnervensystems und ihre Phylogenese. Erste Abth. Untersuchungen über die Physiologie des Froschhirns, S. i-vi, 1-143, 32 fig. *Braunschweig*.
1888. Die Functionen des Centralnervensystems und ihre Phylogenese. Zweite Abth. Die Fische. S. i-xii, 1-127, 28 fig. *Braunschweig*.

## STERNBERG, WILHELM.

1898. Beziehungen zwischen dem chemischen Bau der süß schmeckenden Substanzen und ihrer Eigenschaft zu schmecken. *Arch. f. Anat. u. Physiol., Physiol. Abth.*, S. 451-483.
1898. Geschmack und Chemismus. *Verhandl. der phys. Gesellsch. zu Berlin*, 9 Dezember, 1898. *Ibid.*, 1899, S. 367-371.
1899. Geschmack und Chemismus. *Zeitschr. f. Psychol. u. Physiol. der Sinn.*, Bd. 20, S. 385-407.
1902. Beiträge zur Physiologie des süßen Geschmackes. *Verhandl. der physiol. Gesellsch. zu Berlin*, Jahrg. 1902-03, 5 Dez., 1902, *Arch. f. Anat. u. Physiol., Physiol. Abth.*, 1903, S. 538-543.
1902. Geschmacksempfindung eines Anencephalus. *Zeitschr. f. Psychol. u. Physiol. d. Sinn.*, Bd. 27, S. 77-79.
1902. Ueber das wirksame Princip in den süß schmeckenden Verbindungen, das dem süßen Geschmack zu Grunde liegt, das sogenannte dulcigene Princip. *Verhandl. der physiol. Gesellsch. zu Berlin*, Jahrg. 1902-03, 24 Oct., 1902. *Arch. f. Anat. u. Physiol., Physiol. Abth.*, 1903, S. 196-199.
1903. Ueber das süßende Princip. *Ibid.*, S. 113-119.
1904. Irrtümliches und Tatsächliches aus der Physiologie des süßen Geschmackes. *Zeitschr. f. Psychol. u. Physiol. d. Sinn.*, Bd. 38, S. 259-304.
- \*1904. Le principe du goût dans le second groupe des corps sucrés. *Arch. internat. de Pharmacodynamie et de Thérapie*. Tom. 13, Fasc. 1 et 2.
1904. Zur Physiologie des süßen Geschmackes. *Zeitschr. f. Psychol. u. Physiol. d. Sinn.*, Bd. 35, S. 81-131.
- \*1905. Der salzige Geschmack und der Geschmack der Salze. *Arch. f. Anat. u. Physiol., Physiol. Abth.*, 5/6, S. 483.
1906. Geschmack und Geruch. Physiologische Untersuchungen über den Geschmackssinn. *Berlin*, 1906. S. i-viii, 1-149, 5 fig.

## STRONG, OLIVER S.

1903. The cranial nerves of *Squalus acanthias*. *Science*, N. S., vol. 17, no. 424, pp. 254-255.

## THUNBERG, TORSTEN.

1905. Physiologie der Druck-, Temperatur- und Schmerzempfindungen. Nagel. *Handbuch der Physiologie des Menschen*, Bd. 3, Physiologie der Sinne, S. 647-733.

VAN GEHUCHTEN, A.

1890. Contributions a l'étude de la muqueuse olfactive chez les mammifères. *La Cellule*, A. 6, Fasc. 2, pp. 395-409, Figs. 1-14 (1 pl).

VINCI, GAETANO.

1897. Ueber das Eucain B. *Virchow's Arch. f. path. Anat. u. Physiol. u. f. klin. Med.*, Bd. 149, Folge 14, Bd. 9, S. 217-235, Taf. 8.
1899. Sur l'Eucaine B. (benzoïl-trans-vinildiacétonalkamine). *Arch. ital de biol.*, Tom. 31, pp. 32-36.

VENTSCHIGAU, M. VON.

- 1879a. Beiträge zur Physiologie des Geschmackssinnes. I Theil. *Pflüger's Arch. f. Physiol.*, Bd. 19, S. 236-253.
- 1879b. Beiträge zur Physiologie des Geschmackssinnes. II Theil. Elektrische Reizung der Zunge. *Ibid.*, Bd. 20, S. 81-114.

WALTON, G. L.

1902. The localization of the reflex mechanism. *Jour. of Nervous and Mental Disease*, vol. 29, pp. 337-343.

WALTON, G. L., AND PAUL, W. E.

1906. The cerebral element in the reflexes, and its relation to the spinal element. *Ibid.*, vol. 33, pp. 681-691.

ZWAARDEMAKER, H.

1895. Die Physiologie des Geruchs. *Leipzig*, 1895. S. i-vi, 1-324, Fig. 1-28.
1903. Geschmack. *Ergebnisse d. Physiologie*, Zweiter Jahrg., II Abth., S. 699-725.

FIG. 1.—*Mustelus canis*, the smooth dogfish; lateral aspect.  $\times 1/3$ . The numbers indicate the regions stimulated, as given in the tables.

FIG. 2.—Same individual, ventral aspect.  $\times 1/3$ . It will be noted that this is an immature male and that the claspers are, therefore, only partially developed. Thus, in the adult male, region 41 is caudad of the tips of the pelvic fins, instead of between them as shown in the figure.

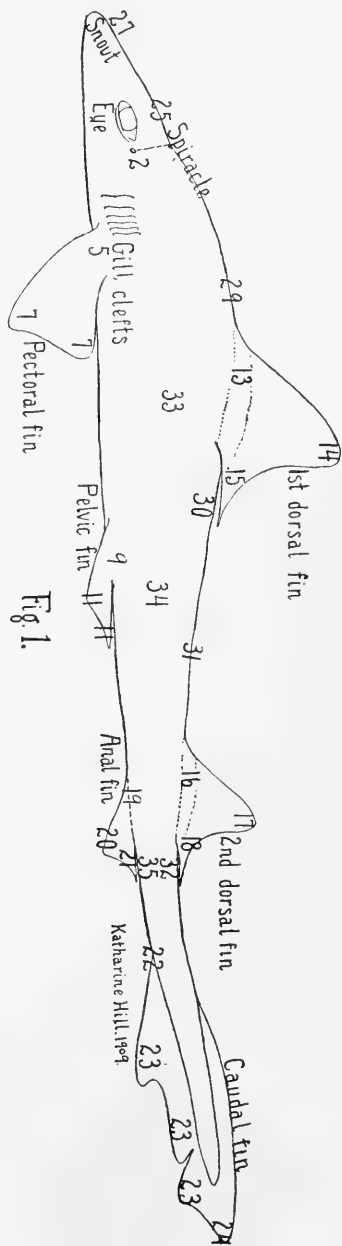

Fig. 1.

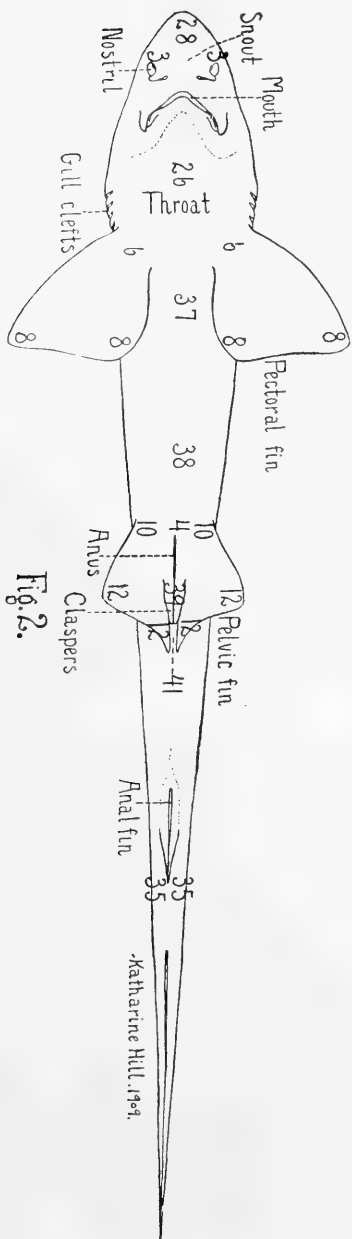

Fig. 2.

FIG. 3.—Dissection of the roof of the mouth of an adult dogfish.  $\times 11\frac{1}{2}$ . On the left of the figure are shown the incisions necessary for the transection of the olfactory crura and the maxillaris-mandibularis V trunk in the living fish, while on the right are seen the relations of the various nerves and blood vessels of the roof of the mouth, as revealed by the dissection of a dead specimen.

1. Incision through the cartilage for section of the olfactory crura (*C*); 2, incision made in cutting the maxillaris-mandibularis trunk (3); 3, maxillaris-mandibularis V. trunk, includes also the buccalis VII; 4, external carotid artery which should be avoided in cutting the nerve; 5, everted mucous membrane of the roof of the mouth; *A. R.*, anterior rectus muscle; *B.*, olfactory bulb; *buc. VII*, ramus buccalis facialis; *C.*, olfactory crus; *C. VII*, ramus from the trigemino-facial complex to the truncus hyomandibularis, probably general cutaneous; *ext. car. a.*, external carotid artery; *G.*, Gasserian ganglion; *g.*, geniculate ganglion; *H.*, cerebral hemisphere; *hyoid. a.*, hyoidean artery; *hyomand. VII*, truncus hyomandibularis facialis; *int. car. a.*, internal carotid artery; *I. O.*, inferior oblique muscle; *I. R.*, inferior rectus muscle; *Mand. V.*, ramus mandibularis trigemini; *Max. V.*, ramus maxillaris trigemini; *Olf. cap.*, olfactory capsule; *Optic*, optic nerve; *pal. VII*, ramus palatinus facialis; *pretr. VII*, ramus pretrigeminalis facialis; *Prof. V.*, ramus ophthalmicus profundus trigemini.

To perform the operations the mouth is pried open, the mucosa is reflected and the incisions made directly, care being taken to avoid the carotid arteries, both internal and external, and the hyoidean. It is necessary to reflect the mucosa, otherwise the location of the blood vessels cannot be determined.

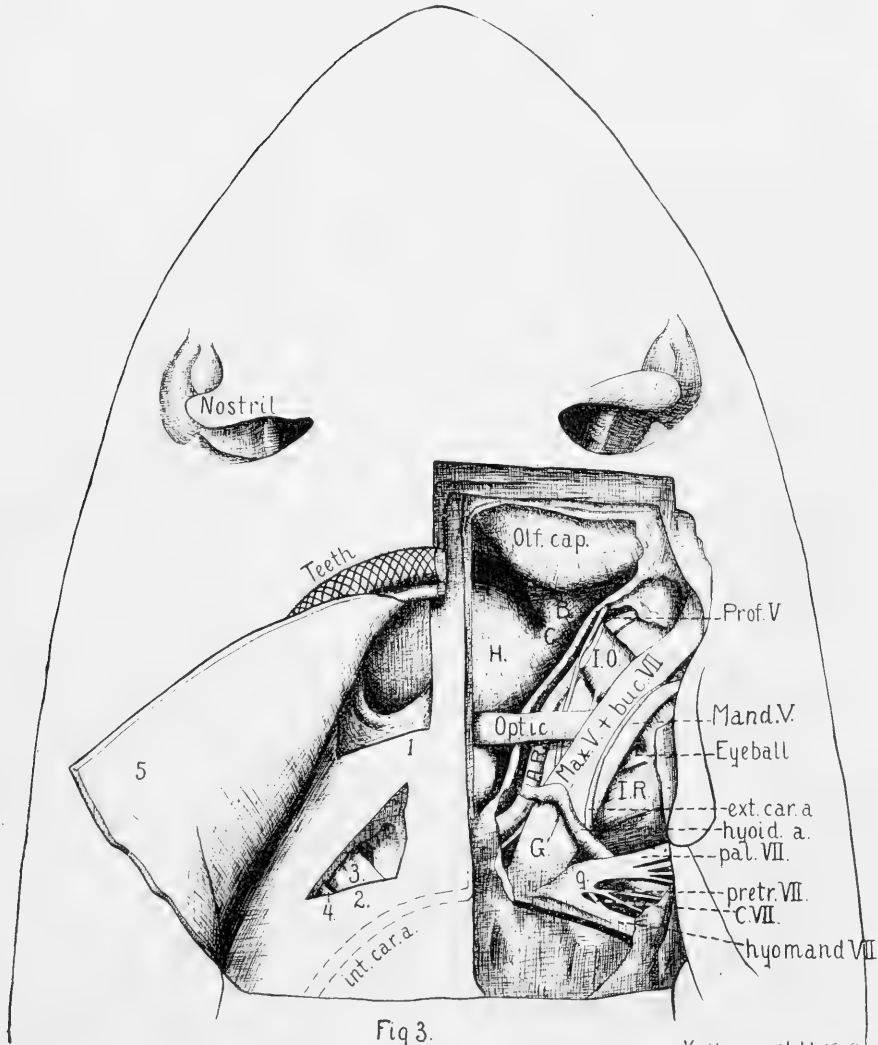

Fig 3.

Katharine Hill, 1909.



# THE WORK OF J. VON UEXKUELL ON THE PHYSIOLOGY OF MOVEMENTS AND BEHAVIOR.

BY

H. S. JENNINGS.

## BIBLIOGRAPHIC LIST.

(In the discussion, reference is made to the author's papers by the use of their numbers in the following list.)

1. Ueber secundäre Zuckung. *Zeitschr. f. Biol.*, vol. 28, pp. 540-549. 1891
2. Physiologische Untersuchungen an *Eledone moschata*. *Zeitschr. f. Biol.*, vol. 28, pp. 550-566. 1891.
3. Physiologische Untersuchungen an *Eledone moschata*. II. Die Reflexe des Armes. *Zeitschr. f. Biol.*, vol. 30, pp. 179-183. 1893.
4. Physiologische Untersuchungen an *Eledone moschata*. III. Fortpflanzungsgeschwindigkeit der Erregung in den Nerven. *Zeitschr. f. Biol.*, vol. 30, pp. 317-327. 1893.
5. Ueber paradoxe Zuckung. *Zeitschr. f. Biol.*, vol. 30, pp. 184-186. 1893.
6. Zur Methodik der mechanischen Nervenreizung. *Zeitschr. f. Biol.*, vol. 31, pp. 148-167. 1894.
7. Physiologische Untersuchungen an *Eledone moschata*. IV. Zur Analyse der Functionen des Centralnervensystems. *Zeitschr. f. Biol.*, vol. 31, pp. 584-609. 1894.
8. Ueber Erschütterung und Entlastung des Nerven. *Zeitschr. f. Biol.*, vol. 32, pp. 438-445. 1895.
9. Vergleichend sinnesphysiologische Untersuchungen. I. Ueber die Nahrungsaufnahme des Katzenhais. *Zeitschr. f. Biol.*, vol. 32, pp. 548-566.
10. Ueber die Function der Poli'schen Blasen am Kauapparat der regulären Seeigel. *Mittheil. d. Zool. Stat. Neapel*, vol. 12, pp. 463-476. 1896.
11. Zur Muskel- und Nervenphysiologie von *Sipunculus nudus*. *Zeitschr. f. Biol.*, vol. 33, pp. 1-27. 1896.
12. Ueber Reflexe bei den Seeigeln. *Zeitschr. f. Biol.*, vol. 34, pp. 298-318. 1897.
13. Vergleichend sinnesphysiologische Untersuchungen. II. Der Schatten als Reiz für *Centrostephanus longispinus*. *Zeitschr. f. Biol.*, vol. 34, pp. 319-339. 1897.
14. Ueber die Bedingungen für das Eintreten der secundären Zuckung. *Zeitschr. f. Biol.*, vol. 35, pp. 183-191. 1897.
15. Entgegnung auf den Angriff des Herrn Prof. Hubert Ludwig. *Zool. Anz.*, vol. 20, pp. 36-38. 1897.

16. Die Physiologie der Pedicellarien. *Zeitschr. f. Biol.*, vol. 37, pp. 324-403. 1899.
17. Der Neurokinet. *Zeitschr. f. Biol.*, vol. 38, pp. 291-299. 1899.
18. (BEER, TH., BETHE, A., und v. UEXKÜLL, J.) Vorschläge zu einer objektivierenden Nomenklatur in der Physiologie des Nervensystems. *Biol. Centralbl.*, vol. 19, pp. 517-521. 1899. Also in *Centralbl. f. Physiol.*, vol. 13, pp. 137-141. 1899.
19. Die Physiologie des Seeigelstachels. *Zeitschr. f. Biol.*, vol. 39, pp. 73-112. 1900.
20. Die Wirkung von Licht und Schatten auf die Seeigel. *Zeitschr. f. Biol.*, vol. 40, pp. 447-476. 1900.
21. Ueber die Errichtung eines zoologischen Arbeitsplatzes in Dar es Salaam. *Zool. Anz.*, vol. 23, pp. 579-583. 1900.
22. Ueber die Stellung der vergleichenden Physiologie zur Hypothese der Tierseele. *Biol. Centralbl.*, vol. 20, pp. 497-502. 1900.
23. Die Schwimmbewegungen von *Rhizostoma pulmo*. *Mittheil. a. d. Zool. Stat. Neapel*, vol. 14, pp. 620-626. 1901.
24. Psychologie und Biologie in ihrer Stellung zur Tierseele. Asher und Spiro's *Ergebnisse der Physiologie*, 1 Jahrg., 2 Abth., pp. 212-233. (Reprinted with the title "Im Kampf um die Tierseele.")
25. Studien über den Tonus. I. Die biologische Bauplan von *Sipunculus nudus*. *Zeitschr. f. Biol.*, vol. 44, pp. 269-344. 1903.
26. Die ersten Ursachen des Rhythmus in der Tierreihe. Asher und Spiro's *Ergebnisse der Physiologie*, 3 Jahrg., 2 Abth., 11 pages. 1904.
27. Studien über den Tonus. II. Die Bewegungen der Schlangensterne. *Zeitschr. f. Biol.*, vol. 46, pp. 1-37. 1904.
28. Studien über den Tonus. III. Die Blutegel. *Zeitschr. f. Biol.*, vol. 46, pp. 372-402. 1905.
29. Leitfaden in das Studium der experimentellen Biologie der Wassertiere. 130 pp. Wiesbaden, 1905.
30. Studien über den Tonus. IV. Die Herzigel. *Zeitschr. f. Biol.*, vol. 49, pp. 307-332. 1907.
31. Studien über den Tonus. V. Die Libellen. *Zeitschr. f. Biol.*, vol. 50, pp. 168-202.
32. Die Verdichtung der Muskeln. *Zentralbl. f. Physiol.*, vol. 22, pp. 34-37. 1908.
33. Die neuen Fragen in der experimentellen Biologie. *Rivista di Scienza "Scientia,"* vol. 4, No. 7, 17 pp.

#### SOME CHARACTERISTIC DICTA.

"We may quietly throw overboard the entire sum of our knowledge thus far acquired, so far as it comes from experiments on the frog's leg. The nerve-muscle preparation has misled us in almost every point" (30, p. 331).



“Furthermore all electro-physiological experiments on muscles have shown themselves to be biologically worthless, so that we may here pass them over in silence” (29, p. 28).

“The fate of biology in Europe, in spite of the efforts of excellent workers, seems to me to be sealed. \* \* \* One need not be a prophet to predict that in a few years biology will be an American science” (29, preface).

“The question of the function of the nervous system in the animal body has aroused a strife between two sciences that must end with the annihilation of one of the two combatants,—and the champions of both sides are determined to carry the combat to the end. \* \* \* While the comparative psychologists debated concerning the amount of sensation, memory, reflection, that one should attribute to these animals, there arose in the growing science of comparative physiology an enemy to the death of all comparative psychology” (24, pp. 212, 213).

“Before objective investigation the sensations, the memory, and thoughts of animals disappeared like fluttering forms of vapor. The iron chain of objective changes, which began with the stimulation of the sense organ and finished with the movement of the muscle, was welded together in the middle. Nowhere remained a smallest spot for the psyche of the animal. Basing itself on these incontestable facts, comparative physiology pronounced the psychological conclusions mere superstitions and denied comparative psychology the right to call itself a science” (24, p. 213).

“We stand on the eve of a scientific bankruptcy, whose consequences are as yet incalculable. Darwinism is to be stricken from the list of scientific theories” (33, p. 3).

“Concerning the origin of species we know, after fifty years of unparalleled effort and investigation, only the one thing, that it does not take place as Darwin thought it did. A positive enrichment of our knowledge has not resulted. The whole enormous intellectual labor was in vain” (31, p. 168).

“When in biology one has freed himself from the idea of development,—an idea which has at last been hunted to final death,—so that one is again in position to look upon each animal as a unity

closed within itself, instead of as the last chance product of an ancestral series that has been speculated together, then form and color gain a new interest and a heightened brilliance" (30, p. 318).

"Driesch succeeded in proving that the germ cell does not possess a trace of machine-like structure, but consists of throughout equivalent parts. With that fell the dogma that the organism is only a machine. Even if life occurs in the fully organized creature in a machine-like way, the organization of a structureless germ into a complicated structure is a power *sui generis*, which is found only in living things and stands without analogy" (33, p. 9).

"It is not to be denied that the vitalists are the victors all along the line. After having put an end to Darwinism, they have seized upon the entire field of the production of animal form, and now threaten the last positions of their opponents" (33, p. 14).

"So there persists in the outer world of objects an unresolvable contradictoriness—" (29, p. 129).

#### INTRODUCTORY CHARACTERIZATION.

J. von Uexküll, of Heidelberg, has long been one of the most active and original workers in the physiology of behavior; his work will be found of the highest interest to all seriously concerned with these matters. It undertakes for the lower animals much the same sort of analysis that Sherrington gives us for higher ones, though with many features that are in the highest degree original. Further, an examination of his work has hardly less interest as a study in scientific ideals and method than for the concrete results attained. That he has been led to radical and iconoclastic views, and that he is not afraid to express these views with decision and picturesqueness will be evident from the quotations given above. The pessimistic impression given by the quotations taken together will not escape the reader; this pessimism appears rather an unintentional result than as characteristic of the animated and militant spirit of our author. The sweeping and perhaps ill-founded character of some of the propositions advanced should not prejudice the reader against the accuracy of the author's work in his own field; this would be a serious mistake.

## INVESTIGATIONS.

Von Uexküll began as a student of the nerve-muscle preparation of the frog (1). He quickly determined to carry the study of the questions involved to the lower animals; this plan, carried out largely at the Naples Station, led to fundamental results. The work first undertaken was a study of the reflexes of the cuttle-fish (2, 3, 4, 7). This was followed by a study of certain sensory problems on the skate (9), by work on the muscle and nerve physiology of the worm *Sipunculus* (11, 25), and by an extensive series of thorough and fundamental papers on the nerve-muscle and sensory physiology of the sea urchin (10, 12, 13, 15, 16, 19, 20). Through these studies the author had developed the outlines of an original system of nerve-muscle physiology, having at its basis the concept of *tonus*. This system he developed farther in the series of *Studies on Tonus* (25, 27, 28, 30, 31),—a series dealing with various invertebrates, which is still in progress, and which we hope may count many numbers besides the five that have appeared. Arising in connection with his systematic series of investigations there have come from his pen many incidental contributions, including notes on special points in nerve-muscle physiology (1, 5, 6, 8, 14, 17, 32), studies of rhythm (23, 26), and discussions of fundamental scientific questions (18, 22, 24, 33). In 1905 a brief textbook (29) was published, giving an outline of the views to which he had come, with directions for practical work.

Characteristic of v. Uexküll is the intellectual working over of results at the time they are reached, so as to give a graphic and comprehensible scheme of the way processes occur. This appears in the very first studies, on the cuttle-fish (2, 3, 4, 7); they show the author's characteristic abhorrence of everything vague, and particularly his objection to psychic explanations in physiology. They contain much important detail on the physiology of muscle and nerve. The paper on the skate (9) is largely a polemic against the use of terms implying consciousness in the nerve physiology of lower animals, directed mainly against W. Nagel. The account of the skate is intended to illustrate the purely objective treatment of the facts, and is perhaps not in itself a strong example of the value of

the method. In this polemic, as in later work, is seen the positive, definite character of the author's thought, with no appreciation for shadings, transitions or compromises; sharpness of concept and of distinctions, black or white, is demanded everywhere.

#### THE WORK ON THE SEA URCHIN.

It is in the series of papers on the sea urchin (10, 12, 13, 16, 19, 20) that the author "strikes his pace" and brings out clearly the important phenomena which form the basis for his peculiar system of concepts. The plan of investigation is to work out the structure of the muscular, nervous and skeletal systems and the way they act together to produce the characteristic behavior of the animal; to work out "the biological plan" of the sea urchin. The paper on *Reflexes in the Sea Urchin* (12) gives a general sketch of this biological plan and the main reflexes which make up the behavior; the structure of the simple nervous system, the reflexes of the pedicellariæ, the spines, the tube-feet, the teeth, are briefly described. Then followed in 1899 a thorough detailed paper on the physiology of the pedicellariæ (16), a paper which must form the point of departure for all further work on these organs. The history of our knowledge of the pedicellariæ, their structure, the different sorts, their uses and particularly the laws of their movements, are developed in great detail. In 1900 came a similarly thorough, and perhaps still more important, study of the movements of the spines (19). Special studies were made of the reactions of the spines to light and shadow (13, 20); for the purpose of obtaining species favorable for this work the author made a trip to the east coast of Africa; the outfit for this trip is described in a separate paper (21).

In general, v. Uexküll found that the various organs of the sea urchin,—each spine, each pedicellaria,—can perform a number of different acts or reflexes, and that these reflexes occur to a large degree independently of each other, so that they may occur when the organ in question is isolated on a small piece of the shell. Thus each organ is a "reflex person." Yet all the differing reflexes of these various "persons" are of such a character that they work together in a systematic way to perform the necessary functions of the animal.

They carry it about, toward food and away from danger, keep the sea urchin clean, capture prey, combat against enemies, and all together do the work of life in a competent way. This is brought about without any regulation by a "higher center," merely through the essentially independent activities of the various parts. Therefore the sea urchin is characterized as a "republic of reflexes." The apparent unity of action is due merely to the way the different actions of the different parts fit into one another, by a sort of preëstablished harmony. "It is not that the action is unified, but that the movements are ordered; that is, the setting off of the different reflexes is not the result of a common central impulse, but the separate reflex arcs are so constructed and so fitted together that the synchronous but independent setting off of the reflexes, as a result of an external stimulus, produces a definite general action of the animal, just as happens in animals in which a common center produces the actions" (16, p. 390). "When a dog runs, the animal moves its feet. When the sea urchin runs, the feet move the animal" (19, p. 73).

But the author finds that the separate reflex-persons are not absolutely independent; impulses may pass from one to the other, in such a way as to produce a unified action of all. But this is due merely to a set of nerve nets having a special arrangement; it is a matter of interconnections, not of regulation from a "higher center." The question may be raised whether this distinction does not depend on an undefined and mystical use of the term higher center. If the higher center, in accordance with the illuminating ideas of Loeb, is after all essentially a place for complex interconnections, then the difference between the sea urchin and higher animals is only one of degree.

Von Uexküll finds that the separate reflexes of the various organs are not absolutely stereotyped, but the action of each part is changed at times in certain ways, often depending on the action of neighboring parts. We have then in the sea urchin an opportunity of studying coördination in its most elementary condition, and thus perhaps of determining the fundamental nature of the phenomena involved. This animal is a sort of model, which can be taken to pieces without serious alteration of the action of the parts; yet in

the animal as a whole the parts do influence one another. The author therefore took in hand a thorough study of the changes in the reflexes and the way they influence each other, undertaking to formulate and define precisely the underlying phenomena. It is here that we find the origin of the most important concepts in von Uexküll's highly original formulation of behavior. It will be worth while therefore to examine carefully a sample of the author's method of analysis; for this purpose we select certain features in the physiology of the spines.

#### TYPICAL EXAMPLE OF METHOD OF ANALYSIS.

It will be recalled that the rounded shell of the sea urchin is covered with long spines. Each spine is a tapering calcareous rod, with a concavity at its base, by which it articulates with a hemispherical elevation of the shell. The spine is held in position by two circles of muscles radiating from the circumference of its base to the shell. These muscles, and particularly the inner circle, are steadily pulling upon the spine, thus holding it stiffly in position. This pulling takes place without external stimulus; it is due to a certain amount of tension which forms the normal condition of the muscles and continues without any such repeated contractions or tremors as are called tetanus. That is, the muscles have a certain normal *tonus*. This *tonus* becomes the central concept in v. Uexküll's formulation of the physiology of movement. The inner layer of muscles is devoted chiefly to maintaining by its constant tension a certain position of the spine; it is an example of one of the two great types of muscular action,—the "Sperrung" or tension, as distinguished from actual contraction, involving shortening. The outer circle of muscles is more active in its changes; they shorten quickly and readily, thus moving the spine in various ways. They exemplify the other great type of muscular action,—"*Verkürzung*,"—shortening or contraction. Tension and contraction v. Uexküll shows occur quite independently of each other, and this independence, with all its theoretical and practical consequences, comes to play a very great part in the later development of v. Uexküll's views; he finds it throughout animals (see 32). The neglect of the fact that we have

here two entirely different functions has, the author believes, led all nerve-muscle physiology into false paths.

The first reflex shown by the spines is as follows: When a certain spot on the body is moderately stimulated, the surrounding spines bend toward it. The muscles of the side of the spine next the point stimulated contract; that is, their tonus is increased. Thus the points of the spines are directed, for example, toward an approaching enemy.

But if the stimulus is very intense, the reaction just described is reversed; the spines bend away from the point stimulated. This result is produced by a decrease in the tonus of the muscles on the side of the spine facing the point stimulated. Thus from the same spot on the body opposite effects may be produced, depending on the strength of the stimulus. This phenomenon is called by v. Uexküll reversal of the reflex ("Reflexumkehr"); it is observed in other organs of the sea urchin and other animals, under various conditions. The author holds it to be due to some sort of apparatus in the ganglion cells; an apparatus that he calls the "tonus switch" ("Tonusschalter"). This reversal is well seen in the spines when a strong chemical stimulus affects the body. Now, a further consequence of such a powerful stimulus is seen. *After* such a stimulus, even a weak stimulus, which formerly caused the spines to bend toward the spot stimulated, now causes them to bend away. So the same stimulus on the same spot may cause two different reactions, depending on what stimulus has preceded it. This phenomenon, very common in animals, v. Uexküll calls the "switching" of the tonus ("Schaltung"); he holds it due to the same apparatus as the reversal of the reflex.

The two reactions of the spines serve, under natural conditions, certain functions. The bending toward a stimulated point serves for defense; the bending away under a strong stimulus, particularly a chemical one, preserves the spines from injury, while giving opportunity for the action of certain large poisonous pedicellariæ, which now bend their envenomed jaws toward the region attacked and seize whatever is there present.

Certain other facts in the physiology of the spines are of extreme importance. A steady tension, not violent, exercised on the muscles

of the spines causes them to lose their tonus; they become limp. This effect of tension on tonus is common among animals. If then a spine is pressed steadily to one side by the fingers, or by the weight of the animal's body, the muscles on the side pressed lose their tonus. The spine, therefore, becomes loosely movable in certain directions, but not in others. On the other hand, a sudden violent increase of tension, or a mechanical jar, increases the tonus, so that the spines stand out firmly.

Now, the loss of tonus, caused in the way just described, is conducted, doubtless by the nervous network, to the neighboring spines. This conduction occurs in such a way that it is the muscles of corresponding sides of the neighboring spines that lose their tonus. (This involves complicated conditions in the nervous net; v. Uexküll holds that it shows the existence of many independent nets.) Hence when a spine is pressed toward one side, the neighboring spines likewise bend in the same direction. This v. Uexküll calls the chaining of the reflexes ("Reflexverkettung"). It shows itself (an important fact) most readily when the spine is bent toward the mouth; the other spines also bend toward the mouth.

These facts have the following result. When a spot on the body is strongly stimulated, so that the spines bend away from it, the disturbance is not limited to those in the immediate neighborhood. The spines in bending away press upon the surrounding spines, tending to bend them down. They are more easily bent toward the mouth than elsewhere, so a new set of spines bend over in that direction. They again press on the next spines, bending them in turn toward the mouth. Thus a sort of wave passes toward the mouth from the point stimulated, the spines bending in turn far over toward the mouth, then back again. The entire phenomenon v. Uexküll calls the wandering of the center of excitation ("Wanderung des Erregungsmittelpunkts").

Another most important fact shows itself. Muscles that are not in tonus are much more easily stimulated to contraction than those which are in tonus. When the muscles have their usual strong tonus, it requires a powerful stimulus to cause them to contract further. But muscles which have lost their tonus as a result of



steady tension (as described above), contract readily in response to even a weak stimulus, tending thus to bend the spine toward that side on which there has been tension.

From this a number of peculiar facts result. As we have seen, a moderate stimulus at a certain point tends to cause the spines to bend toward that point. If, as a result of pressure, the muscles that face the point stimulated have lost their tonus, they respond readily; the spine at once bends toward the side stimulated. But if the spines have been pressed over in the opposite direction, so that their muscles facing the point of stimulation are in strong tonus, no effect is produced; the spines retain their position. Hence, when a spot on the body is stimulated, certain spines will respond while others will not, depending on the previous tonus of their muscles. This phenomenon v. Uexküll calls "Klinkung"; those spines which are in such a condition or position that they can respond to the stimulus are said to be "eingeklinkt"; those which are not are "ausgeklinkt." These expressions may perhaps be translated by "in circuit" and "out of circuit,"—comparing the spines with instruments in an electric circuit. This condition of affairs has great importance for the functioning of the spines in locomotion and elsewhere, and parallel conditions are found in other organisms.

A similar analysis is given by the author for the pedicellariæ, tube-feet, teeth, etc.

Thus by a close and thorough study v. Uexküll has been able to analyze and formulate a number of what have been called vaguely the varying "physiological states" of organs or organisms; such analysis is needed for all cases. By making use of the concepts of Reflexumkehr, Reflexverkettung, Wanderung des Erregungsmittelpunkts, Schaltung, Klinkung, and by observing the changes in tonus and the rules for its increase and decrease, one can explain some of the most important features in the behavior of the sea urchin under natural conditions; locomotion, negative reactions to various stimuli, defence from enemies, capture of food, etc. It is, of course, no disparagement of the value of this analysis that it does not exhaust the matter for the sea urchin. Thus, when the animal is turned on its back, its spines move in ways that would not be expected

from the physiological analysis based on their other movements (19, p. 105); if they did the sea urchin would not regain its normal position. In the starfish the method of action may be changed by the formation of habits, and this is doubtless true also for the sea urchin. Thus any formulation that is complete must provide also for the laws of change of behavior; for its regulatory features. Possibly no complete formulation can ever be reached, but the most direct way to approach it is by such analysis as v. Uexküll gives.

#### LATER INVESTIGATIONS.

We have given this account of the spines as a type of v. Uexküll's methods of analysis; by following carefully such a concrete case the reader will get a better idea of the nature and justification of his work than by any systematic survey of the concepts to which he finally comes. Let us now follow further the development of these concepts. As we have seen, the central concept is that of tonus, and the laws of the changes of tonus are the chief object of research. To research on this matter, to studying the properties of tonus in various organisms, and to devising schemata which shall help us to understand how it acts, and hence how behavior takes place, have been devoted the later researches of v. Uexküll. He has thus far analyzed from this point of view, besides the sea urchin, the worm *Sipunculus* (25), the brittle-star (27), the leech (28), the heart-shaped sea urchin (30), and the dragon fly (31). In the latest contribution, on the dragon fly, v. Uexküll attempts to make provision for a modification of the machinery of behavior through the experiences of the organisms. It would manifestly be impossible to resume here these researches, filled as they are with minute and technical detail.

#### V. UEXKÜLL'S SYSTEM OF CONCEPTS.

A view of v. Uexküll's system of concepts can be gotten most directly from his "Guide to Experimental Biology" (29). But here one does not see the development of the ideas; the actual grounds that have given origin one after another to the peculiar concepts, so that they are likely to seem on first introduction bizarre and artificial, having little similarity to anything dealt with in orthodox physiology.

The fundamental concept is *tonus*. Just what are we to understand by this? V. Uexküll at first defines it merely as the sum of those manifestations of the life of the cell that produce effects on external things (as distinguished from the internal energy used in metabolism, etc.) (19, p. 78). As his work develops, he finds need for a more precise idea of *tonus*. It is defined as a "form of energy" which has the property of flowing in certain ways (20, p. 474). The concept of *tonus* gradually becomes more and more definite. For purposes of handling and imaging it with ease, it becomes convenient to think of *tonus* as a fluid, which flows through a set of tubes (the nerves). This fluid becomes at last identified with Bethe's "Fibrillensäure,"—an actual chemical, visible under the microscope (27, p. 31). But this identification is not held to uniformly.

This fluid *tonus* is contained in a system of tubes, the nerves. "The structure of the nervous system may then be conceived as an aggregate of peculiar vessels united one with another, which interchange and equalize each other's contents with relation both to pressure and quantity" (25, p. 305). From the nerves the *tonus* either passes into the muscles, or causes in them the production of a fluid with similar properties, giving rise to either tension ("Sperrung") or contraction ("Verkürzung"). In dealing with *tonus*, either in the nerves or the muscles, we must distinguish its *quantity* from its *pressure*; these may vary independently, so that any given quantity may have high or low pressure. On the *quantity* of *tonus* depends the contraction of muscles; on the *pressure*, the tension of muscles.

There are certain general laws for the movements of *tonus*. In simple nerve nets it always flows into muscles that are extended (causing them to contract again). This is attributed to a change in the *capacity* of the muscles; extended muscles have greater capacity than contracted ones, so in extending they suck, as it were, the *tonus* out of the nerves. This property gives a remarkable degree of self-regulation to the action of the nerves and muscles.

In most animals, further, the *tonus* shows a marked tendency to flow toward a certain part of the body,—usually the anterior end,—

so that this part responds when any part of the body is stimulated. This part to which tonus flows as water flows into a valley is denominated, with poetic feeling, the vale of tonus ("Tonustal," 25, p. 310; 29, p. 56). After the tonus has flowed into certain muscles, it is possible (in some cases at least) to capture and hold it there, by cutting the nerves leading to the muscles ("Tonusfang," 25, p. 302); the muscles then remain contracted.

During rest the fluid tonus is gradually used up and disappears; at stimulation it is newly manufactured. There exist, however, reservoirs of tonus in the nervous system, so that the lost tonus of the muscles can be replaced without new manufacture.

The nervous system then contains, besides a system of communicating tubes, reservoirs of tonus; at the same time it is an elaborate apparatus for controlling the distribution of tonus. Each muscle has somewhere in the nervous system an organ which is its "representative" (25, p. 303; 29, p. 44). The office of this representative is to see that the tonus pressure in the muscle remains sufficient to cause the tension of the muscle to correspond to the weight which it has to bear. When the pressure in the muscle is insufficient, this acts on the representative (through the nerve) causing it to increase the pressure, until this raises the tension so as to support the weight. The increased pressure is produced by the fact that the representative uses up a certain *quantity* of tonus to increase the pressure of what is left.

The author's further development of this system consists in working out in detail the structure and action of this system of tubes, reservoirs and other machinery, by which the distribution of tonus is controlled. Main tubes, feeders, reservoirs, valves, etc., are devised and represented by diagrams, till we finally get figures which resemble the plan for a dye-works or a flour mill (see for example the schema for *Sipunculus*, 25, Tafel 6).

The method of presentation is in general the ideal construction of an apparatus which could produce the results shown by the organisms. In this construction no attempt is made to represent apparatus that actually exists in the organism; it is merely a figure or illustration; "a mere schema in accordance with which one can group

the experimentally found facts in a convenient way" (25, p. 287). "The schema of indirect investigation is not a theory at all, but merely a sign language by means of which it is possible to at once express new results in a graphic ('anschaulich') way" (27, p. 31). All emphasis is laid on making the illustration thus "anschaulich"; that is, of such a character that one can "see through it"; see how it would work as a machine works. The author makes extensive use of this "fictitious schema" (25, p. 291), basing long discussions for the greater part of entire papers on its properties. Perhaps nowhere else in biology has a figure of speech, as it were, been worked out in such tremendous detail, through a long series of papers.

Regarded thus as a figure or illustration, the author appears very successful in constructing apparatus that would produce results similar in their complication and regulatory character to the processes observed in organisms. This has necessarily been done, of course, by attributing new characteristics to the various components when required. The tonus is sometimes given the characters of a definite material fluid, and much pains is taken to account for the entire quantity; again, it may be produced or disappear as required; sometimes it is considered a form of energy; at times it shows the properties of electricity in producing effects by induction (31, p. 195); at times we are informed that the figure of a fluid quite fails (25, p. 213). When the author attempts to show how his complicated machinery may become modified in a way corresponding to the production of what are called psychologically memory images (31), clearness has to be given up, and the entire figure becomes unconvincing.

As to the value of this figurative and artificial method of presenting the results of work, opinions will, of course, differ. The point can be best discussed in connection with a review of the guiding principles and scientific ideals in the author's work; to this we now turn. It is peculiarly true in the work of v. Uexküll that the author's concrete results cannot be understood without an appreciation of the principles that have guided him. This will lead us to a consideration of his general and theoretical papers.

## THEORETICAL VIEWS AND GUIDING PRINCIPLES.

Perhaps the main characteristic shown throughout v. Uexküll's work is the abhorrence of anything vague, ill-defined or mystical. In his early papers he sets forth clearly the ideal of scientific work as the discovery and presentation of what is verifiable or demonstrable. "We have to do only with processes that can be objectively demonstrated, and to write the history of these processes in an animal from the moment of stimulation to the resulting reaction" (9, p. 559). This led him at once into a polemic against authors that used psychic explanations in work on animal behavior (see 7, p. 608; 9, etc.). The circle was soon widened, and in 1902 v. Uexküll declares that a war of extermination has arisen between comparative physiology and comparative psychology, a war that spells annihilation for one of the combatants and "both are determined to carry the fight to the end" (24). His fundamental point is, of course, the fact that there is no way of observing or verifying the existence of psychic phenomena in animals, so that they cannot form a part of a strictly verifiable science; and a further postulate is that all objective processes can and should be fully presented and accounted for without bringing in anything from outside. To substitute psychological interpretations for certain steps of objective experimental analysis is vicious and destructive of consistent science. V. Uexküll's polemic papers take extreme positions and are written with much picturesqueness of statement; they are of great value for rousing to a realization of the difficulties those who need such a spur. Apparently, however, all the valuable results that would be reached by utterly destroying the unhappy comparative psychologists would be equally well attained by keeping carefully separate the two fields of work. If the experimenter never substitutes a psychological explanation for a physiological one, he may also be interested, as a separate problem, in the development of mind, without injury to his objective scientific work.

This same demand for objective verifiable results, without admixture of anything else, has led v. Uexküll to take a part, with Beer, Bethe, and others, in trying to establish a purely objective nomenclature for the processes occurring in the movements of animals (18;

see also 29). This nomenclature has philosophical value and has been used by a few authors, though its employment is by no means common. There is difficulty, as with all ideal system of nomenclature, devised before investigation is complete, in the fact that its use often implies a precise knowledge of the nature of the phenomena, when such knowledge does not exist. To give precisely the correct name to a process implies that we know fully the nature of the process.

The author's abhorrence of the vague later becomes still more accentuated in the demand (which we have noticed above in our account of his investigations) that work shall be presented always in a way that is "anschaulich"; that is, in such a way that one can see just how the processes would occur, as one sees how a machine works from knowing its structure. It is extraordinary to what an extent the author makes the attainment of this "Anschaulichkeit" the chief object of biological science; he declares it plumply to be the "most essential character of all" ("die allerwesentlichste") for the science of biology (31, p. 184). "Biology is in its essence 'Anschauung'" (33, p. 16).<sup>1</sup> "Only the *anschaulich* structural diagram, not proving, but *showing* the unified working together of different factors, is adequate to the requirement of bringing the life processes together into an intelligible unity without omitting life itself" (31, p. 185). It is only by grasping fully the fact that "Anschaulichkeit" is the author's ideal, that one can understand many of the peculiarities of his work.

The first far-reaching consequence of this ideal arises from the fact that that which is "anschaulich" is not always that which is verifiable. The author is therefore sometimes compelled to a choice between the two, and in his later papers he at such times deliberately chooses the "Anschaulichkeit" in preference to verifiableness. He thus falls into contradiction with his own earlier requirement that we shall deal only with what is objectively demonstrable ("objectiv nachweisbar," 9, p. 559), as well as with the procedure of other in-

<sup>1</sup>The word *intuition*, by which "*Anschauung*" is commonly translated, certainly fails to carry to most minds the same graphic idea as the German word, so that I do not employ it.

vestigators to whom it is more important that scientific propositions shall be verifiable than that they shall be *anschaulich*. Let us here look in a general way at the contrast between the results reached by making "Anschaulichkeit" the ideal, and those which flow from making verifiableness the ideal.

For many investigators the object of science is to prepare a system of verifiable propositions, in order that we may know what to depend on in our conduct; "to know what is true in order to do what is right," as Huxley put it. Verifiable propositions are propositions that say "Under such and such conditions you will find such and such things to occur or exist."<sup>2</sup> Now, if one supplies the conditions set forth, and does not find the predicted things to occur or exist, the proposition is not verifiable, and many would therefore hold that it should be stricken from science. A large proportion of the propositions concerning machine-like structures in organisms, given by v. Uexküll, do not even profess to be verifiable. One of the main objects of investigation is to find out what particular kinds of machines are present in animals, and how these actually present machines have arisen and how they are changing. This object is incompatible with the mere assumption of fictitious machines, for the first result of investigation with this object in view is to cancel these fictitious machines. This would indeed leave our science for a time less sharply formulated, but "at a certain stage in the development of a science a degree of vagueness is what best consists with fertility,"<sup>3</sup> for reference of the phenomena to complete fictitious machines tends to cut off search for the real ones. When we have found out what really occurs in organisms and what machines actually exist there, then our knowledge will be as "anschaulich" as the facts warrant, no more, no less.

To the present reviewer it seems that, even for practical purposes, the author has overestimated the value of a rather gross "Anschaulichkeit." The bringing in of machine-like structures,—tubes, valves, etc.,—that confessedly do not exist, seems rather to confuse

<sup>2</sup>Or, put in a form which holds whatever one's theories, "when you have such and such experiences, you will have such and such other experiences."

<sup>3</sup>Wm. James, *Psychology*, Preface.



than to aid the mind. It is not possible to conclude directly from the properties of the assumed machines as to what physiological properties one will find, for the parallelism is far from complete, so one must try to keep the system of machinery separate from the system of physiological facts; there are two systems to grasp in place of one. The reader finds it difficult if not impossible to disentangle statements which the author wishes to present as verifiable facts, from statements which are a mere necessity for carrying out the figurative schema. V. Uexküll shows all through his work an astounding facility in concluding as to the structures that must be present, from the functions which he sees performed. The reader wonders whether these structures are held to actually exist, or whether they are part of the fictitious schema. The reviewer finds that for his own use it becomes necessary in reading v. Uexküll's work to ask "Now, what did the author here actually observe and demonstrate?" It then becomes necessary to transform or almost re-write a paper before the verifiable results can be disentangled from the figurative presentation. I believe that this condition of affairs has prevented the work of v. Uexküll from exercising the great influence that it deserves from its importance. Nothing would be more helpful to most readers than for the author, after putting his results together in the figurative language of his peculiar system as he has done in his *Guide* (29), to give us a new compendium of his experiments and results, making the test of admission that which is verifiable, or at least that which the author believes will be found verifiable. This would not involve, of course, the omission of his important concepts of "Schaltung," "Klinkung" and the like, for these are names for experimentally verifiable processes and conditions; nor would it involve the omission of general laws, as verifiable statements that apply to whole classes of objects; nor would it exclude hypotheses, presented as such, for these are propositions which the author believes will be found verifiable on further investigation. It would involve simply the omission of what the author himself recognizes as fictitious. I believe it would be found that nothing of value had been lost; that the author's important work would stand out with a clearness not before attained. Further, in the technical accounts of his

investigations, it would be extremely helpful if the author would at least segregate carefully his verifiable, experimental, results from his fictitious schema, if he finds that he cannot bring himself to totally abandon the latter.

This demand for "Anschaulichkeit" rather than verifiableness in a scientific account is what has led to an apparent opposition between v. Uexküll's work and that of some others. Such is the case, I judge, with the differences between his work and my own. He presents his work in an "anschaulich" form that is confessedly not verifiable, while I have tried to present strictly what is verifiable, whether immediately "anschaulich" or not. The results are bound to be different in the two cases. If my work should be presented by the aid of "anschaulich" fictions, or if v. Uexküll should present his own results without these fictions, the two accounts would show a most gratifying agreement; this is especially true now that v. Uexküll has included, in his last Study (31) attempts to show how his machines could be modified by the influences which act on the organism. I have never argued against the existence of machine-like arrangements in organisms. My point was merely that these machines are not fixed and final, but that they are continually changed by the environment and by the action of the organism itself.<sup>4</sup> Personally I believe that even these changes occur in an essentially machine-like way.

The demand for "Anschaulichkeit" at all costs is apparently what has led the author to certain extreme views; to his separating and contrasting biology and physiology; and to his tendency to fall into vital-

<sup>4</sup>In his recent paper on *New Questions in Experimental Biology* (33) v. Uexküll, in presenting a graphic picture of my exposition *if carried to a logical extreme*, has attributed to me extreme views which I have never held. He says that I "denied the existence of the reflex; denied the existence of *any structure* in the central nervous system." This statement I am sure is given as part of an "anschaulich" fictitious schema, not as a statement of verifiable fact; I have made no such denial. Again he quotes me as saying that "the organism is *only* something happening," when what I said is that "The organism is something happening." The difference is like the difference between black and white. I was trying to insist upon certain facts that had been commonly left out of account,—not trying to substitute these facts for everything else known.

ism at certain junctures. Having abandoned (in favor of the construction of fictitious machines) the requirement of finding out what are the real forces at work in organisms, of finding out what machines actually do exist (as determined by the test of verification), the author finds himself in opposition to physiology, which searches precisely for the real (verifiable) forces, materials and machines of organisms. To escape this opposition, v. Uexküll renounces physiology and all its works; renounces finding out the causes of things, and calls himself a biologist only; biology he maintains has an entirely different purpose from physiology. "We distinguish two sciences of animate nature; Physiology, which arranges her materials according to causality; Biology, which arranges her materials according to purposiveness (*Zweckmässigkeit*)" (29, Vorwort). The purpose of biology is to work out the *plan* according to which the body is made up and acts (33, pp. 10, 11, etc.). The *materials*—the actual chemical and physical substances, properties and forces—used in realizing the plan, do not concern biology, but form the field of physiology (28, p. 376). Hence the biologist may content himself with schemata which reproduce what the organism does, even though the organism and the schema are operated by different forces acting on different materials in different arrangements. Thus "When I for example lay out the plan of structure of a worm, and in so doing use any convenient physical schema, it doesn't occur to me at all to touch upon a physical problem. One may always think of any other force as at work in the same object. I am not concerned with that. I seek only for a fitting expression in order to make the plan of the animal *anschaulich*" (28, p. 377). The biologist need not concern himself with causal questions; with physiology. "It is therefore not to be complained of if we biologists, who are asking about the functions of animals, look with much coolness at the end problems of physiology" (28, p. 377).

Renouncing then a causal study for biology, and holding that "Anschaulichkeit" or the demonstration of the production of processes in a machine-like way is the "most essential of all" things in biological explanations, v. Uexküll naturally gets into serious difficulties when he confronts processes which he is unable to present as

“anschaulich” by “searching about for a satisfactory mechanical scheme of structure” (31, p. 188). Such he feels that he finds in all developmental processes, both in development from the egg, and in the development of new features in movement and the organs of movement. “It is greatly to be regretted that we must give up the hope of finding an *anschaulich* structural schema for animal development. But there is no structure that could explain (*veranschaulichen*) its own production” (31, p. 185). Since, then, it is impossible to bring development under the only point of view which seems to v. Uexküll to give a satisfactory explanation, he finds it necessary to take refuge in vitalism. He is, however, under no illusions as to vitalism’s being an explanation; it is a mere reünunciation; “when we therefore give over the production of form to vitalism, this giving over involves a reünunciation of all real understanding in this science” (31, p. 187). In his latest paper v. Uexküll counts himself, if I understand him correctly, as a vitalist so far as developmental processes go, but as a “machinalist” so far as the functioning of developed organs is concerned (33, p. 14).

If in place of making “*Anschaulichkeit*” the end to be reached, one takes verifiableness as his aim, a very different set of views will be reached in biology. There are many fields of exact science in which such “*Anschaulichkeit*” as v. Uexküll demands is not required. To understand how water is produced from oxygen and hydrogen, most chemists do not construct a fictitious machine on the plan of a flour mill or a dynamo. They merely accept the fact as a datum, in connection with other similar facts. V. Uexküll himself mentions a number of fields of science which are not “*anschaulich*” in character (33, p. 16), so that it seems extraordinary to found vitalism on the basis that biology is similar to other sciences in this respect! The only condition that science requires in order that accepted principles of explanation shall apply is this; that differences in resulting conditions shall always be found to be preceded by differences in foregoing conditions, so that nothing shall happen undetermined. But why oxygen and hydrogen in the proportion of one to two should give the properties of water rather than those of alcohol we do not know any more than we know why

in biology one combination produces a sea urchin, another a starfish. Throughout both chemistry and biology we find unpredictable results produced by new combinations. The repeated changes shown by the development of an organism seem, as to intelligibility, quite on a par with a series of transformations due to recombinations of chemicals. If in either field the same combination under the same conditions should sometimes produce one result, sometimes another, then indeed science would be in distress, and if biology were the field in which this occurred, then the biologist might perhaps grasp at vitalism as a drowning man grasps at a straw. Our quotation from v. Uexküll (given above, p. 316), in which he holds that Driesch has shown that the germ cell "does not possess a trace of machine-like structure, but consists of throughout equivalent parts" and that it is "structureless," perhaps implies that he conceives this distressing condition to have been reached. But those who have spent years in working with the astoundingly complex machine-like structures and processes in the chromatin of the germ cell, and have considered the demonstrative evidence brought forward by Boveri, Wilson, Herbst and many others as to the distinctive functions of these various parts in development, will find the statement that the germ cell is structureless and composed of throughout equivalent parts so absolutely schematic and fictitious as to omit *all* the truth!

Taking verifiableness as our aim will likewise leave biology and physiology resting peacefully in union. We shall be interested in the plan of the organism so far as it is *verifiable*; and to work out the verifiable plan we shall be forced to consider the actual forces, materials and arrangements, not fictitious ones. Doubtless physiology has in practice become narrowed; the remedy lies in broadening it till it includes everything verifiable in the study of the processes of organisms.

Criticism of theoretical points is not a proper close for a consideration of work of such solid value as that of v. Uexküll. Though we may differ from him in theoretical ideal and in method of presentation, we must recognize the fundamental soundness of his methods of actual work. Never was a truer principle set forth for

successful biological investigation than that the first requirement is "The continued and accurate observation of the living animal in its environment" (29, p. 75). And v. Uexküll has done more toward an analysis of the internal processes in the behavior of lower animals than perhaps anyone else.

The Journal of  
Comparative Neurology and Psychology

VOLUME XIX

JULY, 1909

NUMBER 4

IMITATION IN MONKEYS.

BY

M. E. HAGGERTY.

*From the Harvard Psychological Laboratory.*

WITH THIRTEEN FIGURES.

CONTENTS.

	PAGE
I. Introductory Statements .....	337
II. Description and Care of Animals Studied .....	340
III. Method of Investigation .....	348
IV. Experiments and Results .....	355
V. General Summary of Results and Conclusions .....	433

I. INTRODUCTORY STATEMENTS.

1. *Statement of Problem.* Popular opinion has generally attributed to monkeys the ability to learn by imitation. As will appear later, experimental evidence on the matter has been of a conflicting nature, but in the main it has not supported the popular belief. The general problem of imitation presents itself in the form of two questions: Do monkeys imitate human beings? and Do they imitate one another? It is conceivable and, indeed, quite probable that an animal which fails to copy the acts of persons, may yet imitate individuals of its own species. In the native state, monkeys must have innumerable opportunities to imitate one another, whereas they rarely, if ever, have opportunity to imitate human beings. Further-

more, a *monkey* lifting a latch is a very different stimulus for an observing monkey from a *person* lifting the same latch. In view of these considerations it is important in an experimental study of imitation in monkeys to deal separately with the two questions proposed above. The first question, Do monkeys imitate human beings? is only indirectly related to the natural activities of the animals; the second, Do they imitate one another? is extremely important for an understanding of the behavior and mental life of monkeys. To discover in what ways certain species of monkeys are influenced by one another's acts has been the chief aim of the investigation which I have here to report.

2. *History of Present Investigation.* The investigation was begun in the Harvard Psychological Laboratory in October, 1907. From that time until June, 1908, the experimenter devoted himself (a) to studying the behavior of three *Cebus* monkeys; (b) to making experiments with these individuals for the purpose of developing methods of testing imitative ability, and (c) to devising and constructing apparatus for experimental work.

In June, 1908, the investigation was transferred to the New York Zoölogical Park in order to make use of the large collection of monkeys available there. The apparatus which had been built in Cambridge, and two of the *Cebus* monkeys which had been used in the preliminary experiments were taken to the Park. Here, under peculiarly favorable conditions the investigation was continued until September. Well-prepared apparatus and methods of experimental procedure, the fine collection of animals and the excellent local conditions provided by those in charge of the Park, greatly facilitated the work and within the short space of ten weeks much was accomplished in the way of results.

3. *The Work of Other Investigators.*—Noteworthy observations concerning the imitative ability of monkeys have been made under experimental conditions by Thorndike<sup>1</sup>, by Kinnaman<sup>2</sup>, by Hob-

<sup>1</sup>THORNDIKE, EDWARD L. The Mental Life of the Monkeys. *Psychological Review, Monograph Supplement*, vol. 3, no. 5, 57 pp. 1901.

<sup>2</sup>KINNAMAN, A. J. Mental Life of Two *Macacus Rhesus* Monkeys in Captivity. *American Journal of Psychology*, vol. 13, pp. 98-148; 173-218. 1902.



house,<sup>3</sup> and by Watson.<sup>4</sup> In the main these observations are but indirectly related to the present investigation, for they are largely concerned with the animal's ability to copy the acts of human beings. On this ground, the work of Hobhouse, which gave positive results, may be excluded from this discussion. The other three investigators, who studied the tendency of monkeys to imitate one another, used, in one form or another, the problem method. One monkey was taught to get food by manipulating a mechanical device; then another monkey was allowed to learn the act by watching the trained animal perform. None of the investigators has given the problem an extended study, since the observations in this particular were incidental to studies of wider scope.

Thorndike reports a series of five experiments on a Cebus monkey. This animal, "No. 3," was, at the time of the experiments, "on terms of war" with No. 1, the animal he was to imitate. In none of the imitation tests did "No. 3" learn to do the act. Thorndike concludes: "There is clearly no evidence here of any imitation of No. 1 by No. 3. There was also apparently nothing like purposive watching on the part of No. 3."<sup>5</sup> "This lack of any special curiosity about the doings of their own species characterized the general behavior of all three of my monkeys and in itself lessens the probability that they learn much from one another."<sup>6</sup>

Kinnaman observed two cases where the conduct of a male rhesus caused the female to learn an act. The problem was to get food by manipulating a mechanism—in one case, the pulling of a plug, in the other, the bearing down of a lever. In each case, the female was given opportunity to get food but failed. The male was then allowed to get food while she was present and watching. In each case she went at once, after seeing the male get food, and operated the mechanism and repeated the performance numerous times later. Kinnaman says: "Here we have a copy in the form of an act. It was copied almost in detail, and that, too, so far as the place of

<sup>3</sup>HOBHOUSE, L. T. *Mind in Evolution.* Chap. X. *London.* 1901.

<sup>4</sup>WATSON, JOHN B. *Imitation in Monkeys.* *Psychological Bulletin*, vol. 5, pp. 169-178. 1908.

<sup>5</sup>P. 40.

<sup>6</sup>P. 42.

laying hold of the plug and the direction of the pull were concerned, both requiring very radical changes from the monkey's own previous efforts."<sup>7</sup> He also says, "It seems to me that the two cases with the box are quite as good examples of imitation as could well be gotten even with human beings."<sup>8</sup>

Watson's contribution to this subject is the latest and agrees with Thorndike's in giving negative results. He reports three imitation tests made upon two *Macacus rhesus* monkeys. In no one of these tests did the watching animal learn to get food by seeing another animal get it. He concludes, "I unhesitatingly affirm that there was never the slightest evidence of inferential imitation manifested in the actions of any of these animals."<sup>9</sup>

If we group the work of the three investigators together, we have ten imitation tests in which four animals were used. One animal manifested imitative behavior in two different tests. None of the other three animals showed any tendency to imitate. From such fragmentary and conflicting evidence it is impossible to conclude what rôle imitation plays in the behavior of monkeys and the need for further investigation is apparent.

4. *Acknowledgments.*—In presenting this report of my investigation, I gratefully acknowledge my indebtedness to the Harvard Psychological Laboratory and, in particular, to Professor Robert M. Yerkes, at whose suggestion I undertook the investigation. His sympathetic coöperation at every stage of it has been invaluable. To Dr. William T. Hornaday, Director of the New York Zoölogical Park, I am deeply indebted for the opportunity to use the facilities of that great institution. His interest and generosity did much to further my work. The photographs which are here reproduced were made for me by Mr. E. R. Sanborn, the Staff Photographer of the Park. I am grateful for his services.

## II. DESCRIPTION AND CARE OF ANIMALS STUDIED.

### 1. *Cebus Monkeys.*

(a) *General Characteristics.*—In my experiments I have used

<sup>7</sup>P. 144.

<sup>8</sup>P. 122.

<sup>9</sup>P. 172.

eleven animals from two genera and seven species. Eight of them represent five species of *Cebus* monkeys. This is the genus with which we are familiar as the consort of organ grinders. The home of these monkeys is South America, especially the head waters of the Amazon and northward into Central America, where they live a gregarious life in the tree tops, feeding on fruit, nuts and insects.

TABLE 1.  
NUMBER, SPECIES, SEX AND PROBABLE AGE OF ANIMALS USED IN THE  
INVESTIGATION.

No.	Species.	Sex.	Age.	Remarks.
No. 1.....	<i>Cebus lunatus</i>	Female	3 years	Bought of dealer in New York.
No. 2.....	“ “	Male	3 “	Bought of dealer in New York.
No. 3.....	“ <i>hypoleucus</i>	“	2 “	Bought of dealer in New York.
No. 4.....	“ <i>fatuellus</i>	Female	6 “	Had been several years in Park.
No. 5.....	“ <i>capucinus</i>	“	5 “	Had been several years in Park.
No. 6.....	“ <i>lunatus</i>	Male	4 “	Had been several years in Park.
No. 8.....	“ <i>hypoleucus</i>	“	7 “	In Park but eight weeks.
No. 9.....	“ <i>flavus</i>	“	1 year	In Park but eight weeks.
No. 10.....	<i>Macacus rhesus</i>	Female	4 years	In Park two years.
No. 11.....	“ “	Male	3 “	In Park two years.
No. 13.....	“ <i>cynomolgus</i>	“	4 “	In Park two years.

They travel about by leaping from one tree to another; in this arboreal life their long grasping tails serve them better than a fifth hand would. The facial portion of the skull is small in comparison with the cranial portion, and many specimens have quite prominent foreheads. Forbes notes that the cerebral cortex is almost as much convoluted as it is in the Old World Apes. The forehead, usually bare of hair, is often wrinkled, giving the monkeys the appearance of being “burdened with sorrows, which,” as Dr. Hornaday remarks, “most captive monkeys certainly are!”

The *Cebus* monkeys are cowards except toward those they can easily vanquish. One fight is usually enough to settle the supremacy of a cage. The whipped animal seldom makes another effort

to rule. The victor, however, often delights in continuing punishment which the vanquished receives with howls and shrieks of fear. The noise made by the victim is out of all proportion to the injury inflicted. A slap, a theft of banana, or even a threat often arouses piercing shrieks.

No. 6 and No. 4 were together one day in a small cage. It was about feeding time and both wanted to be at the wire front. No. 6 was in the way of No. 4 and she slapped him with the palm of her hand. He retreated and doubled up in his characteristic fashion, moving his body up and down and yelling loudly. Any movement of No. 4, even so much as the turn of her head toward him, served to release another volume of shrieks. This continued for several minutes with no further demonstration on the part of No. 4.

On another day, No. 4 was sitting on a brace in the experiment cage with her hands on the wire. Without allowing her to see me move, I touched my finger to the back of her index finger. As if struck by an electric current she leaped to the floor and began to yell vehemently and continued to do so for some time.

I am informed by Dr. Hornaday that the Cebus monkeys which are marketed in this country are obtained when quite young. The offspring rides about on the mother's back and hunters shoot the mother, who falls to the ground with the young still clinging to her. The small animal is then caught and kept in captivity until the keeper desires to ship it to market. This makes it next to impossible for any one who buys these monkeys of dealers to know much about their previous experience.

In a study such as this, however, it is desirable to know all that can be known of each animal's normal activities, so at the risk of multiplying words, I shall give a brief account of each animal used.

(b) *Characteristics of Individual Animals.*—No. 1, Cebus lunatus, female, and No. 2, Cebus lunatus, male, were obtained from an animal dealer in New York City. When they came to the Harvard Psychological Laboratory in November, 1907, they were apparently about three years old and were in excellent physical condition.

No. 1 made herself at home from the start and on the third day

would sit on my knee and eat her banana out of my hand. Within a short time she would ride on my shoulder as I walked about the laboratory, thus being sure to keep near whatever food I might have in my hand. No. 2, however, was more cautious, never coming near except when No. 1 preceded him, and retreating whenever he got his food. His favorite position was sitting on the floor of the cage with No. 1 sitting in front, and his arms clasped tightly around her body. When No. 1 moved, No. 2 would start nervously and try to keep close to her, never once taking his sparkling brown eyes off the persons in the room. Gradually his fear wore off and with No. 1 he went curiously about the cage, biting at every projecting piece of wood, and poking his fingers into every crack and cranny. A small tree was put into the cage and then the animals could stretch their tails by wrapping the tip end around a branch and suspending their whole weight from the limbs, a performance apparently as enjoyable to the monkeys as swimming is for the average boy.

The animals did not like to be separated. No. 2 was especially concerned when No. 1 came out of the cage to get food and he was left alone. Often, when alone, he would utter a shrill piercing sound, a veritable bark. This was unlike their usual noises of chattering, whistling and crying and I took it to be a danger signal, for No. 1 never failed to climb the cage, window or anything else near her when the cry was given. Even when, after a day's fast, she was greedily eating her banana, it would be left with a startling suddenness and she would make no delay until she was at the highest point in the room. She never looked about to discover the danger for herself and never ran on the floor. Her action was always one impetuous scramble to get *up*. She never remained up long and often came down immediately. I never heard her utter the cry. He sometimes gave it when she was out of sight, but again when she was in plain view, and when there was no disturbance in the room. In the wild state, such a cry is probably the signal that some enemy is near, and when given, all that hear it scud to the tree tops as the place of greatest safety.

After a few weeks in the laboratory, No. 1 acquired a pugnacious

attitude toward certain persons, usually strangers. I first noticed it one day when an expressman called to leave a package. He entered without noticing her and when he turned to leave she was on a cage which he must pass in going to the door. Her mouth was open, her teeth exposed, and her body drawn into a crouching attitude as if she were about to spring. I intervened, while the man left, for fear she might bite or scratch him. A day or two later she behaved in the same way toward the laboratory machinist, who came in to do some work. As he went toward the door, her fury increased like that of a dog after a retreating enemy. I began to suspect there was more of bluff than fight in her behavior and my suspicions were fully justified a few days later. Experiments were over for the day and No. 1 was having her freedom about the room to the delight of the several persons present. A stranger entered the room. She was at the opposite end and on top of a six-foot cage when he entered. She immediately prepared for war and her scolding and threatening began. She advanced toward him along the top of the cage by short leaps, which grew shorter as she neared him. Her scolding increased, her hair became erect and her wide-open mouth showed her keen teeth as if she were ready to bite. Suddenly she leaped from the cage toward him (most men would have dodged or struck, but this man did neither) and she landed plump upon his chest. Instantly her harsh cries became more like the purr of a cat, and her hand found its way to his jewelled tie pin and on up to his moustache. She was not angry.

No. 2 never assumed the bluffing attitude. He showed, however, more ingenuity in learning to do things. During his whole life in Cambridge and also in New York he refused to be petted, and when caught was in great fright. This fear often distracted his attention from working at problems. He worked by spurts, glancing at persons in the room and then making a vigorous thrust or pull at the mechanism. It was only by maintaining the most rigid quiet in a room that I could induce No. 2 to give continuous attention to a problem. Despite this fact, however, he learned to get food in devious ways much more quickly than No. 1, whose familiarity with human beings had possibly led her to depend on them for her food.

No. 1 died suddenly, from no obvious cause, at the close of the first experiment. No. 2 was taken to New York in June, 1908. He remained in good health throughout the entire investigation.

No. 3, *Cebus hypoleucus*, male, was a small animal apparently less than two years of age. He was shipped with a mate from New York City to the Harvard Laboratory in March, 1908. He had not long been off the ship which brought him to New York and was in poor physical condition. He never became vigorous, but his good appetite kept him hunting for food. He was one of the animals taken to the Park in June and was used in a number of tests.

No. 4, *Cebus fatuellus*, female, was a large fine animal. She was full grown, probably six years of age and had been in the Zoölogical Park half of that time. She was kept, with Nos. 5, 6, 8, and 9, in a large cage which contained a number of *Cebus* and Spider monkeys and several lemurs. She was the boss of the cage, and was very aggressive toward the other animals, especially when food was put into the cage. She was physically the strongest *Cebus* monkey I have studied, but when she did not readily solve a mechanism she gave up trying sooner than did No. 5. She was always attentive to any movements of the experimenter or of another monkey in the cage. She was not afraid, but would not allow herself to be handled.

No. 5, *Cebus capucinus*, female, was the most active animal I used. She was scarcely ever quiet in the experiment cage except when she crouched in fear. She was almost as strong as No. 4 but had less inclination to fight and to take food from other animals. However, no animal in the large cage excepting No. 4 dared to take food from her. When any new device was exposed in the experiment cage, No. 5 examined every part of it with great rapidity and her interest did not abate if she did not solve the problem at once. She returned repeatedly to every new part in the cage and worked at it persistently, using all her ingenuity and strength to get food or to tear the mechanism to pieces. She was five years of age and had been several years in the Park.

No. 6, *Cebus lunatus*, male, was thoroughly at home with per-

sons. He was very playful and enjoyed being handled. He was as free with strangers as with familiar persons and would pull and play with sticks, pencils, umbrellas or any other thing that any one held out to him. If a person got sufficiently near his cage, he would dig into his pockets for handkerchiefs. As a rule he was not attentive to the other animals; he preferred to attract human attention. For this reason it was difficult to get him to watch the other animal in the imitation tests. He stood third in supremacy in the large cage, yielding only to No. 4 and No. 5. He was four years old and had been in the Park two years.

No. 8, *Cebus hypoleucus*, male, was a new arrival at the Park. He was old, apparently seven or eight years of age, and one canine was missing; the other teeth were very large. He was large and lank, with long bony arms and legs. He moved slowly and when in a new situation was quiet and sluggish. He was used in one imitation experiment only and failed in that. He was apparently afraid most of the time and was whipped by animals much smaller than himself.

No. 9, *Cebus flavus*, male, was the smallest animal used in the investigation. He was probably but little over a year old and had been in the Park but six weeks, having come in with No. 8 and six others. He was very much of a baby, riding on the back of his cage mate most of the time. He was quite excitable and cried a great deal when alone. When with No. 8 he was a perfect parasite, stealing food and riding. Toward No. 3, he developed a fighting attitude and under the protection of No. 6 almost worried No. 3 to death during one night. He did not want to be touched by persons, but his fear did not keep him from getting food within his reach.

## 2. *Macacus Monkeys.*

(a) *General Characteristics.*—The *Macacus* is the most common form of the Eastern monkey. The group contains twenty-five species, many of which are found in captivity and are among the most hardy of captive monkeys. The most common form is the *Macacus cynomolgus* which is found in various parts of Asia and in the East Indian Islands. The tail of this species is quite long and is one



of its distinguishing marks. These animals are large, strong, and apparently courageous. Both the cynomolgus and rhesus monkeys have cheek pouches in which they store food. Both make a show of courage and, in comparison with the Cebus monkeys, are quite courageous.

(b) *Characteristics of Individual Animals.*—No. 10, *Macacus rhesus*, female, was four years old and had been in the Park more than a year, during which time she had been caged with a large female common macaque. Both of these animals had an apparent dislike for strangers and would dash at the side of the cage when any one approached. No. 10 was in the laboratory only three weeks, in a cage with No. 11, a male of her own species. She was much afraid of me at first and rushed about the cage to get away. She soon became quiet and for ten days was an exceptionally good animal for study. She was active, quick and hungry. Before the tests with her were over, she was attacked with dysentery and became useless for experimentation.

No. 11, *Macacus rhesus*, male, was a young animal about three years old but very large. He had a long well-rounded body, well-shaped limbs, and well-developed quarters. During the time he was in the laboratory he was in superb physical condition. He was quick, active and strong. He seemed never to be off his guard. His muscles were always tense and he leaped suddenly and with great force. He was not afraid, but would not allow himself to be handled. No. 10 whipped him, but he showed fight toward all the other animals and never retreated.

No. 13, *Macacus cynomolgus*, male, was a large vigorous animal about four years old, who was not afraid of persons or other animals, yet who was not of a pugnacious disposition. He whipped No. 12, his cage mate, while they were in the laboratory, but after he had settled the supremacy of the cage he lived peaceably with him. Like No. 11, he was always attentive to other animals and seldom failed to see anything he could turn to his own advantage. He was quick and strong, and during the experiments, was in fine physical condition.

### 3. *Care of Animals.*

During the progress of the experiments the animals were kept in the laboratory all the time. They were grouped one, two, and three in small cages, the aim being to secure for each, congenial cage-mates,—not an easy thing to do with the full-grown animals. The cages were cared for and food was given daily by the keeper. The Park Veterinarian, Dr. Blair, stopped occasionally to see that the animals were in good health. No other persons had access to the laboratory, except the experimenter and persons whom he invited to be present at experiments.

The animals were then kept in a normal condition, undisturbed by the crowds of visitors which thronged the Primates' House during the summer. Effort was made to eliminate fear. The experiment cage was large and light and the animals were fed in it so often that they were glad to get into it. No effort was made to handle the monkeys with the hands in transferring them from one cage to another. They were allowed to go down a runway, or to enter a small box which was then transferred to the larger one and the animal was released. Food was given along all parts of this runway and in the cage, and the animals were usually in their normal state when in the experiment cage.

The daily food was given at 2:30 P. M. Enough was given to keep the animals in good condition but not enough to satiate them. The weekly menu, given under the experimenter's direction, was as follows:

- Sunday.* Bananas, yellow corn, sunflower seed.
- Monday.* Boiled potatoes, bread, bananas.
- Tuesday.* Roasted peanuts, bread, apples.
- Wednesday.* Cabbage, lettuce, carrots, bread, bananas.
- Thursday.* Boiled potatoes, bread, apples.
- Friday.* Boiled rice with raisins, bananas.
- Saturday.* Boiled potatoes, bread, dates.

### III. METHOD OF INVESTIGATION.

1. *Problem Method Used.*—I have used in the investigation the problem method only. The animals have been placed in the pres-

ence of simple mechanical devices, the manipulation of which opened doors, disclosed openings, or dropped food into the experiment cage. The motives to action on the part of the monkeys were three: curiosity, the obtaining of food, and the tendency to imitate.

The problems which I have used are all comparatively simple. It is an easy matter to construct devices which monkeys will not manipulate, either on their own initiative or by imitation. The results from such problems, however, have only a negative value in the study of animal intelligence. To demand that an animal perform a wholly new act, that he behave in a way entirely different from his usual ways of acting, is a legitimate mode of procedure for certain purposes. But if a monkey fails to manifest imitative behavior under complex and excessively strange conditions, it is not proof that the animal lacks imitative ability.

Human beings do not imitate all the acts of their fellows, not even all those which it would be profitable to copy, and to judge by such failures would be to class man as a non-imitative animal. This would be manifestly unfair, for in certain other situations the imitative behavior will appear. The fact is that we imitate most often in those situations in which wholly new elements are few. We are reinforced by a great complex of habitual reactions, and, when the new elements are mastered by imitation, these habitual modes of activity complete the learning in a more or less automatic way. Because we take advantage of our fund of habits is, however, no reason to deny that our real advances in learning may be by imitation. We do not demand that a person perform an act wholly and entirely new before we credit him with imitative learning.

We certainly should not be less generous with other animals. They should be met as nearly as possible on their own ground and presented with problems in which they may have the advantage of their fund of inherited and acquired modes of behavior. At first the elements entirely new should be as few as possible. If they are then unable to profit by seeing another animal perform an act the case against their ability to learn by imitation would seem to be conclusive. If under such simple conditions they do

manifest imitative behavior, the complexity of the problems can be increased and thus by successive steps the range of imitative ability can be determined.

Viewing the matter in this way, I deemed it important to give the monkeys an extended preliminary study. I was unable for some time to set problems which seemed well suited to the purpose, and my best ideas seemed to come accidentally as I was observing the animals. From a large number of possible problems, selection and combination was made so that, in the end, I had a group of devices presenting situations adapted to the monkey's ways of doing things. The value of this preliminary work, I am sure, is evident in the results of the experiments.

2. *Laboratories and Apparatus.* (a) *Laboratories.* The experiments made in Cambridge were conducted in a research room of the Harvard Laboratory. The living cages were located against the wall of the large airy room. Between these living cages and the experiment cages, a curtain was drawn while the experiments were in progress. Light fell upon the experiment cages from two large windows so that all parts of the apparatus were well illuminated. The room was on a third floor and on the side away from the street. It was, therefore, exceptionally free from the noises and jars of traffic.

At the Park, a laboratory was arranged in a room at one end of the Primates' House. The room was 15 feet long and 12 feet wide, with good light from two sides and the roof. Along the two sides of the room opposite the windows, were the living cages, where the animals were kept, two and three in a cage. Between these cages and the windows a floor space, 7 by 10 feet, gave sufficient room for the experiment cage described below. Its wire sides were toward the windows so that it might be well lighted. The experiment cage was separated from the living cages by curtains which could be drawn back when the experiments were over.

(b) *Experiment cages.* In presenting problems to monkeys one meets two difficulties at once. If the animals are left free in a room they wander about, examine everything in the room and give only intermittent attention to the problem, thus wasting time.

On the other hand, if the problems are adjusted in a small box, the animal is cramped and often frightened. In order to minimize these difficulties I built an experiment cage (fig. 1) which was 182 cm. high, 124 cm. broad and 92 cm. deep. It was large enough to allow considerable freedom to the animal, and yet not so large but that the monkey was kept near the problem all the time. The top, the floor, the back and one end of the cage were made of rough pine boards. In these board parts of the cage were adjusted several mechanisms. The problem for the monkey was to manipulate one or another mechanical device. The front of the cage and one end were covered with half-inch mesh wire which made possible a view of the entire interior. At the bottom of the front was a slide door through which the animals were introduced into the cage.

This cage was used in all the preliminary experiments and for the first complete set of imitation tests. In the light of knowledge gained in its use, a new and improved cage was built. Hereafter, these two cages will be designated as the old cage and the new cage respectively.

The new cage (fig. 2) was used in all the experiments made at the Park. It was made of clear white pine lumber, was built in sections and put together with bolts. The frame was in four parts, of material  $4\frac{1}{2}$  cm. square. The front frame, *a, b, c, d*, and the back frame, *e, f, g, h*, were each 118 cm. by 180 cm. The end frames, *i, g, k, l*, and *m, n, o, p*, were each 85 cm. by 180 cm. When these four parts were bolted together they made a cubical frame 85 cm. by 118 cm. by 180 cm. Across the front, half way up was a brace, *q*, of the frame material. The end of the brace, *X*, was a favorite place for the animals to perch. The front and one end of the frame were covered with galvanized woven wire of one inch mesh. The back of the cage was covered with four boards, *A, B, C*, and *D*, 29 cm. wide and 2 cm. thick, placed vertically and fastened to the top and bottom of the frame by bolts with wing nuts, *W*. The remaining end of the frame was similarly covered by three boards, one of which, *E*, was fastened as those on the back, and two of which, *F* and *G*, were made into a door hinged at *h*.<sup>1</sup> The top of the cage consisted of three boards *H, I*, and *J*, 29

cm. by 85 cm. which were fastened to the frame in the same way as were the boards of the back. The floor, in one piece, *Z*, rested on the frame at the bottom of the cage and could be taken out for cleaning. In the lower part of board *F* was a slide door, *S*, 24 cm. by 32 cm. whose lower edge was on a level with the floor. The cage was mounted on ball-bearing castors so that it could be moved about easily and quietly.

The boards on the back, end, and top of the cage were half-tongued so that no cracks appeared between them. They were removable and other boards of corresponding dimensions could be substituted. The mechanical devices which were presented to the animals as problems for manipulation were arranged in separate boards. The cage was made ready for experimentation by removing one of the plain boards and substituting a board with a device. This convenience made it possible to shift from one experiment to another with facility.

(*c*) *Problems.*—In the two cages eight problems were arranged. These I shall describe in connection with the statements of results. Here it will be sufficient to designate them by name, as follows:

1. Chute Experiment A. In old cage.
2. Chute Experiment B. In new cage.
3. Rope Experiment. In new cage.
4. Paper Experiment. In new cage.
5. Screen Experiment. In new cage.
6. Plug Experiment. In new cage.
7. Button Experiment. In new cage.
8. String Experiment. In new cage.

3. *Experimental Procedure.*—For the most part, the experiments were made between 7:00 A. M. and 1:00 P. M. when the animals were in a normal state of hunger and when they were fresh from the night's sleep. During some of the later experiments it was necessary to continue the work until later in the afternoon. In such cases, the feeding time was postponed for the animals so used. The first experiment was made on successive afternoons between two and three o'clock.

The general plan of the experiments was as follows: First, each animal was given a fair opportunity to learn to manipu-

late the mechanism in a series of preliminary trials. These trials were usually on successive days, rarely twice in one day. In all experiments, except the Chute Experiment A, which was made in the old cage in Cambridge, the animal was given *five of these preliminary trials, each fifteen minutes in length.* In almost every case the animal had either solved the problem or had become indifferent to the mechanism by the end of this time.

At the close of these preliminary trials, imitation tests were begun with the animals that had failed to learn of their own accord. In these tests, the trained animal was allowed to perform in the presence of the imitator; after this, the latter was given an opportunity to get the food himself. He was permitted to work *ten minutes*, and longer, if he seemed about to solve the problem. If imitation did not occur in the first test, the test was repeated. An animal was not counted to have failed until he had seen the performance a hundred times, and yet was not able to repeat it.

Wherever the experiments varied from this schedule the fact is stated in the account of the experiments.

In some of the tests, the two animals were together in the cage; in other tests the imitator was confined in an observation-box within the experiment cage while the imitatee got food by manipulating the device. This observation-box was approximately 40, by 60, by 80 cm. and was covered on five sides with woven wire of half-inch mesh.

4. *Observation and Description of Behavior.*—My first aim in this investigation has been *to record the facts of behavior.* Just what names to apply to the types of behavior manifested has been a secondary consideration. The question of imitation in animals bears, at present, a somewhat controversial aspect and I have felt that I could best contribute to a clearing away of difficulties by making a full and accurate record of exactly what I saw my animals do under experimental conditions. This I have faithfully tried to do, with the result that I have a paper full of details. However, I am convinced that this is really the way of progress in this matter. Mere forensic insistence on a certain point of view regarding the problem of imitation in animals, may, in the absence of the real

facts of behavior, be a pleasant pastime, but it can add nothing to a solution of our problem.

In describing the behavior of the animals and in interpreting that behavior, it has been my aim to use all terms in as objective a way as possible. Certain words with a subjective implication are, however, so indispensable for convenience that I have ventured to use them, and to define them objectively to avoid misunderstanding.

The verb *see* was needed so often that to have found a roundabout substitute with a wholly objective signification, would have needlessly encumbered the account with words. When an animal's eyes were directed toward a thing, when he turned his head or fixed his gaze apparently in response to the movement of another animal, when he reacted toward an object by going toward it or away from it, I have chosen to say that the animal "*saw*" the thing to which he apparently responded. In case there was an accentuation of such behavior, an apparent increase of muscle tension and eagerness to make such movements, I have said the animal "*saw well*" or "*saw perfectly*." I have said he saw "*fairly well*," if the objective marks of attention were present, but not normally strong. In none of these cases, however, do I intend to imply more than that the animal manifested such behavior.

So, also with the word *experience*. When an animal ate the food which was obtained by the manipulation of a device I have said *he experienced the result* of the act, but throughout the presentation of data and the interpretation thereof, I have meant nothing more than that he ate the food so obtained. I have intended to imply nothing as to the psychic aspect of such behavior.

The same is true of my use of the word *imitation* which I shall define in the general summary of Chute Experiments A and B, page 376.

It has been convenient to use a few common terms with technical meaning. To denote the several times an animal was in the cage alone before he was given an opportunity to learn by imitation, I have used the word *trial*. I have used the word *test* to mean the opportunity an animal had to learn from another animal. The word



covers both the time the imitator was performing and the time the imitator remained in the cage after the removal of the imitator. To indicate the act of the imitator in getting food, I have used the word *performance*. Successive performances are indicated by P. 2, P. 3, etc.

#### IV. EXPERIMENTS AND RESULTS.

##### 1. CHUTE EXPERIMENT A.

###### *A. Description of Device.*

In the top of the old cage (fig. 1), near the wire front and the wire end was a door, *a*, 10 cm. square, which opened inward and was held shut by a device, *b*, on the top of the cage. At a point in the top near the board end and the back, a hollow chute, *c*, 5 cm. square, projected perpendicularly into the cage 60 cm. From the device which held the door shut, a string, *d*, passed to the top of the chute and hung down on the inside to within 10 cm. of the bottom of it. To the end of the string was fastened a bit of iron, *e*, to serve as a hand hold. The top of the chute was covered with a cap, *f*, so that no light could come through it.

In order to secure the food, the monkey must leap from the wire part of the cage to the chute, and, while holding to it, must thrust a hand up inside and pull the string, thereby releasing the small door in the top of the cage and allowing food which had been placed on it to fall to the floor. He must then descend to the floor to get the food.

###### *B. Behavior of No. 2.*

*Preliminary trials.*—First trial, Jan. 4. No. 2 first picked up crumbs of food from the floor of the cage. He then played about on the floor and the wire end and front of the cage. He jumped from the front of the cage to the chute and back to the front. This he repeated five times. He took no notice of the end of the chute. Time: 30 minutes.

Second trial, Jan. 6. The behavior of No. 2 was similar to what it was on Jan. 4. He seemed quite anxious to escape. He jumped to the chute three times. The third jump so shook the chute that the door was jarred open and the food (peanuts) fell to the floor. No. 2 noticed the food immediately and climbed down to eat it. When the nuts had been eaten, he climbed the front of the cage, and, holding with his feet to the wire, reached the swinging door with his hands and thrust his head up through the open door.

Third trial, Jan. 7. No. 2 was quite shy. He ate crumbs from the floor and climbed the wire parts of the cage. During the thirty minutes he jumped to the chute twenty-two times.

Fourth trial, Jan. 8. No. 2 jumped to the chute repeatedly and on the seventh jump he threw his head and shoulders downwards. While hanging by his tail and feet, he looked up the chute, thrust up his hand and pulled the string. The food fell. Twenty times more he jumped to the chute, but did not get food.

On Jan. 9, Jan. 13, Jan. 20, he was tried again and on the latter date he opened the trap door ten times in twenty-seven minutes. He was then counted to have learned sufficiently to set the copy for No. 1.

#### *C. Behavior of No. 1.*

*Preliminary trials.*—No. 1 was first put into the experiment box on Jan. 7. She was quite hungry and scolded and chattered all the time. She picked crumbs from the floor and climbed the wire on the front and the end of the cage. During the thirty minutes she was in the cage she took no notice of the chute.

On thirteen succeeding days for the same length of time she repeated this behavior. On Jan. 21, her jumping about the cage jostled open the trap door. This called attention to the door and several times later she climbed the front of the cage and reached one hand over to the edge of the door. There was, however, no evidence that the chute and door were connected by the animal.

*Imitation tests. No. 1 imitating No. 2.*—First test. At this time, it seemed evident that No. 1 would not of her own accord learn to work the device. For the imitation test she was placed within a wire-covered box, inside and at the end of the experiment cage opposite the chute. No. 2 was then placed in the cage and allowed to open the food door. The small box served as a place from which No. 2 could jump to the chute and thus modified the conditions of the experiment. The box was removed and the two animals were placed in the large cage together. Prof. Yerkes was present and we were agreed that out of the seven times which No. 2 opened the door, No. 1 saw the entire performance twice, and in part, at least, four other times. No. 2 was removed from the cage and No. 1 was left alone for thirty minutes. The following observations are quoted from Prof. Yerkes' notes: "After a few minutes of climbing about, No. 1 looked up at the chute from the floor, stood on her feet, lifted her body and face upward, climbed the side of the cage as if she were making right for the chute, but she did not jump across to it. I am not certain that she looked across at the chute from the side of the cage. During the remainder of the interval I saw no evidences of the influences of what she had seen."

Second test. No. 2 was again placed in the cage and allowed to operate the mechanism. Each time No. 1 got food; sometimes she took all of it. Twice again she saw the entire performance and four times more she saw it in part. No. 2 was then removed and No. 1 was left in the cage for thirty minutes. There were no indications that the behavior of No. 2 had in any way influenced the behavior of No. 1.

The test was repeated on sixteen different days. No. 2 operated the device a total of 253 times. No. 1 saw 204 of these. On no day did she see the entire performance fewer than three times nor oftener than twenty times (see Table 2).

On each day, after being given the opportunity to witness the behavior of No. 2, No. 1 was left in the cage alone for thirty minutes. On Feb. 6, after being alone for a few minutes, No. 1 stood under the chute and looked up at

it. She then ran to the side of the cage as if to climb, but her attention was distracted and she did not climb. Later she climbed the front of the cage and clinging with her feet and one hand, she allowed her body, head and other arm to swing away from the cage toward the chute. This conduct came nearest to suggesting the influence of No. 2's behavior of any during the whole of the experiment.

In all the later tests, No. 1 was more or less attentive to No. 2 and usually got food when he pulled the string, but when he was removed she became quite indifferent to the chute and took her leisure about the cage as if the means of getting food was not present.

TABLE 2.  
NO. 1 IMITATING NO. 2.

Date—1908.	Number of times No. 2 performed the act.	Number of times No. 1 saw No. 2.	Number of times No. 1 saw in part.	Result.	Time in Minutes.
Jan. 30a. . . . .	7	3	3	Failed.	30
Jan. 30b. . . . .	6	3	3	F	30
Jan. 31. . . . .	11	8	3	F	30
Feb. 4. . . . .	17	10	7	F	30
Feb. 6. . . . .	10	10		F	30
Feb. 10. . . . .	12	10	2	F	30
Feb. 17. . . . .	12	10	2	F	30
Feb. 18. . . . .	13	10	1	F	30
Feb. 19. . . . .	10	10		F	30
Feb. 20. . . . .	12	10	2	F	30
Feb. 24. . . . .	10	10		F	30
Feb. 25. . . . .	12	10	2	F	30
Feb. 26. . . . .	22	20		F	30
Feb. 27. . . . .	20	20	1	F	30
Feb. 28. . . . .	23	20	3	F	30
Feb. 29. . . . .	33	20	3	F	30
March 2. . . . .	23	20	3	F	30
Total. . . . .	253	204	35	F	510

*S* means that the imitator did repeat the behavior of the imitatee.

*F* means that the imitator failed to repeat the behavior of the imitatee.

The time is always given in minutes unless otherwise indicated. It was taken with an ordinary watch and where it is recorded in seconds the time was taken from the second hand.

*How No. 1 Learned.*—March 3. No. 1 had been given more than two hundred opportunities to see No. 2 perform the operation and had profited frequently by getting food. It then seemed certain that she would not learn to work the device from seeing No. 2 do it. A stick, two inches wide, was placed from the wire front of the cage to the chute. Within eight minutes, No. 1 had climbed the side of the cage, had walked on the stick to the chute, had swung down and thrusting her hand up the chute had opened the door. The stick was then removed while No. 1 was on the floor. When her food was eaten she became very active, making long leaps all about

the cage, but never once to the chute. She then settled down to her usual behavior and after ten minutes the stick was replaced. She pulled the string once and the stick was again removed. She then resumed her usual conduct for almost ten minutes more. Then, when under the chute, she looked up and her eyes accidentally fell on the chute. She rushed up the front of the cage and leaped to the chute, swung herself down and worked the device. This she repeated several times, although in a much less skillful way than No. 2 was able to do it.

## 2. CHUTE EXPERIMENT B.

### *A. Description of Device.*

This apparatus was a modification of the one used in Chute Experiment A.

From the top of the experiment cage (fig. 3), 30 cm. from the board side and 40 cm. from the board end, a hollow wooden chute, *a*, 5 cm. square, projected into the cage a distance of 70 cm. Inside this chute, 40 cm. from the lower end was a trap door, *b*, hinged to drop downward, but held up by a rubber elastic. To the bottom of this trap door was attached a string, *c*, which hung down to within 10 cm. of the lower edge of the chute. A coiled wire spring, *d*, was tied to the lower end of the string to serve for a hand-hold for the animals. In the top of the cage was a tube leading into the chute from a small feeder (fig. 19, *f*,) adjusted on top of the cage. By pulling a string, attached to the feeder, the experimenter could drop food (sunflower seed and chopped peanuts) upon the trap door.\* Two horizontal rungs nailed to the sides of the chute helped the animal to support himself on the chute.

The problem set for the animal was to leap from the wire front or end of the cage and, while holding to the chute, to swing his head and shoulders down, thrust one hand up the inside of the chute, grasp the coiled spring, and pull the trap door down. The food on the top of the door would then fall to the floor, unless checked by striking the body of the animal. In either case the animal could get it.

### *B. Behavior of No. 2.*

No. 2 had learned to work the mechanism in Chute Experiment A. But when he was first put into the new cage, four months after his last experience in the old one, he apparently had no memory of the chute. Only after several minutes did he go to it. He jumped to it from the front wire. He stopped to examine the opening in the end before he thrust his hand into it. In the old cage he usually thrust his hand into the opening without

\*The essential part of the feeder was a copper plate, 3 cm. wide and 6 mm. thick, arranged to slide back and forth in grooves beneath a food hopper. In the plate was a circular opening into which the food dropped from the hopper. When the string was pulled this opening, full of food, was drawn over a tube leading into the chute, into which the food dropped.

looking at it. After examination, he pushed his hand up the inside and touched the string. Then he became very eager to work and would have worked continually (fig. 4).

*C. Behavior of No. 13.*

*Preliminary trials.*—First trial, August 23. On entering the cage, No. 13 climbed to *X* where he sat for a short time. He then walked along the brace until opposite the chute, when he leaned out toward the chute and touched it with his hands, a little way above the lower edge. Drawing his body back from the chute, he walked along to *X* and went down to the floor. Several times he climbed up and down the wire parts of the cage and then tried to get out at the door. He went back and forth from the door to *X*. In his endeavor to get out of the cage, he pushed on the small doors repeatedly and even climbed the wire front to push on the upper part of the large door. Next he settled at *X* and looked about. He moved down to the floor and up and down the wire. Moving along the brace to the door, he tried to push it open. He then descended to the floor. He tried to climb the corner post opposite *X* and then climbed the wire to the top of the front, going to the floor again and then up to *X*. He was active during the entire time he was in the cage, but he took no notice of the chute after the first three minutes.

Second trial, August 24. The movements of No. 13 on this day were as follows: Up the end of the cage; to the floor; up to the brace and along the brace to opposite the chute; leaned over to the chute and put hands on the lower rung; felt up and down the edges of the chute nearest him; tried to bite the edges of the chute; back to the wire and to the floor; again up to the brace and leaned over to the chute; again bit the edges of the chute; to the floor, about, and looked up at the chute from exactly under it; to the door; up to *X* and perched; to the floor and hunted about; bit the door; again to *X* and perched, looking out through the wire; down to the floor to get a roach and back to the brace; up the wire front, and back to *X*; to the door and back to *X*; along the brace; putting his hands over on the chute, he swung his body to the chute and climbed up on it to the top of the cage and looked at the screws, etc.; tried to bite rung; back to brace and perched at *X*.

Third trial, August 26. Behavior as follows: Climbed wire; perched at *X*; to the floor; to the door; up front and around to the top of the wire end; back to *X* where he sat for a little time; to the floor and hunted all about; to the place where *L*\* had been and hunted for it; back to *X* and along the brace to the large door; turned around, faced the chute, but paid no attention to it; to the floor, all about and back up to *X*; along the brace to the chute; leaned over to it; put hands on the near edges and looked up and down; grasped rung in one hand and pushed other up and down the edges of the chute; back to *X*; to the chute and clung to it while he examined the top of

\*An opening where he had gotten food in a previous experiment.

the cage; on the chute two minutes and then slid down to the end and dropped off; again to the chute and examined the crack in the top of the cage; perched on the rung and looked out of the cage; bit at the edges and then jumped off.

Fourth trial, August 27. Behavior as follows: To *X* and sat down; along the brace and back to *X* and to the floor; up the front and along the brace to *X* and up the end of the cage; to the floor and about all the edges looking for food; up to *X*, along the brace, and to the floor; about the floor and to the door, which he tried to open; to the end of the cage; up, around to the front and sat at *X*; up the end of the cage and down to the floor; to the corner opposite *X*; to the front, up and sat at *X*; up and down the wire; up the front, around to the end and back to the front; to the end and down to the floor; up to *X* and sat; up the front of the cage and shook it.

Fifth trial, August 29. Behavior as follows: Up and down the end of the cage; to the door and up the front; to the chute and sat on the rungs; back to front and to *X* where he sat for some time; to the floor and to the door, which he tried persistently to open; climbed the front and looked about; to the floor and pushed on the door very hard; up the front and perched at *X*; up the end of the cage and back to *X*; along the brace and pushed at the chute; to *X* and down to the door; up the front and to the chute; back to the brace and along it to the end of the cage and back to *X*; to the floor and back to *X*; looked up at *X* from the floor; afterward climbed to *X* and sat there during the remaining part of the time.

*Imitation test.*—*No. 13 imitating No. 4.*\* First test. No. 13 was put into the observation box and the box was set on the floor of the cage so that No. 13 could have a good view of the chute. No. 4 was put into the cage and, at once, began to get food from the chute. No. 13 was attentive to every movement. His record in seeing is as follows:

Performance 1. No. 13 saw perfectly and became very threatening and eager to get out of the cage.

P. 2. Just as No. 4 thrust her hand up the chute, No. 13 looked down. As a result he did not see the pull. He saw her eating food and shook his box with such force that he moved it about over the floor.

P. 3. No. 13 saw perfectly and sat on the floor of his box attentively watching No. 4 eat her food.

P. 4. No. 13 saw perfectly and was eager to get out.

P. 5. No. 13 saw fairly well; he was eager to get out of the box; failing to get free he sat on the floor of his box and watched No. 4 eat the food.

These performances did not occupy more than five minutes. No. 4 was now removed and No. 13 was released in the cage. At first he looked about over the floor for food and then climbed the front wire, stopping on the brace opposite the chute. He leaned over to the chute and while still standing on the brace with his feet, tried to thrust a hand into the bottom of the chute. Failing in this, he ran along the brace to *X* and back again to opposite the

\*The learning of No. 4 will be given later.

chute; catching the rung of the chute in his hands he drew himself over to it; finding himself above the end of the chute he tried to let his body down, first on one side and then on the other, until in the most awkward manner he managed to get near enough to the end to thrust a hand up the inside far enough to reach the string. At once he pulled and the food came tumbling down on his chest and to the floor. Dropping to the floor he picked up the food and ate it. The time from the removal of No. 4 was 40 seconds.

Within one minute he climbed the front wire, reached the chute, and got food in the same manner. On reaching the chute the third time he did not pull himself above the end, but holding to the rung with his hands he dropped his body below the end and placing his feet against the back of the cage steadied himself while he thrust the free hand up inside and pulled the string. Time: 40 seconds. From this time on No. 13 repeated the performance as rapidly as his food was eaten. Within ten minutes he had gotten food eleven times and had eaten it all. From the moment he was released in the cage he seemed bent on getting the food. In his efforts, he made but one useless movement, namely, when he drew back from the chute after first putting his hands on it. This, however, did not indicate a wavering from the end in view. It was merely a drawing back for the renewed effort which he immediately made.

*Summary of Behavior of No. 13 in Chute Experiment B.*

During the preliminary trials No. 13 was exceedingly active, but at the end of the time he had made no progress toward a solution of the problem. He had gone to the chute, but there was no evidence that this was more than a random act in his movements about the cage. He did not notice the end of the chute and in no way did he seem to connect the chute with getting food. During his last trial he was quiet much of the time.

After his preliminary trials he saw No. 4 getting food at the end of the chute five times. He was confined in an observation box so that he could not follow No. 4 about. He did not get any food and he experienced the result in no way. However, when he was released in the cage his behavior was strikingly different from his behavior during any of his preliminary trials. He went almost directly to the place where he had seen No. 4 get food and within two-thirds of a minute he had gotten food for himself by doing essentially the same act No. 4 had done while he was watching her.

TABLE 3.

NO. 13 IMITATING NO. 4.

Date	Number of times No. 4 performed the act.	Number of times No. 13 saw.	Number of times No. 13 saw in part.	Result.	Time in Seconds.
Aug. 29 . . . . .	5	4	1	S	40

*D. Behavior of No. 4.*

First trial. No. 4 spent her time on the floor and the sides of the cage. She was fairly active. After four minutes of random movements about the cage, she hung by her tail and two feet to the front of the cage opposite the chute and swung her body around crane-like toward the chute, looking at it steadily. She then moved about the cage as if she had nothing to do; she either sat quietly or leisurely climbed the cage.

Second trial. No. 4 walked about on the floor; then climbed the wire and looked about. Once or twice she examined the cracks in the floor and in the door. She looked at the chute twice and looked out through the wire toward the window.

Third trial. During the third period No. 4 spent her time on the floor and in climbing the wire. Several times she pulled on the brace across the front of the cage and then remained quiet. She paid no attention to the chute during the entire time she was in the cage.

Fourth trial. On the fourth day No. 4 spent most of her time perched on the brace. She varied this by climbing up and down, catching roaches, and looking out through the wire and the window. She displayed no interest in the chute during the entire time she was in the cage.

Fifth trial. On the fifth day No. 4 spent her entire time on the floor, on the brace, and in climbing the wire. Most of the time she sat still, and when disturbed, simply changed her position and settled down again.

No. 4 paid most attention to the chute on her first day's trial. On the second day she gave it less attention, and on the third, fourth and fifth days none whatever.

*Imitation tests.*—No. 4 imitating No. 2.—The animals were put into the cage together. At first No. 2 was afraid of No. 4, who walked about the floor and climbed the wire at her will. As No. 2 would not work at the chute because of his fear, No. 4 was put into the observation box and the box was placed on the floor of the cage. No. 2 was still afraid and refused to work for some time. After twenty minutes, he leaped to the chute and pulled the string. No. 4 did not see him, but some of the food fell into her box and she ate it. Fifteen minutes later No. 2 jumped to the chute, but he did not pull the string. No. 4 saw him on the chute. Later No. 2 jumped to the chute, pulled the string and caught a seed on his chest. No. 4 saw him on the chute, but did not see him pull the string. The next time No. 4 saw nothing, but got food. No. 2 then became more frightened at No. 4 and refused to jump to the chute during the rest of the morning. Since No. 4 had not seen the entire performance once, she was not given an opportunity to get the food.

Second trial. This trial was made on the afternoon of the same day as the previous test. No. 2 was still much frightened and worked very slowly. The first time he pulled the string and got food, No. 4 was looking. He pulled the string again, but not hard enough to get food, and No. 4 saw him. No. 2 did the same thing again and No. 4 saw him. The fourth time No. 2 pulled the string he got food, but No. 4 did not see. In all, No.



4 saw No. 2 at the chute and pulling the string twice; once she saw him with food at the end of the chute, and twice she got food which fell into her box.

No. 2 was now taken out and No. 4 was released from the observation box. She at once climbed the wire front opposite the chute. Then she leaned toward the chute as far as she could while still holding to the wire with one hand. She drew herself back and descended to the floor, went to the door and then to the wire end, climbed the end opposite the chute, threw her head, shoulders and arms toward the chute, catching the lower part of it in her hands. Then she let go the wire with her feet and tail and drew her body over to the chute, catching it by her feet and wrapping her tail around it. She then swung her head down under the chute and looked up into it, at the same time thrusting her hand up inside. She rattled the metal handhold against the side of the chute and in a moment pulled it. The food fell on her chest and on the floor. The interval was less than one minute, from the time No. 2 was taken from the cage. She then dropped to the floor, ate the food, and climbing the front of the cage, leaped to the chute again and repeated the act in two minutes. She repeated it again in three minutes, and again in five minutes from the time No. 2 was removed, in the meantime, eating all the food that fell to the floor. She repeated the act again in one minute and six times more within the next twelve minutes. In all she operated the mechanism eleven times in twenty minutes and ate all the food—about thirty sunflower seeds. She would now work the device as often as she got the food eaten.

Her manner of solving the problem was direct from the first, and, with one exception, without loss of time or motion.

*Summary of Behavior of No. 4 in Chute Experiment B.*

No. 4 was quite active during her first preliminary trials, but during the later ones she was more quiet and wholly indifferent to the presence of the chute. The conditions of her imitation test differed from the test of No. 13 in the fact that No. 4 herself ate some of the food that came from the chute when No. 2 pulled the string, whereas No. 13 had only seen without experiencing the result of the act. The behavior of No. 4 after being released in the cage was like that of No. 13, in that there was a marked change from the behavior of the preliminary trials. She went directly to the chute and performed the act she had witnessed, securing the same result.

TABLE 4.  
No. 4 IMITATING No. 2.

Date.	Number of times No. 2 performed the act.	Number of times No. 4 saw.	Number of times No. 4 saw in part	Result.	Time in Seconds.
July 29.....	3	0	1	No test.	
July 29.....	4	2	2	S	55
Totals....	7	2	3	S	55

*E. Behavior of No. 11.*

*Preliminary trials.* First trial, August 24. No. 11 was very active and very hungry when put into the cage. He moved about as follows:

Across the floor to the end; up the wire and down again; to the door and looked up at the chute; chewed and pushed at the door trying to get it open; to the front and to the end; up, and back to the floor; to the door; to the front and back to the door, where he was very vigorous in his efforts to get out; to the front; up to the brace and looked all about the chute; shook the cage; to the floor and to the end; looked out through the wire; up the cage and shook it vigorously; to the door and made frantic efforts to get it open; repeated this soon again; up to *X* and perched; to the floor and about; tried the door again and walked about the floor; tried the door again and walked about the floor; up to *X* and perched; to the floor and up to the wire front; shook the cage vigorously and returned to the floor; again made frantic efforts to open the door; up to *X* and sat on the brace; to the door and frantic to open it; to the end of the cage and up the wire; around to the front and reached one arm over to the chute and shook it; to the floor and about; again climbed the front of the cage and reached to the chute; to *X* and perched.

Second trial, August 25. Behavior as follows: Up to the brace and down; repeated; while on the wire looked at the chute; shook the cage; to the end of the cage and down to the floor; looked all about; up the front and shook the cage with great vigor; down to the floor and searched about for food; up the front and shook the cage again; perched on the brace and surveyed the chute carefully for some time; perched at *X*; to the floor and sat near the end; to the front and sat looking out through the wire; to the door and tried to open it; up the front and perched at *X*; carefully surveyed the inside of the cage and looked out through the wire; looked squarely at the chute; up the front and shook the cage vigorously; back to *X* and sat for some time; to the floor and about.

Third trial, August 26. It was past feeding time and the animal was abnormally hungry. He was, therefore, fed on entering the cage, but not enough to satisfy him and he went about the cage as usual looking for food. His movements were as follows: Up the front of the cage and along the brace to the end and down to the floor; from underneath the chute he looked up at it steadily and then climbed the end to *X* where he perched and looked about the cage; shook the cage vigorously and perched again; to the floor and tried to open the door; looked toward the chute and then climbed the end of the cage to *X*; along the brace; back to *X* and to the floor; up to *X* and down the end of the cage again to the floor; sat under the chute; jumped to wire front and ran along the brace to *X*; to the floor; picked up some hulls and smelled them; repeated this several times.

Fourth trial, August 27. No. 11 behaved as follows: Up the end and down to the floor; about the floor and up the front to *X*, where he perched; to the floor and back; to the floor and sat, looking out through the wires; up the front and shook the cage; to the floor and sat at the end of the floor

of the cage; walked about the floor and climbed the front of the cage; to the floor and sat near the end of the cage; crossed the floor to the door and climbed the front wire; along the brace to X, where he perched; to the floor and looked about; to the door and up the front to X; down to the floor, where he sat looking out at the end wire; very alert, but the chute apparently had no interest for him; to the door and pushed, in an effort to get out; he had been very eager to get into the cage, but was now just as eager to get out.

Fifth trial, August 28. The behavior of No. 11 on this day was evidence that he did not expect to find food in the cage. Most of his efforts seemed to be directed toward getting out of the cage. There was no reason for his desiring to leave the cage other than the lack of interest on the inside and his desire to be back in the cage with his mate. He was not in the least frightened. His behavior was as follows: Up the end of the cage and down to the floor; up the front and down to the door; about the floor and to the top of the wire front; around to the top and down to X, where he sat for some time, uttering a cooing call; after a short time, to the floor and about; sat down near the wire end for a time; up the front and shook the cage; to X and perched; to the floor and grabbed the front wire, shaking the cage very vigorously; up to X and perched for some time; down to the floor and back up to X; along the brace and back to X, where he stayed during the remainder of the time.

*Imitation tests.*—No. 11 imitating No. 4. First test. No. 11 was placed in the observation-box, which was then placed on the floor of the cage; No. 4 was free in the cage. No. 11's record in seeing was:

Performance 1. No. 11 was distracted; saw No. 4 on the chute, but did not see the pulling of the string. He saw her eat the food on the floor.

P. 2. No. 11 saw No. 4 on the chute; saw her swinging at the end; saw her pull the string and get the food.

P. 3. No. 11 saw No. 4 leap to the chute, swing down, pull the string, and get the food.

P. 4. No. 11 saw No. 4 on the chute; saw her swing down and get the food; he jumped at the side of his box in an effort to get out.

No. 4 now spent some time on the floor getting food and No. 11 watched her attentively passing from one end to the other of his box as No. 4 walked about. Several times he jumped at her striking the side of his box; when she climbed upon his box he became very threatening.

P. 5. With his eyes No. 11 followed No. 4 about the floor and up over his box to the chute. During the pulling of the string his eyes were riveted on her. She dropped one seed in his box and he ate it.

P. 6. Same as P. 5, except that No. 11 did not get food. No. 11 was very threatening toward No. 4.

No. 4 was now removed and No. 11 was released in the cage. His first movement was to work at the door in an effort to get out of the cage. He then went up to the brace, leaned over to the chute and placing one hand on the side of it, attempted to pull it toward him; he then grabbed the edge of the lower end of the chute in his hand and pulled. Letting go of the chute

he went to X, where he perched for some time. Going to the floor he walked about and then looked up at the chute; he tried to jump to it from the floor, but, though he touched the rung with his hand, he was not able to hold. He then walked about the floor and climbed the front of the cage, walked along the brace and leaning over to the chute, pulled it as before. Going to the floor, he tried to climb the corner post near the chute. Failing in this, he jumped to the chute from the floor, holding with both hands. Pulling himself up to the chute, he bit the rungs and then worked his way around the chute biting at all the edges, but not turning his head down to the end of the chute. Leaping to the front of the cage, he descended to the floor and walked about. Once again he jumped for the chute, but failed to hold on. He then walked about the cage and climbed to X, where he perched for the remainder of the time.

Second test. Conditions were the same as in the preceding test. The record of No. 11's seeing was as follows:

Performance 1. No. 11 was looking at the experimenter and did not see.

P. 2. No. 11 saw, though his attention was divided between the experimenter and No. 4.

P. 3 to P. 5. No. 11 saw fairly well, but did not threaten as on the day before.

P. 6. No. 11 saw perfectly.

No. 4 was now removed and No. 11 was released in the cage. He found a seed on the floor and ate it. He jumped to the chute from the floor, but could not hold. Sitting down beneath the chute he looked up at it and then walked about the floor looking for food. He climbed to X, but returned to the floor after a minute, going to the door, where he tried to get out. Failing to open it, he went to the wire end of the cage and sat on the floor. He tried the door again and then climbed to X, but after one minute came to the floor and sat down. Turning toward the chute, he jumped for it, and catching hold, drew himself up to the chute. For some time he sat on the rung; then he bit his way around the chute. He then shook the chute so hard that the iron attached to the string on the inside rattled. He was then quiet, looking about the cage and at the sides and edges of the chute. Twice more he shook the chute with such vigor that he all but tore it from its fastening at the top of the cage. Becoming quiet, he sat for a moment and then leaped to the front of the cage. He went to X and perched for a moment; he then went to the floor and sat near the wire end of the cage. Time: 25 minutes.

Third test. No. 13 had by this time learned to get food and he was used as the imitator since, in size and general behavior he was much more like No. 11 than was No. 4. No. 11 was put into the observation-box and the box was placed on the floor of the cage. No. 13 was not at first inclined to work, but moved all about the cage. He finally went to the chute and hunted along the top of the cage for roaches. Several times he jumped from the wire side of the cage to the chute and back to the wire.

Performance 1. At last he went to the chute slowly and pulled the string, getting food. No. 11 saw every movement perfectly. No. 13 was suffering from a fall he had gotten a short time before when fighting with No. 10.

He seemed afraid of No. 11. When he would work no more, he was taken out and No. 4 was substituted.

No. 4 operated the chute eleven times. Nine of these performances No. 11 saw. He was alert and every muscle was tense.

In all, No. 11 had seen ten times during this test and a total of twenty times in the three tests.

No. 4 was now removed and No. 11 was released in the cage. He first looked over the floor for food and finding none, climbed the wire front and went over to the chute, shaking it with such vigor that he almost tore it loose from the top of the cage. Jumping back to the brace he went to X and to the floor. Passing to a position immediately under the chute he jumped up to it from the floor and climbed up on it. Without stopping to make examination he swung his body down, held to the rung with one hand, placed his feet against the back of the cage for support and, thrusting the other hand up inside the chute, pulled the string. The food fell onto his chest and on the floor. The time, from the removal of No. 4, was 60 seconds.

Having eaten the food, he again jumped to the chute and in the same position tried to pull the string, but not being able to hold his weight with one hand he had to catch with both; he then pulled himself up on the chute, and having regained his equilibrium swung down and got food as before.

Again he jumped to the chute from the floor, catching the rung in one hand and curling up so as to grasp the rung with his feet also. Then holding by his feet and one hand, he thrust the other hand into the chute as before and got food. He repeated this in exactly the same way, at once. Again he repeated this in the same way, except that he placed his feet against the back of the cage instead of on the rungs of the chute. From this time on he got food as rapidly as he could eat it, most of the time hanging below the chute with his feet braced against the back of the cage.

*Summary of Behavior of No. 11 in Chute Experiment B.*

No. 11's preliminary trials were much like those of No. 13 and No. 4. They ended with No. 11 not having got food and with his being indifferent to the means of getting it. The stimulus-complex was the same as in the case of No. 4, *i. e.*, No. 11 saw No. 4 getting the food and experienced the result of her act himself. When he was released from the observation-box, his behavior was different from what it had been in the preliminary trials. However, it was not sufficiently like the behavior of No. 4 to bring the same result. His attention had been directed to the chute, but not to that part of it which would enable him to get food.

After his second observation his interest in the chute seemed increased, as evidenced by the great vigor with which he shook it. The third test seemed to direct his attention to the important part of the mechanism and he succeeded in getting food as No. 4 had done in his presence. The result, in the case of No. 11, differed from the result in each of the previous cases

in that No. 13 and No. 4 both repeated the act which they had seen *immediately*. No. 11, on the other hand, seemed to learn a part of the act at a time, and only after repeated opportunity to see it, did he learn fully to attend to the act as it was performed in his presence.

TABLE 5.  
No. 11 IMITATING No. 4.

Date.	Number of times No. 4 performed the act.	Number of times No. 11 saw.	Number of times No. 11 saw in part.	Result.	Time in minutes.
Aug. 28.....	6	5	1	F	10
Aug. 28.....	6	5		F	10
Aug. 29.....	12	10		S	1
Total.....	24	20	1	S	21

*F. Behavior of No. 6*

*Preliminary trials.*—First trial. The first few minutes were spent on the floor. After four minutes No. 6 climbed the cage front and reached to the chute with his hands. He repeated this a minute later. A minute later he looked at the chute from the floor, climbed the front of the cage and grabbed the lower edge of the chute in his hands. This he repeated once, and then spent the rest of the time on the floor of the cage.

Second trial. On the second day No. 6 climbed about the cage, then reached to the chute and put one hand slightly into the end of it. He gave no further attention to it and went to the floor. Later, he climbed the front and while holding with tail and feet to the wire reached to the chute, clasping a hand on each side of it about four inches from bottom. This he repeated after eight minutes, and once more before the close of the time.

Third trial. On the third day, No. 6 reached to the chute as on the previous day, after five minutes in the cage. Later, he reached to the chute and tried to get his hands and feet on it while holding to the wire with his tail.

Fourth trial. On the fourth day his only attention to the chute was to look at it once and to attempt to get to it as on the previous day while holding to the wire with his tail. Failing, he spent the rest of his time on the floor.

Fifth trial. On the fifth day No. 6 once climbed the wire and looked at the chute. Later, after running about the floor, he climbed the front of the cage and jumped to the chute to get a cockroach on the back of the cage. While there he explored the top of the cage and jumped back to the side. Once more he leaped to the chute, but he leaped back immediately. During the latter part of the time he remained quietly on the floor of the cage.

*Imitation tests.*—No. 6 imitating No. 2.—First test. No. 6 was put into the observation-box, which was set on the bottom of the experiment cage. No. 2 was free in the cage. No. 2 was interested in No. 6 and pretended fight. Once he ran up the wire, jumped to the chute and leaped to the wire again

at once. Then both animals pretended fight toward another animal which was making a noise behind a curtain.

Performance 1. No. 2 jumped to the chute and jumped back to the wire without pulling the string. No. 6 saw.

P. 2. No. 2 jumped to the chute and pulled the string. No. 6 saw No. 2 on the chute and saw food fall.

P. 3. No. 6 saw as before. An empty shell bounced into the box and No. 6 got it.

P. 4. No. 6 saw No. 2 on the chute, looked away, heard the sound of the trap door, looked back and saw No. 2 at the end of the chute and the food falling to the floor. No. 2 now jumped to the chute twice, but he did not pull the string. No. 6 saw him jump.

P. 5. No. 2 jumped to the chute, pulled the string and the food fell to the floor. No. 2 now jumped to the chute and jumped back to the wire. No. 6 saw nothing No. 2 did.

P. 6. No. 6 saw the entire performance.

No. 2 was now taken out. No. 6 was released from the observation-box. He climbed the cage at the front and reaching over to the chute pushed a hand up inside. He could not reach the string. This occurred only 30 seconds from time of release. He then went down to the floor.

Immediately, he climbed the wire opposite the chute, jumped to it, threw his head and shoulders down, reached up inside and pulled at the string, but, though he gave what seemed a strong pull, it was not sufficient to open the trap door. He raised his body up, but at once bent down again and looked up the chute. He then leaped to the floor. All this happened within two minutes from the time of his release from the observation-box.

Four minutes later he repeated the entire performance, and then dropped to the floor. Four minutes later he leaped to the chute, but did not go to the end of it. He explored the top of the cage instead, leaped back to the wire, and went down to the floor. He did not seem as vigorous as usual.

Three minutes later, he jumped to the chute and in attempting to get in position at the bottom of the chute, lost his hold and dropped to the floor.

This he repeated five minutes later. He held with one hand to the rungs on the chute and allowed his feet and body to hang below. Holding thus with one hand, he tried to put the other up the inside of the chute and being unable to hold himself longer dropped to the floor.

Five minutes later he jumped to the chute and pulled the string, but not hard enough to get the food.

Second test. Conditions were the same as in the previous test. No. 2 was now more active and worked rapidly.

Performance 1 to P. 2. No. 6 saw No. 2 jump to the chute, then looked away, heard the rattle at the chute and looked back to see No. 2 at the end of the chute and food falling to the floor.

Six times more No. 2 operated the chute. No. 6 saw the entire performance each time but one; this one he saw in part.

When No. 2 was out No. 6 found a grain of food on the floor of the cage and ate it. He then climbed the wire, jumped to the chute, and swing-

ing down to the end of the chute pulled the string, but failed to get food. Then he swung down to the floor. Time: one minute. He tried again immediately, but failed to hold and dropped to the floor. After six minutes he jumped to the chute, touched the string with his hand, but did not pull it.

Third test. Conditions were the same as in the previous test.

Performance 1. No. 6 was playing and saw only in part.

P. 2. No. 6 saw the entire performance, though not steadily.

P. 3. No. 6 saw the entire performance.

No. 6 now became angry at No. 2 and tried to get out of his box. No. 2 became frightened and ceased to work for some time. He lay stretched out on the floor and after repeated efforts to get him to work he was taken out, and No. 6 was released in the cage.

No. 6 immediately climbed the front of the cage, leaped across to the chute, swung with one hand to the rung, looked up the chute, pushed his other hand up, lost his grip and fell to the floor. He repeated this within two minutes. Twice again within two minutes he jumped to the chute. Then he jumped to the chute, hung by one hand and looked up inside. He looked at the chute often. He tried again to hang by one hand and look up the chute, but dropped to the floor. He later jumped to the chute twice and looked at the top of the cage.

Fourth test, No. 6 imitating No. 4. Same conditions as before, except that No. 4 was substituted for No. 2.

No. 4 got food fourteen times. No. 6 saw the entire performance five times; seven times he saw the performance in part.

After No. 4 was removed and No. 6 was released, the latter went at once to the front, climbed the wire, jumped to the chute, held by his right hand and touched the string. Then he changed to hold by his left hand and thrust his right hand up to touch the string. After this he dropped to the floor. He repeated this in less than two minutes, not changing hands while on the chute, however. Five minutes later he leaped to the chute, but did not swing down. He did not seem to "get the hang" of holding to the chute with his feet as some of the other animals did. He gave no further attention to the chute.

Fifth test. The conditions were the same as in the preceding test. No. 6's record in seeing No. 4 was:

Performance 1. No. 6 only saw food strike floor.

P. 2 to P. 10. No. 6 saw the entire performance.

P. 11. No. 6 saw in part.

P. 12. No. 6 saw the entire performance.

No. 4 was taken out and No. 6 was released. No. 6 found a seed on the floor and ate it. After two minutes, No. 6 jumped to the chute, but only examined a crack in the cage door. At the end of five minutes, No. 6 jumped to the chute and searched the inside of the chute with his hand, but he did not pull the string. He then took his leisure about the cage till the end of 10 minutes.



*Summary of Behavior of No. 6 in Chute Experiment B.*

No. 6 differed from each of the previously mentioned animals in his preliminary trials. He gave some attention to the end of the chute, on the second day, putting one hand into the end of it a short distance. On the later days, however, he ignored the end of the chute entirely. The stimulus-complex in the first test was the same as in the case of No. 13, namely, the sight of another animal performing an act and getting food thereby. The effect on No. 6 was evident, for within thirty seconds after being released in the cage he had repeated a part of the act he had seen; within a minute he had tried again and repeated the act in every particular, except in the amount of force with which he pulled. This difference, however, kept him from getting the food. Although he failed, he repeated the act entire or in part several times during the next few minutes.

After his second series of observations, he repeated the entire act again, but failed to exert sufficient strength to accomplish the result. During the succeeding tests he persisted in going to the chute, although he ceased to pull the string. He did not cease to investigate the inside of the chute with eyes and hands, although his only means of connecting the chute with food had been his observation of another animal getting food at the chute.

TABLE 6.

## No. 6 IMITATING No. 2.

Date.	Number of times No. 2 performed the act.	Number of times No. 6 saw.	Number of times No. 6 saw in part.	Result.	Time in minutes.
Aug. 5.....	5	2	3	S	2
Aug. 5.....	8	5	3	S	10
Aug. 5.....	3	2	1	S	18

## No. 6 IMITATING No. 4.

Aug. 6.....	14	5	7	S	10
Aug. 7.....	12	10	1	S	10
Total.....	41	24	15	S	50

*G. Behavior of No. 5.*

*Preliminary trials.—First trial, July 30.*—Within one minute after entering the cage, No. 5 had climbed to the chute and had found the string with her hand. She was able to reach the chute from the side of the cage by help of her long legs and tail, which supported her while she grasped the chute in her hands. Later she reached the chute from the end of the cage. Then she swung to it from the side and looked up at the end. She then tried to use her foot to pull the string, and failing, climbed up the chute and examined the top of the cage. Then she braced her feet against the

corner post and pushed the chute with her hands. She was taken with sneezing and, descending, rubbed her nose on the floor. Her time was up soon after this.

Second trial, July 31. On the second day No. 5 reached to the chute with her hands, put one hand up the inside and pulled at the string, but not hard enough to cause the food to drop. Five minutes later she did the same except that she did not pull the string. After the next five minutes she climbed up on the chute and examined the top of the cage. Then she swung her head and shoulders down, touched the string with her hand and dropped to the floor.

Third trial, July 31. On the third day No. 5 was quiet about the cage as if nothing interesting were present. She spent most of her time on the floor.

Fourth trial, August 1. No. 5 ran up and down the wire several times. Then she surveyed the chute and the whole top of the cage from below. She climbed to the chute and examined the top and back of the cage. Then she remained quietly on the floor for ten minutes, after which she looked up at the chute, climbed the cage, reached the chute and struck at the string several times with her hand.

Fifth trial, August 1. At the fifth trial No. 5 was indifferent in the cage for five minutes. Then she climbed to the chute, examined the top of the cage, threw her head down, reached to the string and played with it but did not pull it. Later she jumped to the chute again and examined the back of the cage. The remainder of the time she spent on the floor.

*Imitation tests.*—No. 5 imitating No. 2.—First test. No. 2 and No. 5 were put into the cage together. After a little time No. 2 jumped to the chute. No. 5 climbed the wire opposite the chute, leaned over, put her hand up the inside and touched the string, but did not pull it. No. 5 then went to the floor and No. 2 pulled the string. Two seeds fell to the floor and No. 5 got them. No. 5 did not see the string pulled. The second time No. 2 pulled the string, No. 5 did not see. She heard the seeds drop to the floor and got them, jumping down from the wire front ahead of No. 2. The third time, No. 5 heard No. 2 at the chute and looked up just in time to see him pull the string and to see the seeds fall. No. 5 then went up the wire, jumped to the chute, and tried to pull the string, but did not pull hard enough to get food. No. 2 then became excited and refused to work.

Second test. No. 5 was put into the observation-box and the box was set on the floor of the cage. No. 2 was put into the cage and at once went to work.

Performance 1 to P. 5. No. 5 saw No. 2 on the chute and saw the food drop. She did not see him pull the string.

P. 6. She saw the entire performance.

P. 7. She saw it in part.

When No. 2 was out No. 5 was released. She climbed the front of the cage and leaning over to the chute tried to put one hand up the inside, but could not do it. Time: 50 seconds. She went down to the floor and at once climbed the wire again. She jumped to the chute, wrapped her tail around it, put her feet on the rung, threw head and shoulders down and

looked up inside the chute. She put her hand up and was in the midst of an interested examination when a sneeze from the side cage startled her and she dropped to the floor. Her examination was more direct and longer than at any previous time.

She climbed the cage, jumped to the chute and repeated the examination a minute later. Then she dropped to the floor and wandered about. Six minutes later she jumped to the chute, but only examined the top of the cage.

Third test. No. 5 was not attentive to No. 2. The latter got food seventeen times. Of these performances, No. 5 saw but five; six times she saw in part.

No. 2 was then removed and No. 5 was released from the observation-box. For a time she searched the floor and edges for food. After three minutes she climbed the wire, reached to the chute with her hands and tried to put one hand up the inside, but failed. Then she climbed down to the floor and sat in the corner.

Later she vomited grass which she had eaten out of her bedding and then went about the cage quietly. Her lack of activity was probably due to sickness of stomach.

Fourth test. The box containing No. 5 was fastened to the side of the cage on a level with the lower part of the chute. No. 4 was used instead of No. 2.

Performance 1 and P. 2. No. 5 saw all except No. 4's putting his hand up.

P. 3 and P. 5. No. 5 saw entire performance.

P. 4. No. 5 saw nothing.

P. 6 and P. 7. No. 5 was not interested in No. 4 on the chute; she bowed her head and slept while No. 4 got food.

P. 8 to P. 10. No. 5 saw the entire performance.

No. 4 was now taken out and No. 5 was released from the observation-box. She went at once to the front, climbed the wire, reached to the chute, put one hand up and pulled, but not hard enough to get food. No. 5 was somewhat frightened by the demonstrations of anger which No. 4 made when she was taken out of the cage. No. 5 gave no further attention to the chute during the ten minutes.

Fifth test. No. 5 was put into a box on the floor where she could see No. 2 at the chute. Her record in seeing No. 2 pull the string was as follows:

Performance 1. No. 5 saw nothing.

P. 2. No. 5 saw entire performance.

P. 3 and P. 4. No. 5 saw in part.

Here the apparatus gave some trouble and the test was delayed.

P. 5. No. 5 did not see.

P. 6 and P. 7. No. 5 saw the entire performance.

P. 8 and P. 9. No. 5 did not see the pull; saw food strike floor.

P. 10 and P. 11. No. 5 saw perfectly.

No. 2 was taken out and No. 5 was released. Immediately she climbed to the chute and pulled the string, but not hard enough to get food. Time: 40 seconds. A minute later she threw her head down and looked up the inside

of chute. Later she climbed to the chute, but paid no attention to it. Nor did she pay any more attention to it during the entire time in the cage.

Sixth test. The conditions were the same as in the previous test, except that the string in the chute was lengthened four cm. Of seventeen performances No. 5 saw five completely, six in part, and six not at all. Toward the end of the time she seemed sleepy and paid but little attention.

When No. 2 was out and No. 5 was released she at once climbed to the chute and took a long, steady look up the inside of it, but did not put her hand up. Time: 40 seconds. She then took her leisure about the cage, caught a roach and perched on the brace.

*Summary of Behavior of No. 5 in Chute Experiment B.*

No. 5 did not present the same problem in the imitation tests as the animals previously discussed. She had already performed every part of the act necessary to get food. She had evidently failed because of not exerting sufficient strength. Her interest in the chute seemed to wane in the fourth and fifth preliminary trials and to be accentuated after observing No. 2 in the first and second tests. During the later tests she repeated the act of the animal seen, but she never got the food, and in the fifth test she merely looked up the inside of the chute without putting her hand in.

It seems fair to infer that the increase of interest manifested in the first and second tests and the continuation of interest in the chute through the successive tests was due to No. 5 seeing the other animals getting food at the end of the chute.

TABLE 7.

No. 5 IMITATING No. 2. No. 5 IMITATING No. 4.

Date.	Number of times No. 2 performed the act.	Number of times No. 5 saw.	Number of times No. 5 saw in part.	Result.	Time in minutes.
Aug. 4.....	3	1	0	F	
Aug. 5.....	7	1	6	S	10
Aug. 5.....	17	5	6	S	10
Aug. 6.....	10	5	2	S	10
Aug. 7.....	11	5	2	S	10
Aug. 7.....	17	5	6	S	10
Totals....	65	22	22	S	50

*H. Behavior of No. 3.*

*Preliminary trials.*—First trial. No. 3 moved about slowly in the cage during the entire fifteen minutes, but gave no attention to the device for getting food. He spent his time on the floor and the wire parts of the cage.

Second trial. No. 3 spent the first few minutes on the floor and then climbed the wire and came back to the floor several times. Once when on

the wire front he looked steadily at the chute. Then he climbed about the cage and played on the floor. Once again he took a direct look at the chute from the front of the cage and then played about on the floor.

Third trial. On the third day No. 3 climbed the wire and played on the floor, but paid no attention to the chute.

Fourth trial. On the fourth day he climbed the wire and then spent his time on the floor, going from one corner to another and crouching with his face toward the center of the cage. Occasionally he surveyed the top of the cage. Then he climbed to the brace (across front of cage) and perched. Later he went to sleep on the floor in the corner. Then he climbed the cage and looked about, but took no notice of the chute during the fifteen minutes.

Fifth trial. On the fifth day he remained on the floor for a minute and then climbed the wire. He then sat in the corner of the cage for five minutes before he climbed the wire again. Then he went to rest in another corner. No attention to the chute.

*Imitation tests.*—No. 3 imitating No. 2.—First test. No. 2 and No. 3 were put into the cage together. No. 3 was attentive to No. 2 from the first, partly in order to escape punishment. Each time No. 2 pulled the string, No. 3 got food, and when he got a grain of sunflower seed the second time, No. 2 punished him. No. 3 cried and saw only in part the next time. Three times he saw the whole performance from the floor at different angles and twice from the front of the cage on a level with the chute.

After No. 2 had been taken out No. 3 busied himself on the floor for a few minutes picking over the hulls No. 2 had left. Then he surveyed the chute from the four corners (on the floor) of the cage. Once he climbed the front wire and looked at the chute from its own level. Then he went to the floor and rested in the corner of the cage.

Second test. Conditions were the same as in the previous test. No. 3 was again afraid of No. 2 after the second drop of food. He saw the first two times perfectly from the floor, but missed the third because of his fear of No. 2. The next three times he saw the entire performance from the floor.

With No. 2 out No. 3 went hunting among the empty hulls as before. Then he looked upward toward the chute several times from different positions on the floor. Later he climbed the front of the cage opposite the chute and looked back over his shoulders at it. Then he went down to the floor and remained there.

Third test. Conditions were the same as in the preceding tests. No. 3 was attentive to every move of No. 2 and saw him jump to the chute and pull the string each time but one. He did not get food, however, because of his fear of punishment. At the seventh time, No. 3 got food. Although No. 3 looked steadily at No. 2 when he pulled, it was difficult for him to see No. 2's hand go up the chute because No. 2's body often got in the way.

The first five minutes after No. 2 was out No. 3 was on the floor hunting over hulls dropped by No. 2 and fingering the cracks in the floor. Several

times he looked up at the chute. Then he climbed the cage wire, but did not look at the chute. Later, when under the chute, he looked at it steadily and then started for the front as if to climb, but was turned away by seeing a hull on the floor.

Fourth test. The conditions were the same as in the preceding tests. No. 2 got food fourteen times. Ten of these performances No. 3 saw completely; the other four he saw in part. He kept away from No. 2 because No. 2 slapped him.

When No. 2 was out No. 3 spent his time on the floor hunting over empty hulls and paid absolutely no attention to the chute during the entire time. No. 3 was so little influenced by seeing No. 2 obtain food that it seemed useless to continue the tests longer. They were, therefore, discontinued.

*Summary of Behavior of No. 3 in Chute Experiment B.*

No. 3 was not nearly so active in the preliminary trials as the animals previously discussed. In the imitation tests he seemed to see what was done. What he saw, however, did not seem to influence his behavior in any way unless it was to increase his looking at the chute. He failed to make any effort to get the food for himself.

TABLE 8.

NO. 3 IMITATING NO. 2.

Date.	Number of times No. 2 performed the act.	Number of times No. 3 saw.	Number of times No. 3 saw in part.	Result.	Time in minutes.
Aug. 3.....	8	5	4	F	10
Aug. 3.....	6	5		F	10
Aug. 3.....	11	10		F	10
Aug. 5.....	14	10	4	F	10
Total.....	39	30	8	F	40

*General Summary of Results of Chute Experiment A and Chute Experiment B.*

Taking Chute Experiment B as a whole, we have to consider six animals, no two of which exhibited exactly the same behavior. In the cases of No. 13, No. 4, No. 11 and No. 6, there is a similarity in that each animal showed a *decided change of behavior after witnessing another animal get food from the chute*. Each of these animals repeated with more or less exactness of detail the act which it had seen the other animal perform. Without meaning to imply

anything as to the mental processes accompanying it, I shall call such behavior *imitation*. As I shall use it in this paper, the word imitation is a conceptual short cut to describe a complex form of behavior. It always implies these things: (a) The animal which imitates observes an act of another animal; (b) More or less directly thereafter its behavior is modified in the direction of the act observed; (c) This modification is usually sudden; (d) The behavior is changed to a considerable degree and, when wholly successful, to an exact copy of the act observed. In every case of behavior which I shall call imitative, the animal had abundant opportunity to learn the act by himself so that his repeating the act of the imitatee was apparently due to his observation of that animal performing.

In the case of No. 3 and in the case of No. 1 in Chute Experiment A, there was almost no evidence that the act of the performing animal influenced the animal which saw.

The case of No. 5 is unique. Before seeing another animal perform the act, she had herself done every part of the act necessary to get food. The only way in which she could have been influenced was by being stimulated to exert more force on the pull or by being stimulated to a repetition of the act. She was not influenced in the first way, but the regularity with which she went to the chute after seeing the other animal get food, suggests that she was influenced in the second way. In her habits, she was much like No. 4 and No. 6, and the clear evidence for imitation in the conduct of each of these animals furnishes some ground for a similar interpretation of the behavior of No. 5. However, the evidence on the point is not conclusive and remains rather a conviction in the mind of the experimenter than an established fact.

TABLE 9.

## RESULTS OF CHUTE EXPERIMENT A AND CHUTE EXPERIMENT B.

## I.

Number of animals used.....	7
Cases of successful imitation.....	3
Cases of partially successful imitation.....	2
Cases of failure to imitate.....	2

TABLE 9. (Continued.)

## RESULTS OF CHUTE EXPERIMENT A AND CHUTE EXPERIMENT B.

## II.

Cases of imitation when the imitator was confined during the activity of the imitatee.....	5
Cases of imitation when both animals were together in the cage.....	0

## III.

Cases of immediate imitation.....	4
Cases of gradual imitation.....	1

## IV.

Cases of imitation in which the imitating animal <i>did not</i> himself experience the result of the act before performing.....	3
Cases of imitation in which the imitating animal <i>did</i> experience the result of the act before performing it.....	2

## 3. ROPE EXPERIMENT.

*A. Description of Device.*

For this experiment a hole 5 cm. square was cut in board *D*, 26 cm. from the top of the cage, fig. 5. A door was hinged to one side and opened outward. It was cut so as to fit snugly and when closed was flush with the inside of the board. The only evidence of an opening was the sharp line around the square where the door fitted the board. Before this door, and 27 cm. from it, an inch rope, *b*, hung from a screw eye in the top of the cage to the floor.

In order to get food the animal must climb the rope and, while supporting himself on the rope, push the door open, reach through it and get the food on the outside of the cage. The food was supplied by means of a two-inch leatherette belt connected with the experimenter's table, which stood four feet from the cage. This convenience, together with a string by which the door could be closed after the animal had opened it, made it possible to manage the entire apparatus from the experimenter's table.

There was nothing on the inside of the cage to denote the food on the outside.

*B. Behavior of No. 2.*

*Preliminary trials.*—The following preliminary observations were made in the old cage at the Harvard Laboratory. Each trial lasted 30 minutes.

First trial. At first No. 2 walked about the floor and climbed the front of the cage. He then went about the cage, and once, in passing, touched the rope with his hand. Again he touched it as he went about the cage. He was very active and ran about the cage very rapidly, but made no effort to climb the rope.



Second trial. On the second day the experiment was disturbed by No. 2 getting out of the cage. During the time he was in the cage he made no effort to climb the rope.

Third trial. On the third day he went rapidly about the cage as on the first day. Once, in passing, he picked up the end of the rope. During the thirty minutes, however, he made no effort to climb it.

Fourth trial. On the fourth day No. 2 was quite active and kept moving during the entire thirty minutes, passing over every bit of floor space many times and being repeatedly on every part of the front and end of the cage. He noticed the rope only to touch it momentarily in passing.

Fifth trial. On the fifth day No. 2 was active and eager to get out of the cage. Once he grabbed the rope in his tail and ran up the front of the cage. Later he bit the end of the rope once.

Sixth trial. On the sixth day he was very wild, possibly due to the death of his mate the day before. He made no effort to climb the rope.

Seventh trial. On the seventh day No. 2 behaved as usual. His only notice of the rope was to push it aside in passing.

Eighth trial. No. 2 behaved as usual. Once he stood on his feet and grasped the rope with his hands one above the other as if to climb.

Ninth trial. On this day No. 2 grasped the rope once in the same manner as on the previous day, but let go of it at once. He repeated this several times, but showed no other intention of climbing. He did not look up when holding the rope.

Tenth trial. On the tenth day he went about the cage in his usual way. Once or twice he hooked his tail around the rope and ran up the front of the cage, dropping the rope when half way up.

Eleventh trial. On the eleventh and twelfth days he went about the cage as usual and displayed no interest in the rope.

*Imitation tests.*—No. 2 imitating No. 3.—These tests were made in New York. Both animals were in the cage together.

First test. No. 3 got food twelve times. Ten times No. 2 saw him eating the food and once saw the entire performance. Twice when watching No. 3 eat while on the rope, No. 2 climbed the front wire and leaned toward the rope as if trying to get to the door. During the rest of the time No. 2 was distracted by the other monkeys in the living cages nearby.

Second test. No. 3 was very active and climbed the rope often and rapidly. No. 2 was not accustomed to watch No. 3 and did not look at him, but tried to see out the window and into the other cages. Four times when No. 2 saw No. 3 on the rope he leaned out from the side of the cage toward the rope. Once when No. 3 pushed the rope toward the front of the cage No. 2 caught it in his hands and swung his weight on his hands, but held on to the wire with his feet and tail. Several times when No. 3 was up the rope No. 2 caught the end of it from the floor. No. 2 saw five times in fourteen. When No. 3 was taken out after performing the trick fourteen times, No. 2 tried to climb the post in the corner next to the rope and got two feet from the floor by the help of small sticks nailed to the post. Then he stood on the floor and grasped the rope in

both hands as if to climb, but although he looked up, he did not lift himself from the floor. He tried to climb the post again as before, but when he failed he did not turn to the rope at once; he did, however, a moment later. During the last five minutes of the fifteen he remained in the cage after No. 3 was out, he sat in the corner near the rope, part of the time holding it in his hands.

Third test. No. 2 was more or less distracted by other monkeys in the room and not being very hungry did not observe No. 3 closely. He saw the whole act five times in twelve. He did not watch from first to last. It was counted if he saw No. 3 climb the rope and also get the food, even though his attention was not continuous. In no case, however, did No. 2 watch No. 3 continuously from the time he left the floor until he got the food. No. 2 saw by glances only. Three times he swung out from the wire front and twice he tried to climb the post as in the previous test.

When No. 3 was taken out No. 2 ran about the cage. He grasped the end of the rope when on the floor. He looked up at the door and tried to climb the post. Then he grasped the rope with one hand above the other as if to climb. Dropping the rope he turned to the post, then back to the rope, grasping it in his hands and bearing part of his weight on it. It swung and he took a few steps. Again he grasped the rope and bit the end of it. Then he grasped it with two hands and one foot. Then he turned to the post and put his hands and one foot on it. Then on the other foot he turned as on a pivot and grasped the rope with the three members he had placed on the post. Then he ran to the front of the cage and back to the rope, grasping it again with two hands and one foot and bearing some weight on it, but not enough to lift the other foot from the ground. Then he grasped the rope in his hands and rushed to the wire to climb. This he repeated, wholly or in part, several times more in the next two minutes. He was then taken out twenty minutes after No. 3 had been removed.

Fourth test. When No. 2 and No. 3 came into the cage together No. 2 was very attentive to everything No. 3 did and looked often toward the food door. When No. 3 climbed the rope, No. 2 climbed the wire front of the cage on the first and second trials. When No. 3 pushed against the door with his hands his feet pushed the rope over toward No. 2, who was on the wire front of the cage. No. 2 was eager to grasp the rope and once did grasp it in his hands, but would not let go of the wire with his feet. When No. 3 got the food the rope swung back to a perpendicular position, and No. 2, holding with feet and tail to the wire, threw his body out toward the rope. He repeated this motion several times, and when No. 3 got food the third time No. 2 was able to grab it out of his hands. This he did on the fourth and fifth trials also. No. 3 was then removed and No. 2 became very active on the wire, throwing his body vigorously toward the rope, and failing to grasp it, he repeated the act at once. His motions increased and he seemed frantic to catch the rope. Finally he jumped, catching the rope and holding. At once he jumped back to the wire, and ran down to the floor; he quickly climbed the rope

twice and then jumped from the rope to the wire. Then he climbed the rope, opened the door by pushing on it with his teeth as No. 3 had done, and got food. Next he tried to climb the post in the corner, and then ran up the rope again and got the food. During the next ten minutes he climbed the rope twelve times, getting food most of the times.

*Summary of Behavior of No. 2 in the Rope Experiment.*

No. 2 during a long series of preliminary trials did not climb the rope nor pay any attention to it or to the food door. During the first imitation tests he was not attentive to No. 3, but gradually became so as he saw him getting food, and in the last test his attention was riveted on No. 3 during the whole of the time No. 3 was in the cage. His learning to do what No. 3 did was also a gradual process. When his attention was directed to the food door his first effort to get to it was by climbing the wire front of the cage. His next step was to learn to bear a portion of his weight on the rope. When he got food from No. 3 there was a noticeable increase in his apparent desire to get to the door. The stimulation seemed to increase steadily until finally it forced him to leap to the rope and back to the wire and then to climb the rope from the floor. Once on the rope, he repeated exactly the act of No. 3 and got food in the same way.

TABLE 10.

## NO. 2 IMITATING NO. 3.

Date.	Number of times No. 3 performed the act.	Number of times No. 2 saw.	Number of times No. 2 saw in part.	Result.	Time in minutes.
July 1.....	11	1	10	F	10
July 2.....	14	5	8	F	10
July 3.....	12	5	7	F	10
July 4.....	5	5		S	
Total.....	42	16	25	S	30

*C. Behavior of No. 4.*

*Preliminary trials.*—First trial. No. 4 spent the first few minutes on the floor picking over nut hulls. Then she became very active about the cage. She climbed the rope and investigated the top of the cage and the cracks between the boards. She spent the most of the remaining time on the floor.

Second trial. On the second day No. 4 spent most of the time on the floor swaying back and forth before the door. Nothing inside seemed to interest her and she wanted to get out. Twice she climbed the wire slowly, but paid no attention to the rope.

Third trial. On the third day No. 4 was not so active as usual and perched on the brace most of the time. She gave no attention to the rope.

Fourth trial. On the fourth day No. 4 behaved as usual, spending most of her time on the wire and brace. When on the floor she swayed back and forth before the wire and gave no attention to the rope.

Fifth trial. On the fifth day No. 4 spent most of her time in the corner of the cage farthest from the rope and gave no attention whatever to it.

*Imitation tests.—No. 4 imitating No. 2.*—First test. No. 4 was placed in the observation-box which was fastened to the front of the cage on a level with the food door.

No. 4 was on the floor of the observation-box. She was swaying as usual and this somewhat frightened No. 2, so that he climbed the rope only after three minutes and then jumped to the wire without getting food. This he repeated three times. Then he climbed the rope, tried the door, but failed to push it open. He jumped to the wire at once, after pushing. Then he climbed the rope and opened the door. No. 4 saw in part. No. 2 then tried the door four times unsuccessfully. Climbing the rope brought him close to No. 4 and his fear did not allow him to make a good effort. Then he climbed the rope and opened the door, getting food. No. 4 saw the entire performance.

No. 2 was then removed and No. 4 was released. She climbed the wire on the front of the cage and then on the end. Then she climbed the rope and reached to the hole in the top of the cage. She looked at the door, put her nose to it, and jumped to the front wire, and went to the floor. She then climbed up and down the front and climbed the rope looking at the door and jumping to the front of the cage. Again, she climbed the rope and looked all about the door more intently than before. She returned to the floor, climbed the end of the cage and perched on the brace at X. Again she climbed the rope, examined the top of it, and looked all about the door. Then she became interested in out of doors and soon her time was up.

Second test. No. 4 was in the box as before and No. 2 was somewhat slow and fearful. No. 4 saw five of No. 2's twelve performances completely; four other times she saw a part of the performance.

No. 2 was removed and No. 4 was released. She climbed the rope at once (5 seconds) and smelled and licked the door. Then she returned to the floor. She again climbed the rope and examined the top of it. She looked at the food door carefully, but after coming to the floor she gave no further attention to the rope or the door.

*No. 4 imitating No. 6.\**—Third test. No. 4 was in the box on the floor.

Performance 1. No. 6 climbed at once to the door, pushed it open with his hand and got food. No. 4 saw him smacking his lips when the food was gone, but saw nothing more.

P. 2. No. 4 saw No. 6 reach through the open door and get food, but saw nothing more.

In the sixteen following performances No. 4 saw the entire performance

\*The behavior of No. 6 will be given later, page 385.

twice; she saw No. 6 climb the rope three times, and eleven times she saw nothing.

No. 6 was removed and No. 4 was released. She at once climbed the rope and looked about the food door, but made no effort to open it. She examined the hole in the top and returned to the floor. She climbed the front of the cage and leaped to the rope. She looked at the door, put her palm against it and rubbed her hand over the door. She then fingered the crack around the door, but did not push the door open. She returned to the floor and worked about the edges of the floor for some time. She then climbed the rope, but gave no attention to the door. After a little more wandering she perched on the brace at X and remained quiet.

Fourth test. No. 4 was put in the observation-box on a level with the food door.

Performance 1. No. 4 saw the entire performance.

P. 2. No. 4 saw the entire performance. No. 6 hesitated to climb for fear of No. 4.

P. 3. No. 6 was slow at the door because of watching No. 4 and No. 4 saw perfectly every move.

P. 4 and P. 5. No. 4 saw all except the push on the door. She looked down just as No. 6 pushed.

P. 6 and P. 7. No. 4 saw perfectly.

No. 6 was removed and No. 4 was released; she ran up the rope and put her nose to the food door, but gave no push. She returned to the floor and climbed the wire end and front and examined the edge of the cage door. She spent the remainder of her time without attention to the door or the rope. Later she perched on the brace at X and "hunted fleas."

Fifth test. No. 4 was in the box on a level with the door. No. 6 climbed the rope and opened the door nine times. No. 4 saw every part of the performance five times; three times she saw in part.

When No. 4 was released she at once climbed the rope and looked at the food door. Then she jumped to the wire front and returned to the floor. She examined about the floor edges and climbed up and down the wire. Then she climbed the rope and passed her hand over the food door, but did not push with any force. She then looked at the top of the cage and leaped to the wire front. She perched on the brace at X for the last five minutes.

Sixth test. No. 4 was in the box on a level with the food door. No. 6 got food seventeen times. No. 4 saw the entire performance eight times; once she saw in part.

No. 6 was removed and No. 4 was released. She walked across the floor to the wire end and climbed half way up. Then she leisurely climbed down and walked over to the corner opposite the rope, turned to the rope and climbed it. She stopped exactly at the door, put her right hand against the upper edge of the door, her fingers striking the board above, and pushed. Failing to open the door, she put her left hand lower down on the door, her palm this time striking the board below the door. She pushed again, but failed to open the door, probably because more of the

force of her effort affected the board than the door. Then she changed back to the right hand and planted it squarely in the center of the door, neither her fingers nor palm touching the board. She gave a hard push and the door opened. Time: two minutes. She got the piece of food near the door and thrust her arm farther out and got the piece of banana on the place next below. Then she pushed the door open as fast as I closed it and got food three times. This she repeated ten times as rapidly as the device was reset.

Her hand when placed flat against the door reached from the top to the bottom and was almost as broad as the door. To open the door she must place her hand in the center of it, in order not to strike the edges of the board in some place.

*Summary of Behavior of No. 4 in the Rope Experiment.*

The problem as it came to No. 4 was different from the problem of No. 2. She did not need to learn to climb the rope. She did this as if it were a familiar act during her first few minutes in the cage. What she had to learn was to open the food door. Her own unaided efforts helped her not at all, and during the last four preliminary trials she kept entirely away from the rope. Her first observation of the imitator attracted her again to the rope and to the food door, but she did nothing except to nose about the door. Her second test again directed her attention to the door and possibly increased that attention. The third test augmented her attention to the door and she rubbed her palm over it and fingered the edges. After the fourth test her interest seemed to lag, but after the fifth her attention was as great as after the third. In both the third and fifth tests she used her hand at the proper place and in much the same manner as had the performing animal. The sixth test served to make

TABLE 11.

NO. 4 IMITATING NO. 2.

Date.	Number of times No. 2 performed the act.	Number of times No. 4 saw.	Number of times No. 4 saw in part.	Result.	Time in minutes.
Aug. 10.....	2	1	1	F	10
Aug. 10.....	12	5	4	F	10

NO. 4 IMITATING NO. 6.

Aug. 11.....	18	2	4	F	10
Aug. 11.....	7	5	2	F	10
Aug. 12.....	9	5	3	F	10
Aug. 12.....	17	8	1	S	2
Totals....	65	26	15	S	52

definite the imitative behavior. She repeatedly tried to do what she had seen done and finally succeeded. At no time, until she performed the act herself, did she experience the result of the act, the stimulus-complex being the other animal performing an act and getting food.

*D. Behavior of No. 6.*

*Preliminary trials.* First trial. No. 6 was very active climbing all about the wire and running about on the floor. He caught the rope in his hands and later in his tail. He climbed the rope and in attempting to jump from the rope to the front of the cage he put his foot against the food door and the door opened. He did not notice it, however, and it was closed before he saw what he had done. He climbed the rope several times after and took no notice of the door.

Second trial. On the second day No. 6 was very active on the wire and the rope, but took no notice of the door.

Third trial. On the third day No. 6 behaved as usual, climbing about the wire. He took no notice of the rope.

Fourth trial. On the fourth day No. 6 climbed the wire several times, each time carrying the rope up in his tail. Later he climbed the rope, swung back and forth on it, and after two or three oscillations he leaped to the wire front. He took no notice of the food door.

Fifth trial. On the fifth day he grasped the rope and ran in a circle on the floor. Then he swung on the end of the rope twice. Then he grasped the rope in his tail three feet from the floor and allowed his body to swing. He dropped to the floor and caught flies. He climbed the rope and examined the cracks in the top of the cage. During his entire time in the cage he took no notice of the food door.

*Imitation tests.—No. 6 imitating No. 2.*—No. 6 was put into the observation-box and the box was put on the floor of the cage.

Performance 1. No. 2 spent the first few minutes on the floor of the cage, on the box, and in climbing the wire. He climbed the rope, but came down without any attention to the food door. No. 6 saw No. 2 on the rope.

No. 2 again climbed the rope and worked at the door slightly, but did not open it. No. 6 saw all the movements of No. 2. No. 2 then became frightened at No. 6 and did not work.

P. 2. No. 6 saw No. 2 with the food, but nothing more.

P. 3. No. 2 now became angry and pretended to fight, hanging over the box by his tail and shrieking loudly. No. 6 on the inside of the box jumped and threatened. No. 2 retreated to the corner by the rope and shrieked. Suddenly No. 6 stopped jumping, put his head on one side and purred. No. 2 had done this just before and now repeated it. His fear was gone; he shot up the rope, opened the door and got food. As No. 2 climbed the rope No. 6 looked out through the wire, and when he turned again toward No. 2 the latter was eating his banana. At once No. 6 began to jump up and down in his box to show his anger. No. 2 was again frightened and for several minutes the shrieking was renewed.

P. 4. At once No. 2 jumped to the rope from the front of the cage, but came to the floor without opening the door. He then walked about on the floor for several minutes. Then he climbed the rope, gave one push on the door, but failed to open it. He soon climbed again, opened the door and got food. No. 6 saw him with the food and threatened him; No. 2 shrieked; No. 6 folded his arms; No. 2 lay down on the floor. No. 6 jumped up and down; No. 2 came near the box, and seemed to have no fear.

P. 5. No. 2 climbed the rope, opened the door and got food. No. 6 saw all.

P. 6 to P. 8. No. 2 did as in P. 4. No. 6 saw No. 2 on the rope and at the door, but did not see him open the door.

No. 2 then sat on the floor quietly for several minutes.

P. 9. No. 2 climbed the rope and opened the door, but did not get the food which had dropped off the belt. The food was replaced and No. 2 got it. No. 6 saw all but the opening of the door.

No. 2 was now removed and No. 6 was released in the cage. At once he climbed the rope, put his hand against the door, but failed to open it. He then swung down, hanging by his tail to the rope, and dropped to the floor. He then climbed the rope and examined a hole in the top of the cage. He came to the floor again. Again he climbed the rope and examined all about the door; pushed on the door, but did not open it; he bit at the edge of the door and again pushed on it, opening it. He got the food and descended the rope, immediately afterward climbing the wire.

When the device was reset No. 6 climbed the rope and examined the door with his teeth and fingers; he worked at the edge with his fingers. He then jumped to the wire and in so doing put his foot against the door pushing it slightly; he leaped back at once and pushed the door open with his hand, getting the food.

When the device was reset No. 6 tried to open the door with his fingers and after one effort leaped to the wire. Leaping back he tried to bite the edge of the door and then by a vigorous push with his hand forced it open and got food. The device was reset and No. 6 climbed the rope at once. Placing his palm flat against the door he opened it with the first effort. He repeated the act as soon as the device was ready to operate, and four times more within a few minutes.

In all No. 6 opened the door and got food nine times within sixteen minutes.

#### *Summary of Behavior of No. 6 in the Rope Experiment.*

No. 6, like No. 4, was free on the rope from the first. He became indifferent to it during the later trials and made no progress toward getting food. When he was placed in the observation-box to watch No. 2 he was very attentive to what No. 2 did and seemed quite excited by the conduct of the latter. He saw the entire performance once and in part three times. When he was released his behavior was markedly different from what it had been in the preliminary trials. His attention was directed to the proper place to get the food, and after a few random movements he succeeded in getting food for himself in a manner similar to that which he had seen.



TABLE 12.  
No. 6 IMITATING No. 2.

Date.	Number of times No. 2 performed the act.	Number of times No. 6 saw.	Number of times No. 6 saw in part.	Result.	Time in minutes.
July 3.....	9	1	3	S	5

*E. Behavior of No. 5.*

*Preliminary trials.*—First trial. No. 5 as usual was very active. She climbed the wire side and end of the cage. She climbed the rope and thrust her arm through a hole in the top of the cage. She then hung to the rope at the top of the cage and tried to see through all the cracks in the top. She did not notice the door.

Second trial. On the second day No. 5 behaved as before, going all about the cage, on the wire, up the rope, etc., but did not observe the door.

Third trial. On the third day No. 5 showed no interest in the rope, but spent her time going about the cage.

Fourth trial. No. 5 climbed the wire; returning to the floor, she pushed on the door where she had entered. Once she grasped the rope in passing. Later she climbed the rope, but displayed no notice of the food door.

Fifth trial. On the fifth day No. 5 was active on the floor, on the wire and at the entering door. She grasped the rope in her tail several times; three times she climbed it, but took no notice of the food door.

*Imitation tests.*—No. 5 imitating No. 2.—First test. Both animals were free in the cage.

Performance 1. No. 5 did not see.

P. 2. No. 5 saw No. 2 get food and climbed the rope after him.

P. 3. No. 5 saw the getting of food, but did not see the push on the door.

P. 4. No. 5 saw the entire performance from the brace at X.

P. 5. No. 5 saw in part.

P. 6. No. 5 saw from the front and opposite the rope.

P. 7. No. 5 saw the entire performance and climbed the rope before the door was closed.

P. 8. No. 5 saw the entire performance.

When No. 2 was taken out No. 5 climbed the rope at once and put her hand on the door. She then became interested in the top of the cage. Three minutes later she climbed the rope and put her nose to the food door, but she did not push on it. Two minutes later she repeated this performance. Between the two performances and afterwards she went about the cage, climbed the wire and roamed about the floor for food. Apparently she was very hungry.

Second test. No. 5 was put into the observation-box, which was set on the floor of the cage.

Performance 1 to P. 4. No. 5 saw No. 2 push the door open with his hand in his usual way.

P. 5 to P. 7. No. 5 did not see.

P. 8. No. 5 saw No. 2 at the door with the food and tried to get out of her box. This frightened No. 2 and he became quiet.

P. 9. No. 5 did not see No. 2 until he jumped back to the wire with food.

P. 10. No. 5 saw perfectly.

No. 2 was taken out and No. 5 was released. She walked about the floor and made some efforts to push her hand through the wire to get a paper and to reach the belt. Then she climbed the rope, stopped when half way up to spat a fly, climbed to a small hole above the food door and tried to see out. Then she went down to the floor, walked about and climbed the wire. She jumped to the rope, but took no notice of the door. This she repeated later. Then she went to the floor, became quiet and curled up to sleep.

Third test. No. 5 was put into the observation-box on a level with the upper part of the rope and the food door.

Performance 1 to P. 3. She saw perfectly.

P. 4. No. 5 saw nothing.

P. 5. No. 5 saw perfectly and jumped at the side of the box as if to get food.

P. 6. No. 5 saw in part.

P. 7. No. 5 saw perfectly.

No. 2 was removed and No. 5 was released. She ran up the rope, but took no notice of the food door. She examined the top of the cage with the eye and hand and returned to the floor. She then climbed the rope and examined the food door with her eyes and hand, but did not push on it. She then climbed the wire from the floor and returned to the floor and looked about. She crouched near the door and slept, curled up in a characteristic fashion of her own.

Fourth test. No. 5 was again put into a box on a level with the food door. No. 2 was free in the cage. He got food sixteen times. Five of these performances No. 5 saw completely; five other times she saw in part.

No. 2 was removed and No. 5 was released. No. 5 at once climbed the rope, but a noise frightened her and she jumped to the wire front at once. Then she climbed about the wire and walked about the floor. Next she climbed the rope and looked and smelled about the food door. She returned to the floor and crouched in one corner. Then she lay down and slept.

Fifth test. No. 5 was put into a box on a level with the food door. No. 6 was used instead of No. 2.

At no time did she seem interested in No. 6. Her seeing was accidental and passive. At times when she saw No. 6 going up the rope or at the door she would turn away to look at the floor of her box. No. 5 saw five of fourteen performances completely; five other times she saw in part.

No. 6 was then taken out and No. 5 was released. She spent the entire ten minutes on the floor and in climbing the wire parts of the cage without once going to the rope. At the end of ten minutes she climbed the rope and looked at a crack in the cage door and at a hole in the top of the cage. She took no notice of the food door while on the rope.

She climbed up and down the wire and perched at the brace until she was removed.

Sixth test. Both animals were free in the cage.

Performance 1. No. 6 pushed the door open and got food. No. 5 saw and jumped to the rope from the front of the cage.

P. 2. No. 5 again saw from the front of the cage and jumped to the rope. She put her hand against the door, but did not push.

P. 3 to P. 6. No. 5 saw only in part, the eating of food.

P. 7. No. 5 saw perfectly and started up the rope, but when the food door was closed she came down.

P. 8. No. 5 saw and climbed to the food door, but did not push.

P. 9. No. 5 saw perfectly.

P. 10. No. 5 saw, climbed to the food door and looked through before it was closed.

P. 11. No. 5 saw and jumped to the rope while No. 6 was still getting food. Before the door could be closed she had her nose at the opening and was looking out. When it was closed she immediately pushed it open. In pushing she put her palm squarely against the door.

There was a marked difference between the behavior of No. 5 at this time and her previous conduct. Before, as noted, she had not been interested. Now she became interested and No. 6's movements directed her attention at once to the food door and kept it there almost all the time until she had learned.

After her first effort she could do the trick perfectly, and she repeated it six times within a few minutes.

TABLE 13.

No. 5 IMITATING NO. 2. NO. 5 IMITATING NO. 6.

Date.	Number of times No. 2 performed the act.	Number of times No. 5 saw.	Number of times No. 5 saw in part.	Result.	Time in minutes.
Aug. 10.....	8	5	2	F	10
Aug. 10.....	8	5	1	F	10
Aug. 10.....	7	5	1	F	10
Aug. 12.....	16	5	5	F	10

No. 5 IMITATING NO. 6.					
Date.	Number of times No. 2 performed the act.	Number of times No. 5 saw.	Number of times No. 5 saw in part.	Result.	Time in minutes.
Aug. 13.....	14	5	5	F	10
Aug. 13.....	11	7	4	S	While No. 6 was present.
Total.....	64	32	18	S	55

*Summary of Behavior of No. 5 in the Rope Experiment.*

Like No. 4 and No. 6, No. 5 had to learn to open the door only. In the first test her attention was directed to the door; she went to it, nosed about it and put her hand on the door. The second test did not add anything to her learning, but in the third test she repeated her behavior of the first test. The fifth test added nothing to her ability, but in the sixth, when she was free in the cage with No. 6, his conduct directed her attention to the food door and kept it there until she had learned to get food. At no time did she get food for herself in connection with the performance of No. 6, and the stimulus was never more than No. 6 performing an act and getting the result.

*General Summary of the Results of the Rope Experiment.*

Considering together the four animals used in the Rope Experiment we may note a similarity in the general behavior. First, no animal failed to learn. Second, in the preliminary trials there was a total indifference to the food door and either total or increasing inattention to the rope. Third, without exception, the first imitation test served to direct attention to the door and to the rope. In the case of No. 6, imitation was complete in the first test. Fourth, in the cases in which imitation was not complete in the first test, the successive tests augmented the imitator's attention and in no case were more than six tests needed to perfect the learning process.

Here, as in the chute experiments, we have attentive watching on the part of the imitating animals, followed by an abrupt and radical modification of behavior in the direction of the act observed. This is imitation as we have defined it.

TABLE 14.

## RESULTS OF THE ROPE EXPERIMENT.

I.	
Number of animals used.....	4
Cases of successful imitation .....	4
Cases of partially successful imitation.....	0
Cases of failure.....	0
II.	
Cases of imitation when the imitator was confined during the activity of the imitatee .....	2
Cases of imitation when the two animals were in the cage together.....	2

## III.

Cases of immediate imitation.....	1
Cases of gradual imitation.....	3

## IV.

Cases of imitation in which the imitating animal <i>did not</i> himself experience the result of the act before performing it.....	3
Cases of imitation in which the imitating animal <i>did</i> experience the result of the act before performing it.....	1

## 4. PAPER EXPERIMENT.

*A. Description of Device.*

For this experiment board *E* was used. An opening 17 cm. square was cut, the lower edge 30 cm. from the floor of the cage. The opening was covered on the outside by a hinge door. In the center of this door a hole 5 cm. in diameter was cut and on the outside of the door, just at the lower edge of the circular opening was fastened a food box. With the door open, a sheet of ordinary writing paper was laid over the opening and the door was then closed upon it. The hole in the door and the food in the box were thus hidden by the paper (fig. 6).

The animal could get food by breaking the paper and reaching through the circular hole. On the inside of board *E* was a wooden screen which, when dropped down, covered the whole device. When the paper and food were in place, and the animal or animals in the cage, this screen could be lifted by the experimenter by means of a string. When an animal had broken the paper, the screen was lowered by the experimenter and a new piece of paper was inserted. Then the screen was lifted and all was ready for a second test.

*B. Behavior of No. 2.*

On five different days, from April 6 to April 10, No. 2 was in the cage alone for thirty minutes each day. He did not get food from the box and made but little investigation of the paper. The most he did toward getting food was on April 7th, when he went to the paper, put his hands on the lower edge of the opening and bit at the paper, but did not tear it through.

On April 21, in order to help No. 2 to learn, the experimenter punched a hole in the paper with the point of a lead pencil and the monkey thrust one finger through and tore a larger hole. This was repeated a number of times and No. 2 learned to tear the paper by biting when no opening was made. On April 22 he got food in this way ten times in seven or eight minutes.

*C. Behavior of No. 3.*

*Preliminary trials.*—No. 3 was given four trials of thirty minutes each in the old cage in the Harvard Laboratory. In each of the first two trials

he went to the opening and put his hands on the lower edge of the frame. In the third and fourth trials No. 3 was wholly indifferent to the device, not going to it once.

He was given a fifth trial of fifteen minutes in the new cage at the New York Zoological Park. During this trial he went about the cage leisurely, but gave the paper no attention.

*Imitation tests.*—No. 3 imitating No. 2.—The two animals were in the cage together in each of the following tests.

First test. No. 2 tore the paper and got food, and No. 3 got some of the seeds which No. 2 dropped. No. 3 did not go to the paper. This was repeated twice; the third time No. 3 went to the paper and looked. The fourth and fifth times No. 3 did not see, but the sixth time he went to the paper before the screen was lifted and turned away as No. 2 tore the paper. The seventh time No. 3 got food through the hole after the paper had been torn by No. 2.

No. 2 was now taken out. No. 3 looked at the paper, but became interested in the other monkeys, who were chattering in the nearby cages. He paid no further attention to the paper during the fifteen minutes.

Second test. No. 2 tore a hole in the paper and stepped back. No. 3 went up, thrust his hand through and got food. No. 2 was now taken out for five minutes and No. 3 went to the paper and examined it. He did not bite or push. This he repeated four times.

Third test. No. 2 was now put back and immediately got food. No. 3 searched the box after him, but got nothing. When No. 2 opened it again No. 3 got food, but he failed the next time. No. 2 was now removed. No. 3 went to the place and bit at the paper, but not hard enough to break it through. This he repeated three times.

Fourth test. No. 2 opened the paper and No. 3 grabbed the torn paper and pulled it away. This was repeated twice and then, while No. 2 was eating, No. 3 went to the paper, put his nose against it and pushed. He did not, however, use his teeth. After No. 2 bit through the paper the next two times No. 3 used his hands to tear a larger opening.

When No. 2 was removed from the cage No. 3 went at once to the paper and bit through and got food. This he repeated four times, getting food the last time in ten seconds.

TABLE 15.  
NO. 3 IMITATING NO. 2.

Date.	Number of times No. 2 performed the act.	Number of times No. 3 saw.	Number of times No. 3 saw in part.	Result.	Time in minutes.
July 1.....	7	5		F	10
July 1.....	1	1		F	10
July 2.....	2	2		F	10
July 3.....	3	3		S	$\frac{1}{2}$
Total.....	13	11		S	30 $\frac{1}{2}$

*Summary of Behavior of No. 3 in the Paper Experiment.*

The case of No. 3 is a process of gradual imitation similar to that of No. 11 in Chute Experiment B and of No. 2, No. 4 and No. 5 in the Rope Experiment. The first test directed his attention to the paper and each test thereafter increased that attention and its attendant activity. During the tests he got food a number of times; finally, he repeated the act of No. 2 in the fourth test, after having seen No. 2 get food eleven times.

*D. Behavior of No. 10.*

*Preliminary trials.*—First trial, August 13. No. 10 at first was frightened, due to some disturbance in getting her into the cage. She went about the floor rapidly and up and down the wire as if looking for some way of escape. Once she went to the paper, examined the lower edge of the frame and climbed up on it. Going to the side of the cage, she reached through the wire and tried to pick up straws on the floor outside. She climbed the wire and returned to the floor at once. She now became very persistent in trying to get the straws on the outside, stopping in her efforts only to walk about the cage. She found a hole in the floor which had been used in a former test; she worked at this for a moment; then grasping the frame at the paper in both hands, she shook it vigorously. Then she returned to the straws again. Climbing to X, she perched for a moment and then went to the floor and examined the cracks in the floor and in the door. Then she climbed the wire and remained quiet during the remainder of the time.

Second trial, August 17. No. 10 was on the upper part of the wire end during the first eight minutes. Then she was driven to the floor, where she sat in the corner near the paper. Several times she climbed up on the frame about the paper. Then she sat with folded hands near it. Shortly she climbed the cage front. She went to the floor again and sat near the paper. She climbed the wire front and returned to the paper, surveying it with her eyes. She climbed upon the frame and then climbed the front of the cage. She returned to the floor and walked about.

Third trial, August 18. No. 10 went at once to the wire in her usual excited manner and remained near the top for two minutes. Then she came to the floor; she walked to the door and back to the end of the cage, climbing the wire end. This she repeated several times immediately and continued to repeat it during the next five minutes. From the upper part of the end she surveyed the floor and sides of the cage. She went to the floor and for a little time sat in the corner near the paper. Then she moved over and sat near the wire end. Then she mounted the wire end.

Fourth trial, August 19. Behavior as follows: Up wire end and looked about; around to the front of the cage; back to end and surveyed floor from upper part of it; around to the front and back to end; to floor and walked over to the door; about, looking through the wire and up the end; again to the floor and to the door, back to end and up; around to front and down to the door; glanced at the paper in passing; up the end and back and forth about the wire; to the floor and the door, about the floor; quite free

to go about the floor; put hand on frame near paper in passing; up end of cage.

Fifth trial, August 20. Behavior as follows: On floor and then turned to door which was still open; looked out intently; climbed the cage end; to the front and down to the floor; across to the end and down; around to front; down to the floor; to door and up the end of cage again; to floor and up end of the cage; to the floor; to the door; sat near wire end and climbed cage again. To the floor and to the door; sat near the paper; to door and back to wire end, sat on the floor and then climbed the cage.

Sixth trial, August 21. Behavior as follows: Up the end of the cage and remained for some time; to the front to catch a cockroach and back to the end; surveyed whole cage from end; around to front and down to the floor to look at the door; back up the end of cage; down again; about the floor and up the end of the cage; about the wire. No. 10 was given a sixth test because this was her first experience in the cage and in the earlier tests she had seem disturbed.

*Imitation tests.*—No. 10 imitating No. 11.—First test. No. 10 was in the observation-box on the floor of the cage. No. 11 was free in the cage. No. 10 was attentive to what No. 11 did.

P. 1 to P. 5. No. 10 saw perfectly.

No. 11 was then removed and No. 10 was released in the cage. Immediately she climbed the end to the top and looked back to the floor, to the door, and to the screen. She went to the front, still looking downward. She went to the floor, to the door, and looked at the paper. She turned and climbed the end of the cage again. She went to the front of the cage and looked down at the door and the paper. She went down as far as the brace and looked at the screen. Then she went to the floor, put her hands on the lower edge of the frame and looked at the paper carefully. She turned back to the end of the cage and climbed the wire. Again she went down to the brace and surveyed the floor. She went down to the door and then climbed the wire end again. She repeated this within one minute. She seemed more interested in escaping than in getting food. Again she went to the floor, looked about beneath the frame, and again climbed the end of the cage.

Second test. Conditions same as in previous test. No. 10 was very attentive to the movements of No. 11 and saw as follows:

P. 1 to P. 3. No. 10 saw perfectly.

She tried to get out of the observation-box and shook it vigorously.

P. 4. No. 10 saw perfectly and shook the box.

P. 5. No. 10 saw fairly well.

When No. 11 was released, she ran up the end of the cage. She went to the front and looked at the door and floor. She went to the floor and about to the door. She climbed the end of the cage and returned again to the floor; she went to the paper and put her left hand on upper part and pushed; then she put her right hand on the lower part and pushed. Then she climbed the end of the cage and held fast to wire with head turned back toward paper; she went slowly down to the floor and walked across to the paper; she put two hands up on lower edge of frame and bit a hole at



exactly the right place. She then put her hand in and got food. Time: two minutes.

She tore away all the paper and tried for some time to find more food. Failing in this she climbed the end of the cage again. She remained there until the device was reset. Then she looked around at it for some time. Finally, she went slowly around to the front, climbed down to the floor, tried to look through wire at animals in the living cages, stopped an instant at the door, went on to the paper and with feet on the lower edge of the frame bit a hole in the paper. She thrust her fingers into the hole and tore the paper all off, getting the food.

She then climbed the cage and waited until the device was reset. At once she went to the floor and across to the paper. She bit at it, but the paper did not break. Again she tried it with the same result. Then she tried to break it with her hand. She climbed the end of the cage and remained there a minute. Again she went to the floor and tried to bite through the paper, but failed as before. She walked about the floor and again returned to the paper. This time she bit at the edge of the hole and literally wore a hole in the paper by rubbing her teeth over the wood. When she had made a small hole, she poked one finger through the opening and by a very hard pull tore the heavy bond paper.

*Summary of Behavior of No. 10 in the Paper Experiment.*

In the preliminary trials No. 10 gave almost no attention to the paper, merely looking at it once and passing over it in climbing upon the frame which surrounded it. In the first test she watched No. 11 intently and when he was out of the cage, she manifested an increased interest in the paper. The second test increased this interest and she repeated exactly the behavior of No. 11 within two minutes after his removal.

TABLE 16.

No. 10 IMITATING No. 11.

Date.	Number of times No. 11 performed the act.	Number of times No. 10 saw.	Number of times No. 10 saw in part.	Result.	Time in minutes.
Aug. 23.....	5	5		F	12
Aug. 24.....	5	5		S	2
Total.....	10	10		S	14

*E. Behavior of No. 9.*

*Preliminary trials.*—First trial, July 2. No. 9 was active about the cage. He went to the paper and put his hands on the lower part of the frame. He repeated this soon again. Then he climbed the wire in front; then he

climbed upon the frame at the paper. He whined and called most of the time he was in the cage.

Second trial, July 3. No. 9 took no notice of the paper during the entire fifteen minutes he was in the cage. He climbed about the cage and tried to push the door open.

Third trial, July 4. No. 9 was very active about the cage, but paid no attention to the paper during the first minutes in the cage. Later he went to the paper, bit at the frame and climbed upon it.

Fourth trial, July 5. In the fifth trial No. 9 climbed about the cage and upon the screen frame about the paper. He made no effort to tear the paper.

Fifth trial, July 5. The behavior of No. 9 in the fifth trial was similar to what it was on the previous days. He gave no attention to the paper.

*Imitation tests.—No. 9 imitating No. 2.*—The two animals were in the cage together in each of the following tests.

First test. No. 9 was not at first inclined to be attentive to No. 2. It was not until No. 2 got food the fifth time that he apparently saw the act. Then he put his hands on the bottom of the screen frame and reached one hand through the hole, but he got no food. Several times before the device could be reset No. 9 went to the screen and bit it and climbed upon it. He had not been near the screen that day. During the sixth, seventh and eighth manipulations by No. 2, No. 9 was beside him and saw what was done. Each time he put his hand into the opening, but got no food; each time he climbed upon the lifted screen.

After No. 2 had been taken out No. 9 was quite active, running all about the cage. He went to the screen several times and bit at the edge of the frame. Once he pushed his hand up over the paper and at another time he bit at the inner edge of the frame next the paper.

Second test. No. 9 saw each time and was near No. 2 in the corner of the cage. During the third, fourth, and fifth performances No. 9's hands were on the lower edge of the frame and after the paper had been torn No. 9 got food along with No. 2.

When No. 2 had been taken out No. 9 went to the paper, climbed upon the frame and jumped to the wire. He returned to the paper and bit at the edge of the frame, but not at the paper. Several minutes later he went to the paper and put his nose to it. This he repeated three times. At the last time of the three, he sat on the bottom of the frame and tried the paper with his fingers. He finally tore it and got food at the end of fourteen minutes. When the device was reset No. 9 went to it and sat on the lower edge of the frame. He tried to tear the paper with his fingers, but failed to make a hole. He later went to it and bit at the edge of the frame, but not at the paper. A little later he examined the paper with his nose, but did not bite it.

Third test. No. 9 saw perfectly five times in six and got food twice. When alone he went to the paper, examined it with his nose, and went away. Later he went to the paper and fingered the edges. He then went away, returning once more during the fifteen minutes, but doing nothing.

Fourth test. This test was made forty-seven days after the preceding one. The conditions were the same as in the preceding test except that No. 6 was used instead of No. 2.

Performance 1. No. 9 saw and was just back of No. 6 when he tore the paper.

P. 2. No. 9 was on the back of No. 6, but his head was turned away. Because No. 9 insisted on riding on the cab back of No. 6, the latter was removed and No. 2 was substituted.

P. 3 to P. 7. No. 9 saw No. 2 at the paper from front wire and came down to it. He reached his hand in to get food, but No. 2 had taken it all.

When No. 2 was out No. 9 came down from the wire, climbed the screen frame, and sat on the edge. He jumped to the wire front, but at once returned to the corner by the paper and sat on the floor for some time looking at the paper and at that part of the cage. He then climbed the front of the cage. Twice he came to the floor, climbed the frame at the paper and jumped back to the wire front. After spending some time about the cage and on the floor, he climbed the screen frame and tried to bite the paper. He was too small to reach the hole from the floor and when he got upon the lower edge of the frame his body covered the place where he should bite the paper.

Fifth test. No. 9 and No. 2 were in the cage together. Since No. 9 was so small, a box was placed on the floor below the paper so that he could climb upon it and thus have a more nearly equal chance with the larger animals in exerting his force against the paper.

P. 1. No. 9 saw from the middle of floor.

P. 2. No. 9 saw in part.

P. 3. No. 9 saw from the wire front above the brace.

P. 4. No. 9 did not see the paper torn and did not come down for some time. He saw No. 2 eat the food, sitting on the box.

During each of the previous times he had searched the hole for food and got none. He now paid no attention to the place. No. 2 was allowed to continue eating food at the opening. No. 9 ran all about the cage, but paid no attention to No. 2 and the paper. Finally No. 9 went to the box and got sunflower seed and a piece of banana.

P. 5. No. 9 saw from the top of the wire front. He came down for food and No. 2 punished him; he ran up the cage crying.

P. 6 to P. 10. Did not see. Watching the experimenter.

P. 11 to P. 12. No. 9 saw from above X.

No. 2 was now removed. No. 9 ran up and down the wire and about the floor. Then he went to the box. He looked about for a moment and then pushed his hand over the upper part of the paper above the hole and around the upper edge of the paper. He looked at it and then climbed the wire and went about the cage.

After climbing about the cage, he came back to the paper, and put his hands against it. He did not get his hand over the opening, although he rubbed them about the paper considerably. He then played about the cage.

Sixth test. No. 9 was put into the observation-box and No. 6 was free in the cage.

P. 1 and P. 2. No. 9 saw in part.

P. 3 to P. 7. No. 9 saw the entire performance.

No. 6 was taken out and No. 9 was released. No. 9 ran up the wire, and came back to the floor and to the paper; he looked at it and climbed up on it. He then ran up the wire. Again he went to the paper and bit at the edge of it. Then he climbed up on it and jumped to the wire front. He repeated this performance twice. Then he ran all about the cage and came back to the screen. This he did repeatedly. He seemed more bent on getting out of the cage than on getting food. Several times he put his nose to the paper; but was not persistent about it, looking away at once. Later he bit the lower edge of the frame. Still later he bit at the frame next the edge of the paper.

Seventh test. The box was below the screen. No. 9 and No. 2 were free in the cage.

P.1. No. 9 saw and got a sunflower seed through the opening.

P.2. No. 9 did not see, although he sat near and must have heard the paper tear. He seemed indifferent to No. 2's getting food.

P.3. No. 9 saw from post above X, but did not seem interested.

P.4. No. 9 saw from upper part of wire end.

P.5-P.6. No. 9 saw from the wire above X.

P.7. No. 9 saw from the wire above X, and going to floor got a grape skin No. 2 had dropped.

P.8. No. 9 saw from wire above X. He went to the paper and put his hand in after No. 2 had left.

P.9. No. 9 saw from above X. He went to the floor, put grape skin in his mouth, and went to the paper, where he put his hand in the hole. No. 2 jumped at him and struck him.

P.10. No. 9 did not see.

P.11. No. 9 saw from upper part of wire end; he got grape skin and went to the hole as before.

P.12. No. 9 saw from wire above X.

No. 2 was taken out and No. 9 was left alone. He climbed the cage front at first. He came down to the box beneath paper, and looked all about the paper; climbed frame, jumped to front and ran to end of the cage. Again he went to box and looked all about the paper. He fingered the lower edge of the frame and then put his left hand flat against paper above the hole and pushed; he shoved palm over upper left-hand part of paper. Then he pushed his right hand over lower right-hand corner in the same way. Then he sat on the box and looked. After some time at box he climbed the wire to the upper part of the end. He soon went back to the box, where he sat before the paper and looked all about it. He climbed the frame, jumped to the front and ran up to the top of the wire end. He repeated this entire performance. He went to the box again, looked at the paper and the frame, and returned to the front and end of the cage.

*Summary of Behavior of No. 9 in the Paper Experiment.*

During the five preliminary trials No. 9 gave the paper no attention. The first test brought forth imitative behavior in that No. 9 put his hand through the hole to get food after seeing No. 2 get food. After the removal of No. 2, No. 9 pushed his hand up over the paper as if to tear it, a thing he had not done in the preliminary trials. The second test increased this attention and after repeated fingering at the paper he tore it off and got food. In the later tests he did not succeed in breaking through the paper, but he repeated the movements of No. 2 and gave persistent attention to the paper. His failure was possibly due not to the absence of the tendency to imitate, but to the lack of muscular power to exert sufficient strength to break the paper.

TABLE 17.

## NO. 9 IMITATING NO. 2.

Date.	Number of times No. 2 performed the act.	Number of times No. 9 saw.	Number of times No. 9 saw in part.	Result.	Time in minutes.
July 6.....	8	4	2	F	10
July 7.....	5	5		S	15
July 8.....	6	5		F	10

## NO. 9 IMITATING NO. 6.

Aug. 24.....	7	5	2	F	12
Aug. 24.....	4	2	1	F	10

## NO. 9 IMITATING NO. 2.

Aug. 24.....	8	3		F	10
Aug. 24.....	7	5	2	F	10
Aug. 25.....	12	10		F	15
Total.....	57	39	7	S	82

*General Summary of the Results of the Paper Experiment.*

That the problem set in the Paper Experiment was one easy of solution is evidenced by the fact that of eight animals all but three learned it alone, most of them in the first trial. Of the three animals which did not learn it alone two learned it by a process of gradual imitation. The other one was never more than partially successful, but his failure seemed due to a lack of physical strength rather than to a failure to repeat the act which he saw performed.

Here again, we note attention on the part of the observing animal and a subsequent marked change of behavior (somewhat sudden) in the direction of the behavior observed in the performing animal.

TABLE 18.

## RESULTS OF THE PAPER EXPERIMENT.

## I.

Number of animals used in imitation tests .....	3
Cases of successful imitation .....	2
Cases of partially successful imitation .....	1
Cases of failure to imitate .....	0

## II.

Cases of imitation when the imitator was confined during the activity of the imitatee .....	1
Cases of imitation when the two animals were in the cage together .....	2

## III.

Cases of immediate imitation .....	0
Cases of gradual imitation .....	3

## IV.

Cases of imitation in which the imitating animal <i>did not</i> himself experience the result of the act before performing it .....	1
Cases in which the imitating animal <i>did</i> experience the result of the act before performing it .....	2

## 5. SCREEN EXPERIMENT.

*A. Description of Device.*

The device in this experiment was a modification of the one used in the Paper Experiment. The paper was not used. The string which lifted the screen (fig. 7, *a*) was removed.

The act which the animal had to perform was to push the screen up with one hand and with the other reach through the hole and get food. No animal was tried in this experiment which had not previously gotten food in the Paper Experiment.

*B. Behavior of No. 4.*

No. 4 first pushed the screen up when the paper was being adjusted in the Paper Experiment. She did not, however, tear the paper. The screen dropped back in place and she lifted it again. The fourth time she pushed the screen up, it stuck and did not drop back. She then tore the paper.

When the device was reset, No. 4 pushed the screen up and tore the paper. Thereafter, she lifted the screen and got food when she wanted to.

*C. Behavior of No. 6.*

*Preliminary trials.*—First trial. No. 6 was active, climbing up and down the wire, and upon the screen. He fingered about the edges of the screen, but made no effort to raise it.

Second trial. The second day No. 6 ran all about the cage, climbing the wire and upon the screen. He examined the screw eye where the string had been attached, but made no effort to lift the screen.

Third trial. On the third day he seemed interested in all parts of the cage, examining every crack and hole in it. He fingered the top of the screen as if to move it. Six times he climbed upon the screen. The remainder of the time he busied himself catching flies.

Fourth trial. On the fourth day No. 6 paid no attention to the screen during the fifteen minutes.

Fifth trial. No. 6 paid but little more attention to the screen on the fifth day. Three times he climbed upon it to jump to the wire front and three times he examined the hole above the screen.

*Imitation tests.*—*No. 6 imitating No. 4.*—The two animals were put into the cage together in each of the following tests.

First test. No. 6 was at first indifferent to the movements of No. 4. He usually saw No. 4 get the food, but failed to see him lift the screen. In the six times No. 4 lifted it in the test, No. 6 appeared to see twice. After No. 4 had been taken out, No. 6 paid no attention to the screen for ten minutes.

Second test. The first four times No. 4 lifted the screen No. 6 did not see. He was picking over the hulls left on the floor. The fifth time he saw from the opposite corner of the cage, and while No. 4 was up on the wire front eating, No. 6 went to the screen and looked. The sixth time the screen stuck when lifted, and No. 6 put his hand in and got food. After the seventh time No. 6 went to the screen and pushed on the lower edge of the frame. Then he pulled at the top and went away. He went back immediately and putting both hands on the screen pushed. He then went away, but when No. 4 lifted the screen he saw and went at once to it. Putting his hands on it he pushed it up one-third of the way. Then he pushed it up so as to reveal the hole, and got food. No. 4 pushed it up again and No. 6 saw. Immediately No. 6 lifted the screen and got food.

After No. 4 had been taken out No. 6 lifted the screen eight times in ten minutes. He could do it perfectly.

*Summary of Behavior of No. 6 in the Screen Experiment.*

No. 6 had seen the screen go up in the Paper Experiment and he had experienced getting food when the screen was lifted. However, his five preliminary trials in the Screen Experiment did not lead him to get food. When first in the cage with No. 4 he was not inclined to be attentive. When he saw No. 4 getting food in the second test he at once became inter-

ested in the screen. When once his attention was centered on the screen he very soon repeated the behavior of No. 4, not at first in a perfect way, but in his fifth effort he did it in exactly the way No. 4 had done the act in his presence.

TABLE 19.  
No. 6 IMITATING No. 4.

Date.	Number of times No. 4 performed the act.	Number of times No. 6 saw.	Number of times No. 6 saw in part.	Result.	Time in minutes.
July 6.....	6	2	4	F	10
July 7.....	11	6		S	12
Total.....	17	8	4	S	22

*D. Behavior of No. 5.*

*Preliminary trials.*—First trial. No. 5 examined the cage all over, but she manifested no particular interest in the screen. After ten minutes she looked it over slightly.

Second trial. On the second day she looked out through the wire, poked her fingers through the hole in the door, and then went to the screen and pulled at the screw eye. She was quite active, climbing about the cage rapidly. Once more she went to the screen, and then spent the remainder of the time catching flies.

Third trial. On the third day she bit at the screen frame and pulled at the screen during the first few minutes. She then spent the rest of her time as on the previous day.

Fourth trial. On the fourth day No. 5 showed more interest in the screen at first. She tried to shake the screen frame. Later she fingered the screen and bit at the frame.

Fifth trial. On the fifth day No. 5 bit at the screen frame several times and climbed upon it twice. Most of the time, however, she spent in other parts of the cage.

*Imitation tests.*—*No. 5 imitating No. 4 and No. 6.*—In all of the following tests the two animals were in the cage together.

First test. No. 5 was somewhat wary of No. 4 and did not come near. She saw No. 4 open the screen once in three times. When No. 4 was taken out No. 5 went to the screen and examined it, but she gave it no persistent attention. Later she fingered the lower edge of the screen.

Second test. No. 5 was attentive and saw the lifting of the screen five times.

When No. 4 was out No. 5 went at once to the screen and pulled at the top of it. She then ceased to be interested in it and examined other parts of the cage.



Third test. No. 5 was very hungry. She saw No. 4 open the screen once in the first three times. After the third trial, while No. 4 was up the wire front, eating, No. 5 went to the screen and examined it. She put her fingers into the cracks and climbed upon it to examine the top. The fifth and sixth times she saw plainly, and after each went to the screen and examined it. The seventh time No. 5 saw and hurried to the screen, but No. 4 let it drop and No. 5 turned away without trying to manipulate it. A little later she went to it. Again she saw and did as she had done after the seventh time. Then she turned back to the screen and examined it, thrusting a finger into the cracks about it.

When No. 4 was removed No. 5 manifested no interest in the screen, going to it but once and that at the end of fifteen minutes.

Fourth test. No. 5 climbed upon the screen after No. 4 lifted it the first time. She sat on the brace and saw No. 4 lift it the second time, but she did not go to the screen, nor did she at any time while No. 4 was in the cage.

When No. 5 was alone she went to the screen once during the ten minutes, but she touched no part of it.

Fifth test. No. 5 was somewhat afraid and did not go near the screen while No. 4 was present. She saw No. 4 from the side of the cage and from the floor five times.

When alone No. 5 went to the screen and climbed up on it once. The rest of the time she was indifferent to it.

Sixth test. No. 6 was now used instead of No. 4 on account of No. 5's fear. After the second time No. 5 saw she went to the screen and climbed upon it. She saw five times well.

When No. 6 was taken out No. 5 went to the screen, put her hands against it and pushed, but failed to lift it. She then gave up and paid no more attention to it.

Seventh test. No. 5 saw three times. After the third time she went to the screen and worked, but did not put her hands against it as she had done before. She did the same after seeing the fourth time. After the fifth performance No. 6 was removed.

No. 5 went to the screen and worked vigorously for fourteen minutes. She tried the top of the screen, the bottom of the screen and the frame repeatedly, pushing, pulling, and biting.

Eighth test. No. 5 was interested in the screen on first entering the cage and kept near for a time. She got food when she could; she worked at the screen usually after No. 6 let it down, but was not persistent about it. In all she saw ten times.

No. 6 was now taken out. No. 5 walked about the cage for a time trying to find food in the cracks. After four minutes she went to the screen and grasping it at the top shook it vigorously. She left it at once.

Ninth test. This test was immediately after the eighth. The moment No. 6 re-entered No. 5 became interested in the screen, but did not try to raise it. After the third lift she put one hand on the top of the screen and fingered the bottom with the other hand. She did the same after the fourth

lift. Each time when No. 6 raised the screen No. 5 went to it and looked, but she did not put her hands to the screen. She saw ten times.

When No. 6 went away No. 5 usually fingered and pulled the screen, but did not put her palm against it and push.

When No. 6 was out No. 5 lost interest in the screen and sat down in the corner of the cage.

Tenth test. No. 5 went to the screen on first entering the cage and worked at the lower edge of it and at the frame. No. 6 came and lifted the screen. No. 5 saw plainly and when No. 6 dropped some seeds No. 5 got them. This was repeated a number of times. No. 5 frequently went to the screen and worked while No. 6 was eating, but she never lifted it. She either grabbed the top and shook it or fingered the crack at the lower edge. She saw fifteen times in all.

When No. 6 was out No. 5 became indifferent to the screen and continued so during the entire ten minutes.

Eleventh test. No. 5 was near No. 6; she saw twenty times in thirty performances and often got the food which No. 6 dropped. After each performance No. 5 put her hands on the screen. She usually shook the top. A number of times when No. 6 was opening the screen No. 5 stood upright on her feet, with hands hanging loose and her nose close to the screen. She did not, however, put her hands on the screen while No. 6 was lifting it.

When No. 6 was out No. 5 manifested no more interest in the screen.

Twelfth test. No. 5 was attentive to No. 6 most of the time and saw at least fifteen times in twenty-six. After the third time No. 5 went to the screen and pushed on the frame with her palms; almost every time afterwards she went to the place when she saw No. 6 push the screen up. After the fifteenth time she went to the screen, placed her palms against it and looked all about the lower edge and pulled at the upper part. Once she got food when No. 6 pushed up the screen.

With No. 6 out No. 5 went to the screen and looked at it, but made no effort to get food. She remained quiet in the cage, and after eight minutes went to the screen and examined it with eyes and fingers.

Thirteenth test. No. 5 saw five of ten performances. When No. 6 had been taken out she made no effort to lift the screen.

#### *Summary of Behavior of No. 5 in the Screen Experiment.*

No. 5 had seen the screen lifted in the Paper Experiment and had gotten food by tearing the paper. During her preliminary trials in the Screen Experiment she manifested an interest in the screen, but this interest seemed to fade in the later trials. During the imitation tests, when she was observing No. 4, this interest increased and again died away. No. 6 was substituted for No. 4 and the interest of No. 5 again revived, reaching its highest point during these tests. In the sixth test she seemed nearest to repeating the act she had seen, when, after seeing No. 6 lift the screen five times, she went to the screen and in a manner similar to his put her hands against it and pushed. In the later tests, after failing in all her efforts at the

screen, No. 5 seemed interested in it only when No. 6 was present and working at it.

TABLE 20.

## No. 5 IMITATING No. 4 AND No. 6.

Date.	Number of times No. 4 performed the act.	Number of times No. 5 saw.	Number of times No. 5 saw in part.	Result.	Time in minutes.
July 6.....	3	1	2	F	10
July 6.....	5	5		F	10
July 7.....	7	5		F	10
July 8.....	5	5		F	10
July 9.....	7	5		F	10

## No. 5 IMITATING No. 6.

July 9.....	8	5		F	10
July 10.....	5	5		F	14
July 11.....	11	10		F	10
July 11.....	10	10		F	10
July 14.....	20	15		F	10
July 15.....	30	20		F	10
July 31.....	26	15	3	F	10
Aug. 2.....	10	5		F	10
Total.....	147	106	5	F	134

*E. Behavior of No. 2.*

*Preliminary trials.*—First trial. No. 2 was not active. He examined the screen with his nose and hands and bit at the screw eye in the top of it.

Second trial. On the second day No. 2 pushed the screen, but did not lift it; later he climbed upon it and examined the top of it. This he repeated twice.

Third trial. The third day's behavior was similar to that of the previous day. No. 2 pulled and gnawed at the screen and the screen frame. Part of the time he worked vigorously. Most of the time, however, he was in other parts of the cage.

Fourth trial. On the fourth day No. 2 was more vigorous than ever. He spent five minutes without intermission chewing at the bottom of the screen frame. He then quit and looked at a hole in the door. He made another brief examination of the top of the screen and went away. Several times he returned and examined the screen, once lifting one corner of it by pulling on the screw eye at the top.

Fifth trial. No. 2 was active at the screen, pulling at the top and biting the lower part of the frame. He made no progress, however.

*Imitation tests.*—No. 2 imitating No. 4.—During all of these tests No. 2 and No. 4 were together in the experiment cage.

First test. It was the first time No. 2 and No. 4 were together. They caressed at once and then No. 4 went to the screen. She lifted it five times and got food each time. No. 2 sat by her and seemed to see every movement, although his excitement may have kept his attention from centering on what she was doing. When No. 4 was removed No. 2 displayed no more than usual interest in the screen. He climbed to it, picked at it with his fingers and used it as a stand to climb up the post.

Second test. No. 2 was excited and was attentive to No. 4. He ate the apple crumbs which she dropped after the first opening. At the second and fifth opening he was "picking fleas," and did not see the screen go up.

While she was eating her fifth feed he went to the screen and examined it. The sixth and seventh times she lifted it, he saw perfectly. After the seventh he went to the screen and pushed against the lower edge of the frame and then bit at it where it joined the cage post.

After No. 4 had been taken out No. 2 began to work at the screen. He picked at the lower edge of the frame where it joined the post and then climbed upon the screen. He was too excited to work persistently, running to the side of the cage and starting at every noise. He worked intermittently for six minutes. Then when at the opposite side of the cage he started, ran to the screen and gave a single push upward on the lower edge of the frame. He then put both hands on the frame, but did not push. Because of his activity the period was prolonged to fifteen minutes.

Third test. No. 2 saw No. 4 the first time she got food and climbed the cage to get food from her. He saw the second time and got food from the hole while the screen stuck. When his food was gone No. 2 went to the screen and pulled at the top and pushed at the lower edge. He saw the third time, but became interested in picking fleas from No. 4 instead of getting food. The fourth and fifth times he saw perfectly.

After No. 4 had been taken out No. 2 ran about the cage, but paid no attention to the screen for the first four minutes. Then he worked at the lower edge of the screen a little.

Fourth test. After the third performance No. 2 went to the screen and touched it. After the fourth he went to it, put his hands against it and pushed, but he failed to lift it. Each of the five times he saw very well.

After No. 4 had been removed No. 2 went to the screen a number of times and put his hands on it. He also bit the lower part of the frame and climbed upon the screen.

Fifth test. No. 2 saw No. 4 well each time. He went to the screen after No. 4 had opened it and remained there while No. 4 ate her food. His efforts to get food were feeble.

After No. 4 had been taken out No. 2 climbed up on the screen a number of times, but in no case did he seem bent on getting the food.

Sixth test. No. 2 was interested in No. 4 and saw her get food each time in twenty. A few times he put his hands on the screen.

After No. 4 had been taken out No. 2 moved about the cage and worked but slightly at the screen.

Seventh test. No. 4 was very active and eager for food. No. 2 was fairly attentive, but No. 4 worked so rapidly No. 2 saw but twenty times in forty.

After No. 4 had been taken out No. 2 worked at the lower edge of the screen and at the frame. For ten minutes he kept persistently at the screen, biting and fingering the frame. Not once did he push against the screen to lift it.

Eighth test. No. 2 watched No. 4 at the outset very closely. After seeing her get food seven times he reached his hand to hers to get some food, but he was severely slapped. He made no effort to work at the screen while No. 4 was present.

After No. 4 had been taken out, No. 2 went to the screen and tried to manipulate it. He used his hands at the lower edge of the screen and bit at the screen frame. He kept at it most of the time during the ten minutes.

Ninth test. No. 2 was attentive to No. 4 at first, but when he failed to get food he became indifferent and looked at other things than No. 4. He kept near her, but at a safe distance.

After No. 4 had been removed No. 2 became interested in the screen at once. He fingered the crack at the lower edge, and bit at the frame. He was not persistent, however, and soon went to other parts of the cage. He returned later to the screen for a moment.

Tenth test. No. 2 was not inclined to watch No. 4, but spent his time in picking scraps from the floor. Once he went from the far part of the cage and pushed lightly against the lower edge of the frame with his hands.

After No. 4 had been taken out No. 2 spent his time on the floor. Once only he went to the screen; then he fingered the lower edge, but did nothing more.

TABLE 21.

## No. 2 IMITATING No. 4.

Date.	Number of times No. 4 performed the act.	Number of times No. 2 saw.	Number of times No. 2 saw in part.	Result.	Time in minutes.
July 6.....	5	5		F	10
July 8.....	9	6	1	F	15
July 9.....	5	5		F	10
July 10.....	5	5		F	10
July 11.....	10	10		F	10
July 14.....	20	20		F	10
July 15.....	40	20		F	10
July 31.....	16	10	1	F	10
July 31.....	16	10	3	F	10
Aug. 1.....	35	10	4	F	10
Total.....	161	101	9	F	105

*Summary of Behavior of No. 2 in the Screen Experiment.*

As in the case of No. 5 and No. 6, No. 2 had gotten food in the Paper Experiment and had frequently seen the screen lifted. In his preliminary

trials he manifested an interest in the screen, but made no headway in getting food. In the imitation tests the conduct of the other animal seemed to accentuate his interest at times, but never sufficiently modified his behavior to enable him to get food. In the later tests he seemed interested in the screen only when another animal was present getting food.

*F. Behavior of No. 3 and No. 8.*

In the cases of No. 3 and No. 8 there was apparently but slight influence of the behavior of the imitator. Owing to the lack of space the details are omitted. The tables which follow show the number of tests to which they were subjected. The summaries give all that was important in their behavior.

*Summary of Behavior of No. 3 in the Screen Experiment.*

The behavior of No. 3 was much like that of No. 2. The imitation tests served to quicken his interest in the screen, but it waned even earlier in the series than that of No. 2. At the last, though he repeatedly got food when No. 4 did, he seemed interested in the screen only when No. 4 was working at it.

TABLE 22.

No. 3 IMITATING No. 4.

Date.	Number of times No. 4 performed the act.	Number of times No. 3 saw.	Number of times No. 3 saw in part.	Result.	Time in minutes.
July 6.....	5	5		F	10
July 8.....	8	8		F	10
July 9.....	7	5	1	F	10
July 10.....	5	5		F	14
July 11.....	12	10		F	10
July 14.....	14	10	2	F	10
July 15.....	43	20		F	10
July 31.....	20	10	4	F	10
Aug. 1.....	16	15	2	F	10
Aug. 1.....	18	12	3	F	10
Total.....	148	100	12	F	104

*Summary of Behavior of No. 8 in the Screen Experiment.*

The behavior of No. 8 practically repeated that of No. 3, though his activity evidenced even less influence of the behavior of No. 4. In the first imitation tests his attention to the screen increased slightly, but in the later tests it disappeared almost entirely.

TABLE 23.  
No. 8 IMITATING No. 4.

Date.	Number of times No. 4 performed the act.	Number of times No. 8 saw.	Number of times No. 8 saw in part.	Result.	Time in minutes.
July 6.....	5	1	4	F	10
July 8.....	8	5	1	F	10
July 9.....	5	5		F	10
July 10.....	6	6		F	10
July 11.....	14	10	1	F	10
July 11.....	13	8		F	10
July 14.....	15	12		F	10
July 15.....	25	20		F	10
Total.....	91	67	6	F	80

*General Summary of the Results of the Screen Experiment.*

In the Screen Experiment, but one animal in five learned to get food by seeing another animal get it. The behavior of the successful individual was a clear case of imitation. The behavior of the others agrees in that the first imitation tests show a decided increase of attention to the screen, and more or less effort to get the food. The same accentuation of attention occurred in the case of No. 5 when a new animal was used. These cases also agree in that the attention waned when the efforts to get food were unsuccessful, and that in the end the interest in the screen seemed dependent on the presence of an animal who could lift it. The behavior of No. 5 varied somewhat in that his interest in the screen persisted longer than did that of the other animals.

Although No. 6 was the only animal wholly successful in imitation, it is manifestly unfair to interpret the behavior of No. 5 or No. 2 as cases of total failure. Each of them did repeat, in part, the behavior of the imitator and this repetition seemed due to the action of the imitator. The fact is, that, if we arrange the behavior of the several animals in the order in which the results have been reported, we have a series of cases, in each member of which, the influence of the imitator shows less than in the preceding member. At the beginning, we have in No. 6, successful imitation. At the end, No. 8, who seemed stimulated only to look at the screen more

continuously. Between these extremes are the cases of No. 5, No. 2 and No. 3, which exhibit in a decreasing order the influence of the imitatee. One can well imagine that a large number of such cases would show quite a regular gradation in the complexity of the imitative behavior. In view of the evident gradations in the behavior of the animals I choose to call the cases of No. 5 and No. 2, partially successful imitation.

TABLE 24.

## RESULTS OF THE SCREEN EXPERIMENT.

## I.

Number of animals used in the imitation tests.....	5
Cases of successful imitation.....	1
Cases of partially successful imitation.....	2
Cases of failure to imitate.....	2

## II.

Cases of imitation when the imitator was confined during the activity of the imitatee.....	0
Cases of imitation when the two animals were in the cage together.....	3

## III.

Cases of immediate imitation.....	0
Cases of gradual imitation.....	3

## IV.

Cases of imitation in which the imitating animal <i>did not</i> himself experience the result of the act before performing it.....	0
Cases of imitation in which the imitating animal <i>did</i> experience the result of the act before performing it.....	3

## G. PLUG EXPERIMENT.

*A. Description of Device.*

In board A, a hole 5 cm. square was cut, 35 cm. from the floor (fig. 8, *a*). Covering this hole on the outside of the cage was a slide door, made of glass, set in a wooden frame. Just outside of this glass door, food was exposed. The slide door could be opened by a string, *b*, which passed down under the cage, up the outside of the corner where the wire end met the wire side and through a hole, *c*, 90 cm. from the floor of the cage. The string was attached to the end of a plug, *d*, which fitted into this hole from the inside of the cage. The plug extended into the cage 4 cm. and was 1½ cm. in diameter.



To open the door the animal must climb the wire and pull out this plug (fig. 8). It could then get the food at the door (fig. 9). Conditions were such that when the monkey was looking at the door, his back was toward the plug, and that when he was working at the plug he could not see the door.

*B. Behavior of No. 5.*

*Preliminary trials*—First trial. No. 5 went at once to the plug and tried to bite it. She came down to the door and tried to get food. She went back at once to the plug and bit and pounded it. She pulled on it, but in such a manner that it bound on the edge of the opening and did not come out. She then went to the door again and looked at the food. A moment later she went to the plug and grabbed it in both hands. Then she went to door and struck at it with both hands in a characteristic manner. She tried to reach the string on the outside of the post. Failing in this she went back to the door. She went to the plug and pounded it with her nails. Then she jumped to the screw eye in the top of the cage where the rope had hung in the Rope Experiment. She held by the fingers of one hand and thrust the other arm through a hole (feeder hole) in the top of the cage. She then came down to the floor.

Second trial. On the second day No. 5 was still eager to solve the new problem, the slide door and the plug. She first climbed to the plug and chewed the end of it. Later she descended from the wire and after walking around on the floor went to the door and tapped on it with her nails. She then climbed to the plug and later went to the door. Then she went to the plug and chewed off some splinters. She tried to move it with her hands. Then she went back to the door, tapped it with her nails and later pushed it vigorously.

Third trial. On the third day No. 5 went to the door at once. A moment later she went to the plug. She pulled, bit and pounded it with her nails. She rushed down to the food door to get the food and worked at the door continuously for six minutes. She had several movements which she used repeatedly. She balanced on her feet in the middle of the cage, her body lifted slightly from the floor and almost erect; then she lunged at the door, striking it with both hands. Her aim was not direct enough to land on the glass, usually striking the edge of the opening. She sometimes jumped with such force as to throw her body back into the cage.

Another movement was to grasp the lower edge of the opening with both hands and shake it hard. She found a piece of paper on the floor and put it against the glass and pounded it and pushed on it. Then she tapped with her nails on the glass. Later she climbed the side of the cage near the door and supporting herself with her hands, she put her feet against the door and pushed. The next move was to force paper into the edge of the opening. Once, after vigorous effort, she ran up the post to the plug and pulled, bit and pounded it. The pull was always sideways, never straight out. This vigorous activity continued for twelve minutes. At the last she picked up some refuse, laid it upon the edge of the opening, and went away.

Fourth trial. On the fourth day No. 5 began to shake the door vigorously. She then rushed up to the plug and bit and pulled it. She worked at the slide door intermittently during the remainder of the time.

Fifth trial. The fifth day No. 5 went to the door and worked at the edge. She then climbed to the plug and bit and pulled. Then she ran down to the slide door. She returned to the door repeatedly. She worked persistently and vigorously at it, jumping at it and pounding it.

When No. 5 had failed in her five attempts the plug was pulled partly out of the hole. She was then able to pull it entirely out. She got the connection with the door at once and after a few times worked the device perfectly. She was then used to perform the act for others in the imitation tests.

### *C. Behavior of No. 2.*

*Preliminary trials.*—First trial. No. 2 went to the door at once and looked at the food. He went soon again. He then spent the rest of the time about the cage in the usual manner.

Second trial. On the second day No. 2 climbed to the plug and bit it. He went to the floor and to the slide door. Later he bit the plug a number of times, but not persistently. He went to the door and fingered about the edges, and later pushed it with his hands a number of times.

Third trial. On the third trial No. 2 examined the door with his fingers and then took his leisure about the cage for the remainder of the time.

Fourth trial. On the fourth day No. 2 went to the door, but made no effort to get through to the food. He scratched on the glass and later pushed at it.

Fifth trial. On the fifth day No. 2 went to the door and then climbed the wire part of the cage. Later he went to *X* and bit at it. Still later he went to the door, but turned away. Two minutes later he returned to the door and pushed on it. He repeated this twice.

*Imitation tests.*—*No. 2 imitating No. 5.*—The two animals were put into the cage together in each of the following tests.

First test. No. 2 watched No. 5 most of the time, but did not often see exactly what No. 5 did. He saw five times in fifteen. Once he got food at the door.

With No. 5 out No. 2 worked rather persistently at the door for a few minutes. Then he climbed the post and bit the plug. Several times he came back to the plug and bit it.

Second test. No. 2 was very attentive and got a good view of No. 5. He saw her pull the plug five times in eight, and each time he saw her go from the string to the food.

When No. 5 was removed No. 2 saw the food at the door, but made no effort to get it.

Third test. No. 5 was very eager and pulled the plug repeatedly, getting the food as rapidly as it could be supplied. She pulled when the door was open as well as when it was closed. If the door was not closed after she had gotten food she pulled the plug, but after several pulls she ceased if the

door was not closed. No. 2 sat by and watched all the time. He saw the entire performance ten times.

When No. 5 was out No. 2 went to the door and fingered about it for three or four minutes. He then sat down and whined; he made no further effort to get the food. He did not notice the plug.

Fourth test. No. 2 and No. 5 were very friendly, No. 2 "picking fleas" from No. 5 when she was busy getting food. No. 5 was very eager to get food and rushed from the door to the plug. No. 2 was fairly attentive and saw No. 5 pull the string many times when she got no food. He saw her get the food ten times.

When No. 5 was out No. 2 worked at the door for some time. Then he climbed the post and pulled at the plug with his hands as No. 5 had done. He did not pull it out nor did he persist in pulling. Later he pulled the plug out, but did not see that it had opened the door. It was reset. Several minutes later he came to the plug, pulled it out, saw the door open, and got the food. When the door was reset he worked at it for three minutes, then climbed the cage wire and looked about. He was above the plug; he looked down, saw it, climbed down to it, pulled it out, saw the door open and got food. He pulled the plug again before it was reset. When it was reset he worked at the door for a minute, then climbed the cage, looked about and came back to the door. Then he ran up the plug, pulled it, and got food. He pulled it three times more before it could be reset. He repeated this four times in three minutes, getting food each time.

Three days later No. 2 pulled the plug twelve times within a few minutes, getting food each time.

TABLE 25.  
No. 2 IMITATING No. 5.

Date.	Number of times No. 5 performed the act.	Number of times No. 2 saw.	Number of times No. 2 saw in part.	Result.	Time in minutes.
July 13.....	15	5		F	10
July 13.....	8	5		F	10
July 14.....	20	10		F	10
July 15.....	25	10		S	20
Total.....	68	30		S	50

*Summary of Behavior of No. 2 in the Plug Experiment.*

The Plug Experiment set a different problem from any of the experiments already described. The food was obtained at one place, but the door could be opened only by working at a place removed from the door.

No. 2 made no progress toward a solution of the problem during his preliminary trials. The first three tests did not aid him. In the fourth test No. 5 made more rapid trips between the door and the plug. She seemed

quite excited. Probably her increased activity served as an increased stimulation to No. 2, for after her removal he gave more continuous attention to the door, and then went from the door to the plug and pulled. He repeatedly tried the plug and finally succeeded in pulling it out. After his first success, however, he did not go to the door, although he did after the next. The one experience, however, did not establish a perfect act, for when the device was reset he did not go at once to the plug, but worked at the door instead. He gave up trying to get the food and went about the cage. He went to the plug again only when his eyes accidentally (so it seemed) fell upon it. In the third experience there was apparent an element of accident, but after he got food the third time, he seemed to know the trick perfectly.

#### *D. Behavior of No. 6.*

*Preliminary trials.*—First trial. No. 6 climbed the cage and then went to the door and pushed at it. He examined all about it and then climbed the wire. He grasped the plug three times. Then he went back to the door six times and pushed it. Later he bit the plug.

Second trial. No. 6 was very playful. He leaped about the floor and up the wire. Once he went to the food door and later he went to the plug and bit it. He then went back to the floor and to the food door. He pushed at it and then played about the cage.

Third trial. No. 6 showed no interest in either the door or the plug.

Fourth trial. On the fourth day No. 6 was very active. He looked at the door and later perched at the plug, but he made no effort to pull it out.

Fifth trial. On the fifth day No. 6 went to the door and looked at the food. Then he ran about the cage. He was totally indifferent to the plug, and although he had been eager to get into the cage he was eager to leave it at the end of the period.

*Imitation tests.*—No. 6 imitating No. 5.—The two animals were in the cage together in each of the following tests.

First test. No. 6 soon discovered the food outside of the glass door and when No. 5 opened it No. 6 got the food. No. 5 punished him several times and No. 6 cried so much that his howling compelled his removal.

Second test. No. 6 was in the cage with No. 5 while she opened the door twenty times. He rarely saw—not more than five times in the twenty. No. 6 learned that the door opened and was inclined to sit in front of it. This turned his back to the plug and he did not see No. 5 pull it. Finally No. 5 drove him away from the door and he saw her pull the plug a few times.

When No. 5 was removed No. 6 went to the door and examined it. Then he ran up to the plug, bit at the end of it, and tried to pull it out. He ran down to the door at once. He climbed to the plug and worked at it with his hands. Several times he repeated this trip from the plug to the door and back to the plug.

Third test. No. 5 was very eager to get the food. No. 6 saw only occasionally—five times in fifteen.

When No. 5 was removed No. 6 gave his first attention to the door. Then he climbed to the plug, but did not work at it. He worked persistently at

the door. Finally he opened the door by working at it directly and got the food.

Fourth test. No. 5 was exceedingly active and after getting food would pull the string a number of times before the door was reset or the food replaced. No. 6 saw her ten times in fourteen.

When No. 5 was out No. 6 became very active about the door, working continuously to get the food. Once he ran up the wire and bit the plug.

Fifth test. At first No. 6 was quite indifferent to No. 5, but he became attentive as he saw No. 5 getting food. When No. 5 pulled the plug the eighth time No. 6 climbed the post and pulled it after her. As he pulled it he looked at the door. This he repeated after the ninth performance also, and again after the tenth.

When No. 5 was removed No. 6 went at once to the door; then he played up the wire and came down again to the door. Then he ran up to the plug and pulled it until he got the door open, two minutes after the removal of No. 5. When the apparatus was reset No. 6 began to work at the door. After one minute he climbed the cage, took one look through the wire, and went back to the door. Then in the midst of vigorous pushing at the door he suddenly stopped, fairly flew up the wire to the plug, and pulled it vigorously until it came out and the door opened. He came down quickly and got the food. He repeated this twice in two minutes. The next time the plug stuck, and although he worked at it vigorously, it was ten minutes before he succeeded in pulling it out. He had run about the cage somewhat during that time. He opened the door once afterward.

TABLE 26.

## No. 6 IMITATING No. 5.

Date.	Number of times No. 5 performed the act.	Number of times No. 6 saw.	Number of times No. 6 saw in part.	Result.	Time in minutes.
July 11.....	8		1	F	10
July 13.....	20	5		F	10
July 13.....	15	5		F	10
July 14.....	14	10		F	10
July 15.....	16	10		S	10
Total.....	73	30	1	S	50

*Summary of Behavior of No. 6 in the Plug Experiment.*

In his first preliminary trial No. 6 gave some attention to the food door and to the plug. His interest in the plug disappeared in the later trials. The second imitation test, which may be reckoned as the first, served to direct his interest to the plug. The third and fourth tests did not seem to increase this interest nor to make it productive of profitable results. The fifth test did show a decided increase of attention to the movements of No. 5, and,

finally, a repetition of those movements. The association between the door and the plug, however, did not seem perfect until after No. 6 had succeeded several times in pulling the plug and in getting food. The tendency of No. 6 was to center his attention on the door and, after failure there, to resort to the plug. This may have been due to the fact that he once got food by working directly at the door.

*General Summary of the Results of the Plug Experiment.*

In nicety of imitative behavior, the Plug Experiment furnishes less satisfactory results than do some of the other experiments. This is no doubt due in part to the fact that the food door and the means of its opening were in different parts of the cage. The two things could not well be within the range of vision at the same time. In transferring attention from the door to the plug the animal usually lost sight of the door. He did not see the imitator pull the plug and at the same time see the result of the pull. In case he saw the plug pulled, his eyes must follow the imitator back to the door in order to see the result. Despite this difficulty, the experiment yielded two cases of behavior in which the influence of the imitator was sufficient to guide the behavior of the observing animals to a successful issue. In the successful behavior there seemed to be an element of accident. It is impossible, however, to explain the conduct of either No. 6 or No. 2 as a case of random movement and accidental success, for prolonged opportunity to solve the problem in this way resulted in failure for each of them. Nor does it seem possible to think that No. 2 or No. 6 repeated the movements of No. 5 merely from seeing her perform the act and without connecting with her act the result which followed it. Each of the animals failed to pull the plug after seeing it pulled, until there had been abundant opportunity to see the performing animal get food.

TABLE 27.

RESULTS OF THE PLUG EXPERIMENT.

I.

Number of animals used in imitation tests.....	2
Cases of successful imitation.....	2
Cases of partially successful imitation.....	0
Cases of failure to imitate.....	0

## II.

Cases of imitation when the imitator was confined during the activity of the imitatee.....	0
Cases of imitation when the two animals were together in the cage.....	2

## III.

Cases of immediate imitation.....	0
Cases of gradual imitation.....	2

## IV.

Cases of imitation in which the imitating animal <i>did not</i> himself experience the result of the act before performing it.....	1
Cases of imitation in which the imitating animal <i>did</i> experience the result of the act before performing it.....	1

## 7. BUTTON EXPERIMENT.

*A. Description of Device.*

In this test the slide door (fig. 8, *a*) used in the Plug Experiment was the place where the animal could get food. It could be opened by a button (fig. 10, *b*) in board *D*, which must be pushed to the right. This button was 8 cm. broad at the largest breadth of its pear shape and 14 cm. long. Its lower edge was 22 cm. from the floor. A string, *c*, fastened to the back part of the button passed through a hole, 5 cm. in diameter, in board *D*, and along the outside of the cage to the slide door. The button was fastened to Board *D* at the top by a small bolt. A small knob fastened to the middle of the button enabled the animal to grasp it easily. A screw eye in the board prevented the button from being pushed to the left. The animal could get food by pushing the button to the right and then passing to the slide door in board *A* which had been opened by the movement of the button.

*B. Behavior of No. 3.*

*Preliminary trials.*—First trial. No. 3 worked at the door, biting the edges for ten minutes. He then walked to the button, gave one bite at it, and came back to the door. Later he repeated this, biting the knob on the button. He climbed the cage a number of times and then sat in the corner of the cage near the food door.

Second trial. On the second day No. 3 went to the door and bit at the edge, but not so vigorously on account of nails that had been driven into the edges of the opening to protect it. He went twice to the button and bit the edges. Then he ran about the cage, and finally rested in the corner near the food door.

Third trial. The third day No. 3 again worked at the food door, biting the edges. Then he went to the button, bit at it and came back to the door. He repeated this behavior four times in three minutes.

Fourth trial. On the fourth day No. 3 paid no attention to the door or to the button.

Fifth trial. On the fifth day he worked at the door for a short time. Then he climbed about the cage and ended the period by sitting in the corner near the button. Once he bit at the button.

*Imitation tests.—No. 3 imitating No. 2.*—Both animals were put into the cage together in each of the following tests.

First test. No. 3 was not attentive to No. 2 at first and was somewhat afraid. He saw four times fairly well. Several times the experimenter prevented No. 2 from opening the door because No. 3 was not watching.

When No. 2 was out No. 3 went to the door and worked vigorously for three minutes. He then went to the button, bit it and pulled as No. 2 had done. He came back to the door at once. Then he returned to the button, bit it, and came back to the door. Later he went to the button a number of times.

Second test. No. 3 was afraid and avoided the door and button while No. 2 was present. No. 2 was very active and opened the door much oftener than No. 3 saw. He saw five times in nineteen.

When No. 2 was out No. 3 worked at the door intermittently for several minutes, going once to the button and biting it.

Third test. No. 2 and No. 3 were on good terms and No. 3 kept near No. 2 and watched him most of the time. No. 2 worked very rapidly, but No. 3 saw him *well*, five times in ten.

When No. 2 was out No. 3 worked at the door for a little time, and then went to the button and pulled it back with his teeth. This movement was different from his previous acts at the button, which were mere bites with no effort to pull. He looked out at the opening behind the button and then went to the door and got food. Time: two minutes after the removal of No. 2. He repeated the entire performance within one minute and six times more within ten minutes.

TABLE 28.

## No. 3 IMITATING No. 2.

Date.	Number of times No. 2 performed the act.	Number of times No. 4 saw.	Number of times No. 4 saw in part.	Result.	Time in minutes.
July 27.....	9	4	2	F	10
July 27.....	19	5	4	F	10
July 28.....	10	5	3	S	10
Total.....	38	14	9	S	30

*Summary of Behavior of No. 3 in the Button Experiment.*

At first No. 3 manifested an interest in the door and in the button, but this interest waned as the preliminary trials were continued, and seemed



entirely gone in the fourth and fifth. It received a decided accentuation in the first test, after No. 3 had seen No. 2 get food four times. In the second test it seemed about the same, but in the third test it led No. 3 to repeat in detail the movements of No. 2 and to secure the same result.

#### *C. Behavior of No. 4.*

*Preliminary trials.*—First test. After four minutes in the cage No. 4 went to the button, put both hands on it, bit at the knob and bottom of the button and turned away. She spent the remainder of the time on the floor of the cage and on the wire. She returned to the door a number of times, but made but little effort to get food.

Second trial. On the second day No. 4 went to the door frequently and occasionally to the button, but she made no effort to manipulate either. She was anxious to get out of the cage.

Third trial. On the third day No. 4 went to the door, but made no effort to get food. Later she smelled at the button, but made no effort to move it.

Fourth trial. On the fourth day No. 4 paid no attention to either the door or the button.

Fifth trial. On the fifth day the behavior of No. 4 was as usual. She bit at the button once or twice in passing and went to the door twice.

*Imitation tests.*—*No. 4 imitating No. 2.*—In each of the following tests both animals were in the cage together.

First test. No. 4 at first was not inclined to notice No. 2. She saw five times in twenty-three. No. 2 was frequently prevented from opening the door until No. 4 was looking. She often saw the door open, but paid no attention to the button or to No. 2. When finally she saw No. 2 push the button, she went immediately and did the same thing. She did it three times more while No. 2 was present.

When No. 2 was out No. 4 worked two minutes at the door and then walked over to the button and pushed it back. This disclosed the opening behind the button and she thrust her hand out. She withdrew it immediately and came back to the door and got food. When the apparatus was reset she went to the button immediately; pushed it back, thrust her hand out and came at once to the door and got food. She repeated this four times. Then she ceased to thrust her hand out, and came immediately to the opened door. Within five minutes she had gotten food ten times.

#### *Summary of Behavior of No. 4 in the Button Experiment.*

The behavior of No. 4 was decidedly changed by seeing No. 2 push back the button. For five days, fifteen minutes per day, she had had the opportunity to get the food by pushing the button, but had not done so. Yet she pushed the button within five seconds after seeing No. 2 do it. There is no evidence as to whether she connected the button with the food at the time. The directness with which she later went from the door to the button, pushed it back and came back to the door to get food would indicate that she had made the connection. That the association was complete after the

second experience is evidenced by the directness and rapidity with which she continued to perform the act.

TABLE 29.

## NO. 4 IMITATING NO. 2.

Date.	Number of times No. 2 performed the act.	Number of times No. 4 saw.	Number of times No. 4 saw in part.	Result.	Time in minutes.
July 27.....	23	5	3	S	10

*D. Behavior of No. 5.*

*Preliminary trials.*—First trial. No. 5 worked at the door; then she climbed the cage and came back to the door. She went to the button and spatting it with both hands. Later she bit at the screw eye, held the button, and bit it. She then turned and pushed it with her feet. Later she grabbed the screw eye in her hand and bit it. After twelve minutes she placed herself opposite the door and plunged against it twice with great force. She went to the button, and, placing herself opposite it, plunged against it twice in the same manner. Then she went to the door and looked. She then plunged against the button and spatting it several times; she went once to the door and looked. Later she bit again at the screw eye; she then went from the door to the button and back to the door.

Second trial. On the second day No. 5 worked at the door for the first four minutes. She then went to the button and spatting it. Later she hooked her tail in the wire about three feet above the door, placed her feet on the board A, and, with head down, she lifted her body out from the board and threw her weight on her hands against the door.

Third trial. On the third day No. 5 went to the door, climbed the cage, and after several minutes went to the button and spatting it. During the remainder of the time she went about the cage in the usual way, paying no attention to the door or the button.

Fourth trial. On the fourth day No. 5 went to the door once. Once she went to the button and taking the screw eye in the left hand spatting the button with the right. She gave no further attention to door or button.

Fifth trial. On the fifth day No. 5 went about the cage mostly indifferent to the door and button. Once she spatting the button and bit it. She spent a little time at the door when she was first placed in the cage.

*Imitation tests.*—No. 5 imitating No. 2 and No. 4.—The animals were in the cage together in each of the following tests.

First test. No. 5 watched No. 2 closely and saw the entire performance five times in ten. The first time she saw No. 2 push the button she followed and pushed it back herself. She did not follow to the food. She did this three times on seeing No. 2 do it and usually missed seeing him get food.

When No. 2 was out No. 5 worked vigorously at the door and then went to the button and pulled at the screw eye and the knob, but not in such a way as to open it. Three times she went to the button and back to the door.

Second test. No. 5 saw No. 2 push the button five times in thirteen, but did not follow him to the food door.

After No. 2 had been taken out No. 5 became quite eager about the door for a minute. She went to the button, but made no effort to move it.

Third test. No. 4 was used instead of No. 2. No. 5 saw No. 4 five times in fifteen. She did not follow her about, but kept out of her way.

When No. 4 was removed No. 5 worked a little while at the door and then played about the cage for ten minutes.

Fourth test. No. 5 was afraid of No. 4 and kept away from her, owing to the punishment No. 4 had given her. She kept close watch on No. 4, however, and saw her move the button back and get food. This she saw ten times in nineteen.

With No. 4 out No. 5 looked through the door at the food, but did not work vigorously. She took her leisure about the cage for ten minutes.

Fifth test. No. 2 was again used. No. 2 pushed the button and No. 5 followed and pushed it, and coming to the door got food. No. 5 retreated to the front of the cage and kept her eyes on No. 2. Each time when No. 2 pushed the button No. 5 came to the door for food. She thus prevented him from getting any, for he was afraid of her. Once (fifth trial) she got food, and immediately went to the button and pushed it back.

No. 5 became much more attentive to No. 2 than at any time previously and her eyes flashed from the door to No. 2 and from No. 2 to the door, and always when he pushed the button she came to the door. After seeing him three times more she went to the button again, pushed it back and went directly to the door for food. This she repeated three times, the first two times coming directly to the door, and the third stopping for a moment to examine the opening behind the button. This she repeated once and then performed the entire act six times, not stopping to make any examination of the button.

#### *Summary of Behavior of No. 5 in the Button Experiment.*

Despite her unusual and persistent activity No. 5 did not once push the button during her preliminary trials. Yet she did push it at once after seeing No. 2 do it. Three times she repeated this, but not once did she go to the food door after doing so. What she had learned seemed to avail her nothing until the fifth test. She then followed No. 2 through his entire act of pushing the button and coming to the door to get food. She maintained a heightened interest in No. 2 during the whole of his ten performances, and by the end of the time was able to get food for herself as she had seen him do it. It should be noted that after pushing the button back and securing no result she ceased to push it during the second, third and fourth tests. Where this conduct reappeared it was connected with the getting of the food.

TABLE 30.

## No. 5 IMITATING No. 2 AND No. 4.

Date.	Number of times No. 2 and No. 4 performed the act.	Number of times No. 5 saw.	Number of times No. 5 saw in part.	Result.	Time in minutes.
July 27.....	10	5		F	10
July 28.....	13	5	4	F	10
No. 5 IMITATING No. 4.					
July 28.....	15	5	3	F	10
July 29.....	19	10		F	10
No. 5 IMITATING No. 2.					
July 30.....	10	10		S	While No. 2 was present.
Total.....	67	35	7	S	

*E. Behavior of No. 6.*

*Preliminary trials.*—First trial. No. 6 was very frantic about the food door. He rushed to where the plug had been in the Plug Experiment and worked at the hole in the post. He looked at the button and put his hands on it, but made no effort to move it. Later he bit at it. He then gave up his efforts.

Second trial. On the second day No. 6 tried the door as before, but on account of nails which had been driven in the edge he could not bite it. Once he went to the button and put his hands on it, and ten minutes later bit at it in passing.

Third trial. The third day there was the usual behavior about the cage. No. 6 worked at the door for several minutes and once pulled at the screw eye. Then he took his leisure about the cage.

Fourth trial. On the fourth day No. 6 was very active at the door, biting and pushing it. Once he grabbed the screw eye in passing. He then played about the cage, going to the door frequently, but not working at it.

Fifth trial. On the fifth day No. 6 tried the door a few times, but not vigorously as on previous days. He bit at the button in passing.

*Imitation tests.*—No. 6 imitating No. 4.—Both animals were in the cage together in each of the following tests.

First test. After the first few minutes No. 6 became afraid of No. 4 and kept away from her. In fifty-five performances No. 6 saw only three times. The first time he saw No. 4 move the button, he followed and did the same thing himself, but did not follow No. 4 to the door. When No. 4 was removed No. 6 went at once to the food door and worked incessantly and with great vigor for five minutes. Once during the time he went to the

button and bit it. He did not come back to the door and he went to many other places in the cage as well as to the button. At other times, when near it he paid no attention to the button.

Second test. No. 6 was not so frightened as in the previous test and remained on the floor near No. 4 five times in nineteen. He saw her push the button and get food. The second and fourth times he saw No. 4 push the button he went to it and looked out at the opening.

When No. 4 was out No. 6 became very active with his teeth and hands at the door. After nine minutes he went to the button and pushed it with his hands, but as the push was directly toward the board, and not to one side, as was necessary to open the door, he did not succeed. Later he put his hand on the screw eye.

Third test. No. 6 watched more attentively than in the first test and saw five times in twenty-seven.

When No. 4 was removed No. 6 worked incessantly at the food door with his hands, feet, and teeth. He used his tail to thrust through the wire when he could not reach around with his hand. Once he thrust his tail around the corner of the cage and caught the string to which the banana was attached. He was not allowed to get food in this way. He paid no attention to the button during the time.

Fourth test. No. 6 was more attentive than on any previous day and saw five times in eleven. After seeing the fourth time he went to the button and pushed with his hand, but not in such a way as to open the door. After the fifth time he bit at the lower edge of the button.

After No. 4 was out No. 6 did not go to the button. He worked more or less intermittently at the door for ten minutes.

Fifth test. No. 4 worked slowly and gave No. 6 a good opportunity to see, but he was not attentive and saw only seven times in forty-one. Then his look was not direct. The first time he saw, he went to the button and looked through the hole behind it.

When No. 5 was out No. 6 got food by fidgeting at the door. Then he worked at the door and once bit the button, but he was not at all active.

Sixth test. No. 6 kept his attention on the door during thirty-two performances, but rarely turned his attention to the button even though No. 4 went from the door to the button and back to the door for food repeatedly. His attention was almost wholly on the door. Ten times in the thirty-two he saw No. 4 push the button.

When No. 4 was out No. 6 became very eager at the door and continued so for ten minutes, but did not once go to the button.

Seventh test. No. 6 was quite indifferent to all the movements of No. 4. He often looked at the door as No. 4 left it to go to the button. It was not clear whether No. 4's leaving the door suggested that the door was about to open, or whether No. 6 was all the time interested in the door and showed his interest only when No. 4 left the way clear. He saw five times in thirty-five and then only by glances.

When No. 4 was out No. 6 became at once interested in the door and worked at it most of the time for five minutes. Then he ran about the cage, but paid no attention to the button.

Eighth test. No. 5 was used instead of No. 4. No. 6 was not at all attentive to No. 5. At times he watched the door when No. 5 went to the button. He was not afraid of No. 5, so did not run away. No. 5 worked rapidly and moved the button with wide movements of her arms. No. 6, however, showed no interest in the button.

When No. 5 was out No. 6 paid no attention to the button and but little to the door.

Ninth test. No. 6 was very indifferent to the movements of No. 5 except at the door. He often saw No. 5 get the food at the door and twice got food there himself. The movement of No. 5 from the door to the button and back to the door apparently meant nothing to him.

When alone No. 6 worked intermittently at the door for ten minutes, but did not notice the button.

Tenth test. No. 6 saw five times in the twelve that No. 5 opened the door.

When No. 5 was removed No. 6 became busy at the door, but paid no attention to the button during ten minutes.

*Summary of Behavior of No. 6 in the Button Experiment.*

What No. 6 saw in the Button Experiment seemed to profit him nothing. Once he repeated the movement of No. 4 in pushing back the button, but he did not at that time nor later connect the button with the food door. At no time did he give good attention to what was done in his presence, in the ten tests seeing only fifty-one out of three hundred and three performances.

TABLE 31.

NO. 6 IMITATING NO. 4 AND NO. 5.

Date.	Number of times No. 4 and No. 5 performed the act.	Number of times No. 6 saw.	Number of times No. 6 saw in part.	Result.	Time in minutes.
July 27.....	55	3	2	F	10
July 28.....	19	5		F	10
July 28.....	27	5		F	10
July 29.....	11	5	3	F	10
July 29.....	41	7		F	10
July 30.....	32	10		F	10
July 30.....	35	5		F	10

NO. 6 IMITATING NO. 5.

July 30.....	50	3		F	10
Aug. 2.....	21	3	10	F	10
Aug. 13.....	12	5		F	10
Total.....	303	51	15	F	100

*General Summary of the Results of the Button Experiment.*

Taken as a whole the Button Experiment gives three cases of imitation, no one of them immediately successful in detail. In the cases of No. 4, No. 5 and No. 3, there was an immediate modification of behavior, but in no case was there an exact repetition of the behavior of the performing animal. It did not require many repetitions of the act, however, for each animal to learn to perform the act perfectly.

TABLE 32.

## RESULTS OF THE BUTTON EXPERIMENT.

## I.

Number of animals used in imitation tests.....	4
Cases of successful imitation.....	3
Cases of partially successful imitation.....	0
Cases of failure to imitate.....	1

## II.

Cases of imitation when the imitator was confined during the activity of the imitatee.....	0
Cases of imitation when the two animals were together in the cage.....	3

## III.

Cases of immediate imitation.....	0
Cases of gradual imitation.....	3

## IV.

Cases of imitation in which the imitating animal <i>did not</i> himself experience the result of the act before performing it.....	3
Cases of imitation in which the imitating animal <i>did</i> experience the result of the act before performing it.....	0

## S. STRING EXPERIMENT.

*A. Description of Device.*

From the top of the experiment cage (fig. 11) strings 1, 5, 6, and 7 were dropped downward along each of the corner posts to within 18 cm. of the floor of the cage. Along the back of the cage and 15 cm. apart were suspended three other strings, 2, 3, and 4, in like manner. To the lower end of each string was fastened a small knob, *k*. In the following observations on the behavior of the animals *2t* indicates the second string at the place where it enters the cage, and *2k* indicates the knob attached to the end of the second string.

In the lower part of board *B*, 6 cm. from the floor, was a circular opening, *L*, 5 cm. in diameter. On the outside of the board was a square chute (fig. 12, *a*), the bottom of which, *b*, was level with the bottom of the circular opening, *L*. In the chute, a little way above the opening, was a trap door, *c*, which could be opened by a lever, *d*, to which could be fastened any one of the seven strings above described. In this experiment, string 2 was so attached. By pulling this string the animal on the inside of the cage could open the trap door in the chute and thus cause the food on the door to fall to the bottom of the chute or roll out into the cage through the opening in board *B*. In either case the monkey could get it.

### *B. Behavior of No. 13.*

*Preliminary trials.*—First trial, August 14. When No. 13 entered the cage he went at once to *L* and looked at the opening. He then went to *6k* and, taking it in his hand, bit it, dropping it after the first bite. Recrossing to *1k* he did the same thing, immediately afterward climbing the wire end of the cage. Returning to the floor he went to 5 and to *L*, thence crossing the floor to 6, biting *6k* and recrossing to *2k* and biting it. He then moved about as follows: up the wire; around to 6; back to 1; on the wire; to the floor; to *2k* and bit; thrust his hand into *L*; to *5k* and bit; to *4k* and bit; to the small door and pushed; to *7k* and bit; to 2 and started to climb, but turned his attention to 1 and 3; thrust his hand into *L*; to the door and to 5; across to 7 and up the wire to *X*. The time for the above described behavior was four minutes.

He then continued as follows: perched at *X*; to the floor; to the door and chewed the edges; up to *X* and perched; to the floor; thrust hand into *L*; up to *X*, perched and played with 7; to 1; back to 7 and to the floor; to 6 and looked at it; around to *L* and looked; on around to 7 and up to *X*; to the floor; to 5; up to the top of the cage and examined the hole in the top; to the floor; to 4 and to 7; up to *X*; to the floor, the door, and back to *X*; pulled 7 up to him; about the wire front; to the floor and about the floor to *3k*, which he took in his hand; up to *X*; to the floor; to the door and carried *6k* up to *X*; to the floor and to *2k*; carried *2k* in his hand up to *X* and looked it over; then to the floor and around the cage to 5, 4, 3, and 2 in succession. He gave a jerk at 2 and dropped it.

Second trial, August 15. No. 13 was active as on the previous day, but spent more time in looking and less in running about. He first ran up and down the wire several times; then he went to *L* and looked in. His later movements were as follows: up the wire; to the floor; to the door and bit at the edges; to *L* and looked; up the wire to the brace and back to the floor; to the corner post at *5k* and bit the post; up the wire and bit at it; down to the floor and again up the wire on the front of the cage; perched at *X* for some time and then went to the floor and bit *1k*; carried *1k* up to *X* and worked with it; bit the knob and the end of the string; pulled *7k* up to *X* and chewed it; then went to the floor and walked about; carried *1k* up the side of the cage; after some time returned to the floor, bit at *5k*; carried *2k* up the wire to *X* and farther up the wire.



In none of his movements did he display the same eagerness and expectation as in the previous trial.

Third trial, August 17. On this day No. 13 was even less active than on the second day. He went up the wire to the brace and returned to the floor, going to the door, pushing on it and passing around to *L*. He then carried *2k* up to *X* and bit at the string, dropping it almost immediately. Then he climbed the wire, but returned to *X*, where he perched and remained for some time looking about the cage. Later he went to the floor and examined all around the edge of the floor, but soon returned to *X*, where he remained for some time again. Twice later he climbed the wire to the top, but spent all the rest of his time at *X*, looking about the inside of the cage and out through the wire.

Fourth trial, August 18. The behavior of No. 13 was about the same as in the preceding trial; he climbed to *X* and returned to the floor; he touched *5k* and *4k*; then he carried *2k* up to *X* and bit at the string, dropping it after a moment. For several minutes he sat at *X*. Then he drew *7k* up to him and worked at it for some time. At first he worked directly at the knot and made some progress toward untying it. Then, as if discouraged, he began biting and pulling the protruding end of the string. At the end of several minutes' continuous work he dropped *7k* and went to the floor, tried to climb the post at 5 and passed on to *2k*, which he carried up to *X*, where he chewed at the knot in the string. After a moment he let it drop and swing back to its place. Two minutes later he went to the floor and to *L*, at which he looked intently. Climbing the wire to *X*, he perched for the remaining few minutes he was in the cage.

Fifth trial, August 19. No. 13's behavior was about the same as on the previous day. He climbed up and down the wire several times and examined around the edge of the floor. Carrying *2k* up to *X*, he bit at the knot once and dropped it. Then he played up and down the wire, and going to the door tried to open it, afterwards carrying *6k* up to *X*, biting it and dropping it when he climbed higher up the wire. He climbed to the upper part of the wire and chewed at the edges of the cage frame, but quit when spoken to. Again he carried *6k* up the side and end of the cage, dropped it, and settled at *X* for several minutes. Later he went to the floor, to *L*, to the door and carried *6k* up to *X*. He dropped it at once and remained quiet. Once again he went to the floor and carried *2k* up to *X*, where he chewed the string and licked the knob.

*Imitation tests.*—No. 13 imitating No. 5.—First test. No. 13 was put into the observation-box and the box was placed on the floor of the experiment cage exactly in front of *L*. This position enabled No. 13 to see all the movements of No. 5 in getting food. No. 5 was free in the cage. The two animals had never been together before and No. 5 was much frightened. Instead of working at getting food she crouched in the corners of the cage and occasionally dashed at No. 13 as if to frighten him. Once No. 5 ran up the wire end and leaning over to *2t* pulled it with her teeth. No. 13 did not see the pull, but he saw No. 5 leaning over to the place. He became demonstrative, and No. 5 did nothing but crouch for several minutes. The observation-box

was then moved farther away from *L*, and No. 5 went to *L* and got food. No. 13 saw her get it. He was very impatient and tried repeatedly to get out of the box, working at the door and shaking the box vigorously. No. 5 again waited and after some time went cautiously to *2k*; she took it in her hand, but did not pull with sufficient strength to drop the food. No. 13 saw her do this. For some time No. 5 refused to work on the floor, but she attempted to get to *2t* several times. This she was prevented from doing. Finally she became accustomed to the presence of No. 13 and moved about the floor freely. She then became very eager to get food. Within a few minutes she had operated the mechanism seven times. The record for No. 13 was as follows:

Performance 1. No. 13 saw well.

P. 2, P. 5, and P. 6. No. 13 did not see.

P. 3, P. 4, and P. 7. No. 13 saw and was eager to get out of his box.

If we count the times No. 5 pulled the string, but did not get food, No. 13 saw the performance five times, four of which he saw entire and one in part.

No. 5 was now removed from the cage and No. 13 was released. At once he climbed the end of the cage to *2t* and taking it in his teeth, he pulled it several times. Then he went to the floor and walked about; after some time he went to *L* and got the food that had dropped when he pulled *2t*. When the food had been eaten he climbed to *2t* and pulled the string with his teeth. The dropping of the food made a noise, but No. 13 did not notice it. After several more pulls he went down to *X* and sat there for a short time. Then he went to the floor and walked about, later going to *L* and discovering the food. Stowing it in his cheeks he went up to *X* and ate it. When it was gone he wanted to go up to *2t* again, but was not allowed to do so. He then perched at *X*, and looked about for some time. Going to the floor, he stopped at *L*, looked in, took hold of *2k*, dropped it, looked at *L* again and walked away. He climbed to *X*, and returned to the floor after a little while. He took *2k* in his hands, dropped it and looked into *L*. Then he carried *2k* up to *X* and played with it.

Second test. The conditions were the same as before. No. 5 was not so frightened and worked at once. The record of No. 13 was:

Performance 1. No. 13 saw very well.

P. 2, P. 5, P. 6. No. 13 did not see.

P. 3 and P. 4. No. 13 saw well.

P. 7 and P. 8. No. 13 saw No. 5 get food, but did not see the pull.

P. 9. No. 13 saw, but did not seem attentive.

Of the nine times that No. 5 got food No. 13 saw the whole performance four times and in part twice. No. 5 was then removed and No. 13 was released. At once he went to *L* and got a grain of sunflower seed that No. 5 had left, and carrying it up to *X*, ate it. He then wanted to go to *2t*, but was not allowed to do so. He went down to the floor and to *L*, merely looked at it and passed on to the door. He returned to *L* at once. Searching about he found another seed, which he carried up to *X* and ate. When the food was gone he attempted to go up to *2t*, but was prevented. He went to the floor and walked about, going to *L* twice. Once he looked at *2k*, took

it in his hand, but did not pull. After looking at it a moment he carried it up to *X*, where he bit at it and dropped it. Then he went to the floor, walked about, and climbed back up to *X*, where he remained during the remainder of the time.

Third test. This test was made immediately after the previous one and the conditions were the same. The record of No. 13 was:

Performance 1 to P. 5. No. 13 saw the whole performance and was very savage in his demonstrations toward No. 5, jumping at the side of the cage with wide-open mouth.

Only twice did No. 13 turn his head away from No. 5 and then only for a moment each time.

No. 5 was now taken out and No. 13 was released. He was very slow of movement walking about the floor. Twice he went to *L*, and then climbed the wire to *X*, where he perched for a little while. Going to the floor, he passed the door and thence to *L*, looking into the hole several times. In one hand he took *3k* and in the other he took *2k*, but did not pull at either. Dropping both he climbed the end of the cage, but returned at once to the floor. Stopping at *L*, he clawed the opening with his hand and then climbed the wire to the brace. Going to the floor he tried the door where he had entered the cage and went to *L*, returning again to the door.

For several minutes he worked at the door trying to open it. Once he stopped to turn about and look in at *L*, but renewed his efforts at the door immediately. Giving up opening the door, he went to *L*, took *3k* in his hands, dropped it and started to carry *2k* up the wire, but dropped it; climbed to *X* and perched, playing with *7* and *7k*.

Fourth test. Conditions were the same as in the previous test. The record of No. 13 was as follows:

Performance 1. No. 13 saw plainly.

P. 2. No. 13 did not see and did not seem to be interested as on the day before.

P. 3. and P. 4. No. 13 saw.

P. 5. No. 13 saw very well.

P. 6 and P. 7. No. 13 did not see.

When No. 13 was released he at once climbed to *X*, returning to the floor immediately. Going to *L* he looked in and put his hand into the opening. Passing up by *X*, he tried to get up to *2k*, but was not allowed to do so. He returned to the floor and walked about; climbed to *X* again; and, returning to the floor, he went to *L* and looked in. He then climbed to *X* and up and down the wire end of the cage. Once again he went to *L* and put his hand into the opening.

Fifth test. No. 5 and No. 13 were put into the cage together this time.

Performance 1. No. 13 was at *X* when No. 5 pulled the string the first time; he saw her pull and saw her get food. Climbing down he got the food which No. 5 had not yet eaten. He then became very threatening and No. 5 was frightened.

P. 2. No. 13 saw again from *X* and got the food as before. No. 5 was still afraid of No. 13, who was threatening. When No. 13 had eaten the

food he did not climb the cage as before, but kept near *L*. Only once did he go up, and then to chase No. 5.

P. 3. While No. 13 was at the brace after chasing No. 5 down No. 5 pulled the string. No. 13 saw this and after a moment he went to *L* and got the food. From this on he came to the floor whenever he saw No. 5 near *L*. In her turn No. 5 assumed a threatening attitude toward No. 13.

P. 4. No. 13 saw perfectly from the brace and came slowly down and got the food. No. 5 was not inclined to eat the seeds, having an appetite only for grapes.

P. 5. No. 13 saw while on the floor. No. 5 got the grapes and No. 13 got the seeds.

P. 6. No. 5 pulled the string while No. 13 was climbing the wire. He jumped to the floor and rushed to *L*; No. 5 fled up the wire.

P. 7. No. 5 pulled the string when No. 13 was eighteen inches away. He rushed to *L* and got the grape. A moment later when No. 5 went near the opening, No. 13 rushed to the place and kept such a close watch that for some time No. 5 could not get near *2k*.

P. 8 to P. 10. No. 13 saw from *X* and drove No. 5 away before she could get the food.

P. 11. No. 5 got the grape and No. 13 got the seeds and went up to *X* to eat them.

No. 5 was now removed. No. 13 finished eating the seeds he had gotten and then went to the floor, to *L*, and back up to *X*. He spent almost the entire ten minutes at *X*. Near the end of the time he went to *L* and examined it carefully. Then he looked up at knobs *2k* and *3k*, put his hand on *2k*, took it off, and looked back at *L*. He then climbed to *X*, returned to *L*, and went back to *X*.

Sixth test. No. 13 and No. 5 were put into the cage together again. No. 5 was afraid of No. 13 and kept away from him.

Performance 1. No. 5 pulled the string and got the food. No. 13 saw from the wire near the top of the end of the cage. Coming quickly to the floor, he searched *L* vigorously.

P. 2. No. 5 pulled the string. No. 13 saw plainly and went to *L*. He tried to get food, but No. 5 had taken it.

P. 3. No. 13 saw while on the floor near *L*, and going to the place searched a long time for food. Twice he put his hand on *2k*.

P. 4. No. 13 kept near No. 5 at *L*, and when she pulled the string she had to reach her arm over the head of No. 13. His whole attention was on her movements and he saw perfectly.

P. 5. No. 13 was beside No. 5 at *L* and saw perfectly. He got the grape and frightened No. 5 away.

P. 6. No. 13 saw perfectly, got the food and sat by *L*, so No. 5 did not return. Once he put his left hand on *2k* and straightened out his arm as if to pull, but he did not exert much force on the string. Immediately he thrust his other hand into *L*. Again he took *2k* in his left hand, straightened his arm as before, immediately afterward thrusting his right hand

into *L*. A third time he put his left hand on *2k*, straightened his arm and followed this action by thrusting his right hand into *L* as before. He then went away from *L*.

P. 7 to P. 10. No. 13 watched No. 5 carefully and drove her away from the food, which he ate. He then went up to *X* and watched No. 5. When she went near *2k* he dashed for *L*.

No. 5 was now removed and No. 13 was left alone in the cage. Not all the food that No. 5 had brought down had been eaten, and No. 13 continued eating, going to *L* to get the seeds and climbing to *X* to eat them. When he could find no more food he sat at *L* and scratched the edge of the opening with his hand. Then he grabbed *2k* and pounded it against the board; taking *3k* in his right hand and *2k* in his left, he pounded them together; afterward he did the same with *2k* and *1k*. He then went up to *X* and perched for a moment, but almost immediately went to the floor and to *L*. Thrusting his hand in he searched for food and then looked into the opening intently. Looking up, he took hold of *2k* with his left hand and pounded the board with it vigorously, then bit it and dropped it. Taking *2k* in his hands he went up to *X*, dropping the string as soon as he was settled on the brace. His eyes turned at once to *L* and he went down to it and searched for food; he picked up *2k* in both hands and looked at it carefully; then he pounded the board with it. Dropping it he went up to *X*, returning at once to *L*; he grabbed *2k* in his hand, put it gently against *1k* and dropped both of them; he returned to *X*, and, coming down to *L*, he did the same thing over with *2k* and *1k*. He went up to *X* and tried to go up to *2t*, but was prevented. He then perched at *X*, looking at *L* for one minute. He was intent on the getting of food at *L*, but he seemed puzzled. After looking intently at *L* and the strings he went to the floor and to *L*, stopping to sit down and look the string and opening all over. Then he again went up to *X*.

Again No. 13 left his place at *X* and went to the door, pushing on it in an effort to get out. Being unable to get out, he turned away from the door to *L* and sat down in front of it. Quite slowly he looked it all over and, in the same deliberate manner he looked up to *2k*, took hold of it with his left hand and gave a steady and vigorous pull. The food dropped to the bottom of the chute and his right hand shot into the opening and pulled it out. The food was soon eaten and No. 13 immediately pulled the string again with his left hand, getting the food in the same way as before. Without once leaving his place, he pulled the string six times, eating the food between the pulls. While eating the food the third time, he put his hand up to *2k* several times, but he did not pull hard enough to get the food. When his food was gone, however, he pulled the string with a jerk and the food came. Repeatedly he dallied with the string in this manner while eating the food, but he never failed to give a vigorous pull when the food was gone. For fifteen minutes he sat before *L*, getting food repeatedly. He pulled the string fourteen times in addition to the ones already mentioned, a total of twenty times in all. The time from the removal of No. 5 until No. 13 got food the first time was twelve minutes.

TABLE 33.

## No. 13 IMITATING No. 5.

Date.	Number of times No. 5 performed the act.	Number of times No. 13 saw the entire performance.	Number of times No. 13 saw in part.	Result.	Time in minutes.
Aug. 25.....	7	4	1	F	10
Aug. 25.....	9	4	2	F	10
Aug. 25.....	5	5		F	10
Aug. 26.....	7	4		F	10
Aug. 26.....	11	9		F	10
Aug. 27.....	10	10		S	12
Total.....	49	36	3	S	62

*Summary of the Results of the String Experiment.*

After No. 13 had failed to solve the problem in his preliminary trials, he was allowed to see No. 5 pull the string. During the first tests he was confined in the observation-box. After four tests he still failed, when left alone in the cage. He was then put into the experiment cage with No. 5. The two animals were strange to each other, and No. 13, being the larger, was inclined to follow No. 5 about the cage, punishing her as opportunity offered. Because of this, he was usually near No. 5, when she pulled the string, and often frightened her away before she could get the food. After she had been removed, No. 13, repeatedly searched the food opening, and worked alternately with the three strings nearest the food opening. He seemed to have associated the strings with the getting of food.

When No. 5 was put back into the cage, No. 13, was more attentive than formerly. After No. 5 had been removed, No. 13, worked more continuously at *L* and at the strings. He now singled out string 2 from the others. He grabbed the knob at the end of the string, in his hands; he pounded it against the board, carried it up the wire, and pounded it against the knobs attached to the other strings. Frequently, during this behavior he dropped the string and searched *L* for food. He had advanced one step in his learning. It was not strings that were associated with the getting of food, but it was a particular string.

The only possible explanation for this centering of attention on a particular string, was that No. 13 was imitating the act of No. 5. By repeated and varied effort, No. 13 finally repeated in exact detail the behavior he had witnessed.

TABLE 34.

## RESULTS OF THE STRING EXPERIMENT.

## I.

Number of animals used in imitation tests.....	1
Cases of successful imitation.....	1
Cases of partially successful imitations.....	0

## II.

Cases of imitation when the imitator was confined during the activity of the imitatee.....	0.
Cases of imitation when the two animals were together in the cage.....	1

## III.

Cases of immediate imitation.....	0
Cases of gradual imitation.....	1

## IV.

Cases of imitation in which the imitating animal <i>did not</i> himself experience the result of the act before performing it.....	0
Cases of imitation in which the imitating animal <i>did</i> experience the result of the act before performing it.....	1

## V. GENERAL SUMMARY OF RESULTS AND CONCLUSIONS.

*Cases of Imitation.*

(a) *With Respect to the Several Experiments.*—The seven experiments (Chute Experiments A and B are counted as one) to which the several animals were subjected, yielded a total of sixteen cases of successful imitation, three of which were immediate, and five cases of partially successful imitation. No one of the experiments failed to yield at least one case. Four of the experiments yielded imitation, successful or partially successful, for every animal given the full series of tests (100). The other three gave a total of five failures.

In tabular form this appears as follows:

	CASES OF IMITATION.	CASES OF FAILURE TO IMITATE.
Chute Experiment A and B.....	5	2
Rope Experiment .....	4	0
Paper Experiment .....	3	0
Screen Experiment.....	3	2
Plug Experiment .....	2	0
Button Experiment .....	3	1
String Experiment .....	1	0
	—	—
TOTAL .....	21	5

(b) *With Respect to the Individual Animals.*—Of the eleven animals used, all but two exhibited imitative behavior. These two were given the full series of imitation tests and are recorded as absolute failures. Of the nine animals which exhibited imitative behavior, seven were successful in each experiment in which they were used. No. 3 succeeded twice and failed twice; No. 6 succeeded four times and failed once. No. 5 made the best record, solving three of the problems alone or with slight help from the experimenter and learning all the others (four) by imitation. The record of No. 2 is almost the same, but he required more aid from the experimenter in learning one of the tricks. No. 4 learned two tricks alone, failed on two, and learned three by imitation. No. 9, No. 10, and No. 11, each had one opportunity to manifest imitative behavior, and no one of them failed to do it. No. 13 had two opportunities and imitated in both cases.

On the basis of their ability to learn by imitation the animals may be arranged in three classes.

The first includes those animals which did not manifest a failure. Here would come No. 2, No. 4, No. 5, No. 9, No. 10, No. 11 and No. 13.

In the second group are the animals which succeeded in some tests and failed in others. Here are No. 3 and No. 6.



The third group contains those animals which failed to manifest imitative behavior. Here are No. 1 and No. 8.

The accompanying table exhibits the records of the individual animals.

TABLE 35.  
RECORD OF INDIVIDUAL ANIMALS.

Number.	No. of experiments learned independently.	No. of experiments in which imitation tests were given.	Cases of imitation.	Cases of failure to imitate.
No. 1.....	0	1	0	1
No. 2.....	2	3	3	0
No. 3.....	1	4	2	2
No. 4.....	2	3	3	0
No. 5.....	3	4	4	0
No. 6.....	1	5	4	1
No. 8.....	1	1	0	1
No. 9.....	0	1	1	0
No. 10.....	0	1	1	0
No. 11.....	2	1	1	0
No. 13.....	2	2	2	0

(c.) *With Respect to the Several Species.*—The number of cases of imitation per species is of interest. The results show that the tendency to learn by imitation is not confined to any one species or genus among those studied. The number of animals used is too small and the variation in the number of experiments to which the several animals were subjected is too great for these results to have any significance in showing the relative imitative ability of the various species.

<i>Cebus</i> (6 specimens) .....	17
<i>Cebus lunatus</i> (2 specimens).....	7
<i>Cebus fatuellus</i> (1 specimen).....	3
<i>Cebus capucinus</i> (1 specimen).....	4
<i>Cebus flavus</i> (1 specimen).....	1
<i>Cebus hypoleucus</i> (1 specimen).....	2
<i>Macacus</i> (3 specimens) .....	4
<i>Macacus rhesus</i> (2 specimens).....	2
<i>Macacus cynomologus</i> (1 specimen).....	2

Of the two animals which failed one was a *Cebus lunatus* and the other was a *Cebus hypoleucus*.

TABLE 36.

## THE RESULTS OF THE SEVEN EXPERIMENTS.

I.	
Number of animals used in imitation tests.....	*26
Cases of successful imitation.....	16
Cases of partially successful imitation.....	5
Cases of failure to imitate.....	5
II.	
Cases of imitation when the imitator was confined during the activity of the imitatee.....	8
Cases of imitation when the two animals were together in the cage.....	13
III.	
Cases of immediate imitation.....	5
Cases of gradual imitation.....	16
IV.	
Cases of imitation in which the imitating animal <i>did not</i> himself experience the result of the act before performing it.....	11
Cases of imitation in which the imitating animal <i>did</i> experience the result of the act before performing it.....	10
V.	
Cases of imitation where the result of the act was obtained at the place where the act was performed.....	16
Cases of imitation in which the act was performed at one place and the result was obtained at another place.....	5

\*Counting each animal once for each experiment in which it was used.

## 2. Features of Imitative Behavior.

(a) *Relation Between Animals.*—It is significant to note that imitation did not always occur between animals thoroughly accustomed to each other. It might be supposed that congeniality between animals was a good condition for imitation, but that this is not necessarily so the results of my experiments seem to indicate. As I shall show later, familiarity tends to lessen attention, to make each animal follow its own tendencies. Strangeness and a certain amount of pugnacity seem effective in arousing attention, which is the first condition for imitation. In the String Experiment No. 5 was a total stranger to No. 13 and the latter was highly attentive

to her every movement. The same is true of No. 2 and No. 4, of No. 4 and No. 11 and of No. 4 and No. 13 in the chute experiment. The cases of imitation between animals wholly congenial are less than one-half of the cases recorded.

(b) *Levels of Imitative Behavior.*—Monkeys react to the presence of one another in various ways. At least four levels of reaction are well defined. The first of these is characterized by the simple arrest of attention. One animal walks across the floor of the cage or climbs a pole, and another animal looks in its direction. That monkeys manifest this sort of reaction requires no extended experimentation to prove. Every moving object, and much more, every moving monkey catches their attention. In my investigation the cases where animals failed to respond in this way may be grouped into two classes. The first group has to do with animals which, through being caged together, had become thoroughly accustomed to each other's behavior. No. 6, who had lived in a cage with No. 4, often seemed unaffected by her conduct when he was put into the experiment cage with her. He would go about the cage hunting food and pay no attention to the actions of No. 4 who might be getting food at the time. If, however, under the same circumstances, No. 2, a strange animal, was substituted for No. 4, No. 6 would become alert and apparently see everything No. 2 did. There were other cases of the same sort.

The other group of cases are those in which one animal had whipped another. The whipped animal usually attended to his enemy only to avoid him. When the latter's attention was directed toward some object in a distant part of the cage, the vanquished animal went about hunting food for himself and did not see what the other animal did. It was, of course, quite otherwise with the bully. He was usually inclined to watch his victim, unless something more interesting presented itself.

These cases in which the attention of a monkey was not attracted by the act of another monkey seem explainable by the circumstances under which they occurred. They serve, therefore, to emphasize more strongly the point that monkeys do tend to give attention to the acts of one another. Since such attention is the invariable ante-

cedent of any behavior that may be called imitative it is important to note that it exists.

A level of social response more advanced than mere *looking* is *following*. Here again, it requires but little observation of monkeys to show that the tendency to follow is very strong, especially among the *Cebus* monkeys.

More complicated than mere *looking* or *following* is behavior of this sort: One animal performs an act, gets food in a given locality and goes away. Another animal which observes this behavior goes, immediately after, to that locality, as if to get food. What the second animal does in that locality seems at this level of behavior to have no relation to the behavior of the first animal. There were numerous instances of this sort of behavior among the animals which I have studied. In the Screen Experiment, in particular, there were clear cases. No. 5 repeatedly went to the corner of the cage where No. 4 had gotten food by lifting the screen. The same was true of No. 2, but in neither of these cases did the imitating animal repeat the behavior of No. 4 with sufficient definiteness to succeed. In Chute Experiment B, No. 11's attention was directed to the chute but not to the end of it. When we take account of the fact that No. 5, No. 2, and No. 11, in the instances noted, changed their behavior either in form or in strength from what it had previously been, it is fair to speak of their behavior as imitation. This is the simplest form of behavior to which I have applied the term in this paper. In such cases I have spoken of partially successful imitation.

More clearly entitled to be called imitation is that behavior in which the animal responds to an imitator, not only by going to a definite locality, but by attacking a particular object. In his imitation test in Chute Experiment B, No. 13 went at once to the end of the chute, thrust his hand up the inside, grasped the string, and pulled. The same was true of No. 4, and of No. 6 in the same experiment, of No. 6 in the Rope Experiment and of No. 4 in the Button Experiment. In these cases, attention was centered on a definite object. This investigation presents a number of other cases of similar behavior. It was not always true that when a monkey

attacked the right object he repeated the movement of the imitator in detail. The impulse seemed to be to do something to the object, and the imitating animal used his hands and teeth interchangeably. As a result the behavior of the imitator was often ill adapted to secure the profitable result. Repetition of the act usually refined such behavior until it was correct.

The most perfect type of imitation is exact repetition in detail of the act of the imitator. The case of No. 13 in the Chute Experiment already cited is an example. So also is the behavior of No. 3 in the Button Experiment, and of No. 6 in the Rope Experiment. The investigation furnishes a number of other cases which are approximately as good.

(c) *The Stimulus to Imitative Behavior.*—Some of the animals which I have studied learned to manipulate mechanisms unaided. No. 2 did this with the chute, No. 4 did it with the screen, and a number of the monkeys learned to get food by tearing the paper. In the case of the Paper Experiment and in the case of No. 2 in the Chute Experiment, the stimulus was the mechanism itself. That the mechanism was not a sufficient stimulus in many cases is evident from the large number of failures to learn unaided which the investigation furnishes.

In the Chute Experiments eight different animals were given the preliminary trials and of these six showed no interest in the end of the chute, most of them not even going to it. This, of course, does not prove that they might not have learned how to get food if the trials had been indefinitely prolonged, nor is it necessary to prove this latter thesis in order to interpret the behavior of the monkeys as imitation. What these preliminary tests do establish is *the improbability that a sudden change of behavior should occur in the sixth trial with 70% of the animals used.* For the stimulus to this sudden change we must look to something other than the mechanism itself.

It may not be out of place at this point, to say a word in reply to a criticism often made upon the use of animals kept in a zoölogical garden. The criticism is, that such animals have had innumerable opportunities to learn to do acts about which the experimenter can-

not know, and hence he cannot tell what causes his animals to act as they do. This criticism does not hold against this investigation for every animal was given abundant opportunity to manifest his random activities and to exhibit his stock of tricks. That the situations were unfamiliar is evidenced by the animals' repeated failures to learn. That this criticism is less important than it has been made to seem is evidenced by two facts which come out in this study. First, of the two animals which made the best records in the investigation, No. 5 and No. 2, one had been in the garden several years, the other had never been in the garden until June, 1908, when he was shipped there from Cambridge. He had been bought from a dealer and was presumably fresh from the forest. The other fact is that not one of the Park monkeys learned to work the chute unaided, whereas No. 2 did.

The additional stimulus in the imitation tests was an animal working at the mechanism and food coming from the mechanism. The relative value of these two elements in the imitation-stimulus, this investigation does not show. That in certain *cases the presence of the animal was necessary*, there is sufficient evidence. The behavior of No. 6 in the Screen Experiment is a case in point. No. 6 had seen the screen lifted in the Paper Experiment. Immediately thereafter, he had torn the paper and obtained food. He had done this repeatedly and thus had learned that there was food behind the screen. Yet throughout his entire preliminary trials he failed to lift the screen. It was only after he had seen No. 4 get food by lifting the screen that he did the act himself.

The case of No. 5 in the Button Experiment illustrates the same thing. She had had a great deal of experience with the slide door. Over and over she had served as the imitatee in the Plug Experiment and had eaten more than a dozen bananas which she had gotten after opening the door. Yet she was helpless to get the food when the door was opened by the button. She learned to push the button by watching No. 2 push it.

On the other hand, *there is evidence to show that in certain cases the behavior of the animal unaccompanied by any profitable result is not sufficient to produce imitation.* In general, the monkeys did

not display much tendency to repeat the *mere acts* of other monkeys. That they did not imitate in this way may have been due to the conditions of the experiments. Where opportunity was given for imitation, food was given as a reward. It often happened that when the attention of the imitator was only slight it would be greatly accentuated when the imitatee began to get food. No. 10 and No. 11 were kept in the same cage. No. 10 whipped No. 11 and treated him with indifference. Yet when she saw him get food in the Paper Experiment, she at once showed an accentuation of the objective marks of attention. In the Rope Experiment, No. 2 was indifferent to the behavior of No. 3 until he saw No. 3 with food and his attention was not drawn to the food door until he saw No. 3 get food there. His interest in No. 3 steadily increased until he got food for himself. The same comment may be made upon the behavior of No. 3 when watching No. 2 in the Paper Experiment. In general, No. 4 lorded it over No. 6 and No. 5 when in the living cages, but she invariably became attentive to them when she saw them getting food in the experiment cage.

Thus the facts would indicate that not only the act of the animal, but also the profitable result of that act was a necessary factor in producing imitation. By further experimentation I hope to discover the relative importance of these two elements.





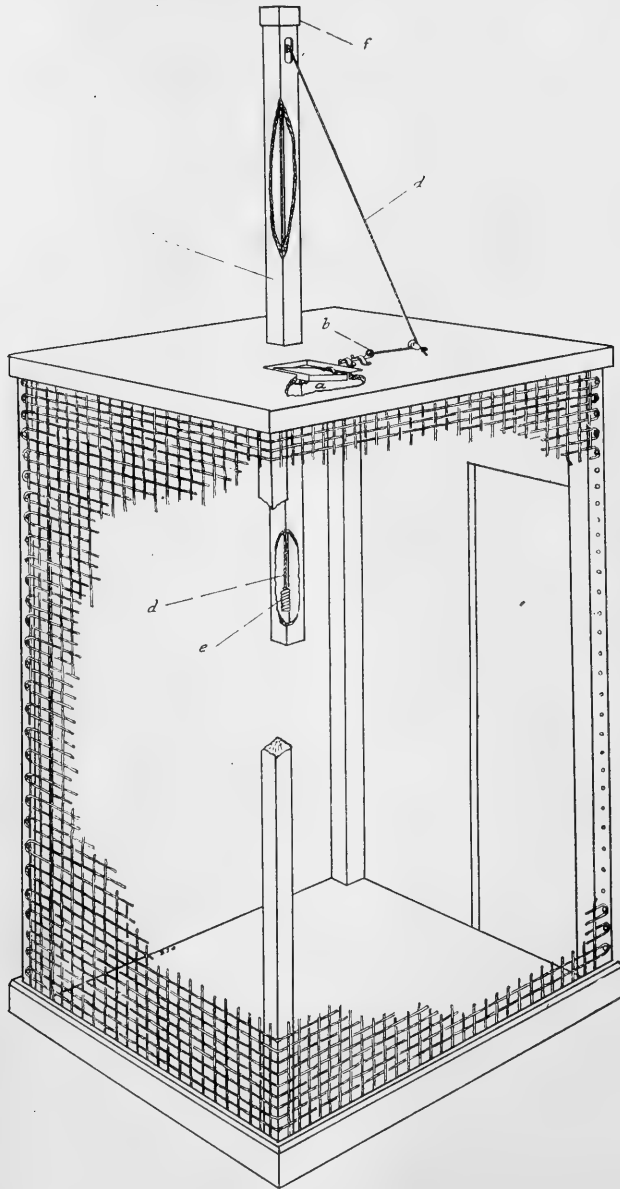

FIG. 1. Old cage (see text, p. 355), Chute Experiment A. *a*, trap door; *b*, device to hold door shut; *c*, chute; *d*, string; *e*, iron for monkey to grasp. (Drawn by B. Spencer Greenfield.)

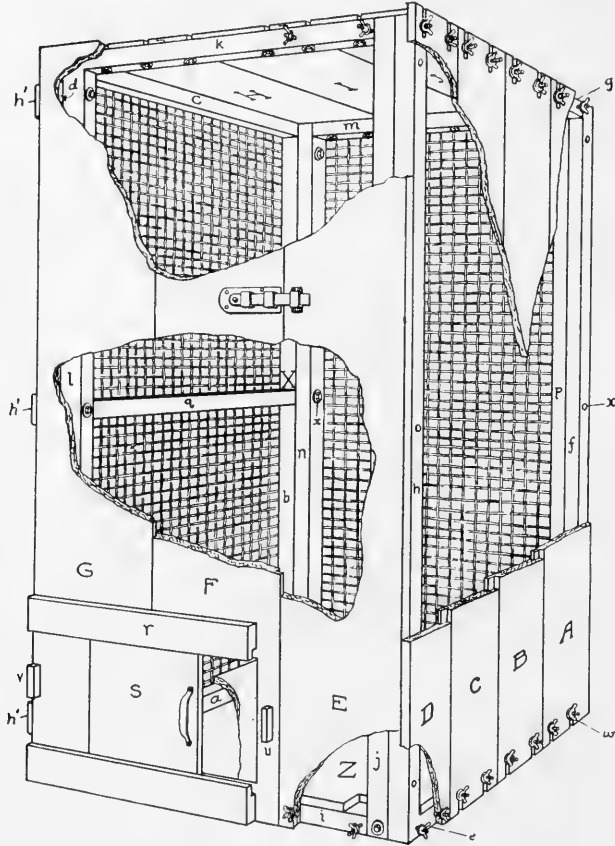

FIG. 2. New cage (see text, p. 351). *a, b, c, d*, front frame; *c, f, g, h*, back frame; *i, j, k, l* and *m, n, o, p*, end frames; *q*, brace across front of cage; *x*, bolts holding frames together; *A, B, C, D*, boards covering back of cage; *E, F, G*, boards covering end of cage; *F* and *G*, door; *H, I, J*, boards covering top of cage; *Z*, floor; *S*, slide door in large door; *h'*, door hinges; *w*, wing nuts; *X*, end of brace where animals frequently perched. (Drawn by B. Spencer Greenfield.)



FIG. 3. New cage showing chute, *a*, with one side open; *b*, trap door; *c*, string; *d*, wire spring handle; *e*, rungs. Page 358.

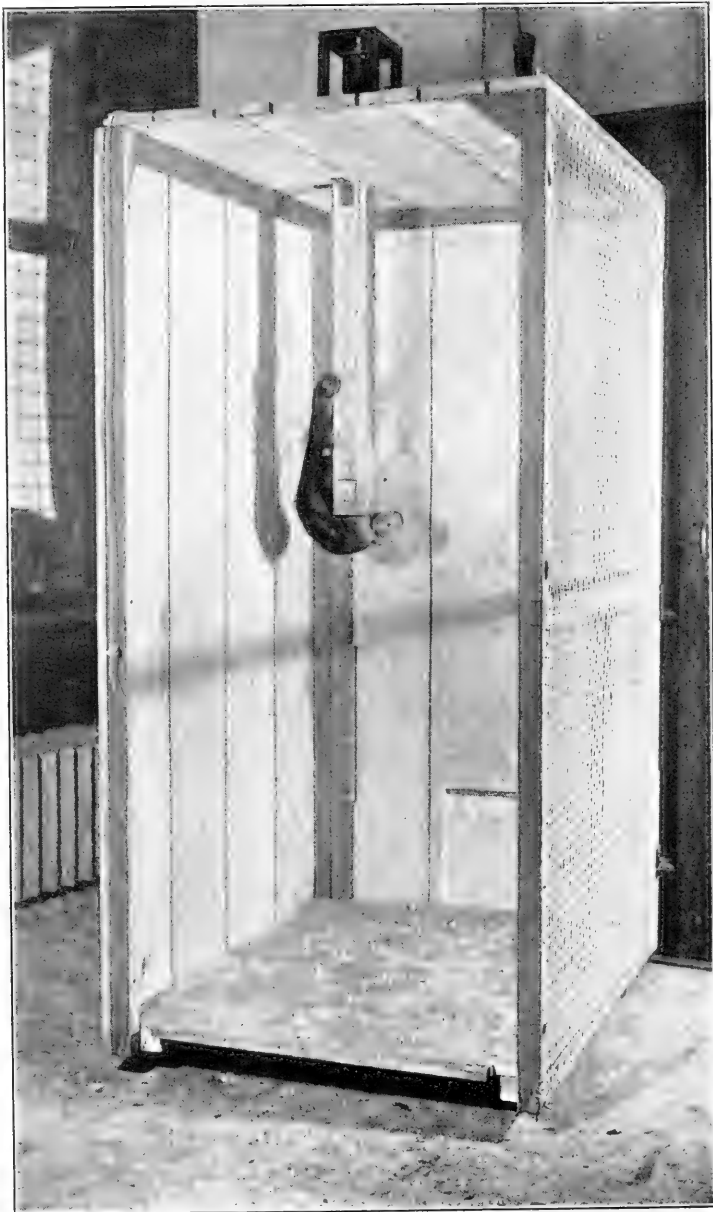

FIG. 4. No. 2 getting food in Chute Experiment B, characteristic position.  
Page 358.



FIG. 5. No. 6 getting food in the Rope Experiment. Page 385.



FIG. 6. No. 6 tearing the paper in the Paper Experiment. Page 391.



FIG. 7. No. 4. to the right, pushing up the screen, *a*, in the Screen Experiment. Page 400.

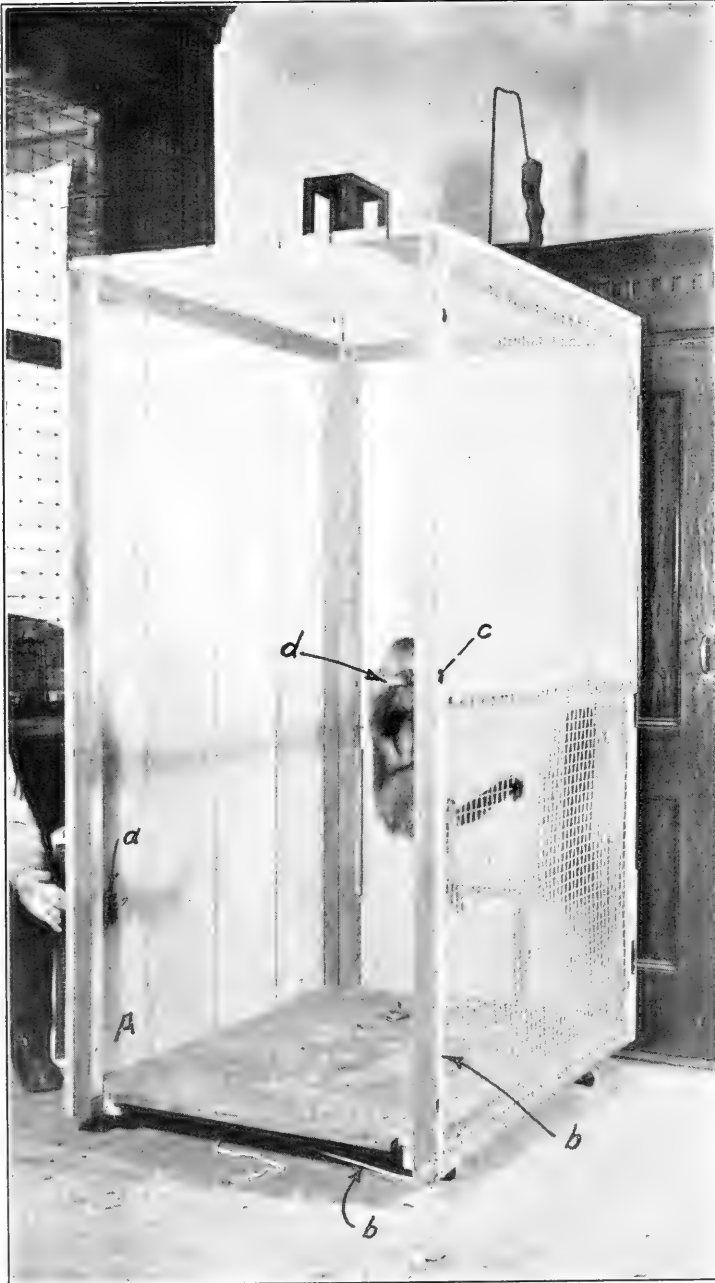

FIG. 8. No. 5 pulling the plug in the Plug Experiment; *a*, slide door; *b*, string; *c*, plug. Page 411.



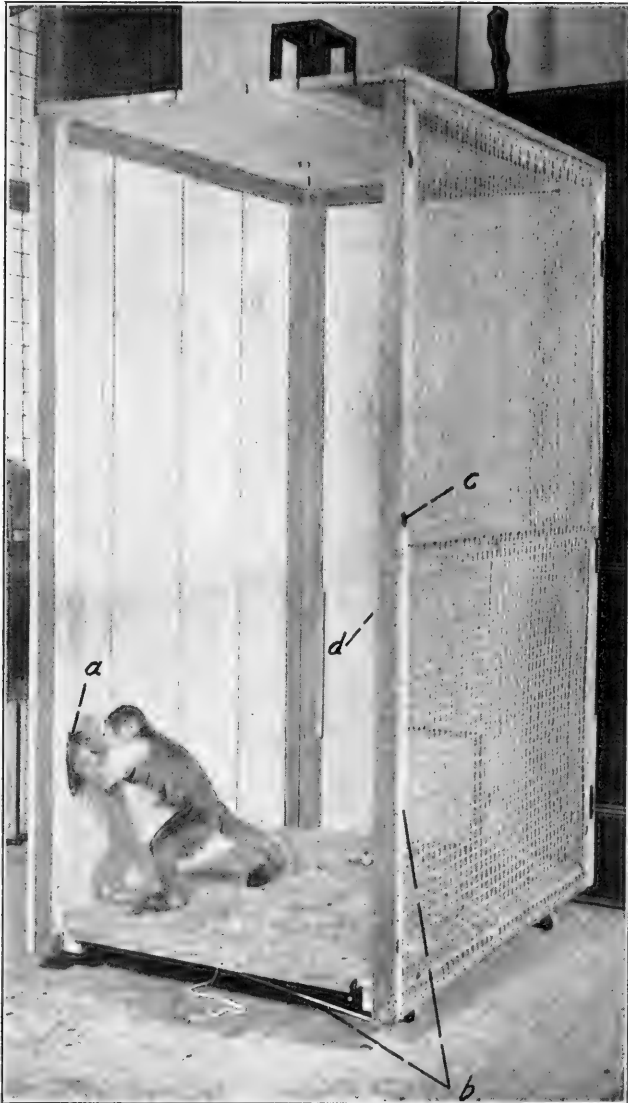

FIG. 9. No. 5 getting food after pulling plug (FIG. 8); *a*, slide door; *b*, string; *c*, plug. Page 412.



FIG. 10. No. 4 pushing the button, *b*, in the Button Experiment; *a*, slide door; *c*, string. Page 419.



FIG. 11. New cage adjusted for the string experiment; *L*, opening where food came into the cage; 1, 2, 3, 4, 5, 7, strings; *2t*, where string 2 entered the cage; *2k*, the knob at the end of string 2. Page 425.



FIG. 12. New cage adjusted for the String Experiment; *a*, chute; *b*, bottom of chute on a level with opening into the cage; *c*, trap door; *d*, lever; 2, string 2; *f*, feeder. Page 426.



FIG. 13. No. 13 getting food in the String Experiment. Page 432.



The Journal of  
Comparative Neurology and Psychology

---

---

VOLUME XIX

NOVEMBER, 1909

NUMBER 5

---

---

THE MORPHOLOGY OF THE FOREBRAIN VESICLE  
IN VERTEBRATES.<sup>1</sup>

BY

J. B. JOHNSTON.

*University of Minnesota.*

WITH FORTY-FIVE FIGURES.

CONTENTS.

	PAGE
Introduction .....	458
I. Descriptive part .....	462
1. Cyclostomes .....	462
2. Selachians .....	464
Notes on head morphology .....	464
Development of the forebrain .....	479
a. The optic vesicle and the primitive optic groove .....	479
b. The floor of the diencephalon .....	482
c. Roof of the diencephalon .....	487
3. Ganoids and teleosts .....	488
4. Amphibians .....	489
5. Reptiles and birds .....	495
6. Mammals .....	495

<sup>1</sup>Neurological studies from the Institute of Anatomy, University of Minnesota, No. 6.

II. Discussion .....	504
1. The anterior end of the head and brain .....	504
2. The homology of the saccus vasculosus .....	506
3. Segmentation of the neural tube in front of the cerebellum. ....	507
4. Boundary between diencephalon and telencephalon .....	508
5. The ventricles and the tela .....	513
6. Dorsal and ventral zones in the diencephalon and telencephalon .....	516
7. Pallium of the telencephalon .....	518
8. Divisions and nomenclature .....	525
Summary and conclusions .....	532
Proposed revision of the BNA .....	533

In all classes of vertebrates the forebrain vesicle of the early embryo gives rise to two secondary brain segments, the diencephalon and telencephalon. The morphological features of the diencephalon are remarkably constant throughout the vertebrate series, although this segment is the most peculiar and irregular in form. There is always a membranous roof, tela chorioidea and one or two epiphyses. The dorsal border of the lateral wall presents a paired enlargement known as the ganglion habenulæ, to which comes from the telencephalon a tract of fibers which often appears as a gross feature—the stria medullaris. The massive lateral walls bound a third ventricle which is narrow from side to side. In these lateral walls develop a considerable number of special centers of which the lateral geniculate bodies are recognizable microscopically in fishes. The ventral wall of the diencephalon is depressed and variously shaped according to the degree of development of the olfactory and gustatory organs. From in front the optic tracts enter through the base and run up in the lateral walls. Behind the chiasma is found always in the embryo and usually in the adult (fishes, amphibians, reptiles) a transverse groove or depression known as the *recessus postopticus*. Behind this is a wider depression which in mammals is provided with thick walls, the *tuber cinereum*, but in fishes and amphibians is a broad bilobed structure with thinner walls, concave within, known as the *lobi inferiores*. Between these and continuing backward and downward from them is a thin walled sac, the *saccus vasculosus*.



This forms the neural part of the hypophysis in mammals and projects more or less directly downward from the tuber cinereum. The connection of the sac with the tuber cinereum is the infundibulum and its cavity may be called the infundibular cavity or recess. The posterior part of the ventral wall forms a second bilobed structure, the corpora mammillaria.

The telencephalon shows greater changes of form and size in different vertebrates than any other segment of the brain. At the same time the essential morphological relations are completely preserved throughout the series from cyclostomes to man. It is part of the purpose of this paper to make this fact more clear and explicit with regard to certain features of the forebrain, but those features upon which there are no differences of opinion may first be sketched. The telencephalon is very deeply bilobed—bifurcated—in front. Each forward prolongation receives an olfactory nerve and is known as the *olfactory bulb*. This may be closely applied to the body of the telencephalon as in cyclostomes and amphibians, or it may be removed by a longer or shorter distance as in most other classes. In the latter case there is an obvious *olfactory tract*. The body of the telencephalon is always bilobed, the lateral halves being joined by thinner portions which are usually membranous or thickened only by nerve fibers. Only in selachians is there a considerable thickening of the median part of the roof by gray matter. The ventricle which continues forward from that of the diencephalon is always bifurcated, each lateral division extending into the olfactory bulb (except in some adult mammals where it becomes obliterated during development). A membranous roof continuous with the tela chorioidea of the third ventricle extends over the whole length of the telencephalon except the olfactory tracts and bulbs. In all classes the lateral halves of the telencephalon are connected at the rostral end by the *lamina terminalis*, a membrane formed by the closing of the anterior neuropore of the embryo. This lamina is always thickened by transverse fibers of two or more systems and sometimes divided into two bundles, the *commissura anterior*. At the lower border of the lamina terminalis is a prominent depression which lies just in front of the optic chiasma and is therefore called

the *recessus præopticus*. In the walls of the lateral ventricles are found the secondary olfactory centers and the *corpora striata*. To these in higher forms are added more complex cortical structures which in mammals become the predominant part of the telencephalon.

The above mentioned general features of the forebrain are universally recognized and require no further comment. Other features remain less well understood or their interpretation is in dispute so that they present problems for solution. These problems may be stated here, and will be discussed after the description of certain features in the embryonic and adult brain which contribute to their solution.

1. The anterior end of the brain. It is generally recognized that the lamina terminalis represents the seam of closure of the anterior neuropore, but the location in the adult brain of the lower border of the neuropore is placed by different authors at various points between the anterior commissure and the infundibulum. The determination of the anterior end of the brain is of fundamental importance for fixing the segmental order of the parts of the forebrain along the brain axis. Thus, if the anterior end of the brain is at the infundibulum, the optic portion of the hypothalamus together with all the telencephalon would be dorsal structures, while if the anterior end lies at the preoptic recess the optic part of the hypothalamus must be considered as belonging to the ventral portion of the brain. In the latter case the olfactory centers would belong to the first segment, in the former they would fall behind the optic chiasma around the dorsal margin.

2. The boundary between the diencephalon and telencephalon. This problem is closely bound up with the first one. Although His placed the anterior end of the base of the adult brain behind the infundibulum and included the *pars optica hypothalami* in the telencephalon, most authors have referred the *pars optica* to the diencephalon and this is the obvious meaning of the tables of the BNA. In the roof of the brain of true fishes and amphibians and in the brains of embryos of most vertebrates occurs a well marked transverse fold of the membranous roof, the *velum transversum*. This is considered as marking the boundary between di- and telencephalon in

the roof. In cyclostomes this is only slightly marked and has been clearly described recently by Sterzi. In mammals the velum has not been recognized hitherto and therefore the boundary line in question is wholly uncertain in mammals.

3. The problem of the membranous roof and its relations to the massive walls and the nervous pallium. This question naturally presented itself to the earlier neurologists because of the obvious great differences between the mammalian or human brain in which the ventricles were apparently wholly covered by massive nervous structures and that of lower forms, especially teleostean fishes, in which a relatively great expanse of membranous roof covers a broad ventricle in the telencephalon. A discussion of this problem naturally involves consideration of the next.

4. The problem of the median and lateral ventricles in the telencephalon and the interventricular foramina. Does the telencephalon possess a median ventricle? One interpretation of the mammalian brain would assign the whole median ventricle in front of the posterior commissure to the diencephalon (third ventricle). The walls bounding this ventricle then belong to the diencephalon and the boundary between di- and telencephalon is assumed to be the interventricular foramina. If, however, the pars optica hypothalami and lamina terminalis belong to the telencephalon, as was held by His, they must carry with them into the telencephalon the adjacent front part of the IIIId ventricle. In the brain of a fish or even of an amphibian there appears at first sight to be a large median ventricle belonging to the telencephalon and it is more or less difficult to fix the location of the foramina leading into the lateral ventricles. In the teleostean and ganoid brain only the olfactory tracts and bulbs appear to possess distinct cavities which could be called lateral ventricles and the whole of the olfactory centers and corpora striata are found in the lateral walls of the median ventricle. There is, therefore, need to determine whether a part of the median ventricle belongs to the telencephalon and to fix for the different classes of vertebrates the homologue of the interventricular foramina.

5. Subdivision of the di- and telencephalon with reference to the longitudinal zones laid down by His in other segments of the brain.

The determination of the anterior end of the brain will fix the extent of the floor plate and roof plate of His and will show the point at which the prolongation of the sulcus limitans must end. In the midbrain, hindbrain and spinal cord the sulcus limitans divides the lateral walls into dorsal or alar plate and ventral or basal plate. In the di- and telencephalon this sulcus can scarcely be distinguished with certainty, but the fact that zones of widely different functions are separated by this sulcus when present leads one to seek the equivalent of these zones and the position of the sulcus in the di- and telencephalon.

Other problems concerning the internal morphology and genetic history of the telencephalon—the origin of the pallium in relation to the primary centers, the evolution of functional localization, etc.,—will be discussed in the present paper only so far as necessary in connection with the subject of nomenclature.

#### I. DESCRIPTIVE PART.

In this part will be brought together under each class of vertebrates the data which bear upon these problems. As will be seen, the new facts to be brought forward are chiefly embryological (selachians; amphibians, mammals). The summaries of facts which have been previously published will be made as brief as possible and the reader is referred to the original papers for more complete accounts.

##### 1. *Cyclostomes.*

In cyclostomes is found a completely bilobed telencephalon, almost as strongly marked as in any class of vertebrates. The reason for taking especial account of this fact in the telencephalon is that the division into symmetrical lateral halves which is present in all parts of the central nervous system is more pronounced in the telencephalon and in mammals and man becomes one of the most striking features of the whole brain. The cause for the decided division of the telencephalon is to be found without doubt in the presence of paired olfactory organs and the importance of the sense of smell. In amphioxus the front end of the brain is not bilobed because there is no localized olfactory epithelium. In cyclostomes the olfactory organ is paired

in the embryo and the mode of development of the mouth, hypophysis and olfactory pit shows that the paired definite olfactory organs are older than the circular mouth. These organs have, therefore, exerted an influence on the brain for a long time previous to the period when cyclostome characters became permanently fixed, and the result is the bilobed telencephalon. This is seen in the presence of massive lateral walls which are connected above, below and in front by relatively thin membranes which are thickened only by transverse fibers and nowhere contain gray matter. It is seen in the forward projection of the olfactory bulbs into which the paired olfactory nerves enter. The olfactory bulbs are sessile; there is no extended olfactory tract or peduncle. It is seen further in the lateral extensions of the ventricle to which attention has been called by Studnicka and the writer (1906). These are rather wide cavities extending into the olfactory bulbs and connected with the median ventricle by narrower openings, the *interventricular foramina*. Owing to the pushing backward of the telencephalon in cyclostomes the lateral ventricle presents a posterior prolongation similar to but not homologous with the posterior horn of the ventricle in mammals. The tela chorioidea of the IIIrd ventricle forms in front of the nuclei habenulæ a broad low *dorsal sac* whose roof in some species is depressed by the epiphysial bodies lying over it. In front of this is a slight transverse fold (better seen in embryos than in the adult) first described by Sterzi (1907) which this author homologizes with the *velum transversum* of other vertebrates. This velum is continued laterally around the brain by a constriction (groove) without and a fold (ridge) within which marks the boundary between the diencephalon and telencephalon. In front of the velum transversum the roof continues for some distance as a thin membrane, the *lamina supraneuroporica* of Sterzi, and then is thickened by the fibers of the superior olfactory decussation. According to Sterzi, the point corresponding to the neuroporic recess of other vertebrates is at the front or lower border of this decussation.

The conditions in cyclostome embryos (solid nerve cord, solid connection of brain with ectoderm instead of open neuropore, compactness of structure) are not favorable for the study of the anterior

end of the brain, and the discussions of v. Kupffer, Koltzoff and others do not seem to the writer to offer anything of value in the present state of our knowledge. (See note, p. 535.)

It should be noted that the ridge in the brain floor which contains the optic chiasma and other decussating tracts is especially high and prominent in cyclostomes and that the pit behind the ridge, *recessus postopticus*, is quite as deep and sharply marked as that in front of the ridge, *recessus præopticus* (commonly called recessus opticus).

## 2. *Selachians.*

### Notes on Head Morphology.

In the adult selachian brain the diencephalon presents no peculiarities of especial importance to our problems. The limit between the

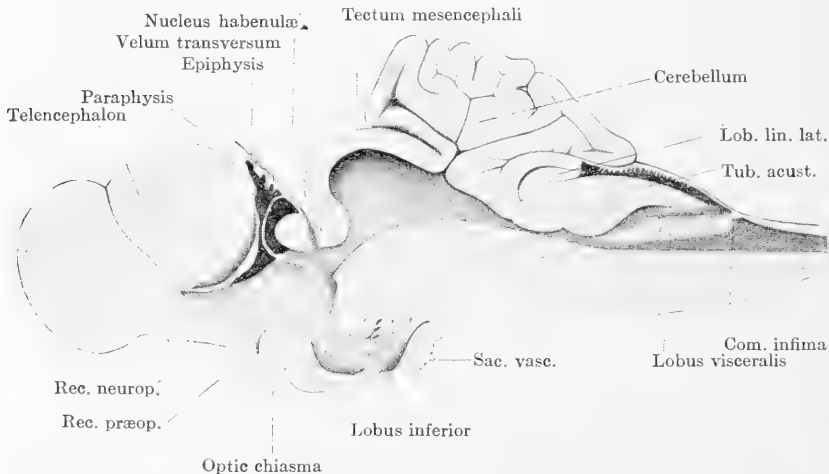

FIG. 1. The mesial surface of the right half of the brain of *Mustelus*. From Johnston, 1906. For the significance of the abbreviations used on all of the figures, see the list at the end of this article.

diencephalon and telencephalon is clearly marked dorsally by a deep velum transversum which forms the anterior wall of the *dorsal sac* belonging to the diencephalon, and the posterior wall of the *paraphysis* belonging to the telencephalon (Fig. 1). In front of the paraphysis the membranous roof is complexly infolded to form the *plexus*

*chorioideus* of the telencephalon. The anterior limb of the plexus is attached to the massive nervous wall which overarches the front part of the median ventricle. In the more primitive selachians such as *Heptanchus* and in *Chimæra* the massive roof is smaller and the membranous roof extends farther forward. As shown in Fig. 1, the massive roof is pierced from the dorsocephalic surface by a vascular canal which reaches nearly to the ventricle. This has been interpreted (Johnston, 1906) as the remnant of a deep groove which separated the lateral lobes of the telencephalon earlier in the phylo-

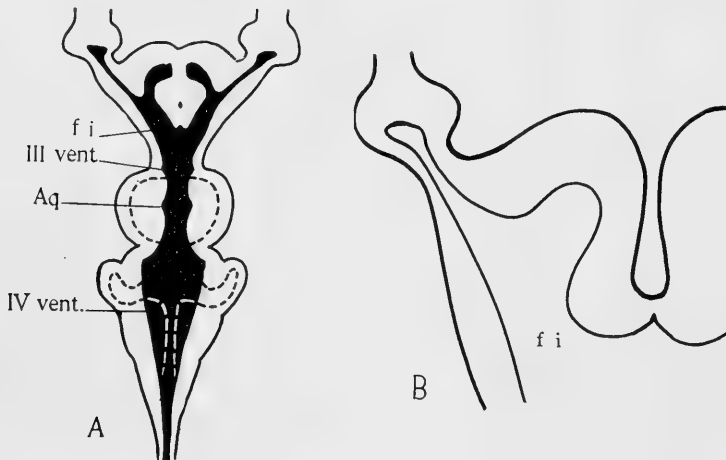

FIG. 2. A, an outline of the brain and brain ventricles of *Mustelus* as seen from above. B, a diagram of one side of the fore-brain to show the primitive relations of the wall and ventricle. From Johnston, 1906.

geny of selachians, and the process by which the present form was reached is indicated by the accompanying diagram (Fig. 2, B).

That portion of the massive roof which lies behind the vascular canal is formed by the great growth of the lateral walls and it has for its basis a fiber-decussation which is comparable in position and in a part of its fiber components to the superior olfactory decussation of *Petromyzon*. In selachians, then, owing to the enormous development of the olfactory centers, that part of the membranous roof of the telencephalon which contains fibers in cyclostomes is invaded by gray matter as well.

The form of the ventricle is shown in Fig. 2, and it is necessary only to point out that quite distinct lateral ventricles are present, that they extend into the olfactory bulbs and that they are connected with the median ventricle by the interventricular foramina. A triangular prolongation of the median ventricle projects a short distance in front of the interventricular foramina to meet the vascular canal mentioned above. This is the recessus neuroporicus.

The solution of the problems of the anterior end of the brain and of the boundary between diencephalon and telencephalon requires the study of the development. Although all the essential facts were first acquired from the study of amphibian embryos (see below), it was thought best to extend the study to other vertebrates, and as the selachians present the most primitive conditions the description of certain important processes hitherto overlooked will be given first as they are seen in embryos of *Squalus acanthias*.

For the material for this study I am deeply indebted to Dr. H. V. Neal. When I wrote to Dr. Neal of my findings in *Amblystoma* and of the desirability of a control study upon selachian embryos he generously sent me from his magnificent collection of mounted preparations of *Squalus* embryos, the specimens representing the stages from B to M of Balfour's notation. These preparations include whole mounts and sections in all three planes prepared by various stains. These are the preparations upon which was based Neal's very valuable paper of 1898 on the segmentation of the nervous system. My attention has been directed chiefly to stages from F (15 somites) to K and M. It has been a great pleasure to verify the clear and accurate descriptions given by Neal of these embryos. I have studied the brain, cranial ganglia, the mesectoderm derived from the neural crest, the mesodermic somites, the branchial clefts and arches, and have given especial care to the region about the forebrain and the premandibular and anterior head cavities. I have made plate reconstructions from frontal and sagittal sections of several stages and have had numerous camera drawings made to illustrate points not shown in the models.

I wish to comment briefly, on the basis of these preparations, upon certain problems that have been under discussion in past years which have some bearing on the special problems being considered here.



Upon the question of the value of the pre-otic "head cavities" as dorsal somites, Neal's statements seem to me very careful and conservative. With regard to the differentiation of sclerotome and myotome, the preparations seem to me to warrant a positive statement that a sclerotome is clearly differentiated in the second or mandibular somite as well as in the third. I am in perfect agreement with Neal's interpretation of the preotic head cavities, including the anterior cavity of Platt as dorsal somites.

Upon the question of a lost branchiomere between the mandibular and hyoid arches, which I have discussed elsewhere (1905) I have been surprised to find so little evidence in the preparations of *Squalus*. While the third somite lies over the hyomandibular cleft and is somewhat constricted or dumb-bell shaped, its two parts enclose a single cavity and the somite extends over the hyoid arch with the mesodermic core of which it is connected. The fourth somite is smaller than the third and shows that it is rudimentary. While it reaches forward to the hyoid arch, it is connected with the mesoderm of the first branchial arch. The fifth somite has practically corresponding relations to the second branchial cleft and the following (second) branchial arch. The sixth somite is clearly connected with the third branchial arch and the seventh somite with the fourth branchial arch. These relations, indeed, may be clearly inferred from Neal's admirable drawings from cleared specimens, Figs. 15, 16, 17. These correspond to the stages from which I have drawn the conclusions stated above. The *posterior ends* of somites (2), 3, 4, and 5 are connected with their respective branchial arches.

I must here make reference to a series of papers on the head problem coming from Prof. H. E. Ziegler's laboratory in Jena (Klinkhardt 1905, Guthke 1906, Ziegler 1908, Brohmer 1909). These authors discuss the fundamental questions of segmentation and the relationship of the cranial nerves. The total material on which the descriptions and conclusions are based consists of ten selachian embryos including four of *Torpedo* between the stage I-K and 20 mm.; four of *Spinax* in the stages K, L, M-N, and 7.78 mm.; one of *Chlamydoselachus* in the stage L-M; and one of *Acanthias* 22 mm. in length.

One new idea is introduced into the subject of head morphology, namely that in the mesoderm the two structures in each segment heretofore known as the somite and the branchial arch together constitute the somite, and the junction of the branchial arch with the pericardial cavity is to be compared with the junction of the trunk somite with the peritoneal cavity. This conception is used in support of the view that mesomerism and branchiomerism coincide. It may be questioned whether the new conception is not more in need of support than that for whose support it was called in. The material which these authors have studied is far from adequate for the study of the primitive segmentation of the head or the morphology of the cranial nerves. This is especially noticeable in their statements regarding the anterior head cavity, which could not be studied in the material on which they worked, and the other head somites, whose development is well advanced in the earliest stage represented in their material. In determining the first segment of the head no value is attached to the first two brain vesicles, the eye, the olfactory nerve, the nervus terminalis, the rudimentary nervus thalamicus, or the epiphyses. The first segment is that of the premandibular somite and the ophthalmicus profundus (to which the name Ciliarganglion is given). This nerve is related to the brain behind the cerebellum in the embryos studied by Ziegler and his colleagues, but whether they would include all the brain in front of the cerebellum in the first or premandibular segment is not stated. Most of the processes upon which an intelligent judgment regarding the primitive segmentation of the head can be based have been completed in selachian embryos prior to the earliest stage studied by these authors.

With regard to the mesectoderm derived from the neural crest which extends down into the mandibular and other visceral arches from the cranial ganglia, I can fully confirm the statements made by Neal and illustrated in his Plate 3 (1898). To these statements one addition requires to be made which is at the same time an addition to the early history of the anterior head cavity and preoral entoderm. The details of the earliest appearance of the anterior head cavity have not been given by Miss Platt or by Neal, who was concerned chiefly with neural segmentation, and Dohrn's (1904) treatment of the anterior head cavity is unsatisfactory.

Hoffmann's description (1896) is more complete, but he failed to recognize the source of the mesectoderm beneath the terminal ridge. What he describes as a median mass between the lower border of the neuropore and the "infundibulum" connecting the anterior head

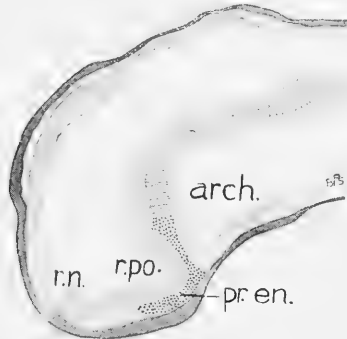

FIG. 3. *Squalus acanthias*, 17 somites, median sagittal section. The notochord is marked by cross lines and the undifferentiated median mass and pre-oral entoderm by dots.

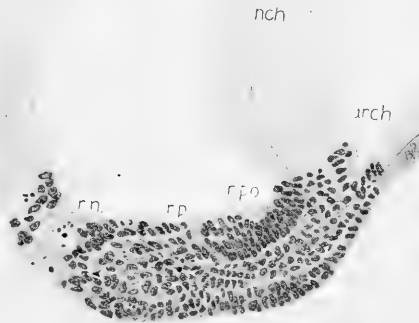

FIG. 4. Detail of a part of the section drawn in Fig 3.  $\times 100$ .

cavities with one another is the mesectoderm derived from the terminal part of the neural crest to be described below.

In embryos of 15 somites the notochord is continuous anteriorly with a thickened mass lying over the anterior end of the archenteron and separated from the entoderm. Laterally the mandibular

somite is connected with both the notochord and the median undifferentiated mass. The archenteron is drawn out anteriorly to a very slender pointed cavity (Figs. 3, 4, 5) which ends beneath a depression in the floor of the brain usually called by authors the infundibulum. As this is not the infundibulum I shall for the present refer to this part of the brain as the "infundibulum," using quotation marks. Following a series of transverse sections forward one sees

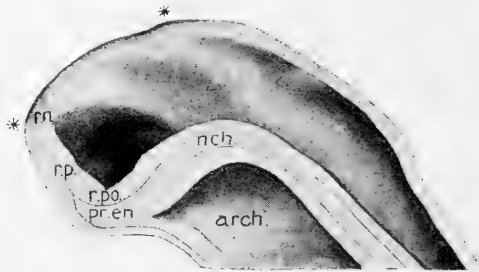

FIG. 5. *Squalus ac.*, 15 somites, medial view of a model of the right half of the head. \*\* part of neural tube which is still open.  $\times 25$ .

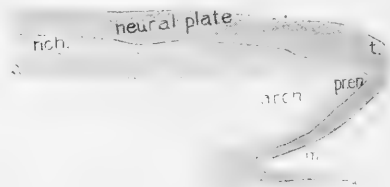

FIG. 6. *Squalus ac.*, Balfour's stage D, sagittal section of anterior end.  $\times 75$ .

that as the narrow archenteron disappears, the proper entodermal wall fuses with the overlying median mass and thence continues forward beneath the "infundibulum" as a solid mass of preoral entoderm. At this time the neuropore and dorsal seam of the neural tube are not yet closed and the preoral entoderm extends up to the point where the neural plate passes over into ectoderm. These relations are properly shown in Neal's figs. C and D. For some time the anterior part of the median mass and the preoral entoderm cause

a conspicuous folding upward of the neural plate in the middle line so that a prominent keel appears in the floor of the neural tube (Fig. 7).

In embryos of 17 somites the preoral entoderm comes into slight but actual contact with the bridge between ectoderm and brain at the lower border of the neuropore. This is indeed the condition which exists from the time the head fold begins to form (Fig. 6).

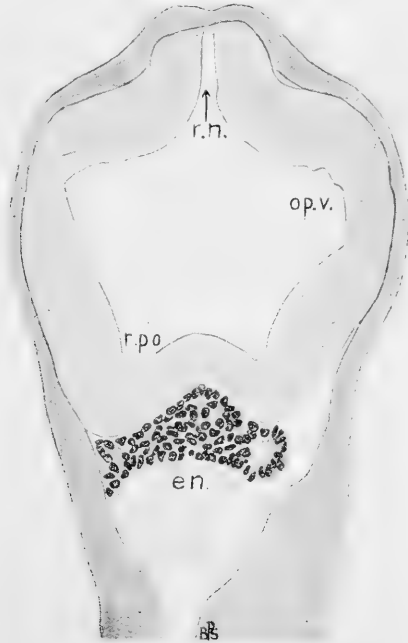

FIG. 7. *Squalus ac.*, 18 somites, frontal section through the premandibular somite and median mass. The right side of the section is a little further dorsal than the left and the cavity of the somite shows only on the right.  $\times 150$ .

In embryos of 18 somites the cavity of the premandibular somite (som 1, v. Wijhe) is first seen in the lateral part of the undifferentiated mass above described (Fig. 7). The median part of this mass maintains the relations just described.

In embryo of 19 somites the mesoderm and preoral entoderm show no change but a very noteworthy structure has appeared between

ectoderm and brain, surrounding the anterior end of the preoral entoderm. Paired sheets or flaps of cells migrating from the ectoderm at the lips of the neuropore extend in between the ectoderm and brain and surround the anterior part of the preoral entoderm on its under or ectal surface. These sheets of cells resemble in every way the neural crest in other parts of the embryo and should be considered as the terminal part of the neural crests.

In embryos of 24 somites the premandibular cavities are somewhat larger and especially longer. The bodies of these somites are

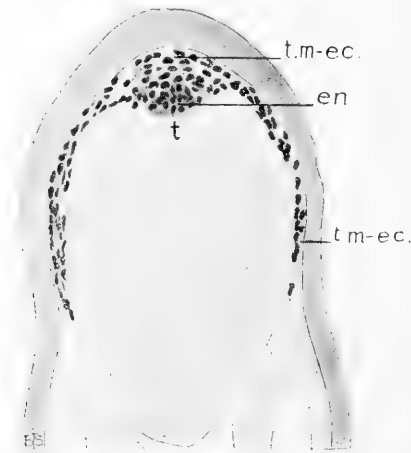

FIG. 8. *Squalus ac.*, 22 somites, frontal section through the terminal neural crest.  $\times 150$ .

in contact with the mandibular somite, are still continuous with the median mass and converge forward and downward like the arms of a letter V to fuse completely with the median mass. In the lateral part of the median mass directly forward from the premandibular somites and *behind* the "infundibulum" are found the first indications of the anterior head cavities. Many mitoses appear here, especially in the front wall of this cavity. The preoral entoderm continues forward beneath the "infundibulum." As compared with earlier stages, before the formation of the anterior cavities the preoral entoderm is *very slender* and at one point beneath the "infun-

dibulum" it is completely obliterated. In some embryos it is impossible to distinguish any preoral entoderm beneath the brain in front of the "infundibulum," but in others there is no doubt whatever that a slender rod of cells lying in this position is the remnant of the anterior part of the preoral entoderm. This rod of cells is surrounded by cells (mesectoderm) derived from the neural crest above described, which constitute by far the largest part of the cells lying in this position. This mesectoderm forms a considerable mass of cells filling a lens-shaped space between brain and ectoderm and between "infundibulum" and neuropore and also extends as a sheet

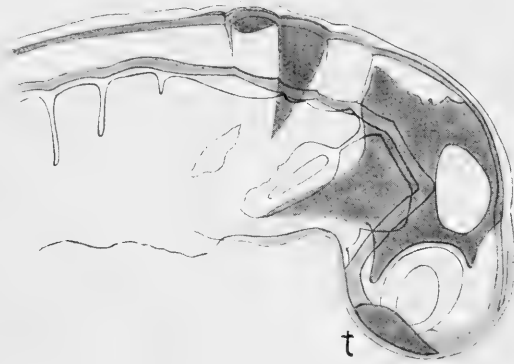

FIG. 9. Neal's Fig. 11 modified by addition of the terminal part of the neural crest. The figure represents the lateral view of a cleared embryo of *Squalus* of 24-25 somites and shows the extent of the mesectoderm derived from the neural crest.

along the sides of the "infundibulum" beneath the optic vesicle. Fig. 9 is a copy of Neal's Fig. 11, Pl. 3, of this stage, with the addition of this mesectoderm.

In one embryo of 26 somites (Fig. 10) I have found the slender rod of preoral entoderm persisting beneath the "infundibulum," but from this time on it is impossible to recognize entoderm in this position. The "infundibulum" has become depressed until it is in contact with the ectoderm and at the same time, whether because of pressure from the "infundibulum" or not, the median part of the preoral entoderm becomes obliterated while its lateral portions form

themselves into the walls of the anterior head cavities. The mesenchymatous cells beneath the front end of the brain are in overwhelming proportion of ectodermal (neural crest) origin.

In Dohrn's beautiful plates illustrating his articles on the mandibular and premandibular cavities, this terminal neural crest is clearly shown. See especially Pl. 9, Figs. 7-12. Dohrn does not distinguish between premandibular mesoderm and the mesectoderm of neural crest origin. The latter he calls the anterior part of the premandibular mesoderm (Præm. 1) after the "infundibulum" has

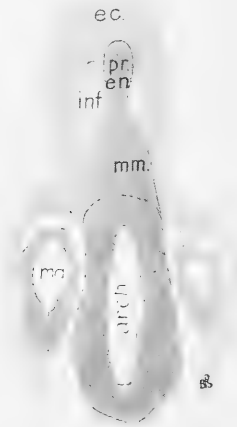

FIG. 10. *Squalus ac.*, 26 somites, frontal section. *inf.*, the so-called infundibulum.

pressed down to meet the ectoderm. In Fig. 8 the origin of this from the neuropore is strongly suggested, especially as the spot marked *neurop.* is at the *upper* border of the lamina terminalis, some distance dorsal to the extreme point to which the preoral entoderm or premandibular mesoderm ever reaches. In Dr. Neal's preparations which I have studied the entoderm has a different tone from the other tissues and there is a decided difference in the form of the cells and in the size of the nuclei between the premandibular mesoderm and the terminal neural crest mesectoderm.

In embryos of 29 and 30 somites (Figs. 11 and 12) premandibular



and anterior head cavities are small, separate from each other, but both connected with the median mass which is crowded behind the "infundibulum." The median band connecting the anterior cavities

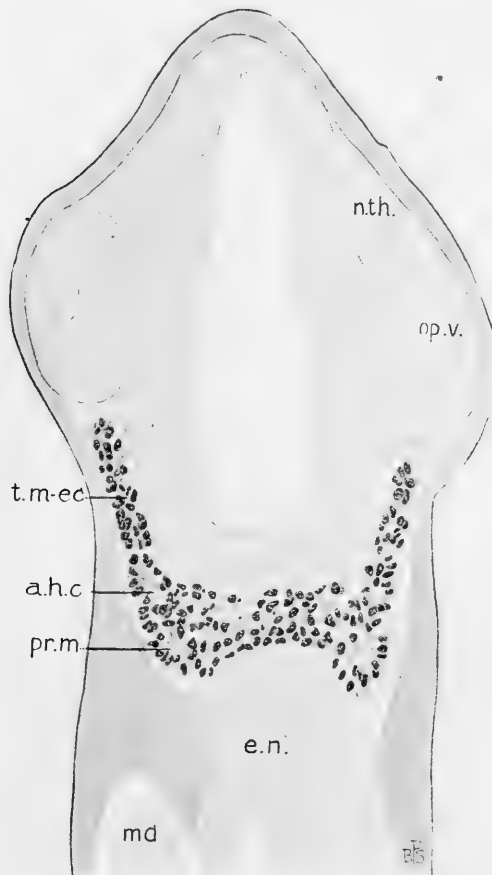

FIG. 11. *Squalus ac.*, 30 somites, frontal section through premandibular and anterior head cavities.  $\times 150$ .

is small and disappears at this stage. The premandibular somites retain the connection with the median mass in which cavities appear in later stages and finally fuse with the cavities of the premandibular somites as fully described by Neal and others. The anterior

cavities extend forward at the sides of the "infundibular" region in the position in which they were first described by Miss Platt. Except where they are in contact with the premandibular somite the

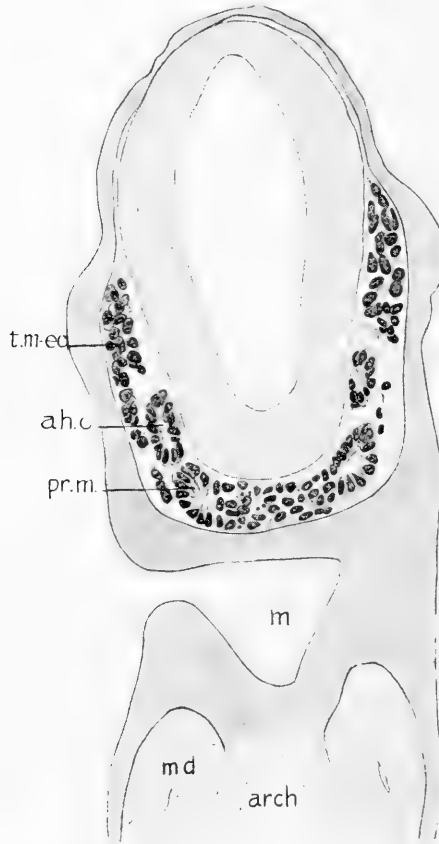

FIG. 12. *Squalus ac.*, 29 somites, frontal section through the premandibular and anterior head cavities. These cavities are slightly more advanced in development than in the 30 somite embryo shown in Fig. 11.  $\times 150$ .

anterior somites are almost completely ensheathed by the mesectoderm derived from the region of the neuropore. The mesectoderm sheet derived from the thalamic nerve rudiment has now come down behind the eye and met with this which lies beneath the eye. From

this stage onward Neal's figures 12, 13, etc., show the distribution of neural crest mesectoderm almost correctly. The mesectoderm lying in the region between the optic vesicle and somite 1 should be continued as a thin sheet between the brain and ectoderm beneath the neuropore and the origin of all this part from the terminal part of the neural crest should be taken into account.

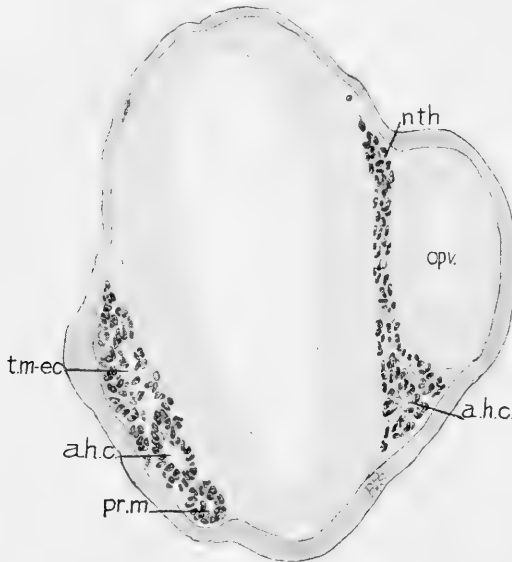

FIG. 13. *Squalus ac.*, 39 somites, frontal section through the anterior head cavities, showing their relation to the premandibular somite (left side) and the mesectoderm derived from the terminal neural crest. The connection between n. thalamicus and terminal neural crest shows on the right side.  $\times 150$ .

The relations of the anterior head cavities to somite 1 and to the mesectoderm remain essentially unchanged up to embryos of 50 somites. Figs. 12, 11, 13, 14 show these relations in frontal sections of embryos with 29, 30 and 39 somites. The brain, mesoderm and mesectoderm with the cranial ganglia have been modelled in an embryo with 42 somites and Fig. 15 shows these relations as seen in the model.

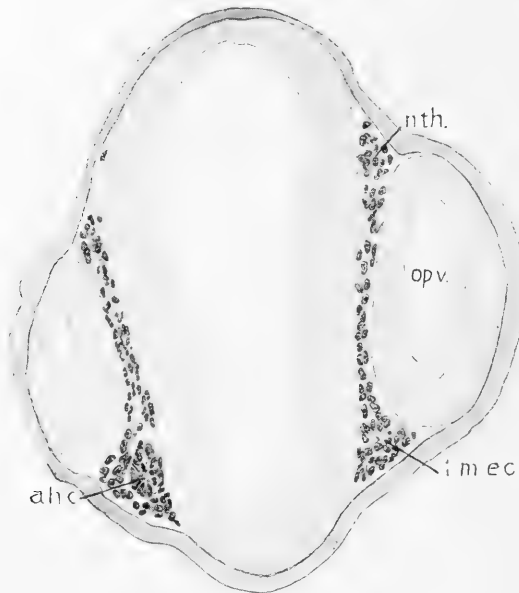

FIG. 14. Section from same series as Fig. 13, passing through the tip of the anterior head cavity on the left side and in front of this cavity on the right side.  $\times 150$ .

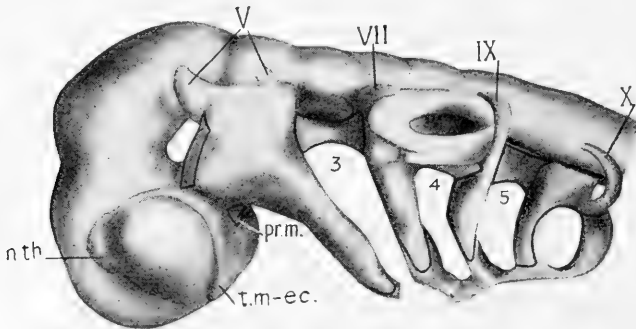

FIG. 15. *Squalus ac.*, 42 somites. Left view of a model of the brain, mesoderm, ganglia and mesectoderm derived from the neural crest. The auditory pit with the ectoderm bordering it are also shown.  $\times 50$ . The boundaries of the mesoderm are marked in black lines. 3, 4, 5, somites of Van Wijhe's series.

## Development of the Forebrain.

a. *The Optic Vesicle and the Primitive Optic Groove.*—The early appearance of the optic vesicles on the open neural plate has been described by Loey (1895), and the writer has elsewhere (1905, 1906, 1909) brought together the evidence that the optic vesicle is derived from the alar plate of the embryonic neural tube. The study of its relations for the present purpose begins with embryos of about 15 somites. The medial surface of the right half of a model of the head of such an embryo is shown in Fig. 5. The neural tube has a cephalic flexure and is open at the neuropore and for a short distance along the dorsal surface. The lateral wall presents two concavities, a broad shallow one for the mid-brain and a deeper one for the forebrain. The depth of this concavity is due chiefly to the formation of the optic vesicle, which seems to involve the greater part of the lateral wall of the forebrain vesicle. In the floor of the brain the optic vesicles of the two sides are connected with one another by a transverse groove or depression which has heretofore been called the "infundibulum." That it does not become the infundibulum will be shown farther on. Its relation to the optic vesicles and its later history suggest that it be called the *primitive optic groove*. Its relations to the preoral entoderm as above described and to the neuropore as seen in Figs. 3, 4 and 5 show that this groove is in the floor-plate of the brain some distance behind the anterior end of the entoderm.

In the embryos with 17 somites, Figs. 3 and 4, the neuropore is closed except at a single point which shows as a thin place in one section of  $6\frac{2}{3}$  microns thickness. The distance from the primitive optic groove to this point is greater than the distance to the lower border of the neuropore in the embryo of 15 somites. The arrangement of the cells in the lower lip of the closing neuropore as seen in transverse and frontal sections shows that there is a process of fusion of the lips of the neuropore from below upward and therefore the last point of the neuropore to remain open is a point in the dorsal seam of the neural tube some distance removed from the anterior border of the neural plate. This part of the seam of closure which represents the length of the neuropore is what is called the

*lamina terminalis*. This is not very long in the embryo of 17 somites, but grows distinctly in length as the forebrain expands. The apparent great thickness of the lamina terminalis in Fig. 3 is of course due to the persistence of the fusion of ectoderm and brain wall at this time. The primitive optic groove is deeper and sharper in outline than in the last stage.

The relations in an embryo of 24 somites are shown in Fig. 16 representing the medial view of a model of the right half of the head. In this is seen the depression of the primitive optic groove until its wall comes into contact with the ectoderm and cuts off the

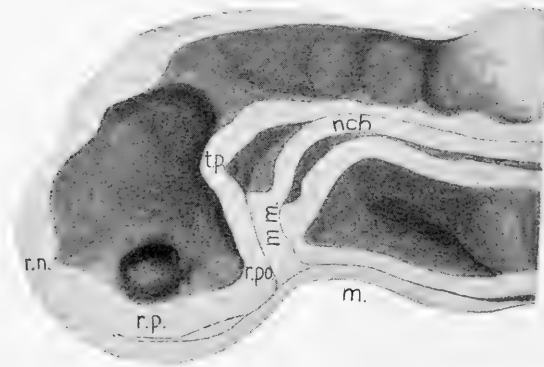

FIG. 16. *Squalus ac.*, 24 somites, medial aspect of a model of the right half of the head.  $\times 75$ .

front part of the preoral entoderm as before described. The lens-shaped space in front of the primitive optic groove is filled chiefly by mesectoderm from the terminal part of the neural crest. The lamina terminalis is marked by a small triangular pit above, the neuroporic recess, and by a rounded shallow pit below. This pit occupies the lower portion of the neuropore space and may therefore be called the *terminal pit*. The optic vesicle is now stalked and the cavity of the stalk is seen near the base of the brain. It is noticeable that this cavity no longer communicates directly with the primitive optic groove. It seems equally closely related to the terminal pit. Between the two pits the brain wall is somewhat thickened.

This thickening corresponds to the anterior border of the neural plate and the lower border of the neuropore. It is the terminal ridge of the early embryo with open neural plate, Figs. 3, 4, 5, 6. From this terminal thickening a ridge is seen in Fig. 16 running obliquely caudo-laterad behind the optic vesicle and cutting it off from communication with the primitive optic groove. This is the beginning of a change in the relations of the optic vesicle which the following stages show completed.

An embryo of 42 somites is shown in Fig. 17 drawn from a model of the right half of the head and a corresponding model of an embryo of Balfour's stage K is shown in Fig. 18. In these it is

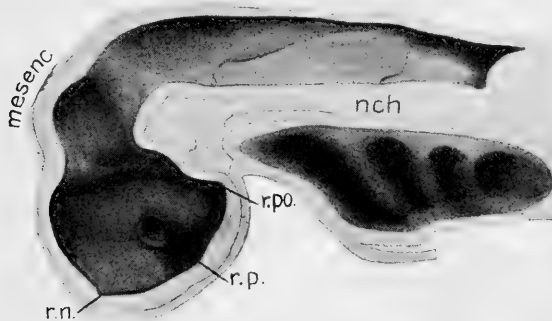

FIG. 17. *Squalus ac.*, 42 somites, medial aspect of a model of the right half of the head. This is the same embryo as the one shown in Fig. 15.

clear that the optic vesicle is no longer connected with the primitive optic groove, but the two vesicles are now connected with one another by the terminal pit at the lower border of the lamina terminalis. This is the pit which remains connected with the hollow optic stalk as long as that persists and is known in the adult as the recessus opticus (His); better called *recessus praeopticus*.

In the latter part of Balfour's stage K the optic tract fibers begin to appear in the chiasma. This lies immediately behind the terminal pit and in front of the primitive optic groove (Figs. 22, A and B), and therefore lies in the terminal ridge. The lateral prolongation of this ridge, which has been described as running obliquely across

the primitive optic groove (Fig. 16), furnishes a pathway for the optic tract fibers as they grow in from the retina to the optic centers in the thalamus and tectum opticum. The ridge may therefore be called the *optic ridge*. The primitive optic groove from this stage on is to be seen just behind the transverse ridge occupied by the optic chiasma and other decussations. Referring to the general description at the beginning of this article it will be seen that what I have called the terminal pit in the early embryo is the same as that called by His the optic recess, and that to which I have in all my previous

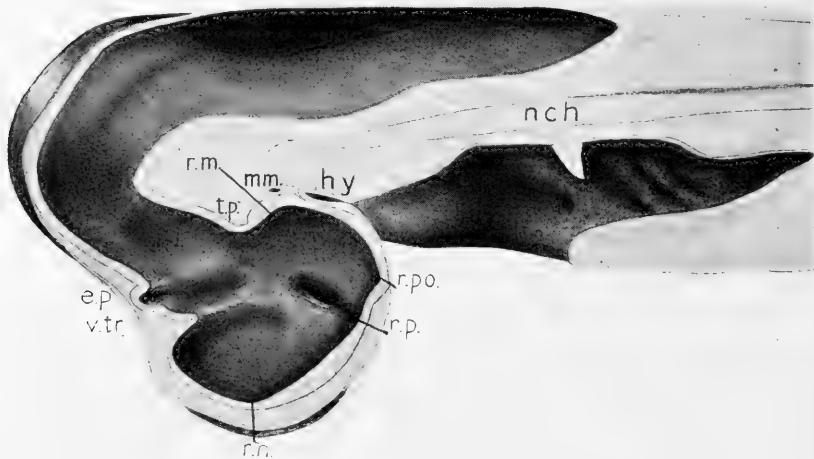

FIG. 18. *Squalus ac.*, late stage K of Balfour, medial aspect of a model of the right half of the head.  $\times 25$ .

papers given the name of preoptic recess. The primitive optic groove I have heretofore called the postoptic recess. These terms have been used by some other authors (Mrs. Gage, Sterzi, and others), but not by all. I wish to emphasize the necessity of recognizing the two pits and applying to them clearly distinctive names, because they are both related to the optic vesicle and because the postoptic recess has heretofore been confused with the infundibulum.

*b. Remainder of the Floor of the Diencephalon.*—As soon as the head-bend of the brain tube appears, a broad depression of the floor of the forebrain vesicle can be seen which corresponds to the future



inferior lobes (Fig. 16). The anterior part of this is the relatively deep and sharply marked primitive optic groove. The posterior boundary is less definitely marked by a slight projection of the brain floor into the ventricle. This is the *tuberculum posterius*. As the broad inferior lobes involve nearly the whole floor of the diencephalon, neither the infundibulum nor the mammillary bodies are to be recognized at this time. Both are developed later within the general



FIG. 19. *Squalus ac.*, 60 somites, parasagittal section near the middle line. The mouth is open. Primitive inferior lobes, epiphysis and velum transversum.  $\times 33$ .

area of the primitive inferior lobes, as specialized portions of their walls.

The mammillary bodies are indicated by a rounded caudal projection of the depressed floor of the diencephalon in embryos with about 80 somites (Figs. 20, 21, 22).

The infundibular recess is not found until after the completion of the changes described in connection with the optic recesses. As in man the infundibulum is the funnel-shaped depression leading from the floor of the tuber cinereum into the neural part of the

pituitary body, so in fishes the infundibular recess must be that somewhat funnel-shaped or trough-shaped depression in the floor of the inferior lobes which leads into the saccus vasculosus, this being the neural portion of the pituitary body in fishes.

The angle of ectoderm from which the hypophysis will be developed can be readily recognized by the stage when the depression of the primitive optic groove has pushed the preoral entoderm out of the way and come into contact with the ectoderm. The hypophysial



FIG. 20. *Squalus ac.*, 80 somites, median sagittal section.  $\times 33$ . Pre- and postoptic recesses, mamillary recess, epiphysis and velum transversum.

ectoderm is in contact with the posterior surface of this depressed part of the brain floor. As the hypophysis pushes in (Figs. 18, 19, and following) its anterior limb remains in contact with the posterior wall of the primitive optic groove. The hypophysis grows back in contact with the rounded surface of the inferior lobes, insinuating itself between the brain floor and the median mass connecting the premandibular somites. As this mass in early stages connects the anterior head cavities also with one another, it may be said that the

in-pushing hypophysis remains always in front of the entoderm and mesoderm except so much of the preoral entoderm as is cut off by the primitive optic groove and aborted beneath the terminal ridge. By stage M (Fig. 22) the hypophysis begins to be constricted off from the ectoderm. It presents a shorter anterior lobe which is



FIG. 21. *Squalus ac.*, stage M. sagittal section.  $\times 33$ . Pre- and post-optic, infundibular and mammillary recesses, epiphysis and velum transversum. The fibers of the optic chiasma appear in the terminal ridge.

directed toward the optic chiasma and a longer posterior lobe which is directed toward the mammillary recess. Opposite the tip of the posterior lobe a special outgrowth of the brain wall represents the beginning of the saccus vasculosus. Although the term infundibulum scarcely applies to anything in the fish brain, yet the depression from which the saccus grows out is the region which corresponds

to the infundibulum of man. The relative position of all these structures is shown in Fig. 22, A and B, from a sagittal series of an embryo in stage M.

The study of sections can be controlled in these young stages by the study of cleared whole embryos. Neal has given a most instructive series of figures from such cleared embryos and I can attest the accuracy and faithfulness of these figures. If Figs. 7 to 11 of Neal's Plate 3 be examined, it will be seen that the optic vesicle shifts from the "infundibulum" to a point in front of the anterior head cavity. This agrees with what I have described above. I have carefully studied these whole embryos with the Braus-Drüner binocular and find that all the facts with regard to the form and position of parts in the optic region of the brain derived from the study of sections and models can be seen with perfect clearness in the whole embryos.

In Dohrn's papers on the mandibular and premandibular somites (1904) the relations of neural plate and preoral entoderm discussed in this section and the last are beautifully illustrated. Plates 1, 4, 6, 7, 9 and 11 show the early stages in the formation of the primitive optic groove and terminal ridge and the relations of the preoral entoderm and premandibular mesoderm derived from it. As is well known, the anterior head cavity of Miss Platt is found only in the Squalidæ and Dohrn does not regard it as a somite. I am forced to believe, however, that he has not analyzed the conditions in *Squalus acanthias* with sufficient care, and that to this is to be attributed his attitude toward the anterior head cavity as well as his failure to recognize the terminal neural crest and the mesectoderm derived from it. In his figures the primitive optic groove is labelled "infundibulum," but it is perfectly clear to me that it is the groove related to the optic vesicles. See Pl. 9, Fig. 9, where the groove marked *Inf.* is the base of the optic stalk. In Pl. 1, Fig. 15, the reference line *Ent. Zw.* passes across the primitive optic groove at the front and the true infundibular recess near the deep end of the hypophysis. Compare Figs. 23, 24, and 25 of this paper. The terminal ridge is especially clear in Dohrn's Pl. 11, where early stages show its form as well as the early stages of *Amblystoma* (see below).

*c. Roof of the Diencephalon.*—In the roof of the interbrain the development of the velum transversum, dorsal sac, epiphysis and paraphysis has been well described (Minot, Sterzi) so that I have



FIG. 22. *Squalus ac.*, stage M, two sagittal sections near the median plane.  $\times 25$ . In addition to the features shown in earlier figures, the optic chiasma, anterior, posterior and habenular commissures are seen.

nothing new to add. I wish only to note that a careful consideration of Dr. Neal's sections and of the models made from them leads me to believe that the segmental position of the optic vesicle is

practically the same as that of the transverse velum. The velum does not become prominent until after the optic vesicle is well formed (stage K), but in some specimens a slight fold representing it can be recognized in models of embryos as early as 24 somites or earlier. I am inclined to think that the velum represents an infolding of the brain wall which is begun early on account of the withdrawal of material from the alar plate to form the optic vesicle. It is the second neuromere whose dorsal half thus gives rise to the retina, while its ventral half becomes depressed and bulged ventro-caudally to form the primitive inferior lobes above referred to.

### *3. Ganoids and Teleosts.*

The diencephalon presents no features of especial importance. There is a greater development of the inferior lobes than in selachians, although the olfactory apparatus is of less importance. This is doubtless to be attributed to the much greater importance of the gustatory apparatus in ganoids and teleosts. The saccus vasculosus reaches a very great development in some of these forms and it has been shown that there is an intermingling of the epithelial sacs of the saccus with those of the hypophysis. The optic tracts form a chiasma in the floor of the brain in some forms and in others cross at some distance from the brain.

The telencephalon presents certain great peculiarities. It is usually somewhat more elongated than that of most selachians and resembles that of *Chimæra* or *Heptanchus*. Also the telencephalon has no massive roof, but only a broad membranous tela continuous with that of the diencephalon. The boundary between the di- and telencephalon in the roof is marked by a velum transversum which forms the front wall of the *dorsal sac* of the diencephalon.

The membranous roof of the telencephalon is much more extensive than in selachians or other vertebrates. In many cases the lateral walls of the telencephalon are rolled outward (laterad) so that the morphological dorsal border is directed laterad or latero-ventrad. This makes the membranous roof in these forms exceedingly broad. The ventricle is correspondingly extensive and toward its anterior end divides into lateral ventricles which extend into the olfactory

bulbs. These relations have been described and figured by several authors. (See Kappers 1906, 1907, Johnston, 1906, Fig. 151.)

#### 4. *Amphibians.*

In the adult amphibian brain the large size of the telencephalon and the form and relations of its nervous and membranous portions are of interest for our problems. The large telencephalon has thinner walls and larger lateral ventricles than are found in selachians. The lateral ventricles are connected with the median ven-



FIG. 23.

FIG. 23. *Amblystoma punctatum*, neural plate stage. Sagittal section of head end. Ectoderm dark, neural plate medium, entoderm light.  $\times 25$ .

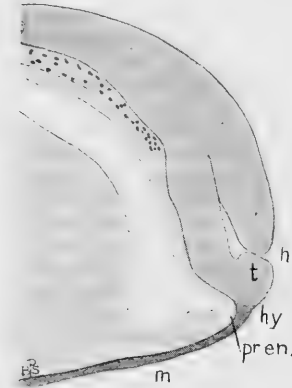

FIG. 24.

FIG. 24. *Amblystoma p.*, neuropore stage. Sagittal section. The section falls to one side of the median plane in the dorsal region and shows the mesoderm lateral to the notochord. Its cephalic limit is the same as that of the notochord.  $\times 25$ .

tricles by wide but well defined interventricular foramina (Johnston 1906, Fig. 150, 151). The lateral ventricles extend forward into the olfactory bulbs and also have a caudal prolongation into the so-called occipital pole of the hemisphere.

The tela of the diencephalon is separated from the membranous roof of the telencephalon by a prominent velum transversum which in the adult becomes complexly folded in connection with the chorioid plexus. In front of the velum is a highly developed paraphysis.

Practically the whole of the membraneous roof of the telencephalon is involved in the two complex structures, the chorioid plexuses which extend into the lateral ventricles and the paraphysis which projects upward between the lateral lobes. The essential fact is that the membraneous roof extends forward over the interventricular foramina to meet the lamina terminalis. The roof of the telencephalon near the middle line is membraneous for its whole length.

The questions regarding the anterior end of the brain and the boundary between diencephalon and telencephalon have been most

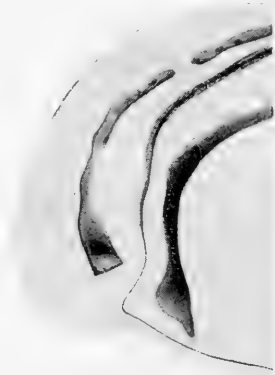

FIG. 25. *Amblystoma p.*, after closure of neuropore, model of the right half of the head, viewed from the medial surface.  $\times 25$ .

carefully studied in embryos of *Amblystoma punctatum*. In these embryos the entoderm, mesoderm and notochord present essentially the same features and the same relations to the brain as in selachians. In particular, the premandibular somites, the median undifferentiated mass in which the notochord ends anteriorly, and the preoral entoderm have the same disposition as in selachians. The only difference is that all the structures are more compact in amphibians and the preoral entoderm is shorter. As Figs. 23, 24, 25 show, the preoral entoderm fills the angle between the floor of the neural tube (neural plate) and the ectoderm and there is a short prolongation of the archenteric cavity into it in front of the site of the future mouth.

The neural plate is bounded by neural folds which meet in front in the transverse *terminal ridge*. This terminal ridge marks the line



along which ectoderm and neural plate meet and, when the neural plate rolls up into a tube, the ridge forms the lower border of the neuropore. These relations are as simple and clear in *Amblystoma* as in *Squalus* (Figs. 23, 24). Even after the neuropore has closed the arrangement of cells and nuclei in this region shows the outline of the terminal ridge. After the brain is separated from the ectoderm the terminal ridge forms a distinct fold, convex toward the ventricle (Fig. 26), which in later stages is occupied by the fibers of the optic tracts in the chiasma (Fig. 33). No neuroporic recess is to be seen in *A. punctatum* in early stages following the closure

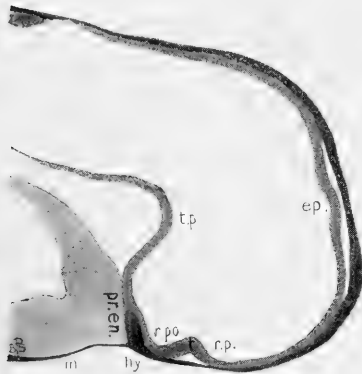

FIG. 26.

*Amblystoma p.*, invagination of hypophysis beginning; primitive inferior lobes. Sagittal section of head.  $\times 25$ .

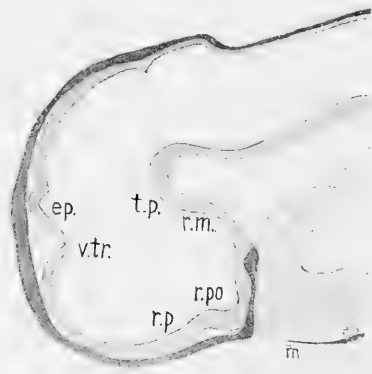

FIG. 27.

*Amblystoma p.*, hypophysial invagination at its height; velum transversum and epiphysis; median sagittal section reconstructed from several sections.  $\times 25$ .

of the neuropore, but in later stages a slight pit is found which may correspond to the neuroporic recess described in other forms (Fig. 33).

The early appearance of the retinal areas on the neural plate was first described by Eycleshymer (1890) and the fact that the optic vesicles are formed from the lateral parts of the neural plate has been pointed out by the writer (1905, 1906). While the neural plate is still open the retinal pits are connected with one another by a shallow groove running just behind the terminal ridge (Fig. 23, r. po). As the neural plate rolls up and the optic vesicles are evaginated this groove grows deeper (Figs. 24, 25) and by the time

the neuropore is closed the front end of the neural tube presents a prominent depression resting against the preoral entoderm and con-

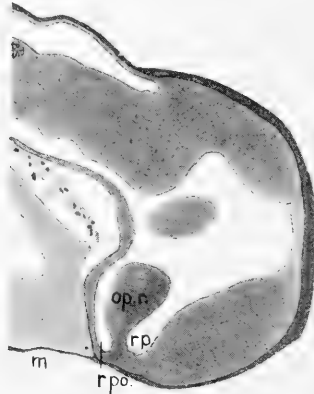

FIG. 28. *Amblystoma p.*, a little more advanced than the one shown in Fig. 27. Parasagittal section through the optic ridge.  $\times 40$ .

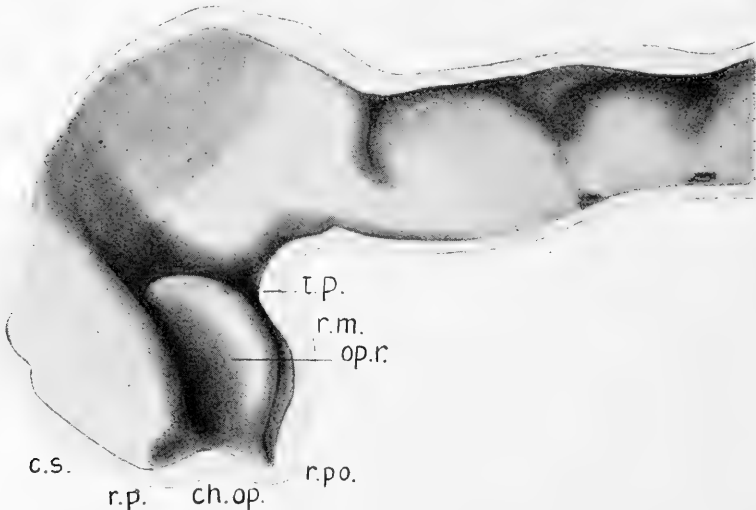

FIG. 29. *Amblystoma p.*, of about the same stage as that in Fig. 28. Model of the right half of the brain seen from the medial surface.  $\times 40$ .

necting the optic vesicles (Fig. 25). This is the primitive optic groove as described in *Squalus*. The model of this stage shows a second angle at the front of the neural tube, separated from the

primitive optic groove by the terminal ridge. This is a pit formed in the lower part of the neuropore and is the *terminal pit* (Fig. 25).

From the earliest stages after the formation of the neural plate and folds, the region from which the hypophysis will be formed can be accurately located. In a median sagittal section of any stage up to the time when the hypophysis is invaginated, a slight reëntrant angle is seen between the terminal ridge and the preoral entoderm. The ectoderm of this angle will form the hypophysis. When the neuropore closes this hypophysial ectoderm is slightly thickened and is continuous with the lower border of the thick plate formed

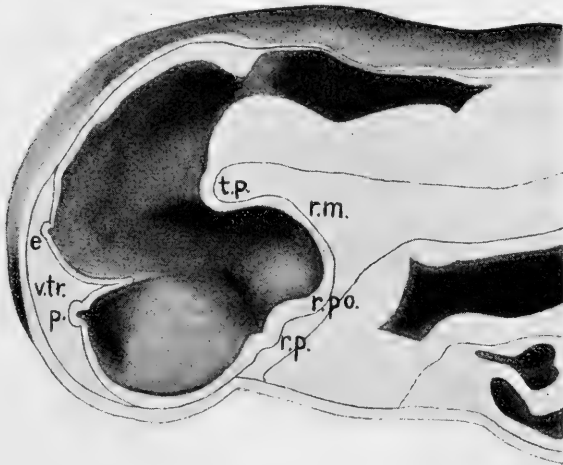

FIG. 30. *Amblystoma p.*, stage when the paraphysis is formed. Model of the right half of the head seen from the medial surface. The model was made from a series of sagittal sections which were oblique to the longitudinal axis, so that the surface of the model lies in the median plane at the fore-brain but passes to the left of the middle at the hindbrain.  $\times 40$ .

by the fusion of ectoderm and neural tube in the neuropore. When the hypophysis begins to push in it presses on the anterior surface of the preoral entoderm and as the primitive optic groove becomes depressed the brain wall presses on the preoral entoderm from above. In this way the preoral entoderm is pushed back and the hypophysis insinuates itself between the entoderm and the posterior wall of the primitive optic groove as in *Squalus*. The preoral entoderm becomes shorter and blunter, but none of it is cut off as in *Squalus*.

The only important difference between *Amblystoma* and *Squalus* is that anterior head cavities are not formed in *Amblystoma*. In later stages the preoral entoderm and median mass proliferate as mesenchyme, so that essentially the same end is reached as in *Squalus*. In some embryos are found indications of a connection of the archentoderm with the hypophysis through the preoral entoderm, but this and the details of the formation of the hypophysis will be described in another paper.

As development proceeds the same shifting in the relations of the optic vesicles is seen as has been described in *Squalus*. In the lateral wall of the forebrain vesicle a thickening is formed which runs

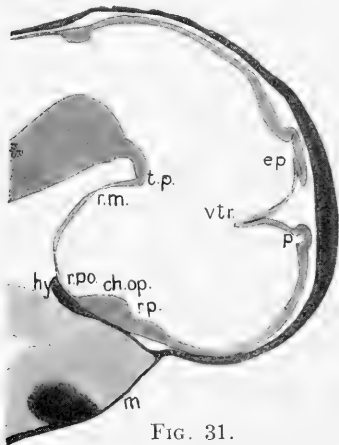

FIG. 31.



FIG. 32.

FIG. 31. *Amblystoma p.*, nearly the same stage as that shown in Fig. 30, median sagittal section of forebrain and midbrain.  $\times 40$ .

FIG. 32. *Amblystoma p.*, later stage, median sagittal section. Note the extreme curvature of the brain in this and following stages.  $\times 40$ .

from the terminal ridge in the middle line obliquely latero-caudad across the primitive optic groove. This thickening is formed in anticipation of the ingrowth of optic tract fibers and may be called the *optic ridge*. It separates the optic vesicles from the primitive optic groove and causes them to be connected by the terminal pit. Figs. 25, 28, 29, 30 show this in sections and models.

By the time the optic ridge is formed the floor of the forebrain vesicle has become depressed to form broad primitive inferior lobes and in the caudal wall of this a *mammillary recess* marks the beginning of the mammillary bodies (Figs. 26 and 27). This is bounded

caudally by the tuberculum posterius. Later, when the hypophysis has reached its definitive position a saccus outgrowth from the inferior lobes appears and the region at which it is connected with the brain may be called the infundibulum. There are therefore in the floor of the forebrain vesicle four recesses formed as in selachians: terminal pit or preoptic recess, primitive optic groove or postoptic recess, infundibulum and mammillary recess.

The formation of the velum transversum, epiphysis and paraphysis need not be described as they are already known (Minot and others). These structures are represented in Figs. 30, 31, 32, 33.



FIG. 33. *Amblystoma p.*, all the chief features of the forebrain developed. Median sagittal section.  $\times 40$ .

#### 5. Reptiles and Birds.

I have to say here only that the study of whole mounts of chick embryos between 20 and 40 hours of incubation shows that the same relations exist in the region of the optic chiasma as in *Squalus* and *Amblystoma*. In early embryos the optic vesicles are connected by a primitive optic groove behind the terminal ridge. Later, the optic ridge is formed, the terminal pit becomes connected with the cavities of the optic stalks, and the optic chiasma occupies the terminal ridge.

#### 6. Mammals.

The chief peculiarity of the mammalian brain is the great size of the cerebral hemispheres. In the adult, as is well known, there is

a membranous tela over the median ventricle and this is continued as the roof of the interventricular foramen into the wall of each hemisphere. In front of the foramina the tela meets the lamina terminalis, so that as in amphibians there is a membranous tela in the median region of the telencephalon for its whole length. For the morphological relations of this tela, the ventricles and the chorioid plexuses it is necessary to study the embryology.

While in all lower classes, except cyclostomes, a prominent velum transversum marks the boundary between diencephalon and telencephalon, in mammals the velum has not heretofore been recognized. The large collection of pig embryos in this laboratory gives excel-

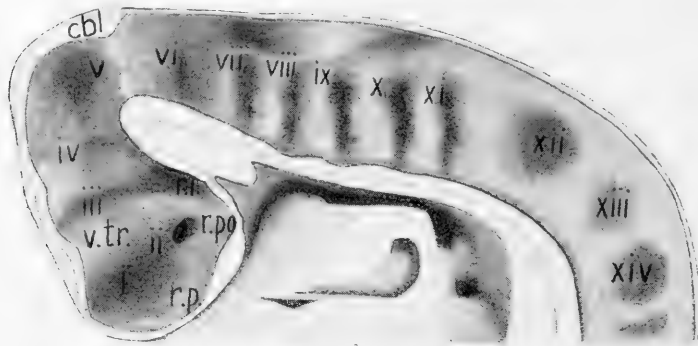

FIG. 34. Pig embryo of 5 mm. Model of right half of head seen from medial surface. The optic vesicles are still connected with the primitive optic groove. The Roman numerals indicate the brain neuromeres.  $\times 25$ .

lent opportunity for comparison with the lower classes described above.

The earliest stage available is a 5 mm. pig cut in transverse series from which a model of the brain has been made (Fig. 34). From the figure it will be seen that this brain agrees very closely with that of the *Squalus* embryo of about 20 somites. The cavity of the optic stalk is continuous with a groove which traverses the median line, the primitive optic groove. Behind this is the primitive inferior lobe, a ventral expansion bounded caudally by the tuberculum posterius. In front of the primitive optic groove is a transverse ridge whose cross section in the median plane presents the form of an arch.

This is the terminal ridge. In front of this is a median pit, the terminal pit. Following the lamina terminalis around the front end of the brain there is found in the dorsal wall a distinct transverse fold, followed by an arched portion and a second more shallow fold. In this fold and for some distance behind it are seen in later embryos the fibers of the posterior commissure and the decussation of the tectum mesencephali. The more anterior and deeper of the two

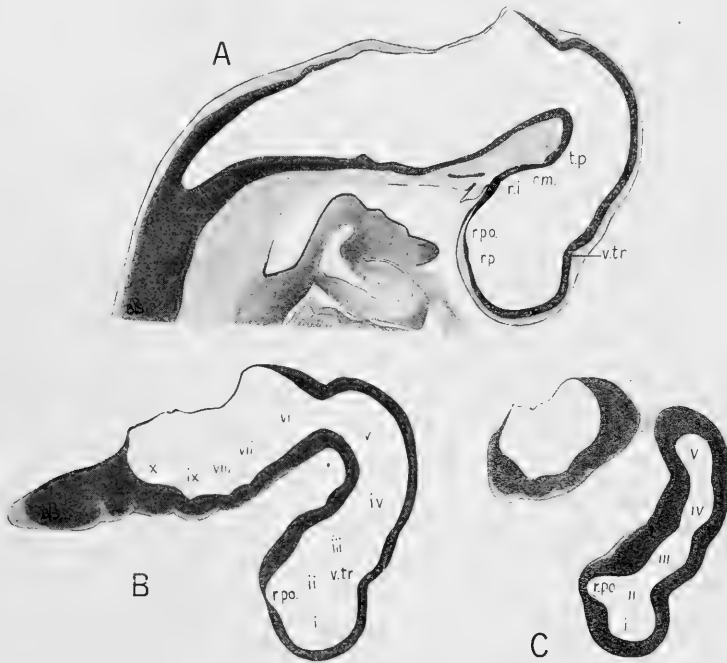

FIG. 35. Pig embryo, 6 mm. A., median sagittal section. B and C, parasagittal sections. Neuromeres numbered in Roman.  $\times 20$ .

folds is the velum transversum, as the further description will make clear. In embryos of 6 and 7 mm. the same change of relations in the optic region takes place as has been described above for *Squalus* and *Amblystoma*. The terminal ridge becomes prolonged caudo-laterad as the optic ridge and in these later appear the optic chiasma and tracts. The identity of these structures in the classes of animals studied is absolutely clear.

The time of development of the mammillary recesses and of the neural part of the hypophysis (saccus vasculosus) varies somewhat in pig embryos. In most 6 mm. embryos the mammillary recess is already clearly recognizable as a caudal expansion of the primitive inferior lobe (Fig. 35, A) whose border above and behind is the tuberculum posterius. From now on the mammillary recess is always clear. Between it and the primitive optic groove the hypophysis lies against the under surface of the primitive inferior lobe. In some 6 mm. embryos there is to be seen just behind the tip of the



FIG. 36. Pig embryo, 9 mm., median sagittal section.  $\times 20$ .

hypophysis in sagittal section a slight, but definite, depression and thickening in the brain floor, the beginning of the evagination of the neural part of the hypophysis. This shows a variable development in embryos between 6 mm. and 9 mm., but is always clearly present in 9 mm. embryos (Fig. 36). After this time the sac grows out and enwraps the tip of the hypophysis and the relations familiar to all embryologists are established. The outgrowth of this sac is the earliest mark of the position of the infundibulum and this is a considerable distance behind the primitive optic groove, as in selachians and amphibians. In later development the floor of the primitive



inferior lobe becomes drawn down in funnel shape and the lateral portions become thickened as the tuber cinereum. It is one of the peculiarities of the mammalian and human brain that the infundibulum is drawn down close behind the chiasma and forms a deeper and narrower funnel than in lower vertebrates. There is no fundamental difference of relations.

The evidence that the fold in the roof which has been called the velum transversum is correctly identified may be seen in Figs. 34

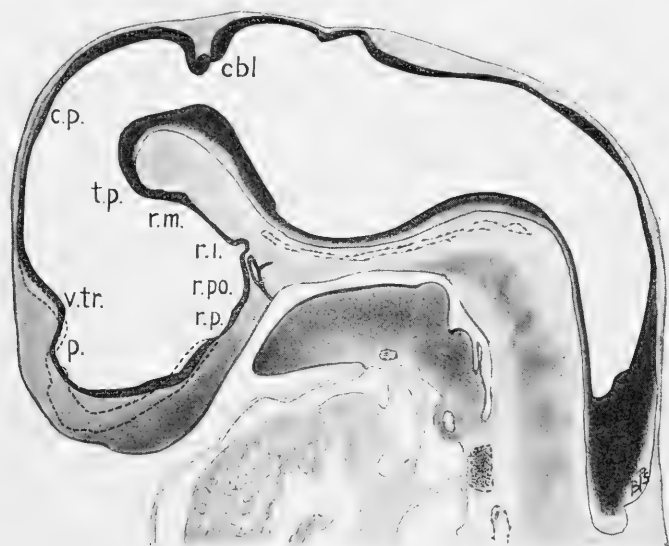

FIG. 37. Pig embryo, 12 mm. Median sagittal section, reconstructed from several sections.  $\times 15$ .

to 39. The posterior commissure is a point about which there is no dispute. In the arch (neuromere) in front of it appears later the epiphysis (Fig. 38). In front of the epiphysis and in the same arch appears the *commissura habenularis*. This arch then is the roof of the diencephalon. It is bounded in front in all other classes of vertebrates by the velum transversum. The fold to which this name has been given lies in the proper segmental position. This is further supported by its relations to the structures in front of it. Immediately in front of the velum the roof is raised in a distinct arch.

This corresponds in position to the paraphysis of lower forms (cf. Figs. 30 to 33): Since there is no glandular development known in mammals, it may be called the *paraphysal arch*, a name which Minot (1901) applies to the corresponding structure in birds. In front of the paraphysal arch a membrane continues forward to meet the lamina terminalis. When the lateral cerebral vesicles are formed it is seen (Figs. 37, 38, 39) that this membrane lies over the ventricle between the interventricular foramina.

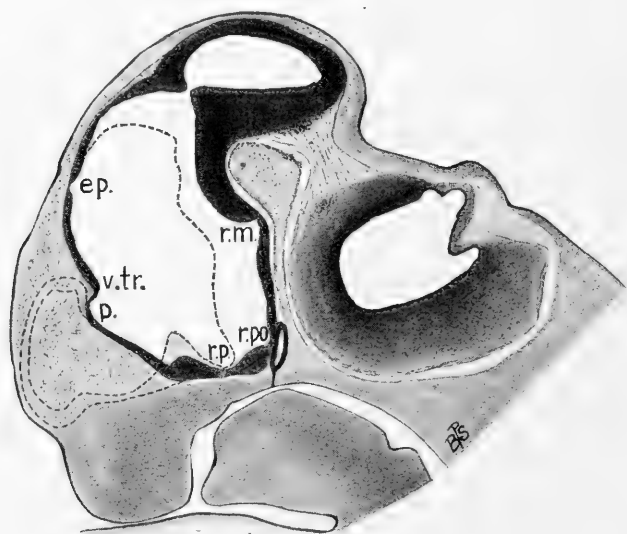

FIG. 38. Pig embryo, 15 mm. Median sagittal section of the forebrain. The dotted outline of the hemisphere is reconstructed from several sections.  $\times 15$ .

As development proceeds the velum transversum becomes a fold with a sharper angle but less deep in proportion to the size of the brain. The paraphysal arch remains a distinct median pouch until the lateral vesicles are well formed. In sagittal sections to one side of the median plane the lateral ventricle appears as a dorsal cavity opening by way of the interventricular foramen in front of the paraphysal arch into the median ventricle. (Fig. 38, 39.) These simple relations persist up to the 17 mm. stage or later. By the

15 to 17 mm. embryo the chorioid plexus of the lateral ventricle is forming. Its position with reference to the velum transversum is shown in a parasagittal section of a 17 mm. embryo (Fig. 40) and in three frontal sections of the brain of a 15 mm. embryo (Fig. 41). The velum transversum is not only a dorsal fold, but is continued around the lateral wall of the brain as the constriction (external fur-

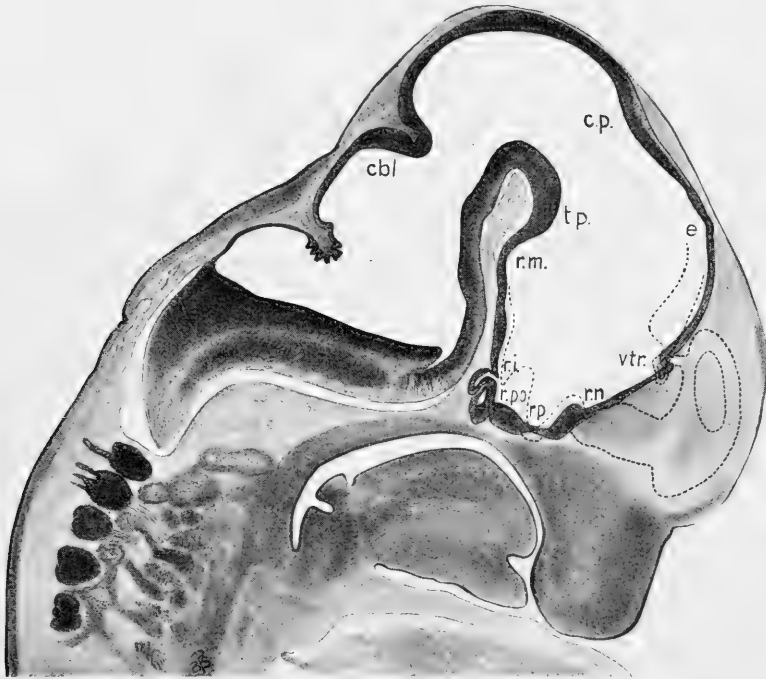

FIG. 39. Pig embryo, 17 mm. Median sagittal section reconstructed from several sections. The outline of the hemisphere lateral to the median plane is shown in dotted lines.  $\times 12\frac{1}{2}$ .

row and internal ridge) between the diencephalon and the telencephalon. By the stage mentioned the cerebral vesicle is sufficiently expanded to push back past the boundary line. In the angle between the vesicle and the diencephalon appears the chorioid plexus pushing into the lateral ventricle. It appears as a folding of the anterior wall or limb of the velum transversum and its lateral prolongation.

In this way appears the chorioid fissure whose further history need not be traced. Near the median plane the plexus appears as a fold projecting into the interventricular foramen and separated from the

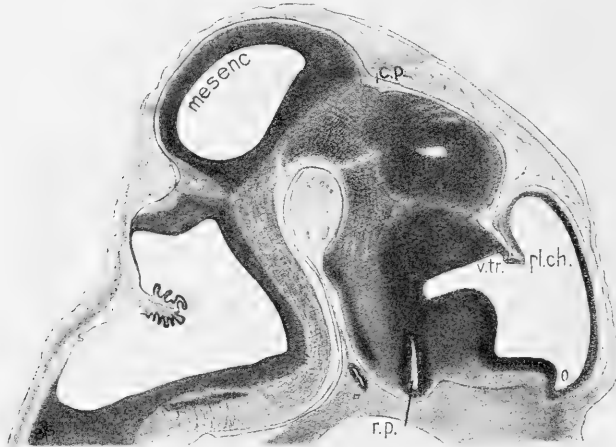

FIG. 40. A parasagittal section from the embryo drawn in Fig. 39.

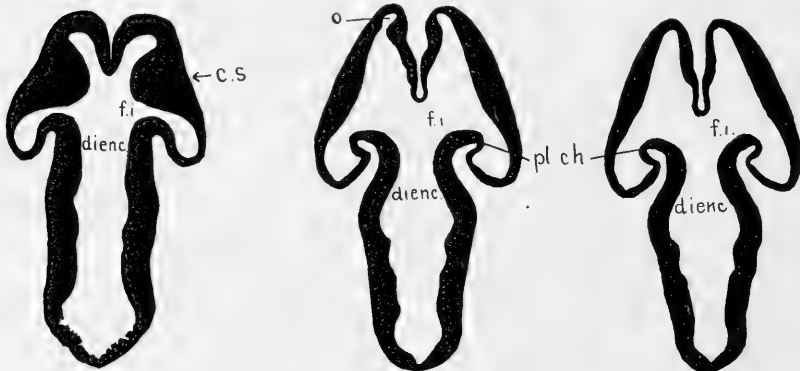

FIG. 41. Pig embryo, 15 mm. Three sections from a frontal series showing the relations of the chorioid fissure and plexus to the lateral hemisphere and the thalamus. The section to the left is the most ventral, that to the right the most dorsal.

velum transversum by the paraphysal arch. From this stage on the plexus grows rapidly and becomes very large and in the median region both the velum and the paraphysal arch become involved in

the plexus and their identity is lost. If the paraphysis is to be found in adult mammals it should be looked for in the chorioid plexus in the middle line between the interventricular foramina. The membranous roof extending forward from the paraphysal arch to meet the lamina terminalis is relatively long in the embryo, spanning the wide opening into the lateral ventricles. In later development these interventricular foramina grow much less rapidly than the hemispheres and the roof in question becomes of insignificant length. This is due in part also to the expansion of the lamina terminalis by the commissures which develop in it.

The neuroporic recess can be located with certainty in the pig embryos. In young stages there appears a slight ridge in each lateral wall just rostral to the preoptic recess. This is the beginning of the corpus striatum. As the two ridges converge toward the middle line they cause a thickening of the lamina terminalis above the preoptic recess (Figs. 38 and 39, between *r. p.* and *r. n.*). This is the location of the anterior commissure in later stages. Above this thickening is another pit which in 15 mm. embryos is a smooth rounded concavity in the middle line, not a transverse groove (Fig. 38). That this is the recessus neuroporicus seems clear from the fact that it is above the corpus striatum and below the interventricular foramina. As the striatum and lateral vesicles grow this pit becomes deeper and more pointed.

Three of the young human embryos described in recent years seem to the writer to give clear evidence that the relations in the optic region are the same in man as in fishes, amphibians and other mammals. The embryo described by Low (1908) shows optic pits on the open neural plate. These are apparently connected with one another by a groove running across the middle line parallel with the terminal ridge. The embryo described by Broman (1896) is 3 mm. long and has the neuropore closed. It shows the terminal ridge essentially like that of *Squalus* or of *Amblystoma*. The optic vesicles are connected with the primitive optic groove caudal to the terminal ridge. Broman noticed the terminal ridge and gave to its ectal, concave surface the name "Fossa interocularis," but did not speak of its significance. The embryo described by Mrs. Gage

(1905) is a trifle larger and considerably more advanced in development. In it the optic vesicles are connected with the pit formed in the neuropore-space. This pit seems to correspond to the preoptic recess above described. From these three embryos it appears very probable that the course of development in man is the same as in the pig and lower forms.

## II. DISCUSSION.

1. *The Anterior End of the Head and Brain.*—Owing chiefly to the lack of certain essential facts, an extensive literature has grown up about the question of the anterior end of the brain. Since the facts which were wanting are supplied in the preceding pages, a detailed review of the discussions from v. Kupffer and His onward would be unprofitable. The determination of the anterior end of the brain is a matter of direct observation. In the study of successive stages in the early development of a selachian, an amphibian and a mammal the essential facts are found to be perfectly clear, and the three forms agree in the form changes of the brain and in the relations of the brain to the ectoderm, entoderm and mesoderm.

The anterior boundary of the neural plate is formed by a transverse ridge, the *terminal ridge*, which is continuous with the neural folds bounding the neural plate laterally. This terminal ridge is clearly seen in successive stages and is readily followed up to the time when the optic chiasma is formed in it. The optic chiasma therefore occupies the anterior border of the floor plate of the brain. This is a matter of fact, not of interpretation.

Behind the terminal ridge lies a transverse groove which laterally becomes continuous with the optic pits or vesicles. This is to be seen from the earliest stages when the optic pits are recognizable in the neural tube or, indeed, on the open neural plate. This groove is the depression which His (1892, 1893) called the *recessus infundibuli* and which v. Kupffer (1893) called the *sinus postopticus*. Later workers have followed His, although his own numerous figures (1892) show that there are two distinct depressions in the region between the chiasma and the mammillary recess. It is clear also (His, 1892, Fig. 2 and p. 162) that the opening into the saccus

vasculosus represents the infundibulum and the depression which he calls recessus infundibuli must be something else. This depression I have called the recessus postopticus (1902, 1906). Because of its relation to the optic pits I have called this in the early-embryo the primitive optic groove.

This primitive optic groove forms a ventral projection of the brain floor which outwardly might be considered as a transverse ridge and it was to this external ridge that His gave the name Basilarleiste. To the groove within he gave the name recessus infundibuli *s. basilaris*. The Basilarleiste of His is not a thickening of the brain floor but a fold which appears within as the primitive optic groove. It is important to make this clear because of the incomparable value of His's work in matters of general morphology. The Basilarleiste in the embryos studied by His meets the front end of the notochord and of the entoderm (Seessel's sac). Upon this relation of the brain to the notochord and entoderm His based the conclusion that the Basilarleiste or the recessus infundibuli formed the anterior end of the brain floor. "In der vorderen Endfläche endigt die Gehirnaxe und es bedarf einiger Vertsündigung darüber, wohin dies Ende zu verlegen sei. In Anschlusse an v. Baer und andere habe ich selber in früheren Arbeiten dies Ende in das Infundibulum oder richtiger ausgedrückt, in die Mitte der Basilarleiste verlegt. Andere, wie neuerdings Keibel, lassen die Gehirnaxe im Chiasma opticum auslaufen. Die Discussion darüber, wer mit seiner Behauptung im Recht sei, hat nur dann einen Sinn, wenn man zuvor festgestellt hat, was unter Gehirnaxe für eine Linie zu verstehen sei. Ich selber habe darunter stets die Mittellinie des Hirnbodens verstanden. Das heisst die Linie, welche, wenigstens auf früheren Stufen längs der Chorda, als der anerkannten Körperaxe verläuft. Diese basilare Axe endigt unzweifelhaft in der Basilarleiste. Versteht man dagegen unter Gehirnaxe eine Linie, welche der Mitte der Röhrenlichtung folgt, so wird diese mittlere Axe in einer Ebene liegen, welche die Grund- und die Flügelplatte des Gehirns von einander scheidet, und ihr Endpunkt trifft die vordere Endfläche im Recessus opticus, bez. dicht vor dem Ort des Chiasma opticum. Wollen wir zur basilaren und zur mittleren Axe noch eine dritte dorsale Längsaxe oder Längs-

linie annehmen, so haben wir deren Ende am oberen Rande der Lamina terminalis zu suchen, vor der Stelle, wo die Fissura chorioidea ihren Anfang nimmt."

Now it must be noticed that more recent work (Platt 1891, Hoffmann 1896, Neal 1898, and others) has shown that the entoderm does not end anteriorly in contact with the Basilarleiste, but extends forward beneath the terminal ridge. His did not study sufficiently early stages to see this. Early stages show clearly that the basal axis of the brain ends not in the Basilarleiste but in the terminal ridge in which later the optic chiasma appears. Furthermore, this is equally true of selachians, amphibians, birds and mammals. It is altogether probable that the same is true of petromyzonts also, for the depression called by Koltzoff "infundibulum" is doubtless the same as the primitive optic groove of other forms. In all vertebrates studied by the writer the entoderm extends forward beneath the transverse ridge which afterward becomes the optic chiasma. The definition of the anterior end of the head previously given (Johnston, 1905) may now be simplified to read: *in all vertebrates the anterior end of the head is the point at which the brain plate meets the general ectoderm at the same time that it comes into contact with the anterior end of the entoderm. This point is marked in the adult by the optic chiasma.*

It has been shown in this paper that the depression in front of the optic chiasma which has been known to His and other authors as the recessus opticus, is related to the optic vesicles only secondarily and is primarily a pit in the basal part of the neuropore (lamina terminalis).

2. *The Homology of the Saccus Vasculosus.*—Here I wish only to point out the homology of the saccus vasculosus of lower vertebrates with the neural part of the pituitary body in man. The saccus vasculosus is an evagination from the floor of the diencephalon which is more or less branched, is lined by ependymal cells and sensory cells, and is supplied by nerve fibers ending in its epithelial lining. In all lower forms it comes into close relations with the hypophysis. In many cases the subdivisions of the two structures become intermingled or interlaced. In man the neural part of the pituitary body



has the same relations but the cavity becomes obliterated. During early development the evagination appears in identical manner and relations in all vertebrates and the writer can see no ground for doubting the complete homology of the structure in all vertebrates.

This homology was understood by His but seems not to be universally accepted. Edinger (1908, p. 203) publishes a schematic figure of a sagittal section of the vertebrate brain in which he shows an infundibulum in contact with the hypophysis and behind it a wholly separate evagination of the brain floor which he calls the sacculus vasculosus. This diagram stands in contradiction to the drawings from actual specimens in the same book (Fig. 167, *Chimæra*; Fig. 175, 176, *Varanus*; Fig. 178, *Ammocætes*; Fig. 181, *Siredon*; Fig. 219, *Hexanchus*). In all of these there is only one evagination of the brain floor between the optic chiasma and the mammillary bodies and it comes into relation with the hypophysis. The writer does not know of any vertebrate in which the condition shown in Edinger's diagram is found.

3. *Segmentation of the Neural Tube in Front of the Cerebellum.*—

In the hindbrain the neuromeres are generally recognized as brain segments corresponding to the segments of the organs in the head. In front of the cerebellum there is no such unanimity of opinion. The writer has discussed this subject at length (1905) and has found nothing in the studies here reported to change any of the conclusions there expressed. On the contrary, the conclusions there based on indirect evidence from other authors are confirmed by direct observation. The segments in the mes-, di- and telencephalon are clearly indicated in Fig. 42, representing parasagittal sections of the brain of a pig of 7 mm. The optic vesicle is here seen somewhat out of line with the other neuromeres but no one would doubt that it represents one brain segment. In front of it is the first segment, from which the telencephalon is formed. Opposite the optic vesicles in the median region is the velum transversum. Behind the optic vesicle are clearly seen in the figure three segments. In connection with the first of these (neuromere iii) appears later the epiphysis. The other two (iv and v) obviously enter into the mesencephalon. In selachians these two segments have connected with them respectively the

thalamic nerve of Miss Platt which probably forms the ciliary ganglion, and the part of the neural crest which forms the ophthalmic division of the trigeminus. The terminal part of the neural crest in close relation with the neuropore *presumably* gives rise to the ganglion of the nervus terminalis in selachians. If this be true, every neuromere of the embryonic brain has connected with it in one class of vertebrates or another some sensory nerve or sense organ (including the optic vesicle and epiphysis. The five brain segments are equally clearly to be seen in Figs. 34 and 35.

4. *Boundary between Diencephalon and Telencephalon.*—The pos-

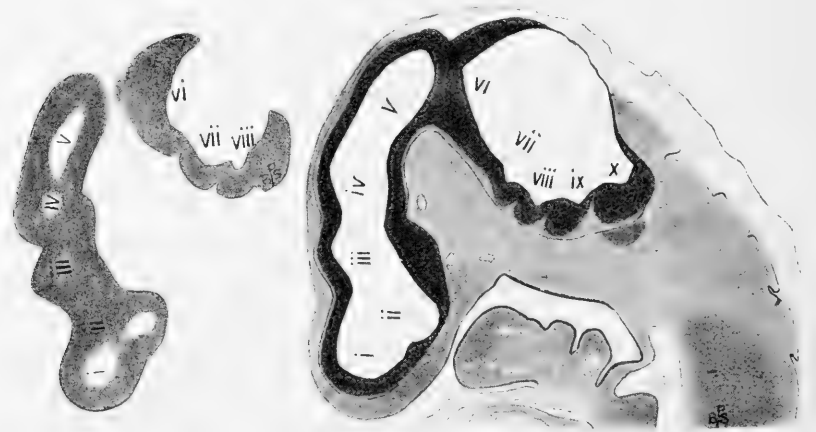

FIG. 42. Pig embryo, 7 mm. Two parasagittal sections to show the segments of the forebrain and mid-brain. Compare figs. 34, 35 and 18.

terior boundary of the diencephalon has never been in dispute. It is the constriction between the forebrain and midbrain vesicles and is later marked dorsally by the posterior commissure and ventrally by the tuberculum posterius. When the forebrain vesicle becomes divided into diencephalon and telencephalon the exact location of the boundary between them has not been entirely clear. In all vertebrates in which a definite velum transversum is recognizable this is considered as the mark of the boundary. The existence of a paraphysis and lateral plexus chorioideus in front of the velum and of a dorsal sac and one or two epiphyses behind it is now so thor-

oughly understood as to need no further comment (Gaupp 1898, Minot 1901, Johnston 1905, 1906).

The velum transversum has been described in cyclostome embryos by Sterzi (1908) and in mammals in the foregoing pages, so that the boundary line sought for is now clear in the brain roof in all classes of vertebrates. From the velum transversum a groove or constriction continues around the sides of the brain. Owing to the early evagination of the optic vesicles this constriction in the dorsal half of the brain occupies the space left vacant, so to speak, by the withdrawal of the retinal tissue. Ventrally the groove is to be thought of as lying in front of the neuromere to which the optic vesicle belongs. The diencephalon consists in its dorsal half of but one neuromere after the withdrawal of the optic vesicle; in its ventral half it includes two neuromeres, the more posterior of which is narrow while the more anterior one forms the depression of the brain floor which I have called the primitive inferior lobe. The boundary between the diencephalon and the telencephalon in the brain floor has been in dispute because of the obscurity which has existed over the optic recesses and the anterior end of the brain.

His placed the boundary behind the infundibulum and assigned the pars optica hypothalami to the telencephalon. He was led to this by his conviction that the telencephalon consisted of a complete brain ring or segment and by his belief that the end of the brain axis was in the Basilarleiste or infundibular recess. As shown above, the optic chiasma is formed in the terminal ridge and therefore occupies the extreme anterior border of the floor plate of the neural tube. If the telencephalon is a complete transverse segment of the brain, as His always insisted, there is no alternative but to include the optic chiasma within it. The primitive optic groove which bounds the optic chiasma behind belongs to the same neuromere with the optic vesicles and therefore is included in the diencephalon. The telencephalon can include no more than the optic chiasma and the associated decussations in the brain floor which lie in the terminal ridge. The boundary between the diencephalon and telencephalon is marked by the velum transversum above and by the primitive optic groove or postoptic recess below. In adult mammals, in which both these land-

marks have disappeared, the boundary can be defined by a line drawn just behind the interventricular foramen and meeting the posterior surface of the chiasma ridge (Fig. 44).

The external groove which separates the diencephalon and telencephalon is usually well marked and in the brains of amphibians,

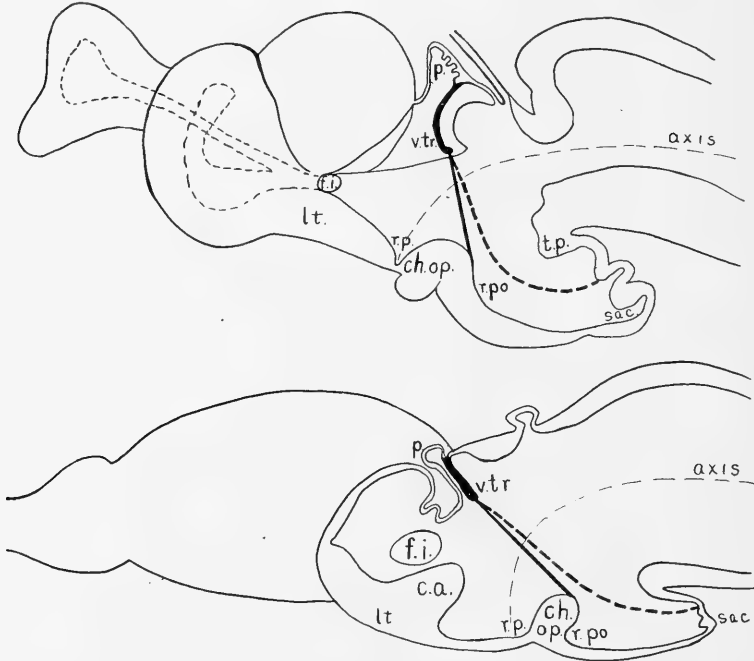

FIG. 43. Sketches to illustrate the boundary line between the diencephalon and the telencephalon. The brains of a selachian (A) and an amphibian (B) are outlined as seen from the medial surface and the boundary set by His is indicated by a dotted line, that fixed in this paper by a heavy continuous line.

reptiles and mammals increases in depth and prominence with the enlargement of the cerebral hemispheres. The description of the early development has shown that the lateral chorioid plexus is formed in mammals immediately in front of the velum transversum and of the groove which continues from the velum transversum around the lateral wall of the brain. From this it results that in the

adult the chorioid fissure is found at the bottom of the very deep groove between the hemispheres and the brain stem and that the boundary between diencephalon and telencephalon runs just along the posterior (thalamic) border of the fissure. These relations are clearly set forth by G. Elliot Smith in a recent paper (1908) on the forebrain of *Lepidosiren*, which agrees in essentials with that of mammals.

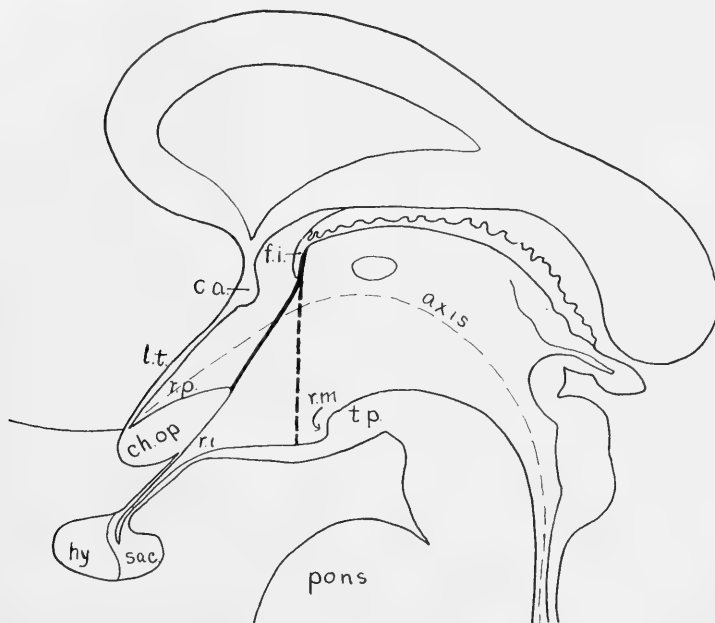

FIG. 44. Sketch of the human brain for comparison with Fig. 43.

When the internal structure of the brain is taken into account it is seen that the boundary line indicated by the development separates centers of different significance. Before it lie the primary and secondary olfactory centers, behind it in the nucleus habenulæ and inferior lobes (tuber cinereum) lie the tertiary olfactory centers with reflex functions. This is not true of the boundary line laid down by His which placed the region of the infundibulum (pars optica hypothalami) in the telencephalon. His was apparently not followed

in this by the Basle nomenclature commission and the tables of neurological terms adopted by the commission contradict His's explanatory notes in that the tables place the pars optica hypothalami in the diencephalon while His states that it belongs to the telencephalon. (See His, 1895, pp. 161, 162.) This is perhaps because anatomists generally have felt the incongruity of assigning the tuber cinereum, infundibulum and hypophysis to the telencephalon. This objection fails when only the chiasma and the fiber decussations adjacent to it are included in the telencephalon.

The usage adopted by the BNA goes to the other extreme and involves at least as bad consequences. The BNA includes the lamina terminalis in the pars optica hypothalami, and implies that the lamina terminalis is the front wall of the diencephalon. The discussion of this usage, which is widely followed by anatomists, will come best in the next section, but here it may be pointed out that it implies the inclusion in the diencephalon of various structures which certainly can not be so interpreted.

*a.* The lamina terminalis contains the anterior commissure, and according to the researches of G. Elliot Smith the corpus callosum and hippocampal commissure develop in it also. These commissures would then all fall in the anterior wall of the diencephalon. This is obviously impractical and confusing and would lead to endless difficulties in fixing an arbitrary boundary.

*b.* The gray matter in the wall of the preoptic recess constitutes generally in vertebrates an important secondary olfactory center which, unless there are strong reasons for assigning it to the diencephalon, should be placed with the other secondary olfactory centers in the telencephalon. All the facts of development and general morphology, however, favor the retention of this center in the telencephalon.

*c.* In many fish-like vertebrates the larger part of the telencephalon (corpus striatum and olfactory lobe) lies lateral to the lamina terminalis and forms the wall of the median ventricle. These structures in fishes would be included in the diencephalon and there would be endless confusion as to the boundary line in various classes. No such confusion and no practical difficulties in the description of the

adult brain arise from the recognition of the boundary suggested above which is clearly marked in the development.

5. *The Ventricles and the Tela.*—An essential part of the question of the boundary between diencephalon and telencephalon is the problem of the median ventricle; specifically, does any part of the median ventricle belong to the telencephalon? The view held by His was that the anterior part of the median ventricle belonged, with the pars optica hypothalami, to the telencephalon. The view which makes the lamina terminalis the anterior wall of the diencephalon assigns the whole of the median ventricle in front of the aqueduct to the diencephalon. It is obvious that the writer must agree with His in recognizing a median ventricle in the telencephalon, although a shorter part of the median ventricle is included than was included by His. The above diagrams (Figs. 43 and 44) show the boundary line of His and that adopted by the writer and it is clear that the short part of the median ventricle between this line and the lamina terminalis belongs to the telencephalon and makes communication with the lateral ventricle through the interventricular foramina.

The view which regards the lamina terminalis as the anterior wall of the diencephalon and of its ventricle denies the existence of any median portion in the telencephalon. This means one of two things: either the diencephalon is the terminal segment of the brain and the telencephalon lies lateral to it as two hemispheres, or the diencephalon is terminal and the telencephalon consists of ultra-terminal hemispheres. Neither of these is true. Aside from the fact that the latter view involves a contradiction in terms, it cannot be considered, because all the evidence shows that the hemispheres are lateral structures. (a) In the ontogeny of all vertebrates the hemispheres arise as evaginations or expansions of the lateral brain wall behind the lamina terminalis; (b) the lateral ventricles thus formed remain always as lateral prolongations of the ventricle and the median ventricle always extends forward beyond the interventricular foramina; (c) when the hemispheres by their great growth push forward beyond the lamina terminalis, as they do in most vertebrates, they are still connected with the lateral wall of the brain stem and in the middle line the lamina terminalis is always the most anterior structure of

the brain in the adult as in the embryo. It is no more true to say that the telencephalon is ultra-terminal than to say that it is post-optic or post-velar. The occipital lobe extends as far behind the velum transversum as the frontal lobe extends in front of the lamina terminalis. The whole hemisphere is a great expansion of a part of the lateral wall of the brain between the lamina terminalis in front and the optic vesicles and primitive optic grooves behind. The point in dispute is whether that portion of the preoptic brain segment which is not carried out in the hemispheres belongs in the diencephalon or the telencephalon.

The first step in answering this question is to see clearly that in the early embryo the lateral hemispheres and the median portion exist together undifferentiated as a simple ring or segment in front of the optic vesicles. This segment is bounded from the earliest stages, even before the neural tube is closed, by the sharply marked primitive optic groove and the optic vesicles. It is only some time after the formation of the optic vesicles that the dorsal part of this simple segment bulges out at either side to form the lateral hemispheres. If the segment is simple at the start, is there any ground for separating the ventral part and adding it to the diencephalon which lies behind the primitive optic groove? The only thing to give support to this view is the connection of the hollow optic stalk with the preoptic recess. Since the optic vesicles have always been referred to the diencephalon, their close relation to the lamina terminalis through the preoptic recess suggests the inclusion of the lamina terminalis in the diencephalon. Now, however, it is shown that the optic vesicles are primarily connected with the post-optic recess and are only secondarily related to the preoptic recess.

In view of this there remains no ground for separating the median and lateral structures which develop from this primitive first segment. The embryological facts leave only one course open, namely, to consider the lateral hemispheres as the dorsal portion, the region of the optic chiasma as the ventral portion of one segment.

Finally, it is impossible to harmonize the relations of the velum transversum in lower vertebrates and in all embryos with the view that the lamina terminalis bounds the diencephalon. That the velum



transversum marks this boundary dorsally is universally agreed. It stands at some distance from the lamina terminalis, however, and if the boundary line is to follow the latter it must run along the roof of the brain and then around its front wall, an obvious absurdity.

A recent writer on the development of the forebrain (Fanny Fuchs, 1908) states that it is only for practical convenience in describing early stages that the term telencephalon should be used at all. Whatever is left after the development of the hemispheres (she recognizes tacitly that there *is* something left) should be reckoned with the diencephalon. She states that in *Rana* the telencephalon has no roof because the di-telencephalic groove meets the upper end of the lamina terminalis. Since she has not studied early stages, has not recognized the velum transversum and gives no figures to show what she includes in the lamina terminalis, her conclusions on this point can have little value. Such figures as Fräulein Fuchs gives show a long median ventricle extending far forward beyond the interventricular foramina. The roof of this, as the writer's own preparations show, is the same as the roof of the similar median ventricle in all other vertebrates, namely a membrane reaching from the velum transversum to the upper border of the lamina terminalis. Fräulein Fuchs has simply included this roof in what she calls the lamina terminalis. This author has studied only the obvious features in the later stages of the development of the forebrain and these give no sufficient ground for any conclusions regarding the morphological value of the telencephalon. There may be quoted here the conclusion of His in his paper on the general morphology of the brain (1892, p. 383): "dass eine solche allgemeine Morphologie nur dann endgültig zu gewinnen ist, wenn wir auf die allerersten Entwicklungsstufen zurückgreifen."

The tela chorioidea of the third ventricle and lateral ventricles requires some comment. It must be noted first that in all vertebrates, embryo and adult, a membranous tela extends over both diencephalon and telencephalon from the habenular commissure to the dorsal border of the lamina terminalis. In all vertebrates except adults of higher forms there is an obvious narrow place in the nervous brain wall between the diencephalon and telencephalon, and the tela

is widest here. This seems to the writer to be due to the withdrawal of nervous material from the dorsal part of the lateral brain walls to form the optic vesicles. This withdrawal of retina-substance leaves a gap which is filled by membranous tela only. The tela in the median region of the telencephalon is perfectly evident in any brain, embryonic or adult, so far as the writer is acquainted. From the posterior part of this tela next to the velum transversum arises the paraphysis or the rudimentary paraphysal arch, and forward from that the tela stretches across the median ventricle between the interventricular foramina. It is equally evident that at all stages of development these foramina are roofed by lateral prolongations of the tela. This is true of all forms with the apparent exception of cyclostomes, teleosts and ganoids. In cyclostomes this is probably due to the compression of the forebrain by the oral funnel and olfactory organ. In ganoids and teleosts the interventricular foramina have been widened beyond recognition by the eversion of the lateral walls. In amphibians and higher forms the prolongation of the tela over the interventricular foramina to become the roof of the lateral ventricles has great importance for the formation of the lateral plexuses. The beginning of these has been described and the only further comment which the writer wishes to make is that the complexity and mystery which the text-books throw around the relations of the velum interpositum and the lateral plexuses should be brushed aside for the sake of the student, who finds the subject difficult enough without artificial stumbling blocks being put in his way. The student should be told simply that the median tela extends laterally as the roof of the lateral ventricle and this becomes infolded to form the lateral plexus. This process continues around the side wall just in front of the junction of the hemisphere and thalamus.

6. *Dorsal and Ventral Zones in Diencephalon and Telencephalon.*—The sulcus limitans of His marks the boundary between alar plate (dorsal zone) and basal plate (ventral zone). The dorsal zone throughout the central nervous system is sensory, the ventral zone motor. Both zones include gray matter and fiber tracts belonging to the correlating mechanisms, and in those segments in which the

primary sensory or motor centers are reduced or wanting owing to reduction or absence of the peripheral organs, the correlating mechanisms constitute the whole of the zone concerned. The writer has repeatedly (1902, 1905, 1906, 1909) emphasized the fact that the longitudinal zones constitute the most fundamental divisions of the brain and hence the sulcus limitans is the most important landmark in the brain. The two sulci converge at the anterior end of the brain to meet in the lamina terminalis and this meeting-point marks the anterior end of the central axis of the brain. The end of this axis is placed at about the middle of the lamina terminalis, namely in the recessus præopticus. The facts set forth in this paper show that the chiasma region must be taken from the lamina terminalis and added to the brain floor. Still, in the writer's opinion, the central brain axis has its ending in the recessus præopticus (Figs. 43 and 44). The reasons for this are to be found in the following facts: (a) the ventral zone of the brain becomes greatly reduced in volume in front of the third nerve by the absence of all motor centers; (b) it is further reduced by the distribution of fiber tracts to various parts of the diencephalon and telencephalon; (c) the sensory centers are represented in the telencephalon by the large olfactory apparatus; (d) the correlating mechanism of the dorsal zone is greatly hypertrophied in connection with the olfactory centers and in higher forms in connection with the somatic cortical centers (neopallium). In other words the ventral zone at the front end of the brain is represented chiefly by the decussating fibers (optic chiasma and commissures of Gudden and Meynert) of the ventral commissural system, while the dorsal zone contains both sensory and correlating mechanisms which are very large. These facts account for the bending down of the sulci limitantes to meet near the ventral border of the lamina terminalis. There is no evidence known to the writer tending to show that the recessus neuroporicus has any significance in this connection. It is only a convenient practical mark of the dorsal border of the lamina terminalis and the anterior end of the brain roof.

In the diencephalon the location of the sulcus limitans is still more difficult. The typical formation of the ventral zone extends

no farther forward than the nucleus of the III nerve, or at most the nucleus of origin of descending fibers in the medial longitudinal fasciculus. The ventral commissural system is interrupted by the downgrowth of the substantia reticularis to form the inferior lobes and mammillary bodies. This downgrowth has so completely altered the relations of parts in the diencephalon that it is practically impossible to trace a boundary line between dorsal and ventral zones. The inferior lobes themselves doubtless represent a part of the correlating substance of the dorsal zones (Johnston 1906, p. 277 and fol.).

7. *Pallium of the Telencephalon.*—A long discussion has been waged over the subject of the general morphology of the pallium since the discovery by Rabl-Rückhard (1882) of the forebrain roof of teleosts. It would not be profitable to enter into the details of this discussion. The hypothesis of Rabl-Rückhard and Edinger was to the effect that lower forms possessed no true or nervous pallium, but that the membraneous pallium as seen in teleosts and other fishes has been transformed into a massive pallium by the development of nervous elements in it. The hypothesis of Ahlborn was that the anlage or beginnings of the pallium of higher forms must be found in the massive portions of the brain of lower forms, that a membraneous (ependymal) roof can never be transformed into a nervous pallium. For many years the Rabl-Rückhard-Edinger hypothesis dominated the field of forebrain morphology by sheer force of the authority of its sponsors. Studnicka made an effort to show the truth of the Ahlborn thesis, but for the time was overborne by Edinger and his followers. Although in his first work the present writer accepted Edinger's views, a wider study of the subject led him to a treatment in 1906 much more nearly in accord with the view of Ahlborn and Studnicka. Kappers and others have added to the discussion and with the fuller knowledge of the comparative anatomical and embryological facts the general morphology of the membraneous and nervous portions of the forebrain may be regarded as a closed subject. Much of the discussion has been due to misunderstanding and differences in the use of terms and it will be sufficient here to define the terms applied to the parts of the forebrain and indicate briefly the differences in form in various classes of vertebrates.

The term *hemisphere* is applied in the BNA to each half of the telencephalon. It would therefore include the right or left half of all that lies in front of a plane passing behind the interventricular foramina and the chiasma-ridge. It is well known that this portion of the brain is not hemispherical in form in all classes. It is somewhat so in cyclostomes, many selachians, amphibians, reptiles, birds and mammals. In Heptanchus, Hexanchus, Chimæra the hemisphere is more elongated and the membraneous roof is more extensive. In ganoids and teleosts the width of the membraneous roof is greatly exaggerated. The nervous walls are rolled outward so that the membraneous roof is attached along the lateral or even latero-ventral aspect and arches up over the ventricle. This eversion of the forebrain walls in teleosts has made the term hemisphere inapplicable in the descriptive sense. However, most of the organs which make up the hemisphere in other forms are present in the teleostean telencephalon and these organs hold the same fundamental morphological relations to one another and to other parts of the brain. Therefore the term hemisphere may be employed throughout the vertebrate series, although in no two classes does the telencephalon approach in the same degree the form of a sphere.

In each hemisphere are represented nervous and membraneous portions. The membraneous portions include the lamina terminalis and the tela chorioidea. The lamina terminalis is supposed to be coextensive with the anterior neuropore, but there is no neuropore in cyclostomes and teleosts and in some other vertebrates (some amphibians at least) the upper border of the neuropore is not marked in the early embryos. Where an unambiguous recessus neuroporicus exists it is the clear mark of the dorsal border of the lamina terminalis. Where this landmark is not clear an arbitrary border for the lamina terminalis must be placed at *some distance in front of the interventricular foramina*. The *tela* forms the roof from the lamina terminalis to the tela of the diencephalon, from which it is separated by the infolded velum transversum. The term *pars supra-neuroporica* of the lamina terminalis which was used by Burckhardt (1894) and is used by Edinger for this portion of the brain roof is wholly without justification.

The nervous portion of the hemisphere includes numerous structures the arrangement of which will be spoken of in the next section on nomenclature. The term pallium has been loosely used by various authors for the membraneous roof of the telencephalon, the dorsal part of the nervous portion and the superficial cell layers in the nervous portion. Eninger uses it in all these senses and in the last edition of his textbook (1908, Bd. 2, p. 249) he distinctly states that the epithelial roof of the teleostean telencephalon is the pallium. "Dieses Dach der Hirnblase heisst Hirnmantel, Pallium cerebri. Dazu gehört auch der auf Fig. 220 noch rein epithelial gebliebene Abschnitt, derselbe, welcher schon bei den Selachiern und Amphibien aus eigentlicher Gehirns substanz besteht." This ambiguity is very unfortunate. Since we have the convenient term *tela* for the membraneous roof of the forebrain, the term *pallium* should be reserved for the cerebral cortex. The question, then, whether teleosts (or other forms) possess a pallium should be answered, not with Rabl-Rückhard by pointing to the membraneous roof, but by ascertaining whether there is present any nervous substance whose fiber connections and functions warrant its being compared with the cortex of higher forms.

It is still too early to define in an exact way what is meant by cerebral cortex. It is not sufficient to define it as superficial layers of cells in the telencephalon because in all classes of vertebrates and in man, superficial gray matter is found in the forebrain whose fiber connections and functions are very different from those of the true cortex. To say that the cortex consists of superficial gray in the roof or dorsal wall of the forebrain gives no means of determining its extent or boundaries. Although the term cortex implies and was first used for superficial layers, it has come in recent years to signify the brain substance which constitutes certain functional mechanisms, whether superficial or not. It is necessary to define the cortex by its fiber connections and from the functional point of view. In mammals the general cortex is understood to be a collection of highly complex centers which exercise functions of correlation and control over bodily movements, etc., through lower sensory and motor centers. The sensory impressions coming to these cortical centers

usually pass over chains of three neurones. The existence of neurone chains of only two links connecting the peripheral sensory surface with the cortex is somewhat in dispute, but it is certain that such chains are relatively few in number. The general cortex provides in its structure the means for association and correlation between the areas concerned with various modes of sense impressions. This general cortex has its efferent pathway over the cortico-spinal tract and other bundles descending through the cerebral peduncle.

In lower vertebrates, in which the general cortex is not yet known, the telencephalon seems to consist of olfactory centers and corpus striatum and it is generally believed that the first cortex to appear was olfactory in function. The writer was the first to attempt a definition of the olfactory cortex (1901, p. 239). It was pointed out that the cortical center receives olfactory fibers of the third order, not of the second order. The olfactory pathway consists of: *fila olfactoria*—*bulbus* and *tractus olfactorius*—*lobus olfactorius* and its efferent fibers—*cortex*. This definition of the cortex has since been adopted and further developed by Kappers (Kappers and Theunissen 1908, Kappers 1908). However, olfactory fibers of the third order run to other centers in addition to the cortex. In the diencephalon the nucleus *habenulæ* and *hypothalamus*, and in the telencephalon itself, the *epistriatum* (*nucleus amygdalæ* in mammals), receive olfactory fibers of the third order (Edinger 1896, Johnston 1898, 1901, Kappers 1906, 1908). The *epistriatum* fulfills this definition in selachians, ganoids and perhaps teleosts when there is no other part of the forebrain that does meet the conditions. However, in higher vertebrates (Kappers 1908) a part of the *epistriatum* becomes gradually pushed back until it finally occupies a position in immediate proximity to the pyriform lobe (*nucleus amygdalæ*), while a true cortical formation appears in the roof of the hemisphere in dipnoans (Elliot Smith 1908) and all higher classes. Now the *epistriatum* of forms above fishes, whose history has been so beautifully traced by Kappers (1908) does not represent all of the formation to which he gives the name *epistriatum* in selachians. The writer has shown that the *epistriatum* in *Petromyzon* (1902) and *Acipenser* (1898, 1901) receives an ascending tract from the

hypothalamus and Kappers (1906, 1908) has recognized this tract also in selachians. I have interpreted this as an ascending gustatory tract (1906, p. 304). The center into which the tract enters at first (Petromyzon) receives secondary olfactory fibers, but in most fishes, especially the selachians in which the olfactory apparatus is highly developed, receives tertiary fibers as well. The entrance of an ascending, presumably gustatory tract, into a tertiary olfactory center in fishes creates a condition analogous to that found in the general cortex of mammals; namely, a center serving for the correlation of two sorts of sense impressions which are received over neurone chains of three links. We seem, therefore, to have in the so-called epistriatum of fishes a primitive olfactory cortex. The gray matter does not consist of superficial layers of cells, but forms part of the wall of the ventricle.

This primitive epistriatum, as seen in Petromyzon and Selachians, is not all accounted for in the history of what Edinger and Kappers call the epistriatum in higher forms. The primitive epistriatum lies in the side wall (floor and roof) of the selachian forebrain (Kappers). The fiber connections which I have worked out in the greatest detail in Petromyzon and Acipenser, show that the epistriatal formation in the side wall continues caudad to the border of the diencephalon, *i. e.*, nearly to the nucleus habenulæ. This is the region called by Kappers the dorsal part of the præthalamus. That this is telencephalic territory is readily shown by the fact that the velum transversum is attached to the lateral wall of the brain just in front of the ganglion habenulæ and behind the peculiar structure here being considered. The primitive epistriatum therefore consists of (1) a dorsal or roof portion, (2) an epistriatum in the narrow sense resting upon the striatum (palaestriatum, Kappers) and (3) a caudal portion forming part of the wall of the median ventricle of the telencephalon. I have shown (1906, Chap. 18) that the caudal portion is of greatest size and importance in Petromyzon, is still of considerable importance in Necturus, and in mammals is represented by a small structure called by older authors the paraphysis but shown by Elliot Smith (1896) to be a nervous structure. The caudal portion decreases in size and importance in the vertebrate series. The second



portion is the true epistriatum which Kappers has traced through the phylogenetic series up to the nucleus amygdalæ of mammals.

The dorsal portion of the primitive epistriatum is seen in the roof in *Petromyzon* and typical selachians, probably in the short roof overhanging a shallow lateral ventricle in *Chimæra*, *Heptanchus* and *Hexanchus*, and possibly in a corresponding structure in ganoids at the anterior end of the olfactory lobe. This structure has generally been wholly lost sight of in ganoids and teleosts and when it reappears in dipnoans and amphibians in exactly the same position and relations as in selachians it has been treated as a new structure, the pallial formation or hippocampus. It must be recognized that the ganoids and teleosts have no other significance than that of a side branch of the phyletic line. The dipnoan brain represents the next step in advance from the selachian, and in the dipnoans the pallial formation appears just where the dorsal part of the primitive epistriatum is found in selachians. The further history of this olfactory pallium has been so clearly worked out by Elliot Smith and others that no further comment on it is needed.

When all fishes are taken into account it is seen that all three parts of the primitive epistriatum receive olfactory fibers and ascending fibers from the hypothalamus. Only the dorsal portion develops into what is universally recognized as olfactory cortex in higher forms (hippocampal formation). Now if it be shown that the ascending tract (gustatory) from the hypothalamus enters the hippocampus we could say that throughout the whole vertebrate series the archipallium (Elliot Smith) is a correlating center for olfactory and gustatory impulses. If it should prove true that the gustatory center is in the hippocampal formation, all parts of the cortex can be defined as correlating centers; the archipallium for olfactory and gustatory impulses, the neopallium for impulses coming from the eye, ear, skin, muscles and joints. General visceral sensation would be represented also in the archipallium.

I have long felt that the term epistriatum is an unfortunate one. In only the smaller number of forms is it descriptive of the structure to which it is applied. The view expressed here and in 1906 is that the body which Edinger called epistriatum is a part of a more

extensive formation which in primitive forms has essentially the same structure and connections in all of its parts. This statement of fact is subject to revision if further studies show it to be incorrect. With regard to the name, however, I find that the extension of the term epistriatum to include all of this formation has led to misconceptions of my meaning. This formation may be described as the visceral correlating center of the telencephalon, or as the correlating substance of the visceral sensory zone of the telencephalon. Instead of the term primitive epistriatum used above, this might be called the primitive visceral cortex. The dorsal portion of it becomes the true visceral cortex (archipallium) when it receives tertiary olfactory and gustatory fibers.

Some of the factors which enter into the definition of the term cortex cerebri may be indicated as follows:

*a.* The term is applied only to structures in the telencephalon (excludes lobi inferiores, etc.);

*b.* The afferent paths of the cortex are predominantly of the third order (excludes the secondary olfactory centers; the cortex shows an uncertain grade of development in the more primitive forms);

*c.* The cortex serves functions of correlation for afferent impulses of two or more kinds (olfactory, gustatory, optic, auditory, etc.; excludes the epistriatum *sensu stricto* or nucleus amygdulæ);

Whether such correlating centers are superficial in position is not of essential importance. The general cortex of mammals is separated from the ventricle only by fibers related to the cortex itself, i. e., by its own white matter. The question of superficial position is of much less importance in the case of the cerebral cortex than in that of the inferior olives, the medial and lateral geniculate bodies, and other centers which are separated from the ventricle by voluminous fiber bundles and gray masses which have no direct relation to themselves.

The point of view of the writer stands in contrast to that of Kappers who in his recent paper (1909) extends the concept of cortex to the lobus olfactorius ("palæocortex") although the centers concerned are simple secondary olfactory centers throughout the vertebrate series. His reason for this is that these centers occupy a superficial position

in mammals (e. g., cortex lobi pyriformis). Elsewhere Kappers insists upon tertiary afferent pathways as the essential criterion of the cortex. The use of two different criteria at different times leads to confusion of thought. I would not apply the term cortex or palæocortex to these secondary olfactory centers, but would use the simple terms lobus olfactorius, lobus pyriformis, etc. I would apply the term cortex to certain functional mechanisms. The above suggestions toward the definition of these mechanisms are of necessity incomplete and in part hypothetical. If such a term as palæocortex were used it should be applied to the morphological forerunner (homologue) of the true cortex.

8. *Divisions and Nomenclature.* The nomenclature of the brain adopted by the Basle commission is still the best that we have, largely because it embodied the results of the indefatigable work and keen insight of His. Before suggesting certain changes in the BNA tables to bring them into accord with the facts I wish to examine briefly the nomenclature offered by some recent authors.

Edinger has shown great fertility and enterprise in the production of new names in brain anatomy. Edinger's terms have arisen from his comparative studies of adult brains and are the expression of his effort to present large and obvious relationships in attractive form. He considers the lamina terminalis as the anterior boundary of the diencephalon, agreeing with the BNA. The narrow portion of the brain extending forward from the optic chiasma (very long in Chimæra) he calls the præthalamus (1908, p. 194). When he comes to describe the telencephalon (p. 251) he describes the lamina terminalis as the plate which unites the two halves of the telencephalon. He treats the anterior commissure system as belonging to the telencephalon and even speaks of the "recessus præchiasmaticus" as one feature of the telencephalon. Here is a contradiction for which there is no remedy in Edinger's mode of treatment. The difficulty is augmented by Edinger's definition of the primitive basal portion of the telencephalon (hyposphærium): the primary and secondary olfactory centers and the corpus striatum. Now the floor of what Edinger calls præthalamus is a secondary olfactory center which I have called the nucleus præopticus. It receives fibers from the bulbus

olfactorius and gives rise to some fibers of the tractus olfacto-habenularis. Considerations of practical convenience and clearness would dictate that this secondary olfactory center be included in the telencephalon, not in the diencephalon.

Edinger distinguishes a neencephalon from a palæencephalon. His palæencephalon includes the lower segments of the brain together with that portion of the telencephalon which he calls the hyposphærium. The neencephalon is the same as his episphærium and includes the tertiary olfactory centers (Elliot Smith's archipallium) and the general cortex (Grosshirn, Elliot Smith's neopallium). Is it true that the whole of the lower segments of the brain are to be set in contrast to that part of the telencephalon to which the name episphærium is given? Are the centers for the cochlear nerve in the medulla oblongata, the inferior olives, the nucleus dentatus in the cerebellum and the auditory centers in the inferior colliculus and metathalamus *older* than the tertiary olfactory centers or the general cortex? Or is it true only that our knowledge of them is older? The terms palæencephalon and neencephalon are undoubtedly useful as expressions of the functional evolution and growth in organization of the whole brain; but as descriptive terms for the topographical features of the brain they would not be useful in the lower brain segments and are decidedly misleading when applied to the forebrain alone.

The terms hyposphærium and episphærium seem to apply fairly well in mammals, but I see no advantage in introducing new terms which will not apply to the brains of lower vertebrates as well.

In describing the minor divisions of the telencephalon Edinger is neither consistent with himself nor with the majority of authors. His description of the olfactory centers is quite confusing and contains several self-contradictions. The body into which the olfactory nerve enters he calls (1908, p. 252) the lobus olfactorius. Almost all recent authors have agreed to use the name bulbus olfactorius for this, while the term lobus olfactorius is given to the collection of secondary centers which make up a greater or less part of the body of the forebrain. To this posterior part Edinger proposes to give the name lobus parolfactorius. This term replaces the term area

olfactoria which Edinger used earlier (1896, p. 141). The present use of lobus parolfactorius is likely to lead to confusion with the *area parolfactoria Broca* used by the BNA, which is only a specific part of the whole group of secondary olfactory centers. Edinger uses the term *area parolfactoria* in the BNA sense in Figs. 247, 275, 279, which are old figures reproduced in this edition without revision. This disregard by Edinger of the usage of the majority of other authors is responsible largely for confusion which arises in the work of younger authors or those who are not thoroughly familiar with the internal structure of the brain. For example, Fuchs (1908) calls the bulbar formation in the frog larva "lobus olfactorius" and applies the term "hemisphere" to the rest of the telencephalon. The confusion of other authors who attempt to follow Edinger's work would be less if Edinger himself always used his terms in the same sense. On p. 260 of the same book he uses the term lobus parolfactorius as synonymous with tuberculum olfactorium at least in reptiles, birds and mammals. This center, Edinger thinks, is a special center for the oral sense, an interpretation which G. Elliot Smith (1909) shows to be wholly improbable. To the secondary olfactory center which covers the lateral and ventral surface of the striatum Edinger gives the names lobus olfactorius (Figs. 230, 231, 234), *area olfactoria* (Figs. 247, 273, 274), cortex olfactorius (Figs. 240, 265, 280), and nucleus tæniæ (Fig. 239).

Professor C. J. Herrick in the course of a very valuable paper on the subdivision of the brain (1908) gives expression to the current idea of the telencephalon in the following sentences. "The telencephalon is well named. It is terminal, not only in position but also in point of time, having been added relatively late in the phylogeny to the rostral end of the original neural tube. The BNA has done well to omit from it the pars optica hypothalami which was originally tabulated as part of this region by Professor His. Originally developed as primary and secondary olfactory centers, it has added successively more and more complexity during the whole course of phylogenetic history." I quote this not for the sake of criticising Herrick's work—for the whole spirit of his paper and most of the details of it are in perfect harmony with my own views—

but because it brings out clearly the difference between the results of the comparative study of adult brains and the results of a complete genetic method in which embryology contributes its just share. The early development shows that as matter of fact the telencephalon is not added late in the phylogeny but is actually the first segment of the original neural tube in all classes of vertebrates. A certain part of this segment expands and grows in complexity with the increasing complexity of the vertebrate organism and of its mode of life. Further, it is clear that the telencephalon originally contained more than primary and secondary olfactory centers. The existence of the *nervus terminalis* is evidence of this; the existence of preoral entoderm and of a well developed neural crest in the telencephalic segment of the embryo is evidence of it; the existence of a well developed correlating center, the corpus striatum, in the brains of all vertebrates, is further evidence. Of all the authors who have represented the telencephalon as purely olfactory in function, not one has shown or attempted to show that the corpus striatum is accounted for by its relations to the olfactory centers alone. The present writer is the only one who has given facts to show the pathway of impulses both to and from the epistriatum and the striatum in lower vertebrates. In my description of the brains of *Acipenser* (1898, 1901) and *Petromyzon* (1902) I showed that olfactory tract fibers ended in the epistriatum and that fibers arising from the cells of the epistriatum ended in the striatum. From the striatum the well known basal bundle (Edinger, Van Gehuchten) passed backward. These results have been confirmed by Kappers (1906, 1908) but Edinger has persistently disregarded the fact that *in his descriptions of the forebrain no fiber tracts are mentioned which would enable either the epistriatum or the striatum to carry out any functions whatsoever*. In the last edition of Edinger's textbook the epistriatum is represented as an end-station for olfactory tract fibers. but no fibers are described in lower vertebrates which go from the epistriatum to any other part of the brain. The striatum, on the other hand, gives rise to the tractus strio-thalamicus, but no fibers are described which come to end in the striatum. The epistriatum receives olfactory impulses but has no way of giving out any impulses; the striatum has an efferent pathway but receives no

impulses. Neither of these important forebrain centers is provided with the means of carrying on any function.

As a further indication that the primitive forebrain has some functions in addition to the olfactory sense, the writer has described two ascending tracts to the forebrain. One of these, the tractus loboepistriaticus, is believed to carry up gustatory impulses to the epistriatum from the tertiary gustatory center in the hypothalamus (fishes and amphibia 1898, 1901, 1902, 1906). If this hypothesis is correct the epistriatum must be regarded as a correlating center for smell and taste and so a forerunner of the smell-taste cortex. A second tract has been traced in *Acipenser* (1901) from the tectum opticum only as far forward as the optic chiasma where it enters the telencephalon. Whether it ends in the corpus striatum or in some other part of the forebrain remains to be seen. In my textbook (1906, p. 336) I have pointed out that the entrance of such a tract as this into the telencephalon constitutes evidence of the beginning of the correlating centers which in higher vertebrates we call the neopallium. The writer has been convinced for some years that the elements or beginnings of all the chief parts of the telencephalon of mammals and man are to be found in the telencephalon of primitive vertebrates.

Herrick's revision of the nomenclature of the diencephalon and mesencephalon contains two new terms, ophthalmencephalon, and medithalamus. As a pedagogic term based on function, "ophthalmencephalon" has my hearty approval. As a morphological subdivision of the brain it is open to the objection that the regions included—retina, chiasma, lateral geniculate bodies, pulvinar and tectum opticum—do not have sufficient morphological unity. The term medithalamus is offered by Herrick provisionally for the things left over after the ophthalmencephalon has been set apart. It thus includes the central gray and a number of nuclei of diverse functions. The fact that it must include the medial geniculate body on the *lateral* surface of the diencephalon seems to the writer a fatal objection to the term medithalamus.

In the diencephalon the epithalamus and hypothalamus are fairly clearly marked both functionally and morphologically. The hypo-

thalamus requires new definition both toward the thalamus and toward the telencephalon. The latter is furnished in the new facts brought out in this paper; the proper boundary between thalamus and hypothalamus can be determined only after we have fuller knowledge of the internal structure. The metathalamus and thalamus each presents morphological unity and cannot well be improved upon at present. The chief changes needed in the BNA at present are such as are required by the new facts regarding the telencephalon and the boundary between it and the diencephalon. These will be indicated below.

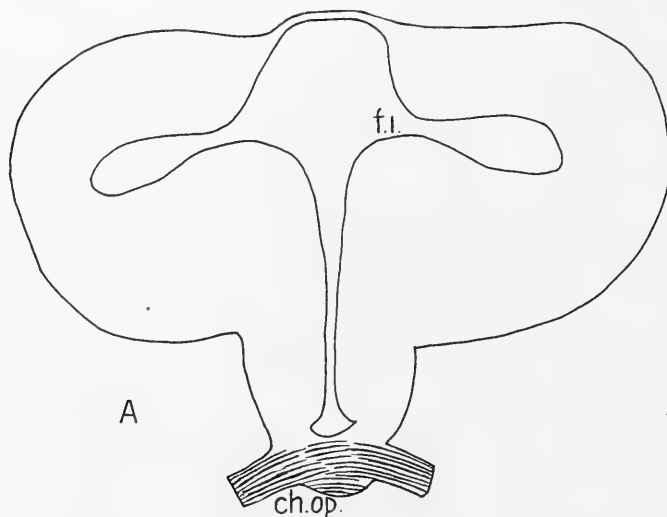

FIG. 45. A, transverse section of the telencephalon of *Petromyzon*.

*Transverse Section of the Telencephalon.*—A true transverse section of any part of the central nervous system must cut across both dorsal and ventral zones of the neural tube and must cut roof plate and floor plate as nearly as possible at the same antero-posterior level. A little reflection will show that while such a section is readily obtained in any of the lower segments of the brain and cord, a true transverse section is seldom cut in the telencephalon. Such a section



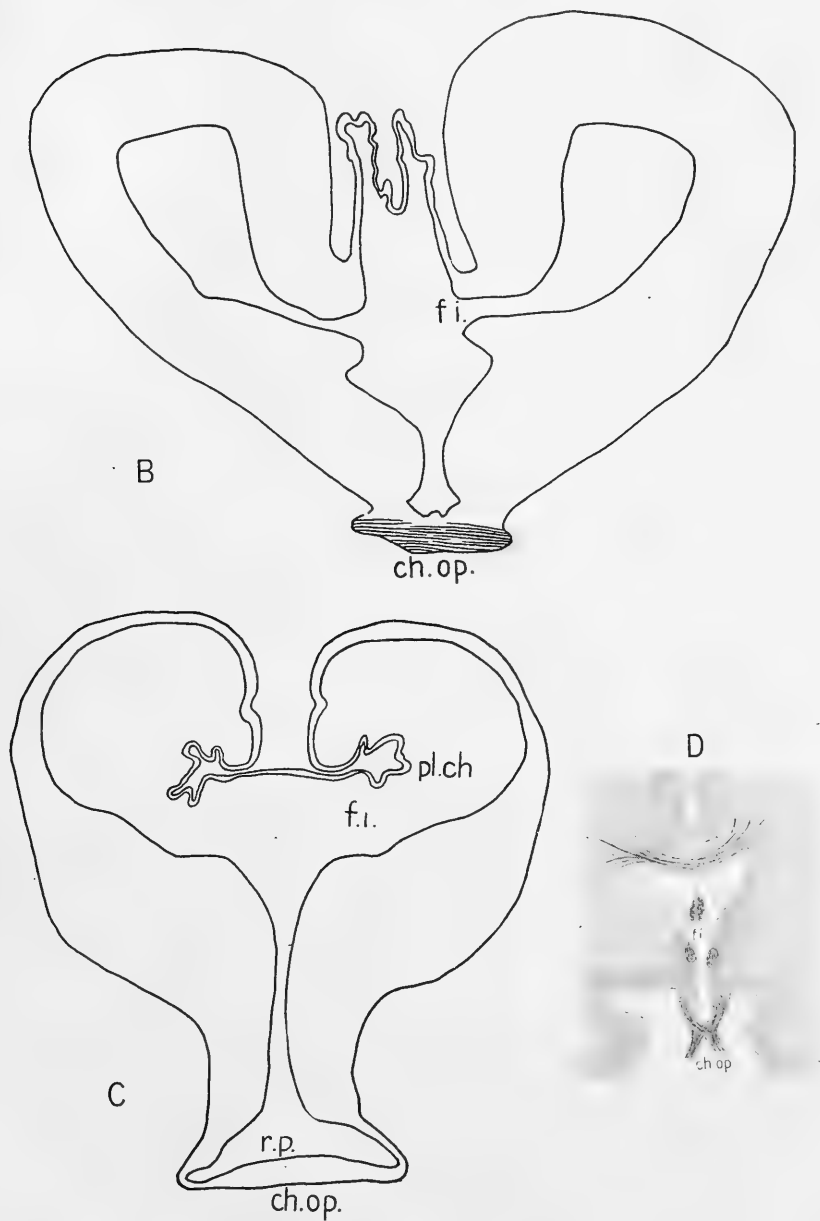

FIG. 45. B, transverse section of the telencephalon of *Necturus*; C, of human embryo; D, of human adult brain.

would pass through the optic chiasma and the interventricular foramina. No other plane would cut both roof plate and floor plate at the same level. Owing to the reduction of the ventral zone and the enormous expansion of the dorsal zone of the telencephalon in all vertebrates, only a small part of the sections of a series can cut both zones, but a section in the plane mentioned may be taken as the true or standard transverse section of the telencephalon. Figures 45 A, B, C, D show such sections of the fish, amphibian and human brain.

#### SUMMARY AND CONCLUSIONS.

1. The neural plate is bounded by neural folds which meet in front at the *terminal ridge*.

2. The optic vesicles are evaginated from the dorsal part of the neural tube and are connected with one another by the *primitive optic groove*.

3. The optic chiasma is formed in the terminal ridge and therefore occupies the anterior border of the brain floor.

4. The lamina terminalis is coextensive with the neuropore and in most vertebrate embryos and many adults its upper border is indicated by a recessus neuroporicus. This is always in front of the interventricular foramina. At the lower border of the lamina is the recessus præopticus.

5. The roof of the telencephalon is always a tela chorioidea.

6. The formation of the optic ridge in anticipation of the optic tract separates the hollow optic stalk from the primitive optic groove and it becomes connected secondarily with the preoptic recess.

7. The velum transversum is clearly present in mammalian embryos as in all other classes of vertebrates.

8. Just in front of the velum in mammalian embryos is a paraphysal arch.

9. The plexus chorioideus of the lateral ventricles forms immediately in front of the velum transversum and in mammals so involves the latter that its identity is lost.

10. The telencephalon is a complete segment or ring of the brain as His believed.

11. The telencephalon is bounded behind in young embryos by the optic vesicles and primitive optic groove; in adults by the velum transversum and the recessus postopticus; in mammals by a line or plane passing immediately behind the interventricular foramina and the chiasma ridge.

12. Externally this boundary is indicated by a furrow which in mammals is very deep and has at its bottom the fissura chorioidea.

13. The basal portion of this segment is reduced in volume owing to the absence of motor nuclei and other structures. It is represented by decussating tracts (optic chiasma, commissures of Gudden and Meynert) and perhaps by a certain amount of gray matter and some longitudinal tracts.

14. The dorsal portion of this segment is greatly enlarged and increases in size and complexity in the vertebrate series. Its increase is believed by the writer to be due to the development of the structures already present in this first brain segment in primitive vertebrates.

15. The sulcus limitans ends in the recessus præopticus. All the olfactory centers and the corpus striatum belong in the dorsal zone.

16. The dorsal zone consists in other brain segments primitively of visceral sensory and somatic sensory columns together with central gray or correlating substance. The olfactory centers constitute the visceral sensory portion of the telencephalon. The somatic portion is represented in higher forms by the general cortex (neopallium), in fishes possibly by the beginnings of this cortex and by the sensory center for the nervus terminalis. The corpus striatum and epistriatum seem to contain the correlating material from which the archipallium and neopallium have developed.

17. The revision of the BNA terms made necessary by the new facts brought out in this paper is indicated in the following table:

#### Mesencephalon

(Pars ventralis—) pedunculus cerebri BNA.

(Pars dorsalis—) corpora quadrigemina BNA.

#### Diencephalon

(Ventral and dorsal portions not clearly definable; four divisions based on purely topographical features).

Ventriculus tertius, pars diencephalica.

Velum transversum.

Epithalamus BNA.

Metathalamus BNA.

Thalamus BNA; requires more careful definition.

Hypothalamus, modified BNA.

    Pars mammillaris hypothalami BNA.

    Pars infundibularis hypothalami.

        Tuber cinereum BNA.

        Infundibulum BNA.

        Hypophysis BNA.

        Recessus postopticus.

Telencephalon

    Ventriculus tertius, pars telencephalica.

    Foramen interventriculare BNA.

    Recessus præopticus (to replace Rec. opticus BNA).

    Recessus triangularis BNA.

Hemisphærium.

    Pars ventralis hemisphærii.

        Chiasma opticum BNA.

        Commissura superior (Meynerti) BNA.

        Commissura inferior (Guddeni) BNA.

    Pars dorsalis hemisphærii.

        Lamina terminalis BNA.

        Commissura anterior (cerebri) BNA.

        Paraphysis.

        Corpus striatum BNA.

        Rhinencephalon BNA.

        Pallium BNA.

            Archipallium (including hippocampus, fornix, etc.).

            Neopallium (including general cortex, corpus callosum, etc.).

Only so much of the BNA tables is included in the above as is necessary to show the changes that should be made to bring those tables into conformity with the new facts. Certain terms are added

to those already in the BNA because they are necessary if the BNA is to be used in comparative neurology: velum transversum, recessus postopticus, recessus præopticus to replace recessus opticus, and paraphysis. The chief changes proposed consist in the shifting of certain terms from the diencephalon to the telencephalon in accordance with the new boundary laid down, and a more complete tabulation of terms under the telencephalon in accordance with the results of a genetic and functional analysis of that segment. The changes are such that it will require very little effort for anatomists and neurologists to adjust themselves to the usage proposed. The advantages are that the tabulation and definitions proposed express accurately the actual relationships, harmonizing the facts of ontogeny and phylogeny with those of adult mammalian and human anatomy. The aim is to adjust neurological terms to the needs of comparative as well as human neurology and to avoid confusion arising from apparent discrepancies between embryology and anatomy, between comparative and human anatomy. These discrepancies now require much time and patient effort in explanations to students. A constant effort is needed to revise our terms to bring them into accord with the facts. Such is the object of the present suggestion.

NOTE TO PAGES 464 AND 506. In a paper which has appeared since this article went to press, Hatschek (*Morph. Jahrb.*, vol. 39, 1909) reaches conclusions with regard to the anterior end of the head in cyclostomes almost identical with my own. His *Basilarrecke* corresponds to my primitive optic groove, his *Basilarlippe* to my terminal ridge. He states that the anterior pole of the craniate body is marked by the *Hypophysenecke*, where the floor of the neural tube and the roof of the archenteron end forward. I cannot agree with Hatschek's statement (p. 519) beginning "Die Basilarlippe stellt den primitiven Vorderwall des Medullarrohres dar." The Basilarlippe or terminal ridge belongs without doubt to the floor of the neural tube and is occupied by bundles of the ventral fiber decussations.

## ABBREVIATIONS USED IN ALL THE FIGURES.

- a.h.c.*, anterior head cavity.  
*arch.*, archenteron.  
*au.*, auditory pit.  
*c.a.*, commissura anterior.  
*cbl.*, cerebellum.  
*c.h.*, commissura habenularis.  
*ch.op.*, chiasma opticum.  
*c.p.*, commissura posterior.  
*c.s.*, corpus striatum.  
*dience.*, diencephalon.  
*ec.*, ectoderm.  
*en.*, entoderm.  
*ep.*, epiphysis.  
*f.i.*, foramen interventriculare.  
*hy.*, hypophysis.  
*lt.*, lamina terminalis.  
*m.*, mouth.  
*md.*, mandibular somite and arch.  
*mes.*, mesoderm.  
*mesenc.*, mesencephalon.  
*m.m.*, median mass connecting the premandibular somites.  
*n.*, neuropore.  
*nch.*, notochord.  
*n.th.*, nervus thalamicus.  
*o.*, bulbus olfactorius.  
*op.r.*, optic ridge.  
*op.v.*, optic vesicle.  
*p.*, paraphysis.  
*pi.ch.*, plexus chorioideus.  
*pr.en.*, preoral entoderm.  
*pr.m.*, premandibular somite.  
*r.i.*, recessus infundibuli.  
*r.m.*, recessus mammillaris.  
*r.n.*, recessus neuroporicus.  
*r.p.*, recessus præopticus.  
*r.po.*, recessus postopticus.  
*t.*, terminal ridge.  
*tcl.*, tela chorioidea.  
*telenc.*, telencephalon.  
*thal.*, thalamus.  
*t.m-ec.*, mesectoderm derived from the terminal part of the neural crest.  
*t.p.*, tuberculum posterius.  
*v.l.*, ventriculus lateralis.  
*v.tr.*, velum transversum.

## LIST OF PAPERS CITED.

- AHLBORN  
1883. Untersuchungen über das Gehirn der Petromyzonten. *Zeit. f. wiss. Zool.*, vol. 39.
- BROHMER  
1909. Der Kopf eines Embryos von Chlamydoselachus und die Segmentierung des Selachierkopfes. *Jenaische Zeit. f. Naturwiss.*, vol. 44.
- BROMAN  
1896. Beschreibung eines menschlichen Embryos von beinahe 3 mm. Länge mit specieller Bemerkung über die bei demselben befindlichen Hirnfalten. *Morphol. Arbeiten*, vol. 5.
- DOHRN  
1904. Studien zur Urgeschichte des Wirbelthierkörpers. 23. Die Mandibularhöhle der Selachier. 24. Die Prämandibularhöhle. *Mittheil. Zool. Sta. zu Neapel*, vol. 17.
- EDINGER  
1896. Vorlesungen über den Bau der nervösen Centralorgane des Menschen und der Thiere.  
1908. Vorlesungen u.s.w., vol. 2.
- EYCLESYMER  
1890. The Development of the Optic Vesicles in Amphibia. *Jour. Morph.*, vol. 8.
- FUCHS, FANNY  
1908. Ueber die Entwicklung des Vorderhirns bei niedern Vertebraten. *Zool. Jahrb., Anat. u. Ontog.*, vol. 25.
- GAGE, S. P.  
1905. A three weeks' Human Embryo, with especial reference to the Brain and the Nephric System. *Amer. Jour. Anat.*, vol. 4.
- GAUPP  
1898. Zirbel, Parietalorgan und Paraphysis. *Merkel u. Bonnet's Ergeb.*, vol. 7.
- GUTHKE  
1906. Embryologische Studien über die Ganglien und Nerven des Kopfes von *Torpedo ocellata*. *Jenaische Zeit. f. Naturw.*, vol. 42.
- HERRICK, C. JUDSON  
1908. The Morphological Subdivision of the Brain. *Jour. of Comp. Neurol. and Psych.*, vol. 18.
- HIS  
1892. Zur Allgemeinen Morphologie des Gehirns. *Archiv f. Anat. u. Entwickl.*, 1892.  
1893. Ueber das frontale Ende des Gehirnrohres. *Archiv f. Anat. u. Entwickl.*, 1893.  
1895. Die anatomische Nomenclatur. *Archiv f. Anat. u. Phys.*, 1895.
- HOFFMAN  
1896. Beiträge zur Entwicklung der Selachii. *Morph. Jahrb.*, vol. 24.

JOHNSTON

1898. The Olfactory Lobes, Fore-Brain, and Habenular Tracts of *Acipenser*. *Zool. Bull.*, vol. 1.  
 1901. The Brain of *Acipenser*. *Zool. Jahrbücher*, vol. 15.  
 1902. The Brain of *Petromyzon*. *Jour. of Comp. Neurol.*, vol. 12.  
 1902a. An Attempt to Define the Primitive Functional Divisions of the Central Nervous System. *Jour. of Comp. Neurol.*, vol. 12.  
 1905. The Morphology of the Vertebrate Head from the Viewpoint of the Functional Divisions of the Nervous System. *Jour. of Comp. Neurol. and Psych.*, vol. 15.  
 1906. The Nervous System of Vertebrates. Philadelphia, P. Blakiston's Son & Co.  
 1909. The Central Nervous System of Vertebrates. *Ergeb. u. Fortschr. der Zoologie (Spengel)*.

KAPPERS

1906. The Structure of the Teleostean and Selachian Brain. *Jour. of Comp. Neurol. and Psych.*, vol. 16.  
 1908. Weitere Mitteilungen über die Phylogense des Corpus Striatum und des Thalamus. *Anat. Anz.*, vol. 33.  
 1909. The Phylogenesis of the Paleo-cortex and Archi-cortex compared with the Evolution of the Visual Neo-cortex. *Arch. of Neurol. and Psychiatry*, vol. 4.

KAPPERS UND THEUNISSEN.

1907. Zur vergleichenden Anatomie des Vorderhirnes der Vertebraten. *Anatomischer Anz.*, vol. 30.  
 1908. Die Phylogenese des Rhinencephalons, des Corpus striatum und der Vorderhirn-kommissuren. *Folia Neuro-biologica*, vol. 1.

KLINKHARDT.

1905. Beiträge zur Entwicklungsgeschichte der Kopf ganglien und Sinneslinien bei Selachiern. *Jenaische Zeitsch. f. Naturw.*, vol. 39.

KOLTZOFF.

1902. Entwicklungsgeschichte des Kopfes von *Petromyzon planeri*. *Bull. de la Soc. Imper. d. Natural. de Moscou*, Année, 1901.

VON KUPFFER.

1893. Studien zur vergleichenden Entwicklungsgeschichte des Kopfes der Cranioten. Heft 1. Die Entwicklung des Kopfes von *Acipenser sturio* an Medianschnitten untersucht. *München u. Leipzig*.

Locy.

1895. A Contribution to the Structure and Development of the Vertebrate Head. *Jour. Morph.*, vol. 2.

Low.

1908. Description of a Human Embryo of 13-14 Mesodermic Somites. *Journal of Anat. and Phys.*, vol. 42.



## MINOT.

1891. On the Morphology of the Pineal Region, based upon its Development in *Acanthias*. *Am. Jour. of Anat.*, vol. 1.

## NEAL.

1898. The Segmentation of the Nervous System in the *Squalus acanthias*. A Contribution to the Morphology of the Vertebrate Head. *Bull. Mus. Comp. Zool. Harvard Coll.*, No. 31.

## PLATT.

1891. A Contribution to the Morphology of the Vertebrate Head based on a Study of *Acanthias vulgaris*. *Jour. Morph.*, vol. 5.

## RABL-BÜCKHARD.

1882. Zur Deutung und Entwicklung des Gehirns der Knochenfische. *Archiv Anat. Phys.*, 1882.

## SMITH, G. ELLIOT.

1896. The Brain of a Fœtal *Ornithorhynchus*. *Quart. Jour. Mic. Sci.*, vol. 39.
1908. The Cerebral Cortex in *Lepidosiren*, with comparative Notes on the Interpretation of certain Features of the Forebrain in other Vertebrates. *Anat. Anz.*, vol. 33.
1909. The Tuberculum olfactorius. *Anat. Anz.*, vol. 34.

## STERZI.

1907. Il sistema nervoso centrale dei vertebrati. Vol. 1. *Ciclostomi. Padua.*

## STUDNICKA.

1895. Beiträge zur Anatomie und Entwicklungsgeschichte des Vorderhirns der Cranioten. *Sitzungsb. d. königl. böhmischen Gesellsch. d. Wissensch. Math-naturw. Classe.*
1896. Beiträge zur Anatomie und Entwicklungsgeschichte des Vorderhirns der Cranioten. *Sitzungsb. d. königl. böhmischen Gesellsch. d. Wissensch. Math-naturw. Classe.*

## VAN WIJHE.

1882. Ueber die Mesodermsegmente und die Entwicklung der Nerven des Selachierkopfes. *Amsterdam.*

## ZIEGLER, H. E.

1908. Die phylogenetische Entstehung des Kopfes der Wirbeltiere. *Jenaische Zeitschr. f. Naturw.*, vol. 43.



# SOME EXPERIMENTS UPON THE BEHAVIOR OF SQUIRRELS.<sup>1</sup>

BY

C. S. YOAKUM.

*From the Psychological Laboratory of the University of Chicago.*

WITH FIVE FIGURES.

## INTRODUCTION.

This paper presents (1) a short account of previous observations on the habits and life activities of the squirrel; (2) some experiments made to compare his simpler learning processes with those of other mammals, and (3) some preliminary tests upon his temperature sense. The squirrels under observation were *Sciurus niger*, or *Sciurus carolinensis*. Melanism and other variations are so common among squirrels that no attempt was made to determine the exact variety.<sup>2</sup>

## I. PREVIOUS OBSERVATIONS OF SQUIRREL BEHAVIOR.

The few statements made by animal observers on the habits and instincts of squirrels are by no means in proportion to the animal's attractiveness, nor to its social nature.

The numerous varieties are found throughout a widely distributed area.<sup>3</sup> The habitat of the squirrel in his American home extends over practically the entire continents of North and South America.

<sup>1</sup>The writer wishes to acknowledge his indebtedness to Professor J. B. Watson for his close supervision of the experiments and invaluable criticism during the preparation of this paper.

<sup>2</sup>INGERSOLL, ERNEST, *Wild Neighbors*, Ch. 1. See also BAIRD, S. F., in U. S. Gov. Reports of Explorations and Surveys, U. S., 1857, page 244.

<sup>3</sup>For the description of the North American varieties, see BAIRD, *op. cit.*, pp. 243-348.

Locally, he lives in wooded tracts and he is especially numerous where nut-bearing trees and plants abound. If we include the many varieties of this order in the statement, the squirrel may be said to make his home in burrows under the ground, among the roots of large trees, in fallen logs, and lastly in knot-holes and in nests built high up in the trees themselves. The varieties studied here are chiefly arboreal, leaving their trees only for food and water and when other exigencies demand travel.

The food of the squirrel is the "fruit and buds of the trees among which he makes his home." He is also, under some conditions, insectivorous and possibly carnivorous.<sup>4</sup> That he is naturally the latter is questioned by Wesley Mills.<sup>5</sup> Pine and spruce seeds are perhaps his most common food in northern regions, and, in general, the nuts indigenous to the region in which the species lives constitute the basis of the food supply.

Some species store food for the winter; others bury the nuts in the loose soil near where they fall, apparently depending upon the large numbers buried and their own rapid exploring ability for the recovery of nuts so hidden. Observation has not fully established this point.<sup>6</sup> The behavior of the squirrel in carrying out the storing instinct has been interestingly described elsewhere.<sup>7</sup> From our own observations it is found that this instinct quickly disappears under the unfavorable conditions of captivity. Experimentation is in progress to determine the means by which the squirrel, almost without error, rejects the faulty nuts and opens or buries only those that are sound.

The tree squirrel does not hibernate. Observation is, however, by no means complete regarding yearly variations in the habits and activities of all varieties.

The literature is full of allusions to the agility, the skill and the general intelligence of the squirrel. These stories and observations are principally of the anecdotal variety. Ingersoll and Mills, in the

<sup>4</sup>Geological Survey of New Jersey, v. 2, pt. 2, 1890, p. 500.

<sup>5</sup>MILLS, WESLEY, *Animal Intelligence*, p. 55.

<sup>6</sup>See INGERSOLL, *op. cit.*, ch. 1.

<sup>7</sup>H. G. SCHMIDT quoted by W. JAMES, *Principles of Psychology*, v. 2, pp. 399, 400.

accounts cited above, give us the longest connected accounts of the habits and life of the squirrel. Their citations practically cover the published observations on the squirrel.

The literature as a whole gives a fairly accurate account of the squirrel as he is seen by the casual observer. Systematic observation and investigation of his associative processes are lacking.

Mills found that the chickeree, *Sciurus hudsonius*, was highly suspicious of any trap or box set to catch him. If caught in one once or twice, he would no longer even investigate the trap. On the other hand, the chipmunk, *Tamias lysteri*, would enter the trap as often as he came near it. Mills considers this an evidence of the superior intelligence of the red squirrel. He makes no attempt to explain the difference in behavior upon the basis of the striking difference in the nesting habits of the animals, the former nesting in trees, the latter burrowing underground. Mills cites the observations of other writers on this point.<sup>8</sup> Numerous scattered observations are collected by this author and by E. Ingersoll, quoted above. We have not repeated these citations, since they are available in their present form and have little bearing upon the further investigations of this paper.

## II. SOME EXPERIMENTS UPON THE ASSOCIATIVE PROCESSES OF THE GREY SQUIRREL.

1. *The Method of Taming the Squirrel.*—The task of taming the grey squirrel is often a difficult one. Some of the animals under observation for as long as six months failed to become entirely tame. Others, captured in semi-wild state, in parks, etc., became sufficiently tame to be used for experimentation in less than two months. The squirrel is compelled by his environment to be ever on the alert, and his arboreal habits make confinement particularly distasteful. Caging without the wheel or in small cages tends to make them weak and unhealthy. If the squirrel be supplied with hard nuts and wood upon which by gnawing he may exercise his muscles and keep his teeth at their normal length, he may be kept for long periods of time in a fairly normal condition.

<sup>8</sup>*Op. cit.*, pp. 52 ff.

For some time after capture the squirrel seeks always to hide. Food will not be taken for hours and then only after a searching exploration of the cage has shown escape to be impossible. The hiding consists in seeking the distant and most inaccessible portions of the cage, burrowing under shavings, paper, hay, or whatever happens to constitute the bedding in the cage. Beginning to eat does not mean that the squirrel has given up hope of escape. All wooden parts of the cage which can be reached by two rows of sharp teeth are rapidly reduced to splinters. Soon the cage either gives way under his fierce attacks, or is found invulnerable; in the latter case, the squirrel bides his time till an open cage door or a faulty lock gives him his opportunity for freedom.

One of my squirrels kept alone in a cage 4 x 3 x 3 feet still preferred the greater freedom of the room after nine months of almost steady work in problem boxes, the maze, etc., and would snatch the slightest opportunity for escape from his cage. To be sure of keeping such an animal, not only the cage, but also the rooms used in experimentation must be kept always free from even small openings. The impulse for freedom is stronger than all others, and undoubtedly constitutes one of the best possible incentives for further experimentation. This impulse to escape from confinement remains in full vigor even after the animal is quite tame.

The squirrel can not be handled as can the white rat and others of his family. The time spent in taming him to the point where he can be touched with the hand is long and unnecessary. The squirrel is tame for many purposes long before he will allow any one actually to hold him. When he is thoroughly tamed, and can be handled, he becomes more or less unfit for experimentation, because of his too decided interest in the movements and actions of the experimenter.

To avoid both difficulties the squirrels were moved about in a small cage. This cage had a square hole, made large enough to admit the animals easily, cut in the center of one side. Feeding the squirrel in this once or twice was sufficient to establish in him the habit of entering whenever it was brought near his living cage. The animal while being fed in this small cage was brought as near

as possible to the experimenter in order to accustom him to the proximity of his keeper. It is only the occasional squirrel which will tame rapidly when left and fed always in the large cage where he makes his home. By this means the animal was not handled during experimentation until he accepted petting almost as a matter of course. The problem-boxes, maze, etc., were also enclosed by wire netting, which allowed the squirrels plenty of space for investigation and still confined their movements to the space of a few feet around the problem-boxes themselves.

2. *Experiments with Problem-boxes.*—The first tests to be described are already familiar to students of animal psychology. They are of value only by reason of the fact that they afford a basis for comparing the behavior of squirrels under given conditions with that of other animals under similar conditions. A further, incidental, point is brought out, namely, that the squirrel if kept under the proper conditions as regards handling, food, etc., becomes a subject entirely suited to the laboratory types of tests.

The problem-boxes used in this first set of tests consisted of simple latch boxes and the modified Hampton Court maze.

The first box is called the "Sawdust box," the second, the "Outside latch box," the third, the "Inside latch box." In the first, the animal must scratch away sawdust until he finds an opening which leads underneath the floor of the box; a hole in the floor gives ingress to the box. The second and third boxes must be entered through a side door fastened with a latch; a spring pulls the door open when the latch is released. In the "Outside latch box" this is accomplished by simply pushing up the bar from its resting place in the socket. The bar of the "Inside latch box" is on the inside and is lifted out of its socket by pulling upon a string which hangs outside the box and near the door.<sup>9</sup>

(a) The Sawdust Problem-box.—Tests on the sawdust box and the outside latch box were completed by Miss Ethel Chamberlain and Miss Lilian Sprague, graduate students in psychology, during the Summer of 1907.<sup>10</sup> The remainder of the experiments began

<sup>9</sup>Photographs and detailed descriptions of the boxes may be found in Watson's *Animal Education*, pp. 33 ff.

<sup>10</sup>In this connection, I wish to thank them for the use of their records.

TABLE I.

SHOWING TIME IN MINUTES FOR EACH SUCCESSIVE TRIAL, NUMBER OF TRIALS  
AND AVERAGE TIME OF TRIALS OF TWO ANIMALS IN LEARNING  
THE SAWDUST PROBLEM-BOX.

No. of Trial	No. 2 Male	No. 3 Female	Average
1	5.02	3.50	4.26
2	2.33	4.00	3.16
3	.45	1.06	.75
4	.98	.65	.81
5	.98	.65	.81
6	.51	.70	.60
7	.46	.53	.49
8	.46	.06	.26
9	.46	1.55	1.10
10	.66	.66	.66
11	.14	1.03	.58
12	1.20	.55	.87
13	.48	.41	.44
14	.63	1.06	.85
15	.05	.37	.21
16	.04	.43	.23
17	.14	.33	.23
18	.09	.50	.29
19	.03	.07	.05
20	.04	.05	.04
21	.07	.44	.25
22	.04	.19	.11
23	.05	.13	.09
24	.01	.05	.03
25	.08	.05	.06
26	.07	.04	.05
27	.03	.08	.05
28	.03	.03	.03
29	.02	.05	.03
30	.03	.02	.02
31	.02	.03	.02
32	.03	.05	.04
33	.03	.20	.11
34	.03	.13	.08
35	.03	.08	.05
36	.02	.03	.03
37	.02	.16	.09
38	.02	.02	.02
39	.02	.11	.06
40	.02	.10	.06
41	.01	.01	.01
42	.01	.01	.01
43	.01	.05	.02
44	.01	.02	.01
45	.02	.01	.01
46	.02	.03	.02
47	.01	.01	.01
48	.03	.01	.02
49	.03	.02	.02





FIG. 1. Constructed from Table I.

in August of that year and continued with many interruptions until August, 1908. The time allotted to each day's test, even when the work was conducted regularly, was very short and this fact accounts, in part, for the irregular number of daily tests.

The records of the learning of the sawdust box are shown in Table I; Fig. 1 shows the learning process in graphic form. The records obtained from the outside latch box are similar and are not given. Both problems are far below the ability of the animals and demand little intelligence beyond that required in the elimination of random movements.

Little need be said at this place by way of comment upon these records. The squirrel's method of solving this problem is quite similar to that of the rat. The only distinctive feature in the learning of the outside latch box was the possible use of vision and the great eagerness with which the animals directed their attack upon an apparently definite object (*i. e.*, the bar). The food was visible through the wires of the problem-boxes and seemed on many occasions to awaken great activity by being thus visible. For example, sawdust, shavings, etc., would more often be scratched away from the side nearest the food, and at such places the fiercest and most persistent attacks were more frequently made. Such movements were made in the beginning of the experiments; as soon as the method of entering the box became in the least fixed, the food itself no longer constituted the specific incentive for making the necessary movements. All the energies of the animals were expended in getting into the box in the quickest manner possible. The problem-box could even be left empty and the squirrel would still make the run. However, unless very hungry, he could not be deceived in this way more than twice; after that the box would lose its attraction.<sup>11</sup>

(b) The Inside Latch Box.—Four animals learned this problem. Two (Nos. 1 and 4) were new to any problem of the kind, though one, No. 4, had previously learned the maze. Nos. 2 and 3 had previously learned both the sawdust box and the outside latch box. No. 1 had been in captivity six months, but had had no training of

<sup>11</sup>The squirrels were trained to this point by Miss Chamberlain and Miss Sprague.

any sort, beyond learning to run in the wheel common to squirrel cages. All were in good condition.

Table II shows the number of trials, time of each trial for each squirrel, the average time for the four animals, the average time for squirrels Nos. 2 and 3, which had been previously trained, and for the untrained animals, Nos. 1 and 4. Fig. 2 represents the last two sets of averages. A is the curve for squirrels 1 and 4, and AB, the curve for Nos. 2 and 3.

The two curves are strikingly dissimilar. Trials 1 and 2, of curve AB, as shown below, are not the average trials of the two animals Nos. 2 and 3. Table II shows that at both of these trials squirrel No. 2 failed to open the problem-box. The curve AB, showing the averages of those animals that had learned the *sawdust* and *outside latch boxes*, is very irregular and does not fall below one minute until after the fourteenth trial. The curve A of the two animals, which came to the problem without previous training on problem-boxes of the type, is a typical learning curve.<sup>12</sup>

In all the early trials, both experienced animals were decidedly uncertain and irregular in their movements and in their mode of attack. The notes taken at this time are definite in their explanation of this difference in the learning process. The following extracts from the diary record will serve to show how the previously acquired habits were "carried over" to the new problem:

Aug. 1, '07, 12 M. Female No. 3 (trained), second trial, ran immediately to door, nosed it and then walked around box; nosed string; climbed on top of box, then off and went to south side; back to door; then back of cage; then to south side, next to door and then completely around again; *scratched* at bottom of cage; went to south side; next to string, nosed it and then mounted

<sup>12</sup>"X" in the table and curve shows where squirrel No. 4 suffered a severe fright during the night preceding the thirteenth test. A cat had been inadvertently fastened in the basement where the squirrels were kept, though not in the same room. She had evidently attempted to get out, and failing, kept up a continuous "meowing" for a large part of the night and was still making considerable disturbance in the morning. At each cry of the cat the squirrel would tremble and crouch, and frequently give the peculiar cry of a squirrel when cornered or badly frightened. The cat was removed early, but at the noon hour, though apparently recovered from fright, the squirrel made abortive and unsuccessful attempts to enter the problem-box.

TABLE II.  
SHOWING RECORDS OF SQUIRRELS IN LEARNING INSIDE LATCH BOX.

No. of trial	Records of Squirrels				Averages		
	No. 1 Male	No. 2 Male	No. 3 Female	No. 4 Female	Total of 4	Nos. 1 and 4	Nos. 2 and 3
1	2.91	Failed	8.16	11.33	7.47	7.12	8.16
2	4.18	Failed	19.15	2.91	9.08	3.54	19.15
3	1.38	1.11	50.00	1.41	13.47	1.39	25.50
4	.13	16.10	47.00	.41	15.91	.27	31.55
5	.63	29.06	7.61	.85	9.53	.74	18.33
6	.10	1.50	4.75	.23	1.62	.16	3.12
7	.28	6.33	9.85	.10	4.14	.19	8.09
8	.70	1.26	9.00	.10	2.76	.40	5.13
9	.20	1.30	6.70	.25	2.06	.22	4.00
10	.13	1.20	1.55	.06	.73	.09	1.37
11	.10	1.15	1.86	.08	.79	.09	1.50
12	.08	6.13	2.01	.06	2.07	.07	4.07
13	.25	1.16	1.76	X 1.45	1.15	.85	1.46
14	.05	.85	1.95	.90	.96	.47	1.46
15	.13	.31	.61	.96	.50	.54	.46
16	.13	.20	.55	.33	.30	.23	.37
17	.08	.25	.28	.13	.19	.10	.26
18	.20	.36	.28	.11	.23	.15	.32
19	.06	.55	.51	.06	.29	.06	.53
20	.31	.16	.20	.18	.21	.24	.18
21	.11	.39	.31	.13	.21	.12	.35
22	.18	.21	.18	.36	.23	.27	.19
23	.05	.10	.11	.05	.08	.05	.10
24	.10	1.29	.25	.03	.41	.06	.77
25	.10	.34	.11				.22
26	.45	.41	.12				.26
27	.15	.16	.13				.14
28	.13	.63	.11				.37
29	.15	.71					
30	a.46	.73					
31	.08	.16					
32	b.50						
33	.90						
34	.13						
35	.10						
36	.10						
37	.30						
38	.13						
39	.10						

NOTE. At 'a' the box was turned to face in a different direction. At 'b' it was turned back to the original position. 'X' represents the effect of a definite emotional element accidentally introduced into the experiment. It is described in a note on p. 549.

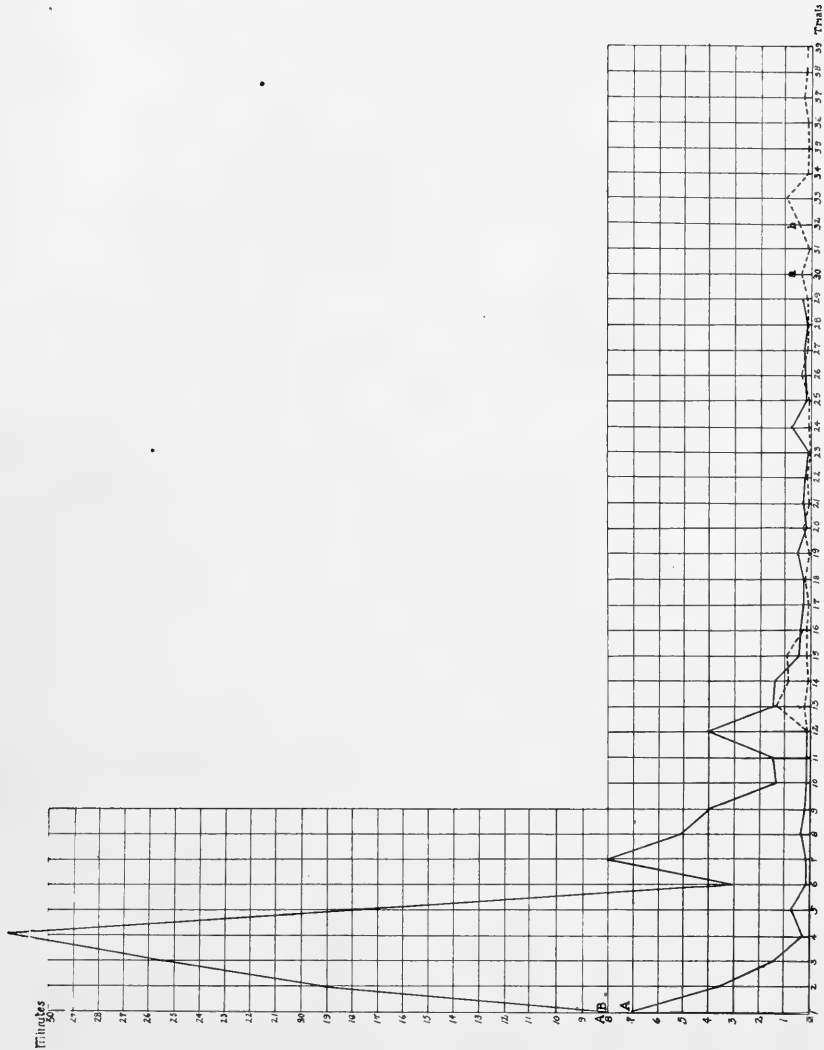

FIG. 2. Constructed from Table II. A. Curves for squirrels 1 and 4. (Previously untrained.) AB. Curve for squirrels 2 and 3. (Previously trained in "sawdust-box" and in "outside latch box.")

to top of cage; tried to open door from top of box; climbed off box, tried door, went completely around box and *worked at door* again; thence to south side, and back to door and then around box again. Finally left problem-box. Climbed back on top, then off over string and to door; went back on top once more, bit at wire netting of cage enclosing problem-box; went around north side, and then back to box; nosed string; played with string, then came to south side, *tried door*, sat and gnawed at wood for two minutes. Stopped; ran around cage several times and went to door again; bit at nail in corner of box; then climbed on top, pulled and bit at string while there until the door came open. Did not notice that door was open and continued to tear at string and pull and tug at wire netting for one minute. Entered, time: 19-15 min.

Aug. 1, '07, 12 M. Male No. 2 (trained), second trial: *Scratched* at north side; at back; ran on top, down to south side; looked around; drank water out of a vessel in corner of large cage; ran over top of box and *scratched* at door; worked very hard here for almost a minute; *scratched* at north side. Pulled and tugged at wire netting on top of cage near the point where string was passed through; examined floor of large cage and *scratched* at door of problem-box; ran around box, listened, ran around again, listened; *scratched* at door and then at south corner, listened, etc. Stopped work after 61 minutes and refused to start again.

Squirrel No. 1, male (untrained), second trial: Touched door with nose, and then ran around box; ran over top of box; repeated this five or six times, trying door each time as he passed it. At intervals would run all over large cage. *No scratching or working at door*, simply touched it or tried to enter, as if door were open. Time: 4.18 minutes.

Squirrel No. 4, female (untrained), second trial: Ran around box, then over it five or six times; tried door twice; touched string several times in running over the box; pulled string, gave two tugs; opened it and jumped from box and ran into food. Time: 2.91 minutes.

It will be seen from these notes that the trained squirrels Nos. 2 and 3 both attempted to enter by biting and scratching at the door and by scratching sawdust, sticks and shavings away from the bottom of the problem-box on all four sides. The movements throughout were evidently those of the early learning processes. The notes also show individual differences quite plainly. Both had learned the two boxes, the sawdust and outside latch boxes. The tendency of No. 3, the female, was to bite and scratch at the door as she had done in learning the outside latch problem. In her work there was very little and, after a few slight attempts, no scratching of the sawdust at the bottom of the box. On the other hand, the male did not carry over the movements learned in his work upon

the outside latch box, but did carry over scratching and gnawing movements acquired in the sawdust box. Both animals apparently found the task of breaking the habits acquired in the one or the other of the earlier experiments almost insuperable. The slightest noise or movement in the room, or the failure on their part to raise the latch at the first pull on the string, would invariably drive them to use some one or more of these previously acquired movements.

The work of the untrained squirrels, Nos. 1 and 4, was of a much different type. "Useless" movements were as much in evidence, and their activity was at all times as great as that of Nos. 2 and 3. However, the movements of 1 and 4 were random movements, "useless" in the sense of not getting the animal nearer its food, and further "useless" since they did not carry out any one particular line of attack, as did the movements of squirrels Nos. 2 and 3. Pulling the string, biting at the wire, running over the box, etc., were random activities directed toward food. The scratching and steady work at the door by the trained animals constituted an activity which the most casual observer would judge to be directed toward effecting a definite mode of entrance to the food box.

An interesting point in learning to attend to the string came out in the work of all four animals. At first, the string went unnoticed or was subjected to the least possible scrutiny and the first pulling was entirely accidental. At the seventh, eighth and ninth trials, the string itself was singled out and became the point of the most eager attack. When found, it was subjected to the severest kind of strains. Hemp string no longer withstood their attacks and had to be replaced by electric light cord, and finally by flexible steel wire. The association between the string and the food supply had become definite, but the movements used in pulling the string had not yet become automatic. After the ninth and tenth trials, the unnecessary time and energy spent on the string were gradually eliminated, until finally a single pull on the string became the cue for a rush to the door. Frequently in later trials, this pull was made so hastily that it failed to open the door.

(c) The Maze.—The method of conducting the experiments on the maze is practically a repetition of that adopted in work upon the

TABLE III.  
SHOWING INDIVIDUAL AND AVERAGE TIME OF SUCCESSIVE TRIALS IN  
THE MAZE. (TWO ANIMALS.)

No. of Trial	No. I Male Minutes	No. IV Female Minutes	Average
1	29.00	1.25	15.12
2	10.25	3.80	7.02
3	9.56	1.86	5.71
4	4.75	1.05	2.80
5	6.33	2.50	4.41
6	3.14	1.83	2.48
7	1.22	1.86	1.54
8	1.19	.70	.94
9	2.83	1.08	1.95
10	1.91	.65	1.28
11	1.45	.38	.91
12	.67	.81	.74
13	.85	.83	.84
14	.58	.61	.59
15	.43	.66	.54
16	*4.00	.55	2.27
17	.29	.61	.45
18	1.40	.56	.98
19	.56	.45	.50
20	.60	.55	.57
21	.45	.45	.45
22	.60	.63	.61
23	.45	.36	.41
24	.98	.38	.68
25	.33	.28	.30
26	.86	.26	.56
27	.80	.26	.53
28	.66	.26	.46
29	.41	.25	.33
30	.80	.50	.65
31	.51	.28	.39
32	.26	.25	.25
33	.34	.26	.30
34	.40	.25	.32
35	.23	.25	.24
36	.22	.28	.25
37	.50	.26	.38
38	.35	.30	.32
39	.50	.26	.38
40	.36	.26	.31
41	.50	.25	.36
42	.40	.26	.33
43	.21	.28	.24
44	.23	.28	.25
45	.23	.28	.25
46	.30	.26	.28
47	.25	.40	.32
48	.35	.35	.35
49	.48	.28	.38
50	.35	.28	.31

\*No particular reason can be found for the high record of squirrel No. 1 in the 16th trial. All the conditions were as usual, the animal simply stopped in the maze. No errors.



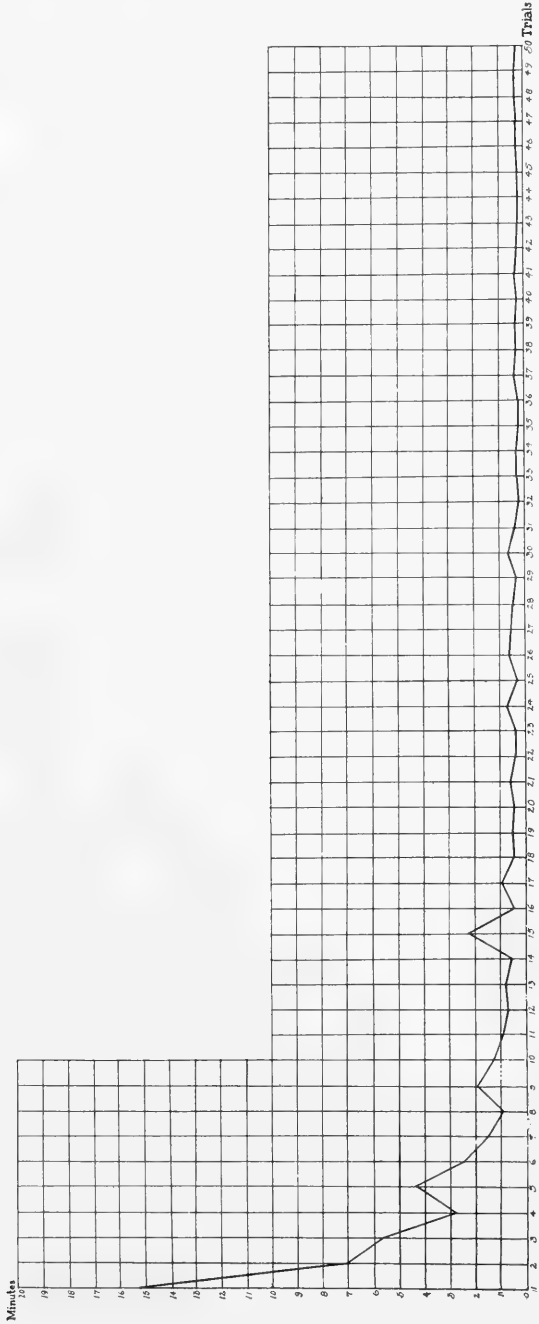

FIG. 3.—Showing in graphic form the records of two animals in learning the Hampton Court maze.

white rat. The Hampton Court maze used in the preliminary rat experiments at the Chicago laboratory was employed in this test.<sup>13</sup> It was covered with wire netting. The food box was so arranged that the animal could be transferred to the entrance by means of a small control page described above (p. 544). A sliding trap door was inserted in the passageway just in front of the last turn which led to the food box. This was left open during the running of the maze and was closed as soon as the squirrel had entered the food compartment. Such precautions were necessary in order to prevent the return of the animal after the nut had been found or when it was desired to remove him from the food box for another trial, or to return him to his cage after the trials of the day had been completed.

The numerical results of the record are quite similar to the curve given by the learning process of the white rat.<sup>14</sup> The accompanying table and curves show the records made by the two squirrels which learned the maze.

The process of learning the maze is for these two squirrels similar in all essential particulars to that of the rat. The early trials were characterized by all possible errors and hesitations. Time and time again the animal would almost make the run perfectly, only to stop at the last runway and return to the starting place. The elimination of errors was fairly gradual with certain persistent errors lasting in both animals until as late as the twentieth trial.

One point was noticed which seems worthy of mention. The animals, even after having completely learned the maze, were easily disturbed. The slightest movement on the part of the observer, any noise outside of the room, or a bright beam of sunlight on any part of the maze, all must be investigated before the squirrel would continue. The hungriest squirrel could be stopped at any place in the runway and made to turn into a cul-de-sac or to go back to the starting point by moving the finger along the wire netting above him. If the observer happened to appear anywhere within the squir-

<sup>13</sup>See WATSON, J. B., *Kinaesthetic and Organic Sensations: their Rôle in the Reactions of the White Rat to the Maze*, p. 10.

<sup>14</sup>Cf. WATSON, *op. cit.*, appendix.

TABLE IV.

SHOWING EFFECT OF DARKENING MAZE AND OF ROTATING MAZE.

No. of Trial	Male Minutes	Female Minutes	Average
Total Darkness			
1	.38	.52	.45
2	.26	.41	.33
3	.30	.33	.31
4	.26	1.40	.83
5	.30	.45	.37
6	.31	.53	.42
7	.58	.53	.55
8	.45	.45	.45
9	.30	.95	.62
10	.28	.35	.31
11	.26	.43	.34
12	.30	.41	.35
13	.28	.36	.32
14	.28	.30	.29
Lights on			
15	.28	.36	.32
16	.25	.30	.27
17	.26	.31	.28
18	.26	.30	.28
19	.26	.30	.28
20	.26	.40	.33
Maze turned 180°			
21	.46	.96	.71
22	1.05	.66	.85
23	.31	.61	.46
24	1.05	.46	.75
25	.38	.33	.35
26	.36	.25	.31
27	.31	.25	.28
28	.38		
29	.30		
30	.28		
31	.41		
32	.46		
33	.33		
34	.30		
35	.28		
36	.25		
37	.26		
38	.25		
Maze turned 270°			
1	3.25	.57	1.91
2	.30	.46	.38
3	.60	.30	.45
4	.28	.26	.27
5	.28	.25	.27
6	.40	.28	.34
7	.30	.36	.33
8	.28		
Maze turned 360°			
1	.33	.33	.33
2	.38	.26	.32
3	.30	.83	.56
4	.35	.33	.34
5		.32	
6		.50	
7		.38	
8		.36	

rel's field of vision, the animal would stop a moment and look up, or try to get out, at the place nearest the observer. Timidity also often produced hesitations and slowed the time without actually resulting in error. The actual care of the squirrel in the maze turns out to be distinctly more difficult than is the case with the white rat. The former is much more easily disturbed emotionally than the latter. Curiosity and the desire for social contact with the experimenter also often cause interruptions in the squirrel's run through the maze.

(d) Effects of Darkening the Maze and of Rotating the Maze.—Table IV and Fig. 4, appended below, show the effects of darkening the maze and of rotating the maze  $180^\circ$ ,  $270^\circ$ , and  $360^\circ$  on two squirrels trained to run the maze in the light.

The irregularity in the record apparently produced by the absence of the light appeared only when the light was turned out *after the animals had obtained their "cue."* That it is caused by distinctly emotional changes and not by a loss of "cues" due to the darkness, follows from the fact that when all lights in the room were turned out *before* the squirrel was started, there was neither hesitancy nor error. Even in the cases where the lights were turned out *after* the animal had started, a simple hesitancy was the only error present—the rest of the trip being made as automatically as in the light.

When the maze was rotated  $180^\circ$  and  $270^\circ$  respectively, the behavior of the animal was decidedly different. Errors were a frequent occurrence. The animals often ran back to the starting place, hesitating and disturbed on both the forward and the backward runs. The rotation to  $270^\circ$  seemed provocative of the greatest confusion. The last error after the change was made appeared at the tenth trial. The rotation to  $360^\circ$ , after practise at the two positions just mentioned, produced no errors. There was slight confusion, however, and the time was slower than the fastest perfect time of the earlier tests. This series of trials does not appear in the curve.

These records have not added much in any exact way to our knowledge of the sensory "cues" used by the squirrel in *learning* and later in *automatically running* the maze. Those who observed the animals at any time were convinced that the sensory factors operative in the learning process and in the perfected maze habit were other

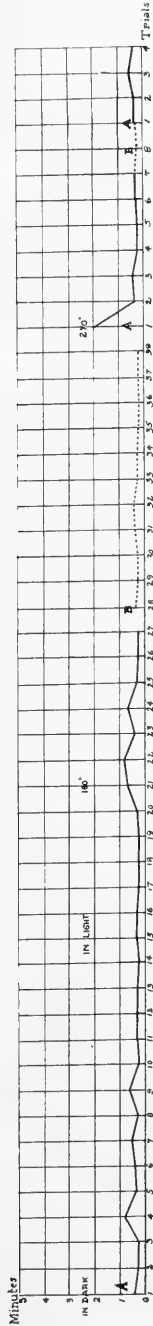

FIG. 4.—Constructed from Table IV. Showing effect of darkening maze and of rotating maze. Portions of the curve marked A are formed from the average record of two squirrels. The parts marked B and drawn as dotted lines are records made by squirrel No. 1 not paralleled by the work of squirrel No. 4. The time of each trial is shown in the table.

than those contributed by the distance receptors. These latter sense organs frequently presented difficulties to the learning process rather than actually assisting it. Such cannot be considered as rigidly proved, but the general and specific behavior of the animals points to such a conclusion.

### III. TESTS ON TEMPERATURE SENSE.

The habit of the squirrels on cold days or whenever the temperature of the room became decidedly lower than usual, of burrowing under shavings, sawdust or cotton, led to an attempt to devise means of testing the temperature sense by the use of the discrimination method. In this connection, the animal's method of covering itself is interesting. The squirrel will draw the shavings, or cotton, up in a pile in one corner of the cage, and will then burrow into it. When finally hidden in the pile, all that is visible is a portion of the tail; if this is drawn aside the tip of the nose and finally the entire head become visible. The little animal thus lies curled up in its nest with the tail as the final addition to its covering.

The temperature test to be described was made in the first place with a view to determining the general features of the temperature sense; in the second place, for the purpose of testing the range and fineness of this sense. The tests as originally planned are not completed. One of the animals was accidentally killed, and the work on the other was stopped by reason of the experimenter's removal to a distant locality. It is probably better to look upon these results as being qualitative and preliminary rather than to consider them as being standards quantitatively determined.

The apparatus was constructed as follows: Two galvanized iron boxes (A and B, Fig. 5) were made with outside dimensions of 9 x 9 x 24 inches. They were built like square-sided pipes, as shown in the drawing, the inner opening being 5 x 5 inches and running the entire length of the box. The space between the outer and inner jackets was two inches deep and entirely enclosed the central cavity with the exception of the ends. This enclosed space was supplied with three vents, an inlet (I), an outlet (O) for the water supply, and an air vent (V) to relieve the pressure when

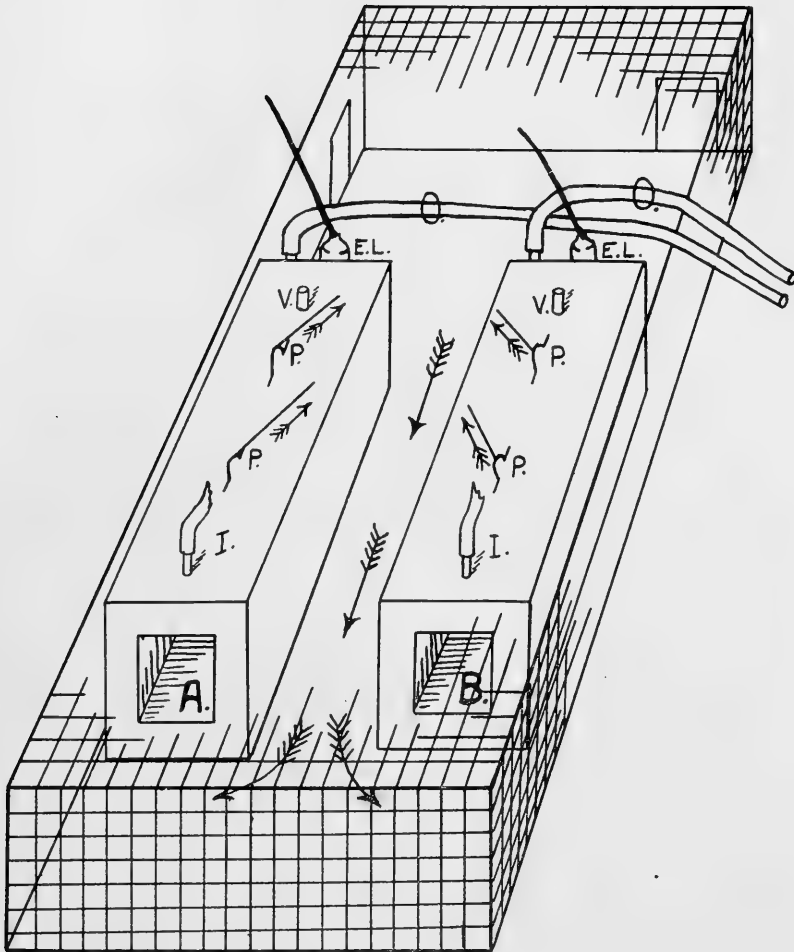

FIG. 5.

water was admitted to the vessel, or when the vessel was emptied. This third vent was not needed so long as the circulation of water was constant. The outlet was placed at the bottom of the encircling jacket and brought to a level with the upper part of the box. Arranged thus, it could be used to siphon all the water out, which not only prevented the possibility of rust, but also at the same time afforded the opportunity for beginning work immediately on subsequent days, by eliminating the necessity of heating a large body of cooled water in the jackets.

In the bottom of each of these 5 x 5 inch inner passages small cubical pans were sunk flush with the floor to a depth of one inch. These pans served as food receptacles. They were placed near the end farthest from the opening used as an entrance for the animal (thus avoiding any possibility of the use of vision). The back of each box was covered by a ground glass plate, behind which a 16 candle power light (EL) was placed. The boxes were painted throughout a dull black, and every effort exerted to make them absolutely alike. The experimenter found this successful so far as his own discrimination was concerned.

The temperature of these boxes was regulated by forcing hot and cold water of the desired temperature to circulate through them. A triple faucet was used, two vents giving cold and hot water, respectively, and the third so attached that the water from the first two could be mixed and any desired temperature of water obtained. The overflow ran into a sink near by.

The regulation of the temperature was not wholly exact. In the first place, the temperature of the room varied slightly from day to day. The extreme limit of this variation during this series of experiments was 3 degrees. The temperature near the experimental boxes necessarily varied according as the needs of the experiment demanded high or low temperatures. Further, this surrounding air varied considerably during the experiment. It was finally decided that the temperature should be said to be that obtained by a rapidly registering Centigrade chemical thermometer when its glass surface was held against the inner surface of the uniformly heated box, five inches from the mouth or entrance. The mercury of the bulb



TABLE V.  
TESTS ON TEMPERATURE DISCRIMINATION OF SQUIRRELS.

Series by days	Male Squirrel				Female Squirrel			
	40° C. Right	15° C. Wrong	40° C. Right	25° C. Wrong	40° C. Right	25° C. Wrong	40° C. Right	30° C. Wrong
1	1	3	4	0	4	2	5	5
2	2	3	4	0	0	6	6	2
3	3	4	2	2	4	3	9	2
4	3	0	4	0	5	4	9	2
5	6	1	1	3	3	6	7	0
6	3	2	4	1	5	4	4	3
7	6	2	2	0	7	3	6	1
8	6	0	2	1	9	0	4	1
9	4	0	5	0	3	0	6	1
10	5	0	4	2	5	2	5	3
11	5	0	6	0	8	1	8	1
12	4	0	3	1	4	1	7	3
13	10	0	2	0	10	0		
14	4	0	1	0	9	0		
15 <sup>1</sup>	2	2	3	0	10	0		
16	2	1	2	0				
17	4	0	4	0				
18	3	0	3	0				
19			3	0				
Totals:	62 <sup>2</sup>	15	59	10	86	32	76	24
Percentage...	80%		85%		73%		76%	

<sup>1</sup> At this point a change in conditions was made, see p. 567.

<sup>2</sup> Exclusive of series 15, 16, 17 and 18.

did not come in contact with the side of the box. It was determined by a series of trials that when the temperature thus obtained was 40° Centigrade, the air in the center of the opening the same distance from the entrance was from 1.5° to 1.25° lower. These conditions were kept constant and tested before and *during* each daily series of experiments.

Flexible rubber tubing was used for making the water connections from the overhead piping. This tubing permitted the raising of one box over the other, which was necessary in order to rule out the position factor. Shifting the large heavy boxes was done by means of a rope and pulley (P). The temperature boxes themselves, the space in front of them, the passageway between them,

and a considerable space behind them, were screened in by wire netting. Sliding wire partitions served to confine the animal in any desired portion of the enclosed space during the adjustment of the apparatus. The passageway between the boxes as they stood in position was five inches wide. The animal entered from behind and passed between the boxes to the open space in front, and there had the choice of turning into the opening of either box.

It will be seen that these tests were made upon few animals. All of the animals, however, were in good condition and the experimenter feels that the results, as far as they go, are representative.

The first set of tests was made upon the male squirrel. The conditions of this test were as follows: Box A, the standard (which contained the food in all the tests), was kept at a temperature of  $40^{\circ} \pm 2^{\circ}$  C. Box B, the variable, during the formation of the discrimination habit was kept at the temperature of  $15^{\circ} \pm 2^{\circ}$  C. A record of this test is shown in the first three columns of Table V.

After discrimination had become definite, the temperature of the variable box was raised to  $25^{\circ} \pm 2^{\circ}$  C. Columns 4 and 5 of the same table show the results of this change.

The second set of tests was made upon a female. In this case, as in the one above, the standard box A was kept at a temperature of  $40^{\circ} \pm 2^{\circ}$  C., but the variable B was kept at a temperature of  $25^{\circ} \pm 2^{\circ}$  C. After the association had become definite, the temperature of the variable was raised to  $30^{\circ} \pm 2^{\circ}$  C. The latter part of this test (discrimination between  $40^{\circ}$  and  $30^{\circ}$ ) was not completed, but the work was carried far enough to leave no doubt that the discrimination of this difference was possible. Table V, columns 6, 7, 8 and 9, show the results of the whole test.

A similar set of tests was made upon three white rats. Table VI shows the records of these animals and the temperatures used.

(a) *Discussion of results of tests upon squirrels.*—The behavior of the squirrels in this test varies little from recorded descriptions of like experiments in other sensory fields. The "controls" used were such as to eliminate sensory factors other than that of temperature. It may be well to mention in some detail the precautions taken.

Position was ruled out by reversing the direction of the turn the animal must make to enter the proper box. Our experience in this part of the control is quite similar to Professor Yerkes' description.<sup>15</sup>

TABLE VI.  
TESTS ON TEMPERATURE DISCRIMINATION OF WHITE RATS.

Series by days	No. 1		No. 2		No. 3	
	40° C. Right	24° C. Wrong	40° C. Right	24° C. Wrong	40° C. Right	24° C. Wrong
1	3	3	3	3	3	3
2	3	3	3	3	4	2
3	2	4	4	2	4	3
4	3	2	3	3	3	3
5	2	1	6	2	4	3
6	2	0	4	0	1	2
7	3	2	5	0	4	1
8	2	2	4	3	3	2
9	6	2	2	4	4	2
10	7	1	3	1	4	1
11	2	0	6	1	5	2
12	2	3	5	0	6	1
13	9	2	5	0	4	2
14	9	0	5	0	5	0
15	10	0	9	0	10	1
16	10	0	9	0	9	0
17			10	0	10	0
18			10	0	10	0
Totals.....	75	25	96	22	93	27
Percentages...75 %			81 %		77 %	

It was found impossible to eliminate the position factor to the point where it became non-operative. This failure to rule out position was used in the latter part of the series as a semi-control test. Going twice or three times into the box in one position was sufficient to establish a preference in favor of that side. Changing the right-left relation of the boxes at this stage constituted a severe test, both of the temperature association and of the squirrel's patience. No failures to choose correctly between the boxes are recorded at the stage where this test was tried.

<sup>15</sup>The Dancing Mouse, The Macmillan Co., '07, p. 91 ff.

As has already been mentioned, all visual difference between the boxes was eliminated. The boxes were of the same size, both were painted black and closed at the back by ground glass windows. Behind these windows, 16 c. p. electric lights were placed in order to prevent the possibility of unequal lighting (at times these lights were interchanged). The food boxes were sunk into the bottom of the passage way, and nut hulls and the kernels used for food could not be seen from the upper part of the entrance. To prevent any possibility of this, however, both food boxes were partly filled with empty nut hulls, and toward the close of a series, with whole nuts and pieces of nuts. In a control test, both lights behind the boxes were turned off entirely, leaving both boxes in total darkness; finally, first one light and then the other was turned off to determine the firmness of the association.

Smell was eliminated by rubbing the side and bottom of the five-inch passage way with nut kernels and with other aromatic substances. Food was frequently placed in both food boxes, when the discrimination had been established, to test thoroughly the absence or presence of smell associations as well as visual.

In order to be certain that all the factors other than temperature were alike in both boxes, the box which was made the standard on one day (40°) was used as the variable on the succeeding day. This alteration was not constant, *i. e.*, not made every other day. It was feared that even this regularity might be learned by the squirrel, so that the change of the standard temperature from one box to another was made quite frequently in the midst of a single day's series.

To prevent discrimination in the runway on any basis whatever, the sides were covered with asbestos. It was not particularly intended that discrimination on the basis of temperature should not take place here, but in order to eliminate secondary criteria, it seemed better to eliminate differences in temperature as well.

After the association had been formed, an effort was made to determine *how* the squirrel detected the temperature of the box. This was very incompletely done, for the reason that it was desired to confuse the animal as little as possible in order that the later experiments might proceed immediately. Asbestos pieces were prepared

to fit snugly over the front lower edge of the entrance. These were placed over both boxes and thus shut out all temperature discrimination by contact, thus forcing the animal to depend upon the air in the entrance to the tunnel. The effect is shown in the records of the first set of tests, series 15, 16, 17 and 18, Table V.

The squirrel was plainly confused, which he showed by sniffing the air and testing each box once or even twice before entering. He soon learned, however, to depend upon the air at the entrance of the box in deciding which box to enter. It seems quite possible that under the first set of conditions, the squirrel was discriminating partly by actual contact with the metal of the box and partly by means of the air at the entrance.

(b) *Discussion of results of tests upon white rats.*—Table VI shows the work of three white rats on temperature discrimination. The method used was slightly different from that pursued with the squirrels. The rats seemed so uncertain and irregular in their early tests, that it was practically necessary to develop a position habit. Such a habit was accordingly developed and then broken. The rat learned to find the food in one box by position, then the position was changed and he was compelled to learn a new position. To the observer at least the earlier stages of the learning process seemed to be much more easily detected by this method than by the method used in the experiments upon the squirrels.

#### IV. CONCLUSION.

1. In the solution of the problems placed before the squirrel in the series of experiments, it is shown that the squirrel learns by the trial and error method. His learning curves are in the main similar to the curves representing the learning processes in the white rat.

2. The greater irregularities in the curves obtained from the squirrel may, perhaps, be explained on the basis of emotional factors that are more prominent in these animals than in the rat. The greater sensitivity to emotional disturbances seems to be due to the fact that the distance receptors play a larger rôle in the life of the squirrel than in the rat. Experimental proof of this seems possible.

3. Successful training in certain problems is highly prejudicial

to the further training of the same animal in problems which present a large number of similar conditions. Different methods of opening the *same* problem box constitute such unfavorable conditions. A latch problem box and the maze, for example, do not present enough identical conditions to interfere with the learning process of the one when the other has been learned first.

4. The grey squirrel and the white rat can form associations upon the basis of a temperature sense. Actual tests show that the squirrel can discriminate between two boxes when they differ in temperature by 25°. In the case of one animal tested, a difference of 10° in the temperature of the box was found discriminable. Further tests with a more accurate apparatus would in all probability show that the discriminable difference in temperature may be much less. The experiments upon the white rats show that a difference of 16° is easily discriminated.

5. *Incentives* which may be used easily in further investigations with the squirrel are: hunger, disagreeable odors and tastes (bad nuts, onions, etc.), gnawing impulses, and love of exercise and greater freedom. This last incentive is especially strong in the squirrel.

The ability of the squirrel to detect an edible nut from a faulty one probably contains the sense, or senses, in which the keenest discriminative power of the squirrel is reached.

# TROPIC AND SHOCK REACTIONS IN PERICHÆTA AND LUMBRICUS.

BY

E. H. HARPER.

*From the Zoölogical Laboratory of Northwestern University.*

WITH TWO FIGURES.

## CONTENTS.

	PAGE
Introduction .....	569
Movements of Perichæta .....	569
Methods of Stimulation .....	572
Chemical Stimulation of the Anterior End .....	572
Negative reaction types .....	573
Relation to the musculature .....	575
Frequency of the reaction types under different degrees of stimulation .....	576
Variability of the types .....	576
The tropic tendency in the different reaction types .....	578
The two-phased character of the reaction types .....	580
"Unterschiedsempfindlich" responses .....	580
Reactions to Light .....	581
Note on Experiments with Electrical Stimulation .....	584
Conclusions .....	584
Summary .....	585
Literature List .....	587

## INTRODUCTION.

*Perichæta bermudensis* (Beddard) is an exotic earthworm of active habits found in greenhouses. Members of this genus are frequently known as eel-worms. Its movements are more complex than those of our common species. A description of some of the movements will be given preliminary to a consideration of its reactions.

*Movements of Perichæta.*—1. Locomotion of the usual type.

2. Rolling with the middle of the body in advance. In this maneuver the middle region extends causing a stretching of the

worm and the ends initiate the righting movements, making the animal to roll over and over. Waves of contraction of the circular muscles pass over the middle but are blocked at the ends which remain passive as to extension, but continue to perform the righting movements seemingly in response to the pull exerted upon them by the middle. In addition to the pull there is some mechanical twisting of the middle of the body in its extension to one side and it may be this that stimulates the ends to execute the righting movements. It appears probable also that the circlets of setæ on each segment, which are a family characteristic of the *Perichætidæ*, may be functionally correlated with the rolling movement, helping the maneuver by their action as hold-fasts. This is however a matter of inference. The essential features are the activity of the middle in extension and of the ends in initiating the righting movements.

3. Shrinking movements, involving the longitudinal muscles only. These may be confined to the more irritable ends, or they may be general, involving the whole body. They have one obvious characteristic distinguishing them from the use of the muscles in locomotion. In the latter the muscular contractions pass along the body progressively from segment to segment. In shrinking, however, the body, or at least the active portion of it, acts as a whole and suddenly.

A second characteristic distinguishes them from the similar movements of many forms such as the leech, *Clepsine*. They occur singly only in their weakest form. With increasing stimulation there is a tendency to the production of a quick succession of movements. *Clepsine* rolls into a ball and remains quiescent in a high state of muscular tension; but such states are unstable in the earthworm and lead to a rapid succession of contractions. *Perichæta* exhibits these sudden shrinking movements in a very high degree and they have given it the common name of eel-worm. Its form and habits are obviously not adapted to such a protective device as rolling into a ball and remaining quiet. After a single shrinking movement of the weak type or even after a strong series of movements it may remain motionless in a slightly contracted state, which appears rather as an exhibition of sluggishness than of muscular tension, although it suggests the state of "deceptive quiet," which Whitman describes in the leech.



These movements may be classified as follows:

(a) Retraction of the head or tail.

(b) A sharp recoil of the head often accompanied by a slight recoil of the tail. There may be several successive retractions.

(c) With stronger stimuli the middle becomes involved in the shrinking and there is an increasing tendency to a rapid succession of movements. These tempt one to use an illustration which may call attention to mechanical features of the case. If one pushes together the ends of a cylindrical coil of wire, unless perfect equality of pressure is maintained the coil will spring to one side. In an elongated soft bodied animal mechanical features of this sort are present in the contraction of the longitudinal muscles. Squirring movements are produced in regard to which one cannot always distinguish whether they are due to unilateral contractions, or to the mere mechanical inability to contract the body in a straight line. But there is no uncertainty in respect to the strongest form of shrinking movements that they are due to rapidly alternating contractions of opposite muscle bands. When partly stupefied in a solution of chloretone the characteristic springing movements are given when more chloretone is added, and the movement thus slowed down consists of throwing the body into a coil, first to one side and then to the other. The worms jump about in lively fashion when handled and they may do the same when uncovered from their burrows. They may jump in the same direction for a foot or so, but this appears to be the result of chance and perhaps of momentum acquired rather than of definitely directed movements. The leaping can hardly be called a form of locomotion, though it involves some translatory movement.

From this account of the shrinking movements it appears that they range from mere retraction of the ends to a rapid succession of alternating movements, but all involve the longitudinal muscles alone, and are characterized by their suddenness and the action of the body, or its active portion, as a whole instead of by waves of contraction as in locomotion. For description the terms retraction, squirming and leaping may be employed; but it is manifest that these movements make a continuous series with infinitesimal gradations not susceptible of exact description without the aid of a kinematograph.

4. Extension movements of groping or searching, usually with some uplift of the end and turning to and fro. Such movements interrupt ordinary locomotion and are apt to be followed by a change of direction. They show evidence of increased sensitiveness in the extended state, or what we may call the analogue of "attention." In intense form they may simulate the appearance of pain reactions.

5. In regard to the movements of the setæ in locomotion there is probability that the unusual arrangement of these structures in circllets on each segment may be correlated with the peculiar forms of movement described. They may assist not only in rolling but in the very free movements of jumping which are characteristic of the *Perichætidæ*. They are not, however, especially involved in the problems here considered. The same may be said of other forms of movement associated with food getting, etc.

*Methods of Stimulation.*—Mechanical stimuli may be precisely localized, but are difficult to graduate in intensity. Chemical stimuli afford the readiest means of obtaining a graded series of intensities, and may be fairly well localized. Acid solutions were used to evoke the various grades of negative responses. Such stimuli are characterized by the prolongation of their effects, with decreasing intensity due largely to movements of the animal and extrusion of mucus. Electrical stimulation has been tried to obtain the effects of a gradual increase of intensity, by means of a rheonom. Some aspects of the reactions to light have also been considered.

#### CHEMICAL STIMULATION OF THE ANTERIOR END.

In the following account the results will be given of stimulation with acid solutions (HCl) of different intensities. A unilateral stimulus was applied with a fine brush within the first few segments. The experiments were tried in dim light, with its effects as far as possible equalized from different sides, the worms crawling on moistened ground glass or filter paper. *Perichæta* gives a series of negative responses conditioned by the intensity of the stimulus coupled with the physiological state of the animal. This series of reactions will be described first, and then the frequency of their occurrence

under different degrees of stimulation. For reasons to be given it is convenient to classify the negative reactions under five types.

*Negative Reaction Types.*—I. To a very weak stimulus the worm usually responds by checking forward movement, with sometimes a slight pause, after which it ordinarily turns away from the stimulated side and creeps forward.

II. To a slightly stronger stimulus, the preceding reaction may be accompanied by some shrinking back of the head during turning. This is transitional to the second type in which the anterior end recoils rather suddenly, after which a pause may sometimes occur. The worm then usually turns away from the stimulated side and creeps forward.

III. With increasing stimulus, stronger shrinking movements occur, after which in the third type of response the worm creeps backward for a while, then forward and turns ordinarily away from the stimulated side as in the other reactions. In a typical case, during the interval of backward creeping there is a period of uncoordinated movements in which the anterior end attempts to extend. At each interval in the extension of the posterior end the anterior end makes a negative turn and these increase in strength at each trial until it succeeds in regaining the lead. In some other cases the activity of both ends subsides and a pause in the reaction occurs.

IV. After a still stronger stimulus and a stronger shrinking movement of squirming or leaping, in the fourth type of reaction the worm begins immediately to roll sidewise for a time, after which it creeps backward usually for a while, then forward as before.

V. In the strongest type of response, after leaping about for a time the worm begins at once to creep rapidly forward, manifesting a tendency sooner or later to turn away from the stimulated side. Another common form of this reaction is for the worm to make a single leap, turning end for end and beginning at once to crawl rapidly forward. This movement differs only in extent and suddenness from the second type. It is the ordinary reaction of *Lumbricus* to a maximum stimulus. *Perichæta* more commonly gives its characteristic leaping movements for a time instead of a single sudden turn. This strong turning end for end may occur at the

outset, or after a period of jumping. After prolonged leaping the act of turning tends to become less pronounced. It is most marked when it occurs at the beginning. It involves shrinking as well as turning, but the movements are so fused as to be scarcely distinguishable. In general, type V is either a fused shrinking and turning movement of pronounced character, or an initial prolonged leaping followed by creeping forward with a tendency to turn displayed as a rule less conspicuously. The two forms are manifestly intergraded.

*Lumbricus terrestris* agrees with *Perichæta* in respect to the first three types. Its maximum response consists, as above stated, of the single turning movement preceded frequently by some squirming and followed by rapid forward crawling.

This series of negative reactions exhibits two prominent features. First, type I appears as the end reaction of the more complex types. Second, all the types but the first begin with some form of shrinking. Moreover, there seems to be some immediate relation between the intensity and extent of the initial shrinking movements and the subsequent actions. In type II the shrinking back of the head is not sufficient to change the direction of movement, for the worm resumes forward crawling. In type III the stronger shrinking leads to temporary suspension of forward movement, while the posterior end takes the lead. In type IV there is a suspension of both forward and backward creeping, after the initial shrinking; but extension movements are able to be resumed in the less irritable middle, causing a stretching of the worm, and also some twisting in its sidewise extension. The ends initiate the righting movements and the worm rolls over and over for a time. It then resumes creeping, usually backward for a time, then forward. In type V after the maximum stimulus and shrinking there occurs immediate rapid, forward creeping. It is manifest that shrinking movements interrupt, not to say inhibit, movements of extension. In the weaker types of reaction II and III shrinking is more or less confined to the anterior end as indicated by a momentary or temporary suspension of forward movement. In types IV and V the same condition is extended over the body more fully. Type IV shows that when extension is

suspended at the more irritable ends it may continue in the middle. And type V indicates that when the whole body is involved most completely in the shrinking movement extension finds its first outlet at the anterior end.

*Relation to the Musculature.*—Certain anatomical features of the musculature need to be considered in connection with these types

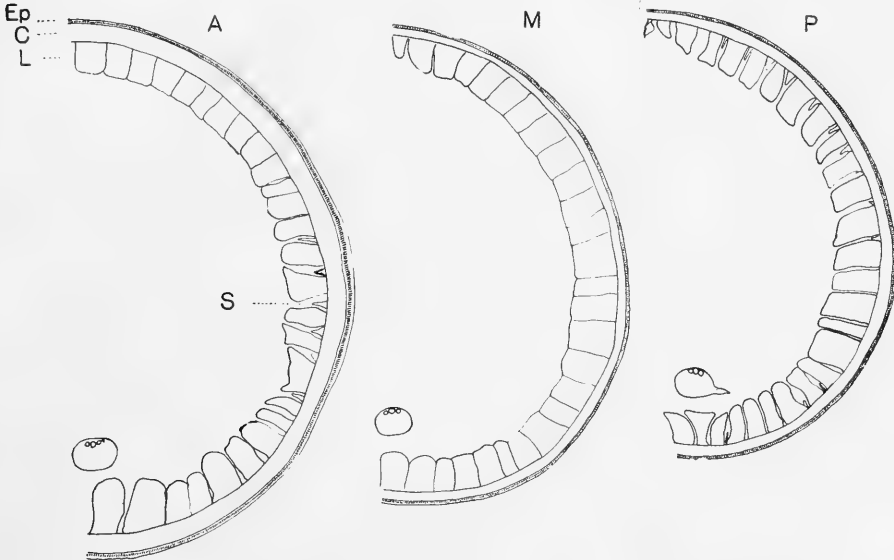

FIG. 1. This is to show the extent of circular and longitudinal muscles in different regions. A is from a section through the sixth segment from the anterior end; M, from a section in the middle region; P, from a section through the sixth segment from the posterior end; Ep, epidermis; C, circular muscles; L, longitudinal muscles; S, muscles of the setae.

of reaction. A comparison of a section through the sixth segment from the anterior end with sections through the middle and the sixth segment from the posterior end shows that the circular musculature is highly developed in the anterior end, its thickness being twice that in the other regions. The longitudinal musculature is rather uniformly developed throughout the whole length. The reaction of type V involves the completest activity of the whole longitudinal and circular muscular systems, and under these conditions the anterior

end takes the lead in locomotion on account of its greater adaptation for extension, and also since its longitudinal muscles are not developed especially more than elsewhere it would perhaps be less under the influence of a general inhibition of extension in the case of maximum shrinking movements.

*Frequency of the Reaction Types under Different Degrees of Stimulation.*—A statistical presentation of the results of stimulation is necessary to give adequate account of the relative frequency of the different types. The subjoined table I shows the occurrence of the different reaction types under different degrees of stimulation, each type in Fig. 2 being represented by its curve. It will be seen that the different types culminate at different points. Type I has its highest frequency with a stimulus not exceeding  $1/32$  per cent HCl. Behavior under similar stimulation with tap water showed almost uniformly indifferent results, indicating that with proper care in applying the stimulus mechanical irritation may be practically eliminated. The frequency of type I falls off rapidly. The second type culminates with a strength of stimulus equal to  $1/8$  per cent and falls off rapidly thereafter. Type III begins to appear with a relatively weak stimulus but culminates at  $1/2$  per cent. Type IV appears first with a stimulus of  $1/4$  per cent HCl. and culminates at about 1 per cent. It does not become a predominant reaction at any time and in this respect differs from the others, each of which with some strength of stimulus becomes the prevailing type of response. The fifth attains its maximum with 10 per cent acid.

*Variability of the Types.*—The table shows the results of the interaction of external stimulus and physiological state, the succession of types corresponding to increase of stimulus and the extent of each type indicating a variability in the physiological receptivity among different individuals. This variability would appear less in a classification based solely upon the initial phases of the reactions. For example, those cases of type III that appear in the 10 per cent column nearly all began with the leaping movement. Those in the  $1/4$  per cent column began with a weak shrinking movement. Each type exhibits an increase in intensity. Type II also shows a wide range of variability, for types II and V are both, according to defini-

TABLE I.  
PERCENT OF FREQUENCY OF DIFFERENT REACTION TYPES UNDER DIFFERENT STIMULI.

Strength of Stimulus	Number of Reactions	Percentage of Reaction Types				
		I	II	III	IV	V
Water* . . . . .	*	*				
$\frac{1}{32}\%$ HCl. . . . .	50	60	40			
$\frac{1}{16}$ " " . . . . .	50	24	74	2		
$\frac{1}{8}$ " " . . . . .	50	10	78	12		
$\frac{1}{4}$ " " . . . . .	150	1	27	65	7	
$\frac{1}{2}$ " " . . . . .	150		13	74	13	
1-2 " " . . . . .	100			39	16	45
10 " " . . . . .	100			26	14	60

\*Negative reactions to tap-water of room temperature were unrecognizable.

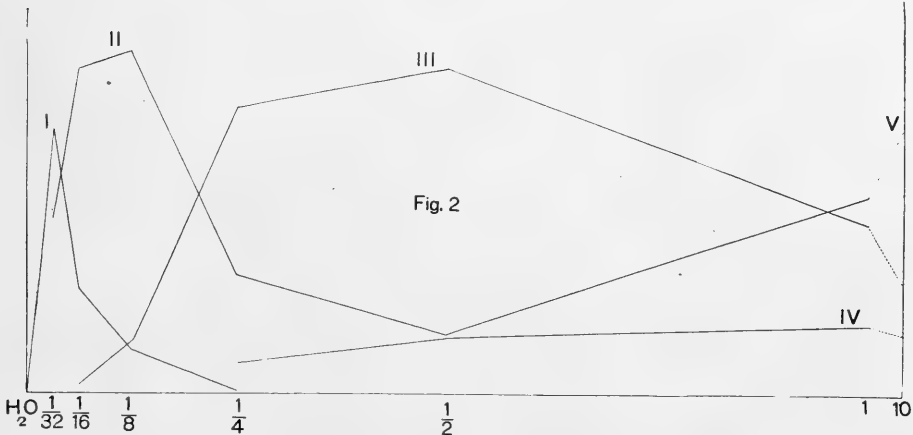

FIG. 2. This shows the frequency polygons of the negative reaction types under different degrees of stimulation. The different types are indicated by Roman numerals. Since types II and V are intergraded, they are shown by a single line. The figures indicate strength of acid (HCl). Same data as Table I.

tion, some form of shrinking movement followed by forward creeping. But if all such cases are plotted together, it is found that they form two curves and this is the basis for calling them distinct reactions. It was pointed out in the description of type V that some of those reactions consisted of a single quick turn end for end and that this movement differs only in extent and intensity from type II. It is quite immaterial whether such a reaction is classed under II or V, since all gradations are found between the two types. If an attempt is made to keep them distinct, the two curves slightly overlap.

*The Tropic Tendency in the Different Reaction Types.*—In a second table is given the data on direction of turning in the different types. It is seen that about 70 per cent of negative turns were recorded in types I to III. There is a falling off in the case of V to 60 per cent, but quite a large number of undetermined cases are included. Type V is a movement of such swiftness that there is greater difficulty in its observation. That is not the case in the other types to nearly the same extent, for the negative turning occurs in types III and IV at the beginning of resumption of forward movement after a period of backward crawling, and the necessary pause in the movements of the worm at such a time makes it usually possible to determine the direction of turning. This is of course especially true when there is some approach to circus movements, as it sometimes happens that the turning is repeated a number of times. When the worm begins to move forward at once after the initial phase, it crawls more rapidly and the tendency to crawl straight forward is sometimes marked. Sometimes the tropic tendency appears after the worm has quieted down somewhat, but owing to its doubtful character in such cases they were classed as a rule as undetermined.

It should be emphasized that the tropic tendency is a feature that appears after the period of excitement due to the stimulus has subsided or else as the primary response to a very weak stimulus. Jennings in a recent paper ('06) takes the general position that the tropic reaction in the case of the earthworm is only one feature and that a subordinate one of a complex behavior. It may be added that as a feature of the complex responses it may often disappear or appear



as a rudimentary reaction. Over against such cases must be placed its typical occurrence in unmistakable form in large numbers of cases and its usual appearance in a good majority. In the case of chemical stimuli there is some difficulty in precise localization when a unilateral effect is sought. A slight swelling at the point of application is indicative of a distinct local effect. All of the data include considerable numbers of undetermined cases, as it was thought better to include all cases observed even when an accurate determination of the direction of turning was not made. This reduces the apparent negativity of the results, but it was thought better to give the data in this way as an index of the obscurity of the reactions in many instances. On the whole the data may be judged to indicate that the effectiveness of a directive stimulus is diminished when the shock produced by it is excessive. This result appears in tables II and III.

TABLE II.

SHOWING PERCENT OF NEGATIVE TROPIC REACTIONS IN THE DIFFERENT TYPES (PERICHAETA).

TYPES	I	II	III	IV	V
Number of Cases	58	161	287	63	111
Number Negative	44	117	192	44	67
Percent Negative	75.8	72.6	66.9	69.8	60.3

TABLE III.

SHOWING PERCENT OF NEGATIVE TROPIC REACTIONS (LUMBRICUS).

	Number of Cases	Percent Negative
Primary Responses.....	50	72.
Secondary Responses.....	260	65.3

In table II the results for *Perichæta* are given; in table III the same for *Lumbricus terrestris*. In the latter the responses are

grouped as primary and secondary. The term secondary is applied to those tropic reactions occurring as a final phase of a complex reaction.

*The Two-phased Character of the Reaction Types.*—The weakest reaction type is single-phased unless the checking of movement and the commonly occurring pause after the stimulus is counted as standing for an initial phase. All the others include an initial, shrinking movement and a concluding negative turn. Types III and IV include also some intermediate movements. They are nevertheless properly classed as two-phased. The backward locomotion in type III is only an incident during the recovery of extensibility by the anterior end. In type IV the rolling is due to the continuation of the power of extension in the middle during the period in which the more irritable ends are recovering from the effects of the stimulus sufficiently to extend. In type V these intermediate forms of movement are cut out of the reaction owing to the fact that the stimulus has made itself more generally felt and the natural outlet for extension movements is the anterior end, when the whole body is involved in the inhibition due to shrinking. The possibility of extension of the posterior end and the middle of the worm and the consequent locomotion in types III and IV are then to be regarded as due to an incomplete inclusion of these regions in the inhibition of extension under submaximal stimulation. With a maximal stimulation they may be inhibited from extension more thoroughly than the anterior end, which is simply the result of the fact that the anterior is the best adapted for extension movements.

*“Unterschiedsempfindlich” responses.*—The distinction between unterschiedsempfindlich and tropic reactions originally made by Loeb in the example of certain tube-dwelling annelids may be quoted here. *Serpula uncinata*, a tubicolous annelid, bends toward the light and also withdraws suddenly into its tube from the stimulus of a shadow cast upon the oral end. There is a family resemblance between the reactions of this annelid and the earthworm, except for their opposite forms of heliotropism. The earthworm turns away from all but the weakest light (Adams, '03) and also exhibits the familiar reaction of withdrawing into its burrow on illumination of

the anterior end. The retraction of the head of *Serpula* is ascribed to the change produced by the stimulus and is a shock effect. The turning toward the light is attributed to the constant action of the stimulus, producing a differential tonus of the musculature of the two sides either directly or by reflex action.

The chemical stimuli described in this paper differ from light, of course, in that they are transitory and decreasing in intensity. These reactions have been described as consisting of two phases in types II to V, an initial shrinking and a final negative turning. The latter is a phase of the reaction that appears after the initial excitement has worn off.

It may appear then that in the two-phased reactions to chemical stimuli the shock effect and the tonic effects are dissociated as successive phases of the same reaction instead of separate reactions as in the case of *Serpula*. Moreover it is seen from types I and II that the threshold for shock effects is higher than for tonic effects. A stimulus which is too weak to cause the worm to shrink back may be able to produce a differential tonus of the two sides and lead to negative turning. Also after the shock effect of a stronger stimulus has worn off its continuing action may produce a tonic effect when forward crawling is resumed, after some intermediate forms of movement. We have therefore the primary tropic reaction occurring after a very weak stimulus, and a secondary one occurring as the final phase of a reaction to a stronger stimulus after the shock has subsided.

#### REACTIONS TO LIGHT.

Reactions to light are characterized by the relative absence of shrinking movements and by the great length of the latent period. To get well marked sudden effects worms must have been kept in the dark. A comparison will be made here to see to what extent the analysis of negative reactions already made will apply. Reactions corresponding to the first three types in a general way were obtained by the use of a fifty candle power incandescent reflecting bulb, with a cylinder of black paper to transmit the rays. Different effects were obtained by simply varying the distance. With weak light fifty trials showed twenty-six negative turns (type I) six with initial retraction (type II)

and eighteen cases of creeping backward (type III). Using the same apparatus so as to give the maximum sudden illumination of the anterior end, fifty trials gave four of type I, five of type II and forty-one cases of backward creeping. Seven of the latter showed initial retraction of the head, in some cases strongly marked. The results indicate the infrequency of shrinking movements before negative turning and hence the unimportance of type II; also the absence of shrinking before backward crawling in light of moderate strength. The long latent period and absence of shrinking point to such reactions as constant stimulus effects, for responses attributed to the change produced by the stimulus ought to give evidence of the shock in resulting movements or inhibitions. Withdrawal into the burrow may be effected by backward creeping without evidence of shock and hence the analogy with *Serpula* fails in some cases, as the latter is described as suddenly withdrawing into its tube on the stimulus of a shadow. *Perichæta* may, however, with strong light and sudden illumination give a shock reaction analogous to that of *Serpula*.

If illumination of the anterior end is continued through the period of backward creeping, the worm eventually resumes forward crawling and turns away from the light. Or if the illumination is shifted from the anterior to the posterior end during backward crawling, the worm moves forward and almost always turns away from the previously stimulated side, showing the after effects of the stimulus. These after effects show the tonic character of the stimulus very clearly. During backward crawling the effect of the stimulus on the anterior end was latent, though it may, to be sure, sometimes be exhibited in uncoördinated turning movements of the head.

In weak light the worm makes extension movements of the head, thrusting it forward and drawing it back. Such retractions might be regarded as due to shock, if the worm is more sensitive when extended. But they have more of the appearance of a return to normal after extreme extension than of shock retractions. After feeling about, the worm usually turns decidedly in one direction. Torrey ('07) referred to a paper by the writer on *Perichæta* as affording an instance of the distinction between *unterschiedsempfindlich* and *tropic* responses.

It was shown that weak light may be rendered inconstant as a stimulus by the movements of the earthworm, since in projecting the anterior end forward the photoreceptor cells become more exposed and the sensibility to light is consequently increased. There is an alternation therefore of varying degrees of sensibility to light in locomotion and this may account for the random character of many movements in weak light and the slowness of the process of orientation. On the other hand, immediate and continuous orienting effects may be observed in light of sufficient strength ('05).

Torrey cited this instance as an example of two fundamentally different types of response occurring in the same animal for the same stimulus, light. In the weak light, the inconstant stimuli (made so by the movements of the animal) give rise to reactions of *unterschiedsempfindlichkeit*. On the other hand in stronger light the tropic or orienting effects are produced. The view that the reactions in weak light are *unterschiedsempfindlich* is then based on the proposition that the anterior end becomes more sensitive when extended and that the worm tends to turn away more strongly after an extension of the head. It is a natural inference that it reacts to the change of intensity felt in extension. The character of the reaction ought however to be considered as well as the nature of the stimulus. Retraction into the burrow on sudden illumination is a clear example of a shock reaction. It was pointed out above that the threshold for tropic responses was lower than for shock reactions. It is easy to convince oneself that the same rule holds for light. As described above one may cause turning movements in response to either sudden or steady illumination and rarely a shrinking movement. If a worm which has extended its anterior end, then makes a turn away from the light, is that to be interpreted as an *unterschiedsempfindlich* response because it followed a change of intensity of the light upon the cells? If so turning responses would have to be separated into two classes on a merely logical basis, corresponding to no real difference in the reactions. The other supposition that the threshold for tropic, *i. e.*, tonic responses is lower than for shock effects, corresponds to observed differences in the reactions. Tropic effects of brief duration might be produced by stimuli too weak to produce any shock effect.

When reactions to light are compared with those to other stimuli to which the earthworm is more responsive it becomes evident that a distinguishing feature of the light reactions is the relative absence of shock effects, as denoted by shrinking, and we conclude that changes of intensity must be communicated to and through the photo-receptors too slowly to be effective as an immediate stimulus, even though tonic effects may become quite apparent after a sufficient interval.

#### NOTE ON EXPERIMENTS WITH ELECTRICAL STIMULATION.

The experiment was tried of stimulating with an electric current gradually by means of a rheonom. A tetanizing current was used. For electrodes a small piece of sponge saturated with water was fastened over the platinum tips. The instrument was so adjusted that with the arms of the rheonom in the maximum position the current caused retraction of the head. The stimulus was then introduced while the arms of the rheonom were being rotated from minimum to maximum position. It was possible with the current thus gradually introduced to obtain a turning response instead of shrinking.

#### CONCLUSIONS.

The interpretation of shrinking movements as unterschiedsempfindlich reactions is manifestly supported by their time relation to the stimulus in all cases and their sudden character. The tropic response is not a sudden movement and it may be preceded by a slight pause, as shown above under type I. The only exception to the last statement is found in connection with the sharp turning response designated as the "end for end" reaction under type V. But this was explained to be a fused shrinking and turning movement. The same kind of a reaction of a weaker form is found in the transitional response from type I to II in which the turning movement is more sudden and accompanied by shrinking back. In type II, however, after the initial sharp recoil of the head there may be a slight pause and the subsequent turning is a quiet movement. It may be said then that turning movements of the anterior end are never indicative of shock except when combined (fused) with

a shrinking movement. The tropic response in the earthworm differs in this respect therefore from that usually found, *e. g.*, in arthropods. Indeed, the earthworm is a serviceable form for study in just this point that it shows us the tropic response dissociated usually from shrinking movements which are due to the change produced by the stimulus, while the tropic response itself appears due to continuing tonic effects after the shock of the stimulus has subsided.

Annelids illustrate some general aspects of animal behavior in about the same degree that they afford a recognized type of generalized structure among segmented animals. It is an advantage that the movements of the earthworm may be described directly in terms of muscular activities rather than of the movements of appendages. Only the movements of the minute muscles which control the setæ are of a kind which must be studied in a less direct way through their effects. There may be an advantage in studying the muscular basis of movements more directly. If, for example, it is desired to distinguish the shock effects from tonic effects of stimuli upon an animal, such basic differences may be lost sight of if we study only movements of body and appendages rather than their muscular basis. The earthworm with its shock and tonic effects of stimuli usually dissociated and occurring as successive phases of the same reaction, and its occasional exhibition of these effects fused, is a valuable introduction to the study of more specialized behavior in groups like the arthropods.

#### SUMMARY.

1. In the earthworm, since the reactions may be described directly in terms of muscular activities rather than of movements of body and appendages, the shock and tonic or tropic effects of stimuli may be recognized, usually as successive phases of a reaction, sometimes fused.
2. The tropic reaction appears alone only as the response to a very weak stimulus, since the threshold for tonic effects is lower than for shock (*unterschiedsempfindlich*) effects.
3. In all higher forms of responses both shock and tropic effects

are recognizable usually as successive phases of the reaction (initial shock and final tropic effect).

4. Shock effects consist of shrinking movements which range in intensity from local retractions of the more irritable ends to general movements of the body. The latter are especially well developed in *Perichæta*. These movements are single only in their weak form, as with increase of the stimulus is developed a tendency to a rapid succession of contractions. High states of muscular tension are unstable in the earthworm, unlike those animals which can roll into a ball for defence.

5. The degree of stimulation and the resulting shrinking movements give rise to a progressive series of negative reaction types. In type II shrinking back of the anterior end interrupts forward movement only temporarily. In type III it is interrupted longer while backward creeping takes place. In type IV both ends are affected and stop extension, which goes on in the less irritable middle region causing the rolling movement. Sidewise extension causes stretching and some twisting and the ends initiate the righting movements. Rolling is followed by backward crawling usually, then by crawling forward. In type V the maximal stimulus causes the cutting out of the intermediate forms of movement, rolling and creeping backward, and instead the worm creeps forward at once, the movement for which it is best adapted by its musculature. With a maximal stimulus the posterior end and middle are more thoroughly inhibited from extension than the anterior.

6. With a series of graded stimuli the reaction types attain their greatest frequency, as shown statistically, under different degrees of stimulation. Each type exhibits increase of intensity with the stimulus.

7. Owing to the fact that the tropic response appears by itself only as the result of a very weak stimulus or as a secondary effect of a stronger one after its strength has subsided, this reaction is likely to be counteracted by internal factors. Hence in respect to the tropic response the behavior appears determined by the external stimulus in a somewhat less degree than in many animals.

8. Owing to the low receptivity for light, shock effects are infre-



quent except under conditions of strong and sudden illumination. Physiological state is of unusual importance in connection with receptivity to light.

9. An electrical stimulus when suddenly introduced produces shrinking, when introduced gradually may produce only turning.

NORTHWESTERN UNIVERSITY, ZOÖLOGICAL LABORATORY.

April 16, 1909.

#### LITERATURE LIST.

ADAMS, GEORGE P.

1903. On the negative and positive phototropism of the earthworm, *Allolobophora foetida* (Sav.), as determined by light of different intensities. *Am. Jour. Physiol.*, vol. 9.

HARPER, E. H.

1905. Reactions to light and mechanical stimuli in the earthworm, *Perichæta bermudensis* (Beddard). *Biol. Bul.*, vol. 10, pp. 17-34.

JENNINGS, H. S.

1906. Factors determining direction and character of movement in the earthworm. *Jour. of Exp. Zoöl.*, vol. 3, no. 3, pp. 435-455.

LOEB, J.

1907. Concerning the theory of tropisms. *Jour. of Exp. Zoöl.*, vol. 4, no. 1, Feb., '07, pp. 151-156.

TORREY, HARRY BEAL.

1907. The method of trial and the tropism hypothesis. *Science*, N. S., vol. 26, no. 662, Sept. 6, pp. 313-323.

WHITMAN, C. O.

1899. Animal behavior. Woods Hole Lectures. *Boston*, 1899.



## LITERARY NOTICES.

Georges Bohn. *La naissance de l'intelligence. Paris, Flammarion, 1909. Pp. 350.*

Those who have for some years been following with interest the experimental work of Georges Bohn, the great value of which has lain in its careful analysis of the normal environmental conditions of certain lower animal forms, will welcome in this book a clear statement of the theoretical convictions he has adopted, partly as a result of his investigations, and partly under the influence of certain teachers. Throughout Bohn's work the doctrines of Loeb have evidently been guiding principles, and in the present book his allegiance to "*Villustre biologiste américain*" is acknowledged with an enthusiasm which almost amounts to hero-worship. Loeb's conception of the tropism, of sensibility to difference, of "associative memory" as the criterion of the psychic, are foundation stones in the structure of Bohn's work, and even Loeb's view of the functions of the central nervous system has exerted an influence.

Thanks to the author's sharply defined expression of his opinions, and to their highly positive character, it is possible to state them quite concisely. The actions of the lower animals, he holds, are governed by three principles: that of the tropism, that of sensibility to difference, and that of "the association of sensations." The tropism always involves definite orientation of an animal's body in such a way that symmetrical points are equally stimulated by an outside force. Thus when Claparède suggests an analogy between the innate tastes and proclivities of human beings and the tropisms of simple animals, he is omitting from the concept of the tropism its most essential feature, orientation. Combined with the tropism there appears a second influence: sensibility to difference. A change in the intensity of the force acting produces an interruption of the tropic movement; most frequently a tendency for the animal to rotate upon itself through 180°. This reaction Bohn regards as an expression of "Nature's tendency to fight against variation," and as a guard against the dangers into which the unopposed tropism might lead the organism. Whether sensibility to difference or tropism shall prevail when the two influences are brought simultaneously to bear upon an animal depends upon the amount of change in the stimulus intensity, and upon the physiological condition of the animal: sometimes the onward march under the control of the tropism is merely subjected to slight deviations and fluctuations as a result of sensibility to difference in the intensity of the stimulus, sometimes the tropism may be completely reversed. The "trials and errors" described by Jennings as characteristic of the behavior of the lowest animals are held by Bohn, as he has elsewhere stated, to be simply the effects of sensibility to difference. A subordinate rôle is played by what the author calls "the law of return to a state of repose," according to which "after the cessation of stimulation, the movements persist, but progressively diminish in intensity." As an

illustration, the gradual weakening of phototropism in an animal placed before a lighted window is cited, but certainly in such a case, where the stimulus is continuous, we often find not a weakening but an intensification of the tropism, as Holmes observed in *Ranatra*. By the way, it was surely a slip to represent, on page 187, the righting reaction of a planarian as an illustration of spiral movement which "facilitates progression through the water."

The most interesting sections of the book are those dealing with "association." As has been said, Bohn holds "associative memory" to be the criterion of the "psychic." But a person who approaches comparative psychology from the starting-point of a psychologist finds great difficulty in coming to an understanding with one who sets out from the biological side, in regard to the meaning of the term "psychic." To the former the term psychic implies consciousness. Sometimes, it is true, we find "functional" psychology talking of sensations when it means sensory physiological processes without any subjective aspect, but in general the psychologist uses psychological terms for mental processes only. The case is otherwise with the biologist. Bohn says that he himself means by such terms as sensation, "not the facts of consciousness, inaccessible to me, but the nervous processes upon which they are superposed." Elsewhere he remarks, "The sensation in the psychological sense is an epiphenomenon, true; but as such it is superimposed upon another phenomenon which takes place in the nervous system, which is amenable to experimental study, and which is often called sensation; which may be so called if one specifies that the word is taken in a physiological sense. The word sensation does not necessarily imply consciousness." So far as this word, indeed, is concerned, we need not, perhaps, be overscrupulous, for the mere response to a sensory stimulus does not, to our author and to Loeb, involve "the psychic;" but Bohn's expressions, and his adoption of association as a test of the psychic, certainly imply that there is such a thing as a psychological aspect to animal behavior. What is the psychic, which is not necessarily involved in sensation, but of whose presence "associative memory" assures us? It is certainly puzzling to have Bohn, in expounding Loeb, tell us that "the latter does not deny psychic phenomena in the lower animals; for him, these phenomena are physiological reactions which result from associative memory." We are, however, used to the confusion of psychological and physiological in Loeb's case; but Bohn is writing genetic psychology, and the psychologist is saddened when he reads such a statement as this: "I shall not speak here of the consciousness of animals. I do not deny it, but I cannot know anything about it. I shall speak of psychism, the word designating the complexity of phenomena which I can more or less successfully analyze." Why talk about the criterion of the psychic, an epiphenomenon superimposed upon certain nervous processes, if you mean by "psychic" only the nervous processes themselves? It is indeed interesting to note that they sometimes reach a certain degree of complexity, and one may call them "associative memory" when they do, if one's sense of the fitness of names is not acute, but they are evidently not a criterion of anything but themselves,

unless we are willing to suppose that we *can* know something about the consciousness of animals.

However, putting aside this difficulty, we may consider what our author has to say about the development of the psychic, when its existence has been guaranteed by the presence of association. There are two laws, he tells us, which govern the association of stimuli. The first of these is that if the combined action of several stimuli is at the outset necessary to produce a certain reaction, after this combination and its resulting reaction have been many times repeated, one of the stimuli assumes predominance and is able, alone, to set off the motor response. The other law Bohn calls that of association by similarity: it states that the characteristics common to a class of objects become the stimuli which cause reaction, the essential stimuli, so that an animal reacts in the same way to a whole class of objects whose individual differences produce no effect. It is doubtless the reviewer's fault, but these two laws do not seem quite fundamentally distinct. It might be supposed that when, according to the first law, one stimulus assumes the predominance in a group, various causes may operate to bring it into ascendancy, and that one of these causes may be the frequency of its occurrence, if it is a characteristic common to a class, as compared with the infrequent occurrence of any given individual characteristic; thus the second law would be a special case under the first. But this is not Bohn's idea. He supposes that in the case of the first law all the stimuli in the group have been at the start effective stimuli: the reaction fails if any one of them is lacking. In the case of the second law, the stimuli which represent the individual characteristics are not effective even at the outset. "The simplification is made at the origin: many elements do not succeed in entering into the association." This being so, it is not apparent why the second law should be called a law of association at all. If a hermit crab acts toward a wooden ball as it acts toward a shell, and one grants that curvature of a solid surface is the only effective stimulus in both cases, it is impossible to see where there has been any association of stimuli. We should not speak of association if a totally deaf animal reacted in the same way towards an object making a sound and the same object silent.

It is evident, Bohn points out, that among the lower invertebrates the formation of associations must be very limited on account of the small number of sensational elements that are available. What he calls "the first psychic revolution" occurs with the higher development of the eye, which furnishes a far greater variety of associable elements. At various points in his argument the author lays stress on the paramount importance of the sense of sight for mental development. But he seems to regard its significance as consisting chiefly in the multiplicity of sense discriminations which the perfected eye makes possible; whereas a deeper meaning lies in the fact that the eye is the great "distance receptor," and as such serves the purposes of association as no organ whose stimulation directly affects life and death can do. The second "psychic revolution" occurs with the development of the cerebral hemispheres. In these the results of even a single stimulation may be preserved and become effective to determine future reaction: thus we

have the possibility of ideation, of forecasting the future. But now comes a surprise for the reader. There was a third psychic revolution, and it occurred when man entered upon the scene. "Man did what no animal had been able to do: he discovered fire, he made tools, he used speech; in a word, he did more than foresee phenomena, he became in some sort their master. There is a hiatus between the intelligence of animals and human intelligence; I do not think that we are ready to fill this hiatus." Here we can only regret that our author is not a student of the human mind: as such, he might not have been able entirely to supply the missing terms, but he could have made a better attempt than this. Must genetic psychology give up in despair at the most interesting point? Finally, we may have "psychic regressions" occurring when the effects of associations are handed down to later generations as "false," *i. e.*, secondary, tropisms; an illustration being the attraction of insects to flowers. The only comment necessary upon this is that it stands or falls, of course, with Lamarekianism: Bohn is an avowed Lamarekian.

On the whole, one cannot feel for the theoretical discussions contained in this book the cordial admiration one felt for the author's experimental researches. The reason, however, lies rather in the general conditions under which we judge the work of others than in anything peculiar to the present case. The truth is that one is never so grateful for theory as for fact, because theory always arouses the critical instinct, while in the presence of a newly ascertained fact we have still something of the humility which is our natural attitude towards the Unknown from which the fact has so lately emerged. We are so much better acquainted with the origin of theories than with that of facts! Nevertheless the theories may be actually more valuable, through the very opposition they arouse, than many facts; and comparative psychologists should find their debt to Bohn, already great, largely increased by the courage and force with which he has set forth the broader views that guide and result from his researches.

MARGARET FLOY WASHBURN.

The Journal of  
**Comparative Neurology and Psychology**

VOLUME XIX

DECEMBER, 1909

NUMBER 6

THE RADIX MESENCEPHALICA TRIGEMINI.<sup>1</sup>

BY

J. B. JOHNSTON.

WITH THIRTY-TWO FIGURES.

The first author to correctly describe the midbrain or "descending" root of the trigeminus was Meynert. In his chapter on the brain of mammals contributed to Stricker's *Handbuch der Lehre von den Geweben*, he describes the root in the following manner: "This root descends along the outer side of the central, tubular gray matter of the aqueduct, and passes onward through the region of the pons, in the meantime constantly increasing in bulk, and buried in the lateral region of the gray floor of the ventricle that lies along the inner surface of the *processus cerebelli ad cerebrum*. It presents on cross-sections a semi-lunar surface, which Stilling and Deiters took for an ascending trochlearis-root, and along its inner border lie, through a large part of its course, the clusters of cells from which the fibers of the root spring, so disposed as to remind one of grape clusters. These cells are distinguished from those of the *substantia ferruginea* by the roundness of their form, and by their containing no pigment" (American edition, p. 733). He does not discuss the possibility of the root being motor in character, but simply describes it as one of the primary

<sup>1</sup>Neurological Studies from the Institute of Anatomy, University of Minnesota, No. 8.

roots by whose confluence the sensory root is formed. In the section on the tegmentum occur the following paragraphs which bring forward most important considerations for the interpretation of this nerve root: "Even within the limits of the upper corp. bigem., the central tubular gray matter encloses nuclei that give rise to the motor nerve roots referred to, which lie more or less near the median line; also a laterally disposed sensory nerve tract, the roots of the 5th cerebral nerve. The fibers composing these roots originate at the outermost border of the gray matter that surrounds the aqueduct of Sylvius, in small collections of large bladder-shaped cells 60 microns in length and 45-50 microns in breadth (Fig. 272 V), and form themselves by degrees into a series of bundles whose transversely-cut surfaces, succeeding each other like the links of a chain (as seen in cross-sections made in this region), lie in a curved line around the outer edge of the thick wall of gray substance which surrounds the aqueduct (Figs. 273 and 274, 5'). The cell masses from which spring the two kinds of nerves, motor and sensory, have then, even in the region of which we have been treating, the same general position in relation to each other that they retain throughout the whole extent of the central tubular gray matter, those connected with the motor nerves lying in the neighborhood of the median line, and towards the anterior part of the ring of gray substance, while those connected with the sensory nerves are placed laterally and at the same time towards the posterior part of the same ring, and the nerves of this region thus become anatomically analogous to the anterior and posterior spinal nerves" (p. 704-5).

At the time that Meynert wrote, the origin of this root from a collection of large cells in the locus cœruleus was not surprising, as indeed all the other sensory roots were described as arising in certain collections of cells. When later, as one of the results of the Golgi silver technique, it was found that the motor nerves alone arose from cells within the central nervous system while the sensory nerve fibers arose from cells in the spinal and cranial ganglia, serious question was raised as to the sensory character of this root. This aspect of the case appealed especially to Kölliker and Van Gehuchten. Kölliker (1896) describes the origin of the bundle from a scattered



column of large spherical cells which extends forward as far as the level of the III<sup>d</sup> nerve. Very small and inconspicuous at this point, the bundle increases in size until it reaches the level of the deep nuclei of the cerebellum when it bends down, pushes between the sensory and motor roots and joins the motor root.

The large cells are most numerous at the region where this root bends down to join the other roots, and there form a special nucleus. "Merkel schildert diese Zellen als bipolar und giebt weiter an, dass dieselben alle einen feineren centralen und einen groben peripherischen Ausläufer besitzen welche beide Achsencylinderfortsätze darstellen. Nach dieser Schilderung würden somit mitten im Gehirn bipolare Nervenzellen vorkommen, wie im Acusticus und in den Ganglien niederer Wirbelthiere, und wäre bei dem jetzigen Stande der feineren Nerven-anatomie nur Eine Auffassung möglich, nämlich die, dass die absteigende Wurzel des Trigemini ein sensibler Nerv ist, der die Ursprungsstelle seiner Nervenfasern mitten im Gehirn hat. Die feinen centralen Fasern von Merkel müssten in diesem Falle in derselben Weise als Endfasern angesehen werden, wie die in das Rückenmark eintretenden Elemente der Spinalganglien" (p. 289). Against this view Kölliker urges that fibers of this root are very coarse while those of the sensory root of the trigeminus are fine. He also carefully studied the large cells of origin and found them to be *multipolar*. Referring to Golgi's statement, based on isolation preparations, that the cells of origin are unipolar, Kölliker says: "Trotz aller Hochachtung vor meinem gelehrten und so verdienten Freunde muss ich doch Merkel's und meine positiven Ergebnisse höher stellen, und kann ich daher davon absehen, die Schwierigkeiten für eine physiologische Erklärung zu betonen, die das Vorkommen unipolarer Zellen im Centralorgane hervorrufen würde, grösser noch als die Annahme bipolarer solcher Elemente im Sinne Merkel's." He concludes: "Als Facit aus allem, was über die absteigende Trigemini-wurzel bekannt ist, stehe ich nicht an, dieselbe als eine *motorische* zu bezeichnen. Die Dicke ihrer Fasern, der Anschluss an die Portio minor und die Unmöglichkeit einer anderen Deutung sind die Hauptargumente. Dazu kommt die Grösse ihrer Ursprungszellen, die freilich nicht entscheidend ist. Welche Muskeln dieser Wurzel unter-

stehen, ist freilich nicht von Ferne zu errathen; doch darf man vielleicht an den Tensor veli palatini und den Tensor tympani denken, schwerlich an den Mylo-hyoideus und Biventer anterior." It must be said that Kölliker's figures are not convincing as to the statement that the bundle in question joins the motor root.

Van Gehuchten (1895) studied the origin of this root in Golgi silver preparations of the young trout. He describes and figures two cells with their fibers. One cell is bipolar. It has an ascending slender branching process which Van Gehuchten calls a dendrite and a very coarse sinuous descending process which he calls the axone. The descending process passes out in the sensory root of the trigeminus. The other cell is unipolar, but its large process divides at a short distance from the cell. One branch is a coarse descending process which runs to the level of the trigeminal root. The other branch consists of several slender processes which Van Gehuchten calls dendrites. Van Gehuchten decides that the descending root is motor in function and says: "Le faisceau de fibres nerveuses appelé par les auteurs racine supérieure du nerf trijumeau, appartient donc en réalité, au moins chez la truite, au nerf de la cinquième paire. Cette racine supérieure constitue une racine motrice. Cette conclusion importante est en pleine concordance avec les prévisions de Kölliker. Le savant anatomiste de Wurzburg s'est prononcé en faveur de la nature motrice de la racine supérieure, en se basant uniquement, comme il le dit lui-même, sur 'die Dicke ihrer Fasern, der Anschluss an die Portio minor, die Grösse ihrer Ursprungszellen und die Unmöglichkeit einer anderen Deutung.'

"Notre conclusion, au contraire, est basée sur un fait positif; nous avons vu le prolongement cylindraxile d'une de ces cellules nerveuses se recourber en dehors et devenir fibre constitutive du nerf périphérique."

Cajal (1896) was so fortunate as to have these cells and fibers beautifully impregnated by the Golgi method in the mouse, and the prevailing notions regarding this root rest chiefly, perhaps, on his description. The essential points are clearly illustrated in his Figs. 1 and 2. The cells are unipolar in the adult form, although in embryos they may have several small dendrites. The thick process is

directed downward and grows more slender. As the fibers approach the motor nucleus they give off branching collaterals which form a rich plexus in this nucleus. Most of the fibers give from two to four collaterals to the motor nucleus, some divide into two nearly equal branches, one of which enters the motor nucleus, the other going on with the motor root. None of the collaterals go beyond the motor nucleus, and none turn toward the raphé to form a motor decussation. "Nach unserem Dafürhalten ist diese interessante Anordnung der motorischen Collateralen fast einzig in ihrer Art; in den Wurzeln des Facialis, des Hypoglossus und des Oculomotorius sahen wir sie niemals und bei den vorderen Wurzeln der Medulla spinalis ist sie sehr selten" (p. 16).

Wallenberg (1904) describes descending degeneration (Marchi method) of the mesencephalic root in the pigeon and the duck after lesion in the tectum mesencephali. He states that the bundle sends a few isolated fibers into the median nucleus of the cerebellum and that while the most of them go out of the brain with the motor root of the trigeminus, some fibers go on caudal to the level of the "Cochlearis-Eckkernes," where they end in the formatio reticularis near the motor cells. He mentions that Probst has seen similar fibers to the formatio reticularis caudal to the trigeminus in mammals. It should be noticed that the author states (l. c., p. 526-7), "war es mir bei 5 Tauben und 2 Enten durch Anätzung resp. Anstich lateraler Teile der Rinde des Lobus opticus bis an das Wandungsgrau des Seitenventrikels möglich, Fasern der cerebralen Quintuswurzel an ihrer Ursprungsstelle zu zerstören und sie als dicke schwarze Bündel bis zum Austritt aus der Brücke und in den Bulbus hinein zu verfolgen." From this it appears that the exit of these fibers with the motor root of the trigeminus was not shown by the Marchi degeneration method, but rests on other methods.

Just as this paper is being put in final shape for the printer I have received through the kindness of the author a paper by Tello (1909) in which he figures the cells of origin of the mesencephalic root in teleosts (*Salmo trutta*). The figure agrees with my findings in *Acipenser* and young teleosts and *Amia*. The author makes no reference to Van Gehuchten's paper and his observations are evidently an independent confirmation of Van Gehuchten's results.

These are the chief anatomical contributions known to the writer which give positive evidence as to the character of the root bundle in question. Merkel and Krause as cited by Kölliker (1896, pp. 289, 292) described the cells of origin as bipolar cells, the dendrite descending, the axone ascending. Edinger considers that the cells of origin in lower vertebrates lie in the large-celled nucleus tecti. P. Ramón (1904) has found the cells in the pigeon both in the nucleus tecti near the median line and also far laterally in the tectum, as Wallenberg found them in the duck. Bechterew (1887, 1899) expresses his adherence to Meynert's view that this bundle joins the sensory root. Held (1893) states that a part of the motor root arises from the locus cœruleus and the cell-column in the mesencephalon. In the human fœtus these cells stained by the Golgi silver method show numerous branching dendrites. Others, as Miss Sabin (1907), have expressed themselves as unable to determine whether the mesencephalic root leaves the brain with the sensory or the motor root.

Merkel (1874) described this as a trophic root and this view was supported by Mendel (1888) on the basis of a case of hemiatrophia facialis. The facts which Mendel brings forward will be referred to later on. Bregmann (1892) found that cutting the motor branch of the trigeminus caused degeneration of the motor root and the mesencephalic root.

Since the prevailing view at the present time is that the radix mesencephalica is a motor root it will be well to summarize the evidence thus far offered in support of this view.

1. The fibers arise from cells in the locus cœruleus and corpora quadrigemina.
2. The fibers degenerate downward after destructive lesion in the tectum mesencephali of birds.
3. The fibers pass close by the motor nucleus of the trigeminus in mammals and according to most authors join the motor root to leave the brain. Since the motor root is independent of the sensory root and ganglion the fibers are presumed to be motor fibers.
4. The fibers degenerate along with the motor root after cutting the motor ramus.

The third of these evidences will be dealt with in the present paper. The first, second and fourth, although fully accepted, are not in themselves conclusive evidence that the root is motor. The fact that fibers of a peripheral nerve arise from cells situated within the central nervous system is *not* evidence at all that the fibers are motor fibers. The only conclusive evidence that the fibers of a bundle are motor is to trace them continuously to motor end plates within a muscle or to demonstrate their action physiologically. The origin of fibers from central cells is not even presumptive evidence that the fibers are motor unless the cells lie in the ventral (motor) zone of the cord or brain. The cells in question lie in the roof. A large part of the ganglion cells of the dorsal sensory nerves in *Amphioxus* lie within the central nerve cord (Johnston, 1905) and in fishes and amphibians many cells are found in the dorsal zone of the spinal cord and in some cases in the medulla oblongata which give rise to sensory fibers of the dorsal nerve roots. Among the many studies of these so-called giant cells, cells of Rohon, etc., I need only refer to the papers by Van Gehuchten (1897) and the writer (1900). In view of these well known facts, the most natural assumption is that peripheral fibers arising from cells in the brain roof would be sensory fibers as in all lower vertebrates.

The fact that the fibers of this root degenerate downward after lesion of the tectum is evidence only that they arise from cells in the tectum and not that they are motor in function.

The degeneration of this root after cutting the motor rami of the trigeminus is much the strongest evidence thus far brought forward. The weak point in the argument is that the motor rami contain sensory fibers also and hence the peripheral operation is inconclusive. The mesencephalic root may supply sensory fibers to the mixed rami.

#### OBSERVATIONS.

In 1905 the writer described the radix mesencephalica in *Scyllium canicula*, *Acipenser* and *Necturus*, showing that in each of these the bundle joined the sensory root of the trigeminus. Since then the bundle has been studied in *Scyllium stellare*, *Squalus acanthias*, *Cryptobranchus*, the common toad, a turtle, the mole, rabbit, rat, mouse, cat, pig embryos, one human embryo of 15.5 mm. and in

fœtal human brains prepared after the method of Flechsig. The cells of origin have been studied in *Scyllium*, *Squalus*, *Acipenser*, the toad, the rabbit, rat, and the human embryo. The preparations of this embryo were demonstrated at the meeting of the American Association of Anatomists at Ann Arbor, in 1906, and the results of the study of the mole, rat and cat were reported in a paper read at that time.

Instead of a systematic review of the findings in each of these species, which would require a series of long and tedious descriptions, it seems best to take up the important features which bear upon the

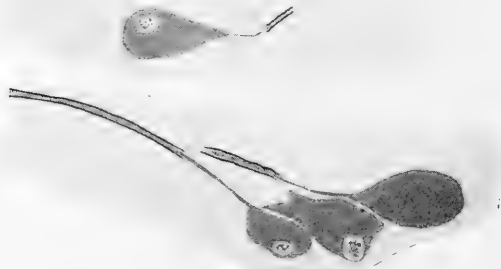

FIG. 1. Camera drawings of cells of the nucleus magnocellularis tecti in *Scyllium* showing their processes entering the radix mesencephalica trigemini.

connections and function of this bundle. The more important points have been clearly seen in all the species mentioned.

1. *The Origin of the Bundle.*—So far as the cells in the locus cœruleus of mammals are concerned, there has been no serious question as to the origin of these fibers from the large vesicular cells since this was first stated by Meynert. The demonstration of this by Cajal by means of the Golgi silver method left nothing to be desired. As for the cells in the mesencephalon of fishes (nucleus magnocellularis tecti), I expressed some doubt in my earlier paper. At that time I had not seen Van Gehuchten's paper and my preparations did not show the entrance of processes of the large cells into the trigeminal bundles. Later preparations of the brains of *Scyllium canicula*, S.

stellare and *Squalus acanthias* show as clearly as may be desired the entrance of the large processes of these cells into the bundles of the radix mesencephalica trigemini and the appearance of a sheath on each such fiber a short distance from the cell (Figs. 1, 2 and 3). This is seen in a very large number of cells and it is only the circuitous course often taken by the large processes which makes it difficult to demonstrate. The drawings are taken from Weigert sections in which the sheaths are perfectly fixed and stained while the cells and processes are stained by acid fuchsin. The bundles of fibers belong-



FIG. 2.

FIG. 2. *Squalus acanthias*, showing the same as Fig. 1.

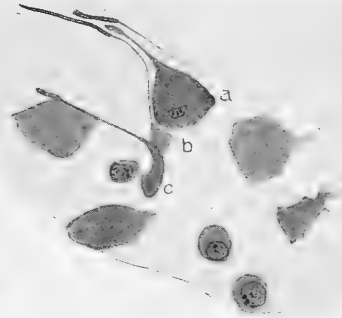

FIG. 3.

FIG. 3. *Squalus acanthias*, showing the same as Fig. 1. *a*, *b*, *c*, three cells, parts of which are cut away in the section.

ing to this root in selachians are so distinct from all other fibers that there can be no doubt that the processes of the large cells actually become fibers of this root. The same has been clearly demonstrated in sections of the sturgeon brain not used for the previous study.

The origin of the fibers has been seen in the toad and will be described in the following section. In the rat, mouse and rabbit they have been studied in sections prepared by the Cajal and Bielschowsky silver methods, and it need only be said that the description by Cajal is confirmed (Figs. 4 and 5).

2. *The Position and Character of the Cells of Origin.*—In all fishes and amphibians studied the cells of origin are located in the tectum mesencephali, the majority of them near the median line. They are always massed along the median line without apparent bilateral symmetry or any other regularity of arrangement. In the selachians they are often piled two or three deep at the median line. Laterally they form a single row or are scattered, an occasional cell being found at the extreme border of the proper roof portion

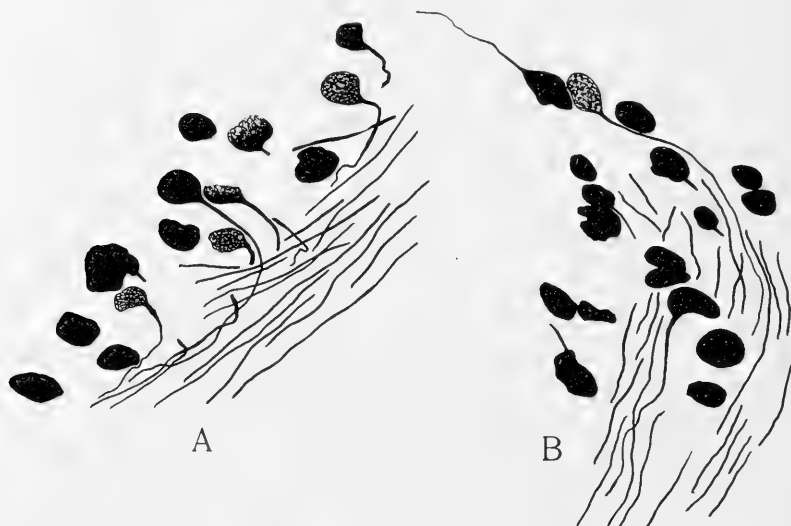

FIG. 4. Cells of origin of the radix mesencephalica in the locus caeruleus of the rat. A is farther mesad and cephalad; B, farther caudad and laterad. In B two cells send their processes caudad (toward the left).

of the tectum (Fig. 6). In *Scyllium* and *Squalus* they extend throughout the entire length of the tectum and the greatest number of cells is found at the posterior part of the tectum. In *Scyllium stellare* there is an especially large group which extends into the medullary velum so that several cells lie beneath and behind the crossing fibers of the IVth nerve. In *Acipenser* the cells are to be found only in the anterior part of the tectum, the majority of them in the immediate vicinity of the posterior commissure (Johnston, 1901). In *Anaia* embryos and young up to 25 mm. in length, the



cells have the same position. In the youngest embryo that I have studied the cells are seen in the thin portion of the tectum behind the posterior commissure and in 25 mm. specimens in which this portion of the tectum bulges forward over the posterior commissure the cells immediately surround the blind pouch thus formed. In one specimen 35 cells were counted, 28 of which were closely packed above the posterior commissure, the other 7 scattered laterally and dorsally in

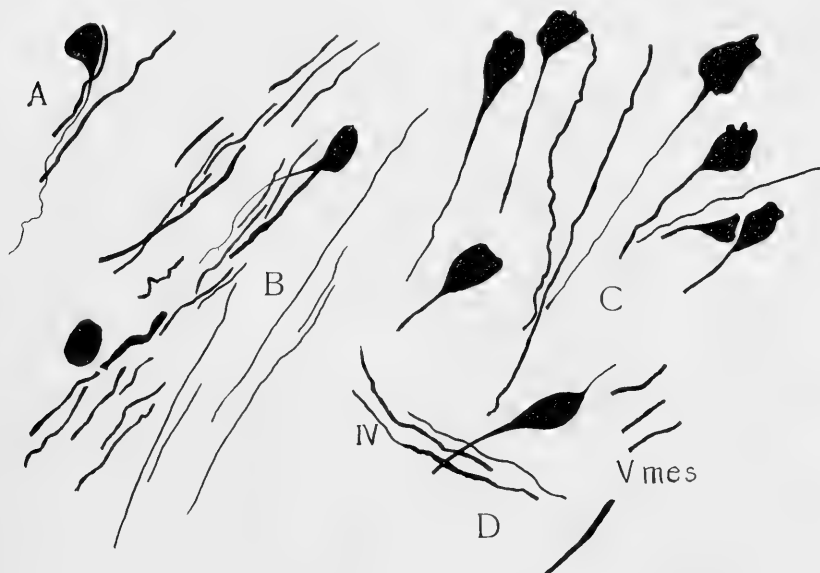

FIG. 5. Cells of origin of the radix mesencephalica in the rabbit. A, from inferior colliculus; B, caudal to n. IV; C, seven cells from different regions brought together; D, a bipolar cell near n. IV.  $\times 175$ .

the near vicinity. In *Catostomus* (young) the cells have a similar arrangement, the great majority being grouped around the anterior end of the cavity of the tectum, a few being found along the mid-dorsal line and an occasional cell placed farther laterally. In brief, in selachians the cells are much more numerous, extend the whole length of the tectum and the largest collection is in the posterior region; in ganoids and teleosts the cells are fewer, are confined to the anterior half of the tectum and are collected chiefly at the

anterior border. In fishes I have seen none of the large cells along the course of this bundle caudal to the velum medullare anterius.

In *Necturus* the cells are found throughout the length of the tectum, are most numerous in the posterior part and are very few near the anterior border. Except near the anterior border, every transverse section of the tectum shows from three to six of these cells and one or two of the number are situated laterally, somewhere within the medial one-half of the tectum. One cell was seen at the lateral border of the tectum. In *Cryptobranchus* the arrangement is similar, but the greater number of cells are in the anterior half of

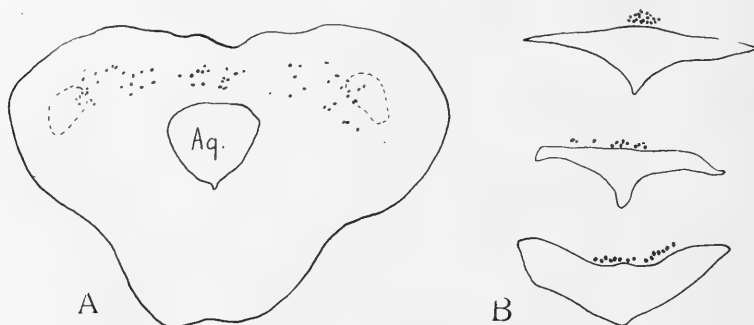

FIG. 6. A, transverse section of the mesencephalon of the toad. A section through the anterior part of the lateral cavities was drawn and the cells inserted under the camera from several sections farther forward. The cells near the middle lie in the section outlined, those at the sides mostly lie in front of the lateral cavities. B, three sections through the posterior, middle and anterior parts of the tectum of *Scyllium*. Only the outline of the aqueduct is drawn and the cells in their proper position with reference to it.

the tectum, while in the posterior half the cells are more strictly grouped at the median line, *i. e.*, in the roof plate. In the frog the cells are fewer in number and, so far as I have seen, are placed far laterally in the dome-shaped tectum. In the toad the cells are much more numerous than in the frog. They are situated in the anterior part of the tectum, there being two large groups in the anterior bulging wall of the tectum connected by a large continuous collection which extends across the median line (Fig. 6). The urodeles show close similarity to the selachians; the anura show great specialization in the arrangement of these cells.

In mammals, as already frequently described, the greater collection of these cells is found in the locus cœruleus and they extend forward sparsely even in the superior colliculus.

With respect to the ventricle and the layers of the brain wall these cells vary in position within wide limits. I see nothing of fundamental importance in this connection, but the following facts are of interest. The usual position of the cells is perhaps outside the ependymal layer and among the deepest layers of nerve cells. In a few cases in larval *Amblystoma* and *Desmognathus* I have noticed cells in a superficial position similar to that of the giant cells of the cord in the trout (Harrison, 1901). In the frog and especially in the toad many cells are deeply imbedded in the brain wall among the fibers of *decussatio tecti*. Near the median line in selachians and *Necturus* the cells are often so crowded that the ependymal cells are pushed aside and these cells seem to form the wall of the ventricle. This is especially noticeable in *Scyllium*, where a large collection of cells is found on the deep face of the *decussatio veli* and the *trochlearis* (Fig. 9). Here in sagittal sections the ependyma seems to be displaced or destroyed and the group of large cells projects directly into the ventricle. Similarly in several instances in *Scyllium* and *Necturus* I have found isolated pear-shaped cells hanging down into the ventricle, suspended by their large processes which pass up between the ependymal cells into the tectum. The sections were not broken and all the elements were in perfect order.

As to the characters of these cells, I have made no extended or minute study of their morphology, but in the course of examination of many brains several important features have been noticed which bear upon their interpretation. The typical form is usually said to be vesicular, pear-shaped or balloon-shaped with a single large process. This statement may, I think, stand for the "typical" form, whatever that may mean. It is undoubtedly true, however, as described by Merkel, Held, Kölliker and Van Gehuchten, that at least some of the cells have more than one process. Sargent (1904) figures these as multipolar cells in several fishes, and in my preparations of Selachians, *Acipenser* and the toad many cells may be seen which have one or more processes in addition to the large process. This large

process may arise from the small end of a pear-shaped body or as one of the dendrites of a multipolar cell. The small processes are sometimes well developed dendrites and occasionally the cells present a typical multipolar or stellate form. Usually, however, the processes give the impression of small and unimportant dendrites. I am inclined to think with Cajal (1896) that these dendrites are embryonic and transitory, but would add that they have greater importance and permanence in fishes than in higher forms. Often, even in

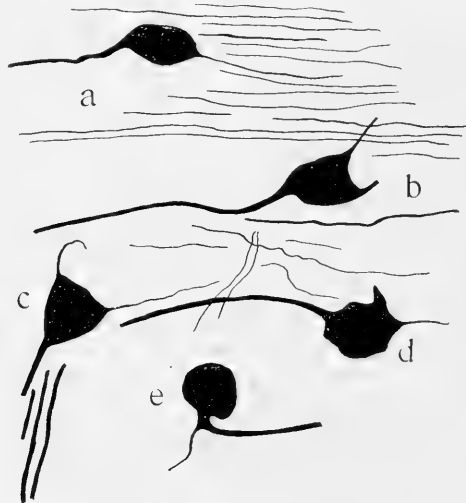

FIG. 7. Five cells from the nucleus tecti of the toad. *a*, bipolar with coarse dendrite and fine axone; *b*, *c*, *d*, multipolar, having in addition to the large process a true axone and a small dendrite; *e*, pear-shaped cell whose single process divides into a coarse dendrite and a slender axone. The cells are taken from different sections.  $\times 175$ .

fishes, I have been unable to find any processes besides the one large one. The large process, however, in selachians and the toad has occasionally been seen to divide at a short distance from the cell into two branches, one thick and one much finer (Fig. 7). There is a certain similarity between these and the unipolar cell figured by Van Gehuchten. In silver preparations of the brains of the rat, mouse and rabbit I have looked for a branching of the large process near the cell-body, but have not seen it. A more extensive and careful

search may reveal such branching in some of the cells, but there is reason to think that the collateral branching described by Lugaro and Cajal is the chief form of branching in mammals.

In addition to the protoplasmic processes or dendrites these cells have in some forms at least a fine process which must be regarded as the true axone. The description of bipolar cells with ascending axones by Merkel and Krause must be given some weight, although Cajal subsequently saw only the descending thick process. It is possible that not all the cells are alike, that some of them are unipolar (Cajal) and others multipolar (Kölliker, Held) and still others bipolar with differentiated dendrite and neurite (Merkel and Krause). It is certainly true that in the toad both multipolar and bipolar cells exist and that in both forms a typical slender axone can be distinguished from the thick process (and from the small dendrites of the multipolar cells). A considerable proportion of the cells in the toad brain prepared by the Cajal ammonia-silver method show clearly typical axones (Fig. 7). I have drawn only cases in which the thick process and the axone can be seen in the same section, but there are many cases in which the processes of the same cell are to be found in adjacent sections. The characteristics which show the process in question to be an axone are its typical cone of origin, its slender uniform caliber and its deep staining. The neurofibrillæ in a few cases are seen in the cone of origin converging into the fiber. The large process which has heretofore been called the axone is broad, pale and tapering so that it has the appearance of a dendrite until it has gone some distance from the cell and taken on its myelin sheath. As seen in the figures, the axone may arise from the cell body of a stellate cell bearing one or two small dendrites, or from one pole of a spindle-shaped cell whose other pole gives rise to the thick dendrite, or from the dendrite itself a short distance from the cell (Fig. 7). *In every case in which a true axone was found the thick process entered the descending bundle and the axone penetrated the substance of the tectum itself.*

In the rabbit (Fig. 5 D) an occasional bipolar cell is seen whose slender axone takes an ascending direction.

In ordinary stains the cell body is large, pale, uniformly granular,

and contains a large clear nucleus with sharply defined nucleolus. The resemblance of these cells in form and structural appearance to spinal ganglion cells has been noted or used as a means of description by Meynert and most later authors. This comparison is not only apt as far as general appearance is concerned, but in every particular a close resemblance can be drawn. The size, the vesicular form, the possession of small dendrites, the bipolar form with one thick and

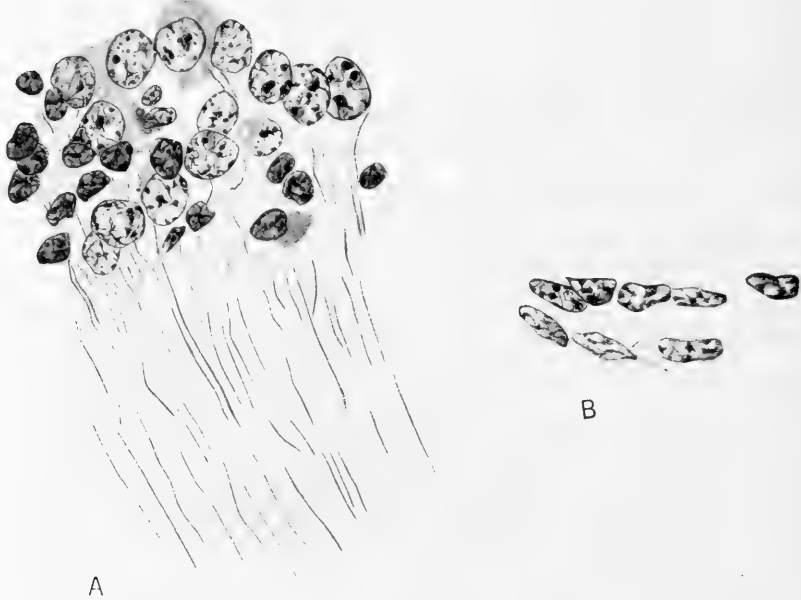

FIG. 8. Two camera drawings from a transverse section of the brain of a human embryo of 15.5 mm. (Embryo H. 19.) A, the cells and fibers of the radix mesencephalica; B, some cells of the motor nucleus of the trigeminus. The magnification is the same in both figures. Only the nuclei are to be seen in most of the cells.

one slender process are all duplicated by adult or embryonic spinal ganglion cells. The internal structure also is like that of spinal ganglion cells, even to the disposition of the neurofibrillæ, so far as these are shown in my silver preparations. In position also these cells correspond perfectly to the giant cells in the spinal cord of fishes and amphibians and to the cells in *Amphioxus* which are homologous to the spinal ganglion cells.

In the human embryo of 15.5 mm. the cells in question are large and possess large clear nuclei so that they are strikingly different from the surrounding cells. This is shown in Fig. 8, which also serves to compare these cells with the cells of the motor nucleus of the trigeminus in the same embryo.

3. *The Embryonic Origin of the Cells*.—I have made no effort to trace the whole history of these cells because I have no series of embryos of any form in which the cells are numerous. However, in all stages that I have examined the cells in the tectum have the same position as in the adult. As they lie in or adjacent to the roof plate of the neural tube it is clear that they have their origin in this region. It seems most probable that they have been derived from the neural crest during development, having been enclosed in the neural tube as are the giant ganglion cells of the spinal cord. There is a close resemblance between the cells in the spinal cord and those in the tectum in young fishes and adults. In mammalian embryos, those cells which come to occupy the locus cœruleus in the adult lie not at the dorsal border of the medulla but near the sulcus limitans (Figs. 13 and 14). At the level of the velum and IVth nerve the cells are near the dorsal border of the brain throughout life.

4. *The Course of the Radix Mesencephalica*.—In all the forms studied the general course of the bundle of large fibers is the same. Running caudally through the lateral part of the tectum the bundle passes through the lateral part of the velum medullary anterius or corresponding region, continues on the internal surface of the brachium conjunctivum and internal face of the lateral wall of the fourth ventricle (locus cœruleus), passes over the motor nucleus of the trigeminus, turns laterad at the same time and crosses the motor root bundles at a greater or less angle, and joins the sensory root at the point of exit or joins the spinal trigeminal tract some distance caudal to the root. As it passes through the velum medullare the bundle, in the forms studied by me, always holds the same relation to the IVth nerve and other bundles in the velum: namely, it runs lateral and dorsal to the ascending root portion of the IVth nerve and ventral to the trunk of this nerve after its decussation. The radix mesencephalica trigemini also runs beneath the decussatio veli

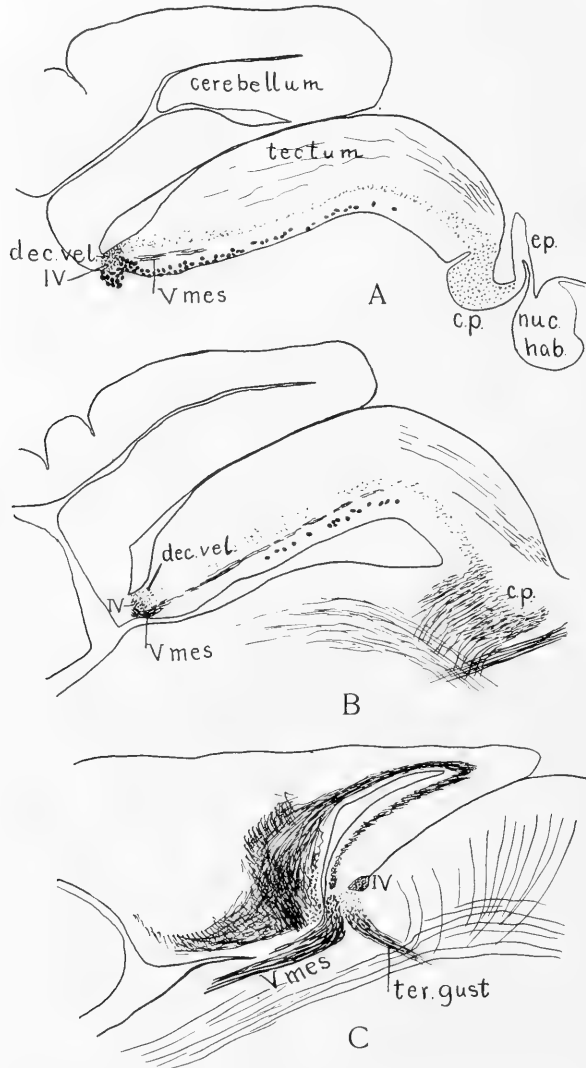

FIG. 9. Three sagittal sections of the tectum of *Scyllium stellare*. A, nearly median, showing the greatest extent of the nucleus tecti. B, through the lateral part of the aqueduct. The mesencephalic bundle is seen passing beneath the trochlearis. C, farther laterad. The fibers of the decussatio veli turn downward and forward as the tertiary gustatory tract. The radix mesencephalica passes caudad on the inner surface of the acusticum.  $\times 16$ .



or deep decussation of the cerebellum. This decussation in all sub-mammalian forms studied is the commissure of the nucleus visceralis cerebelli (secondary gustatory nucleus). The radix also runs beneath the tractus tecto-cerebellaris, which I have identified in the selachians,

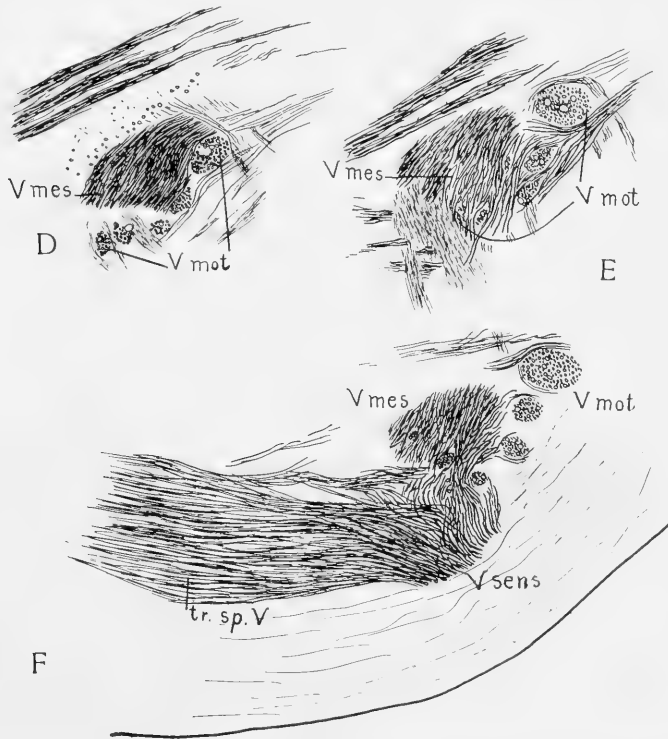

FIG. 10. Three sections from the same series as those drawn in Fig. 9, but farther laterad. Only the mesencephalic bundle and its immediate surroundings are drawn. At D it comes into contact with the bundles of the motor root of the trigeminus, at E it is passing beyond the motor bundles, at F it joins the tractus spinalis trigemini to form the sensory root. The mesencephalic bundle crosses the motor bundles nearly at right angles and there is no indication of interchange of fibers.  $\times 50$ .

Acipenser, and the mammals studied including the human embryos. The course of the bundle in *Scyllium canicula*, *Acipenser* and *Necurus* was described in my previous paper. I wish to make certain additional notes on the basis of preparations made since that paper

was published. In *Scyllium canicula* the course of the radix mesencephalica through the cerebellum was somewhat complex and I suggested that this accounted for Edinger's mistaking this bundle for a tractus tecto-cerebellaris. In *Scyllium stellare* the course of the bundle is identical with that in *S. canicula* except that it makes a much less complex bend or loop in passing through the cerebellum into the velum medullare anterius. The course of the bundle is so direct that there is no chance of losing or mistaking it in following it

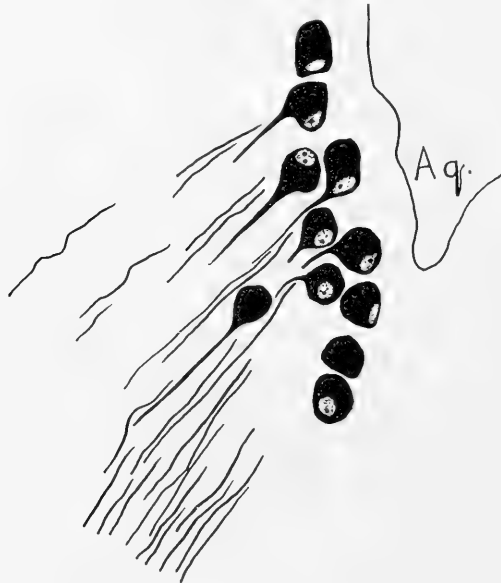

FIG. 11. *Acipenser rubicundus*; some cells of the nucleus tecti as seen in a transverse section. The bundle of fibers is the beginning of the radix mesencephalica.  $\times 175$ .

through transverse sections. The same is true of *Squalus acanthias*. Also, in sagittal sections of *Scyllium stellare* the whole course of the bundle is very clearly followed (Figs. 9 and 10). The way in which the mesencephalic bundle crosses the motor root bundles in these sagittal sections makes it quite impossible to make any mistake as to which root the mesencephalic bundle enters.

In *Acipenser* the bundle was previously followed only into the tectum, not to its cells of origin. I have since traced the bundle in

other preparations with perfect clearness around the lateral part of the tectum to the nucleus magnocellularis tecti. The fibers run in a broad bundle immediately outside the ependymal layer and at the anterior border of the tectum are seen in transverse sections bending toward the median line and joining the large cells (Fig. 11).

In the turtle the whole course of the bundle is remarkably clear. At its exit there is some intermingling with the motor roots, which is not seen in fishes or amphibians and suggests the complex relations seen in adult mammals.

In mammals the structures in the region of the trigeminal roots are more crowded than in lower vertebrates and the relations of the mesencephalic root have been difficult to make out on that account. So long as the fact that the cells of origin lay in the brain did not seem to be of especial importance for the interpretation of the bundle, authors inclined to believe that it joined the sensory root. After the formulation of the neurone doctrine and the law that sensory fibers arise from peripheral ganglion cells and motor fibers from central cells, most authors saw a connection of the mesencephalic bundle with the motor root of the trigeminus. I believe that this accounts for the change of opinion from Meynert and the older authors to Kölliker, Van Gehuchten, Cajal and recent authors. The mesencephalic root is very difficult to trace to its exit in mammals, the differences of opinion are most natural, and the opportunities for seeing what one wishes to see are admirable. When I first studied this root in *Scyllium* I fully expected to find it join the motor root, as I had been convinced so far as mammals and birds were concerned by the work of Cajal and of Wallenberg. I was greatly surprised by what I found in *Scyllium*, but in all the forms studied since I have never been able to trace the bundle into the motor root or to find good reason for doubting its connection with the sensory root.

Instead of burdening the paper with an extended description and with numerous figures of the various brains, I will make one or two notes on the course of the bundle in adult brains and depend upon the figures from the human embryonic and foetal brains to demonstrate the essential relations in mammals. It is necessary to give attention only to the relations of this bundle to the motor and sensory roots, since the course of the upper part of the bundle is well understood.

The first mammal in which the bundle was followed with certainty was the mole, whose brain is comparatively simple and primitive. In it the bundle runs caudad *over* the motor nucleus without any complex relation to it and then bends downward and forward to enter the spinal trigeminal tract and leave the brain in the sensory root. The large cells in the locus cœruleus are widely separated from

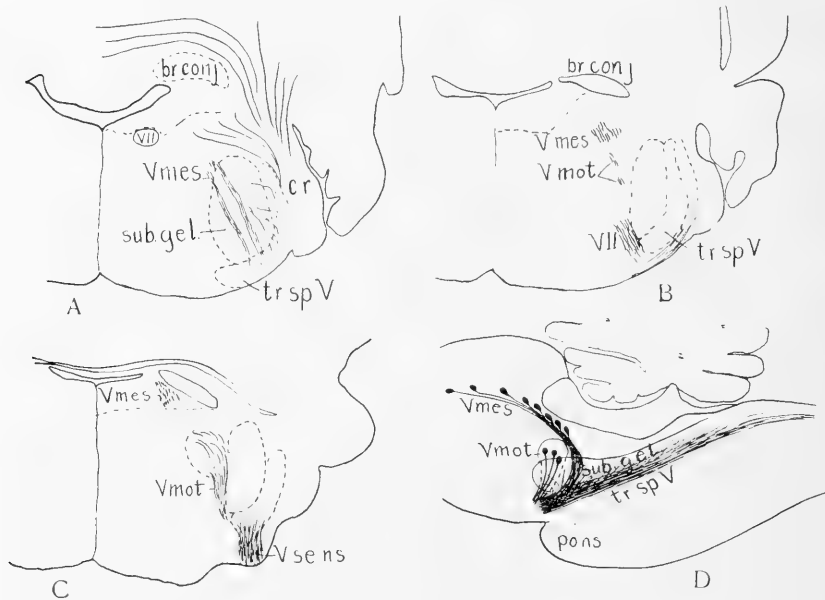

FIG. 12. Sketches to show the course of the mesencephalic root in the common rat. A, B, C, camera outlines from transverse sections; D, diagram of the roots projected on the sagittal plane. In A, the mesencephalic bundle bends down through the substantia gelatinosa to enter the spinal trigeminal tract. Its fibers then run forward to leave the brain in the sensory root (C).

the motor nucleus and closely related to the granular layer of the cerebellum. I hope to study and describe this relation later, but it is to be noted here that there is nothing to suggest any relation of the locus cœruleus to the motor nucleus of the trigeminus or to any other motor area.

The essential features seen in the mole gave the key to the study of other mammals. In the rat (Fig. 12) and cat it was found

that although the bundle traverses the upper surface of the motor nucleus much more closely than in the mole it still passes on to join the spinal trigeminal tract caudal to the motor nucleus. The confusion into which previous workers have fallen may easily have arisen from the fact that the bundle comes down from the locus cœruleus upon the dorso-cephalic surface of the motor nucleus close to the motor bundles as they make their exit from the nucleus. There is even some intertwining of the motor fibers with the mesencephalic fibers. Then the latter fibers instead of bending down with the motor bundles turn lightly dorsad and follow over the motor nucleus as a dorso-ventrally compressed bundle, the coarseness of whose fibers makes it possible to trace them with certainty. The bundle then bends down around the caudal surface of the motor nucleus, inclines laterad and pierces the substantia gelatinosa. Here the fibers are gathered in small bundles parallel with and mingled with the terminal bundles of sensory trigeminal fibers in the substantia gelatinosa. Passing through this they enter the spinal trigeminal tract. The diagram in Fig. 12 indicates this peculiar course of the bundle in the adult. No such complex relations exist in the embryo (see below) and the bundle is traced with ease. In the adults, in the beginning of my study, repeated efforts to find the bundle at all at the level of the trigeminal roots were fruitless. It might be thought that sensory fibers of the trigeminus destined to the mesencephalon would go directly up in the ascending root through the sensory nucleus or along with the cerebellar fibers and so pass cephalad from the motor nucleus to reach the locus cœruleus. I wasted much time and effort at first in the attempt to find such fibers, and it was only by tracing the bundle down from above, first in the mole and then in the rat and cat, that its course was made out.

In the mole, cat and human embryo of 15.5 mm. there are strong indications that when the bulk of the mesencephalic bundle joins the sensory root of the trigeminus, a few fibers continue on caudad to the level of the vestibular nerve. Wallenberg (1894) saw fibers of this bundle in birds continue caudad to the level of the "Cochlearis-Eckkernes" and he mentions that Probst has seen such a caudal continuation of this bundle in mammals. These caudally directed

fibers probably arise from cells of the locus cœruleus, as in the caudal part of the locus cœruleus in the rat a considerable part of the large cells send their large processes caudad away from the trigeminal bundle (Fig. 4 B).

There are two great advantages in the study of the bundle in

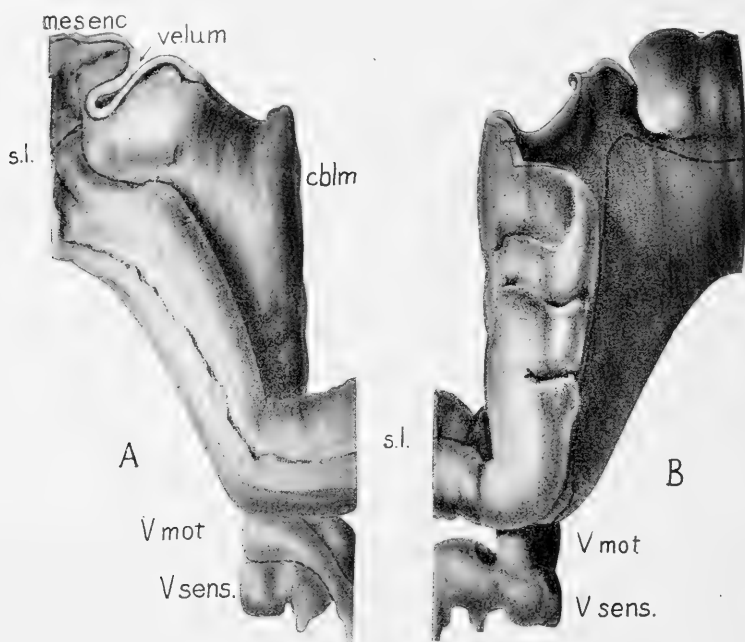

FIG. 13. A model of the right half of the brain of the human embryo II. 19. from the level of the VIIth nerve to that of the IIIrd nerve. A, from the medial surface; B, from the lateral surface. The sulcus limitans is indicated by a dotted black line, and on the outer surface and on the trigeminus the boundary line between sensory and motor structures is indicated in the same way. The radix mesencephalica runs dorsal to the sulcus limitans through its whole course.

embryonic brains. First is the simplicity of structure which enables one to trace the bundle with perfect ease and certainty. Second is the clearness of the general morphological relations. It is easy to determine whether the mesencephalic root and its nucleus of origin lie in the sensory or in the motor zone of the brain. I was fortunate to receive in 1905 a human embryo which measured after fixation

in formalin 15.5 mm. The embryo is small for its stage of development. The specimen was so fresh that the tissues show an almost perfect histological fixation and the brain is in excellent condition

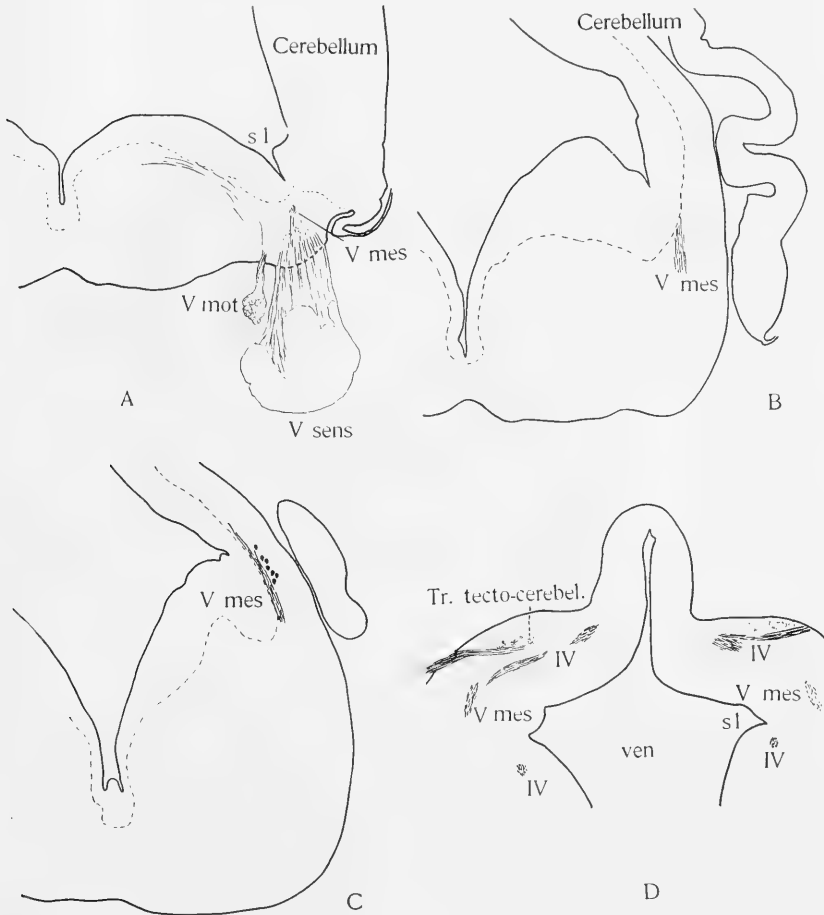

FIG. 14. Camera outlines of four transverse sections through the brain of the embryo II. 19. These sketches show the course of the mesencephalic bundle from the sensory root of the trochlearis. Note its relations to the sulcus limitans, the two arms of the trochlearis and the tr. tecto-cerebellaris.

for study. The specimen was cut in a perfect series of frontal sections 10 microns in thickness and stained in Delafield's hæmatoxylin. The bundle can be traced readily in this embryo with either high or

low power objectives and its course has been demonstrated to many persons at two meetings of the American Association of Anatomists and elsewhere.

The general morphological relations are to be seen from Figs. 13, 14, 15, 16. In a section through the roots of the trigeminus (trans-

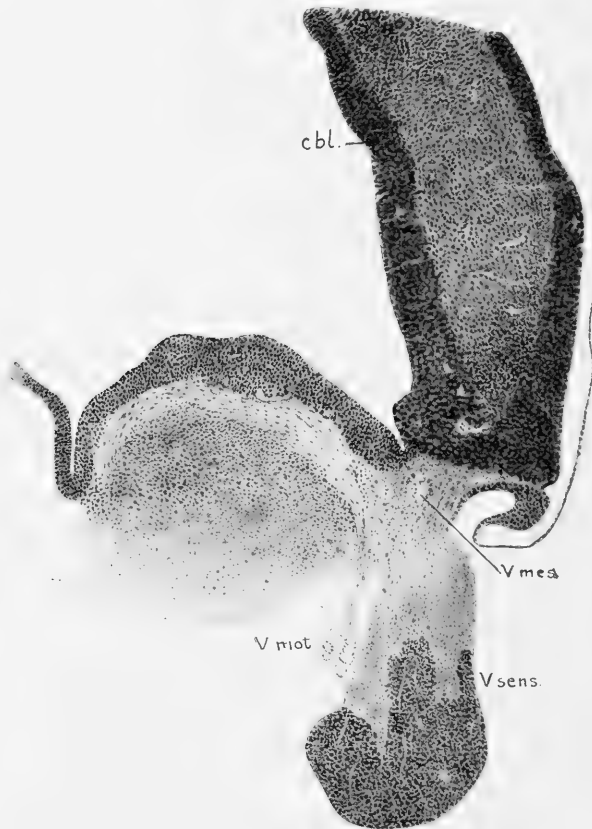

FIG. 15. A transverse section of the brain of the embryo H. 19 through the trigeminal roots. The mesencephalic bundle lies imbedded in the sensory root, widely separated from the motor root.

verse section at this level) the sensory and motor roots are separated by a considerable interval, as is usual in mammalian embryos. The distinctness of the motor root from the sensory root and ganglion peripherally is well known. The section of the brain shows a very



deep lateral groove in the wall of the fourth ventricle, the *sulcus limitans* of His. Lateral to this the sensory zone (acoustic and trigeminal centers) of the medulla is continued dorsally by the developing cerebellum. Medially from the *sulcus limitans* is, of course, the thick brain base containing the motor centers. These relations are clearly seen in the model (Fig. 13) which includes a part of the medulla oblongata, the cerebellum and a part of the midbrain.

The course of the mesencephalic bundle from the sensory root up to the velum medullare is shown in Fig. 14, A, B, C, D. Fig. 15 shows the actual appearance of the section of which Fig. 14 A is an outline sketch. It will be seen that the sensory root enters the brain lateral to the *sulcus limitans*, while the motor root bends mesad into its nucleus in the base. The mesencephalic bundle lies in the midst of the sensory root fibers as a distinct compact bundle. As it passes forward (Fig. 14 B, C, D) it gradually rises above the *sulcus limitans* until at the velum medullare it assumes the typical relations to the IVth nerve described above. At the level shown in Fig. 14, C, and caudal to that are found the large cells which later occupy the locus *cœruleus*. They are all located lateral and dorsal to the dense layer of central gray which surrounds the *sulcus limitans*. The bundle and the cells related to it are therefore wholly in the dorsal or sensory zone of the brain as in fishes, amphibians and reptiles.

The relation of the mesencephalic bundle to the cerebellar fibers of the trigeminus is shown in three other sketches (Figs. 16, 17, 18) taken from sections between those drawn in Figs. 14, A and B. These sketches show that in the early embryo the mesencephalic bundle is intimately associated with the ascending sensory root of the trigeminus, as was to be expected from its relations in lower vertebrates. It is also evident from all these figures that in the young embryo the mesencephalic bundle has not the remotest apparent relation to the motor root or nucleus. That these relations become so greatly modified in the adult is due to a number of influences among which are probably the great growth of the cerebellum and the vestibular nuclei related to it and the great size of the corpus restiforme, all of which tend to crowd the sensory bundles of the trigeminus closer to the motor nucleus. Another important factor is

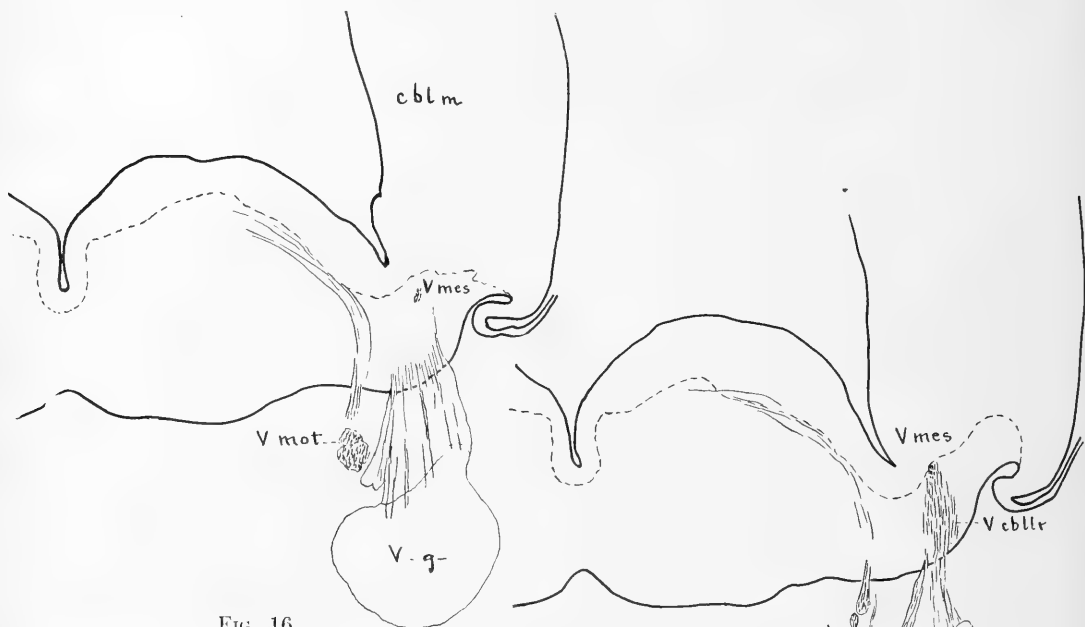

FIG. 16.

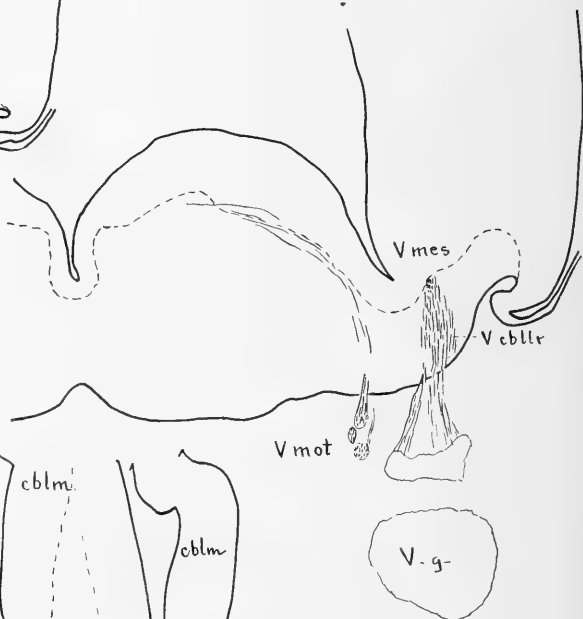

FIG. 17.

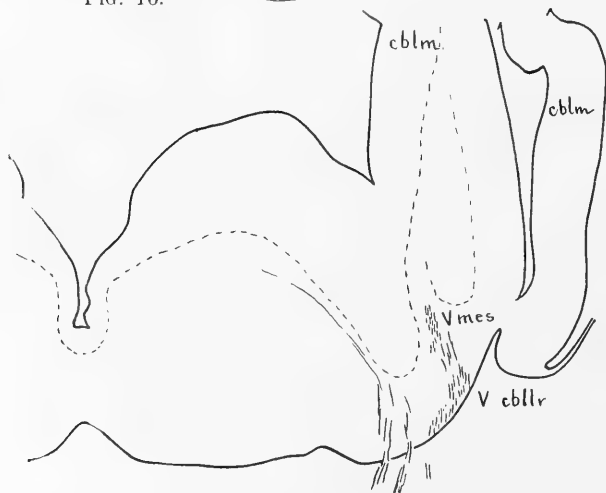

FIG. 18. V mot

FIGS. 16, 17, 18. Three camera sketches of transverse sections of the brain of the embryo H. 19 taken between the levels of the sections shown in Fig. 14 A and B. Fig. 16 is just in front of Fig. 14 A, and Figs. 17 and 18 are respectively five and ten sections farther forward. These sections show the intimate relation of the mesencephalic bundle to the cerebellar fibers of the trigeminus.

probably found in the collateral branches from the mesencephalic fibers which enter the motor nucleus.

In the pig embryos the course of the mesencephalic bundle has been found to be identical with that in the human embryo described above.

Through the courtesy of Professor Harlow Gale I have had the opportunity to study preparations of foetal brains of 27, 37 and 42 cm. These are Weigert preparations made in His's laboratory at Leipzig in 1897 for the embryological study of fiber tracts after the method of Flechsig. In these series every other section was mounted, the alternate sections being mounted in series which remained in His's laboratory. If those series are still available it will be possible for some one now at Leipzig to review the following description and confirm or correct the results.

Human foetus of 27 cm., transverse sections. In a foetus of this stage the medullation of the nerve roots and of the fasciculus longitudinalis medialis is much stronger than that of any other fibers in this region. At the level of the trigeminus roots a few internal arcuate fibers are seen and some fibers in the brachium pontis. The sensory and motor roots of the trigeminus are therefore quite clear from confusion with any other kind of fibers. Furthermore, the brain is somewhat embryonic in its form and owing to the slight development or absence of numerous fibers which later appear, there is as yet little of the crowding and density of structure which makes it so difficult to thread one's way in sections of the normal adult brain. That this is so will be evident from Fig. 19, which fortunately shows the whole length of the mesencephalic root through the region in which its course and relations are at all in doubt. The section passes through the sensory root near its exit and through the motor nucleus. As is well known, the bundles of the motor root, starting from their nucleus, are directed more cephalad than the sensory root and so pass beneath the sensory root to emerge on the surface of the pons cephalad from it. In this section the sensory root is cut lengthwise as it pierces the pons in nearly the transverse plane. In sections just behind this the sensory root turns caudad as the spinal trigeminal tract. Since the motor root runs diagonally

cephalad its bundles are cut obliquely and reach in this section only as far as the internal or dorsal border of the pons. The outline of the motor nucleus is indicated by a dotted line and it is evident that the greater part of the motor root comes from this nucleus. Dorsal to the nucleus are seen fibers passing over it and turning down parallel with the motor bundles. In adjacent sections it is clearly

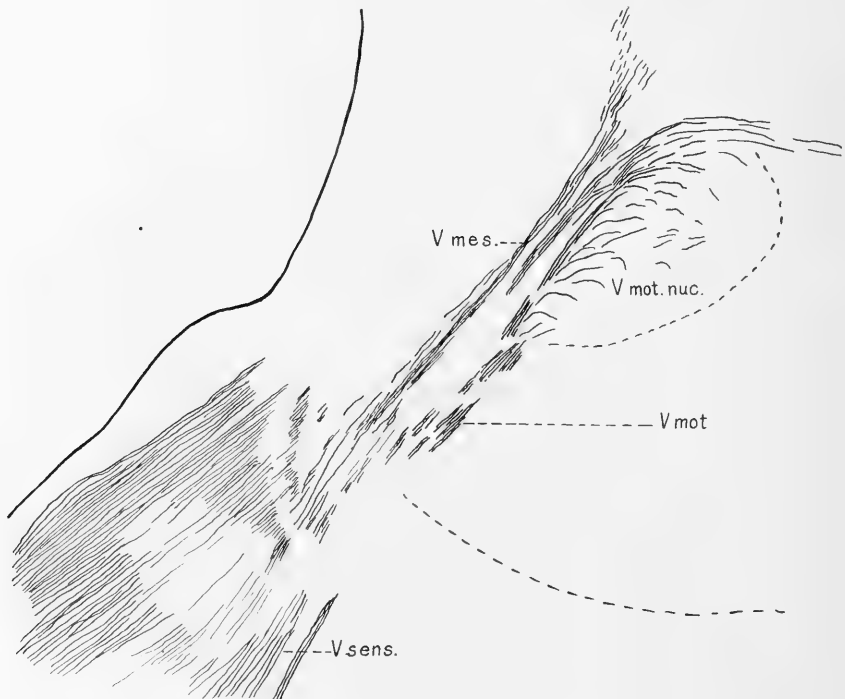

FIG. 19. Human fetus, 27 cm. Transverse section of the trigeminal roots on the left side. Weigert stain.  $\times 25$ . Camera drawing.

seen that these fibers form definite bundles which go out with the motor root. They are the crossed fibers of the motor trigeminus. These are all the fibers which enter the motor root in this specimen.

The mesencephalic root continues in the transverse plane from the sensory root to a point dorsal to the motor nucleus, where it turns forward to go through the isthmus to the tectum mesencephali. The connection of the mesencephalic bundle with the sensory root in this

section is unmistakable, since both lie in the plane of the transverse section and the mesencephalic fibers run directly among the sensory bundles. The motor bundles are crossing the mesencephalic bundle obliquely. In the sections caudal to this one, other fasciculi of the

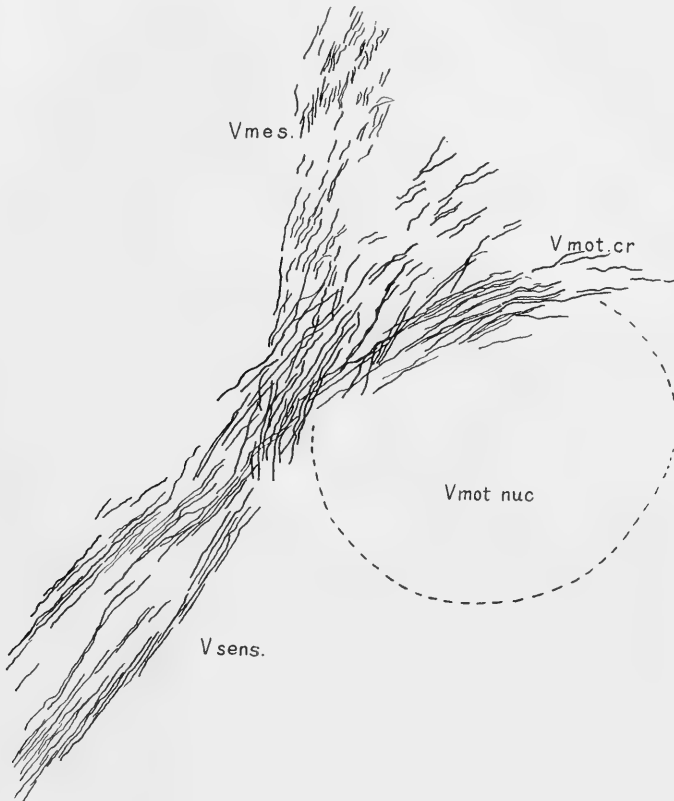

FIG. 20. Section next anterior to that shown in Fig. 19. An interlacing of the mesencephalic fibers with the crossed motor fibers. The two form with the sensory root a Y-shaped figure. The mesencephalic fibers descend among the sensory fibers in the stem of the Y, while the motor fibers in their oblique course forward leave the section at the point where the two bundles interlace.

mesencephalic bundle are cut lengthwise and show exactly the same relations as are seen in this section. In the section next cephalad there is an interlacing of the fibers of the crossed motor root with the most cephalic fibers of the mesencephalic bundle. As this is the

point at which all the confusion of the two kinds of fibers arises, this section is drawn in Fig. 20. The motor roots are cut obliquely, the sensory root is cut nearer to its point of exit. The crossed motor bundle crosses the mesencephalic bundle at such an angle that the two kinds of fibers can be clearly distinguished. It is not necessary to describe other sections of this series. Cephalad from this the mesencephalic bundle has its usual position. The relative position of the cell column of the mesencephalic root and the motor nucleus is clear in these sections. The motor nucleus extends forward six sections from the one drawn in Fig. 20, and the cells of the mesencephalic root appear in the fourth section cephalad from that of Fig. 20, so that there is an overlapping of the two for three sections of this series or six sections of the complete series. The cells of the mesencephalic root lie one millimeter or more dorsal to the motor nucleus and are separated from it by the bulk of the mesencephalic bundle itself and by the crossed motor bundle.

In this embryo the mesencephalic root, coming from its cell column which lies dorsal and cephalic to and separated from the motor nucleus, runs ventro-laterad lateral and caudal to the motor bundles, which it crosses obliquely, and leaves the brain in the heart of the sensory root.

Fœtus of 42 cm., transverse sections. The 42 cm. fœtus is taken up next in order to compare the transverse sections with those just described. One section from each half of the brain is shown in Figs. 21 and 22. The two sections are nearly at the same level. In the section through the left half of the brain (Fig. 21) the cerebellar portion was broken away as indicated by the dotted line; in the right hand section (Fig. 22) the reticular formation was broken as indicated by the dotted line, but neither of these breaks in any way affected the structures under consideration. An examination of the figures will show that the chief relations here are identical with those in the earlier fœtus. Medullation is now much more general. The reticular formation contains many medullated fibers and the pons, acoustic area and cerebellum show fairly numerous fibers. The sensory root is cut just at the point where a part of its fibers are turning into the spinal trigeminal tract, which is better formed on

the right (Fig. 22), since that section is somewhat further caudal than the left-hand one. Many fibers of the sensory root enter the chief sensory nucleus and the cephalic end of the substantia gela-

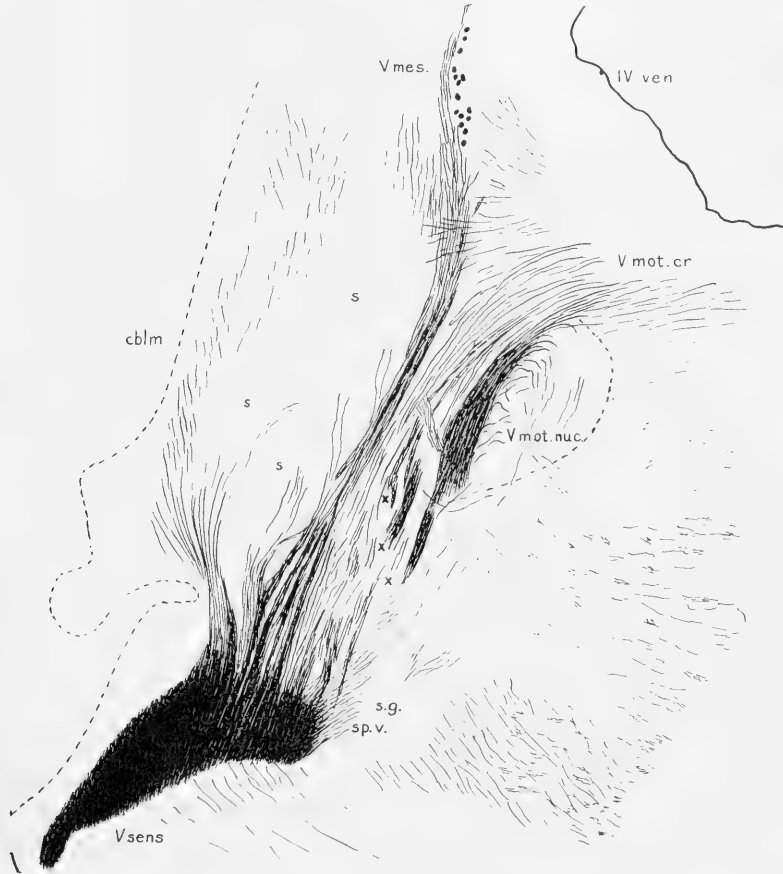

FIG. 21. Human fœtus, 42 cm. Transverse section through the trigeminal roots on the left side. The short heavy line at the left below is the outer surface of the pons. *x, x, x* indicate the ends of the motor bundles, where they leave the section. All the fibers below and to the left from these are sensory.  $\times 20$ .

tinosa. In each section is seen a large bundle of sensory fibers passing dorsad over the outer surface of the sensory nucleus. A part of the fibers enter that nucleus, the remainder seem to pass on to the cerebellum.

The motor nucleus is indicated in Fig. 21 by a dotted line and in Fig. 22 by the line along which the section was broken. Its dorso-lateral surface is covered, as in the younger specimen, by bundles of the motor root. On each side there is a broad but loose bundle of decussating fibers and beneath this are denser bundles of fibers arising

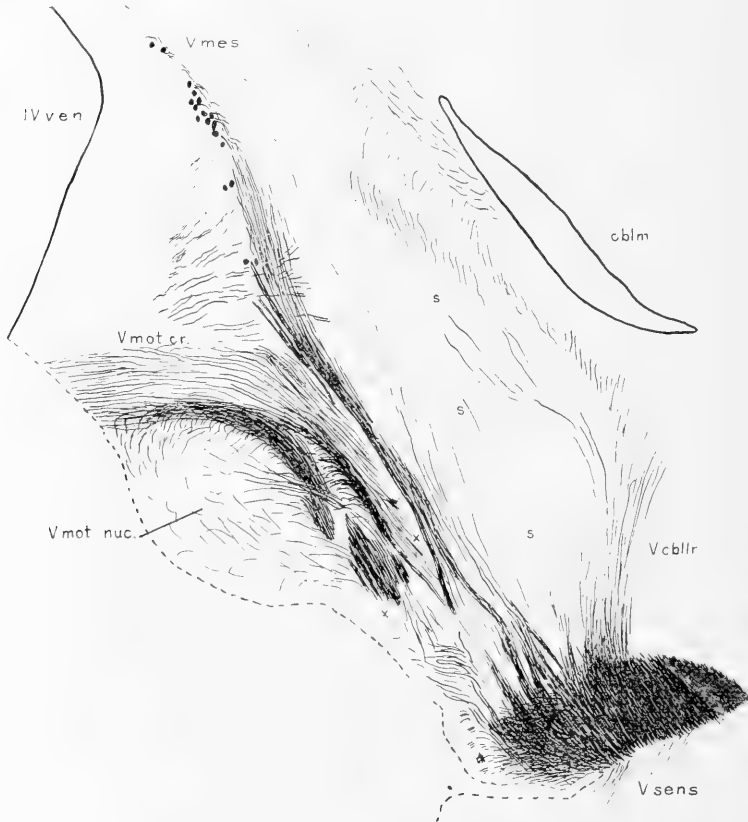

FIG. 22. Same specimen as in Fig. 21, two sections farther caudal on the right side.  $\times 20$ .

from the motor nucleus of the same side. The motor bundles run ventro-cephalad and are cut obliquely in the section a short distance ventral to the lower border of the motor nucleus.

The mesencephalic root of both sides is clearly formed of fibers from the sensory root and only obliquely crosses the motor bundles



as those pass downward and forward beneath it. In sections caudal to those shown in these figures the same relations maintain, except that the mesencephalic bundle is more widely separated from the motor bundles in successive sections. It is seen in Fig. 21 that fibers pass out from the mesencephalic bundle to end in the sensory nucleus. The close relation of this bundle to the sensory nucleus is clearer in the next sections caudad. Here it is distinctly seen that the mesencephalic bundle runs through the sensory nucleus and in the case of many sensory fibers it is difficult to tell whether they accompany the bundle or end in the sensory nucleus. Also it appears that many sensory root fibers run through the lateral part of the sensory nucleus or over its lateral surface and continue parallel with the mesencephalic bundle to enter the cerebellum. Some of these relations are shown in Fig. 22, which is taken from the second section in this series caudal to the one shown in Fig. 21. In the sections next cephalad from those figured, the same interlacing of mesencephalic fibers with decussating motor fibers as was seen in the 27 cm. fœtus is present and gives a confused picture. This interlacing is difficult to unravel in transverse sections because of the greater number of fibers medullated as compared with the younger stage and a drawing of this would not be clear unless it were made diagrammatic by omitting many of the fibers. The study of the sections convinces me that there is only an interlacing together with a certain crowding, as compared with the younger fœtus, and that the mesencephalic fibers all join the sensory root. From the horizontal sections next to be described this interlacing is drawn as accurately as possible under the camera without any schematizing, and the evidence for the conclusion here stated will be seen in those figures. It should be borne in mind, however, that in both the series of transverse sections above described the greater part of the mesencephalic root clearly passes down to the sensory root wholly separate from the motor root, so that any doubt that might exist regarding its possible relation to the motor root would attach to only the small part of its fibers.

The cells of the mesencephalic root are drawn in black in Figs. 21 and 22. It is clearly seen here that these cells are separated from the motor nucleus by the motor root bundles and by the arcuate



FIG. 23. Human foetus, 37 cm., frontal section through the inferior colliculus and isthmus.  $\times 20$ . Description in the text.

fibers of the acoustic area. In these figures the cells are removed from the motor nucleus by about the diameter of that nucleus itself. The cells shown in Fig. 22 are the nearest cells to the motor nucleus.

Fœtus of 37 cm., horizontal or frontal sections. From this series nine sections are drawn (Figs. 23 to 32) showing the course of the mesencephalic root from the mid-brain to its exit in the trigeminus. For the purpose of demonstrating whether this bundle is connected with the motor or sensory root it will be best to follow it from above downward in the description. In sections through the decussation



FIG. 24. The sixth section of this series (12 of the whole series presumably) ventral to that drawn in Fig. 23.  $\times 20$ . Description in text.

of the trochlearis the mesencephalic bundle is seen passing forward deep in the corpora quadrigemina, or rather along their base, and reaching nearly to the bundles of the posterior commissure. Cells are seen at intervals along the bundle, twenty or more being counted in a single section on one side. A drawing of such a section has not been made because this part of the course of the bundle is familiar to every one. Fig. 23 shows a section of the mesencephalic bundle beneath the posterior colliculus at the point where it begins to turn ventrally. Far forward appears the root of the trochlearis, to the left is the lateral lemniscus, and between them is the brachium con-

junctivum whose fibers are lightly medullated. In Fig. 24 the greater part of the fibers have turned ventrad and are cut across in the section. Owing to the fact that the fibers of this bundle are cut across in the frontal series, their course will not appeal so quickly to the eye in the following figures as in those taken from the transverse series, but the evidence of the relations of the fibers will be much more complete from an examination of both series of figures. In Fig. 24 the mesencephalic root appears as several small bundles of fibers obliquely placed in the section. The fibers may now be grouped into three main areas as an aid in tracing their further course. These areas are indicated roughly by the position of the

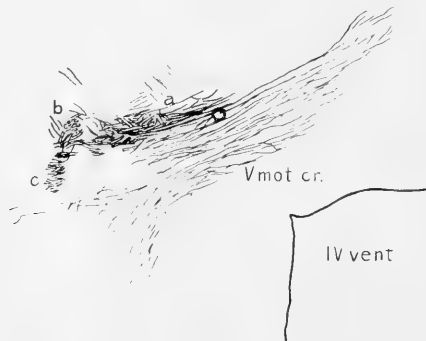

FIG. 25. The third section of this series ventral to the last.  $\times 20$ . Description in text.

letters *a*, *b* and *c*. The fibers adjacent to *b* and *c* form one fairly continuous flattened bundle which is wider cephalo-caudad. Adjacent to *a* are numerous oblique fibers, some of which are longer than others. These belong to the more ventrally placed bundles in the mesencephalon and are just now joining the root-bundle. Between *a* and the bundle *b-c* in this figure are some intermediate fibers which in Fig. 25 have joined *b* or *c*. In Fig. 26 the motor nucleus appears and is outlined by a dotted line and by the motor bundles which partly embrace its caudal surface. At least a part of the broad bundle running diagonally past the motor nucleus consists of decussating motor fibers from the other side. For convenience the motor bundles will be designated by the last letters of the alphabet and these decussating fibers are labeled *z*, while the homolateral bundles

*y* and *x* are seen arising from the nucleus. It should be noticed now that the mesencephalic bundle *b-c* lies caudo-lateral to the motor nucleus and is distinct from the motor bundles. It will make the understanding of the following figures more easy if the reader holds in mind that from here on the mesencephalic root is destined to run latero-ventrad and slightly caudad to its point of exit, while the motor root bundles run ventro-cephalad and laterad, so that at this point the bundle *b-c* shows its nearest approach to the motor bundles. It is this bundle *b-c* whose separate course has been clearly shown in the transverse sections. The bundle *a* in this figure is to be found

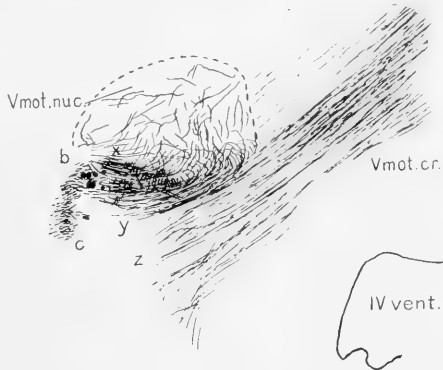

FIG. 26. The second section of this series ventral to the last.  $\times 20$ . Description in text.

among the motor bundles, this being the point at which the interlacing already described takes place. The fibers will be recognized as a row of short lines set at an angle to the direction of the motor fibers. It is in reality a very thin flat bundle which lies chiefly between the decussating and homolateral motor fibers. This section is the one in which these fibers are most completely intermingled with the motor fibers. To render the relations more clear, I have drawn the same section at a higher magnification so as to be able to show the exact position of the fibers of bundle *a* more clearly (Fig. 27). Every fiber is drawn under the camera with great care. I am unable to find a single fiber of the mesencephalic bundle which seems to turn into the motor bundles.

Above and below the section just described the relations of bundle *a* are entirely clear. Proceeding with the series, Fig. 28 shows the full extent of the motor nucleus and all of the motor bundles formed. The nucleus is pear-shaped with the small end caudad. A few decussating motor fibers are seen passing over this small part of the nucleus to join the bundle *z* which receives also fibers from this part of the nucleus. The bundle *y* is also a mixed bundle of decussating and homolateral fibers. From the large cephalic part of the nucleus are being formed the remaining motor bundles which are marked

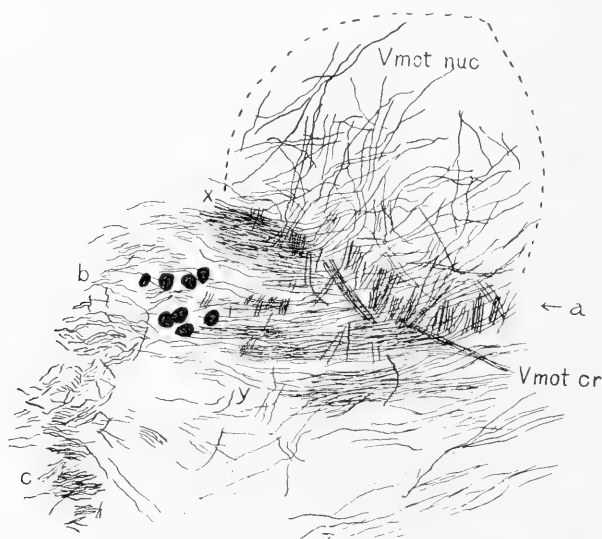

FIG. 27. Same as in Fig. 26.  $\times 78$ . Description in text.

*v*, *w* and *x*. Between the bundles *x* and *y* are seen the curving fibers of the bundle *a* of the mesencephalic root, just extricating themselves from the motor bundle *x*. Lateral to the bundle *a* are seen the fibers of the bundle *b-c*, now loosely scattered. The letters *a*, *b* and *c* stand at the angles of a triangle which includes the fibers of the mesencephalic root and nearly all the fibers appearing within this triangle belong to that root. All these fibers are clearly traced in the intermediate sections. It is probable in this and the following sections that a few of the fibers in the *a-b-c* area end in the sensory nucleus,

for as Fig 28 clearly shows, the mesencephalic root is running directly through the sensory nucleus. There now appears in this section the most dorsal portion of the main sensory root of the trigeminus, just at the point where it is giving fibers to the sensory nucleus and where the most of its fibers are turning caudad as the spinal trigeminal tract. There also appear in the figure the root of the vestibularis and of the motor facialis.

In Fig. 29 appear besides the sensory and motor roots and nuclei of the trigeminus, the motor facialis, the cochlearis, fibers of the



FIG. 28. The fourth section of this series ventral to the last.  $\times 20$ . Description in text.

trapezoid body, etc. The motor bundles of the trigeminus are collected opposite the cephalic end of the motor nucleus, except the bundle *z*, which still receives decussating fibers and is closely related to bundle *a* of the mesencephalic root. The fibers of the *b-c* area have now collected into two fairly distinct groups of small bundles. The bundles *c* are evidently joining the sensory root and are intermingled with the fibers which are passing caudad in the spinal trigeminal tract. The other relations in this figure will be clear from the labelling.

The following figures require little comment in addition to the description given beneath each. The sensory and motor roots now run on to their places of exit, the motor in front of the sensory. Of the motor root bundles, the one which is chiefly composed of decussating fibers, bundle *z*, lags behind the others, remains close to the



FIG. 29. The third section of this series ventral to the last.  $\times 20$ . The heavy lines to the left mark the outer surface of the brain. Description in the text.

sensory root and leaves the brain as a separate rootlet in this fetus. Of the mesencephalic root the bundle *c* joined the sensory root in Fig. 29, the bundle *b* enters the sensory root in Fig. 30, while the bundle *a* appears as three small compact bundles, the last of which is seen joining the sensory root in Fig. 31. The relations of the



spinal trigeminal tract, the cochlearis, the facialis and the trapezoid body are drawn for the sake of orientation.



FIG. 30. The fifth section of this series ventral to the last.  $\times 20$ . Description in the text.

The horizontal sections of the 37 cm. foetus fully support the description of the mesencephalic root in the transverse sections of

the 27 and 42 cm. stages. The general conclusion may be stated thus: in the human embryo of 15.5 mm. the mesencephalic root of the trigeminus is connected with the sensory root and is clearly not connected with the motor root or nucleus, but is widely separated



FIG. 31.



FIG. 32.

FIG. 31. The second section of this series ventral to the last.  $\times 20$ . The motor and sensory roots of the trigeminus, the cochlearis and motor facialis are shown. The outer surface of the pons is toward the left. A broken line separates the motor and sensory roots. The fibers of the motor bundles have a much darker and more opaque stain than those of the sensory bundles.

FIG. 32. The sixth section of this series ventral to the last.  $\times 20$ . The motor and sensory roots of the trigeminus are shown near their point of exit. In these last two sections there is nothing except their deeper stain to indicate that bundles *y* and *z* are motor bundles. They are readily traced continuously through the series as described in the text. The broken line separates the motor and sensory roots.

from them; in the later foetus of 27, 37 and 42 cm. stages the mesencephalic root is gradually crowded closer to the motor nucleus and root and where it passes over the dorso-caudal surface of the nucleus a small part of its fibers are interlaced with the decussating motor fibers and with a few of the homolateral fibers; by far the greater

part of the root remains wholly distinct from the motor root and nucleus; all the fibers of this root mingle intimately in the sensory root of the trigeminus with the fibers which end in the chief sensory nucleus and with those which go to form the spinal trigeminal tract.

#### DISCUSSION AND CONCLUSIONS.

The important considerations regarding this mesencephalic root are (1) the character and significance of its cells of origin; (2) the course, position and connections of the bundle in the brain and (3) the peripheral distribution of its fibers.

That the fibers arise from cells in the brain in all classes of vertebrates there is now, I believe, no reasonable doubt. I have shown in this paper that in fishes and amphibians the great majority of these cells lie in or near the mid-dorsal line in the tectum mesencephali. Since the same root bundle of the trigeminus arises from these cells and from those in the locus cœruleus in mammals, I know no reason to doubt, and I know of no author who doubts, that the cells in the two situations belong to the same category. We are dealing with the same set of cells throughout all vertebrates and those in mammals must be regarded as having migrated farther from the place of origin, at the mid-dorsal line. The facts are all in favor of the supposition that these cells have been derived from the neural crest just as the giant ganglion cells in the spinal cord have been. The cells located in the locus cœruleus in mammals will require some additional explanation such as the supposition that they have migrated probably from the mesencephalic segment along the course of the nerve bundle. I see no possibility of denying that these cells arise in the extreme dorsal region of the brain in all vertebrates and I know of no other structures with which they can be compared than the giant cells in the spinal cord. The reason for comparing these with one another is that both send their processes out in sensory nerves.

The similarity of the mesencephalic cells in size, form and structure to the spinal ganglion cells and to the dorsal cells of the spinal cord is another strong argument. It is important to notice that in both classes of cells bipolar and unipolar examples are found which give rise to coarse peripheral processes (dendrites) and slender cen-

tral processes (axones). The ground for this comparison is as perfect as can be desired so far as the animals thus far studied are concerned.

I have already pointed out that the bundle has essentially the same course and position in the brains of all classes and I need only repeat that it is always situated in the dorsal zone of the brain. There is not known in any part of the brain or spinal cord of any vertebrate a root bundle of any motor nerve which runs longitudinally in the dorsal half of the brain wall. The trochlearis is the only motor nerve which enters the dorsal zone of the brain in any part of its course, and that only to decussate. On the other hand, all the sensory nerves, their roots and longitudinal bundles in all vertebrates are strictly confined to the dorsal half of the neural tube. This is *not* a demonstration that this bundle is sensory in function, but it shows that the presupposition is that it should be sensory. We expect all primary bundles in the dorsal half of the brain wall to be sensory; the burden of proof rests with those who would consider this bundle to be motor.

The connections of the bundle in the brain require further study. Since all the evidence goes to show that the large processes of the cells are peripheral sensory fibers comparable to the peripheral processes of the spinal ganglion cells or the dorsal cells of the spinal cord, we should look for connections in the brain similar to those set up by the central processes of the spinal ganglion cells. I have shown (1900) that the giant cells in the cord of fishes are bipolar and that their axones run in the dorsal tracts, so that these neurones resemble embryonic spinal ganglion cells in everything but the position of their cell bodies. The cells in the mesencephalon of the toad are unipolar, bipolar or multipolar and possess true axones which enter the substance of the tectum. The same is probably true of the bipolar cells described by Merkel and Krause and of those which I have seen in the rabbit. I consider it probable also that one of the several processes which Kölliker saw on these cells may have been a true axone. The same may be said of the two cells figured by Van Gehuchten. Each has a slender ascending process which is probably the true axone. My line of reasoning here is that the existence of

true axones with central distribution is what we should expect in view of the fact that the peripheral process goes into the sensory nerve and is therefore the dendrite, and in view of the disposition of the processes of the giant or dorsal cells of the spinal cord which is well understood. I am satisfied that such central axones entering the substance of the tectum are not uncommon in fishes and amphibians. If the bipolar (and multipolar) cells in mammals are interpreted in the most simple and direct manner, they must be placed in the same category. But the majority of cells in mammals seem to have only a single process which sends collaterals into the motor nucleus of the trigeminus. Are these collaterals to be regarded as the central axone and the point of their origin as the T-division of the single process of the ganglion cell? I should hold this hypothesis in doubt until we have a very thorough knowledge of these neurones. It involves the supposition that these neurones begin as bipolar cells (already known), change into unipolar cells as do the spinal ganglion cells, and that the single process grows to an enormous length in case of those neurones whose cell bodies lie in the tectum. On the other hand, Van Gehuchten figures the collaterals from the large processes at the level of the motor nucleus of the trigeminus in the trout, while from his figures and from my sections of *Acipenser* and selachians I believe that the cell bodies in the tectum bear true axones. The only other case in the vertebrate nervous system which comes to my mind in which axones or axonic collaterals are given off from the afferent or dendritic process of a neurone in addition to an axone arising from the cell body, is the case of the giant cells in the spinal cord of fishes (*l. c.*, p. 376). These neurones possess ascending axones arising from the cell body and descending axones arising from the dendrite. (For other conditions occurring see the paper referred to.) The motor collaterals in the case of the trout (Van Gehuchten) and mouse (Cajal) would seem to correspond closely to the descending axone arising from the dendrite of the giant cells in the cord of teleosts. This suggests the hypothesis that what may be called a descending or accessory axone has grown in importance in higher forms, while the true axone ending in the tectum has been reduced and possibly is absent from most of the cells in mammals. On this

hypothesis the motor collaterals would be analogous (not homologous) to the motor collaterals in the spinal cord, and serve for direct reflexes between the sensory surfaces about the mouth and the muscles controlled by the trigeminus. This is perhaps the most important function of the mesencephalic root bundle and is sufficient to account for the growing predominance of the motor collaterals.

I have gone thus far with these speculations in order to show that very interesting problems lie here for other workers—to determine more completely the morphology of these neurones in all classes of vertebrates, the disposition of their central processes, their origin and development and especially the history of the several processes, the axones and the motor collaterals. The size of the mesencephalic root and its constancy in all classes of vertebrates are sufficient proof of its importance and of the value of further studies along the lines indicated.

The peripheral course of the fibers is the one point of crucial importance in the question at issue. In showing that the mesencephalic root bundle in selachians, ganoids, urodeles, anura, reptiles, insectivores, rodents, ungulates, carnivores, and man leaves the brain in the sensory root, I believe that I have established the strongest probability that the bundle is sensory in function. In mammals and man the motor root runs over the surface of the trigeminal ganglion without interchange of fibers. In many lower forms the motor root is almost as distinct. I do not know of any case in vertebrates in which motor fibers leave the brain in a sensory root and join the motor rami peripherally.

Exact and conclusive proof of the sensory character of this bundle would be obtained by one or a combination of the following operations: (a) Destruction of the cells of origin or cutting the mesencephalic root at any point central to the Gasserian ganglion without injury to the latter, followed by examination of the peripheral trunks of the trigeminus by the Marchi method to determine the distribution of the degenerated fibers. (b) Violent tearing out of one of the peripheral sensory rami in each of several animals with later study of the cells of origin to determine which ramus it is whose rupture causes destruction of the cells by retrograde degeneration. I have not found time or favorable conditions to attempt these operations.

One clinical case has come to my notice in the literature which furnishes almost as clear results as could be expected from the second form of operation. This is the case of facial atrophy reported by Mendel (1888). The patient had suffered, twenty-five years before her death, from interstitial neuritis of the left trigeminus. Microscopic examination of the trigeminus showed the end products of the neuritis in the root and all the rami, but the maxillary division was very much more seriously affected than any other part of the nerve. In some sections of the maxillary nerve there appeared only small islands of normal nerve fibers among the thick connective tissue septa. The cells of the trigeminal ganglion appeared entirely normal. In the brain the only abnormal changes found were the reduction in the size of the mesencephalic bundle of the trigeminus and reduction in the number of the cells in the substantia ferruginea on the left side as compared with the right. The facial nerve showed no change either centrally or peripherally. The motor nucleus of the trigeminus was normal. The vesicular cells in the mesencephalon from which part of the mesencephalic bundle arises appeared normal. Mendel interpreted his results as evidence that the mesencephalic bundle had specific trophic functions. The simplest interpretation seems to me to be that the destruction of nerve fibers in the peripheral rami had resulted in retrograde degeneration of part of the fibers of the mesencephalic bundle and atrophy of their cells of origin. The Gasserian ganglion appeared normal, the motor nucleus appeared normal. Either there had been no degeneration in either of those or the atrophy of certain cells had been so complete in the course of twenty-five years that there were no results apparent to Mendel. The Gasserian ganglion, however, had not offered a block to the degeneration of fibers of the mesencephalic bundle passing through it, and the atrophy of cells in the comparatively small locus cœruleus could be detected by counting. *The division of the nerve which was much the most deeply affected is wholly sensory.* The obvious conclusion is that the mesencephalic bundle is sensory in function and this harmonizes with all the considerations urged in the present paper.

Although I began the study of this bundle four and a half years

ago, fully expecting to find it a motor bundle as described by Cajal, Wallenberg and others, I have been unable to find any good evidence for this interpretation.

I have pointed out (1905, 1906) that the existence of a general sensory (cutaneous) column extending up into the tectum mesencephali is a strong support for the theory of primitive functional divisions of the nervous system with which all readers of recent literature have become familiar. This general interpretation rests upon the demonstration of true axones of the ganglion cells ending in the tectum and is more secure than before so far as the primitive brain is concerned. The hypothesis suggested above implies that the tectum mesencephali in mammals has largely lost its primary general sensory function.

#### ABBREVIATIONS USED IN ALL THE FIGURES.

- a, b, c*, bundles of the radix mesencephalica.  
*Aq.*, Aqueduct.  
*br. conj.*, brachium conjunctivum.  
*cbllm.*, cerebellum.  
*c. p.*, commissura posterior.  
*c. r.*, corpus restiforme.  
*dec. vel.*, decussatio veli.  
*ep.*, epiphysis.  
*lem. lat.*, lemniscus lateralis.  
*loc. cœr.*, locus cœruleus.  
*nuc. coch.*, nucleus cochlearis.  
*nuc. hab.*, nucleus habenulae.  
*s.*, sensory nucleus of trigeminus.  
*s. l.*, sulcus limitans.  
*sg. or sub. gel.*, substantia gelatinosa.  
*ter. gust.*, tertiary gustatory tract.  
*tr. sp. V*, tractus spinalis trigemini.  
*V cbllr.*, cerebellar fibers of trigeminus.  
*V g.*, ganglion trigemini.  
*V mes.*, radix mesencephalica trigemini.  
*V mot.*, motor root of trigeminus.  
*V mot. cr.*, decussating fibers of motor trigeminus.  
*V mot. nuc.*, motor nucleus of trigeminus.  
*V sens.*, sensory root of trigeminus.  
*VIII c.*, nervus cochlearis.  
*VIII vest.*, nervus vestibularis.  
*Ven.*, fourth ventricle.  
*v, w, x, y, z*, bundles of the motor root of the trigeminus.



LIST OF PAPERS CITED.

BECHTEREW.

1887. Ueber die Trigeminiwurzeln. *Neurolog. Centralb.*, 1887.  
 1899. Die Leitungsbahnen im Gehirn und Rückenmark. *Leipzig*, 1899.

BREGMAN.

1892. Ueber experimentelle aufsteigende Degeneration motorischer und sensibler Hirnnerven. *Jahrbücher f. Psychiatrie*, Vol. 11.

CAJAL.

1896. Beitrag zum Studium der Medulla Oblongata, des Kleinhirns und des Ursprungs der Gehirnnerven. *Leipzig*, 1896.

GOLGI.

1893. Intorno all' origine del quarto nervo cerebrale. *Atti della reale Accad. dei Lincei*, Ser. V, Vol. II.

HELD.

1893. Beiträge zur feineren Anatomie des Kleinhirns und des Hirnstammes. *Archiv f. Anat. und Entwickl.*, 1893.

HARRISON.

1901. Ueber die Histogenese des peripheren Nervensystems bei Salmo salar. *Archiv f. mikrosk. Anat. und Entwickl.*, Vol. 57.

JOHNSTON.

1900. The Giant Ganglion Cells of Catostomus and Coregonus. *Journal of Comparative Neurology*, Vol. 10.  
 1905. The Radix mesencephalica trigemini. The ganglion isthmi. *Anat. Anz.*, Vol. 27.  
 1906. The Nervous System of Vertebrates. *P. Blakiston's Sons & Co., Philadelphia.*

KÖLLIKER.

1896. Gewebelehre. 6te. Auflage, Vol. 2.

LUGARO.

1894. Sull' origine di alcuni nervi encefalici. *Archivio di ottalmologia*, Vol. 2.

MENDEL.

1888. Zur Lehre von der Hemiatrophia facialis. *Neurolog. Centralb.*, 1888.

MEYNERT.

1871. The Brain of Mammals. In Stricker's Handbuch der Lehre von den Geweben. American Translation. *Wm. Wood & Co., New York*, 1872.

PONIATOWSKY.

1892. Ueber die Trigeminiwurzel im Gehirn des Menschen nebst einigen vergleichend-anatomischen Bemerkungen. *Jahrbücher f. Psychiatrie*, Vol. 11.

RAMON.

1904. Origen del nervio masticador en las aves, reptiles y batracios. *Trabajos del lab. d. invest. biol. de la Univ. d. Madrid*, Vol. 3.

SABIN.

1901. An Atlas of the Medulla and Midbrain. *Friedenwald Company, Baltimore*, 1901.

SARGENT.

1904. The Optic Reflex Apparatus of Vertebrates for Short-circuit Transmission of Motor Reflexes through Reissner's Fiber; its Morphology, Ontogeny, Phylogeny and Function. *Bul. Mus. Comp. Zool.*, Vol. 45.

TELLO.

1909. Contribucion al conocimiento del encefalo de los teleosteos. Los nucleos bulbares. *Trabajos d. Lab. d. invest. biol. de la Univ. d. Madrid*, Vol. 7.

VAN GEHUCHTEN.

1895. De l'origine du pathétique et de la racine supérieure du trigumeau. *Bull. de l'Acad. Royale des Sciences de Belgique*. 3 Serie, Vol. 29.
- 1895 a. Les cellules de Rohon dans la moelle epinière et la moelle allongée de la truite (*trutta fario*). *Bruxelles*, 1895.
1897. Contribution à l'étude des cellules dorsales (Hinterzellen) de la moelle epinière des vertebres inferieurs. *Bruxelles*, 1897.

WALLENBERG.

1904. Neue Untersuchungen über den Hirnstamm der Taube. *Anat. Anzeiger*, Vol. 25.
1904. Nachtrag zu meinem Artikel über die cerebrale Trigeninuswurzel der Vögel. *Anat. Anzeiger*, Vol. 25.

A NEW ASSOCIATION FIBER TRACT IN THE  
CEREBRUM.

WITH REMARKS ON THE FIBER TRACT DISSECTION METHOD OF  
STUDYING THE BRAIN.

BY

E. J. CURRAN,

*Assistant in Anatomy, Medical School of Harvard University.*

WITH THREE PLATES.

In April and May, 1908, while as an undergraduate pursuing the elective course in advanced anatomy in the Harvard Medical School under Professor Dwight, I was repeatedly and agreeably surprised with the ease and accuracy with which many of the fiber tracts of the brain, the nuclei, and the deep origins of some of the nerves could be dissected by methods slightly modified from those employed in studying other parts of the body. Through the kindness of Professor Dwight and Dr. Warren, I was allowed to use a large number of brains for dissection, in the course of which new and impressive pictures of well-known structures were continually occurring. With such novelty and distinctness did these stand out that one not familiar with the original works of the early anatomists would almost be convinced that a new method of attacking the difficult problems of brain anatomy had been discovered. The attempt to follow fiber tracts by dissection seems to be the most natural method for investigation of the larger structures in the brain, and one that would be first thought of. So it is not surprising to learn that before the advent of the microscope, among the different methods of brain study attempted by our predecessors, fiber-tract dissection had a place, and many of the larger structures were displayed with considerable skill. With the introduction of the microscope, however, this method became neglected, and one cannot see in the text-books of to-day a single

example of a fiber tract dissection of any merit. Prof. J. B. Johnston,<sup>1</sup> University of Minnesota, published in November, 1908, an excellent paper on brain dissection in which is mapped out an elaborate course which he follows in teaching and in which anatomy is taught with reference to the function. In this paper the following of the tracts of known function is emphasized and dissection of some of the large bundles in the cerebrum is described. Recently Dr. Jamieson<sup>2</sup> published two beautiful dissections, and made an appeal for this kind of work as an adjunct to the section studies now so much used. I learned from this publication that he had been dissecting brains for the past four years. Professor Hove also has been successfully doing fiber tract dissection.<sup>3</sup> As to the reliability of the method, Dr. Jamieson says that he has never been obliged to abandon a tract as an artifact; and this has also been my experience. So reliable do I consider it that I have been using it as an adjunct in research work, and in the following pages I shall endeavor to convince the reader that not only may an adequate idea of well known structures be acquired, but that by the use of this method new tracts may be discovered which can finally be verified by the microscope, and more easily thus verified on account of their having first been dissected. Microscopic sections of such can be cut in the direction of the fibers, and this does not entail the work of following a large series of transverse or, as is more usually the case, oblique sections, which in an adult human brain must be so large and numerous that the danger of losing the continuity is always very great. I have used the dissection method in class this year, and am convinced that it makes the work of the teacher and that of the student much easier and, as compared with the section studies, renders demonstration of the essentials of brain anatomy perfectly simple.

#### METHODS.

To prepare the brain for dissection, any of the hardening fluids in general use will give good results; but I prefer a 10 per cent formalin solution injected through the carotid artery while the brain is *in situ*.

<sup>1</sup>*Anat. Record*, Nov., 1908.

<sup>2</sup>*Jour. of Anat. and Phys.*, April, 1909.

<sup>3</sup>*Anat. Record*, April, 1909, p. 247.

If we use a stronger solution the fibers will be firmer for dissection, but the nuclei will become bleached, and there will be no definite line of demarcation to distinguish the gray from the white matter. The brain should remain *in situ* for a day or two; this is a sufficient length of time to allow of hardening to such a degree as will enable it to retain its shape. It should then be removed and placed carefully in a 10 per cent solution of formalin for three weeks or a month. I have also obtained good results when the brain was taken out shortly after death and preserved in the above solution without carotid injection. In case of early removal, the fluid has time to penetrate to the center before softening takes place.

The only instrument necessary is a blunt pair of forceps which, when closed, are smooth and even at the edges where they meet. When such forceps are closed, they act as a blunt dissector. As well as separating fibers with the forceps thus arranged, it is sometimes necessary to lift bundles out of their places and to pull on them in order to ascertain the direction of their fibers. For this purpose the interlocking ridges should be fine and transverse in direction, to permit of a gentle but firm grip on small bundles of fibers without the danger of tearing or breaking them. Forceps with a few large sharp teeth at the end should not be used. When museum preparations are being made, a very sharp knife will be of use to cut off ragged ends and to trim the dissection. Too much trimming sometimes produces a dissection which, though finely finished, is less instructive than one which has not been trimmed at all. The latter shows the direction of the fibers, and any work that is to be done on it should not be such as would obscure this; otherwise the full value of the work would be lost.

In developing skill in this method, it is necessary to have an abundance of material at one's disposal. Almost every viewpoint revealed by dissection will be new, and the dissector will often be unwilling to proceed further with the dissection in hand, because in trying to show a deep set of structures he will have displayed a new and attractive view of another set, not originally intended, which perhaps lie more superficially than or close to the structures first intended to be shown. Although it may be desirable to save this

specimen, it must be destroyed in further proceeding to make the one first attempted. Consequently the best plan in such a case is to begin anew on another brain if there is plenty of material available. The fibers of the brain are so easily removed that one has to be continually on guard against proceeding too quickly and attempting to show too much at once. It is better to show a little in each dissection and to do a greater number to cover the ground. For this reason I recommend beginning at the cortex, studying the superficial fibers first, and making a series of dissections, each deeper than the preceding one, until the whole brain has been gone through. It is well to dwell upon some of the difficulties to be met with, and to say something of the methods which I use to overcome or diminish them. By careful observation during the dissection of over 200 brains, human and others, I was able to gather certain facts, and abstract with tolerable accuracy certain laws regarding the structure of the white matter of the brain, which have been of great use to me in my subsequent dissections. The chief difficulties are caused by intercrossings with other tracts. These intercrossings take place at various angles, and on this depends the degree of difficulty. The nearer to a right-angled crossing it is, the more difficult it will be to dissect. If the fibers are almost parallel—or merely interlocking at an acute angle—the tract can easily be followed, but if the angle at which they cross each other is much greater than this, it will be impossible to dissect them unless one tract is markedly larger than the other, or its fibers are in isolated bundles. When one tract is much smaller than the other, it becomes lost at the intercrossing and only the larger one can be followed. The intercrossing and intermixing of fibers from different systems is, for obvious reasons, greater near the cortex than is to be found deeper, consequently the superficial dissections and the terminals in the cortex of deep dissections are less certainly made out than deeper tracts themselves. I have also observed that fibers arising in adjacent convolutions or adjacent nuclei and going to a distance to be distributed to adjacent areas soon gather together and continue in a compact bundle, which is in some cases thoroughly isolated from the surrounding structures until near the points of distribution, when they spread out and proceed to their

different places of termination. Moreover, the more distant the areas united by these fibers, the deeper are they from the surface; and, conversely, the more superficial the fibers in the cortex are, the closer are the areas they unite. In other words, the long associating fibers lie deeply and the sort lie superficially. This is an important and a helpful law; for it enables us, when we meet a tract lying deeply, to say with tolerable certainty that it unites distant parts of the cortex or distant nuclei. A tract is more easily dissected if followed from the place where it appears as a separate bundle to its distribution in the cortex. Owing to the tendency of fibers to form into bundles in all long tracts there is a line of cleavage which, if found and followed, assists us to overcome the intercrossing difficulty which appears as we approach the cortex from within. A dissection hard or even impossible to do when started from one point will be easy when begun in another. If the difficulty of finding the right place in which to begin is appreciated, there will be less reason for disappointment at any failure to get the best results in the initial attempts. By considering for a moment the behavior of any substance having longitudinal fibers, such as an ordinary board, when subjected to the process of splitting we are able to glean some information which assists us in splitting, or separating, the white substance of the brain, which also has longitudinal fibers. If we take a piece of board, the grain of which is straight, and make a cut in the direction of the grain for a couple of inches along the board, but close to the edge so that the strip will be narrow, and then with our fingers separate the strip, we shall find that by the time we have pulled it asunder for a couple of feet the strip is much narrower than when we began, the split not having continued exactly in the grain of the wood. If, on the other hand, we start the split in the middle of the end of the board and then tear it asunder, we shall find that the board is split in the grain of the wood. Here the resultant of the applied forces is acting in the right direction, and there is no tendency, as in the former case of the small strip, for one side to bend and the other to remain straight and thus allow the bend to be continually breaking off fibers from the smaller until the strip becomes narrow, and, if we proceed far enough, tapers out

to a sharp point. If there were no bend in the small strip it would split in its natural line of cleavage along the course of its fibers. We can correct the curve by applying our forces at a point very close to the separating part and keeping them close all the way down the board. The above are simple facts known to everybody, and what I wish to impress upon the reader is that the laws hold good when applied to brain dissection. The brain dissection which I advocate is an application of these laws. We must find the line of cleavage and properly apply the forces so that there will be an equal pressure and equal resistance on each side, and the fibers will not be forced into a false separation by breakage. Of course we know that if there are intercrossing fibers which run singly or in very fine bundles, there must be a certain amount of breakage. This cannot be avoided, but our purpose in gross dissection is to arrive at a knowledge of the macroscopic anatomy with a view of helping the microscope, and also for practical surgical purposes. If we know that there is a large bundle running from one place to another, even though we are not aware of its function, we do at least know that it is important on account of its size, and we assume that it must be doing some great and necessary work.

If we wish to dissect deep structures at once, it is best to shell off the superficial fibers with our fingers. For this we must use a pair of thin rubber gloves so that we may not injure the deeper structures with our nails. Those superficial fibers which are less easily shelled off will be found to be connected with deeper structures in well defined bundles. In this shelling also it is important to keep constantly in mind the knowledge which we gain in consideration of the simple process of splitting wood, referred to above. Finally, when we have dissected a number of brains and have compared the microscopic findings with the dissected fibers, we gain a very accurate knowledge of the texture and behavior of brain substance which goes with its microscopic appearance. It will not be convenient for us to make a microscopic preparation of everything we dissect, but we may have access to such things already made, and by this comparison be able to tell almost exactly what some of its predominating microscopic characters are without microscopic examination.



It was my intention at the outset in writing this paper merely to report the discovery of a new or hitherto undescribed tract in the cerebrum, but since the chief method of investigation used in this research is not well known, I thought it desirable to delay the reader with the foregoing description. It was in the practice of this method while applying it to well-known structures in order to obtain a more perfect knowledge of them that I frequently found a long associating bundle of fibres uniting the occipital lobe with the frontal, and taking a course to the external side, and very close to the base of the lenticular nucleus, and in immediate relation with the anterior commissure as it enters the temporal lobe. At first I was not inclined to consider it as uniting the occipital with the frontal lobe, and thought that it probably belonged to the lower horizontal fibers of the external capsule. Subsequent investigation disproved this and brought out its true nature—that of continuous fibers uninterrupted by nuclei at any place in its course. All the fibers of the external capsule can be traced in gross dissection to their origin with perfect distinctness, and there can be no false continuity of fibers because they break off easily about their nuclei and the breaking off corresponds with what one would expect from the microscopic appearance. The fasciculus occipito-frontalis described by Dejerine<sup>4</sup> and others takes a course widely different from that of this bundle. Although authorities differ as to its exact location, all agree that as it passes from the front to the back of the brain it is in immediate relation with the corona radiata about or above the level of the highest point of the lenticular nucleus. Some say that its fibers are among those of the fasc. arcuatus (superior longitudinal bundle), which lies well above the lenticular nucleus and to the external side of the corona radiata; while others place it to the inner side, in close relation with the caudate nucleus (Forel). No one has ever suggested that it takes a course below these points. I have been unable to convince myself that it exists as a continuous bundle in any of the positions mentioned. However, since the fasciculus which I am about to describe lies, throughout the greater part of its course, in the deep white matter of the temporal lobe, swinging well below the thickest

<sup>4</sup>Anatomie des Centres Nerveux, 1905.

part of the base of the claustrum, and very near the base of the lenticular nucleus, as it passes over to the frontal lobe, I shall refer to it in this paper as the fasciculus occipito-frontalis *inferior*, or briefly as the fasciculus.

The fasciculus occipito-frontalis inferior is a large associating bundle of fibers uniting, as its name indicates, the occipital with the frontal lobe. It also contains fibers which join the frontal lobe with the posterior part of the temporal and parietal lobes. While the greatest number of its fibers proceed directly to the occipital lobe and can be there recognized as a more or less distinct bundle, yet before it has reached this lobe a number of its fibers have turned off and terminated in the cortex of the posterior part of the temporal lobe and also in a small portion of the posterior part of the parietal lobe. From all parts of the frontal lobe the fibers of this fasciculus can be traced converging to a single bundle which swings round the lower external side of the nucleus lentiformis, at which place it appears as a distinct bundle, the cross section of which has an area of about one fourth inch or more. It proceeds for a short distance as a distinct and almost round bundle, and again spreads out to a fan shape as it approaches and enters the occipital lobe. Its lower fibers sweep round so as to embrace the posterior horn of the lateral ventricle, as shown in Plate II, Fig. 4, and more distinctly in Fig. 3 (F. o. f. i.<sup>2</sup>). From the anterior extremity of the island of Reil to the end of the posterior horn of the lateral ventricle the fasciculus occipito-frontalis inferior has certain definite and well-marked relations with the surrounding structures which must be referred to in order that we may understand its exact position. At the outset I would emphasize the fact that as it swings to the lower external side of the lenticular nucleus and the external capsule it stands out with striking distinctness and is at once recognized as a separate bundle isolated from the surrounding structures by the directness and compactness of its fibers. I have stated in my description of the methods employed in this work, the law that when fibers from adjacent parts are proceeding to distant adjacent parts, they tend to gather together to form a bundle and thus proceed as far as possible before spreading out to their point of distribution. At the place in question—low

down on the external side of the lenticular nucleus—the compact bundle is seen distinctly in all the dissections, Plates I and II. Since this is the place in which it is most marked as a separate tract, I shall begin a somewhat detailed description of it here. The dissections are self-explanatory, and it is only necessary to mention the structures in direct relation with the fasciculus. If we turn to Figs. 1 and 2 we can see that the whole of the middle and posterior parts of the fasciculus uncinatus lie below the fasciculus occipito-frontalis inferior. The upper part of the fasciculus uncinatus has been removed so that we may be able to see the lower part of the fasciculus occipito-frontalis inferior. In Fig. 3, the fasciculus uncinatus has been wholly removed to show more thoroughly the other structures which form the bed on which the fasciculus occipito-frontalis inferior lies at this position. The picture is not an exact lateral view. The cerebellar end is raised so that the photograph would show part of the under surface of the lenticular nucleus and the relation of the anterior commissure. It will be noticed that the anterior commissure turns up and enters the temporal lobe (Ant. C<sup>1</sup> and C<sup>2</sup>) where its fibers spread out and mingle with the temporal part of the corona radiata. This is shown in Figs. 3 and 4 and is present but not clearly seen in Fig. 2. These two systems, the corona and anterior commissure, together with part of the fasciculus uncinatus, which is removed in Fig. 3, but shown in Fig. 2, form the bed on which this part of the fasciculus occipito-frontalis inferior rests. This bed is supported by the roof of the descending horn of the lateral ventricle (Roof desc. h. Fig. 3) which consists, on its upper surface, of the fibers from the temporal part of the corona radiata; then from above down those from the tapetum, from the stria semicircularis, and from the tail of the nucleus caudatus. Near the end of the temporal lobe the amygdaloid nucleus with its great radiation to the cortex—the fasc. amygdalo-temporalis (F. a. t., Fig. 2) lie under the temporal part of the corona radiata.

The posterior part of the bed of the fasciculus occipito-frontalis inferior, behind the posterior end of the lenticular nucleus, is made up of the following structures from above downward:—optic radiation, tapetum, and the ependyma of the post. horn of the lat. ventricle. This holds good all the way back, from the posterior end

of the lenticular nucleus to the end of the posterior horn of the lateral ventricle. About the anterior third of the posterior horn, and still further back, there is a great intercrossing with the fibers of the optic radiation, tapetum, and others. Indeed, throughout the whole posterior end there is, to some extent, intercrossing of fibers.

It is desirable to keep in mind that the structures constituting the bed enter into the formation of the roof of the posterior and descending horns of the lateral ventricle with which they are thus in close relation. The hippocampus major, being in floor of the descending horn, has a close relation to the bed. The cut edge of the hippocampus major is shown in Fig. 3. Winding round and embracing the whole of the posterior part of these structures are many fibers of the fasciculus occipito-frontalis inferior, which are shown so well in Figs. 3 and 4 (F. o. f. i.<sup>2</sup>). The choroid plexus, not shown in Fig. 3 owing to the view-point from which it was taken, but present in the dissection from which the photograph was taken, lies above the hippocampus major (Fig. 3) in close relation with the fibers as they begin to wind under the lateral ventricle from the external aspect.

Having described the bed on which the fasciculus occipito-frontalis inferior lies, it now remains for me to point out the internal, external, and superior relations about the island of Reil, and the external relations throughout the remainder of its course. It has been mentioned that the lower fibers of the fasciculus were partly hidden by the uncinata fasciculus (see Fig. 2). The gray matter of the cortex of the island of Reil, and the extreme capsule lie on the external side of it. The base of the claustrum rested, as it were, on this part of the fasciculus occipito-frontalis inferior, in the shadow (Fig. 2) immediately above the bundle. Most of the fibers of the external capsule begin about this place, arising as they do from the claustrum and basal grey. The deepest layer of the external capsule is very thin in this place and begins lower down under the fasciculus, separating it from the lenticular nucleus throughout the region of the island of Reil. This layer and the rest of the external capsule has been removed in Fig. 3, to show the close relationship of the fasciculus to the lenticular nucleus. As regards its relations with

other white matter as it enters the frontal lobe, there is little to be said beyond the fact that it is soon lost in intercrossing with the internal and external capsules, corona radiata, etc. It is distributed largely to the external side of the frontal lobe, and to Broca's area.

The posterior part of the fasciculus (from the posterior end of the lenticular nucleus to the occipital pole) has, in immediate relationship with it, fibers from the superior temporal convolution. These are to be seen in Fig. 2 (F. o. t.) and in Fig. 3 streaming backward from the white substance of the superior temporal lobe. They constitute a broad flat band leaving the sup. temp. convolution by way of the posterior surface of its medullary substance throughout its whole length. They are the first long associating fibers met after removing the short ones which connect the superior with the middle convolution. I do not identify it with the fasc. longitudinalis infr., for this is shown in many of the text-books lower down, and for descriptive purpose in this paper it is referred to as the fasciculus occipito-temporalis. In Fig. 1 it has been removed to show the fasc. occ. front. inf. passing under the fasc. arcuatus. The fibers of the fasc. occ. temp. run for a short distance two or three centimetres before mixing with the fasc. occ. front. infr. and the optic radiation. On the outer side, and lower down, not shown in any of the pictures, lies the inferior longitudinal bundle, some of the fibers of which far back in the occipital lobe intercross with the fasciculus. Lying immediately over this fan-like spreading of the fasciculus occipito-frontalis inferior and the other fibers running above it in the same direction, which have already been described and are shown in the pictures, are the arcuate bundles and the fasc. trans. occ. (F. trans. o., Fig. 2). The former, as previously pointed out, are joined by very large bundles of the corpus callosum on their way to the cortex. They make up the greater part of the medullary substance of the superior and middle temp. convolutions and much of the inferior. In order to get into the sup. and mid. temp. convolutions the fasc. arcuatus (F. arc.<sup>2</sup>, Fig. 1) divides into anterior (F. arc.<sup>1</sup>, Fig. 1) and posterior (F. arc.<sup>3</sup> and F. arc.<sup>4</sup>, Fig. 1) branches. Besides these two branches a number of fibers continue directly backward and end in the parietal lobe about the angular gyrus and the superior end of

the mid. temp. convolution. These are to be seen in the dissection, Fig. 1. Both this and the posterior descending branch are closely associated posteriorly with the fasc. trans. occ., some of which enters the mid. temp. convolutions with some of the shorter transverse vertical association fibers belonging to the angular gyrus and the anterior part of the occipital lobe. The fasc. trans. occ. is very striking in its appearance, size, and complete isolation from the longitudinal fibers under it, among which is the fasciculus occipito-frontalis inferior. It is easily dissected as a broad vertical bundle about half an inch in depth and extending in width from the pole of the occipital lobe to the arcuate fibers. In Fig. 1, 2, and 3 the middle part of it is removed to show more completely the fasc. occ. front. inferior. The fibers are at right angles to the fibers of the fasciculus occipito-frontalis inferior, and to the optic radiation. They are separated from the fasciculus by a thin layer of neuroglia which is apparent to the naked eye. It is nearly 1 mm. in depth. There is no difficulty in recognizing this soft spongy substance in dissecting this region, and when we meet it we know that the next structure to be revealed is the fasciculus occipito-frontalis inferior intermixing with the optic radiation and the fasc. occ. temp.

The fasciculus occipito-frontalis inferior is pierced at its lower edge by fibers from the tapetum, as is shown in Fig. 1. Excepting this, there is little intercrossing of transverse fibers with it along the greater part of its course, which is well shown in Figs. 1 and 2 at various intervals peeping from behind other structures or exposed throughout the whole of its course as seen in Fig. 4.

In all these dissections a great part of the whole of the temporal lobe, and some of each of the other lobes, are removed and the brain, as dissected, presents a new and unusual picture which may not be readily understood at first glance. I have supplemented these dissections with cross sections of a brain cut as indicated at A, B, C (Fig. 8). The position of the fasciculus in each of the three sections (Figs. 5, 6, and 7) with its chief relations at those points, is indicated. There is also a diagrammatic representation of its course shown in the outline drawing, Fig. 8.



PLATE I.\*

FIG. 1.

This is a photograph from a dissection made to show the general course of fasciculus occipito-frontalis inferior from the lateral aspect of the brain. F. o. f. i.<sup>1</sup>, F. o. f. i.<sup>2</sup>, F. o. f. i.<sup>3</sup>, F. o. f. i.<sup>4</sup>, fasciculus occipito-frontalis inferior; F. unc., fasciculus uncinatus; F. Rol., fissure of Rolando; Ext. c., external capsule, with window cut in it to show Nuc. lent., nucleus lentiformis, and arteries to same; F. arc.<sup>2</sup>, fasciculus arcuatus (horizontal part); F. arc.<sup>1</sup> ant. br., anterior bundles from descending branch of fasc. arc.; F. arc.<sup>3</sup> post. br. and F. arc.<sup>4</sup> post. br., posterior descending branch of fasc. arc. Fibers from c. c., fibers from corpus callosum chiefly, but some arcuate fibers with them. The white substance of superior temporal lobe in the upper portion consists of fibers from the fasciculus arcuatus, internal capsule, external capsule, and corpus callosum. Fibers from tap., fibers from the tapetum perforating the corona rad. and the Fasc. o. f. inf. to proceed to the end of the temp. lobe. F. trans. o., a posterior part of the fasc. transversus occipitalis. In this dissection most of this bundle is removed showing a large window through which the fasc. o. f. inf. can be seen. At the anterior of this window a small part of the fasc. trans. occ. still remains.

FIG. 2.

This is a photograph of a dissection from the lateral aspect, made to show the anatomical relationship of the fasciculus occipito-frontalis inferior to adjacent anatomical structures. Occ. lobe, occipital lobe; F. o. f. i.<sup>1</sup>, F. o. f. i.<sup>2</sup>, F. o. f. i.<sup>3</sup>, F. o. f. i.<sup>4</sup>, fasciculus occipito-frontalis inferior; F. trans. o., a large bundle of fibers, the posterior part of which belongs to the vertical transverse occipital fasciculus and the anterior part belongs to the fasc. arcuatus plus a considerable quantity from the corpus callosum; F. o. t., fasciculus occ.-temporalis sweeping back from the white substance of the sup. temp. convolution; Ext. c., external capsule; Nuc. lent., nucleus lentiformis showing through a window in external capsule; P. of opt. thal., pulvinar of opt. thalamus, also showing under and in front of it are the geniculate bodies and the crus; Cna. (t. pt.), the broken edge of the temporal part of the corona radiata lying on the descending fibers of the tapetum, stria semicircularis and the tail of the caudate nucleus which latter does not show well in this picture; F. a. t., fasc. amygdalo-temporalis; F. u., fasc. uncinatus.

\*The dissections from which the photographs (Figs. 1, 2, 3 and 4) were made are now to be seen in the Warren Museum, Harvard Medical School.



E. J. CURRAN.

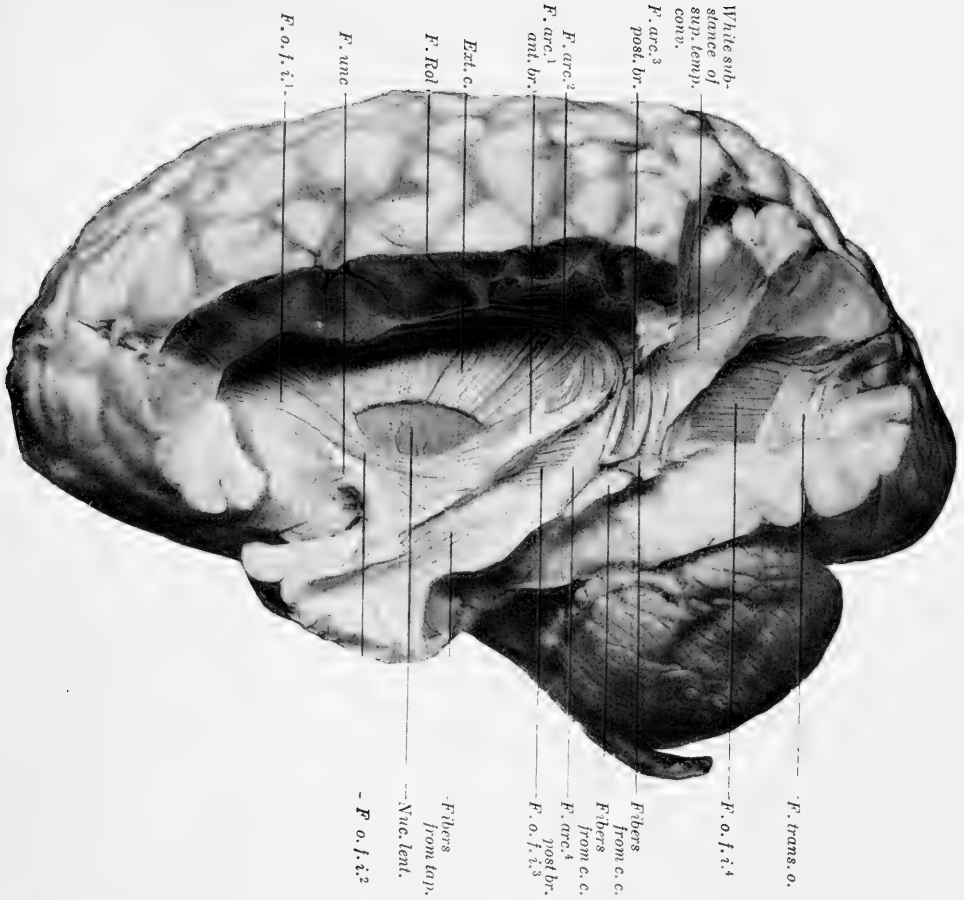

FIG. 1.

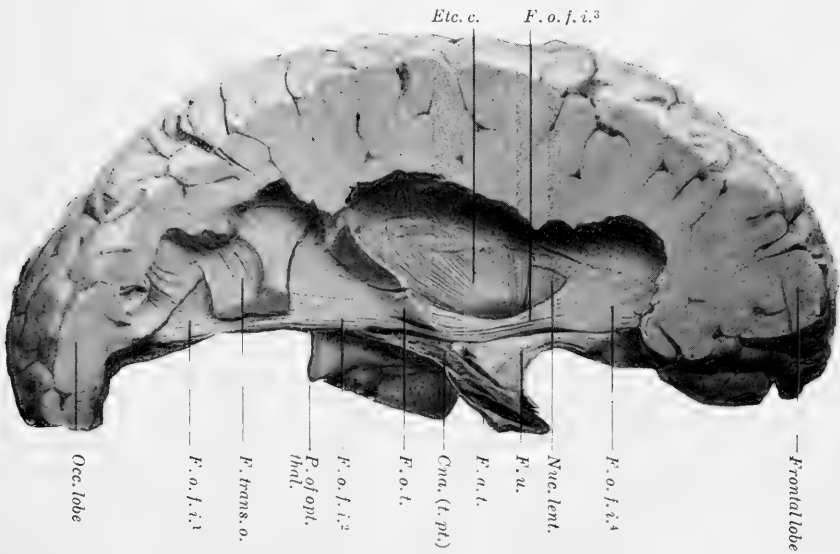

FIG. 2.





## PLATE II.

FIG. 3.

Photograph of a dissection of the brain, from the lateral aspect. Occ. lobe, occipital lobe. F. o. f. i.<sup>1</sup>, F. o. f. i.<sup>2</sup>, F. o. f. i.<sup>3</sup>, fasciculus occipito-frontalis inferior, cut before it reaches the frontal lobe. Nuc. lent., nucleus lentiformis. F. trans. o.<sup>1</sup>, F. trans. o.<sup>2</sup>, fasc. trans. occ., greater part removed to show the fibers of the fasciculus occipito-frontalis inferior at this place as it spreads over the posterior horn of the lateral ventricle. F. o. f. i.<sup>2</sup>, shows some of the fibers of the fasc. occip. front. inf. as they curve round the under surface of the posterior part of the descending horn of the lateral ventricle and the posterior horn itself, as they proceed to the under surface of the occipital pole. Hipp., cut edge of hippocampus major. F. arc.<sup>1</sup>, anterior descending branch of fasc. arcuatus entering the white substance of the sup. temp. convolution. F. arc.<sup>2</sup>, fasc. arcuatus (horizontal part). L. g. b., lateral geniculate body. Cua., corona radiata, temporal part. Corona, corona radiata to frontal lobe. Ant. c.<sup>1</sup>, ant. c.<sup>2</sup>, anterior commissure. Roof desc. h., roof of descending horn of lat. ventricle. The roof of desc. horn is made up of fibers of the thalamic radiation, the tapetum, stria semicircularis, and tail of the caudate nucleus. Ext. c., part of the ext. capsule left on the nuc. lentiformis.

FIG. 4.

Photograph of a rough dissection of the full course of fasc. occip. frontalis inf., F. o. f. i.<sup>1</sup>, and F. o. f. i.<sup>2</sup>, seen from the lateral aspect. The fasc. uncinatus has been removed, and also the descending branches of the fasc. arcuatus (F. arc.) have been cut off and dissected away, and the transverse vertical occipital associating bundle has been removed. Ext. cap., external capsule. Opt. tr., optic tract. Ant. c.<sup>2</sup>, broken edge of anterior commissure as it spreads out into the temporal lobe. Corp. alb., corpus albicans. Cr., crus cerebri. Cua., edge of the temporal part of corona radiata.

E. J. CURRAN.

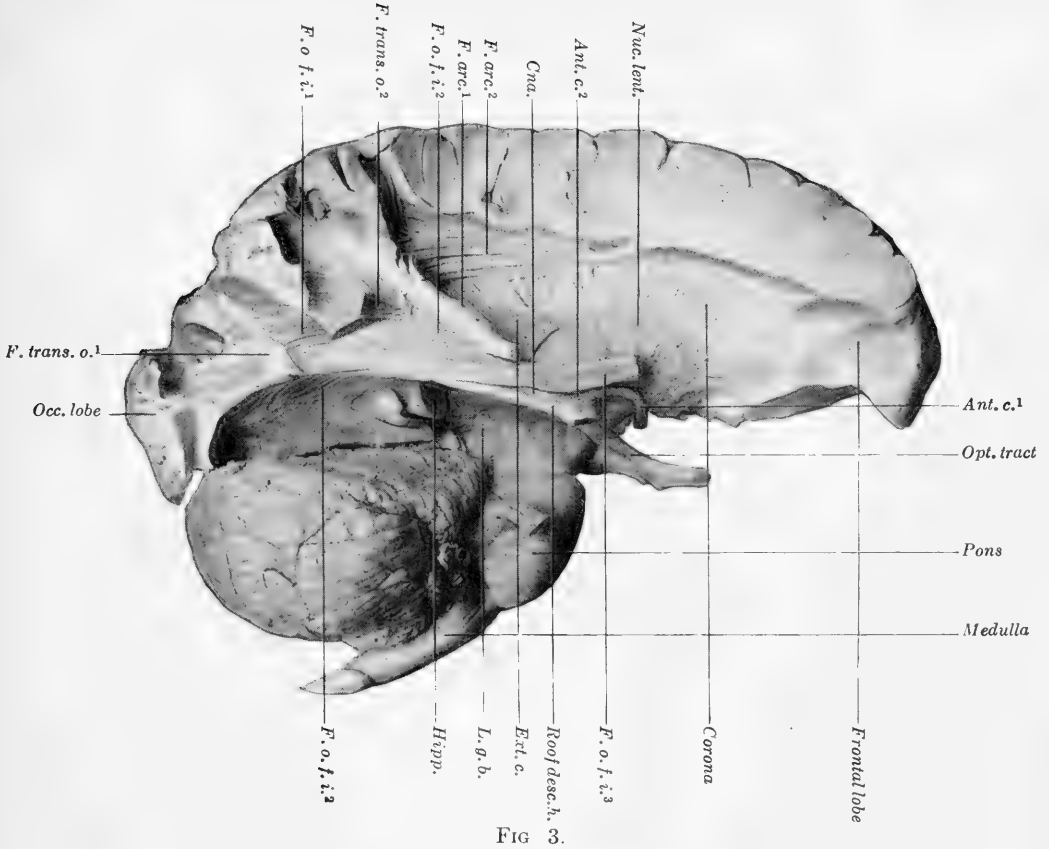

FIG 3

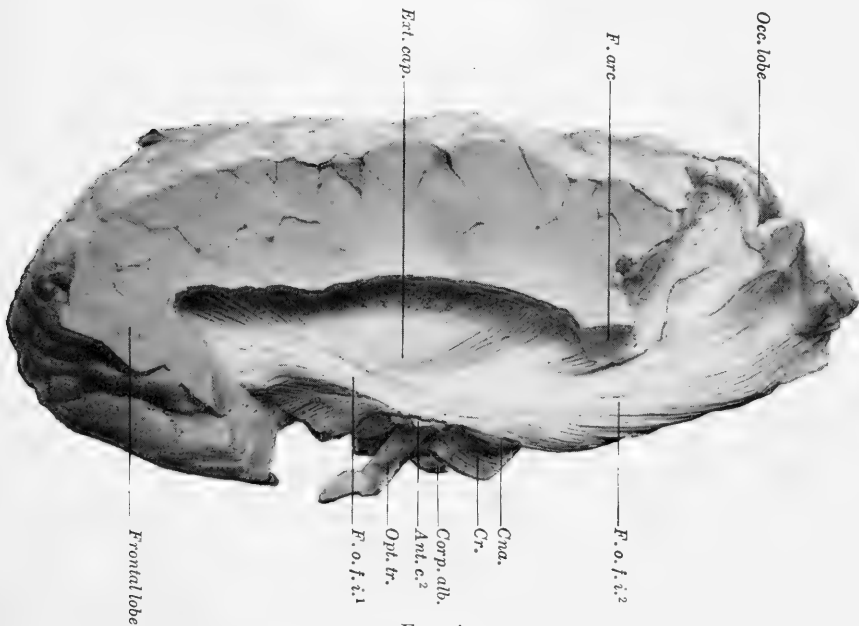

FIG. 4.





### PLATE III.

#### FIG. 5.

A drawing of a transverse section of a brain cut in line A, Fig. 8, to show the position of the fasc. occip. frontalis inf. and other structures in relationship with it. The index lines explain the drawing.

#### FIG. 6.

A drawing of a section cut at position of line B, Fig. 8, showing the fasc. occ. front. inf. in relation with other structures in the cross section. N. r., nucleus ruber. S. n., substantia nigra. L. v., lateral ventricle. N. l., nucleus lentiformis. Other abbreviations in the plate explain themselves.

#### FIG. 7.

A drawing of a section in the line C, Fig. 8, showing relation of the fasc. occip. frontalis infr. to the posterior horn of lateral ventricle and surrounding structures. The position of the fasc. o. f. i. and optic radiation are not shown as intercrossing, but it must be understood that a great deal of intermixing of fibers takes place here which cannot be represented in the drawing.

#### FIG. 8.

This is a rough drawing of the outlines of the brain from which the preceding cross sections were made, the exact positions of which are shown by the lines A, B and C. The dotted lines from the frontal to the occipital lobe represent diagrammatically the course of the fibers of the fasciculus occipito-frontalis inferior.



E. J. CURRAN.

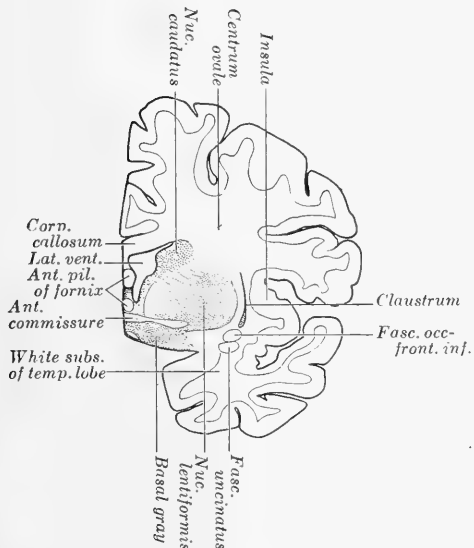

FIG. 5.

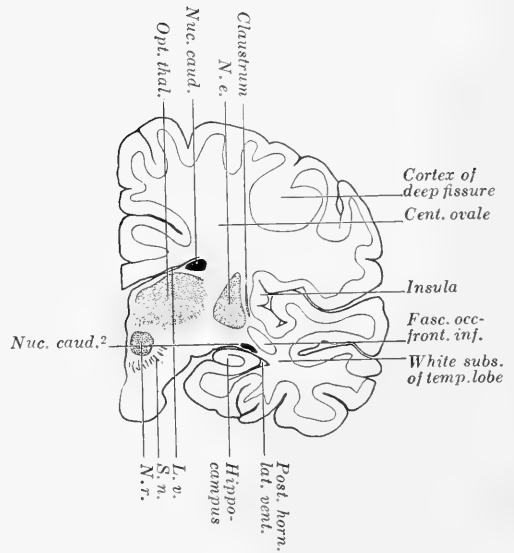

FIG. 6.

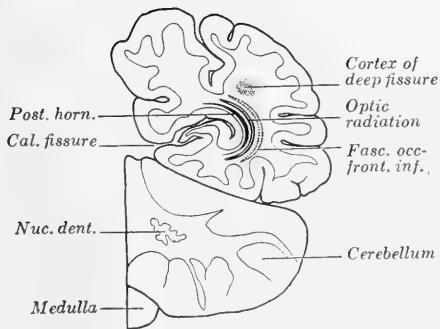

FIG. 7.

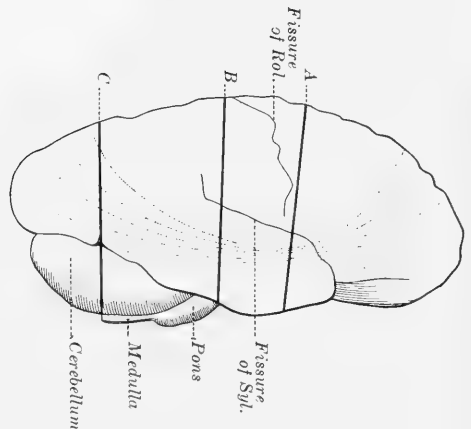

FIG. 8.



## VISUAL DISCRIMINATION IN RACCOONS.

BY

L. W. COLE AND F. M. LONG.

WITH ONE FIGURE.

In a former paper concerning the behavior of raccoons certain discriminations which they made between two colored objects which differed both in color and brightness were described.<sup>1</sup> These were purely sensory discriminations (*i. e.*, an added motor factor which the animals later spontaneously contributed to the experiment was not an essential feature of it). We wished, if possible, to ascertain, further, whether these animals can discriminate colors of equal brightness, and some months after the above mentioned paper was published we began at the University of Oklahoma the experiments here described. The work was completed at Harvard University. The method used was that of employing reflected light under conditions of daylight illumination.

In using this method we at first adopted the procedure which Kinnaman had used in investigating the color vision of monkeys.<sup>2</sup> Later this procedure was modified in order to adapt it for use with the raccoon. The method has been used, with varying details, in

<sup>1</sup>COLE, L. W. Concerning the intelligence of raccoons. *Jour. of Comp. Neur. and Psych.*, vol. 17, pp. 211-261. 1907.

<sup>2</sup>KINNAMAN, A. J. Mental life of two *Macacus rhesus* monkeys in captivity. *Amer. Jour. of Psych.*, vol. 13, pp. 98-148 and 173-216. 1902.

researches on the color vision of the dog by Himstedt and Nagel,<sup>3</sup> by Samojloff and Pheophilaktowa,<sup>4</sup> and by Orbeli.<sup>5</sup>

Since the results obtained by these workers are important, it seems desirable to give a brief account of their investigations. Nagel believes, because of the very common occurrence of protective coloration in animals, that ability to discriminate colors must be widely distributed in the animal kingdom.<sup>6</sup> He holds to this view especially in the case of birds and mammals.<sup>7</sup> Believing, then, that the negative results of Lubbock's experiments<sup>8</sup> were inconclusive,<sup>9</sup> Himstedt and Nagel proceeded as follows. They first taught a poodle to bring them a red ball (or rod) at the command "bring red." When the animal had learned to do this, balls of blue, of gray, and of other shades of red were added. From among these balls, the animal learned to bring a very bright red at the first command, at the second, strawberry red, then carmine, then, if no more reds were present, a bright orange colored ball, and finally, if he was still commanded to bring red, he would select a ball covered with Bismarck-brown of a distinctly reddish hue. Thus the animal seemed to discriminate red and its similars (for us), from other colors, and from grays. Later, Himstedt extended the training to other colors, with a like result.

Samojloff and Pheophilaktowa pursued the following plan. They first pasted a disk of green paper on the front of a small box in which they placed a small bit of food. The dog was taught to get the food

<sup>3</sup>HIMSTEDT, F., and NAGEL, W. A. Versuche über die Reizwirkung verschiedener Strahlenarten auf Menschen- und Tieraugen. *Festschrift der Albrecht-Ludwigs-Universität in Freiburg.* 1902.

<sup>4</sup>SAMOJLOFF, A., und PHEOPHILAKTOWA, A. Ueber die Farbenwahrnehmung beim Hunde. *Zent. f. Physiol.*, Bd. 21, S. 133. 1907.

<sup>5</sup>YERKES, R. M., and MORGULIS, SERGIUS. The method of Pawlow in animal psychology. *Psych. Bull.*, vol. 6, pp. 257-273. 1909. This review includes a synopsis of the dissertation of Orbeli. ORBELI, L. A. Conditioned reflexes resulting from optical stimulation of the dog. Dissertation. *St. Petersburg.* 1908. (Russian.)

<sup>6</sup>NAGEL, W. A. Der Farbensinn der Tiere. S. 5. 1901.

<sup>7</sup>S. 14.

<sup>8</sup>LUBBOCK, J. On the senses, instincts and intelligence of animals, p. 277. 1888.

<sup>9</sup>NAGEL, W. A. Der Farbensinn der Tiere. S. 19-29. 1901.

from this box. Next they placed beside the first box two others like it except that they bore disks cut from Nendel's series of gray papers. In order to get the food the dog must now discriminate the green disk from the gray ones. At first the lightest grays were used. Nos. 1 and 2, then the darker ones in order up to No. 50. In the first series of 613 trials the dog made, on the average, 30 per cent of mistakes, while in the second series of 560 trials this was reduced to 10 per cent. In the first series, grays No. 17 and No. 18 were so often confused with the green that the investigators at first thought the dog was quite unable to make the discrimination. It was also only after much training that he was able to distinguish the dark gray from the green. So slow was his progress in learning that Samojloff and Pheophilaktowa changed the question whether the dog discriminates colors, to the question whether he can, after much practice, be brought to do so. From the evidence of their records they answer this question in the affirmative, but apparently not with perfect confidence.

Orbeli used the salivary reflex method of Pawlow. By this method, after the presentation of a particular stimulus has been repeatedly accompanied by the act of feeding the dog, the presence of the stimulus will cause a secretion of saliva. The amount of the secretion and, to a less extent, its degree of viscosity, serve to indicate the intensity of the stimulation.

By means of a projecting lantern, visual stimuli were thrown on a screen in front of the dog. Thus the animal's perception of form, size, movement, brightness and color was tested. Images of various colors (red, yellow, green, blue and violet) were received on the screen.

As to color vision, Orbeli derives the following conclusion from the results of his experiments. "A study of conditioned salivary reflexes furnishes no indication that rays of light of different wave-length are received as distinct stimuli by the eye of the dog. Conditioned salivary reflexes are always determined by changes in the intensity of light independently of its composition" (quality).

Samojloff and Pheophilaktowa set out to answer two questions, namely, (1) whether the dog discriminates colored from equally bright gray objects, and (2) whether he discriminates equally bright

but differently colored objects. They seem to have answered only the first question (as restated above). Our experiments sought for an answer to the second question in the case of the raccoon.

The objects which were presented to the raccoons to discriminate were thirty-nine of the Milton Bradley colored papers and five of the Hering gray papers of equal (and nearly equal) brightness with certain groups of the colors, as determined by Rood's flicker method.<sup>10</sup> According to their respective brightnesses, these forty-four papers were divided into six groups of six each, one group of five, and three papers of equal brightness with three others were substituted for the latter during a part of the experiments recorded in Table 14. The flicker method as employed by Rood is inexact from the standpoint of human psychology, yet the flicker principle is being employed increasingly in color photometry.<sup>11</sup>

Our thanks are due to Professor Titchener for retesting for us by the flicker method the first group of colored papers selected and for valuable suggestions with regard to them. We are also indebted to Professor Yerkes for criticism and assistance.

In order to select our groups of colored papers, we first made fifty Maxwell disks from the successive grays of the Hering series, then ninety disks from the standard colors, the tints, and the shades of the Bradley series. We then selected one of the gray disks, *e. g.*, No. 5, and, under a high illumination of diffused daylight, we combined it with an equal area of each of the colored disks in order. The color mixer was made to rotate thirty-three and six-tenths times per second. The observer faced this compound disk of equal parts of the gray and the color at a distance of one meter. If, at this rate of rotation and in this illumination, a colored disk gave no flicker perceptible to either of two observers it was assumed to be of equal brightness with the gray. We attempted further to reduce any difference of brightness by testing the raccoons under a *much lower illumination* than that under which we selected the colors. The colored papers thus selected were afterwards compared as to amount

<sup>10</sup>Rood, O. N. On a color system. *Amer. Jour. of Sci.*, vol. 44, pp. 263-270. 1892.

<sup>11</sup>TITCHENER, E. B. *Exp. Psych.*, vol. 2, Pt. 2, p. 87. 1905.

of flicker with the grays just lighter and just darker than the one we were using as a standard.

After a group of colors corresponding to a certain gray had been selected the proportions of black and white in the gray were determined by comparing it with a composite disk of the Bradley black and white. This involved a comparison of a moving with a motionless disk of a different texture and doubtless our judgments here are not especially accurate. However, the figures which give the proportion of white in each gray disk serve merely as descriptive terms in Table 1 and have nothing to do with the experiments.

The tests of the colors by the flicker method were made in as high an illumination as the observers found at all practicable between the hours of ten A. M. and three P. M. on cloudless days. The experiments with the raccoons were conducted in a very much lower illumination but during the same hours. The papers, both gray and colored, had been in the laboratory about one year at the beginning of the tests. They were kept covered in the drawers of the paper case which, we may add, was not resorted to by students. It is evident from the notes of fading in Table 1 that some of the colors were not as dark as recently purchased papers. For example, violet shade 1, and red orange shade 2, which, on June 28th matched Gray No. 25, had faded by December 27th to match Gray No. 20 and, therefore, they appear in both groups.

After the brightness of the papers of Group 5 had been determined, they were sent to Professor Titchener in order to ascertain whether our use of the flicker method had been reasonably accurate. He wrote us as follows: "I have no objection, then, to your quoting me (if you care to do so) to the effect that by this method the first four disks were practically equivalent and the fifth only a little out of the way by being too bright." . . . "You may say, I think, that the animals judged these four by color alone, provided, of course, that we make the initial assumption that their scale of brightness values coincides with our own." The "first four disks" were violet-blue tint 2, orange-yellow shade 1, red-violet tint 1, and red-orange tint 1. Under the high illumination that we used, red-orange tint 1 gave a just noticeable sensation of flicker.

In the tables, we have given each group of papers the number of the gray in Hering's series which was used as a brightness standard in selecting the colored papers which constitute the group. There are twenty-one colors which gave no flicker, when rotated with their respective grays, twelve which gave a just noticeable flicker sensation, and six which gave an amount of flicker just noticeably greater than that of the twelve colors. In Table 1 these degrees of flicker are designated by the numerals 0, 1, and 2, respectively.

TABLE 1.

## BRIGHTNESS OF CERTAIN MILTON BRADLEY COLORED PAPERS AS DETERMINED BY ROOD'S FLICKER METHOD.

## GROUP 2.

*(December 27, 1907.)*

Hering's Gray Paper No. 2 = 81.5 per cent white.

Green-blue	.....tint 2.....	0
Yellow-green	.....tint 1.....	0
Orange-yellow	.....tint 1.....	0
Orange	.....tint 1.....	0
Green-orange	.....tint 1.....	1
Yellow-orange	.....tint 1.....	2

## GROUP 5.

*(June 28, 1907.)*

Hering's Gray Paper No. 5 = 44 per cent white.

Red-violet	.....tint 1.....	0
Violet-blue	.....tint 2.....	0
Orange-yellow	.....shade 1.....	0
Red-orange	.....tint 1.....	1
Violet	.....tint 2.....	2

## GROUP 10.

*(December 25, 1907.)*

Hering's Gray Paper No. 10 = 23 per cent white.

Blue-violet	.....	0
Green-blue	.....	0
Orange	.....shade 1.....	0
Yellow-green	.....shade 2.....	0
Red	.....tint 1.....	0
Yellow-orange	.....shade 2.....	1
Blue-green	.....shade 1.....	2
Red-violet	.....	2



GROUP 15.

(December 26, 1907.)

Hering's Gray Paper No. 15 = 15 per cent white.

Orange	.....	1
Red-orange	.....shade 1.....	1
Violet	.....	1
Green-blue	.....shade 1.....	2
Orange-red	.....	2

GROUP 20.

(December 27, 1907.)

Hering's Gray Paper No. 20 = 11.25 per cent white.

Violet	.....shade 1.....	0
Blue-violet	.....shade 1.....	0
Blue	.....	0
Violet-blue	.....	1
Red-orange	.....shade 2.....	1
Red-violet	.....shade 1.....	2

GROUP 25.

(June 28, 1907.)

Hering's Gray Paper No. 25 = 9.8 per cent white.

Blue-violet	.....shade 2.....	0
Violet-blue	.....shade 1.....	0
Blue	.....shade 1.....	0
Red-orange	.....shade 2.....	0 <sup>12</sup>
Violet	.....shade 1.....	0 <sup>12</sup>

GROUP 30.

(December 27, 1907.)

Hering's Gray Paper No. 30 = 7.75 per cent white.

Violet-red	.....shade 2.....	0
Green-blue	.....shade 2.....	1
Orange-red	.....shade 2.....	1
Red-violet	.....shade 2.....	2

After we had secured a series of colors of equal brightness, as determined by the flicker method, we covered each of five ordinary drinking glasses, or tumblers, with one of the colored papers of the series, and a sixth with the gray equal in brightness to the colors. These six glasses, thus covered, with differently colored papers, were to be

<sup>12</sup>Faded by December 26th almost to match gray No. 20.

presented to the animal simultaneously in order to determine whether he would learn to select the glass in which food was placed. Only two animals were used, as we had found in numerous earlier tests with four animals that they did not exhibit individual differences of behavior so pronounced as to invalidate general conclusions. These animals are designated by numbers as in the earlier paper.<sup>13</sup>

As a means of presenting the row of glasses to the animal, we first employed a board such as Kinnaman<sup>14</sup> had used in testing the color vision of monkeys, and Davis<sup>15</sup> afterwards employed for the same purpose with raccoons. In this board, 5 feet by 8 inches by 11¼ inches, round holes, eight inches apart, were sunk to the depth of one-half inch. Into these holes the bottoms of the glasses fitted closely. The position of the food glass on this board was changed after each trial.

This board was used by us on the floor for two days. On the third day we raised it four inches above the floor, and later ten inches above it. Thus raised on supports, we used it for the tests of the three following days. We give the results obtained with this piece of apparatus for each of the two raccoons during the six days. The average number of trials per day was 198. The colors of Group 5 were used and the food was placed in the glass covered with OYS 1. The percentages of right choices are given to the nearest integer.

TABLE 2.  
RACCOON No. 2.

Day.	1	2	3	4	5	6
RVT 1.....	27%	22%	21%	16%	14%	15%
VBT 2.....	19%	10%	16%	14%	14%	15%
OYS 1.....	18%	15%	17%	23%	24%	24%
ROT 1.....	18%	18%	12%	18%	15%	16%
VT 2.....	9%	20%	20%	12%	16%	13%
Gray 5.....	9%	15%	14%	17%	17%	17%

<sup>13</sup>COLE, L. W. Concerning the intelligence of raccoons. *Jour. Comp. Neur. and Psych.*, vol. 17, pp. 211-261. 1907.

<sup>14</sup>KINNAMAN, A. J. Mental life of the two *Macacus rhesus* monkeys in captivity. *Amer. Jour. of Psych.*, vol. 13, p. 139. 1902.

<sup>15</sup>DAVIS, H. B. The raccoon: a study in animal intelligence. *Amer. Jour. of Psych.*, vol. 18, p. 479. 1907.

TABLE 3.  
RACCOON No. 3.

Day.	1	2	3	4	5	6
RVT 1.....	9%	6%	25%	18%	10%	16%
VBT 2.....	37%	29%	11%	16%	9%	13%
OYS 1.....	27% <sup>16</sup>	20%	24%	23%	29%	23%
ROT 1.....	4%	11%	11%	12%	20%	19%
VT 2.....	9%	4%	12%	13%	18%	10%
Gray 5.....	14%	30%	17%	18%	14%	19%

It is evident from these tables that Raccoon No. 2 did select the food color more often than any other color after the first three days, and that No. 3 did the same on the third day and thereafter. Sixteen and two-thirds per cent would have been chance selection, yet an average of nearly twenty-four per cent persisted after the third day's practice with No. 2 and after the second day's practice with No. 3. Since this per cent continued during 700 trials, the fact must receive consideration, for this deviation from chance could not be maintained during so many trials except by some constantly operating cause.

The investigator who uses this apparatus, however, must assume that the animal's hunger will impel him to pass by every glass except the one in which food has been found in the preceding trials. This assumption certainly is not justified in the case of the raccoon, for the animal has a strong instinctive tendency to explore every opening it finds. An auger hole in the floor, the space beneath a chip, or an uneven board, the experimenter's pockets, cuff, or the bottom of his trousers' leg were all provocative of this reaction. The naturalists tell us that the raccoon secures his food by reaching into the holes of crawfish, getting minnows or insects from the water-filled tracks of cattle, and by catching the beetles and bugs which he finds under chips and pieces of bark in the forest. However this may be, we found that at first the raccoons could not pass by a single food container without both reaching into it and looking into it. Instead, the animal would go to one end of the row of vessels, explore the first

<sup>16</sup>This high per cent of right choices is doubtless accidental, as we had to discontinue work with this raccoon after twenty-two trials on this day.

one carefully by touch and sight, then the next, and so on until the vessel with food in it was found. It would then go on in the same way to the end of the row, and often back again, rarely skipping a single vessel. When, in the later trials, they made 24 per cent of right choices, they of course passed by some of the glasses which did not contain food.

Because of this instinctive propensity of the raccoon, it seemed plain to us that open feeding vessels would not serve satisfactorily to test the visual sense of this animal. We did not, however, leave the question to be decided by observation alone. For after having tested our animals by means of closed vessels for some time we returned, in the case of Raccoon No. 3, to the use of the Kinnaman apparatus to see whether the former type of numerical record would reappear.

Thus we have in the following tables, the record of this raccoon while learning to discriminate RVT 1 and, after his choices were nearly perfect with closed glasses, his record on the same colors with open glasses. The figures represent series of thirty trials each.

TABLE 4. <sup>17</sup> Closed Glasses.				TABLE 5. Open Glasses.						
RACCOON No. 3.				RACCOON No. 3.						
RVT 1.....	24	27	27	RVT 1.....	7	6	3	5	6	2
VBT 2.....	1		2	VBT 2.....	2	3	6	4	7	
OYS 1.....	3	1	1	OYS 1.....	6	7	9	4	3	4
ROT 1.....				ROT 1.....		4	2	9	7	4
VT 2.....	2	1		VT 2.....	6	4	8	8		11
Gray 5.....		1		Gray 5.....	9	6	2	7	7	9
Total.....	30	30	30	Total.....	30	30	30	30	30	30

It is evident from these records that open feeding vessels may actually obscure a discrimination habit which is fairly well established. Yerkes has shown, in the case of the crab, that a test which runs counter to a strong instinctive impulse is unsatisfactory.<sup>18</sup> As

<sup>17</sup>Food was placed in all the glasses after the first series of thirty trials and the food-glass was frequently exchanged for another of the same color in order that it might not become soiled by the animal's paws.

<sup>18</sup>YERKES, R. M. Habit formation in the green crab, *Carcinus granulatus*. *Biol. Bull.*, vol. 3, p. 241. 1902.

tests of raccoons with open feeding vessels seem to have just this defect, we devised the apparatus which is shown in Fig. 1.

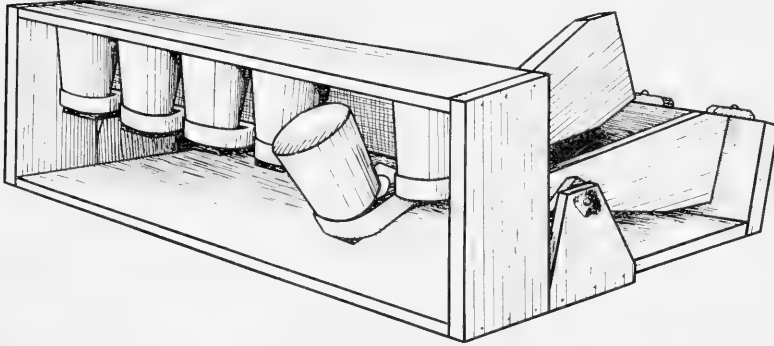

FIG. 1. Color discrimination apparatus.

In this device the feeding vessels were clamped up against the cross-board so that the animal must select the glass at which he pulled by its outside appearance only, and without being able either to reach into it or to look into it before it was selected. By means of the thumb buttons at the rear of the apparatus every glass, except the one containing food, was locked against the top board. A pull on this glass depressed the short arm of the lever and exposed the top of the glass. A pull, or even the slightest touch, on any other than the food glass was recorded as a wrong choice. When the animal had secured the food, he was removed to the other end of the room, while an assistant placed food in the glass and changed its position in the row of glasses. The changes of position were made at random, except when the animal had formed a habit of approaching one end of the row. In that case we sometimes avoided putting the food glass at that end, in order that it might not be the first glass approached.

On the first day that we used this apparatus, Raccoon No. 2 was given 171 trials, and he selected the food-glass 122 times, thus giving 71 per cent of right choices. The last thirty-seven choices were all correct. The next day, however, this animal made but 35 per cent of correct choices. (Our notes show that he was not hungry, and often touched no-food glasses in passing along the row.) Below is



Since Raccoon No. 3 learned to select the food container twenty-nine out of thirty times while No. 2 made series of thirty perfect choices, it is evident that the power to discriminate between the colored glasses was present. By what means the discrimination was made will be discussed later. From the beginning, we noticed that neither of the raccoons ever swerved toward the food-glass from a distance of even a foot. Instead the animal would come to the row of glasses, and then, with his nose close to them, he would go along the row until the food-glass was found. There was often very prompt recognition of this glass when the animal came close to it, *e. g.*, he sometimes came to the glass next to it, when, instead of looking at the latter, he seemed all at once to catch sight of the food-glass and would make a sudden grasp for it. In a very few cases, also, after the animal had almost or quite passed the food-glass, he suddenly seemed to recognize it, and turned back.

From the very beginning of the tests with closed glasses, we attempted, by means of control tests and various precautionary methods, to determine whether the raccoons were selecting the food-glass by smell or by sight. While these tests were interpolated at numerous places in the series of experiments, it will be clearer to group them together and discuss them later. Consequently we shall give here the records of the animals' learning to discriminate various food-glasses. These will appear in the order of the experiments, but the reader will remember that some of the control tests interrupted the series so that this order is not quite consecutive in time.

So far the animals have learned to select OYS 1. VBT 2 was next used as a food-color. Learning to select this glass involved, of course, ceasing to react positively to OYS 1. Hence Tables 8 and 9 show the unlearning of the reaction to OYS 1 and the learning to select VBT 2.

Using the same group of papers we next placed food in the glass covered with Gray 5, so that the animal was forced to select the gray from among the colored papers.

In the same series of papers, Group 5, we next taught the animals to select RVT 1. Raccoon No. 2 selected this color fourteen, twenty, twenty-four, and thirty times, respectively, in four series of thirty

TABLE 8.  
VBT 2 in Group 5.  
RACCOON No. 2.

Color.	First Day.					Second Day.				Third Day.					
RVT 1.....	5	8		1		1					2				
VBT 2.....	7	9	14	16	19	13	26	27	24		20	28	29	29	30
OYS 1.....	4	4	10	10	8	12	3	2	3		5	1			
ROT 1.....	9	2	4	2	2				1						
VT 2.....		4	2		1	1	1		1		1	1	1	1	
Gray 5.....	5	3		1		3		1	1		2				
Total.....	30	30	30	30	30	30	30	30	30		30	30	30	30	30

TABLE 9.  
VBT 2 in Group 5.  
RACCOON No. 3.

Color.	First Day.					Second Day.				Third Day.					
RVT 1.....	2	9	1	6	7		3	1	1		1		1	4	
VBT 2.....	7	11	8	11	17	13	24	22	19		23	26	26	16	26
OYS 1.....	10	3	16	3	3	6		5	6		2	2	2	5	
ROT 1.....	5	4	1	2	2	4	2		3		3	1			1
VT 2.....	3	3	4	3	1	4		1	1		1	1	1	4	1
Gray 5.....	3			5		3	1	1						1	2
Total.....	30	30	30	30	30	30	30	30	30		30	30	30	30	30

TABLE 10.

TABLE 11.

Color.	Gray 5 in Group 5. Raccoon No. 2. First Day.						Color.	Gray 5 in Group 5. Raccoon No. 3. First Day.							
RVT 1.....	1	3		1			RVT 1.....	2		3	1	1			
VBT 2.....	8	7	4	1	2		VBT 2.....	1	5						
OYS 1.....	10	2	4	1	2		OYS 1.....	8							
ROT 1.....	3	4	5				ROT 1.....	1		1	1	1			
VT 2.....	1	2	3	2			VT 2.....	3		1	1				
Gray 5.....	7	12	14	25	30	26	Gray 5.....	15	25	25	27	28			
Total.....	30	30	30	30	30	30	Total.....	30	30	30	30	30			



trials each. No. 3 selected it twenty-four, twenty-seven, and twenty-seven times in each of three series of thirty trials. Since No. 3 seemed now to have learned to distinguish RVT 1 as the food-color, we, at this point, returned to the use of Kinnaman's apparatus with the result shown in Table 4, page 666.

These tests completed our experiments with the papers of Group 5. From this group OYS 1, VBT 2, Gray 5, and RVT 1 were used to cover the glass in which food was placed. The raccoons readily learned to discriminate the food-glass from the others in each of these cases. The remaining two papers of this group, VT 2 and ROT 1 were not used as food-colors.

The animals were next tested on the remaining groups of Table 1 in the following order: Groups 25, 15, 10, 2, 20, and 30. Unless otherwise stated in the tables the tests were complete in one day's experiments.

TABLE 12.  
BS 1 in Group 25.

Color.	Raccoon No. 2.		Raccoon No. 3.		
BVS 2.....	2	1	3		
VBS 1.....	1		3		
BS 1.....	22	29	22	27	30
ROS 2.....	1		3		
VS 1.....	4		2		
Gray 25.....					
Total.....	30	30	30	30	30

TABLE 13.  
OS 2 in Group 15.

Color.	Raccoon No. 2.			Raccoon No. 3.	
OS 2.....	22	28	30	23	30
ROS 1....				3	
V.....	2			2	
GBS 1....	1			1	
OR.....	3	2		1	
Gray 15..	2				
Total..	30	30	30	30	30

TABLE 14.  
OS 1 in Group 10.

Color.	Raccoon No. 2.		Raccoon No. 3.	
BV <sup>19</sup> .....	3		1	1
GB <sup>19</sup> .....	1		10	2
OS 1.....	19	29	17	24
YOS 2.....			1	
BGS 1.....	5		2	
Gray 10 <sup>19</sup> .	2	1	1	1
Total....	30	30	30	30

TABLE 15.  
GBT 2 in Group 2.

Color.	Raccoon No. 2.					Raccoon No. 3.		
GBT 2.....	5	11	11	25	27	11	17	30
YGT 1.....	10	3	6	1	1	4	2	
OYT 1.....	3	1	1	2	1	5	3	
OT 2.....	4		4		1			
GYT 1....	4	8	4	1				
YOT 1.....	4	7	4	1		10	4	
Total....	30	30	30	30	30	30	30	30

<sup>19</sup> For a third test of thirty trials YGS 2, RT 1, and RV were substituted for BV, GB, and Gray 10. Both the animals selected YGS 2 twice, RT 1 once and the food color, OS 1, twenty-seven times.

It seems evident from a comparison of Table 15, with the preceding tables and with the following one, that light colors were most difficult for the animals to discriminate. If such is the case, the rather long time required to learn the series which matched Gray 5, is partly accounted for. Group 5 was the first one we tried, and some time was required for the animals to learn to operate the mechanism. As this was soon learned, however, our tables show that discriminations were more readily made among dark than among light colors.

TABLE 16.  
VS 1 in Group 20.

Color.	Raccoon No. 2.			Raccoon No. 3.		
VS 1.....	10	26	27	20	26	29
BVS 1.....	8	2		2	1	
B.....	2					
VB.....	2		1	2		
ROS 2.....	4	1	1	2	2	
RVS 1.....	4	1	1	4	1	1
Total...	30	30	30	30	30	30

TABLE 17.  
GBS 2 in Group 30.

Color.	Raccoon No. 2.			Raccoon No. 3.	
VRS 2...	3	1		1	L. 3
GBS 2...	17	27	29	29	14
ORS 2...	5	1			5
RVS 2...	5		1		5
Gray 30..		1			2
Total...	30	30	30	30	30

It seemed to us that No. 3 made most of his errors when he seemed to be looking at the colors with his left eye. Since his twenty-nine correct choices in the first thirty trials of the above series showed that he could discriminate the food-color, we compelled him to walk along the row of glasses from left to right in the second series of thirty trials. His correct choices were at once reduced to fourteen. Our suspicion that his left eye was defective arose from the fact that the animal, unless prevented from doing so, invariably went to the right end of the row of glasses, then along it to the left with his right eye thus nearest to the row. The above reduction in the number of his right choices, and our record of his earlier errors, indicate that his vision with the left eye was poor as compared with the right eye, and as compared with the vision of Raccoon No. 2.

The records above do not give all the training in discrimination of colored papers which was demanded of the raccoons, for some of the control tests required many trials. The tables do show, however, that

nine different colors and one gray have been selected by the raccoons from colors which were equally bright for the human eye. In all, thirty-nine different colors were used, and from these the ten food-colors had to be chosen. Up to this point, however, we cannot be sure that the selections were not made by the sense of smell.

*The Possibility of Selection by Odor Differences.* We have already stated that the raccoons never swerved toward the food-glass from a distance of one or two feet. In fact, they seemed to be unable to distinguish the food-glass from the others at a distance of more than four or five inches. Thus the animal's nose was always very close to the glasses and we were always confronted with the possibility that a keen sensitiveness to odors might account for the behavior we observed. The discrimination by smell might have come about in any one of three ways. (1) The animal might have detected the odor of food when near the glass which contained food. (2) He might, as it were, follow his own trail, and this might be done in either of two ways: (a) since the animal ate the food from his paws and also laid hold of the food-glass more than the others he might soon get an odor of food from the *outside* of the glass; (b) he might in a similar way detect the native odor of his paws as stronger on the food-glass than on the others, due to repeated pulling at the glass even though he did not communicate the odor of food to it. The last supposition while hardly probable is, nevertheless, possible. (3) The animal might be able to discriminate between the odors of the pigments of the colored papers.

With closed glasses the first possibility is easy to deal with. We used bread as food and often allowed it to become so dry that it had hardly any odor for us. In addition to this we put food in all the glasses, usually the same amount that we put in the food-glass, sometimes more than that glass contained. From the first day's work with closed vessels our rule was to put food in all of them during at least half of the trials. In a large part of the experiments, we put food in all at the beginning of the day's work. During a smaller portion of the time all the glasses contained food during the last thirty or sixty trials. In no case did this seem to modify either the animal's behavior or his record of discriminations.

Was the animal following his own trail? We first met this possible difficulty by providing for each set of colored glasses six food-glasses all of the same color. After five trials with one glass we removed it from the room and put a second one in its place. After five or six trials more, a third food-glass was used and so on. Had the animal been selecting the food-glass by any odor attached to it (except that of its pigment) this exchange of food-glasses should have confused him. It did not do so, and in the later experiments we changed the food-glass only every tenth trial. Again, if the animal were selecting the food-color by any odor except that of the pigment, he should learn to select a food-glass from a group, all of which were covered with the same color. On July 15th No. 2 was given a set of glasses covered with OYS 1, and he pulled at all of them. At the end of half an hour he had so scratched the yellow papers that the scratched places would soon have served as distinguishing marks. The result was the same with No. 3. He was tested with the six yellow glasses on the same day. We repeated such tests with the food-color of several later groups. We also filled the glass holder with tumblers, all of which were covered with Gray 5, and gave the animals opportunity for olfactory discrimination. In the first thirty trials Raccoon No. 2 made seventy-eight pulls at the glasses, eleven of which were at the food-glass, but in six of these eleven cases the food-glass was the first one to which the animal came. He passed by one of the glasses only nine times in the seventy-eight attempts. We restate these facts in the same order in the first line of Table 18.

These records show that the animals soon ceased to try to distinguish one glass from another and pulled blindly at almost all of them. By going but part way down the row and then returning to the point of beginning, it was possible for the animals to pull repeatedly at several of the glasses without coming to the one which contained food, and thus to make such records as those of the last series in each table. The failure of the animals in this experiment gives further evidence that they were not using smell in the color tests.

On continuing these experiments with No. 2, though he was very hungry, the large number of selections which yielded no food seemed, to a great extent, to inhibit the impulse to pull at the glasses.

We next varied the experiment by rubbing apple on the inside of the food-glass. Both the raccoons then very promptly learned to select it, but now we could often make out *distinct sniffing and the animals held the nose very close to the top of the glass as they had not done before*. This is doubtless the best evidence we have that odor was not a guide in the color tests. If the animal had to direct his nose to the top of the glasses in order to detect the odor of apple in a glass whose inner surface had been thoroughly rubbed with it, then any odor less strong

TABLE 18.  
Gray 5 in a Group of Gray 5.  
RACCOON No. 2.

No. of Series of 30 Trials each.	No. of Pulls.	No. of Pulls at Food-Glass.	Food Glass First One Reached.	Passed by Without Pulling.
1	78	11	6	9
2	63	16	6	25
3	60	18	9	22
4	141	6	4	8

TABLE 19.  
Gray 5 in a Group of Gray 5.  
RACCOON No. 3.

No. of Series of 30 Trials each.	No. of Pulls.	No. of Pulls at Food-Glass.	Food Glass First One Reached.	Passed by Without Pulling.
1	77	12	7	5
2	111	9	7	7
3	104	5	5	1
4	199	2	2	0

than this could have had no effect or else it surely would have elicited the same behavior. The same reaction was elicited by the use of meat and cake as food. The only odor not excluded by these experiments is that possibly due to the different pigments of the colored papers. True, the papers had been kept for some months in the same drawer, and the glasses were close together in the row, yet this only makes discrimination by the pigment odor improbable, not impossible.

In order to exclude this type of discrimination, we first placed the colored papers inside the glasses. We believed that this would so diminish the pigment odor, if it did exist, as to put it below the threshold of the animal. Or, if not, that it would so reduce the pigment odor that it would be completely eclipsed by the food odor when food was placed in all the glasses. In the light of the experiment above, in which apple was used as a stimulus, it is practically certain that, with the colored papers inside the glasses, no odor of the pigment could be sensed by the raccoons.

The effect, for the human eye, of putting the paper inside the glasses was to make only a vertical strip of color visible in each glass. While the intensity of the colors seemed much reduced, the reduction seemed equal for all the papers, so that differences in brightness seemed no more pronounced than before. The test proved to be a very difficult one. We had taught the animals to select VBT 2 as a food-color when the papers were on the outside of the glasses. We continued to use it as a food-color after putting them within the tumblers. The results of the experiment are shown in Tables 20 and 21.

TABLE 20.  
VBT 2 in Group 5.—Papers inside the Glasses.  
RACCOON No. 2.

Color.	First Day.			Second Day.			Third Day.			Fourth Day.			
RVT 1 .....	1	7	3	5	1	6	1	3	1	5	6	4	2
VBT 2 .....	9	5	13	5	11	12	21	12	9	13	9	16	21
OYS 1 .....	*	*	*	10	4	4	7		8	4	8	2	3
ROT 1 .....	3	4	4	2	4	3	5	4	1	6	3	5	2
VT 2 .....	7	3	1	1	5	2	1		6	4	1	4	
Gray 5 .....	5	6	5	7	5	3	2	4	5	3	5	2	2
Total .....	30	30	30	30	30	30	30	30	30	30	30	30	30

\* Our supply of OYS 1 was exhausted and on this day we used a second glass covered with Gray 5 to which the responses were 5, 5 and 4, respectively.

Though only the vertical strip of color was visible, the raccoons succeeded in selecting the food-glass twenty-five and twenty-six times, respectively, on the fourth day of training.

TABLE 21.  
VBT 2 in Group 5.—Papers inside the Glasses.  
RACCOON No. 3.

Color.	First Day.	Second Day.	Third Day.	Fourth Day.
RVT 1.....	3	4 3 5	6 2 9	1 2 2 2
VBT 2.....	7	9 9 9 17	14 16 16 13	13 24 24 25
OYS 1.....	5	4 1 1	6 1	1 1 1
ROT 1.....	6	4 6 6 1	3 2 2	6
VT 2.....	5	3 8 7 2	3 7 4	2 2 3 2
Gray 5.....	4	6 3 3 9	1 11 2 2	2 2
Total.....	30	30 30 30 30	30 10 30 30	25* 30 30 30

\* Due to error in counting trials.

As a further means of excluding the pigment odor, we coated the paper-covered glasses of Group 20 with shellac, with the result shown in Table 22.

TABLE 22.  
VS 1 in Group 20.—All Glasses Covered with Shellac.

Color.	Raccoon No. 2.					Raccoon No. 3.			
BVS 1.....	5	3	3	1	1	2			
B.....	1	4	1	1	1	1	1		2
VS 1.....	6	18	24	27	26	25	29	30	28
VB.....	4	3	1		1				
ROS 2.....	9	1			1	1			
RVS 1.....	5	1	1	1		1			
Total.....	30	30	30	30	30	30	30	30	30

In the two tests recorded above the two animals should have failed to discriminate if they were selecting the food-glass by the odor of the pigment.

In case of discrimination by odor the raccoons should choose correctly in the dark. They were tried in the dark on Group 30 which, it will be remembered, they had learned very readily by daylight. Each animal was given thirty trials. Raccoon No. 2 selected the food-glass six times, No. 3 selected it five times. Apparently these choices were made only when the food-glass was the first one to which they came. In all other cases they pulled at every glass in order until

the food-glass was reached. In cases of turning back before food was obtained they pulled at some of the glasses twice in each trial. Except in the first fifteen trials with Raccoon No. 2 there was food in only one glass, GBS 2.

It seems fair to conclude, from these experiments, that the animals were not making their selections of the food vessel by means of the odor of the food, of the pigment, nor of their own paws. Evidently the discrimination was a matter of vision or of some sense unknown to us.

*Visual Discrimination.* Since the possibility of discrimination by means of the sense of smell has been eliminated, we must inquire by what visual criteria the different colored papers were distinguished. Watson has pointed out that "the surfaces of the papers differ greatly owing to accidents in manufacture, dyeing, ironing, etc.," and that there is difficulty in pasting them upon surfaces so that slight differences do not appear.<sup>20</sup> Discrimination by means of these criteria must be guarded against, and in the case of the raccoons it was done as follows. (1) Not one food-glass alone was used but a half dozen different ones of the same color. (2) As already stated (p. 674), at the end of a test, we filled the glass holder with six glasses of the same color to see whether the animals could pick out the single one in which food was placed. They simply pulled at every glass. Besides testing the animals, in this way, on several colored papers, they were also tried on gray and white. It seems apparent, therefore, that they were not being guided in their choices by any secondary criteria which the papers may have presented. The possibilities, then, seemed limited to two. Either the animals discriminated between the several glasses (*a*) by means of their brightness differences, or (*b*) by means of their differences in color.

(*a*) As we have stated, the colors were selected so as to be of equal and very nearly equal brightness for the human eye, and as wide a range of brightnesses was used as the ninety colored papers would furnish. The value of our tests rests on the assumption that colors of equal brightness for the human eye may be somewhere near

<sup>20</sup>WATSON, J. B. Some experiments bearing upon color vision in monkeys. *Jour. Comp. Neur. and Psych.*, vol. 19, pp. 3-4. 1909.



equal in brightness for the raccoon. We now have to ask whether there is any evidence to justify this assumption.

After training our animals to select Gray 5 from the colored papers of Group 5 we substituted for the latter Grays 3, 4, 6, 7 and 8 of the Hering series. Raccoon No. 2 was given only sixty trials with these papers. The results appear in Table 23.

TABLE 23.  
Gray 5 in Grays 3-8 inclusive.

Gray.	Raccoon No. 2.	Raccoon No. 3.			
3	3	1	1	1	
4	17 1				
5	6 19	28	27	26	27
6	2 5	1			1
7	3		2	1	
8	2 2		1	2	1
Total	30 30	30	30	30	30

It appears from this table that Raccoon No. 2 confused Gray 4 with Gray 5 in the first thirty trials and showed, in the second thirty, that he was learning to discriminate Gray 5. This animal was not hungry, as he had just been given ninety trials on Grays 5, 10, 15, 20, 25, and 30, which series presented no difficulty of discrimination. Table 23 shows that Raccoon No. 3 made very few mistakes.

It seems evident, when these records are compared with those of the color-discrimination tables, that the brightness differences between the colors of any group were less for the raccoon than the brightness differences between any two of these consecutively numbered gray papers. This agrees with human vision, for Professor Titchener wrote us as follows: "We tried to arrange the four equivalent disks in a scale or order of apparent brightness, by the eye alone; and we got into great difficulties at once. I do not think that any two of us would have taken the same arrangement except by chance. We all felt pretty sure that VT2 was the lightest of the five, though it is true that suggestion (from experiments I have mentioned) may have played a part here."

If the raccoons were discriminating the colored papers by brightness differences alone these differences must have been very near their difference threshold for brightness, for they learned very slowly to make the discriminations. But the brightness difference between some pairs of these papers *was greater than that between other pairs*, since some of the colors were inexact matches for the gray. If, then, we were not below their difference threshold with the exact matches, but only near that threshold, the inexact matches should not have been chosen at all, or at least, *fewer* mistakes should have been made on inexact matches. As a fact *almost an equal number* was made on each class, as shown by the following table.

TABLE 24.

Raccoon No.	2	2	3	2	3	2	3	2	3	2	3	2	3	2	3	Total average.
Average number of errors on exact matches.....	9.6	20.3	15.3	6.3	41	16.5	26	5	7	3	5.3	12.6	5.3	6	1.5	12.04
Average number of errors on inexact matches.....	10.	15.	11.	7.5	51	17.	28	10	4.5	2.5	1.5	16.5	8.	5	4	12.76

The total averages for exact and inexact matches are practically the same. This seems to be excellent evidence that we were below the animal's difference threshold for brightness. If such was the case, they must have been discriminating by color differences alone. In this average are included all the colors, both dark and light, so that the figures apply to the whole range of papers used.

When Yerkes tested the dancing mouse by means of colored papers the records showed at once that the dancer cannot distinguish green from blue, nor violet from red.<sup>21</sup> As the raccoons have given no case of failure to discriminate colored papers, it would seem from this comparison that their vision is more nearly like that of human beings than like that of the dancing mouse, or the common mouse.<sup>22</sup>

Table 25 gives the average number of the raccoons' errors on each wrong color and the number of their errors on each gray. Of course, records for Gray 5 which were made after we had used it

<sup>21</sup>YERKES, R. M. The dancing mouse, pp. 147 and 149. 1907.

<sup>22</sup>WAUGH, K. T. The role of vision in the mental life of the mouse. Doctor's thesis, Harvard University. 1907. (Unpublished.)

as a food-glass do not appear in the table. The records for other grays are those obtained after the animals had been brought to avoid Gray 5, by having been trained on VBT 2 as a food-glass in the group to which Gray 5 belonged.

TABLE 25.

Raccoon No.	2	2	3	2	3	2	3	Total	2	3	2	3	2	3	2	3	Total
Av. number of selections of each wrong color....	10	16.7	13.2	7	44	17	30.6	138.5	2.2	2.7	2.	1.7	2.2	4.2	5.3	4.6	24.9
Number of selections of gray....	9	24.	15.	6	49	16	16.	135.	0.	0.	2.	0.	3.	2.	1.	2.	10.

If by the use of the flicker method we did not secure colors which were equally bright, for the animals, with the gray which was used as a standard, they should not have made wrong choices by selecting the gray. Or, at most, they should have made very few such errors.

The first half of Table 25 shows almost as many mistakes on the gray as on any single wrong color, though some hundreds of trials which should have discouraged the tendency to make these mistakes on gray, preceded those which are tabulated (see pp. 667 and 668). In the latter half of the table the animals seem to have profited by the fact that they had never found food in the gray. This might be because of a difference in brightness, or because, after long practice with food in colored glasses, the animals began to pay more attention to the colored papers and less to the grays.

Comparison of the tables, then, reduces the question to this. If the papers were not equally bright for the animals they should have made fewer mistakes than they did. This is shown by their records on the consecutive grays. On the other hand, if the papers were equally bright for the animals and yet they were color-blind, the excellent records they made on the food-glasses finds no explanation.

(b) So far, then, as evidence can be gained by the use of reflected light, we think it probable that the raccoon can be made to discriminate objects by their color alone. We do not think that in their native state they are often called upon to make pure color discriminations. Samojloff and Pheophilaktowa concluded, only, that the dog *can*

make color discriminations, not that he does so without training.<sup>23</sup> Our raccoons also required many trials before they made fairly good records with the first group of papers which we used.

We state the above conclusion tentatively only because the use of reflected light is possibly inadequate for the solution of this problem. We regard our work as preliminary, and we hope to complete the investigation by the use of methods<sup>24</sup>, which had not been described until our experiments were almost completed.

*Summary.* (1) Open feeding vessels were unsatisfactory in testing visual discrimination in raccoons because of an instinctive tendency they have to explore such vessels by touch.

(2) In the cases of discrimination described in this paper the raccoons seemed not to make a selection with the eyes at a distance of more than four or five inches from the glasses.

(3) So far as evidence can be gained by our use of the method of reflected light, it indicates that the raccoon is able to discriminate by differences of color.

(4) Many trials were required with the first group of colors used before a high per cent of right choices was made.

(5) The animals learned most quickly to select the food-glass when dark groups of colored papers were used.

*Memory for Visual Differences.* Thirty-four days after the raccoons had learned to select RVT 1 as a food-color, and without training during this period, they were again tried with food in this glass. Raccoon No. 2 gave no evidence of having been trained on this group of papers and selected RVT 1 9, 16, 23, and 29 times respectively in each of four series of thirty trials. His learning series for RVT 1 was 14, 29, 24, and 30 correct choices in each series of thirty trials. Raccoon No. 3 selected the RVT 1 27 times out of the first

<sup>23</sup>SAMOJLOFF, A., und PHEOPHILAKTOWA, A. Ueber die Farbenwahrnehmung beim Hunde. *Zent. f. Physiol.*, Bd. 21, S. 133.

<sup>24</sup>YERKES, R. M. The dancing mouse, p. 152 ff. 1907. Methods of studying color vision in animals. *Science*, N. S., vol. 29, p. 432. 1909. Also WATSON, J. B. Some experiments bearing upon color vision in monkeys. *Jour. Comp. Neur. and Psych.*, vol. 19, p. 1, 1909.

thirty trials and was perfect in the second thirty. He thus selected the food-glass three times more in each of the two re-learning series than in the learning series. One hundred and eight days later, and meantime without practice, he selected this color 15, 25, and 29 times in each series. The utmost that can be said, therefore, is that in the case of the two animals, relearning was a little more rapidly accomplished than learning. So, also, must the fact of much more rapid learning in the later experiments be given some weight after due allowance is made for the darker colors being easier for the animals to discriminate. Group 2, for example, which was not dark, was evidently learned much more quickly than it would have been without previous training. The animals' behavior is thus greatly modified by past experience, but the effect of having learned to discriminate objects by means of a specific brightness or color difference, at any rate if that difference be slight, does not last more than a few days. This might be expected since in its native state the raccoon is probably not called upon either to detect or remember such slight differences as were used in these experiments.

Finally, it may be remarked that the animal which gave the better "memory" record above for discrimination of colored papers was the one which gave evidence of superior motor memory for fastenings. This animal also required the greatest number of trials in both cases for the original formation of the associations. So much evidence for a mechanical law of association in animal psychology.



A STATISTICAL STUDY OF THE MEDULLATED NERVE  
FIBERS INNERVATING THE LEGS OF THE  
LEOPARD FROG, RANA PIPIENS, AFTER  
UNILATERAL SECTION OF THE  
VENTRAL ROOTS.

BY

ELIZABETH HOPKINS DUNN.

*From the Anatomical Laboratory of the University of Chicago.*

WITH ONE FIGURE.

CONTENTS.

	PAGE.
The material studied and the methods employed .....	685
Distribution of the nerve branches supplying the leg of the leopard frog and of frog E in particular .....	689
Character of the nerve branches, muscular, cutaneous or articular, in which medullated nerve fibers have dropped out, and comparison with corresponding findings for the control frog IIB.....	690
Discussion of the loss of a small number of efferent medullated nerve fibers from the unoperated leg of frog E.....	699
Splitting nerve fibers among the afferent medullated nerve fibers to the leg of the frog .....	703
The distribution of the muscular afferent and the cutaneous afferent medullated nerve fibers to the various segments of the leg of the frog.	705
Estimation of the number of afferent medullated nerve fibers in the leg of frog E, and their distribution to the segments of the leg .....	707
The innervation of the foot of the frog .....	712
The size of the afferent medullated nerve fibers, and the level of their distribution .....	713
Relation of the area of the axis cylinder to the area of the medullary sheath in the cross sections of the largest medullated nerve fibers in the operated leg of frog E .....	716

THE MATERIAL STUDIED AND THE METHODS EMPLOYED.

The study of the innervation of the leg of the common leopard frog was begun by the author in 1898. In 1900 a report on the innervation of the thigh was completed and in 1902 the material had been extended to include data for the shank and foot.

The findings in the second paper give the number of medullated nerve fibers in the main trunks of the two hind legs of one frog at the successive levels of the thigh, the shank, and the foot, and the numbers in the primary branches to the thigh and the shank. From these data there was determined for each segment of the leg, the number of medullated nerve fibers destined to innervate the skin, the number for the muscles, and those for the knee and ankle joints. Certain measurements of the diameters of the medullated nerve fibers were also accomplished.

It was then found desirable to make a further differentiation of the medullated nerve fibers according to their function. To this end an attempt to destroy the efferent medullated nerve fibers by severing the ventral roots of the spinal nerves supplying the hind leg was made in the spring and summer of 1904. In August of that year a successful operation was performed and the life of the frog was maintained for eight months with the expectation that the medullated nerve fibers separated from their perikarya would degenerate and thus the medullary sheaths would be broken down and be unstained in a preparation treated by the osmic acid method of staining.

As sterilization of the skin in preparation for the operation was well nigh impossible, the instruments used for the skin incision were discarded and the remainder of the operation performed with sterile instruments kept in sterile distilled water. As has been found advisable in operations upon the central nervous system, antiseptics were avoided. Ether was used for the anæsthetic. The body of the frog was kept cool and moist by pads of wet sterilized cotton.

A considerable skin incision was made in the dorsal midline and the flaps reflected. The transverse processes of the vertebræ with the surrounding tissues were severed completely on one side, and partially upon the second side, thus forming a flap of bone and muscle which at the close of the operation was replaced to form a protection for the spinal cord. The constant oozing into the spinal canal with consequent obscuring of the field of operation was met by the use of capillary drainage formed by a rolled thread of absorbent cotton.



The ventral roots of the VIIIth, IXth, and Xth spinal nerves, Gaupp's enumeration, were identified, torn loose from the cord, and left free in the spinal canal. Every precaution was taken to prevent the injury of the dorsal roots, the spinal ganglia, or the nerves distal to the ganglia, and later microscopical observation showed the intact condition of these tissues and the anticipated degeneration in the ventral roots.

After the readjustment of the tissue flap, the skin wound was sealed with collodion. Healing was by primary intention, and while slow, seemed to be complete before the shedding of the collodion dressing.

For the eight months following the operation the frog was kept in a metal refrigerator at a temperature below that of the room but above the freezing point. While the temperature was not absolutely uniform, owing to some irregularities in replenishing the ice, the conditions approximated those furnished by the ordinary laboratory method of keeping frogs in a tank with access to running water. As usual with laboratory frogs, attempts at feeding were unsuccessful.

The physical signs of the success of the operation were the flaccidity of the leg under various conditions, and the absolute failure of motor response by the operated leg to unpleasant stimuli, even when the stimuli were so intense as to produce vigorous motion of the remainder of the body. No marked changes were noted either in the skin of the leg or in the size of the muscle mass, and later microscopic examination of the leg muscles on the two sides showed no loss of striation on either side, but a slightly less deep stain for the operated leg.

The nerve tissue to be examined was partially fixed in situ with a 1 per cent solution of osmic acid, and after removal was immersed in such a solution for twenty-four hours. The material was then washed thoroughly in distilled water, dehydrated, cleared and imbedded in paraffin. The sections were cut transversely to the long axis to a thickness of four micra, and mounted in the usual way.

The measurements of individual nerve fibers were made by the aid of the ocular micrometer.

The methods of enumeration were those elaborated by Hardesty,

1899, and used by the author in the previous investigations of 1900 and 1902. The photographic method was used for the larger trunks, with the section constantly under observation through the microscope for control, while the smaller trunks were counted under the net. A high degree of magnification was used in order to identify the small medullated nerve fibers and any partly degenerated nerve fibers, if such fibers were present. In almost every section from the operated leg was found a small number of medullated nerve fibers which had been stained a deep black, a few such nerve fibers were observed in the intact leg. They were interpreted as nerve fibers in process of degeneration showing drops of myelin and were not included in the enumerations. It has been thought that a few medullated nerve fibers are constantly breaking down in the peripheral nervous system.

The question of the effect of degenerating nerve fibers upon adjacent supposedly intact nerve fibers has also been raised by some of the conditions found in this frog. The facts noted are discussed in the last section of this paper.

Thanks are due for many helpful suggestions to Professor H. H. Donaldson, now of The Wistar Institute of Anatomy and Biology, at whose suggestion this study was begun, and to Professors R. R. Bensley and C. J. Herrick of the University of Chicago.

TABLE I.

Names and designations of the primary nerve branches passing to the muscles and skin of the thigh in the leopard frog, *Rana pipiens*.

- C. Nervus cruralis.
- S. Nervus ischiadicus.
  - S2. Ramus cutaneus femoris posterior.
  - S3. Ramus muscularis to the M. pyriformis.
  - S4 & S5. Rr. musculares to the M. gemellus and the M. obturator internus.
  - S6. R. profundus posterior.
  - S7. R. muscularis to the M. ilio-femoralis.
  - S8. R. profundus anterior.
  - (S8x. R. muscularis to the M. ilio-fibularis.)

TABLE II.

Names and designations of the primary nerve branches passing to the muscles and skin of the shank in the leopard frog, *Rana pipiens*.

- T. Nervus tibialis.
  - Ta. Ramus cutaneus cruris posterior.
  - T $\beta$ . R. muscularis to the M. plantaris longus.
- T1. R. superficialis of the N. tibialis.
  - T1a. R. muscularis to the M. plantaris longus.
  - T1b. R. cutaneus cruris medialis inferior.
- T2. R. profundus of the N. tibialis.
  - T2a. R. cutaneus cruris medialis superior.
  - T2b. Rr. musculares for the M. tibialis posticus.
- P. Nervus peroneus.
  - Pa. R. articularis genu et pedis.
    - Pa $\alpha$ . R. articularis genu.
    - Pa $\beta$ . R. articularis pedis.
  - Pb. R. cutaneus cruris lateralis.
  - Pc. R. muscularis to the M. extensor cruris brevis.
  - Pd. Rr. musculares to the M. peroneus.
- P1. N. peroneus lateralis.
  - P1a. Rr. musculares to the M. tibialis anticus longus.
- P2. N. peroneus medialis.
  - P2a. R. muscularis to the M. tibialis anticus longus.
  - P2b. Rr. musculares to the M. tibialis anticus brevis.

#### DISTRIBUTION OF THE NERVE BRANCHES SUPPLYING THE LEG OF THE LEOPARD FROG AND OF FROG E IN PARTICULAR.

A comparison of the innervation of the leg of the leopard frog with that of *Rana esculenta* has been made in previous papers, Dunn, 1900 and 1902. The terminology and the designations for the nerve branches used in those papers have been adopted for this paper. Tables I and II, repeated in the present paper, summarize the names and designations of the branches to the thigh and the shank. The terminology follows that for *Rana esculenta* in Gaupp's edition of Ecker's and Wiedersheim's *Anatomie des Frosches*, 1896-1901, with such minor modifications as slight differences in innervation have made necessary.

In the operated frog E but one anomalous branch was found in the thigh. S4 and 5, which usually leave the N. ischiadicus by a common trunk, were found in the left leg joined, in the beginning of their course, to S6.

In the shank some deviation from the tabulated scheme is found in the derivation from the N. tibialis, before its division into T1 and T2, of a small cutaneous branch, while a larger cutaneous branch was given off from T1 from which no cutaneous branch usually arises. Two muscular branches were also found where one usually is present. The upper branch of P2a in the left leg was not found, because of anomalous branching or of faulty technique. The substituted number of nerve fibers in this case is marked by parentheses wherever it is mentioned in the tables.

CHARACTER OF THE NERVE BRANCHES, MUSCULAR, CUTANEOUS OR ARTICULAR, IN WHICH MEDULLATED NERVE FIBERS HAVE DROPPED OUT, AND COMPARISON WITH CORRESPONDING FINDINGS FOR THE CONTROL, FROG IIB.

The value of the present study for the frog depends largely on the uniformity in the numbers of medullated nerve fibers for the corresponding trunks and branches on the two sides. This uniformity was determined in the previous studies, Dunn, 1900, and 1902.

These nerve trunks are made up of two groups of medullated nerve fibers, those leaving the spinal cord by way of the ventral roots, or ventral root fibers, and those connected with the dorsal roots and spinal ganglia, or dorsal root fibers. The ventral root fibers conduct impulses chiefly, if not entirely, away from the central nervous system and are therefore named efferent nerve fibers. The dorsal root fibers conduct impulses toward the central nervous system and are termed afferent fibers. Either descriptive term is used in this paper when referring to these two groups of nerve fibers.

The present inquiry determines not only the number of dorsal root or afferent nerve fibers at various levels, remaining intact after the severing of the ventral roots, but by a comparison of each primary branch with the corresponding branch of the opposite leg shows us the approximate number of degenerated ventral root or efferent fibers at each level.

Counts of the medullated nerve fibers were made at selected levels for the two legs. Fig. 1, repeated from page 307, Dunn, 1902,

TABLE III.

Showing the number of medullated nerve fibers at various levels in the legs of the operated frog E.

		Operated.		Intact.	
		L.		R.	
C.	Nervus cruralis .....	(1,247)		1,468	
S <sub>1</sub> .	N. ischiadicus above branches .....	3,236		4,930	
Total at entrance to thigh .....		4,483		6,398	
S <sub>2</sub> .	N. ischiadicus below branches .....	2,424		3,452	
Estimated to thigh .....		2,059		2,946	
T.	N. tibialis .....	1,503		1,998	
P.	N. peroneus .....	1,028		1,417	
Total at entrance to shank .....		2,531	2,531	3,415	3,415
T1.	T. superficialis .....	306		391	
T2.	T. profundus .....	497		712	
P1.	P. lateralis .....	205		283	
P2.	P. medialis .....	527		612	
Total to entrance to foot .....		1,535	1,535	1,998	1,998
Estimated to shank .....			996		1,417

Parenthesis indicates substituted number, see page 690.

TABLE IV.

Showing the observed number of medullated nerve fibers innervating the muscles and skin of the thigh in the operated frog E.

	MUSCULAR.		CUTANEOUS.	
	Operated.	Intact.	Operated.	Intact.
	L.	R.	L.	R.
S2.			369	398
S3.	14	32		
S4.	23	62		
S5.	47	90		
S6.	290	615	103	100
S7.	23	55		
S8.	147	264		
S8x.	38	66		
From N. ischiadicus...	582	1184	472	498
From N. cruralis.....	192	413	(1055)	1055
Total to thigh.....	774	1597	1527	1553

TABLE V.

Showing the observed number of medullated nerve fibers innervating the muscles and skin of the shank in the operated frog E.

	MUSCULAR.		CUTANEOUS.	
	Operated.	Intact.	Operated.	Intact.
	L.	R.	L.	R.
Ta.			(261)	260
Tβ.	32	66		
T1a.	42	89		
T1b.			329	313
T2a.			109	108
T2b.	69	140		
Pb.			379	397
Pc.	24	57		
Pd.	16	29		
P1a.	15	39		
P2a.	(40)	138		
P2a.	(40)			
P2b.	25	43		
Total to shank . . . . .	303	601	1078	1078
Paα. R. art. genu. . . . .			8	8
Paβ. R. art. pedis. . . . .			8	7
Total . . . . .			1094	1093

TABLE VI.

Showing the number of medullated nerve fibers at various levels in the legs of frog IIB. (Adapted for control from Dunn, 1902.)

		L.		R.	
C.	Nervus cruralis . . . . .	1630		1627	
S <sub>1</sub>	N. ischiadicus above branches . . . . .	5499		5480	
	Total at entrance to thigh . . . . .	7129		7107	
S <sub>2</sub>	N. ischiadicus below branches . . . . .	3962		3942	
	Estimated to thigh . . . . .	3167		3165	
T.	N. tibialis . . . . .	2224		2279	
P.	N. peroneus . . . . .	1922		1873	
	Total at entrance to shank . . . . .	4146	4146	4152	4152
T1.	T. superficialis . . . . .	480		529	
T2.	T. profundus . . . . .	840		833	
P1.	P. lateralis . . . . .	345		333	
P2.	P. medialis . . . . .	821		802	
	Total at entrance to foot . . . . .	2486	2486	2497	2497
	Estimated to shank . . . . .		1680		1655

TABLE VII.

Showing the observed number of medullated nerve fibers innervating the muscles and skin of the thigh in the frog IIB. (Adapted for control from Dunn, 1902.)

	Muscular.		Cutaneous.	
	L.	R.	L.	R.
S2+S3.	23	55	375	352
S4+S5.	150	167		
S6.	710	705	142	141
S7.	67	65		
S8.	311	318		
S8x.	73	78		
From N. ischiadicus...	1334	1388	517	493
From N. cruralis.....	471	442	1159	1185
Total to thigh.....	1805	1830	1676	1678

TABLE VIII.

Showing the observed number of medullated nerve fibers innervating the muscles and skin of the shank in the frog IIB. (Adapted from Dunn, 1902.)

	Muscular.		Cutaneous.	
	L.	R.	L.	R.
Ta.			322*	216*
Tβ.	20*	31*		
T1a.	147	142		
T1b.			260	347
T2a.			126	125
T2b.	136	134		
Pb.			480	482
Pc.	42	46		
Pd.	75	52		
P1a.	2	47		
P2a.	457	464		
P2b.	24	26		
Total to shank.....	903	942	1188	1170
Paα. R. art. genu.			9	10
Paβ. R. art. pedis			8	8
			1205	1188

\*In the original article the records for the muscular fibers of Tβ appeared in the columns for the cutaneous fibers and the cutaneous of Tα in those for muscular fibers.

gives a composite dissection of the lumbo-sacral plexus of the leopard frog, *Rana pipiens*, with the lines broken at the points at which counts were made. Tables I and II explain the designations and the destinations of the individual nerve branches. S<sub>1</sub>, S<sub>2</sub>, and S<sub>3</sub> indicate successive levels in the course of the nervus ischiadicus.

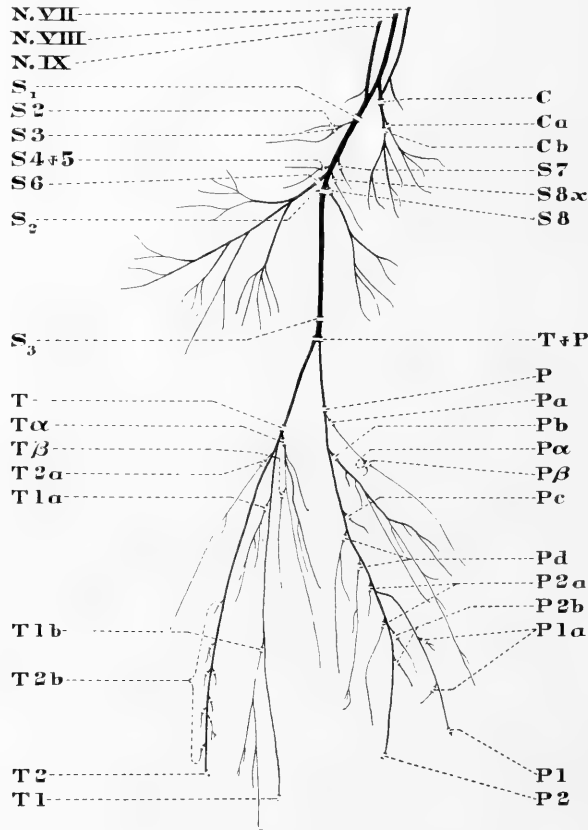

FIG. 1.

The succeeding tables present the findings for frog E, with the addition of explanatory findings for the control frog IIB in Tables VI, VII, VIII, X and XVII.

Frog E was a female, length 229 mm., corrected weight at the time of killing 49 grams. The initial corrected weight could not be



ascertained at the time of operating and when obtained showed undoubted loss of weight in the frog due to its eight months of fast.

The control, frog IIB, was a female, length 234 mm., corrected weight 61.5 grams.

If we consider first some general statements regarding the findings for frog E, Table III introduces the counts at the levels of interest in the main trunks of the nerves innervating the leg. The distribution of nerve fibers to the leg in the frog is by the *nervus cruralis* and the *nervus ischiadicus*. All the nerve fibers of the *nervus cruralis* are distributed to the thigh, while the *nervus ischiadicus*, after giving off its thigh branches, divides in the lower third of the thigh into the *nervus tibialis* and the *nervus peroneus* which furnish branches to the shank, then subdivide and carry nerve fibers to the foot.

Counts of both the *cruralis* and the *ischiadicus* at the entrance level of the thigh, of the *ischiadicus* below its thigh branches, of the *tibialis* and *peroneus* at the entrance to the shank, and of their subdivisions at the ankle, permit calculations as to the probable number of medullated nerve fibers innervating the tissues of each segment of the leg, and at these levels counts were made and entered in Table III.

In addition counts were made of the medullated nerve fibers in the various primary branches. Table IV contains the counts for the thigh. Here further differentiation has been made between those branches innervating muscles and those innervating skin. Table V deals in the same way with the branches to the shank. These three tables contain in brief all the data which we possess for frog E dealing with the matter of enumeration. Additional tables for frog E have been introduced only for the sake of clarifying or emphasizing certain points.

Three corresponding tables from the findings for frog IIB are introduced for control. These tables are modified from former tabulations given on pages 311-317, Dunn, 1902. They are Tables VI, VII, and VIII, pp. 692, 693.

The most obvious information gained by a glance at the three tables for frog E is this, that while certain branches show almost identical

numbers of fibers for the two legs, others show a great disparity, the greater numbers in the latter instances being for the intact leg. Noting the distribution of the nerve branches in which a considerable lack of uniformity appears, we find that they carry medullated nerve fibers to the muscles. The branches carrying no nerve fibers to the muscles, namely the cutaneous and articular branches, show a like number of medullated nerve fibers for each leg. In the sections of nerve branches for the muscles, localized blank spaces appear with no medullated rings but the faint circular outlines of nerve fibers which are no longer present, the simulacra of dead nerve fibers.

Apparently no medullated nerve fibers pass from the ventral roots to the knee or ankle joints, since there is no variation for the operated leg, but the supply is derived from the dorsal root nerve fibers. The counts for the articular nerve fibers appear in Table V and show the same number for the two legs. A marked paucity of medullated nerve fibers to the joints is shown in frog E as it was in frog IIB. A more detailed study of this articular innervation is under way. In frog E there are eight medullated nerve fibers in each leg passing to the knee, and to the ankle eight fibers in the operated leg as against seven fibers in the intact leg.

The distribution of the medullated nerve fibers to the segments of the leg on the intact side of frog E corresponds roughly to that found for frog IIB. One or two brief statements regarding this distribution may be of interest. In the first place the numbers at the various levels in the main trunks are less for frog E than for frog IIB which has the same length but a greater weight. Frog E, Table III, shows 6398 nerve fibers at the entrance to the thigh, 3415 nerve fibers at the entrance of the shank, and 1998 nerve fibers at the entrance to the foot as against 7107, 4152, and 2497 at corresponding levels for frog IIB, Table VI. It would seem as though the differences at the various levels might easily come within those of individual variation, which were found to be very considerable in the instances of the frogs used for the first study, Dunn, 1900.

A relation which may possibly be of more significance is that shown by a comparison of the large nerve branches in the corre-

sponding segments of the legs of the two frogs. On comparing muscular branches we find that the right thigh of frog E, Table IV, has 1597 medullated nerve fibers as against 1830 in the right thigh of frog IIB, an excess for frog IIB of 237 medullated nerve fibers, or 13 per cent of the fibers in the muscular branches of the right thigh of frog IIB. The cutaneous branches for the right thighs show 1553 medullated nerve fibers for frog E as against 1678 medullated nerve fibers for frog IIB, an excess for frog IIB of only 125 nerve fibers, or 7 per cent of the nerve fibers in the cutaneous branches of the right thigh of frog IIB. In the right shanks the excess for frog IIB is, among the muscular branches, 341 nerve fibers, and among the cutaneous branches 100 nerve fibers. In each segment of the right leg the operated frog E shows a greater variation from frog IIB in the number of nerve fibers within its muscular branches than in the number of nerve fibers within its cutaneous branches. This again may be a matter of individual variation or may show a loss of medullated nerve fibers from the muscular branches of the right leg of frog E. If the latter is the condition, the inference naturally follows that the difference is due to a loss of nerve fibers during the long period of artificial inactivity, and that the degenerated fibers may be efferent in character. Several unsuccessful attempts have been made to test this possibility in control frogs kept in similar conditions, but as no decisive findings can be quoted at the present time it seems best not to delay the publication of the present paper for a longer time, in order to secure such findings.

It seems, however, advisable to consider the arguments for and against efferent degeneration in the right leg of frog E, even though the percentage of such possible degenerating medullated nerve fibers is small, being about 1 per cent for the thigh. Of interest in this connection are the findings for the branches to the thigh in two frogs of the same length and of approximately the same weight, Dunn, 1900, pages 233 and 234. With a weight difference of but 4.3 grams, the heavier frog B had 212 more muscular nerve fibers in the right thigh than had frog C, but a less number of cutaneous medullated nerve fibers by 403 than had frog C. These numbers certainly argue for a wide range of individual variation.

While individual variation must receive due consideration, a more definite argument for the dropping out of efferent medullated nerve fibers from the unoperated leg of frog E is found in the decrease in the number of nerve fibers in the N. ischiadicus at successive levels in the right thigh. This point will be taken up in detail in the next section.

#### DISCUSSION OF THE LOSS OF A SMALL NUMBER OF EFFERENT MEDULLATED NERVE FIBERS FROM THE UNOPERATED LEG OF FROG E.

A comparison of the observed number of medullated nerve fibers with the estimated number of medullated nerve fibers was made for the thighs of frog B and of frog C, Dunn, 1900, and of frog IIB, Dunn, 1902, and for the shanks in frog IIB, Dunn, 1902. In the six thighs of these three frogs the excess of observed over estimated medullated nerve fibers varied from 6 per cent to 10 per cent of the number of observed nerve fibers. The numbers in the two thighs of any one frog varied, however, in no instance by more than 1 per cent, thus for frog IIB, Table X, the percentage excess for the left thigh is 9 per cent, for the right thigh 10 per cent; for the left shank 21 per cent, for the right shank 22 per cent. We see that, while the percentage excess in any segment varies considerably in successive frogs, in any one frog the percentage excess varies but slightly for corresponding segments in the two legs. This was to be expected since in any frog the counts for any level vary but slightly for the two legs.

Let us now consider the conditions found in frog E, as shown in Table IX. We find that on the operated side with only afferent nerve fibers the percentage excess is approximately the same as that for both legs of frog IIB, showing 10 per cent for the thigh and 28 per cent for the shank. In the supposedly intact leg the percentage excess is much less than on the operated side, being 6.5 per cent for the thigh and 16 per cent for the shank. This percentage disparity might be explained by the presence of a relatively larger number of splitting nerve fibers on the operated side among the afferent nerve fibers remaining there, than in the unoperated leg where afferent and efferent nerve fibers are both present, were it

not for the fact that the actual excess, not the percentage excess, of nerve fibers is greater on the operated than on the intact side, being 242 nerve fibers for the operated leg and 204 nerve fibers for the intact leg.

TABLE IX.

Showing the excess of observed over estimated medullated nerve fibers to the thigh and the shank of frog E.

	OPERATED.	INTACT.
Thigh.	L.	R.
Observed.....	2301	3150
Estimated.....	2059	2946
Excess of observed.....	242	204
Percentage excess.....	10	6.5
Shank.		
Observed.....	1397	1694
Estimated.....	996	1417
Excess of observed.....	401	277
Percentage excess.....	28	16

TABLE X.

Showing the excess of observed over estimated medullated nerve fibers to the thigh and shank of frog IIB.

(Reproduced from Dunn, 1902, page 314.)

	L.	R.
Thigh.		
Observed.....	3481	3508
Estimated.....	3167	3165
Excess of observed.....	314	343
Percentage excess.....	9	10
Shank.		
Observed.....	2108	2130
Estimated.....	1660	1665
Excess of observed.....	448	465
Percentage excess.....	21	22

If we are correct in interpreting this excess as due to the presence of splitting nerve fibers, it becomes necessary to consider in what way the presence of splitting fibers would modify the enumerations at the various levels of the two legs.

According to the distribution of their subdivisions, splitting nerve fibers may be of three types which we may term arbitrarily types I, II and III. Let type I include those nerve fibers whose subdivisions after splitting follow two pathways, one subdivision passing to the branches and the other continuing in the main trunk. Let type II include those nerve fibers which send both subdivisions to the branches, then type III may represent the group which sends both subdivisions to continue in the main trunk. Any combination of the three types of splitting nerve fibers, provided the number of splitting nerve fibers is not increased, would give the same apparent excess of nerve fibers, namely two in each instance. The only method of varying the apparent excess by varying the relations of the splitting fibers is by increasing or decreasing the number of nerve fibers which split. If the number of splitting nerve fibers were increased the excess would correspondingly increase. In the same way a decrease in the number of splitting nerve fibers would lessen by that exact number the excess of nerve fibers.

If to a fixed number of nerve fibers, some splitting, some non-splitting, another group of nerve fibers be added, by no combination of splitting fibers in the added group could the actual number of splitting fibers in the combined group be decreased. The excess would be unmodified if no new splitting fibers were present in the combined group, or, if splitting fibers were added, the excess would be correspondingly increased.

The excess may be modified by two conditions: the retention at the level below the branches of nerve fibers which have disappeared above the branches, or the presence of fibers at the higher level which have disappeared at the lower level. In the first instance the excess would be increased, in the second, decreased.

Returning now to the findings for frog E, let us attempt to analyze the disparity between the excess for the left leg and that for the right leg. Either percentage excess might be within the normal variation for the frog as determined by previous enumerations, Dunn, 1900, 1902. It is necessary therefore to marshal the arguments for and against the integrity of the nerve fibers, and hence of the findings for each leg.

Since the left leg is the one affected by the operation, we consider first whether some change has occurred in that leg which has modified and vitiated the results. The left leg retains only afferent nerve fibers. We can compare those that innervate the skin with those that innervate the skin on the right or unoperated side. In Table IV we find 1527 cutaneous nerve fibers for the left thigh, 1553 cutaneous nerve fibers for the right thigh. In the shanks, Table V, we find, curiously enough, 1078 cutaneous nerve fibers for each side. At the same levels the cutaneous nerve fibers for both legs are intact.

Comparing, Tables IX and X, the excess in the left leg of frog E and that in the left leg of frog IIB we find the excess numbers bear approximately the same percentage relation to the observed numbers as was found for frog IIB, but the actual numbers are much less, so that a large number of efferent fibers, many of them splitting, might be added to the afferent nerve fibers without surpassing the numbers which might be present in the combined groups, if the observed numbers for frog E were scaled to those for frog IIB.

Furthermore we are able to compare the findings regarding excess nerve fibers on this operated side in a long stretch of the nervus ischiadicus where no branches have left the main trunk, although the main trunk has subdivided at the lower level. In Table III, the N. ischiadicus below its branches on this left side shows 2424 nerve fibers while its continuing branches, the N. tibialis and N. peroneus together show 2531 nerve fibers, an increase of 107 nerve fibers or a percentage increase over the nerve fibers at the upper level of more than 4 per cent. In frog IIB, Table VI, we have between the same levels an increase of 184 fibers in the left leg, and 210 nerve fibers in the right leg, a percentage increase of about 5 per cent. The left leg then seems to have suffered no change further than the loss of the sectioned ventral root nerve fibers.

Turning to the findings for the right leg of frog E, let us ascertain first what this same region in the N. ischiadicus will reveal. According to Table III, the upper level, that of the N. ischiadicus below the branches, shows 3452 nerve fibers, while the N. tibialis and the N. peroneus together at the entrance to the shank show 3415 nerve fibers, a decrease of 37 nerve fibers. That is, at this lower level in

place of an expected percentage increase of 5 per cent as in frog IIB, we find a dropping out of nerve fibers so that at the lower level fewer nerve fibers are found than at the upper level. It would appear then that in the right leg of frog E where efferent fibers are present, a peripheral loss of fibers can be absolutely proven. Such a loss of nerve fibers does not appear among the afferent nerve fibers of the left leg.

Let us see what influence upon the findings for the right leg such degenerating nerve fibers might have. We have previously shown that the loss of nerve fibers peripherally would decrease the excess of the observed number of nerve fibers. That excess is 242 nerve fibers for the left thigh of frog E, and 204 nerve fibers for the right thigh. The left thigh contains only afferent nerve fibers, of which 242 fibers split. If in the right thigh where efferent nerve fibers are also found, no splitting is found among the efferent nerve fibers, the number of splitting afferent nerve fibers should at least equal the number found among the afferent fibers of the left thigh. At least 38 nerve fibers must have dropped out at the lower level which had appeared at the higher level. We have reason, however, to believe that splitting occurs among the efferent nerve fibers as well as among the afferent nerve fibers, so the number lost is probably greater than 38 fibers, and just so much greater as it will be when increased by the number of splitting efferent nerve fibers.

If at successive levels additional nerve fibers have disappeared an explanation is furnished for the greater disparity in the excess for the two shanks than for the two thighs.

The tabulations for the muscular branches confirm this theory of peripheral efferent loss: Table IV shows 774 afferent nerve fibers for the muscular branches of the left thigh as against 1597 combined nerve fibers for the right thigh, giving a difference of 823 efferent nerve fibers. Table V for the shanks gives 303 afferent nerve fibers in the left shank as against 601 combined nerve fibers in the right shank, a difference of 298 efferent nerve fibers. At the lower level some efferent nerve fibers may have dropped out from the right leg.

If we accept this argument for the loss at successive lower levels of efferent nerve fibers from the unoperated leg we must consider



the possibility of the loss of certain efferent nerve fibers also at the entrance level of the leg. Even if frog E has the same length as has frog IIB, it is not probable that it has the same number of medullated nerve fibers or the same proportional numbers of afferent and efferent nerve fibers as has frog IIB. Between frogs C and B with the same length a wide variation exists, Dunn, 1900. Nor can we advance an argument from the proportional numbers of medullated nerve fibers in the ventral and dorsal nerve roots which later innervate the leg, because some afferent nerve fibers and possibly some efferent nerve fibers are given off in the pelvis and have not been considered in this enumeration for the branches to the leg. From the size of the nerve branches concerned several hundred nerve fibers might have been so disturbed.

We are therefore justified in assuming that some loss of efferent nerve fibers has occurred in the nerve roots for the right side, and that complete retrograde degeneration is inconsiderable, the retrograde degeneration being confined chiefly to the periphery.

The disparity of excess fibers in the two legs of frog E is then due to injury to a few of the efferent nerve fibers of the supposedly intact leg of frog E. Such a change in the medullated nerve fibers might be the result of the somewhat abnormal conditions under which this frog was kept. The possible causes and extent of such a retrograde degeneration from disuse are of great interest, but cannot be taken up at this time.

#### SPLITTING NERVE FIBERS AMONG THE AFFERENT MEDULLATED NERVE FIBERS TO THE LEG OF THE FROG.

Granting that this possible vitiation of the findings for the intact leg of frog E exists, we must consider the value of our counts and the scope of the conclusions which we may draw from them.

As already established, no vitiation of our findings for the left or operated side is probable. We have then in that leg enumerations at various levels of the complete afferent medullated nerve supply for the leg. In the main trunks those counts for the nerve fibers innervating the muscles and those for the nerve fibers innervating the skin are combined, but in the primary branches the muscular and

cutaneous supply may be distinguished. It is possible also to determine the number of medullated afferent nerve fibers which split in the thigh.

TABLE XI.

Showing the observed number of afferent medullated nerve fibers in the primary muscular and cutaneous branches of the left operated thigh of the frog E.

	Muscular.	Cutaneous.	Combined.
S2		369	369
S3	14		14
S4	23		23
S5	47		47
S6	290	103	393
S7	23		23
S8	147		147
SSx	38		38
From the N. ischiadicus.....	582	472	1054
From the N. cruralis.....	192	1055	1247
Total to the thigh.....	774	1527	2301

TABLE XII.

Showing the observed number of afferent medullated nerve fibers in the primary muscular and cutaneous branches of the left operated shank of the frog E.

	Muscular.	Cutaneous.	Combined.
T $\alpha$		261	261
T $\beta$	32		32
T1 $\alpha$	42		42
T1b		329	329
T2 $\alpha$		109	109
T2b	69		69
Pb		379	379
Pc	24		24
Pd	16		16
P1 $\alpha$	15		15
P2 $\alpha$	80		80
P2b	25		25
Total to shank.....	303	1078	1381
Pa $\alpha$ . R. art. genu.....		8	8
Pa $\beta$ . R. art. pedis.....		8	8
Total.....		1094	1397

From Table XI we learn that in the primary branches to the thigh, actual count shows the presence of 774 afferent medullated

nerve fibers to the muscles and 1527 afferent nerve fibers to the skin, making a total of 2301 afferent medullated nerve fibers to the thigh. Table III gives us the number 2059 as the estimated number of afferent medullated nerve fibers innervating the thigh. The excess then is 242 nerve fibers. Such an excess we have interpreted as occasioned by the presence of splitting nerve fibers in the main trunks or in the branches. The percentage excess in this instance is 10 per cent.

Table XII, giving the enumerations in the primary branches of the shank, shows 303 afferent medullated nerve fibers in the branches to the muscles, 1078 medullated nerve fibers in the branches to the skin and 16 fibers in the branches to the joints, a total of 1397 afferent medullated nerve fibers to the tissues of the shank. Table III gives us as the estimated number of afferent fibers to the shank, 996 afferent medullated nerve fibers, an excess of 401 splitting afferent nerve fibers in the shank, a percentage excess of 28 per cent.

We may then make the generalization that among the segregated afferent medullated nerve fibers splitting occurs and that it occurs in about the percentage found in the combined afferent and efferent nerve fibers of an intact nervous system. That would imply that splitting occurs among afferent nerve fibers as demonstrated here, and among efferent nerve fibers at approximately the same percentage, since a like number of splitting nerve fibers must occur among the efferent nerve fibers to maintain the percentage unchanged for the combined afferent and efferent nerve fibers.

#### THE DISTRIBUTION OF THE MUSCULAR AFFERENT AND THE CUTANEOUS AFFERENT MEDULLATED NERVE FIBERS TO THE VARIOUS SEGMENTS OF THE LEG OF THE FROG.

We are further justified in making a comparison of the muscular afferent supply with the cutaneous afferent supply in both the thigh and the shank. In the thigh we find that the afferent supply to the muscles is 34 per cent of the entire afferent supply, the remaining 66 per cent innervating the skin. In the shank the muscular afferent fibers make up 22 per cent of the entire afferent supply to the shank, the remaining 78 per cent innervating the skin. Combining the

enumerations for the two segments we find that 26 per cent of the afferent medullated nerve fibers for the thigh and the shank innervate muscles and 74 per cent innervate skin.

If we confine our attention to the fibers innervating the skin, we may obtain a rough estimate of the relative number of cutaneous pathways for the thigh and the shank, and their relation to the area of skin innervated. In connection with an investigation published by Donaldson, 1903, a series of measurements was made of the cutaneous areas for the thigh, the shank and the foot in the common leopard frog. By those measurements the skin of the thigh was found to be 36 per cent of the total area of the skin of the leg, and the skin of the shank 26 per cent of the entire leg area. The thigh area bore a relation of 36 : 26 to that of the shank, or roughly speaking a relation of 7 : 5.

With 1527 medullated nerve fibers to the skin of the thigh and 1094 medullated nerve fibers to the skin of the shank we have a relation of 1527 ; 1094 or again 7 : 5. The distribution of the afferent medullated nerve fibers to the skin of the thigh is then in the same proportion to the area of the skin innervated as is that of the fibers innervating the skin of the shank. So far as we can draw any conclusions from the frog we find the number of cutaneous pathways in both the thigh and the shank proportional to the area of the skin to be innervated. If then any superior richness of afferent endings occurs in the skin of either of these segments it is due to branching of these primary pathways nearer their terminations in the skin.

The afferent supply to the muscles of the two segments may be compared in the same way. In the thigh 774 afferent medullated nerve fibers are destined for the muscles, in the shank 303 afferent medullated nerve fibers pass to the muscles. The ratio here is 774 : 303, or 8 : 3. Donaldson and Schoemaker in 1900 ascertained that the percentage values for the weights of the thigh and the shank were respectively 64 and 24 per cent of the entire muscle weight for the leg. The ratio of 64 to 24 when reduced to its lowest terms is 8 : 3.

The distribution of the muscular and of the cutaneous afferent medullated nerve fibers to these two segments is proportional to the

mass of the tissue innervated, that is to the area of the skin and to the weight of the muscles. This is with reference to the number of nerve fibers in the primary branches, without correction for splitting fibers.

ESTIMATION OF THE NUMBER OF EFFERENT MEDULLATED NERVE FIBERS IN THE LEG OF FROG E, AND THEIR DISTRIBUTION TO THE SEGMENTS OF THE LEG.

Our numerical findings would be complete if we could add to them an estimation of the number of efferent medullated nerve fibers at the various levels. This estimation would be made by finding the differences at the various levels between the combined fibers on the unoperated side and the afferent fibers on the operated side. In making and discussing such an estimation the question of the dropping out of efferent nerve fibers from the unoperated leg is of prime importance.

TABLE XIII.

Estimating the number of efferent medullated nerve fibers in the leg of frog E.

	Afferent.	Total.	Efferent.
	L.	R.	Difference.
At entrance to the thigh.....	4483	6398	1915
Below branches to the thigh.....	2424	3452	1028
Estimated to thigh.....	2059	2946	887
At entrance to the shank.....	2531	3415	884
Below branches to the shank.....	1535	1998	463
Estimated to shank.....	996	1417	421

Table XIII contains the estimation of the efferent fibers at the various levels of the main trunks, and Tables XIV and XV contain the estimations for the branches to the thigh and the shank respectively.

According to Table XIII the estimated number of efferent medullated nerve fibers to the thigh is 887 nerve fibers. In Table XIV the number for the primary branches is 823. The difference between these, 64 fibers, shows a loss of fibers from the thigh. In all our

results similarly carried out an excess of fibers has been found rather than this loss. Sixty-four medullated nerve fibers then have dropped out either from the primary branches or from the lower level of the main trunk or perhaps divided between the two. This is the number

TABLE XIV.

Giving the estimation of the number of efferent medullated nerve fibers in the primary muscular branches to the thigh of frog E.

	Afferent.		Total.	Efferent.
	L.	R.	Difference.	
S3	14	32		18
S4	23	62		39
S5	47	90		43
S6	290	615		325
S7	23	55		32
S8	147	264		117
S8x	386	66		28
Total from N. ischiadicus..	582	1184		602
Total from N. cruralis....	192	413		221
Total to thigh.....	774	1597		823

TABLE XV.

Giving the estimation of the number of efferent medullated nerve fibers in the primary muscular branches to the shank of frog E.

	Afferent.		Total.	Efferent.
	L.	R.	Difference.	
T $\beta$	32	66		34
T1a	42	89		47
T2b	69	140		71
Pc	24	57		33
Pd	16	29		13
P1a	15	39		24
P2a	80	138		58
P2b	25	43		18
Total to shank.....	303	601		298

lost if no splitting occurs among those remaining. The probability however is that splitting occurs among both afferent and efferent fibers in about the same percentages. The argument for this splitting among the efferent fibers was given in the discussion of splitting among the afferent fibers and is based on a comparison of the per-

centage of splitting among the afferent fibers of frog E, and that among the combined fibers for both legs of frog IIB.

The percentage excess among the afferent fibers for frog E is found in Table IX and is 10 per cent for the thigh and 28 per cent for the shank. The percentage values for frog IIB from Table X show 9 per cent for the thigh and 21 per cent for the shank. Both of these sets of percentages are taken from the left leg.

The percentage excess for the right or unoperated leg of frog E is 66.5 per cent for the thigh and 16 per cent for the shank. This percentage is considerably less than the corresponding excess for frog IIB, 9 per cent for the thigh and 21 per cent for the shank, and still less than the percentage for the operated leg of frog E in which afferent nerve fibers alone appear.

When we compare the percentage excess of the smaller number of medullated afferent nerve fibers found in the left leg of frog E with the percentage excess for the larger number of combined afferent and efferent medullated nerve fibers in the left leg of frog IIB, 2301 for frog E and 3481 for frog IIB, if splitting occurs only among the afferent fibers, the percentage excess for the smaller number in frog E should be considerably greater than for the combined afferent and efferent nerve fibers for frog IIB. This is not the relation observed; on the contrary the percentage of excess among the combined fibers, 9 per cent, is much the same as that for the afferent fibers alone, 10 per cent, therefore we may conclude that among the efferent nerve fibers splitting occurs in about the same percentage as among the afferent medullated nerve fibers.

The number of fibers dropped out from the right thigh of frog E should be corrected by the addition of the number of splitting fibers to the known loss of 64 nerve fibers. To ascertain the number of splitting fibers we reckon the proper percentage of 823 fibers, the estimated number of efferent medullated nerve fibers in the thigh branches. Ten per cent of 823 is 82. We may conclude that at least the sum of these two sets of nerve fibers, 64 and 82, or 146 efferent nerve fibers, has dropped out from the right thigh of frog E. We are not able to say whether these have dropped out from the branches or from the main trunk.

A similar comparison may be made from the same tables showing the relations in the shank of the right leg of frog E. Here also between the level above the branches to the shank and the level below the branches to the shank, a number of nerve fibers have dropped out. The same arguments for the efferent character of these nerve fibers hold as were used for those of the thigh.

The existence then of a loss from among the efferent medullated nerve fibers in the unoperated leg of frog E vitiates to a certain extent the estimations for the efferent nerve fibers in frog E. The findings, however, for a large number of muscular branches in the thigh and the shank, as shown in Tables XIV and XV, run so evenly for the various branches, and the probable number of fibers which has dropped out from each branch is so small, that we feel justified in discussing the results as they stand without correction.

Sherrington, 1894, after investigations of single muscle branches in the cat and monkey, found that "In a muscular nerve trunk from one-third to one-half of the myelinate fibers are from cells of the spinal root ganglion." The fibers passing by a muscular nerve trunk include, according to Sherrington, fibers passing to adjacent tissues, such as the tendons and the perimysium. I have not myself been satisfied that there may not be some innervation of tissues lying not immediately adjacent to the muscles from the afferent medullated nerve fibers running in the so-called muscle branches. It seems possible that there may be still to be described a considerable nerve supply to subcutaneous tissues not passing by way of the cutaneous branches and it is hoped that this may be shown later. The findings of Head and Rivers, 1908, demand for their anatomical interpretation such a layer of nerve endings lying between the deep muscular endings and the superficial cutaneous endings. And such a distribution of the afferent nerve fibers would account for the rather large number of afferent pathways in trunks to the muscles which Sherrington found in the cat and the monkey, and which has been found here for the frog.

Without attempting to correct for lost fibers, the findings show the number of estimated efferent medullated nerve fibers in the primary muscular branches, Tables XIV and XV, to be approximately equal



to the number of afferent medullated fibers. The number of afferent medullated nerve fibers is slightly less than half the total number of medullated nerve fibers in a muscular branch.

If we attempt to correct for the lost fibers by comparison with the numbers of cutaneous and muscular nerve fibers found in the various segments of frog IIB, not by an attempt to scale the entire number of nerve fibers to those for frog IIB, our results are as follows:

The average number for the cutaneous nerve fibers of the two thighs of frog IIB is 1677 nerve fibers, see Table VII. The average number for the muscular nerve fibers for the two thighs is 1818 nerve fibers. The average number for the cutaneous nerve fibers for the two thighs of frog E is 1540 nerve fibers. The corrected number of muscular nerve fibers for frog E is represented by the sign  $x$ . Our proportion then will stand, the number of cutaneous nerve fibers of frog IIB: the number of muscular nerve fibers of frog IIB:: the number of cutaneous nerve fibers of frog E: the corrected number of muscular nerve fibers of frog E. For the thigh the proportion will stand  $1677 : 1818 :: 1540 : (1669) x$ . The number of muscular nerve fibers counted in the thigh branches of the right leg of frog E is 1597 nerve fibers. This number is less by 72 nerve fibers than the number estimated by the proportion, 1669 nerve fibers. In proportion to frog IIB the number of medullated nerve fibers to the muscular branches of the right thigh of frog E should be increased by 72 nerve fibers, making the total number of medullated nerve fibers to the muscular branches of the right thigh of frog E 1669 nerve fibers. The afferent fibers segregated in the left thigh number 774, and the difference between 1669 and 774 gives us 895, the number of efferent medullated nerve fibers to the thigh of frog E. This corrected number would decrease the fraction of medullated afferent fibers in the total number of medullated nerve fibers to the thigh, but the number would not be reduced to the one-third sometimes found by Sherrington, 1894.

Correcting in the same way the muscular nerve fibers to the shank of frog E we have  $1193 : 923 :: 1093 : (844) x$ . The number found by actual count is 601, and the difference between 844 and 601 is 303, giving us 541 as the corrected number of efferent nerve fibers for the shank.

In the thigh the efferent nerve fibers in the primary branches outnumber the afferent fibers, making up more than one-half of the total number of medullated nerve fibers. In the shank the efferent nerve fibers furnish nearly two-thirds of the entire number of medullated nerve fibers.

With these corrected numbers, which are of course only approximate, let us see what relation the numbers of efferent nerve fibers for the thigh and the shank bear to the weights of the muscles of the respective segments.

Using the same percentages from the paper of Donaldson and Schoemaker, 1900, as were used in the discussion of the afferent nerve fibers, we learn that the percentage values for the weights of the muscles of the thigh and shank are respectively 64 per cent and 24 per cent of the entire muscle weight for the leg of the frog, and that the ratio is 8 : 3. With the corrected numbers, 895 efferent medullated nerve fibres for the thigh and 541 efferent medullated nerve fibers for the shank, the ratio for the two segments would be 895 : 541, or nearly 8 : 5. This more nearly approximates the ratio of the areas of the skin of the two segments than it does the weights of the muscles, the former being 7 : 5.

We may conclude then that while the afferent medullated nerve fibers are distributed to the segments according to the mass which they innervate, the cutaneous afferent according to the area of the skin of the segment and the muscular afferent according to the weight of the muscle of the segment, the efferent nerve fibers are not distributed according to the mass which they innervate, since a greater richness of nerve supply is found in the distal segment, in this instance the shank. While no attempt has been made to correct for splitting nerve fibres, it is possible that, if such a correction could be made, this peripheral richness of pathways for efferent impulses would still be maintained. Although splitting increases in the peripheral segment, shown in frog IIB and in the afferent fibers of frog E, it is not so great as to reduce largely the ratio.

#### THE INNERVATION OF THE FOOT OF THE FROG.

We are now at a point where the discussion of the innervation of the foot is possible. From Table III it appears that at the entrance

to the foot on the operated left side of frog E, there are 1535 medullated nerve fibers. On the right side we find 1998 combined afferent and efferent nerve fibers. How these numbers are distributed to the muscles and skin of the foot we do not know, and an estimation based upon the distribution in the thigh and shank does not seem profitable. At some future time it may be possible to count the number to the skin and to the muscles of the foot. When that is done we may be able to assign the afferent and efferent fibers to their destinations and consider their relations. It is, however, of interest to note that of the total number of afferent fibers to the leg of the frog 45 per cent pass to innervate the thigh, 21 per cent to the shank, and 34 per cent to the foot.

#### THE SIZE OF THE AFFERENT MEDULLATED NERVE FIBERS, AND THE LEVEL OF THEIR DISTRIBUTION.

Turning our attention to the size of the medullated nerve fibers, we are able to make a comparison of the size of the largest cutaneous afferent nerve fibers and the largest muscular afferent nerve fibers. This is done for both the thigh and the shank by selecting and measuring the largest nerve fibers from primary branches containing approximately the same number of nerve fibers.

The average areas in square micra are given in Table XVI. It appears that very large afferent nerve fibers pass to the skin and to the muscles, and that in both the thigh and the shank the muscular branches contain the largest afferent fibers. The ten largest fibers in muscular branches to the thigh average 183 square micra, the ten largest in cutaneous branches to the thigh average 174 square micra. For the shank the ten largest fibers in branches to the muscles average 139 square micra, the ten largest nerve fibers in branches to the skin average 124 square micra.

Measurements were made of the largest fibers alone because of technical difficulties. A study of the branches in which purely muscular or purely cutaneous afferent fibers were found, such a study as could be made without measurements, showed that both the muscles and the skin received fibers of various sizes, but that the supply of small fibers to the skin was much more abundant than that

to the muscles. Dunn, 1900, after a comparison of intact muscular and cutaneous branches, arrived at the conclusion that the muscular branches containing medullated afferent and efferent nerve fibers

TABLE XVI.

Showing the relation in square micra of the average areas of the ten largest muscular afferent and the ten largest cutaneous afferent nerve fibers in the thigh and in the shank of the left leg of frog E.

	In square micra.	
	Muscular.	Cutaneous.
Ten largest nerve fibers in primary thigh branches..	183	174
Ten largest nerve fibers in primary shank branches.	139	124

TABLE XVII.

Showing the average areas in square micra of the largest medullated nerve fibers at various levels in the operated and unoperated legs of frog E as compared with one another and with the corresponding averages in the intact leg of frog IIB.

No. of fibers.	Region.	FROG E.		FROG IIB.
		Operated.	Intact.	Intact.
		L.	R.	L.
22	N. ischiadicus above branches to thigh.....	276	257	230
13	N. ischiadicus above branches to thigh.....	294		
16	N. ischiadicus below branches to thigh.....	260	194	173
11	N. ischiadicus below branches to thigh.....	276		
22	In primary branches to thigh.....	242	241	213
8	In primary branches to thigh.....	287	276	233
13	In primary branches to thigh.....	269		
5	In primary branches to thigh.....	289		
16	Above branches to shank.....	239	195	165
11	Above branches to shank.....	245		
10	Below branches to shank.....	162	143	106
7	Below branches to shank.....	180		
16	In branches to shank.....	173	179	128
6	In branches to shank.....	207	197	145
11	In branches to shank.....	189		
4	In branches to shank.....	224		

could be distinguished from the cutaneous branches containing afferent medullated fibers by the greater number of nerve fibers of a uniform size in the muscular branches. In the present study, after

eliminating the efferent fibers, it appears that among the afferent nerve fibers the greatest number of nerve fibers of uniform size pass to the muscles.

All the findings in this study regarding the size of the medullated nerve fibers point to a fundamental uniformity underlying their distribution. The probabilities seem to lie between two alternatives. Either, first, a difference of function must be correlated with size; this might be possible among the cutaneous nerve fibers where a greater variation in size is coexistent with the need for transmission of various cutaneous sensations. Or, second, size may depend upon the amount of tissue to be innervated by the single fiber. Some preliminary measurements still unpublished seem to show that in the case of the medullated efferent fibers a direct relation exists between the diameter of the muscle fiber and that of the nerve fiber by which it is innervated.

Herrick, 1902, in discussing the significance of the size of nerve fibers in fishes, states, page 333, "that each functional system of peripheral nerves has tolerably definite fiber characteristics; the basis for which is unknown; that these characteristics are by no means invariable, but that fibers of a given system may show considerable differences in caliber and medullation in a single animal, and that some of these differences, at least, can be correlated with the degree of functional development of the peripheral end-organ."

Johnston, 1908, has a very suggestive paper on the significance of the caliber of the parts of the neurone in which he points out the extreme differences in size in the non-medullated nerve fibers of the lamprey.

A further discussion of the literature cannot be made at this time, but it is hoped that an accumulation of findings may make possible a later discussion of the caliber of the medullated nerve fiber in the leopard frog.

It has been shown, Dunn, 1902, that the largest medullated nerve fibers passing to the leg of the frog are not found at levels below the thigh but appear in the primary branches to the thigh. This finding discredited the theory of Schwalbe that the largest nerve fibers run the longest distance.

In the course of the present investigation it was found possible to corroborate the previous finding by a study of the conditions in the unoperated leg of frog E, and to determine the condition existing among the afferent nerve fibers in the left or operated leg of frog E. Table XVII gives the measurements from frog E for the afferent fibers, and for the combined afferent and efferent fibers, and for the combined nerve fibers from frog IIB. Because of the absence of efferent nerve fibers from the operated leg of frog E the total number of nerve fibers is decreased at each level. To make possible comparison with the unoperated leg and with frog IIB both the full number and the relative number were included, the latter in each instance standing alone below the former.

The findings for frog IIB are confirmed by the measurements for the unoperated leg of frog E. The average area of the 22 largest nerve fibers at the level above the branches to the thigh is 257 square micra. That of the corresponding 16 nerve fibers at the level below the branches is 194 square micra, while the corresponding 8 nerve fibers in the branches have an average area of 276 square micra. Similarly the largest nerve fibers at the entrance to the shank are found in the branches to the shank and not in the main trunks below the branches.

In the operated leg there is shown a similar distribution of the largest afferent nerve fibers at each level to the tissues of the adjacent segment. Table XVII shows that larger medullated nerve fibers, both muscular and cutaneous, are found in the thigh than in the shank.

RELATION OF THE AREA OF THE AXIS CYLINDER TO THE AREA OF  
THE MEDULLARY SHEATH IN CROSS SECTIONS OF THE LARGEST  
MEDULLATED NERVE FIBERS IN THE OPERATED LEG OF FROG E.

A swollen condition of the individual nerve fibers in the operated leg is shown by the uniformly larger size of the nerve fibers on this side when compared with corresponding nerve fibers on the unoperated side. As this condition prevails throughout the leg it does not vitiate the results of a comparison of the caliber of the nerve fibers at various levels of the operated leg. It does unfortunately prevent

that comparison of the nerve fibers of the operated leg with those of the unoperated leg, by which we might ascertain the relative sizes of the largest afferent and efferent nerve fibers.

TABLE XVIII.

Showing the ratio of the average areas in square micra of the ten largest medullated nerve fibers to the average areas of their axis cylinders at various levels in the operated leg of frog E.

	Axones.	Fibers.	Ratio A:B.
	A.	B.	
N. ischiadicus above branches to thigh....	143.99	294.98	1:2.50
N. ischiadicus below branches to thigh....	158.37	277.12	1:1.75
In branches to thigh .....	126.28	230.20	1:1.82
Above branches to shank.....	131.44	251.65	1:1.91
Below branches to shank.....	80.42	167.87	1:2.08
In branches to shank.....	77.60	155.26	1:2.00

One result of the pathological condition found in the nerve fibers of the operated leg of frog E is shown in Table XVIII, in which are given measurements in square micra of the cross sections of the entire medullated nerve fibers and their axis cylinders, with the ratios. The ten largest nerve fibers at various levels in the operated leg were selected. The results of the measurements do not correspond with the one to one relation between the axis cylinder and the medullary sheath found by Donaldson and Hoke, 1905. The changes in frog E consist of a slight swelling of the axis cylinder and an associated thinning of the medullary sheath. While the largest average deviation found in the normal nerve fiber was 2.3 per cent, the most marked deviation in this frog is 12 per cent. The variation is of significance as showing the effect of abnormal conditions upon the peripheral nervous system without apparent interruption of physiological function, and may be due to one or more of the abnormal conditions present in frog E.

#### CONCLUSIONS.

After complete degeneration of the medullated nerve fibers passing by the ventral nerve roots to the left leg of a leopard frog, a study of the medullated nerve fibers for both the operated and the intact legs permits the following conclusions.

1. Since the number of medullated nerve fibers is practically the same for all corresponding cutaneous and articular branches for the two legs, but is much less for the muscular branches of the operated leg than for the muscular branches of the intact leg, the ventral root medullated nerve fibers are distributed chiefly if not entirely by way of the muscular branches.

2. Of the 2301 dorsal root or afferent medullated nerve fibers in the primary branches of the operated thigh 774, or 34 per cent, were found in muscular branches and 1527, or 66 per cent, in cutaneous branches.

3. Of the 1397 dorsal root or afferent medullated nerve fibers in the primary branches of the operated shank 303, or 22 per cent, were found in muscular branches and 1094, or 78 per cent, in cutaneous branches.

4. Directing our attention to the dorsal root or afferent medullated nerve fibers passing by way of the primary cutaneous branches, we find the number to the thigh has a ratio to that for the shank of 7 : 5. From a previous measurement of the skin areas of the thigh and the shank we find the same ratio of 7 : 5.

5. A ratio of approximately 8 : 3 was found for the thigh and shank muscle weights by Donaldson and Schoemaker, 1900. The dorsal root medullated nerve fibers in the primary muscular branches of the thigh and shank of the operated leg have the same ratio 8 : 3.

6. The dorsal root medullated nerve fibers are then distributed to the thigh and the shank in proportion to the mass of tissue innervated, that is, the cutaneous in proportion to the area of the skin of the two segments, and the muscular in proportion to the weights of the muscle masses of the two segments.

7. Among the dorsal root medullated nerve fibers innervating the segments of the leg in the frog, splitting of nerve fibers occurs in both the thigh and the shank. The percentage of distal excess is 10 per cent for the thigh and 28 per cent for the shank, differing but slightly from the excess for the combined ventral and dorsal root fibers in the legs of the control frog IIB. From this it would appear that splitting occurs in both afferent and efferent medullated nerve fibers in the leg of the frog, and in about equal proportions among each.



8. The absolute enumerations for the ventral root nerve fibers are vitiated by the dropping out from the unoperated leg of a small number of medullated efferent nerve fibers. This loss increases toward the periphery.

9. Correcting the enumerations by those of frog IIB, we find that the medullated afferent fibers make up less than half of the total nerve fiber supply to the muscles. This holds true for the thigh and for the shank.

10. The efferent medullated nerve fibers are not distributed to the two segments of the leg according to the respective weights of muscles, but the distal segment has a greater richness of innervation.

11. No detailed statement of the innervation of the foot can be made at this time, but of the total number of afferent medullated nerve fibers to the leg, 34 per cent innervate the foot, as against 45 per cent to the thigh and 21 per cent to the shank.

12. Among the afferent medullated nerve fibers less variation in size occurs among those passing to muscles than among those passing to the skin.

13. The largest afferent nerve fibers in both the thigh and the shank pass to the muscles and not to the skin.

14. The previous finding, Dunn, 1902, that the largest medullated nerve fibers passing to the leg run the shortest distance, and in each segment are given off in the branches to that segment, is confirmed here, and is established in regard to the dorsal root medullated nerve fibers.

15. The individual afferent nerve fibers in the operated leg show some deviation from the one to one relation of the axis cylinder and medullary sheath found by Donaldson and Hoke, 1905, due to a slight swelling of the axis cylinder and an associated thinning of the medullated sheath.

REFERENCES.

- DONALDSON, HENRY H., and HOKE, G. W.  
 1905. On the areas of the axis cylinder and medullary sheath as seen in the cross sections of the spinal nerves of the vertebrates. *The Journal of Comparative Neurology and Psychology*, Vol. 15, No. 1, pp. 1-16.
- DONALDSON, HENRY H., and SCHOEMAKER, DANIEL M.  
 1900. Observations on the weight and length of the central nervous system and of the legs in frogs of different sizes. *The Journal of Comparative Neurology*, Vol. 10, No. 1, pp. 109-132.
- DONALDSON, HENRY H.  
 1903. On a law determining the number of medullated nerve fibers innervating the thigh, shank and foot of the frog, *Rana virescens*. *The Journal of Comparative Neurology*, Vol. 13, No. 3, pp. 224-257.
- DUNN, ELIZABETH H.  
 1900. The number and size of the nerve fibers innervating the skin and muscles of the thigh in the frog (*Rana virescens brachycephala*, Cope). *The Journal of Comparative Neurology*, Vol. 10, No. 2, pp. 218-242.  
 1902. On the number and on the relation between diameter and distribution of the nerve fibers innervating the leg of the frog, *Rana virescens brachycephala*, Cope. *The Journal of Comparative Neurology*, Vol. 12, No. 4, pp. 297-328.
- GAUPP, ERNST  
 1896-1901. A. Ecker's und R. Wiedersheim's Anatomie des Frosches. *Braunschweig*.
- HARDESTY, IRVING  
 1899. The number and arrangement of the fibers forming the spinal nerves of the frog (*Rana virescens*). *The Journal of Comparative Neurology*, Vol. 9, No. 2, pp. 64-112.
- HERRICK, C. JUDSON  
 1902. A note on the significance of the size of nerve fibers in fishes. *The Journal of Comparative Neurology*, Vol. 12, No. 4, pp. 329-334.
- JOHNSTON, J. B.  
 1908. On the significance of the caliber of the parts of the neurone in vertebrates. *The Journal of Comparative Neurology and Psychology*, Vol. 18, No. 6, pp. 609-618.
- RIVERS, W. H. R., and HEAD, HENRY.  
 1908. A human experiment in nerve division. *Brain*, Vol. 31, pp. 323-450.
- SCHWALBE, G.  
 1882. Ueber die Kaliberverhältnisse der Nervenfasern. *Leipzig*.
- SHERRINGTON, C. S.  
 1894. On the anatomical constitution of nerves of skeletal muscles, with remarks on recurrent fibers in the ventral spinal nerve roots. *The Journal of Physiology*, Vol. 17, p. 211.

# FACTORS DETERMINING THE REACTIONS OF THE LARVA OF TENEBRIO MOLITOR.

BY

MAX MORSE.

WITH TWO FIGURES.

The coleopteran genus *Tenebrio* is represented in America by several species, but a few of the commonest and best-known members are introduced species, which have been imported from Germany. I refer to *Tenebrio molitor* and *obscura*. The adults of these two forms may be readily distinguished by differences in texture of the elytra, but the larvæ are distinguishable except to the trained entomologist who is familiar with the various species. The species *molitor* is the better known, although *obscura* is found associated with it very frequently. Both species may be obtained, throughout the year, from natural history and aquarist shops in the larger cities, where they are used as food for birds, lizards, and the like.

The reactions of these larvæ to light have been studied by Loeb ('91), by Radl ('03) and by Cole ('07). Loeb found them to be decidedly negatively phototactic, and he also described marked stereotropism (as Radl did later) which overpowers even the strongly negative reaction to light. Cole made a detailed study of the reaction of the larvæ to luminous areas of different sizes.

The following observations concern the method of response of the animals to light and gravity.

Before entering into the discussion of the reactions, a word may be said concerning the organs for the reception of light. These lie on either side of the head, immediately posterior to the base of the antennæ, upon the elevation bounding the antennal sulcus posteriorly. They may be recognized by the brownish pigment which may be seen

through the chitin overlying the light receptor apparatus. I have sectioned heads of the larvæ and been enabled to study the histology of the organs in Delafield hematoxylin stains. A median section through one organ is shown in the accompanying Fig. 1. In this particular section, the chitin overlying the area had been torn off by the microtome knife, but in other sections, where, unfortunately, the histological elements were not as well preserved as in the present one,



FIG. 1.—*a*, section through an eye-spot of a larva of *Tenebrio molitor* at right angles to the surface of the body. *b*, portion of chitin covering the eye-spot of another section, in which the chitin overlying this eye-spot was intact. The canals running from the surface to the interior through the chitin are characteristic of the chitin over the whole of the head and not of this part of the body alone.

the chitin was intact, and I have drawn in *b* a portion to show the characteristic structure. As Cole remarks, there are no lenses formed in the chitin over the "eyes," nor is there any difference in the transparency of the chitin in these regions from that over other parts of the head. When the eyes are examined in the living animal, with a hand-lens, it is seen that the chitin is as dense and as opaque to light as in other parts of the body. This fact, with the condition of the other elements of the eyes, indicates that the whole apparatus is structurally an imperfect organ for the reception of light.

Immediately beneath the chitin is a single layer of deep cells with conspicuous nuclei, and these cells pass into a region of yet deeper (longer) cells as we pass from the pigmented area. There is thus left, in the region of the pigment, a space containing the pigment and a granular material of apparently homogeneous constitution. The pigment is grouped in two cups into the bases of which delicate fibers, presumably nerve fibers, enter. I have not been able to determine from my material, whether there are any elements which might be light-receiving in function within these cups, *i. e.*, between the pigment and the layer of cells lying immediately beneath the chitin. The pigment seems to be absent from the region at the bases of the cups, where the fibers enter, and the sensory organs may lie in this region. The fibers lead from the pigment bodies posteriorly, where the two sets join and then, turning laterally, pass out into the cellular mass at the sides and in the rear of the eye-spots, where they become indistinguishable. I have not been able to examine the eyes in a neurological stain, as should be done, but the general character of these organs may be gained from this brief study.

#### OBSERVATIONS.

*The body surface as a whole is sensitive to light of great intensity.* A larva was placed in a rubber tube 5 cm. long, having a bore such that the worm fitted snugly within it. The anterior end of the larva was directed towards the sunlight which fell obliquely upon the tube. The larva soon began to crawl backward and finally the tip of the abdomen was pushed out of the tube into the sunlight for three or four segments. Immediately the worm reversed its direction of motion and crept back into the tube. A heat-filter had been interposed between the sun and the tube and cooled paper had been introduced beneath the tube, so that heat reactions were eliminated. The same reaction was observed in cases where the tip of the abdomen became exposed to the sunlight as the worm maneuvered in the shadow and inadvertently threw its abdomen outside the shadow. When the tip of the abdomen, which had previously been painted with a mixture of lampblack and vaselene, was exposed to the sunlight, no reaction followed.

Nevertheless, there is no orientation exhibited by virtue of this reaction. This was made evident by painting one side of the animal with the lamp-black mixture, leaving the head exposed. A worm thus treated turned away from the light, bending the body indifferently towards the right or the left, as in a normal specimen. Obviously, if the worm were oriented by unilateral stimulation of the general body surface, it would turn in the direction of the covered side, the light affecting the exposed portion causing greater movement on that side and hence the bending away from it.

*Orientation takes place by means of the light receptors, entirely.* These organs of both sides of the body were covered and the larva thrown into the sunlight with its anterior end directed towards the light. The animal was entirely indifferent, moving directly towards the light as well as away from it. The ocelli are therefore the only organs of orientation to light in the larva.

Unilateral stimulation was then examined. The pigment spots of one side (the right) were covered with the mixture and the worm placed in the light as before. Orientation occurred, whereby the larva turned away from the light and continued in a more or less straight path as far as it was permitted to go. One individual in forty exhibited circling. This larva had the ocelli on the right side blackened and when placed in the illuminated area, it began to move in circles with the covered side within. However, after a few circles, the animal ceased circling and moved in a straight path away from the light. A check was made to this experiment, to obviate any chance of some of the ocelli being left exposed, by the use of a hot needle to sear the chitin of that side of the head. When this was done on *both* sides of the head, no response to light was given, and it is fair to assume that when applied to one side, it is equally efficient.

The fact that the ocelli on one side of the head were able to orient the animal, was seen in another set of experiments. An individual was selected to fit the rubber tube and the ocelli on the right side of the head were covered with the lampblack mixture. The anterior end of the animal was directed towards the light. Diffuse light was used. As the animal emerged from the tube, the number of times it turned to the right and the number of times to the left were

counted. In order to be certain that the experiment was conducted in as normal and natural a manner as possible, a long tin box, a meter long and two decimeters square, blackened within and provided with a window at either end, one of which being used by the observer from a hood, was employed and the tube discarded. After covering the ocelli, of one side (the right), and placing the animal within the box with its long axis in the long axis of the box, facing the light, the number of times it turned towards the right or the left was observed and the results are recorded below:

1.....	Right	14.....	Right
2.....	Left	15.....	Right
3.....	Left	16.....	Left
4.....	Left	17.....	Left
5.....	Left	18.....	Right
6.....	Right	19.....	Right
7.....	Left	20.....	Left
8.....	Left	21.....	Right
9.....	Left	22.....	Right
10.....	Left	23.....	Left
11.....	Left	24.....	Left
12.....	Left	25.....	Left
13.....	Right		

About one-third of the reactions, it will be seen, are dextral while two-thirds are sinistral. It is evident from this that unilateral stimulation has no orienting effect or else such an effect is compensated. If there were such an effect, there would scarcely be such a large proportion of reactions not amenable to the rule. Moreover, judging from the circling experiment, where the circling is towards the covered side, the data here given are exactly the reverse of what we should expect. Similar indefiniteness of reaction is to be seen in the behavior in general. These random movements will now be considered.

*Random movements.* As the larva crawls away from the light, the head is seen to sway from side to side rhythmically, as if performing testing movements. The amplitude of the sway is such

that the ocelli of one side or the other are exposed to light, coming, of course, from the rear. Then the head is swung to the opposite

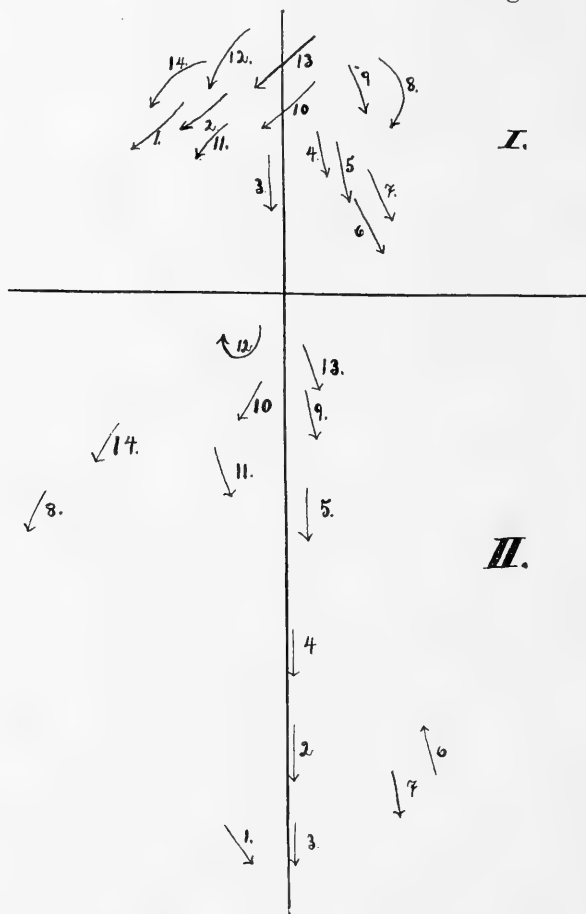

FIG. 2.—Chart showing the positions of fourteen larvæ, which had been thrown promiscuously into an illuminated area (the light coming from the top of the chart), the positions being taken in I a few seconds after their exposure to the light and in II one minute afterwards. The individuals are designated by numbers to aid in comparing their successive positions.

side until the ocelli of that side are exposed, and the action is repeated.

The testing movements are seen in other cases. Thus, when a



worm is first thrown upon an illuminated area, it very frequently does not immediately orient, but the head is swung from side to side and up and down, and only after this is done is a definite direction taken.

Cole mentions similar observations. The chart herewith given represents the positions of fourteen individuals a few seconds after being thrown into an illuminated area (I) and again one minute after this (II). Within this time, some had moved a decimeter away (number 3, for example,) while others (as number 13) had simply swung in their tracks.

In the case of unilateral stimulation made by covering the ocelli of one side, we see the same testing movements. In this case, when the sway is greater towards one side than the other, the path is a segment of a circle. Such movements may be so compensated that the path is straight.

In many respects, the reactions of this larva are similar to those described by Jennings ('06) for *Lumbricus*. Thus, if the larva be stimulated first on one side and then on the other, one of the following reactions may occur:

1. It may turn towards the stimulated side.
2. It may turn away from that side.
3. It may creep backward.
4. It may creep forward.
5. It may raise and lower its head and wave it about.

These reactions may follow in the same individual or they may be exhibited successively, by different worms. I have found it impossible to correlate these variations of behavior with external factors.

As to the method of reaction with respect to random movements little can be said. At first glance, it seems evident that the orientation is the result of a selection of such random movements. Closer study leaves one in doubt as to whether there is not something more to be determined. The circling reaction is such as one would expect to find if there is a mechanical response such as the theory of tropisms demands. In only one case were circling movements observed, and then only for a short time, but whether this single case represents anything with bearing on the general question is doubtful.

The tropism theory, at least in its naïve form, cannot be made to apply to the behavior of this larva. It has been already shown that, although the general body-surface is sensitive to light, no orientation is produced thereby. Again, if two of the three legs be removed from one side of the body and the animal placed in the light, the normal orientation takes place. The same results are obtained if the ocelli on one side of the body are covered. Obviously, then, compensation occurs so that even in the absence of the two legs the function is taken up by the remaining one.

Harper ('05) determined for the earthworm, *Perichæta*, that the stronger the light, the more regular the reactions and the fewer the random movements. The meal-worm exhibits the same condition.

*Geotactic responses.* The larvæ are positively geotropic. An individual was placed on an incline in a dark-room where the only illumination was from a red photographic lantern. Previously, it was determined that the larva did not react to this light. The larva reacted to inclinations of 5 degrees or more, by moving down the incline. Compared with phototactic responses, geotactic are insignificant. If an individual be placed on an incline with light of even low intensity falling from the lower end, the animal will move up the incline rather than approach the light.

In this connection, the reactions of those larvæ which were found running on the surface of the meal, were examined. It was suspected that such larvæ were either positively phototactic or negatively geotactic. They proved to be neither. Intensity of light seems to have some effect, for if a strong light be suddenly thrown upon them, they immediately begin to burrow. A mechanical shock produces the same effect. Thigmotactic reactions were tried, such as sifting meal upon them or piling it in front of them as an invitation to burrow, but none did so.

It is evident that this larva, low in the scale as it is, presents highly complex behavior, the factors of which are but slightly known.

LITERATURE CITED.

COLE, L. J.

An experimental study of the image-forming powers of various types of eyes. *Proc. Am. Acad. Arts and Sciences*, vol. 42, pp. 335-417. 1907.

HARPER, E. H.

Reactions to light and mechanical stimuli in the earthworm, *Perichæta bermudensis*. *Biol. Bull.*, vol. 10, pp. 17-34. 1905.

JENNINGS, H. S.

Modifiability in behavior. II. Facts determining direction and character of movements in the earthworm. *Journ. Exp. Zool.*, vol. 5, pp. 435 ff. 1908.

RADL.

Untersuchungen in den Phototropismus der Thiere. Leipzig, 1903.

LOEB, J.

Untersuchungen zur physiologischen Morphologie der Thiere. Würzburg, 1891.





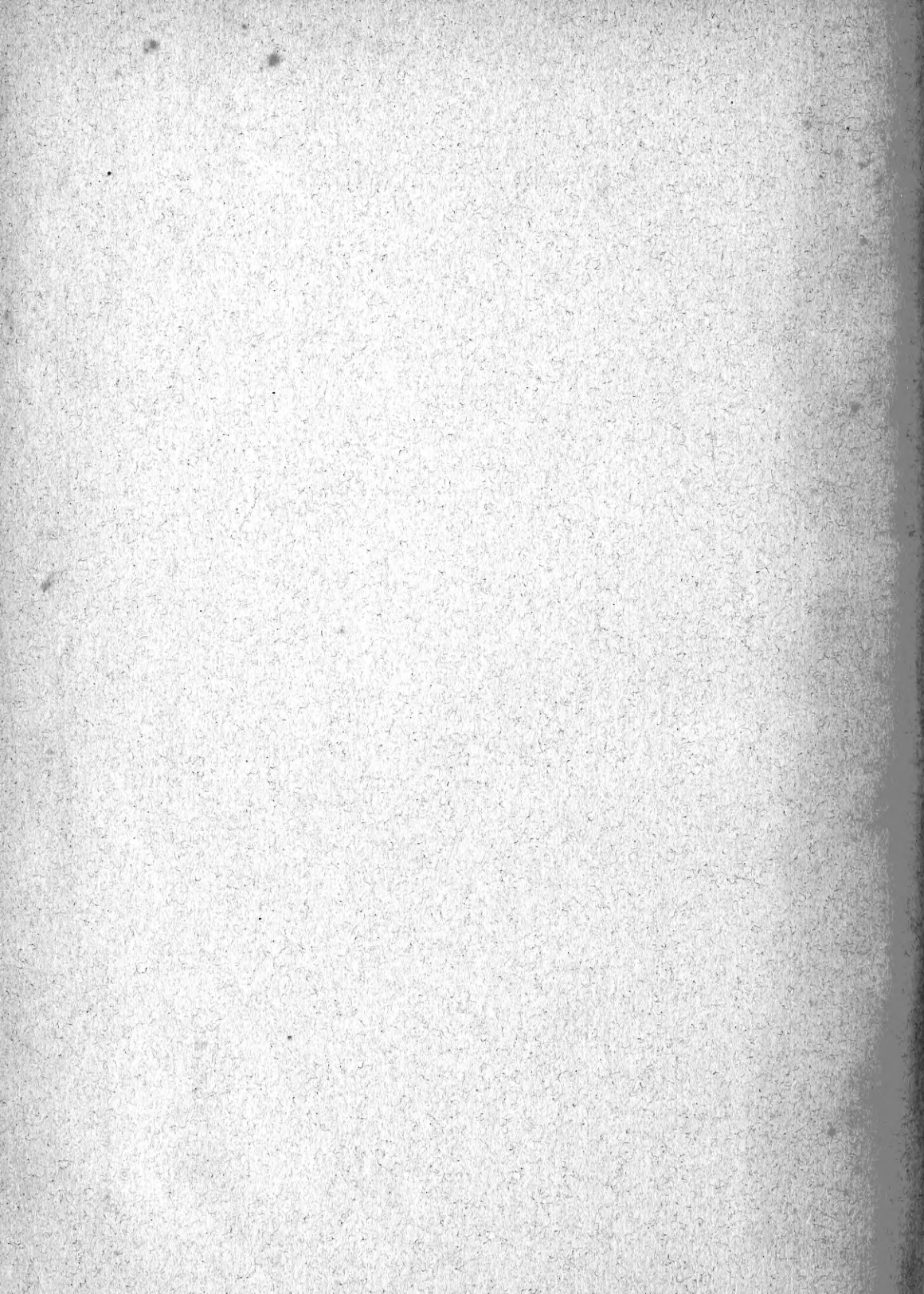

MBL WHOI Library - Serials



5 WHSE 01973

1107

