

*Education.*—Instruction in the principles of mechanics and in their practical application to agriculture should be given to youths above the age of fourteen. By means of short courses and extension lectures the needs of farmers and specialized workers who require more than a general knowledge of agricultural machinery could probably be met, and local authorities should be encouraged to provide instruction in such subjects as tractor driving and mechanics, and the principles of internal combustion engines.

The committee recognize the difficulty in securing efficient instructors. The type of instructor required is a combination of the engineer and the agriculturist. Instruction in engineering, including workshop practice, should form the basis of his training, and should be followed by instruction in agriculture.

Agricultural machinery should be given a more prominent place in the curricula of agricultural colleges and farm institutes, and in the case of the former there should be attached to the staff at least one specialist whose whole time would be available for teaching and advisory work on this subject.

Further, there should be available at each institution besides the machinery and implements used on the farm, a well-equipped machinery workshop, and an exhibition of the principal types of machines and implements on the market.

*Advice and Propaganda.*—Expert advice on the subject of agricultural machinery should be provided in all counties, and the Ministry of Agriculture should encourage and co-ordinate demonstrations of agricultural machinery in every county or area. Local lectures illustrated by the lantern and kinematograph should be encouraged, and for this purpose lantern slides and kinematograph films, illustrating the use and care of agricultural implements and machines, might be provided by the Ministry of Agriculture.

As to propaganda, the committee is of opinion that nothing promises such success as demonstrations conducted by persons of known impartiality and adequate technical knowledge. But not everything can be demonstrated, and there is also need of the above-mentioned lectures with kinema and lantern, and well-chosen and attractive posters and pamphlets. These, in turn, may be supplemented by attractively written and illustrated articles supplied to the local press.

---

### Plant Nurseries in Quarantine for Pests.

The nurseries listed in the last two issues of the *Journal* (pages 287 and 348) were still in quarantine on the 1st July, 1920, with the exception of the following, which have been released:—

E. Krohn, Esselen Street, Pretoria.

J. H. Laubscher, Graaff-Reinet.

Botanic Gardens, Graaff-Reinet.

---

Keep your *Journals*! The contents will be indexed every six months and a copy of the index sent to each subscriber.

## RODENT INJURY TO TREES.

### Cause, Prevention, and Repair.

By W. F. SCHLUPP, B.Sc. (Agr.), Entomologist, School of Agriculture and Experiment Station, Potchefstroom, Transvaal.

RODENT injury to trees is of frequent occurrence in certain parts of the Union. In this article the various ways and means of dealing with the problem are discussed. The farmer or fruit grower can select the method best suited to his own particular case.

The trees most commonly injured are those of the orchard, but occasionally shade trees and plantations are damaged. This article deals principally with the protection of fruit trees, but some of the methods described are adaptable in other cases.

The rodents responsible for the damage are hares, field mice and rats. In addition to rodents, small antelopes sometimes do much injury.

*Cause of Rodent Injury.*—The damage is nearly always done in winter and spring, and the immediate cause is a lack of green plants and other food. However, in most of the cases that have come to the notice of the writer the primary cause has been neglect of the orchard. By allowing a rank growth of grass and weeds to spring up, favourable conditions for rodents are produced; the vegetation affording the animals a shelter from hawks, owls, and other natural enemies.

*Preventive Measures.*—The best preventive measure is clean cultivation. By this we mean keeping the orchard free of weeds, etc., during the dry season, as it is in dry winters and springs that the trees are generally attacked. During the wet summer season a cover crop may be grown, but at the end of the rainy season this should be ploughed under and not allowed to remain on the ground over winter. Grass and other vegetation growing around trees should be destroyed. In addition to sheltering rodents, rank vegetation may sometimes increase the chance of damage by insects and fungi.

When all that is desired is protection of the trees from a few rodents that occasionally enter the orchard, the winter prunings are sometimes left lying on the ground until spring, in order that the animals may feed upon these instead of upon the trees. A few cabbages, mangels, etc., could also be placed about the orchard. This is sometimes successful in preventing injury, but is only a compromise measure and may at times result in attracting a few more rodents to the vicinity.

*Fencing.*—Rat and mouse proof fences are practically out of the question. For hares, poultry netting with 1½-inch meshes is suitable. A height of 3 feet is suggested, although 2½ feet or even 2 feet would



XJ  
•0876

Vol. 1  
1920

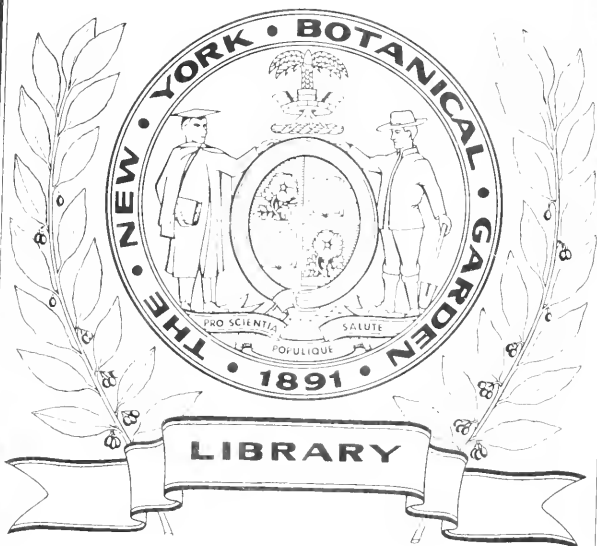





630-70  
808



UNION OF SOUTH AFRICA

DEPARTMENT OF AGRICULTURE

JOURNAL  
OF THE DEPARTMENT OF  
AGRICULTURE

VOLUME I.—APRIL TO DECEMBER, 1920

*Published by the*  
*DEPARTMENT OF AGRICULTURE*  
*PRETORIA*

LIBRARY  
NEW YORK  
— BOTANICAL  
GARDEN

PRETORIA  
THE GOVERNMENT PRINTING AND STATIONERY OFFICE  
1921

	PAGE
Cattle, Export of, from the Union to Great Britain (Note) .....	196
Cattle, Importation of .....	159
Cattle in the Union .....	278
Cattle, Poisoning of, by Feeding on Ergotized Paspalum .....	422
Cattle, Poisoning of, by Feeding on Old Mealie Lands .....	138
Cattle, Sale of, in Southern Rhodesia (Note) .....	596
Cattle, The Prevention of Contagious Abortion in .....	8
Cause and Prevention of Lamziekte, The .....	221
Cereal Crops and of Supply, Prospects of (Note) .....	582
Cereal Experiments at the School of Agriculture, Elsenburg, Results of Winter .....	45, 111
Cereals, Position of the World's (Note) .....	608
Cheese, Butter and (Note) .....	482
Cheese, Butter and Export of (Note) .....	607, 708
Cheese, Poor Grade Australian (Note) .....	804
Chemical Analysis of Soils .....	341
Chemical Laboratories, New (Note) .....	610
Cigar Tobacco Investigations .....	427
Cinema Films Depicting South African Agriculture, Exhibition of (Note)...	703
Citrus Canker, The Eradication of .....	124
Citrus Export, Experiments (Note) .....	622
Citrus Export, Season 1920 (Note) .....	291, 740
Citrus Fruit Shipments, Preventing Wastage in (Note) .....	799
Coccidiosis of the Fowl .....	815
Composition and Valuation of Fertilizers and Feeding Stuffs .....	368, 591
Consignors of Produce, Advice to (Note) .....	608
Contagious Abortion in Cattle, The Prevention of .....	8
Co-operation in Agriculture, Fundamental Principles of .....	383
Co-operation in England, Agricultural (Note) .....	257
Corrigenda .....	591, 679, 795, 867
Cotton Culture .....	615, 795
Cotton Exports (Note) .....	350
Cotton Gins (Note) .....	588
Cotton Growers' Competitions .....	804
Cotton-growing Prospects (Note) .....	192
Cotton-seed, Importation of (Note) .....	709
Cotton-seed, The Danger Lurking in Imported (Note) .....	798
Cow-testing Associations .....	149
Crop and Live Stock Report .....	107, 218, 313, 410, 506, 602, 696, 791, 887
Crops, 1919-20, The Union's Summer (Note) .....	428
Crops, The World's (Note) .....	483, 710
Crossing of North African and South African Ostriches, The .....	737
.	
Dairy, Plan of a Small Farm .....	862
Dairy Show, London, Successful Exhibits (Note) .....	83
Dasheen Root, Madumba (Note) .....	806
Departmental Notices .....	316
Department of Agriculture during the War, The .....	183, 271, 363, 463, 551, 643
Dipping of Sheep in So-called Carbolic Dips, The .....	536
Dipping, Sheep, The Use of Hard or Saline Waters for .....	40
Dipping Tanks, Pretoria District (Note) .....	803
Dip-testing Apparatus (Note) .....	610
Disease, Animal (Note) .....	705
Diseases in the Union, Outbreaks of Animal .....	779, 880
Domestic Animals and Poultry in South Africa, Ticks Found on Man and	317
Drought Commission (Note) .....	611
Drought of 1918-19, The .....	144
Drying-out of Maize during Rail Transit (Note) .....	398
.	
East Coast Fever in the Pretoria District (Note) .....	455, 612
East Coast Fever, Practical Hints for the Prevention and Eradication of	58
East Coast Fever, Recent Outbreaks of (Note) .....	396
Effects of Storms on Certain Forests in the Tsolo District, Cape Province	750
Egg-laying Competition .....	172 (Note) 614
Egg-laying Competition, Cedara (Note) .....	707
Eggs, Export of (Note) .....	611



	PAGE
Eggs and Poultry, South African, Export of .....	258
Eggs, South African Standard for, and Poultry .....	64
Elevators, Grain (Note) .....	397
Employees on Farms (Note) .....	530
Entomological Conference, A Successful (Note) .....	607
Entomology, Notes from the Division of .....	168
<i>Eucalyptus Globulus</i> , Parasitic Attack on .....	852
European Corn Borer, The (Note) .....	123
European Foul Brood Bee Disease .....	245
Experiments, Citrus Export (Note) .....	622
Experiments and Investigations .....	162, 281, 388, 478
Experiments, Land for: "Prinshof" (Note) .....	610
Export of Cattle from the Union to Great Britain (Note) .....	196
Extent of the Union and the Area Cultivated (Note) .....	394
Factors that Affect the Growth, Reproduction, and Maturity of Tobacco .....	728
Farm Foods, The Fertilizers, Seeds, and Pest Remedies Act (No. 21 of 1917) .....	32
Farm Labour, Recruitment of (Note) .....	290
Farming in the Early Cape Days .....	531
Farms, Employees on (Note) .....	530
Fattening, Lamb .....	458
Feeding Stuffs, Composition and Valuation of Fertilizers and .....	368
Fencing (Note) .....	382, 591
Fencing Materials (Note) .....	642
Fertility of the Soil, Building up the .....	755
Fertilizers and Feeding Stuffs, Composition and Valuation of .....	368, 591
Fertilizers, Farm Foods, Seeds, and Pest Remedies Act (No. 21 of 1917) .....	32
Fibre Plants, South African .....	570
Fire Protection, Methods of .....	413
Flag Smut of Wheat .....	252
Flanagan, The Gift of the Late Mr. (Note) .....	85
Flowering Plants of South Africa, The (Note) .....	705
Foul Brood Bee Disease, European .....	245
Fowl, Coccidiosis of the .....	815
Fowl Lice, Naphthalene for (Note) .....	557
Friesland Bull, "Admiral Beatty." The (Note) .....	288
Fruit and Vegetables, A Great Manufacturing Scheme (Note) .....	390
Fruit Crop, Western Province (Note) .....	584
Fruit Export (Note) .....	625, 721, 861
Fruit Export Act, The .....	349
Fruit Export, July, 1920: A Record Shipment (Note) .....	585
Fruit-fly Remedy, The Mally .....	859
Fuller, Mr. Claude: A Recognition (Note) .....	711
Fundamental Principles of Co-operation in Agriculture .....	383
<i>Gazette</i> , Notes from the .....	94, 204, 304, 402, 492, 587, 681, 772, 869
Geese .....	732
Grafted Vineyards .....	561
Grain-eating Birds: A Poison (Note) .....	560
Grain Elevators (Note) .....	397
Grain, etc., Export of .....	106, 217, 244, 340, 505, 589, 754, 833
Grain, Sterilization of (Note) .....	828
Growing of Mine Props on the High Veld, The .....	261
Gum, South African, A (Note) .....	75, 834
Ham and Bacon (Note) .....	612
Hemp, Ambari or Deccan (South African Fibre Plants) .....	570
<i>Hibiscus cannabinus</i> , L. (South African Fibre Plants) .....	570
Hides and Skins .....	809, 858
Hides, Curing of (Note) .....	83
Hides, Pure Salt for (Note) .....	851
Hides, Wet, for Shipment: Marking of Goods (Note) .....	167
Hive made from Paraffin Boxes, A Cheap Serviceable .....	844
Honey (Note) .....	270

	PAGE
Importation of Cattle, The .....	159
Imported, Pure-bred Stock .....	678
Index for the <i>Journal</i> (Note) .....	581
Infectious Diarrhœa: "Bloedpens" in Lambs .....	286
Inoculation and Dosing of Breeding Ewes (Note) .....	808
Inspection of Vines: Notice to Viticulturists and Vine Nurserymen (Note) .....	711
International Refrigeration Conference at Paris (Note) .....	289
Investigation and Research .....	76
Investigations and Experiments .....	162, 281, 388, 478
Irrigation, Brak in its Relation to .....	13
Irrigation Enterprise in the United States of America .....	829
Irrigation in the Union .....	676
Jams, South African (Note) .....	44
John, Death of Mr. W. O. (Note) .....	701
Jointed Cactus Extermination, Prickly Pear and (Note) .....	481
<i>Journal</i> , Important Notice (Note) .....	187
<i>Journal of the Department of Agriculture</i> .....	1
Kaffir Corn, Production in the Union (Note) .....	182
Karakul Sheep .....	509, 626
Karakul Sheep, Registration of (Note) .....	710
Kudzu .....	558
Lamb Fattening .....	458
Lambs, "Bloedpens" in: Infectious Diarrhœa .....	286
Lamziekte. The Cause and Prevention of .....	221
Leaf Spot of the Pea Nut or Monkey Nut, A .....	528
Library of the Department of Agriculture, The .....	135
Limestone Resources of the Union (Note) .....	80
Literature, Agricultural (Note) .....	805
Literature, Recent Agricultural .....	96, 206, 305, 403, 496, 593, 687, 780, 876
Live Stock Mortality in the Union (Note) .....	295
Live Stock (Pure-bred Stock Imported) .....	678
Live Stock, Sale of, at Cedara School of Agriculture (Note) .....	490
Live Stock, Sale of, at Grootfontein (Note) .....	611
Local Market, The (Note) ( <i>see</i> under "Market") .....	606
Locusts, Control of (Note) .....	708
Locusts (Note) .....	797
Lucerne-seed (Note) .....	841
Lung-sickness: An Outbreak (Note) .....	612
Machinery, Development of Agricultural .....	442
Madumba (Dasheen) Root (Note) .....	806
Maize, Cost of Production of (Note) .....	600, 801
Maize Crop of the Union, The (Note) .....	294
Maize Crop, 1920. United States (Note) .....	801
Maize during Rail Transit, Drying Out of (Note) .....	397
Maize Production in the Four Provinces (Note) .....	186
Mahlet and Wattle Bark (Note) .....	706
Mally Fruit-fly Remedy, The .....	859
"Mariendahl," Purchase of (Note) .....	194
Marketing of Meat (Note) .....	486
Market Prices, Local .....	110, 220, 315, 412, 508, 604, 679, 698, 699, 793, 794, 890, 891
Mealie Lands, Poisoning of Cattle by Feeding on Old .....	138
Meat Export (Note) .....	82
Meat, Frozen (Note) .....	54
Meat, Marketing of (Note) .....	486
Meat Statistics .....	105, 216, 312, 409, 504, 601, 695, 790, 887
Meat Supplies for the United Kingdom .....	655
Meetings of Officers of the Department (Note) .....	797
Menace of Anthrax, The .....	671, 795
Merino Ram, The (Note) .....	189
Mine Props on the High Veld, The Growing of .....	261
Minister of Agriculture, The (Note) .....	187
Monkey Nut, Leaf Spot of the Pea Nut or .....	528
Monkey Nut (Pea-nut Growing) (Note) .....	642

	PAGE
Mohair Market (Note) .....	731
Mohair, Valuable Exhibit of Manufactured, and Wool (Note) .....	717
Mylabris Beetles .....	741
Nagana (Note) .....	705
Naphthalene for Fowl Lice (Note) .....	557
Notes from the Divisions .....	168, 591, 685, 777, 874
Orange River, Along the .....	359
Orange Stocks Used in California (Note) .....	654
Organization of Farmers (Note) .....	161
Ostriches, The Crossing of North African and South African .....	737
Ostrich Feathers (Note) .....	480
Oversea Market, South African Produce on the 86, 200, 300, 411, 493, 589, 683, 774, 871	871
Paper, Shortage of .....	221
<i>Pappea capensis</i> Seed .....	760, 867
Parasitic Attack on <i>Eucalyptus globulus</i> .....	852
Paspalum, Poisoning of Cattle by Feeding on Ergotized .....	422
Pea-nut Growing (Note) .....	642
Pea Nut or Monkey Nut, A Leaf Spot of the .....	528
Pernicious Scale in the Orange Free State (Note) .....	171
Pest, Fighting a Notorious: Pink Boll-worm (Note) .....	527
Pest Remedies Act (No. 21 of 1917), The Fertilizers, Farm Foods, Seeds, and .....	32
Pests, Imported (Note) .....	169
Pig as an Economical Producer of Food, The .....	623
Pig Production (Note) .....	277
Pink Boll-worm (see Note, Fighting a Notorious Pest) .....	527
Pirbright Cattle-Testing Station (Note) .....	85
Plan of a Small Farm Dairy .....	862
Plant Nurseries in Quarantine for Pests (Note) 190, 287, 348, 444, 590, 670, 740, 818	818
Poisoning of Cattle by Feeding on Ergotized Paspalum .....	422
Poisoning of Cattle by Feeding on Old Mealie Lands .....	138
Poison, A: Grain-eating Birds (Note) .....	560
Poisons, Rat (Note) .....	485
Poor-white Problem, The (Note) .....	764
Pork and Bacon, South African (Note) .....	457
Poultry and Eggs, South African, Export of .....	258
Poultry and Eggs, South African Standard for .....	64
Poultry Congress, World's (Note) .....	706
Poultry in South Africa, Ticks Found on Man and His Domestic Animals and .....	317
Poultry Shows: Organization (Note) .....	196
Poultry Yard Month by Month .....	197, 298, 400, 489, 585, 679, 770, 867
Practical Hints for the Prevention and Eradication of East Coast Fever...	58
Prevention of Lamziekte, The Cause and .....	221
Prices, Oversea, of South African Produce 91, 202, 302, 495, 590, 684, 776, 795, 873	873
Prickly Pear (Note) .....	802
Prickly Pear and Jointed Cactus Extermination (Note) .....	481
Prickly Pear as a Stock Food .....	848
"Prinshof": Land for Experiments (Note) .....	610
Produce, Advice to Consignors of (Note) .....	608
Produce on Show, South African (Note) .....	569
Produce on the Oversea Market, South African 86, 200, 300, 411, 493, 589, 683, 774, 871	871
Produce, Oversea Prices of South African 91, 202, 302, 495, 590, 684, 776, 795, 873	873
Producer of Food, The Pig as an Economical .....	623
Productive Wealth of the Union (Note) .....	582
Progress of Agriculture in South Africa, The .....	3
Pure-bred Stock Imported .....	678

	PAGE
Railage of Sheep to Fresh Pasturage (Note) .....	428
Railway Figures, Interesting (Note) .....	426
Railway Transport: Hints to Consignors (Note) .....	581
Rams, Care of (Note) .....	395
Rat Poisons (Note) .....	485
Rats, Danger of (Note) .....	260
Rats in Sugar-cane .....	55
Recruitment of Farm Labour (Note) .....	290
Refrigeration Conference at Paris, International (Note) .....	289
Research and Investigation .....	76
Results of Winter Cereal Experiments at the School of Agriculture, Elsenburg .....	45,
Retirement of the Secretary for Agriculture (Note) .....	605
Rhodesian Cattle and Maize (Note) .....	580
Rinderpest (Note) .....	803
Rodent Injury to Trees .....	445
Sale of Cattle in Southern Rhodesia (Note) .....	596
Sale of Live Stock at Cedara School of Agriculture (Note) .....	490
Sale of Live Stock at Grootfontein (Note) .....	611
Scholarships in Agriculture, Oversea (Note) .....	704
Schools of Agriculture and Experiment Stations, At the 100, 209, 308, 406, 500, 597, 690, 785.	881
Secretary for Agriculture, Retirement of the (Note) .....	605
Seed, <i>Pappia capensis</i> .....	760,
Seeds, Export of (Note) .....	188
Seeds, Some Common Adulterants Found in Agricultural .....	26
Seeds: The Fertilizers, Farm Foods, and Pest Remedies Act (No. 21 of 1917) .....	32
Seville Oranges (Note) .....	866
Sheep and Wool Industry, Concerning the (Note) .....	79
Sheep for the Export Trade, Breeding .....	838
Sheep in So-called Carbolic Dips, The Dipping of .....	536
Sheep, Railage of, to Fresh Pasturage (Note) .....	428
Sheep, The Use of Hard or Saline Waters for Dipping .....	40
Shortage of Foodstuffs and Raw Materials (Note) .....	81
Skins, Hides and .....	809,
Skins, Seal, Remarkable Prices (Note) .....	208
Skins, Sheep and Goat (Note) .....	187
Soil, Building up the Fertility of the .....	755
Soils, Chemical Analysis of .....	341,
Soils of the Cape Province, The Agriculture and .....	152, 351, 429, 660,
Soils, Representative Transvaal .....	704,
Spinose Ear-tick, The .....	647
Springhaas (Note) .....	314
Staff Changes, Appointments, Transfers, etc. 92, 203, 303, 411, 488, 592, 694, 789.	887
Stock Food, Prickly Pear as a .....	848
Storms on Certain Forests in the Tsolo District, Cape Province, The Effects of .....	750
Straw, Wheat, and Its Value to the Land .....	712
Sugar-cane, Rats in .....	55
Sunflower Seed Export (Note) .....	659
Ticks Found on Man and His Domestic Animals and Poultry in South Africa .....	317
Timber Resources, The Union's (Note) .....	675
Timber Supply, The Union's (Note) .....	807
Tobacco, Cigar, Investigations .....	427
Tobacco, Factors that Affect the Growth, Reproduction, and Maturity of Tobacco-leaf Beetle (Note) .....	728
Tobacco-leaf Slug (Note) .....	168
Tobacco-leaf Slug (Note) .....	709
Toktokje Beetles in Millions (Note) .....	169
Toll of the War, The .....	646
Tomato Canker, A .....	718
Tractors, Offer of (Note) .....	749
Trade, The Union's External .....	213

	PAGE
Transvaal Soils, Representative .....	704, 722
Trees, Rodent Injury to .....	445
Tsetse Fly Investigations (Note) .....	799
Turkeys .....	472
Use of Hard or Saline Waters for Sheep Dipping, The .....	40
Vaccines, etc., Telegraphic Requests for (Note) .....	171
Vegetable Garden, The .....	199, 299, 401, 491, 586, 681, 770, 868
Vegetables, Fruit and: A Great Manufacturing Scheme (Note) .....	390
Vines, Inspection of: Notice to Viticulturists and Vine Nurserymen (Note) .....	711
Vineyards, Grafted .....	560
Vintage of South Australia, The 1920 .....	754
War, Agriculture and the .....	66
War, The Department of Agriculture during the ... 183, 271, 363, 463, 551, .....	643
War, Toll of the .....	616
Wattle Bark, Composition of Natal (Note) .....	702
Wattle Bark, Mallet and .....	706
Weeds of South Africa: "Canada Thistle" .....	73
Wheat and Flour (Note) .....	367
Wheat Crop of 1919-20, The World's (Note) .....	296
Wheat Crop of the World, The (Note) .....	808
Wheat, Flag Smut of .....	252
Wheat-growing in South Africa (Note) .....	191
Wheat Production of the Union (Note) .....	190
Wheat-straw and its Value to the Land .....	712
Wheat, The World's: A Forecast (Note) .....	609
Willow Leaves, Food Value of .....	456
Wine and Brandy, Prize (Note) .....	291
Wine Competition, 1919, Colonial (Note) .....	193
Winter Cereal Experiments at the School of Agriculture, Elsenburg, Results of .....	45, 111
Women's Work (Note) .....	158
Wool Industry, The (Note) .....	609
Wool Prices, The Great Advance in (Note) .....	296
Wool, Valuable Exhibit of Manufactured, and Mohair (Note) .....	717
World's Cereals, The Position of the (Note) .....	608
World's Crops (Note) .....	483, 710
World's Harvest, The (Note) .....	134
World, Wheat Crop of the (Note) .....	808



# AUTHORS' INDEX.

	PAGE
Bagnley, A., B.Sc., F.I.C.—Building up the Fertility of the Soil ... ..	755
Baker, E., B.Sc., Lecturer in Botany, Elsenburg School of Agriculture— Methods of Fire Protection ... ..	413
Bedford, G. A. H., F.E.S., Entomologist, Division of Veterinary Research, Onderstepoort, Transvaal—Ticks Found on Man and His Domestic Animals and Poultry in South Africa ... ..	317
Botha, C. Graham, Chief Archivist for the Union—Farming in the Early Cape Days ... ..	531
Bottomley, A.M., B.A., Mycologist, Division of Botany; and K. A. Carlson, Conservator of Forests, Transvaal Conservancy—Parasitic Attack on <i>Eucalyptus globulus</i> ... ..	852
Carlson, K. A., Conservator of Forests, Transvaal Conservancy—The Growing of Mine Props on the High Veld ... ..	261
Carlson, K. A., Conservator of Forests, Transvaal Conservancy, and A. M. Bottomley, B.A., Mycologist, Division of Botany—Parasitic Attack on <i>Eucalyptus globulus</i> ... ..	852
Cillie, P. J. (C.'s son), Member of Commission of Investigation—Grafted Vineyards Report ... ..	561
Cleghorne, W. S. H., B.Sc., A.M.I.Mech.E., Lecturer in Engineering, School of Agriculture, Potchefstroom—Plan of a Small Farm Dairy	862
Cross, T. B., Poultry Instructor, School of Agriculture, Cedara— Egg-laying Competition, 1918-19 ... ..	172
Turkeys ... ..	472
Curson, H. H., M.R.C.V.S., Veterinary Research Officer, Grahamstown— Coccidiosis of the Fowl ... ..	815
Doidge, E. M., M.A., D.Sc., F.L.S., Mycologist, Division of Botany— The Eradication of Citrus Canker ... ..	124
A Tomato Canker ... ..	718
Hall, Thos. D., B.A., M.S.Agr.—Food Value of Willow Leaves ... ..	456
John, W. O., Lecturer in Poultry, Elsenburg School of Agriculture— South African Standard for Poultry and Eggs ... ..	64
Export of South African Eggs and Poultry, 1919 ... ..	258
Geese ... ..	732
Juritz, Chas. F., M.A., D.Sc., F.I.C., Agricultural Research Chemist— The Use of Hard or Saline Waters for Sheep Dipping ... ..	40
Wheat-straw and its Value to the Land ... ..	712
Calcium Cyanamide ... ..	765
Prickly Pear as a Stock Food ... ..	848
Joubert, F., Assistant Instructor in Dairying, Elsenburg School of Agri- culture—Cow-testing Associations ... ..	149
King, H. E., Secretary, South African National Union—Canning Clubs	548
Koeb, Pieter, B.Sc.Agr., Manager, Tobacco Experiment Station, Elsen- burg, Mulders Vlei—Cotton Culture ... ..	615
Lansdell, K. A., Division of Botany; and I. B. Pole-Evans, M.A., D.Sc., F.L.S., Chief, Division of Botany— The Weeds of South Africa—Notes on "Canada Thistle" ... ..	73
Lansdell, K. A., Division of Botany— Some Common Adulterants Found in Agricultural Seeds ... ..	26
<i>Pappia capensis</i> Seed ... ..	760
A South African Gum ( <i>Combretum erythrophyllum</i> , Burch.) ... ..	834
Lounsbury, C. P., B.Sc., Chief, Division of Entomology—European Foul Brood Bee Disease ... ..	245
Marchand, B. de C., B.A., D.Sc., Chief, Division of Chemistry— The Fertilizers, Farm Foods, Seeds, and Pest Remedies Act (No. 21 of 1917) ... ..	32
Chemical Analysis of Soils ... ..	341
Representative Transvaal Soils, I ... ..	722
Meynhardt, G. J., Assistant Experimentalist; and T. G. W. Reinecke, Principal—Results of Winter Cereal Experiments at School of Agri- culture, Elsenburg ... ..	45, 111

	PAGE
Mitchell, D. T., M.R.C.V.S., Veterinary Research Laboratory, Onderstepoort—	
Poisoning of Cattle by Feeding on Old Mealie Lands ... ..	138
Poisoning of Cattle by Feeding on Ergotized Paspalum ... ..	422
Morkel, W. A. K., M.Sc., Lecturer in Animal Husbandry, Elsenburg School of Agriculture—The Pig as an Economical Producer of Food	623
Perold, A. J., B.A., Ph.D., Member of Committee of Investigation—Grafted Vineyards Report ... ..	561
Pole-Evans, I. B., M.A., D.Sc., F.L.S., Chief, Division of Botany and Plant Pathology; and K. A. Landsell, Division of Botany—The Weeds of South Africa: Notes on "Canada Thistle" ... ..	73
Pole-Evans, I. B., M.A., D.Sc., F.L.S., Chief, Division of Botany and Plant Pathology—South African Fibre Plants (Ambari or Deccan Hemp. <i>Hibiscus cannabinus</i> , L.) ... ..	570
Putterill, V. A., M.A., Mycologist, Division of Botany—Flag Smut of Wheat ... ..	252
Reinecke, T. G. W., Principal; and G. I. Meynhardt, Assistant Experimentalist—Results of Winter Cereal Experiments at the School of Agriculture, Elsenburg ... ..	45, 111
Relief, Johs., Registrar of Co-operative Agricultural Societies—Fundamental Principles of Co-operation in Agriculture ... ..	383
Ribbink, Paul, Librarian—The Library of the Department of Agriculture ... ..	135
Rivers, O., Officer in Charge of Sheep, School of Agriculture, Potchefstroom—	
Lamb-Fattening ... ..	458
Breeding Sheep for the Export Trade ... ..	838
Robinson, E. M., M.R.C.V.S., Veterinary Research Officer, Onderstepoort—The Prevention of Contagious Abortion in Cattle ... ..	8
Scherffins, W. H., M.Sc., Chief, Division of Tobacco and Cotton—	
Cigar-tobacco Investigation ... ..	427
Factors that Affect the Growth, Reproduction, and Maturity of Tobacco ... ..	728
Schlupp, W. F., B.Sc.Agr., Entomologist, School of Agriculture, Potchefstroom—	
Rodent Injury to Trees ... ..	445
Mylabris Beetles ... ..	741
Skaife, S. H., M.A., Entomologist, School of Agriculture, Cedara—	
Rats in Sugar-cane ... ..	55
A Cheap Serviceable Hive Made from Paraffin Boxes ... ..	842
Stead, Arthur, B.Sc., F.C.S., Lecturer in Chemistry, Grootfontein School of Agriculture—	
Brak in Its Relation to Irrigation ... ..	13
The Agriculture and Soils of the Cape Province...152, 351, 429, 660	819
The Dipping of Sheep in So-called Carbolic Dips ... ..	536
Stent, Sydney M., Botanist, Division of Botany, Pretoria—Kudzu ( <i>Peararia thunbergiana</i> ) ... ..	558
Story, Colin, Baddaford, Fort Beaufort—The Spinose Ear-tick ... ..	647
Stuart, J. S. Niblock, Acting District Forest Officer, Umata—The Effects of Storms on Certain Forests in the Tsolo District, Cape Province ...	750
Theiler, Sir Arnold, K.C.M.G., Director of Lamziekte Research—The Cause and Prevention of Lamziekte ... ..	221
Tribolet, I., Chief, Division of Horticulture—	
The Fruit Export Act ... ..	349
Along the Orange River ... ..	359
Van der Bijl, Paul A., M.A., D.Sc., F.L.S., Mycologist in Charge, Natal Herbarium—A Leaf Spot of the Pea Nut or Monkey Nut Plant ...	528
Van Niekerk, S. W., Government Viticulturist, Member of Committee of Investigation—Grafted Vineyards Report ... ..	561
Wahl, R. Owen, B.A. (Hons.), Lecturer in Zoology and Entomology, Grootfontein School of Agriculture—Karakul Sheep ... ..	626
Webb, Jas. L., F.R.C.V.S., G.V.O., Ixopo—Practical Hints for the Prevention and Eradication of East Coast Fever ... ..	58
Williams, C. O., B.Sc., A.R.C.S., Chemist, School of Agriculture, Cedara—Composition and Valuation of Fertilizers and Feeding Stuff	368





PRICE 5/-  
PER ANNUM.

# Journal

of the

Department of

# Agriculture

ISSUED BY AUTHORITY OF THE  
MINISTER OF AGRICULTURE.

## PRINCIPAL CONTENTS.

- The Progress of Agriculture in South Africa.  
 The Prevention of Contagious Abortion in Cattle.  
 Brak in its Relation to Irrigation.  
 The Weeds of South Africa. Notes on "Canada Thistle."  
 Results of Winter Cereal Experiments at Elsenburg—1.  
 Fertilizers, Farm Foods, Seeds and Pest Remedies Act (No. 21 of 1917).  
 The Use of Hard or Saline Waters for Sheep Dipping.  
 South African Standard for Poultry and Eggs.  
 Rats in Sugar-Cane.  
 Practical Hints for the Prevention and Eradication of East Coast Fever.  
 Some Common Adulterants found in Agricultural Seeds.

PRICE **6D** PER COPY

# NOTICE TO CONSIGNORS OF FRUIT.

## WESTERN PROVINCE FRUIT SEASON, 1920: RAILWAY FACILITIES.

---

[NOTE. Although the bulk of the deciduous fruit crop of 1920 will have been disposed of by the time this note—furnished by the Railway Administration—is likely to appear, the information it contains remains of interest and its appeal for co-operation continues.—  
ACTING EDITOR ]

---

Following the practice in vogue for a number of years, the Railway Administration has again made special arrangements for the transit of the Western Province fruit crop to Union markets, as well as the more distant markets in adjoining territories and also to the ports for shipment overseas.

The publication of the principal features of the system followed for handling the fruit crops in transit by rail may stimulate interest amongst producers and lead to a more hearty co-operation on their part with the railway authorities, so as to ensure the maximum success in the movement of fruit crops. It is not, of course, suggested that co-operation has hitherto been entirely or even generally lacking.

Owing to the crops in the more southern regions of the fruit area maturing earlier than those beyond the Paarl District, it is possible to deal with the bulk of the crops from the two areas separately. During January-February Huguenot Station is the centralizing depot for all consignments of fruit (except when in full truck loads), and to this station the traffic is forwarded by certain trains. On arrival at the depot it is sorted out and made up into full truck loads for the different destinations or, when there is not sufficient for any one destination station, for a series of stations within a particular area, thereby ensuring a minimum of handling and delay at the various depots en route.

Similarly, during the months of March and April, a concentration depot will be established at De Doorns for the purpose of sorting out, marshalling, and despatching fruit in the manner most suitable to secure its arrival at destination in a proper condition.

From the centralized points the traffic is sent forward by a special train, connections being made at junction stations for consignments destined for points off the main route.

To secure as far as practicable direct connections and to avoid week-end arrivals, the following are the days on which fruit for the

[Continued on page 3 of cover.]

# CONTENTS.

APRIL, 1920.

	PAGE
"THE JOURNAL OF THE DEPARTMENT OF AGRICULTURE" ... ..	1
THE PROGRESS OF AGRICULTURE IN SOUTH AFRICA... ..	3
THE PREVENTION OF CONTAGIOUS ABORTION IN CATTLE ... ..	8
BRAK IN ITS RELATION TO IRRIGATION ... ..	13
SOME COMMON ADULTERANTS FOUND IN AGRICULTURAL SEEDS ... ..	26
THE FERTILIZERS, FARM FOODS, SEEDS, AND PEST REMEDIES ACT (NO. 21 OF 1917)... ..	32
THE USE OF HARD OR SALINE WATERS FOR SHEEP DIPPING ... ..	40
RESULTS OF WINTER CEREAL EXPERIMENTS AT THE SCHOOL OF AGRICULTURE, ELSENBURG, MULDER'S VLEI, CAPE PROVINCE ... ..	45
RATS IN SUGAR-CANE ... ..	55
PRACTICAL HINTS FOR THE PREVENTION AND ERADICATION OF EAST COAST FEVER ... ..	58
SOUTH AFRICAN STANDARD FOR POULTRY AND EGGS ... ..	64
AGRICULTURE AND THE WAR ... ..	66
"THE WEEDS OF SOUTH AFRICA" ... ..	73
RESEARCH AND INVESTIGATION ... ..	76
NOTES ... ..	79
<p>Concerning the Sheep and Wool Industry—Anthrax—Limestone Resources of the Union Shortage of Foodstuffs and Raw Materials—Meat Export Successful Exhibits, London Dairy Show—Curing of Hides—Pirbright Cattle Testing Station—The Gift of the Late Mr. H. G. Flanagan—Brands and Earmarks (page 12)—Advisory Committee on Agricultural Matters (page 25) South African Jams (page 44) Frozen Meat (page 54) Agricultural Policy (page 72)—South African Gum (page 75).</p>	
SOUTH AFRICAN PRODUCE ON THE OVERSEA MARKET ... ..	86
OVERSEA PRICES OF SOUTH AFRICAN PRODUCE ... ..	91
STAFF ... ..	92
STAFF CHANGES ... ..	92
NOTES FROM THE "GAZETTE" ... ..	94
RECENT AGRICULTURAL LITERATURE... ..	96
AT THE SCHOOLS OF AGRICULTURE AND EXPERIMENT STATIONS ... ..	100
MEAT STATISTICS ... ..	105
EXPORT OF GRAIN, ETC. ... ..	106
CROP AND LIVE STOCK REPORT ... ..	107
LOCAL MARKET PRICES ... ..	110

## DATES OF AGRICULTURAL SHOWS STILL TO BE HELD.

(As Notified at 29th February, 1920.)

---

### CAPE PROVINCE.

East London.—7th and 8th April.

---

### TRANSVAAL PROVINCE.

Witwatersrand.—31st March to 5th April.  
Rustenburg.—24th May.

Klerksdorp.—26th and 27th May.  
Pretoria.—31st May to 2nd June.

---

### NATAL PROVINCE.

Newcastle Agricultural Society.—2nd and  
3rd June.  
Vrijheid Agricultural Society.—8th June.  
Dundee Agricultural Society.—10th and  
11th June.  
Klip River Agricultural Society (Lady-  
smith).—15th and 16th June.  
Umvoti Agricultural Society (Greytown).—  
16th and 17th June.  
Weenen Agricultural Society (Estcourt).—  
17th and 18th June.

Royal Agricultural Society (Maritzburg).—  
22nd to 25th June.  
Durban and Coast Agricultural Society  
(Durban).—29th June to 2nd July.  
Zululand Show Society (Eshowe).—7th July.  
Richmond Agricultural Society.—14th July.  
Dronk Vlei Agricultural Society.—14th July.  
Camperdown Agricultural Society.—21st  
July.  
Ixopo Agricultural Society.—22nd July.

---

### ORANGE FREE STATE.

Harrismith.—1st or 2nd week in April.

Bethlehem.—14th and 15th April.



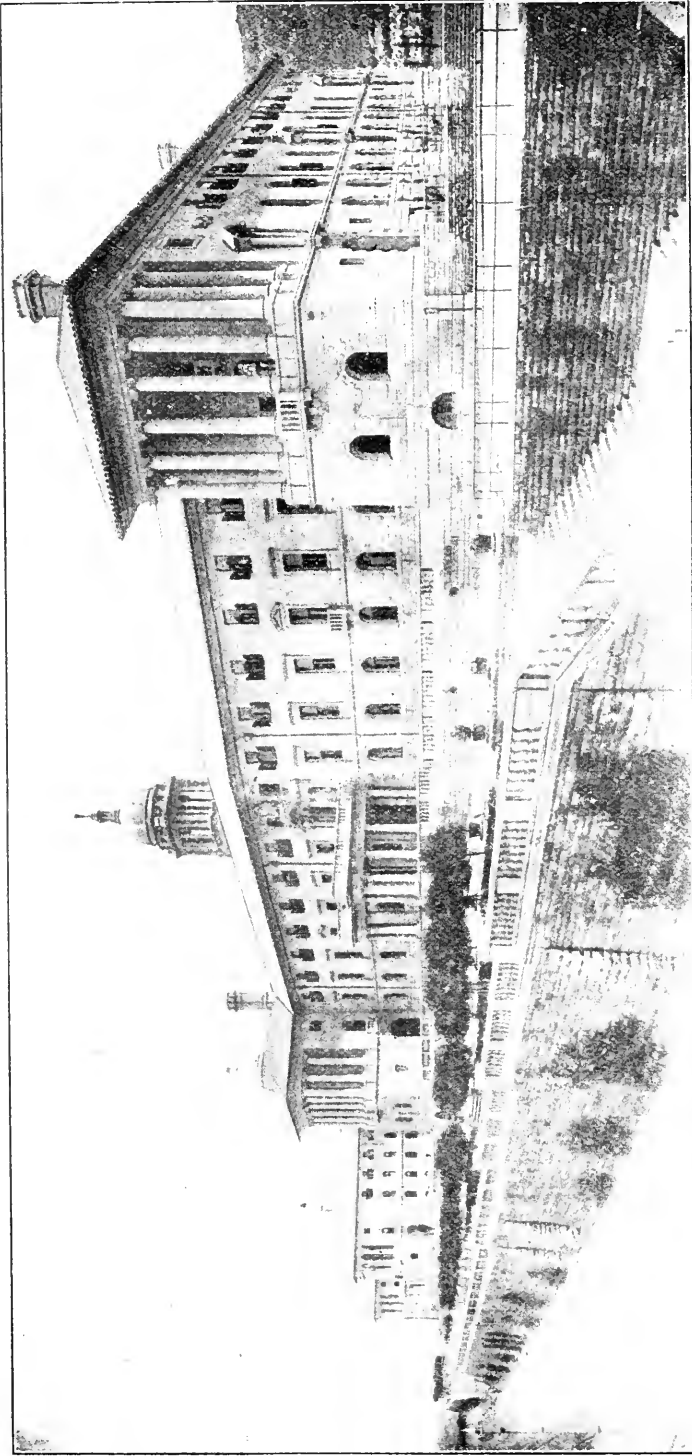

*Photo by courtesy of*

**THE UNION BUILDINGS, PRETORIA.**

(HEADQUARTERS: "JOURNAL OF THE DEPARTMENT OF AGRICULTURE.")

*(Published by the S.A.B.)*



# JOURNAL OF THE DEPARTMENT OF AGRICULTURE.

VOL. I.

APRIL, 1920.

No. 1.

Published monthly in English and Afrikaans by the Department of Agriculture  
Union of South Africa.

SUBSCRIPTION: Within the Union and South-West Protectorate, **5s.** (otherwise **6s.**)  
per annum, post free, payable in advance.

Applications, with subscriptions, to be sent to the Government  
Printer, Box 373, Pretoria.

---

## “THE JOURNAL OF THE DEPARTMENT OF AGRICULTURE.”

---

**The Official Organ of the Department.**

---

The publication of *The Agricultural Journal of the Union of South Africa*, the late official organ of the Department of Agriculture, was suspended, to the regret of the Department, in August, 1914, owing to the financial situation created by the war. The lack of an official organ has been a source of great inconvenience and loss both to the Department and the farming community, for with the suspension of the *Journal* one of the principal means of keeping the public advised of the activities of the Department was closed. That the *Journal* fulfilled its functions in the past, and that its revival is necessary in the interests of all engaged directly or indirectly in the farming industry, is evidenced by the widespread desire for its republication. Happily, circumstances permit of the publication again of the *Journal*, the first number of which is now offered to the public.

JUL 17 1925

As in the past, the object of the *Journal* will be to get into close touch with all engaged in agriculture by keeping them informed of what the Department is doing, and of such matters affecting their interests as come under its purview, and by publishing for their benefit articles dealing with the many and diverse problems which face the farmer in South Africa.

#### THE AGRICULTURAL PRESS.

In announcing the reissue of the *Journal*, it is desired to state that it is not intended to compete with the agricultural Press of the country, but to supplement its efforts, and the opportunity is taken to express appreciation of the good services rendered to the country by the agricultural Press, which is proving invaluable in the dissemination of information to the farmer.

The function of the *Journal* will be to act as a link between the farmer and the Department of State which is charged with the furtherance of his interests. The information it will publish will, for the most part, be official, and therefore of a nature not otherwise readily accessible to the farmer.

It has been decided to charge subscribers resident in the Union (including the South-West Protectorate) at the rate of 5s. per annum, and outside the Union 6s. per annum, post free, subscriptions being payable in advance. The income which will be obtained from subscriptions is likely to be far short of the cost of printing and publishing the *Journal*. On the other hand, it is desired that the *Journal* will be accessible to and valued by all whose interests it is intended to serve, and that the small charge will have the effect of inducing the support of all who are in need of the assistance which the *Journal* will render, and who will appreciate the benefits it will confer.

---



## THE PROGRESS OF AGRICULTURE IN SOUTH AFRICA.

### A Retrospect.

SINCE the dawn of agricultural enterprise in South Africa, when the early settlers on the shores of Table Bay grew vegetables for their own consumption and for provisioning the ships of the Netherlands East India Company, the story of husbandry in our country shows an unceasing struggle with conditions of Nature—often forbidding and ungracious. It shows, also, achievement in spite of the many and peculiar problems which beset the toilers whose livelihood depended on the fruits wrung from the soil. The history of every country reveals difficulties contended with in subduing untamed Nature to the will of man, and the story of South Africa's struggle will rank with that of any country in its magnitude and varying fortunes.

Much has been achieved since the early days, when vegetable growing developed into vine culture and wheat growing, and when stock-breeding first commenced. Numerous plagues, pests, and droughts have been encountered and overcome, and many economic problems have been solved. Agricultural South Africa has left behind it for ever the days of bare existence and of dependence on the produce of other lands. When the first glow of wealth from the mines revealed by contrast the humble part of our agriculture, there was heard the word that the country's wealth lay solely in its minerals. That is also of the past for such progress has been made that agriculture is now recognized as the premier industry of the Union. The cares and anxieties of past problems soften and fade as time goes on, and one looks ever to the future with its hopes and possibilities. Indeed, in his eagerness to meet the morrow, man is apt to forget the small beginnings of early days and to undervalue the work already accomplished.

It is therefore at this stage of our agricultural history that there may be profit in reviewing the progress of the past, so that as we look back over the distance travelled, we may take stock of the finished work that has led us onwards to our present development.

Evidence abounds of the remarkable advance of farming in recent years, and there are few, if any, countries in the world which can, comparatively speaking, show better progress than ours. Although the conditions set up by the war augmented and hastened the prosperity we now enjoy, the root of the real and substantial progress we have made is the unremitting efforts of the farmer and the Department of Agriculture in South Africa. While the individual and collective activity of the farmer is, naturally, the greatest factor in the agricultural progress of the country, an important part is played by the Department, and it is this that will form the main subject of this review.

Our agricultural progress is reflected in increased production, decreasing imports, and increasing exports of farm produce, improved

methods of farming, the rising value of farm land, and in many other ways. For instance, in 1898, the year before the Anglo-Boer war, there were imported into South Africa £3,500,000 worth of grain, meat, and other foodstuffs, and the value of agricultural exports (excluding ostrich feathers) amounted to £3,800,000, of which wool and mohair contributed £3,000,000. Against this, in 1918, when population was greater and prices much higher, the imports of similar foodstuffs had fallen to £2,165,317, while the exports of farm produce (excluding ostrich feathers) amounted to £17,610,042. Further, whereas in 1898 maize and maize meal to the value of £184,312 were imported into South Africa, the trade has now been reversed, and in 1918 we exported £2,262,469 worth of these products. It is true that in 1918 our exports benefited by the prevailing high prices, but on the other hand our oversea export trade suffered through lack of freight and of arrested production owing to scarcity of fertilizers, etc.

See how dairying has advanced. The days of individual and often haphazard butter-making have vanished, and co-operative dairying is rapidly spreading. In 1898 we imported butter and substitutes to the value of £289,041 and cheese £98,433, but twenty years later we exported £96,756 worth of butter and £25,911 of cheese, both of a high standard of quality.

The same tendency is noted in all our imports and exports; the one is steadily decreasing and the other, both in quantity and quality, rapidly rising. No longer do we import huge quantities of meat; instead the past few years have seen the commencement of what is probably going to be one of the Union's chief agricultural exports—meat. No longer does imported jam vie with, and often oust, our local jams; to-day the home article is found on all tables and is finding its way to the oversea market. Wool, still our most important pastoral export, continues to mount rapidly in value; the phenomenal prices obtained for it recently are in the minds of all. The trade in wattle bark and extract, an entirely new industry, has made great progress, and it is interesting to note that a portion of our production goes to Australia, the home of the wattle. Sugar is now an exportable commodity; formerly it was imported to meet deficient production. In addition, several new products are coming to the fore. Lucerne seed is being exported to the Argentine and Australia; beans are sent to England for seed and for consumption; the shipments of cotton are increasing, and chicory and several minor crops are also very promising. Tobacco growing is an important industry, and markets beyond the local one are necessary for its produce. A short time ago pigs were much neglected; now they are in great demand for bacon. The production of eggs (considered a small matter by the farmer with wide acres, but of much importance to many people and the country at large) instances also the spirit of progress, for instead of importing large quantities as in earlier years, we now supply our own wants and have an appreciable surplus for export.

A significant feature of our progress is revealed in the value of farm requisites imported. During the year before the Anglo-Boer war, 1898, the imports of agricultural machinery and implements were valued at £192,471, whereas in 1913 they amounted to £615,885. This is remarkable when the comparatively small number of farmers in the Union is taken into account.

While the returns of imports and exports furnish a good

indication, they do not fully disclose the progress that has been made and which, perhaps, is wholly realized by those only who have lived in South Africa for the past twenty years. Although much remains to be done, farming has emerged from its old status and is now on an entirely different plane. The majority of farms are fenced and frequently sub-divided into paddocks, superior farm buildings have been erected, while irrigation works and other permanent improvements are seen on all sides. Transport and marketing facilities improve yearly, and, above all, better methods of farming are practised. Individualistic and nomadic occupation has given way to settled organized industry. The development of mining (bringing money into the country), an extended railway system, and other agencies, also have their share in the forward movement; the war which ravaged the country seventeen years ago, and the recent conflict in Europe and elsewhere, have left in their wake the need for greater production and enterprise; our young men have visited and returned from countries oversea with valuable experience; and men from other parts have made their homes with us and have brought with them new ideas and learning. These advantages have materially aided us in our fight with the problems of South Africa's climate, soil, and economics.

Out of the failures and successes of the past is evolved outstanding evidence of the country's suitability for pastoral pursuits. The improvement in recent years in our live stock has been wonderful. There has been a steady stream into the Union of high-class animals from Europe, Australia, and elsewhere, and splendid studs have been established. Well over 60,000 pure-bred animals have been registered in the South African Stud Books, and locally-bred stock have sold for huge sums, merino rams fetching £1500 each; a Friesland bull, "Admiral Beatty," bred at the Potchefstroom School of Agriculture and Experiment Station, was sold recently for £5250.

Departments of State, such as Agriculture, Railways, Posts, Lands, Irrigation, Forestry, Land Bank, etc., have played a large part in our marked development, especially during the past two decades, and it is probable that in no country with resources similar to ours has the State fostered and guided its agricultural industry more systematically and thoroughly. At the outbreak of the Anglo-Boer war there were Departments of Agriculture in the Cape Colony and in Natal, but in the Transvaal and the Orange Free State there were no organizations of this nature; in the two latter territories systematic control and organization of agriculture was introduced under Crown Government following the conclusion of hostilities. The evolution of the Union Department of Agriculture is well known; it is organized on similar lines to those which characterized the late Transvaal Department, the latter having been modelled largely upon the United States Department of Agriculture.

When established, the present Department of Agriculture was found at the outset to lack scientific and technical officers, a great disability in the successful control of an industry like farming. The building up of a scientific staff was proceeded with, and though recently hampered by the war, its numbers are now nearly double what they were at the time of Union, but still not nearly what they ought to be. Then, also, suitable equipment for dealing with the many problems awaiting investigation was sadly lacking, and this

had to be made good in the face of serious difficulties; much is still needed, but much, also, has been accomplished, and at present the Department possesses laboratories, etc., which have been instrumental in many ways in the rapid rise of the Union's farming industry. At Onderstepoort, near Pretoria, there is now one of the largest and best equipped institutions in the world for investigating diseases of animals peculiar to warm countries, and from it results of the greatest scientific and practical value have been obtained. In Pretoria and at the various schools of agriculture and experiment stations, buildings and other forms of equipment are being gradually extended. Altogether the Department is in an immeasurably better position than it was a few years ago, and able, therefore, to cope to a large extent with the many calls upon it resulting from the visible expansion of agriculture in South Africa.

Valuable progress has been made in legislation affecting the farmer. Comprehensive and up-to-date Acts dealing with diseases of live stock and crops, and with fencing, dairying, exports, etc., have been passed. Combined with these there are other Acts, such as those concerning irrigation, land settlement, land bank, forestry, census, etc. The whole covers a wide field and provides an excellent basis of legislation.

The history of the eradication and control of diseases of live stock, and the men who figure so prominently in it, discloses the wide gulf between the old days of grappling with diseases of obscure origin, or of fleeing from them, and the present standard of knowledge and equipment. Our country is particularly prone to epizootic diseases, but much has been done in their control and suppression. We are free from foot-and-mouth disease, such a plague in Europe. Rinderpest has been effectually stamped out, as well as lung-sickness. Swine fever, mange, glanders, and epizootic lymphangitis have been reduced to small proportions. The cause of East Coast fever, red-water, gall-sickness and gallamziekte, blue-tongue in sheep, and other diseases, has been discovered, and it is believed that fresh discoveries are imminent. The value of this knowledge must be worth millions of pounds every year to the country. These discoveries have now rendered possible the keeping of animals in parts admirably suited for stock, but which formerly could not be used, and, generally, have been the main factor in the gratifying progress observed in the livestock industry which is of such moment to the Union.

Another chapter in our history concerns the combating of local and imported diseases of stock, the development of our economic plants, and the introduction and distribution of new varieties. The present dimensions and importance of our maize crop owe much to the teaching of officers of the Department, who created interest in maize growing and advocated improved methods of cultivation, selection of seed, etc. The introduction of teff grass has had far-reaching and beneficial results; indeed, this crop now vies with lucerne and has an acreage double that of the latter crop. In like manner the Department has brought to the notice of farmers with good, practical results, several leguminous crops. Kikuyu grass has proved an excellent pasture grass in places suited to it, and is being widely grown. The Department's aid also in developing the tobacco and cotton industries is bearing fruit to-day.

One of the scourges of the country, the periodic invasion by

locusts, has been mastered by particularly brilliant and successful organization. Although there are grounds for believing that visitations may be expected from time to time, with the measures now in vogue for combating them there is no cause for alarm, and the devastation formerly caused by the pest need no longer be feared. The terrible havoc caused by the locust is well known, and the passing of this menace forms an epoch in the forward march of our agriculture.

So in many other branches of farming the stimulus of the Department has been beneficial. The remarkable progress of dairying has already been referred to. A share is claimed in the development of citrus and deciduous fruit culture and marketing, in the suppression of scab combined with the immense advance in the standard of our sheep and the sorting and packing of wool for market, in the information obtained through the researches of our chemists, especially in soils and fertilizers, while the building up of a comprehensive library of agricultural literature places a wealth of knowledge at the door of all.

Probably one of the most useful and successful of all the Department's activities, and of unsurpassed importance in the country's advance, was the education of farmers through the establishment of schools of agriculture. The work allotted to these institutions is varied and far reaching; the education given to students, the distribution of bulletins, the delivering of lectures and demonstrations given to farmers, and advice freely given have all added to the uplifting of agriculture. Another striking sign of our advance is the establishment of the Government Faculties of Agriculture at the University of Stellenbosch and the Transvaal University College.

Not without precedent in other countries, the spread of co-operation in the Union has at times been chequered, but it is daily becoming more firmly established, and its helpfulness is spreading far and wide. The Department has aided in the establishment and supervision of many co-operative societies. Arising from the growing spirit of co-operation are increased production and improved quality, but, above all, is the gratifying sense of greater benefits which will follow the ever strengthening bonds of co-operation in the Union.

The farming industry comprises many branches, each with its particular problems. Much can be written on the progress made by each, and statistical and other evidence thereof can be adduced. It is not possible to do so, however, in this short review, and we must be content to direct attention to some of the phases of progress and rely on the reader's knowledge of agricultural conditions a few years back and of what they are to-day. That our progress has increased with the years is evident. Compared with the position of certain countries, our advance will appear to have been slow; compared with our own resources and disabilities the advance of recent years has been remarkable. We now stand at the threshold of greater achievement, for out of our past experience there has been created an atmosphere of scientific inquiry and a desire for good, thorough work which augur well. In our retrospect we pay homage to the struggles of our agricultural pioneers, and are grateful for the example set us by competent and earnest men who have done so much in uplifting us. In the knowledge that our young men are learning the lessons of the past and are taking advantage of the facilities existing to-day for education and research, we turn with hope to the future.

## THE PREVENTION OF CONTAGIOUS ABORTION IN CATTLE.

By E. M. ROBINSON, M.R.C.V.S., Veterinary Research Officer,  
Veterinary Research Laboratory, Onderstepoort.

IN view of the great importance of cattle-breeding to the future of South Africa, a popular article on the prevention of contagious abortion in cattle should prove very useful to stock-owners. The present position as regards the distribution of the disease is that there are very few parts of the Union which have no infected farms. Not only does the disease spread rapidly through dairy herds, but under ranching conditions on some of the largest cattle farms in the country it has swept right through the herds, reducing the annual increase by births of calves to practically nothing for two or three successive years. Amongst the natives' cattle in the western and northern Transvaal the disease has, in many places, become more or less endemic, and an equilibrium has been reached, so that a fair number of abortions occur annually, but most of the cows calve normally. The danger of further spread is a very real one, as at present a great many farmers do not realize the danger of buying cows from other farms without first finding out whether those farms are free from the disease or not.

As this article is chiefly devoted to preventive measures against contagious abortion, it will not be necessary to give a long description of the symptoms of the disease, as these have been given fully in a bulletin by Sir Arnold Theiler (*Local Series No. 25, 1918, Department of Agriculture, Union of South Africa*). In the ordinary case a cow or heifer will, without any previous symptoms, abort, the foetus usually being at about the seventh month of pregnancy. Premature calving may take place at any time during the 280 days of the gestation period, wherein lies one of the chief dangers, as, when abortion occurs in the first three months of pregnancy, the foetal membranes practically always come away with the foetus, and unless the cow is tied up in a stall, the foetus may never be seen and the cow will shortly afterwards come in season again. Unless an owner is on his guard such a case may be overlooked and the cow simply considered as not having held to service. After the fourth or fifth month of gestation it is usual for the afterbirth to be retained after an abortion, and there is usually a brownish discharge from the vagina, sometimes containing small yellowish lumps, but there may be very little discharge at all. A further source of danger is the cow which calves at the right time, but gives birth to a calf, normal in size, but weak, and retention of the afterbirth occurs. Some cows will even give birth to strong healthy calves and not retain the afterbirth for more than twenty-four hours. Such animals are a dangerous source of infection to uninfected stock, as they have infected afterbirths and spread infection, although not to the same degree as a cow with the typical symptoms does. Practically without exception, infected cows harbour the organism of contagious abortion in the

udder, and the milk remains infected constantly for periods up to six or seven years in some cases, even after several apparently normal calves have been produced. Uterine infection in a slight degree during gestation remains for several years, the probability being that at every pregnancy after abortion the uterus becomes reinfected from the udder.

As regards the channels of infection, it seems certain that the great majority of cows become infected by eating infected material, such as portions of an infected afterbirth or food contaminated with the infected discharges from a case of abortion. If a cow does not eat her own afterbirth or portions that break off, it is practically certain to be eaten by other cattle, as one may frequently observe.

The amount of infection spread during one act of abortion and during the few succeeding days is very great, so that too much care cannot be taken in disposing of infected material. The bull as a carrier of infection probably does not play anything like the part he was once assumed to. Usually by the time a cow comes into season again after aborting, there is very little, if any, infection left in the vagina or uterus, as secondary infections such as those caused by ordinary pus-producing organisms rapidly take its place, and it has been found impossible with the methods at our disposal to trace any abortion infection in the uterus or vagina six weeks to two months after an abortion.

The bull may act in a mechanical way as an agent in transferring infection from one cow to another, but probably plays no big rôle as a spreader of infection. It would be unwise, however, to dismiss him altogether as an infecting agency, as it has been found that in a small proportion of cases bulls which have been exposed to abortion infection do actually develop lesions of the genital tract. Several cases have been reported from the United States of America of bulls which had infection of the testicles and vesiculæ seminales, the receptacles for the semen after it is formed, but no experimental work had been done to determine whether such bulls could infect cows.

What part infected milk plays in the spread of infection, we do not know yet, but it seems unlikely that it is a very important one. It is possible that in a few cases the milker infects one cow from another during the milking, as the disease can be produced by infecting the udder through the teats, but usually it requires a large quantity of infected material. The possibility of the faeces of calves which drink infected milk being a source of infection has not been experimentally determined, as it is practically impossible to isolate the organism of abortion from a mixture of bacteria such as is found in faeces.

As regards the resistance of the causal organism of contagious abortion to atmospheric conditions in South Africa, experiments are at present in progress to determine this. Much difficulty has been experienced in determining the presence of abortion organisms in a mixture with others as well, and so far guinea-pig inoculation has had to be relied on. The guinea-pig is susceptible to infection, and can be used to isolate the abortion bacillus from contaminated material, but, unfortunately, there are many organisms, in air and soil, which rapidly kill guinea-pigs. The disease produced by the abortion bacillus in guinea-pigs is a chronic one, and great enlargement of the spleen is usually the only lesion found when the animals

are killed two months after inoculation. From this enlarged spleen the abortion bacillus can be obtained in pure culture in most cases. From the experiments so far carried out, it would seem that the resistance of the abortion organism to heat and drying is much greater than was formerly thought, therefore the necessity for the proper disposal of infected material is emphasized.

The diagnosis of contagious abortion clinically is not always easy, as it has to be differentiated from abortion due to other causes. When several abortions occur in a herd at or near the same time, and the cows have retained afterbirths, the diagnosis is rarely in doubt, but should this not be the case, the first abortion may not be taken much notice of, particularly if no others occur shortly afterwards. The diagnosis by means of the agglutination test, which can only be carried out in a bacteriological laboratory, is a very practical and useful method, but necessitates the taking of a sample of blood from the suspected animal. This test of the blood, or rather the serum of the blood, will show whether the animal is infected, but an abortion cannot be predicted, for, as has been previously stated, all infected cows do not abort. Abortions due to injuries are probably not as frequent as was formerly thought, but in South Africa, redwater and other diseases, which cause high temperatures in the affected animals, often produce abortion, though rarely with retention of the afterbirth. A few cases have lately been reported from the United States of America of cases due to another organism, the so-called "vibrio of abortion," but as yet it is not known whether this organism occurs in South Africa or not. Some years ago a substance called "Abortin" was made from a culture of abortion bacilli and used to diagnose the disease by observing whether any reaction took place in the suspected animal after subcutaneous inoculation of the material, as occurs in tuberculosis and glanders with tuberculin and mallein respectively. "Abortin" was found to be quite unreliable as a diagnostic agent, so quickly fell into disuse.

As regards treatment of a case of abortion to prevent further spread, it is essential to isolate the cow at once in a stable or kraal to which no other cattle have access. If the abortion has occurred in a stall near to another cow, as in a cow byre, very thorough disinfection is necessary. All the bedding should be burnt, and the whole byre thoroughly scrubbed out with a strong disinfectant solution such as any of the coal-tar disinfectants. This disinfection should be done very thoroughly, and if the foetus is found it should be burnt. The cow, when isolated, should have her hind-quarters scrubbed every day for a week with disinfectant, and the afterbirth, if retained, must be removed. It is difficult and unnecessary to remove a retained afterbirth before the forty-eighth hour after calving or abortion, but it should not be allowed to remain more than three days. The womb should be washed out every day with two or three gallons of normal salt solution, 1 part common salt to 100 parts of water, or 2 tablespoonfuls to a gallon. Disinfectants are to be avoided for washing out the womb, as they cause straining and do not have any marked beneficial effect. The best method of washing out the womb is to get a piece of thin hose-pipe about 4 or 5 feet long, and in one end to fix a tin or glass funnel. If the free end of the pipe is put through the mouth of the womb and the salt solution poured into the funnel held about two feet higher



than the cow's back, the fluid will run into the womb easily and will siphon out again when the funnel is lowered, a distinct advantage over syringing. All the fluid should be removed if possible, and what does not siphon out should be mopped up with pieces of cotton wool. The removal of a retained afterbirth presents some difficulty to the inexperienced, and a good deal of practice is necessary before one can be removed properly. In removing it, the hand should be passed through the mouth of the womb and the afterbirth peeled off the cotyledons or button-like bodies on the uterine wall. Gentle traction should be exerted on the afterbirth to assist in the loosening process, but great care should be taken not to break it, as in that case bits may stay in the womb and not be found. When removed, the afterbirth should be very effectively destroyed, if possible by fire. If the cow has a discharge from the womb it should be washed out every day with normal salt solution till the discharge stops. A solution of hypochlorite of soda in the proportion of 1 part to 200 of water may be used before the salt solution, and will often remove bits of dead tissue which would not otherwise come away. After the discharge has stopped the cow should not be returned to the herd, but kept apart and, if the first case in the herd, it would probably pay to send her to the butcher. If several abortions occur, a separate herd of infected cows must be made and a special bull kept for it alone. The size of the herd determines the policy to be adopted when introducing measures for the control of the disease. On some of the large ranches with more than 1000 cattle the disease has got out of hand so quickly that it was decided to allow it to spread through the whole ranch as quickly as possible, as it is known that most cows do not abort twice, and a small proportion only more than twice. In this way the heavy loss occurs only in a period of about two years and is not a constant annual loss. This method is only to be recommended where control by isolation of infected animals is impossible and until protective vaccination can be introduced on a large scale. In the case of a small herd in which several abortions occur, it is a good plan to isolate the infected cows and have the sera of the remaining apparently normal cows subjected to the serological test at intervals of two months. Although troublesome, this method of cleaning a herd from infected cattle can be carried out effectively on a small scale, and is applicable to valuable herds. When a herd of infected cows is maintained, it must have a separate attendant, as even milking of an uninfected cow by any one who has recently milked an infected cow should not be allowed.

Preventive vaccination seems to be the most hopeful method of dealing with the disease in the future. It has been carried out on a large scale in the British Isles during the past few years with success, and a few herds have been inoculated recently in South Africa with promising results, but it has not yet been introduced generally in this country. The method of vaccination consists in inoculating heifers about two months before they are put to the bull for the first time with a large dose of living abortion bacilli subcutaneously. Uninfected cows can be inoculated before being again put to the bull. When vaccinated in this way, about 90 to 95 per cent. of the animals will calve normally though exposed to natural infection. Dead cultures gave disappointing results both as preventive and curative agents. The introduction of vaccination means an admission that the disease cannot be checked in any other way, and will mean

that all the herds in the country will have to be inoculated sooner or later. The vaccine will find its widest application amongst ranching herds, as in small breeding herds control by means of isolating infected cattle would probably be found better. Quarantine measures were introduced in South Africa some years ago for the control of contagious abortion, but recent findings with regard to the course of the disease have caused them to be temporarily suspended.

The outlook as regards the prevention and control of contagious abortion in South Africa becomes more hopeful as the stock-owner's interest in prevention of stock diseases increases and preventive measures receive more attention than curative ones. The disease is bound to spread further than it has done so far, but the methods of diagnosis in use during the last few years probably account for the increase in the number of infected farms. There is no law at present to prevent a farmer from selling a cow which has aborted, and many such cows have been sold with other cows' calves passed off as their own. It is the stock-owner himself who should be on his guard against introducing the disease into his herd when buying fresh cattle, particularly on auction sales where the history of the cattle is obscure, and he should take all reasonable precautions to prevent what may result in something of the nature of a catastrophe to his cattle, involving heavy financial loss.

---

## **Brands and Earmarks.**

A new method of branding and earmarking stock has been devised by Mr. W. A. M. Robertson, B.V.Sc., Chief Veterinary Officer attached to the Live Stock Division, Department of Agriculture, Melbourne, Victoria, which has aroused a good deal of interest and has been widely noted in the Press.

According to available particulars of the system, branding is imprinted by means of a hot iron (fire branding) in the same way as our branding is done. The only difference in the two systems, as far as can at present be ascertained, is that straight lines are employed instead of angles (letters and numerals), as used in the system laid down in Ordinance No. 15 of 1904 (Transvaal). Further inquiries are, however, being made into the matter.

When legislation is contemplated and a Consolidation Bill dealing with the branding of live stock in the Union is being prepared, "Robertson's Method of Branding and Earmarking Stock," as well as the methods in force in other countries, will receive careful consideration with a view to our system being modified, if desirable.

## BRAK IN ITS RELATION TO IRRIGATION.

By ARTHUR STEAD, B.Sc., F.C.S., Lecturer in Chemistry,  
Grootfontein School of Agriculture.

[This article was originally delivered in the form of a lecture at a meeting of the Cradock Farmers' Association and was printed in a section of the Press. In view of the importance of the subject, the lecture is published in full together with illustrations furnished by Mr. Stead.—ACTING EDITOR.]

THE result of long experience has led me to the belief that brak is much more widespread, and its deleterious effects of much greater economic importance than is generally supposed; of economic importance, because quantities too small to be visible or detectable by taste are yet able to depress the yields of crops, thereby discounting the value of irrigation works to a degree that demands attention.

I propose to deal with the subject in a simple way, and yet, at the same time, somewhat fully, even at the risk of touching on aspects that may not be of particular local application. I feel sure that your patient attention can be relied upon.

### THE VARIABLE EFFECT OF BRAK.

The same quantity of the same kind of brak affects the yield of no two different crops to the same degree; and indeed this varying effect applies also to different varieties or strains of the same crop. This means that plants possess varying powers of resistance to brak. A similar condition of affairs is to be found in the animal kingdom, for do we not all know that, given the same adverse conditions, the resistance of different animals to them differs enormously, that different breeds of the same animal resist to quite different degrees, and also that animals of the same breed may show varying powers of resistance.

This at once suggests that wherever brak conditions obtain it may be possible, by growing the right strain of the right crop, to reduce the evil effects of the brak of any particular soil to a minimum. Probably the best way to get the best resisting strains is by selecting seed from plants which are found to be much superior to the average.

### DECLINING YIELDS FOLLOWING IRRIGATION.

Let us inquire why it is that our wheat crop, for instance, gives poor yields in comparison with those obtained in Europe.

The farmer when questioned on this point generally replies that if he had the water when he wanted it he could equal the European average every time. My experience is that he cannot continuously do so.

I know of instances in which lands, situated in areas of too little rainfall to produce any crop, have been brought under permanent irrigation and have yielded as much as ten bags of wheat per acre; while the most that could be got out of them a few years later was five

or six bags. This means a decline in yield of nearly half. It also means that for that particular crop the value of the irrigation works has depreciated 50 per cent., which is surely an alarming development.

There may be those who would put down the decline to the soil having become depleted of one or more plant foods. The possibility of this having happened in so short a time is very remote indeed, especially with respect to the type of land usually irrigated. It is much more likely that the use of water has introduced what may be termed "adverse" or "limiting" factors, the action of which results in full benefit not being derived from the water supply.

Frequently the limiting factor is brak and sometimes it is an excess of water.

#### YIELDS IN THE PRESENCE OF BRAK.

Now, although brak may prevent any yield whatever being obtained, and even prevent the germination of seed, it must not be thought that even if average yields are obtained there is no brak. As a matter of fact a little brak in the soil is a good thing, provided it is of the right kind. The right kind of brak assists in maintaining a good physical condition of the soil without which the latter cannot give its maximum yields. Brak also exerts a beneficial influence in rendering the plant nutrients of the soil available. But brak of whatever kind, if present in excess, leads to diminished yields, the decrement being proportionate to the excess of brak. The greatest losses are no doubt those which are not noticed; they are akin to, say, a return of 4 per cent. on money invested, when by better management 5 to 7 per cent. would be obtained. Losses from brak only follow when water is used wastefully. By wastefully is meant in either too little or in too great quantity. Included in the latter instances are lands whose condition is such that they should not be irrigated at all.

#### IRRIGATION DEMANDS KNOWLEDGE AND SKILL.

The onlooker is apt to assume that it is a much simpler matter to grow crops under permanent irrigation than under a good rainfall; but there is not the least doubt that the production of crops under irrigation demands much more skill and knowledge than the production of crops under rainfall only. One has only to consider why so many millions of money have been lost in the shape of lands ruined by irrigation to appreciate the truth of my assertion.

#### THE MEANING TO BE ASSIGNED TO THE WORD "BRAK."

Before proceeding further it is necessary that we should be agreed upon the meaning to be assigned to the term "brak." The word is closely related to the English word "brackish," which means salty. If "brak" be used in this sense, then it is only when a water or soil is salty to the taste that it can be said to be brak. There are farmers who hold this view, especially in the north-west, where a fresh water is one that tastes neither salty nor bitter as distinct from one that does.

Such reputed fresh water may, however, be quite unsuited for



*Plate I.*

Photograph of part of a field of meales. The meales in the foreground and in the background have grown well, and have tasselled. The dark line running through the centre of the meale field marks the boundary of an area of very slow and inferior growth resulting from bad texture of the soil produced by the action of excess of water. This area of poor growth is seen to better advantage in Plate II, which is reproduced from a photograph taken from a point at right angles to the position from which the above photograph was taken.

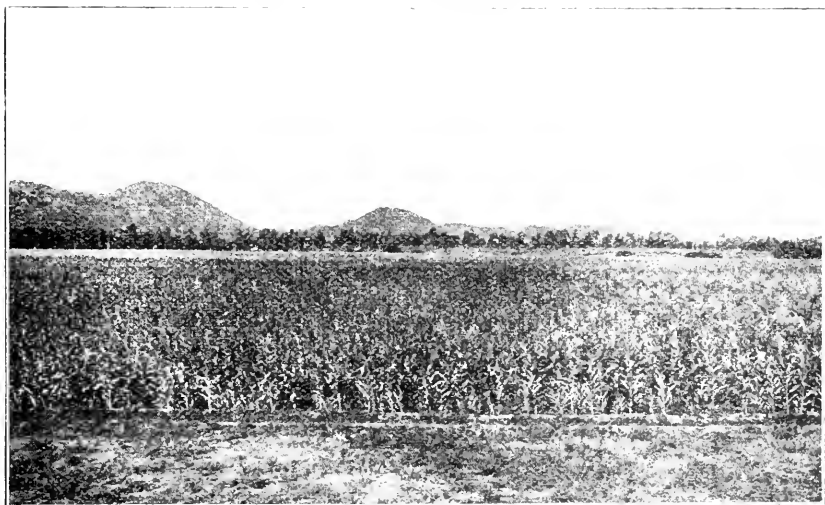

*Plate II*

Another view of the field of meales which appears in Plate I. The plants in dark area are of poor growth and have not yet tasselled. Many of them are also yellowish in colour. Note area of superior fully tasselled growth surrounding this patch.

irrigation. For example, a water described in the north-west as "lekker vars water" was found on analysis to contain no less than 89 parts of sodium carbonate per 100,000 parts water, an amount which would cause considerable injury if applied to a stiff soil or even to a fine sandy loam.

Again, there are farmers who would not regard a soil as brak unless it were visibly so. A soil may, however, be white at the surface with a certain kind of brak and yet produce good crops, while a quantity of another kind of brak insufficient to be visible would cause much more harm.

There are others who, regardless of taste, consider any whitish appearance on the surface of the soil (especially if this resulted after water had run over it) as brak; there are those who describe any land now bare, but formerly clothed with vegetation, as brak land, whereas it may or it may not be brak. Frequently, and often with truth, permanently wet land is described as brak, whereas it may not be brak.

In the Karroo waters are frequently described as brak which are really only rather hard; presumably on account of the whitish residue they leave behind on natural evaporation. Then, again, certain muddy waters are sometimes stated to be brak, presumably because of the shiny paint-like coating of silt they leave behind them, whereas no water that is brak in the sense that it is salty would leave such a deposit.

Enough has been said to indicate the need for a standard meaning of the term "brak." The meaning attached to the term in this paper and the one which, if I may presume to say so, should be adopted generally is that condition of a soil or of a water in which, for agricultural purposes, there is an excess of any kind of salt. This meaning is practically the meaning assigned to the term "alkali" in America or "usar" in India, when used in reference to soil.

Included in the term "salt" in the above definition are common salt (sodium chloride), glauber salt (sulphate of soda), carbonate of soda, bicarbonate of soda, nitrate of soda (Chili saltpetre), the corresponding salts of potash, epsom salts (sulphate of magnesia), and others. The commonest constituents of brak are one or more of the first four.

Of these the most feared is carbonate of soda, the least feared sulphate of soda. It is this latter salt with which the soil may be white and yet produce crops. It is the misfortune of the Union that a very large proportion of its waters which are available for irrigation contain more or less carbonate of soda, usually in the form of bicarbonate of soda, however.

#### THE ORIGIN OF BRAK IN INLAND SOILS.

Lands close to the sea are brak because the sea water has rendered them so; but the occurrence of brak lands hundreds of miles inland, and at altitudes of several thousand feet above sea-level, cannot be explained in this way.

It will be found that wherever brak lands occur inland the annual rainfall is low—usually less than 2 inches.

Now in the natural course of events salts are continuously being formed in the soil through certain natural agencies, as, for instance,



*Plate III.*

Photograph of good, bad, and indifferent plants taken out of the field, photographs of which appear in Plates I and II. The smallest plant is about 2 feet high only. All plants are of the same age.

changes of water, air, and temperature. In districts of plenty of rain the salts thus formed are dissolved as the rain sinks through the soil and are eventually carried to the ground-water and out into the natural drainage channels of the region, i.e. the rivers. The amount of salt formed is, relatively speaking, very small even in the course of a whole year; but such as it is, it gets carried out into the rivers and finally into the sea. The amount of water in the sea does not increase with time; because the sea loses as much water by evaporation as it gains in rain and from the rivers which flow into it. The water evaporates, but the salts are not able to do this and are therefore left behind in the sea. Thus we may presume that the sea was originally fresh water, but that it has gradually become salt at the expense of the land.

Now let us consider the case of a rainfall which is not sufficient to cause drainage from the soil. Evidently the salts which are formed in the soil must remain there, so that soil which in the beginning was not brak has become brak through there not having been sufficient rain to cleanse it. Now among the salts which are gradually formed in soils are some which serve plants for food. Therefore in arid lands not only do the soils contain brak, they also contain considerable accumulations of available plant food. That is why our Karroo soils are so much more fertile than, say, our coastal soils.

Lands of the arid interior are therefore more or less brak, and, furthermore, comparatively rich in plant food, because the rainfall has not been sufficient to cause drainage from them. Generally speaking the soil contains more or less brak wherever it is necessary to irrigate to grow crops. Brak waters, however, may be found in humid as well as in arid regions.

#### DISTRIBUTION OF BRAK IN THE SOIL.

The brak of any given soil may be concentrated at one or more levels, or it may be somewhat evenly distributed throughout the depth of the soil. Whatever the distribution be it has been determined by several factors, among which are (a) the nature of the soil, (b) its vegetal covering, and (c) the rainfall. Irrigation tends to alter the distribution of brak in the soil. Its action in this respect may be anything from good to bad.

I now propose to examine from the brak point of view some of the more frequent soil conditions.

##### (a) *The Soil is Freely Permeable and the Underdrainage is Good.*

If sufficient water be used to cause a general movement of water through the soil and out the latter will be gradually freed of any brak it originally possessed. When these are the conditions the irrigator seldom experiences trouble. If, however, he has not sufficient water to cause adequate drainage he may experience the dreaded "rise of brak."

##### (b) *The Soil is Permeable but the Drainage is Bad.*

It is evident that unless some artificial system of drainage is supplied the application of water cannot remove any brak from the soil. On the other hand, the application of water in the absence of





*Plate IV.*

Photograph of a portion of the same mealie field at the junction of good and bad growth. This photograph was taken 80 days from seeding and before the mealies had tasselled. The best plants were then 8 feet high, the worst less than a foot and a half. Note how the ground is cracked open, showing that the soil contains much clay. It is just the type easily deteriorated by excessive water.



*Plate V.*

THE EFFECT OF BRAK.

Photograph of a portion of the same field. Here a watercourse had been filled in with material from a military manure dump. The mealies have not been able to withstand the effect of the excess of nitrates in the soil.

drainage will gradually raise the water-table, rendering any deep-rooted crop that may be in occupation of the soil unthrifty, and accumulating the brak of the soil nearer and nearer to the surface will finally render the soil unfit for any agricultural purpose. The deeper the soil the longer this evil will be developing, provided the same amount of water is applied to the shallow as to the deep soil. If the soil, however, is deep enough it is possible to irrigate it successfully, even if very brak, provided one has a good water and the requisite skill. The basis of the method of handling the water under these circumstances is by a first heavy watering to drive the brak deep down so as to leave several feet, if possible, of dry soil between the ground water and the depth to which the irrigation water has penetrated. Subsequent waterings should be sufficient in quantity to meet the needs of the crop, but no more. It will usually happen that after a few years the brak which had been driven down has commenced to rise again: it is again driven down by a heavy watering.

(c) *The Soil is Not Permeable but the Drainage is Good.*

This is a condition that not only occurs naturally, but is also created as a result of irrigation. It is evident that the good drainage cannot be made use of until the soil has been rendered permeable. A special instance of the kind is the occurrence of hard pan at a less or greater distance below the surface. The worst type of hard pan is that due to the cementing action of sodium carbonate. Such a pan is almost entirely impervious to water, unless this latter contain constituents such as gypsum, which are able to destroy sodium carbonate. It cannot be too strongly emphasized that the irrigation of an impermeable soil is a very hazardous undertaking.

(d) *The Soil is Impermeable and the Drainage is Bad.*

It would be difficult to imagine a more adverse condition of the soil. Usually such land is impossible of utilization.

Having outlined the more important types of soil conditions and the principles underlying the treatment they should receive, I now proceed to a few happenings that are common in irrigation practice.

#### THE APPEARANCE OF BRAK AFTER IRRIGATION.

Let us suppose that we have a paraffin tin full of soil, and further, that we make the soil thoroughly wet by pouring water on the top of it. If, now, we place this tin in the sun the soil will sooner or later dry out. The soil loses the water added to it by the process known as evaporation. The water at the surface is lost first, and as it is lost more rises from below to take its place, so that finally there is none remaining in the tin. The last water to be lost is naturally that which penetrated deepest.

Now, let it be supposed that in filling the tin we mixed some salt in with the lower soil. The water which penetrates down to the lower soil will dissolve the salt, and finally will carry it towards the surface, where the water will evaporate and, since it cannot take the salt with it into the air, leave the salt behind. Thus by watering soil which contained salt in its lower layers we have brought the salt from the lower layers to the top layers. Something of the same kind occurs

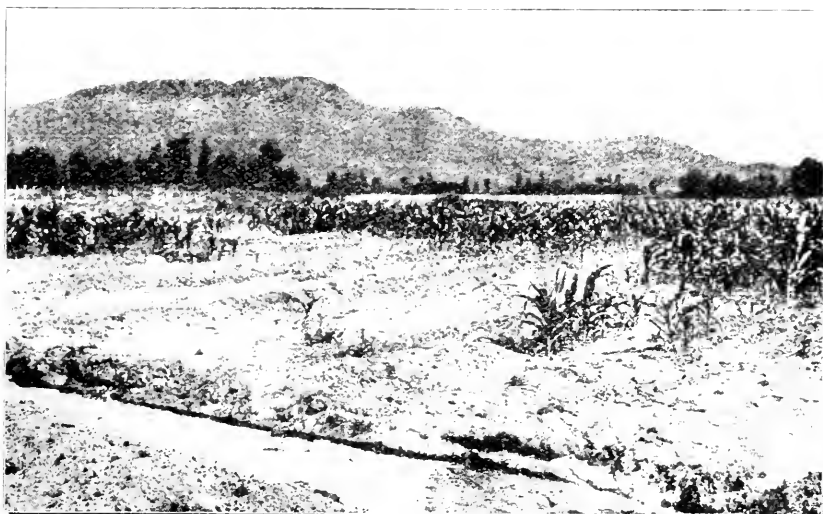
*Plate VI.*

## THE EFFECT OF BRAK.

Photograph of a high corner of the same mealie field where brak had killed some of the plants and rendered others unthrifty. The brak in this case consists chiefly of common salt. The use of more water here would have driven the brak down. Note the white efflorescence of brak in the field as well as at the side of the furrow.

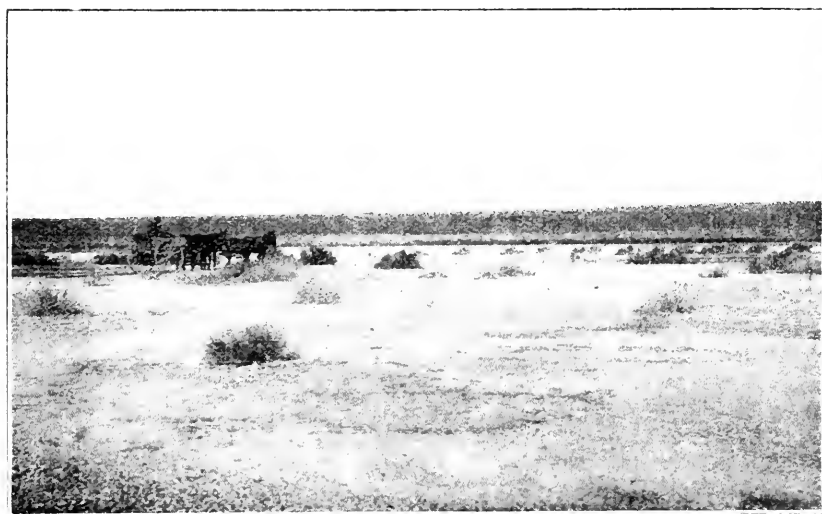
*Plate VII.*

## AN ALARMING RISE OF BRAK.

This photograph is of land below a dam. Water held on the other side of the dam wall has raised the very brak subsoil water to within "capillary" reach of the surface. As the subsoil water evaporates, it leaves the salts behind as a white efflorescence. Many acres of land below this dam are too brak to support useful vegetation. Note also the line of brak in the dam wall.

when soil which at the beginning showed no brak at the surface becomes brak after irrigation. When this happens and the drainage is good it is because the irrigator has used insufficient water to wash the alkali out through the drainage. The practice of applying water in several light irrigations in place of a fewer number of heavier ones is a prolific cause of this kind of trouble. The practice has also the added objection that it tends to make the plant shallow rooted, which of itself is a considerable handicap.

It should now be clear that wherever brak exists the method of irrigation should be such that there is on the whole a downward movement of water, because, if on the whole the movement be upward, the brak of this soil down to the depth the water penetrates is slowly but surely brought to the surface.

The reason why brak should not be allowed to rise to the surface is that brak has its greatest power for injury when it is in the neighbourhood of the root-crown of the plant. Illustrative of this is the fact that land too brak at the surface to grow anything useful may, by a single heavy irrigation, be reclaimed for cultivation at least for a time, the heavy irrigation having the effect of driving the brak deep into the soil.

It happens only too frequently that the irrigator has too little water to enable him to keep the brak well down. If this be so much can be done to improve matters by maintaining an efficient soil mulch which not only reduces the evaporation of moisture from the soil to the air, but also prevents the accumulation of brak at the surface of the soil. The choice of crop is also an important matter. The best crops under the circumstances are those which send their roots down deeply and at the same time shade the soil well, as, for instance, lucerne.

The deep rooting habit is beneficial in this way. If the crop is deep rooted much of the water it takes up from the soil enters its roots down in the soil. This being so, the amount of water which can possibly be evaporated at the surface is correspondently reduced, and with it the amount of brak. Thus, in the case of lucerne, we have a crop which is often difficult to establish on brak land, but which, once its roots are down and it shades the soil, is able to tolerate brak to a higher degree than most useful crops.

The appearance of brak at the surface consequent on irrigation is known amongst irrigators as "the rise of brak." Speaking generally, the rise of brak is proportionate to the amount of water evaporated at the surface of the soil. Anything that reduces the amount of evaporation at the surface of the soil therefore reduces the rise of brak.

It must be understood that in no case does all the brak of a soil rise to the surface. Neither must it be forgotten that there may be a rise of brak of sufficient degree to cause decline in crop yields and yet not sufficient to be discernable. Again, there may be a rise of brak only towards the end of the season. In this case the crop may have done splendidly at the beginning, yet indifferently towards the end.

The effect of cultivation in preventing injury from brak is so great that the late Professor Hilgard (than whom no one living has had a wider experience of brak problems) states in his book on soils that deep preparation of the land (to assist the downward movement of water) and the maintenance of an efficient soil-mulch (to prevent evaporation) are the prime essentials to success.

## ARE BRAK WATERS USABLE UNDER CERTAIN CIRCUMSTANCES?

Connected with the rise of brak the question of the use of brak water may be considered.

If the water contains sodium carbonate and it is used on stiff soils these latter will be rendered more difficult to till and perhaps quite impermeable to water.

This is particularly the case with waters which remain muddy for a long time on account of the sodium carbonate they contain. On the other hand a very loose soil is much improved by irrigation with such a water.

Lands which are irrigated with sodium carbonate waters should be manured with gypsum, which will destroy the sodium carbonate.

Frequently an effect of using sodium carbonate waters is to produce an impervious layer at a greater or less depth below the surface. This layer has the effect of restricting the penetration of roots and also of reducing the amount of water that can be used in one irrigation. If the water is also a muddy one the effect is similar, but often the top soil is so badly affected that it will not let water through it sufficiently fast. Cultivation helps in such cases at first, but in the end becomes more and more difficult owing to the deteriorated physical condition of the soil.

If a water does not contain sodium carbonate, but is otherwise highly charged with salts, it may sometimes be used with advantage. As to whether this can be done will depend on the degree of brakness and on the manner of usage. Such waters can only be used on soils that are highly permeable to water and possessed of excellent under drainage. Such a water must permeate deeply and pass out as drainage. It must therefore be used in heavy waterings. Under no circumstances should these be light, unless they are immediately followed by irrigation with good water, the combined irrigations being sufficient to cause the necessary penetration and drainage. In this way a brak water may be used to eke out an inadequate supply of fresh water.

## LEAKAGE FROM CANALS AND FURROWS.

Where canals run through sandy land or other porous strata a good deal of trouble is experienced and lands are eventually ruined.

Canals usually occupy the higher levels of the land they irrigate. The water which seeps from them not only tends to fill up the soil in the vicinity of the leakage, but also travels underground along a line of natural drainage and may eventually find its way into a river. If, however, the rate of travel is not sufficient to keep pace with the seepage from the canals the soil will gradually fill up with water. But before this happens much damage will have been done.

The rising water-table will kill out lucerne and other deep-rooted cultures in the worst type of case; in others the crop will become unthrifty. The reason for this is that the bottom roots get drowned. If the lands are sloping signs of trouble are often first noticed in the lower lying lands, which may become permanently moist right to the surface. If the soil through which the seeping water passed contained much brak a lot of it will be accumulated in these lower lying lands. Now a waterlogged soil is bad enough, but when an excessive quantity

of brak accompanies the condition the result can be better imagined than described. I have met instances where even the brak bushes have died.

When the sub-soil water has risen high enough to keep the surface soil permanently moist it will in most cases entail drastic and costly measures to prevent the trouble from spreading. Timely warning of what is happening is of great advantage in such cases. This may be obtained by observing the water-levels in a series of boreholes, which can be very cheaply put down with an ordinary post auger, having extra lengths of rod if necessary. If the water-level in any hole rises the irrigator may know that he is putting more water on the land than the drainage can cope with.

Every irrigator should have a post auger not only for making holes in which to observe ground water levels, but also to see how deep the water sinks at the spot on which it is applied. This is necessary because the same watering will sink to different depths in different lands. The method of applying water and allowing it to run into a bed until it has reached the lower end may result in too much or too little water being applied. If the soil is porous too much water will sink in at the top end of the bed, while if the soil is stiff too little will penetrate any where.

#### THE PENETRATION OF SOIL BY WATER.

When land is irrigated for the first time it may not take the water so well as it does on the next occasion. Thereafter there is only too frequently a progressive decline in the rate at which the water penetrates. This applies particularly to soils that could be classed as loams and clays.

This deterioration in the physical properties of the soil is always greatest in cases where water is used in excess. The desirable crumb-like structure of the soil gets destroyed and the soil becomes more or less consolidated. I cannot here enter into the causes save to say that it in the course of irrigation there is a development of sodium carbonate in the soil this may arise through using too much water or it may be added in the water. Unfortunately for us the occurrence of carbonate of soda in the waters available for irrigation is very general, which means that much of the soil that can be irrigated requires very careful and intelligent handling to prevent it from deteriorating. In a case which has recently come under my notice five or six years of irrigation have resulted in the greatest difficulty being experienced in producing what at best can be called a poor seed-bed. The following are the operations necessary to prepare that land for seeding:—

The land is first watered, it is then disced, rolled, ploughed, disced again, and then harrowed with a zig-zag harrow.

I was shown some land that had been watered a week previously as the first step in the above operations. The land had a dry skin, but below this it was very wet and pasty to a depth of about six inches; below this depth it was much drier and of apparently good physical condition. It is evident that the water could not penetrate properly. By the time the soil is sufficiently dry to turn over, the surface has dried out to a hard unbreakable mass. This land is yielding about five to six bags of wheat per acre. One can imagine what the yield would be if it were possible to form a good seed bed.

SUMMARY.

1. Where the rainfall is so slight that it is necessary to irrigate crops, the soil contains more or less brak.

2. Brak waters may occur in both dry and humid areas.

3. By brak is meant a condition of soil or water in which there is too much saline matter for agricultural purposes.

4. If a soil is well drained and is permeable to water no trouble is experienced from brak if sufficient water is applied to cause drainage. By causing drainage the soil is gradually freed from the brak it contained.

5. Soils that are permeable to water but lacking in drainage should, if sufficient water is applied to them to cause drainage, be artificially drained to prevent the soil from becoming waterlogged.

6. When not enough water is applied to the soil to cause a general downward movement of water, brak may gradually accumulate at the surface.

7. Brak should not be allowed to accumulate at the surface, because it is in this position that it is able to do most harm.

8. Deep preparation of the soil and the maintenance of a surface mulch to prevent evaporation are essential to success in cultivating brak lands.

9. Crops which are deep rooted and which shade the land are the best for brak lands, because they prevent evaporation at the surface and therefore the rise of brak.

10. Lands may be ruined by leaking canals and furrows unless the drainage is sufficiently good to deal with the excess water.

11. Brak waters may be used for irrigation under special conditions, but the use of water which contains sodium carbonate is not to be recommended for the finer types of soil, especially if the water is muddy. The action of the sodium carbonate, in addition to its effect on the crop, is to render the soil impermeable and to depreciate its tillage qualities.

12. Irrigation farming requires much more skill and knowledge than rainfall farming.

---

### **Advisory Committee on Agricultural Matters.**

A Government Notice (No. 238 of 4th February, 1920) states that the Minister of Agriculture has approved of the appointment of the Executive Committee of the South African Agricultural Union as a Committee to advise him on matters relating to agriculture.

## SOME COMMON ADULTERANTS FOUND IN AGRICULTURAL SEEDS.

By K. A. LANSDELL, Division of Botany, Pretoria.

[This article is the first of a series to be published describing the common impurities in seed and how they can be recognized—ACTING EDITOR.]

THERE can be little doubt that many of the foreign weeds now found in South Africa have been introduced into this country by the importation of impure seed, also that the sowing of impure seed is largely responsible for the spread of weed pests in the Union.

Farmers frequently send in to this Division for determination weeds which more often than not are asserted to have suddenly appeared on the lands and were not noticed before. The usual explanation is that they were introduced as impurities in seed which had been sown. It is essential that farmers should see that the seed they buy is free from such impurities. If this simple precaution is taken in time, expense entailed in fighting the weeds will not only be saved, but a better crop will result, as the growing weeds rob the soil of moisture and mineral foods. Some of the common impurities found in agricultural seeds are Dodder (*Cuscuta* spp.), Burweed (*Xanthium spinosum*), Cockle-bur (*Xanthium* spp.), the Malta Thistle (*Centaurea melitensis*), the Spear Thistle (*Cnicus lanccolatus*), Star Burr (*Acanthospermum* spp.), Mexican Poppy (*Argemone Mexicana*), Khaki Weed (*Alternanthera achyrantha*), and the Dwarf Marigold (*Schkuhria bonariensis*).

The most dangerous impurity of clover seed is that of dodder. If dodder is introduced into a lucerne crop and allowed to ripen its seeds the ground may become infected for at least five to ten years. Superficially the seeds of many weeds resemble those of the associated agricultural crop seed so closely that a sample of seed must be examined carefully if the impurities are to be detected. In making an analysis of seed, first of all the contents of the bag or different parts of the bulk should be emptied out and thoroughly mixed. A small sample is then taken from the top, middle, and bottom of the receptacle containing the seed. These three samples are mixed and spread on a sheet of white paper and carefully examined. The aid of a simple magnifying glass will be found useful in many cases. With a needle or some other pointed instrument separate the impurities from the good seed. By weighing the impurities and comparing the weight with the sample a rough estimate can be made of the total weight of impure seed in the bulk of the sample.

### DODDER IN LUCERNE.

Plate I, figs. 1 and 2; Plate II, figs. 1 and 3. The seed of Dodder is spherical or oval in shape, greyish or yellowish-brown in colour, and the surface is slightly rough. It resembles the lucerne seed very much, but the latter is larger and kidney-shaped.





FIG. 1.



FIG. 2.



FIG. 3.



FIG. 4.



FIG. 5.



FIG. 6.



FIG. 7.



FIG. 8.



FIG. 9.



FIG. 10.



FIG. 11.



FIG. 12.



FIG. 13.

- FIG. 1.—Dodder Seed (Natural Size).  
 FIG. 2.—Dodder Seed (Enlarged).  
 FIG. 3.—Malta Thistle Seed (Natural Size).  
 FIG. 4.—Malta Thistle (Enlarged).  
 FIG. 5.—Spear Thistle Seed (Natural Size).  
 FIG. 6.—Spear Thistle Seed (Enlarged), with Pappus removed.  
 FIG. 7.—Russian Tumble Seed (Natural Size).  
 FIG. 8.—Russian Tumble Seed (Enlarged).  
 FIG. 9.—Russian Tumble Seed (Enlarged), inside of Seed.  
 FIG. 10.—Mexican Poppy Seed (Natural Size).  
 FIG. 11.—Mexican Poppy Seed (Enlarged).  
 FIG. 12.—Milk Thistle Seed (Natural Size).  
 FIG. 13.—Milk Thistle Seed (Enlarged), with Pappus removed.

Plate 1.

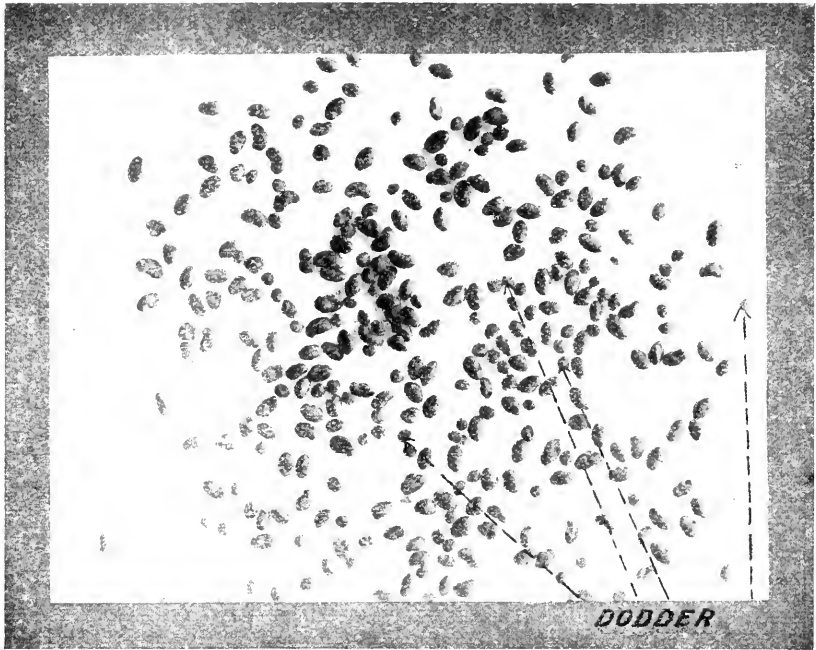

FIG. 1 and 3. - Dodder in Lucerne.

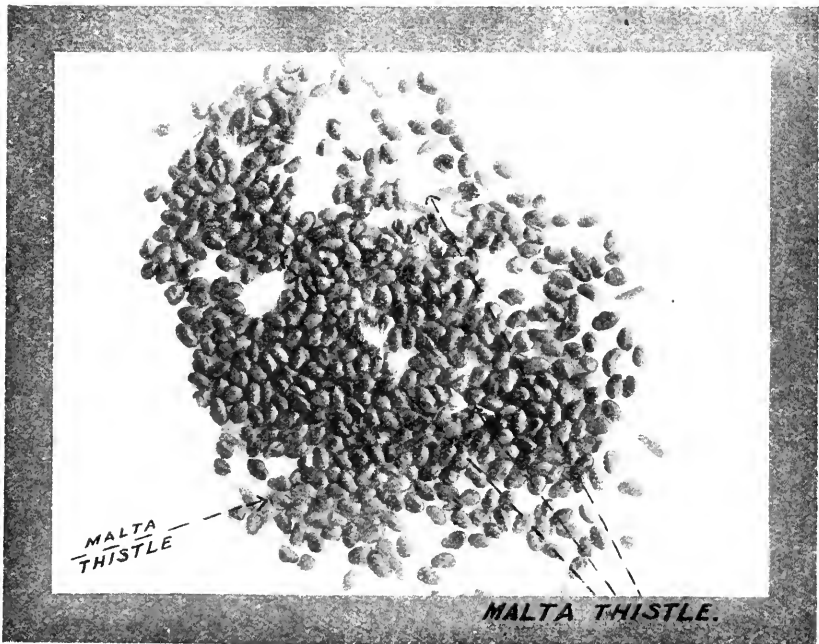

Plate II.

FIG. 2 and 3. The Malta Thistle in Clover Seed.



FIG. 1 and 3. The Spear Thistle in Clover Seed.

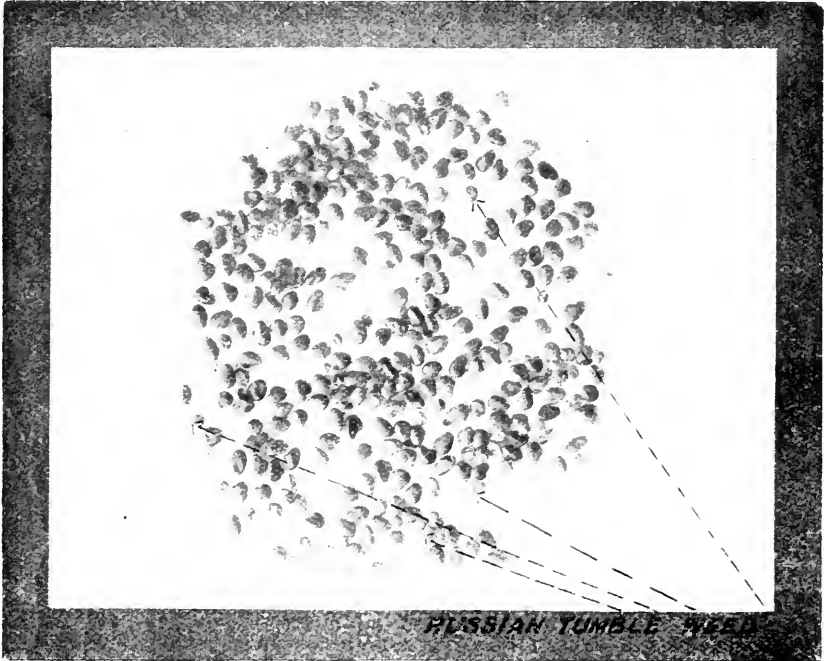

Plate III.

FIG. 2 and 3.—Russian Tumble Weed in Clover Seed.

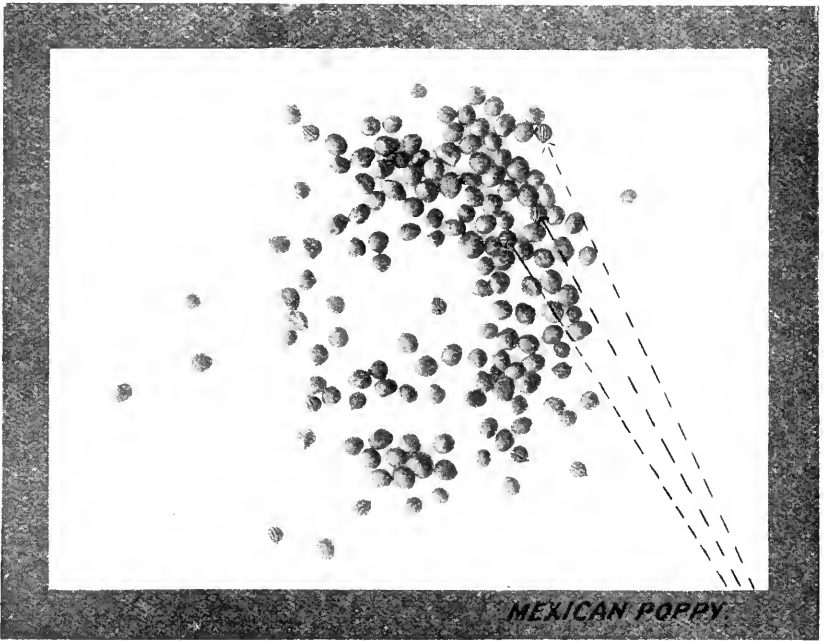
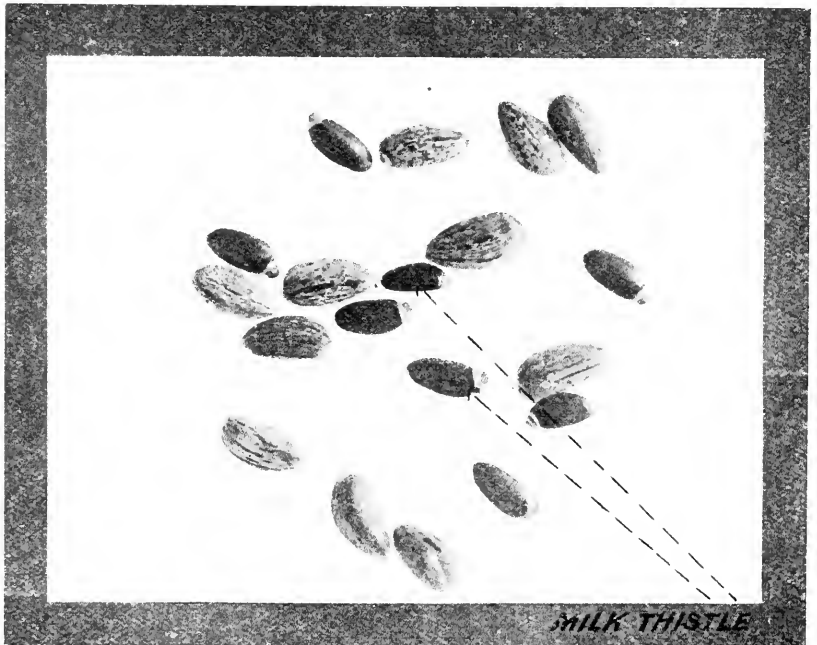

FIG. 1 and 3.—The Mexican Poppy in Brassica Seed.



*Plate IV.*

FIG. 2 and 3.—The Milk Thistle in Artichoke "Seed".

## THE MALTA THISTLE IN CLOVER SEED.

Plate I, figs. 3 and 4; Plate II, figs. 2 and 3. The seeds of the Malta Thistle (*Centaurea melitensis*, L.) are oblong in outline, with darker grey longitudinal markings, and often with a shiny coat. The base terminates in a small hook, and the apex may be tipped with stiff hairs. The seeds are easily recognized in clover, as the short stiff hairs seldom fall away and the seeds of clover are quite devoid of hairs.

## THE SPEAR THISTLE IN CLOVER SEED.

Plate I, figs. 5 and 6; Plate III, figs. 1 and 3. The seeds of the Spear Thistle (*Cnicus lanceolatus*, L.) are flattened, oblong in outline, shining, light-grey in colour with blackish longitudinal markings, and the apex is tipped with long feathery hairs. As the feathery hairs often become detached from the seed, the large size and the presence of the longitudinal black markings have to be relied upon for distinguishing these seeds from that of clover.

## RUSSIAN TUMBLE WEED IN CLOVER SEED.

Plate I, figs. 7 and 8; Plate III, figs. 2 and 3. The seeds of Russian Tumble Weed (*Salsola kali*) are very small, irregular in shape, somewhat resembling a flattened top, and are reddish-yellow in colour. It can at once be distinguished from clover seed, which are oval or kidney-shaped, by the small projection in the middle of the seed. The seeds of the *Salsola* are so small that a magnifying glass should be used to detect them.

## THE MEXICAN POPPY IN BRASSICA SEED.

Plate I, figs. 9 and 10; Plate IV, figs. 1 and 3. The seed of the Mexican Poppy (*Argemone Mexicana*) is spherical, black in colour, with a pitted surface and is crested on one side.

It resembles the seed of the brassica very much, but can be at once distinguished by the pitted surface.

## THE MILK THISTLE IN ARTICHOKE SEED.

Plate I, figs. 11 and 12; Plate IV, figs. 2 and 3. The Milk Thistle (*Silybum marianum*) has oblong flattened seeds, blunt at the base, shining, and brown in colour, with numerous black markings. At the apex are long fine hairs which often fall away when the seed is dry. They resemble the seed of the artichoke in shape, but are not so long and are darker in colour.

*N.B.*—The seeds were photographed by Dr. E. P. Phillips of this Division.

## THE FERTILIZERS, FARM FOODS, SEEDS, AND PEST REMEDIES ACT (No. 21 of 1917).\*

### ITS OBJECT AND APPLICATION.

By B. DE C. MARCHAND, B.A., D.Sc., Chief, Division of Chemistry.

IN 1917 an Act was passed which governs the sale of fertilizers, farm foods, seeds, and pest remedies. This Act was brought into force on the 30th November, 1918, and regulations, made under Section 7 thereof, relating to the sale of fertilizers and farm foods were published in the *Gazette* of the 30th August, 1918. Subsequently these regulations were withdrawn and amended regulations, published in the *Gazette* of the 28th March, 1919, came into force on the 1st April, 1919.

The object of the Act is to protect purchasers of the articles named from having worthless ones imposed upon them. The main principle of the Act is contained in Sections 3 and 6. These may therefore be quoted in full:—

Section 3 (1).—Every person who sells any fertilizer shall give or send to the purchaser at the time of delivery an invoice stating the quantity sold, the name or brand under which the fertilizer is registered, and also the chemical constituents thereof which have been registered as prescribed by regulation in respect of such fertilizer. That statement in the invoice shall be deemed to be a guarantee that the article is as described therein.

(2) Every person who sells any farm food shall give or send to the purchaser at the time of delivery an invoice stating the quantity sold, the name and brand under which the farm food is registered, and also the chemical constituents thereof which have been registered as prescribed by regulation in respect of such farm food. That statement in the invoice shall be deemed to be a guarantee that the article is as described therein.

Section 6.—No person shall supply any fertilizer, farm food, seed, or pest remedy which is not of the nature, composition, or quality as described when sold to the purchaser.

The whole Act, together with the regulations, is really summed up in these two sections; the other sections are, for the most part, concerned with the *application* of these two.

### REGISTRATION.

Section 3 provides also that fertilizers and farm foods must be registered, while Regulations Nos. 1 and 2 prescribe how this is to be done.

The procedure is as follows:—

Every vendor of a fertilizer or farm food must fill in certain forms in duplicate: these forms are forwarded to the Department of Agriculture. If found in order, that is correctly filled in and complying with any regulations that have been made in respect to

\* In this article *Section* refers to the sections of Act No. 21 of 1917, while *Regulation* refers to those published under Government Notice No. 436 of 1919.

the article to be registered, these forms are signed by the Head of the Department or by some one acting on his behalf, one form being returned to the sender and the other filed in the register kept by the Department. No fee is charged for such registration. No person may sell any fertilizer or farm food in respect of which such a certificate has not been issued. (Regulation No. 1.)

Any vendor in the second place must be in possession of an invoice or other evidence of registration before he may sell a fertilizer or farm food. (Regulation No. 30.)

INVOICES.

Having duly registered his wares the seller must, as prescribed by Section 3, give the purchaser an invoice setting out the registered particulars of the fertilizer or farm food; this invoice is by Section 3 a *guarantee*.

It is to be noted that a vendor in the second place must also give an invoice.

For his own protection the purchaser should see that he gets an invoice in the form prescribed by Regulation No. 6 or by Regulation No. 20. The forms are as follows:—

1.—*For Fertilizers.*

Phosphoric Oxide per cent.			Nitrogen per cent.	Potash per cent.	Lime per cent.	* Iron Oxide and Alumina per cent.		The Form in which Nitrogen is Present.	The Form in which Potash is Present.
Soluble in Water.	Soluble in 2 per cent. Citric Acid Solution.	Total.				*	*		

\* To be filled in in the case of raw phosphate rock.

NOTE.—Plain percentages must in all cases be inserted, not a range of figures. Percentages must not be stated beyond the first decimal place.

2.—*For Farm Foods.*

Protein.	Fat (Ether Extract).	Fibre.	Moisture.	Ash.	* Lime.	* Phosphoric Acid.

\* Only to be filled in in the case of bone meal, bone dust, and bone flour.

NOTE.—Plain percentages must in all cases be inserted, not a range of figures. Percentages must not be stated beyond the first decimal place.

It is to be noted that in addition to the particulars of the chemical composition of the fertilizer or farm food the invoice must bear the name or brand under which the article is registered.

## BRAND.

In order to prevent confusion each fertilizer or farm food must be given a "brand." A brand is defined as "the impression of any letter, number, geometrical figure, mark, sign, or character, or combination thereof of sufficient size and of suitable colour to be easily legible, upon any bag, barrel, package, or parcel containing any particular brand of fertilizer, farm food, seeds, or pest remedy, and sufficient to identify it and to distinguish it from any other kind of fertilizer, farm food, seeds, or pest remedy, or in the case of seeds within such bag, barrel, package, or parcel." (Section 26.)

In short, a brand is of the nature of a trade mark. The brand serves to distinguish the bone meal, for example, sold by one firm from that sold by another. A register of brands is kept by the Department, and "the acceptance for registration of any proposed brand or brands shall be subject to the approval of the Department, and no brand deemed by the Department to be so similar to one already registered as to be liable to be mistaken for the latter or to be of an insufficiently distinctive nature for the purposes of these regulations shall be accepted for registration."

The brand must be legibly and durably marked on all receptacles in which fertilizers or farm foods are offered for sale or sold. (Regulation 5.)

A vendor is not compelled to use a different brand for each class of fertilizer sold; thus there may be an "XYZ" brand of bone meal and an "XYZ" basic slag offered by the same firm, the *name* of the fertilizer serving in such case to distinguish the one from the other. The same vendor is *not*, however, permitted to use the same brand for two fertilizers having the same name but differing in chemical composition. For example, if a vendor wishes to register two qualities of bone meal he may do so provided a separate brand is used for each. Thus:—

Firm.	Name of Fertilizer.	Brand.
(1) AB & CO.	Bone Meal.	XYZ
(2) AB & CO.	Bone Meal.	PQR

The net result is that every fertilizer offered for sale is distinguished from every other by the name taken in conjunction with the brand.

## NATURE.

The fertilizer must be sold under the appropriate name. This is so obvious as to need no explanation. The nature of the fertilizers which may be sold under certain names is, however, defined or partially defined by some of the regulations. Thus, bone dust must be of such fineness as to permit of at least 50 per cent. thereof passing a sieve having round holes 1 mm. in diameter [Regulation No. 15 (2)], whilst basic slag must be sufficiently fine to permit of at least 80 per cent. thereof passing a specified sieve [Regulation No. 11 (2)]. Attention is particularly called to the definitions of sulphate of potash and muriate of potash implied by Regulation No. 18 (1). No fertilizer may be sold under the name sulphate of potash (potassium sulphate) unless it "contains" at least 48 per cent. of potash, that is, the article must consist of not less than 88.5 per cent. of actual potassium sulphate; and similarly for muriate of potash.



Potash salts of less purity are supposed not to be entitled to the name applied to the pure article. It is to be noted that for many common commercial fertilizers no standards are laid down. In a number of these, such as nitrate of soda and sulphate of ammonia, the "refraction," as it is called in the trade—that is the percentage of matter other than that chemically entitled to the name used—is practically constant and the articles are to all intents standardized by the trade. Should occasion arise, however, it is obvious that the principle adopted for potash salts could be extended to other fertilizers. No definitions have been adopted with respect to farm foods, but as a matter of course the article must actually be what it purports to be.

#### CONTROL.

Under Sections 14 and 15 an officer in the public service who acts under written authority from the Department may enter any premises where fertilizers, farm foods, etc., are kept or suspected of being kept for sale and purchase samples of these articles. These samples must be divided each into three parts, one of which must be sent to an analyst duly appointed. The officer purchasing, being a buyer, must be furnished with an invoice. Should the fertilizer or farm food be found upon analysis or examination to be not of the nature, composition, or quality as described in the invoice proceedings may be instituted against the seller for contravention of Section 6 or of any regulation which may apply in the particular case. Another portion of the sample must be handed to the seller, who may, if he doubts the analysis furnished by the official analyst, submit the portion for analysis to any analyst not being in Government employ. The seller may also, under certain conditions, demand a further analysis. (Section 19.)

Any purchaser of a fertilizer or farm food, not being the officer authorized thereto, may under certain conditions take samples and submit them to a duly appointed analyst. (Regulation No. 27.) The regulation should be carefully studied by those who desire to take advantage thereof. It must be remembered that failure to comply with the details will almost certainly stultify any subsequent legal proceedings.

#### SAVING CLAUSES.

A vendor in the second place who purchases a duly registered fertilizer or farm food under a written warranty and, having no reason to believe that the article was otherwise, who sells it in the same state as that in which he bought it is not liable for any shortcomings in the article.

Further, if the seller prove that the sample was not representative, which it might not be in certain cases, and if he prove in addition that there is reasonable ground for believing that the article was fraudulently placed in the containing receptacle he shall be discharged.\* (Section 21.)

*It should be noted that proof of intention to defraud is not necessary.* (Section 20.)

---

\* Cases similar to those which would fall under this portion of Section 21 are not unknown. In a recent prosecution for milk adulteration, one analyst found about 3½ per cent. of fat in one portion of the sample while another found over 11 per cent. in another. It is obvious that the portions were not the same, the fault lay in the sample or the sampling.

## LIMITS.

In Regulation No. 24 a table of limits is given, and it is provided that "fertilizers and farm foods shall be deemed to be sufficiently in accord with the guaranteed or registered composition if upon analysis the actual percentages be found not to fall below those stated in the invoice or in the certificate of registration by more than the limits set forth in this regulation."

This regulation requires some little explanation. At first sight it would appear that a vendor is permitted to register and invoice a certain quantity of any constituent over and above the quantity actually contained in the fertilizer. The "limit" fixed for total phosphoric oxide in bone meal, for example, is 1 per cent.; if a sample of bone meal, registered and invoiced as containing 24 per cent. of phosphoric oxide, were found upon analysis to contain 23 per cent. it would be "deemed to be sufficiently in accord with the guaranteed or registered composition." This does not mean, however, that the buyer, in assessing the value of a fertilizer, must take the limits into consideration; he must not argue that if 18 per cent. of phosphoric oxide in superphosphate is guaranteed he can only count on getting an article containing 17.5 per cent. (the limit in this case is 0.5 per cent.). It is true that a vendor *might* increase the guaranteed amount by the limit with intent to defraud, but this is unlikely, as a study of the reasons for fixing the limits will show. It must be remembered in the first place that fertilizers and farm foods are, as a rule, sold in comparatively large quantities, that a sample taken for analysis is small (it is fixed by regulation as of about 6 lb. weight), and that the actual portion analysed by the analyst is much smaller still. It is obvious that if two different samples are analysed *exactly the same* analytical results will only be obtained if the material is perfectly uniform. Uniformity of two or more samples is aimed at by the method of sampling prescribed by Regulation No. 22, but absolute uniformity is difficult of attainment. The vendor, if he employs a mixing process, tries to make the article as uniform as possible. He must do this because for application to the soil a fertilizer must be uniform, since the farmer would be very dissatisfied if he found after the fertilizer had been distributed that all the active ingredients were concentrated on one portion of the land while the other portion had received little or none. The crop would probably suffer on both portions.

The person taking the sample also tries to secure uniformity by taking portions from several packages, mixing these well, and then taking a portion of this mixture. This process is repeated by the analyst in "sampling down," as it is called. Certain articles are manufactured in a very uniform condition, others can easily be mixed to a high degree of uniformity, others again are extremely difficult to mix so as to secure reasonable homogeneity. This is taken into account in fixing the limits, which are not the same for all classes of fertilizers and farm foods. Another source of any difference there may be in the analyses of two samples is the analytical error. There is always a certain amount of experimental error in analytical processes. These are not performed with the absolute mathematical precision of a machine. Part of the error is due to the *method* employed in the analysis. Few, if any, analytical processes are

absolutely exact; the error may be infinitesimal, but it is there nevertheless. Then again there is the personal factor; cases arise in which one analyst may consistently get higher results than another analyst using the same process and working under the same conditions. People are not machines, and no two people are *exactly* alike. It must be noted, however, that the errors in the analysis may be either plus or minus errors; that is, if the analyst repeats the analysis many times some of the results will be too low, some too high, while a few may be exact. There is just as much likelihood that the result will be too low as that it will be too high. The analytical error is as a rule very much less than the error in sampling and mixing. The limit is fixed at a figure which it is believed is higher than any ordinary errors of sampling and analysis can possibly be. This is in order to give the guarantee every benefit of these errors. We now see that a vendor who deliberately guarantees more of any ingredient than he knows the fertilizer or farm food to contain loses this benefit. Let us take the example quoted above of a bone meal guaranteed to contain 24 per cent. of phosphoric oxide, but actually containing 23 per cent. Supposing the analyst to report 22.8 per cent., the bone meal will be reported as not sufficiently in accord with the guaranteed composition and the vendor is liable to prosecution. Yet the difference between the 23 per cent. actually present and the 22.8 per cent. found may well be due to errors of sampling and analysis. Had the vendor guaranteed only the 23 per cent. actually present he would be protected against the small error of 0.2 per cent. As it is, he has deliberately thrown away this protection by an over-guarantee. Merchants should take this into account in framing their registrations and guarantees. The registration figures are presumably based on the results obtained by an analyst employed by the vendor. Such a figure is also open to errors of sampling and analysis, and these errors may take the opposite direction to those which come into play in the official analysis. Manufacturers would be well advised to round off the figures furnished by their analysts. For example, if the analyst reports 15.7 per cent. water soluble phosphoric oxide in a superphosphate, the safest plan is to guarantee 15.5 per cent. No monetary loss is incurred, as there can be no appreciable difference in selling price. Many firms adopt this principle, and it is certain that they are not losers thereby, as the security that their guarantees will never be challenged and that a prosecution on this score will never be instituted (and a prosecution means a great deal, even if there be no conviction), will amply pay for any small but doubtful loss sustained by under-guaranteeing.

#### CONCLUSION.

Two points may be brought to the notice of vendors. Firstly, that a range of figures, e.g. "nitrogen 2 to 3 per cent." is not admissible in either registration or invoice, and, secondly, that percentages must be given to *one decimal place* only.

These provisions, contained in the footnote to Regulation No. 2, do not seem to have sufficiently attracted the attention of those responsible for the completion of the registration forms.

It will be seen that the buyer of fertilizers and farm foods is protected by the guarantee from having worthless articles imposed upon him. He can no longer be misled by specious advertisements,

unaccompanied by figures setting out the composition of the article, or by figures which are intended to be misleading.

The manufacturer or vendor of fertilizers or farm foods is protected against the unfair competition of worthless goods, and has his wares placed on an equal basis, or on as equal a basis as is possible, with those of all other vendors. The seller who supplies a fair article at a fair price is safeguarded against the trader who supplies a low-grade article at a high price, justifying the price by some specious argument as to quality of the goods.

An examination of the registrations effected during the first year of the operation of the Act shows that the number and variety of ready-mixed "complete" fertilizers offered for sale is enormous. We are of opinion that this is a mistaken policy for the fertilizer trade. It is impossible that a "complete" fertilizer for any particular crop will be equally effective on that crop in all cases. Cases of failure to increase crop yields are bound to occur, with the result that the particular fertilizer gets a bad name. Another effect which such failures have is the general disrepute in which commercial fertilizers are held by certain farmers. The majority of farmers in South Africa have to be educated in the use of fertilizers. If, when the farmer has been induced to take up commercial fertilizers, a failure ensues the result is that that farmer will buy no more fertilizer for a long time to come, and the value of commercial fertilizers will have to be demonstrated to him a second time. Before the Act came into force complaints were made from time to time by farmers that the commercial fertilizers they had bought were "no good." Analysis frequently showed that the quality of the fertilizer *was* good: in many cases the best that was to be had. Failure was due merely to the unsuitability of the fertilizer for the particular case. We feel sure that it is not to the ultimate good of the country as a whole, nor in the long run to the merchant, to persist in the practice of supplying and using standard mixtures for all cases. We have not reached a stage in agricultural science in which it is possible to lay down rules for manuring. Each case is a problem which must be considered on its merits. Vendors are not agreed as to the proportions of the various ingredients which should be supplied for a particular crop. It is impossible under the circumstances that they should be agreed. The following table, compiled from the registrations published in the *Gazette* of the 2nd January, 1920, is given as an index of the range in mixed fertilizers, intended for the maize crop, offered for sale in the Union.

Registered Composition.			Ratios : Nitrogen taken as Unit.		
Nitrogen.	Phosphoric Oxide.	Potash.	Nitrogen.	Phosphoric Oxide.	Potash.
Per cent.	Per cent.	Per cent.			
2	10	6.5	1	5	3.3
2	9	2	1	4.5	1
3	12	1	1	4	0.3
2.5	11	1.5	1	4.4	0.6
2.5	9	2	1	3.6	0.8
2	12	3	1	6	1.5
2	9	2	1	4.5	1
3	12	1	1	4	0.3
2.5	12	0	1	4.8	0
1.5	12	2	1	8	1.3
2	13	3	1	6.5	1.5
2.5	12.5	2	1	5	0.8
2.5	10	1.5	1	4	0.6
2.5	9.5	3	1	3.8	1.2
2.5	9.5	2.5	1	3.8	1
2.5	15	2.3	1	6	1
2	13	1.5	1	6.5	0.8
3	15	3	1	5	1
1.8	13.1	2.7	1	7.3	1.5
2.5	14	2	1	5.6	0.8
1.5	12	2.5	1	8	1.7
2.2	8.5	2.5	1	3.9	1.1
3.0	5.5	4.0	1	1.8	1.3
2.2	13.5	5.0	1	6.1	2.3
1	9	3	1	9	3
3	12	1	1	4	0.3
2.5	9.5	2.5	1	3.8	1

We find that for one of nitrogen the proportion of phosphoric oxide varies from 1.8 to 9, while potash varies from 0 to 3.3. On examining some of the mixed fertilizers offered one would conclude that manuring was a fairly exact science, as instance the following :—

Crop for which Fertilizer is intended.	Nitrogen.	Phosphoric Oxide.		Potash.
		Soluble in Citric Acid.	Total.	
	Per cent.	Per cent.	Per cent.	Per cent.
Tobacco ... ..	3.0	8.0	9.0	3.5
Potato ... ..	3.0	8.0	9.0	3.0
Vine... ..	3.0	8.0	10.0	3.0
Grain ... ..	3.0	8.0	10.0	2.5

The apparent nicety with which these crops can, judging by the above figures, distinguish variations in the proportions in which the fertilizer constituents are present is remarkable. We are confident that these differences would not be reflected by the crop under ordinary farming conditions. It would have been better had the manufacturers confined themselves to one mixture only.

It is possible, of course, that in the variety of maize fertilizers listed above the farmer may find one which exactly suits his requirements, but no farmer can afford to determine by experiment—the only satisfactory way—which will be the most suitable for his conditions.

## THE USE OF HARD OR SALINE WATERS FOR SHEEP DIPPING.

By DR. CHAS. F. JURITZ, M.A., F.I.C., Agricultural Research Chemist.

ABOUT ten years ago representations were made to me regarding the difficulty experienced by farmers in certain districts in securing a uniform dipping fluid when mixing the natural waters of those districts with well-known proprietary sheep and cattle dips. A few tests were subsequently made in the laboratories of the Cape Department of Agriculture, then under my charge, and the indications at the time pointed to the desirability of a more extensive investigation of the subject. Recently the subject again came before my notice, and, under the circumstances, it may serve a useful purpose to record some details of the tests above alluded to.

Early in 1909 the Magistrate of Calvinia wrote to the Department commenting on the failure of dipping operations to eradicate scab, and suggesting that this failure might be due to the insolubility of the dipping materials in the waters of the district. No analysis of those waters had up to that date been made in the Cape laboratories, but it appeared likely that they would be found to contain lime and magnesia salts, and the suggestion was accordingly made by me that an investigation be made with a view to ascertain whether such brak waters diminish or prevent the solubility of carbolic dips, in respect of which it seemed probable that their action would be chiefly manifested. At the same time I proposed to test the effect on sodium arsenite and on lime and sulphur dips. The last named, I considered, would present the least difficulty with brak waters. The plan was to procure three or four gallons of brak water from different sources and to make a chemical analysis of each; also to test the dissolving effect (*a*) of the brak waters, and (*b*) of pure distilled water, by shaking each up separately with sodium arsenite in the proportion of 5.4 grammes of the arsenite to 1 litre of water, i.e. in the proportion (5 lb. per 100 gallons) recommended for practical dipping operations.

In October, 1909, it was reported that waters on the farms Biesjesvlakte and Roodeklipheuvel, in Area II, Clanwilliam Division, would not mix either with Cooper's dip or with carbolic dips. Two samples of water were accordingly procured from the farms mentioned.

The samples were analysed by Mr. E. V. Flack, the analyses resulting as follows:—

*In grains per gallon—*

	Biesjesvlakte.	Roodeklipheuvcl.
Total solids at 105° C. ... ..	526.12	510.16
Total solids at 180° C. ... ..	492.52	486.64
Silica ... ..	1.53	3.85
Oxide of iron and alumina ...	.77	.42
Lime ... ..	25.69	59.92
Magnesia ... ..	33.69	14.31
Alkalies calculated as Na <sub>2</sub> O...	189.62	166.62
Sulphuric oxide ... ..	29.52	9.33
Chlorine ... ..	279.28	282.07
Carbon dioxide ... ..	2.83	1.14

*In parts per 100,000—*

Temporary hardness ... ..	9.20	3.70
---------------------------	------	------

The proportions of salts contained in solution may, therefore, be assumed to be the following, in grains per gallon:—

	Biesjesvlakte.	Roodeklipheuvcl.
Calcium carbonate ... ..	6.43	2.59
Calcium sulphate ... ..	50.18	15.86
Calcium chloride ... ..	2.82	102.95
Magnesium chloride ... ..	80.62	34.00
Sodium chloride ... ..	357.83	314.44

Mixing tests made in the laboratory showed that these waters refused to mix with carbolic dips, but that sodium arsenite dissolved in them quite easily. Difficulty was experienced in obtaining a good solution of sodium arsenite in sea-water, and, after standing, a precipitate occurred showing that sea-water is unsuitable for mixing with sodium arsenite dips.

In 1913 three samples of water were obtained from the following sources in the Calvinia Division:—

1. Sous Puts.
2. Verdwaal Vlei Puts.
3. Bitterputs East Puts.

The following were the analytical results, stated in grains per gallon:—

	1.	2.	3.
Total solids at 105° C. ... ..	388.4	464.0	734.8
Total solids at 180° C. ... ..	374.6	445.0	709.2
Silica ... ..	2.64	2.60	3.24
Oxide of iron and alumina ...	.56	.32	1.60
Lime ... ..	28.48	38.48	67.00
Magnesia ... ..	26.96	49.54	77.41
Alkalies calculated as Na <sub>2</sub> O	109.10	94.78	150.66
Carbon dioxide ... ..	—	5.98	14.48
Sulphuric oxide ... ..	87.50	173.07	203.02
Chlorine ... ..	132.95	82.01	191.35
Sulphuretted hydrogen ... ..	—	2.25	—
Free sulphuric acid ... ..	2.35	—	—

From these figures it was calculated that the waters contained the following salts in solution:—

	1.	2.	3.
Calcium carbonate ... ..	—	13.59	32.91
Calcium sulphate ... ..	69.16	74.91	117.96
Magnesium sulphate ... ..	67.35	148.62	200.44
Magnesium chloride ... ..	10.71	—	25.18
Sodium sulphate ... ..	—	53.06	—
Sodium chloride ... ..	205.90	135.14	284.31

These waters also failed to form satisfactory emulsions with a carbolic dipping fluid, a precipitate being formed in the water immediately upon addition of the dip. On attempting to use the waters so as to make up solutions of 80 per cent. arsenite of soda of the strength prescribed for dipping, i.e. in the proportion of 3 lb. of the arsenite to 100 gallons of water, 5.71 ounces remained undissolved in the case of No. 1, 2.86 ounces in the case of No. 2, and 2.98 ounces in the case of No. 3. The quantity of water received was insufficient to allow of a complete test with lime and sulphur dips, but as such tests seemed very desirable I suggested (in April, 1913) that further samples of the Calvina waters be procured for this special purpose. The Secretary for Agriculture looked upon the results above recorded as confirming suspicions which he had had for some time, and was very anxious that the experiments in connection with lime and sulphur dips should be carried out, and directions were given accordingly. The laboratory had, however, by that time been transferred to the Department of the Interior, and, as far as I am aware, no further steps were taken in the matter.

About a year previous to the last work on the Calvina waters, it had been persistently reported from the Kentani district in the Transkei, that solutions of sodium arsenite, made up at proper strength, had failed to destroy ticks, although solutions containing the same proportions of arsenite were said to have yielded good results elsewhere. The presence of salts in the water was suggested as a remotely possible reason of diminished efficiency. Samples of water from nine different localities in the district were therefore procured and tested with regard to their saline contents with the following results, in grains per gallon:—

Locality.	Total Dissolved Salts.	Chlorine.
Qombolo ... ..	40.60	14.2
Macibe... ..	30.52	11.5
Nytura... ..	30.24	8.7
Takazi... ..	52.08	16.9
Gqungqe ... ..	67.48	29.8
Nxaxo... ..	37.80	10.1
Godidi... ..	39.48	12.8
Ndebe... ..	18.76	3.0
Teko ... ..	15.40	2.3

In addition to the above laboratory examinations, practical tests were made with all these waters for the purpose of ascertaining their suitability for use with sodium arsenite. The results of these tests were satisfactory in every case, no precipitation of arsenic taking place.

It is apparently still quite uncertain whether calcium,



magnesium, or sodium salts in waters influence the solubility of the dips more, and also whether it is the sulphate or the chloride of any of these three elements that has the greater inhibiting effect. Moreover, as already pointed out, certain classes of dips may be seriously affected—at least by some of the above salts—and others either not at all, or else by other salts. What is needed, therefore, in order to perfect such an investigation, is to correlate the waters of a particular district with the class of dip to which they are best suited.

#### EXPERIENCE IN THE UNITED STATES.

Quite opportunely for the conditions in South Africa the United States Department of Agriculture has recently issued, in Farmer's Bulletin No. 798, on "The Sheep Tick," a warning against the use of certain classes of sheep dips, particularly of the carbolic type, with brak, alkali, or hard waters. It will undoubtedly be of advantage to take over some of the cautions and advice there given.

In the United States, as with us, hard or brak waters are found more or less frequently in all parts, and, where it is possible to do so, their use for dipping purposes should be avoided.

When soft water is used for making up a dip the mixture has greater wetting power than when some of the hard waters are used. If the wetting power of a mixed dip is low the fluid has a tendency to form small bead-like drops all over the wool instead of uniformly covering the entire surface. If we increase the wetting power of such a mixture we make it more efficient because we ensure the more even distribution of the active principle and the maximum possible wetting for all parts of the animal that are covered by the liquid. Even good dips may become ineffective if they are made up with alkali water. In this respect, then, the American experience confirms our own.

Before any coal-tar, creosote, cresol, or carbolic dip is mixed with hard or alkali (brak) water, a test should be made to see whether such admixture results in a permanently uniform fluid; or whether a separation between the liquids occurs, something like when oil and water are shaken up and left to stand for a short while; or else, whether a soft semi-solid, or curdy precipitate or sediment settles down. Such a test may be carried out by placing a measured quantity of dip in a clean bottle or jar of clear glass and adding to this, mixing thoroughly meanwhile, approximately the same proportion of water (preferably warm) that would be added to the dip in actual practice. If after standing for one hour the mixture is no longer uniform, but separates out in two layers—if, for instance, an oily layer or a mass of globules appears either on the surface or at the bottom of the mixture, that kind of water should be regarded as unfit for making up the dip, at all events without further treatment.

In some cases, however, it is impossible to get any other than permanently hard waters for making up dips. It is then necessary to "break" the water by adding to it carbonate of soda in the proportion of from 1 to 4 pounds of salt per 100 gallons of water, according to the hardness of the latter. In bad cases, however, it would be desirable to have the water analysed and obtain professional advice on the best manner of correcting the water so as to render it suitable for preparation of dipping mixtures.

## THE NATURAL WATERS OF THE UNION.

As far as concerns a chemical survey of the natural waters of the Union, nothing very extensive has yet been done, but attention may be directed to the series of articles in the *Cape of Good Hope Agricultural Journal* of May—July, 1908, in which I discussed the underground waters of the Cape Province. The purest waters examined were (1) the soft waters of the Table Mountain geological series, that is to say, those flowing from the ranges of lofty mountains which extend southwards from the neighbourhood of Van Rhynsdorp to Paarl and Stellenbosch, and eastwards from Swellendam to Humansdorp, and (2) those of the Stormberg series, i.e. the belt of country bordering on the Drakensberg, in the north-east of the Province. The total mineral salts dissolved in the Table Mountain waters are generally under 10 grains per gallon. In the waters of the Karroo formation lime and magnesium compounds abound, rendering them hard, either temporarily, owing to the presence of calcium and magnesium carbonates, or permanently on account of the presence of calcium and magnesium sulphates, together with sodium sulphate and chloride. The total salts usually range between 80 and 150 grains per gallon. The waters of the Malmesbury beds contain a wide range of salts in solution, from 50 up to 400 grains per gallon, chiefly sodium and magnesium chlorides, and the salinity of the Bokkeveld beds seems to be even higher, in one case over 700 grains of salt per gallon having been found. Other geological formations yielding very saline waters are the Dwyka and Uitenhage series. The former stretches, in its widest extent, north-eastwards from Calvinia to Kimberley, while the largest area covered by the latter covers the Divisions of Uitenhage and Alexandria. Sodium chloride and calcium carbonate appear to be the principal salts in those waters, but in some cases large proportions of magnesium chloride are also found. In the Uitenhage formation the saline contents of various waters have been found to be 500, 800, 1100, and even 2200 grains per gallon.

The whole subject discussed in these pages needs, however, fuller inquiry, not only from the point of view of the distribution of various types of saline and hard waters within the Union, but also in regard to the effect of these different types of water on sheep and cattle dips.

---

---

### South African Jams.

Amended Statutory Rules and Orders governing the import prices of colonial jams in the United Kingdom have recently been issued, which provide a much better price for Cape gooseberry jam than formerly. The inclusion in the schedules of jams made from melons will also help them. It has been decided that komfijts do not fall under the definition of jams, and they will, therefore, be admitted without restriction of prices. The amendments are mainly due to representations made by the Acting Trade Commissioner in London to the authorities concerned, and our thanks are due to Mr. Canham for his efforts.

## RESULTS OF WINTER CEREAL EXPERIMENTS AT THE SCHOOL OF AGRICULTURE, ELSENBURG, MULDER'S VLEI, CAPE PROVINCE.

By T. G. W. REINECKE, Principal, and G. J. MEYNDARDT,  
Assistant Experimentalist.

CEREAL investigations have been carried on at the School of Agriculture, Elsenburg, for several years. Unfortunately, owing to the hilly nature of the farm, the soil is of varying composition and depth. It was found extremely difficult to select a site for the Experimental Division where the soil was sufficiently uniform to yield comparable and reliable results. The present site is, according to the records, the third one selected since the founding of the school. Work was commenced on this site in 1915. Even here it soon became apparent, in the case of the fertilizer trials, that the number of check plots provided was totally inadequate to eliminate the effect of soil differences.

The investigations in progress embrace the following:—Rotation, soil fertility, fodder, seeding experiments, and variety trials.

### ROTATION AND SOIL FERTILITY EXPERIMENTS.

#### (a) *Comparative Values of Various Crops as Green Manures.*

These trials were commenced in 1915. The following has been the rotation practised and the fertilizer treatment applied:—

Year.	Rotation.			Fertilizer Treatment per Acre.
1915	...	Green Manure	...	100 lb. Basic Slag. 25 lb. Muriate of Potash.
1916	...	Oats	... ..	70 lb. Basic Slag. 70 lb. Superphosphate. 35 lb. Kraal Ash. 15 lb. Nitrate of Potash.
1917	...	Green Manure	...	100 lb. Basic Slag. 25 lb. Muriate of Potash, plus 20 lb. of Nitrate of Soda to Mustard and Oats.
1918	...	Wheat	... ..	75 lb. Superphosphate. 75 lb. Government Guano.
1919	...	Oats	... ..	75 lb. Superphosphate. 75 lb. Government Guano. 50 lb. Nitrate of Soda as top dressing.

TABLE I.  
*Yields of Oats and Wheat Crops.*

KIND OF GREEN MANURE.	YIELD IN LB. PER ACRE.					
	Grain and Straw.			Grain.		
	Oats. 1916.	Wheat. 1918.	Oats. 1919.	Oats. 1916.	Wheat. 1918.	Oats. 1919.
Lupins, 1915 } Burt Oats, 1917 } ... ..	2470	1700	1870	1170*	647	687
Spring Vetch { 1915 } { 1917 } ... ..	3405	2087	2291	1700*	870	843
English Mustard { 1915 } { 1917 } ... ..	4018	2880	2250	1873	1230	892
Field Peas { 1915 } { 1917 } ... ..	3777	3003	2446	1837	1280	918
Hairy Vetches { 1915 } { 1917 } ... ..	3282	2237	2326	1735	920	883

The results marked \* are each the average of two plots only; the other results are the averages of three plots in each case.

NOTE.—In the case of the plots planted to lupins in 1915 it should be mentioned that the germination of the seed was very unsatisfactory. No seed was obtainable in 1917, so that Burt oats was substituted for lupins.

Of the remaining four legumes which were given proper trial field peas and English mustard have proved the best. The mustard received in 1917 a small dressing of nitrate of soda in addition to the phosphate and potassic fertilizers applied to the legumes. The results from mustard are nevertheless remarkable.

It appears that hairy vetch must be considered a better green manure than spring vetch.

The high yields of oats in 1916 and of wheat in 1918 are significant. In the case of the plots where field peas and mustard were ploughed in, these yields are double the returns normally obtained from this type of soil with a fertilizer treatment, such as the grain crops received in the two applications prior to their harvest. The yield of oats in 1916 for both green manures amounts to approximately twelve bags per acre, and the yield of wheat in 1918 six bags per acre. The large yields must be attributed to the green manure.

Where the green manure can be cheaply grown by being sown at a time when the operation does not interfere with the seeding of marketable crops such as wheat or oats, the system is strongly recommended. The operations of fallowing usually commence after the middle of June. From this time on to the end of August catch green manure crops should be sown on the fallowed land and ploughed under in late spring, before the soil has become too hard—if possible, as soon as the crops are in full flower. Field peas lend themselves admirably to this system of soil improvement and are being grown extensively for this purpose on the farm lands of this station.

The seed should be sown fairly thick, and, if possible, a portion of the phosphatic fertilizer intended for the succeeding grain crop

should be applied at the same time; this ensures a more vigorous growth of peas in the time available, and an improvement in the action of such slow acting phosphate fertilizers as basic slag and bone dust.

It is realized that field pea seed is very expensive to-day, but this system of soil improvement and enrichment is probably more economical and as efficient as any other.

Pea seed can be grown cheaply enough by the farmer himself in this section of the country. Early seeding is, however, very necessary where peas are to be grown as a field crop for seed. The crop must be sown in this case at the very earliest opportunity in autumn in order that the seed may have hardened by the time the caterpillar (*Heliothis obsoleta*) becomes most active in the spring.

(b) *Green Manures versus Feeding off by Stock as a Means of Improving Fertility.*

In this experiment the system of soil improvement by means of ploughing under a green manure crop is compared with a system in which the same crop is fed off by stock.

In conjunction with these two series of plots a third series is run as a check in which the entire crop is removed as hay.

A comparison of the three systems of soil treatment resulting from—

- (a) ploughing under an oat and vetch crop,
- (b) grazing off an oat and vetch crop,
- (c) removing as hay an oat and vetch crop,

as measured by the returns from the subsequent crops of wheat, receiving the identical treatment with a standard fertilizer dressing, has been carried on for four years.

The rotation for all plots in the experiment was the following:—

1916—Oats and vetch.

1917—Wheat.

1918—Wheat.

1919—Same as 1916, etc.

The fertilizer treatment was as follows:—

				Per Acre.
Oats and Vetch Crop, 1916	...	80 lb.	Superphosphate.	
		40 lb.	Kraal Ash.	
		15 lb.	Nitrate of Soda.	
Wheat, 1917	... ..	100 lb.	Superphosphate.	
		50 lb.	Nitrate of Soda.	
		25 lb.	Muriate of Potash.	
Wheat, 1918	... ..	75 lb.	Superphosphate.	
		75 lb.	Government Guano.	

Yields of wheat for the different systems of soil treatment are given below:—

TABLE II.

Treatment.	Yield of Grain and Straw in lb. per Acre.			Yield of Grain in lb. per Acre.		
	1916.	1917.	1918.	Average.	1917.	1918.
A.—Oats and Vetch Crops ploughed in	2734	1038	1886	880	406	643
B.—Oats and Vetch Crop grazed off	1464	1126	1295	523	444	483
C.—Oats and Vetch Crop removed as hay	1324	994	1159	471	382	426

The above yields are the averages of five plots in each case.

After carrying oats and vetches the plots were all ploughed in the spring, the green manure plots some four weeks before the others.

It will be noticed that the system of returning the whole oats and vetch crop to the soil has resulted in an average annual return of wheat per acre of a little over three bags; feeding off with sheep not quite two and a half bags per acre; and removing the crop as hay a little over two bags. Greater differences may be expected between systems B and C as time goes on, for although the system of cropping outlined in C is better than that usually practised by grain farmers, the farmer cannot hope to maintain the organic matter content nor the nitrogen balance of his soil by this means only.

The attention of grain farmers is drawn to system B of soil treatment. A similar system by which one crop in a grain rotation is grazed off by sheep could with advantage be adopted by many growers. A large proportion of the plant food and a fair proportion of the organic matter of the crop will be returned to the soil by this means. The system has gained favour in many parts of Australia, where merino or cross-bred ewes with cross-bred lambs at foot are grazed on crops such as oats or kale.

The relative economy of these systems of soil treatment can only be determined later when results have been obtained over a longer period and the treatments have affected the soil in a definite way, in spite of opposing influences which may be at work.

#### MANURIAL EXPERIMENTS.

These can be divided under three heads:—

1. Liming experiments, of which there are three intended to test the relative merits for soil improvement of caustic lime as against ground limestone, and to decide the most economical dressings of these forms of lime to apply.

2. Trials with Saldanha Bay raw rock phosphate.

3. General manurial experiment, which will later show amongst other things—

(a) Which is the best form of phosphate for this soil—superphosphate, basic slag, bone dust, or Cape Cross phosphate.

- (b) The necessity or otherwise for cereals of dressings of nitrogen and potash fertilizers in addition to phosphates on this soil.

In all these experiments wheat and oats were grown under a definite system of rotation.

On account of the unevenness of soil, definite conclusions cannot be drawn yet from the results of these experiments. As mentioned earlier in this article, the number of check plots was found insufficient. For instance, it became apparent in 1917 in the general manurial experiment that three check plots out of a total of eighteen plots were not sufficient to counteract the effect of soil differences, and the number was in consequence increased to six.

From the results obtained thus far, the writers feel justified, however, in concluding that bone dust and basic slag are both suitable phosphatic fertilizers for this type of soil, provided the fertilizers can be added to fallowed land ("braak" land) some time before seeding. Under such a system better returns and a more healthy condition of the soil will result from the use of bone dust or basic slag than from the use of superphosphate in this climate and on this type of soil.

The rotations practised in the various experiments mentioned are the following:—

- |  |   |
|--|---|
| (a) <i>Wheat.</i><br><i>Oats.</i><br><i>Field Peas as Green Manure.</i>  | (c) <i>Wheat.</i><br><i>Oats.</i><br><i>Fallow</i> with catch, Green Manure Crop of Field Peas.   |
| (b) <i>Wheat.</i><br><i>Oats.</i><br><i>Field Peas</i> for Grain. Pea hulls and residues returned to the soil. | (d) <i>Wheat.</i><br><i>Oats</i> and Vetch for Hay.<br><i>Oats</i> for Grain.<br><i>Fallow</i> with catch, Green Manure Crop of Field Peas. |

The last rotation is considered a good one in this section of the country, and is one which should, at any rate to some extent, maintain the supply of organic matter and nitrogen in the soil. The catch green manure crop of peas is not always as bulky a crop as may be desired. As stated before, thick seeding should be resorted to, and this at the present prices of field pea seed makes the system somewhat expensive. The amount of organic matter in the grain soils of the Western Province is, however, a consideration of paramount importance, and of the methods at our disposal to-day for effectively and economically maintaining the organic matter content of the soil the system outlined is probably one of the best, for the reason that nitrogen is added to the soil as well in a cheap way.

#### HAY FODDER EXPERIMENTS.

These experiments consist of the growing of mixed crops of legumes and cereals in order to determine (1) which varieties combined will give the largest yield of a nutritious, palatable hay, and (2) the best rates of seeding.

Tables III, IV, V, VI give the yields of hay per acre for the years 1916, 1917, 1918, and 1919 respectively, in each case in order of size of yields.

TABLE III.  
*Yields of Hay for 1916.*

Fodder Mixture : Seeding per Acre.	Hay Yield in lb. per Acre.	Fodder Mixture : Seeding per Acre.	Hay Yield in lb. per Acre.
Algerian Oats ... 50 lb. }	8,810	Van Niekerk Wheat 35 lb. }	5,870
Hairy Vetch ... 20 " }		Spring Vetch ... 25 " }	
Burt Oats ... 50 " }	8,310	Rye ... 30 " }	5,630
Field Peas ... 50 " }		Spring Vetch ... 50 " }	
Smyrna Oats ... 50 " }	8,010	Cape Barley ... 20 " }	5,620
Field Peas ... 50 " }		Rye ... 20 " }	
Algerian Oats ... 10 " }	7,880	Spring Vetch ... 20 " }	5,430
Rye ... 10 " }		Cape Barley ... 40 " }	
Hairy Vetch ... 25 " }	7,520	Field Peas ... 50 " }	5,160
Spring Early Wheat 35 " }		Cape Barley ... 20 " }	
Spring Vetch ... 25 " }	7,250	Smyrna Oats ... 20 " }	5,035*
Huguenot Wheat ... 35 " }		Spring Vetch ... 25 " }	
Spring Vetch ... 25 " }	6,900	Algerian Oats ... 10 " }	4,970
Thew Wheat ... 35 " }		Rye ... 10 " }	
Spring Vetch ... 25 " }	6,680	Spring Vetch ... 20 " }	4,080
Mediah Wheat ... 35 " }		Cape Barley ... 40 " }	
Spring Vetch ... 25 " }	6,435*	Spring Vetch ... 25 " }	4,080
Algerian Oats ... 50 " }		Nepal Barley ... 40 " }	
Spring Vetch ... 20 " }	6,390	Field Peas ... 50 " }	
Rye ... 40 " }			
Field Peas ... 50 " }			

Yields marked thus \* are averages of two plots.

In the year succeeding this trial, rye and Cape barley were not sown in the same fodder mixture, as together they yielded too coarse a hay; neither was Cape barley sown in the same mixture with oats, as it proved too early maturing for any of the varieties of oats.

The varieties of wheat tried proved unsuitable for hay mixtures, the cured fodder being unpalatable and too coarse. These wheats were in consequence not tried again.

Both Cape barley and rye were found too early to be sown with hairy vetch, and were subsequent to this season confined to mixtures with spring or French winter vetch.

TABLE IV.  
*Yields of Hay for 1917.*

Hay Mixture : Seeding per Acre.	Yield Hay in lb. per Acre.	Hay Mixture : Seeding per Acre.	Yield Hay in lb. per Acre.
Algerian Oats ... 50 lb. }	3,130	Algerian Oats ... 30 lb. }	2,055*
Hairy Vetch ... 20 " }		Spring Vetch ... 40 " }	
Cape Barley ... 40 " }	2,660	Algerian Oats ... 50 " }	2,040*
Field Peas ... 50 " }		Spring Vetch ... 20 " }	
Burt Oats ... 40 " }	2,565*	Burt Oats ... 50 " }	1,900
Field Peas ... 50 " }		French Winter Vetch 20 " }	
Rye ... 30 " }	2,390	Algerian Oats ... 40 " }	1,895*
French Winter Vetch 50 " }		Spring Vetch ... 30 " }	
Smyrna Oats ... 50 " }	2,310	Rye ... 20 " }	1,850
French Winter Vetch 20 " }		French Winter Vetch 30 " }	
Algerian Oats ... 75 " }	2,065*	Algerian Oats ... 40 " }	1,825*
Spring Vetch ... 50 " }		Spring Vetch ... 25 " }	

Yields marked thus \* are averages of two plots.



Yields of mixtures of oats, rye, and vetches were very low and are not given in the table. Similarly, mixtures of gluyas and Union wheats with vetches gave low yields and a poor hay in each case. The inclusion of wheat in these experiments was discontinued in the following seasons.

The hay produced from either Cape barley or rye with vetches was not readily eaten by stock, so that these crops were also omitted from the hay mixtures after 1917.

From a study of the above results it will be seen that the sowing of greater quantities of vetch seed than 20 lb. to the acre were not justified in oat and vetch mixtures.

TABLE V.  
*Yields of Hay for 1918.*

Hay Mixture : Seeding per Acre.		Yield in lb. per Acre.	Hay Mixture : Seeding per Acre		Yield in lb. per Acre.
Smyrna Oats ...	50 lb. }	2,600	Burt Oats ...	45 lb }	2,340*
Spring Vetch ...	20 " }		Hairy Vetch ...	15 " }	
Algerian Oats ...	50 " }	2,580	Smyrna Oats ...	50 " }	2,235*
Hairy Vetch ...	20 " }		Hairy Vetch ...	10 " }	
Smyrna Oats ...	45 " }	2,560*	Burt Oats ...	50 " }	2,125*
Spring Vetch ...	15 " }		Hairy Vetch ...	10 " }	
Burt Oats ...	50 " }	2,390	Burt Oats ...	40 " }	1,680*
Spring Vetch ...	20 " }		Field Peas ...	50 " }	

Yields marked \* are averages of two plots.

Peas were found to give an impalatable hay, and moreover the crop proved too early for any of the varieties of oats grown. The growing of peas was in consequence discontinued in these experiments.

Although Smyrna oats and spring vetch have given a slightly better return of hay to the acre than Algerian oats and hairy vetch, yet the Smyrna oat cannot be recommended for the purpose of hay, as it yields relatively coarse fodder.

Where a mixture of oats and vetch is to be grown for silage the Smyrna variety could with advantage be grown with a variety of vetch; since it is about fourteen days earlier maturing than Algerian oats, spring or French winter vetch should be chosen in preference to hairy vetch.

At this stage of the experiment it was concluded that not less than 50 lb. of oat seed to the acre should be sown along with vetches in order to obtain maximum yields of hay.

TABLE VI.  
*Yields of Hay for 1919.*

Hay Mixture : Seeding per Acre.					Hay Yield in lb. per Acre.
Algerian Oats ...	...	...	...	50 lb. }	1,936*
Hairy Vetch ...	...	...	...	20 " }	
Texas Oats ...	...	...	...	50 " }	1,676*
French Winter Vetch ...	...	...	...	20 " }	
Burt Oats ...	...	...	...	50 " }	1,426*
Spring Vetch ...	...	...	...	20 " }	

\* These yields are averages for five plots in each case and represent, therefore, good standards of comparison of the various combinations of cereal and vetch.

It will be observed that Smyrna oats was replaced by Texas for the reason previously mentioned that the former does not make a good hay.

Two rotation experiments in a range in which wheat is grown every third year, and is followed by two crops of oats for hay in one case and two crops of a mixture of oats and vetches in the other, furnish comparative results in respect of the hay produced.

These results are given in Table VII hereunder.

TABLE VII.  
*Hay Yields.*

Kind of Hay.	Seeding per Acre in lb.	Hay Yield in lb. per Acre.	
		1918.	1919.
A.—Oats alone ... ..	50 Algerian Oats ... ..	3,666	2,354
	30 Algerian Oats ... ..	3,372	—
B.—Oats and Vetch ... {	20 Spring Vetch ... ..	—	2,430
	30 Algerian Oats ... ..		
	20 French Winter Vetch ...		

There were five plots under each treatment, so that the results in each case are averages of five plots.

In both the years 1918 and 1919 the same plots carried the same crops. In 1920 the whole range will again carry wheat. The rotation for the two halves of the range will be:—

A.—1st Year: Oats for hay.

2nd Year: Oats for hay.

3rd Year: Wheat.

B.—1st Year: Oats and vetches for hay.

2nd Year: Oats and vetches for hay.

3rd Year: Wheat.

As regards the actual yield of hay, oats alone gave a higher yield in 1918 than oats and vetch, but in the following year the position was reversed. The oats in the oats and vetch plots appeared more vigorous during the period of growth in 1919 than that in the plots under oats alone.

The feeding value of oat and vetch hay is far superior to that of oats alone. Stock also prefer the mixed hay. Although there is more work involved in the curing of the mixed hay (this applies to all legumes), yet the farmer is well compensated for the extra trouble and expense involved in the higher feeding value of the hay produced.

Vetch hay, whether it be the hairy, spring, or French winter variety is greatly relished by stock, and in protein content it stands on a level with lucerne hay. An oats and vetch mixture makes good ensilage. The crop should, however, be cut when the oats are in the dough stage if possible. For ensilage a mixture of 50 lb. Smyrna oats and 20 lb. spring vetch or French winter can be recommended. Such a crop should be sown early so that it can be cut and put into

the silo in October. In any ordinary season in these parts an aftermath of vetches will spring up and will afford very useful grazing, or may be ploughed in as a green manure.

In a good season at this institution a fair crop of seed has been obtained from the second growth of vetch. Owing to the ravages of the caterpillar, especially on soil which had previously carried legumes, this is considered about the safest method of producing vetch seed in these parts.

Crops of vetch seed have, however, been successfully grown on areas of this farm where legumes had not been planted for some considerable time previously, away from any source of infestation by the green caterpillar. In this case the vetches were sown early in April (a plan similar to that adopted for peas) so that the seed could harden before the caterpillar pest is at its worst.

Mention should be made of the fact that commercial vetch seed may contain seed of the many varieties of wild vetch. These are troublesome plants as weeds, especially in a wheat crop. As the seed of one of our commonest wild vetches found here has a diameter about equal to the thickness of a wheat kernel, wheat is not readily cleaned of these seeds by winnowing.

Stock will readily eat the wild vetch when green, so that the weed can be kept under by grazing the stubble and cultivated fallow ("braak") lands with sheep or cattle.

#### SUMMARY.

1. Taking into consideration both palatability of hay and yield per acre, combination of the various varieties of oats and vetches have been found the best for hay.

2. Hairy vetch and Algerian oats have consistently given the highest yield of hay.

3. Where an earlier maturing crop is desired, hairy vetch should be substituted by spring or French winter in combination with Burt, Algerian, or Texas oats, *vide* results 1916, 1917, 1918, and 1919.

4. For ensilage a mixture of Smyrna oats and spring or French winter vetch can be recommended in addition to the mixtures mentioned under 2 and 3.

5. Rye, barley, wheat, and field peas have not been found desirable crops for hay mixtures.

6. To obtain maximum yields of mixed hay per acre with oats and vetches, no less than 50 lb. oats should be sown per acre.

7. The quantities of oats and vetch seed recommended to be sown are 50 lb. oats and 20 lb. vetch per acre.

#### SEEDING EXPERIMENTS.

##### *Drilling versus Broadcasting of Seed and Fertilizer.*

Experiments with cereal crops to compare the system of drilling in seed and fertilizer with that of broadcasting both by hand have yielded results which prove very definitely the advantage of drilling.

Results are appended in Table VIII.

TABLE VIII.

Year.	Variety and Quantity Seed Sown per Acre.	Size of Plot.	Yield Grain per Acre.		Increase per Acre due to Drilling.
			Seed and Fertilizer Drilled.	Seed and Fertilizer Broadcasted.	
1915	Wheat ... .. 35 lb.	$\frac{1}{2}$ acre	385 lb.	305 lb.	80 lb.
1916	Algerian Oats... .. 45 "	$\frac{1}{2}$ "	1,588 "	1,460 "	128 "
1918	Wheat (Union Sel. 81) 45 "	1 "	817 "	609 "	208 "
1919	Wheat (Gluyas Early) 50 "	1 "	1,012 "	675 "	367 "

NOTE.—In every year the dressing of fertilizer and seed was the same for both methods of sowing.

The drill is undoubtedly a valuable adjunct for successful wheat growing. In practice the farmer will find that his drill is economical of seed as well as fertilizer, and in all cases he can expect much better yields from drilling than from broadcasting.

Seeding by the method of broadcasting necessitates two harrowings as against one harrowing in the case of drilling. If it be assumed therefore that the farmer can plough in the sowing season a maximum area of 21 acres per day, it is calculated that in seeding and fertilizing this area by hand-sowing he requires two labourers to do the sowing and a third labourer with four light draught animals to handle the harrow, whereas to drill the same area would require two 6-foot drills, each handled by one labourer and four light draught animals.

(This article will be concluded in the next number of the *Journal*, when variety trials of wheat and oats will be dealt with.)

## Frozen Meat.

The Secretary of State for the Colonies sends advice of an application made to the Norwegian Government for an exception to the prohibition of the importation of fresh meat into Norway from overseas, to be made in favour of frozen meat from the British Oversea Dominions. Should such permission be obtained it will be necessary for exporters to comply with the regulations of the Norwegian veterinary authorities. While the quantity of fresh Danish beef available precludes anything like a demand at present for frozen meat in Norway, it is understood that there is a good market for salt mutton, which may be imported into Norway from any country subject to the ordinary veterinary regulations.

---

## RATS IN SUGAR-CANE.

---

By S. H. SKALFE, M.A., Entomologist, School of Agriculture, Cedara, Natal.

---

ON the whole the sugar planters in South Africa are singularly fortunate in having very few pests of importance to contend with. Compared with the conditions found in other sugar-growing countries, the plantations here are remarkably free from such troubles as fungous diseases, borers, mealy-bug, froghoppers, etc. Recently, however, the sugar farms on the Umfolozi Flats have suffered severe losses from the depredations of rats.

The rats in question are not the cane rats proper, *Thryonomys swinderemianus*, but four or five different species of ordinary field rats. They are present in enormous numbers in fields of cane ten months old and older. Cane younger than ten months is not troubled much by these rats as it does not seem to afford them enough shelter against owls and hawks. The rats are found on all the farms along the banks of the Umfolozi River, but in most cases the damage is moderate compared with what is found on two or three farms along the north bank. On these farms the rats teem and cause great damage by gnawing through the base of the cane, causing it to fall and dry out. Mr. Jack Martens, of River View, whose farm is perhaps the worst infested of all, was cutting during November last (on the occasion of the writer's visit there) only seven tons of cane to the acre instead of an average of thirty-five tons.

The rats causing the trouble are nearly allied to the common house rats and resemble them closely in general appearance. They are apparently widely spread in South Africa, yet it is seldom we hear of them causing such serious damage as related above. They are reported to be giving trouble at Empangeni, not as a pest of sugar-cane, but as a nuisance in a cotton field where they robbed the bolls as soon as they were open, removed the seed, and lined their nests with the fibre. An experimental plot of cotton on Mr. Duncan's farm, at Umfolozi, was treated in exactly the same manner, and although the plants did well, there was no cotton to be gathered as the rats took it all.

The trouble at Umfolozi seems to be entirely due to an upset in the balance of nature. The farms in this district suffered severely from floods in February, 1918, and the planters state that hundreds of snakes were killed by these floods. Formerly snakes were very common in the plantations but now they are seldom seen. Thus the rats were rid of one of their chief enemies and consequently have been able to breed enormously under the ideal conditions of an abundant food supply, ample shelter, and freedom from persecution. Hawks and owls abound, but as the rats make their homes amid the dense growth and thick trash of the older fields they are practically immune from attacks by these enemies. The theory that the present outbreak is indirectly due to the floods is borne out by the fact that the worst infested farms are those which suffered most from the floods.

In all probability the balance of nature will be restored sooner or later. The natural enemies of the rats will be attracted by the abundance of their prey, and in the presence of an ample food supply they in turn will breed up and eventually restore the rodents to their original numbers. But in the meantime something has to be done to check the damage.

The chief object of the writer's visit to Umfolozi early in November last was to try out a virus kindly supplied by the Union Commerciale, Smith Street, Durban. This virus is manufactured by the Pasteur Institute, Paris; it is sent out in tubes and known as "Pâte Verte." It is said to have been highly effective against rats in the trenches during the late war. The application of the virus is very simple; it has to be spread on bait and placed where the rats can get at it and devour it.

Two dozen field rats were captured and placed in a large roomy cage. Every day for a week these rats were fed on short lengths of sugar-cane smeared liberally with the virus. They ate the cane quite freely, yet at the end of the week all were as healthy and happy as some others which were not fed on the virus. Either these particular species are immune from the organisms which are pathogenic to ordinary rats, or else the virus had lost its virility owing to its age. One of the first essentials in using a virus is to obtain it as fresh as possible, otherwise the disease-producing organisms may die out or lose their virulence. The virus used at Umfolozi was at least two months old, and this may have been the cause of its failure to act.

#### SEVERAL POISON BAITS

were tried on other caged rats to see if a bait could be found which was more attractive than sugar-cane. The poison used in every case was a sweetened 2 per cent. solution of strychnia hydrochloride. Extensive experiments in America have proved that strychnine is about the best poison to use in the destruction of rodents. The soluble hydrochloride was used as it is more easily applied to the baits in the form of a solution than the insoluble strychnine crystals. Raisins, slices of potato, sweet potato, carrot, and short lengths of fresh cane were soaked in the 2 per cent. solution for an hour or so and then placed in the cages with the rats. Next morning twelve out of the twenty rats were dead and during the day seven more died leaving only one alive. The raisins, potato, sweet potato, and carrot had been left severely alone, but the cane had been freely eaten. Thus it was found easy enough to destroy cage specimens but the application of the bait under field conditions was a different matter. The poisoned cane could not be scattered broadcast owing to the danger of oxen finding it and eating it. It was also found impracticable to search for the holes and place the bait down each hole owing to the dense growth of the older plantations and the thick covering of dead foliage.

A third method that was tried seemed more hopeful. It is the practice of the planters to burn the trash and dead vegetation before cutting their cane. By surrounding a field as it was being burnt it was found that very few rats were driven out by the fire and still less were found dead after the fire. Thus it was concluded that they were all

driven into their burrows by the fire and an attempt was made to dig them out. The majority of the holes were found to be lodged among the roots of the cane, consequently it was impossible to dig out the rats without injuring the roots to a certain extent. The burrows were by no means deep and were easily opened up. In nearly every case one or more rats were found at the bottom of each burrow and in some cases as many as ten were found in one hole. The rats were dazed and stupefied by the fire and were easily caught and destroyed.

Thus we have here a comparatively simple means of getting this pest under control under the present conditions. The planters could burn off just enough cane early in the morning to suffice for the day's cutting. After the cane has been cut the natives could be set on to dig out and destroy the rats on the piece of land just cut. It would be inadvisable to leave the destruction of the rats till next day for from observations made it would seem that the great majority of the rats, if not all, trek overnight from the field that has been cut into the neighbouring standing cane.

From the planters' point of view there are two objections to this measure. First the roots of the cane are somewhat injured by the digging, and secondly labour is scarce and difficult to obtain. But the need for some such remedy is desperate, and the present writer is convinced that the loss entailed by the damage to the roots and cost of labour will fully be set off by the increased crops obtained.

The expense and trouble of the suggested remedies are surely justified in the case of a pest which causes such heavy losses as the present one, amounting to 75 per cent. of the crop or more on at least two of the farms visited.

The planters are very keen on the idea of a virus which will start an epidemic among the rats and eventually wipe them out. Nothing could be better, provided such a virus could be found. In the first place, although several viruses have been put on the market at various times, seldom have any of these proved satisfactory. The rats in the trenches in Flanders were congregated in large numbers over small areas, were mostly ravenously hungry, and were easily induced to take the baits offered. Under these conditions the use of a virus proved very effective, but it is extremely doubtful whether the same effects would be obtained by the use of a virus in the cane fields. In the second place, it is very difficult to obtain fresh virus in South Africa. The writer made inquiries of most of the big dealers in agricultural supplies in Pietermaritzburg and Durban, and only from the Union Commerciale was he able to obtain any at all. The latter firm had only two tubes in stock and these were generously placed at the writer's disposal for experimental purposes. This meagre supply was all used up at Umfolozi with the results detailed above. Thus it would seem that the planters' hope of the pest being overcome by the use of a virus is doomed to disappointment, and that some such measures as those discussed in this article will have to be adopted, troublesome and expensive though they seem.

---

---

## PRACTICAL HINTS FOR THE PREVENTION AND ERADICATION OF EAST COAST FEVER.

BY JAS. L. WEBB, F.R.C.V.S., G.V.O., Ixopo.

ALL the information necessary for the prevention and eradication of East Coast fever has from time to time been given to the stock-owning community, and while I can bring forward nothing better than has already been advocated, a reiteration of the methods, together with a few notes on their practical application, may perhaps serve a useful purpose.

### PREVENTIVE MEASURES.

1. *Cattle-proof Fences and Gates around the Farms.*—East Coast fever is spread by the dropping of infected ticks; this may be done by cattle, infected with the disease, being driven or straying on to clean areas, and can to a great extent be obviated by good boundary fences, gates, and fenced roads. Ticks may also be picked up on clothing, blankets, numnahs, hay, thatch, grass, and carried long distances from infected to clean veld. Natives attending feasts on infected areas, and then returning to clean farms, are, to my mind, a possible source of danger in that they are liable to carry infected ticks; and donkeys with long coats, trekking over infected ground, might pick up ticks which, without attaching themselves, drop off after a time. Ticks may also be carried from infected veld by flooded rivers and deposited on clean areas, so that although good fences are a protection against the principal source of infection it is possible for infected ticks to gain access to clean farms in spite of them.

2. *Regular Dipping and Hand-dressing.*—I think it can now be taken for granted that farmers recognize the necessity of regular dipping, but many perhaps consider that the immersion of their cattle once every seven days in a standard strength arsenical solution is sufficient to prevent an outbreak of East Coast fever. Such is undoubtedly not the case; it will, of course, lessen the number of ticks and minimize the risk, but it will not act as an absolute preventive. It would be necessary to dip every three or five days, and at the same time thoroughly hand-dress the ears and under the tails and the brushes of the tails. I think one might safely say if this were properly carried out it would act as an absolute preventive measure. Farms adjacent to infected areas are, as one would expect, most likely to become infected even although they are properly fenced. This was exemplified in the Ixopo District, where five farms adjoining an infected one, all of them fenced, became infected. On four of these farms the first case was diagnosed and the disease went no further. It is, therefore, obviously necessary to go in for short interval dipping and hand-dressing on farms adjoining badly infected ones.

3. *Diagnosis of the First Case.*—The diagnosis of the first case of East Coast fever on a farm is one of the best methods of preventing its further extension. In the Ixopo District, on twelve farms where the first case was diagnosed and active measures taken at once, no



further cases occurred; this speaks well for early diagnosis. In order to obtain this desirable result farmers must not rely on their own diagnosis of sickness or deaths amongst their cattle unless the cause is quite obvious. Smears must be sent from any beast about the death of which there is the slightest suspicion. Do not say a death is due to such diseases as gall-sickness, redwater, vegetable poisoning, snake bite, quarter evil, etc., without sending a smear. It is often impossible for an expert to determine (especially in tick-conveyed diseases) without the aid of the microscope, so always go to the trouble of sending a smear to the proper authorities.

*Taking of Smears.*—I would like to give a word of advice here about the taking of smears, as hundreds are forwarded which are quite useless for the purpose of diagnosis for several reasons, the commonest being that they are taken too long after death, with the result that any disease organisms present are obscured by those of putrefaction. Smears are also sometimes taken on improper material, such as coloured glass, convex bottle glass, dirty glass, and even paper. It should be remembered that the most reliable diagnosis for East Coast fever is obtained from a smear taken from the inside of a lymphatic gland or the spleen (milt). A bloodsmear is not nearly so good, although better than nothing, and is the only material an amateur is likely to obtain successfully from the live animal. In order to make a good smear from a dead animal, the sooner it is taken after death the better. Remove a lymph gland—the one in front of the shoulder is perhaps the easiest to get at—have a piece of thin clean clear glass ready, cut the gland open with a clean knife, then lightly draw the surface of the glass over the cut surface of the gland and allow it to dry, or, if the spleen is selected, cut it open and remove a little of the contents on the point of a pen knife, spread this as thinly as possible over the glass with the edge of the knife; on no account stick the pieces of glass together like a sandwich with the material in between, as such a method is quite useless. Although, as before mentioned, smears should be taken from a lymph gland or the milt for the diagnosis of East Coast fever, it is as well at the same time to send a blood smear taken from an ear, for then if the disease happens to be redwater, anaplasmosis, trypanosomiasis, or anthrax it can often be diagnosed.

It is frequently inconvenient for a farmer to attend to take smears from a beast which dies at a native kraal on his property. (I take it every farmer insists on such deaths being reported to him.) To obviate the necessity for personal inspection, show the natives how to remove a lymph gland and instruct them to always bring such a gland from any beast which dies, no matter what they consider has been the cause of death. From this take a smear and forward for microscopical examination. I have personally found this system to answer well on infected farms, as it enables one to know the number of deaths which are occurring and to ascertain also the date of the last death from East Coast fever.

Possibly fear of the fifteen months' quarantine regulation deters some farmers from being too anxious to know from what disease a beast may have died, but it is undoubtedly better to choose the lesser of the two evils and put up with the quarantine rather than risk the gross infection of their farms with its resultant heavy losses.

4. *Supervision over Cattle owned by Native Tenants.*—In many instances an outbreak of East Coast fever on a European-owned farm first occurs amongst the cattle owned by native tenants. Farmers would be well advised to keep a count of all such cattle and to see that the full number is brought to the tank on each dipping day, also to insist that no cattle are brought on or taken off the farm without their consent being first obtained.

This point requires emphasizing. It is my experience that farmers rarely know the number of cattle owned by their native tenants. In two outbreaks amongst native-owned cattle recently attended by me the farmer in one case thought his tenants had about thirty head, but when they came to be counted he was surprised to find there were seventy. In the other case one hundred and fifty was the number given, and there were found to be two hundred and sixty. Owing to this slackness, especially when the cattle are rarely seen, it is impossible for a farmer to know whether any cattle have been taken off or brought on his farm without his knowledge. It is a direct encouragement to natives to evade the permit system, besides being a grave danger. Natives often have cattle at kraals in widely separated parts of a district, and if disease breaks out at a particular kraal the various owners want to get their cattle away. If they can take them to a farm where they know the addition will not be discovered the chances are they will do so, the result being a fresh infected centre. If practicable, it is an advantage to segregate the native cattle to a given part of the farm, fence them off, and give them a separate dipping tank. Under such conditions it would often not be necessary to place the whole of the farm under quarantine.

#### METHODS FOR ERADICATION OF EAST COAST FEVER.

1. *Short Interval Dipping and Hand-dressing.*—As previously mentioned, the dipping of cattle every seven days will not prevent an outbreak of East Coast fever; therefore as a means of eradicating the disease it is almost useless. Short interval dipping must consequently be introduced immediately an outbreak on a farm is discovered. This means the immersion of cattle in an arsenical solution containing 2 lb. arsenite of soda to each 100 gallons of water every five days, or in a solution containing 1 lb. of arsenite of soda per 100 gallons every three days. Either appears to be equally efficacious; the former method is rather severe on milch cows, working oxen, and calves; the latter being less severe, apparently having no ill effects, but it probably interferes more with the ordinary routine of the farm work. A compromise between these two dipping periods is a bi-weekly dipping, viz., every third and fourth day. This answers well, providing the arsenical strength is increased 25 per cent. and, as the cattle get used to it, 50 per cent., viz.,  $1\frac{1}{4}$  to  $1\frac{1}{2}$  lb. of arsenite of soda per 100 gallons of water. I might here mention that in several instances where gross infection existed better results were obtained by the use of the full "laboratory" mixture, which, in addition to arsenite of soda, contains soft soap and paraffin, although I prefer adding to the dip, in the proportion of 1 gallon to every 1000 gallons, one of the soluble carbolic dips, such as kerol. This has the effect of keeping the dip sweet and the carbolic odour probably prevents ticks attaching themselves as quickly as they otherwise would. Although

regular dipping in the correct strength arsenical solution is absolutely essential, yet even this fails unless it is accompanied with thorough hand-dressing inside the ears, under the tails and brushes of the tails, especially so once the veld is grossly infected. There are several methods of applying the hand-dressing solution, but to start with it is very necessary that a substantial long race should be erected into which the cattle can pass as they leave the tank, and where they can be closely jammed while the dressing is applied. When large numbers of cattle have to be handled perhaps the easiest way is to have buckets containing an arsenical solution of the same strength as that contained in the tank and to apply it by means of a suitable sprayer—a large garden syringe with a spray nozzle answers well; by this method the solution reaches the ticks situated in the depths of the ears; and when the hand-dressing is left to natives to handle they are more likely so to apply the solution thoroughly than by any other method. If the dip from the tank is used it should be strained through a piece of sacking before use so as to remove hair which would otherwise block the syringe. A useful solution for ear-dressing is made of Cooper's powder dip—3 ounces rubbed into paste with a little water; mix with  $\frac{3}{4}$  lb. of soft soap and a little more water, and a wine bottleful of raw linseed oil, mix, then add a wine bottleful of paraffin, mix the whole thoroughly together, then add water gradually, stirring all the time to make the mixture up to 4 gallons; this can be applied with paint brushes or with swabs, or the syringe, both to the ears and under the tails. The brushes of the tails should be clipped, or at any rate the hair cut off level with the docks so that the dip can get at the ticks there.

A few tips to prevent ill results from dipping:—

- (a) Have an isometer, and so make sure the tank is kept at proper strength. If under it is useless for the purpose required, and if over the cattle are likely to get scalded.
- (b) Never send thirsty cattle to be dipped; they are apt to drink the arsenical solution, and it does not take much to kill a beast. I know of two instances, which happened just recently, where valuable imported cattle, a Devon cow and a Shorthorn bull, drank dip before entering the tank—the former recovered, the latter died.
- (c) Remove the thick winter coats over the back and loins by means of a curry comb, otherwise they absorb too much dip and it then remains too long in contact with the skin, resulting in scalded and broken skin through which at subsequent dippings the arsenic can gain access to the system with fatal results. These ill-effects are aggravated if cattle with matted coats are exposed to rain, as the moisture dissolves the arsenic.
- (d) Remove all scum from a tank, as this settles on the backs of cattle and is also a cause of scalding, especially if the coats are long.
- (e) Keep tanks full. Cattle are less likely to injure themselves when entering or going out.
- (f) Have a good fence around the tank and kraals to prevent cattle gaining access to them when not being dipped.

Have a deep hole dug within this fenced enclosure into which throw scum and the dirty dip, etc., when the tank is cleaned out. Numbers of cattle are poisoned through drinking dip out of sumps and even the tank itself, by licking up the scum which has been thrown out, and by licking earth around the tank which has been saturated with overflow, etc., from the tank and draining pens.

- (g) Use a dredger to remove the sediment which collects at the bottom of tanks; this prevents waste, as the whole tank will not require cleaning out so often.

2. *Isolation or Destruction of all Diseased Animals.*—Theoretically this should not be necessary, for the reason that if all diseased cattle are dipped and hand-dressed regularly at short intervals no ticks capable of conveying infection should escape, but in practice it is found too risky to leave diseased animals to roam at will. Dipping, and more particularly hand-dressing of the ears, around the eyes, etc., are generally not sufficiently thorough to obviate the escape of a few ticks. Again, when cattle are very ill they cannot travel any distance to a tank, and of course to leave them undipped is fatal to the eradication of the disease, consequently the destruction or isolation of all the diseased cattle is strongly recommended (the former for preference), but natives often object to even their sick cattle being destroyed, and in that case the diseased animals must be isolated in a small, well-fenced camp and not removed even for dipping purposes.

3. *Grass Burning.*—On infected farms the grass should be burned at the season when it is likely to destroy the greatest number of ticks, which would be as early as possible in the winter when the grass has dried sufficiently.

4. *Temperature Camps.*—This method of dealing with an outbreak of East Coast fever is generally impracticable. It gives excellent results where clean fenced veld can be obtained, but infection is rarely confined to any particular paddock. The procedure is to temperature the whole herd on the infected land. All cattle with normal temperatures are placed in a paddock known to be free from infection; these cattle must now be temperatured early every morning for thirty days, and any showing abnormal temperatures are destroyed or returned to the infected part of the farm. This method often means that the cattle in the clean paddock are cut off from the dipping tank because they cannot reach it without passing over infected veld. It answers well when cattle can be temperatured and removed from an infected farm on to a clean one provided with a tank.

#### CATTLE MOVEMENTS.

I have made no mention of the control of cattle movement under the permit system as a means of preventing the spread of East Coast fever. This undoubtedly plays an important part in combating the disease, but it hardly comes within the province of individual farmers, who can, however, help considerably towards its practical application.

The present system no doubt often proves irksome to both European and native cattle owners, and the latter especially sometimes go away dissatisfied when their applications for movement of cattle are refused, because they cannot grasp the necessity for such

action when, for instance, concerned with a quarantined area on which no deaths have occurred for six or twelve months. A better spirit of co-operation might be engendered if farmers would explain to their native tenants the reason why they have to obtain permits and show them the danger to his neighbours of an individual who moves cattle without a permit, especially after it has been refused by the authorities, or who fails to comply with the conditions of a permit. It is not natives alone who offend against the permit system. Only recently it came to my notice that a European who bought cattle at a sale, and who received a permit to remove them to his farm by rail, decided that this was too much trouble or expense and sent them off by road. He may or may not have known the route was through infected farms, but it was, and the cattle went to his farm situated in a clean area in another district. This shows the danger to a district an individual can be who fails to carry out the conditions of a permit.

Farmers could help in the course of their travels by seeing that natives driving cattle were in possession of correct permits. They might also, when they do not desire their native tenants to bring more cattle on to their farms, directly refuse. They should not give them a note to the permit officer setting forth the native's requirements and ask him to refuse same, when from an East Coast fever point of view such refusal cannot be justified, nor should they send their natives with notes asking for permits which they know are bound to be refused. It is not fair in such cases to put the onus of refusal on the officials.

East Coast fever is a disease which undoubtedly could be eradicated from the country if every stock owner could be prevailed upon to carry out the necessary measures. As has been demonstrated in numerous instances, it is a comparatively easy matter to wipe the disease off farms and native locations, and the losses are not heavy provided the disease is diagnosed early; consequently with the co-operation of stock owners and officials it should be possible to rid the whole country of the disease. The great stumbling-block is the native population, who do not understand the nature of the disease and the way it is carried from sick to healthy cattle, and therefore do not realize the necessity for the preventive measures adopted. The only way to deal with them is to place all native-owned cattle under a certain amount of European supervision—on European-owned farms where there is a resident white man such supervision should be part of his duty, and in native locations the Government provide the necessary supervision. It is the native-owned farms and farms with absentee landlords, and many of the Crown lands, which want looking after, for these farms are usually situated in the least accessible and hottest parts of the country, where it is most suitable for tick-life and consequently most likely to harbour tick-conveyed diseases. It is difficult to obtain the services of reliable men who will live in these areas and carry on the work of supervision. In the Ixopo District, I am glad to say, practically all native-owned cattle outside the private farms receive a certain amount of supervision, mostly by Europeans living close to the native areas concerned. This system of local supervision has given good results and is less expensive to the country.

## SOUTH AFRICAN STANDARD FOR POULTRY AND EGGS.

By W. O. JOHN, Lecturer in Poultry, Elsenburg School of  
Agriculture.

### LIVE TABLE POULTRY.

*Characteristics of Table Fowls.*—They may be of any breed or cross, provided they conform to the desired shape and quality.

*Head.*—Eye, comb, face, wattles, etc., a bright healthy appearance.

*Body.*—Characteristic of the particular breed. *Shape*, broad and deep; *breast*, broad and well rounded; *breast-bone*, long and straight, carrying ample flesh; *back*, broad and moderately long; *skin*, supple, elastic, and of fine texture (indicating health and condition); *colour of skin*, white preferred, other colour permissible; *feathers*, full coat (blood feathers or stubs undesirable).

*Legs and Feet.*—Characteristic of breed, of medium length, as fine in bone as is consistent with breed, set well apart, allowing for development of breast meat. Legs covered with clean, smooth scales (denoting youth); colour, white preferred, other colour permissible.

*Weight.*—In accordance with age and breed. All other points being equal, a determining factor will be the best *weight* according to *age*.

### SCALE OF POINTS.

Size and shape ... ..	10
Uniformity of quality ... ..	15
Youthfulness ... ..	10
Quantity and quality of breast meat ... ..	10
Long straight breast-bone ... ..	15
Fineness of bone ... ..	10
Texture and elasticity of skin ... ..	10
Colour of skin ... ..	5
Absence of offal and surplus fat ... ..	10
Condition of feathers ... ..	5
	100

*Serious Defects.*—Crooked breast, excessive coarseness, abdominal fat, aged, full of blood feathers, lack of uniformity where pairs or trios are shown, any sign of ill-health.

### DRESSED OR TRUSSED TABLE POULTRY.

The general characteristics applying to *live* table poultry will hold good in this standard, with the exception that the method of killing, drawing, shaping, trussing, and the general excellence of the finished bird must receive due consideration.

**NOTE.**—Head and legs should be left on (as an index to health and age), but must be properly cleaned.

## SCALE OF POINTS.

Size, quality, and age ... ..	10
Quantity and quality of breast meat ... ..	10
Length of breast-bone (5), straight keel or breast-bone (5), fineness of bone (5) ... ..	15
Absence of offal and surplus fat ... ..	10
Skin, texture (5), appearance (5), colour (5) ...	15
Correct bleeding ... ..	10
Attractive shaping ... ..	10
„ trussing ... ..	10
General marketable appearance ... ..	10

---

100

---

*Serious Defects.*—Badly bled, skin torn or blistered, any unsightly openings in body (due to bad trussing), excessive coarseness, excessive abdominal fat, aged, crooked or bent breast, dirty or scaly legs, etc.

## EGGS.

The general character of the exhibit should be uniformity of shape, size, colour, quality of shell, freshness, and weight.

Exhibit of 12 eggs: every egg should be (as nearly as possible) of the same shade, i.e. white, brown, or tinted; to be displayed on round dishes or plates, and weighing from 26 oz. to the dozen upwards for fowl eggs, and 35 oz. and upwards to the dozen for duck eggs. When packed in boxes, commercial or otherwise, method of packing to be given due consideration.

## SCALE OF POINTS.

Uniformity of shape ... ..	10
„ „ size ... ..	10
„ „ colour ... ..	10
Quality of shell ... ..	10
Freshness ... ..	25
Weight ... ..	25
Best display on dish (12 eggs) or packing in box (any number) ... ..	10

---

100

---

*Serious Defects.*—Fowl eggs less than 24 oz. to the dozen or duck eggs less than 35 oz. to the dozen, great lack of uniformity, dirty or soiled eggs, and stale eggs.

## AGRICULTURE AND THE WAR.

### Effect on Importations of Essentials.

#### Position at the Close of 1919.

THE farming industry in South Africa is dependent on a number of articles which are not produced in the country. The outbreak of war caused a general dislocation in their importation, freightage was scarce and expensive, oversea production fell off in some cases owing to the manufacture of war essentials, the needs of manufacturing countries were first considered causing a shrinkage of products available for oversea customers, and, generally, obtaining supplies was a serious problem. Restrictions on the export of merchandise contributed to the difficulty.

The goods ordinarily obtained from oversea directly essential to our agricultural industry are chiefly:—

- Fertilizers.
- Agricultural machinery.
- Agricultural implements.
- Fencing material.
- Seeds, sprays, dipping material, etc.

Hereunder are statements of importations for the ten years 1909 to 1918 inclusive. Examination thereof, taking into account enhanced costs caused by the war, will indicate the extent to which oversea supplies diminished during the war.

A brief report on the effect on our agriculture by the curtailment of these supplies and the outlook in regard thereto at the end of 1919 is given below in respect of certain essential articles, viz.:—

#### FERTILIZERS.

The soils of the Union are, as a rule, by no means rich, particularly in the winter rainfall area of the Cape Province, where the greater portion of the Union's wheat production is grown. With the exception of about 6000 tons Government guano per annum and a certain amount of bone manure, the Union was entirely dependent upon countries oversea for its supplies of artificial fertilizers, to the extent shown in the statement hereunder. Phosphatic fertilizers are most required for the Union's soils, nitrogenous ones, with the exception of guano which is obtained in South Africa, not being used to any extent in this country; in fact, sulphate of ammonia, a concentrated nitrogenous manure manufactured in Natal, is now being exported from the Union. Phosphatic fertilizers were obtained almost entirely from Great Britain and the continent of Europe and when war broke out these sources of supply were entirely closed. Efforts were made to obtain supplies from the United States of America and Japan, but none was to be had except at prohibitive prices. An



endeavour was made also to procure phosphatic rock from the Seychelles Islands, but owing to the difficulty of freight nothing has yet come of the matter; these phosphates were sold, prior to the outbreak of war, at from 45s. to 50s. per ton, and were mainly shipped to Hamburg for the manufacture of superphosphates. At the same time the possibility of local production received earnest attention and all known or likely sources of fertilizers in the Union were inquired into, but no new supplies of importance were disclosed. The position in the Union was acute. Owing to high prices all available bones in the country were collected and other materials of manurial value were used to the utmost. The supply of Government guano was restricted to the growing of wheat in view of the pressing need for increased production of the crop, and the screenings from the guano islands were also collected and used for fruit trees and vines. To what extent these expedients helped to relieve the situation cannot be gauged, but there is evidence that the lack of fertilizers seriously curtailed the area put under crop and lowered the crop return per acre. The Government was asked to procure and sell fertilizers from overseas, but it was considered wiser for supplies to come through the usual trade channels, though at the same time no effort was spared by the Department of Agriculture to assist merchants to obtain supplies for sale; an exception was made, however, in respect of a deposit of phosphatic guano at Cape Cross, in the South-Western Protectorate, formerly German South-West Africa, estimated at 4000 tons, which was purchased by the Government for re-sale to farmers in the same way as Government guano. Shipping difficulties gave trouble in removing this deposit, and supplies came in slowly, 737 tons having come to hand at the end of March, 1918, the total quantity sold and delivered at the end of 1919 being 3826 tons. Attention was given also to the deposit of iron and alumina phosphates at Saldanha Bay, but this has proved disappointing.

The requirements of the United Kingdom at one time were absorbing most of its production of phosphatic manures, only small quantities of super being released for export. The position at the end of 1919, though still abnormal, was becoming easier, fairly large consignments of superphosphate and basic slag coming in. Prices were still ruling high. It is estimated that the Union requires annually something like 35,000 tons superphosphate and 10,000 tons basic slag, with the prospect of steadily increasing requirements, and supplies are much below this figure; the imports of "manures and fertilizers" for the year 1919, amounted to 12,617 tons only, mostly imported during the last few months of the year.

It will be seen, therefore, that the commencement of 1920 finds the Union still in a parlous position, and necessity urges the exploiting of every likely source of supply.

#### AGRICULTURAL MACHINERY AND IMPLEMENTS.

The Union agriculturists' dependence on the manufactures of other lands, especially in agricultural machinery, is well known, and a long continued stoppage of supplies would paralyze the country's agricultural industry. The Customs returns hereunder show the extent to which the Union's supplies fell off after the outbreak of war. Manufacturers oversea, in many cases, directed their energies to war

munitions; the consequent falling off in manufactures (for which also the country of origin had first lien), together with the scarcity and high rate of freight, created a serious shortage in the Union. Yet, on the other hand, agricultural development continued to extend in this country, and, in the instance of its 2500 crop correspondents, who report on the average and condition of the main crops, seldom was lack of machinery and implements put forward as a cause of reduced acreage. Apparently good stocks of machinery and implements were in the country at the outbreak of war, while their rising cost and growing scarcity induced the farmer to take greater care of his goods, and their life was thus considerably prolonged. The half-used and partially discarded article was requisitioned, renovated, and put into use again. Local firms were able to cope to a large extent with the work of renovation and to manufacture locally numbers of ploughshares and implements. Although prices increased very considerably, the farmer, with greater care of his goods and with the incentive of rising prices for his produce, was able to pay increased prices for his machinery and, generally, realizing his opportunity, spared no effort to make the most of his time and cultivated to the utmost. Thus it is that, notwithstanding a diminishing overseas supply of agricultural machinery and implements, the development of the Union continued.

It follows, however, that pre-war stocks will become exhausted and renovated machinery will wear out, and unless oversea supplies come in more freely the Union's agriculture will eventually suffer very materially. It is not apparent that this position has yet been reached; on the other hand all restriction on importations have been removed and goods are coming into the country, but generally the position was still abnormal at the end of 1919 and the Union's requirements continued to exceed supplies.

#### FENCING MATERIAL.

Among the benefits of fencing are labour saving (in that it obviates the employment of herders, etc.), the protection of crops and stock, and the minimizing of disease dissemination. The Census of 1918 shows there were 76,149 farms in the Union (exclusive of native locations, reserves, etc.), 38,498 of which were wholly fenced and 29,667 partially. The Union is dependent on overseas supplies of fencing material, and a lack thereof would react on agricultural development. As a result of the war supplies fell to a very low ebb, and at one time were practically unobtainable, while prices were prohibitive, rising to three or four times as much as was formerly paid, and very little fencing was carried out as a consequence. The position at the close of 1919 was a little easier, however, material coming in more readily with a slight decline in prices. Things had not, of course, reverted to pre-war conditions both in regard to supplies and prices, and fencing was not being extended to the same extent as would otherwise have been the case.

#### DIPS.

Dipping of live stock is essential in this country, materials for the purpose being largely imported from overseas. Arsenite of soda is the principal material used in cattle dipping, and on the outbreak of war supplies fell off so considerably that the Government had to

grant exemptions in certain cases of compulsory dipping owing to lack of material. Every effort was made to secure supplies oversea and freightage for same, but the country's requirements could not adequately be met and the situation became serious. Relief was obtained eventually by the establishment of a local factory, which commenced the manufacture of arsenite of soda for sale at a reasonable price. As far as can be seen this factory, together with an easier situation overseas, was meeting the local demand and no fear of dearth of the article is now anticipated.

Lime and sulphur, largely used in the preparation of sheep dip, were also difficult to obtain and prices ruled very high, so that farmers curtailed dipping as much as possible. Prices at the end of 1919 were still high, but supplies appeared to be sufficient for immediate requirements and there was no apprehension of a dearth.

It is likely that live stock were affected by a scarcity of dipping materials—to what extent cannot be judged—but no marked set-back in animal husbandry has resulted, and the position was very near to normal at the close of 1919 so far as supplies were concerned.

#### AGRICULTURAL SEED.

At the outbreak of war the Union had progressed far in the matter of producing its seed requirements, but it was still necessary to import certain seeds such as potato, mangold, swede, turnip, cauliflower, vetch, etc. Supplies ran low as a consequence of the war and the Agricultural Department was approached by seedsmen in regard thereto. While the importation of seed from oversea was disturbed, consignments continued to reach the country, and although difficulty in obtaining supplies and the high price of seed must naturally have had a retarding influence, there is no evidence that development was reduced in any marked degree on this account. On the other hand, the growth of seed to meet local requirements was greatly stimulated, and the Union's locally grown seed now compares favourably with that of other countries. So far as could be seen the position of overseas' seed supply was easy at the end of the year and no hardships through scarcity were known.

#### OTHER MATERIALS.

The price of various materials for spraying fruit trees, etc., rose considerably and cases of difficulty in obtaining supplies were reported, but generally there was, and is, no marked shortage as a result of the war, and in this respect no set-back to agriculture occurred.

At one time during the war there was a shortage of tin-plate used for the manufacture of cheese-making utensils, and the industry was seriously retarded, but supplies were procured and the situation became easy.

A general survey of the country's agricultural progress during the past years of war brings prominently into view the fact that—owing to unprecedented high prices for produce, the necessity for augmenting local supplies, and the world's demand for foodstuffs—there was sufficient incentive to our agriculturists to produce to the utmost. Thus notwithstanding limitations to our development caused

by the scarcity of essentials, the acreage under crop in the Union was increased generally and especially in wheat and maize. It is significant, also, that reported shrinkages in acreage were due almost entirely to adverse climatic conditions, and in a number of cases to lack of fertilizers and seed. Scarcity of labour was also a cause of restricted sowings in some districts, but while the war drew from the country a large number of coloured and native persons it did not very materially aggravate the agricultural labour question which has been and continues to be a source of difficulty in parts of the Union.

The Customs returns of exports hereunder demonstrate the extent to which agricultural and pastoral products were exported, showing generally a marked increase on pre-war exports and pointing to a gratifying extension of the agricultural industry.

It may be mentioned here that the activities of the Department of Agriculture were severely handicapped during the war owing to the absence of many of its officers on Active Service, the difficulties of obtaining new officers, and the restriction of expenditure, in addition to its having to cope with special functions and questions arising out of the war.

It is clear that the scarcity of overseas supplies did affect our agricultural development, but to what extent no statistical data are available. In spite, however, of this retarding influence the country progressed agriculturally, and to-day it holds a more important position among the world's agricultural producers than it did before the war, while its future prospects have never been brighter. The position at the end of 1919 in respect of the adequate supply of certain essentials was still somewhat obscure and trade far from normal, but with the withdrawal of restrictions and the resumption of manufactures the position is steadily improving, so that it is hoped that at no distant date adequate supplies will be available to meet the Union's requirements.

#### VALUE OF IMPORTS OF CERTAIN ARTICLES USED IN AGRICULTURE.

Year.	Agricultural Machinery.	Agricultural Implements.	Water Boring Machinery.	Fencing Material, Wire Stand- ards, etc.	Stoods.	Sheep Dip.	Bags for Corn, Coal, etc.	Binding Twine and Harvest Yarn.
	£	£	£	£	£	£	£	£
1909	116,974	333,059	19,243	260,230	30,868	75,435	314,238	9,630
1910	148,964	426,942	20,342	430,925	40,912	80,165	332,564	9,090
1911	196,417	492,388	11,556	519,166	53,329	74,197	365,016	18,364
1912	221,092	448,794	23,815	457,374	41,481	90,803	475,862	18,179
1913	209,202	404,672	37,353	593,542	40,450	107,872	485,547	19,103
1914	161,052	361,522	19,570	356,621	25,119	44,231*	504,026	22,457
1915	75,348	259,924	4,074	112,843	18,819	74,105*	642,547	17,136
1916	72,012	116,618	6,901	81,722	23,517	82,650*	689,526	21,215
1917	63,936	446,687	8,664	108,656	19,563	66,878*	896,533	40,501
1918	84,916	495,155	1,865	80,353	29,742	72,473*	1,348,322	157,279†

\* Including Cattle Dip.

† Including £136,419 from Australia.

STATEMENT OF EXPORTS.

*Quantity and Value of certain South African Agricultural Products exported from the Union during the calendar years 1913, 1917, and 1918.*

Produce or Article. (Produce or Manufacture of the Union.)	1913.			1917.			1918.		
	Quantity.	Value.	Quantity.	Value.	Quantity.	Value.	Quantity.	Value.	
Animals, Living ... ..	No. 29,690	£ 38,106	No. 20,103	£ 41,569	No. 21,633	£ 54,485	No. 21,633	£ 54,485	
Bark (Wattle) ... ..	lb. 145,717,738	309,329	lb. 92,551,571	223,982	lb. 107,901,898	287,290	lb. 107,901,898	287,290	
Bark Extract ... ..	...	—	2,781,188	49,520	8,339,439	124,887	8,339,439	124,887	
Beech Leaves ... ..	163,812	32,071	124,110	20,151	89,675	16,948	89,675	16,948	
Butter ... ..	45,318	2,979	2,979,224	196,020	1,316,834	96,756	1,316,834	96,756	
Maize ... ..	22,914,744	65,169	468,702,325	1,519,860	509,495,794	1,600,137	509,495,794	1,600,137	
All other Corn, Grain, Meal, Fodder, and Forage ...	24,892,856	69,373	157,371,444	751,139	205,348,016	955,281	205,348,016	955,281	
Ostrich Feathers... ..	1,023,307	2,953,587	219,048	175,019	108,924	88,628	108,924	88,628	
Eggs, Poultry ... ..	No. 1,498,920	8,555	No. 5,910,778	38,799	No. 1,710,368	12,099	No. 1,710,368	12,099	
Fruit, Fresh (including Nuts) ... ..	lb. ...	52,000	lb. ...	22,738	lb. ...	16,917	lb. ...	16,917	
Jams and Jellies ... ..	431,876	6,960	2,330,775	49,161	3,300,419	77,795	3,300,419	77,795	
Hair, Angora ... ..	17,355,882	876,255	3,630,828	280,636	19,645,684	1,641,889	19,645,684	1,641,889	
Hides and Skins ... ..	...	2,017,863	...	2,637,735	...	3,288,465	...	3,288,465	
Horns ... ..	...	16,214	...	3,542	...	2,363	...	2,363	
Meats ... ..	198,083	5,858	47,350,476	1,049,433	18,818,409	177,418	18,818,409	177,418	
Sugar, Molasses, and Treacle ... ..	12,045,371	18,467	4,437,496	60,174	6,098,350	7,451,8	6,098,350	7,451,8	
Tobacco (unmanufactured) ... ..	240,549	14,728	729,611	36,113	1,173,888	82,552	1,173,888	82,552	
" Cigars and Cigarettes ... ..	3,685 gall.	851	162,853 gall.	50,466	258,059 gall.	77,041	258,059 gall.	77,041	
Wines ... ..	55,469 lb.	11,515	331,522 lb.	49,674	452,428 lb.	112,613	452,428 lb.	112,613	
Wool, Sheep ... ..	176,971,865	5,719,288	117,657,142	8,782,280	115,634,498	9,689,630	115,634,498	9,689,630	
	—	12,219,168	—	16,038,014	—	17,777,672	—	17,777,672	

## IMPORTS OF FERTILIZERS (TONS OF 2,000 LB.).

Year.	Basic Slag.	Bone Manure.	Guano.	Nitrate of Soda.	Potash Manures.	Sulphate of Ammonia.	Phosphates.	Super-phosphates.	Phosphates Raw.	All other N.O.D.
1909	—	*	691	—	—	—	15,462	—	—	7,863†
1910	—	2,189	366	—	—	—	23,724	—	—	7,331†
1911	—	2,638	875	—	—	—	25,443	—	—	7,492
1912	—	3,445	456	—	—	—	32,616	—	—	6,366
1913	5,970	1,714	351	73	1,997	400	—	11,013	8,585	761
1914	6,832	1,400	1,128	25	713	231	—	36,836	377	9,105
1915	9,027	2,019	726	—	51	67	—	33,911	—	6,548
1916	6,231	143	19	14	—	50	—	20,000	—	3,943
1917	636	409	315	—	11	47	—	6,958	—	701
1918	--	3,361	580	—	—	—	—	6,792	5,056	779

### Agricultural Policy.

Mr. Lloyd George addressed in London on the 21st October last a large gathering of farmers and others concerned with agriculture, and outlined the policy which would be pursued by the Imperial Government with the object of uplifting agriculture in the British Isles. He referred to the decline of agriculture in that country since 1870, and the causes thereof, and stated that, notwithstanding its present position, and the fact that foodstuffs to the value of £150,000,000 which could be raised in country were being imported annually from abroad, agriculture remained their greatest industry. The numbers of those engaged in it, the populations directly dependent upon it, its importance from the point of view of the security of the State, its position as the nursery for workers from which other industries of the land have been built up, all pointed to the premier importance of agriculture in the British Isles. By increased agricultural production, the State would receive as great a service as that rendered by any other industry, and the present depreciated value of the British sovereign owing to the adverse balance of trade would be removed.

In order to induce increased cultivation a definite policy was needed, which should include guaranteed security to the cultivator, for "Confidence is the best fertilizer of the soil." This security was, firstly, that of the State, so that the farmer will not be ruined by unexpected developments in the outside agricultural world; secondly, the guarantee by the landlord of security of tenure of the land; and, thirdly, the determination of the farmer himself to produce as much as possible.

"Co-operation," Mr. Lloyd George stated, "is the word for Capital and Labour in all industries at the present moment, and without it we shall fail." Credit facilities, transport facilities, scientific State aid, and the regeneration of rural life were also mentioned as matters of vital importance to the successful forward movement of agriculture in the British Isles, and formed part of the Government's agricultural policy.

\* Included with "Artificial."

† Classified as "Artificial."

“THE WEEDS OF SOUTH AFRICA.”

Notes on “Canada Thistle”

(“*Cnicus Arvensis*,” Hoffm.—Family “Compositae”).

By I. B. POLE EVANS, M.A. D.Sc., F.L.S., Chief, Division of Botany and Plant Pathology, and K. LANSDELL, Division of Botany.

[NOTE.—It is intended to publish these notes, with coloured plate, in the series of articles entitled “The Weeds of South Africa,” issued by the Department as Local Series Bulletins.—ACTING EDITOR.]

THE “Canada Thistle,” also termed “Thistles,” “Cursed Thistle,” “Green Thistle,” “Creeping Thistle,” “Prickly Thistle,” is of European origin.

It is found in most countries in the world, including South Africa, where at present it has only been reported from the borders of Natal, the Transvaal, and from the Cathcart Division in the Cape Province.

Without doubt, it is one of the worst weed pests known to agriculture. Nearly every European country has wrestled with it, as well as the United States, Canada, and New Zealand.

The most noxious part of the “Canada Thistle” is the horizontal creeping root stock. These are round and slender, and look like tough, white whip cords lying 2 to 3 feet underground. They creep in every direction, often to a length of a dozen feet or more, and send up new plants at short intervals. Its rapid spread is due to these root stocks, while each cut joint is able to produce a new set of plants.

The plant is an erect perennial, growing to a height of 1 to 4 feet. The stem is slender and free from prickles. The leaves at first appear in a dense cluster, then alternately along the stem. They are from 3 to 5 inches long, very much cut, and armed with sharp spines along the margin, vivid green in colour on the surface, lighter in colour beneath. The flowers are “thistle-like,” and borne on long flower stalks, which are smooth. The flowers are male and female, and are borne on different plants. They are nearly always purple in colour, although white flowers may sometimes be found.

The “seed” is comparatively smooth, of a light brown colour, slightly curved to one side. The apex is equipped with bristle-like hairs called the “Pappus”; when these hairs fall off the apex is cup-shaped, with a pointed tubercle in the centre. The body of the seed tapers slightly to the base, which is round. The plant is propagated by seed, and the creeping root stock. The former are distributed by birds, threshing machines, sheep, hay, agricultural seeds, and manure.

In America and New Zealand every means known has been adopted to cope with the spread of this plant. The following extract on the

eradication of "Canada Thistle" on grazing lands is taken from the New Zealand Department of Agriculture "Leaflets for Farmers":—  
 "Any measures preventing the plant from developing leaves will be effective. The following have been thoroughly tried: Cut

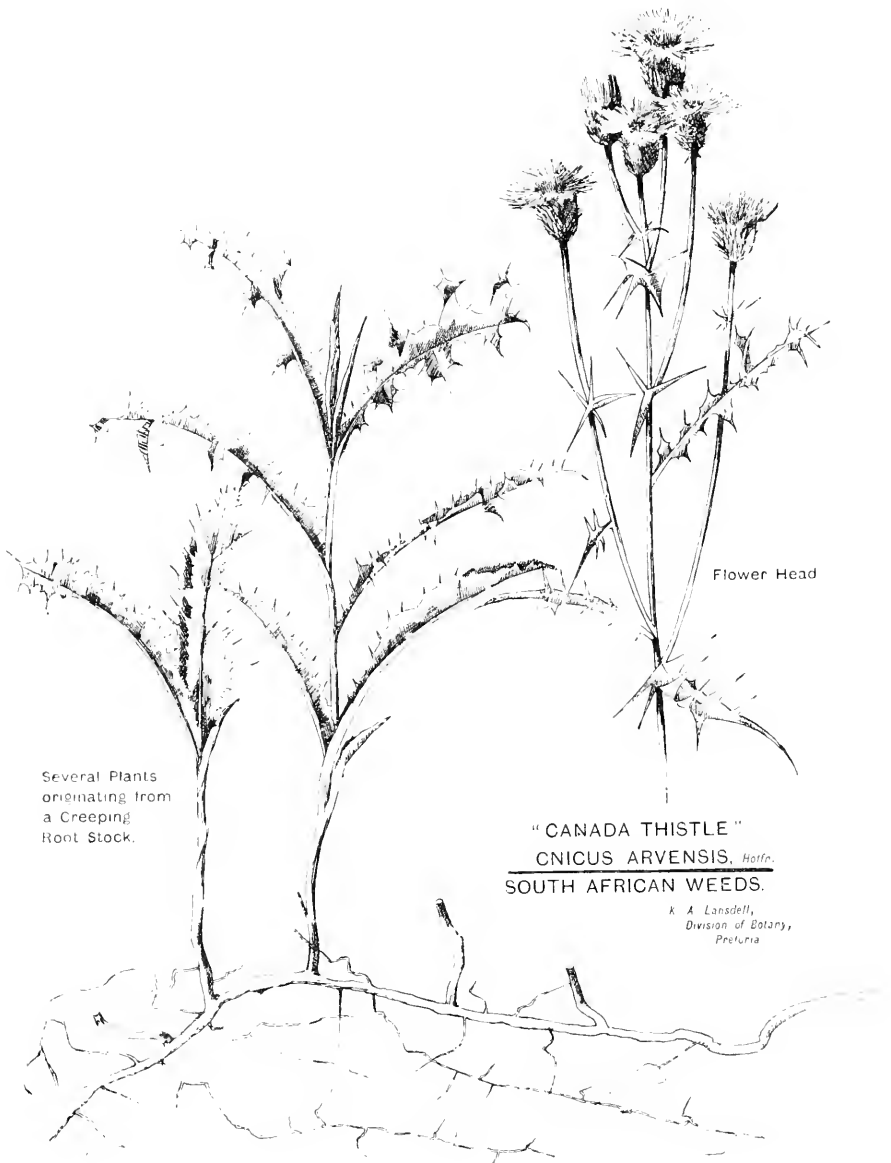

the thistles down close to the ground—if a large patch use a scythe—then dose the ground well with a solution of arsenic, carbolic acid, or other poison. The wash from sheep dips will do, or even a liberal dressing of common salt. Repeat the treatment if possible as soon as



the plants show above ground; never allow them to develop leaves. Remember that the leaves are the lungs of the plant, and without them it must die. Even old-established plants will, by this treatment, be eradicated in two years; a proper vigilance will prevent the pest ever again obtaining a foothold.

"The expense and trouble will be more than repaid by the result, i.e. extermination, and that will be more cheaply and more easily effected now than some years hence. The 'Canada Thistle' never dies out. Slowly but surely its roots penetrate in all directions, and if the farmer does not eradicate the thistle, the thistle will eradicate the farmer."

---

### South African Gum.

*Gum tragacanth* is a species of gum produced in Asia Minor and used in calico printing, medical compounds, leather manufacture, etc. The present price locally of the gum is from 15s. to 20s. per lb. Finding it difficult to obtain a supply for use in his tannery and boot-making factory at Silverton, near Pretoria, where the gum is used as a finishing compound for putting a gloss on leather, Mr. Chas. Maggs approached this Department for assistance in an endeavour to secure raw supplies in the Union. The matter was at once taken in hand by Dr. Pole Evans, the Chief of the Division of Botany, who was able in a very short space of time to provide a gum, the product of our local vegetation, which after severe tests was pronounced by Mr. Maggs to be highly suitable, and satisfactory for his purpose. Observations made by the Botanical Division show that the local gum has better keeping qualities than the imported article. There is a large demand for gums of this nature, and a sample has been sent to the Imperial Institute for valuation on the London market. The local gum was obtained from the tree known botanically as *Combretum salicifolium* and locally as the "Rodeblad," "Vaderlandswilg," or "Bosveld-wilg," which grows plentifully in the neighbourhood of Pretoria, seeds freely, and is apparently easily raised from seed.

It may be added that in appreciation of the many services rendered him by the Division of Botany and of its valuable work in exploiting the natural resources of our country, as instanced above, Mr. Maggs has sent Dr. Pole Evans a cheque for £100 to be devoted towards the furtherance of botanical research work, for which there is such a wide field in the Union.

## RESEARCH AND INVESTIGATION.

### Department of Agriculture.

In addition to the performance of their current duties, the various Divisions of the Department of Agriculture are largely engaged in original research and investigation. The subjects of these may be roughly classified into five groups as follows:—

- (a) Diseases of animals.
- (b) Diseases of plants.
- (c) Insect pests.
- (d) Improvements of crops.
- (e) Utilization of various natural and other resources.

In addition to the above, a botanical survey of the Union is being carried on under the Chief, Division of Botany, and a consultative committee.

The activities of the various Divisions are as shown hereunder.

#### (a) DISEASES OF ANIMALS.

##### DIVISION OF VETERINARY RESEARCH.

###### *Diseases due to Bacteria.*

*Anthrax.*—Investigation of method of infection; variations in and nature of immunity. Improvements in producing protective vaccine.

*Contagious Abortion.*—Natural and artificial methods of infection. Biological study of causal bacterial and protective vaccination.

*Quarter Evil of Cattle.*—Improved methods of vaccine production.

*Redwater of Cattle.*—Biology of parasite. Improved methods of immunizing susceptible cattle.

*Gallsickness of Cattle.*—Nature of causal organism in conjunction with redwater in cattle specially imported for the purpose.

*Dourine or Malade du Coit.*—Isolation of trypanosome with a view to establishing a strain in experimental animals by means of which a diagnosis of infected animals can be made by serological methods.

*Biliary Fever in Dogs.*—Methods of protective immunization and treatment of animals already infected.

###### *Diseases due to Filtrate Viruses*

*Horse Sickness.*—Entomological surveys of horse sickness areas. Transmission experiments with suspected mosquitoes. Nature of immunity conferred by inoculation and best means of protection by serum therapy. Study of the virus.

*Heartwater of Cattle.*—Demonstration of nature of virus. Possibility of establishing immunity by vaccination.

*Diseases due to Plant Poisons.*

Feeding tests with suspected plants or fungi.

*Diseases due to Parasites.*

Investigation of life-history of *Strongylus filaria*, *Distoma hepaticum*, and *Strongylus instabilis*. The pathological conditions produced in the infected host. Methods of prophylactic and medical treatment.

*Diseases of Unknown Origin.*

*Staggers in Horses*.—Pathological studies to clear up conditions conducive to causation and enable control of disease.

*Staggers in Cattle*.—Research to confirm results of feeding experiments.

*Dunziekte in Horses*.—Experiments to ascertain causal agent, incubation period, etc.

*Stijfziekte in Cattle*.—Investigations and ecological survey to ascertain if disease is caused by a veld plant.

*Osteoporosis in Horses*.—Investigation with a view to elucidating cause.

*Lamziekte in Cattle and associated condition of Pica*.—Research as to means of prevention.

*Gauwziekte in Sheep*.—Experiments with a view to confirming theory that disease is of plant origin and to ascertain actual causal agent.

The *Biochemical Section* of the Division is carrying on work on—

- (a) Animal nutrition with special reference to malnutrition and diseases influenced by diet.
- (b) Phytochemistry and soil chemistry in reference to pica as precursor to lamziekte.
- (c) Production of toxins by putrefactive bacteria with special reference to lamziekte.
- (d) Chemical and physiological investigation of South African poisonous plants.
- (e) Chemical study of parasiticides.
- (f) Dips, dipping, and control of changes in dipping tanks.

## DIVISION OF BOTANY.

Botanical investigations, in conjunction with Division of Veterinary Research, of gallamziekte, gouwziekte, jagziekte, geel-dikkop, stijfziekte, dunziekte.

## (b) DISEASES OF PLANTS.

## DIVISION OF BOTANY.

Research work into citrus canker, potato and tomato diseases. Bacterial spot of citrus, bacterial blight of pear blossoms, citrus fruit spot, black spot of mangoes, die-back of fruit trees, apple cracking disease, dry-rot of maize, walnut bacteriosis, bean bacteriosis, root disease of sugar-cane, cane leaf-spot, cotton bacterial spot, almond and apricot die-back, and flag smut of wheat.

## (c) INVESTIGATION OF INSECT PESTS.

## DIVISION OF ENTOMOLOGY.

Special study of maize stalkborer, tobacco leaf beetle (*Lema bilineata*), cotton insects, specially the Soudan bollworm. Scale insects, specially *Chrysomphalus dictyospermi*. Woolly aphis, termites, false codling moth, and lucerne caterpillar.

## (d) IMPROVEMENT OF CROPS.

## DIVISION OF TOBACCO AND COTTON.

*Tobacco*.—Establishment of new varieties by hybridization. Purifying established varieties by close in-breeding. Increasing leaf numbers, shape of leaf, flavour, and aroma by selection and in-breeding. Testing different styles of curing sheds. Fertilizer and crop rotation experiments.

*Cotton*.—Improvement of existing varieties by selection. Variety comparative tests for heaviest yields and best quality lint. Planting at different distances to ascertain which will give heaviest yields. Ratooning to determine utility of perennial crops as compared with annual planting. Comparison of crop from locally grown as against imported seed.

## AGRICULTURAL RESEARCH CHEMIST.

Investigation, chemical and physical, of wheat soils of the Union and similarly of tobacco soils, with a view to ascertaining the soil condition which yields the best crops.

## DIVISION OF CHEMISTRY.

Interaction between fertilizers and certain typical Transvaal soils.

## (e) UTILIZATION OF NATURAL AND OTHER RESOURCES.

## DIVISION OF BOTANY.

Investigation of fibre plants, plants useful for paper-making, dye plants, food plants, oil plants, medicinal plants, indigenous grasses, veld-burning and overstocking.

## AGRICULTURAL RESEARCH CHEMIST.

Utilization of waste from wool washeries. Examination of brines, bitters, and salts from South African salt pans. Chemical examination of fodder plants and poisonous plants. Examination of rock likely to contain phosphates. Study of oils from different varieties of eucalyptus and oil-content of eucalyptus leaves at various stages of growth.

## DIVISION OF CHEMISTRY.

Investigation of the active principle of "slangbossie," the alleged antidote for snakebite.

(*Note*.—In addition to the above, a great deal of work is being done at the Schools of Agriculture, particulars of which will be given in ensuing numbers of the *Journal*.—ACTING EDITOR.)

---

**NOTES.**

---

**Concerning the Sheep and Wool Industry.**

Mr. A. G. Michaelian, Principal Sheep and Wool Expert, Department of Agriculture, left early in February last for Australia to purchase stud sheep for the Government and also for private individuals. Accompanying Mr. Michaelian were six young South Africans proceeding to the Sydney Technical College on Government scholarships for the study of sheep and wool. Their names are A. G. J. van Zyl, A. M. le Grange, F. C. P. Stow, A. R. van der Merwe, B. Hartigan, and J. H. Kruger, and they were chosen as among the best students in the sheep and wool course held last year at the Grootfontein School of Agriculture, Middelburg, Cape. They will return to the Union for service in the Department at the end of 1921.

---

**Anthrax.**

A Press Circular (No. 9/1919, dated 5th July, 1919) was issued by the Department drawing attention to the dangers of anthrax in wool, mohair, skins, hides, etc., recommending certain precautions to prevent the spread of the disease and to ensure disinfection of our produce, and pointing out the adverse manner in which our exports of such produce would be affected in case the disease spreads. In this connection farmers are advised that the Imperial Parliament has passed an Act to control the importation of goods infected or likely to be infected with anthrax, and to provide for the disinfection of any such goods. It is styled the Anthrax Prevention Act, 1919, and provides for the prevention of importation into the United Kingdom, either absolutely or except at any specified ports and subject to any specified conditions as to disinfection and otherwise, of goods infected or likely to be infected with anthrax. It empowers the Imperial Government to declare goods of any specified class which are of any specified origin, or are exported from or through any specified country or place, as likely to be infected with anthrax. It provides also for the carrying out in the United Kingdom of the disinfection of infected goods and the cost of all services in connection with such disinfection are chargeable to the importer. It is obvious, therefore, that farmers residing in anthrax-infected areas should leave no stone unturned to deal in a radical manner with cases of this disease which may occur on their holdings. No animal dying under suspicious circumstances should be skinned or cut up; smears should be taken from the blood of the ear of suspected animals and sent to the Government Laboratory, Onderstepoort, for examination and report; deaths should be reported to the police and carcasses of such animals should be burned or buried at a depth of six feet, preferably in quicklime, in some spot where they are not likely to contaminate any water supply, and the graves fenced in or bushed over. When the existence of the disease is definitely confirmed, no time should be lost in inoculating in-contacts.

## Limestone Resources of the Union.

Attention is directed to a report\* submitted by the Director of the Geological Survey on the limestones of the Transvaal and part of Bechuanaland and Natal. This is the first part of the survey; the work is still in progress, and a report on the limestones of the rest of the Union will be issued at a later date. The introduction to the above report states: "Among the foremost essentials of any industrial community is a good supply of limestone, conveniently situated, and of suitable quality, and the present investigation has been undertaken with a view to ascertaining to what extent and in what localities a supply of limestone is available suited to the various requirements of modern industry." The uses of limestone are many, one of them being as a fertilizer for agricultural purposes, and the report deals with the origin and distribution of limestones, and gives full particulars of the locality, character of the deposit and of the limestone found in that part of the Union investigated thus far, so that the purchaser and user of limestone will find information as to the localities in which suitable material may be found. Many of these deposits (of secondary limestone) scattered over the country may ultimately be of considerable importance for local agriculture as sources of agricultural lime. Special reference is made to the deposits of lime suitable for agricultural purposes found at the following localities:—

Umzinkulu, Natal (used by sugar planters).

Northern Waterberg: Farms Zwartberg No. 1037, Welvaart No. 1194, Van Wijksfontein No. 1195.

Pietersburg: Farm Vaalboschlaagte No. 614.

Potchefstroom: Farms Roodepoort No. 22, Elandskuil No. 110.

Marico: Farms Paardevallei No. 62, Weltevreden No. 61, Kruis River No. 154, Kalkfontein No. 60, Vergenoegd No. 3, Uitvlucht No. 63, Kaalplaats No. 97, Buffelshoek No. 284.

Christiana: Bessieslaagte No. 23 (Nooitgedacht).

Lydenburg: Kalkfontein No. 1488.

Bechuanaland: Laxey, on the Mashowing River, Gamolilio.

In connection with the use of lime for agricultural purposes the report states: "It is probable that the supply of lime . . . may ultimately take the first place from the broad point of view of national importance," and, further on: "The great increase in fertility which generally follows upon the application of dressings of lime in such cases has often been pointed out. Over the greater part of the well watered areas of South Africa the soil is extremely deficient in lime, especially in the eastern portion, and when the fact is realized by the farmers themselves, there can be no doubt that a very large demand for agricultural lime will arise, if it can be supplied at a sufficiently reasonable price."

The chief object for using lime agriculturally is to neutralize the acid in the soil; also, it loosens and improves the texture of heavy clay soils and consolidates excessively light and sandy soils. The

---

\* "The Limestone Resources of the Union." Vol. I.—"The Limestones of the Transvaal and portions of Bechuanaland and Zululand," by W. Wybergh, with a Chapter on the Deposits of Port Shepstone and Hermansburg, Natal, by A. L. du Toit, D.Sc., F.G.S. Geologist). (Price 5s., Government Printer, Pretoria.)

class of lime and its application are dealt with in the report, as well as other matters affecting its use in agricultural production. Altogether, the report is of much importance and interest, and brings to the fore the existence in the Union of a mineral which, with other so-called "base metals," is worthy of attention.

### Shortage of Foodstuffs and Raw Materials.

The world's shortage of foodstuffs and raw materials creates a great opportunity for South African agricultural enterprise.

In analysing the situation in Europe, Mr. Henry Hoover, the United States Food Administrator, estimates that the population of Europe is at least 100,000,000 greater than can be supported without imports. In order to pay for these imports they must live by the production and distribution of their exports, and the situation is aggravated not only by lack of imported raw materials but by low production of European raw materials. Generally, in production, Europe is far below her requirements to maintain life and health and unparalleled importation is needed to meet the deficiency. Mr. Hoover states "unless productivity can be rapidly increased there can be nothing but political, moral, and economic chaos"; and, further, "The entire surplus productivity of the Western Hemisphere is totally incapable of meeting the present deficiency in European production if it is long continued." The only solution of the problem lies in increased production and at the maximum individual effort.

In view of the great shortage the following figures of production in the Northern Hemisphere are extracted from the last Bulletin received, at the time of writing, from the International Institute of Agriculture, Rome (No. 12, December, 1919). These figures include most of the principal producing areas in the Northern Hemisphere, but some countries, especially in Europe, have not furnished statistics, and, of course, are not included.

#### *Yield of certain of the Northern Hemisphere Crops, 1919.*

(NOTE.—1 quintal = 220 lb.)

Crop.	1919 (Provisional Figures).	1918 (Final Estimates).	Five Years' Average, 1913 to 1917.	Percentage of 1919 compared with	
				1918 (1918=100).	5 Years' Average, 1913 to 1917 (Average= 100).
	Quintals.	Quintals.	Quintals.		
Wheat ... ..	564,652,736	609,146,074	585,163,508	92.7	96.5
Rye ... ..	48,034,040	48,641,037	38,204,289	98.8	125.7
Barley ... ..	130,751,909	153,575,397	131,227,392	85.1	99.6
Oats... ..	313,735,692	370,368,950	344,399,516	84.7	91.1
Maize ... ..	794,519,156	691,717,311	760,640,896	114.9	104.5
Potatoes ... ..	215,719,521	245,050,287	208,472,170	88.0	103.5

The following details of certain of the large producing countries are interesting. The figures are included in the above totals:—

Crop.	1919 (Provisional Figures).	1918 (Final Estimates).	Five Years' Average, 1913 to 1917.	Percentage of 1919 compared with	
				1918 (1918=100).	5 Years' Average, 1913 to 1917 (Average= 100).
<i>Wheat</i> —	Quintals.	Quintals.	Quintals.		
U.S.A. Winter ...	191,676,330	151,987,480	151,100,619	128.1	128.8
U.S.A. Spring ...	55,294,747	97,610,456	64,078,385	56.6	86.3
British India ...	76,223,846	100,812,183	97,459,228	75.6	78.2
Canada ...	53,111,610	51,458,717	71,647,070	103.9	74.6
France ...	48,438,170	61,435,840	61,135,155	78.8	79.6
Italy ...	46,148,000	49,885,000	47,303,000	92.5	97.6
England and Wales	17,372,198	22,926,337	15,156,409	75.8	111.6
<i>Rye</i> —					
U.S.A. ...	21,477,054	22,907,384	12,700,754	95.8	169.1
France ...	7,070,010	7,349,860	9,150,100	96.2	77.3
Spain ...	6,868,088	7,733,387	6,652,778	88.8	103.2
<i>Barley</i> —					
U.S.A. ...	43,173,441	55,817,965	43,372,480	77.3	99.5
Japan ...	19,917,774	19,432,145	18,889,239	102.5	105.5
Spain ...	19,879,763	19,703,126	16,922,852	98.4	114.5
<i>Oats</i> —					
U.S.A. ...	177,013,473	223,292,809	193,236,308	79.3	91.6
Canada ...	63,405,394	65,745,914	63,373,692	96.4	100.1
France ...	21,129,320	25,619,760	39,569,562	95.4	61.7
<i>Maize</i> —					
U.S.A. ...	739,232,602	656,060,584	698,362,139	112.7	105.9
<i>Potatoes</i> —					
U.S.A. ...	95,807,124	108,892,849	94,622,970	88.0	96.2
Canada ...	35,912,056	28,403,761	20,110,330	126.4	178.3

Certain other crops are also reported upon: among them the linseed crop in 1919 is estimated to be 39.5 per cent. less than the average crop from 1913 to 1917, while, on the other hand, the sugar beet crop is 115.3 per cent. greater.

In the United States of America the tobacco crop of 1919 is 20.6 per cent. greater than the average crop for the five years 1913 to 1917, but its cotton crop is 16.7 per cent. smaller.

The position in regard to the 1919-20 crops in the Southern Hemisphere is not yet reported by the Institute; the 1918-19 crop of wheat, it may be pointed out, was 5.9 per cent. greater than the average crop for the five years 1912-13 to 1916-17, but it was 29.9 per cent. less than the 1917-18 crop.

## Meat Export.

A cargo of 40,880 quarters of South African beef was shipped on the 20th August, 1919, per s.s. "Meissonier," on order for the Imperial Government, and was landed at Genoa on the 12th September and following days. The following is extracted from the report of the Receiving Commission in Genoa on the shipment:—"On inspecting the cargo the meat was found to be in perfect condition of



preservation and freezing. It did not, however, have a good appearance owing, in our opinion, to the preparation being not very good, a fact due to what we consider as insufficient experience on the part of the workmen engaged in the slaughtering. With regard to the quality of the meat, we think that the cargo cannot be regarded as good as the meat imported from Brazil and from the Argentine.

On the whole the meat was found to be lean. The quarters were large, belonging to rather bony animals, and in our opinion they will not yield more than 50 per cent. of meat. The meat was of dark, redish colour, the fatty parts being of yellowish colour, thus indicating that the cattle were not of a very fine breed and rather mixed with regard to age and sex."

---

### Successful Exhibits, London Dairy Show.

At the last London Dairy Show held at Islington, 21st October, 1919, the outstanding feature of the South African exhibits was the success of cheese exhibits from East Griqualand for which Messrs. Jack Moxham, Co-operative Industries, Limited, Rustfontein, Kokstad, East Griqualand, obtained the First Prize and Gold Medal, and Mr. T. T. Joyner, Glen Edward, Franklin, East Griqualand, the Second Prize and Silver Medal. A third exhibit from the Rocky Ridge Cheese Factory, Kokstad, East Griqualand, was judged to be almost equal in quality to the two winning ones, but was disqualified owing to certain conditions regarding size and weight not being complied with. These being the first exhibits of South African cheese at the London Dairy Show, where they are in competition with the produce of other countries (over twenty New Zealand factories were competing), our success is very gratifying. The judge was particularly pleased with the quality of the cheese, which he pronounced as excellent.

The butter exhibits entered for competition did not meet with the same success as the cheese. The London Dairy Show takes place, however, at a time of the year when our cream is extremely scarce and its quality far below show standards; while this would always be an obstacle, the judge's criticisms generally will prove valuable and will, it is trusted, lead to the better success of our butter at future shows.

---

### Curing of Hides.

The Trade Commissioner for South Africa in London, when recently in Holland, visited the warehouses of the Amsterdam Hide and Leather Exchange and was much impressed with the quality of the hides imported from Java, which were on view in large quantities. There was a neatness and finish about them which indicated that great pains were taken to prepare this very important article in the best possible manner for the export trade.

Inquiries revealed that hides exported from Java are treated on the following lines:—

- (1) The hides are carefully taken off the animals in a neat manner by skilled slaughtermen. In skinning, great care is taken that the hide is not cut in any way, for incisions

- are the cause of the so-called "skin cuts," and when the hides are cut to some depth there appear in the leather what is still worse, namely the "skinholes."
- (2) After the hide has been taken off the animal, it is placed on a table and whatever flesh there may have remained on it is scraped off with a knife (specially made for this purpose). Care is also taken that the hide is cleared of all blood, slime, and fat.
  - (3) It is recommended to take the skin of the head and the legs off the hide (legs to be cut off at the knees).

It is strongly recommended that hides, before undergoing the drying process, be immersed in a weak solution of poison. In Java, the so-called "Hamburger skin poison" is used, specially manufactured for this purpose. During the war this skin poison was also imported from America. Directions for use are issued with the tins of poison by the manufacturers. The fresh hides are salted slightly and then dried. This is termed the dry-salted process.

*The Drying Process.*—This is done in different ways. One firm dries the hides in the sun, the other under trees or in the shade, others again do the drying in an open shed, etc. The last mentioned is considered the best method, because the hides do not get sunburnt and are not exposed to rain. Rain and sun have harmful effect on the hide, and tanners are very particular on this point.

*The Stretching of Hides.*—This is best done on frames which in Java are made of bamboo. The hides, when dry enough, are folded lengthways (from head to tail) with flesh side out and hair inside. The hides are piled on top of one another and left in well ventilated place until they are thoroughly dry.

*Sorting of Hides.*—Sorting of hides is done in the following manner:—

- (1) Extra heavy.
- (2) Heavy.
- (3) Middling.
- (4) Extra light.

Under no circumstances must the different qualities or grades 1, 2, 3, 4 be mixed.

*Damage to Hides.*—Animals are often branded, once or more, on the most valuable parts of the skin. The brandmarks or rather burnt patches turn into holes when tanning is in process; this happens also to the skins of animals cut by barbed wire, etc.

*Loss through Bad Flaying.*—In this connection it is interesting to note that a prominent member of the Farmers' Federation of the United Kingdom, Mr. Densham, who visited South Africa at the end of 1919, and studied at first hand the local leather industry, lays stress on the need for the improvement of South African hides. He calculated that in the Rand and Pretoria districts alone a sum of at least £150,000 per annum is being lost owing to bad flaying. His experience showed that bad flaying made our hides unsuitable for sole leather, and that during the war the Argentine hide received preference on this account when purchases were made for military purposes. Mr. Densham advocates the formation of an association, such as the one now operating in England, which arranges at various places demonstrations on the best methods of flaying.

### **Pirbright Cattle Testing Station.**

We have been favoured with extracts from letters written by a prominent exporter of cattle who recently visited the Pirbright Cattle Testing Station, Surrey, England, where pure-bred stock for South Africa are tested prior to export, to satisfy himself that the animals there were well cared for. In relating his visit he writes: "I have nothing but a most flattering report to send you of my visit. . . . The premises are ideal, out in the open country, the loose boxes are built of brick, whitewashed inside, and the woodwork creosoted; they (the stock) seem to be getting an abundance of good hay, and a ration of 2 lb. linseed cake, 2 lb. bruised oats, and 4 lb. bran daily, plus 14 lb. of roots, and good water *ad lib.* is at their disposal. Everything is clean and comfortable; the animals are all isolated from each other; the boxes are beautifully ventilated; the doors are in two halves; the upper half can be opened and left open at pleasure when the weather is fine. There are two ranges of loose boxes, with a fine stretch of grass paddock between the two rows, where the animals can be individually exercised. The cattle are conveyed to and from the station by cattle floats."

---

### **The Gift of the Late Mr. H. G. Flanagan.**

The National Herbarium has been enriched by the acquisition of Mr. Flanagan's herbarium, which he bequeathed to the Union Government. The value of this collection cannot be estimated in money, as it contains a great many types and unique specimens of South African plants.

The late Mr. Flanagan was a well-known farmer in the Komgha District, and was a partner in the firm of Messrs. Flanagan Brothers. He was not only a successful farmer but a man of very wide tastes in scientific matters. He was a keen botanical collector, and was considered by some herbarium workers to have excelled any of his contemporaries in the excellent manner in which he prepared his specimens. For many years he was a constant correspondent on botanical matters with the late Professor MacOwan, and then with the late Dr. Bolus. He built up a very fine herbarium, which is an almost complete record of the flora of the Komgha District, but his collection also contains plants from the Molteno District, Witzieshoek in the Orange Free State, the Mont-aux-Sources, Rhodesia, and Pondoland. By exchanges his herbarium was enriched by specimens from other parts of South Africa. Many South African plants were collected for the first time by Mr. Flanagan, and in glancing through the recent volumes of the "Flora Capensis" and other botanical publications this is evidenced by the large number of species named after him.

---

## SOUTH AFRICAN PRODUCE ON THE OVERSEA MARKET.

### Notes from Reports of the Acting Trade Commissioner.

#### Year 1919.

*Ostrich feathers* were put up to auction for the first time since the war in June last year, when 27,000 lb. were sold for a total value of £30,000; prices being 24 to 25 per cent. higher than in 1914. Later on, neutral and allied countries were making inquiries for South African feathers. The Trade Commissioner arranged for displays in the windows of prominent West End Stores in London. It is considered these displays will have a direct value in view of the spring sales and fashions. He has also arranged for a series of public sales of ostrich feathers during the year 1920.

*Wool.*—The first series of *wool sales* since the war were held in May and June, when South African free wools of poor quality were offered, as also Government wools. Practically the whole of the August wool offerings of 7,248 bales were purchased for export. Competition during September was very keen, British, Continental, and American buyers competing. The French demand increased in October, when greasy wools were much sought. The November auctions closed on a basis fully on a par with the high level values established for Australian Merino wools. It was further somewhat difficult to arrive at the actual clean basis on which wools were then selling. However, taking good, 12-months' combing wools, it worked out at from 125d. to 128d. per lb. *ex* London Warehouse, top-making sorts costing from 110d. to 118d. and 6-months' from 75d. to 80d. French competition for long, greasy combing wools continued keen during December. Considerable quantities of South African wools, forming part of the Imperial Government's purchases, were also offered, and these had a somewhat depressing effect on the market. Some of these wools had been on hand for a considerable time, with consequent depreciation in quality.

The *mohair* market was not very strong, owing to large stocks of Turkey mohair offering, and also because the machinery plant available to many mohair spinners had been reduced by being turned into wool spinning.

French buyers continued for a time keen on *Cape Merino Skins*. Shippers are recommended to make offers, *c.i.f.* Bordeaux, as soon as direct steamers are available.

*Cotton seed* of good, average quality was estimated at £24 per ton, *c.i.f.* United Kingdom. The Trades Commissioner, however, reports that it was difficult to give prices in the absence of samples. As the prices for cotton seed are governed by the ascertained oil content of the seed, he urged that average samples of the year's crop be sent him for valuation, and recommended that the seed shipped be delinted as far as possible.

*Raisin shipments* showed a great improvement, which was most gratifying, and the grading left little to be desired.

*White Granulated Sugar* was of excellent quality and was expected to be admitted in time at a preferential rate of duty.

*The Wattle Bark* market remained very firm, owing in a large measure to the extreme shortage of stock and big demands from the Continent, prices for parcels afloat being quoted at £18. 15s. for ground and £18. 10s. chopped. The demand for chopped bark increased later on, particularly for shipments direct to Antwerp, Marseilles, and Bordeaux. *Wattle Extract* was quoted at £44 per ton on account of the demand exceeding the supply. These conditions prevailed till the close of the year. Some delay in the delivery of the November bark extract shipments was occasioned owing to detention by the Customs Authorities on account of the alleged sugar content of the material. Through the energetic intervention of the Trade Commissioner the parcels were eventually released.

*Meat shipments* were well reported on, both as regards quality and butchery. *Bacon* shipments were satisfactory, but *Pork* was defective in August. The manner of slaughtering and preparing for export left much to be desired, especially in the November shipments, which had a deleterious effect on the market. For *Beef* the quartering of the hinds was deficient; they can with advantage show 9½ instead of 8½ joints of the vertebrae. It is also thought that much will be gained by chilling the meat before quartering. Union meat shippers should prepare for keen competition in the near future, by having first-class shipments for the London market.

*Horns* came in demand in August, with the result that of the 125,000 South African ox and cow horns offered 124,000 were sold.

*Poultry and eggs* were prominent in September, and continued very popular. The shipments gave considerable satisfaction. As the Russian supplies of the past could not be depended on, all supplies from South Africa are welcome, thus affording an opportunity for the South African trade in this line of becoming established on the London market. The egg shipments for November of 3831 cases were quite satisfactory as regards condition, quality, and grading; the demand was good, and no difficulty was experienced in disposing of them. The condition of the Christmas consignment of turkeys was very good, but not of fowls and geese, the latter being inferior in size and quality. Prospects for frozen poultry remain good, but shippers must put up their goods in an attractive manner, paying due regard to proper grading, packing, etc. Some small parcels of turkeys, geese, and fowls were found to be unfit for sale.

*Exhibits.*—The Trade Commissioner mentions that the show window exhibition continues to arouse a good deal of interest. He has arranged for an extensive programme of exhibition in the United Kingdom and on the Continent, including a special display of ostrich feathers. It is intended later on to transfer this exhibit to Paris. A special display of the principal produce from the Union was put up at the Utrecht Fair (Holland) on the 24th February. The display will be transferred to Brussels early in April. Arrangements are also being made to have the South African fruit export trade represented at the shows of the Royal Horticultural Society, the Royal Agricultural Society, and at the Bath and the West of England Agricultural Shows. The Swiss Government has invited the Union to be represented at the Dominions Exhibition to be held in Lucerne in July next.

## January, 1920.

*Wool.*—Public sales of privately owned South African wool were held during January, and 4071 bales were catalogued. The wool attracted considerable interest and bids came freely. Brokers state that the selection in greasy wools, although by no means good, was better than on previous occasions, but there was still too large a proportion of small lots of unattractive poorly grown staple. For the long combings, competition was excellent at prices which showed no appreciable change from those ruling on the 17th December. Short rubbishy parcels were irregular and weak at a 5 per cent. decline. Snow whites, on the whole, were a better lot than previously. Whilst there was nothing of super quality or bulk, there were several parcels of medium length which showed good style and appearance. On the average, there was no change in prices for snow whites, though the tendency was in buyers' favour. There were very few Transkeis or Basutos on offer. There was a fair show of fine crossbreds, coarse whites, greys, etc., for which the demand was not so good as it was in December.

*Prices.*—The highest figure paid for greasy combings was 60d. This was secured for the top fine of a well-bred, well-classed clip from the Heidelberg District. Other Westerns sold at from 40d. to 46d. The best price for Easterns was 50d., which was paid for a rather short-grown Kaltrarian lot. Other prices, for wools shipped from Port Elizabeth, ranged from between 38d. for moderate length staple to 44½d. for a good combing of different yield. Some so-called Natalis of fair length made up to 43½d. Short supers were a poor lot. The lowest fetched in the neighbourhood of 23d., and the better ones went up to about 30d.

*Snow Whites.*—These made a fair show. 81d. was paid for a bright clean Western of moderate length. The Paarls on offer were on the small side, and were mostly withdrawn. 80d. was made for the best of the Port Elizabeth parcels. Smaller and more specky lots sold round about 70d., and good seconds made from 56d. to 62d. East Londons were rather poor, being mostly short as well as faulty. They sold between 58d. and 65d. Natalis sold up to 76d. The best of the fine crossbreds were withdrawn. Lower lots sold at 56d., coarse whites at 42d., blacks at 56d., and greys at 50d. There was very little demand for white or coloured kempies.

The date of the next sales is not yet fixed, but it will probably be about the middle of February.

*Mohair.*—A few transactions in good Cape Firsts have taken place during the past month, but inquiries continue to be very small, as spinners appear to be hard pressed to deliver wool yarns and cannot afford to put machinery on to mohair. There is little, if any, demand for lower class hair, which is, at the moment, quite unsaleable. The last transaction in winter hair was at 25¾d. delivered at Bradford, but it is problematical whether this price would be obtainable to-day.

*Goatskins.*—At the public auctions held on the 22nd January, 68,231 Cape goatskins were offered and 21,987 sold. Brokers report that, apart from several shipments from Mossel Bay, there was a poor representation from the Western Province, nor were there any standard lines from Algoa Bay or East London; in fact, the catalogues

were largely made up of secondary grades and damages. Heavy and medium weights of Western Province origin advanced about 2d. per lb., and on light and extra light the gain may be put at 5 per cent. In "dry damages" and bastard skins there was no appreciable change. The few sales of Eastern Province skins afforded little or no indication of the market, and brokers regard values in this category as nominally unchanged to a fraction higher for good selections.

*Angora Skins.*—On the same occasion 130,066 Cape Angora skins were offered and 29,221 sold. On the whole there is no change in prices to report, and inquiry was again much restricted; a slight advance was secured for a line of Algoa Bay skins of "light" selection, and a fair number of "clips" changed hands at quite firm rates.

*Cape Sheepskins.*—Cape sheepskins auctions were held on the 14th January, when 137,974 Cape sheepskins were offered, and 76,011 sold. The collection was not very attractive, the supply of really good skins with full-grown wool being on a small scale. There was only a moderate attendance of buyers. Combing wools of the best kinds sold at 1d. per lb. over the rates ruling at last auction. Long wools, particularly when on the short side, were frequently 1d. per lb. lower. Short wools, also, were in most cases reduced in value to a like extent, and shorn were by no means in demand. Full-woolled lambs sold without change. Damaged combings and long wools were usually 1d. per lb. lower. Damaged short were in small request, nor was there much interest shown for damaged shorn.

*Coarse-woolled sheepskins* secured rather better competition, but on the whole were unchanged.

Of 57,428 Common Cape (Glovers) sheepskins offered, 18,862 were sold. The standard selections of large and medium skins were mainly represented by Mossel Bay product, and for these an advance was obtained of about 1s. to 2s. per dozen over the prices ruling in the November auction. Bye sorts were in poor request.

*Wattle Bark.*—The market of late has been fairly active, and chopped is to-day worth £22. 10s. per ton c.i.f., whilst ground is ruling at £22. 15s. The demand from the Continent is decidedly weaker owing to the recent arrival of large direct shipments.

*Ostrich Feathers.*—Ostrich feather auctions were held at the Mining Lane Saleroom on the 2nd and 3rd instant, when 2212 lots were catalogued, the weight being 98,600 lb. as against 84,000 lb. in September last. Several parcels had certain limits put upon them, which were somewhat higher than present values, and, as a result, withdrawals were frequent. Only about 1000 lots were sold, realizing approximately £100,000. There was a good attendance of buyers, and France and America appeared to take a large proportion of the goods sold, but the Home trade was quiet. Although this was the first sale held since September, 1919, the demand was not up to expectations. It is thought that the heavy depreciation on certain of the foreign exchanges, coupled with delays in transport, may have largely contributed to the limited demand, and in order to help buyers the brokers have decided to postpone the next sale until the 3rd May.

*Beef.*—During January certain small parcels of South African beef were placed on Smithfield market, and, on the whole, the condition has been satisfactory. Whilst the meat generally may be

described as quite useful, it is still very plain. The London market is at the moment full up with large supplies of imported meat, and it is only with difficulty that the maximum prices can be realized for the very best quality. The following are the average prices ruling for imported frozen beef:—

Brazilian: Hinds, 6s. 8d. to 7s. 8d. per stone of 8 lb.: fores, 3s. 8d. to 4s. 8d. per stone of 8 lb.

South African: Hinds, 6s. 8d. to 7s. 8d. per stone of 8 lb.: fores, 4s. 4d. to 5s. 4d. per stone of 8 lb.

Argentine: Hinds, 7s. 8d. per stone of 8 lb.: fores, 5s. 8d. per stone of 8 lb.

New Zealand: Hinds, 7s. to 7s. 8d. per stone of 8 lb.: fores, 5s. to 5s. 8d. per stone of 8 lb.

Australian: Hinds, 7s. to 7s. 8d. per stone of 8 lb.: fores, 5s. to 5s. 8d. per stone of 8 lb.

New Zealand and Australian sheep and lambs, 7s. per stone.

From Monday, 2nd February, the price of imported beef will be reduced by 2d. per lb.

*Drugs.*—The first drug auction of the year was held on 15th January, when various South African products were offered.

*Aloes.*—Sixty-nine cases were catalogued, but only 16 cases were offered. These were all sold. The balance of what was catalogued, *ex* "Durham Castle," could not be landed in time to be sampled for sale. Prices were decidedly dearer; fair to good hard bright selling at 78s. to 80s., whilst hard but rather drossy brought 77s., with one case hard bright but mixed part livery 73s. per cwt.

Since the last sales there has been a good demand at steadily advancing prices, "best" having been sold at 77s. 6d. to 80s.

With regard to *c.i.f.* business I am informed by the brokers that very little has been done owing to shippers not being in a position to make offers. The last price paid was 57s. 6d. per cwt. *c.i.f.* London, but in their opinion 60s. could be obtained to-day, as buyers are asking for offers.

*Buchu.*—A fair business has taken place at very satisfactory prices. Most of what has recently arrived has now been sold. Present values will, no doubt, be maintained until supplies of the new crop arrive on the London market, and at the present time it is very difficult to estimate what the prices will be for the new season's crop. Brokers are inclined to the opinion that prices might fall.

*Guaza.*—Very slow trade, with practically no demand. Eighty-one packages offered and all withdrawn, there being no bids of any sort.

*Argol.*—Seventy-four packages (Lees) offered and withdrawn, there being no demand for low-testing quality. Good quality (Argol) remains in good demand. Fair to good grey and white, 100s. to 105s.; brownish or good pink, 85s. to 95s. per cwt.

*Quince Seed.*—In auction nothing offered, but brokers state that a *c.i.f.* offer at about 3s. would probably lead to business.

*Liquorice Root.*—Not any offered, but in fair demand.

*Myrtle Berry War.*—Present value is rather uncertain. Brokers quote fair quality, 130s. per cwt.



## OVERSEA PRICES OF SOUTH AFRICAN PRODUCE.

February, 1920.

MARKET PRICES OF SOUTH AFRICAN PRODUCE IN THE UNITED KINGDOM,  
CABLED BY THE ACTING TRADE COMMISSIONER, LONDON.*South African Wool.*

February prices show no change of any importance as compared with January: slight tendency downwards.

*Mohair.*

No change.

*Cape Hides.*

Wet Salted, heavy	...	...	...	...	1s. 6d. to 1s. 9d.	per lb.
Dry Salted	...	...	...	...	2s. 2d. to 2s. 2½d.	per lb.
Dry	...	...	...	...	1s. 8d. to 2s. 3½d.	per lb.

*Cape Angora Skins.*

Heavy	...	...	...	...	1s. 8d.	per lb.
Light	...	...	...	...	2s.	per lb. Damaged, in proportion.

*Cape Merino Sheep Skins.*

Extra long	...	...	...	...	...	2s. 4d. to 2s. 10d.
Long	...	...	...	...	...	2s. to 2s. 4d.
Short	...	...	...	...	...	1s. 5d. to 1s. 10d.
Shorn	...	...	...	...	...	1s. 6d. to 1s. 11d.

*Common Cape Glover Sheep Skins.*

Extra large	...	...	...	£8. 15s.	to	£11. 10s. 6d.	per doz.
Medium	...	...	...	£6. 10s. 6d.	to	£10.	per doz.
Light	...	...	...	£4.	to	£6. 5s.	per doz.

*Bitter Aloes.*

70s. to 85s. per cwt.

*Natal Wattle Bark.*

Chopped	...	...	...	...	...	£21. 15s.
Ground	...	...	...	...	...	£22. 10s. c.i.f. per ton.

*South African Beef, Hinds.*

7s. per stone, 7lb.

*South African Beef, Fores.*

5s. per stone, 7 lb. Market is very uncertain.

*Cotton (February futures).*

Highest	...	...	...	...	...	...	28.25d.
Lowest	...	...	...	...	...	...	27.57d.

All other articles, no change.

**STAFF.****Department of Agriculture (including Agricultural Education).**

## HEADS OF DIVISIONS.

## ADMINISTRATION.

Secretary for Agriculture.—F. B. Smith, C.M.G.  
 Under-Secretary for Agriculture.—P. J. du Toit (presently engaged on the Public Service Commission of Inquiry).  
 Acting Under-Secretary for Agriculture.—G. N. Williams.  
 Under-Secretary for Agriculture (Education).—E. I. Macmillan, B.S.A.

## DIVISIONS.

Sheep.—Chief : B. G. L. Enslin.  
 Veterinary Research.—Director of Veterinary Research : Vacant.  
 Veterinary.—Principal Veterinary Surgeon : C. E. Gray, M.R.C.V.S.  
 Dairying.—Superintendent of Dairying : E. O. Challis.  
 Botany.—Chief : I. B. Fole Evans, M.A., D.Sc., F.L.S.  
 Tobacco and Cotton.—Chief : W. H. Scherffius, M.Sc.  
 Horticulture.—Chief : I. Tribolet.  
 Viticulture.—Government Viticulturist : S. W. van Niekerk.  
 Entomology.—Chief : C. P. Lounsbury, B.Sc.  
 Chemistry.—Chief : B. de C. Marchand, B.A., B.Sc.  
 Chemical Research.—Agricultural Research Chemist : C. F. Juritz, M.A., D.Sc., F.I.C.  
 Library.—Librarian : P. J. S. Ribbink.  
 Co-operation.—Registrar, Agricultural Co-operative Societies : J. Retief.  
 Dry Farming.—Government Agronomist : H. S. du Toit.  
 Guano Islands.—Superintendent : W. R. Zeederberg.  
 Grain Inspection.—Chief Inspector of Grain : G. F. Nussey.  
 Brands and Fencing.—Registrar of Brands and Controller of Fencing : M. van Niekerk (Acting).  
 Journal of Agriculture.—Editor : G. W. Klerck (Acting).

## SCHOOLS OF AGRICULTURE AND EXPERIMENT STATIONS.

Elsenburg (Cape) ... ..	Principal : W. J. Lamont.
Groo fontein (Cape) ... ..	" R. W. Thornton.
Cedara (Natal) ... ..	" J. Fisher, B.Sc., N.D.A.
Glen (Orange Free State) ... ..	" M. J. A. Joubert, B.S.A.
Potchefstroom (Transvaal) ... ..	" T. G. W. Reinecke, B.A., M.Sc.Ag.

**STAFF CHANGES.**

## (1) AGRICULTURE.

DATE.	NAME OF OFFICIAL AND NATURE OF CHANGE, ETC.
12/9/19	E. K. Jacklin : Appointed Assistant Inspector of Co-operative Societies. Transferred from Audit Office.
30/9/19	S. Keightley : Senior Sheep Inspector, Bedford, Cape Province. Superannuated.
1/10/19	Miss. A. M. Corbishley : Appointed Assistant at Kew in connection with the South African Botanical Survey.
8/10/19	Dr. Kind, Dr. Scheuber, and Dr. Meier : Appointed Veterinary Research Officers on three years' agreement.
27/10/19	Dr. E. C. Gill : Appointed Veterinary Research Officer on three years' agreement.
31/12/19	C. R. Dewey : Dairy Instructor. Resigned.
22/1/20	A. A. Curson : Veterinary Research Officer, transferred from Veterinary Research Laboratory, Onderstepoort, to take charge of Veterinary Research Laboratory, Grahamstown, vacant through death of Dr. Robertson.
29/2/20	T. Hamilton : Dairy Inspector. Resigned.

## (2) AGRICULTURAL EDUCATION.

DATE.	NAME OF OFFICIAL AND NATURE OF CHANGE, ETC.
6/9/19	E. G. Parish, B.Sc. : Transferred from Elsenburg to Glen School of Agriculture as Vice-Principal.
31/10/19	Alex. Holm : Under-Secretary for Agriculture (Education), resigned to take up the post of Director of Agriculture, Nairobi, British East Africa. Mr. Holm was the first General Manager of the Potchefstroom Experiment Farm (1903), and on the establishment of the School of Agriculture at that centre was appointed Principal (1909). On 1st October, 1912, he accepted the post of Under-Secretary for Agriculture (Education), which he held until date of leaving the Department.
1/11/19	E. J. Macmillan, B.S.A. : Principal, School of Agriculture and Experiment Station, Potchefstroom, was appointed Under-Secretary for Agriculture (Education) on the resignation of Mr. Holm. Mr. Macmillan, before accepting the Principalship of Potchefstroom, served from 1904 in several capacities in the Orange Free State Department of Agriculture, Bloemfontein.
31/10/19	P. Fowlie, N.D.A. (Hons.) N.D.D. : Itinerant Instructor and Experimentalist, School of Agriculture, Cedara. Resigned.
31/1/20	Miss C. Lavecar : Lecturer in Domestic Science. Resigned.
31/1/20	D. J. Potgieter, B.Sc. (Agr.) : Itinerant Instructor and Experimentalist, School of Agriculture, Glen. Resigned.
1/2/20	J. Quinlan, B.A., M.R.C.V.S. : Lecturer in Veterinary Science, School of Agriculture, Potchefstroom, transferred to Veterinary Research Laboratory, Onderstepoort.
20/12/19	E. Holmes Smith, B.Sc. : Botanist, School of Agriculture, Potchefstroom. Resigned.
2/20	T. G. W. Reinecke, B.A., M.Sc. (Agr.) : Principal, School of Agriculture, Elsenburg, transferred to Potchefstroom <i>vice</i> E. J. Macmillan, B.S.A.
2/20	W. J. Lamont : Vice-Principal, Groofoontein School of Agriculture, promoted to Elsenburg.

## MOVEMENTS, ETC., OF OFFICERS.

## SHEEP DIVISION.

After an absence of seven months, Mr. Enslin, Chief of the Sheep Division, has returned to the Union from a tour in Europe and America, and resumed his duties in the Division.

Senior Sheep and Wool Expert McCail has been temporarily transferred to Headquarters and appointed Acting Principal Sheep and Wool Expert during Mr. Michaelian's absence in Australia. Mr. Leo Visser, after successfully completing his course in sheep and wool in Australia, has been appointed Sheep and Wool Expert in the Union. Mr. O. C. Weeber has been transferred to the South-West Africa Protectorate, where he has taken up the post of Principal Sheep Inspector.

## DAIRY DIVISION.

Dairy Inspector Gow has been away for the past three months in East Griqualand inspecting all cheese factories and creameries under the Dairy Industry and Factory Acts, and instructing in cheese making and grading cheese. Owing to the resignation of Mr. J. F. Stephenson, Official Cheese Grader in that District, Mr. H. G. Rae was appointed in his place on twelve months' probation, and has accompanied Inspector Gow for the past four or five weeks for the purpose of being initiated into his duties. Dairy Inspector Oosterlaak has been busily engaged for some time past in various parts of the Transvaal, where, since the late rains, dairying is once more going ahead.

## VETERINARY RESEARCH.

Mr. R. E. Montgomery, at present on leave in England, has accepted a post under the Uganda Administration, and the Union Government has agreed to his transfer. Arrangements are not yet complete as to Mr. Montgomery's successor.

## NOTES FROM THE "GAZETTE."

Attention is drawn to the following matters of interest which appeared in the *Union Government Gazette*.

GAZETTE.		(Abbreviations: "Proc."—Proclamation; "G.N."—Government Notice.)
No.	Date.	ITEMS.
1016	24/12/19	The removal of citrus trees from certain areas in the Districts of Rustenburg, Waterberg, and Pretoria is prohibited by G.N. No. 172 of 1919 (Agricultural Pests Act, 1911).
1016	24/12/19	The compulsory dipping of cattle in "seven-day," "five-day," and "three-day" dips in certain areas in the Districts of Zoutpansberg, Barberton, Pretoria, Pietersburg, Piet Retief, Richmond, New Hanover, Pietermaritzburg, Weenen, Lions River, Klip River, Umzimkulu, and Mount Ayliff is required by G.N. Nos. 1719 of 1919, and 78, 240, 289, 324, and 370 of 1920.
1018	9/1/20	
1023	30/1/20	
1025	6/2/20	
1026	13/2/20	
1028	20/2/20	
1029	27/2/20	
1016	24/12/19	Regulations for eradication of scab in the Union superseding those previously published under G.N. Nos. 1183 and 1184 of 1914, and 1288 of 1917, came into force on 1st January, 1920, as per G.N. Nos. 1702 and 1703 of 1919 (Diseases of Stock Act, 1911).
1016	24/12/19	A regulation prescribing the manner of reporting deaths of stock and the treatment of carcasses of such stock in certain Magisterial areas in the Transvaal, appears in G.N. No. 1722 of 1919.
1016	24/12/19	The Minister of Agriculture has declared the "felling season" for indigenous timber in the Transkeian Conservancy to be from 1st April to 30th September in each year, with effect as from 1st January, 1920. (G.N. No. 1727 of 1919.)
1029	27/2/20	The slipping season for indigenous wood in the Transkeian Forest Conservancy will in future remain open until the 31st March following the close of the felling season. All wood not slipped by that date will be forfeited to the Government unless permission has been previously obtained. G.N. No. 1859 of 1914 is accordingly amended. (G.N. 340.)
1016	24/12/19	The Governor-General has approved of certain regulations for the insurance of mules and horses against death while undergoing treatment for immunization. (G.N. No. 1728 of 1919.)
1021	16/1/20	The disposal of certain Crown lands by public auction at Calvinia and Lady Frere on 28th and 10th April; at Robertson, Upington, and Clanwilliam on 24th April, 11th and 21st May; at Ladismith and East London on 8th and 1st May, respectively, is notified in G.N. Nos. 109, 110, 315, and 316 of 1920.
1028	20/2/20	
		The sale of certain Crown lands in various districts of the Transvaal, in terms of section 5 of the Crown Lands Disposal Ordinance, 1903 (Transvaal), has been approved of by the Governor-General. (G.N. No. 304 of 1920.)
		Under the same section referred to above, the Governor-General has sanctioned the setting apart of certain lands in various districts of the Transvaal as public reserves. (G.N. No. 306 of 1920.)
		The Governor-General has further approved under the above Ordinance the cancellation of certain reserves at Vereeniging and Schweizer Reneke. (G.N. No. 321 of 1920.)
1016	24/12/19	Jam has been added to the list of articles for which a permit is required for export. (G.N. No. 1001 of 1919.)

GAZETTE. (Abbreviations: "Proc."—Proclamation; "G.N."—Government Notice.)		
No.	Date.	ITEMS.
1021	16/1/20	Irrigation Districts of Tabankulu, Transkei: Klein Klaas Voogds River, Robertson: George Impala, Barberton: and Umfolozi, Natal; have been established by Proc. Nos. 8, 9, 10, and 13 of 1919, and the boundaries of the Leeuw Gamka Irrigation District in Prince Albert, amended by Proc. No. 12 of 1919.
1023	30/1/20	Semi-protection under the Scab Regulations has been extended to the Districts of Bredasdorp, Swellendam, Caledon, Stellenbosch, Paarl, Malmesbury, and the northern portion of the Cape District (G.N. No. 173); also to the Districts of Ixopo, Ipoela, Impendhle, Lions River, and Estcourt. (G.N. No. 285 of 1920.)
1025	6/2/20	
1025	6/2/20	<i>The Minister of Agriculture has approved of the appointment of the Executive Committee of the South African Agricultural Union as a committee to advise him on matters relating to agriculture.</i> (G.N. No. 238 of 1920.)
1025	6/2/20	Lists of European and native stock brands registered during the quarter ended 31st December, 1919, for the Transvaal, are published in G.N. No. 258, 1920, and lists for the Orange Free State and the Cape in G.N. Nos. 257 and 259, 1920, respectively.
1026	13/2/20	Amended Regulations for the export of fruit are published in terms of section 7 of the Fruit Export Act (No. 17 of 1914). (G.N. No. 260, 1920.)
1026	13/2/20	The compulsory dipping of sheep under the Scab Regulations is required in the Districts of Ixopo, Ipoela, Impendhle, Lions River, Estcourt, Elliot, Barkly East, and portion of Aliwal North (G.N. No. 293 of 1920); Edenburg, Smithfield, Blomfontein (G.N. No. 368); and must be completed in the Natal and Orange Free State districts mentioned above by 31st May, 1920. (G.N. No. 256 of 1920.)
1026	13/2/20	Woodcutter boards for the Crown forests in the George, Knysna, and Humansdorp Districts have been appointed by the Minister of Agriculture, with effect from 1st January, 1920. (G.N. No. 264 of 1920.)
1026	13/2/20	The grain of maize and barley has been included in the term "Maize and Barley Plants" for purposes of section 2 of the Agricultural Pests Act, 1911. (Proc. 32 of 1920.) Section 9 (2) of the above Act requires that the importation of such plants shall be subject to certain restrictions and the grain of maize and barley imported into the Union from oversea is declared subject to these restrictions. (Proc. No. 33 of 1920.)
1028	26/2/20	The demarcation of the Barkhuis Berg Forest Reserve and of a certain lot in Harkerville Forest Reserve in the Division of Knysna is defined in G.N. Nos. 308 and 343 of 1920, and of Tontu Forest Block, Flagstaff, in G.N. No. 358.
1029	27/2/20	
1029	27/2/20	Regulations in connection with the taking of the <i>Second Annual Census of Agricultural, Horticultural, Viticultural, Dairying and Pastoral Production</i> , have been approved of by the Governor-General under the Statistics Act of 1914. Penalties for non-compliance with these regulations are also provided. The census will be taken in April. (G.N. No. 344.)
1029	27/2/20	Application for the lease of certain Zoutpansberg and Bethal holdings will be received by the Lands Department up to 9th April under the provisions of the Land Settlement Act, No. 12 of 1912, and Crown Lands Disposal Ordinance, 1903 (Transvaal). (G.N. Nos. 339, 349, 353.)
1029	27/2/20	The Department of Mines and Industries notifies that <i>two Scholarships for the study abroad of Industries and Commerce</i> will be awarded in 1920, and will be open to persons resident within the Union. The value of each scholarship will be £250 for a period of two years or more according to circumstances. Intending applicants should refer for further particulars to G.N. No. 350, 1920.

## RECENT AGRICULTURAL LITERATURE.

By THE LIBRARIAN, DEPARTMENT OF AGRICULTURE.

### I.—UNION GOVERNMENT PUBLICATIONS.

#### (A) DEPARTMENT OF AGRICULTURE.

*Bulletins published between the 20th October, 1919, and 1st March, 1920 (obtainable from the Librarian Department of Agriculture):—*

Price per copy.		Number of Publication.
1d.	Dry-Land Farming, by H. S. du Toit ... ..	L.S. 82.
1d.	Sugar-Cane Culture, by E. R. Gessner... ..	L.S. 84.
1d.	Fruit-Drying, by I. Tribolet ... ..	L.S. 85.
Gratis.	Report of Motor-Tractor Ploughing Trials at the Elsenburg School of Agriculture, Mulder's Vlei. C.P.	L.S. 86.
Gratis.	Sixth Congress of Co-operative Agricultural Societies in the Transvaal and Orange Free State, held at Pretoria on the 13th May, 1919	L.S. 87.
1d.	Report on the First Duck Egg-Laying Competition, held at Cedara	L.S. 88.
1d.	Report on the Fifth Egg-Laying Competition, held at Potchefstroom	L.S. 89.
3d.	Pigs and Piggeries, by Morkel and Cleghorne... ..	2/1919.
1d.	Breeding Experiments, with N. and S. African Ostriches, Part V, by Prof. Duerden	3/1919.
3d.	Observations on Soil Erosion, by Wm. Torrance ... ..	4/1919.
1d.	The Fig and Willow Borer, by D. Gunn ... ..	6/1919.
1d.	Breeding Experiments with N. and S. African Ostriches, Part VI, by Prof. Duerden	7/1919.
3d.	Fourth Report on Cattle-Feeding Experiments, held at Cedara and Potchefstroom	8/1919.
1d.	Report on Cold Storage Conditions for Export Fruit at Capetown, by I. B. Pole Evans	2/1920.

#### (B) MISCELLANEOUS REPORTS, ETC., OF INTEREST TO FARMERS.

*(Obtainable from the Government Printer, Pretoria.)*

1s.	Office of Census and Statistics: Quarterly Abstract of Union Statistics, No 1, January, 1920	S.P. 15.
5s.	Office of Census and Statistics, Pretoria: Statistics of Population, 1917	U.G. 37—'19.
6d.	Excise, Superintendent of, Report of, 31st December, 1918... ..	U.G. 23—'19.
1s. 9d.	Deeds, Registrars of the several Provinces of the Union, 1917 ... ..	U.G. 8—'19.
5s. 6d.	Housing Committee. Report of... ..	U.G. 4—'20.
7s. 6d.	Irrigation, Director of, Report, 1st April, 1917, to 31st March, 1918	U.G. 49—'18.
1s.	Kakamas Commission of Inquiry ... ..	U.G. 55—'19.
7s. 6d.	Lands, Department of, Report 1st January, 1917, to 31st March, 1918	U.G. 53—'18.
10s. 6d.	Mines and Industries, Department of, Report year ended 31st December, 1918	U.G. 38—'19.
5s. 6d.	Native Affairs, Department of, Report, 1913—1918 ... ..	U.G. 7—'19.
2s. 6d.	Railways and Harbours, Report of, year ended 31st March 1919 ... ..	U.G. 59—'19.
9d.	South-West Africa, The Mandate for, and Draft Conventions ... ..	U.G. 44—'19.
2s. 6d.	Surveyors-General of the several Provinces of the Union, 1917, Report	U.G. 9—'19.
2s. 6d.	Taxation of Incomes derived from Farming operations ... ..	U.G. 3—'19.
6s. 6d.	Wheat-growing, Departmental Committee on ... ..	U.G. 42—'19.

### II.—THE AGRICULTURAL PRESS OF SOUTHERN AND TROPICAL AFRICA.

#### SOME ARTICLES OF INTEREST.

*Die Boer* (Bijvoegsel tot "De Volkstem"), Pretoria, 13 Februarie 1920.  
 Achteruitgang Beesboerderij.  
 Besproeiing van die Kalihari.  
 Koei-erfjes of Kafferboontjies, deur G. J. Bosman, B.Sc.

*Die Boerenvrou* (Posbus 984, Pretoria), Februarie 1920.

Die eerste Voortrekkersvrou van Suid-Afrika.

Goggas op Hoenders.

Hoe om Saadplantjies aan te kweek.

*The Farmers' Journal* (Nairobi, B.E.A.), Thursday, 29th January, 1920.

A Simple Farm Shed, by H. F. Birchall.

Hints on Coffee Growing in British East Africa.

Geology of Planes, by Thomas Scott, B.Sc.

East Africa as the World's Future.

Spice Gardens, by W. J. Thomson.

*The Farmers' Weekly* (Bloemfontein), 18th February, 1920.

Farm Mechanics, by Geo. Morgan.

Wind-Power for Mills.

From Hide to Leather, by C. Williams, Chemist, School of Agriculture, Cedara.

Tagasaste and Tree Lucerne, by J. P. F. Sellschop, School of Agriculture,

Potchefstroom.

With the Botanical Division: A chat with Dr. Pole Evans.

*Die Landbouwer* (Posbus 1035, Pretoria), 31 Desember 1919.

Angora Bokhaar.

Notule van 'n vergadering van die Dagelike Bestuur van die Transvaalse Landbou

Unie, Donderdag, 18 Desember 1919.

*Die Landbou Weekblad* (Posbus 267, Bloemfontein), 18 Februarie 1920.

Waterpasse, deel 5, deur R. J. van Reenen.

Mielies, Wisselbou, G. J. Bosman.

Oorboshuis, deur J. C. Faure.

*The Natal Witness* (Supplement, "The Farmers' Day," Pietermaritzburg), 14th February, 1920.

Poultry-Keeping.

Pig Breeding and Management, by W. A. K. Morkel, M. Sc.

*Rhodesia Agricultural Journal* (Department of Agriculture, Salisbury, Rhodesia), February, 1920.

Ensilage, by J. A. T. Walters.

Notes on the Theory and Practice of Feeding Cattle in Southern Rhodesia, by

R. C. Simons.

Tobacco Culture: Growing on the Farm, by H. W. Taylor, B.Agric.

Salisbury White Maize, by H. G. Mundy, F.L.S.

Tobacco Pests of Rhodesia, by R. W. Jack, F.L.S.

Percentage of Butter Fat in Cream, by A. Brunn.

Statistics of Crops grown by Europeans in Southern Rhodesia, 1918-19, by F. Eyles.

The Hydraulic Ram, by A. C. Jennings, A.M., I.C.E.

Afforestation in Zululand, by J. S. Henkel.

Poultry, by A. Little.

Cattle on Shares, by E. A. Nobbs, Ph.D., etc.

Stock Regulations.

First Annual Egg-Laying Test, Rhodesia, 1920-21.

*The South African Dairyman* (Box 925, Durban), January, 1920.

Mr. Bains and Co-operative Creameries.

The Famous Breeds of Britain: The Shorthorn, Part 3, by Farmer George.

*The South African Farm News* (Box 963, Johannesburg), January, 1920.

A Separate Party.

The Cost of Living, by Oupa.

Cattle Industry, by Bos.

Notes on Farms: the position in Natal, by J. Forsyth Ingram.

Meat Profiteering, by R. W. Hodges.

Is rain responsible for the lack of stock food and the starvation of cattle, or is the farmer?

Silos for the Masses, Part 2.

Bacteria of the Dairy Industry.

Dairy Farming, by W. H. Courtenay.

Pig-Raising and Bacon-Curing in South Africa.

Agricultural Motor-Power, by August Karlson.

The Farm Orchard, by H. B. Terry.

- The South African Fruit Grower and Small Holder* (Box 3958, Johannesburg), December, 1919.  
 Aphicides, by W. F. Schlupp, Entomologist, School of Agriculture, Potchefstroom.  
 New Freighters for South Africa, by Colonist.
- South African Gardening and Country Life* (Box 3958, Johannesburg), January, 1920.  
 A Drought Garden, by D. Fairbridge.  
 Plants of the Bible and Biblical Lands, Part 5.  
 A Frosty Garden.  
 Carnations from a commercial point of view.
- The South African Journal of Industries*, January, 1920.  
 Vegetable Fats and Oils, by Professor M. Rindl, I.N.G.  
 South African Rubber, by T. R. Pim, F.L.S., etc.  
 Olives, by I. Tribolet.  
 Employers and Employees, by H. Warrington Smyth, M.A., C.M.G.  
 Research Scholarships and Grants-in-Aid.
- South African Poultry Magazine* (Bloemfontein), January, 1920.  
 The World's Poultry Congress: Meeting at the Hague, September, 1921.  
 Throttling the Industry, by "Cape South-Western."  
 The Industry Defended, by "Progressive."  
 The South African Poultry Association: Official Minutes of the 16th Annual Conference, Pretoria, 10th-15th November, 1919.
- The Poultry Review and Small Holder* (Johannesburg), 1st February, 1920.  
 South African Ancona Club, Annual General Meeting.  
 Poultry Farming for a Living, by Graham Hope.  
 Tuberculosis of Poultry.
- South African Sugar Journal* (Box 925, Durban), February, 1920.  
 The Victor Cane-Cutter.  
 Natal Planters' Union: Suggested Amalgamation of the Unions.  
 Scientific Co-operation needed.  
 Notes on the Cotton Industry, by W. B. Wilson, B.S.Agric.
- The Sun and Agricultural Journal of South Africa* (Box 634, Johannesburg), November, 1919.  
 Agriculture and Industry, by N. O. Curry.  
 My Industrial Tour, by the Editor (Dr. Wm. McDonald).  
 South African Pioneers (1): "Mr. T. W. Beckett."  
 Agricultural Stagnation, by C. E. Wilson, Secretary, South African Grain Trade Association.  
 The Afrikaner Cattle Industry, by Pieter Koch, B.Sc.  
 The Romantic Story of T-eff.  
 Correspondents' School of Agriculture: Lecture No. 1: "On the Pea Nut or Ground Nut."

### III.—AGRICULTURAL PUBLICATIONS IN OTHER PARTS.

#### REVIEWS AND EXTRACTS.

##### (a) ROYAL COMMISSION ON AGRICULTURE: INTERIM REPORT (C.D. 473).

"The Journal of the Ministry of Agriculture," London (formerly the Board of Agriculture), commenting, in the January, 1920, number on the above Report (issued 19th December, 1919), states that the main recommendation put forward is that guaranteed minimum prices should be fixed annually in respect of wheat, barley, and oats grown in Great Britain on the same principle and conditions as laid down in Part I of the Corn Production Act, 1917, the producer being allowed an unrestricted market for his produce but the State retaining the right to control prices in case of national emergency. The object of the proposed guarantees is to encourage the growth of cereals and arable cultivation. Recommendations are made regarding the basis for the annual fixing of prices. Accompanying the report is the minority report, with arguments against the policy of guarantees and in favour of leaving the farmers free to cultivate without guarantees their land according to their own views, and to obtain prices for their cereals not less than those at which grain is imported. One member favours continuous guarantees for wheat and oats, based on the level of agricultural wages, with a minimum of restriction on farmers' freedom of action.



*(b)* ELECTROLYTIC TREATMENT OF SEEDS BEFORE SOWING (WOLFERYN PROCESS).

This process is claimed to cause marked increase in yield, and forms the subject of an article by E. J. Russell, D.Sc., F.R.S., in the January issue of the "Journal of the Ministry of Agriculture," London. The result of various experiments at Rothamsted and elsewhere is that electrified seed failed to give any increase in yield under the carefully controlled conditions of an experiment station trial, and the process, therefore, lacks certainty and cannot be compared in effectiveness with manuring, which succeeds nearly every time if properly carried out. The writer of the article is not prepared, on present evidence, to say that the process never succeeds, but the risk of failure seems so great that the farmer should look upon it as an adventure which may or may not prove profitable.

*(c)* LIVE STOCK INSURANCE INSTITUTE OF LOWER AUSTRIA.  
(CATTLE SECTION, 1914 TO 1918.)

Hermann Kallburner, in the International Review of Agricultural Economics for January, 1920, shows the development of this class of insurance in Austria, notwithstanding the very great difficulties and losses caused by the war. In 1913-14 the Institute paid out damages on 2.43 per cent. as against 3.40 per cent. in 1917-18 of all cattle insured. The average insured value of a head of cattle was in September, 1913, 387 crowns and in September, 1918, 948 crowns (1 crown = 100 heller = 10d. at par). The rise is connected with the increase in prices of butchers' stock and draught cattle. The tariff of premiums in force since October, 1916, is shown in the article.

During the period stated the Institute paid on 72,594 cases of loss, damages amounting to 22,340,168 crowns. In addition to the numerous losses against which animals may be insured, the Institute is extending its insurance to losses resulting from epidemics (foot and mouth disease, anthrax, rabies, glanders, influenza, pulmonary phthisis), transport, pregnancy and consequent diseases, castration and other operations, etc. Owners of small live stock, especially of pigs and goats, will be able to insure their animals in future.

*(d)* INTERNATIONAL INSTITUTE OF AGRICULTURE, ROME.

The eighth volume of the recently published "Annuaire International de Legislation Agricole" (International Year-Book of Agricultural Legislation) surveys the world's legislation in 1918, that is, during the concluding period of the war, and the transition from a state of war to one of peace. It is a volume of 1200 pages. In accordance with the method followed in previous years, the more important legislative provisions are printed *in extenso*, translated into French, while of the others only the title, both in the original language and in French, is given, together with the number and date of the official publication in which they appear. The International Institute of Agriculture keeps in its archives of documentation the complete text of all these measures. The Year-book contains also a long analytical introduction in English, briefly describing the laws and orders published in full in the volume. This introduction indicates the general lines of Agricultural Legislation promulgated in 1918 in the various countries of the world. Two indices make the Year-book easy to consult: the first, a chronological index by countries; the second, a subject index. There is also a full table of contents in English. The price of the volume is 15 francs, and may be obtained by forwarding an order for that amount to the "Institut International d'Agriculture, Service des abonnements et publications," Villa Umberto I, Rome, Italy.

*(e)* "THE RIGHT USE OF LIME IN SOIL IMPROVEMENT."

This book, by Alva Algee, Secretary of the New Jersey State Department of Agriculture, recently published by the Orange Judd Company, New York (Kegan Paul, Trench Trubner & Co., London), is a valuable addition to the existing literature on the subject, and will do much to dispel the doubt and indecision regarding the value and use of lime in the land. Careful investigation into the relative values of various forms and sources of lime are of comparatively recent date, and agricultural literature 20 years ago contained little about soil acidity. The author divides his book into the following chapters: Lime and soils; sour soils; evidences of acidity; tests for acidity; sources of lime; definitions; ground limestone; storing lime in the soil; fresh burned lime; burning lime; lime hydrate; other forms of lime; magnesian lime; what shall one buy; application; amount of lime per acre; special crop demands.

## AT THE SCHOOLS OF AGRICULTURE AND EXPERIMENT STATIONS.

January and February, 1920.

CERARA, NATAL.

JANUARY, 1920.

*Climatic.*—The rainfall for January, 1920 (up to and including the 27th) was 6.9 inches. The mean maximum temperature was 78° and the mean minimum 59.2°. The weather was hot at the beginning of the month with mists at night. There were steady rains in the middle of the month. The winds were moderate, and on the whole climatic conditions were very favourable for agriculture.

*Field Operations.*—Silage, maize, and cowpeas were planted early in the month. Japanese millet, vetches, teff, and linseed were also sown.

*Crops.*—The main grain crop of maize (Hickory King) was planted in November and December and growth was satisfactory during the month. Top grub is giving little trouble as most of the first generation were destroyed by means of a trap crop. One hundred and forty acres were planted with Hickory King. One hundred and thirty-one acres of maize for silage were planted at the beginning of the month and germination and progress have been good. Twenty acres of cow-peas were planted in October last but have made slow progress. Thirty acres more were planted at the beginning of the month and are doing well. Sixty acres have been ploughed for teff grass this month and the seed sown has germinated well. About twenty acres have been seeded. Ten and a half acres of Up-to-date and Flourball potatoes were planted in September and October, but these have suffered somewhat from drought and the yield is poor. Fourteen acres of Japanese millet and three acres of linseed were sown. Germination has been good.

*Stock.*—The welcome rains during the month greatly improved the condition of the veld. The stock are doing very well and the milk yield is improving. There were two births during the month, a Shorthorn heifer calf and a Friesland bull calf.

*Orchard.*—Operations during the month have been mainly directed to harvesting fruit. Fruit fly has given much trouble although frequent sprayings with fly-bait have been applied. The failure of the bait to check the fly is ascribed to the fact that the frequent rains wash off the bait almost as soon as it is applied. Fresh growth has started on the trees owing to the rains. A cover crop has been sown to check this and summer pruning is receiving attention.

FEBRUARY, 1920.

*Climate.*—The rainfall for the month (up to and including the 22nd) was 6.97 inches. The average number of hours of sunshine per day was 6.4 hours. On the whole the days were overclouded with rain at frequent intervals, in fact the rain has been in excess of agricultural needs.

*Field Operations.*—Soya beans, cowpeas, Kikuyu grass, teff, and rape were planted. The harvesting and selection of potatoes has commenced.

*Crops.*—Hickory King maize has made good growth and a fair yield is probable.

About five acres of linseed have been destroyed by an outbreak of caterpillars closely resembling the army worm. This pest is, however, being rapidly killed off by diseases and parasites and little further trouble is anticipated from them.

*Stock.*—During the month four Ayrshire calves were born and one Shorthorn. One Shorthorn cow died of old age. One of the cows developed milk fever the day after calving, but this was cured in five hours by inflating the udder.

*Orchard.*—The continued wet weather has favoured the development of fungous diseases. The plum harvest is now finished and the harvesting and storing of apples is proceeding. A large portion of the orchard has been planted with green manuring crops.

*Students.*—Sixty students are in residence at present; six are taking a special course at Winkel Spruit.

### ELSENBURG, MULDER'S VLEI, CAPE.

JANUARY, 1920.

Exceptionally dry and hot weather prevailed. The total rainfall registered was but 0.03 inches as against the normal average of 0.96 inches, and the shade temperature reached 98° F. on several occasions. As a result the summer crops (maize and rape mainly) suffered and are not up to usual standard at the time of writing, and natural grazing is scarce. Considerable scorching of fruit occurred in both vineyard and orchard and young fruit trees are somewhat backward.

*Farm and Live Stock.*—Field operations were carried out under difficulties. The entire experimental fields for 1920 experiments were disc-cultivated, about 35 acres of farm land ploughed, and about 30 acres under maize cultivated. There are approximately 40 acres of land under maize, 20 acres being under irrigation. This crop will be used for ensilage. About 45 acres of land are under rape, which provided feed for the stock during December and January. Further, there are 25 to 30 acres of lucerne lands, and a few acres under sorghums.

The grape crop appears to be ripening fairly well. Varieties susceptible to oidium had been sulphured at the end of December, and no trace of the disease can be noticed. A certain amount of summer pruning was carried out in the orchard and the bulk of the plum crop harvested. The quality of the latter was uniformly good.

At the time of writing the live stock, in spite of the scarcity of natural feed, are all in good condition, except a few individuals, notably among the sheep. Fortunately a considerable quantity of oat and vetch silage has been available. The cattle herds were submitted to tests for contagious abortion early in the month by Mr. J. B. Quinlan, M.R.C.V.S. The Elsenburg herds were found to be quite free of the disease, but four cows of the Mariendahl herd reacted to the test; a few others were doubtful cases, among them the bull used by the previous owner of the farm. The four cows and the bull were immediately disposed of to the butcher.

*Experimental and Investigational Work.*—A considerable amount of experimental and investigational work is in progress in the several divisions.

*Extension Work.*—A great deal of extension work was carried out during the month in most divisions of the institution, consisting mainly of external lectures, visits to farms in order to give advice, and attendance at the offices of the Department of Agriculture, Capetown, for consultation purposes. Worthy of special mention is the short course in wine-making held at Elsenburg from the 5th to the 10th of January (inclusive), which was attended by twenty-four men, and included both lectures and laboratory work.

On the 22nd instant the Annual Poultry Conference was held at Elsenburg and was attended by some 220 persons. It was very successful, the lectures and papers being of a high order and the discussion following each most keen.

On the 13th instant a party of Australian troops paid a visit to the institution and evinced great interest in the various phases of work being carried out.

*The School.*—The number of applications received to date for the present school year, which will commence on 2nd February, is far in excess of the accommodation of Elsenburg and Mariendahl together. The enrolment of accepted students to date numbers 93, of whom 57 are returned soldiers.

FEBRUARY, 1920.

The severe drought of the past months continued unbroken, except for a small precipitation of 0.17 inches on the 9th instant which afforded a very slight measure of relief. This represents the total rainfall for the month as against the normal average of 0.49 inches. The weather was somewhat hot and windy, but not excessive in either respect. The maximum temperature recorded was 95° F. on the 2nd instant and the minimum 49.5° F. on the 24th.

*Field Crops and Fruit.*

Though the growth of rape has not been up to standard this season the crop was of incalculable benefit to stock for grazing purposes during the month, both at Elsenburg and at Mariendahl. The dry weather has been a great set-back to the maize crop, but about 70 tons of ensilage were obtained from 20 acres grown without irrigation.

Three hundred bags of oats were threshed at Elsenburg this month, and 760 bags of oats and 10 bags of rye at Mariendahl: 300 bags of seed oats (four standard varieties) and 200 bags of seed wheat (thirteen standard varieties) were available for disposal to farmers.

The applications for seed numbered over 300, so that only small quantities could be allocated to each applicant. It should be understood that this institution cannot and does not aim to supply to any one applicant more than a small quantity of seed, and from this the farmer is expected to produce his own seed for future seasons. Further, our object is to propagate seed especially suited to the areas served by Elsenburg, so that no seed is supplied to applicants in other areas.

The vintage was started on the 6th instant and completed during the month. The chief varieties dealt with being White French, Steen, Hermitage, and Green Grape. Wine Stone (Argol) to the value of £51. 8s. was obtained from the casks. Over 18 tons of grapes from the Mariendahl vineyard were sold.

The Chalcot and Burbank plum crops were picked, the yields on the whole being poor. The pear crop is exceptionally poor this season, many trees having failed to set any fruit at all. The varieties taken in during the month were Clapp's Favourite, William's Bon Chretien, and Beurre Hardy at Elsenburg, and William's only at Mariendahl. A south-east gale early in the month caused heavy windfalls in both orchards. A quantity of apples, prunes, sultanas, and William's pears is being dried.

*Live Stock.*—As a whole the live stock are in excellent condition, though natural grazing is very poor. During the month there were twenty-three cows in milk at Elsenburg and forty-six at Mariendahl. A lot of twelve pigs was sold to the Wellington Bacon Factory at 9d. per pound live weight, and a number of young boars and sows from the experimental pig lots has been booked for sale at seven to ten guineas a piece, prices which speak well for the quality of the animals bred in the experimental lots.

*Experimental and Investigation Work.*—The fifth application of dusts and sprays in connection with the codling moth control experiments was made, and the investigation concluded. Unfortunately the general pear crop of this season is so poor that the records obtained cannot be considered reliable; the same applies to the records in connection with experiments on fusicladium control.

In the chicory experiments roots were collected, dried, and roasted, and samples of the ground chicory were submitted to firms in Capetown. It is concluded that good chicory can be grown in this area.

A number of samples of agricultural material (fertilizers, spray fluids, water, feeding stuffs, etc.), was analysed and reported on in the Chemical Laboratory.

*The School.*—The 1920 session started on the 2nd instant, the total enrolment of students being 95.

---

 GLEN, ORANGE FREE STATE.
 

---

JANUARY, 1920.

*Climatic Conditions.*—Ten duststorms of varying intensity were experienced during the month, the worst being on the 10th. The result of these is seen in the deposit of sand over the place, which is banking up into small dunes. The drought is not yet broken and the country is still parched and dry, the grass remaining brown with no sign of young shoots worth speaking of.

The rainfall for the month was .66 inches over seven days; heaviest fall .24 inches. In the corresponding month last year the rainfall was 4.71 inches over eight days; heaviest fall 1.85 inches. The rainfall for December, 1919, was only .4 inches, and for the previous six months less than half the average rainfall for the period. Thus there has not yet been sufficient rain to permit of ploughing, nor has any seed been planted in the dry lands.

*The School.*—The new session has commenced with 15 senior diploma students, 35 junior students, and 5 one year practical training students. Amongst the 50 diploma students are 27 returned soldiers.

*Field Operations.*—Owing to the continued drought field operations were confined entirely to the irrigable lands. Irrigation of lucerne has been continued; teff, oats, and mealies have been seeded, and mangels planted.

*Crops.*—These are all very backward.

*Live Stock.*—The veld is only just carrying on the stock. All the camps are stocked so that very little change of grazing can be given to the animals. Oats, mealies, and bran are being fed to mares, and foals at grass. The condition of the stock is being fairly well maintained; the great difficulty will be a few months ahead unless very good rains soon arrive. There is very little grazing beyond the bush; grass has made no growth whatever. A South Devon bull was calved during the month, weighing 137 lb. A young Lincoln red bull, Nelsrust Governor McCallum, has been purchased from Nelsrust and is in use in the herd. Mr. Southey's Wanganella ram, Pride 2nd, has been hired for six weeks for the Wanganella Stud Flock.

*Staff.*—Several staff changes are taking place this month. Mr. Lewis, stockman; Mr. Van der Walt, shepherd; and Mr. Potgieter, B.Sc., experimentalist, are resigning. The new appointments made are Mr. Forsyth, stockman; Mr. Watermeyer, shepherd; Mr. Joubert Cilliers, lecturer in engineering.

FEBRUARY, 1920.

*Crops.*—The rainfall for the month was 4.86 inches. Although it was too late for ordinary summer crops, maize for ensilage, teff and rye were planted and sown immediately it rained. As warm weather with occasional showers continued throughout the month crops and veld made rapid growth.

The prospects of wintering of stock on the veld are very promising. Great difficulty will, however, be experienced to obtain the required quantity of bulk feed for the winter.

*Live Stock.*—Although no direct losses have occurred through poverty, several deaths have taken place, indirectly due to the prolonged drought.

*School.*—It is expected that the one year returned soldier students will be in residence early next month, as the building is nearing completion.

*Equipment.*—Several buildings are in the course of erection, namely, dairy and three staff houses.

Considerable improvement has been made at the poultry plant. Several big runs were sub-divided and twelve houses were made.

## GROOTFONTEIN, MIDDELBURG, CAPE.

JANUARY AND FEBRUARY, 1920.

*Diploma Course Students.*—The institution opened on the 26th January with 33 senior students and 37 junior students; total 70. This is the full complement.

*Returned Soldiers' Course.*—This course reopened on the 10th January, after a fortnight's break, with a full complement of 22 men. The work carried out by these returned soldier students, and their attention to their work, has been excellent.

*Farm Section.*—During the month of January owing to the unparalleled drought, practically all work at Grootfontein, as well as in the surrounding area, came to a standstill, every effort being made to keep the stock in good condition. On the 28th January rain started to fall, and on the 30th the drought broke and 1.34 inches was registered for the month. During February the rains continued, and over 6 inches has been registered for February. This permitted of farming operations going ahead. Forty acres of teff were sown, the same area of millet; 20 acres laid down to Kikuyu grass, and ploughing is being continued every day for the purpose of putting in oats and other winter cereals for winter grazing and for next year's fodder crops. It is intended to use the millet for silage. It is expected to reap 100 tons of lucerne at about the end of February or early in March.

*Experimental Section.*—Some splendid results were secured in this section, especially with regard to wheat selections and hybrids, and Mr. Donkin, the experimentalist in charge, is preparing reports on this work for publication at the earliest possible date. The experiments with Kikuyu grass and Soudan grass, etc., have also proved very successful.

*Sheep Section.*—Mr. Warren, lecturer on sheep and wool, is conducting very useful experiments with regard to the feeding of sheep, using specific quantities of food daily and weighing the sheep every week. The results procured should be of great value to the sheep farmers as a whole.

The Grootfontein agricultural and stock exhibit is going as a whole to the Port Elizabeth show, and portions of the exhibits are being divided up between Molteno and Aliwal North.

*Live Stock.*—The following numbers of animals of different breeds are kept at the institution for tuitional purposes, etc.:—

Cattle.—Frieslands, Shorthorns, Herefords, Africanders, Hereford cross Africanders	...	...	...	...	...	...	...	...	259
Oxen	...	...	...	...	...	...	...	...	501
Mules	...	...	...	...	...	...	...	...	21
Horses	...	...	...	...	...	...	...	...	52
Donkeys	...	...	...	...	...	...	...	...	42
<i>Sheep.</i> —Wanganella, Tasmanian, cross-breeds, Karakuls	...	...	...	...	...	...	...	...	1447
Angora goats	...	...	...	...	...	...	...	...	200
Ostriches	...	...	...	...	...	...	...	...	162
Pigs	...	...	...	...	...	...	...	...	33
Poultry, various breeds	...	...	...	...	...	...	...	...	818
Water fowl, various breeds	...	...	...	...	...	...	...	...	22
									3157
Total	...	...	...	...	...	...	...	...	3157

#### POTCHEFSTROOM, TRANSVAAL.

JANUARY AND FEBRUARY, 1920.

The total number of students receiving instruction from this institution is 112, about 50 per cent. of whom are returned soldiers.

*Live Stock.*—The drought which continued through the latter part of last year and into the beginning of this year naturally affected the condition of the beef herds and dry stock, but in spite of the trying conditions most of the animals kept remarkably well.

*Crops.*—The drought is responsible for the poor condition of crops at this time of the year. Late crops benefited much from the light showers that fell during January, and the prospects are considerably improved. The supply of irrigation water was reduced very much and had naturally to be used for the lucerne lands. To forestall the effects of the drought as much cultivation as possible was applied to the maize crops and kept these growing fairly well. When the prospects of good grain and seed crops became doubtful, every opportunity was taken to establish good fodder crops. The light showers followed by spells of drought and hot days made the establishment of good teff crops impossible and lands had to be resown again and again; however, the good soaking rains during the first week of this month promise some success with this crop, while things in general are improving very rapidly.

## MEAT STATISTICS.

## I.—RETURN OF BEEF INSPECTED AND PASSED FOR EXPORT DURING THE MONTH OF FEBRUARY, 1920.

Place.	Cattle.			Carcasses.		
	Inspected.	Rejected.	Passed.	Inspected.	Rejected.	Passed.
Durban ... ..	938	—	938	938	84 $\frac{3}{4}$	853 $\frac{1}{4}$
Pietermaritzburg ...	612	—	612	612	40 $\frac{1}{2}$	571 $\frac{1}{2}$
Pretoria ... ..	—	—	—	—	—	—
Johannesburg ... ..	—	—	—	—	—	—
Bloemfontein ... ..	—	—	—	—	—	—
Capetown ... ..	338	—	338	338	196	142
Port Elizabeth ... ..	—	—	—	—	—	—
Germiston ... ..	—	—	—	—	—	—
TOTAL ... ..	1,888	—	1,888	1,888	321 $\frac{1}{4}$	1,566 $\frac{3}{4}$

Beef actually exported during the month of February, 1920: Total 2,295 quarters. (*Ex* Durban 477 quarters; *Ex* Capetown 1,818 quarters.)

Total shipments of Beef in quarters—

1916 ...	115,992	1918 ...	123,354	*1920 ...	2,295
1917 ...	309,214	1919 ...	285,367		

## II.—RETURN OF CATTLE IMPORTED INTO THE UNION FROM ADJOINING TERRITORIES.

Territory.	Imported February, 1920.	Total from 1st January, 1920, to 29th February, 1920.
For Slaughter—	No.	No.
Rhodesia ... ..	1,791	3,868
Bethuanaland Protectorate	1,524	3,225
S. W. Africa ... ..	1,379	2,754
Swaziland ... ..	104	517
Basutoland ... ..	—	—
For Breeding—		
Rhodesia ... ..	800	1,952
Bethuanaland Protectorate	1,029	1,280
TOTAL ... ..	6,627	13,596

## SUMMARY OF IMPORTS.

Calendar Year.	For Slaughter.	For Breeding.	Total.
	No.	No.	No.
†1916	26,580	—	26,580
1917	47,970	5,440	53,410
1918	36,767	13,286	50,053
1919	40,574	16,693	57,267

\* Total to 29th February, 1920.

† 1st July to 31st December only.

## EXPORT OF GRAIN, ETC.

RETURN OF GRAIN, ETC., GRADED AND EXPORTED THROUGH THE VARIOUS PORTS DURING THE MONTH OF FEBRUARY, 1920.

NOTE.—In this return the gross weight per bag of Maize is 203 lb., Maize Meal 183 lb., Hominy Chop 183 lb., Kaffir Corn 203 lb., Oats 153 lb., Barley 163 lb., Rye 203 lb., Beans 203 lb., Peas 203 lb., Lucerne Seed 193 lb., Millet (average) 220 lb.

Port.	Grain, etc.	No. of Bags Shipped during February, 1920.	Total No. of Bags Shipped from 1st July, 1919, to 29th February, 1920.	Stocks on Hand on 29th February, 1920.
CAPETOWN	Maize .. .. .	1,900	178,954	—
	Maize Meal .. .. .	26,923	326,437	1,008
	Hominy Chop .. .. .	—	5,825	—
	Kaffir Corn .. .. .	—	28,550	—
	Oats .. .. .	—	20,328	—
	Barley .. .. .	—	504	—
	Rye .. .. .	—	629	—
	Beans .. .. .	915	2,550	154
	Peas .. .. .	—	300	—
	Lucerne Seed .. .. .	49	4,604	—
Millet .. .. .	—	431	—	
DURBAN	Maize .. .. .	200	255,672	—
	Maize Meal .. .. .	9,677	398,095	24,280
	Hominy Chop .. .. .	—	—	—
	Kaffir Corn .. .. .	—	6,215	—
	Oats .. .. .	—	5,518	—
	Barley .. .. .	—	—	—
	Rye .. .. .	—	945	—
	Beans .. .. .	—	7,854	1,726
	Peas .. .. .	—	300	—
	Lucerne Seed .. .. .	—	—	—
Millet .. .. .	—	125	—	
EAST LONDON	Maize .. .. .	—	123,490	—
	Maize Meal .. .. .	—	111,308	4,285
	Hominy Chop .. .. .	—	—	—
	Kaffir Corn .. .. .	—	4,758	—
	Oats .. .. .	—	—	—
	Barley .. .. .	—	2,417	—
	Rye .. .. .	—	1,530	—
	Beans .. .. .	—	420	—
	Peas .. .. .	—	—	—
	Lucerne Seed .. .. .	—	—	—
Millet .. .. .	—	—	—	
PORT ELIZABETH	Maize .. .. .	9,435	160,493	2,154
	Maize Meal .. .. .	—	14,704	—
	Hominy Chop .. .. .	—	—	—
	Kaffir Corn .. .. .	—	3,587	—
	Oats .. .. .	—	—	—
	Barley .. .. .	—	5,465	—
	Rye .. .. .	—	—	—
	Beans .. .. .	—	450	—
	Peas .. .. .	—	—	—
	Lucerne Seed .. .. .	—	—	—
Millet .. .. .	—	—	—	
LOURENÇO MARQUES	Maize .. .. .	4,458	16,376	—
	Maize Meal .. .. .	—	31,627	—
	Kaffir Corn .. .. .	—	—	—
	Beans .. .. .	—	400	—
	Peas .. .. .	—	—	—

## SUMMARY.

	Exported February, 1920.	Total Exported 1st July, 1919, to 29th February, 1920.	Stocks on Hand at all Ports on 29th February, 1920.
Maize .. .. .	Bags. 15,993	Bags. 734,895	2,154
Maize Meal .. .. .	36,600	1,018,071	29,603
Hominy Chop .. .. .	—	5,825	—
Kaffir Corn .. .. .	—	43,110	—
Oats .. .. .	—	23,376	—
Barley .. .. .	—	8,984	—
Rye .. .. .	—	3,104	—
Beans .. .. .	915	11,671	1,860
Peas .. .. .	—	300	—
Lucerne Seed .. .. .	49	4,604	—
Millet .. .. .	—	431	—
TOTALS .. .. .	53,657	1,854,374	33,617



## CROP AND LIVE STOCK REPORT.

February, 1920.

### MAIZE.

Correspondents were asked to report on the condition of the crops in their neighbourhood as at 29th February, 1920.

A revision of the estimated *normal* production 1919-20 was deemed necessary, and the basis was increased to 12,705,100 bags.

As compared with the condition of the crop at 31st January, 1920, the prospects are stated to have improved owing to favourable weather during February, 1920, by 6 per cent., so that the estimated production has risen from 10,338,500 to 10,971,200 or an increase of 632,700 bags.

At this figure the crop prospects still remain 14 per cent. below normal for the Union. As applied to the various Provinces, the improved prospects are reported to be as follows:—Cape Province, 11 per cent.; Transvaal, nil; Orange Free State, 9 per cent.; and Natal, 2 per cent.

While the Western High Veld (Transvaal) shows an improvement of 26 per cent. as compared with the previous month, a decline was reported of 7 per cent. in the Eastern High Veld, 2 per cent. in Central Transvaal, and 1 per cent. in the Low Veld, leaving the position as at 29th February, 1920, at 16 per cent. below normal, or the same as at 31st January, 1920.

Lydenburg reports show the condition to be 8 per cent. above normal, and in the Orange-Free State, Bethlehem and Vrede are reported as expecting a crop of 3 and 2 per cent. above normal respectively.

### KAFFIR CORN.

The prospects in respect of this crop are reported to have improved to an extent of 4 per cent. for the Union, the estimated production for the current season now being 1,162,000 bags as against 1,089,800 at the end of the previous month.

The prospects in the various Provinces are reported to have improved as follows:—Cape Province by 13 per cent., Transvaal by 3 per cent., Orange Free State by 8 per cent., and Natal by 2 per cent.

In the Transvaal, the position in the Central Districts remains unchanged, whereas increased prospects of 2 per cent. are reported from the Eastern High Veld and 27 per cent. from the Western High Veld. On the other hand, a decline of 5 per cent. is reported from the Low Veld.

### TOBACCO.

As far as this product is concerned, the crops appear to have revived even to a larger extent, an improvement of 9 per cent. being reported for the Union, distributed as follows:—

Cape Province, 11 per cent.; Transvaal, 7 per cent.; Orange Free State, 15 per cent.; and Natal, 9 per cent.

As a result of these improved conditions, the estimated production has risen from 7,370,500 lb. as at 31st January, 1920, to 8,791,800 lb. as at 29th February, 1920.

## CONDITION OF LIVE STOCK.

Compiled from Reports furnished by Sheep and Stock Inspectors.

Area.	Large Stock.	Small Stock.
CAPE—		
South West ... ..	<i>Medium.</i> Good in Caledon, Paarl, Cape, Stellenbosch, and parts of Piquetberg and Swellendam; poor in Ceres, Bredasdorp, and parts of Worcester	<i>Good to medium.</i> Poor in Bredasdorp and parts of Ceres and Worcester.
North Western... ..	<i>Medium to poor.</i> Good in Kenhardt and parts of Calvinia	<i>Medium.</i> Poor in Hopetown, Van Rhynsdorp, and parts of Fraserburg, Namaqualand, Victoria West, and Calvinia.
South Coast ... ..	<i>Medium.</i> Good in Alexandria, Bathurst, and parts of Humansdorp, George, and Uitenhage	<i>Medium.</i> Good in parts of Humansdorp, Uitenhage, and George.
Southern Karroo ... ..	<i>Poor.</i> Medium in Oudtshoorn and Uniondale	<i>Poor.</i> Medium in Oudtshoorn and Uniondale.
Central Karroo... ..	<i>Medium to poor</i> ... ..	<i>Medium to poor.</i>
Northern Karroo ... ..	<i>Poor.</i> Good in Richmond and medium in Colesberg	<i>Poor.</i> Good in Richmond and medium in Colesberg.
Eastern Karroo ... ..	<i>Poor.</i> Medium in Bedford and parts of Cradock and Steynsburg	<i>Medium to poor.</i>
Bechuanaland ... ..	<i>Good to medium.</i> Fat in parts of Vryburg and Mafeking	<i>Good to medium.</i> Fat in parts of Mafeking and poor in parts of Gordonia.
Griqualand West ... ..	<i>Good to medium</i> ... ..	<i>Medium.</i> Poor in Kimberley.
North Eastern ... ..	<i>Medium to poor.</i> Fat in parts of Elliot, Barkly East, and Maclear. Good in parts of Wodehouse, Maclear, and Barkly East	<i>Medium to poor.</i> Fat in parts of Barkly East, Maclear, Elliot, and Herschel; good in parts of Molteno and Maclear; poor in Albert and parts of Elliot.
Border ... ..	<i>Good to medium.</i> Fat in parts of East London and poor in parts of Queenstown	<i>Good to medium.</i> Fat in parts of East London and Kingwilliamstown.
Transkeian Territories...	<i>Good to medium.</i> Fat in Elliotdale, Flagstaff, and Tabankulu, and in parts of Bizana, Matatiele, St. Marks, Mount Fletcher, Tsolo, Mount Currie, Libode, Mqanduli, Umzimkulu, and Willowvale.	<i>Fat to good.</i> Medium in parts of Engcobo, Idutywa, Kentani, Matatiele, and Port St. Johns.
TRANSVAAL—		
Eastern High Veld ... ..	<i>Good to medium.</i> Fat in parts of Bethal, Standerton, and Wakkerstroom	<i>Good to medium.</i> Fat in parts of Carolina, Middelburg, Piet Retief, and Ermelo.
Central ... ..	<i>Good to medium.</i> Fat in parts of Heidelberg, Krugersdorp, Rustenburg, and Potchefstroom	<i>Good to medium.</i> Fat in parts of Krugersdorp, Rustenburg, and Potchefstroom.
Western High Veld ... ..	<i>Good.</i> Fat in Marico and medium in parts of Christiana	<i>Good.</i> Fat in Christiana and medium in parts of Lichtenburg.
Low Veld ... ..	<i>Good to medium.</i> Fat in parts of Pietersburg, Waterberg, and Louis Trichardt; medium in Barberton and parts of Lydenburg.	<i>Good to medium.</i> Fat in parts of Pietersburg, Lydenburg, Waterberg, and Louis Trichardt.

Area.	Large Stock.	Small Stock.
<b>ORANGE FREE STATE</b>		
North Eastern ... ..	<i>Good to Medium.</i> Fat in parts of Vrede and Harris-smith	<i>Good to medium.</i> Fat in parts of Vrede, Frankfort, Bethlehem, and Harris-smith.
North Western... ..	<i>Good to medium.</i> Poor in parts of Kroonstad	<i>Good to medium.</i>
South Eastern ... ..	<i>Medium to poor.</i> Good in Wepenaar, Zastrou, and Ficksburg, and fat in Thaba 'Nehu	<i>Good to medium.</i> Fat in parts of Thaba 'Nehu, Smithfield, and Ficksburg.
South Western... ..	<i>Medium and Poor.</i> Fat in parts of Boshof and in a few parts good	<i>Medium.</i> Good in Philippolis and parts of Boshof, Faure-smith, and Bloemfontein.
<b>NATAL—</b>		
High Veld or Highland	<i>Good to medium.</i> Fat in parts of Dundee, Utrecht, Vryheid, and Paulpietersburg	<i>Good.</i> Fat in Paulpietersburg and in parts of Utrecht, Vryheid, and Dundee: medium in Bergville.
Middle Veld or Midland	<i>Fat to good</i>	<i>Fat to good.</i> Medium in Help-makaar.
Coast ... ..	<i>Good to medium.</i> Fat in parts of Dundee, Utrecht, Paulpietersburg, and Vryheid	<i>Good.</i> Fat in parts of Paulpietersburg, Dundee, Utrecht, and Vryheid: poor in parts of Bergville.

## FARMERS.

The Journal of the Department of Agriculture is published in your interests.

It is to be printed in English and Afrikaans, and issued once every month.

Every farmer should subscribe to it and keep it for reference.

The subscription for residents in the Union and South-West Protectorate is 5s. per annum, post free, payable in advance.

Send a postal note for 5s. with your name and address (an application form is attached to this number) to the Government Printer, Box 373, Pretoria.

This will ensure you getting the Journal regularly.

LOCAL MARKET PRICES.

RATES OF AGRICULTURAL PRODUCE AND STOCK RULING AT THE 16TH MARCH, 1920.

CENTRE.	Wheat Flour.			Boer Meal.			Mealies.			Malted Meal.			Barley.			Oats.			Oat-day.			Lucerne Hay.			Potatoes.					
	Per 100 lb.			Per 200 lb.			Per 200 lb.			Per 150 lb.			Per 150 lb.			Per 100 lb.			Per 100 lb.			Per 150 lb.			Per 150 lb.					
	Min.	Max.	s. d.	Min.	Max.	s. d.	Min.	Max.	s. d.	Min.	Max.	s. d.	Min.	Max.	s. d.	Min.	Max.	s. d.	Min.	Max.	s. d.	Min.	Max.	s. d.	Min.	Max.	s. d.	Min.	Max.	s. d.
<i>Cape Province</i> —																														
Alwal North.....	50	0	50	0	38	0	38	0	35	0	35	0	32	6	32	6	32	6	30	0	11	6	12	6	20	6	20	6	25	0
Beaufort West.....	52	6	55	6	33	0	37	0	33	0	37	6	35	0	40	0	40	0	27	6	30	0	11	6	32	6	35	0	30	0
Capetown.....	50	0	51	0	33	0	37	0	33	0	37	0	35	0	29	0	30	0	24	0	25	0	11	6	24	0	30	0	30	0
East London.....																														
Grahamstown.....																														
Kimberley.....	49	0	50	6	35	0	36	0	30	0	31	6	25	0	30	0	40	0	18	0	18	6	12	0	27	0	30	0	48	0
Kingwilliamstown.....																														
Port Elizabeth.....	45	0	53	0	33	0	37	0	32	0	31	0	27	0	36	0	45	0	21	0	24	0	11	0	15	0	30	0	39	0
Queenstown.....																														
<i>Natal</i> —																														
Durban.....																														
Pietermaritzburg.....																														
<i>Orange Free State</i> —																														
Beaufort West.....	58	0	65	0	30	0	40	0	27	0	30	0	28	0	40	0	47	6	28	6	35	0	10	6	22	6	26	6	26	6
Kimberley.....	50	0	50	0	35	0	35	0	27	0	30	0	26	0	30	0	30	0	27	6	30	0	10	6	21	0	21	0	22	0
Port Elizabeth.....	53	6	53	6	33	0	37	0	27	6	33	0	32	0	18	6	19	0	25	0	27	6	12	6	35	0	40	0	40	0
Queenstown.....	45	6	48	6	33	0	37	0	28	0	33	0	26	0	38	0	42	0	29	0	32	3	10	6	6	0	30	6	26	0
<i>Natal</i> —																														
Durban.....																														
Pietermaritzburg.....																														
<i>Orange Free State</i> —																														
Beaufort West.....	15	0	16	0	1	0	1	0	1	0	1	6	0	9	1	3	2	0	4	6	5	1	10	0	5	0	5	0	5	0
Capetown.....	10	0	12	0	0	4	1	0	0	9	1	4	1	0	2	0	2	6	3	0	3	6	10	0	20	0	20	0	160	0
East London.....	18	0	27	0	—	—	—	—	0	9	1	4	1	0	2	0	2	6	2	6	3	0	15	0	40	0	40	0	120	0
Grahamstown.....	6	0	12	0	—	—	—	—	0	10	1	3	0	10	1	4	1	0	2	0	4	1	2	0	30	0	30	0	40	0
Kimberley.....	7	6	16	0	0	8	1	0	0	7	1	3	0	11	1	2	3	6	1	6	3	3	16	0	100	0	100	0	140	0
Kingwilliamstown.....	21	0	24	0	—	—	—	—	0	10	1	2	1	0	1	6	1	0	2	4	3	8	16	0	25	0	25	0	90	0
Port Elizabeth.....	6	0	15	0	—	—	—	—	0	8	1	2	0	9	1	0	1	11	2	6	4	6	17	10	45	0	45	0	50	0
Queenstown.....																														
<i>Natal</i> —																														
Durban.....	12	0	23	0	—	—	—	—	0	11	0	8	0	9	1	3	2	4	2	9	3	3	17	0	50	6	50	6	7	0
Pietermaritzburg.....																														
<i>Orange Free State</i> —																														
Beaufort West.....	10	0	15	0	—	—	—	—	0	10	1	3	0	10	1	0	2	6	3	6	4	2	—	—	—	—	—	—	—	—
Kimberley.....	16	0	17	6	0	6	0	8	—	—	—	—	—	—	—	—	—	—	—	—	—	—	—	—	—	—	—	—	—	
Port Elizabeth.....																														
<i>Transvaal</i> —																														
Pretoria.....	7	0	20	0	—	—	—	—	—	—	—	—	—	—	—	—	—	—	—	—	—	—	—	—	—	—	—	—	—	
Johannesburg.....	7	3	13	9	—	—	—	—	—	—	—	—	—	—	—	—	—	—	—	—	—	—	—	—	—	—	—	—	—	

\* Live weight per lb. † Dressed weight, including hides, offal, etc., per 100 lb.  
 ‡ The rates quoted for produce sold in bags include, as a general rule, an additional 3 lb. for weight of bag.



PRICE 5/-  
PER ANNUM.

# Journal

of the

Department of

# Agriculture

ISSUED BY AUTHORITY OF THE  
MINISTER OF AGRICULTURE.

## PRINCIPAL CONTENTS.

- Results of Winter Cereal Experiments at Elsenburg—II.
- The Eradication of Citrus Canker.
- Poisoning of Cattle by Feeding on old Mealie Lands.
- The Drought of 1918/19.
- The Agriculture and Soils of the Cape Province—I.
- Cow Testing Associations.
- The Library of the Department of Agriculture.
- Importation of Cattle.
- Egg-Laying Competition: Cedara School of Agriculture.
- The Botanical Survey of the Union.
- The Department of Agriculture during the War—I.
- Experiments and Investigations—I and II.

PRICE **6D** PER COPY

## LIST OF BULLETINS AVAILABLE FOR DISTRIBUTION.

### Application to be made to the Department of Agriculture, Pretoria.

Applicants for bulletins are requested kindly to quote the *full number* of each, as shown hereunder, and to enclose also payment for same. The cost of each bulletin is indicated; those not marked are issued *gratis*.

#### AGRICULTURE.

- Agriculture, Law of Diminishing Return in. By H. H. W. de Villiers, B.A. U.R. 29/1914.  
 Dry Farming. By H. S. du Toit, Superintendent, Government Dry-land Station, Lichtenburg. T.F.B. 130.  
 Dry Farming, What is. By Dr. W. Macdonald, Dry-land Agronomist. T.F.B. 66.  
 Dry-land Farming. By H. S. du Toit 3d. L.S. 82.

#### AGRICULTURAL EDUCATION.

- National College of Agriculture for South Africa. By Dr. W. Macdonald, Editor, *Union Agricultural Journal*. U.R. 1/1913.  
 National College of Agriculture for the Transvaal. By Dr. W. Macdonald, Editor, *Union Agricultural Journal*. U.P.  
 National College of Agriculture for the Transvaal, III. By Dr. W. Macdonald, Editor, *Union Agricultural Journal*. U.P.

#### BOTANY.

##### GENERAL.

- Bordeaux Mixture, The Preparation of. By E. Doidge, M.A., Assistant Plant Pathologist. U.F.S. 20.  
 Collecting of Botanical Specimens and the Making of a Herbarium. By E. Percy Phillips, M.A., D.Sc., F.L.S., Division of Botany. L.S. 71.  
*Prosopis juliflora*, The Mesquite or Algaraba Tree; and *Prosopis pubescens*, the Screw Bean. By C. C. Robertson, M.F., Research Officer, Forest Department. U.R. 67/1914.  
 Seed Testing, The Value of. By E. Harrison and E. Baker, School of Agriculture, Cedara. U.R. 10/1914.  
 Water Hyacinth. By Miss S. M. Stent, Herbarium Assistant, Division of Botany. U.R. 68/1913.

##### PLANT DISEASES.

- Apple, Bitter Pit of the. By I. B. Pole Evans, B.A., B.Sc., F.L.S., Plant Pathologist. T.S.B. 1.  
 Apple Tree Canker or Black Rot Fungus in South Africa. By I. B. Pole Evans, M.A., B.Sc., F.L.S., Plant Pathologist. T.F.B. 25 and U.F.B. 12.  
 Copper Carbonate, Ammoniacal Solution of. By E. Doidge, M.A., Assistant Plant Pathologist. U.F.B. 17.  
 Citrus Canker. By I. B. Pole Evans, M.A., B.Sc., F.L.S., Chief, Division of Botany and Plant Pathology. L.S. 30.  
 Citrus Fruits, A New Disease of. By I. B. Pole Evans, M.A., B.Sc., F.L.S. U.F.B. 14.  
 Citrus Canker and its Eradication, The Characteristics of. By E. M. Doidge, M.A., D.Sc., F.L.S. 1d. 3/1918.  
 Cane, Root Diseases in. By P. v. d. Bijl, M.A., D.Sc., F.L.S. 1d. 4/1918.  
 Dikvoet, Club Root or Finger and Toe (*Plasmodiophora brassicae* Woronin) in South Africa. By I. B. Pole Evans, M.A., B.Sc., F.L.S., Chief, Division of Plant Pathology and Mycology. U.R. 30/1913.

[Continued on page iii of cover.]

# CONTENTS.

MAY, 1920.

	PAGE
RESULTS OF WINTER CEREAL EXPERIMENTS AT THE SCHOOL OF AGRICULTURE.	
EISENBURG, MULDER'S VLEI. CAPE PROVINCE ... ..	111
THE ERADICATION OF CITRUS CANKER ... ..	124
THE LIBRARY OF THE DEPARTMENT OF AGRICULTURE ... ..	135
POISONING OF CATTLE BY FEEDING ON OLD MEALIE LANDS ... ..	138
THE DROUGHT OF 1918-19 ... ..	144
COW-TESTING ASSOCIATIONS ... ..	149
THE AGRICULTURE AND SOILS OF THE CAPE PROVINCE ... ..	152
IMPORTATION OF CATTLE ... ..	159
EXPERIMENTS AND INVESTIGATIONS ... ..	162
NOTES FROM THE DIVISIONS ... ..	168
EGG-LAYING COMPETITION ... ..	172
THE BOTANICAL SURVEY OF THE UNION ... ..	180
THE DEPARTMENT OF AGRICULTURE DURING THE WAR ... ..	183
NOTES ... ..	187
<p>Important Notice—The Minister of Agriculture—Sheep and Goat Skins—Export of Seed—The Merino Ram—Plant Nurseries in Quarantine for Pests—Wheat Production of the Union—Cotton Growing Prospects—Colonial Wine Competition, 1919: Awards and Judges' Report—Purchase of "Mariendahl"—Wheat Growing in South Africa—Export of Cattle from the Union to Great Britain—Poultry Shows: Organization—The European Corn Borer (page 123)—The World's Harvest (page 134)—Women's Work (page 158)—Organization of Farmers (page 161)—Wet Hides for Shipment—Marking of Goods (page 167)—Telegraphic Requests for Vaccines, etc. (page 171)—Kaffir Corn: Production in the Union (page 182)—Maize Production in the Four Provinces (page 186)—Scab: Protected Districts (page 201) Seal Skins: Remarkable Prices (page 208).</p>	
THE POULTRY YARD MONTH BY MONTH ... ..	197
THE VEGETABLE GARDEN ... ..	199
SOUTH AFRICAN PRODUCE ON THE OVERSEA MARKET ... ..	200
OVERSEA PRICES OF SOUTH AFRICAN PRODUCE ... ..	202
STAFF CHANGES ... ..	203
NOTES FROM THE "GAZETTE" ... ..	204
RECENT AGRICULTURAL LITERATURE... ..	206
AT THE SCHOOLS OF AGRICULTURE AND EXPERIMENT STATIONS ... ..	209
DATES OF AGRICULTURAL SHOWS STILL TO BE HELD ... ..	212
THE UNION'S EXTERNAL TRADE ... ..	213
MEAT STATISTICS ... ..	216
EXPORT OF GRAIN, ETC. ... ..	217
CROP AND LIVE STOCK REPORT ... ..	218
LOCAL MARKET PRICES ... ..	220

## STAFF.

### Department of Agriculture (including Agricultural Education).

#### HEADS OF DIVISIONS.

##### ADMINISTRATION.

- Secretary for Agriculture.—F. B. Smith, C.M.G.  
Under-Secretary for Agriculture.—P. J. du Toit (presently engaged on the Public Service Commission of Inquiry).  
Acting Under-Secretary for Agriculture.—G. N. Williams, D.S.O.  
Under-Secretary for Agriculture (Education).—E. J. Macmillan, B.S.A.

##### DIVISIONS.

- Sheep.—Chief : B. G. L. Enslin, D.S.O.  
Veterinary Research.—Director of Veterinary Research and Education : Sir Arnold Theiler, K.C.M.G.  
Veterinary.—Principal Veterinary Surgeon : C. E. Gray, M.R.C.V.S.  
Dairying.—Superintendent of Dairying : E. O. Challis.  
Botany.—Chief : I. B. Pole Evans, M.A., D.Sc., F.L.S.  
Tobacco and Cotton.—Chief : W. H. Scherffius, M.Sc.  
Horticulture.—Chief : I. Tribolet.  
Viticulture.—Government Viticulturist : S. W. van Niekerk.  
Entomology.—Chief : C. P. Lounsbury, B.Sc.  
Chemistry.—Chief : B. de C. Marchand, B.A., D.Sc.  
Chemical Research.—Agricultural Research Chemist : C. F. Juritz, M.A., D.Sc., F.I.C.  
Library.—Librarian : P. J. S. Ribbink.  
Co-operation.—Registrar, Agricultural Co-operative Societies : J. Retief.  
Dry Farming.—Government Agronomist : H. S. du Toit.  
Guano Islands.—Superintendent : W. B. Zeederberg.  
Grain Inspection.—Chief Inspector of Grain : G. F. Nussey.  
Journal of Agriculture.—Editor : G. W. Klerck (Acting).

##### SCHOOLS OF AGRICULTURE AND EXPERIMENT STATIONS.

Elsenburg (Cape)	...	...	...	Principal : W. J. Lamont.
Grootfontein (Cape)	...	...	...	„ R. W. Thornton.
Cedara (Natal)	...	...	...	„ J. Fisher, B.Sc., N.D.A.
Glen (Orange Free State)	...	...	...	„ M. J. A. Joubert, B.S.A.
Potchefstroom (Transvaal)	...	...	...	„ T. G. W. Reinecke, B.A., M.Sc.Ag.





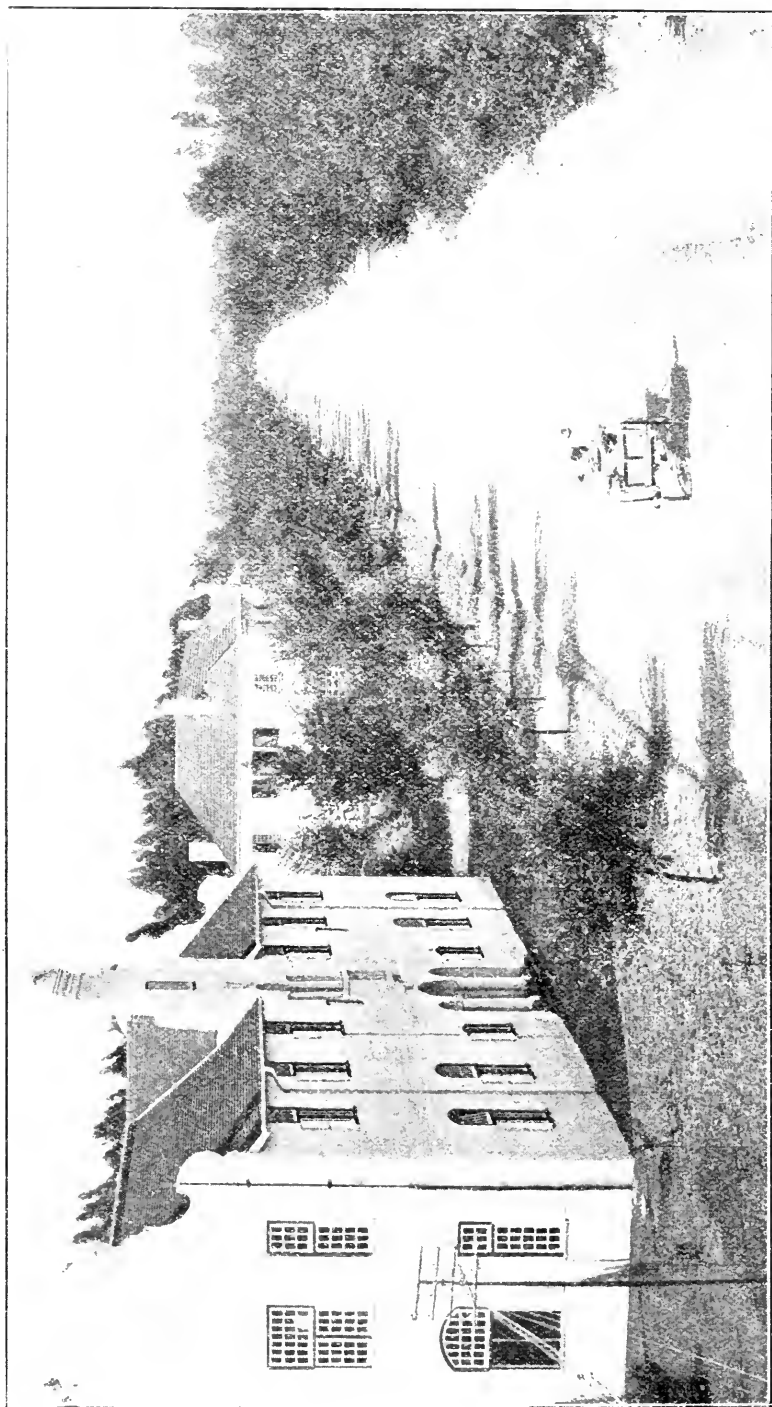

POTCHEFSTROOM SCHOOL OF AGRICULTURE AND EXPERIMENT STATION.  
The Main Avenue.<sup>1</sup>



# JOURNAL OF THE DEPARTMENT OF AGRICULTURE.

VOL. I.

MAY, 1920.

No. 2.

Published monthly in English and Afrikaans by the Department of Agriculture,  
Union of South Africa.

SUBSCRIPTION: Within the Union and South-West Protectorate, **5s.** (otherwise **6s.**)  
per annum, post free, payable in advance.

Applications, with subscriptions, to be sent to the Government  
Printer, Box 373, Pretoria.

## RESULTS OF WINTER CEREAL EXPERIMENTS AT THE SCHOOL OF AGRICULTURE, ELSENBURG, MULDERS VLEI, CAPE PROVINCE.

By T. G. W. REINECKE, Principal, and G. J. MEYNHARDT,  
Assistant Experimentalist.

[The first part of this article appeared in last month's *Journal*.—ACTING EDITOR.]

### VARIETY TRIALS OF WHEAT AND OATS.

#### WHEAT VARIETIES.

- I.—“ Common ” or Soft Wheats.  
II.—“ Durum ” or Hard Wheats.

#### *Adaptability of the Two Classes of Wheat.*

The area served by this Institution comprises the coastal districts from Namaqualand to Knysna, extending inland to embrace the Districts of Ceres, Worcester, and Montagu. Considerable variations of soil and climate are observed in this area. There, are for instance, remarkable differences in the rainfall of the various districts, as will readily be seen from the following table:—

District.	Time of Precipitation.	Average Rainfall.
Eisenburg, Paarl ... ..	April to November ... ..	28 inches.
Van Rhynsdorp ... ..	” ” September ... ..	4—6 ”
Darling ... ..	” ” ” ... ..	14—16 ”
Caledon... ..	” ” October ... ..	18—20 ”
Ruggens, Bredasdorp... ..	” ” September ... ..	15—18 ”
Coastal, ” ... ..	” ” October ... ..	18—22 ”
Montagu (inland) ... ..	” ” September ... ..	8—10 ”
Knysna ... ..	May ” February ... ..	30 ”

Generally speaking, the coastal districts from Piquetberg to Bredasdorp, and some of the adjoining inland districts with annual rainfall of from 10-30 inches, are better adapted to the cultivation of the "common" or soft wheats; whereas the inland sections, such as the Districts of Worcester, Robertson, Montagu, and a portion of Riversdale, with a rainfall below 10 inches, are more suited to the "durums" or hard wheats.

The "durums" are known to thrive better than the soft wheats in drier sections; on the other hand, the latter do better under more humid conditions.

Further, it is significant to note that the wheat areas of the coastal belt have shallow soils which are acid in nature and of poor mechanical condition, whereas the inland districts referred to have in general a porous soil of great depth which is rich in lime.

### I.—"COMMON" OR SOFT WHEATS.

*Classification according to Maturity.*—Generally speaking, wheats are classified as follows:—

- (1) Early; (2) Medium Early; (3) Midseason; (4) Medium Late; (5) Late.

For our purpose we shall confine the classification to three groups only, viz.:—(a) Early; (b) Midseason; (c) Late.

The latter classification is used, as it indicates better the various periods of maturity of each class. However, it should not be assumed that all varieties coming under the same class are necessarily of "identical maturity," e.g. Florence wheat is classed under (a), but is considerably earlier than either Primrose or Gluyas, which are included in the same class. Again, Rieti and Kleintrouw both belong to group (c), but the former is several weeks later than Kleintrouw.

In discussing varieties of wheat in regard to their suitability for various sections of the country, one of the main considerations is the question of rust resistance. Certain varieties of wheat are undoubtedly more rust-resistant than others, e.g. the very late variety Rieti, although it may show rust, is not affected by the fungus to the same extent as Federation, Wolkoorn, and Steinwedel.

On the other hand, certain wheats, owing to the length of their growing period, usually escape rust when sown in late autumn or early winter, for the reason that by the time rust appears (late spring) the plants have reached a stage of growth when the fungus has little or no effect on the kernel.

No variety of wheat can, however, be claimed to be "rust proof." It must be remembered that the susceptibility to rust varies according to the season, yet the varieties given in accompanying Tables I, II, and III have thus far all shown fair rust-resistant and rust-escaping qualities. Varieties which are not satisfactory in this respect have been discarded. A list of these is to be found in Table IV of this article. Tables I, II, and III specify Early, Midseason, and Late varieties respectively, which are recommended for the south-west Cape.

TABLE I.  
*Early Varieties.*

Variety or Selection No.	Grain Yield in lb. per Acre.				Average Return per Acre for Years 1916-1919.	Remarks.
	1916.	1917.	1918.	1919.		
Union Selection 17 ...	1150	735	888	1010	946	Straw medium to long. Average sized, brown, tip-bearded ear. Tillers well. Full sized, plump, white kernel. Is of same maturity as Gluyas Early.
" " 7 ...	900	865	966	900	908	Tillers well and grows above the average height. Has a long light-brown, tip-bearded ear. The kernels are large, round, and plump.
" " 11 ...	1025	870	876	820	898	Tillers moderately. Has a long, serrated, light-brown, tip-bearded ear.
" " 52 ...	955	840	840	—	*878	Grows to an average height with erect and strong straw. It is the earliest of all Unions. The ears are light-brown in colour, of an average size, and tip-bearded. The kernels are white and very uniform. Recommended for all areas along coast, especially for those with a light rainfall.
" " 31 ...	860	580	—	1110	*853	Grows to an average height and has a thin, self-supporting straw. This variety tillers very well. The ears are of average size, brown and beardless. The lower part of the ear has a tendency to produce extra spikelets. Of medium early maturity like C. 11, etc. The kernels are more plump and round than that of abovementioned selections and are keeled.
" " 81 ...	795	785	726	980	820	Tillers very well and has a strong self-supporting straw. The ears are long, tip-bearded and brown in colour.
" " 116 ...	830	885	648	765	782	Straw medium to long, and is thin yet self-supporting. Has a long, tapering, white, tip-bearded ear. This is the latest maturing of all Union Selections.
Primrose 54-2 (54-1, 1915-16)	940	540	618	965	766	Tall, erect growing variety that tillers very well. The ears are brown, tip-bearded and above the average size. Slight tendency to rust.
Union Selection 33 ...	830	745	696	715	747	Source unknown. Is rather tall growing. The straw is strong and self-supporting. The ear is brown and tip-bearded. Recommended for coastal areas. The grain is white.
Selection 4-3... ..	475	575	1074	820	736	(This is the latest of the early varieties detailed here.)

\* Average for three years only.

*N.B.*—All Unions are recommended for the coastal areas, especially from Darling-Bredasdorp. Not recommended for cultivation under irrigation on account of rust.

TABLE I—(continued).

Variety or Selection No.	Grain Yield in lb. per Acre.			Average Return per Acre for Years 1916-1919.	Remarks.
	1916.	1917.	1918. 1919.		
Union Selection 94-1	780	740	630 735	721	Grows above the average height and has a coarse straw which grows very erect. The ear is long, white, square, and tip-bearded. This variety tillers exceedingly well and is earlier than 28, 116, and 81. Tendency to rust during a very wet season.
Florence and Ghuyas Early No. 17	—	757	750 620	*712	This is a hybrid between Florence and Ghuyas. The cross is not yet fixed, and yields both white and brown tip-bearded ears. The brown ear is a few days later than the white. Tillers moderately well for such an early variety, and does not shatter as does the parent Florence.
Ghuyas Early 41-2 ...	870	480	564 835	687	A straight selection of ordinary Ghuyas Early. This variety shows the same defect as ordinary Ghuyas in that it is liable to lodge.
Selection 7-2 ...	500	565	918 735	680	This variety tillers well and has a white bald ear. The grain is small, round, and white. Recommended for coastal areas. It is of medium early maturity, being about 10 days earlier than Selection 4-3.
Union Selection 28 ...	—	660	678 700	*679	Erect growing, thin straw. Tillers well. The ears are brown, bald and short, with tendency to go square. The kernel is small, very round and plump, and probably the most uniform in kernel of all Unions. The variety is somewhat susceptible to rust.
Van Niekerk ...	880	575	510 500	616	A strain of ordinary Van Niekerk. A bearded, brown ear with coarse short straw which is weak.
Florence 57 ...	720	400	522 600	561	The yields of this variety are by no means a criterion of its yielding qualities, as the crop was in every case harvested several weeks later than was advisable or necessary, due to the fact that at this time the other varieties were still unfit for harvesting.
Bombay 44-3 ...	475	430	654 525	521	Is short growing and has a brown, bearded ear with small, white kernel. Recommended for inland areas for dryland cultivation. Unsuited for coastal areas as it is rather liable to rust.

\* Average for three years only.

N.B.—All Unions are recommended for the coastal areas, especially from Darling-Bredasdorp. Not recommended for cultivation under irrigation on account of rust.

## DESCRIPTION OF VARIETIES.

*Florence*.—Imported originally from Australia, and is the earliest variety grown. It is of medium height and of good stooing capacity. The ears are white, tapering, slightly tip-bearded, and of medium size. The grain is white and plump. This variety can be recommended for all parts of the south-west Cape, especially where the growing period is a short one and the rainfall light. It should, however, be remembered that it is very liable to shatter in some localities; therefore it should be harvested betimes whenever east winds are prevalent.

*Primrose, Sel. 54-2*.—Somewhat later than Florence. It tillers fairly well. The straw is thin, strong, and self-supporting, although inclined to be long. The ear is white, long, tapering, and beardless. The original Primrose was imported from Australia. The selection made at this institution has a long, plump kernel very similar to that of Gluyas Early, whereas that of the original Primrose is flat, round, and deeply keeled.

Primrose is recommended for both the coastal and inland districts of the south-west Cape. In the latter districts it is subject to injury by frost, and thus should not be sown too early.

*Gluyas Early, Sel. 41-2*.—Gluyas Early is of about the same maturity as Primrose. It is of medium height, does not tiller too well, and is very liable to lodge.

The glumes are brown and the ears tip-bearded with spikelets rather irregularly set. The kernel is long, full, and white.

The original Gluyas was imported from Australia. The selection made at this Institution does not differ materially from the Gluyas so widely grown by the farmers of the Western Province. As already mentioned it is of about the same maturity as Primrose, and these two varieties are often grown together, for the reason that this practice makes harvesting easier, in that Primrose—which has a strong, self-supporting straw, helps to keep the Gluyas from lodging.

*Van Niekerk* is medium early and grows to an average height. Has heavy foliage and coarse straw which is liable to lodge. The ears are brown, flaked with white, and are fully bearded. The kernel is long, plump, and white. This variety is not a consistent yielder, and is therefore not as strongly recommended as other varieties in this class.

*Selection 4-3*.—A few days later than Van Niekerk. It stools exceedingly well and has a tall yet self-supporting straw. The ear is very similar to that of Van Niekerk, except that it is club-tipped and tip-bearded and shows a slight wave. The kernel is long, plump, and white.

*Selection 7-2*.—Also a selection made locally. Grows to an average height and tillers remarkably well for a medium early variety. The ear is long, bald, and white with spikelets irregularly set. The kernel is small, round, and white.

*Union Selections*.—These selections of wheat have originated from a cross between the Australian variety Gluyas Early and the variety Darling.

Dr. Nobbs, the Director of Agriculture in Rhodesia, is credited with making the cross at Elsenburg about the year 1907. The various selections grown to-day are the progeny of the original crossbred, and were made by Prof. Neethling in 1912. Some ten to fourteen of the most promising selections have now been grown here for the past six seasons. The returns of these selections for the last four years on large plots (one-fifth acre) are very promising. These are given in Table I above.

On account of inequalities of soil the experimental fields were removed in 1914-15 to the present site. For this and other seasons the returns for these two years of the Union selections as well as of certain of the other standard varieties are not included in the table of results.

As can be seen from the table of results, and as is the experience of farmers throughout the coastal belt from Darling to Bredasdorp, the selections must be considered better yielders than any of the early varieties.

As compared with Gluyas Early, which is still extensively grown in the sections referred to, the Union Selections are better yielders, tiller better, and are less liable to lodge. The Union Selections are, however, subject to rust in certain localities and in certain seasons. The early maturing selections are not affected to the same extent as the later ones, such as Unions 28 and 116.

Before a description of each of the Union Selections, recommended for the coastal belt of the south-west Cape, is given, a short description of the other parent Darling is necessary.

*Darling*.—This is a tall-growing variety which stools moderately well. It has a hollow straw which is inclined to be weak on soils of high fertility. The ears are creamy white in colour, bald, fairly long, and inclined to taper. The spikelets are open; the grain is small, plump, and white.

The following characteristics are possessed by the various Union Selections:—

- (1) Some show the bald characteristic of the parent Darling, whereas others are tip-bearded like Gluyas.
- (2) The majority have light or dark-brown ears, but a few are creamy white in ear like the parent Darling.
- (3) As regards maturity, U. 52 is the earliest; U. 17, 11, and 94-1 are somewhat later; and U. 28, 81, and 116 are the latest.
- (4) It is interesting to note that U. 52, 9, and 17 resemble the parent Gluyas in foliage, straw, and especially in shape, colour, and size of the ear; whereas U. 94-1 and 116 resemble in these respects the parent Darling.

*Bombay, Sel. 44-3*.—The variety Bombay was originally introduced from India and closely resembles the variety Kleinkoorn, grown extensively in some of the inland districts of the Cape. Bombay is a short-growing variety, varying in height from 2-2½ feet. The selection 44-3 tillers well, has a thin strong straw, but is inclined to lodge.



The ear is fully bearded and brown. The kernels are small, semi-hard, white, and somewhat long.

Kleinkoorn is considered the oldest variety known to farmers in this country. Of recent years it has been subject to rust. It is interesting to note that this variety is favoured in many of the Karroo Districts and in the Transvaal, where it is grown both under dryland conditions and under irrigation.

*Florence* × *Gluyas Crossbred*, *Sel.* 17, is a cross between the varieties *Florence* and *Gluyas Early* and is of quite recent origin. This selection has been grown for the last three years only. In this season the selection showed two distinct strains which have been separated and will in future be grown apart. The cross-bred *Florence* × *Gluyas* promises exceedingly well and should be favoured in those sections of the south-west Cape where the seasons are short.

TABLE II.

*Midseason Varieties.*

Variety.	Grain Yield in lb. per Acre.				Average Return per Acre.	Remarks.
	1916.	1917.	1918.	1919.		
Bobs × Rieti No. 10 ...	—	1,175	1,000	1,058	1,078	
Darvan ... ..	—	—	—	1,015	1,015	
Red Egyptian No. 29 1	—	630	996	1,123	916	
Spring Early ... ..	990	610	738	990	832	
American No. 8 ... ..	1,215	630	390	890	781	
Rieti × Gluyas No. 81...	—	725	750	785	753	

*Bobs* × *Rieti* No. 10.—A cross between the Australian variety *Bobs* and ordinary *Rieti*. *Bobs* is essentially a midseason variety, whereas *Rieti* is the latest variety cultivated locally. The cross is several weeks earlier than the *Rieti* parent, although in appearance very similar to it. It has a long light brown ear, fully bearded. It tillers exceedingly well, has a thin culm, and grows well above the average height. The kernel is very like that of *Gluyas Early*, except that it is dark in colour. This selection, although inclined to shatter, does not show the tendency to the same extent as some of the other selections of this cross.

*Darvan*.—This variety has become very popular of recent years. It has a white ear which is club-tipped and slightly tip-bearded. The grain is short, plump, and white. The plant tillers well and possesses a straw which, although coarse, is self-supporting. This is the *Darvan* generally grown, and not the cross-bred between *Darling* and *Van Niekerk* of the same name.

*Red Egyptian* No. 29-1.—A straight selection of *Red Egyptian*, better known as *Rooi-beentje*. It also goes under the names of *Rooi-koring* or *Rooi-baard*. The ears are short, club-tipped with short

beard, and reddish brown smooth chaff. The kernel is red and soft. This variety grows erect, is below the average height, and tillers exceedingly well. It is both drought and rust-resistant, and is often grown with good results under irrigation.

*Spring Early*.—This selection has a light brown full-bearded ear. The grain is long, red, and semi-hard. This variety is still extensively grown throughout all parts of the south-west Cape, especially in the Districts of Caledon and Bredasdorp, where the rainfall is moderate. The variety is subject to rust in sections where the season is long and the rainfall heavy.

*American No. 8*.—A selection of the Australian variety. The ears are long, narrow, compact, and beardless with smooth brown chaff. It holds the grain exceedingly well. The kernel is small, round, red, and soft. This selection is tall growing with thin strong straw. This variety is not recommended for areas with a large rainfall since it is subject to rust. It is suited to those inland areas where south winds are prevalent at harvest time and where dry conditions prevail.

*Rieti × Glynas No. 81*.—A cross between the ordinary Rieti and the Australian variety Glynas Early. The ears are brown, fully bearded, and of an average size. The kernel is large, plump, and white. This cross tillers moderately well; grows to an average height and has a self-supporting erect straw. The object of this cross was to get an earlier maturing variety than Rieti, and one which would stool better and not show the same tendency to shatter. This selection possesses a white kernel unlike the other selections of the same cross-bred. In addition it does not shatter as readily as the parent Rieti.

TABLE III.

*Late Varieties.*

Variety.	Grain Yield in lb. per Acre.				Average Return per Acre.	Remarks.
	1916.	1917.	1918.	1919.		
Kleintrouw. Selection 12-1	1,445	712	1,278	1,200	1,171	About two weeks earlier than Rieti.
Rieti 36-1 ...	1,595	560	882	1,015	1,041	The latest variety grown in this area; has good rust-resistant qualities.
Bossiesveld or Standardton Winter	1,325	595	888	825	908	Several days earlier than Rieti. It is exceedingly liable to shatter.
Upperent ...	1,395	480	726	—	867	A few days earlier than Kleintrouw.
Selection J. ...	1,025	565	750	900	841	Of the same maturity as Bossiesveld.

*Kleintrouw Sel. 12-1*.—A selection made in 1907 from a bulk crop of Australian wheat, the seed of which was originally imported by the Government. The ear is medium long, white, and tip-bearded. The grain is small, white, plump, and soft. This selection grows to

a medium height with abundant foliage and tillers exceedingly well. The straw is thin and erect. This variety is several weeks earlier than Rieti.

*Rieti 36-1.*—This is a straight selection of long-eared Rieti so extensively grown by the farmers of the south-west Cape. The ear is brown, very long, lax, tapering, and fully bearded with spikelets set far apart. The kernel is large, plump, dark brown, and soft. Tillers exceedingly well with a long self-supporting straw. This variety shatters badly. For short seasons this variety has proved too late.

*Bossiesveld or Standerton Winter.*—This variety is believed to be the same as Red Victoria. The former is grown in the south-west Cape, whereas Red Victoria is grown in the high veld of the Transvaal. The ear is white, fully bearded, and of average size. The straw is fine yet self-supporting. The kernel is small, round, red, and soft. This variety is very liable to shatter and should be cut betimes wherever south winds are prevalent at harvest time.

*Uppercut.*—A selection from the Australian variety. It is similar to Kleintrouw, but has a shorter ear and does not tiller to the same extent as does Kleintrouw. The kernel is small, round, white, and inclined to be soft.

*Selection "J."*—A local selection, believed to be a strain of ordinary Rieti. The ear, although long and fully bearded, is more compact than that of Rieti. The kernel is large, plump, very dark, and soft. This variety tillers well and is not so liable to shatter as is the case with Rieti.

TABLE IV.

This table contains a detailed list of varieties which have now been under trial for a number of years, but which have proved unsuited to the conditions of this area:—

Variety.	Maturity.	General Remarks.
Yandilla King ...	Late ...	White ear, tip-bearded, plump, white kernel. Tall growing, with coarse straw.
Marquis ... ..	" ...	Long, white, tapering, tip-bearded ear. Small plump, red kernel.
Marshalls No. 3 ...	" ...	Long, white, symmetrical, tip-bearded ear. Plump, white kernel.
Comeback... ..	Mid-season	Light-brown, tip-bearded ear; white plump kernel. Thin erect straw.
Genoa ... ..	"	White, compact, bald ear. Small white kernel. Tall growing.
Heynes Blue Stem	Very Late	The ear is white and slightly tip-bearded. The glumes are hairy; the kernels large and reddish brown. On account of very late maturity and poor rust resistance, this variety has never yielded a crop.
Bobs ... ..	Mid-season	Long, white, bald ear. Small, round, white kernel; coarse straw.
Siebritz ... ..	"	White, fully bearded ear; dark red; semi-hard grain.
Darling ... ..	"	Long, white, tapering, bald ear with small, round white kernel.
Du Toit ... ..	"	White, tip-bearded ear, with small, round, white kernel, thin, erect culm.
Kleinkoorn ...	Early ...	Fully bearded, brown ear, plump kernel, short growing.

TABLE IV—(continued).

Variety.	Maturity.	General Remarks.
Sonora ... ..	Late ...	Short, brown, bald ear; glumes hairy; small, round, white kernel. Very similar to Wolkoon in ear and kernel.
John Brown ...	Mid-season	Long, tapering, light-brown ear with white, plump kernel.
Wolkoon ... ..	"	Brown, regular ear; glumes hairy, small, round, white kernel.
Federation ...	"	Brown, square, bald ear; grain white and soft.
Baard Koorn ...	"	White, bearded ear, with white kernel
Leaps Prolific ...	"	Short, white, tip-bearded ear; white kernel.
Bunyip ... ..	Early ...	Tip-bearded, broad, white ear; large, round, white kernel; short coarse straw; an Australian Hay Wheat.
Eksteen ... ..	Mid-season	White, bearded ear; also goes under the names of "Vroë Baard" or "Eenbeen."
Firbank ... ..	Early ...	Long, white, tapering, bald ear with soft, white kernel. Grows tall and is very liable to lodge; an Australian Hay Wheat.
Steinwedel ...	" ...	White ear, tip-bearded and very similar to Bunyip. White, soft kernel and is grown in Australia for hay purposes.
Prelude ... ..	Mid-season	White, fully-bearded ear, small red kernel; very susceptible to rust.
Hawkesbury ..	"	Long, white, bald ear, white, round kernel, weak straw.
Fourie ... ..	Early ...	Long, fully-bearded, white ear, long, amber kernel.
Myburgh ... ..	Late ...	Long, white, fully-bearded ear; long, dark kernel; coarse, weak straw.
Cedar ... ..	Mid-season	Long, tapering, bald, white ear. Small red kernel. Very liable to lodge.
Huron ... ..	Late ...	Long, white ear, which is slightly tip-bearded. Broad, dark kernel.
Cross-bred 53 ...	" ...	Tapering, white, tip-bearded ear. Glumes hairy; grain, white and plump.
Preston ... ..	" ...	Bearded, brown ear; small, round, white and red, soft kernel.
Karkov ... ..	" ...	Bearded, creamish white ear; small, red, soft kernel. Very susceptible to rust.
Rymer ... ..	" ...	White, tapering, bald ear; white kernel; shatters readily.
Jonathan ... ..	Mid-season	White, bald ear; grain plump and white.
Red Fife ... ..	Late ...	Very long, white bearded ear; small, red kernel; shatters readily.
Warren ... ..	Mid-season	Short, white bald ear with white kernel
Huguenot ... ..	Late ...	Durum type; a beardless selection of Medeah; long, white, flinty kernel; an Australian Hay Wheat.
Alaska Winter ...	Late ...	Durum type. On account of its branching head is also called "Sewe Aar." The kernel is small, round and soft. A very poor yielder.

## II.—"DURUM" OR HARD WHEATS.

As previously mentioned in this article, on account of soil and climatic conditions the Durums have thus far given exceedingly low returns in the coastal areas, and we feel justified in saying that their cultivation should be restricted to the inland Karroo soils.

Table V gives the returns per acre for 1916-19 inclusive of a few varieties of this class of wheat.

TABLE V.  
*Hard Wheats.*

Variety.	Yield in lb. per Acre.				General Remarks.
	1916.	1917.	1918.	1919.	
Medeah 35-9 ...	525	400	612	656	Our S. A. Medeah, also called "Zwart Baard." In Russia it goes under the name of "Chernouska." White ear with black beard. Grain light; tendency to produce soft kernels here. This is the oldest known durum in these sections.
Yellow Nicaragua, Selection 20-2	—	405	618	—	Yellow in ear and beard, with large, deep, yellow grain. Grows above the average height.
Belotourka, Selection 10-1	—	450	552	—	Similar to Nicaragua, but with more compact ear and shorter glumes. Light yellow, long grain.
Van Heerden, Elsenburg Selection	—	—	498	—	Very like Belotourka, but with a short broad ear, which is plump; typical, durum kernel.
Kubanka, Selection 52-1	—	—	636	415	This is very like Belotourka, but with a broader ear. Large, light yellow grain.
Z 37. Local Selection	—	435	600	405	Creamy white ear and beard. Tillers well. Dark grain with percentage of soft grains.
Alaska Winter ...	—	250	—	475	Also known as "Sewe Aar." It is very liable to rust and gives a very poor grain return.
Huguenot ...	255	100	—	—	A beardless selection of Medeah, very susceptible to rust.

The following varieties are still under trial:—Black Don, Black Persian, Black Goose, Wild Goose, Taute, Golden Ball, Bontaar.

#### SUMMARY: WHEATS.

Of the early wheats, Union Selections 17, 7, 11, 52, 31, 81, and 116 should be given preference in the south-west Cape over both Gluyas Early and Primrose, the two varieties most commonly grown in this area.

In those sections where the seasons are short Union 52 is recommended, since it is the earliest maturing of any of the Union Selections.

Florence is the quickest maturing variety of all the early wheats which can be recommended for the south-west Cape. It is especially suited to sections with a small rainfall and short rainy season. It can be sown later than any other variety mentioned in Table I.

Of the mid-season varieties, the cross-bred Bobs × Rieti Sel. No. 10 is very promising. This wheat and Red Egypt have both yielded better than Spring Early, the standard variety of this class.

Of the late varieties, Kleintrouw must be given preference over Rieti, the standard late wheat of the south-west Cape, in regard to both yield and earliness of maturity. Rieti is extremely late and in consequence the crop will suffer in short seasons from drought and from shattering by south-east winds.

## OAT VARIETIES.

At one time the only oat variety grown in this area was the old Cape Oat (Boerhaver), but for various reasons this variety has practically disappeared from local cultivation. At present Algerian is the best known and most popular oat, and Texas is also an extensively cultivated variety. These two varieties and a number of others have been submitted to trial at this station for several years.

Table VI shows the relative grain yields of the different varieties undergoing trial.

TABLE VI.

Variety.	Grain Yield in lb. per Acre.				Average Return for 4 Years.
	1916.	1917.	1918.	1919.	
Algerian ... ..	1,020	1,110	1,030	1,805	1,241
Sidonian ... ..	1,060	1,335	1,080	1,375	1,213
Smyrna ... ..	1,120	970	1,098	1,500	1,172
River Plate ... ..	955	1,025	1,124	1,445	1,137
Texas ... ..	805	1,200	1,014	1,525	1,136
Appler... ..	785	855	900	1,655	1,049
Bancroft ... ..	735	885	798	1,525	986
Burt ... ..	870	835	1,025	990	930

*Algerian.*—This is certainly the most popular variety throughout the Union. It possesses the advantage of having a very fine straw which makes a good oat-hay and at the same time is a very consistent yielder of grain.

*Sidonian.*—This variety has a large kernel. It tillers exceedingly well but has a coarse straw which is very liable to lodge. It is of late maturity and suited only to the coastal areas.

*Smyrna.*—A strong growing variety with abnormally large grain. The straw is very coarse, which makes it unsuitable for hay purposes. It is about fourteen days earlier than Algerian. This variety has given very good results on inland Karroo soils, especially under irrigation.

*River Plate.*—This variety has a plump, white kernel. It tillers well, but is weak in straw and inclined to shatter. It is of the same maturity as Sidonian.

*Texas.*—A short-growing variety with fine straw and short, plump, red kernel. Although slightly later than Algerian it is extensively grown in the coastal districts of the south-west Cape.

*Appler.*—Like Texas, this variety grows below the average height. It tillers well, but has a weak straw and is inclined to shatter.

*Bancroft.*—This variety is of the same maturity as Texas and has a plump, brown kernel. The straw is very weak and liable to lodge.

*Burt.*—A variety with fine straw and light kernel. It tillers very well, is of exceedingly early maturity, and is particularly suited for hay. It is, however, liable to shatter where south winds are prevalent at harvest time.

## SUMMARY: OATS.

Algerian is still deservedly the most popular oat variety of the south-west Cape for both hay and grain. As a grain oat, Texas stands second to Algerian in the same area.

Burt is a variety of recent introduction, and is becoming popular as a hay oat on account of its extremely early maturity. This variety, due to the smallness and lightness of its grain is not favoured as a grain oat.

Smyrna is better suited to the inland sections of the South Karroo than to the coastal belt, and answers well under irrigation. It yields a coarse hay and is chiefly grown for grain.

---

### The European Corn Borer.

Maize, a plant of American origin, has met in South Africa a native African insect, the maize stalk borer, which damages the growing plant more than all other insects combined. Quite a different insect, but one which attacks the plant in much the same way, has lately found its way from the old world to America. It attacks a very wide variety of plants apart from maize and other plants of the grass family, and it is thought to have got into America with importations of hemp from Europe. In 1917 it was discovered near Boston, Massachusetts, and an investigation disclosed that it occurred throughout an area of only about a hundred square miles. By the middle of 1919 this infested area had increased to 1600 square miles, and two supplementary infested areas had been discovered. The Florida Plant Board's *Quarterly Bulletin* states as follows about the pest:—"What is regarded by entomologists as one of the most serious insect pests yet found in the United States has occupied an area of 1400 square miles near Boston, Mass., an area of about 200 square miles on Cape Cod, and still another area of 300 square miles at Schenectady, New York. This insect is the European corn borer, *Pyrausta nubilalis* Hubner, and it threatens to do more damage, in the aggregate, than any pest with which the farmers or fruit growers of America have yet had to contend. Already the States of Massachusetts and New York have each expended nearly \$100,000.00 in fighting it, and the U.S. Department of Agriculture is using a Congressional appropriation of \$250,000.00 for the same purpose, appropriated by Congress in August, 1919. The Department is asking for an additional appropriation of \$500,000.00, and a conference of State Commissioners of Agriculture and Official Entomologists, held at Albany, N.Y., and Boston, Mass., on 28th and 29th August, has recommended to Congress that \$2,000,000.00 be appropriated at once to combat the pest, with the additional appropriation, later, of as many more millions of dollars as may be necessary "

## THE ERADICATION OF CITRUS CANKER.

By E. M. DOIDGE, M.A., D.Sc., F.L.S., Mycologist,  
Division of Botany.

IN the *South African Journal of Industries* for January, 1919, the citrus canker situation up to December, 1918, was reviewed by Dr. Pole Evans in an article entitled "Citrus Canker in South Africa and its Eradication."

The progress made during the past few months has fully justified the determination of the Government to continue the eradication campaign, and there is every indication that the opinion expressed by Dr. Pole Evans that eradication can be accomplished in two or three years' time will be justified.

The following table shows the number of orchard trees found infected each month from 1st July, 1917, when the regular inspection was organized:—

	1917.	1918.	1919.
January ... ..	—	3,889	25
February ... ..	—	1,878	61
March ... ..	—	2,134	60
April ... ..	—	934	88
May... ..	—	513	45
June ... ..	—	602	19
July ... ..	217	119	5
August... ..	55	6	32
September ... ..	248	159	19
October... ..	13	228	8
November... ..	35	60	2
December ... ..	1,182	50	2
	1,750	10,572	366

Canker has been found on 98 properties, on 53 of these all citrus trees have been destroyed, so that there is no possibility of reinfection. The total sum paid in compensation up to date is £71,862. 17s. 8d.

A more detailed statement is appended showing the farms involved and the localities where canker is likely to recur, and the accompanying maps illustrate the progress of the disease since the publication of the article in the *Journal of Industries* for January, 1919.



## CITRUS CANCKER.

Farm.	District.	Number of Infected Properties.	Dates of Inspection.			Date on which Cancker was last found.	Number of Properties on which all Citrus Trees have been Destroyed.	Total Number of Trees—			Possibility of Further Infection.
			1917.	1918.	1919.			Found Infected.	Destroyed.	Left on Infected Properties.	
Bokfontein No. 647	Rustenburg..	14	July Aug. Oct. Dec.	Jan. Feb. Mar. May June Sept.	April, 1919	7	5,294	9,095	10,055	*	
Buffelsontein No. 558	Rustenburg..	5	Nov. Dec.	Feb. Mar. April May June Sept. Oct. Dec.	June, 1919	3	1,284	3,710	1,774	All trees in diseased orchards destroyed.	
Buffelshoek No. 900	Rustenburg..	5	—	Mar. April June July Sept. Nov. Dec.	Nov., 1919	4	400	1,470	213	All trees in diseased orchards destroyed.	
Buffelspoort No. 668	Rustenburg..	2 (One of these is composed of 14 large orchards)	—	Jan. Feb. Mar. April May Aug. Sept. Oct. Nov. Dec.	Oct., 1919	1	5,143	13,233	8,790	*	
Cavers.....	Bedford.....	1	Nov.	Jan. Mar.	Mar., 1918	1	19	773	0	—	

\* See note hereunder.

## CITRUS CANKER—(continued).

Farm.	District.	Number of Infected Properties.	Dates of Inspection.			Date on which Canker was last found.	Number of Properties on which all Citrus Trees have been Destroyed.	Total Number of Trees—		Possibility of Further Infection.	
			1917.	1918.	1919.			Found Infected.	Destroyed.		Left on Infected Properties.
Crocodile-drift No. 327	Pretoria.....	3	Sept.	Jan. April July Dec.	Feb. July	Jan., 1918	2	99	112	47	All diseased orchards destroyed.
De Kroon No. 420	Pretoria.....	15	Sept. Oct. Nov. Dec.	Jan. Feb. Mar. April May June July Aug. Sept. Oct. Nov. Dec.	Jan. Feb. Mar. April May June July Aug. Sept. Oct. Nov. Dec.	Sept., 1919	4	1,699	1,351	3,488	*
Elandsdrift No. 284	Rustenburg..	1	Oct.	Dec.	Feb. Mar. April Aug. Oct. Nov.	Feb., 1919	0	3	18	507	*
Fairy Vale.....	Albany.....	1	Nov.	April	Jan. April	June, 1916	0	1	1	500	—
Greyingspost No. 111	Pretoria.....	2	—	Feb. Mar. May June Aug. Nov. Dec.	Mar. June Sept.	Mar., 1918	0	471	471	1,366	*
Groenkloof No. 418	Rustenburg..	1	Nov.	June Dec.	—	June, 1918	1	52	429	0	Diseased orchard destroyed.

\* See note hereunder.

CITRUS CANCKER—(continued).

Farm.	District.	Number of Infected Properties.	Dates of Inspection.			Date on which Cancker was last found.	Number of Properties on which all Citrus Trees have been Destroyed.	Total Number of Trees—		Possibility of Further Infection.
			1917.	1918.	1919.			Found Infected.	Destroyed.	
Hartebeesthoek No. 524	Pretoria.....	2	Nov.	Mar. April July Dec.	Jan. Mar. July Aug. Oct.	Aug., 1919	1	235	1,563	300 *
Kafferskraal No. 915	Rustenburg..	6	—	Mar. April June Aug. Dec.	Jan. Feb. April Aug. Sept. Oct.	Feb., 1919	3	41	272	198
Klipdriif No. 123..	Pretoria.....	1	—	June	Oct.	June, 1918	1	300	450	0
Krokodilpoort No. 411	Pretoria.....	1	—	May	Sept.	May, 1918	1	1	8	0
Middelkops.....	Pretoria.....	1	Nov.	May	—	May, 1918	1	400	591	0
Mill Gardens.....	Modder River, C.P.	1	—	—	—	—	1	Nursery stock destroyed by owner	—	0
Nylstroom Town Lands	Waterberg...	1	—	July	Jan. Nov.	July, 1918	0	24	34	6
Pretoria Town Lands	Pretoria.....	1	—	—	Jan.	—	1	212 (Nursery stock)	212	0
Pretoria North Town Lands	Pretoria.....	3	—	Jan.	Aug. Nov.	Aug., 1919	3	32	77	0
Richmond No. 121	Barberton...	1	—	—	—	April, 1917	1	—	100 (Destroyed by owner)	0

\* See note hereunder.

## CITRUS CANCKER—(continued).

Farm.	District.	Number of Infected Properties.	Dates of Inspection.		Date on which Canker was last found.	Number of Properties on which all Citrus Trees have been Destroyed.	Total Number of Trees—		Possibility of Further Infection.
			1917.	1918.			Found Infected.	Left on Infected Properties.	
Rietfontein No. 431	Rustenburg..	4	Dec.	Feb. Mar. May June Aug. July	May, 1919	3	170	601	509 *
Rietfontein No. 606	Rustenburg..	2	Dec.	Mar. May July Sept. Dec.	Dec., 1917	0	22	214	597 Diseased orchards destroyed.
Roodekopjes No. 44	Pretoria.....	2	—	April May July	May, 1918	2	144	226	0 Diseased orchards destroyed.
Roodekopjes No. 171	Rustenburg..	2	—	Mar. May July Aug. Sept. Dec.	Mar., 1918	0	107	147	102 Diseased orchards destroyed.
Roodepoort No. 2148	Waterberg...	4	July Dec.	Jan. Feb. April July	April, 1919	3	316	3,244	1,176 *
Schoongezicht No. 144	Pretoria.....	1	—	May July Nov.	May, 1918	0	12	12	588 *
Spruitfontein No. 431	Rustenburg..	1	—	April June Sept. Oct.	Dec., 1918	0	14	34	91 Diseased orchards destroyed.

\* See note hereunder.

## CITRUS CANKER—(continued).

Farm.	District.	Number of Infected Properties.	Dates of Inspection.		Date on which Canker was last found.	Number of Properties on which all Citrus Trees have been Destroyed.	Total Number of Trees—			Possibility of Further Infection.
			1917.	1918.			1919.	Found Infected.	Destroyed.	
Visser'shoek No. 45.	Pretoria.....	2		Mar. May June Aug. Nov. Dec.	April, 1919	1	26	256	269	*
Waterval No. 544..	Rustenburg..	1	Oct.	Mar. Aug. Sept. Oct. Dec.	Oct., 1917	0	1	1	500	—
Wildbeesthoek No. 611	Pretoria.....	2	Sept.	Feb. May June	July, 1919	0	9	77	299	Diseased orchards destroyed.
Zilkatsnek No. 379	Pretoria.....	1	Dec.	Jan. Feb. Mar. Aug. Sept.	April, 1918	0	170	1,921	1,154	Diseased orchards destroyed.
*Sandfontein.....	Waterberg....	1	Dec.	—	Feb., 1919 Nov.	1	943	2,828	0	—

\* See note hereunder.

Some explanation is necessary in connection with the possibility of further infection indicated in the last column. There are only two farms, namely, De Kroon No. 420 and Buffelspoort No. 668, on which the disease is likely to recur to any extent; some infection may also be found on Bokfontein No. 647 and Hartebeesthoek No. 524, but it is not anticipated that any large number of trees will be involved. On a number of farms (6), Elandsdrift No. 284, Greylingsspoort No. 111, Rietfontein No. 431, Roodepoort No. 2148, Schoongezicht No. 144, Vissershoeck No. 45, it is very unlikely that canker will recur, but as the diseased orchards have not been entirely destroyed it is within the bounds of possibility that further infection may be found, and these orchards are being kept under strict surveillance. There are twenty-three farms on which all diseased orchards have been destroyed, and hence no further infection is possible; the sites of the orchards which have been burned are, however, periodically inspected, as canker is occasionally found on sucker shoots growing from pieces of root left in the ground. In destroying and removing the trees it is impossible to be certain that the roots are entirely destroyed. The sucker shoots sometimes become infected from canker organisms in the soil, where they can survive for a considerable time.

Every possible precaution is being taken to prevent fresh outbreaks. No planting of citrus trees is allowed in the quarantined area, except by special permit [see Agricultural Pests (Citrus Canker) Act, 1919, appended]. Permission to raise or plant citrus trees is only given where the proposed orchard site is at a safe distance from an infected area, and trees must be obtained from a nursery outside the quarantined area. No sanction for raising nurseries in the quarantined area is granted at present.

---

ACT (No. 10, 1919) TO AMEND THE AGRICULTURAL PESTS ACT, 1911,  
IN RESPECT OF LAND OR PLANTS INFECTED WITH CITRUS CANKER.

---

Be it enacted by the King's Most Excellency Majesty, the Senate and the House of Assembly of the Union of South Africa, as follows:

1. (1) Except with the permission of the Minister of Agriculture, no person shall, after the commencement of this Act, plant or raise or keep any citrus plant—

(a) on any land on which any citrus plant has, owing to the presence of citrus canker, been destroyed on the authority of the Minister of Agriculture under the powers of the Agricultural Pests Act 1911 (Act No. 11, 1911) or on any land adjacent to such land; or

(b) on any land within an area proclaimed or notified under the said Act to be a quarantined or restricted area by reason of the presence of citrus canker:

But nothing in this section shall be construed as prohibiting the keeping on any such land of plants existing thereon on the eighth day of July, 1918.

(2) Any person who contravenes the provisions of this section shall be guilty of an offence and liable on conviction to the penalties prescribed by section *twenty-seven* of the said Act.

MAP

Showing Farms infected with Citrus Canker in the Magaliesberg Area, and their relation to clean farms, 31st December, 1919.

K. A. LANSDELL, del., Division of Botany, Pretoria.

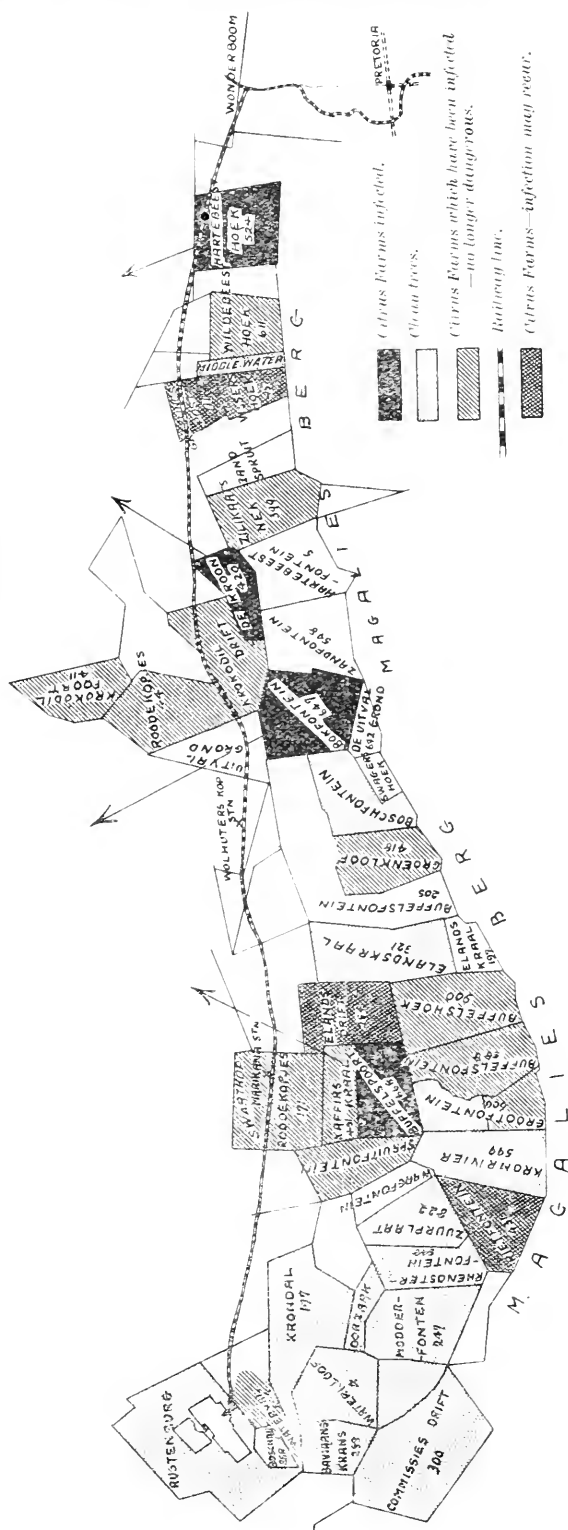





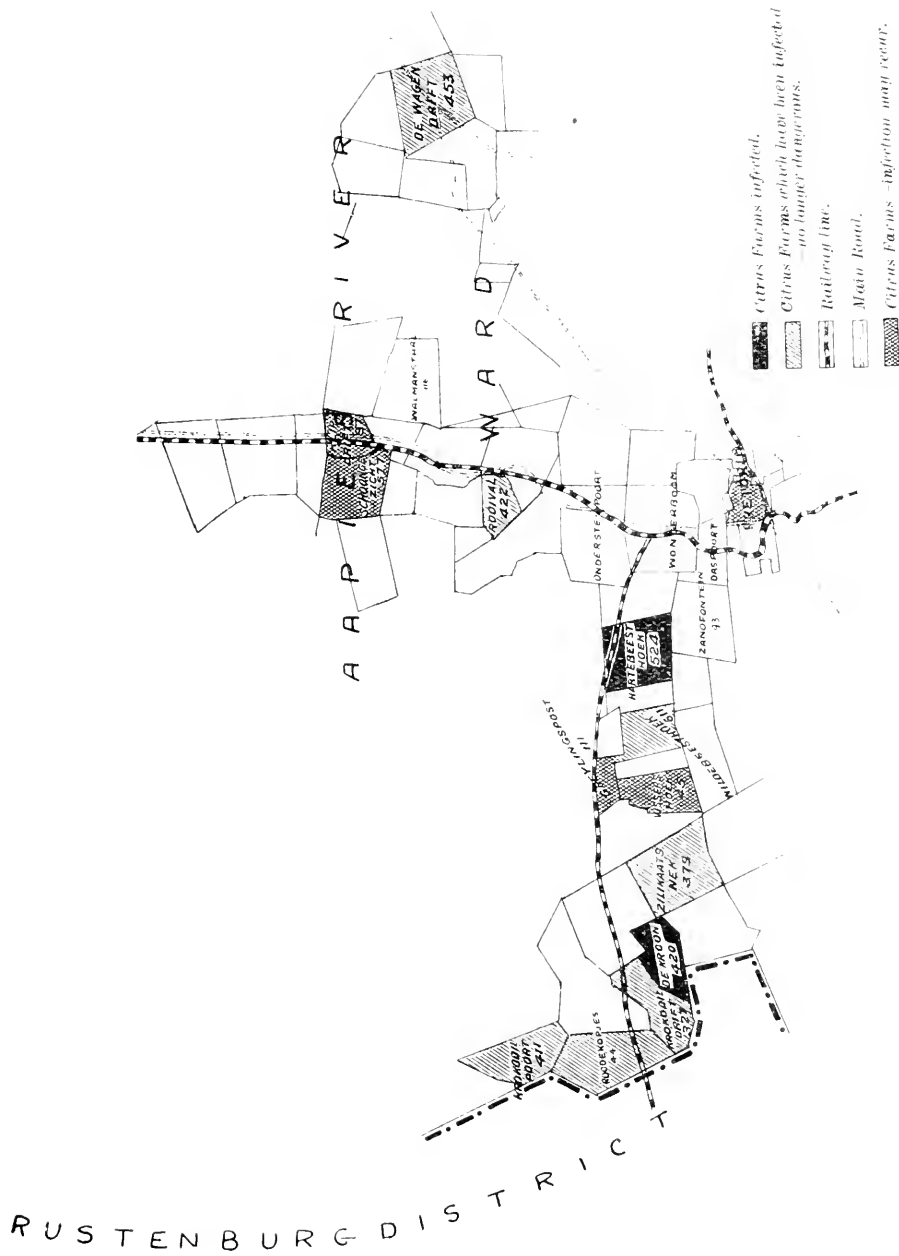

2. (1) Notwithstanding anything contained in section *seven* or in section *fifteen* of the said Act, no compensation shall be paid to the owner or occupier of any nursery or of any premises, in respect of—

- (a) the destruction after the thirty-first day of March, 1920, of any plant on account of its having been infected with citrus canker; or
- (b) the destruction after the commencement of this Act of any plant planted, raised, or kept in contravention of section *one* of this Act.

(2) Notwithstanding anything in the said Act contained, any agreement entered into with the Department of Agriculture since the eighth day of July, 1918, whereby any person has undertaken not to claim compensation under the said Act in respect of the destruction of his plants by reason of the presence of citrus canker shall be binding on such person and on any person deriving from him title to the land on which the plants existed.

3. This Act may be cited for all purposes as the Agricultural Pests (Citrus Canker) Act 1919.

## The World's Harvest.

The following interesting statistics are extracted from the International Crop Report, February, 1920:—

### *Northern Hemisphere, 1919.*

Crop.	Percentage of World's Yield Represented.	Yield 1919, compared with	
		1918 (=100).	Average 1913-17 (=100).
	Per cent.	Per cent.	Per cent.
Wheat*... ..	60	93·3	96·5
Barley ... ..	40	80·2	88·5
Oats ... ..	55	86·9	90·2
Maize ... ..	75	115·6	104·9
Potatoes ... ..	25	96·1	94·4
Tobacco ... ..	60	101·8	118·5
Cotton ... ..	80	104·4	94·9
Wine ... ..	80	105·4	109·4

\* In the Southern Hemisphere the Australian wheat crop of 1919-20 is only 54·4 per cent. the quantity of the previous season's yield and as low as 38·3 per cent. of the country's average yield for the five years ended 1917-18.

## THE LIBRARY OF THE DEPARTMENT OF AGRICULTURE.

By PAUL RIBBINK, Librarian.

THE Library of the Department at Pretoria is becoming one of the most valuable assets the research worker in agriculture and the farmer have at their disposal. Housed in a noble circular room in the Union Buildings with radiating book shelves of teak, it is becoming indispensable to the Department, and a great attraction to a numerous and increasing body of students of agriculture and journalists, as well as to practical farmers. The reading tables are laden with agricultural literature from every part of the world, some 3000 different serials in all. The shelves contain books covering every branch of agriculture and other allied subjects.

A library constitutes part of the tools of trade of the investigator of agricultural matters, who, with a well equipped collection at his service, finds his work greatly lightened through the possession of data already published in connection with similar problems in other countries. In many cases the country is saved months of salaried time and considerable experimental funds on investigation, through the possession of its library, and the more up-to-date and complete that library is, the greater the efficiency the Department and its value to the public. Libraries form a most vital part of a nation's equipment to hold its own in the struggle for an honourable place in civilization and a fair share of the benefits thereof.

In other countries, such as Great Britain and the United States, the value of business literature has been recognized, and we even find large business houses and banks possessing their own collections; notable among these in the United States of America are the National City Bank with 20,000 volumes and 400,000 indexed pamphlets; the Metropolitan Life Insurance Company with 19,000 volumes, and the J. P. Morgan Company with more than 6000 volumes.

The new Library catalogue is now being prepared and will be published during this year. The general arrangement, cataloguing, and classification is on the Dewey decimal system, although in a form modified to suit the immediate requirements of the collection. The number of books amounts to roughly 9000 bound volumes and 5000 unbound volumes, with 14,000 bulletins and leaflets, and 3000 periodicals. The main subjects, numbering about 500 with numerous sections, are grouped somewhat as follows and are limited to publications bearing on agriculture and its branches:—

- (1) General literature, including biography, travels, history, etc.
- (2) Reference books (such as dictionaries, encyclopaedias, directories, etc.).
- (3) Public documents (blue books, etc.).

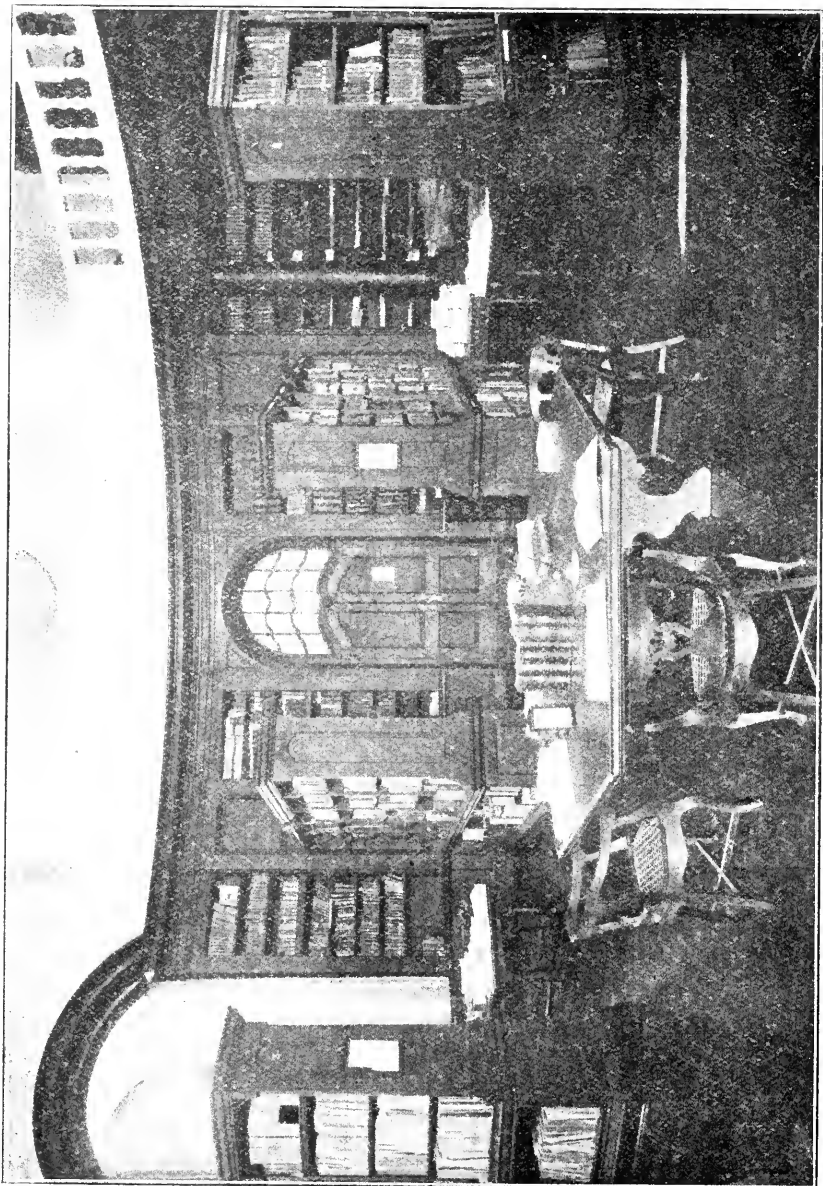

The Library, Department of Agriculture, Union Buildings, Pretoria.

- (4) Bibliography (including library and publishers' catalogues, etc.).
- (5) Economic sciences (statistics of various countries, education, political and social economy, finance, labour, wages, rent, commerce, etc.).
- (6) Useful arts (engineering, manufactures, trades, etc.).
- (7) Mathematics (surveying, etc.).
- (8) Agriculture (and all its branches).
- (9) Physical science (physics, geography, meteorology, chemistry, geology, etc.).
- (10) Biological science (natural history, zoology, entomology, embryology, evolution, heredity, botany, bacteriology, pathology, etc.).
- (11) Scientific periodicals and societies (transactions, memoirs, etc.).

Among these numerous works there are, naturally, items of

#### OUTSTANDING INTEREST TO EVERY ONE.

For instance, under travels we find books like those of Barrow on travels in Southern Africa with early descriptions of the country, and numerous illustrations and valuable information concerning products, animals, etc. Under agriculture such works as translations of the treatises by "Cato and Varro" on Roman farm management make excellent reading, and are invaluable to the student of agricultural history and economics. Many works of this description written in the days of ancient Rome and Greece enunciate principles which still hold good to-day and give opinions and advice remarkable for their wisdom. Under botany, Johan Commelin's work, published in Amsterdam in 1697, is of particular interest to South Africa, containing as it does descriptions of plants found at the Cape of Good Hope and sent to the Botanic Gardens in Amsterdam by Governor Simon van der Stel. A most important part of the collection is formed by the old English classics, such as the works of Jethro Tull (1674-1740), Sir John Sinclair (1754-1835), Arthur Young (1741-1820), etc. Many other items of considerable interest could be mentioned. Naturally, up-to-date works for the practical farmer bulk largely; for example, a person wishing to build a silo on modern lines can find what he wants as well as the one wanting to know the particular crops most likely to bring him in the best returns in his district.

Though the Library is still far from complete, the casual visitor will find that its value has not been over-rated. His appetite for books of general culture and literary interest will be well satisfied, while, at the same time, the practical value of the library to him, either as a farmer or as a student, will be considerable, and he will be stimulated to further reading, either by repeating his visits or by making use of the scheme under which ordinary books (which do not include works of reference) are lent out under special regulations, copies of which may be obtained from the Librarian.

## POISONING OF CATTLE BY FEEDING ON OLD MEALIE LANDS.

By D. T. MITCHELL, M.R.C.V.S., Acting Director of Veterinary Research, Veterinary Research Laboratory, Onderstepoort.

DURING recent years, in various parts of Natal, a number of cases of paralysis in cattle have occurred when the animals have been allowed access to mealie lands for grazing purposes in the latter part of the winter.

It is customary in Natal, when harvesting mealies, to discard all badly formed cobs, which are either left on the stalk or dropped on the ground. In this way, when cattle are changed to old lands, there are lying around considerable numbers of old and damaged cobs which have been exposed to the weather for some months, and these are readily eaten by the cattle. Owing to this, and to the fact that the cobs are found in many of the districts in a very mouldy condition, it has been suspected by farmers, in areas where the paralysis among cattle occurs, that this condition is due to cattle eating a large quantity of these diseased mealies. Positive experimental evidence on the subject was, however, lacking. Feeding tests carried out at the Veterinary Research Laboratory, Pretoria, with material (mealies on cob) obtained in the Ixopo Division, Natal, failed to give any positive results. The animals used in these experiments were two sheep, two goats, one calf, and one mule. The experiments were continued for three weeks, during which time the calf, sheep, and goats received an average total of 33 lb. of cobs per week, and the mule 15.5 lb. per week.

During the last five weeks of the tests soaked mealies were given. One heifer was fed on a culture of the fungus grown on crushed maize from one to one-and-a-half months; this animal consumed 23 lb. of this material between 19th and 31st March. No symptoms other than a slight loss of weight could be observed in any of the animals under observation.

From the subsequent experiments on *Diplodia*-infected maize it would appear that the quantities fed at Pretoria were too small to produce effects, or, what is more probable, that the supply of cobs forwarded for experiment contained only a small percentage of infected grains.

Reference to these experiments will be found in a pamphlet\* published by Dr. Van der Byl, of the Division of Plant Pathology.

This pamphlet gives a detailed description of *Diplodia zea*, with photographs of infected maize cobs, and should be consulted by those interested in the feeding tests referred to herein.

\*“Preliminary Investigation of the Deterioration of Maize infected with *Diplodia Zeae* (Schw.) Lev.” from the Transactions of the Royal Society of South Africa, Vol. IV, Part 3, 1915.

From these previous experiments it was concluded that the maize so infected had no harmful effect on animals to which it was fed.

Although these results were fairly conclusive, the experience of many farmers pointed definitely to the harmful results of allowing cattle to graze in mealie lands where cobs were abundant and which, for the first few days at any rate, constituted almost the sole article of diet.

For this reason it was decided to commence a series of experiments at the Maritzburg Laboratory, utilizing mealie cobs obtained from farms where the disease had recently occurred.

Through the assistance of Mr. Power, Senior Veterinary Surgeon, Natal, sufficient material was obtained for the tests from various farmers in the Estcourt Division. Some cobs were forwarded to the Government Botanist, Pretoria, for determination of the infecting fungus present, and were reported on by him as follows: "The mealie cobs referred to in your minute of 30th September last are infected with the fungus *Diplodia zea*."

For the tests four oxen were selected which had been on the station for about two years and had been fed only on grass in the paddocks adjoining the laboratory. These animals were about five years old and in good condition. During the experiments they were tied up in the stable and watered by hand with water obtained from the river close by. The mealies on the cob were fed as received from the farmers, but in all cases the mealie grains only were eaten, the central core being rejected. It is, therefore, difficult to say definitely what weight of material was actually eaten.

Quantities of material fed:—

Ox No. 88	... ..	360 lb.
Ox No. 90	... ..	270 lb.
Ox No. 94	... ..	225 lb.
Ox No. 87	... ..	<i>ad lib.</i> about 145 lb.

Of these four animals one ox did not show any departure from the normal, and the remaining three developed typical symptoms.

#### GENERAL NOTES ON THE EXPERIMENT.

With the exception of Ox No. 87, the feeding on the mealie cobs was discontinued as soon as the first symptoms were shown. In the case of Ox No. 87 the feeding was continued up to the time of death. It is considered that had the feeding of cobs been discontinued when symptoms of improvement were shown, death would not have ensued. In the other animals under experiment no medicinal treatment of any sort was administered, and the recovery in their case is attributed to the fact that as soon as the first symptoms of paralysis or inco-ordination of movement were first observed the animals were not given any more mealie cobs. The additional ration of sugar-cane which was administered in their case could not be supposed to have any special curative influence other than that exercised in general by the good nursing which was accorded to the cattle. The amount of cobs fed to the experimental animals was considerable. In the case of Ox No. 87, it was observed that although this animal consumed the smallest quantity it was followed by fatal results, and that although a similar quantity of mealie cobs

of the same lot was fed to animal No. 94, this animal recovered. The effect produced would doubtless depend on the degree of infection of any particular lot of cobs with fungus, but in view of the above-mentioned fact it would appear that the particular idiosyncrasy of the animal was also a determining factor.

The general health of the animals in experiment did not seem to be greatly affected. The appetite was well maintained, and with the exception of a slight degree of diarrhoea in the earlier stages no derangement of the stomach or intestines could be noted. In the latter stages constipation was present.

Practically no elevation of temperature was noted, and it was on this account, associated with the fact that the appetite was maintained well throughout, that there was such a slight loss of condition in the animals during experiments.

The foregoing experiments demonstrated conclusively that the feeding of oxen with mealie cobs infected with *Diplodia zea* produced a condition in the laboratory experimental animals which was indistinguishable from that occurring in cattle which gained access to mealie lands, and it was therefore concluded that the conditions were one and the same. As it was still not possible to say what was the actual exciting cause of the intoxication—whether it was due to the fungus, to the products of its metabolism, or to alterations in the starchy content of the grain on which the fungus was growing—a series of experiments were therefore undertaken to elucidate this point.

Through the kindness of Dr. Van der Byl a pure culture of *Diplodia zea* was obtained and a number of preliminary experiments undertaken in order to ascertain under what conditions the fungus could be grown in bulk on maize, etc.

After some preliminary work it was found that the *Diplodia* would grow well at 27° C. in Mason's jars filled with sterile crushed maize. The lids of these jars had a half-inch opening drilled through to allow for inoculation of the medium with fungus spores. Growth was allowed to proceed for two months.

#### NOTES ON THE EXPERIMENTS.

Of the three animals which partook of the culture of *Diplodia* on sterile maize in quantities of 20 lb. each two developed symptoms.

These symptoms resembled those produced by feeding on infected cobs, but the onset after the commencement of feeding was shorter, and the symptoms were much more acute. The period during which clinical symptoms remained was shorter and recovery more rapid. These differences can be accounted for by the fact that the animals received a large dose of more highly concentrated material than was the case in the cob-fed animals.

The absence of symptoms in one ox may have been due to a tolerance resulting from an attack in the preceding year.

#### CONCLUSIONS.

From these experiments it was concluded that a condition indistinguishable clinically from that produced by feeding on infected cobs or occurring naturally in infected mealie lands could be set up by feeding on a culture of *Diplodia zea* grown on sterile maize.



Further experiments were carried out to determine whether allied species of fungi (mucor) grown under identical conditions would produce similar symptoms and whether *Diplodia zea* grown on a cellulose medium would give rise to the condition when the medium was fed.

All these experiments gave negative results.

#### GENERAL CONCLUSIONS.

(1) That a disease in cattle characterized by inco-ordination of movement and paralysis is set up by feeding on mealie cobs which are infected with *Diplodia zea*.

(2) The cultures of *Diplodia zea* grown on sterile maize when fed produce clinical symptoms indistinguishable from those set up by feeding on infected cobs.

(3) That the intensity of the symptoms and the mortality depend upon the quantity fed and on the percentage of infection present in the grains.

(4) That cultures of allied species of fungi grown on maize are incapable of setting up similar clinical symptoms.

(5) That the causal factor is not the fungus itself, but must be looked for in the material which is formed as a result of the interaction of *Diplodia zea* during its development in the starchy content of the maize grains.

#### GENERAL DESCRIPTION.

The following is a brief description of the disease as it occurs under veld conditions:—

*Geographical Distribution.*—In Natal the reports of the presence of the disease would appear to be limited to the high veld parts of the country, and in these areas the occurrence of a disease in cattle resembling this condition has been very common during the last two seasons. In most cases it has been impossible to entirely eliminate all other factors, such as poisoning by poisonous plants, etc., owing to lack of opportunity to investigate each outbreak reported, but it may be taken that cases of the disease have occurred in most of the high veld mealie-producing centres of Natal. The losses were most severe during the season preceding these experiments in the Estcourt Division, and it was from this district solely that the material was obtained for experimental purposes. Reports of a few outbreaks have also come to hand from the Ixopo Division, but material obtained from this district failed to reproduce the disease in animals at the Research Laboratory, Onderstepoort.

*Seasonal Occurrence.*—The disease is limited to the late winter months, July to September. This is the period when veld grazing is very scanty, and it is the custom for farmers to turn their cattle at this time into the mealie lands for better food.

*Animals Affected.*—The disease is limited to cattle, animals of all ages and sexes being equally susceptible. Some reports have mentioned the fact that sheep were also susceptible, but up to the present it has not been possible to confirm this. Horses, mules, and

donkeys would not appear to be susceptible, as these animals graze over the same area where cattle are dying of the disease without suffering any harmful results. No cases have been recorded of goats or pigs having been affected.

*Cause.*—The disease is only found associated with mealie lands, and it is popularly supposed by the farmers of the affected areas that it is caused by feeding on mealie cobs which have lain for some months on the ground. In the experimental investigations mealties which had been subjected to these conditions were found to be capable of producing a similar train of symptoms, and this supports the opinion of the farmers. Examination of the cobs fed revealed the fact that a very great percentage were infected with the fungus *Diplodia zea*. Experiment evidence has shown that cultures of *Diplodia zea* in sterile maize when fed to animals can set up clinical symptoms which are similar to those shown in animals contracting the disease naturally, and further experiments indicate that the results are produced by a substance of, at present, unknown composition formed during the growth of the fungus in the maize grains.

#### TIME AFTER EXPOSURE AT WHICH THE FIRST SYMPTOMS ARE SHOWN.

In natural conditions in the veld, cases have been known to occur in six to eight days after the animals were placed in the lands. In the laboratory experiments the shortest time which elapsed between the commencement of feeding on the cobs until the first symptoms were shown was three days and the longest fifteen days. The animal which developed symptoms in three days was a very ravenous feeder, and this may account for the short time which elapsed before symptoms were shown. It may be taken that the development of the symptoms depends on the quantity eaten and the condition of the cobs with reference to their degree of infection by the fungus.

*Symptoms.*—The first symptoms noted are lachrymation and salivation accompanied by slight quivering of the muscles of the flank and shoulder. The back is slightly arched, and the animal stands with its legs farther apart than normal. The head is carried low and the ears droop slightly; the faeces are mostly soft, but no diarrhoea is present. In this stage, if the animal is walked, only slight symptoms of inco-ordination of movement are to be noticed. Later, these symptoms are aggravated—profuse salivation and lachrymation are apparent—muscular tremors become general. The coat stares, back is very much arched, and the animal has a dejected appearance. Progression is slow and the animal only walks when compelled to do so. Symptoms of inco-ordination of movements are evinced by high stepping of the legs. Lateral swaying of the body and sometimes a tendency to progress with the hindquarters bent to one side. The animal falls after walking a short distance, unless supported. These symptoms last for about one or two days, after which the animal is unable to rise without assistance, and when lifted stands with the legs wide apart and the head down, and showing irregular spasmodic contractions of the leg muscles. The tail is flaccid; on walking the animal knuckles over at the fetlocks of both fore and hind limbs, frequently plunging head foremost on the ground after a short distance. Sensation is retained in the muscles. Rumination is suspended, but the animal feeds occasionally and

drinks fairly well. If cobs are still administered to the animal the symptoms become more pronounced, and soon the animal is unable to stand on being lifted. It remains lying on the ground, feeding occasionally. Constipation now ensues, the faeces which are passed being coated with mucous, which is blood-tinged. Death is preceded by a complete loss of tone of the muscles, the animal lying stretched out and comparatively limp.

If feeding on the mealie cobs is discontinued when well-marked clinical symptoms develop, recovery is fairly rapid. The appetite returns and the animal feeds on green stuffs freely. The symptoms of paralysis disappear in a few days, but stiffness in movements persists for some time. In one case which recovered, knuckling over at the fetlocks continued for over a week when other symptoms had disappeared and the animal developed a bony callus on the anterior aspect of the fetlock joints of the fore legs.

The temperature shows practically no alteration throughout the illness. The pulse is early affected, becoming rapid and thready, and in the case which terminated fatally almost imperceptible for the last two days of life.

*Lesions on Post-Mortem.*—In one case which was available for examination the chief lesions present were a well-marked catarrhal enteritis, affecting the small and large intestines. Acute diffuse hyperaemia of both kidneys and well-marked congestion of both lungs.

*Mortality.*—The mortality varies considerably on the various farms. In some, practically all the animals which develop symptoms succumb, while in others a large percentage recover. It would appear that the mortality is greater in the latter part of the season.

*Treatment.*—No treatment was adopted in the case of the animals which recovered and in which the disease had been artificially produced, other than good nursing. It is necessary to remove the animals at once from the lands as soon as the initial symptoms appear. Affected animals should be given a saline purge, so as to empty the intestines of ingested irritant material. The animal should, if possible, be housed and given some green food, or if none is available an addition of a daily dose of linseed oil to the ordinary food is indicated.

*Prevention.*—Collection of all damaged cobs at the harvesting should be practised. As the suspected causal fungus is most prevalent in old mealie lands, these lands should be allowed to lie fallow for a season or, if this is impossible owing to lack of other suitable agricultural lands on the farm, strong measures should be adopted to get rid of the fungus itself on the lands. In view of the fact that the fungus had been demonstrated in the stalks as well as in the cobs, it would be advisable to burn off all the vegetation in the lands as soon after the mealies are harvested as was possible. By this means, complete sterilization of the whole area would be ensured, and in the following season the cattle might be allowed access to the mealie lands with safety.

It is strongly recommended, however, whatever general treatment of the lands is carried out, that on succeeding years *all* cobs should be harvested.

## THE DROUGHT OF 1918-1919.

### Estimated Loss of Live Stock and Produce.

ALTHOUGH there are some parts of the country where rain is still sorely needed (March, 1920), the great drought which prevailed over a wide extent of the Union during 1918-1919 has now happily spent itself, and we can endeavour to form an estimate of the loss to our pastoral and agricultural industries by one of the severest dry spells known in the history of South Africa. It will be recognized that from such information as is available an estimate only can be framed, but though the actual loss and its full economic effects on the country will never be known, it is considered that the information now placed before the public is reasonably accurate and will show clearly the degree of loss we have sustained and justify the natural dread with which farmers view the recurring droughts which rob them of their stock and crops.

In obtaining information as to the effects of the drought, the Department had the assistance of all magistrates and sheep inspectors, whose knowledge of local conditions enabled them to give, as a rule, valuable details of mortality of stock and decrease of crop production in the areas served by them, and it is largely on this information that the estimates hereunder have been based.

#### RAINFALL.

To determine the extent to which the conditions prevailing generally throughout the Union during 1919 are reflected in the rainfall for that year as compared with previous years, a schedule was prepared from information supplied by the Meteorological Office giving in detail the annual rainfall at various centres in the Union over a period of years extending from 1900 to 1919 inclusive. This shows that, with the exception of 1903, the rainfall of 1919 was the lowest during the past twenty years. The following summary sets out the position clearly:—

Province.	Mean Rainfall (inches) for Years :					
	(5) 1900-4.	(5) 1905-9.	(5) 1910-4.	(5) 1915-9.	(20) 1900-19.	Total Rain- fall, 1919.
Cape ... ..	16·42	18·02	17·51	16·64	17·15	13·03
Natal ... ..	34·67	42·63	40·79	42·95	40·40	34·19
Transvaal ... ..	25·12	29·17	25·83	29·03	26·96	22·54
Orange Free State	20·12	20·79	19·27	21·80	20·45	14·27
Total Average ...	24·08	27·65	25·85	27·56	26·24	21·19

It will be observed that compared with the average rainfall for the stated periods of five years from 1900, and for the whole period of the past twenty years, the total rainfall in 1919 is deficient in each instance.

## ESTIMATED LOSSES OF LIVE STOCK.

Apart from the Transkeian Territories, where it was not possible to obtain reliable figures, the drought is estimated to have been the direct cause of the following losses:—

Province.	Large Stock.		Small Stock.	
	Total: Through Poverty.	Through Poverty.	Through Slaughter of Offspring.	Total.
	No.	No.	No.	No.
Cape ... ..	100,259	2,267,400	1,163,900	3,431,300
Natal ... ..	41,090	32,350	19,360	51,650
Transvaal ... ..	43,609	187,000	112,700	299,700
Orange Free State ... ..	61,385	971,600	629,300	1,594,300
Total ... ..	216,325	3,160,750	1,916,200	5,376,950

Losses of large stock were severest in the Cape Province, where 6.76 per cent. of the total cattle is estimated to have perished. In the Northern Karoo 31.51 per cent. died, and in the Central and Eastern Karoo nearly 12 per cent. Heavy losses were reported also from the western high veld of the Transvaal and the south-west of the Orange Free State, estimated at 12.05 per cent. and 10.19 per cent. respectively of the total animals. For the whole Union, it is estimated that 3.98 per cent. of its total large stock was lost.

In adult small stock the deaths through poverty were 11.02 per cent. of the Union's total, nearly three times the percentage mortality of large stock. The Karoo and north-western districts of the Cape suffered most, the flocks there being depleted by from 20 per cent. to 24 per cent.

It is among the progeny of the small stock, however, that enormous losses occurred, the total for the Union being placed at 45.16 per cent. Again the Karoo districts show the greatest losses, the mortality in the Northern Karoo being as high as 89.05 per cent. The Southern Karoo with 78.11 per cent. and the north-western Orange Free State with 72.52 per cent. also suffered severely.

## LOSSES OF CROPS.

With the aid of its crop correspondents, the Department was able to gauge the extent to which the lack of rain affected the principal crops of the country. From this cause it is estimated that the following quantity of produce was lost:—

Crop.	Cape.	Transvaal.	Orange Free State.	Natal.	Total Union.
Wheat, 1919 ... ..	602,300	44,300	116,200	—	762,800
Oats (Hay), 1919 ...	9,996,800	2,302,000	1,682,300	—	16,981,100
„ (Grain), 1919 ...	321,200	39,300	107,800	—	468,300
Barley, 1919 ... ..	147,600	—	7,700	—	155,300
Maize, 1918-19 ... ..	1,021,142	1,630,318	1,989,600	482,700	5,123,760
Kaffir Corn, 1918-19 ...	202,400	136,300	70,100	127,200	536,000
Tobacco, 1918-19 ...	1,563,800	382,400	12,900	13,700	1,972,800

(NOTE.—Oat-hay, 7 lb. per bundle; barley, 150 lb. per bag; all other bags, 200 lb.)

The effects of the drought are epitomized in the statement of percentages given hereunder, revealing the areas of the Union from which the heaviest toll was exacted.

An examination of the percentage deficiency in rainfall as compared with the mortality of cattle and stock and decreased agricultural production discloses some apparently disproportionate features, the solution of which would have to be sought for and found in a variety of factors such as

- (1) the relative extent of the various areas and the feeding capacity of the natural veld thereof;
- (2) the facilities of producing and providing artificial feeding;
- (3) the ratio of evaporation as applied to each area, having regard to topographical conditions;
- (4) the locality of the various areas in relation to what are known to be the arid or semi-arid regions of the Union.

#### CONCLUSION.

In addition to the actual losses of stock and crops, the natural increase of live stock has been adversely affected through losses actually sustained in breeding stock, and also the reduced capacity of breeding stock, which survived the adverse conditions, to produce offspring. Owing to the impoverished condition of the surviving stock, it was quite impossible in some districts to put rams to the flocks.

That the drought has most adversely affected a number of farmers, particularly those with slender resources, is, unhappily true, but it came at a time of unprecedentedly high prices for wool, skins, hides, and produce generally, and this has been of great assistance to the bulk of our farmers in mitigating its effects. Although conditions in the native territories did at one time threaten disastrous results as far as foodstuffs, particularly maize, were concerned, the tension has since materially been relieved, and any cause for alarm which may have existed has practically disappeared.

DROUGHT, 1919.

*Comparative Statement showing the deficiency in rainfall during 1919 throughout the Union reflected in losses of stock and decrease in agricultural production.*

	Percentage Deficiency Rainfall, 1919.		Percentage of Losses.					Decrease per Cent. in Agricultural Production.				
	As Compared with mean 1915-1919.	As Compared with mean 1906-1919.	Cattle.	Small Stock, Adult.	Lambs and Kids.	Wheat.	Oats (Hay).	Oats (Grain).	Barley.	Maize.	Kafir Corn.	Tobacco.
Cape Province—												
South-West	22.80	26.17	0.37	1.55	6.61	8	19	15	—	—	—	—
North-West	52.73	48.19	10.91	20.11	60.15	15	37	39	—	—	—	7
South Coast	29.16	21.75	0.03	1.50	—	9	31	16	23	—	—	21
South Karoo	51.35	58.87	3.61	16.91	66.82	15	35	33	—	—	—	10
Central	48.28	51.79	11.75	20.81	78.11	57	17	29	53	—	—	—
Northern	62.81	68.54	31.51	23.75	89.05	18	—	—	—	—	—	—
Eastern	33.57	35.22	11.51	20.51	69.93	79	15	56	71	—	—	—
Bechnaaland	16.27	22.91	1.14	4.61	31.81	—	—	—	13	—	—	—
Griqualand West	36.80	47.78	2.18	1.32	1.01	—	—	—	—	—	—	—
Border	38.72	41.97	9.85	6.57	30.21	77	69	71	62	—	—	20
North-East	39.88	49.21	5.59	6.99	11.31	81	69	83	51	20	—	20
Transkei	29.19	23.15	—	—	—	56	65	57	37	21	—	68
Average	37.21	41.29	6.76	13.51	49.30	28	39	19	32	40	—	25
Natal—												
High Veld	39.87	—	1.06	7.16	20.12	—	—	—	—	17	—	19
Middle Veld	22.61	22.61	2.07	2.39	—	—	—	—	21	15	—	—
Coast	21.65	12.91	—	—	—	—	—	—	21	33	—	6
Average	28.05	—	1.51	1.59	9.1	—	—	—	20	27	—	2

(Continued.)

## DROUGHT, 1919—(continued).

*Comparative Statement showing the deficiency in rainfall during 1919 throughout the Union reflected in losses of stock and decrease in agricultural production—(continued).*

	Percentage Deficiency in Rainfall, 1919.		Percentage of Losses.				Decrease per Cent. in Agricultural Production.					
	As Compared with mean 1915-1919.	As Compared with mean 1900-1919.	Cattle.	Small Stock, Adult.	Lambs and Kids.	Wheat.	Oats (Hay).	Oats (Grain).	Barley.	Maize.	Kaifir Corn.	Tobacco.
Transvaal—												
Eastern High Veld	8.49	0.62	1.07	2.16	11.89	11	24	34	—	11	13	18
Central	35.74	26.25	2.20	6.24	12.15	10	15	20	—	42	23	4
Western High Veld	27.39	26.40	12.05	14.32	68.62	14	3	2	—	17	17	8
Low Veld	16.46	12.99	0.93	2.82	36.82	17	8	25	—	12	15	10
Average	22.02	16.56	2.80	5.50	23.17	13	18	28	—	24	18	6
Orange Free State—												
North-East	37.53	25.49	1.93	6.01	41.65	52	37	41	—	40	28	—
North-West	34.96	29.98	3.49	5.04	72.52	—	27	24	—	28	31	2
South-East	27.19	28.50	4.90	9.01	46.50	53	47	51	—	18	54	—
South-West	54.86	54.70	10.19	13.95	61.41	49	—	—	—	26	52	—
Average	38.63	34.67	3.69	8.81	51.47	53	39	41	—	39	35	2
SUMMARY.												
Cape Province	37.21	41.29	6.76	13.51	49.30	28	39	19	32	40	45	25
Natal	28.05	—	1.51	4.59	9.43	13	18	28	—	20	27	2
Transvaal	22.02	16.56	2.80	5.50	23.17	13	18	28	—	24	18	6
Orange Free State	38.63	34.67	3.69	8.81	51.47	53	39	44	—	39	35	2
TOTAL AVERAGE	31.48	30.84	3.98	11.02	45.16	28	33	23	32	31	29	15



## COW-TESTING ASSOCIATIONS.

By F. JOUBERT, Assistant Instructor in Dairying, Elsenburg School of Agriculture.

THE keeping of records in an intelligible and dependable form of the milk production of dairy cows is very largely responsible for the rapid development and improvements which have taken place in our dairy herds in the past few years. In this respect the breeders of Fries cattle have been doing good work, especially in keeping records of heavy producers. The statement that the grade cow has no value as a breeder has little weight among dairymen who know the real situation. It must be recognized that, for many years to come, the great bulk of our dairy products will be obtained from grade cows.

It is not every one who can go in for pure-bred dairy females, and from our best graded female stock must come our future dairy herds. It is because the grade cow has a real value as a breeder that our dairymen must take up cow-testing work, so that they may know more definitely from which cows it will be worth while to save the heifer calves, and also which cows are the most profitable to keep.

### THE ORIGIN OF COW-TESTING AND THE GROWTH OF THE MOVEMENT.

The keeping of milk records of cows had its origin in Denmark in the year 1892. The first association for carrying on cow-testing was established at Askov, in Denmark, in 1895. Since then the movement has grown with increasing rapidity, and at the present time its branches have extended into every part of the world where the dairying industry is regarded as important.

Cow-testing has been introduced into South Africa at a comparatively recent date, and is at the present time almost entirely confined to pure-bred herds.

In 1913 the first cow-testing association was established in South Africa at Darling (Cape), under the supervision of the Darling Creamery. During the period of the war the work was discontinued, but even in the course of its short existence it did some splendid work, and enlightened the farmers on many hidden facts of the industry. Later on, similar associations were started at Mooi River, Natal, and in the Orange Free State. Members of these associations agree to submit their entire herd of cows for purposes of ascertaining their production by means of weights of milk and tests of butter-fat. Towards the end of 1916 the Friesland Cattle Breeders' Association of South Africa decided on an official milk record scheme for Friesland cows, the recording work of which is now being carried out in accordance with the most up-to-date methods by the officers of the Dairy Division of the Department of Agriculture.

With these associations (apart from the Friesland Breeders' Association) the test is carried out in the following manner: A man experienced in handling the Gerber test, and with the required knowledge in dairying, is engaged by the association, and visits each herd

once a month, usually in time for the evening milking. His method of procedure is usually as follows:—

- (1) Weighs and samples the milk from each cow that evening.
- (2) Makes an estimate of the feed given each cow per day.
- (3) Again weighs and samples each cow's milk the following morning.
- (4) Tests the samples of milk of each cow for percentage of butter-fat.
- (5) Computes the total feed consumed for the month by each cow.
- (6) Computes the total milk produced for the month by each cow, using the weights obtained as an average.
- (7) Computes the butter-fat produced for the month by each cow, using the average test as the test for the month.
- (8) At the end of the year he computes the profit or loss on each cow by estimating the amount for feed consumed, figured at market prices, as against the milk yield and butter-fat produced, calculated at the creamery prices.

Thus at the end of a cow's lactation period, the farmer has before him in a concise form full particulars of the cow's performance, including costs of feeds, cost of producing a gallon of milk and a pound of butter-fat, profit over cost of feeding, etc. This information gives the farmer a very close approximate idea of the profit or loss on each individual cow in the herd.

#### THE OBJECTS OF KEEPING MILK RECORDS

are principally to find out the annual production of milk and butter-fat of each cow, so that poor and unprofitable ones may be detected and eliminated from the herd, and the future herd be built up from the progeny of the cows which give a large yield of milk rich in fat. When a record of the cost of food and attendance for each cow is kept in conjunction with the milk records, the farmer is furnished with the necessary data for comparing cows both in respect of economy in producing cheap milk and butter-fat and capacity for yielding large quantities.

The profit which could be made from each cow, by utilizing her milk for any particular purpose, may be calculated by valuing the milk at the price for which it could be sold for that particular purpose, and then subtracting from it the cost of upkeep of the cow. The following records illustrate that the cow which produces the greatest quantities of milk and butter-fat is not necessarily the most economical one:—

	Lb. of Milk Yielded.	Per cent. of B.F. in Milk.	Lb. of Fat Yielded.	Cost of Food and Attendance.	Cost of 1 gallon of Milk.	Cost of Producing 1 lb. Fat.
				₹ s. d.	d.	d.
Cow A ... ..	15,521	2.81	428	28 5 5	4.37	15.8
" B ... ..	11,847	2.92	346	21 0 3	4.26	11.5
" C ... ..	10,005	3.32	332	18 18 0	4.53	13.6

These figures show that although Cow A yields the largest quantities of milk and butter-fat, yet Cow B is more economical, producing milk and butter-fat at a lower cost, while of the three cows C is the most economical in the production of butter-fat.

The profit which would be derived from each of these cows if the butter-fat were sold to a creamery at the average price of 1s. 4d. per lb. is shown in the following table:—

				Lb. of Butter-fat.	Value at 1s. 4d. per lb.	Cost of Food and Attendance.	Profit.
					£ s. d.	£ s. d.	£ s. d.
Cow A	...	...	...	128	28 10 8	28 5 5	0 5 3
" B	...	...	...	316	23 1 4	21 0 3	2 1 1
" C	...	...	...	332	22 2 8	18 18 6	3 4 8

This table shows that cow A, though the greater producer, is the least profitable in the production of butter-fat.

It must be understood, however, that it is the exception rather than the rule that the cow with the lesser yield is more economical than the cow with the greater yield. It is mentioned here merely for showing the information which may be gained from the milk records, and not to cast reflections on the economy of the cows with the high milk yield. In the present instance, cows A and B may have been fed uneconomically.

#### THE ADVANTAGES OF TESTING.

The keeping of records and the testing of cows give the farmer a greater interest in his cows and in his farming generally. It is known that cows owned by a farmer who keeps milk records are better fed and better managed than those of one who neglects this important work. The keeping of milk records acts as a guide to proper and judicious feeding. It affords a means of selecting the best cows for breeding high-class dairy cattle, and indicates a method of identifying bad or unprofitable cows with a view to their elimination from the herd. Where the milk is weighed daily the records serve as a guide to the health of the cows, as well as a check on the milkers.

Milk records are generally responsible for greater cleanliness in and around the cowsheds and in the handling of the milk, resulting in better and cleaner milk. After an experience of a few years with these associations, I find that the work is being constantly more highly appreciated by the dairyman.

While there is to-day a world shortage of milk, butter, and cheese, and labour and foodstuffs are scarce and dear, we cannot lay too much stress on the importance of going in for the best animal only. The only method of finding out which is the best cow is by submitting the milk of each individual cow to the Babcock or Gerber test.

## THE AGRICULTURE AND SOILS OF THE CAPE PROVINCE.

By ARTHUR STEAD, B.Sc., F.C.S., Lecturer in Chemistry, Grootfontein School of Agriculture, Middelburg, Cape.

### INTRODUCTORY.

UNDER the above title it is proposed from time to time to record the progress made by the Chemical Section of the Grootfontein School of Agriculture in soil survey work.

The work was begun during 1915, but owing to depleted and ever-changing staffs consequent on the war much less progress has been made than had been anticipated. None of the work has yet been finished, but it is thought that some of it has reached a stage which would justify the issue of a report in the interests of farmers.

In soil survey work it is highly desirable that the soil chemist should collaborate with the botanist and the geologist. While there are hopes of such co-operation in the future it has been hardly possible up to the present on account of shortness of staff and press of work. The writer would, however, acknowledge valuable assistance received from Dr. Pole Evans, of the Botanical Division, and Dr. Rogers and Dr. Du Toit, of the Geological Survey.

It might be urged that such work as this should await the time when the desired collaboration would be assured; but that might mean that our farmers would have to wait indefinitely for information concerning the chemical and physical characteristics of their soils which they rightly look to the Department of Agriculture to furnish.

It will, therefore, be understood that these articles are published with the full knowledge that the data on which they are founded are incomplete in important respects; also with the knowledge that the best has been done under the abnormal circumstances that have obtained during the past years of war and disorganization.

### I.

#### THE WITKOP DISTRICT.

About two hours by motor from Burgersdorp, east south-east of that place, and about midway between it and Jamestown, there is a characteristically coloured and shaped pile of rock called Witkop. (See Plate I.)

The kop, doubtless, gave its name to the farm on which it is situated, the farm its name to the Post Office, and the latter its name to the surrounding area.

Witkop Post Office is situated on a plateau high up in the Stormbergen at an altitude of at least 6000 feet above sea level. The climate of the district is, therefore, healthy and invigorating, cool in



*Plate I.*

Witkop.

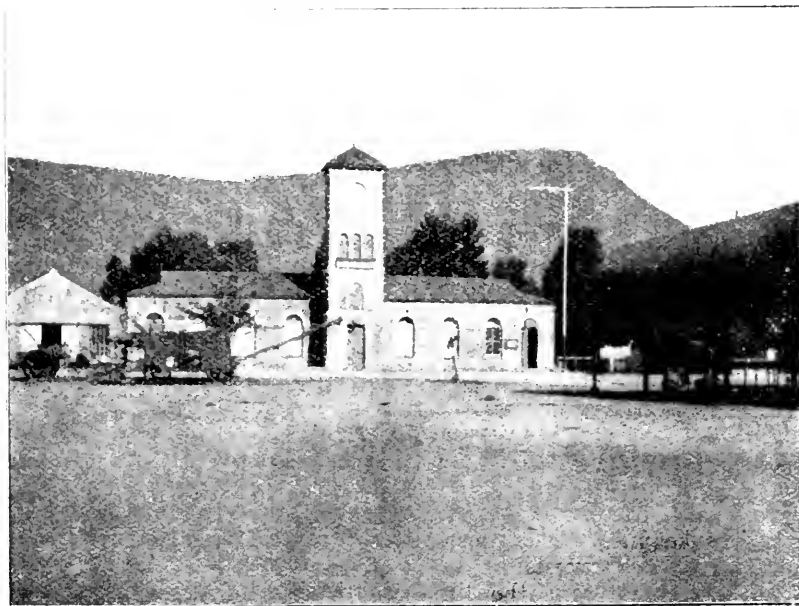

*Plate II.*

Burghersdorp Town Hall and Market Place.

summer, cold and somewhat bleak in winter. Stock of all kinds do well, and little trouble is experienced on account of disease. The country is well covered with grass, but trees and scrub are conspicuous by their absence, excepting round the homesteads, where they appear to thrive so well that one wonders why, in such a bleak winter area, nothing has been done in the way of afforestation or the planting of shelter belts for the protection of cattle and sheep. Owing to the severity of the winter lambing does not take place until October, when the weather is not only warmer but the veld good and the sheep in excellent condition. Clean flocks are shorn in February, scabby ones in November. There would appear to be a good number who shear during the latter month.

The average rainfall is about 24 inches. January, February, and March are the rainiest months. Snow usually falls in winter, and September generally yields enough rain to ensure a good crop of wheat and adequate grazing for the lambing ewes.

The climatic conditions on the whole would seem to be particularly suited to wheat, which is the principal crop. Barley, oats, rye, and potatoes are also grown. The last-named crop is a somewhat recent introduction, due to Mr. Brumberg, the storekeeper, postmaster, and produce dealer at Witkop. It would appear that the potato crop had set the Witkop farmers thinking. They had found that to grow potatoes before wheat meant a considerable increase in the yield of the latter crop. All were convinced on that point.

But it would appear that all did not wish to grow potatoes, because that crop calls for a greater amount of tillage than any other crop they had grown hitherto. The farmer wanted also to introduce the potato effect on all the wheat he grew, but he could not do this because of the impossibility of putting as much land under potatoes one year as he desired to sow to wheat the next. Doubtless, the knowledge that legumes possessed the power of enriching the soil had spread to Witkop, and nothing was more natural than to suspect the potato to be endowed with similar power.

Thus it came that the Witkop farmers asked us to investigate their soils and tell them what fertilizers would serve the same purpose as the potato crop and give less trouble.

#### POTATO AND WHEAT CULTURE.

Lands intended for potatoes are ploughed in March. New lands are ploughed shallow, old lands deep. They are then allowed to lie exposed to the winter weather until August, when they are again ploughed, cross-ploughed, and harrowed. The potatoes are planted in November, the sets being dropped into furrows made by the plough as the land is being ploughed for the fourth time. Probably, also, the land is harrowed. The usual distance between the sets is 10 inches in and 28 inches between the rows. The favourite variety is "Up-to-date."

Frequently, during the growing season, the crop is tilled for the purpose of keeping down weeds, and, finally, it is lifted with forks from about May onwards.

It is evident that the land for wheat following potatoes has received very thorough tillage, not only in the preparation for the potato crop, but also throughout the period the latter occupies the

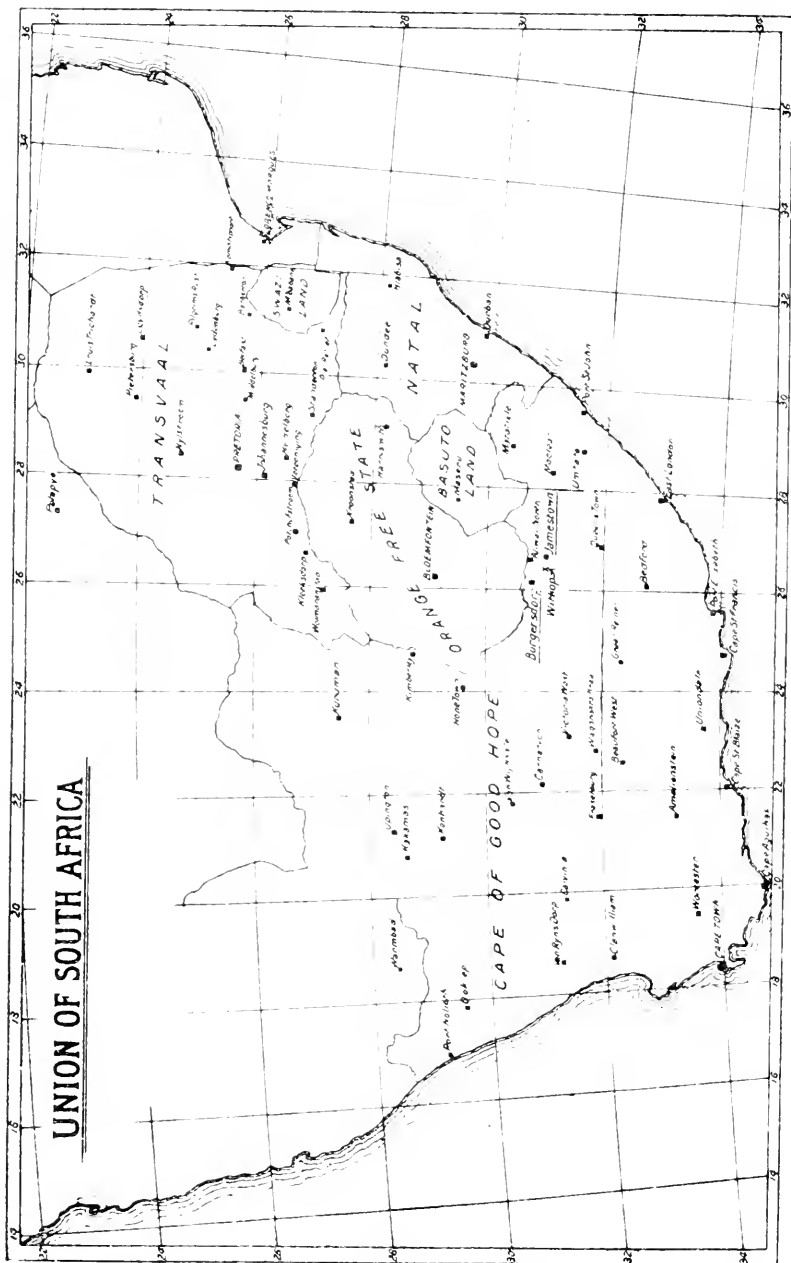

Map showing the situation of Witkop, Burghersdorp.

ground. This thorough cultivation not only has the effect of increasing the available plant food in the soil, but it also results in the conservation of a large proportion of the usually abundant rainfall of January to March. When, however, wheat follows wheat, there is a minimum of cultivation. The crop is not cultivated during growth, and the stubble is not ploughed in until it is time to sow the next crop. When that time arrives the land is ploughed, the seed sown broadcast, and harrowed in. Owing to the compacted state of the soil much of the rain which falls in January, February, and March is lost to the succeeding crop. This is in striking contrast to what happens when wheat follows potatoes and most of the late summer rains are conserved in the soil.

If this be the correct interpretation of the relationship of the potato crop to the wheat crop that follows it, no fertilizer can take the place of the former crop, but much benefit would be derived from breaking up the stubble as soon after harvest as possible and repeating the operation should the rains compact the soil or weeds take possession of it.

It would, however, seem that the farmer is prevented from ploughing after harvest by reason of the necessity to transport his grain to Burgersdorp, which is over thirty miles distant. If that be so, then no great improvement of methods can be expected until such a time as the transport difficulty is solved in the shape of better railway facilities.

*Co-operation.*—The district is fortunate in the possession of a co-operative cheese factory, i.e. the Stormberg Cheese Factory. Farmers can dispose of all their surplus milk at this factory at a reasonable price, and if the supplier should happen to be a shareholder he usually receives a bonus as well as a dividend. There is no doubt that this cheese factory, apart from being a commercial success, has made itself felt as a factor in the agricultural development of the district. Farmers finding that it costs no more to feed good than inferior cattle are gradually improving their herds. With improved herds will follow better methods of farming, for since it pays well to feed good cattle the farmer will endeavour to produce more food-stuffs.

In 1917 the output of the factory was 25,501 lb. of cheese, a figure that had increased in 1918 to 24,695 lb.

The valuation of farms for Divisional Council purposes is from £3 to £4 per morgen, but in the open market from £6 to £8 is easily obtained. The price of land is certainly rising here as in other parts of the Union, as may be gathered from the fact that a portion of Witkop was sold not long ago for over £11 per morgen. A competent authority gives it as his opinion that a value of £20 per morgen is not excessive for the best of cultivated lands.

The main source of income to the farmer would appear to be sheep. Crops also return a good outlay on expenditure, and cattle are a very useful sideline.

Fertilizers have not been used up to the present, so there is hope that, by a judicious scheme of manuring and the increase in foodstuffs produced that would follow, the stock carrying capacity of farms can be enlarged.



At the present time a farm of 600 morgen, of which about one-fourth is under cultivation, will carry throughout the year 1000 small and 150 big stock, by no means a mean achievement.

The times for sowing, reaping, lambing, etc., are somewhat different from those which obtain in districts of lower altitude, but similar latitude. The following "Farm Year" according to Mr. Andrew de Klerk, of Lemoenkraal, will, therefore, be of interest:—

January–February	...	Reaping, threshing, and transporting produce to Burgersdorp.
February	...	Shearing.
March	...	New and old lands are ploughed in preparation for potatoes.
April	...	Rye is sold for grazing purposes.
May	...	Potatoes are lifted and put in pits.
May–July	...	Wheat and oats are sown, also barley, particularly in July.
August	...	Potato lands are reploughed and harrowed.
September	...	Work is confined principally to sheep and transportation of potatoes to Burgersdorp.
October	...	Lambing.
November	...	Potatoes are planted.
December	...	Usually a slack month. Potatoes are cultivated to keep down the weeds.

#### SOILS, CROPS AND YIELDS.

Three principal classes or types of soil are recognized by the farmer, i.e.

- (1) the black turf\* ;
- (2) the sand-bult† ;
- (3) the mixed sand and turf.

*The black turf* is a heavy clay loam, rich in organic matter, which is found in valley bottoms. The ground water level is usually not more than a few feet from the surface, while the water itself is well charged with carbonates.

This type of soil is noted for its lasting fertility. Most crops grow too rank on it, barley invariably lodging. This is the best wheat soil of the district. As far as that crop is concerned the only drawback to the soil is that the crop frequently gets lodged. Potatoes are grown sometimes on the lighter types of this soil.

When virgin, a forty-fold‡ return of wheat is obtained in a good season, and the soil continues to give excellent crops for twenty-five years at least.

*The sand-bult* is a sedentary fine sandy soil, retentive of moisture, but infertile, even when virgin.

\* Turf is here doubtless used in the same sense as the Danish word "torf," meaning peat.

† A gentle undulation is called a "bult."

‡ The farmer usually reckons his crop yields in bags from a bag of seed sown. Since the amount of seed sown per acre varies with district, the following data are furnished:—A full bag of wheat sows 2 morgen, of barley 1½ morgen, of oats 1½ morgen, of rye (for seed) 3 morgen, and 12 bags of potatoes plant one morgen (2 1/9 acres).

When virgin this soil gives a seven-fold return of potatoes in a good season. If potatoes are grown the following year the yield would not be more than three-fold.

Wheat grown after the first crop of potatoes gives a maximum return of eighteen-fold, dropping to ten-fold the next year, and becoming so low the year after as to be unpayable. Rye is generally sown at this stage, and yields about fifteen-fold. After one or two crops of rye have been taken the land is allowed to revert to pasturage, and soon becomes covered with blauwzaad grass, blauwbloemetjes, and Cape clover, which afford very good grazing. With regard to the vegetation just mentioned, this only applies to sand-bult soil derived from red beds.

*The mixed turf* is a colluvial soil lying at the lower slopes of rather steep hills. It is similar in mechanical make-up to the sand-bult type, but it is fairly rich in organic matter. It gives not only better yields, but it lasts longer under cultivation.

Virgin land of this type will give a ten-fold return of potatoes, followed the next year by a thirty to forty-fold return of wheat. If potatoes follow, the yield would decrease by about one-fifth of the virgin yield. Wheat would now yield no more than from fifteen to twenty-fold, and this return would be maintained for several years, provided potatoes and wheat alternate. It may be mentioned that potatoes do not give satisfactory returns if grown two years in succession on the same land.

On virgin land one bag of oats will give 1500 bundles weighing about 2700 lb., dropping to 1000 bundles the third year, after which there would appear to be no further decline.

---

[The next instalment of this report will deal with the geology of the area, the chemical and mechanical composition of the soils, and suggestions for their manurial treatment.]

---

## Women's Work.

Each country has its own problems and conditions: "distance lends enchantment," but closer acquaintance sometimes brings into view the sterner realities of a country, and, possibly, as time and space divide us from the land we have left its own problems seem less formidable and in contrast its privileges are more to be desired. That this is the experience of a lady who received a Government bursary for study in Domestic Science, and is now at the University of McGill, Canada, is evident from letters written to her mother in South Africa, which we have been permitted to see. She writes:—" . . . I would never like to live in this country, because there are no natives to do the dirty work, and one has to do it all oneself. The daughters of the farmers here work just as hard as the men. They have to do all the milking, and have to help with the ploughing, and as for taking out the potatoes and onions, the girls have to do it all. Thank heaven I am a South African!"

## IMPORTATION OF CATTLE.

### Measures to Prevent Introduction of Disease.

THE history of South Africa's efforts to prevent the introduction into her borders of animal diseases, stretches back many years, and figuring prominently in it are the legislative measures passed for preventing the importation of tuberculous cattle. No cattle from oversea were permitted to enter the country without passing the tuberculin test at the port of entry. Importers, as a consequence, took the precaution of having their cattle tested and passed by veterinary surgeons oversea, whose bona fides and competency were unquestioned, but notwithstanding this, many of these animals (6 per cent. or more in some years) reacted to the tuberculin test when applied on arrival in South Africa. Importers and breeders in South Africa, to whom the matter was one of great moment, were greatly exercised as to the means of removing the cause of the loss and delay which ensued. Repeated requests and resolutions came from various influential agricultural bodies and breeders' associations for suitable arrangements to be made for the testing, wherever possible, of cattle prior to export, so as to ensure the shipment of sound animals only, and remove the necessity of the test on arrival in South Africa. As an outcome, the matter was taken in hand by General Botha, who, when in England in 1911, entered into negotiations with the British Government, resulting in the establishment by the Board of Agriculture and Fisheries of a Testing Station at Pirbright, Surrey, for the reception of cattle to be tested for tuberculosis prior to export to the Union, thus centralizing all testing under Government supervision, and doing away with the

#### OLD AND UNSATISFACTORY METHOD

of having cattle tested on private farms under varying conditions. The necessary legislation, prepared in conformity with the wishes of the farmers of South Africa, to meet the new conditions was provided in the Diseases of Stock Act Amendment Act, 1916, which makes it compulsory for cattle arriving from oversea from countries making satisfactory provision for the establishment of a Government Testing Station to be provided with a certificate to the effect that they have been isolated at such a station for not less than twenty-eight days, subsequently subjected to and successfully passed the tuberculin test, and thereafter sent direct to the ship. Cattle from countries where no Government testing stations are provided, will, according to the Act, be quarantined at the port of arrival in South Africa and tested as heretofore, owners being given the option of removing, at their own expense, reacting animals to the country of origin or having them destroyed without compensation.

At present the only testing station meeting the requirements of the Act is the one at Pirbright, but soon after that was

completed war broke out, and shipping difficulties rendered its use impracticable, consequently the old arrangement of testing cattle on arrival at the Union seaports had to be continued. This was the position until towards the latter half of 1919, when circumstances permitted the station reverting to its original purpose. Consequently Government Notice No. 1140 of the 27th August last was issued making it compulsory for all cattle from Great Britain arriving at the Union ports on or after the 1st November, 1919, to pass through Pirbright and be subject to the provisions of the Act (No. 25 of 1916) referred to above. It may here be mentioned that while the Union Government has the right to retest any animal which, on arrival from Great Britain, presents symptoms or appearances suspicious of tuberculosis, or any other proclaimed disease, and to destroy it if the animal gives a positive reaction, it is not expected that the need for detention or retest is likely to arise in many instances after animals have passed through Pirbright.

#### ACCUMULATION OF STOCK AWAITING SHIPMENT.

As is well known, the close of the war found a great shortage in freighting and large numbers of cattle intended for export were accumulated in Great Britain awaiting shipment, while a gradual improvement in shipping facilities lead to increased purchases of cattle for South Africa. The result was, as was to be expected, that the accommodation at Pirbright (sufficient for 100 head of cattle) was strained to its utmost, and congestion arose causing some delay in treating all the animals awaiting the required quarantine and testing prior to shipment. It is anticipated, however, that when the first rush is over and the export of cattle becomes normal and shipping is more regular, the accommodation at Pirbright will prove to be ample, and that exporters will no longer have the difficulty or delay which was experienced at the outset. There is, of course, no objection to the provision of other Government testing stations, similar to Pirbright, should the export of pure-bred stock assume such proportions as to justify it. In this connection the Department has already been approached by Sir Henry Dundas, a member of the Council of the Highland and Agricultural Society, Scotland, who pointed out some of the difficulties which will be experienced by Scottish breeders in sending cattle to Pirbright. Sir Henry was advised that such cattle might be tested in Scotland, provided a station were established there, under Government control similar to the one at Pirbright, but that under no circumstances will the Government of South Africa be satisfied with tests carried out on the premises of the breeder.

Importers are naturally anxious for the well-being of their stock at Pirbright; there is no need to fear on that account, as cattle are well cared for at the station. A short paragraph appeared in the April, 1920, number of the *Journal* giving the result of a visit to Pirbright by a prominent exporter of stock, whose remarks form an unsolicited testimonial to the excellent conditions prevailing there, and coming from one whose interests are largely centred in the business, should in itself bring reassurance to importers in the Union.

It has come to the notice of this Department that certain importers, whose animals are accompanied by Pirbright certificates, are not appointing agents to receive these animals on arrival at the

port of entry, being apparently under the impression that the Department will undertake to supervise transshipment, feeding, and the forwarding of their stock. As this is impracticable, the owners of such animals are reminded that it is still necessary to adhere to the old system of appointing agents to look after these animals when they land and to make arrangements with the Railway Department for despatch to their destination when the usual formalities respecting permits, etc., have been complied with.

---

### Organization of Farmers.

The Paarl Farmers' Association (one of the oldest of its kind in the country) is actively engaged in an endeavour to establish similar organizations throughout the Western Province, it being felt that this important agricultural area of the Union lacked proper organization among farmers whose interests were suffering as a result. It was considered that a network of active associations would result in marked benefit and ensure, moreover, proper weight to the many interests of Western Province farmers when discussed at the meetings of representative agricultural bodies. The movement is receiving the warm approval of the Government, it being recognized that the establishment of such associations throughout the country would carry many benefits. The Paarl Farmers' Association was established in 1894, and the following extract from a leaflet issued by its secretary and treasurer, Mr. James Gribble, gives the object of the Association:—

“The Association is a voluntary union of farmers to protect the interests of, and to advance farming industries. Friendly discussions take place at the monthly meetings; committees are appointed to inquire into matters and to carry out certain duties. Vigilance is exercised where action is necessary in any question affecting the industry, and the Association serves as a channel whereby the views and requirements of the district can be better placed before the Government than by individual effort. The Association is also a convenient medium whereby experts from the Department of Agriculture can come into closer touch with and assist farmers. Individual members obtain benefit by means of the stock fairs, in the purchase of sheep manure, distribution of farming literature, useful information and assistance through their secretary, and farmers in the district will find it to their advantage to join, not, however, to obtain direct benefit in return for subscriptions paid or time given, but with the true desire to co-operate with each other for the good of the country.”

It is pleasing to hear from Mr. Gribble that many requests reach him, not only from the Western Province, but from other parts of the Union as well, for information and advice in starting and working a Farmers' Association, an earnest of the spirit of organization among farmers to-day.

## EXPERIMENTS AND INVESTIGATIONS.

### Work at the Schools of Agriculture and Experiment Stations and Sub-Stations.

[A review of the research and investigational work being carried out by the various Divisions of the Department of Agriculture appeared in the April, 1920, number of the *Journal*.  
—ACTING EDITOR.]

#### I.—AT CEDARA, NATAL.

##### ROTATION MANURIAL EXPERIMENT.

At the School of Agriculture, Cedara, Natal, an investigation is in progress to determine which is the better farming practice under Natal conditions (*a*) the continued use of quickly available phosphates such as superphosphate, (*b*) the use of insoluble phosphates. It is generally recognized that superphosphate gives a larger and more immediate return when compared with other phosphatic manures, but the question it is desired to settle is whether continued use of this manure is a sound practice when carried on for a considerable term of years. In order to test this, land has been chosen which has hitherto never been fertilized and which has recently been broken up. Two areas have been chosen, one for treatment with the readily available forms of phosphoric acid, and the other for the insoluble form such as Saldanha Bay phosphate. These manures are not being used alone, but limed plots (slaked lime) are being tried out with the superphosphate plots and ground limestone plots along with the insoluble phosphate plots. Manure of the same value year by year is being applied, and the experiment is designed to run for a number of years. The land is being cropped under a rotation system, which is:—

Maize—First year.

Maize—Second year.

Teff—Third year.

Cowpeas and Soya Beans—Fourth year.

After a number of years data will be available to prove whether (*a*) or (*b*) is the better farming practice. A system of permanent agriculture should aim at the gradual betterment of the soils of the farm, and not their depletion. The use of superphosphate on soils of the red doleritic type is open to question as to its being good practice. There are considerable data to prove that the residual value of superphosphate on such soils is practically *nil*, the unused phosphate reverting into iron or aluminium phosphate, very insoluble forms in the soil, and so passing beyond the power of the plant immediately to attack.

The use of phosphates which are not readily soluble, on the other hand, will build up in the soil a reserve of phosphate which, undergoing natural decomposition, will in the course of a few years, it is believed, yield up a sufficiency of plant food for crops.

By the use of limestone and insoluble phosphate together it is thought that it may be possible so to alter the nature of the soil that legumes may be grown with comparative ease. At present clovers, lucerne, beans, etc., are practical failures on the majority of Natal farms, and this experiment is designed to try and bring the soil into a condition suited to legumes. If this can be accomplished, the agriculture of the whole Province may be advanced to a considerably higher scale.

#### EXPERIMENTAL ERROR IN MAIZE TRIALS.

Trials are to be carried out during the present season on maize to determine what error must be allowed for in the explanation of results secured from manurial trials, etc. Variations in yields are due to many causes. Soil irregularity; irregularity of manuring; of planting; irregularity of weed growth; of insect attack, etc., all tend to render the results of experiments of less value than they ought to be. This season an endeavour is being made on maize lands to treat them with as great uniformity in every respect as is practically possible. Results will be obtained from these plots which will be of value as showing what error may occur in any experiments connected with the maize industry, and what margin must be allowed for in the results secured from experiments when the results are being interpreted. Far too frequently practices are formulated from the results of experiments upon differences which are completely covered by the experimental error.

#### EXPERIMENTS WITH GRASSES.

A trial is in progress at the present time with several different kinds of grasses to determine their yielding capacity, their longevity, and their suitability to Natal soils in the mist-belt. In a pastoral country it is highly desirable that as much knowledge as possible should be obtained regarding grasses, both indigenous and exotic. Though Natal has upwards of 200 different species of grasses little has hitherto been done to determine if any of them are suitable for planting or sowing.

A commencement has been made with small plots of indigenous grasses, and these small plots are to be extended considerably this year.

Trials on a larger scale are being made with—

Kikuyu Grass (*Pennisetum longistylum*),

Tall Fescue (*Festuca elatior*),

Cocksfoot (*Dactylis glomerata*),

Rhodes Grass (*Chloris gayana*),

Still larger areas of Kikuyu Grass are being put down to test its value as a pasture grass, and later on to prove the possibility or otherwise of eradication of this grass. Should it prove to be fairly easily eradicated it will prove a most welcome aid to a system of rotation where two or three years' pasture is included to rest the land.

## CO-OPERATIVE EXPERIMENTS.

Objections may be, and frequently are, lodged against experiments because they are not typical of the different parts of the country, i.e. a true finding for the middle veld areas is not necessarily correct for the higher veld areas. In order to overcome these objections a commencement has been made in the carrying out of experiments at various centres in the Province. These experiments are carried out on a co-operative basis with different farmers. Experiments are being conducted in the Ladysmith District and in the Thornville Junction District upon maize, cowpeas, and teff, worked in rotation to avoid as far as possible the single crop abuse, and to encourage systems of diversified agriculture. These experiments are as follows:—

First year—Maize.

Second year—Maize.

Third year—Teff.

Fourth year—Cowpeas.

The cowpea is the restorative crop for the grain crop, and the teff crop is a cleaning crop on account of the density of cover which it yields. The cowpeas are cut for hay in some of the experiments and ploughed in in others.

A scheme of manuring is also in operation in conjunction with these rotation experiments. Results to date seem to prove the feasibility and desirability of such a system of crop rotation, and also the need for diversified farming, where stock forms a not unimportant part of the farmer's activities.

## THE IMPROVEMENT OF THE YIELD OF CROPS BY SEED SELECTION.

A commencement was made three or four years ago in the improvement of the maize yield by a correct system of seed selection, but for various reasons it has not been possible to continue with this work, but the importance is such that, in spite of many difficulties, it is being undertaken again.

By a system of selection the sugar content of the sugar beet has been raised to 20 per cent. from a modest 4-5 per cent. The low yield of maize in the Union is capable of very considerable improvement by correct seed selection. The farmer of to-day is too apt to take seed maize which is only apparently good, whereas what is required are high-yielding varieties in which high yields are an inborn character.

Improvement by selection is also to be carried out on the potato crop, which is also apt to be sorely neglected in so far as correct seed selection is concerned. With correct selection an endeavour will be made to prove whether it is possible or not to do without fresh importations of seed potatoes, a practice very generally in vogue at the present time.

## INDIGENOUS FORAGE PLANTS.

Trials are being undertaken to determine the value of indigenous species of plants as forage plants.

It has been observed that where cattle have access to it none of the indigenous cowpea (*Vignap*), which is a perennial, is allowed to



grow, flower, and seed, due to the hard grazing which it receives. At Cedara, in areas fenced off from grazing, this plant is rapidly increasing, so that at the end of November, when in full flower, the areas have a distinct purplish tinge due to the colour of the blooms. Seeing that such a plant is readily eaten by stock, and knowing the value of the cowpea as a cattle food, an endeavour is being made to propagate this plant from cuttings with a view to the establishment of an area for the growth of seed. The advantages of an area of a permanent crop of this description are obvious, and such crops are badly needed.

Another legume with which trials are to be made is an indigenous lotus. This plant is closely grazed where stock have access to it, but in fenced off areas it grows well and seeds. Seeds are to be collected this season to try if it is not possible to establish areas of this plant, which will rival lucerne in value as a forage plant.

A species of indigenous clover, found chiefly on the edges of vleis, will likewise receive attention.

#### WATER GRASS (*Cyperus esculentus*).

A thorough study of this plant is contemplated, as it is considered that this is the worst weed which the farmer has to contend with. The seeding of the plant and its life-cycle are to be studied. The influence of organic matter upon its virility and various methods of eradication are to be tried. Sprays, ploughings, and grazing are all to be tried in an endeavour to find some easy means of combating this weed.

#### THE WATTLE PESTS.

Investigational work on the diseases of the wattle bagworm (*Acanthopsyche junodi* Heylaerts) is being carried out, mainly with the object of determining whether it is possible to utilize any fungal diseases in the artificial control of this serious wattle pest. The chief of these diseases is a deadly fungous disease (*Isaria psyllidac*, Pole Evans). This disease has already been investigated by the Chief of the Division of Botany, but the work was dropped some time ago, partly owing to the poor results of preliminary field tests and partly owing to pressure of other work. The object of the investigational work now being carried out is to determine the modes of infection, the development of the parasite within its host, the seasonal history of the fungus, whether it has alternative hosts or not, and also to find out if possible some simple and inexpensive means of cultivating this fungus artificially, so that spores may be obtained in sufficient quantities for field tests.

Other diseases of the wattle bagworm, such as wilt and a bacterial disease, will also receive attention as time permits.

The brown cockchafer (*Hyperpholes sommere* Burm) is a destructive pest both in the larvae and adult stages; as a white grub buried in the soil it feeds on the roots of various plants, and as an adult beetle it feeds on wattle foliage.

The larva is attacked by a fungus, an *Isaria* sp, very similar to the fungus of the bagworm. It may be identical, and the cockchafer grub may be an alternative host, therefore this disease is also being studied.

Finally, the obscure "frog-hopper" disease of young wattle trees is being investigated. "Frog-hopper" causes a malformation and stunting of young trees and entails much damage in some plantations. The cause of this distorted growth has never been determined, and it is obviously impossible to prescribe remedial measures until the cause of the trouble is known.

#### LIVE STOCK INVESTIGATIONS.

Several breeds of cattle, both beef and dairy, are maintained at the institution and their behaviour noted under identical conditions. Investigations into the cost of producing milk are also to be undertaken. Little is known as regards the cost of milk production in this Province, and detailed costs will be of great value to the many farmers engaged in the dairying business.

Feeding trials with oxen are carried out from time to time also.

#### BLOSSOMING RECORDS.

There are many factors which require to be taken into consideration in the establishment of an orchard, not the least being the suitability of the varieties selected to the locality. The environment may be ideal yet poor results obtained, due to negligence of the following factor. Pollen from certain flowers is sometimes ineffective in the flowers in which it is produced, due to several factors which need not be discussed here. Such flowers fail to produce fruit. In order to obtain a setting of fruit in a variety of this nature, it is essential to have pollen from a different variety to effect the necessary pollination. It is evident, therefore, that where pollen is required for this purpose the two varieties of plants must flower at the same time, or very nearly so. The factor, therefore, of the mixing of varieties of apples, varieties of pears, etc., becomes very important, and where a variety is self-sterile another variety, blooming at the same time, must be introduced.

Careful record is kept of the blossoming times of different varieties of fruit at Cedara, and this information, together with that obtained at other centres in the Union, will be published in due course.

---

## II.—AT WINKEL SPRUIT, NATAL.

---

#### SUGAR-CANE.

At the sub-station at Winkel Spruit trials are being made with various manures upon sugar-cane, and with the effect of trashing against burning of cane. Varieties of cane are also being tested. Whilst the Uba is the standard cane at the present time, other canes are promising to do better than this under identical conditions. These are being tried out further before any definite statement can be made regarding them. Soft canes are also being tried, but up to the present they have not proved a success.

Trials with the planting of tips, butts, and middles are in progress, as likewise manurial trials.

## FIBRE CROPS.

Trials are in progress with several species of fibre plants to ascertain the most promising under local conditions. Sisal, Furcraea, New Zealand Flax, and other fibres are being cultivated.

## FRUITS.

*Pineapples.*—Variety trials with about a dozen varieties are in progress. Distance of planting experiments running conjointly with a rotation experiment with various legumes are also in progress. The legumes, which pineapples are following, are ground nuts, cowpeas, and Canadian Wonder beans.

*Bananas.*—Variety trials with about twenty varieties have been in progress for some time now, and the sections are coming into bearing, so that data will soon be available as to the variety which is proving itself most suited to the coastal belt.

*Citrus.*—Trials with several varieties of oranges, lemons, and grape fruit have been in progress several years, and data now are becoming available as to the advisability or otherwise of endeavouring to grow citrus on the coast belt.

*Mangoes and Arocada Pears.*—Sections of land have lately been planted with both these varieties of fruits, and research work into their grafting, budding, etc., with improved varieties is being undertaken.

## STARCH CROPS.

The chief starch-producing crops grown, though not for extraction purposes, are sweet potatoes, arrowroot, and cassava. About fifteen varieties of sweet potatoes are undergoing trial, ten of these having very recently been received from U.S.A. It is expected to find from these, varieties that will reach maturity during the short summer months frequently experienced on the high veld.

Several varieties of arrowroot and cassava are under trial.

Ginger is also grown and large crops produced, but there appears to be no market for the ginger root at present.

---

**Wet Hides for Shipment—Marking of Goods.**

The Union-Castle Mail S.S. Company draw attention to the extreme difficulty experienced by their London principals in sorting out according to marks the various shipments of wet hides. This is attributed to the fact that the tin disk attached to each bundle rusts, with the result that the marks are illegible on arrival at the port of discharge. It has therefore been decided by the Railway Department that only consignments bearing zinc or strong galvanized-iron or wooden disks with the marks clearly stamped thereon are to be accepted for shipment.

---

## NOTES FROM THE DIVISIONS.

---

### DIVISION OF ENTOMOLOGY.

---

*Australian Bug*.—About thirty years ago the Australian bug or Dorthesia (*Icerya purchasi*) was a frightful pest to citrus trees, roses, and certain other plants in parts of the Cape Province. It had reached Capetown from Australia in 1873, and gradually increased and spread. In 1892 the so-called Vedalia ladybird (*Novius cardinalis*) was introduced and the pest was speedily subjugated. Ever since, however, there have been local outbreaks of the bug here and there all over the country, and a close search in almost any large garden or orchard in which grow any of the most favoured food plants of the insect will disclose its presence in small numbers. The Vedalia, and to a minor extent certain native ladybirds, soon find the occurrence unaided and practically extinguish them; but every year apprehension of trees being killed leads to a number of urgent appeals for ladybirds being made to the Government. The bug is generally far more prevalent along the Witwatersrand than anywhere else in the country, a circumstance associated with the high altitude and the abundance of trees favourable to the insect. In the warmer parts of the country the Vedalia appears to keep actively after the bug throughout the winter, while in the high veld it is rarely much in evidence except at midsummer, and the bug breeds for months with little molestation. For reasons not very clear the bug was much less common around Johannesburg in the 1918-19 season than for years previously; and it was far more prevalent in Pretoria through the winter and spring of 1919 than at any time since Union, and probably ever before. The season was particularly dry, and a few black wattle street trees succumbed to the combined weakening effect of the insect and the drought. Many scores of black wattle and jacaranda trees were quite heavily infested, and not a few of the latter kind of tree seemed to suffer seriously from the attack. The Vedalia seemed absent through the winter and spring, but as summer came on it showed up everywhere, and in a few weeks suppressed the outbreak and then quickly dropped out of sight again. In early December thousands of the ladybird in all stages could be collected in an hour or so, where in January it was hard to find any at all. The Division for some time has been endeavouring to have colonies of the ladybird reach Ceylon and Brazil alive in order to suppress outbreaks of the bug in those countries. There is hope that success has attended recent shipments.

*Tobacco Leaf Beetle*.—Tobacco growers throughout South Africa are asked to be on the watch for, and to report to the Division of Entomology, the presence on growing tobacco of a slender yellow and black striped beetle about one quarter inch in length which develops

from a slimy sluglike grub. The insect in question, *Lema bilineata*, is believed to be an accidental importation from South America, whence it may not unreasonably be suspected to have come with forage during the South African war about twenty years ago. Since 1913 it has been reported from Durban, Cedara, Paulpietersburg, and Mooi River in Natal; from Piet Retief and Wakkerstroom in the Transvaal; and from the Tarka and Bathurst Districts of the Cape Province. The experience of Piet Retief tobacco growers indicates that the insect is a pest that may necessitate systematic spraying with an arsenical poison several times every season, and that this may considerably increase the cost of tobacco production. The beetles are long lived. The female lays eggs off and on for several months, generally in clusters of 15 to 40, and to a total of 1000 to 2000. The eggs are long and yellow, and the clusters are easily found on the leaves of the food plants. The slimy grubs feed up rapidly, and in summer mature in about two weeks from the laying of the eggs. They then go to the ground to pupate, and the beetles emerge in about another fortnight. Breeding ceases during the fall and adult beetles live over to the following summer. Living beetles have been found deep in a bale of cured tobacco, and are said by farmers to be common in curing sheds. It is therefore suspected that the pest is being spread with shipments of newly baled tobacco, and that in the fall and winter it may also hide itself in other produce and thus be carried to distant places. Besides tobacco, the insect feeds readily on stinkblaar (*Stramonium*) and on several weeds (*Physalis* and *Nicandra*) closely related to the Cape gooseberry. The plants are sometimes quite destroyed. Fortunately the insect feeds but little on the potato plant.

*Imported Pests.*—The tobacco leaf beetle is not the only South American insect that has spread to South Africa. The Argentine ant is a notorious example. It is popularly supposed to have reached the Cape Peninsula with forage from Argentina during the South African war; but as a matter of fact it occurred both at Stellenbosch and Kingwilliamstown years before, and it is likely to have got to South Africa from Madeira. Another apparent introduction from South America is a Melyrid beetle named *Astylus atramaculatus*, which in the last few years has been observed to be very common in lucerne fields near Pretoria. It is a small yellow and black beetle somewhat resembling the smallest of the Mylabrid beetles that so commonly feast on flowers, often showing a partiality for the blossoms of broad beans and of apple trees, but the Melyrids have the reputation of being beneficial insects. Their larvae are said to be carnivorous, and the beetles are credited with living on insect eggs and small soft-bodied insects.

*Toktokje Beetles in Millions.*—During December, Mr. P. E. Potter, Divisional Superintendent, South African Railways, Pretoria, sent to the Division of Entomology specimens of a toktokje beetle that he wrote occurred in great numbers for about five miles along the railway near Granite (Zoutpansberg District). He added: "Some two years ago, I am told, the beetles infested the neighbourhood in millions. They were able to cross over one rail by means of the ballast, which was packed on the outer side, but they could not escape from between the rails, as the inner side afforded a sheer height of some 3½ inches, and the beetles were thus trapped between the rails

and died in millions. These beetles seem to travel from the west, going in an easterly direction."

Dr. L. Peringuey, Director of the S.A. Museum, identified the species as *Psammodes illotus*, Py. The number of species of *Psammodes* is very great, and many of the various species are so much alike that it is difficult to separate them. As a class they are familiar insects in the veld, being the large, heavy-bodied, brownish to black, non-flying beetles that one so commonly sees lumbering along without apparent purpose. Occasionally they pause and tap the bare ground

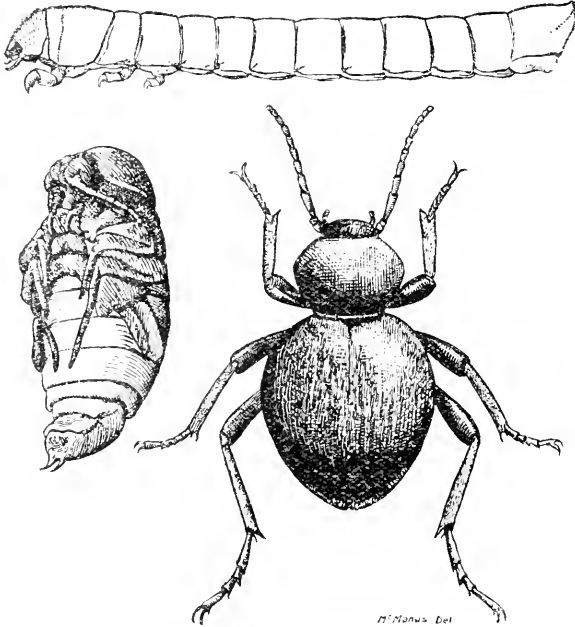

TOK-TOKJE: At top, larva, about full grown: at left, pupa removed from cell: at right, adult beetle. All enlarged one-half.

smartly with the tip of the abdomen, thus producing the peculiar knocking noise, a sex call, that gives them their popular name. The beetles appear to be practically harmless; but the larvae of all kinds are supposed to feed on the roots of plants, and so the railway must be considered to be serving a useful purpose in trapping beetles to their death. Occasionally larvae are found damaging the roots of maize and wheat, but they seem to be far more abundant at the roots of veld grasses than in cultivated lands.

*Butterflies in Swarms.*—Northern Natal and much of the southern part of the Transvaal was treated during December to the novelty of prodigious numbers of white butterflies all flying in one direction. Judging from the letters that reached the Division of Entomology the movement was at its height between the 7th and 18th of the month. Not unnaturally many farmers thought that the butterflies portended outbreaks of the mystery (army) worm or of some

similar pest, but the particular butterfly (*Belenisis mesentina*) is not one known to trouble cultivated plants. The officers of the division are ignorant as to where the hordes came from, and even as to the usual food plants of the species; but the butterfly has been reared at Pretoria from a common veld bush (*Rhus* sp. probably *viminialis*), and it is suspected that it is the larvae of this species that sometimes defoliates the witstam tree (*Capparis albitranca*). Swarms of the same butterfly have been reported in other years, not only in Natal and the Transvaal, but in the Orange Free State and eastern districts of the Cape Province. While the insects seen at one time all proceed in one direction, the direction of movement is variable. At Pretoria the movement was generally northerly, but on one morning one of the officers of the Division observed that it was then easterly. Two correspondents wrote that it was to the north-west, two others that it was north-east, and others that it was east; several stated that it was against the wind.

*Pernicious Scale in the Orange Free State.*—Pernicious (San Jose) scale was first recognized in South Africa during 1911, when it was discovered at a number of centres in the Transvaal and Natal. As the years have gone by it has become more and more a pest in the localities where it is under observation, but it is still more a garden than an orchard pest. The town of Pretoria is fast becoming generally infested, and each year for several years the plant nurseries in and near the town have been found to have become invaded; much of the time of one plant inspector is taken up with precautions exercised against the spread of the pest with plants sent away from the town. No occurrence of the insect is known or suspected anywhere in the Cape Province, and until recently the only occurrences known in the Orange Free State were at Kroonstad and at Viljoens Drift, the latter a small place across the river from Vereeniging, in the Transvaal. It now appears that the insect occurs in the Free State, near the Natal border. Writing in January from Thoreng, P.O. Harrismith, a correspondent sent specimens to the Division of Entomology with the information:—"I am sending you a piece of plum branch infested with a blue-grey scale which is fast killing apples too. This horrible pest crams the branches and sucks the sap; in a few weeks the tree is dead." The insect, in reality, is generally present two or more seasons before a tree is likely to succumb to its attack, but it commonly happens that it is not observed until trees are damaged beyond recovery.

---

### Telegraphic Requests for Vaccines, etc.

Urgent telegrams for vaccines, etc., are frequently addressed to the head office of the Department in the Union Buildings, Pretoria, and have to be sent on to the Laboratory at Onderstepoort, thus causing delay. All applications of this nature should be made direct to the Director of Veterinary Research, Onderstepoort, whose telegraphic address is "Microbe," Pretoria.

## EGG-LAYING COMPETITION.

### Report on the Second Egg-Laying Competition held at the School of Agriculture, Cedara, Natal, 22nd April, 1918, to 21st April, 1919.

By T. B. Cross, Poultry Instructor.

THE second egg-laying competition, open to breeders of pure-bred poultry residing in South Africa, commenced on 22nd April, 1918, and terminated on the 21st April, 1919.

*Site, etc.*—The site, houses, and runs were exactly the same as those in use in the first egg-laying competition held at Cedara in 1917-1918, a full description of which is given in Bulletin (Local Series) No. 70, obtainable from the Librarian, Department of Agriculture, Pretoria, at 1d. per copy.

*Entries.*—Twenty competitors made entries of twenty-four pens, each pen containing five birds.

The competing pens consisted of:—

- 15 pens of White Leghorns.
- 4 pens of White Wyandottes.
- 1 pen of Anconas.
- 1 pen of Black Leghorns.
- 1 pen of Barred Plymouth Rocks.
- 1 pen of Black Orpingtons.
- 1 pen of White Orpingtons.

With the exception of three pens of White Leghorns from the Transvaal, all entries were from competitors residing in Natal.

Generally speaking, the quality of the competing birds was not nearly so good as in the previous competition; many immature birds were entered, and several did not lay for the first three months of the competition.

In the heavy breeds, particularly Black Orpingtons, birds of exhibition type were included in the pen and consequently did poorly.

The moult commenced early and was very prolonged; this may have been influenced by the extremely bad hatching season experienced the previous year, hence the poor average records. The weather during the competition was normal for the locality; the climate at Cedara is very changeable, and in summer hot days are invariably followed by cold misty nights, which certainly does not tend to stimulate egg-production.

The conditions governing the competition were similar to those in the former contest, viz., from the commencement of the competition only 2-oz. eggs being accepted, but 1 $\frac{3}{4}$  to 2 oz. eggs were recorded.

*Feeding Menu.*—The feeding menu was similar to that of the first competition, wet mash being fed in the morning, green food at noon, and grain in the afternoon; flint grit, oyster-shell, and vegetable



charcoal were always before the birds; fresh water was supplied daily, and always shaded.

The mash consisted of equal parts by bulk of wheaten bran and pollard and green food, chiefly rape, cabbage, and lettuce, cooked overnight, to which was added meat meal in the proportion of  $1\frac{1}{2}$  to 2 lb. per 100 birds; to this was added a small quantity of salt. The daily allowance of mash was about 2 oz. per bird. At noon, finely chopped green food was supplied; this varied according to the season, but more than sufficient was always available. The following was chiefly used: Lettuce, rape, cabbage, green buckwheat, and Kikuyu grass.

In the afternoon, usually about 4 p.m. in summer and half an hour earlier in winter, grain was fed in the scratching litter; as in the previous competition the ration consisted of two parts oats, two parts kaffir corn, one part each of buckwheat, sunflower seed, and crushed maize.

In wet stormy weather a little extra grain was given at noon to keep the birds employed under cover. The allowance of grain per bird per diem was about 2 oz.

Epsom salts were occasionally given in the mash during the fine weather. A plentiful supply of scratching litter being on hand, a frequent change was made.

The quantities of food consumed were:—

Food.	Weight.		Amount.		
	lb.	£	s.	d.	
Wheaten Bran ... ..	1,650	7	8	6	
Meat Meal ... ..	625	4	7	6	
Pollard ... ..	1,594	8	0	0	
Mealie Meal ... ..	250	1	0	7 $\frac{1}{2}$	
Green Food ... ..	1,375	2	10	0	
	5,494	£23	6	7 $\frac{1}{2}$	
Oats ... ..	1,220	6	2	0	
Kaffir Corn ... ..	1,280	6	2	3	
Buckwheat ... ..	850	5	12	7 $\frac{1}{2}$	
Crushed Maize ... ..	875	3	3	4 $\frac{1}{4}$	
Sunflower Seed ... ..	450	2	5	0	
	4,675	£23	5	2 $\frac{3}{4}$	
Grit and Oyster-shell ... ..	830	4	3	4	
Charcoal ... ..	350	1	1	0	
Salt, coarse ... ..	10	0	5	0	
Epsom Salts ... ..		0	5	0	
	1,220	£5	14	4	
TOTALS					
Mash ... ..	5,494	23	6	7 $\frac{1}{2}$	
Grain ... ..	4,675	23	5	2 $\frac{3}{4}$	
Grit, etc. ... ..	1,220	5	14	4	
	11,389	£52	6	2 $\frac{1}{4}$	

The total cost of feeding during the twelve months was £52. 6s. 2 $\frac{1}{4}$ d., giving an average cost per bird per annum of 8s. 8 $\frac{1}{2}$ d.

*Egg Production.*—The total yield for the twelve months was:—

Standard weight eggs ... ..	10,832
Underweight ... ..	2,747
<b>Total ... ..</b>	<b>13,579</b>

Average per bird 113.16.

The total value of eggs laid during the competition was £113. 1s. 3¼d. These were valued on the basis of the prices ruling on the nearest market (Pietermaritzburg) during the year. The average price of first grade eggs was 2s. 6¼d. and second grade 1s. 11½d.

#### ANALYSIS OF EGG-PRODUCTION.

Breed.	Under 50.	51-100.	101-150.	151-180.	181-200.	Total.
White Leghorn ...	1	13	42	15	1	75
White Wyandotte ...	1	5	12	2	—	20
Ancona ...	—	3	1	1	—	5
Black Leghorn ...	—	2	3	—	—	5
Barred Rock ...	—	3	1	1	—	5
Black Orpington ...	—	5	—	—	—	5
White Orpington ...	1	1	—	—	—	5
<b>TOTAL ... ..</b>	<b>6</b>	<b>35</b>	<b>59</b>	<b>19</b>	<b>1</b>	<b>120</b>

#### DEATHS.

Cause.	Pen No.												Total.
	2.	8.	9.	10.	11.	14.	18.	19.	20.	21.	22.	23.	
Tuberculosis... ..	1	1	2	—	—	1	—	—	—	—	—	1	6
Abscess on the Esophagus... ..	—	—	—	—	—	—	—	1	—	—	—	—	1
Pneumonia ... ..	—	—	—	1	—	—	—	—	—	—	—	—	1
Peritonitis ... ..	—	1	—	—	—	—	—	—	1	—	—	—	2
Tumour on Gizzard... ..	—	—	1	—	—	—	—	—	—	1	—	—	2
Rupture of Blood Vessel ... ..	—	—	—	1	—	—	—	—	—	—	—	—	1
Rupture of Oviduct ... ..	—	—	—	—	1	—	1	—	—	—	—	1	3
<b>TOTAL ... ..</b>	<b>1</b>	<b>2</b>	<b>3</b>	<b>2</b>	<b>1</b>	<b>1</b>	<b>1</b>	<b>1</b>	<b>1</b>	<b>1</b>	<b>1</b>	<b>1</b>	<b>16</b>

#### REJECTION.

Pen No. 6 ... ..	1	Pen No. 16 ... ..	1
Pen No. 8 ... ..	1	Pen No. 18 ... ..	1
Pen No. 11 ... ..	1		

Sixteen deaths occurred from various causes, five birds were rejected, and four were replaced. Two of the birds rejected were "going light," one from anaemia, one rheumatism, and one tumour in abdomen.

*Weights.*—The average weight per bird in the competition pens are as follows, taken in October, 1918:—

Pen No.	Breed.	Average Weight per Bird.
1	White Leghorn ... ..	2 lb. 15 oz.
2	" " ... ..	3 " 4 "
3	" " ... ..	3 " 3 "
4	White Wyandotte ... ..	4 " 7 "
5	Black Leghorn ... ..	3 " 10 "
6	White Leghorn ... ..	2 " 11 "
7	" " ... ..	3 " 0 "
8	" " ... ..	2 " 12 "
9	White Orpington ... ..	4 " 15 "
10	White Leghorn ... ..	3 " 0 "
11	" " ... ..	3 " 0 "
12	Black Orpington ... ..	5 " 3 "
13	White Leghorn ... ..	2 " 14 "
14	Barred Rock ... ..	5 " 4 "
15	White Leghorn ... ..	3 " 4 "
16	" " ... ..	3 " 1 "
17	White Wyandotte ... ..	1 " 11 "
18	" " ... ..	3 " 8 "
19	White Leghorn ... ..	3 " 5 "
20	" " ... ..	3 " 2 "
21	White Wyandotte ... ..	5 " 1 "
22	Ancona ... ..	3 " 1 "
23	White Leghorn ... ..	3 " 7 "
24	" " ... ..	3 " 8 "

#### AWARDS.

The silver and bronze medals presented by the South African Poultry Association for the pens laying the greatest number of standard weight eggs during the competition were won by Pens Nos. 13 and 19, both White Leghorns, the property of Messrs. Crozier and Brown, Johannesburg, and H. E. Dunning, Pietermaritzburg, respectively. Pen No. 13 laid 671 full-weight eggs, 52 under-weight, and No. 19, 656 full-weight eggs and 74 under-weight.

A generous donation of £5s. 5s. each was made by the following poultry clubs to the prize list of the competition:—The Natal Poultry Club, the Durban and Coast Poultry Club, and the Klip River Poultry Club; and £1. 1s. from the Greenwood Park and Red Hill Poultry Club.

This was allocated by the advisory sub-committee as follows:—

- (a) £2. 2s. for pen of light breeds laying the largest number of standard eggs during the competition. Won by Pen No. 13, White Leghorns, the property of Messrs. Crozier & Brown, Johannesburg with 671 full-weight eggs.
- (b) £1. 1s. runner-up to winner of (a). Won by Pen No. 19, White Leghorns, the property of Mr. H. E. Dunning, Pietermaritzburg, with 656 full-weight eggs.
- (c) £2. 2s. for pen of heavy breeds laying the largest number of standard eggs during the currency of competition. Won by Pen No. 17, White Wyandottes, the property of Mr. C. B. Upton, Pietermaritzburg, with 618 full-weight eggs.

- (d) £1. 1s. runner-up to winner of (c). Won by Pen No. 4, White Wyandottes, the property of Mr. C. Amas, Pietermaritzburg, with 530 full-weight eggs.
- (e) £2. 2s. for individual White Leghorn laying largest number of standard eggs during currency of competition. Won by Hen No. 71, Pen No. 15, the property of Mr. R. Porritt, Pietermaritzburg, with 155 full-weight eggs.
- (f) £1. 1s. runner-up to winner of (e). Won by Hen No. 75, Pen No. 15, the property of Mr. Porritt, Pietermaritzburg, with 155 full-weight eggs.
- (g) £1. 1s. for individual light breed, other than White Leghorn, laying the largest number of standard eggs during the currency of the competition. Won by Hen No. 110, Pen No. 22, Ancona, the property of Mr. W. C. Ferguson, Dundee, Natal, with 139 full-weight eggs.
- (h) £1. 1s. for individual White Wyandotte laying largest number of standard weight eggs during currency of competition. Won by Hen No. 19, Pen No. 4, the property of Mr. C. Amas, Pietermaritzburg, with 141 full-weight eggs.
- (i) £1. 1s. for individual heavy breed, other than White Wyandotte, laying largest number of standard weight eggs during currency of competition. Won by Hen No. 59, Pen No. 12, Black Orpington, the property of Mr. M. J. C. Anderson, Vryheid, with 78 full-weight eggs.
- (j) £2. 2s. for hen laying largest number of standard eggs during last three months of competition. Won by Pen No. 22, Anconas, the property of Mr. W. C. Ferguson, Dundee, Natal, with 98 full-weight eggs.

## SUMMARY.

Duration of contest, 12 months.

Number of pens, 24.

Number of birds, 120.

Total number of eggs laid, 13,579.

Value of eggs laid, £113. 1s. 3¼d.

Cost of feeding, £52. 6s. 2¼d.

Profit over cost of feeding, £60. 15s. 1d.

Average market price per dozen, 2s. 6¼d. first grade, 1s. 11½d. second grade.

Average cost of feeding to produce 1 dozen eggs, 11.09d.

Average number of eggs laid per pen, 565.74.

Average number of eggs laid per bird, 113.16.

Average cost of food per pen, £2. 3s. 7d.

Average cost per hen, 8s. 8½d.

Profit over cost of food per pen, £2. 10s. 7½d.

Profit over cost of food per pen, 10s. 1½d.

Eggs laid by winning pen, 2 oz. and over, 671; 1¼ to 2 oz., 52.

Highest value of eggs laid by any pen, £6. 10s. 6¼d.

Lowest value of eggs laid by any pen, £2. 4s. 11½d.

## CEDARA EGG-LAYING COMPETITION.

22nd April, 1918, to 21st April, 1919 (5 Hens to Pen). Final Results. Grand Totals for Twelve Months' Operations.

Pen No.	Final Egg Position.	Final Value.	Owner.	Breed.	1918.			1918.			1918.		
					April May.	May June.	June July.	July August.	August September.				
1	17	12	E. S. Bowman	White Leghorns	a.	b.	c.	a.	b.	c.	a.	b.	c.
2	8	9	L. Ragsbaw-Smith	"	2	13	18	22	22	8	66	1	5
3	15	5	A. S. Paul	"	5	12	13	15	15	32	76	1	85
4	10	3	C. Anas	White Wyandottes	3	18	18	15	15	15	83	1	90
5	12	23	W. B. Stewart	Black Leghorns	3	11	31	3	6	6	80	—	94
6	7	27	A. B. Clency	White Leghorns	2	2	55	3	33	10	71	—	64
7	6	34	Glenwood F. Yards	"	3	30	30	—	30	37	71	—	86
8	22	7	V. H. Brisley	"	12	9	30	11	39	5	57	—	87
9	23	51	M. J. C. Anderson	White Orpingtons	—	—	66	3	32	5	30	1	53
10	9	2	Mrs. S. Bennett	White Leghorns	5	12	—	—	17	14	18	—	52
11	14	2	R. Porritt	"	2	1	6	—	32	2	77	2	93
12	20	—	M. J. C. Anderson	Black Orpingtons	—	—	13	—	18	1	65	—	76
13	1	42	Crozier & Brown	White Leghorns	11	11	73	—	19	1	77	—	83
14	18	5	W. C. Ferguson	Barred Rocks	10	3	15	—	8	10	53	—	84
15	3	17	R. Porritt	White Leghorns	1	1	61	2	10	—	89	—	88
16	16	7	R. B. Lyle	"	13	—	27	3	24	—	76	2	85
17	5	45	C. B. Upton	White Wyandottes	1	—	81	1	17	—	71	—	94
18	19	20	V. H. Brisley	"	28	—	44	25	1	20	56	4	81
19	2	33	H. E. Dunning	White Leghorns	16	—	76	2	18	12	77	—	99
20	11	48	Duke Bros.	"	4	—	54	—	11	—	74	—	79
21	24	—	E. Shackelford	White Wyandottes	36	5	2	12	1	10	26	—	47
22	13	28	W. C. Ferguson	Anconas	—	—	41	—	26	—	70	1	78
23	4	49	James Groves	White Leghorns	13	—	71	—	1	21	88	—	98
24	21	—	E. E. Holman	"	—	—	1	—	1	—	25	—	82

a. 2 oz. and over.

b. 1 1/2 oz. and over.

c. Unmarketable.

## CEDARA EGG-LAYING COMPETITION.—(Continued.)

22nd April, 1918, to 21st April, 1919 (5 Hens to Pen), Final Results, Grand Totals for Twelve Months' Operations.—(Continued.)

Pen No.	Final Egg Position.	Final Value	Owner.	Breed.	1918.		1918.		1918.		1918 1919.		1919.	
					September October.	October- November.	November December.	December January.	December January.	January February.				
1	17	12	E. S. Bowman	White Leghorns...	a	c	a	c	a	c	a	c	a	c
2	8	7	L. Baughaw-Smith	"	65	31	15	70	10	64	1	39	11	40
3	15	13	A. S. Paul...	"	69	2	80	9	59	6	59	11	49	22
4	10	10	C. Amas	White Wyandottes	68	16	16	32	21	31	28	20	23	22
5	12	14	W. B. Stewart	Black Leghorns...	71	1	54	5	48	8	39	6	30	7
6	7	8	A. B. Cheney	White Leghorns...	68	3	72	7	44	13	25	6	39	8
7	6	9	Glenwood P. Yards	"	83	1	60	14	1	59	59	6	45	5
8	22	21	V. H. Brisley	"	96	—	75	4	59	2	68	—	55	2
9	23	24	M. J. C. Anderson	White Orpingtons	27	32	1	17	12	2	9	22	6	12
10	9	2	Mrs. S. Bennett	White Leghorns...	64	18	28	47	1	9	42	—	8	20
11	14	20	R. Porritt	"	71	13	41	39	26	36	34	23	45	22
12	20	22	M. J. C. Anderson	Black Orpingtons	70	—	54	9	31	16	59	7	34	14
13	1	1	Crozier & Brown	White Leghorns...	44	25	47	25	1	15	29	4	12	1
14	18	19	W. C. Ferguson	Barred Rocks	88	1	57	10	56	10	64	6	46	11
15	3	4	R. Porritt	White Leghorns...	58	30	23	24	32	29	11	21	18	28
16	16	18	R. B. Lyle	White Leghorns...	89	2	63	19	49	18	62	8	3	55
17	5	15	C. B. Upton	"	56	21	16	35	15	37	18	28	1	38
18	19	16	V. H. Brisley	White Wyandottes	70	1	46	2	46	1	59	3	43	7
19	2	3	H. E. Dunning	White Leghorns...	48	16	11	33	1	31	5	2	11	5
20	11	15	Duke Bros.	"	104	3	62	20	1	62	11	60	7	48
21	24	17	F. Shackleford	White Wyandottes	76	—	57	4	42	8	19	—	12	—
22	13	11	W. C. Ferguson	Anconas	36	34	20	15	37	19	3	1	19	5
23	4	6	James Groves	White Leghorns...	64	6	27	13	13	17	23	9	45	6
24	21	23	E. E. Holman	"	90	1	55	2	48	8	34	1	64	—
					82	8	27	42	13	15	10	20	24	12

a. 2 oz. and over.

b. 1½ oz. and over.

c. Unmarketable.

CEDARA EGG-LAYING COMPETITION.—(Continued.)  
 22nd April, 1918, to 21st April, 1919 (5 Hens to Pop.), Final Results. Grand Totals for Twelve Months' Operations.—(Continued.)

Pen No.	Final Egg Position.	Final Value	Owner.	Breed.	1919.			1919.			Totals.				Total Cash Value of Eggs Laid.		
					February-March.		March-April.	1919.		March-April.	a.	b.	c.	d.	£	s.	d.
1	17	12	E. S. Bowman	White Leghorns	—	1	—	—	—	—	—	335	285	—	4	13	0 <sup>1</sup> / <sub>2</sub>
2	8	7	L. Bagshaw-Smith	"	3	1	2	19	2	—	—	583	58	2	5	7	11 <sup>2</sup> / <sub>2</sub>
3	15	13	A. S. Paul	"	6	—	—	13	—	—	—	416	160	—	4	12	2 <sup>3</sup> / <sub>4</sub>
4	10	10	C. Amas	White Wyandottes	18	3	—	28	—	—	—	530	35	—	4	19	0 <sup>1</sup> / <sub>2</sub>
5	12	14	W. B. Stewart	Black Leghorns	3	—	—	7	—	—	—	482	51	—	4	10	7
6	7	8	A. B. Cheney	White Leghorns	8	—	—	—	—	—	—	589	42	1	5	5	11 <sup>3</sup> / <sub>4</sub>
7	6	9	Glenwood P. Yards	"	4	—	—	11	—	—	—	609	8	—	5	5	8 <sup>3</sup> / <sub>4</sub>
8	22	21	V. H. Brisley	"	—	6	1	8	—	—	—	221	199	13	3	1	7 <sup>1</sup> / <sub>2</sub>
9	23	24	M. J. C. Anderson	White Orpingtons	—	—	—	—	—	—	—	185	157	—	2	1	11 <sup>1</sup> / <sub>2</sub>
10	9	2	Mrs. S. Bennett	White Leghorns	10	—	—	32	3	—	—	563	173	—	6	9	8 <sup>3</sup> / <sub>4</sub>
11	14	20	R. Porritt	"	15	3	—	15	—	—	—	445	50	—	4	1	5 <sup>1</sup> / <sub>2</sub>
12	20	22	M. J. C. Anderson	Black Orpingtons	—	—	—	—	—	—	—	281	115	2	2	14	1 <sup>1</sup> / <sub>2</sub>
13	1	1	Crozier & Brown	White Leghorns	12	2	—	24	—	—	—	671	52	—	6	10	6 <sup>1</sup> / <sub>2</sub>
14	18	19	W. C. Ferguson	Barred Rocks	7	21	—	5	18	—	—	307	216	1	4	2	0 <sup>3</sup> / <sub>4</sub>
15	3	4	R. Porritt	White Leghorns	14	1	—	26	—	1	—	653	71	5	6	5	2 <sup>3</sup> / <sub>4</sub>
16	16	18	R. B. Lyle	"	6	—	1	8	—	—	—	376	169	2	1	4	9 <sup>1</sup> / <sub>2</sub>
17	5	5	C. B. Cinton	White Wyandottes	22	1	—	24	—	—	—	618	17	—	5	18	5 <sup>1</sup> / <sub>2</sub>
18	19	16	V. H. Brisley	"	2	15	1	12	9	—	—	301	210	18	4	6	5 <sup>3</sup> / <sub>4</sub>
19	2	3	H. E. Dunning	White Leghorns	9	1	—	8	—	—	—	656	74	1	6	6	1
20	11	15	Duke Bros.	"	—	—	—	17	—	—	—	489	12	—	1	6	10 <sup>1</sup> / <sub>2</sub>
21	24	17	E. Shackelford	White Wyandottes	2	39	6	1	28	—	—	134	419	67	4	5	6 <sup>1</sup> / <sub>2</sub>
22	13	11	W. C. Ferguson	Anconas	22	2	—	31	—	—	—	471	54	—	4	14	4 <sup>1</sup> / <sub>2</sub>
23	4	6	James Groves	White Leghorns	17	—	—	6	—	—	—	641	21	1	5	17	8 <sup>3</sup> / <sub>4</sub>
24	21	23	E. E. Hoffman	"	10	—	—	1	—	—	—	276	99	—	2	13	9 <sup>3</sup> / <sub>4</sub>
											10,832	2,747	114	£113	1	34	

a, 2 oz. and over. b, 1<sup>1</sup>/<sub>2</sub> oz. and over. c, Unmarketable.

## THE BOTANICAL SURVEY OF THE UNION.

### A Matter of Far-reaching Importance.

A matter which had long been advocated by the Division of Botany and urged on by the Scientific and Technical Committee took definite shape when on the 18th February, 1918, at a meeting for the purpose of discussing the organization of a Botanical Survey of the Union, attended by officers of the Divisions of Botany and of Veterinary Research, the Forest Department and the Schools of Agriculture, it was unanimously decided that the aims and scope of the survey should be:—

- (1) To continue and extend the survey and systematic work already carried out by the Division of Botany on the vegetation of the country.
- (2) To continue and extend the survey work already carried out by the Division of Veterinary Research on the relation of such vegetation to the unsolved stock diseases of South Africa.
- (3) To continue and extend the collections of the plant parasites of the indigenous vegetation already made by the Division of Botany and proceed with its examination as a possible reservoir of diseases of cultivated plants and of domesticated animals, and, in particular, map their distribution.
- (4) To continue and extend the work already accomplished by the Forest Department in further ascertaining the composition of the indigenous forests, the value of their products, and their industrial possibilities.
- (5) To study the vegetation from an industrial point of view.
- (6) To study the vegetation in its relation to agricultural and pastoral developments.
- (7) To study the plant succession under natural and artificial conditions.
- (8) To study the vegetation of the veld in connection with its feeding value and carrying capacity and distinguish botanically between "sour" and "sweet" velds, good and bad pastures.
- (9) To study the disturbing influence of burning, manuring, cultivation, drainage, irrigation, overstocking, insect and plant pests on the natural vegetation.
- (10) To study plant distribution according to geological, orographical, and climatological conditions, and the conditions which influence the different plant formations.
- (11) To extend our knowledge of the medicinal and poisonous plants of the country.



- (12) To study the influence of South African conditions on the structure and physiology of our plants and in particular the causes which give rise to non-parasitic diseases.
- (13) To compare and correlate our flora and its associated animal and plant diseases with those existing in other parts of the world under somewhat similar telluric and climatic conditions.
- (14) To devote more attention to the soil and its micro-organisms.

At the same meeting the best means of carrying out such a survey and of securing proper organization, co-ordination, and co-operation between the Government Departments concerned and voluntary workers were unanimously agreed upon. They included the appointment of the Chief, Division of Botany, as director, with the assistance of an advisory committee; the dividing of the country into convenient botanical areas, each controlled by a botanist; the establishment of a Central Herbarium at Pretoria with regional herbaria, and the working thereof; the special examination at Kew of all plants submitted (Miss A. M. Corbishley was appointed for this purpose on the 1st October last); the publication from time to time of all matters of interest arising from the survey, etc.

The scheme was approved of by the Minister of Agriculture, the following Advisory Committee being formed:—

- I. B. Pole Evans, M.A., D.Sc., F.L.S., Chief, Division of Plant Pathology and Botany, and Director of the Survey.
- Professor J. W. Bews, M.A., D.Sc., Natal University College.
- Mrs. L. Bolus, B.A., South African College, Capetown.
- Dr. R. Marloth, M.A., Ph.D., Capetown.
- Professor G. Potts, M.Sc., Ph.D., Grey University College, Bloemfontein.
- Professor S. Schonland, M.A., Ph.D., Rhodes University College, Grahamstown.
- C. E. Legat, B.Sc., Chief Conservator of Forests;
- E. R. Montgomery, M.R.C.V.S., Director of Veterinary Research.

The Advisory Committee met twice in 1918, once each in Capetown and Pretoria, making considerable progress in matters of organization, and drew up the following division of the country into administrative areas, viz.:—

1. The south-western area under Dr. Marloth.
2. The south-eastern area under Professor Schonland.
3. The eastern area, including Pondoland, Natal, and Zululand, under Professor Bews.
4. The Orange Free State and Basutoland under Professor Potts.
5. Griqualand West and all the country north of the Vaal River under the direct supervision of the Director of the Survey.

## THE FIRST PUBLICATION

will soon be issued as Memoir (No. 1) by Professor Schonland on "The Phanerogamic Flora of the Divisions of Uitenhage and Port Elizabeth," being an account of the flowering plants of these Divisions, and forming a companion to the lists, published by the South African Philosophical Society and the Royal Society of South Africa, of the plants of the Cape Peninsula (by Bolus and Wolley Dod) and of Natal (by J. Medley Wood).

An appreciative note on the establishment of the Botanic Survey appears in the Bulletin of the Royal Botanic Gardens, Kew (No. 10, 1919), in which the writer refers to "the enlightenment of outlook in matters connected with the learning of scientific knowledge on practical affairs which experience has taught us to expect on the part of the Government of the Union of South Africa."

**Kaffir Corn—Production in the Union.**

The following statement shows the total quantity of Kaffir corn grown in the four Provinces of the Union (note: 1 muid = 200 lb.):—

PROVINCE	Census 1911 (1910 Crop). Muids.	Census 1918 (1918 Crop). Muids.	Estimated Crop, 1919. Muids.	Estimated Crop, 1919. Muids.
Cape of Good Hope	299,422	465,683	254,500	220,200
Natal	594,132	337,024	334,700	433,400
Transvaal	462,758	837,650	631,800	653,200
Orange Free State	191,414	161,058	129,000	104,800
Total—Union	<u>1,547,726</u>	<u>1,801,415</u>	<u>1,350,000</u>	<u>1,411,600*</u>

A comparison of the Census returns of 1911 and 1918 shows that, while the production of Kaffir corn made an appreciable forward movement in the Cape and Transvaal Provinces, there is a considerable falling off in the production of the crop in Natal, and in the Orange Free State also there is a small reduction.

The above figures show that the total kaffir corn crop in 1918 was produced as follows:—

In Cape of Good Hope	26 per cent.
Natal	19 .. ..
Transvaal	46 .. ..
Orange Free State	9 .. ..
	<u>100 .. ..</u>

\* Preliminary estimate. Adverse weather conditions have reduced the prospects. See the Crop Report, page 218.

## THE DEPARTMENT OF AGRICULTURE DURING THE WAR.

[This article briefly reviews the work carried out by the various branches of the Department during the years of the war, and records some achievements despite the many difficulties encountered through the abnormal conditions then existing. ACTING EDITOR.]

EVIDENCE of the advance of agriculture in South Africa is visible on all sides. The application of scientific methods of farming, the growth of concerted effort, and organization engendered by education and the experience of the past are bearing fruit in greater production, increasing numbers of pure-bred live stock, and a higher standard in the quality of our products. Our country, which not so long ago had to depend—if not for its life, then for most of its comfort—on the production and energy of other countries, has now shaken off this stigma: its importance as an exporting country looms ever larger in the eyes of the world and the promise of future development was never brighter.

The Department of Agriculture is charged with the duty of promoting and guiding the country's agricultural activities, and unceasingly watches over and strives to advance the interests relegated to it. The task is a great one, for it involves the building up of the farming industry, which has truly been termed "the backbone of the country." The Department, as constituted to-day, is one of the outstanding forces in the life of the Union, and it is well that the farmers of the country whose interests are so dependent on its activities should know what is being done by their own Department and realize the efforts it is putting forward to ensure their well-being.

An agricultural journal enables the Department to keep in touch with the farmers, but this means was denied it since August, 1914, and in order therefore to bridge in a measure the hiatus, and to give a brief sketch of some of the matters coming under the purview of the Department during the stress of the great war, the following notes are given. To do so will necessitate touching on a wide range of subjects, and many of far-reaching importance in themselves which entailed considerable anxiety, thought, and time on the part of the Department, have had perforce to be passed without special reference. Fuller particulars are obtainable from the published annual reports of the Department for the financial years covering the period dealt with in this article.

The situation created by the war was a most trying one. Besides seriously reducing the staff by withdrawing officers from it and rendering it impossible to fill many of the vacancies occurring in it, the war imposed a great many additional duties upon the Department of a pressing nature and far from easy to discharge, whilst the ensuing financial stringency and the increased cost of running the Department contributed to the difficulty of the task. Indirectly, also, the war added materially to the work of the Department, for the resultant high prices and keen demand for foodstuffs and products of the soil gave a great impetus to agriculture, leading to many branches of

farming coming to the fore earlier than they otherwise would have done. Like many young industries, these new developments required a great deal of attention to enable them to make the most of the unique opportunity presented of establishing themselves. The necessity of those industries becoming self-supporting and gaining a footing in the overseas market, on which they will ultimately have to depend, demanded unremitting attention. Although, as will be seen, a good deal of work was done and advances made in many directions, the risks with a depleted staff were considerable, particularly in connection with diseases of stock. The war, therefore, greatly upset the Department and caused the postponement of many extensions that were in progress or imminent when hostilities broke out, and which would have materially increased its usefulness.

Before passing on to the work done by the various divisions of the Department, it is felt that the public should know what it costs the country. The following figures show the total expenditure and revenue, viz.:—

Year ended 31st March.	(1) Agriculture (exclusive of Agricultural Education).		(2) Agricultural Education.		Total Excess of Expen- diture over Revenue.
	Expenditure.	Revenue.	Expenditure.	Revenue.	
	£	£	£	£	
1915 ...	394,633	62,116	87,442	42,709	377,250
1916 ...	382,945	106,279	73,238	24,821	325,083
1917 ...	397,564	86,196	72,923	27,961	356,330
1918 ...	500,006	124,918	81,778	38,339	418,527

#### VETERINARY DIVISION.

This division deals with the prevention of the introduction of contagious diseases of live stock into the Union, with the eradication of such diseases as are already present, and with the protection of live stock against enzootic diseases by inoculation and other means. It also advises and assists farmers regarding diseases of stock.

During the financial year 1914-15 East Coast fever was severe in the Transkeian Territories, and varying fortunes were reported from other parts of the Union, some areas which had previously been declared clear showing fresh outbreaks of the disease while others shook it off. In Natal the outbreaks showed a decline, although the disease was still widespread in Zululand. There was a good deal of mortality from anthrax, while an abundant rainfall induced virulent and widespread horse-sickness and blue-tongue. Gallamziekte was gradually breaking out in new centres. Nagana was spreading in Zululand, but the position in regard to glanders and lung-sickness was satisfactory.

During 1915-16 about half of the professional staff and a number of stock inspectors of the Veterinary Division were on active service, and the work of coping with animal diseases was greatly handicapped. With the exception of anthrax and East Coast fever, there was fortunately no serious extension of disease of any kind. Outbreaks of anthrax were numerous in the Transvaal and Cape Provinces, while East Coast fever showed a considerable recrudescence in Natal and in a lesser degree in the Transvaal; the position in the Cape Province was easing, though still bad in native areas. The policy in regard to tuberculosis in cattle was maintained, but the Stock Disease Act was

amended to allow of the admission of cattle into the Union without being tested for tuberculosis after arrival, provided they had been tested at a Government station in the country of origin, immediately before shipment, in a manner approved by the Minister. Other scheduled contagious diseases were not much in evidence, nor were horse-sickness, blue-tongue, and other non-scheduled epizootic diseases as prevalent as usual.

Although labouring under great difficulties in 1916-17 owing to continued shortage of staff, due principally to the war, no serious extensions of contagious diseases occurred, and on the contrary good progress was made, the outlook being encouraging. This is a matter for congratulation in view of the grave risks attending the movements of live stock for military purposes without the means of sufficient veterinary supervision.

During the year an additional duty was placed on the division through being made responsible for the inspection of meat prior to export, which was stimulated by the war and commenced earlier than was contemplated. East Coast fever continued to give cause for alarm, and in the Transvaal and Natal there were extensions of the disease in certain centres, but the erection of dipping tanks and fencing was having beneficial results, and though no great improvement in the disease was disclosed by statistics, the position was considered to be better and more hopeful than it had yet been. With the exception of East Coast fever, anthrax was responsible this year for greater mortality amongst live stock than the whole of the other contagious diseases combined. It increased rapidly, particularly in the Transvaal. Owing to staff shortage little could be done in regard to tuberculosis in cattle. There was considerable discussion in regard to the question of the amount of compensation (one-quarter of the value) paid for animals slaughtered on account of tuberculosis, which it was held should be increased to three-quarters of the value. The testing of cattle prior to shipment could not be carried into effect owing to the war, so imported cattle were continued to be tested at the ports. Of 455 cattle tested 3.5 per cent. reacted and were destroyed. In order to facilitate trade, arrangements were made for the admission into the Union of slaughter cattle from Rhodesia and Swaziland in the same way as from the Bechuanaland Protectorate, and altogether 43,689 slaughter cattle were brought into the Union during the year.

The year 1917-18 witnessed a continuance of the shortage of staff and the attendant danger of the spread of animal disease, but fortunately nothing untoward occurred. During the year, 1380 outbreaks of disease were dealt with, 1127 animals from oversea were examined at the ports, and the introduction of 51,000 head of cattle from adjoining territories was supervised. East Coast fever continued to engage the major portion of attention. In the Transvaal the disease continued in several districts, and though its virulence had abated in Natal, fresh outbreaks constantly appeared. The regrettable continuance of the disease was attributed in a large measure to lack of thorough dipping, a result to some extent of the cost of dipping materials. The policy regarding tuberculosis continued in force, and although a Bill was introduced in Parliament increasing the amount of compensation payable, congestion of work in Parliament caused the matter to lapse. The testing of cattle for tuberculosis before shipment to the Union was still not possible owing to the war. Anthrax

caused a good deal of trouble and was prevalent—one outbreak in Boshof being more virulent in type than any previously experienced. Contagious abortion caused considerable loss, and no satisfactory method for treating the disease has been devised. Early in the year disquieting reports were received of the spread of rinderpest in German East Africa, and with a view to preventing the spread of the disease southward a commission was sent to inquire into the matter. This commission was occupied for over a year, and as a result of their efforts their object seems to have been achieved by the immunization of about 100,000 head of native cattle in a belt of country extending from Lake Nyasa to Lake Tanganyika, which checked the southward extension of the disease. The season being a wet one, a number of non-proclaimed diseases, such as horse-sickness, blue-tongue, wire-worm and other parasites in sheep were more prevalent, but, on the other hand, gallamziekte in cattle was less in evidence than usual. The supervision of meat exported was continued, practically the whole quantity exported, 279,085 quarters, which arrived in good condition, being purchased by the Imperial Government at 5½d. per lb. f.o.b. The meat, which was largely derived from unimproved cattle of the country, was reported as being good, but a fair amount of it was considered only third rate in quality, being apparently from oldish animals.

(This review will be continued in subsequent issues of the *Journal*.)

### Maize Production in the Four Provinces.

The following table showing the total production of maize in the four Provinces will prove useful for purposes of comparison (note: 1 muid = 200 lb.):—

PROVINCE.	Census 1911 (1910 Crop). Muids.	Census 1918 (1918 Crop). Muids.	Estimated Crop, 1919. Muids.	Estimated Crop, 1920. Muids.
Cape of Good Hope	1,727,864	2,387,488	1,415,000	1,296,600
Natal ... ..	1,805,745	1,443,898	1,855,000	2,143,200
Transvaal ... ..	3,310,613	4,553,921	5,139,000	5,536,500
Orange Free State	1,788,294	4,254,784	3,151,000	3,765,300
Total—Union ...	<u>8,632,516</u>	<u>12,640,091</u>	<u>11,560,000</u>	<u>12,741,600*</u>

Thus the Union's production of maize in 1918 was 46 per cent. greater than it was eight years previously, while the 1919 crop is estimated to be 8.5 per cent. less than that of 1918, owing principally to unfavourable conditions.

The above figures show that in 1918 the Union's total crop was produced as follows:—

In Cape of Good Hope ... ..	19 per cent.
In Natal ... ..	11 per cent.
In Transvaal ... ..	36 per cent.
In Orange Free State ... ..	34 per cent.
	<hr/>
	100 per cent.

\* Preliminary estimate. Adverse weather has reduced the prospects. See the Crop Report on page 218.

## NOTES.

---

### IMPORTANT NOTICE.

---

THE *Journal* will contain most of the matter published by the Department. It is sent to all libraries in the Union, as well as to various other institutions and societies, while the subscription, 5s. per annum, is small, consequently it should be within the reach of all. As a comprehensive index of its contents will be published half-yearly, inquirers for advice on any subject which has appeared in the *Journal* are likely in future to be referred to the number in question for the information they require.

It is essential, therefore, that all who wish to avail themselves of the advice and information tendered by the Department should

OBTAIN AND KEEP EACH NUMBER,

as published, of the *Journal of the Department of Agriculture*.

Apart from and in addition to the matter printed in the *Journal*, special bulletins will be published from time to time as occasion demands. They will be issued as "Science Bulletin No....." or "Bulletin No....." as the case may be, notification thereof being made in the *Journal* and copies being obtainable on application to the Department of Agriculture.

---

### The Minister of Agriculture.

It is announced (14th April, 1920) that the Honourable H. C. van Heerden has resigned the Portfolio of Agriculture, and that this Portfolio will be taken over by the Honourable F. S. Malan, in addition to those of Mines and Industries and of Education.

---

### Sheep and Goat Skins.

In June last year a small consignment of sheep and goat skins was sent to London to ascertain whether a trade in this class of skin could not be established on the market there. Reports on the consignment are to the effect that the tannage, though somewhat dark, is one that would find a satisfactory sale in London, but that the skins were very much mixed in quality, size, and substance, and would need proper grading and sorting if they are to be saleable. Many of them were catalogued as light in substance, broken (some very badly) on the grain, ill-shapen, and holey, and lightly ribbed. Only skins of good quality, evenly classed for size and substance, are saleable.

A well-known local firm of fellmongers and tanners, commenting on the matter, states that the majority of sheep-skins marketed in the Union are of very inferior quality owing to lack of care by farmers. The flaying is bad and the drying worse, reducing the value of the skin. Greater care would mean higher prices, easily attainable by

salting skins and shade drying them so as to ensure their remaining flexible and not cracking on the grain when packed. This firm states:—

“ In our experience of buying what are marketed here as sound sheep-skins, we think only some 14 per cent. on average give sound pelts on removing wool and tanning skins, and when you take into consideration the difference in value between an absolutely sound pelt and an inferior one (probably 3s.), it is easily shown that the loss amounts to thousands of pounds in the course of a year.”

### Export of Seed.

In view of inquiries received from New York regarding the purchase from the Union of certain classes of seed, the following extract from the Seed Importation Act of the United States of America (24th August, 1912) is given for general information:—

(1) The importation into the United States of seeds of alfalfa, barley, Canadian blue grass, Kentucky blue grass, awnless brome grass, buckwheat, clover, field corn, Kaffir corn, meadow fescue, flax, millet, oats, orchard grass, rape, reedtop, rye, sorghum, timothy, and wheat, or mixtures of seeds containing any of such seeds as one of the principal component parts, which are adulterated or unfit for seeding purposes under the terms of this Act, is hereby prohibited; provided, however, that such seed may be delivered to the owner or consignee thereof under bond, to be recleaned in accordance with and subject to such regulations as the Secretary of the Treasury may prescribe, and when cleaned to the standard of purity specified in this Act for admission into the United States such seed may be released to the owner or consignee thereof after the screenings or other refuse removed from such seed shall have been disposed of.

(2) That seed shall be considered adulterated within the meaning of this Act: First, when seed of red clover contains more than 3 per cent. by weight of seed of yellow trefoil, or any other seed of similar appearance to and of lower market value than seed of red clover. Second, when seed of alfalfa contains more than 3 per cent. by weight of seed of yellow trefoil, burr clover, and sweet clover, singly or combined. Third, when any kind or variety of the seeds or any mixture contains more than 5 per cent. by weight of seed of another kind or variety of lower market value and of similar appearance: provided that the mixture of the seed of white and alsike clover, red and alsike clover, or alsike clover and timothy, shall not be deemed an adulteration under this section.

(3) The seed shall be considered unfit for seeding purposes within the meaning of this Act: First, when any kind or variety of clover or alfalfa seed contains more than one seed of dodder to five grammes of clover or alfalfa seed respectively. Second, when any kind or variety of the seeds or any mixture described in Section 1 of this Act contains more than 3 per cent. by weight of seeds of weeds.

(*Note.*—Regulations superseding previous ones for the enforcement of the above Act were issued under Treasury Decision No. 35363 to take effect from 15th May, 1915.)



## The Merino Ram.

Mr. A. G. Michaelian, Principal Sheep and Wool Expert, gives the following description\* of what is considered an ideal ram. This number includes an illustration ("The Merino Ram") of a merino ram bred in South Africa which bears out this description:—

"The merino ram should be a well-built, symmetrical sheep, standing on four good, strong, straight legs, wide across the shoulder and loins, with a deep chest, straight back, and well sprung ribs. He should have good thighs, be well let down and roomy, with a good

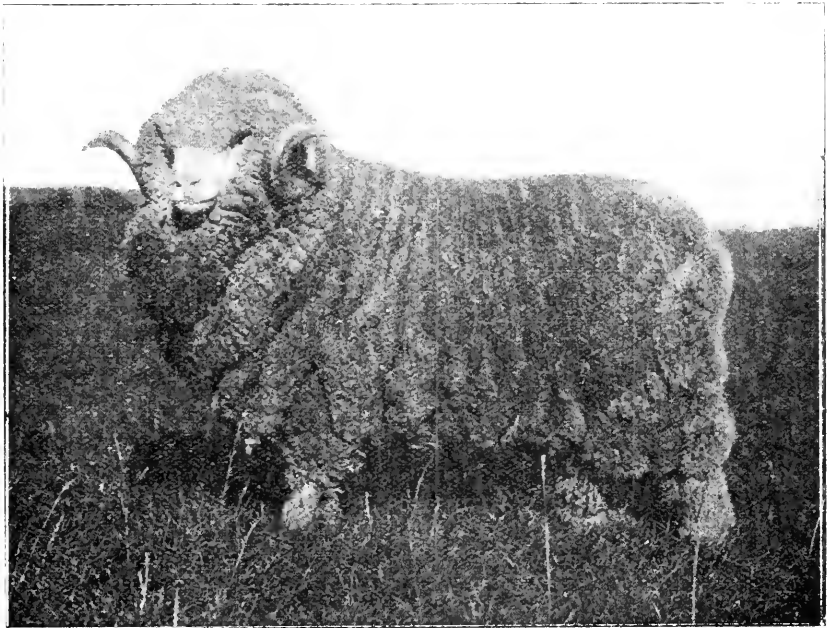

Photo of a Magnificent Ram, bred in South Africa.

underline. He should have a strong, well-shaped, masculine head, with good, thick, well-curved horns of a good colour, showing distinct corrugation; a kind, soft, open face, with a kind eye, a broad, thick muzzle, with a good, sound mouth and soft, downy ears. The head must be set on the body with a rather short, thick neck.

He should have a full, bold, even front, with a good tail, and should move with a free, bold, masculine carriage.

He should be well and evenly covered with a strong, bright, masculine fleece, with plenty of 'guts' in it, of good length, full of character and quality, with a good tip.'

### Plant Nurseries in Quarantine for Pests.

The following plant nurseries have been quarantined because of insect pests and plant diseases. Some of the quarantines may be removed before the coming winter sale season, and a few even before this notice reaches the public. The position shown is that on 10th April. The nurseries in Natal, Orange Free State, and portions of the Transvaal have not yet been inspected for the present season.

During the existence of a quarantine, the occupier of the nursery is forbidden to dispose of any of the plants involved.

Name of Nurseryman.	Address.	Cause of Quarantine.	Extent of Quarantine.
S. Todd & Sons ...	Pietermaritzburg	Red scale ...	Portion of citrus.
D. A. English & Co. ...	"	" " ...	" " "
F. Grace ...	Berlin, C. P. ...	" " ...	" " "
P. C. S. Gaylard ...	"	" " ...	All of citrus.
Smith Bros. ...	Vineyard, Uitenhage	" " ...	Portion of figs and pears.
Municipal Nursery ...	St. George's Park, Port Elizabeth	Circular purple scale	Palms.
W. H. Oliver ...	East London ...	Red scale ...	Whole nursery (apples).
J. Hobson & Co. ...	Kingwilliamstown	" " ...	Portion of citrus.
Botanic Gardens ...	Graaff-Reinet ...	" " ...	All citrus.
" " ...	"	Woolly aphid ...	All apples.
J. H. Laubscher ...	"	Red scale ...	All citrus and figs.
Municipal Nursery ...	Somerset East ...	" " ...	All citrus.
W. T. Atwood ...	Observatory, C.T.	" " ...	Whole nursery.
C. F. Marais ...	Wellington ...	" " ...	All citrus.
J. S. Rossouw ...	"	" " ...	" "
N. S. v. d. Merwe ...	"	" " ...	" "
E. Krohn ...	Mare Street, Pretoria	Pernicious scale and other pests	Whole nursery.
E. Krohn ...	Esselen Street, Pretoria	Pernicious scale and other pests	Part of nursery: various kinds of plants.
V. d. Wal & Reese ...	Derdepoort, Pretoria	Pernicious scale...	Parts of peaches, plums, and pears.

### Wheat Production of the Union.

It is well known that the Union does not produce sufficient wheat to meet local requirements—to what extent will be gathered from the following table of importations into the Union of wheat (including flour reduced to grain):—

Imports in 1912 ... ..	1,271,367 bags (200 lb.).
" " 1913 ... ..	2,244,224 "
" " 1914 ... ..	1,637,797 "
" " 1915 ... ..	1,561,196 "
" " 1916 ... ..	1,697,046 "
" " 1917 ... ..	1,134,226 "
" " 1918 ... ..	534,000 "
" " 1919 ... ..	588,600 "

There was an increase of 23 per cent. in the acreage put under wheat in 1917, and, according to the last Census, the total wheat production of the Union that year was 3,044,855 bags, a record for the Union.

the average yield per acre (not including native grown wheat) being 2.98 bags, or 9.93 bushels of 60 lb. The condition of the 1917 crop is estimated, however, to have been slightly below normal, so that a full return may be taken at about 3 bags, or 10 bushels per acre. (NOTE.—The estimated crop in 1918 was 2,695,000 bags and 1,990,000 bags in 1919.)

According to the Census, the actual returns for 1917 were as follows:—

	Yield per Acre, 1917.			
Cape ... ..	3.08	bags	or	10.27 bushels.
Natal ... ..	1.74	..	..	5.8 ..
Transvaal... ..	2.79	..	..	9.3 ..
Orange Free State...	2.47	..	..	8.23 ..
	<u>2.98</u>	..	..	<u>9.93</u> ..

It is estimated, however, that the 1917 crop was below normal, and that a full yield per acre should have been as follows:—

	Percentage below Normal.	Estimated full Yield per Acre in an Ordinary Favourable Season.
Cape... ..	2 per cent.	3.14 bags or 10.47 bushels.
Transvaal... ..	30 ..	3.99 .. .. 13.29 ..
Orange Free State	7 ..	2.66 .. .. 8.85 ..
	<u>5</u> ..	<u>3.14</u> .. .. <u>10.45</u> ..

It is interesting to compare the above with the wheat yields obtained in the principal wheat growing countries of the world, as shown in the table hereunder:—

	Average Yield per Acre in Bushels.	
	1911-1913.	1916.
United States ... ..	14.5	11.75
Russia in Europe ... ..	(a) 10	9.07 (1914)
India ... ..	12.2	10.23
Canada ... ..	20.17	21.18
France ... ..	19.8	16.08
Australia ... ..	12.1	13.22
Argentine ... ..	(b) 9.3	10.19
Italy ... ..	16.3	14.65
Germany ... ..	33.1	27.75 (1915)
Hungary ... ..	(c) 19.9	17.89 (1915)
Spain ... ..	12.8	14.66
Russia in Asia ... ..	(a) 10	12.44

(a) Average for the Russian Empire; (b) Average for 1912-14:  
(c) including Austria.

In some of the smaller producing countries the yield was as follows:—United Kingdom (1911-13), 32.2 bushels; (1916), 28.48 bushels; New Zealand (1916), 23.20 bushels. The highest return for 1916 was 38.52 bushels in Denmark, and the lowest 4.69 in Tunis.

## Cotton Growing Prospects.

Mr. W. H. Scherffius, Chief, Division of Tobacco and Cotton, who has recently returned from a visit to the United States, spending a few weeks also in England, asked to give his views on the cotton market and its bearing on South African cotton growing, states that with cotton, as given in the latest reports, standing at about 2s. 1d. per 1 lb. of lint in England for American middlings, the outlook for the cotton farmer in South Africa is exceedingly good, for should he produce a crop of only 600 lb. of seed cotton per acre, it is worth £15 to £20. A number of farmers who have been growing cotton for the past two or three years have produced double and some more than double this amount. With the world demand for more cotton and a shortage increasing each year, there is little prospect of the price falling to any considerable extent for years to come. Mr. Scherffius doubts whether American middlings will ever again be quoted at less than 1s. per lb.

That South African cotton growers are alive to the situation is evidenced by the fact that over a hundred have entered a competition given by the British Cotton Growers' Association, who offer prizes of £50 and £25 respectively for the best 50 acres and 10 acres of cotton. In awarding the prizes the main points considered are—

- (a) best cultural methods employed;
- (b) yield; and
- (c) quality.

Mr. Scherffius will decide on the first two points, while the quality will be judged by one of the experts of the Association.

South Africa has now passed the "sample stage" in cotton culture. Last year the Union produced approximately 2,000,000 lb. of seed cotton, and if the season improves the acreage planted this year should give a considerable increase over last season.

There are a number of people who intend to go in for cotton culture on a plantation basis, each undertaking running into hundreds of acres. It is known that certain farmers have this year more than 400 acres each under cotton, and that there is contemplated the starting also of a steam plough system next year with a view to planting hundreds of acres to cotton.

Our ginning facilities have greatly improved in the last few years, but if the increase in cotton production progresses at the present rate, considerable increase in the number of gins will be required. Then, also, the time is approaching when oil mills will be needed to work the seed into stock food, in the form of cake and meal, and also for the extraction of the oil for food and commercial purposes. Such a mill, it is believed, is now in process of construction.

Mr. Scherffius advises prospective growers that while the cotton plant is exceedingly delicate and tender when very young, once it is established, a few weeks old, there is no commercial crop that stands drought better. Information desired on cotton culture may be obtained by communicating with the Chief, Tobacco and Cotton Division, Union Buildings, Pretoria.

## Colonial Wine Competition, 1919—Awards and Judges' Report.

At the Brewers' Exhibition held towards the close of 1919 at the Royal Agricultural Hall, Islington, London, a number of samples of South African wines were entered in the Colonial Wine Competition and received awards in the following classes. Australian wines taking all the first prizes:—

- 3rd Prize (Class B).—Red, light claret type, two years old or over.
- 3rd Prize (Class C).—Red, full-bodied, Burgundy type, two years old or over.
- 2nd Prize (Class F).—Muscat character and rich white wines, over 30 per cent. alcohol, two years old or over.
- 3rd Prize (Class K).—Red, light claret type, two years old or over.
- 3rd Prize (Class L).—Red, full-bodied, Burgundy type, two years old or over.

The jurors, reporting on the wines and spirits exhibited, state that owing, unfortunately, to transport difficulties the wines submitted for competition were not so numerous as in the years before the war, and several of the samples were found out of condition and difficult to judge, otherwise the specimens received were of a satisfactory quality. Altogether there were 111 samples of wines and spirits from Australia and South Africa, and these were arranged in classes according to the entries, viz.:—

### 1st.—*Light White Wines.*

These wines were of good character and should be popular, several showing fine quality and a marked improvement.

### 2nd.—*Red Claret Type.*

This class was well represented, and the wines generally were well made, sound, reliable, and of good style.

### 3rd.—*Full Burgundy Type.*

This class also had a number of exhibits; the wines have good body, some fairly pronounced in style, and the quality generally good, although they did not show such a rich fruity character as some of those submitted in previous years.

### 4th.—*Sweet Muscatel and Port Types.*

These wines are pleasant and agreeable, and some excellent samples were found in both the light and ruby colours.

### 5th.—*Sparkling Wines.*

A distinct improvement has been made in this class, some of the samples being of good style and quality and most attractive.

### 6th.—*Brandy.*

These samples varied considerably in quality and style, one, however, being of special merit.

Speaking generally, the samples exhibited were of a good marketable variety and well worthy of competing with those from the older

wine-producing countries. It is pleasing to note that South Africa was more fully represented, and there should be a future for its wine products, the exhibits being very promising. The Australian section, however, with its greater variety, still obtains the best results.

### Purchase of "Mariendahl."

About the middle of May, 1919, at the time when the Government scheme for the training of returned soldiers was being formulated, and it had been decided that the schools of agriculture would take a lead in the training of these men, the farm Mariendahl, adjoining Elsenburg, came on the market. The owner, Mr. W. Gilchrist, asked for tenders for the purchase of the farm as a running concern, and the Secretary for Lands, on behalf of the Government, proved the successful tenderer. The place was taken over on the 2nd June, 1919.

The immediate object of the purchase was to provide for the training of returned soldiers at the Elsenburg School of Agriculture. Under the scheme of training decided on there are two courses open for soldiers:—

- (a) The regular school course, which is the official two-year diploma course.
- (b) A one-year's course, which is almost entirely practical and in which no systematic courses of lectures are given in those branches of farming taught at Elsenburg.

Since Mariendahl was well stocked and liberally equipped with implements, etc., it was possible with little expense to adapt the place so as to afford the men a suitable course in practical agriculture.

Mariendahl had been organized as a dairy farm by the late owner, who held contracts for the supply of fresh chilled milk to several institutions, etc., in Capetown, and his dairy herd (some 150 head of Cape cattle, mostly of the Fries strain) was tested annually and freed of tuberculosis. These were included in the purchase, as were also the draught animals.

Amongst the large quantity of tools, machinery, and implements purchased with the farm, there is a 1½-ton refrigerating plant with the necessary operating engine. The engine is adapted also for working a grain grinder, silage cutter, etc. The farm buildings consist of a long, rambling homestead, a cowbyre for 80 cows, a dairy for cooling and handling milk, two wooden silos, one wagon and implement shed with horse stable and stores. In addition there are a roomy manager's cottage and several smaller cottages for white and coloured employees.

The farm consists of 900 acres, the greater proportion of which is arable land, utilized for the growing of grain and forage crops for the cattle. There are, however, 22 acres planted to pear trees and 15 acres to vines.

When the farm was taken over, the homestead was remodelled at small expense to form a hostel for students, and as early as the end of August there were in residence there a matron and 25 students.

The manager's cottage is occupied by a field instructor, who is also the officer responsible for the details of the management of the farm and the discipline of the soldier apprentices.

By the end of September the herd of cattle had been reduced to 80 head as a result of the transfers of breeding stock to other training farms. The yield of milk at the time of writing would approximate 90 gallons per diem.

Early in the spring, a young orchard of 1100 trees comprising about equal numbers of apricots, peaches, and prune trees was planted, and the vineyard enlarged by another 3000 vines. In addition about 2 acres of land have been planted to turkish tobacco. It is proposed to develop these branches of farming in order to afford a better general training for all students.

The soil at Elsenburg is not as suitable for the growing of the varieties of fruit mentioned as that of Mariendahl. Further, it is considered that in the future Mariendahl farm, as an adjunct of Elsenburg, should be run as a commercial unit, and that the experimental and investigational work in field, orchard, and vineyard, should be confined to Elsenburg. Such an arrangement would be of great educational value to future farmers of this part of the country.

---

### Wheat Growing in South Africa.

Wheat growing in our country presents problems both of a cultural and economic nature, and the report\* of the Departmental Committee appointed by the Minister of Agriculture to inquire into the conditions of wheat growing in the Union gives a comprehensive view of the subject. It is dealt with in relation to the whole farming system in our wheat-growing areas, and constitutes therefore a permanent record of a considerable part of our agriculture, for wheat is the most important of all the autumn and winter-sown cereal crops in the Union, and ranks second to maize in the value of farm crops produced in South Africa. The Committee's duties consisted of (a) an educational campaign and (b) an economic investigation, so that the evidence obtained from the large number of interviewed people experienced in the several branches of the subject and the findings of the Committee, together with the statistical and technical data included in the report, form a valuable work.

The report deals with the factors affecting production in the various areas of the Union capable of wheat cultivation; comments on difficulties of transportation and labour; outlines the work of the Department of Agriculture in assisting wheat growers by experiments, seed breeding, distribution of pure seed, etc.; gives the miller's point of view; describes the system of marketing with the need for an independent system of rural finance for the agricultural industry, etc. The absence of uniformity of grades receives attention, and certain remedies are suggested. The influence of the war on local wheat production, the increased cost thereof, and the war measures adopted in other countries to increase wheat production, are also referred to. Altogether, a great deal of important information and advice is given in the report, which should prove most valuable to the farmer, the student, and others concerned in the position of the Union as regards its production of that vital article—the bread of the people.

---

\* "Report of the Departmental Committee on Wheat Growing." U.G. 42. 1919: price 6s. 6d.; obtainable from the Government Printer, Pretoria.

## Export of Cattle from the Union to Great Britain.

An Order (No. 10056, of 5th May, 1919) of the Board of Agriculture and Fisheries brings once more into operation the law (suspended for a while) concerning the prohibited introduction into a port of Great Britain of cattle, sheep, goats, or swine from certain countries, whether such animals are carried as ship's stores or otherwise. As an outcome of representations, however, regarding the admission of Friesland cattle from the Union, advice has been received that they will be admitted into Great Britain on the following conditions:—

- (a) That the cattle would only be imported on the order of bona fide purchasers in Great Britain and under the auspices of the Government of the Union of South Africa and of a recognized breed society.
- (b) That the importations would be limited to pedigree cattle of the Holstein (Friesland) breed.
- (c) That the cattle would be required to be landed at a foreign animals' quarantine station to be defined by an Order of the Minister, and be there detained and isolated for a period of four calendar months after landing, the Ministry reserving to themselves the right to slaughter all or any of the animals without compensation other than the sum realized by way of salvage of the carcasses in the event of the appearance amongst them of foot-and-mouth disease, contagious pleuro-pneumonia, or cattle plague.
- (d) All expenses incurred in connection with the import of cattle in question would have to be borne by the importers.

---

## Poultry Shows: Organization.

We have received a useful little pamphlet entitled "A Few Notes and Suggestions for the Organization and Conduct of Poultry Clubs and Shows," compiled by Mr. P. H. Taylor, Secretary to the South African Poultry Association. The object of the pamphlet is to assist newly-formed poultry clubs and agricultural societies in organizing poultry shows, and secretaries of such bodies would be well advised to obtain a copy. We understand the Poultry Association will be pleased to supply copies on application to P.O. Box 692, Pretoria.

---

We advise you to get each copy of the *Journal* and to keep it. A full index will be sent every six months to each subscriber. Experience proves the *Journal* to be a useful book of reference. It will be so in the future. Every farmer is asked to get the *Journal* and ~~not to lose it~~.—It is likely that some day, in answer to an inquiry, you may be referred to an article in the *Journal*. Keep your *Journal*!



## THE POULTRY YARD MONTH BY MONTH.

---

BY J. J. JORDAAN, Lecturer and Instructor in Poultry. School of Agriculture, Glen Orange Free State.

---

SINCE in practice the South African poultry breeder's year commences with the breeding season, these notes will start with the present number of the *Journal* and be continued monthly for twelve months.

In view of the vast extent of the Union and its varying conditions of climate, soil, environment, etc., notes such as these can serve as a general guide only. They do not profess to contain *all* that requires to be done in each month in the year, but are intended to show the irreducible minimum which *must* be done month by month by the poultry breeder who wishes to run his business or hobby on correct and profitable lines.

It would lead us too far to attempt in these notes to deal with more than a small proportion of these diseases, accidents, and untoward occurrences which may—and indeed do—crop up from time to time even in the best regulated poultry yard, and which are, and must remain, matters for the individual breeder to deal with to the best of his ability. In this connection it may be pointed out that the Poultry Instructor at the School of Agriculture which serves the area in which the breeder resides, is at all times ready and willing to furnish advice in all matters relating to the poultry yard, free of charge—when in difficulty or doubt a letter to him is well worth while.

The following points, which constitute the main principles of poultry breeding and are applicable to the whole year, may here be mentioned in order to avoid repetition month by month, viz. :—

- Fresh, sweet soil in the runs.
  - Abundance of cool, clean, drinking water.
  - Suitable and sufficient housing accommodation.
  - Correct and regular feeding.
- 

### MAY.

---

#### *Egg Production.*

New laid eggs are very expensive during this month. Endeavour therefore to obtain all eggs possible from pullets and hens not in the breeding pens, using forcing foods and spices if necessary : the price of new laid eggs will warrant this at this time of year.

Warm housing at night, exercise during the day, abundance of green food and drinking water, and warm mash in the mornings, to which a liberal amount of meat meal, Crayferine, or cut green bone has been added, and good wholesome grain food dug into the ground, giving as much variety as is obtainable, should produce eggs if the birds are of a laying strain.

#### *Feeding.*

The following will be found a good laying mash :—

- 3 parts bran (wheaten).
- 2 parts crushed oats.
- 6 parts lucerne-hay or meal.
- 1 part pollard.
- $\frac{1}{2}$  part meat meal, Crayferine, or green bone.

*Breeding Pens.*

The same mash, minus the meat meal, Crayferine, and green bone, fed "dry" to the breeding hens in the morning, and the grain food fed at night with liberal supplies of green food at mid-day, should suffice.

Specially see to the feeding of the male bird; he must be kept in good condition; feed him separately from the hens at midday with a little table scraps.

Do not allow the temptation of high prices for new laid eggs to lead you into forcing the breeding-pen birds to produce abnormally, for this will only be at the cost of fertility and will result in weakened chicks.

Nor should eagerness to fill the incubator, or to supply orders for day-old chicks or settings of eggs, lead to the above, as it is a poor policy in the end.

Again, do not put more hens to the male bird than he can possibly fertilize. The following are safe numbers as a guide. Heavy varieties, 3 to 6. Light varieties, 5 to 9.

This is one of the best months of the year to hatch chicks, but they must be from eggs produced normally.

All eggs should be gathered daily, as eggs if exposed to frost are liable to give poor hatching results, and are not so good for eating owing to evaporation being so much more rapid.

*Incubation.*

Visit your incubator room at night just before retiring, and note the temperature of the room as well as that of the drawer; a little attention in this direction may prevent losses from "dead in shell."

If the hens go broody, give them eggs; they are useful in looking after incubated chicks as these hatch. In spite of all the abuse showered on the old broody hen in regard to broken eggs, insects, etc., there are few of our large breeders who do not hatch their show and competition winners under the hen.

When the machine is due to hatch, do not open the drawer to show every friend the little things coming out. *Once* a day is the most it should be done. The drawer should on no account be opened more than once daily during the hatching period.

*Chickens.*

After being hatched do not feed the chicks for 36 to 48 hours or bowel trouble will result.

Their first feed should be coarse sand or very fine flint grit. Therefore, for the first three or four weeks coarse oatmeal and chicken croats are best, with liberal feeds of finely chopped green food and ants, but no damp or moistened food should be given them.

Milk to drink will also be found excellent, but it should always be given either sour or fresh. The former is better.

The feeding should be a little at a time, but often, about every three hours as much as they will clean up readily.

Do not pamper or attempt to rear weak chicks, as these are a fruitful source of trouble even if they do live.

Visit your small chicks after having been to the incubator house and see that they are comfortable; observation and interest will soon show if they are, and if not, what is wrong.

Should the air smell foul on opening the lid of the brooder, the ventilation is bad. If the chicks are swarming upon each other they are either cold or seeking fresh air. If screaming and shivering, they are cold, wanting warmth. If gasping and drooping wings, they are overheated and need more ventilation. If sleeping and spread out over the floor, they are contented and comfortable. Feel their crops; at night these should be hard and full.

---

The *Journal* aims at keeping farmers informed of what the Department of Agriculture is doing, also of such matters affecting their interests as come under its purview. The *Journal* contains original articles for the guidance of the farmer on the many and diverse problems which face him. Every farmer should read it and keep it.

## THE VEGETABLE GARDEN.

May, 1920.

By H. B. TERRY, Cert. R.H.S., Lecturer in Horticulture, School of Agriculture,  
Potchefstroom.

MUCH can be done to augment the supply of vegetables for winter and spring use. Digging, trenching, and manuring are of the greatest importance at this time of the year. All decaying matter from passing crops should be destroyed and buried to prevent the breeding of insect pests.

The following may be sown in open ground, not to be transplanted:—

**BROAD BEANS.**—Sow in drills 2 feet 6 inches apart and place the beans 12 inches apart in the rows. They like a fairly heavy soil that has been well manured. Do not attempt to cramp this crop otherwise the pods will not set.

**LETTUCE.**—Cos varieties such as White Paris, etc., should be sown. This popular salad requires rich moist ground and cannot be well grown without. Do not sow too thickly and thin out to about 9 inches apart.

**PARSNIP.**—A small sowing may be made. Deep well worked soil is essential; thin out the seedlings before they choke one another by overcrowding.

**PEAS.**—May continue to be sown. Stratagem, Pride of the Market, Dr. McLean, Sutton's Matchless are all useful. Where very severe frosts are experienced, the peas are liable to become frosted.

**RADISH.**—Make continuous sowing of Turnip Rooted, French Breakfast, and other quick maturing sorts. The reason radishes become puffy, hollow, and hot is because they are not used fast enough.

**SPINACH.**—Given some well manured ground and a plentiful supply of water, together with plenty of hoeing later, a sowing of Prickly Winter may be made.

**TURNIPS.**—Make good sowings of Six Weeks, Red Top White Globe, Jersey Lily; thin the seedlings out when strong enough to prevent them falling over; failure to thin out ruins the crop.

**ONIONS.**—Transplant seedlings from sowing made in February or March; the ground should have been prepared some time ago. Before planting, the soil should be made firm as onions dislike a spongy soil to root in. Make the rows 15 inches apart, and set the plants 6 to 8 inches apart in the rows. Do not plant deeper than 1 inch, as good bulbs are only produced at or on the surface.

**LEEKS.**—If available may be transplanted in a similar manner to onions.

**CELERY.**—Should be making good progress, and will need to be tied up with paper before earthing up to blanch the stalks. Water should be generously given to enable this crop to become crisp.

**CABBAGE.**—May still be transplanted, and provided the soil is rich they will make good growth during the winter and provide a certain crop for spring use when most vegetables are scarce.

**CAULIFLOWERS.**—Will soon be fit for cutting, that is the early sorts; as the heads appear it is advisable to break in a few of the inner leaves to protect the flower from the weather. Provide copious supplies of water if good heads are desired.

**MUSTARD AND CRESS.**—May be sown in tins and boxes under cover or on the stoep. When grown in the open it does not attain sufficient length for cutting, but under partial shade it easily reaches 3 to 4 inches quickly.

(The writer will be pleased to give further information on application to him.)

## SOUTH AFRICAN PRODUCE ON THE OVERSEA MARKET.

### Extracts from Report of the Acting Trade Commissioner.

February, 1920.

*Wool.*—At the February auctions, which concluded on the 27th instant, 5688 bales of South African “free” wool were offered. The market, however, was most disappointing and a large proportion of the quantities offered was withdrawn, owing partly to the high limits put on the various parcels. The improvement which took place in the prices for Australian merinos was not shared by greasy Cape wools at any period during the sales, and although during the second week of the auctions there was a certain amount of Continental competition for medium and inferior snow whites which caused an advance of about 5 per cent., this appreciation was not maintained, and at the close of the sales prices for all descriptions were about on a par with the closing rates of the January auctions.

The following are the nominal quotations now ruling for South African wool:—

	Western Province.	Eastern Province.	Natal.
Snow white, super ... ..	80d. to 95d.	75d. to 91d.	—
Snow white, average to good ...	64d. to 79d.	—	—
Snow white, short ... ..	—	60d. to 74d.	—
Snow white, inferior ... ..	42d. to 63d.	—	—
Snow white, faulty ... ..	—	38d. to 59d.	—
Scoured, super ... ..	—	—	60d. to 80d.
Scoured, inferior ... ..	—	—	38d. to 59d.
Grease, superior ... ..	38d. to 60d.	40d. to 68d.	39d. to 54d.
Grease, average to good ... ..	26d. to 37d.	29d. to 39d.	27d. to 38d.
Grease, inferior ... ..	18d. to 25d.	18d. to 28d.	18d. to 26d.

*Mohair.*—The market demand for mohair was quiet during the month, the only feature of interest being the offering of 500 bales at public auction on the 18th February. There was a fair attendance of buyers but competition was very small and the bulk of the mohair was withdrawn.

The following prices are based on those realized at the auction:—

Summer kids, 37d. to 43d. per lb.

Summer firsts, 26d. to 28d. per lb.

Winter hair, 24d. per lb.

Mixed, 12d. to 20d. per lb.

Greys, 14d. per lb.

*Hides.*—Auction sales were held on the 5th February, and the offerings of South African hides were considerable, but a large proportion of the goods were of an unattractive nature. Wet salted hides were not dealt in to any great extent, but dry and dry salted of “heavy” weight, of first and second selections, which were in small supply, appreciated about ½d. to 1d. per lb. as compared with January prices. Extra heavy weights, chiefly dry salted of good quality, sold at fully 1½d. per lb. above the rates ruling at the previous sales. Third and fourth class skins were not in demand. Kips and calf skins of first and second selections secured good competition, but thirds were in poor demand.

The following are the average prices ruling for South African hides, c.i.f. terms:—

Wet salted (best heavy), 18d. to 21d. per lb.

Dry hides (heavy), 20d. to 27½d. per lb.

Dry salted, 26d. to 26½d. per lb.

Second quality hides, about 1d. per lb. less.

Kips and calf skins (firsts), 32½d. to 33½d. per lb.

Kips and calf skins (seconds), 29½d. to 30½d. per lb.

*Sheep Skins.*—Auction sales were held on the 26th February, when 323,789 Cape sheep skins were offered and 209,046 sold. On the whole the collection was moderately attractive. In many cases the combing and long-woolled skins were irregular in growth of wool, and there were few large strings of Western Province origin.

The skins sold at the following average prices:—

Extra long wool, 26½d. to 30d. up to 33¼d. per lb.

Long wool, 24d. to 27½d. up to 29½d. per lb.

Short wool, 18d. to 21d. up to 25¼d. per lb.

Shorn wool, 17½d. to 20d. up to 23¼d. per lb.

Lambs, 17d. to 21d. up to 24¼d. per lb.

Coarse long wool, 19¾d. to 20d. up to 21½d. per lb.

*Glovers' Skins.*—Of 68,788 common Cape (Glovers') sheep skins offered 9294 sold. The small turnover was practically confined to the standard selections of large and medium skins, and of these Mossel Bay consignments sold at an advance of about 15 per cent. over the January auction rates. In by-sorts there was little or no trade, and the limits imposed by shippers are far above the figures at which glove manufacturers find it worth while to put such grades into work.

*Common (Glovers').*—Extra large, 150s. to 195s. up to 235s. per dozen; medium, 120s. to 135s. up to 200s. per dozen; light medium, 80s. to 100s. up to 125s. per dozen

*Wattle Bark and Extract.*—The present price for chopped is £21. 15s. and for ground £22. 10s. Extract is at present standing at £47 c.i.f. with upward tendency in sympathy with Quebracho.

*Ostrich Feathers.*—Since the sales on the 2nd February the market has been rather quiet, but prices have remained firm. Broken wings, common blacks and drabs and boos are in fair demand, but best wings are not much inquired for at the moment. The market is still handicapped by the low rate of exchange between Paris and London.

*Meat.*—During the month several parcels of South African beef were placed on the market, and the quality was somewhat better than certain previous shipments this season. A price up to 7s. a stone (8 lb.) for hindquarters has been made for prime quality, but the greater portion averaged from 5s. 10d. to 6s. 6d. for hinds and 4s. 6d. for forequarters

---

## Scab: Protected Districts.

The Scab Regulations provide for the establishment of "Protected Areas," i.e. areas which are either wholly free from scab or contain a small percentage of infection only, and into which no stock is allowed, unless clean and twice dipped under supervision of an inspector. In the beginning of 1917 eight districts in the Cape Province were proclaimed protected. This number was gradually increased, with the result that (at the beginning of March) in the Cape 51 districts are so protected; in the Orange Free State, 5; in the Transvaal, 6; and in Natal, 5.

In addition, three districts in the Cape and three in the Orange Free State are undergoing a compulsory dipping with a view to protection. On account of the very severe drought of the past year, it was not possible to carry out dipping to any extent, otherwise greater progress would have been shown. It may be mentioned that from the Cape Peninsula to East London all the coastal districts are protected.

## OVERSEA PRICES OF SOUTH AFRICAN PRODUCE.

March, 1920.

### MARKET PRICES OF SOUTH AFRICAN PRODUCE IN THE UNITED KINGDOM, CABLED BY THE ACTING TRADE COMMISSIONER, LONDON.

#### *South African Wool.*

4500 bales offered March auction. Long, greasy combing 5 per cent. dearer.  
Prices other wool on a par with February auction.

#### *Mohair.*

No change.

#### *Cape Hides.*

Market dull; prices nominal.

#### *Cape Angora Skins.*

Nominally 5 per cent. decline.

#### *Cape Merino Sheep Skins.*

Firm; prices unchanged.

#### *Natal Wattle Bark.*

Market declined owing to large stock.

Chopped	...	...	...	...	£18 10 0	spot or to arrive.
Ground	...	...	...	...	19 15 0	to £20 5 0 c.i.f.

#### *Ostrich Feathers.*

Demand quiet.

#### *Maize.*

S.A. No. 2 White Flat: inquiries being made @ 85s. c.i.f.  
(La Plata maize, May shipments 70s., May-June shipments 68s. 6d., 68s. 9d.)

#### *South African Beef.*

Hinds	...	...	...	...	...	6s. 2d. per stone (8 lb.)
Fores	...	...	...	...	...	4s. " " (8 lb.)

#### *South African Tobacco.*

Virginian type: 1s. 3d. to 2s. 6d. per lb. in accordance with grades.

#### *Cotton (March futures).*

Highest	...	...	...	...	...	...	27.0d.
Lowest	...	...	...	...	...	...	26.12d.

#### *Cotton Seed.*

Market quiet. (Egyptian April-May shipments. £23; Bombay, £17 spot, April-May shipments, £16. 15s.)

#### *Sunflower Seed.*

£60 per ton, small lots for feeding purposes. £25 to £30 per ton, crushed.

#### *Horns.*

Large	...	...	...	...	£9 15 0	to	£14 15 0	per 100.
Medium	...	...	...	...	4 5 0	"	5 10 6	" "
Small	...	...	...	...	1 2 6	"	2 3 0	" "

## STAFF CHANGES.

### (1) AGRICULTURE.

DATE.	NAME OF OFFICIAL AND NATURE OF CHANGE, ETC.
29/2/20	A. F. Harber : District Veterinary Surgeon, Natal. Resigned.
9/2/20	Dr. M. Zschokke and Dr. R. Schärren : Appointed as Veterinary Research Officers on three years' agreement.
29/1/20	R. W. M. Mettam : Appointed as Veterinary Research Officer on three years' agreement.
9/2/20	G. McIntyre and J. F. McIntyre : Appointed as District Veterinary Surgeons, with Headquarters at Vryheid and Potchefstroom respectively, on three years' agreement.
1/2/20	V. A. Putterill : Transferred from Division of Botany, Pretoria, as Mycologist in charge at Capetown.
9/2/20	J. Creere Emmett : Senior Sheep Inspector, Vryheid, resigned to stand for Parliament.
2/3/20	B. W. Sutton : Appointed as Dairy Inspector.

### (2) AGRICULTURAL EDUCATION.

DATE.	NAME OF OFFICIAL AND NATURE OF CHANGE, ETC.
16/3/20	J. W. Cleghorne : Appointed Lecturer in Engineering at the School of Agriculture, Glen.
—	E. K. Hall, M.Sc. Ag., recently returned to South Africa on completion of his studies at the University of Illinois, U.S.A., has been appointed Lecturer in Animal Husbandry at the School of Agriculture, Glen, Orange Free State.
29/3/20	P. J. J. Fourie, M.R.C.V.S., who was granted a Government Scholarship in 1915, to pursue his studies at the Royal Veterinary College, Dublin, has recently returned and has been appointed Lecturer in Veterinary Science at the School of Agriculture, Grootfontein.
—	B. S. Parkin, M.R.C.V.S., who was granted a similar scholarship to Mr. Fourie, has been appointed to the Lectureship in Veterinary Science at the School of Agriculture, Elsenburg. Mr. Parkin, after qualifying about July, 1918, enlisted in the Imperial Army and saw service in India and the Afghanistan Border.
—	R. Bigalke, formerly Assistant Chemist at the School of Agriculture, Potchefstroom, and subsequently employed in the Departamento Maritimo at Lourenço Marques, has been appointed Lecturer in Zoology and Entomology at the School of Agriculture, Glen.

### MOVEMENTS, ETC., OF OFFICERS.

#### SHEEP DIVISION.

Mr. L. H. Visser, Sheep and Wool Expert, lately returned from studying in Australia, has been appointed to the Western Province area, with headquarters at Paarl. Mr. Visser passed with "*Honours*" in his final examinations in Sydney, and was placed second in a class of 40. Portion of his two years' stay in Australia was spent on the well-known Bundeman station. Farmers desirous of securing Mr. Visser's services should write to him direct at Paarl, Cape Province.

Mr. V. Loxton, Sheep and Wool Expert, has been appointed to Natal and East Griqualand area, which includes also portion of the Orange Free State as far as Harrismith. His headquarters and address will be Colonial Buildings, Pietermaritzburg.

Mr. D. L. Mellet, Sheep and Wool Expert, has been appointed to assist the Lecturer in Sheep and Wool at the Grootfontein School of Agriculture, Middelburg, Cape Province, for six months, but he will be able to undertake also a limited amount of urgent work, sheep-classing and mating, in that area.

## VETERINARY RESEARCH.

Owing to Mr. R. E. Montgomery's impending transfer to the Uganda Protectorate. Sir Arnold Theiler will again assume control of the Division, together with the Veterinary College which is being established at Onderstepoort.

## HORTICULTURAL DIVISION.

Mr. Tribolet, the Chief, proposes to visit the following centres, leaving Pretoria on the 3rd of May and returning on the 29th. Lectures will be given in places where they can be arranged and farms visited where convenient:—Warmbaths, Nylstroom, Haakdoorn, Potgietersrust, Pietersburg, Zoekmakaar, Bandolierkop, Louis Trichardt, Mara, Duivelskloof, Tzaneen-Haenertsburg, Acornhoek, Godwan River.

## AGRICULTURAL EDUCATION.

Mr. A. C. Pigott, Farm Manager, Potchefstroom School of Agriculture, has returned to duty after a period of long vacation in the United Kingdom. Mr. E. Baker, B.Sc., Lecturer in Botany, Elsenburg School of Agriculture, proposes leaving shortly on a six months' visit to England.

---



---

**NOTES FROM THE "GAZETTE."**

Attention is drawn to the following matters of interest which appeared in the *Union Government Gazette*:—

(Abbreviations: "Proc."—Proclamation; "G.N."—Government Notice.)

*Gazette.*

No.	Date.	ITEMS.
1027	18/2/20	The duty on wheat in the grain, wheaten flour, and wheaten meal, and maize in the grain; as imposed in Class I of the First Schedule to Act No. 26 of 1914, has been temporarily suspended (by the Governor-General) until Parliament passes suitable legislation during the present session. (G.N. No. 303.)
1032	12/3/20	The Governor-General has approved of the reduction of the stock rate in the Kentani District from 1s. 6d. to 1s. G.N. No. 914 of 1919 is amended accordingly. (G.N. No. 429.)
1032	12/3/20	The compulsory dipping of cattle in the three-day and five-day dips respectively has been ordered in certain portions of the Dundee, Ikopo, Umvoti, Estcourt, Ngotshe, Camperdown, Paulpietersburg, Butterworth, Idutywa, Umzimkulu, Willowvale, Queenstown, Mount Ayliff, Zoutpansberg, Pietersburg, and Lydenburg Districts. (G.N. Nos. 424, 449, 486, 544, 565, 613.)
1039	1/4/20	The compulsory dipping of sheep has been ordered in Carnarvon District (G.N. No. 450), Rouxville and Bethulie Districts (G.N. No. 462), and Maclear District (G.N. No. 559).
1034	19/3/20	The Department of Native Affairs publishes regulations for the eradication of various noxious weeds in the Shiloh Mission Station, in the Division of Queenstown, and in the Esson Mission Station, Uitenhage Division, under the Mission Stations and Communal Reserves Act, No. 29 of 1909 (Cape), the regulations to be carried out by the Boards of Management of the above locations. (G.N. No. 468/9).
1034	19/3/20	It is notified that the importation of maize and barley, under permit referred to in Proclamation No. 33 of 1920, will only be allowed in small quantities as seed intended for sowing, and then only when the introduction is deemed desirable. Further requirements are also laid down under which permits are to be applied for. (G.N. No. 506—17/3/20.)



(Abbreviations: "Proc."—Proclamation; "G.N."—Government Notice.)  
*Gazette.*

- | No.  | Date.    | ITEMS.   |
|------|----------|--|
| 1034 | 19/3/20  | The Secretary for Lands notifies that the sale of farms in certain districts of the South-West Protectorate has been approved of by the Governor-General in terms of the 1912 Land Settlements Act, as amended by South-West Protectorate Land Settlement Proclamation No. 14 of 1920. (G.N. No. 466.)<br>The appointment of members to the South-West Protectorate Land Board, in terms of the Act and Proclamation above referred to, is also notified. (G.N. No. 467.)<br>The Crown Lands referred to in G.N. No. 315 of 20th February, 1920, which are to be sold in front of the Court-house, at 10 a.m., on the 11th May, are now stated to be Peace Islands Nos. 1 and 2 in the Orange River, Division of Kenhardt. (G.N. No. 481.)<br>Certain Crown lands in Gordonias District will be sold by public auction in front of the Magistrate's Office in Uppington on the 11th May, at 11 o'clock forenoon. (G.N. No. 489.) |
| 1036 | 26/3/20  | The Secretary for Lands will receive applications up to the 7th May for the allotment of certain holdings in the Standerton District on Conditional Purchase Lease. (G.N. No. 535).  |
| 1040 | 9/4/20   | Up to the 13th May applications for unallotted farms in the South-West Protectorate will be received by the Department of Lands, Windhuk. Full particulars are given in G. N. No. 590.   |
| 1040 | 9/4/20   | Applications for certain lands in the Zoutpansberg District will be received by the Secretary for Lands, Pretoria, up to 21st May. (G.N. No. 592.)   |
| 1036 | 26/2/20  | Regulations for reporting and controlling the disease known as Dourine in Equines have been approved of by the Governor-General under the Stock Diseases Act (No. 14 of 1911). (G.N. No. 542.)   |
| 96S  | 26/3/20. | The High Commissioner for South Africa notifies in the <i>Official Gazette</i> that the amount of duty payable under the Bechuanaland Protectorate Cattle Export Duty Proclamation, 1916, shall be raised from 2s. 6d. to 5s. The provisions in the Proclamation respecting "calves" are also amended. (Proc. No. 9.)<br>The Hlatikulu District of Swaziland is declared an infected area on account of East Coast fever in the above <i>Gazette</i> . (Notice No. 25 in terms of Swaziland Diseases of Stock Proc., 1918.)  |
| 1040 | 9/4/20   | All brands registered in the Cape Province under the Cape Acts No. 12 of 1890 and No. 4 of 1897, for the quarter ending 31st December, 1919, are published in G.N. No. 600.<br>The brands registered in the same period for the Free State under the Orange River Colony Brands Registration Ordinance of 1903, are notified in G.N. No. 619.  |

---

Do not lose your copy of the *Journal*. A full index will be sent subscribers every six months. The *Journal* will prove a useful book of reference to every farmer. In time it will be a valuable compendium of advice and information on farming in South Africa.

## RECENT AGRICULTURAL LITERATURE.

By PAUL RIBBINK, LIBRARIAN, DEPARTMENT OF AGRICULTURE.

### I.—UNION GOVERNMENT PUBLICATIONS.

MISCELLANEOUS REPORTS, ETC., OF INTEREST TO FARMERS.

(Obtainable from the Government Printer, Pretoria.)

Price per copy.	Number of Publication.
3s. Forest Department, Annual Report for the year ending 31st March, 1919. Including Report on Railway Sleeper Plantations ...	U.G. 47—'19.
1s. Meat Trade Commission appointed to inquire into the condition of the Meat Trade of the Union. Report ... ..	U.G. 9—'20.

### II.—THE AGRICULTURAL PRESS OF SOUTHERN AND TROPICAL AFRICA.

#### SELECTED ARTICLES.

*Die Boer* (Bijvoegsel tot "De Volkstem"), Pretoria.

20 Februarie 1920. Kongres van die Transvaalse Skaap- en Bokboere (14 Februarie 1920 te Volksrust).

12 Maart 1920. Die Mieliekwessie.

26 Maart 1920. Landbou en Landbouskole.

*Die Boerenvrou* (Posbus 984, Pretoria).

Maart 1920. 'n Kleindogter van Jan van Riebeeck.

Iets oor Bije en Heuning.

*Farmers' Advocate*, South African (P.O. Box 247, Bloemfontein).

January, 1920. Anthrax: Cause, Symptoms, Treatment.

How to grow Winter Food for Dairy Cows. III. Ensilage, by W. E. Clark.

February, 1920. Settlement Possibilities in South-West Africa, by D. W. Drew, M.L.A.

Hereford Cattle, by W. G. C. Batten.

March, 1920. Agricultural Lime.

*The Farmers' Journal* (Nairobi, B.E.A.).

5th February, 1920. East Africa as the World's future Spice Gardens, by W. J. Thompson, M.R.C.A. (Continued from Vol. 2, No. 5.)

18th March, 1920. Gelding of Stock, by Stockman.

*The Farmers' Weekly* (Bloemfontein).

25th February, 1920. The New Protectorate (South-West Africa), by German Settler.

3rd March, 1920. Wheat Economics, by H. Wolfe, M.Sc.Agric. (Concluded in issue of 16th March.)

10th March, 1920. The Rosebank Show. (List of Awards given in issue of 17th March, 1920.)

24th March, 1920. Maize in South Africa. (G. J. Bosman, B.S.A.)

Port Elizabeth Show. (List of Winners in issue of 31st March, 1920.)

31st March, 1920. Hand-rearing of Calves, by H. Cooke, B.S.A.

Friesland Breeders Meeting. Annual Meeting, Bloemfontein, 24th March, 1920.

The Central Show, Bloemfontein, 23rd to 25th March, 1920.

- Die Landbouwer* (Postbus 1035, Pretoria).  
15 Februarie 1920. No. 17. Vermeerdering van ons Mielie-produksie.
- Die Landbou Weekblad* (Postbus 267, Bloemfontein).  
10 Maart 1920. No. 38. Stoommasiene en Verbrandingsmotors op die Plaas, deur W. S. H. Cleghorne.  
24 Maart 1920. Die Reënval van Suidafrika.
- The Natal Witness* (Supplement, "The Farmers' Day," Pietermaritzburg).  
6th March, 1920. The Cotton Industry.  
11th March, 1920. Beef Production (to be continued).  
20th March, 1920. Successful Dairying.
- The South African Dairyman* (Box 925, Durban).  
February, 1920. No. 4, Famous Breeds of Britain. No. 2, "Devons". by "Farmer George". (Continued in March issue, No. 3.)
- The South African Farm News* (Box 963, Johannesburg).  
February, 1920. The Horse-Breeding Industry, by W. H. Courtenay.
- The South African Fruit Grower and Small Holder* (Box 3958, Johannesburg).  
February, 1920. Are our Fruit Export Regulations wrong?
- South African Gardening and Country Life* (Box 3958, Johannesburg).  
February, 1920. The Koopman-De Wet House, by Dorothea Fairbridge. (Continued in March, 1920, issue.)
- The South African Journal of Industries* (Government Printer, Pretoria).  
February, 1920. No. 2. Tea Industry in South Africa.—I, by Hon. W. F. Clayton, M.L.A.  
Vegetable Fats and Oils.—II, by M. Rindl, Ing.D.
- South African Poultry Magazine* (Bloemfontein).  
March, 1920. No. 98. Utility v. Exhibition, by R. Vivyan.  
Official Egg-Laying Competitions, by R. P. Kirkwood. Maritzburg.
- The South African Poultry Review and Small Holder* (Johannesburg).  
March, 1920. No. 11. Breeding to Standard, by A. A. Colville.
- South African Sugar Journal* (Box 925, Durban).  
March, 1920. New Method of Treating Uba Juice.  
Notes on the Cotton Industry, by W. B. Wilson, B.S.Agric.
- The Sun and Agricultural Journal of South Africa* (Box 634, Johannesburg).  
January, 1920. New Zealand Tall Fescue (*Festuca Arundinacea*), by Joseph Burt-Davy.  
February, 1920. Electrification of Cane-Sugar Mills, by Chas. Griffith, O.B.E.  
March, 1920. The Sunflower, its Uses and Cultivation, by Joseph Burt-Davy.
- The Week End* (Box 413, Pietermaritzburg).  
3rd April, 1920. The Peanut or Earthnut.  
10th April, 1920. Cleanliness in Dairying, by "Agricultur."

---

### III.—AGRICULTURAL PUBLICATIONS IN OTHER PARTS.

---

#### REVIEWS AND EXTRACTS.

**COLD STORAGE OF FRUIT.**—This has received special attention in New Zealand and forms the subject of an article in the *New Zealand Journal of Agriculture* for January, 1920, Vol. XX, No. 1. Advice is given on the stage of ripeness at which the various varieties of apples and pears are to be picked, also a summary of findings resulting from various tests to which the fruit was subjected at different periods of storage. In addition, tests made of the results of careless and careful handling, respectively, emphasized the great importance of placing the fruit in storage in the best possible condition promptly after picking. In regard to wrapping, apples were found to be of better general appearance if wrapped before cold storage, but it made little difference to pears. The results of the experiments demonstrate the important part of the orchardist in the ultimate success of the cold storage of fruit.

LICKS FOR LIVE STOCK.—*The Agricultural Gazette* of New South Wales for January, 1920, Vol. XXXI, Part I, contains an interesting article on Licks for Live Stock for different classes of country. A list is given of formulæ recommended for different ailments and includes the following:—Stomach Worms (flake); Worms in Lambs; Lungworm in Sheep; Defective Bone Development; *Osteo malicia*; Lime for Stock; Anti-partum Paralysis in Sheep; New Disease in Sheep (Black Disease).

A few of the formulæ contain such substances as bone meal, bone ash, calcium phosphate or lime, to supply material deficient in soil or herbage, and may be regarded as bone-forming salts. The bulk of the ingredients have medicinal action and are not met with in the soils. The article deals with samples of soil analysed, stated to have been used as a "natural lick" by stock, especially sheep, and, in the case of "Black Disease", reported to have a beneficial effect.

THE BEET SUGAR INDUSTRY.—In the *Victorian Journal of Agriculture* for February 1920, is a continued article from the December, 1919, and January, 1920, issues. The two previous papers dealt with the general reasons for further development of the industry with an account of its history in the colony, by-products, cultivation, seeding and fertilizing, and harvesting. February's contribution deals with beet seed, new beet sugar factories, requirements for their establishment and consequent success, capacity, cost, etc. In addition, general information is given regarding the industry in some of the principal beet sugar producing countries. We learn that in the United States of America there are nearly 100 factories producing 800,000 tons of beet sugar while cane interests represent about 250,000 tons, and America's home requirements are over 4,000,000 tons per annum, mostly imported from Cuba as cane sugar. The American Government is encouraging expansion of sugar beet growing.

PEPSIN *versus* RENNET IN CHEESE-MAKING.—Mr. H. M. Merker, in the *Journal of Dairy Science*, Vol. II, No. 6, November, 1919, states that owing to conditions mainly brought about by the war, pepsin has replaced rennet almost entirely in cheese-making, except in cheese of the sweet curd variety. It is being used in all parts of the world and is much cheaper. Experienced cheese-makers have concluded, after several years' experience, that the loss of butter-fat in the whey is the same with either pepsin or rennet. Pepsin may be activated by the addition of hydrochloric acid to a limited extent, and decidedly activated when used in conjunction with soluble calcium salts. The three important points to be observed in connection with the use of pepsin are:—

- (1) The addition of a good, live starter (lactic acid culture).
- (2) The milk should be heated to 88° F.
- (3) The acidity should be 0.20 per cent. lactic acid before adding the pepsin.

## Seal Skins—Remarkable Prices.

Sealing operations are carried out at the various Government Guano Islands, and the skins obtained are shipped to London for sale. The prices obtained in 1914-15 ruled low, for some shipments only 9s. per skin being obtained, and during the 1915-16 season sealing operations were entirely suspended owing to the slump prevailing in the fur skin market. The following year there was a rise in the market, and sealing was renewed, the skins obtaining satisfactory prices. The market continued to rise, the prices per skin in 1917-18 being from 31s. 2d to 37s. 6d.; in 1918-19 the average was £2. 18s. Advice is now received of remarkably high prices on the London market on the 29th January last for Government seal skins, pup skins realizing from £15. 15s. to £33. 10s., the average price of two shipments being £22. 19s. 6d. and £21. 12s. 10d. Practically all the skins were bought on account of America, and it is believed they are being shipped there direct.

## AT THE SCHOOLS OF AGRICULTURE AND EXPERIMENT STATIONS.

March, 1920.

CEDARA, NATAL.

*Climatic.*—The rainfall for the month (up to and including the 23rd) was 6.93 inches. The mean maximum temperature was 71.8° F. and the mean minimum 57.4. On the whole the weather was unfavourable to the crops, most of the days being overclouded with continuous light rains.

*Field Operations.*—Kale, rape, parsnips, and Kikuyu grass were planted, and potatoes and sunflowers harvested.

*Crops.*—The maize crop still promises well despite the excessive rains, but the cow-peas have been adversely affected and are suffering severely from fungous diseases. The sunflowers made excellent growth on heavy vlel soil and the artichokes promise a good yield. The millet has made excellent growth and the bulk of it is being cut for green fodder.

*Stock.*—Three Friesland calves were born during the month, one heifer and two bulls. The Aberdeen-Angus show cow, Nannie of Denoon, gave birth to a fine heifer calf on the 16th of the month. One Ayrshire calf, a heifer, was born. Four Shorthorn heifers from Onderstepoort were added to the stock during the month. All the stock are in fine condition.

*Orchard.*—Woolly aphid seems to have flourished in the orchard during the continual wet weather. This pest was treated with tobacco wash, paraffin emulsion, Harbas, and resin wash, the last spray giving the best results. Pear leaf blight and the bitter rot of apples have done a certain amount of damage despite continual spraying with bordeaux mixture.

*Chemical Laboratory.*—A sample of an extract from a local indigenous tree, said to have good tanning properties, was analysed. The analysis of the dry, solid extract showed that it contained only 43 per cent. of tannin matter, while the colour was exceedingly deep, and in every way compared very unfavourably with wattle extract. A specimen of latex from an indigenous plant submitted for examination had over 57.98 per cent. of resins and only 13 per cent. of pure rubber, which precluded its exploitation as a source of rubber, although it might possibly be used for other purposes. The work carried out just before the war on the composition of Natal wattle bark has been resumed, and a start has also been made with investigating the composition and comparative nutritive value of the more common indigenous grasses.

*Entomological Section.*—A large brown ant, *Phagiolepis custodiens*, is giving trouble to some farmers in the New Hanover district, worrying stock and natives by biting ferociously. The same ant occurs at Cedara but gives no trouble. Experiments with poison baits, cyanide solution, and corrosive sublimate have proved that the sublimate is the most efficacious remedy. Some wattle plantations around Pietermaritzburg have been badly infested with bag-worms this season, but the last heavy rains of the past three months have caused great mortality among them, due chiefly to the fungous disease and to polyhedrae wilt, an obscure disease that is very virulent and highly contagious.

ELSENBURG, MULDER'S VLEI, CAPE.

The weather generally was fairly cool, though still abnormally dry. The total rainfall recorded to date is 0.17 inches, which fell on the 20th instant, whereas the normal March rainfall is 1.12 inches. The maximum temperature recorded was 92.8° F. on the 19th instant.

*Field Operations and Crops.*—The preparation of land for the coming season's crops has been seriously delayed by the continued drought, both on the farm and in the Experimental Division. About 50 acres of "braak" land were summer ploughed this month, but it was impossible to plough the stubble lands on account of the hardness of the soil.

A further 22-acre field of maize was cut and turned into ensilage, the yield being about 80 tons; 40 tons of vlei grass were cut and stacked for bedding purposes; 150 bags of oats (Algerian) and 50 bags of rye were threshed during the month.

In connection with the vintage, the wines were racked this month and the casks filled.

In the Horticultural Division several varieties of pears were picked and packed for the local markets. The Beurre Bosc, Louise Bonne, Forelle, and Keiffer (in part) varieties were picked, the yields of Beurre Bosc and Forelle being poor, but the Louise Bonne and Keiffer crops were fairly good, both in yield and quality. 139 trays of Louise Bonne pears were sent to the Johannesburg market and realized five shillings per tray. A few trays of Keiffer pears were also sent to Johannesburg, but the bulk of the crop was cut up for drying purposes.

*Live Stock.*—The condition of the live stock in general is fair. Milk yields of the dairy cattle dropped somewhat during the month. The pigs are in good condition, and a large number of sows farrowed during the past three or four weeks. A number of pigs from the experimental pig lots were sold, as follows: Five large black gels for breeding purposes at 10 guineas each; eight large black barrows to the Wellington Bacon Factory at £7. 10s. each; and six cross-bred large black Berkshire pigs at the same price.

*Buildings.*—The old dairy building, which was destroyed by fire some time back, has been rebuilt, and is now used by the Experimentalist as a seed store, office, and laboratory. A fine modern dairy is in process of building at present and is nearing completion. An intensive breeding house is being built in the poultry division. Work was continued on this during the month, and the house is now about one-half completed.

*Experimental and Investigational Work.*—Work in the experimental division is still held back by the dry weather, no fertilizers having been applied yet, due to the impossibility of working the land. The other laboratory and field experiments are progressing favourably.

*Rosebank Show.*—The Western Province Agricultural Society's Annual Show was held at Rosebank on the 2nd to 5th March, inclusive. A large number of Elsenburg live stock, principally cattle, was exhibited, and a general exhibit representative of all divisions of the school was also staged as part of the Government exhibit. The live stock exhibits were awarded nine first prizes, five seconds, and one third, as well as two championships (Jersey bull and Jersey cow). The Jersey cattle were outstanding in their classes. In the group classes the Elsenburg entries were awarded second prize in both heavy and light breeds (Friesland and Jersey respectively). With only two exceptions the live stock exhibit consisted entirely of animals bred at Elsenburg, and the two exceptions were both unplaced. Several members of the staff acted as judges in various sections at the show.

The entire student body attended the show and was conducted around in groups by different members of the staff to each section of the show in turn. In this way they received much useful instruction in regard to the judging of all classes of stock and farm produce, as well as a great deal of valuable general information in regard to the various exhibits.

The live stock judging competition proved a great success, the judging of the students being very creditable in all the classes. The students who took part in the butter-making competition also acquitted themselves very well, one of them being awarded the championship.

---

#### GLEN, ORANGE FREE STATE.

---

*Climatic.*—The total rainfall for the month up to date (26th) was 6.29 inches. The bulk was registered during the first week of the month, when the Modder River overflowed its banks in various places west of Glen. Considerable damage was done to pumping plants and several farmers were obliged to leave their homes as they were completely surrounded by water. Fortunately no damage

was done to the pumping plant here, although some expenditure was incurred in removing a heavy deposit of mud and overhauling the plant as it was completely submerged.

*Crops.*—Field operations were interfered with considerably owing to the excessive rains. It was only possible to get on the irrigated land last week, so that ploughing, seeding, etc., was practically at a standstill. On the dry lands (sandy soils) 35 acres of rye were planted for winter feed. Whatever crops were planted before the heavy rains, as also the veld, made abnormal growth during the month. Although grain feed, such as oats, will be scarce during the winter, there will be an abundance of grazing and bulk feed. The planting of oats and weeding of lands are in full swing. Owing to the wet condition of the lands weeds have become very bad.

*Live Stock.*—All are in good condition. Three Friesland heifers are due to calf shortly and will be entered in the official milking competition. Ten donkeys, some registered and other not, were sold at the Bloemfontein show on the 25th, and realized from £17. 10s. to £42. 10s. each.

Six animals, consisting of one Clydesdale stallion, one Percheron stallion, and two mares and two Catalonian donkey jacks were exhibited at the Bloemfontein show, and five first and one second prizes were secured.

*Extension Work.*—The Winburg, Ladybrand, and Bloemfontein shows were visited by members of the staff and various sections were judged.

*The School.*—There are fifty-nine students now in residence.

*General.*—Considerable research work in connection with proposed irrigation works are proceeding in the chemical laboratories.

The Bloemfontein show, as usual, attracted a large number of farmers and exhibits from various parts of the Union. The judging competition instituted this year was of particular interest to the schools, a judging team from each competing. Grootfontein came first, with Potchefstroom second, and Glen a close third.

---

#### GROOTFONTEIN, MIDDELBURG, CAPE.

---

*Climatic.*—Rainfall for February, 6.76 inches on fifteen days. Mean temperature: Maximum, 79.7°; minimum, 57.5°.

*Students.*—The returned soldier six months' course men were given a surprise or test examination. All passed in the various subjects, such as cattle and sheep judging, soils and manures, horticulture, etc., many with honours.

*Farm Section.*—Hay-making is in full swing, the lucerne crops being exceptionally fine. The tef and millet are promising well, and the oats are looking exceptionally promising.

*Experimental Section.*—Some ten acres of land have been laid down to a sheep feeding experiment, testing various varieties of oats, barley, etc. Only the varieties which proved best last season are being retested and several additional varieties.

*Sheep Section.*—Special work was carried out in this section in connection with the Inter-School Judging Competition, Bloemfontein, on the 23rd inst., which was won by Grootfontein. Special work was carried out in the cattle section for the same reason.

*Chemical Section.*—During the month analytical work was pressed forward. Thirty-one samples were received for examination, and a certain amount of extension work was carried out by the officer in charge.

*General.*—During the month the Entomologist, with the assistance of other officers, continued to fight the fly trouble, which has increased since the rains.

---

#### POTCHEFSTROOM, TRANSVAAL.

---

*The School.*—The number of students in residence during March was as follows: Diploma (second year), 31; diploma (first year), 35; one year, 7; ex-soldiers (one year course), 39.

*The Staff.*—Mr. May, M.R.C.V.S., was transferred from the Veterinary Division as lecturer in veterinary science at this institution. Mr. Walenkamp

has been appointed assistant to the Horticulturist, and Mr. A. Skibbe, formerly assistant chemist at Elsenburg, has been appointed to this position held here by Mr. G. M. Hay, now resigned to take up other studies. During the month several officers were absent judging and lecturing at the agricultural shows held at Amersfoort, Middelburg, Ermelo, Bloemfontein, Krugersdorp, Vrede, Carolina, Johannesburg, and S.A.R. Poultry Show, Johannesburg, while other extension work was also carried out whenever possible.

*Crops.*—These have derived much benefit from the heavy rainfall, amounting to 7.98 inches, which was recorded during February, and the outlook is much brighter than it was earlier in February.

The prospects of the maize crop improved greatly during the month, and there is now every promise of a fairly good yield per acre. A fine stand of over 26 acres of mangels has been obtained and the roots are developing fast. 74 acres of teff have been sown this season and a very fair crop is likely to be harvested. Nearly 60 acres of leguminous crops have been planted this season for seed, hay, silage purposes, and green manuring, good growth has been made. Other crops, such as potatoes, pumpkins, and tobacco have also grown well and give promise of heavy yields.

*Live Stock.*—All have greatly improved in condition with the good pastures obtained after the heavy rains, and animals for the Witwatersrand Agricultural Show received hand-feeding and were got into show condition.

*Poultry.*—The egg-laying competition started on the 1st inst., there being sixty-nine pens of four birds per pen.

*Horticultural.*—All the late maturing varieties of apples and pears were harvested, stored, or disposed of. The work of ploughing the orchard was begun and will be continued until the whole has been completed one way.

---

## DATES OF AGRICULTURAL SHOWS STILL TO BE HELD.

(As Notified at 31st March, 1920.)

---

### TRANSVAAL PROVINCE.

Klerksdorp.—18th and 19th May.  
Lichtenburg.—21st May.  
Wolmaransstad.—26th May.  
Haenertsburg.—27th May.  
Pretoria.—31st May to 2nd June.  
Potchefstroom.—9th June.

Rustenburg, 9th June.  
Pietersburg.—16th and 17th June.  
Barberton.—18th June.  
Tzaneen.—9th July.  
Nylstroom.—29th and 30th July.

---

### NATAL PROVINCE.

Newcastle Agricultural Society.—2nd and 3rd June.  
Vrijheid Agricultural Society.—8th June.  
Dundee Agricultural Society.—10th and 11th June.  
Klip River Agricultural Society (Lady-smith).—15th and 16th June.  
Umvoti Agricultural Society (Greytown).—16th and 17th June.  
Weenen Agricultural Society (Estcourt).—17th and 18th June.

Royal Agricultural Society (Maritzburg).—22nd to 25th June.  
Durban and Coast Agricultural Society (Durban).—29th June to 2nd July.  
Zululand Show Society (Eshowe).—7th July.  
Richmond Agricultural Society.—14th July.  
Dronk Vlei Agricultural Society.—14th July.  
Camperdown Agricultural Society.—21st July.  
Ixopo Agricultural Society.—22nd July.



## THE UNION'S EXTERNAL TRADE.

## I.—IMPORTS.

(Excluding Removals from Rhodesia.)

Article.	Twelve Months ended 31st December.			
	1918.		1919.	
	Quantity.	Value.	Quantity.	Value.
(1) <i>Animals Living.</i>		£		£
Horses, mares, geldings ... No.	159	15,295	183	20,245
Bulls and oxen ... ..	207	20,961	19,972	243,197
Cows and calves ... ..	475	32,568	375	26,516
Donkeys and jackasses ... ..	18	1,800	—	—
Sheep and lambs ... ..	149	9,141	86,100	143,022
Pigs... ..	5	115	28	680
Poultry ... ..	233	501	365	852
All other ... ..	—	527	—	638
Total ... ..	—	80,908	—	435,156
(2) <i>Certain Articles of Food and Drink.</i>				
Butter ... .. lb.	2,425,369	167,227	356,035	32,226
Cheese ... ..	233,908	14,498	20,334	2,037
Coffee, raw ... ..	47,616,892	851,986	17,525,617	690,871
Condiments ... ..	1,324,705	42,663	504,868	32,651
Confectionery, etc. ... ..	936,436	67,278	2,636,120	223,435
Corn, grain, meal, etc.				
Beans and peas ... ..	958,965	9,344	2,519,350	22,208
Dholl ... ..	4,559,497	25,557	2,762,569	30,494
Maize ... ..	44,836	196	1,299,961	4,319
Malt ... ..	1,181,375	15,083	2,132,927	22,159
Oats ... ..	23,884	160	—	—
Wheat ... ..	75,414,159	444,620	45,199,647	278,466
Flour (or meal), wheaten ..	23,598,271	209,667	54,390,182	469,377
Dripping and fats for food ..	413,326	13,018	749,238	30,861
Farinaceous preparations... ..	1,751,902	43,448	4,740,832	109,429
Fruit, Fresh ... ..	—	801	—	2,343
Almonds and nuts ... ..	5,107,047	64,495	1,666,915	36,334
Dates ... ..	1,176,212	17,740	1,771,686	32,295
Dried and others ... ..	350,831	12,927	1,531,806	57,503
Bottled and tinned ... ..	65,531	2,913	71,296	4,065
Lard and substitutes ... ..	22,825	1,192	32,571	2,537
Meats—				
Salted (bacon, ham, etc.) ..	343,779	15,736	109,820	6,654
Tinned ... ..	1,332,016	78,105	1,680,359	88,003
Milk, condensed ... ..	3,853,842	140,851	8,647,689	342,553
Pickles and sauces... ..	1,041,370	52,476	1,150,756	64,900
Rice... ..	76,939,758	151,176	40,981,699	381,040
Spices ... ..	4,743,160	195,342	3,593,330	112,539
Spirits (potable) ... .. galls.	433,722	411,703	271,747	303,312
Sugar and products ... .. lb.	44,947,998	330,123	73,694	73,577
Tea ... ..	10,237,455	472,274	7,346,990	421,601
Vegetables, tinned... ..	353,537	10,407	767,185	24,828
Vinegar ... .. galls.	17,102	3,664	24,007	8,519
Wines ... ..	63,727	55,509	47,542	73,411
Total <i>all</i> articles of food and drink (including other items not enumerated above) ...	—	4,722,118	—	4,851,859

## I.—IMPORTS—(continued).

(Excluding Removals from Rhodesia.)

Article.	Twelve Months ended 31st December.			
	1918.		1919.	
	Quantity.	Value.	Quantity.	Value.
(3) <i>Miscellaneous.</i>		£		£
Fencing materials ... cwts.	—	80,353	—	334,767
Fodder and forage ... lb.	1,263,758	4,391	1,577,180	5,300
Hides and skins ... ..	2,101,471	75,047	2,566,313	143,406
Hops ... .. cwts.	4,999	35,178	4,695	37,596
Agricultural machinery and implements ... .. No.	—	580,071	—	765,992
Water boring machinery ... ..	—	1,865	—	2,687
Windmills... ..	—	30,251	—	71,323
Wool presses ... ..	—	*	—	4,390
Manures and fertilizers ... lb.	33,133,831	117,123	25,234,777	72,937
Seeds, garden and vegetable ..	218,962	29,602	258,809	27,794
Sheep and cattle dips ... ..	—	72,473	—	156,348
Tobacco, Unmanufactured ..	449,876	32,708	354,812	42,369
Cigars, cigarettes ..	121,417	72,566	41,836	107,344
Other manufactures ..	65,111	6,011	56,255	9,688
Wood and timber ... .. cub. ft.	—	1,063,282	—	1,247,180
<b>TOTAL IMPORTS OF MERCHANDISE (including imports from Rhodesia) ...</b>		<b>47,397,389</b>		<b>46,712,795</b>

Not distinguished.

(NOTE.—The total value of merchandise imported and re-exported was £4,036,501 in 1918 and £3,966,629 in 1919.)

## II.—EXPORTS OF SOUTH AFRICAN PRODUCE.

(Excluding Removals to Rhodesia and Ships' Stores.)

Article.	Twelve Months ended 31st December.			
	1918.		1919.	
	Quantity.	Value.	Quantity.	Value.
(1) <i>Animals Living.</i>		£		£
Horses, mares, and geldings No	282	5,784	263	9,563
Mules and donkeys ... ..	154	2,995	260	5,129
Pigs ... ..	3,444	11,190	3,762	8,896
Sheep and lambs ... ..	2,025	2,306	1,849	2,221
All other ... ..	—	32,210	—	21,172
<b>Total ... ..</b>		<b>54,485</b>		<b>46,981</b>

## II.—EXPORTS OF SOUTH AFRICAN PRODUCE—(continued).

(Excluding Removals to Rhodesia and Ships' Stores.)

Article.	Twelve Months ended 31st December.				
	1918.		1919.		
	Quantity.	Value.	Quantity.	Value.	
(2) <i>Certain Articles of Food and Drink.</i>		£		£	
Butter and substitutes ... lbs.	1,333,679	97,548	434,914	35,259	
Cheese ... ..	424,993	25,911	1,525,638	80,417	
Confectionery and jams ... ..	3,681,880	102,163	8,950,031	235,335	
Eggs ... ..	1,713,828	12,136	7,132,481	61,456	
Fruit, dried and preserved ... lb.	4,053,477	91,841	6,731,895	199,249	
Fruit, Fresh—	No. of				
Citrus ... ..	boxes	4,076	2,777	54,677	38,973
Deciduous ... ..		34,813	9,034	74,698	14,398
Grapes ... ..		6,883	1,982	14,253	4,456
All other... ..		—	3,154	—	7,598
Corn, grain and meal—					
Maize ... ..	lb	509,495,794	1,600,137	246,265,197	1,145,408
Maize meal ... ..		167,115,124	662,332	367,875,772	1,836,180
All other... ..		32,291,573	273,943	82,081,307	451,751
Meats, fresh and frozen ... ..		18,712,447	469,538	44,670,938	1,084,745
" preserved and cured ... ..		105,962	7,880	1,347,716	86,228
Spirits, potable ... ..	galls.	5,609,087	175,427	38,243,756	492,776
Sugar, syrup, molasses,					
treacle ... ..	lb.	756,102	3,352	8,917,253	56,599
Vegetables ... ..		—	50,772	—	33,865
Wines ... ..	galls.	452,428	112,613	402,656	106,349
Total all articles of food and drink (including other items not enumerated above) ...	—	4,041,482	—	6,330,248	
(3) <i>Miscellaneous.</i>					
Aloes ... ..	lb.	539,677	6,417	1,202,982	13,522
Bark, wattle ... ..		107,904,898	287,220	126,645,584	386,096
" extract ... ..		8,339,459	124,887	13,761,262	216,086
Buchu leaves ... ..		89,675	16,948	149,166	37,130
Cotton, raw ... ..		183,228	11,799	289,890	19,251
Hair, Angora ... ..		19,645,681	1,641,889	16,942,021	1,654,235
Hides and skins ... ..		—	2,288,465	—	4,985,353
Horns ... ..		194,971	2,355	1,861,116	24,565
Manures ... ..		4,798,932	67,538	10,723,606	127,799
Ostrich feathers ... ..		108,924	88,628	904,611	1,646,014
Tobacco, all kinds ... ..		1,731,947	159,593	1,603,672	137,326
Wool ... ..		115,634,498	9,689,630	184,927,986	17,919,088
TOTAL MERCHANDISE OF SOUTH AFRICAN PRODUCTION EXPORTED (including removals to Rhodesia) ...	—	28,912,736	—	48,132,123	

The *Journal* is the Department's medium of making known its activities. It contains information of value to every farmer in the Union. Keep it for reference.

## MEAT STATISTICS.

### I.—RETURN OF BEEF INSPECTED AND PASSED FOR EXPORT DURING THE MONTH OF MARCH, 1920.

Place.	Cattle.			Carcasses.		
	Inspected.	Rejected.	Passed.	Inspected.	Rejected.	Passed.
Durban ... ..	2,137	—	—	2,137	87 $\frac{3}{4}$	2,049 $\frac{1}{4}$
Pietermaritzburg ...	462	—	—	462	6 $\frac{1}{2}$	455 $\frac{1}{2}$
Pretoria ... ..	49	—	—	45	—	45
Johannesburg ... ..	72	—	—	72	—	72
Bloufontein ... ..	—	—	—	—	—	—
Capetown ... ..	—	—	—	—	—	—
Port Elizabeth ... ..	—	—	—	—	—	—
Germiston ... ..	—	—	—	—	—	—
<b>TOTAL</b> ... ..	<b>2,720</b>	<b>—</b>	<b>—</b>	<b>2,716</b>	<b>94<math>\frac{1}{4}</math></b>	<b>2,621<math>\frac{3}{4}</math></b>

Beef actually exported during the month of March, 1920: Total 1,852 quarters.  
(*Ex* Durban 1,702 quarters; *Ex* Capetown 150 quarters.)

Total shipments of Beef in quarters—

1916 ...	115,992	1918 ...	123,354	*1920 ...	4,147
1917 ...	309,214	1919 ...	285,367		

### II.—RETURN OF CATTLE IMPORTED INTO THE UNION FROM ADJOINING TERRITORIES.

Territory.	Imported March, 1920.	Total from 1st January, 1920, to 31st March, 1920.
For Slaughter—	No.	No.
Rhodesia ... ..	1,024	4,892
Bechuanaland Protectorate	2,228	5,453
S. W. Africa ... ..	1,080	3,834
Swaziland ... ..	91	608
Basutoland ... ..	—	—
For Breeding—		
Rhodesia ... ..	1,392	3,344
Bechuanaland Protectorate	2,455	3,735
<b>TOTAL</b> ... ..	<b>8,270</b>	<b>21,866</b>

### SUMMARY OF IMPORTS.

Calendar Year.	For Slaughter.	For Breeding.	Total.
	No.	No.	No.
†1916	26,580	—	26,580
1917	47,970	5,440	53,410
1918	36,767	13,286	50,053
1919	40,574	16,693	57,267

\* Total to 31st March, 1920.

† 1st July to 31st December only.

## EXPORT OF GRAIN, ETC.

RETURN OF GRAIN, ETC., GRADED AND EXPORTED THROUGH THE VARIOUS PORTS DURING THE MONTH OF MARCH, 1920.

NOTE.—In this return the gross weight per bag of Maize is 203 lb., Maize Meal 183 lb., Hominy Chop 183 lb., Kaffir Corn 203 lb., Oats 153 lb., Barley 163 lb., Rye 203 lb., Beans 203 lb., Peas 203 lb., Lucerne Seed 103 lb., Millet (average): 220 lb.

Port.	Grain, etc.	No. of Bags Shipped during March, 1920.	Total No. of Bags Shipped from 1st July, 1919, to 31st March, 1920.	Stocks on Hand on 31st March, 1920.
CAPETOWN .. ..	Maize .. .. .		178,954	
	Maize Meal .. ..	198	326,935	40
	Hominy Chop .. ..		5,825	
	Kaffir Corn .. ..		28,550	
	Oats .. .. .		20,328	
	Barley .. .. .		504	
	Rye .. .. .		629	
	Beans .. .. .		2,550	
	Peas .. .. .		—	
	Lucerne Seed .. ..		4,604	
Millet .. .. .		389		
DURBAN .. .. .	Maize .. .. .		255,672	
	Maize Meal .. ..	13,756	341,851	
	Hominy Chop .. ..		—	
	Kaffir Corn .. ..		6,215	
	Oats .. .. .		3,648	
	Barley .. .. .		—	
	Rye .. .. .		947	
	Beans .. .. .		7,851	1,441
	Peas .. .. .		300	
	Lucerne Seed .. ..		—	
Millet .. .. .		123		
EAST LONDON ..	Maize .. .. .		123,400	
	Maize Meal .. ..		114,298	
	Hominy Chop .. ..		—	
	Kaffir Corn .. ..		4,758	
	Oats .. .. .		—	
	Barley .. .. .		2,415	
	Rye .. .. .		1,530	
	Beans .. .. .		420	
	Peas .. .. .		—	
	Lucerne Seed .. ..		—	
Millet .. .. .		—		
PORT ELIZABETH ..	Maize .. .. .		160,493	810
	Maize Meal .. ..		14,704	
	Hominy Chop .. ..		—	
	Kaffir Corn .. ..		3,587	
	Oats .. .. .		—	
	Barley .. .. .		5,465	
	Rye .. .. .		—	
	Beans .. .. .		450	
	Peas .. .. .		—	
	Lucerne Seed .. ..		—	
Millet .. .. .		—		
LOURENCO MARQUES	Maize .. .. .		16,976	
	Maize Meal .. ..		34,627	
	Kaffir Corn .. ..		—	
	Beans .. .. .		400	

## SUMMARY.

	Exported March, 1920.	Total Exported 1st July, 1919, to 31st March, 1920.	Stocks on Hand at all Ports on 31st March, 1920.
	Bags.	Bags.	Bags.
Maize .. .. .	—	734,895	810
Maize Meal .. ..	14,254	1,092,325	40
Hominy Chop .. ..	—	5,825	—
Kaffir Corn .. ..	—	43,110	—
Oats .. .. .	—	23,976	—
Barley .. .. .	—	8,384	—
Rye .. .. .	—	3,104	—
Beans .. .. .	—	11,671	1,441
Peas .. .. .	—	300	—
Lucerne Seed .. ..	—	4,604	—
Millet .. .. .	—	434	—
TOTALS .. .. .	14,254	1,868,628	2,291

## CROP AND LIVE STOCK REPORT.

March, 1920.

### MAIZE.

Reports received this month deal with the progress being made by the growing crop, its condition as at 31st March being as follows:—

*Cape Province.*—As compared with conditions at the end of February there is a decline of 2 per cent. While prospects have improved in the South Coast Districts, there has been a severe set-back in Bechuanaland owing principally to the abnormal rains causing damage. In the Transkei also excessive rains caused some damage, whereas frost in some parts reduced the prospects by 1 per cent.

*Transvaal.*—The crop condition is reported to have declined 10 per cent., as compared with the previous month. Throughout the Eastern High Veld the prevalence of frost caused a good deal of damage, the anticipated yield falling from 17 per cent. to 29 per cent. below normal. In addition, droughty conditions were stated to be prevalent in parts of Middelburg and Standerton Districts. In the Central Districts the absence of rain, particularly in Heidelberg and parts of Pretoria, caused an appreciable decline. Frost and scarcity of rain likewise reduced the prospects in the Western High Veld where the crop declined by 3 per cent.

*Orange Free State.*—Although the presence of frost caused some damage to the crops the reduced prospects are not so marked as in the case of the Transvaal. The decline was confined mainly to the North-eastern Districts. Normal conditions are, however, still reported to exist in Bethlehem and Vrede, and fairly satisfactory in Lindley and Senekal. The District of Harrismith and parts of Heilbron experienced early frosts, which placed the crop at 27 and 26 per cent., respectively, below normal. The South-eastern and South-western Districts were able to report slightly improved conditions, resulting from the rains which fell in these parts.

*Natal.*—The condition of the crops continued practically the same as reported at the end of February.

*Summary.*—The area under cultivation this season is estimated to be 21 per cent. less than last year, yielding, under ordinary normal conditions, 12,741,600 bags. Owing, however, to the adverse conditions under which crops are maturing, the estimated production is expected to be 20 per cent. less or 10,234,400 bags. According to the latest available figures, the estimated consumption in the Union is considered to be 9,500,000 bags.

From these figures it might be inferred that there is likely to be a surplus of about 600,000 bags, but, in view of the difficulties attending any reliable forecast, owing to the uncertainty of the extent to which crops may have suffered as a result of the frost, it would seem desirable to await the reports disclosing the final condition of the crop at 30th June, 1920.

### KAFFIR CORN.

The prospects of this crop at the end of March in the Cape Province are practically unchanged.

In the Transvaal there is a marked falling off in condition in the Eastern High Veld owing to frost and grub in many parts, and similar conditions are reported from the Free State.

While there is a decline in the crop condition in Natal the estimated production is not expected to be affected to any appreciable extent.

*Summary.*—The reports for March point to an estimated further decrease of 21,200 bags, the crop being estimated at 19 per cent. below normal at which figure it should return 1,140,800 bags.

## TOBACCO.

The condition of the crop is reported as follows at 31st March, 1920:—

The crop of the Cape Province has declined 7 per cent. and is now 34 per cent. below normal as compared with 27 per cent. at the end of the previous month. In Oudtshoorn District it is reported to have declined from 16 per cent. to 35 per cent. below normal, owing to droughty conditions in those parts.

In the Transvaal a very slight decline is reported. In the Orange Free State conditions have improved, the position being 5 per cent. below normal as compared with 10 per cent. at the end of the previous month.

The prospects in Natal remain practically unaltered.

*Summary.*—The crop condition for the Union declined by 4 per cent. during the month and is 24 per cent. below normal, which reduces the originally estimated production to one of 8,386,100 lb.

## SUGAR CANE.

The Natal Sugar Association reports as follows for February, 1920:—

Heavy rainfall was general during February, and on the North Coast and Zululand temperature conditions favoured rapid growth. On the South Coast rainfall was also very heavy, but the temperature conditions were less favourable. Generally the condition of crop can be reported as within 5 per cent. of normal.

## CONDITION OF LIVE STOCK.

Compiled from Reports furnished by Sheep and Stock Inspectors.

Area.	Large Stock.	Small Stock.
<b>CAPE—</b>		
South-West ... ..	<i>Good</i> ... ..	<i>Good.</i>
North-West ... ..	<i>Medium to poor</i> ... ..	<i>Medium to poor.</i>
South Coast ... ..	<i>Good to medium</i> ... ..	<i>Medium.</i>
Southern Karroo ... ..	<i>Medium</i> ... ..	<i>Good to medium.</i>
Central Karroo... ..	<i>Good to medium</i> ... ..	<i>Good to medium.</i>
Northern Karroo ... ..	<i>Good to medium</i> ... ..	<i>Good to medium.</i>
Eastern Karroo ... ..	<i>Medium</i> ... ..	<i>Good.</i>
Bechuanaland ... ..	<i>Fat</i> ... ..	<i>Good.</i> Fat in parts.
Griqualand West ... ..	<i>Fat</i> ... ..	<i>Good.</i> Fat in parts.
North-Eastern ... ..	<i>Fat.</i> Good to medium in parts	<i>Fat.</i> Good to medium in parts.
Border ... ..	<i>Good.</i> Fat in parts ... ..	<i>Good.</i> Fat in parts.
Transkeian Territories... ..	<i>Good.</i> Fat in parts ... ..	<i>Good.</i> Fat in parts.
<b>TRANSVAAL—</b>		
Eastern High Veld ... ..	<i>Good.</i> Fat in parts ... ..	<i>Good.</i> Fat in parts.
Central ... ..	<i>Good.</i> Fat in parts ... ..	<i>Good to medium.</i>
Western High Veld ... ..	<i>Good.</i> Fat in parts ... ..	<i>Good.</i>
Low Veld ... ..	<i>Fat to good</i> ... ..	<i>Good.</i> Fat in parts.
<b>ORANGE FREE STATE</b>		
North-Eastern ... ..	<i>Fat to good</i> ... ..	<i>Fat.</i>
North-Western... ..	<i>Good to medium</i> ... ..	<i>Good.</i> Fat in parts.
South-Eastern... ..	<i>Good</i> ... ..	<i>Good.</i>
South-Western... ..	<i>Good</i> ... ..	<i>Fat to good.</i>
<b>NATAL—</b>		
High Veld or Highlands	<i>Fat to good</i> ... ..	<i>Fat to good.</i> Medium in parts.
Middle Veld or Midlands	<i>Fat to good</i> ... ..	<i>Fat to good.</i>
Coast ... ..	<i>Good.</i> Fat in parts ... ..	<i>Good to medium.</i>

Keep your *Journals!* The contents will be indexed every six months and a copy of the index sent to each subscriber.

## LOCAL MARKET PRICES.

RATES OF AGRICULTURAL PRODUCE AND STOCK RULING AT THE 15TH APRIL, 1920.

CENTRE.	Wheat.		Wheat Flour.		Boer Meal.		Mealies.		Mealie Meal.		Borley.		Oats.		Lucerne Hay.		Potatoes.						
	Min.	Max.	Min.	Max.	Min.	Max.	Min.	Max.	Min.	Max.	Min.	Max.	Min.	Max.	Min.	Max.	Min.	Max.					
	s. d.	s. d.	s. d.	s. d.	s. d.	s. d.	s. d.	s. d.	s. d.	s. d.	s. d.	s. d.	s. d.	s. d.	s. d.	s. d.	s. d.	s. d.					
<i>Cape Province—</i>																							
Alival North.....	50	50	38	38	0	75	0	35	0	32	6	30	0	40	0	12	0	20	0				
Beaufort West.....	52	60	35	37	0	55	6	33	6	35	0	40	0	26	0	11	6	30	6				
Capetown.....	52	6	53	0	0	31	6	32	6	30	0	30	0	25	0	11	6	27	0				
East London.....						30	0	32	6							11	9	12	6				
Grathamstown.....	30	0	30	6	0	32	0	34	0	30	0	37	6	30	9	12	0	25	0				
Kimberley.....	51	0	55	0	37	0	70	0	32	0	40	0	50	0	18	0	5	0	31				
Kingwilliamstown						15	6	16	0							13	0	5	0				
Port Elizabeth.....	48	0	50	0	0	32	0	37	0	22	6	31	6			11	0	12	0				
Queenstown.....																							
<i>Natal—</i>																							
Durban.....	20	0	30	0	0	25	0	30	0	23	0	30	0	20	0	10	0	12	0				
Pietermaritzburg.						25	0	32	0	24	0	26	0			10	0	18	0				
<i>Orange Free State—</i>																							
Bloemfontein.....	53	0	58	0	75	0	78	0	32	0	35	0	29	0	35	0	11	6	15				
Harrismith.....	47	0	50	0	37	6	70	0	29	6	29	6	33	0	35	0	12	0	19				
<i>Transvaal—</i>																							
Pretoria.....	53	0	53	6	0	30	6	34	3	25	9	26	9	23	6	10	6	5	3				
Johannesburg.....	50	6	54	6	0	25	6	34	9	25	9	26	9	26	6	9	6	8	0				
CENTRE.	Onions.		Tobacco (Boer		Beans.		Beef.		Mutton.		Fresh Butter.		Eggs.		Cattle (Slaugh-		Sheep.		Pigs.				
	Min.	Max.	Min.	Max.	Min.	Max.	Min.	Max.	Min.	Max.	Min.	Max.	Min.	Max.	Min.	Max.	Min.	Max.	Min.	Max.			
	s. d.	s. d.	s. d.	s. d.	s. d.	s. d.	s. d.	s. d.	s. d.	s. d.	s. d.	s. d.	s. d.	s. d.	s. d.	s. d.	s. d.	s. d.	s. d.	s. d.			
	Per 120 lb.	Per 120 lb.	Per 100 lb.	Per 100 lb.	Per 200 lb.	Per 200 lb.	Per lb.	Per lb.	Per lb.	Per lb.	Per lb.	Per lb.	Per dozen.	Per dozen.	Per 100 lb.	Per 100 lb.	Per 100 lb.	Per 100 lb.	Per 100 lb.	Per 100 lb.			
	s. d.	s. d.	s. d.	s. d.	s. d.	s. d.	s. d.	s. d.	s. d.	s. d.	s. d.	s. d.	s. d.	s. d.	s. d.	s. d.	s. d.	s. d.	s. d.	s. d.			
	£ s. d.	£ s. d.	£ s. d.	£ s. d.	£ s. d.	£ s. d.	£ s. d.	£ s. d.	£ s. d.	£ s. d.	£ s. d.	£ s. d.	£ s. d.	£ s. d.	£ s. d.	£ s. d.	£ s. d.	£ s. d.	£ s. d.	£ s. d.			
<i>Cape Province—</i>																							
Alival North.....	12	6	13	6	1	6	1	9	0	10	0	1	33	3	6	10	0	25	0	20	0		
Beaufort West.....	11	0	15	9	0	4	1	0	0	10	0	1	31	3	6	4	0	10	0	20	0		
Capetown.....	18	0	24	6	0	45	0	65	0	0	9	1	0	2	0	16	0	26	0	40	0		
East London.....	18	0	19	6	1	0	1	4	0	10	1	2	3	2	0	12	0	18	0	40	0		
Grathamstown.....	8	0	11	0	0	55	0	63	6	0	5	1	31	3	6	4	4	12	0	40	0		
Kimberley.....	8	0	11	0	0	40	0	67	0	1	1	1	8	2	7	2	1	4	4	50	0		
Kingwilliamstown	8	0	12	0	0	20	0	30	0	0	8	1	0	3	3	4	2	3	4	50	0		
Port Elizabeth.....	8	6	15	6	0	70	0	90	0	0	8	1	0	8	1	0	0	8	1	130	0		
Queenstown.....	5	0	15	0	0															50	0		
<i>Natal—</i>																							
Durban.....	12	6	35	0	40	0	73	0	0	5	0	9	0	8	1	3	2	3	3	6	0		
Pietermaritzburg.						0	8	0	11	0	10	1	0	3	9	4	9						
<i>Orange Free State—</i>																							
Bloemfontein.....	10	0	16	0	0	40	0	60	0	1	3	2	0	7	3	9	4	9	16	0	25	0	
Harrismith.....						0	10	1	0	1	0	2	6	3	3	0	4	0	12	0	25	0	
<i>Transvaal—</i>																							
Pretoria.....	16	0	26	6	40	6	44	6	434	0	53	0	0	10	1	3	2	3	2	6	3	9	
Johannesburg.....	12	0	20	6	0	8	0	8	0	11	1	3	1	9	2	9	2	0	3	0	10	0	

\* Live weight per lb. † Dressed weight including hides, offal, etc., per 100 lb.  
 ‡ The rates quoted for produce sold in bags include, as a general rule, an additional 3 lb. for weight of bag.



PRICE 5/-  
PER ANNUM.



# Journal

of the

Department of

# Agriculture

ISSUED BY AUTHORITY OF THE  
MINISTER OF AGRICULTURE.

## PRINCIPAL CONTENTS.

- The Cause and Prevention of Lamziekte.  
European Foul-Brood Bee Disease.  
Flag Smut of Wheat.  
Export of South African Eggs and Poultry.  
The Growing of Mine Props on the High Veld.  
The Department of Agriculture during the War—II.  
Cattle in the Union.  
Experiments and Investigations—III, IV, and V.  
Infectious Diarrhoea: "Bloedpens" in Lambs.

PRICE **6D** PER COPY

## LIST OF BULLETINS AVAILABLE FOR DISTRIBUTION.

### Application to be made to the Department of Agriculture, Pretoria.

Applicants for bulletins are requested kindly to quote the *full number* of each, as shown hereunder, and to enclose also payment for same. The cost of each bulletin is indicated: those not marked are issued *gratis*.

#### ENTOMOLOGY.

- Bee Moth Superstition. Reprinted from the *Agricultural Journal*, May, 1914. U.R. 33/1914.
- The Bagrada Bug. By D. Gunn, Division of Entomology. 1d. 9/1918.
- Black Wattle, Some Insects Injurious to the. By C. H. Hardenburg, M.A., Division of Entomology. 6d. 1/1918.
- Cabbage Moth, The Small. By D. Gunn, Division of Entomology. 1d. U.R. 8/1917.
- Codling-Moth. By C. P. Lounsbury, Chief, Division of Entomology; and J. C. Faure, Orange Free State Entomologist. 3d. L.S. 22.
- Codling-Moth and its Control in the Western Province. By F. W. Petty, B.A., Entomologist, School of Agriculture, Elsenburg. 3d. U.S.B. 9.
- Cotton Pests in South Africa, A Preliminary Report on. By C. K. Brain, M.Sc., M.A., Division of Entomology. 1d. L.S. 50.
- The European Faul Brood. By C. P. Lounsbury, Chief, Division of Entomology. 1d. 10/1918.
- The Fig and Willow Borer. By D. Gunn, Division of Entomology. 1d. 6/1919.
- The White-lined Grape Vine Sphinx Moth. By D. Gunn, Division of Entomology. 1d. 11/1918.
- Phoracantha Beetle, The. By C. P. Lounsbury, Chief, Division of Entomology. 1d. L.S. 24.
- Remedies and Advice for the Treatment of Insect Pests. (Illustrated Chart.) 1s. 3d.
- Poison Bait Remedy for House Fly. By C. P. Lounsbury, Chief, Division of Entomology. L.S. 27.
- Sweet Potato Sphinx, The. By J. C. Faure, B.Sc., M.A., Division of Entomology. 1d. U.R. 20/1914.
- Potato Tuber Moth. By William F. Schlupp, B.Sc. (Agric.), Entomologist, School of Agriculture, Potchefstroom. 1d. U.R. 4/1917.
- Pea and Bean Weevil. By S. Skaife, B.A. (Hon.), Division of Entomology. 3d. 12/1918.
- Pernicious Scale. By C. K. Brain, M.Sc., M.A. 1d. L.S. 61.
- Quince Borer and its Control. By F. W. Petty, B.A., Entomologist, Elsenburg Agricultural School. 3d. U.R. 2/1917.
- Skin Maggot on Man. By C. Fuller, Division of Entomology. U.R. 47/1914.
- Warble Flies. By C. P. Lounsbury, Division of Entomology. U.R. 56/1914.
- Wattle Bagworm. By C. Fuller, Division of Entomology. 3d. U.R. 28/1913.
- Wheat Louse, The. By W. Moore, B.A., Lecturer in Entomology and Zoology, School of Agriculture, Potchefstroom. U.R. 29/1913.

[Continued on page iii of cover.]

# CONTENTS.

JUNE, 1920.

	PAGE
THE CAUSE AND PREVENTION OF LAMZIERTE ... ..	221
EUROPEAN FOUL-BROOD BEE DISEASE ... ..	245
FLAG SMUT OF WHEAT ... ..	252
EXPORT OF SOUTH AFRICAN EGGS AND POULTRY, YEAR 1919 ... ..	258
THE GROWING OF MINE PROPS ON THE HIGH VELD ... ..	261
THE DEPARTMENT OF AGRICULTURE DURING THE WAR ... ..	271
CATTLE IN THE UNION: THE TRADE IN BEEF ... ..	278
EXPERIMENTS AND INVESTIGATIONS ... ..	281
INFECTIOUS DIARRHOEA: "BLOEDPENS" IN LAMBS ... ..	286
NOTES ... ..	288
<p>The Friesland Bull "Admiral Beatty"—International Refrigeration Conference at Paris Recruitment of Farm Labour—Citrus Export Season, 1920—Prize Wine and Brandy—The Maize Crop of the Union—Live Stock Mortality in the Union—The World's Wheat Crop of 1919-20—The Great Advance in Wool Prices—Shortage of Paper (page 221)—Export of Grain, etc. (page 244)—Agricultural Co-operation in England (page 257)—The Danger of Bats (page 260)—Honey (page 270) Pig Production (page 277)—Springhaans (page 314).</p>	
THE POULTRY YARD MONTH BY MONTH ... ..	298
THE VEGETABLE GARDEN ... ..	299
SOUTH AFRICAN PRODUCE ON THE OVERSEA MARKET ... ..	300
DATES OF AGRICULTURAL SHOWS STILL TO BE HELD ... ..	301
OVERSEA PRICES OF SOUTH AFRICAN PRODUCE ... ..	302
STAFF: APPOINTMENTS, TRANSFERS, ETC. ... ..	303
NOTES FROM THE "GAZETTE" ... ..	304
RECENT AGRICULTURAL LITERATURE... ..	305
AT THE SCHOOLS OF AGRICULTURE AND EXPERIMENT STATIONS ... ..	308
MEAT STATISTICS ... ..	312
CROP AND LIVE STOCK REPORT ... ..	313
LOCAL MARKET PRICES ... ..	315
DEPARTMENTAL NOTICES ... ..	316

## STAFF.

### Department of Agriculture (including Agricultural Education).

#### HEADS OF DIVISIONS.

##### ADMINISTRATION.

Secretary for Agriculture.—F. B. Smith, C.M.G.

Under-Secretary for Agriculture.—P. J. du Toit (presently engaged on the Public Service Commission of Inquiry).

Acting Under-Secretary for Agriculture.—G. N. Williams, D.S.O.

Under-Secretary for Agriculture (Education).—E. I. Macmillan, B.S.A.

Acting Chief Clerk.—F. W. Green.

##### DIVISIONS.

Sheep.—Chief : B. G. L. Enslin, D.S.O.

Veterinary Research. Director of Veterinary Education and Research : Sir Arnold Theiler, K.C.M.G.

Veterinary.—Principal Veterinary Surgeon : C. E. Gray, M.R.C.V.S.

Dairying.—Superintendent of Dairying : E. O. Challis.

Botany.—Chief : I. B. Pole Evans, M.A., D.Sc., F.L.S.

Tobacco and Cotton.—Chief : W. H. Scherffius, M.Sc.

Horticulture.—Chief : I. Tribolet.

Viticulture.—Government Viticulturist : S. W. van Niekerk.

Entomology.—Chief : C. P. Lounsbury, B.Sc.

Chemistry.—Chief : B. de C. Marchand, B.A., D.Sc.

Chemical Research. Agricultural Research Chemist : C. F. Juritz, M.A., D.Sc., F.I.C.

Library.—Librarian : P. J. S. Ribbink.

Co-operation.—Registrar, Agricultural Co-operative Societies : J. Retief.

Dry Farming.—Government Agronomist : H. S. du Toit.

Guano Islands.—Superintendent : W. R. Zeederberg.

Grain Inspection.—Chief Inspector of Grain : G. F. Nussey.

Journal of Agriculture.—Editor : G. W. Klerck (Acting).

##### SCHOOLS OF AGRICULTURE AND EXPERIMENT STATIONS.

Elsenburg (Cape) ... .. Principal : W. J. Lamont.

Grootfontein (Cape) ... .. .. R. W. Thornton.

Cedara (Natal) ... .. .. J. Fisher, B.Sc., N.D.A.

Glen (Orange Free State) ... .. .. M. J. A. Joubert, B.S.A.

Potchefstroom (Transvaal) ... .. .. T. G. W. Reinecke, B.A., M.Sc.Ag.



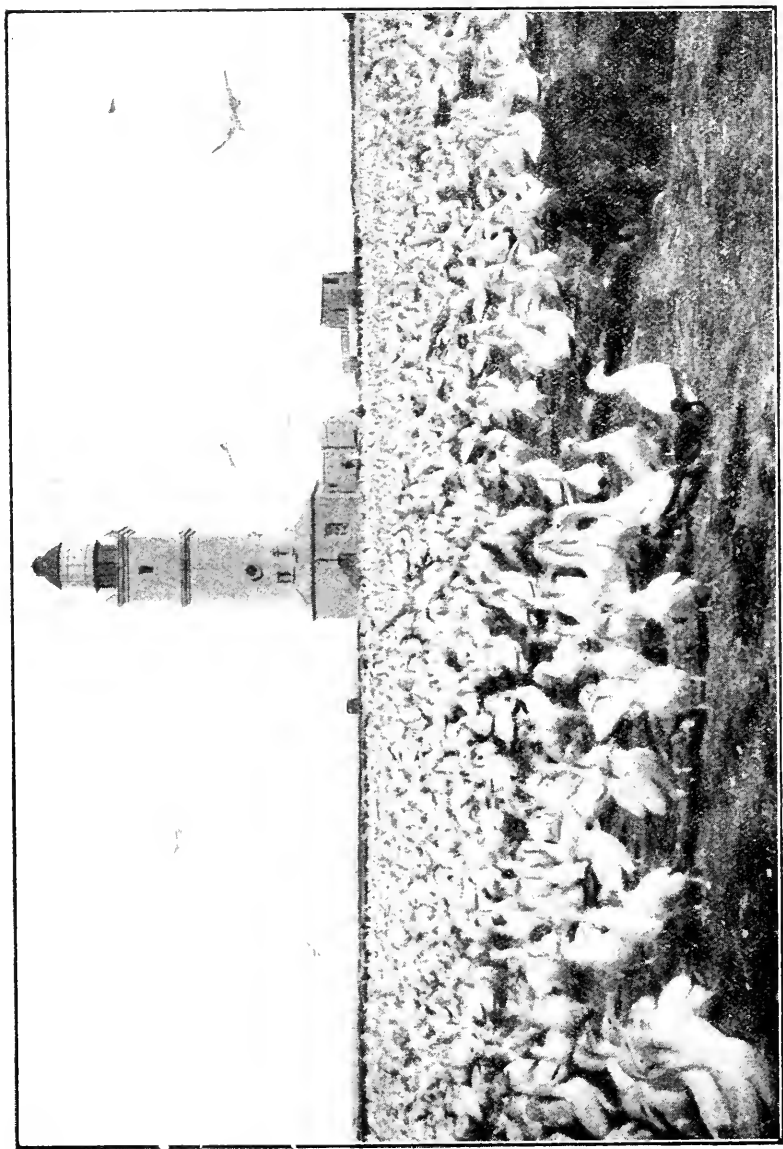

**BIRD ISLAND, PORT ELIZABETH**

One of the Government Guano Islands, showing Malagas Breeding Flats, with Lighthouse in background.



# JOURNAL OF THE DEPARTMENT OF AGRICULTURE.

VOL. I.

JUNE, 1920.

No. 3.

Published monthly in English and Afrikaans by the Department of Agriculture,  
Union of South Africa.

SUBSCRIPTION: Within the Union and South-West Protectorate, **5s.** (otherwise **6s.**)  
per annum, post free, payable in advance.

Applications, with subscriptions, to be sent to the Government  
Printer, Box 373, Pretoria.

## SHORTAGE OF PAPER.

WE regret to announce that owing to the shortage of paper, it is necessary, for the time being, to confine the size of the *Journal* to the smallest limits. Further, the quality of paper on hand precludes a satisfactory reproduction of certain illustrations, consequently a number which ordinarily would have appeared will need to be withdrawn.

## THE CAUSE AND PREVENTION OF LAMZIEKTE.

By SIR ARNOLD THEILER, K.C.M.G., Director of Lamziekte  
Research.

*(Being results of investigations undertaken by Sir Arnold Theiler,  
Professor P. R. Viljoen, Dr. H. H. Green, Dr. P. J. du Toit,  
and Dr. H. Meier.)*\*

### INTRODUCTION.

IN March of last year the announcement was made that the cause of lamziekte had been discovered, and an explanation was offered which harmonized the previously conflicting views concerning the etiology of the disease. It was then shown experimentally that the primary

\* NOTE.—In the work upon lamziekte, co-operation was arranged between Mr. R. E. Montgomery and myself, as between the Lamziekte Research Laboratory at Arnoedsvlakte and the Veterinary Research Division at Orderstepoort, the latter division being initially under the charge of Mr. R. E. Montgomery as Director, and subsequently under that of Mr. D. T. Mitchell as Acting Director.

In regard to the botanical work involved in the investigations, I wish to take this opportunity of expressing my great obligations to Dr. I. B. Pole Evans, Chief of the Division of Botany, Pretoria, for his unflinching help.

I also wish to express my appreciation of the work of the general staff, more particularly that of Mr. Theo. Meyer, technical officer in charge of Arnoedsvlakte, for his enthusiastic devotion to the experiments.—A.T.

cause responsible for disease and death, was a *toxin* derived from animal debris scattered about the veld.

It may be recalled that an intoxication theory had been put forward eight years ago by the senior author, but that the toxin was at that time associated with the vegetation of the lamziekte areas rather than with the animal debris common to farms all over the country. In the revised exposition the vegetation of the lamziekte areas still plays a prominent rôle, but now becomes the remote and not the primary cause. It accounts for a subsidiary complaint termed "osteophagia," practically harmless in itself and not sufficiently serious to deserve the name "disease," but of the utmost practical consequence as an essential link in the etiological chain of lamziekte.

Another old view of causation (the "pasteurella theory") maintained that lamziekte was due to infection of the animal by a pathogenic bacterium, and, although this had to be abandoned when experimental investigation rendered it untenable, the new explanation revived the idea of bacterial activity from an altogether different angle of vision. Instead of a "pathogenic bacterium" it predicated a "toxicogenic saprophyte": that is to say, an organism which lives on dead organic matter but which does not infect the living animal, or is harmless to the live animal until it has operated upon the carcass of a dead one.

Finally, the new view explained why it was that lamziekte was mainly a disease of cattle, and although occasionally reported in the goat and the ostrich, did not occur naturally amongst animals such as the sheep and the horse.

Indeed, nearly all the earlier theories on the causation of lamziekte became involved in the new view, in the light of which they all showed up as "partial truths." For this reason, perhaps, its enunciation was promptly followed by a shoal of claimants for the honour of discovery. The novelty of the explanation offered in March, 1919, was simply that it seized upon the idea of a toxicogenic saprophyte and forged together into one complete chain all the loose links of the past. As a coherent conception of causation it rendered positive proof possible and opened a fresh field for experimental inquiry into methods for control of the disease.

The experimental work of the past year has abundantly justified the earlier announcement, and much has been done towards developing the original conception in directions of practical consequence to the farmer. Methods for the prevention of lamziekte are being worked out, and it is hoped that within the next few years this dreaded disease will be brought under control and the areas decimated in the past once more become profitable for cattle rearing.

The purpose of this article is to give a popular account of the facts so far ascertained and of the lines of attack now being followed up, the detailed exposition of the experimental protocols being reserved for a more technical publication. Figures, wearisome to the general reader, will be avoided as far as possible and only a running commentary offered.

#### THE CHAIN OF CAUSATION.

The conception itself was communicated in a Press interview for the *Farmers' Weekly* of 7th May last year, but may be recapitulated



in different fashion here. The etiological chain may, for purposes of popular exposition, be shown in six links, enumerated as follows:

1. The toxin which poisons the animal.
2. The toxicogenic saprophytes which elaborate the toxin.
3. The carcass material out of which the toxin is manufactured.
4. The pica (allogriphagia, osteophagia) or depraved appetite which impels the animal to eat decomposing matter which it would otherwise shun.
5. The vegetation which produces the pica, the soil upon which that vegetation grows, and the climate of the district.
6. The susceptibility of the animal concerned, towards pica and towards the toxin.

In considering lamziekte only as a naturally contracted disease of cattle this last link falls away, since all cattle are susceptible to the toxin and nearly all cattle are susceptible to pica, although the degree of abnormal craving is partly a question of individual idiosyncrasy. But it must not be forgotten that goats, ostriches, and poultry can also contract lamziekte naturally, and that one of the first consequences of the discovery was the proof that nearly all animals could develop lamziekte experimentally. The disease has been produced experimentally in horses, sheep, goats, rabbits, guinea-pigs, ostriches, and ducks, and could doubtless be produced in man, if any of our staff were bold enough to try the experiment.

With ostriches and poultry Link 4 of the etiological chain is unnecessary, since they do not need to display pica, but may pick up fragments of toxic bones or carrion in the ordinary course of events. Fortunately, they are less susceptible to the toxin than are cattle. Goats occasionally eat "pensmist" permeated with toxin from the carcass, and so contract lamziekte without necessarily showing pica. It has also been reported that donkeys are occasionally observed to eat "pensmist," in which case stray cases of natural lamziekte in donkeys are easy to understand.

It is also interesting to mention that rats appear to be very resistant to the toxin; in more than one case a rat being found to stand a dose big enough to kill an ox. This is fortunate for the rat, since—although one does not speak of it as possessed of depraved appetite—hunger may drive such an omnivorous animal to eat toxic material.

Sheep are very susceptible to the toxin, and the only reason why they do not contract lamziekte naturally is that they do not develop the comparatively trivial "osteophagia" or "bone-craving," even though exposed to the same veld conditions as the cattle. The growing practice of stocking the lamziekte areas with sheep, simply because cattle could no longer be reared profitably, now finds its explanation not in the fact that sheep are immune to lamziekte, but in the fact that they are not "bone-eaters."

At this point it should be pointed out that the practice of rearing sheep *along with cattle* on the lamziekte areas has in the past increased the incidence of lamziekte amongst the cattle. The sheep,

though they do not naturally contract the disease themselves, die from other causes, and since the farmer has rarely troubled to remove dead sheep from the veld they have supplied one of the commonest sources of toxic carcass material. Sheep and cattle should therefore not be reared on the same veld unless every precaution is taken to *keep the farm clean*.

Horses, donkeys, and most other live stock are also susceptible to the toxin but, like sheep, do not contract lamziekte because they do not develop pica.

The susceptibility to pica is therefore an important link in explaining why lamziekte is dominantly a disease of cattle, and why it is so rarely reported in other animals. Other animals only get it by accident.

In regard to the susceptibility to the toxin itself, the main practical bearing as it affects cattle concerns the possibility of establishing an immunity.

Of the six links in our chain each one is equally important from a general scientific point of view. From a practical point of view the most important link is the one we can break most *easily* and most *cheaply*. But since we are not yet quite certain which this is, the problem must be studied as a whole in a broad scientific spirit.

Any one effective break is sufficient to eradicate lamziekte, and the reason why the disease is not rampant over greater areas in South Africa than is actually the case, is simply that there are many places in which the chain happens to be naturally broken. It is a well-known fact that lamziekte has been steadily spreading over the country and appearing on farms where it was formerly unknown. This is because one or other of the missing links is supplied by the operation of some other cause, and one of the preventive measures of the future may well take the direction of blocking the insertion of missing links into new areas.

Whether the control of lamziekte in the known lamziekte areas will be sufficient to prevent its spread to areas now healthy, depends altogether upon the method of control adopted. Thus, if the method adopted is the complete destruction of all carcass material (Link 3), then lamziekte could never spread. But if the chain were only broken by an immunizing process (Link 6) it would not completely prevent the spread. It would only protect the individual animal but would not remove the cause.

To break Link 2 of the chain without breaking Link 3 is practically impossible, since the organisms are sporulating ones and infect the soil. Once into the soil we have no practical method of dealing with them, although they may die out of their own accord in the course of years if, by removing all carcass material, they are prevented from multiplying.

It may well happen, however, that Link 2 is naturally absent in certain areas. If this is so, and the toxicogenic saprophytes, i.e. the particular bacteria which elaborate the poison from the decaying animal remains, are absent on any farm, there can be no lamziekte. Carcasses then undergo the ordinary non-toxic type of putrefaction occasioned by ordinary harmless bacteria, and the rotten bones, bits of hide, flesh, etc., do not produce the disease even if the cattle have pica and eat the obnoxious material. This is a state of affairs which

does seem to exist in parts of South Africa—on most Natal farms, for instance—and presumably exists in those countries where pica is reported but where lamziekte is not recognized. But if an animal leaves a lamziekte area and dies soon after in a clean area, its own carcass (Link 3) may serve as pabulum for the multiplication of the toxicogenic saprophytes (Link 2) introduced into its own intestine while grazing on the lamziekte region. Toxic material (Link 1) may then be produced and a large number of organisms scattered around the immediate vicinity. If this happens in a district where conditions (Link 5) are such that pica (Link 4) is prevalent, a new focus of lamziekte may be set up and the disease so appear in an area in which it was previously unknown.

It does not necessarily follow that an animal so dying will reproduce large numbers of the toxicogenic saprophytes, but it *may*, and certainly often *does*. Other factors, as not yet fully understood, also govern the decomposition of carcasses and regulate the extent to which a live animal can scatter Link 2. If the organisms are so introduced into a new area they may remain in the soil for some time after the carcass has decomposed and is no longer toxic, but if they get no chance of perpetuating themselves by infecting a fresh carcass they probably die out in time, under competition with the normal soil bacteria and protozoa. If, on the other hand, animals are dying in the new area from other causes, such as drought, fresh carcasses may become infected and the lamziekte organisms thus be multiplied. If for some reason pica is present in the new area, but is not acute, the mortality from lamziekte may remain low, appear in some years and not in others (Link 5), and possibly even disappear altogether.

With this short illustration of the interaction of the different factors involved, we may proceed to consider in more detail a few of the aspects of the experimental work of the year which has elapsed since the present explanation was first propounded.

For this purpose we may take the links in the order in which they were enumerated, at the same time indicating their interdependence upon one another by overlapping in the discussion.

### THE TOXIN.

We have stated that the eating of carrion causes lamziekte, and it may again be emphasized that any sort of carrion may serve as origin of the toxin. It happens that rotten bones are probably the most frequent source actually ingested by the cattle, but this does not mean that such bones are more toxic than other carcass material. It merely means that bone material is less obnoxious, and that even those animals showing the most depraved appetite will pick and choose when they get the chance. The pica is dominantly an "osteophagia," i.e. a craving for bones, and if the cattle can gratify it with bones they will, generally speaking, not touch anything else. Indeed, unless osteophagia is acute they will select the sweetest bones they can find.

When pica is very bad, cattle will blindly attempt to satisfy it in all sorts of ways and go for hide, dried fragments of flesh, coal, rags, and even tins. The scientific name of this form of craving is "allogriphagia," i.e. a craving for all sorts of unusual things, as distinct from "osteophagia" or bone-craving proper. But generally the

preference is for bones, and for this reason rotten bones represent one of the most serious sources of danger. It must, however, be emphasized that this most frequent source of toxin is not the most toxic material available, and that a small amount of putrefying flesh may frequently kill more rapidly than a large amount of rotten bones. Any sort of carrion, of whatever origin, is liable to contain the toxin and is therefore dangerous. Lamziekte has been produced experimentally at Armoedsvlakte by drenching material obtained from the carcass of a horse, an ox, a sheep, a lamb, a goat, a kid, a steenbok, a mierkat, a fowl, and an ostrich. The toxicity of the material varies with the nature of the material itself, with the stage of decomposition, and with the conditions of putrefaction, but if the causal organism is there no animal débris is safe.

The most toxic material of all has been prepared in the laboratory, where the conditions of putrefaction are under control. It is now quite easy to prepare laboratory carcass material (cultures in minced liver) so toxic that 0.0001 gm. (less than a quarter-millionth of an ounce) per kilogram body-weight is fatal to cattle by subcutaneous injection, i.e. less than half a grain can be made to produce typical lamziekte in a beast weighing over 600 lb.

When given by the mouth the amount of this laboratory carcass material required is much larger, but even then less than a gram (about one-thirtieth of an ounce) may prove fatal. In one experiment 2½ grams, or about one-tenth of an ounce, of what we regarded as only moderately toxic material, produced typical lamziekte in a beast weighing 700 lb. in less than a week. It is quite possible that natural material in the veld may be found as toxic as our laboratory product, but so far veld material has only been found which is capable of producing the disease in quantities of one ounce or more.

An animal showing marked craving may easily ingest several ounces of obnoxious material or several pounds of less objectionable stuff. Of bones, the natural selection of the craver, the quantity ingested may be extraordinarily high. A marked craver will chew bones for hours at a stretch. The behaviour of a batch of such cravers before a testing trough of sterilized bones (*vide infra*) is characteristic and noisy, the crunching and crackling being referred to by the staff at Armoedsvlakte as the "bone concert." The actual quantity of toxic bones required to produce lamziekte may vary from a few ounces of stinking bones to a few pounds of slightly odorous bones. By the time bones are bleached and "sweet" the toxicity has practically disappeared, and owing to the selective tendencies of the cattle the picking of such bones then tends to become a preventive of lamziekte instead of a cause. This is what we call the "bone paradox"—bones slay and bones save!

Other material, such as flesh, also becomes non-toxic in course of time, but by reason of its chemical composition can never become preventive of pica.

The length of time material remains toxic on the veld is not known with certainty, but it must vary considerably with the time of the year, the rate of putrefaction, and the weathering to which it is subjected. Even bones can certainly remain toxic for over six months, and other material probably longer.

Within limits the rapidity of onset of lamziekte is proportional

to the quantity of toxin ingested. The difference between the acute and sub-acute form of the disease is largely dependent upon the amount eaten, and in experimental work an animal can be killed in from seventeen hours to ten days almost at will, by varying the size of the dose. Doses approaching the "minimum lethal dose" generally produce typical symptoms in about five days.

The toxin itself is thermo-labile, i.e. is easily destroyed by heat. It is destroyed in a few minutes at 80° C., and at 75° C. by more prolonged heating. Sterilized bones, which were toxic before heating, can be used to cure pica.

The toxicity of 0.0001 c.c. per kilo, previously mentioned, refers to the Berkefeld filtrate of a highly toxic culture in minced liver tissue. The closest analogy we can find for the lamziekte toxin is the toxin of *B. botulinus*, but complete identity with this toxin is excluded by its physiological behaviour towards different animals. With a species of animal for which botulinus toxin may be very poisonous the lamziekte toxin appears to operate less powerfully, and vice versa. The symptoms of experimental botulism in cattle are also distinctly different from lamziekte.

In regard to a practical attempt to break the etiological chain at the toxin point little need be said. The obvious thing to do is to collect all material to which any suspicion of toxicity can attach, burn it, bury it, or fence it up out of the reach of stock.

#### THE TOXICOGENIC SAPROPHYTIC BACTERIA.

The fact that an organism or group of organisms is responsible for the toxin production was *a priori* obvious once the nature of the toxic material was discovered. Direct proof was obtained by the usual laboratory methods of sub-cultivation, and indeed the most toxic laboratory material we now possess was derived by sub-culture in suitable media (minced liver tissue) from the very sample of veld bones which led to the discovery of the cause of lamziekte.

The fact that the organisms concerned in producing the toxin are saprophytic rather than parasitic, i.e. flourish in dead organic matter rather than in the living animal, was at once suggested by the observation that the experimental production of the disease was quantitatively related to the amount of infected material fed. It was also supported by the fact that all the experiments of earlier years upon the transmission of lamziekte on the theory of a pathogenic bacterial cause, were negative, and that the disease had been shown to be neither infectious nor contagious in the scientifically accepted sense. Further evidence was readily obtained by the injection and drenching of sterile toxin obtained by passing extracts of toxic material through a Berkefeld filter. Such a filter retained the bacteria, as evidenced by cultural study of the filtrate, but allowed the toxin to pass through. As converse proposition, cultures which were toxic in large amount were found to be non-infective in small amount, and material in which the toxin was destroyed by a heat treatment (75° C. to 80° C.) which did not destroy the spores, failed to produce lamziekte. The toxin therefore produced the disease when separated from the bacteria, but the spores did not produce the disease when separated from the toxin. Apparently the living animal is able to get rid of any bacteria with which it may happen to become

infected, before these bacteria have had time to produce toxin, and the disease only occurs when the organisms grow saprophytically upon dead organic matter.

The organisms themselves belong to the anaerobic group, i.e. they only grow in absence of air or in association with aerobes which take up such oxygen of the air as finds access to the putrefying material, or in association with oxidizing enzymes and easily oxidizable organic matter (e.g. in liver tissue exposed to air). The fact that they grow in mixed culture with other organisms explains why it is that carcass material exposed to the atmosphere becomes toxic. It must not be imagined that they are the cause of putrefaction. They may possibly contribute to decomposition, but the real stinking putrefaction is the work of the other common bacteria with which they are associated.

As just stated, they are sporulating organisms, and although toxic material may be rendered non-toxic by boiling for a few minutes it may become toxic again after the undestroyed spores have germinated out. To sterilize toxic material completely it is necessary either to heat under steam pressure at about 130° C. or to boil on each of three successive days.

So far the causal organism has not been isolated in pure culture, although that may be accomplished at any moment now. The technical difficulties in the way are considerable. Impure toxic cultures, however, are easily obtained, in which three different sporulating organisms are constantly present. Two of these dominate the cultures, but when taken alone produce no toxin. The predominant one appears to be *B. putrificus*, a common soil anaerobe. The second dominant organism is a "racquet" form. The third is of "drum-stick" form, and is the one to which suspicion attaches at the moment.

Since the different members have not yet been completely separated it is not yet possible to state which is responsible for toxin production. Indeed, we are rather inclined to think that two, or all three, are essential: that ordinary putrefactive bacteria prepare the medium for the particular bacteria which actually produce the toxin. At first we were inclined to consider that we were dealing with *B. botulinus*, but comparison of the physiological effect of lamziekte toxin with the toxin from two different strains of *botulinus* excludes identity.

All these details will be cleared up in time, but meanwhile the more urgent economic experiments required for the elucidation of practical points, are being pressed with the highly virulent toxin produced in mixed cultures. As already mentioned, this toxin is so powerful that a quantity of 0.0001 c.c., or a few millionth parts of an ounce per kilogram body-weight, injected under the skin, is sufficient to produce lamziekte in cattle. The dosage required to produce the disease experimentally in other animals such as horses, sheep, goats, rabbits, guinea-pigs, ostriches, and poultry, varies according to the species of the animal. The minimum lethal dose produces typical lamziekte in cattle in about five days, but the period can easily be reduced to within twenty-four hours by sufficiently increasing the dose.

Once it had been established that lamziekte is produced by a toxin elaborated by bacterial action in carcasses undergoing putrefaction: that in all probability it is produced in no other way: and

that it is not produced by normal putrefaction occasioned by the ordinary widely distributed bacteria: the question naturally arose: How does a carcass become infected under natural conditions?

Experiments were carried out to answer this question. A cow which had died on the veld from another disease was allowed to decompose with an intact skin. Putrefaction set in rapidly. After twenty hours the spleen was removed and drenched to a tollie, which duly developed lamziekte and died. Although the dose of putrefying material was fairly high, the period of twenty hours represents a rate of toxin production which is phenomenally rapid. As a rule a few days elapse before carcass material is toxic. The interesting point in this experiment, however, is just the very fact that the brevity of the period practically excludes infection of the spleen from the outside through the intact skin, and throws the weight of evidence in favour of infection from the intestinal contents of the carcass immediately after death. The intestinal contents themselves could, of course, easily be infected by the ingestion of infective but non-toxic material, without producing death. Partially bleached bones, from which the toxicity has disappeared but which still harbour spores of the toxicogenic saprophyte, are very common on the veld, and such material would infect the intestine without necessarily doing any harm to the animal. Another source of harmless infection of the intestine may be particles of infected soil, and grass infected by spore-laden dust from the site of an old cadaver. This experiment indicates an infection from the *inside* of the carcass.

Another interesting experiment was carried out with a full-time foetus from a cow which died on the eve of calving. Since there is no direct intercourse between the blood of the mother and the blood of the foetus, it may be accepted that the unborn calf was not infected with bacteria from the cow. This calf was at once removed and exposed to putrefaction on the veld. Material subsequently collected from it, and drenched to a tollie, promptly produced lamziekte. This calf, then, represents a case of infection from the *outside*.

Control experiments were carried out in fenced paddocks at Onderstepoort, i.e. a non-pica area free from lamziekte. Post-mortem-room carcasses, to which no suspicion of lamziekte infection was attached, were exposed on the local veld. Putrefaction set in as usual, but the carcass material proved non-toxic. Certain animals were then drenched with toxic material sent from Armoedsvlakte, contracted lamziekte, and died. On putrefaction these carcasses now proved toxic, thus indicating again the infection of the cadaver through the intestine. The disease could readily be maintained in the Onderstepoort paddock by carrying the infection through successive animals, poisoning each one by drenching the carcass material of its predecessor in woe. This was done through seven generations, and then abandoned as a conclusive experiment. A tendency, however, was noted towards non-toxic putrefaction in some of the animals (negative duplicate experiments) drenched with experimentally produced carcass material, thus suggesting that the local conditions (climate, competitive putrefactive flora, etc.) were less favourable to toxin production than at Armoedsvlakte. On the other hand, a non-infected carcass from the post mortem table, exposed in the vicinity of the toxic carcasses of the experimental paddock,

developed toxin production, thus indicating that infection could be transmitted over some considerable intervening space.

In regard to Onderstepoort a low degree of natural infection does, however, exist, since in more than one case last summer a local carcass developed a toxicity which could not be traced to foreign infection. Whether this low natural infection is a permanent feature of the area, or whether it is merely maintained on the Onderstepoort farm by the constant introduction of animals from the outside, is not yet clear. In any case it does not matter much, since there is practically no pica on the farm, and therefore no danger of the stock acquiring natural lamziekte.

In regard to the natural distribution of the causal organism throughout the country very little can be said as yet. We know that there are areas in which the organism is present, but in which no lamziekte occurs because pica is absent; and we know that there are extensive areas in which pica occurs but from which the organism appears to be absent, and which are therefore free from lamziekte; but that is all.

In regard to the scattering of infection, four common modes may be regarded as important—blow-flies for short distances, and dust, birds, and moving animals, for longer distances.

When examining a carcass undergoing decomposition during the warmer parts of the year, the presence of blow-fly larvae in enormous numbers is noted, and these larvae undoubtedly assist in the rapid putrefaction of the cadaver. They are themselves toxic, and although generally left untouched by pica animals, they can produce the disease experimentally when drenched in sufficient amount. The pupae from such larvae are also toxic, and the causal organisms can be obtained in mixed culture either from larvae or pupae. Undoubtedly the blow-fly larvae help to distribute the toxin-producing bacteria throughout the carcass, especially by carrying the infection from the aerobic surfaces into the anaerobic depths of the tissues; while the blow-flies themselves can help to scatter infection by mechanical carriage from one carcass to another.

But in the winter months, when blow-flies are absent, carcasses may still develop toxicity, and the flies are therefore by no means essential to distribution. Under these conditions we must assume infection from soil and dust. As already mentioned, the causal organisms produce spores, and, as in the analogous cases of anthrax and quarter-evil, such spores may remain viable in the soil for a considerable length of time. Exactly how long an infected soil can remain infected we do not know. It is an interesting problem for the future to determine the interval over which a soil can harbour viable spores or germinated bacteria, in competition with the normal soil flora, once the favourite habitat (carcass material) is abolished.

We have just stated that carcasses may develop toxicity in the winter time, but it must now be emphasized that winter decomposition is not nearly so dangerous as the rapid putrefaction of summer. During the last winter season at Armoedsvlakte a considerable proportion of the carcasses were found non-toxic, and of the carcasses which were toxic a larger quantity of débris was required to produce the disease. During the cold dry weather the tenacity of the carcass is rather to mummify than to putrefy. Blow-fly larvae, those agents



of speedy dissolution, are absent, and both temperature and humidity are against rapid putrefaction. Furthermore, the absence of larvae to ensure toxic infection throughout the whole cadaver, and of the blow-flies themselves to act as mechanical carriers from carcass to carcass, throws the onus of infection upon soil and dust, and so leaves greater opportunity for ordinary non-toxic putrefaction wherever the soil is not heavily infected and aerial spores are infrequent. Sometimes such carcasses are toxic in one part and non-toxic in another, indicating a localized rather than a generalized infection with the toxicogenic saprophyte.

As another instance of the influence of weather upon the toxicity of carrion may be cited the observation that carcasses are less toxic after heavy rains, particularly old carcasses of which the skeleton is the major portion. The most poisonous parts of the residual putrefying soft tissues are washed down into the soil, the carcass remnants are partially leached out and aerated, and conditions tend to be created for the dominance of a more aerobic flora which is not only subversive of the interests of the anaerobes, but which may possibly tend to destroy the preformed toxin. The bleaching and "sweetening" of toxic bones is hastened by the leaching and aerating action of rains, and the toxicity steadily falls off with time. The influence of rains may possibly have another effect merely in virtue of the water conveyed to the carcass. From laboratory experiments it would appear that toxin production is much less marked in liquid than in semi-solid media, although this perhaps depends upon the quantity of substrate as well as the quantity of water. Whatever be the explanation, the fact remains that carrion is rendered less toxic by the weathering action of rain.

The seasonal variation of toxicity of carcass material is of great importance in connection with the control of lamziekte, especially in relation to the seasonal variation of "osteophagia" (*vide infra*).

Returning to the spread of the causal organism, we may regard the long-distance carriers as birds and moving stock; to a less extent dogs or jackals, and wind laden with dust. Dogs and jackals carrying bones and carcass material, are certainly responsible in some cases for carrying infection from place to place on the same farm and to neighbouring farms. Spores may also be distributed through their faeces.

The spread of the actual spores is to some extent analogous to the spread of anthrax spores, but there are important differences arising from the fact that anthrax is an infectious disease in the ordinary sense of attacking the live animal, while lamziekte is not, strictly speaking, an infectious disease at all. It is simply a ptomaine poisoning of saprophytic origin, and only affects certain species of animals under certain specified and localized environmental conditions. If it ever became desirable to bring it within the scope of an Infectious Diseases Act it might be scheduled in popular language as infectious, but in the scientific sense it is no more an infectious disease than is botulism or ergotism, both of which spread by infection—of dead matter in the former case, and of the living plant in the latter.

We know, however, that a beast can carry the causal bacteria in its intestines, and that these can multiply as soon as the animal dies;

but we do not know how long such bacteria can remain in an animal once it has been removed out of a lamziekte area if it does not die; nor do we know to what extent its faeces will scatter spores. If the beast should die outside a lamziekte area, we do know, from the Onderstepoort experiments, that its carcass is very likely to become toxic, but we do not know enough concerning environmental conditions of putrefaction, and localization of pica, to know how likely it is that such will propagate the disease.

These are all points which have to be cleared up in the future. Meanwhile we must admit that the disease can spread, and is steadily spreading to areas in which it was formerly unknown. Experience shows that the scattering of the causal organisms is a slow process, but it is none the less a serious menace which must be brought under control.

At present there are many areas in which pica is prevalent, but in which the disease is unknown. Such are the danger grounds. In Natal, for instance, the carcass material collected for experimental purposes has so far proved non-toxic, although gathered from farms on which craving was very pronounced. Some of these areas may possibly be safeguarded by a moister climate, and other conditions of putrefaction about which we know little as yet. But there are also areas in which we know that no safeguards exist and which are only saved by the localized character of their infection: as, for instance, on two neighbouring farms, with the same climate, on the same type of soil, and belonging to the same owner, who adopts the same precautions against the disease in both places, but finds his mortality high on one and negligible on the other. Such differences are most probably due to a difference in soil infection and the absence of mechanical carriers of spores from one area to the other. Once a carcass on the clean farm becomes infected, however, the process of multiplication of the toxicogenic saprophytes may proceed very rapidly. Each animal that dies of lamziekte, or from any other cause, is then liable to become a breeding ground, and infection may become so heavy as to drive the unfortunate owner to abandon cattle rearing altogether.

In regard to the measures for controlling lamziekte it is practically hopeless to attempt to eliminate the organism by any other means than destroying its food supply, i.e. by cleaning the farm of all carcass material. If this is done the remaining soil infection will slowly die down, and so long as all dead animals are disposed of as soon as discovered, the bacteria may possibly die out altogether, and the danger from undetected small fragments of carrion so disappear.

#### THE MATERIAL OUT OF WHICH THE TOXIN IS MANUFACTURED.

So much has been said on this matter under the two preceding headings that little remains to be discussed. It is sufficient to emphasize again that any dead animal whatsoever, from whatsoever cause it died, can serve as substrate or material out of which the toxin can be elaborated.

The important constituent of the substrate is the protein or nitrogenous matter, and all the tissues of the body are associated with protein. Even bone contains just about as much nitrogenous organic

matter as it does mineral matter. Toxin production may vary with the nature of the tissue, and appears to be more active in tissues such as liver and spleen than in muscle and bone, but it can occur in any part of a carcass provided the conditions of life of the toxicogenic bacteria are suitable.

It is more than likely that protein-rich vegetable material such as beans would also prove to be a good substrate, although this has not actually been tested, and it is not impossible that any dead vegetable matter at all could serve for toxin production provided the requisite degree of anaerobiosis (exclusion of air) were maintained. Fortunately the organism is not parasitic upon the living plant any more than upon the living animal, and although dead vegetation may possibly serve as substrate the dead grasses of grazing areas are too freely permeated by air to be any source of danger. We should not be surprised, however, if an occasional infection in a silo occurred, and the disease broke out in any animals which were fed upon the silage. But such stray happenings would not be reported as lamziekte and need not be considered.

The point of importance is that in the lamziekte areas dead animal matter is practically the only source of danger, and that at certain times of the year such carrion can become so violently toxic that although a farm appears to be clean, and no carcasses of large animals can be found, yet the presence of carrion derived from such small animals as lizards, frogs, tortoises, barbels, hares, mierkats, birds, liguans, etc., may be legitimately held responsible for a small outbreak of lamziekte. Indeed, experience has shown that when pica is at its worst during the droughty season after the spring rains, the worst cravers amongst a herd will eat such unusual things. Cattle have been actually observed to eat dead barbels, and it is now possible to understand why lamziekte has been definitely associated with pans, in the minds of some farmers.

The greatest source of danger is, of course, from large animals dying on the veld, wounded game, cattle, sheep, lost lambs, kids, or ostrich chicks; also calves or foals which have been slipped and are not missed at once. Naturally enough, so long as the carcasses of large animals are carefully disposed of, so long will the greatest danger be removed, but so long as the carrion of even the smallest beast of the field is there, so long can a small mortality from lamziekte be expected at certain seasons of the year on farms where pica is acute. This mortality may be negligible during the cold winter months, when such carrion of small animals tends to shrivel up and mummify rather than to putrefy, but it cannot be altogether discounted in the summer.

The raw material from which the lamziekte toxin is elaborated thus represents the most important link in the etiological chain, and it is there that the first effort should always be made to break the chain. If *all* carrion is removed, toxin production is excluded and the toxicogenic saprophytes will die out altogether in time. It is, however, practically impossible to remove animal debris *completely*, and some small amounts are sure to be overlooked; but overlooked carrion becomes non-toxic in course of time by further decomposition and weathering, and although it may certainly remain toxic for six months, or perhaps even a year, it will sooner or later lose its poisonous character. By reducing the general level of veld carrion,

the general level of veld infection is also reduced, and the risk attaching to overlooked carcasses of small animals will become negligible, and may finally disappear altogether.

Since the difficulties of completely clearing all carrion from the veld are considerable, the margin of safety is increased by trying to break the chain of causation of lamziekte at two points instead of only one. The second point of weakness which the farmer can get at immediately, is represented by the depraved appetite or pica of the cattle.

#### PICA OR DEPRAVED APPETITE.

It is a generally known fact that over large areas of South Africa, cattle show an abnormal craving, particularly for bones. Indeed the fact is so well known that farmers in many districts look upon it as a natural thing and only notice it when it becomes so pronounced as to constitute a public nuisance, i.e. when the cattle congregate around the homestead or Kaffir huts, devour the washing, bags, clothes, riems, skins, and miscellaneous rubbish, and persistently return when driven away. Such acute manifestations are what is understood by craving in the worst districts, and a man brought up in such districts will quite ignore the subdued craving, manifested only for bones, which is common on farms where pica is comparatively mild.

As already mentioned, the term pica, in the ordinary dictionary sense, means depraved appetite of any sort, and of any origin. In the human subject, for instance, it sometimes occurs as a concomitant of ovarian disease. The general craving for rubbish is termed "allotriophagia" and the distinctive craving for bones is termed "osteophagia." The pica of the lamziekte areas is probably due mainly to one cause (shortage of phosphorus), and its distinction from other forms of pica must therefore be kept in mind.

Understanding the true connection between pica and lamziekte as we now do, it is easy to realize why some sort of connection between the two should have been so frequently surmised by the observant farmer. In correspondence, farmers have frequently drawn attention to the fact that when craving appeared lamziekte was not far off. Indeed, Dr. Hutcheon, of the old Cape Veterinary Service, went so far as to explain bone-eating as a definite premonitory symptom, and to formulate a definite deficiency theory in which lack of lime and phosphate was held to be the *cause* of lamziekte. We now understand exactly where his hypothesis breaks down, and although it failed to explain lamziekte it can profitably be revived to explain osteophagia. Hutcheon's view, however, was empirically useful in breaking a link of a then unknown chain, and it was made the basis of bone-feeding experiments by Borthwick and by Spruell—Borthwick at Wittelclayrug and Spruell at Koopmansfontein, distinctly showing that if bone meal were supplied regularly at the rate of three to four tablespoonfuls a day, the mortality from lamziekte was materially reduced. We now understand the full connection: bone meal breaks Link 4 (craving) of our etiological chain and Link 1, the primary cause (toxin), is accordingly separated.

But the Hutcheon hypothesis failed to throw any light on the immediate cause of the disease and was abandoned when it was found that craving and lamziekte were not invariably associated together;

that on some very bad pica farms lamziekte was unknown. The bone paradox was not suspected—that the giving of sweet bone meal merely prevented the ingestion of toxic veld bones. The second link, the toxicogenic saprophyte, was not surmised.

Furthermore, the psychological circumstance, referred to above, obscured the truth; the circumstance that farmers, and indeed most veterinary surgeons who were aware that even European cattle sometimes "ate the washing off the village green," took no notice of mild bone chewing, but regarded it as normal, and treated it rather as a harmless pastime indulged in by the cattle to pass eternity upon an uninteresting veld. This led to the constant reiteration that lamziekte occurred independently of pica. Obviously, if this had been true, and lamziekte and pica each occurred independently of one another, there could be no fundamental relation between the two diseases.

It was not until the real nature of lamziekte, as a special kind of ptomaine poisoning, had been grasped, and the chain of causation visualized as a whole, that the full distinction between a natural predilection for a sweet bone and a genuine abnormal craving, became apparent. Once the idea of the toxicogenic saprophyte was brought in as etiological link, it became obvious that although pica could quite well occur without lamziekte, and lamziekte perhaps occur accidentally (as it does experimentally) without pica, lamziekte could only occur as an enzootic and epizootic disease in areas where pica was fairly pronounced.

This led to the necessity of introducing into our work some system of *measuring* craving on a quantitative basis, so as to be able to distinguish between the comparatively normal and the definitely abnormal, and express both the degree of pica and the prevalence of pica on some definite chartable basis. This was done by utilizing bones at varying stages of decomposition. It was found quite easy to pick a stinking bone which only those animals showing a very marked craving would touch and a perfectly bleached sweet bone which practically every animal would chew, or at least toy with. Intermediate degrees of craving could be identified by intermediate bones, but since this was cumbersome for routine testing of cattle, only two grades of bone were actually adopted—"sweet or bleached" and "distinctly rotten." The latter were picked out as veld bones which would produce lamziekte if drenched in sufficient amount, but were then sterilized to render them non-toxic. The former were selected so as to be quite unobjectionable to any beast which showed any clearly defined craving at all, but to be sufficiently objectionable to the real normal non-craver.

In measuring craving, a very simple method of routine testing was adopted. Two sets of troughs, placed at opposite ends of a large enclosure, were provided with test bones, one with the sweet and the other with the sterilized rotten. The cattle to be tested were admitted first to the rotten bones. The number which picked and chewed these was noted and recorded as "marked cravers." Those which refused to touch the rotten bones were then admitted to the sweet bones, and the number which picked and chewed again noted. These were recorded as "mild cravers." The remainder which, by the way, would still usually take a ration of sweet bone meal if offered, were entered up as "non-cravers."

All the cattle at Armoedsvlakte were tested once a week as a matter of routine, so that the effect of treatment and the seasonal variation of craving could be plotted in the form of curves showing the effect of the particular factor under investigation. Really scientific records of osteophagia were thus obtained for the first time.

The seasonal variation curve dates back to May, 1919, when 40 per cent. of all grazing animals admitted to the test showed craving. There was then a gradual increase until 5th August, when the maximum craving was reached, and 80 per cent. of all the cattle ate rotten bones. From that date onwards a gradual descent in the curve was noted, until 27th October, by which time the craving had again fallen to 40 per cent. During this period the weather had been continuously dry, but as it grew warmer the spring vegetation began to appear, and this is regarded as responsible for the diminution in pica. During the ensuing fortnight rain fell, the young vegetation became almost luxuriant, and by the middle of November the craving had rapidly fallen to 6 per cent. of all the animals tested; had vanished except for the more or less chronic cravers.

This minimum craving was maintained through a fortnight of rainless weather, and then, as the young grass wilted, it rapidly returned, reaching a maximum of 82 per cent. within three weeks. For the next two months of drought it oscillated around this figure.

The craving curve, up to that date, therefore showed pronounced craving while the cattle were grazing upon the old grass of the preceding rainy season, reduced craving as the young spring vegetation began to shoot, practically no craving after the beneficial effect of the rains upon the young grass, but a recrudescence of craving during the ensuing drought when the young grass wilted and shrivelled up—a craving which remained high so long as the drought continued.

In the middle of January, 1920, the drought broke, the pasture rapidly recovered, and it was naturally thought that the craving would again disappear. The unexpected happened, however, and notwithstanding the ample supply of good green grass, and the absence of wilting, the craving did not fall to the previous 6 per cent., but only to 50 per cent. As the age of the grass advanced towards maturity, the craving curve again rose, and by the end of March once more stood at 80 per cent. of all the cattle tested.

This behaviour was a little difficult to understand at first, but was found to be correlateable with the phosphorus content of the growing vegetation. We cannot yet offer a complete explanation of the precise relationship between the wilting of the young grass and the rise in the pica curve, but we hope to get further evidence next time the phenomenon occurs. The general behaviour, however, can be satisfactorily explained upon a phosphorus-deficiency theory which we hope to elaborate finally as main factor in the explanation of pica; not necessarily as only factor, and not necessarily in the conventionally accepted sense of a deficiency disease. In passing, it must be made clear that any such hypothesis bears no relation to any sort of deficiency theory for lamziekte *per se*, but bears only on the correlated craving; further, that it has nothing to do with osteomalacia or osteoporosis or any other disease which has been mixed up with lamziekte in the past and is confused with it still by some recent authors.

During the period of initial high craving, hay cut from the grazing areas showed the very small proportion of 0.08 per cent. phosphoric oxide. During the period of rapid growth after the rains, the young grass showed 0.56 per cent. of phosphoric oxide, or seven times as much. During the period of lowest craving the phosphorus content remained fairly high, and as the craving rose again the percentage of phosphorus in the grass steadily fell. By 15th January it was down to 0.18 per cent. phosphoric oxide.

The poor response of the craving curve to the second rains is explained by the fact that the ageing vegetation, though green and fairly luxuriant, remained low in phosphorus; the older plants containing proportionately less than the young spring shoots.

The phosphorus curve and the pica curve are roughly inverse to one another, and up to the date of the last analysis the bone-eating increases as the phosphorus in the grass diminishes. It is too soon to say how rigorous the relationship is, but the general trend is borne out by facts obtained from other experiments.

Generally speaking, a liberal mixed ration rich in phosphorus reduces the craving fairly quickly, though much depends upon the components of the mixture; and a single ration of wheat bran containing 2 per cent. phosphoric oxide reduces craving in grazing animals in a few weeks, when fed at the rate of about 2 lb. per day. The quantity of bran required appears to be roughly proportional to its phosphorus content. Curiously enough, however, lucerne hay of phosphoric oxide content 0.5 per cent., fed at the rate of 10 lb. per day over a period of six weeks, did not reduce craving in a batch of ten grazing animals; although the absolute phosphorus intake was just as high as in the case of the bran-fed cattle. This observation requires repetition and elucidation, but meanwhile suggests that it is not only the actual proportion of phosphorus which is important, but also the balance of other constituents in the mineral matter of the plant. This is a complicated question and may therefore be left for discussion in a more technical paper.

It would appear that craving can be removed by almost any phosphorus compound, provided it is assimilable and convertible into the form of phosphate. Bone meal, the obvious preventive for bone craving, generally reduces pica almost to zero within a month when fed at the rate of about 4 ounces per head per day, although the quantity required varies throughout the season and is larger with some animals than with others. As soon as the bone meal is withdrawn the craving begins to return, and in the course of a few weeks comes back to the percentage shown by grazing controls. The winter craving requires rather more bone meal for reduction than does the summer craving—a fact correlated with the phosphorus content of the vegetation. With cows, heifers, and young oxen, a craving removed by bone meal returns rather more rapidly after cessation of dosing than in the case of working oxen. A very heavy ration of bone meal of about 1 lb. per day may sometimes reduce the craving to zero in one or two weeks. If lamziekte is bad, therefore, large quantities ( $\frac{1}{2}$  lb. to 1 lb.) should be given until the osteophagia subsides.

Calcium phosphate can take the place of bone meal, and this compound is quantitatively superior to bone meal if fed as precipitated calcium phosphate, but inferior if fed as ground mineral

phosphate. Not only the quantity of phosphate must be taken into consideration, but also its availability.

Sodium phosphate can take the place of calcium phosphate.

Pure phosphoric acid is rapidly effective when given either in the drinking water or in the form of a paste made up with mealie meal. The quantity required per day corresponds roughly to the quantity of phosphorus in an effective daily ration of bran, and 16 to 26 gram (phosphoric oxide) per head reduces craving completely in a few weeks' time, in all but the most persistent cases.

Whatever substance be fed, it seems that the common factor of phosphorus must always be present. The behaviour with pure phosphoric acid indicates that the base in combination is unimportant, except in so far as it affects the absorption and utilization of the compound itself. The compromise between "cheapness" of compound and "efficacy per unit of phosphoric oxide" has not yet been arrived at, but we hope to get some South African firm to put a cheap easily digestible phosphate on the market. Meanwhile we recommend bone meal as the cheapest prophylactic on sale. Compounds of elements necessary for plant nutrition, other than phosphorus, do not reduce pica when fed in excess, nor does plant ash as a whole.

Substances such as sulphur, salt, iron sulphate, mineral acids, organic acids, arsenical compounds, kerosene, glauber salts, aromatic drugs, and other non-phosphatic compounds which have been tested, all failed to reduce craving. Strong acids such as hydrochloric, and bases such as lime, show a tendency towards aggravating the craving. This is probably explicable upon the phosphorus hypothesis: increased urinary elimination of food phosphorus in the former case, and decreased absorption from the gut in the latter.

Incidentally it may be remarked that a high ratio of lime to phosphorus in the mineral matter of a plant may possibly have a similar effect to a low absolute percentage of phosphorus, and we are yet prepared to substitute an excess-lime hypothesis for a phosphorus-deficiency theory. We do not yet wish to bind ourselves to any one single explanation of the observed facts, but wish to avoid adopting too simple an explanation for what may yet turn out to be a complicated business.

The fact remains, however, that administration of suitable phosphorus-rich materials has so far proved the only way of reducing craving, while lack of phosphorus appears to be the common factor in the production of osteophagia under various conditions.

This latter point was illustrated by showing that the vegetation of the lamziekte veld at Armoedsvlakte maintained pica, and could produce pica when fed in stalls either as cut hay or as botanically independent grasses. Thus mixed hay, krul grass (*Digitaria eriantha*), and besem grass (*Aristida uniplumis*) all reproduced pica in cattle in which craving had been previously removed on a balanced ration. But low phosphorus content was the recognizable common factor.

An independent experiment, designed from the opposite angle, was carried out at Onderstepoort, in an area free from lamziekte, in an enclosure devoid of growing vegetation. A ration of wheat chaff (as coarse fodder), selected as low in phosphorus as possible (0.16 per cent. phosphoric oxide), and Fanko, a flaked maize product (breakfast food) containing only 0.09 per cent. phosphoric oxide, was compounded so as to provide as low an absolute intake of phosphorus as



possible. Ten cravers sent from Armoedsvlakte were placed on a balanced ration until the craving had disappeared and were then switched over on to this phosphorus-low synthetic ration, derived wholly from products of a non-lamziekte area. The craving was slowly reproduced. This evidence, taken together with the Armoedsvlakte tests and the phosphoric acid experiment, affords strong support for a straightforward phosphorus-deficiency theory for the explanation of osteophagia.

If this view is valid and we can call osteophagia a mild deficiency disease, we have a very interesting instance of a physiological abnormality which in itself is of no particular consequence, but which is of enormous importance as a link in the etiological chain of a truly devastating disease. It is perhaps difficult to understand how cattle can grow to maturity, reproduce their kind, and complete the cycle of their being as fat well-conditioned beasts, when the veld is deficient in a constituent essential to their metabolism. We would expect the "law of the minimum" to hold, and a minimum of any one necessary dietary factor to control the growth of the animal. But in the spring of this year the weight and condition of the cattle increased most markedly just as the craving became most acute. The fact must simply be that these beasts get more than their physiological minimum, but less than their optimum requirements; that the veld is not so deficient as to induce real phosphorus starvation, but merely so deficient as to induce a cry for more. This raises the very interesting question of minimum phosphorus requirements of cattle, the text-book statements of which would seem to require revision. In osteophagia we have an indicator of considerable value.

It may be emphasized that individual variation of craving in different cattle is very great, and that although liberal feeding with bone meal, bran, or other phosphorus-rich material, will stop pica in the great majority of cases, a few individuals retain their craving very persistently and require very large doses of bone meal over extended periods before the osteophagia disappears. Is there in this a tendency for craving to degenerate into habit? Of an animal so losing its fastidiousness as to minimize the distinction between a slightly rotten bone and a wholly clean bone? Or can pica have more than one origin?

The habit or predilection aspect of the question is of some interest to the farmer's pocket when he proposes to reduce pica by feeding bone meal. If bone meal is supplied *ad lib.* erstwhile cravers will cheerfully go on eating it long after they are reduced below the point at which they would pick up dangerous rotten bones, or even bleached bones, from the veld. Sweet bone meal is something of a "delicatessen" even to the perfectly normal beast, and there is the curious fact, which may be called the "second bone paradox," that cattle which will no longer chew a sweet bone will readily eat the same bone if it is ground up to a fine meal.

In practice, therefore, bone meal should be given on some definite system, so as to keep down the expense. Not all cattle are cravers, and hence it is not necessary to feed the whole herd. The marked cravers, which are most liable to contract lamziekte, can be picked out by periodic testing against sterilized rotten bones in troughs, much in the manner described already. As craving is manifested the bone-eaters can be separated from the others and fed on bone

meal; three or four ounces per head per day, or more ( $\frac{1}{2}$  to 1 lb.) if lamziekte is rife, and it is necessary to reduce the craving quickly. Testing should be carried out as a matter of weekly or fortnightly routine during the most dangerous part of the year, in order to sort out the animals which develop craving later, and readjust the ration of bone meal for those which are losing pica.

Since the toxicity of carcass material is usually at its worst during the period of the droughts, i.e. in the spring and early summer, this is the time when it is most essential to control craving. In the winter, when overlooked carrion is less toxic, it may be found cheaper to take a small risk than to feed expensive bone meal, even if the craving is markedly present. As mentioned earlier, we shall probably be able to introduce a cheaper substance for reducing craving, but meanwhile the farmer had better stick to bone meal as such, and remember that the more thoroughly he cleans his farm from carcass material the less necessary does the supplementary bone feeding become.

At this point it should be emphasized that the expense of bone meal feeding should not be debited wholly against protection from lamziekte. A bone meal ration improves the condition of the cattle of the lamziekte areas most markedly, and the farmer will generally find that the increased price he gets for the beasts he puts on the market will more than pay the cost of the bone meal. The difference in general thrift, glossy skin, and sleekness of appearance, may well add a pound or two to the cash value of an animal.

Reverting again to the nature of pica, we may explain that we regard abnormal craving as a nervous disorder which may possibly be produced by some injurious constituent of a diet as well as by lack of a necessary constituent, and perhaps even occur as a secondary condition in other maladies. In passing, it may be again recalled that extreme pica may be manifested not only towards the phosphates (bones) which are lacking, but towards anything at all—the white-wash of a wall or the wire of a fence.

The wool-eating of sheep, for instance, is a form of abnormal appetite which need bear no relationship to phosphate deficiency—a type of deficiency to which sheep are less susceptible than cattle, and which therefore does not manifest itself as bone-eating. And it may be further added that, with cattle, any circumstance which upsets the beast may temporarily reduce its craving; a railway journey, a sudden change of diet, an attack of diarrhoea, or the permanent low health of semi-starvation. This is a circumstance which must not be lost sight of in experimental work. The best conditioned animals are also usually those which show the worst craving, and as cattle fall off in condition they tend to lose craving. It is a common wail of the farmer that he loses his best beasts from lamziekte, while the poverty-stricken weeds most frequently escape.

We may now make a few comments on the fifth link of the etiological chain, upon which we are stringing the discussion.

#### COMPOSITION OF VELD VEGETATION AND SOIL.

We have just stated that we believe, tentatively at least, that the main factor in the production of osteophagia concerns the lack of phosphorus in the vegetation. This, however, does not exclude an influence of other variations in the composition of the veld grasses.

It may well be, and to a certain extent must be, that the percentage of phosphorus in a grass has to be correlated with its general feeding value, and with the season of the year, in getting at a full explanation of pica; that a mere analysis of vegetation for phosphorus content is but a poor indication of the extent to which it is likely to produce osteophagia; and that neither the percentage amount nor the absolute daily intake of phosphorus can be considered alone, but that the proportion required is partly conditioned by the total amount of food metabolized. There are several experimental indications pointing in this direction which have to be worked up in the future, but for the moment we may content ourselves with a generalized phosphorus theory.

In passing, it may be mentioned that young grass growing over burned veld, and subsequently subjected to drought, appeared to produce more marked craving in grazing cattle than did neighbouring unburnt veld.

In regard to the chemical composition of the soil it may at once be stated that, other things being equal, a soil very low in phosphoric oxide will tend to produce a vegetation low in phosphorus content, but that a limit is set by the minimum physiological requirements for growth of the plants concerned. The available phosphorus content of a soil is reflected even more in the density of the vegetation it can carry than in the phosphorus content of that vegetation, and a small increase in the available phosphate of a soil (as by manuring) is more likely to reflect itself in an increased luxuriance of growth. Other factors also enter, and climate—especially rainfall—is important.

Although, then, low phosphate content is characteristic of the soils of lamziekte areas (a fact emphasized by Juritz twenty years ago), a mere analysis of a particular soil is not sufficient to enable one to estimate the degree of pica which will characterize the area from which the soil is sampled. Two soils in different districts may show a similar analysis but yet differ in regard to the incidence of pica in the cattle they support, and, as already shown, the degree of pica is dependent upon the season of the year.

The question of soil composition in relation to pica does, however, deserve more attention than it has hitherto received, especially since the soil from different parts of the same lamziekte farm may vary considerably both in composition and in depth. This is the case at Armoedsvlakte.

Certain manurial experiments are also in progress at Armoedsvlakte, but these are directed by theoretical rather than immediately practical considerations, since it is felt that any attempt to alleviate pica by phosphatic dressings would be far too costly over the wide lamziekte areas of cheap land. Theoretically it might be possible to break the etiological chain at this link, but so long as the farming of the areas remains extensive rather than intensive the job would cost more than the market value of the land. It may be casually remarked in passing that any bone meal fed to cattle is not wasted wholly in guarding against mortality from lamziekte, but goes to enrich the soil and increase the burden of vegetation it can carry; a very minor consideration, however, in view of the size of the areas in question and the low price of the land. The effect of bone meal on the condition of the animals—already mentioned as enhancing their market value—is a more remunerative consideration.

## CLASS OF ANIMAL AND SUSCEPTIBILITY TO DISEASE.

It has already been stated that most animals, including sheep and horses, are susceptible to the lamziekte toxin, but never contract the natural disease simply because they do not develop pica, and hence, never, except by accident, ingest obnoxious material. For practical purposes, excluding the stray natural cases amongst goats, ostriches, and poultry, cattle come into almost exclusive consideration.

At this point, therefore, it is only proposed to refer to the possibility of breaking the etiological chain by reducing the susceptibility of the beasts threatened with the disease: in other words, by immunizing them against the toxin which they are liable to pick up from the veld. There is a possibility of doing this by injection of a modified toxin and so engendering an anti-toxin in the body of the animal. This problem is a difficult one, since nature, and not man, confers immunity. Experience has shown that any natural immunity which exists towards the toxin is of very short duration, and cattle which have just recovered from one attack of lamziekte can succumb to another very soon after. But it is just theoretically possible to build up an experimental immunity of longer duration and perhaps devise a scheme whereby a temporary immunity could be made to tide over an urgent period, and so gain time to break the chain of causation at another link.

This line of attack is being vigorously pursued, but it is too soon to hold out any prospect of success.

Although it is desirable for the control of lamziekte to have as many ways of breaking the etiological chain as possible, it must again be emphasized that only by breaking Link 3, i.e. removing material out of which the toxin is manufactured, can the *cause be removed*. Attack at Link 6, i.e. decreasing the susceptibility of the animal, can only protect the particular animal immunized, and that probably only for a very short time. It will not prevent toxin production, which can occur in carcasses of animals dying from other diseases or from drought, and which therefore can spread all over the country irrespective of the use of a possible lamziekte vaccine. All efforts to clean the farm must therefore be made, and in the process the farmer can comfort himself with the reflection that he is not only stamping out lamziekte, but other diseases, such as anthrax, as well.

The degree of success depends upon the energy of the farmer himself. At Armoedsvlakte, where the mortality from lamziekte was 30 per cent. in 1914, the mortality with a herd of 500 cattle was reduced to below 2 per cent. after the measures here advocated were adopted in 1919.

## CONCLUSION—PRACTICAL MEASURES FOR PREVENTION.

This article may now be concluded with a few provisional practical directions for control, based upon the measures followed at Armoedsvlakte during the last season. They will be improved upon later, but for the present they will be found serviceable. They may be addressed personally to the farmer who has suffered most heavily from lamziekte in the past:—

1. *Clean your farm* of all bones and carrion and *keep it clean*.

For this purpose it is necessary to secure *all carcass material* of the animals which die on the farm and deposit it in some safe place,

such as a dry well or jackal-proof camp, where dogs or wild animals cannot get at it. If any animal is suspected of having died of anthrax it should be buried and not merely fenced in.

The veld should also be searched when calves or foals are slipped; for lost lambs, kids, or ostrich chicks; thoroughly search also for the carcasses or remains of all wild animals, even the small ones such as birds, hares, mierkats, tortoises, etc.

2. The bones of the animals so collected need not be destroyed, but can be utilized for testing your animals for bone-craving according to the method described below.

Such *test bones* should not be completely bleached, but so selected as to have a *slightly putrid* odour, so that only cravers will touch them. They must then be sterilized by boiling or steaming them for *one hour* on each of *three successive days*. These sterilized bones should still smell putrid, but if properly sterilized will be perfectly harmless.

3. Now *test* your entire herd of cattle to find out which animals are bone-eaters (cravers) and which not.

To do this, place the sterilized rotten bones in troughs and bring your animals up to them in groups of about ten, leaving them sufficient time to pick up and chew the bones if they wish to. The animals which are thus proved to be bone-eaters should be removed from the herd.

4. Now *feed the bone-eaters with bone meal*.

You need not go to the expense of feeding the other animals which are not cravers and will therefore not get lamziekte. Such animals would still eat sweet bone meal if offered, but they will not pick up toxic rotten bones from the veld.

The craving can be stopped quickest by giving a *large daily ration* of bone meal ( $\frac{1}{2}$  lb. to 1 lb.) to each of the bone-eaters. The craving will then disappear in from one to three weeks' time. In order to ascertain this, test the animals once a week or once a fortnight.

When once the craving for bones has stopped it can be kept down by supplying a *small daily ration* (3 to 4 oz.) of bone meal. Test the animals regularly to make sure of this.

The animals which continue to eat the sterilized rotten bones or test bones should receive the large ration until the craving stops. They can then go on to the small ration.

5. In the meantime the animals that did not eat bones at the first test should be *retested* to find out whether any of them have since acquired a craving. All such cravers should be removed from the herd and treated in the way indicated above.

6. The *feeding of bone meal* is best carried out with a large number of small troughs. If the number of bone-eaters is too large the herd should be divided up into two or more lots, each lot to contain not more animals than the number of troughs available.

If this is not done, and too few troughs are used, the weaker animals will not get a chance of eating their ration and their craving will not be removed.

It is advisable to mix a little bran with the bone meal. A little salt may also be added, although this is not really necessary.

7. Bone meal need not be fed all the year round, since this would be too expensive. It should be supplied when the craving is at its worst. This will be found to be during the dry season, in the spring and early summer, before the heavy rains set in. After the rains the craving may almost disappear for some time, but it may return towards autumn.

During the winter bone meal feeding is not so necessary, although craving may be present to some extent. This is because any carcasses of small animals, which you have failed to find, are not so poisonous as in summer. But if you miss *much* carcass material it will be necessary to feed bone meal all the year round. If you keep your farm as clean as possible all the year round it will only be necessary to give bone meal during that part of the summer when craving is at its worst. If you could only manage to keep your farm perfectly free from *all* carcass material you would not need to feed bone meal at all.

8. By carrying out the bone meal feeding according to the scheme detailed here, i.e.

- (a) feeding only to bone-eaters and not to the entire herd;
- (b) reducing the ration when the craving stops;
- (c) feeding only during certain seasons of the year;

you will find the cost comparatively low and you will be able to afford it, especially as the improved condition of your cattle will itself recompense you.

9. Remember that on the experimental farm of Armoedsvlakte the losses from lamziekte amounted to 30 per cent. of all the cattle in 1914, but that in 1919, when the system of control here described was first introduced, the losses fell to less than 2 per cent. The system has therefore been *tried and found effective*. If the system is carried out *methodically* it will be found much less troublesome than it appears at first sight.

10. As last injunction, remember the first paragraph:—*Clean your farm and keep it clean.*

---

## Export of Grain, etc.

Pressure on space, combined with the present small export of grain, etc., requires the suspension of the statistical table under the above head published in the past two issues of the *Journal*. The position on the 31st March, 1920, was given on page 217 of the May, 1920, *Journal*. Returns for April, 1920, show there were shipped 275 bags mealie meal, 145 bags lucerne seed, 430 bags beans, and 672 bags millet. The stocks on hand at all ports on 30th April was (in bags): Maize, 642; maize meal, 1424; and beans, 911.

---

Do not lose your copy of the *Journal*. A full index will be sent subscribers every six months. The *Journal* will prove a useful book of reference to every farmer. In time it will be a valuable compendium of advice and information on farming in South Africa.

## EUROPEAN FOUL-BROOD BEE DISEASE.

By C. P. LOUNSBURY, B.Sc., Chief, Division of Entomology.

### PREVALENCE OF THE DISEASE.

THE existence of European foul-brood in the Union was officially announced in Department of Agriculture Bulletin No. 10, 1918. At the time of the announcement Mr. A. J. Attridge, of the Division of Entomology, was about to visit various localities in the four Provinces to determine whether or not the disease was of wide occurrence and to make observations bearing on its importance. Mr. Attridge's tour had to be greatly curtailed owing to the pandemic that swept South Africa at the time, and it has not seemed worth while since to continue with the inspection. He was unable to visit the south-eastern and southern districts of the Cape as had been planned, but it does not seem probable that the conditions prevailing in those parts are much better or worse in respect of bee diseases than were found to prevail elsewhere. He visited and inspected apiaries in and near Potchefstroom, Johannesburg, Pretoria, Rustenburg, Pietermaritzburg, Durban, Bloemfontein, and Queenstown; and in one or more of the apiaries at or near each of these centres he found diseased larvae which, by subsequent microscopic examination, the writer became satisfied suffered from European foul-brood. An unhealthy or dead larva here and there in a comb was found in the majority of colonies, but there were only a few much diseased colonies, and more often than otherwise in these exceptional cases the trouble present appeared to be entirely apart from foul-brood. The sporadic unhealthy larvae were in many instances victims of foul-brood, while quite as commonly it was decided that the disease named sacbrood was the affliction and in other cases what the trouble was remained undecided. The most pronounced cases of foul-brood were in apiaries of experienced and relatively well-informed bee-men who were incredulous when they were told the disease was present. As the outcome of the inspection I have come to the conclusion that European foul-brood occurs practically all over the country, but that it is exceptional for it to ravage colonies seriously. Before Mr. Attridge went on the tour we knew the disease in the Malmesbury, Cape, Stellenbosch, Paarl, and Caledon Districts, and we have since obtained positive evidence of an outbreak near Sterkstroom, Cape Province.

### CERTAINTY OF THE IDENTIFICATION.

The disease was first brought to official notice in South Africa through an extensive outbreak in the Berg River-Hopefield area of the Malmesbury District late in 1917. Material was then sent to the U.S.A. Bureau of Entomology to determine if the conclusion that

the disease was really European foul-brood was correct. The reply received removed any room for doubting the identification.

When on his long tour of inspection, Mr. Attridge took specimens from most of the colonies in which he found evidence of disease, taking full frames of brood in many instances and he sent these promptly to Pretoria. The material thus obtained was subjected to close study by Dr. C. K. Brain, of the Division, and by the writer. In the course of the laboratory work hundreds of stained smears were examined, and a large number of bouillon cultures made of organisms found in dead and dying brood. The particular organism, *Bacillus pluton*, which, after a most painstaking and prolonged investigation, officers of the U.S.A. Bureau of Entomology concluded was responsible for foul-brood, was nearly always demonstrated when the general appearances were indicative of the disease; and, as described to be characteristic by the American investigators, *Bacillus alvei* was generally found in the association. The former organism does not admit of cultivation in ordinary culture media and its recognition depended entirely on the "microscopic picture," while the determination of the organism accepted as *B. alvei* was confirmed by culture tests. Subsequently a score or more of prepared smears, representative of specimens from various localities, were sent to the U.S.A. Bureau of Entomology for the favour of examination by its bee-disease specialists, and abundant authoritative confirmation of the identifications was thus obtained.

Organisms other than *B. pluton* and *B. alvei* found at Washington to occur in the smears included *Bacillus vulgatus*, *Bacillus orpheus*, and *Streptococcus apis*. What was suspected to be *Bacillus mesentericus* was also found.

#### SUBSIDENCE OF BERG RIVER-HOPEFIELD OUTBREAK.

The outbreak of the disease in the Berg River-Hopefield area practically died out with the 1917-18 honey season. Under instructions, Mr. Attridge spent nearly a week during December, 1918, in making an inspection of the principal stands. He found the great majority of colonies to be strong and working well, and without obvious signs of disease. Only in very exceptional colonies did he find much dead brood. He sent full frames from seven such diseased colonies, at as many places, to Pretoria for study, and only in specimens from two of the places were the typical European foul-brood organisms demonstrated. In all the other cases there were found only organisms that are believed to be saprophytic, and it is conjectured that the brood died owing to being subjected to bad bee-keeping conditions. Colonies having ceased to die out and the production of honey having again become satisfactory, without the application of measures to suppress foul-brood, I think that the heavy losses in 1915-17 must have been due far more to unfavourable seasons in association with negligent bee-keeping than due to foul-brood. The bee-keepers concerned may resent the imputation that their methods are faulty; and perhaps in fairness I should add that, for all I know, their careless ways may be more efficient in the long run than would be the much closer attention to details that good bee-keeping demands. The bees in the normal year, under the prevailing climatic and plant conditions, seem to be quite capable of looking



after themselves with very little attention; and in the case of large apiaries it may be more profitable, under the prevailing labour conditions, to risk occasional heavy losses than to go to the trouble of guarding against them.

To ascertain if the improvement in 1917-18 had been continued I wrote to a number of prominent Western Province bee-keepers in the past October. The leading Malmesbury District bee-keeper, in the course of his reply, stated:—

Last year my apiaries, bar the infected one, came through all right and gave me a good crop. This season swarms are all strong, even in the infected apiary, and I expect a heavier crop. There are very few signs of any colonies having European foul-brood, so that, in my opinion, the disease has not come to stay.

The person who probably keeps the largest number of colonies in the Caledon District replied, *inter alia*:—

I have to report that my bees wintered well. I have not yet come across any symptoms of the disease, but have not yet handled all the colonies. . . . Where the disease was present in a few cells of the brood of certain colonies last autumn I have found the bees to have recovered entirely, having built up rapidly during the last month. In cases of weak colonies I have found this to be due only to old queens.

Another Caledon bee-keeper wrote:—

In the spring a year ago my bees were in a very bad way from foul-brood and I suppose insufficient stores for the winter. Ten out of thirty colonies had dwindled away and died, and the rest were weaker than I had ever known them (I have kept bees here since 1911). By last autumn (May, 1919) I had increased my bees to thirty strong colonies, and I left a super partially filled with honey on each for their winter supplies. I examined my bees on the 21st October and found all except two colonies pretty strong, and some very strong indeed, with supers quite full of honey. The two weak colonies have foul-brood; the others I have not examined this spring, though last spring every hive had foul-brood.

#### CONDITIONS UNDER WHICH EUROPEAN FOUL-BROOD OCCURS.

It was pointed out in Bulletin No. 10 that European foul-brood is far more in evidence during the spring and early summer than at other times of the year. On this phase of the subject Dr. E. F. Phillips, the Chief Apiculturist of the U.S.A. Department of Agriculture, wrote to the Division of Entomology, under date of 18th August, 1919, as follows:—

. . . . You will, I am sure, find European foul-brood more prevalent in poor seasons, especially those in which the earlier honey-flows are meagre. In 1918 there was an epidemic of the disease in Michigan, when the clover honey-flow failed, and this year New York and Indiana are hard hit, in both States the clover honey-flow being rather poor. This probably accounts for conditions with you in 1915-17. When the early honey-flows fail all colonies are weakened, making them easy prey for the

disease. As I have previously explained, by providing proper conditions in the wintering of the bees and by providing abundant stores to last over in case of early dearth, the bee-keeper may almost entirely prevent an outbreak even in a region where the disease is endemic.

#### TREATMENT FOR EUROPEAN FOUL-BROOD.

In Bulletin No. 10 (pages 9-12) advice by Dr. Phillips, in a letter dated 30th March, 1918, is given in respect of the treatment of European foul-brood; but so much is quoted on more drastic measures that one may get the impression that the advice in the letter is inadequate. Dr Phillips has since written to say he is no longer sceptical of the soundness of the dequeneening remedy known as the Alexander treatment, and that the common failure of this remedy was due to its application to weak colonies. He refers to U.S.A. Farmers' Bulletin No. 975 for the latest knowledge on the subject. This bulletin is entitled "The Control of European Foul-brood," and Dr. Phillips is its author. The following paragraphs contain the information most needed to supplement what is stated in the account of the disease published in our Bulletin No. 10:—

European foul-brood is a disease of weak colonies. While at times one may observe larvae dead of this disease in strong colonies, usually they are removed before the disease can do much harm. It should be pointed out, further, that it is the colony which is failing to increase in strength in the spring which is most seriously affected, for a small colony which is rich in young and vigorous bees, and which is increasing in strength, is often able to overcome the disease. It is therefore a disease of weak rather than small colonies. The disease is prevalent in the spring and early summer. . . . The disease disappears later in the summer unless the colony has become so badly weakened that it cannot remove the dead larvae. Such weakened colonies usually die in winter or in a time of dearth. Colonies do not as a rule die as a direct result of European foul-brood. There may still remain some dead larvae in the combs, showing that the bees have not been able to remove all of them, but in any but the worst cases even these disappear. If conditions which commonly prevail in early summer again appear there may be a recurrence of the disease the same season.

This disappearance of the disease usually accompanies the beginning of the honey-flow. At this time, unless the colony has already reached maximum strength, there is a rapid increase in brood rearing and the colony increases in strength, bringing about conditions unfavourable for the development of the disease. If the honey-flow fails, the disease may continue, and under such conditions is at its worst. It should be noted that in regions where the early honey-flows are uncertain or usually lacking European foul-brood has done the most damage, for in years of failure the disease spreads with such rapidity that the entire region becomes badly infected. European foul-brood is rarely observed in regions where an early honey-flow is certain.

The earliest brood of the year usually escapes with little loss. . . . This in all probability is due to the fact that the

colonies have been able to remove most of the disease during the previous summer and there has been left only a little of the infecting material.

The bees are able under suitable conditions of colony strength and resistance to clean the cells so thoroughly that when future larvae are reared in these cells the disease is not contracted.

The method of spread of the disease is not well known, although there is some evidence that the infection is carried chiefly by nurse bees. It has been observed that under some circumstances it may be transmitted through feeding, but the experience of bee-keepers indicates that contaminated honey is not the common means of carrying the disease. It is well known that honey from infected colonies may be given to healthy colonies with entire safety, provided the healthy colonies are in such condition that they are able to resist the disease. It is therefore not necessary to disinfect the honey from colonies having European foul-brood, as is the case with that from colonies suffering from American foul-brood.

It has not been found necessary to disinfect hives, combs, or frames from diseased colonies. This does not indicate that the germ causing the disease is absent from such material, but that if present it does not do any damage.

Strength of colony is fully as important as resistant stock. Unfortunately too many bee-keepers fail to provide conditions necessary to the bees in order that the colonies may be at the proper strength in time to combat European foul-brood successfully. It is good bee-keeping to have all colonies strong, and nothing leads to large honey crops as does this factor, yet throughout the country there are thousands of bee-keepers who annually fail to get half the crop through failure to have strong colonies at the right time. When the honey-flow comes early in the season, as is the case throughout most of the United States, it is important that every colony be at maximum strength early in the spring. Since European foul-brood appears in the spring and early summer good bee-keeping practice again coincides with the requirements for preventing the ravages of this disease.

One difficulty arises from the fact that there is no standard for strength of colony, and what one bee-keeper considers a strong colony may be considered weak by another and better bee-keeper. At the opening of the honey-flow every colony from which a full crop is to be expected should be strong enough to have ten full combs of Langstroth size filled with brood. Of course this brood may be in a larger number of combs, since the bees usually store some honey at the top of each comb, but it is easy to estimate the brood in terms of full combs. If, now, we accept the same standard for the desired strength of colony for the purpose of resisting European foul-brood, we will have a condition under which (assuming resistant stock) this disease will never get a start in any colony in the apiary. It is, of course, recognized that such a standard is seldom realized before or at the beginning of the honey-flow, and this fact is the reason for the loss of so much honey as well as the full explanation of the ravages of European foul-brood in so many places. It is

suggested that each bee-keeper in a region where European foul-brood exists ask himself whether his colonies are actually in as good condition at the opening of the year as he has supposed, and that he find out how strong the colonies may be made by providing the best of conditions for the development of the colony population. A bee-keeper whose colonies do not measure up to this standard should not condemn the standard until he assures himself that it is entirely impossible, under his conditions, to reach it.

Obviously the proper wintering of bees becomes a matter of the highest importance in regions where European foul-brood is found. Those who fail to practice good wintering are the ones who first lose so many colonies that they become discouraged and give up bee-keeping, while those whose wintering has been better are able to treat the disease, although their standard of colony strength may not be high enough entirely to ward it off.

Good bee-keeping, in so far as handling the bees is concerned, consists of providing conditions in the fall so that the colony is full of young, vigorous bees for winter; of providing conditions of protection and good stores, such that the bees are not depleted in numbers and vitality during the winter by excessive heat-production; of providing plenty of stores, adequate room for breeding, and abundant protection during the period of heavy brood-rearing in the spring; and of preventing reduction in the strength of the colony by swarming. All of these things, and there are no others of importance, pertain to keeping colonies strong. The bee-keeper who provides conditions such that the bees can keep up their strength will not only reap the honey-crop but he will escape the ravages of European foul-brood.

To a large degree the failure of American bee-keepers to get their colonies strong enough is due to the use of small hives that are insufficiently protected during the winter and spring. The single-walled hive was first made as a means of reducing the cost. Such a hive is a good tool for a bee-keeper, but it is a poor home for the bees. When the 10-frame hive was found too large to be filled with bees in time for them to go into the supers as soon as the honey-flow opened, instead of protecting the hive the use of the 8-frame hive was commonly adopted. This hive is in rather general use throughout the United States, although fortunately it is now being replaced by the 10-frame hive in many localities. In order that the bee-keeper may reduce his labour, it would be well to raise the standard of colony strength by providing better protection and more room for the bees. This will to a large degree eliminate the spring manipulations so often practised, will get better crops, and will make European foul-brood a minor trouble of the apiary.

When strong colonies, headed by vigorous queens, of resistant stock are present European foul-brood will usually make little, if any, headway, yet from time to time there may appear cases which require treatment. The shaking treatment used for American foul-brood is often advocated for European foul-brood, and is recommended by many inspectors of apiaries. It was recommended in previous publications of this Department, but

later observations show that other methods are more reliable. . . . The same amount of stores left with the colony the previous fall will usually do more good than heavy spring feeding as a means of disease control.

The remedial measures here described should be used only to remove the disease if it enters the apiary. Preventive measures should then be employed to avoid a recurrence of the disease.

The dead larvae are easily removed from the cells, and the remedial treatment serves to provide conditions such that these may be removed by the bees during a period when no new diseased material is appearing in the combs. Usually the queen is removed from the colony, and, since a queen whose colony becomes badly infected is rarely of any value, she is killed. In five or six days all queen cells are removed, so that the colony is hopelessly queenless. The workers do not clean out the diseased cells so rapidly unless they have a queen or a queen-cell. . . . If only a few diseased cells are observed, and if the colony is fairly populous, the queen may simply be caged and released later when the dead brood is removed.

The length of time necessary for the cleaning out of the dead larvae varies with the strength of the colony, and for weak colonies it may be necessary to wait until all brood has emerged before giving a young queen. This method should not be employed unless each colony has enough bees to sustain at least five combs full of brood. Some colonies seem to clean out dead brood more rapidly than others of the same strength. If the honey-flow comes early it will usually be possible to reduce the period of queenlessness to a few days. A bee-keeper may use the time necessary for cleaning up as an indication of the strength of his colonies, for if he finds a long time needed he may be sure that his colonies, for some reason, are not as prosperous as they should be. If it is certain that there will be no honey-flow until midsummer or later it is not so necessary, from the standpoint of good bee-keeping, to have all colonies strong so early in the year, but it is surely an exceptional locality where there is nothing for the bees to get in early summer.

Where the bee-keeper is dependent on a late honey-flow it is often desirable to move the bees during the early part of the season to some place where nectar may be obtained. This will often be easier and less expensive than treating the colonies. For example, the author was shown a location in the west where European foul-brood caused great annoyance during the spring, while apiaries not many miles away were able to get enough nectar to ward off the disease, and at the same time to give the bee-keeper enough profit to justify the expense and time of moving. In such a case preventive measures are cheaper and better than the remedial measures here described.

---

The *Journal* is the Department's medium of making known its activities. It contains information of value to every farmer in the Union. Keep it for reference.

## FLAG SMUT OF WHEAT.

By V. A. PUTTFRILL, M.A., Mycologist, Division of Botany,  
Department of Agriculture.

FLAG smut in wheat, commonly known also as "Tulp brand" or "Stoel brand" is a disease which has only lately been brought to the



FIG. 1.

notice of the Division of Botany, but which has probably been present in South Africa for a number of years. It has been known in Australia as a serious trouble since 1868, and has been recorded on wheat in Japan, 1895, and on wheat in India, 1906.

According to McAlpine, in South Australia it does as much damage as rust, and in Victoria and New South Wales it is not uncommon for half the wheat crop to be lost through it. In South Africa during the last two or three years wheat farmers at Zeerust, in the Marico District of the Transvaal, have been considerably alarmed at the loss in their wheat crops sustained through the ravages of this smut. While the total loss up to now may not be considered very great in that district, yet in some wheat-fields lately visited almost half the crop was found to be affected.

Fig. 1 is a photograph of the yield of an average square yard of a badly diseased wheat-field near Zeerust; No. 1 shows the partially diseased stools, the diseased stalks on the left, and the stalks which have formed ears on the right; No. II shows the totally diseased stools,

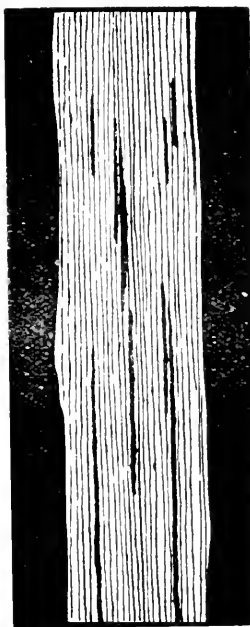

FIG. 2.

and No. III those which had formed normal ears, and on which no indications of the disease were visible. The actual numbers of diseased and of healthy stools in the product of this square yard was counted, and was as follows:—

Healthy stools ... ..	33
Ears produced by the above ... ..	85
Diseased stools ... ..	20
Partially diseased stools ... ..	7
Healthy ears produced by the above ... ..	9
Diseased stalks ... ..	10

Thus the actual percentage of stools showing disease, as compared to the number of healthy stools in this field, would be 45 per cent.

## GENERAL CHARACTERS AND SYMPTOMS.

The disease first becomes visible to the naked eye as black streaks on the leaves, parallel with the veins, and extending along the length of the leaf blade. (See Fig. 2, which is an enlarged drawing of a portion of a leaf.)

The whole plant is stunted, and the leaves frequently become much twisted and distorted. The whole stool may be diseased, in

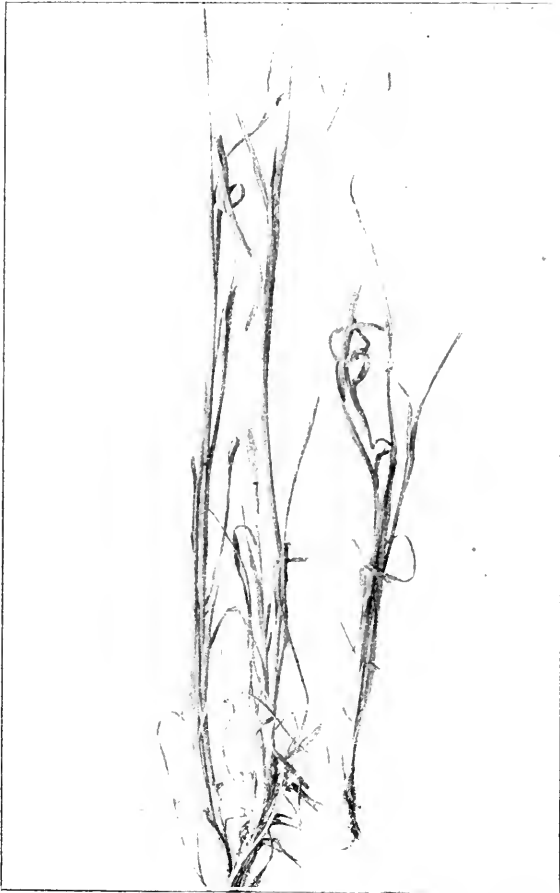

FIG. 3.

which case it is killed outright, or else only some of the shoots of the stool, the rest forming normal ears, though undersized ones. The general appearance of a typically diseased wheat plant reminds one of a common cattle tulp plant, and it is from this similarity in appearance which has given rise to the South African name of "Tulp brand" for the disease (Fig. 3). Fig. 4 is a photograph taken in a wheat-field where the disease is prevalent, and shows in the foreground a normal stool on the right, and a diseased one on the left; the latter is less than



half the height of the former, and has made no evident attempt to form ears. As a rule the plant is attacked so severely that it is unable to produce even young ears; sometimes a diseased stalk does form an ear with grain, but usually the ear is attacked while still very young and enclosed in its leaf sheath.

#### CAUSE OF DISEASE.

Flag smut of wheat is caused by a fungus, *Urocystis tritisi*, Koern., and is nearly related to other smut-causing fungi, such as



FIG. 4.

e.g., stinking smut of wheat or loose smut of oats. The only parts of the fungus which one can see without the aid of a microscope are the spores or seed-like bodies of the fungus; these are black, and are readily visible, but only because they are produced in such vast numbers. Each spore itself measures only about one-thousandth of an inch in diameter, so that about a million spores placed side by side in a single layer would cover an area of only one square inch. Fig. 5 is a drawing of a single spore, magnified about 1800 times, showing

how it is divided internally into a number of compartments or cells, two in this case, and surrounded by a jacket of smaller, lighter-coloured cells outside, which protects it from the effects of prolonged drought. The spores are produced in the tissues of the leaves and are visible internally as the black streak previously mentioned, and are liberated as a black, sooty powder. (See Fig. 2.)

#### INFECTION.

Infection of the wheat plant probably takes place when it is in the seedling stage, through spores of the fungus which are present in the soil. Each spore germinates by sending out a short germ tube at the end of which a number of daughter spores are formed. These are much smaller than the mother spore, and each is able to infect the growing tissue of the wheat plant. The fungous threads, known collectively as the mycelium of the fungus, permeate the tissues of the

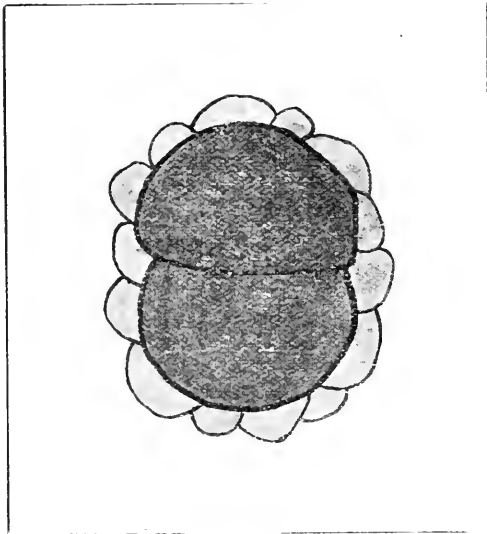

FIG 5.

wheat plant and cause the stunted growth and distortion of the stalks and the leaves. Ultimately, when the food supply provided by the host begins to be exhausted, the mycelium divides up in various ways to form the spores, which turn black. The wheat-plant, if badly diseased, is, as a rule, killed at this stage, and many of the spores find their way to the soil, where they rest "and lie in wait" for next season's wheat crop.

#### PREVENTIVE MEASURES.

As infection comes from spores present in the soil, it can be understood that the usual treatment of the seed with chemicals, such as formalin, etc., which are used for the control of other cereal smuts, is not going to be much help. This treatment is of value, however, in that any smut spores adhering to the seed coat would be killed, and thus the danger of introducing the disease into clean lands would be lessened to some extent.

The straw from a diseased crop, if practicable, should be burnt; at any rate, it should not be fed to the cattle, as the resulting manure will contain smut spores, which are quite capable of causing infection. The same is true of the very dangerous practice of allowing the diseased straw to rot in the cattle kraals, in order to augment the supply of manure, which is afterwards ridden back to the wheat lands, often to prove a very doubtful blessing. Infection may be spread in many other ways: spores may be blown about by the wind, or they may be carried about from one place to another in the mud or the soles of one's boots or on animals' hoofs, or by irrigation water. Up to the present the only means which can be recommended to check the disease is to refrain from planting wheat for several seasons in soil which has borne a diseased crop; that is, practise crop rotation. As wheat is the only cereal attacked, as far as is known, by the smut, other cereals, besides other field crops, can be grown without danger. Further, when a wheat land is known to be free from the smut, no effort should be too great to see that land remains clean, and on no account should manure be applied to it which might possibly be contaminated with the spores of the fungus.

#### CONCLUSION.

The reason why flag smut has failed to cause the consternation amongst wheat-growers which, from the possibilities for destructiveness it seems to possess, one might have expected, is owing possibly to the insignificance as regards appearance and to the dwarfed and withered growth of the diseased as compared to the healthy plants. It is sincerely to be hoped that every precaution will be taken to prevent the spread of this disease, otherwise it may become a very serious pest in our wheat districts.

---

### **Agricultural Co-operation in England.**

An interesting feature of agricultural co-operation in England is the great strides made during the past year. This is referred to in an article on the subject by the Secretary of the Agricultural Organization Society, London, who shows that the conditions which prevailed in England shortly after the war, such as the unstable market in farmers' requirements, uncertainty as to results following decontrol, the prospect of keen competition in imported food, etc., caused apprehension among farmers for the future of their industry. As a consequence a campaign for greater agricultural co-operation was started, which, under the prevailing circumstances, met with instant success. Indeed, the progress made is described as being little short of phenomenal. Agricultural co-operation is, of course, not new in England, but its growth since the war almost entitles it to be described as a new movement, and one which is certain to affect very considerably the future of agriculture in that country.

---

Keep your *Journals*! The contents will be indexed every six months and a copy of the index sent to each subscriber.

## EXPORT OF SOUTH AFRICAN EGGS AND POULTRY, YEAR 1919.

Report by W. O. JOUX, Officer Administering Egg Export  
Regulations, Elsenburg School of Agriculture, Mulders Vlei.

OWING to difficulties in obtaining steamer space, there was no over-sea export during 1918. By 1919 conditions had somewhat improved, the armistice had been concluded, and the high hopes for better export facilities in 1919 were not disappointed, more than sufficient space being available.

The shipments for the year 1919 were as follows: February, 2166 cases; September, 5321 cases; October, 4166 cases; and November, 4527 cases. Total, 16,180 cases.

This constitutes another record in our egg export. Previous exports were:—

Year.	No. of Cases.	Year.	No. of Cases.	Year.	No. of Cases.
1914 ...	1,927	1916 ...	14,959	1918 ...	Nil.
1915 ...	5,968	1917 ...	12,189	1919 ...	16,180

It will be seen that steady progress is being made with our export business, while at the same time the interests of the South African consumer are guarded. At no time during the year was there a dearth of eggs on the home markets, care being taken to safeguard against any possible shortage. Charges have been levelled at the Department of permitting over-export, and that eggs will be 8s. to 10s. a dozen during coming autumn and winter in consequence. It may be well to show the fallacy of such an argument.

During the year 1919, the Union exported to United Kingdom ports 5,938,072 eggs, and our total exports to all countries reached 7,613,824 eggs. It will therefore be seen that our total export was less than one egg per head of fowls, the numbers of fowls in the Union being 8,436,140, according to the Agricultural Census of 5th May, 1918.

This, I think, proves conclusively that South Africa has not over-exported.

The following returns show the export of eggs and poultry, both as merchandise and ships' stores during the year 1919:—

Country.	Eggs.		Live Poultry.		Frozen Poultry.	
	No.	Value. £	No.	Value. £	Lb.	Value. £
United Kingdom... ..	5,938,072	50,247	—	—	88,734	5,164
British East Africa ... ..	—	—	64	72	—	—
Ascension ... ..	200	2	6	7	—	—
South-West Africa Pro. ... ..	221,743	2,293	1,969	591	—	—
Belgian Congo ... ..	104,372	4,836	536	153	—	—
Portuguese East Africa ... ..	566,414	4,058	5,362	865	4,390	344
Southern Rhodesia ... ..	480,779	4,545	5,768	1,361	5,157	400
Northern Rhodesia ... ..	2,241	18	472	216	—	—
<b>Total ... ..</b>	<b>7,613,821</b>	<b>65,999</b>	<b>14,177</b>	<b>3,265</b>	<b>98,281</b>	<b>5,908</b>
Shipped as Ships' stores... ..	1,529,309	17,031	19,530	4,513	136,860	9,371
<b>GRAND TOTAL... ..</b>	<b>9,143,133</b>	<b>83,030</b>	<b>33,707</b>	<b>7,778</b>	<b>235,141</b>	<b>15,279</b>

Of the eggs exported, the Western Province (Cape) produced 13,388 cases of 360 eggs. Northern areas and Natal were responsible for 778 cases. It will therefore be seen that nearly the whole overseas export trade was supplied by the Cape. The export to Portuguese East Africa, Rhodesia, Belgian Congo, etc., is better distributed. Johannesburg shares largely with the Cape in this trade. The trade in ship's stores is confined chiefly to Capetown, and Durban in a lesser degree.

*Regulations.*—It was found that all shippers were keen on observing the regulations. In one or two instances only was it necessary to compel shippers to regrade and repack the whole of the parcel.

*Grading.*—On the whole there is room for improvement in respect of several marks. Many on the other hand are excellently graded. Some few attempt the dodge of packing good eggs on top and in the bottom layers, so that whatever side may be opened good grade may be in sight, then they pack indifferently graded eggs in the middle of cases. This is poor policy for the packer, as every one packing in this way is placed on the "not to be trusted" list. Two or three of such shippers have been the cause of some rather adverse comments from London. However, the "marks" and "shippers" are known, and strict watch will be kept on their future packing.

*Packing* on the whole was very good. Evidence of this is found in the fact that breakages in transit are returned as practically nil.

*Reception on London Market.*—Reports from the Trade Commissioner in London show that on the whole South Africa can rightly be proud of the excellent reputation made in London by its eggs. Public opinion places them next in order of merit to the Irish or Danish eggs. Let us see that we maintain that position. What we *must* see to is that our eggs are first grade for size and quality, and we shall hold our own in any market.

*Egg Prices.*—The highest prices in London for first grade was 120s. per case of 360 eggs, and the lowest price 100s. to 102s. The very high prices realized is due to the fact that nothing but the best in regard to freshness was allowed to be sent; 90 per cent. of the whole total was first grade.

#### EXPORT OF POULTRY TO LONDON.

During 1919 was the first occasion on which South Africa attempted shipping poultry on a commercial scale. There were three shipments, one each in September, October, and November, comprising 4 cases of ducks, 40 of geese, 61 of fowls, and 733 of turkeys, a total weight of 88,734 lb.

The London trade reports on these shipments show that there is much room for improvement in killing, grading, and packing poultry for export.

The export officer reports having examined all the poultry placed on board at Capetown, and found only one packer's mark which could be said to approach export requirements. Under this mark the birds had been properly bled, were tied attractively, grade quite fair quality of birds, individually excellent, collectively left something to be desired as regards evenness in size. Taking the parcel as a whole it was good, and was well reported on from London.

Other marks contained birds of excellent quality as regards fatness, etc., but badly bled, and packed before the carcasses had been cooled right through, and badly graded and unattractive when opened up. These are faults that must be remedied, and no doubt will be, as packers get better acquainted with up-to-date killing methods.

The area from which the poultry came is very general. Some of the very best turkeys examined were Orange Free State bred and Johannesburg killed and packed. The quality of these birds left little to be desired. Natal was responsible for some very nice parcels also. Johannesburg on the whole sent forward the greatest number of uniformly good quality; Capetown sent one or two marks of very fair quality.

*Poultry Prices.*—Average per lb., 2s. 4d. to 2s. 6d. for turkeys; 1s. 4d. to 1s. 6d. for geese; 1s. 6d. to 1s. 10d. for ducks; and 1s. 2d. to 1s. 4d. for fowls; according to grade and appearance on opening up.

On the whole it is thought that South African shippers are to be congratulated on the year's export trade.

Regarding future shipments of poultry, the following is advised: Kill properly by "bleeding," do not break the neck, grade to uniform size and weight, thoroughly cool before packing, pack in standard boxes, tie up each bird attractively, wrapping the head in grease paper, also each bird wrapped separately. Stencil plainly on case the number and sex of birds, gross and net weight, for example:—

E.  
Mark S.A.  
Turkey Hens. 10.  
Net Weight. 80 lb.  
Gross Weight. 95 lb.

Remember always that when taking the net weight of birds at time of packing to allow  $2\frac{1}{2}$  to 3 lb. for shrinkage when freezing; if this is done, the "net" stenciled weight should fairly represent the contents. Always pack poultry for freezing in a way that when the case is opened up, the contents are shown in the most attractive manner possible. Given this attention the future of our export is assured.

---

## The Danger of Rats.

The attention of maize and grain growers, dealers, and others engaged in the handling and storage of grain, forage, and foodstuffs is drawn to the outbreak of bubonic plague in the Hoopstad District. The disease is primarily a rat disease and infection is carried from rat to man by fleas. There is serious danger of spread of the disease by sick and dead rats in broken maize sacks, forage, etc., and as maize in the affected area is now being collected, no time should be lost in starting an anti-rat campaign by all persons concerned. Rats and mice are a serious menace both as carriers of plague and as destroyers of agricultural production, and farmers throughout the country are advised to keep their farms clear of them.

## THE GROWING OF MINE PROPS ON THE HIGH VELD.

By K. A. CARLSON, Conservator of Forests, Transvaal Conservancy.

[Reprints of this article will be issued by the Forest Department as "Forest Department Bulletin No. 1 of 1920," and correspondence on the subject should be addressed to that Department. -ACTING EDITOR.]

### INTRODUCTORY REMARKS.

AFFORESTATION is a subject which has been receiving a great amount of attention during recent years, and the shortage of timber during the war greatly accentuated interest in the matter. While it is recognized that the growing of timber for technical purposes involves a large outlay of capital, from which large returns cannot be expected for many years, and is therefore an undertaking more suited for State and other permanent institutions than private enterprise, yet the cultivation of trees, especially when they are likely to bring in a comparatively early return, is a proposition which appeals to many. It is therefore not surprising that large numbers of trees have been and are being planted on the high veld for the production of rough mining timber, props, and lagging, especially as such planting at the same time can be made to provide shade and shelter for stock and crops and to improve farms generally.

Many applications for advice on this subject are received by the Forest Department, and this bulletin has been prepared with a view to assisting people who intend to plant with the above object.

In so far as the growing of mine props is concerned, a word of warning must be given. The market for mine props is not unlimited, and over-production within the next few decades is not improbable. As it is the fashion now to start syndicates for the production of this class of material, usually on what is described as the "plot system," it is well that promoters and investors alike should bear this in mind. Before embarking on a scheme of tree-planting, the following factors should be taken into consideration and each one carefully studied.

### SITUATION.

Although some classes of industrial timbers can be grown, within limitations, in parts of the high veld table lands, this area cannot compete in the production of high grade material of large dimensions with true forest land on and in the vicinity of our eastern mountain ranges and escarpments with their higher rainfall and more equable climate. The high veld, however, is well enough adapted for growing props, lagging, fuel, and other low-grade wood. A large portion of the high veld area has the advantage of proximity to markets, an important factor in these days of increasing railway

rates. It will be readily understood that the ratio of transport charges permissible on timber is in direct proportion to the quality of the material. The advantage of proximity to market enjoyed by most of the high veld area is, however, somewhat counterbalanced by the severity of climatic conditions.

#### SOIL.

A careful examination of soil conditions is very important in selecting a site. Superficially there appears to be little or no variation of the soil over large stretches of the gently undulating plains. But if test pits are sunk, considerable variation in depth will often be found, due to presence of banks of "ou' klip" and other solid rocks or impermeable clays and pan formation, more or less near the surface. Such conditions may have far reaching effects on the growth of the trees, and may lead to serious loss if not guarded against from the start. Trees often flourish for a number of favourable years even on shallow soil and then go off suddenly, hence the error of planting in such ground may not be discovered for some years.

#### SURFACE VEGETATION.

The nature of the surface vegetation is an important factor to consider. Virgin veld is by far the best, as very little cultivation after planting is then necessary. Weedy old lands, on the other hand, give much trouble in this respect, and the best plan is to clean them thoroughly before planting. Such weeds exhaust the surface moisture necessary for young trees that have not yet got their roots into the sub-soil, and the cost of cleaning after planting is far greater than before. Besides, many blanks will occur, always expensive to refill, which, if neglected, will result in understocking; also in risk from fire and bad growth. Nothing will be lost in growth by waiting a year or two while the soil is being cleaned before planting. Teff is a useful crop for this purpose, and brings in a good return. Quick grass is particularly deadly, especially to drought tender species, such as *Euc. viminalis*, and should be got rid of at all cost before planting, otherwise land infested with it should be left alone if the expense of cleaning is considered too great. During the drought in 1919 large and small patches of this species, even up to ten years of age, and on deep soil, died on the high veld due to presence of quick grass in open stands, while the same species on much shallower soil, but in "normal" stands and free from quick grass, remained unaffected.

#### CLIMATE.

Droughts, frosts, and cold winds are the principal climatic influences adversely affecting tree growth on the high veld. The erratic variations in these influences and the impossibility of foreseeing when extremes are likely to occur, have to be taken into account when embarking on a large scheme of planting. What may seem clearly indicated some years may appear equally clearly be contradicted in other seasons. Given a fair season or two to start with, a right selection of species and situation, and afforestation may seem a simple enough proposition for a time. But only a close study



over a long period of years, noting the behaviour of each species during a variety of seasons and in all manner of situations, will enable the planter to avoid climatic traps and pitfalls. The results of study and experience up to the present time are given under the heading "silvicultural notes," each species being dealt with separately.

#### ESPACEMENT.

Espacement has an important bearing not only on the successful establishment of a stand of trees, but on its future development, the quality of wood produced, and the general economy of management. Too often those intending to go in for afforestation are under an impression that planting espacement is a common factor which can be applied to any species, situation, or circumstances, and that some day they will harvest approximately the same number of trees that were originally planted. Such is far from being the case. Nature's method is to regenerate in more or less dense mass formation which, when unassisted by man, has to undergo a slow process of survival of the fittest before final development is reached. The science of forestry, evolved by man, consists in hastening this process to secure his needs more quickly. We cannot, however, afford to discard nature's example entirely, and must base our silvicultural methods on certain fundamental natural principles. One of these principles is to secure what is technically known as "forest conditions" at an early stage. In a young stand this condition is reached when it is sufficiently dense to exclude weed-growth without necessity for further cultivation, and no stand on the high veld can be considered established, or safe against damage from frost, drought, and fire, until then. To attain this end most economically, the planting espacement has to be varied according to differences in rate of growth and individual habits of species, such as natural erectness or otherwise of stem, density of lower branches, etc.

Having secured "forest conditions," the forester's attention is next concentrated on maintaining what is known as a "normal stand" throughout the remainder of the rotation. By "normal stand" is understood that particular density which, without sacrificing "forest conditions," will maintain normally vigorous growth in the best stems. Everything depends on maintaining this density. A too open stand is exposed to the dangers of understocking, and, if too dense, loss of increment takes place. As the stand develops the correct density is maintained by a process of thinning whereby espacement is constantly increased and the number of stems to the acre reduced. This operation is of the utmost importance, and demands great skill and experience. The lungs and stomach of a tree lie in its crown, hence it must be seen to that the crowns of those individuals intended for the main crop are properly developed and not allowed to deteriorate. Every species has its own individuality of habit which must be taken into account when thinning. Furthermore, its habit varies according to situation and age, and whether it is growing pure or in mixture with other kinds. Where, as in this country, many hundreds of species have to be dealt with in scores of different situations and mixtures, the number of combinations that have to be studied may be more readily imagined than calculated. But one thing should be remembered, an error of

judgment in the conducting of thinnings may not be eradicated throughout the rotation of a crop.

CHOICE OF SPECIES.

As the bulk of the timbering in the mines is required to last only a few years, durability is not essential. A low grade quality of timber can therefore be used, provided it is sufficiently straight. Advantage is taken of this circumstance to plant the most rapid growing species without consideration as to durability. A certain amount of strength is, however, necessary, and experience goes to show that in this respect *Eucalyptus coriacea*, when grown on the high veld, fails to come up to the required standard. With this exception, and a few others that will be referred to later, the choice of species is mainly limited by soil and climatic conditions.

To meet the above requirements, the following are the principal species used, viz., *Eucalyptus viminalis*, *Euc. rostrata*, *Euc. Maidenii*, *Euc. globulus*, and *Euc. sideroxylon*. The requirements of each are discussed in detail hereunder.

SYLVICULTURAL NOTES.

The following notes apply only to the species above referred to under the conditions to be met with on the high veld, and must not be taken as applicable to all parts of the country.

*Eucalyptus viminalis*.

This is the favourite tree on account of its rapid growth and hardness to frost, though not quite immune in exceptional seasons or in bad frost hollows. It is sensitive to drought on shallow soils and on lands infested with quick grass, but hardy enough on deep, clean soil. It should be safe on 6 feet or more of soil where the rainfall ranges from 24 to 30 inches. The lower the rainfall the greater the depth of soil required. Sub-soil is included in the expression "depth of soil," provided it is sufficiently porous for moisture and roots to penetrate. This tree may flourish for some years even in shallow soil, but is then liable to fail suddenly when the limit of moisture is reached. A planting espacement of 6 feet by 6 feet (1210 to the acre) is, as a rule, the safest. In good conditions a light thinning or cleaning may be required in the fourth or fifth year. Thinnings have to be repeated at intervals up to the tenth or twelfth year. Light and frequent thinnings are the best, but much depends on the seasons experienced, the frequency and degree being regulated accordingly. The final stand suitable for mine props is reached at the age of twelve to fifteen years in favourable circumstances, and should then consist of approximately 450 to 500 trees to the acre, averaging 8 to 12 inches in diameter at breast height. The first cleaning will produce mostly latbs and sticks. Later on lagging, sprags, and firewood will be got, and, still later, a percentage of props will be included in the thinnings. The following table may be used as a rough guide for thinning a stand of *Eucalyptus viminalis* in a good situation with a planting espacement of 6 feet by 6 feet intended for props:—

Original stand ... ..	1210	trees per acre.
Fourth to fifth year thin to ...	900	.. ..
Fifth to sixth year thin to ...	750	.. ..
Sixth to seventh year thin to...	600	.. ..
Seventh to eighth year thin to	500	.. ..

In exceptionally favourable conditions the planting espacement may be made wider, 9 feet by 9 feet being the limit (538 trees to the acre). In this case only a little thinning will be needed towards the latter part of the rotation. But, as a rule, this plan is not recommended, as it involves much more cultivation and incurs the risk of introducing quick grass, which may be fatal to the crop. In the wider espacement greater thickness is attained in the lower part of the bole in a short time, but, on the other hand, this tends to a more pronounced taper. Though prop sizes are thus secured somewhat earlier in the bottom lengths, there is more waste in the upper part, and the percentage of props in the final stand will be smaller than in a stand that has been kept normal from the start. If, on the other hand, felling in a widely espaced stand is delayed until the upper part of the stem is more developed, the lower part will become too thick for props.

The wood is of an inferior quality, and is unsuitable for industrial purposes even when mature. Its present commercial value is entirely due to the present scarcity of timber, serving well enough for temporary purposes where nothing better can be got. It is planted on a large scale, almost exclusively by private enterprise, especially in the vicinity of the mines. How long the demand for this class of timber will be maintained it is impossible to say, but should the supply of props at any time exceed the demand, the market for *Eucalyptus viminalis* timber will become restricted, and will disappear entirely when sufficient better class timber is available.

#### *Eucalyptus rostrata.*

This timber is strong and durable when mature, and is therefore useful for any industrial purposes where such qualities are needed. A good depth of soil, say, 6 feet or more, is required for it to attain large saw-log dimensions, but less depth will suffice for props, say, down to 3 feet. It needs sub-soil moisture, and does not object to brak or to inundation in a fairly mild climate, but is less frost-hardy than *Euc. viminalis* during the first few seasons, and must therefore be kept out of low-lying situations on the high veld. Once well established it will withstand any cold experienced in these parts, and does not suffer from drought if the stand is kept sufficiently dense to exclude quick grass. The crown is usually light, and in an open stand its natural habit is branchy and crooked, hence close planting and early thinning is necessary to produce straight stems. A planting espacement of 4 feet by 4 feet (2722 to the acre) is therefore recommended as the safest, especially in weedy lands. In good clean ground, 6 feet or more in depth, 5 feet by 5 feet (1742 to the acre) may suffice. It is a fairly fast grower, but takes about five years longer than *Euc. viminalis* to attain prop sizes. On the other hand it is a safer permanent crop in case the demand for props should decline.

#### *Eucalyptus Maidenii.*

This tree is of comparatively recent introduction, the oldest stands in the Transvaal being about thirteen years. But sufficient experience has been gathered to justify advantage being taken of its many good qualities, provided great care is exercised in selecting the right situation. It is a handsome tree with a foliage difficult to

distinguish from *Euc. globulus* (the ordinary blue gum), but it differs from the latter in having a cleaner and straighter stem less inclined to taper. So far it has also proved hardier to frost and drought than the latter within certain limits of soil and situation. On the high veld these limitations are 6 feet of soil, avoidance of frost-hollows, protection against cold winds, and 24 inches average rainfall. Other conditions being favourable, less than 24 inches may suffice, but this cannot be said for certain. Rate of growth is perhaps slightly in its favour over *Euc. globulus*, and almost, if not quite, equal to that of *Euc. viminalis*. Like *Euc. rostrata* and *Euc. globulus* it is liable to be cut by very cold winds during the first two or three seasons, but will be safe if these are survived. In situations exposed to cold wind, the best plan is to plant only behind the shelter of blocks or belts of *Euc. viminalis*, and if any failures occur they should be filled up at once with the latter species. A planting espacement of 6 feet by 6 feet is recommended so that the trees will close up quickly and protect each other from cold. At this espacement up to 15 or even 20 per cent. of failures can be neglected unless they occur in large patches. There is little information available as to quality of the wood, except that it is hard and strong. It is probably at least equal to that of the blue gum. In a normal stand of 6 feet by 6 feet, thinning should commence about the fourth or fifth year. Under proper treatment it should attain prop sizes as quickly as *Euc. viminalis*, and it is probable that a normal stand will then contain a higher percentage of props to lagging and firewood than the latter, but as will have been gathered, greater skill is necessary in sylvicultural treatment so as to minimize risk of failure.

#### *Eucalyptus globulus.*

The ordinary blue gum is too well known to need description. As for its sylvicultural treatment and attainments on the high veld, all that need be said is that they are about the same as for *Euc. Maidenii*, except that the precautions stipulated in case of the latter are even more necessary. The timber of *Euc. globulus* is of good quality for many industrial purposes when grown to maturity and properly seasoned. It will, however, only reach that maturity under favourable conditions.

#### *Other Eucalypts.*

There are a number of other eucalypts grown on the high veld with more or less success, such as *Euc. stuartiana*, *Euc. coriacea*, *Euc. cinera*, *Euc. gunnii*, *Euc. amygdalina*, and *Euc. sideroxylon*. The last mentioned is the only one of these that produces a strong and durable commercial timber, and may be worth planting in situations too dry for *Euc. rostrata*, though it also requires good conditions to reach its best development. The reason it is not included among those specially recommended is that, conditions being equal, it produces a smaller volume per acre than *Euc. rostrata*, to which it otherwise approximates in respect of sylvicultural treatment. The timber of the other species are no better than, and in some respects inferior to, *Euc. viminalis*, and mostly of slower growth, so that there is no object in growing them except for shelter.

*Eucalyptus Deanci.*

Is a later introduction of some promise, but not yet widely enough tested. It is similar to *Euc. viminalis* in growth and appearance, and has the advantage of a denser foliage.

## COST OF PLANTING AND MAINTENANCE.

It is of little value to base the costs of operations for any particular scheme on general averages as so much depends on local conditions. Costs should be worked out at "per acre" as a fixed unit, not per tree as is so frequently done. The reason for this will be readily understood when it is pointed out that whereas the original planting may be anything from 1210 to 2722 trees to the acre, the final crop may vary from 50 to 500 trees per acre according to the size and quality of material it is intended to produce. The balance of the trees are, of course, accounted for in failure and thinnings, the value of which may vary from nothing to nearly equal that of those felled in the final crop. The following are the main items that have to be taken into account in calculating costs:—

1. Administration and supervision.
2. Preparation of planting plan.
3. Fencing.
4. Preparation of ground.
5. Transplants.
6. Planting.
7. Cultivation.
8. Fire protection.
9. Thinning.
10. Transport.

From the notes here appended each operator, with his knowledge of local conditions, is best able to calculate costs of operations for himself.

1. *Administration and Supervision.*

On the skill and economy of the management from start to finish depends the ultimate success or failure of the whole scheme. The operations dealt with in this paper are of the simplest known in forestry. Yet unless the administration is guided by expert sylvicultural knowledge and experience, there are many pitfalls for the unwary, all of which tend to financial loss if not guarded against. Given proper technical guidance, actual supervision becomes a mere question of common sense and energy.

It goes without saying that under competent supervision the larger the area dealt with, up to a point, the lower will be the cost per acre under this head. It is also self-evident that economy of administration and supervision is not so much a question of £. s. d. as of its quality.

2. *Preparation of Planting Plan.*

Planting schemes are too often entered upon without a definitely worked out plan. As a rule there is too much hurry to plant anything anywhere as soon as the idea is first conceived in order not to

lose a season. This hurry leads to doing things in the wrong order, and may involve the loss of much time and money. Preparation of the planting plan includes a detailed examination of every part of the area; a rough survey and construction of a map on which should be shown a complete system of compartments, roads, nurseries, buildings, etc., for the most convenient and economic future working of the scheme; a comprehensive scheme for protection against fire or cold winds; allocation of species to each compartment according to soil, aspect, and elevation; regulation of espacements; directions as to the order in which planting should proceed, and numerous other details. Close attention to such details in proper sequence does more to lessen costs than is usually realized.

### 3. *Fencing.*

This cost has to be calculated according to ruling rates at time of erection. Cost per acre is smaller for compact areas of regular shape than scattered, irregular, or long and narrow strips.

### 4. *Preparation of Ground.*

New ground should be broken in late summer before it dries out, and fallowed through winter. Before planting the following summer the ground must be cross-ploughed and brought to a tilth as for ordinary field crops. The cost per acre will depend on local conditions of labour, stock, and implements used, or on the ruling contract rates. Weedy old lands must be brought to as clean a condition as possible before planting, especially if there is quick grass. This is done most economically by cropping with teff grass.

### 5. *Transplants.*

The cost of transplants depends on the number required per acre as regulated by the espacement (6 feet  $\times$  6 feet = 1210; 5 feet  $\times$  5 feet = 1742; 4 feet  $\times$  4 feet = 2722) and the number of replacements that may be necessary. In a large enough venture to warrant the employment of a nurseryman, it is cheaper to raise the transplants on the spot and save transport. The present Government tariff for transplants is £3 per 1000, exclusive of railage.

### 6. *Planting.*

A gang of twenty men under a good overseer should, if properly organized, plant from 10,000 to 20,000 trees a day on easy ground, depending on their skill and experience. The number of reliable planting days during a season, taking a general average for the high veld, is probably not more than twenty. The necessity for thorough organization to make the most of these is therefore apparent.

The cost per acre will vary according to the necessary espacement, local labour conditions, and the efficiency of the organization.

### 7. *Cultivation.*

Cost of cultivation after planting is mainly affected by the surface condition of the soil and the rapidity with which trees close up and kill the grass and weeds. This cost may vary from a few shillings per acre in clean virgin soil to several pounds in weedy old lands, especially if the stand is understocked on account of too wide planting or failures. In the latter event weeds may get so out of

hand as to preclude the use of cultivators, and hand labour has to be resorted to. Once a "stand" has attained "forest conditions," no further cultivation is necessary.

#### 8. *Fire Protection*

In a properly laid out plantation under efficient management, the cost of fire protection should be small. This cost may, however, easily become unduly swelled by bad planning in the first instance and by delay in arriving at "forest conditions." The risk of loss from fire is smallest in a well kept "normal stand" and becomes greater the more a stand deviates from the normal.

#### 9. *Thinning.*

It has been pointed out that after establishing "forest conditions," the next consideration is to maintain a "normal stand" throughout the rotation of the crop by means of periodic thinnings. Also that the degree and frequency of these thinnings must be regulated according to the species, situation, variation of seasons, and the class of material it is desired to produce. The first thinning is usually called a cleaning when the material removed is too small or inferior to yield a monetary return. As a rule the cost of cleaning is very small. In the vicinity of markets the sale of material from subsequent thinnings should more than cover the cost of the operation to an ever increasing extent, thus bringing in a gradually growing interest on the capital outlay before the final crop is felled.

It is safer to thin lightly and frequently than too heavily at one time, but undue delay may result in serious loss of growth and injury to the final crop.

#### 10. *Transport.*

Cost of transport has a very important bearing on the financial result, and depends entirely on local conditions. Valuable timbers can, of course, stand a much higher rate of transport than low grade material.

### YIELD.

When it was first decided to write this Bulletin, it was hoped to include some average figures of yield for certain of the more important species, such as *Euc. viminalis*, *Euc. rostrata*, and *Euc. globulus*, of which there are many private plantations on the high veld, and more particularly within the "Rand" area, ranging from ten to thirty years of age. On investigating these it was found, however, that in no single instance have they been treated on proper silvicultural lines, nor have any records been kept in the necessary form, and there are no Government plantations within the areas which are typical of the conditions of soil, climate, and species dealt with in the present publication. Under the circumstances all idea of including even approximate figures of yield had to be reluctantly abandoned for the present.

### PLOT SYSTEM.

The usual system on which a tree planting syndicate bases its prospectus is to divide the area into 10 or 20 acre plots and to offer these to the public as freehold stands. There are some serious drawbacks to this plan which are probably not realized either by promoters or investors.

It has been shown that over any given extent of area, however uniform superficially, there is certain to be more or less important changes of conditions which affect tree growth. While each investor pays an equal amount for his plot, he has no guarantee that he will secure an equal share in the results, and it is a pure gamble whether he obtains the best results or hardly any at all. Once an investor has secured his plot he is, presumably, at liberty to treat it in any way he considers fit to the danger of adjoining ploholders. Thus he may fail to secure it against risk from fire, or by untimely or excessive cutting expose his neighbours to damage from winds or violent storms. Failure to remove trees weakened by drought may result in attacks by borers such as the phoracantha beetle and other similar insect pests, which may spread throughout the whole plantation.

Truly economic management can only be effected by treating an area as a whole. Costs of operations carried out separately on small plots are always much more expensive. This is, no doubt, recognized by promoters or they would not offer to do the planting for investors. But this principle applies even more to the processes of thinning, final felling, and marketing. Possibly promoters may be willing to undertake these operations also at a price, but even then many obstacles to economy may arise unless complete unanimity exists between ploholders as to manner of treatment and time and methods of disposal.

Included in the purchase price, syndicates usually make themselves responsible for maintenance during the first three years. There is, however, no guarantee that the essential "forest condition" will have been attained by that time, and, as has already been shown, a stand cannot be said to be finally established until this condition is attained. As a rule, ten to twelve years are estimated for the final crop, but twelve to fifteen is more probable for *Euc. viminalis* and *Euc. Maidenii*, and then only under good conditions, while the average for *Euc. rostrata* and *Euc. sideroxylon* is considerably longer.

That a little knowledge is a dangerous thing is more applicable in forestry than most other activities because of the long time one has to look ahead. Yet expert knowledge is often claimed on the slenderest basis, such as a few years' experience in tree-planting; or it is thought that a chat with an expert will suffice to gain enough knowledge for all practical purposes.

The above remarks are not intended to discourage afforestation, for which there are undoubtedly good prospects when conducted on sound lines, but to help the beginner to steer clear of the many points of danger which may lead to financial wreck if not seen in time.

---

## Honey.

In connection with the Grocers' Exhibition to be held in London on the 18th September, 1920, a colonial honey competition is being arranged. Full particulars may be obtained on application to the Acting Trade Commissioner, 90 Cannon Street, London, who is prepared to receive samples of honey for exhibition and to arrange for their entry.



## THE DEPARTMENT OF AGRICULTURE DURING THE WAR.

[This article, which commenced in the May, 1920, issue, briefly reviews the work carried out by the various branches of the Department during the years of the war, and records some achievements despite the many difficulties encountered through the abnormal conditions then existing.—ACTING EDITOR.]

### SHEEP AND WOOL.

THIS division is charged with the eradication of scab, the promotion of sheep and goat industries by advising upon the grading and management of sheep and goats, and the preparation and marketing of wool and mohair.

During the year 1914-15 operations against scab received a severe set-back. The rebellion and the campaign in West Africa caused the absence of over 100 sheep inspectors, and, in addition, excessive rains in the northern Provinces brought on serious outbreaks of various diseases amongst sheep, so that dipping operations were impeded in many parts. At this time, also, the regulations regarding scab were made more stringent, and power was given to proclaim as protected any area free from scab, and no small stock could be moved into such area unless at prescribed times and places.

This year saw on the whole a reduction as compared with the previous year in the quality and value of exported wool. Shortly after the outbreak of war the market for wool was dislocated and prices for merino wool dropped to a low figure, the demand being chiefly for cross-bred wool (suitable for soldiers' uniforms), which is not largely grown in South Africa. The world's supply of this class of wool, however, apparently could not meet the demand, and merino wool had to some extent to be brought into use. Arrangements were also made with the British Government for supplying the American market. As a consequence the demand for merino wool increased rapidly and prices recovered correspondingly from the low prices which ruled at the end of 1914.

In 1915-16 the absence of several officers on military duties was a considerable handicap, while the old trouble continued of areas controlled by many individual sheep inspectors being too large for one man to do justice to. Then, also, the rebellion referred to above rendered it impossible to control movements of infected stock over a wide area of the Union.

Owing to disorganization no statistics could be collected in 1914 regarding the extent of infection of scab in sheep, but during that year, as already stated, there was a large increase in the number of infected sheep. In 1915, however, the position was considerably improved, as the new conditions regarding staff, etc., were being coped with, but the set-back was not made good, the percentage of infected flocks at the end of 1915 being 1.43 as compared with 0.99 in 1913. The numbers of sheep and goats were seriously depleted, due principally to drought in 1915, which was estimated to have accounted

for three million head, of which two and a half million were lost in the Cape Province. The number of sheep and goats showed a great reduction during the two years, being 47,214,000 in 1913 and 40,352,000 in 1915. Although the flocks showed a falling off in numbers, the quality of our sheep and wool continued to improve, and much was done by the sheep and wool experts in attaining this progress. Classing flocks, establishing studs, selecting rams, inspecting sheep for the Stud Book, lecturing, demonstrating, judging at shows, and generally advising and assisting farmers with their sheep and wool were all matters which engrossed their attention. At this time began the rise in the price of wool, which was later to reach such undreamed of heights, and the great loss of stock from drought referred to above was thus accentuated by the high prices realized for wool and mohair. At the end of 1916 greasy wool fetched from 1s. 1d. to 1s. 6½d. per lb. for superior quality, from 10d. to 1s. 3d. for average quality, and from 7d. to 11d. for inferior quality, while mohair realized at the same time 14d. to 18½d. per lb.

The set-back in the campaign against scab owing to the causes mentioned above was entirely overcome in 1916-17, the percentage of infected flocks at the end of 1916 being .81 as compared with 1.43 in 1915 and .99 in 1913. Improvement continued also in the farming of woolled sheep, and further stimulus was given by the high prices which prevailed for wool and mutton. Large sales of stud sheep were held at which high prices were realized, both for imported and home-bred sheep. The price of wool continued its upward course, merino greasy wool being sold at from 10½d. to 1s. 11d. per lb. at the coast, and from 11d. to 2s. 4d. per lb. in London, towards the close of 1916. At this time also the importation of mutton was a thing of the past, thus foreshadowing a future export trade in mutton, which, in addition to wool, is such a great feature in sheep countries like Australia, New Zealand, and the Argentine.

During 1917-18 the position regarding scab infection continued to improve, the percentage of infected flocks at the end of 1917 being .36 as compared with .81 the year before. This improvement was noticeable also in the condition of the sheep arriving at the abattoirs. The policy of selecting areas free from scab (and large enough to warrant the necessary precautions without unduly hampering the movement of sheep), protecting them from reinfection, and increasing them by the addition of adjoining areas as they become clean, was continued with satisfactory results, and but for lack of staff its application would have been more extensive.

Although the preparation of wool for the market was better than in earlier years, serious complaints were made of false packing, a practice which should be vigorously suppressed; the shortage of freight also emphasized the necessity for the proper pressing of bales. It was estimated that South African wool occupied 50 per cent. more cargo space than Australian wool. The wool clip was a good one and wool never reached so high a figure before. The shortage of freight, however, resulted in a large accumulation of wool at the coast, with the consequent danger of damage by moth and other agencies. The matter was represented to the Imperial Government, who confirmed the position regarding freight shortage and offered to purchase the whole of the clip, delivered at the ports, at 55 per cent. above the price

paid for wool *ex* warehouse during the year previous to the outbreak of war, plus half the profit, if any, realized by the sale of wool not required for the use of the British Government or its allies, which it was estimated would be about half the wool, these being the terms on which the Australian and New Zealand wool clips were bought. A conference of leading farmers and wool buyers and merchants was held at Pretoria to consider this offer, and as an outcome the Imperial Government withdrew their original scheme in favour of one agreeing to purchase any wool offered within thirty days, the wool to be delivered at warehouse at the ports and paid for after valuation. Under this arrangement about one-third of the wool clip was sold, but at that time, contrary to expectations, freight to the United States of America and Japan became available, and the better class wools were purchased freely on behalf of those countries at about 4d. per lb. above the price obtained under the Government scheme. This was represented to the Imperial Government, who consented to the withdrawal of wool already registered under their scheme by any one desirous of doing so, and this relaxation was availed of to the extent of 59,597 bales. Thanks, therefore, to the offer of the Imperial Government and the unexpected buying on behalf of the United States of America and Japan, the problem of the accumulated stocks was solved.

The Sheep Division strives to eradicate scab. Much good work is done in this direction and infection has been reduced to small proportions, but comment is often made on the continued presence of the trouble and the failure to eradicate it entirely and permanently. It must be realized, however, that there are few, if any, countries in the world in which the disease is more difficult to cope with than South Africa. The vastness of the country, rendering supervision and control arduous and difficult, scarcity of water, recurring periods of drought and the consequent trekking of sheep, kraaling of sheep for protection against jackals and other vermin, are serious obstacles to contend with. Then, also, large numbers of non-woolled sheep and goats harbour scab, and the disease does not cause the same measure of loss in the value of their produce as would occur in that of woolled sheep; the former class of sheep is largely owned by backward farmers, and it is obvious that, lacking the same incentive to cleanse as impels the owner of the woolled sheep, the menace of scab will continue in such quarters until the danger can adequately be coped with. The matter is complicated by the large number of natives scattered throughout the country who almost invariably have grazing around their kraals a few non-woolled sheep and goats, which are a further source of scab. Thus it is that while in parts of the country occupied by progressive farmers with the necessary facilities for dealing with the disease, scab has been entirely eradicated, there are parts where it still prevails, and the danger of the reinfection of clean areas continues and has to be guarded against. Consequently complete eradication, if ever accomplished, will be a lengthy business, but there are good prospects of speedy control in the chief wool-producing areas and a gradual improvement in others. The erection of dipping tanks, the extension of fencing, the decrease of trekking by road and conveyance of sheep by rail, and the destruction of vermin are all helping to reduce scab. Above all, the evergrowing interest in sheep and wool by progressive farmers who, determined to keep

their flocks clean, will demand equal care from their neighbours in the cleansing of flocks, will lead eventually to the almost complete absence of scab in the country. In the meantime the carrying out of the laws framed with this end in view must be continued. Any relaxation may lead to a serious set-back as witnessed during 1914-15, when circumstances necessitated the absence of a number of sheep inspectors. On the other hand, efficiency and economy call for a strengthening of the numbers detailed to combat the disease, for, in addition to the advantages the farmer will derive by a speedy control of scab, an increased expenditure for a short period would be cheaper in the long run than the present heavy expenditure indefinitely.

#### VETERINARY RESEARCH.

The Union possesses one of the largest and best equipped institutions in the world for investigating diseases of animals peculiar to warm countries, and results of the greatest value both from scientific and practical points of view have been obtained from it.

During the war the institute had to work under the greatest difficulties owing to the absence of officers on active service, shortage of stores, etc., but on the whole it carried out successfully its functions under the most adverse conditions that have existed in the history of the division.

It was of paramount importance to maintain the routine activities of the division, and the extent to which this was done will be recognized when it is mentioned that from the 1st April, 1914, to the 31st March, 1918, there were prepared and distributed the following numbers of doses: Blue-tongue vaccine, 6,019,974; redwater and gall-sickness vaccine, 56,823; anthrax vaccine, 1,796,260; black-quarter vaccine, 919,386; mallein (issued to Defence Department), 40,000; tuberculin (approximate number imported and distributed), 28,000; and vaccine lymph (1914-15 only, since when in hands of medical authorities), 412,693.

In addition, 73,099 microscopical and pathological anatomical specimens were examined, 2818 mules inoculated against horse-sickness (2 per cent. died), agglutination tests for contagious abortion conducted, while a number of reports and papers were published and lectures delivered. The quantity of correspondence dealt with was large, the number of letters and telegrams received and dispatched amounting to 250,856.

As much time as possible was devoted during 1914-15 to research and investigations into the many problems facing the stockowner, among others being an investigation on the spot of the disease of Nagana (Trypanosomiasis), which was spreading in Zululand, and certain recommendations made (1915-16) for preventing its spread by localizing game, the agency by which the disease was spread. Experiments were continued in regard to protective inoculation against horse-sickness, and extensive experiments in dipping as a preventive of the disease were also under consideration. During the year Professor Hedinger, of Basle University, who was specially engaged to investigate the cause of gallamziekte, advanced a theory regarding the presence of "Sarcosporidia," which, however, was eventually found not to be the cause of the disease, and a further series of experiments was undertaken by Sir Arnold Theiler and Mr. P. R. Viljoen.

In 1915-16 there were three laboratories—Onderstepoort, Grahamstown, and Allerton—and two field stations, one near Vryburg, Cape, and the other in the Orange Free State, the three chief subjects of research being gallamziekte in cattle, horse-sickness, and wire-worm in sheep. Dr. Hedinger's theory in regard to the cause of gallamziekte being abandoned, Sir Arnold Theiler continued investigations into the disease based on his original grass toxin theory. The work in connection with horse-sickness progressed favourably and reached a stage promising the discovery of a method conveying a high degree of immunity with small risk of loss; experiments in ascertaining whether protection could be obtained by dipping were also undertaken at Onderstepoort and batches of horses were dipped at intervals of three, five, and seven days in arsenite of soda, to which in some cases was added a film of paraffin oil, fish oil, etc. The results showed that, although absolute protection could not be given, a satisfactory percentage of horses that had been dipped at short intervals survived natural infection. The life-history of wire-worm in sheep was investigated further and the results published. Attention was given to many other diseases (as detailed in the Annual Report of the Director), all of which are of importance to the country.

The division was greatly handicapped in 1916-17 by the absence of several members of the staff on active service, and in addition a heavy tax on its time was imposed by a large increase in routine work, diagnosing diseases, manufacturing preventives or remedies, but despite these duties a number of investigations were undertaken which have materially increased our knowledge of several diseases. Experiments were continued into the cause of horse-sickness, 2859 horses being inoculated, but the practice was not perfected. On the other hand, a safe and simple remedy for wire-worm and tape-worm in sheep and lambs was discovered. Investigations into gallamziekte were continued, but no definite conclusions regarding the character of the disease were arrived at. In co-operation with the Division of Botany it was discovered that jagziekte in horses and geeldikkop in sheep are due to eating particular plants. Many other researches were carried out in regard to diseases in horses, cattle, sheep, and ostriches.

During 1917-18 the inoculation of sheep for blue-tongue, introduced by the division some years previously, was largely practised, and the newly discovered remedy for wire-worm and tape-worm in sheep was also very popular; and there is no doubt that the use of the two was instrumental in saving the lives and improving the condition of millions of sheep. This call for its services is a tribute to the usefulness of the division and indicates the greater attention now being given to live stock. Experiments in the inoculation of horses against horse-sickness gave better results than anticipated, but an unfortunate outbreak of staggers hampered this work. Research concerning lamziekte in cattle was retarded through various causes. It was not prevalent that year, and laboratory accommodation was limited. The latter difficulty was removed, however, in 1918, when the investigations thus rendered possible led to the conclusion that the disease was due to an intoxication with the poison that originates in putrid substances, and is mostly found in remains of carcasses of animals of any description, and that the primary condition for contraction of lamziekte is an abnormal craving. This abnormal craving is brought about by the condition of the pasture which varies at different times

of the year. The disease is the result of two different conditions, one intimately connected with the pasture and leading to abnormal craving, and the other the intoxication with the toxin that is contained in putrid material. Horse-sickness, pernicious anaemia, slapziekte, jagziekte, and dunziekte in horses; anthrax, imapunga (black lung), contagious abortion, and stijfziekte in cattle; geelkopp, scab, wire-worm, and gouwziekte in sheep; chick disease and worms in ostriches; were all subjects for research during the year, and details of the results are published in the Annual Report of the Director.

#### DAIRYING.

In June, 1914, the Superintendent of Dairying completed an extensive tour of Australia and New Zealand, and his report contains valuable information regarding the exportation of dairy production and other matters affecting the industry. During that year (1914-15) two experiments in the shipment of cream and butter were made, and one of these consignments was reported on as unsurpassed by butter from any other British Dominion.

There were fifty-two creameries, seventy cheese factories, and about ninety-seven cheeseries in the Union in 1915-16, and the production of butter and cheese made satisfactory progress, pointing to a rapid development of the industry and the near approach of an export trade. Small test shipments demonstrated the fact that South African creamery butter would be favourably received on the English market. Very high prices, ranging from 1s. 6d. to 1s. 10d. per lb., were paid for butter-fat during the season.

During the year 1916-17 the development of dairying went on apace and the importations of butter and cheese, so considerable in earlier years, were reduced to small dimensions, and, moreover, the year was an epoch-making one in the history of South African dairying, for it witnessed the beginning of the export trade in butter. Evidence of the growing interest of farmers in the industry was shown in the numerous requests for assistance received by the Dairying Division, whose officers were kept exceedingly busy in giving advice by letter and in person, as well as in giving lectures and demonstrations and judging at shows, etc. The best of the butter and cheese sent to England during the year was very favourably reported on and realized as much as the best Canadian and New Zealand butter, but a good deal of it lacked uniformity and quality.

The year 1917-18 saw further strides in the industry. Greater quantities of butter than formerly were exported, and the imports fell to a negligible figure. Not only was the production of butter and cheese sufficient for our own requirements, but a considerable surplus of butter and a small surplus of cheese were exported, for which, owing to the needs of the British Government, an excellent market was obtained. The growth of cheese-making in particular was remarkable, the number of cheese factories increasing from the few not many years previously to no less than 120. During the year a Cheese Grader and Instructor for East Griqualand was appointed (and not long after cheese from this part of the Union obtained first and second prizes in competition with the produce of other British Dominions at the Islington Show, 1919), and a milk record scheme was instituted by the Friesland Cattle Breeders' Association (the milk records being supervised and controlled by this division), which will

be of great assistance to the breed and to dairying generally, and was welcome as an indication of a disposition towards self-help on the part of the farmer. The year was an important one also in regard to legislation, a Bill being presented to Parliament and eventually passed (Dairy Industry Act, 1918) providing comprehensive and up-to-date legislation on dairying matters, particularly the production and grading of butter and cheese for export.

Thus during the stress of the world war dairying made excellent progress in South Africa. Nevertheless, as pointed out by the Superintendent of the Dairying Division, much remains to be done before the industry will be placed on a thoroughly sound basis and be independent of the stimulus afforded by the high prices caused by the war. Although the improvement in dairy cattle has been remarkable, and the management of stock, collecting and transport of milk and cream, and making of butter and cheese have shown such gratifying progress, much scientific investigation is still necessary to enable us to keep abreast of the times and solve some of the many problems confronting the industry.

(This review will be continued in subsequent issues of the *Journal*.)

---

### Pig Production.

A prominent produce merchant of London visited the Union recently to ascertain its business possibilities, and in reviewing the impressions of his visit, refers to our wide scope for increasing production in pigs, which, he says, only wants impetus given to it by farmers generally. As an illustration, he cites the case of Denmark (a small country in comparison with ours) which in normal times killed from 45,000 to 60,000 pigs per week, for which there is a ready market in England. Commenting on the pig as a "rent producer" and its immunity from certain of the drawbacks attending crop production, he states: "If farmers went in largely for pigs they would of necessity keep sufficient stock of food to provide for droughts, and, further, the pig would not be affected by hailstorms as it instinctively makes for shelter." It has been proved that we can produce suitable bacon hogs for the oversea market. There was no better bacon in London during September and October last than some from the Union, although, he points out, the produce of some of our factories, while of fairly good quality, was of entirely unsuitable cuts for the English market. "The Wiltshire cut," he adds, "is the only form of cut that appeals to the English trader—that is, the entire side, and it is further important that it should be made widely known to bacon curers that a side of bacon should weigh from 56 lb. to 75 or 80 lb. for export. Anything smaller than 56 lb. does not produce good bacon. It becomes much too salt and hard in the process of curing."

---

The *Journal* is the Department's medium of making known its activities. It contains information of value to every farmer in the Union. Keep it for reference.

## CATTLE IN THE UNION.

### The Trade in Beef.

In view of the importance of our cattle industry and the place it is expected to take as a source of the world's meat supply, the following statistics will be of interest to all concerned in the development of the industry.

The number of cattle in the Union and the increase of our herds during the past fourteen years may be gauged from the following table:—

*Number of Cattle in Each Province.*

Year.	Cape of Good Hope.	Natal.	Transvaal.	Orange Free State.	Union.
1904 (General Census)...	1,954,399	666,903	515,956	363,204	3,500,459
1911 " " ...	2,715,330	456,987	1,339,298	1,286,234	5,796,949
1918 (Census of Agriculture) ...	2,410,934	977,252	1,888,443	1,575,295	6,851,924

Thus the number of live stock in the Union in 1918 was nearly double (96 per cent. more) what it was in 1904 (when herds were depleted after the Anglo-Boer war) and 18 per cent. greater than it was seven years ago.

*Deaths of Cattle.*—The following table shows the mortality among cattle during the two Census years 1910-11 and 1917-18 owing to disease and drought, also the percentage of deaths compared with the total number of stock:—

Year.	From Disease.		From Drought.		TOTAL.	
	No.	Per Cent.	No.	Per Cent.	No.	Per Cent.
1910-11	249,807	4.3	188,066	3.2*	437,873	7.5
1918-19	219,227	3.2	20,497	0.3	239,724	3.5

The estimated mortality caused by the drought of 1918-19 was fully dealt with in the May, 1920, issue of the *Journal*.

*Cattle in other Countries.*—For purposes of comparing the position of the Union with that of the principal cattle countries of the world the following table is given:—

\* Including causes other than drought and disease.



Country.	Year.	Total Number of Cattle.	Country.	Year.	Total Number of Cattle.
India British ...	1914-5	128,310,000*	France ...	1913	14,807,000
India Native States ...	1913-4	12,236,000*	United Kingdom ...	1910	11,765,000
United States ...	1910	61,804,000	" ...	1918	12,311,000
" ...	1920	68,132,000	Australia ...	1910	11,745,000
Russia in Europe ...	1914	32,704,000	" ...	1916	10,459,000
Russia in Asia ...	1914	17,331,000	Canada ...	1911	6,533,000
Brazil ...	1916	28,962,000†	" ...	1918	10,051,000
Argentina ...	1914	25,867,000	Austria ...	1910	9,159,000
Germany ...	1913	20,994,000	Hungary ...	1913	6,045,000
" ...	1915	20,317,000	Uruguay ...	1916	7,803,000
France ...	1910	14,533,000	Italy... ...	1914	6,646,000

*Beef Exporting Countries.*—The following is a list of the principal beef exporting countries of the world during the years 1911-13:—

Country.	Beef Exported.	
	Average 1911-13.	Other Years.
	lb.	lb.
Argentina ...	940,299,000	1,067,680,000 (1917)
Australia ...	301,882,000	307,545,000 (1916)
United States ...	213,722,000	101,923,000 (1917)
New Zealand ...	80,513,000‡	111,700,000 (1914-6 average)
Denmark ...	43,485,000‡	—
China ...	8,787,000	36,961,000 (1917)
United Kingdom... ..	27,595,000§	—
Netherlands ...	326,176,000§	—
Other Countries ...	36,957,000	—
TOTAL ALL COUNTRIES ...	1,979,446,000	

*Beef Importing Countries.*—In comparison with the above it is found that the countries importing the largest quantities of beef were as follows:—

	Beef Imported (Average 1911-13). Lb.
United Kingdom ...	1,413,965,000
Netherlands... ..	256,296,000
Germany... ..	212,150,000

*Imports and Exports of the Union.*—For some time after the Anglo-Boer war the country's herds were depleted in numbers, and the demands for cattle-breeding purposes and transport work were so considerable that large quantities of frozen meat had to be imported to supply the requirements of the population, both civilian and military. The steady progress since made is illustrated by the following figures, which show that, whereas during the past four years the imports of beef into the Union were negligible, the

\* Including young Buffaloes.

† Including Buffaloes.

‡ The numbers of cattle in these countries were : New Zealand (1911) 2,020,000, (1918) 2,888,000 ; Denmark (1917) 2,453,000.

§ These countries also import large quantities as shown below.

quantities exported (the bulk going to England and Egypt for military purposes) assumed large proportions:—

Year.	Imports of Beef into the Union.	Exports of Beef. S.A. Produce.
1903 ... ..	98,127,258 lb.	—
1904 ... ..	57,582,999 "	—
1913 ... ..	8,949,753 "	121,261 lb.
1914 ... ..	737,950 "	463,767 "
1915 ... ..	16,957 "	5,971,727 "
1916 ... ..	6,969 "	17,686,121 "
1917 ... ..	5,680 "	47,252,995 "
1918 ... ..	Nil.	18,656,658 "
1919 ... ..	Nil.	14,408,861 "

The quantity exported, however, does not represent the Union's actual surplus, for numbers of cattle are imported into the Union from adjoining territories as follows:—1916, 26,580\*; 1917, 53,410; and 1918, 50,053; an average of 43,348 head per annum. In 1919 the number introduced was 57,267.

The class of export meat averaged about 150 lb. per quarter, or 600 lb. per head of cattle. At that rate the quantity of beef exported during the years 1916-18 would be equivalent to an annual average supply of 46,442 head of cattle, exclusive of the following quantity of fresh South African beef exported as ships' stores:—1916, 1,574,491 lb.; 1917, 2,744,415 lb.; 1918, 2,470,309 lb.; total, 6,798,215 lb.; equivalent to 3777 head of cattle per annum. In 1919 there were shipped 1,954,319 lb., or 3257 head of cattle.

Summarized, the trade of 1916-19 was as follows:—

Source of Supply.	Estimated No. of Live Stock.			
	Annual Average for Three Calendar Years 1916-18.		Calendar Year 1919.	
	Exported.	Imported.	Exported.	Imported.
Export of Beef ... ..	46,442	—	71,915	—
Beef as Ships' Stores ... ..	3,777	—	3,257	—
Live Animals ... ..	1,180	5943	1,077	606†
From adjoining territories ... ..	—	43,348	—	57,267
	51,399	43,942	78,349	57,873
Balance of Exports over Imports	7,457		20,476	

*The Actual Surplus of Beef.*—This summary points, therefore, to the conclusion that during the three years 1916-18 which herald the beginning of the Union's meat export trade, the surplus of the country's produce was comparatively small, being approximately at the rate of 7457 head of cattle or 4,474,200 lb. of beef per annum. In 1919, however, notwithstanding the prevalence of a severe drought, there was a surplus of some 20,476 head of cattle, equivalent to 12,285,600 lb. of beef, a marked increase on the average of the prior three years.

\* 1st July to 31st December only.

† From Overseas only.

---

## EXPERIMENTS AND INVESTIGATIONS.

---

### Work at the Schools of Agriculture and Experiment Stations and Sub-Stations.

---

[NOTE.—In last month's issue the work in hand at Cedara and at Winkelspruit, Natal, was reviewed. —ACTING EDITOR.]

---

### III.—AT GROOTFONTEIN, MIDDELBURG, CAPE.

---

#### (a) AGRICULTURAL SECTION.

*Cereals.*—The principal experiments in the above section are connected with cereals, chiefly wheat. Several hundred varieties, selections, and cross-breeds are being tested, and, where found suitable, are issued to co-operative farmers.

About 100 of the best varieties are kept pure, a true to type selected ear from each being sown each season. Some 360 selections from cross-breeds, importations from other countries, and from crops, are also under test. Eighty varieties were received from overseas, some of which are new cross-breeds. Eighty-three varieties that have been, and still are, showing good qualities are being increased for purpose of distribution to farmers. One hundred and ten varieties were sown in September to test resistance to rust. Forty varieties are undergoing a "smut" resistance test, and twenty varieties from coastal areas to note environment effects under Karroo conditions on colour of chaff and grain.

Seventeen varieties of oats and eleven of barley are being grown as pure lines, and two varieties each of rye and emmer to increase seed supply.

*Lucerne.*—Eight varieties are being tested for drought resistance, one variety in an inoculation test, and eight new varieties have been received from America and are now producing seed for increased area.

A variety (Chinese) is being allowed to seed for distribution, as it has shown splendid frost and drought resistance, also an increased area is being sown for production of seed.

*Spineless Cactus.*—Thirty varieties are being grown, some of which are giving good results; about 100 selected leaves showing variation in growth and freedom from spines and fruit are now growing in nursery plots. During season 1919, 8500 leaves were sold.

*Other Experiments.*—Twelve grasses, thirty-six millets, and kaffir corn, beans, peas, vetches, mealies, mangolds, linseed, etc., are being tested, also four commercial fertilizers on Algerian oats, and a sheep-feeding experiment (grazing) of about twelve acres, consisting of wheats, oats, barley, emmer, rye, rape, and kale.

*Seed Distribution.*—One hundred and twenty-eight lots of seed, amounting to 2750 lb. in weight, were issued to thirty-nine farmers in twenty districts on the co-operative principle; this allows farmers to make tests suitable to their local conditions.

#### (b) POULTRY SECTION.

*Fattening Tests.*—The object of these tests is to collect data as to the most suitable foods, also the most profitable breeds for table birds, and to prove to breeders that it pays to fatten poultry for table purposes.

*Incubation.*—Tests have been conducted with the object of determining the most suitable periods during the first twenty-one days of incubation) of supplying moisture to the eggs.

*Laying Tests.*—Sixty birds of various breeds are undergoing a twelve months' test for egg production, the object of this being to find out the best performers with a view of increasing the egg yield; birds are tested in their first year, and the proved producers are used in the second year for breeding purposes.

#### (c) HORTICULTURAL SECTION.

The following experiments are in progress:—

- (1) Various treatments to crab apple seed with a view to ascertaining best treatment for propagating same.
- (2) To ascertain whether crab apples from Yokohama, Japan, are blight-proof in South Africa.
- (3) Almond and peach as a stock for the Karroo.
- (4) Quince cuttings and root grafts (quince) for stock purposes.
- (5) Old blight-proof sweet apple and Northern Spy as a stock for apples—
  - (a) to infest both stocks with blight in the nursery and to ascertain whether they are absolutely blight-proof;
  - (b) easiest method of propagating above stocks.
- (6) Myrobolan seedlings and cuttings for stock production.
- (7) Various quantities of gypsum to ascertain the effect in counteracting deleterious result of sodium carbonate present in the soil.
- (8) Best season and easiest way to propagate Old Man saltbush (*Atriplex nummularia*). Testing five other varieties of saltbush for germination and suitability.
- (9) Cost, yield, and quality of vegetable seed, carrot, beet, parsnip, and onion.
- (10) Soil treatment to counteract tomato blight.
- (11) Propagation of new variety of grape originating as a sport on the black currant grape vine. The sport is white, large, and fleshy, contains few seeds, and is probably suitable for raisin making.
- (12) The breeding of new varieties of apricot to secure a late blooming variety for this area; the hybrids were, unfortunately, killed by late frost in October.

(d) OSTRICH SECTION.

*Cross-breeding Experiments.*—Experiments are being conducted to find out whether the feathers of the ostrich can be improved by introducing the density and strength of the North African feather into the length, breadth, and shapeliness of that of the South African bird. For this purpose extensive cross-breeding experiments are being conducted with North African and South African varieties of ostrich.

*Line-breeding experiments.*—An attempt is being made to ascertain to what extent line-breeding, i.e. (a) the mating together of brother and sister, and (b) mating of father and daughter, can be carried on with ostriches without having a detrimental effect on the constitution of the bird.

*The Best Breeding Age.*—Experiments to find out whether the first lot of chicks which a pair of birds produce are superior to those produced later in life.

*How long the same Birds should be Mated together.*—Experiments are being conducted to ascertain whether the breeding birds should not be mated differently each year. That is, when breeders are mated the same way over a considerable period whether the chicks do not gradually deteriorate in quality.

*Number of Feathers in the Wing.*—It has been ascertained that a great variety exists in the numbers of feathers produced in the wings of different birds. An attempt is being made by mating together birds with high numbers and others with low numbers, to find out whether these numbers cannot be relatively increased or decreased in their progeny.

*The Pineal Vesicle.*—It has been found that a structure similar to the pineal vesicle found in some reptiles exists in the embryo of the ostrich. This structure appears for a few days and again disappears before hatching. Investigations are being made to find out whether this structure is actually similar to the pineal vesicle or third eye of reptiles.

*Embryology.*—Up to the present practically no work has been done on the embryology of the ostrich. An attempt is now being made to collect and preserve a complete set of embryos from the start of incubation to the time of hatching.

(e) CHEMICAL SECTION.

Soil and water investigations are being continued. Reports dealing with these will be published in the *Journal* from time to time.

(f) ZOOLOGICAL SECTION.

Karakul sheep investigations are still in progress. Reports from 1916 to date are being published in the *Journal*. Investigation work to ascertain secondary host of tapeworm in ostriches.

---

 IV.—IN THE COASTAL AREA.
 

---

The following agricultural experiments are directed from the Grootfontein School of Agriculture:—

*Uitenhage District.*—Varieties of lucerne, grasses, mangolds, clovers, peas, barleys, rye, and flax =  $6\frac{1}{2}$  acres on Sundays River.

Manurial wheat experiment =  $2\frac{1}{2}$  acres, Elands River.

*Humansdorp District.*—Cereals varieties: 57 wheat, 10 oats, 8 barley, 2 rye, 1 emmer.

Manurial experiment with wheat, in all 21 acres.

*Hankey Municipality.*—Continuation of lucerne experiment, also beans, maize, mangolds, ground nuts, etc. = 2 acres; manurial experiment with wheat at farm Orange Grove =  $2\frac{1}{2}$  acres.

*Uniondale District.*—Farm Somerset's Gift, manurial experiment with wheat =  $2\frac{1}{2}$  acres.

*Albany District.*—At farm Mount Pleasant, manurial experiment with wheat =  $2\frac{1}{2}$  acres.

NOTE.—Several summer crop experiments will be commenced throughout this area as soon as rain falls.

---

 V.—AT GLEN, ORANGE FREE STATE.
 

---

## (a) AGRICULTURAL SECTION.

The Experimentalist is devoting his attention to the following points with crops:—

1. *Varieties most suitable for the various parts of the Orange Free State.*—Special attention is devoted to (a) length of vegetative period, so that information may be available as to whether the various sorts will have time to ripen in any special district with short season; (b) selection within the varieties; (c) resistance to rust and other plant diseases; (d) suitability of varieties for poor soil. The results of the above experiments will give a fair idea of the kind of crop that can be recommended in various circumstances.

2. *Quantity of seed to be sown per acre or morgen.*—In this connection consideration will be given to (a) the purpose for which the crop was planted; mealies, for example, are planted more thickly for silage than for grain; (b) the quantity of seed per acre or morgen with different rainfalls; (c) distance of planting for best result; (d) quantity of seed necessary under (a) and (b) for irrigated and dry lands.

3. *Fodder crops.*—(a) Arrangements for a regular supply of green food throughout the year; (b) mixed crops, e.g. mealies and cowpeas, or peas and oats; (c) suitability of crops for grazing, especially in winter.

4. *Time of planting.*—The influence that the time of planting has on the harvest. The time of the first rain has an important bearing on this question, also the object whether for seed or fodder.

5. *Rotation*.—Importance of rotation in connection with the following points: (a) Preventing exhaustion of the soil. Tests will be made in green manuring, e.g. the best crops to use for the purpose. (b) The best rotation for the various sorts of farms, e.g. a grain farmer needs a different rotation from a cattle farmer.

6. *Manuring Trials*.—(a) The best manures to use for the various farm crops; (b) the quantity necessary for different soils; (c) the residual effect of various manures.

#### (b) POULTRY SECTION.

Problems connected with incubation are among the chief occupying attention at the present time. Experiments are in progress in determining the cause (and, if possible, the remedy) of chick "dead in shell." The effects of extra supply of oxygen in the egg-drawer are being tested, and individual records of the incubation results for a large number of hens are being kept to determine whether "dead in shell" is not either wholly or largely a question of hereditary weakness in the present stock.

Efforts are being made to determine the sex of chickens at the time of hatching or within twenty-four hours. For some years now laying strains of Silver Campines, White Wyandottes, Speckled Sussex, and Light Sussex are built up by selection and by testing in single pens.

#### (c) CHEMISTRY SECTION.

The time of the present staff is fully occupied with routine work of analysis of soils and other samples sent in. It is hoped when proper facilities are provided to commence plot experiments and to undertake a systematic study of the various kinds of soil in the neighbourhood of the Institution.

#### (d) ANIMAL HUSBANDRY.

The lecturer hopes soon to commence investigation into the cost of production of milk and of pigs for bacon.

#### (e) ECONOMIC RESEARCH.

(a) The most paying crops; the cost of cultivation and the result must be carefully compared. This must run over a period of at least five years in order to have satisfactory records for such crops as lucerne. (b) The degree to which intensive farming can be carried out. This will naturally differ with the different crops, distance from market, etc. The object is simply to determine how much capital invested one acre or morgen can carry before it ceases to be productive.

#### (f) CO-OPERATIVE EXPERIMENTS.

Close contact with the farmers of each district in connection with the above points is desirable. Farmers will thus be invited to assist as much as possible in getting definite and reliable results. For this purpose seed, etc., will be distributed to any farmer who is willing to assist.

## INFECTIOUS DIARRHŒA: "BLOEDPENS" IN LAMBS.

SEVERAL requests having been received for remedies or preventives in cases of infectious diarrhœa among young farm stock, the following notes on the disease are extracted from the *Agricultural Journal of the Cape of Good Hope* (No. 2, Vol. XXXII):—

Bloedpens is confined to very young lambs, and has been shown to be due to an infective organism which enters the system of the young animal through the navel cord, either during or immediately after birth.

The cord which passes through the navel is made up, among other matters, of blood vessels, which, in the womb, carry the nutritive blood from the mother to the fetus, and the used-up impure blood from the fetus to the mother. At birth this cord is severed, and the blood flow stopped by a clot which forms in the vessels. Soon after separation the end of the cord shrivels, and the aperture through which it passes heals up. The extremity of the cord in the navel dies, and, under favourable circumstances, becomes absorbed. Conditions which favour the absorption of the dead part hasten the closing of the navel so that in a healthy, new-born animal there is a natural process to prevent the entrance of injurious matter through it. It is well known to physiologists and pathologists that anything which retards the natural healing process favours the growth of microbes (disease germs) there, and affords a means for their entrance into the blood vessels which distribute them through the system.—(Professor Penberthy.)

It will be seen, therefore, that anything which exercise a debilitating influence on the newly-born animal, such as cold, stormy weather, a feeble and debilitated condition of the mother, due to defective feeding or other unfavourable conditions, previous to lambing, would tend to retard the healing and closing of the navel, and thus leave it to a condition favourable to the entrance of infective organisms, and in this manner predispose the young animal to become affected. But, as already remarked, all these adverse surroundings are merely circumstances which favour the development of this complaint, the originating cause of the disease is a special infective organism which enters the system of the young animal through the open vessels of the cord either during or immediately after birth. It is further evident that this affection is contagious, and may be introduced into a herd or flock by an affected calf or lamb, and if the conditions are favourable to its development it may spread through the herd or flock, affecting a large proportion of the young soon after they are dropped.

*Treatment.*—This should be preventive, principally. Care should be exercised not to introduce an affected lamb into the fold, and if the disease makes its appearance in the flock the affected ones with their mothers should be promptly removed from the others and kept completely separated, having separate veld as



well as separate kraals. All the succeeding lambs should have their navels cleaned and disinfected, and, when dry, painted over with tincture of iodine as soon after they are dropped as possible.

The dry surface manure of the kraal should be cleared off and burned. All the sheds in which such animals have been placed should be thoroughly cleaned and disinfected. But if the disease becomes prevalent, the whole of the pregnant ewes which have still to lamb should be placed in a new kraal, or one in which no such cases have occurred.

*Aids to Treatment.*— It is very evident that the lamb's stomach is weak and unable to digest the ordinary quantity of milk which its mother supplies, hence the teats of the ewes should be drawn, so as to limit the amount which the sick lamb can obtain, and in lambs over a week old, in addition to the common salt solution recommended, give a tablespoonful of glauber salts, or bicarbonate of soda, mixed in a wineglassful of warm water, and carefully administered.

### Plant Nurseries in Quarantine for Pests.

No new quarantines on nurseries were applied up to 1st May and three announced under date of 10th April (*vide* *May Journal*, p. 190) have been withdrawn. The list of quarantines in force on 1st May is as follows:—

Name of Nurseryman.	Address.	Cause of Quarantine.	Extent of Quarantine.
S. Todd & Sons ...	Pietermaritzburg	Red scale	... Portion of citrus.
D. A. English & Co. ...	"	" "	" " "
F. Grace ...	Berlin, C. P. ...	" "	" " "
P. C. S. Gaylard ...	"	" "	All of citrus.
Smith Bros. ...	Vineyard, Uitenhage	" "	... Portion of figs and pears.
Municipal Nursery ...	St. George's Park, Port Elizabeth	Circular purple scale	Palms.
W. H. Oliver ...	East London ...	Red scale	... Whole nursery (apples).
J. Hobson & Co. ...	Kingwilliamstown	" "	... Portion of citrus.
Botanic Gardens ...	Graaff-Reinet ...	" "	... All citrus.
"	"	Woolly aphid	... All apples.
J. H. Laubscher ...	"	Red scale	... All citrus and figs.
Municipal Nursery ...	Somerset East ...	" "	... All citrus.
W. T. Atwood ...	Observatory, C.T.	" "	... Whole nursery.
C. F. Marais ...	Wellington ...	" "	... All citrus.
E. Krohn ...	Mare Street, Pretoria	Pernicious scale and other pests	Whole nursery.
E. Krohn ...	Esselen Street, Pretoria	Pernicious scale and other pests	Part of nursery : various kinds of plants.

Do not lose your copy of the *Journal*. A full index will be sent subscribers every six months. The *Journal* will prove a useful book of reference to every farmer. In time it will be a valuable compendium of advice and information on farming in South Africa.

## NOTES.

### The Friesland Bull "Admiral Beatty."

Frieslands have topped the sale lists in South Africa for some years, and the Friesland bull, "Admiral Beatty," Reg. No. 987, S.A. Stud Book, is the most renowned sire of any breed which has been seen in the country. His dam was Foekje XIX, No. 4097, N.R.S., by Jan, No. 3265, F.R.S. This cow was imported by the School of

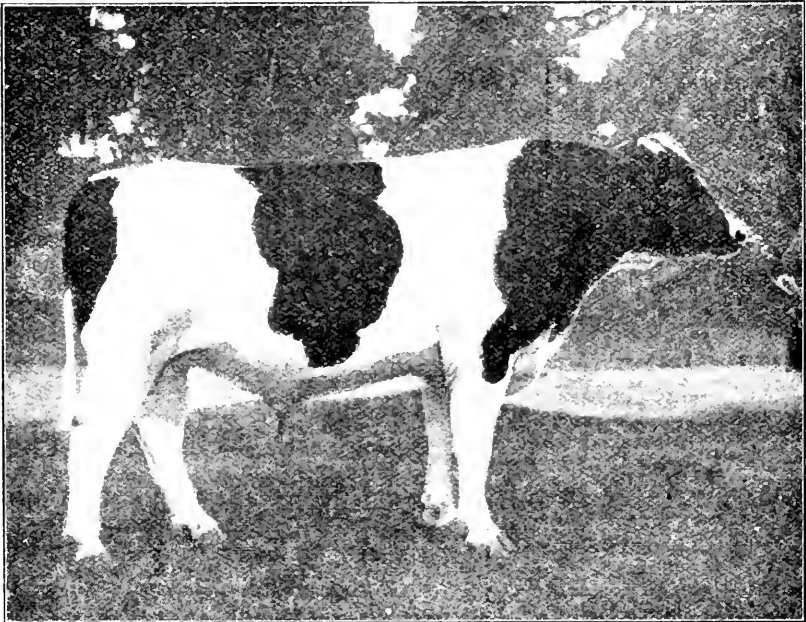

The Friesland Bull "Admiral Beatty."

Agriculture, Potchefstroom, in 1913, and was then in calf to the bull Alva VI, No. 1144S, N.R.S. The calf was born at Potchefstroom on 13th October, 1913, and was sold in September of the following year at the Annual Stock Sales to Messrs. Brown & Fleming, Balfour. This bull has been a winner at many shows, but it is as a sire that "Admiral Beatty" has proved his great worth and has achieved such noted success. He was sold in July, 1917, to the Hon. Joseph Baynes, Nelsrust, for £1000, and two years later was repurchased by his former owners at the record price of £5000.

Many of the progeny of "Admiral Beatty" have already been sold at high prices. The following list shows the principal sales of his get during the first three years in use as a sire:—

<i>Bull.</i>	<i>Heifer.</i>
Nel's Rust Beatty ... £3400	Craigie Bess ... .. £500
Craigie Elect II... .. 2000	„ Beatrice ... .. 500
„ Alf ... .. 1700	„ Heike... .. 500
„ Footprint ... 950	„ Ella ... .. 500
„ Elect I ... .. 750	„ Elsie ... .. 500
„ Pride II... .. 650	„ Ziempeje ... .. 500
„ Pride I ... .. 500	„ Afke ... .. 500
„ Arnold ... .. 500	„ Roosje ... .. 500
„ Heather... .. 350	
„ Dorando ... 310	

A son of Craigie Bess, by Koppies Kraal Marthus, was sold at last September sales for £2000.

### International Refrigeration Conference at Paris.

The vast trade in the world's supply of perishable foodstuffs depends upon the adequate supply of cold storage accommodation. The subject is a complex and far-reaching one, and one affecting the well-being of many countries, whose interests in the matter are identical. Accordingly the subject of refrigeration was taken up internationally in 1908, when the Association Internationale du Froid, a semi-official organization, was created. This association performed a useful initial function, but was interrupted by the outbreak of war. In June, 1919, however, at the initiative of the French Government, the Governments, States, Dominions, and Colonies entitled to immediate membership in the League of Nations were invited to participate in an International Conference on Refrigeration for the purpose of creating an international official organization for the study of questions on refrigeration in place of the association formed in 1908.

The Conference was held in Paris on the 15th, 16th, and 17th December, 1919. Thirty-eight States, Dominions, and Colonies responded to the invitation of the French Government and sent delegates to the Conference, at which a scheme was drafted for the formation of an International Institute of Refrigeration under the control and authority of a general Conference composed of representatives nominated by the participating Governments. The principal objects of the Institute are:—

1. To stimulate investigations into scientific, technical, and industrial questions of international scope, relating to the refrigerating industry.

2. To examine measures respecting the best methods of conservation, transit, and distribution of perishable produce.

3. To publish all information concerning the world's frozen food situation, compiled from a triple standpoint: origin of production, circulation, consumption.

4. To centralize for the purpose of immediate publication all technical, economical, and statistical reports and documents related to the production and use of refrigeration.

5. To concentrate, with a view to remedial administrative measures, all existing laws and legislative data that in any way affect international exchanges of produce.

6. To organize International Refrigeration Congresses.

7. To be in constant communication with adherent professional and scientific bodies in order to determine the practical value of their conclusions and adoption.

All questions affecting the economic interests, legislation, or administration of a State are excluded from the activities of the Institute.

The above covers a very wide field, and the realization of the objects of the proposed Institute will confer a benefit on all people whose daily needs depend upon the proper conservation and handling of perishable foodstuffs. The Union Government has agreed to subscribe towards the funds of the Institute and will share in the benefits which such association will confer.

A Congress to deliberate on and confirm the draft scheme will be held in Paris on the 21st June, 1920, at which duly accredited representatives of the various countries concerned are being invited to be present.

### Recruitment of Farm Labour.

The Secretary for Native Affairs draws attention to the constant and ever-increasing demand for native labour for every class of employment which makes the position of farmers most difficult, as generally they cannot afford to pay the same wages as employers of labour in industrial concerns. Their efforts to engage labour personally result more often than not in disappointment, whilst the employment of labour agents is often too expensive and unsatisfactory to be indulged in.

As recruiting personally or through an individual labour agent has not been found satisfactory, two alternatives suggest themselves, viz. :—

(a) For the farmers to combine and arrange for some established recruiting organization to supply their wants. If this is done, it will be necessary for the farmers to subscribe to stringent regulations, subject to penalties for infringement.

(b) For the farmers to combine and form their own recruiting organization in competition with the organizations already in the field. Here again stringent regulations would be necessary.

The Transkeian Territories and the northern Transvaal are the most likely areas in which to recruit farm labour. Whilst Natal and Zululand contain large numbers of natives, experience shows that the prospects of securing there any appreciable number for farm work are unfavourable.

### LAWS GOVERNING NATIVE RECRUITMENT.

Farmers are not prohibited by the provisions of Act No. 15 of 1911 from sending out natives in their employ to engage natives

whether *over or under* the age of 18 years for employment in domestic, agricultural, or general farming operations, unless the farmer or the native so sent out is in effect acting as a labour agent or, in the case of the native, as a runner.

When a farmer or other person in the course of obtaining natives for his own employment procures natives on behalf of another farmer, but is not engaged in the recruitment of natives for profit as an habitual business or as his trade or calling he will not, by such isolated act of recruiting, be deemed to be practising as a labour agent and to fall within the requirements of the Act.

If, however, a body of farmers or other individuals united under an organization for the procuring or supplying of native labour actively undertake recruiting, the agent or agents acting on behalf of such an organization will necessarily come under the provisions of the law and be required to be licensed. Under the provisions of Section 6 of the Act, a licence cannot be issued in the name of such company, partnership, or association, and such agents are prohibited from recruiting natives under the age of eighteen years.

As an employer of agricultural labour can recruit natives for his personal employment, he can exercise this power through the medium of a servant, whether European or native, and such servant need not be licensed.

By Section 8 (3) of the Act, a labour agent cannot recruit for more than one employer of native labourers without the consent of the Director of Native Labour. By the provisions of paragraph (2) of Government Notice No. 1793, of December, 1912, the magistrate of the district is vested with the powers conferred on the Director when the endorsement sought is to recruit for employment in agricultural or domestic service.

---

### **Citrus Export Season, 1920.**

The citrus crop of 1920 is likely to be a light one, but the quality of the fruit generally will be above the average. A small crop, combined with a shortage of fruit boxes, will naturally affect the export trade this season. About 2000 tons per month of cold storage space will be available on steamships for carrying the fruit to the oversea market, and as few pines are expected for export, the space should be sufficient to cope with the trade. It is estimated that next year some 4000 tons of cold storage accommodation will be required monthly during the season (four months) for the citrus and pineapple export trade.

---

### **Prize Wine and Brandy.**

An analysis was carried out by Mr. St. C. O. Sinclair, Government Analyst, Capetown, of twenty-five samples of wine and one sample of brandy, awarded prizes at the Western Province Agricultural Society Wine Show, 1919.

The following are the analytical results:—

WINE.

No. of Sample	Prize No. and Description.		Alcohol by Vol.	Extract.	Ash.	Fixed Acid.	Vol. Acid p.m.	Sulphurous Oxide.		Sulphates, as SO <sub>3</sub> .
								Total	Free.	
								m p.l.	m.p.l	
			%	%	%	%			%	
<i>Class 1.—Light Dry White Wine.</i>										
1	1st.	Lion Distillery ...	10.82	1.65	.16	.540	.618	158.6	5.6	.028
2	2nd.	R. Cloete ...	11.80	2.05	.29	.716	.876	163.2	7.2	.013
<i>Class 2.—Light White Wine (slightly sweetish type).</i>										
3	2nd.	Lion Distillery ...	13.60	6.46	.29	.393	.632	115.6	6.4	.031
<i>Class 3.—Dry White Wine (Sherry Type)</i>										
4	2nd.	Lion Distillery ...	13.30	2.09	.22	.512	.840	140.8	5.6	.043
<i>Class 6.—Stein.</i>										
5	2nd.	Lion Distillery ...	10.05	1.53	.16	.492	.708	176.8	4.8	.028
<i>Class 7.—Green Grape.</i>										
6	1st.	Lion Distillery ...	10.60	1.80	.17	.544	.672	171.0	6.0	.026
<i>Class 8.—White French.</i>										
7	1st.	Lion Distillery ...	10.78	1.80	.17	.570	.636	164.0	6.4	.027
<i>Class 9.—Riesling or Sauvignon Blanc.</i>										
8	1st.	Lion Distillery ...	11.20	1.79	.15	.559	.606	176.8	5.6	.039
<i>Class 10.—Any other variety of Wine.</i>										
9	1st.	Lion Distillery ...	10.71	1.67	.16	.519	.708	182.4	8.4	.027
<i>Class 11.—Light Dry Red Wine (Claret Type).</i>										
10	1st.	F. F. Versfeld ...	13.60	2.95	.30	.550	.726	33.6	24.0	.040
11	2nd.	O. Rathfelder ...	14.50	2.18	.25	.507	.618	19.2	12.6	.029
12	3rd.	High Constantia Estate	12.21	2.10	.27	.625	.558	26.0	26.4	.030
<i>Class 12.—Light Dry Red Wine (Burgundy Type).</i>										
13	1st.	F. F. Versfeld ...	13.29	2.72	.30	.551	.834	30.0	22.8	.021
<i>Class 13.—Heavy Red Wine (Port Type).</i>										
14	1st.	R. Cloete ...	17.20	9.55	.30	.563	.378	26.4	15.0	.034
<i>Class 15.—Hermitage (Dry).</i>										
15	1st.	O. Rathfelder ...	13.50	2.29	.25	.503	.558	25.2	15.6	.023
<i>Class 16.—Cabernet de Sauvignon.</i>										
16	1st.	O. Rathfelder ...	12.82	2.32	.25	.600	.588	21.0	14.4	.034
17	2nd.	F. F. Versfeld ...	13.60	2.62	.29	.508	.798	30.0	24.0	.024

No. of Sample.	Prize No. and Description.	Alcohol by Vol.	Ex-tract.	Ash.	Fixed Acid.	Vol. Acid p.m.	Sulphurous Oxide.		Sul-phates, as SO <sub>3</sub> .
							Total.	Free.	
							m.p.l.	m.p.l.	
<i>Class 18.—Wine made from any other variety of Grapes.</i>									
18	1st. O. Rathfelder ...	13.80	2.55	.30	.568	.612	30.6	21.0	.016
<i>Class 20.—Light Dry White Wine.</i>									
19	1st. Lion Distillery ...	11.05	1.74	.18	.510	.774	199.2	9.0	.026
20	2nd. Lion Distillery ...	10.70	1.62	.15	.556	.615	169.2	10.2	.021
<i>Class 21.—Light Dry Red Wine (Claret Type)</i>									
21	1st. O. Rathfelder ...	13.20	2.09	.24	.480	.588	21.6	18.0	.038
22	Reserve. High Constantia Estate	13.10	2.28	.28	.607	.576	24.0	18.0	.025
<i>Class 22.—Light Dry Red Wine (Burgundy Type).</i>									
23	1st. O. Rathfelder ...	13.31	2.25	.26	.545	.438	27.6	18.0	.028
24	Reserve. High Constantia Estate	12.37	2.24	.26	.600	.624	19.8	16.2	.051
<i>Class 24.—Red Wine.</i>									
25	1st. A. P. Burger ...	16.61	18.05	.54	.515	1.260	33.6	12.8	.031

BRANDY.

*Class 19.—Pure Wine Brandy.*

No. of Sample.	Prize No. and Description.	
26	1st—N. Thatcher:—	
	Proof spirit ...	105.0 per cent.
	Equivalent to ...	5° O.P.
	Sike's hydrometer reading on original sample ...	4.8° O.P.
	Absolute alcohol by volume ...	59.9 per cent.
	Extract in grammes per 100 c.c. ...	.09
	Ash in grammes per 100 c.c. ...	.01
<i>In Parts per 100,000 of Absolute Alcohol.</i>		
	Volatile acids ...	55.0
	Compound ethers ...	160.1
	Higher alcohols ...	303.9
	Aldehydes ...	17.5
	Furfural ...	.42
	Total secondary constituents ...	536.92

REMARKS.

Samples Nos. 10, 12, 13, and 17 contain free sulphurous oxide in excess of the limits allowed by Section 2 (e) of Act No. 15 of 1913. The remaining samples comply with the provisions of the Act.

In the cases of Samples Nos. 2, 4, 19, and 25, the volatile acid exceeds the limits laid down in the Society's regulations.

### The Maize Crop of the Union.

It is interesting to compare the position of the Union's principal crop with the production of maize in the foremost maize growing countries of the world. For this purpose the following statistics are given:—

		Total Production.
1916	... United States ... ..	2,504,193,825 bushels.
1915	... Hungary ... ..	175,025,170 ..
1916	... Argentine Republic ... ..	156,202,330 ..
1915	... Rumania ... ..	83,767,793 ..
1915	... British India ... ..	79,684,680 ..
1916	... Italy ... ..	76,326,678 ..
1916	... Russia in Europe ... ..	69,786,137 ..
<i>For the 1917-18 season the Union produced</i>		<i>42,133,633 ..</i>

In Mexico a very large acreage is put to maize, ranking next to that of the United States, but poor agricultural methods result in poor yields. The latest available statistics show that in 1906 Mexico produced 110,065,000 bushels.

The total production of the principal maize growing countries of the world is given (U.S.A. Year Book, 1918) at 3,642,103,000 bushels in 1916, the annual average production for 1911-13 being 3,813,408,000 bushels and for 1914-16, 3,873,868,000 bushels.

The 1917-18 maize season in the Union was an unfavourable one, sowings and the early growth of the crop having been affected by excessive rains, and it is estimated that the final condition of the crop which was returned by the Census as being 12,640,090 bags of 200 lb. was 32 per cent. below normal. Therefore, had the season been an ordinarily favourable one the crop would have yielded approximately 18,588,000 bags or 61,960,000 bushels of 60 lb.

*Yield per Acre.*—The yield per acre obtained in the Union is very low in comparison with that obtained in other countries as the following figures show:—

		Yield per Acre.
1916	... United States ... ..	23.63 bushels.
1915	... Hungary ... ..	28.26 ..
1916	... Argentine Republic ... ..	15.73 ..
1915	... Rumania ... ..	16.09 ..
1915	... British India ... ..	13.12 ..
1916	... Italy ... ..	19.93 ..
1916	... Russia in Europe ... ..	19.04 ..
<i>The return per acre in the Union for 1917-18 was</i>		<i>7.3 ..</i>

The above return per acre of 7.3 bushels is equivalent to 2.2 bags per acre, but had the season been favourable the full return per acre in the Union would have been approximately 3.2 bags or 10.7 bushels, not taking into account the production of native locations, reserves, etc.



## Live Stock Mortality in the Union.

An examination of the Census statistics recently published furnishes the following interesting aspect of the deaths among the live stock of the Union during the Census years of 1910-11 and 1917-18:—

*Percentage of deaths in comparison with the total number of Live Stock.*

Class.	Deaths from Disease.		Total Deaths from all Causes.	
	1910-11. per cent.	1917-18. per cent.	1910-11. per cent.	1917-18. per cent.
Cattle ... ..	4.3	3.2	7.5	3.5
Sheep ... ..	1.8	10.1(a)	12.3	15.1
Goats ... ..	.9	12.1(b)	8.6	15.4
Pigs ... ..	—	—	—	5.4
Ostriches ... ..	11.9	—	20.3	23.1
Horses, Mules, and Asses ... ..	—	—	3.2	8.3
Horses and Mules only ... ..	—	10.3	—	10.9

(a) Exclusive of lambs.

(b) Exclusive of kids.

*Monetary Loss through Mortality in Live Stock.*—The following table shows the returns of live stock which died during 1917-18, and an approximate valuation thereof. The latter is considered to be a somewhat low valuation at ordinary prices, and if the higher prices now current were applied the loss would, of course, show a higher figure:—

Class of Stock.	Total No. of Deaths.	Value per Head.	Total Value.
Horses and Mules ... ..	94,741	£12 0 0	£1,136,892
Asses ... ..	23,683	4 0 0	94,732
Cattle ... ..	239,724	6 0 0	1,438,344
Sheep ... ..	2,461,300	0 15 0	1,845,975
Lambs ... ..	2,064,699	0 6 0	619,410
Goats ... ..	726,689	0 10 0	363,345
Kids ... ..	510,209	0 4 0	102,042
Pigs ... ..	56,658	1 0 0	56,658
Ostriches ... ..	72,716	2 0 0	145,432
<b>Total ... ..</b>			<b>£5,802,830</b>

Thus, of the total estimated value of live stock lost during 1917-18, sheep and goats contributed 50 per cent.; cattle, 25 per cent.; horses, mules, and asses, 21 per cent.; ostriches, 3 per cent.; and pigs, 1 per cent.; total, 100 per cent.

An estimate of the loss of live stock owing to the severe drought of 1918-19 is published in the May, 1920, issue of the *Journal*,

## The World's Wheat Crop of 1919-20.

The latest International Crop Report from Rome (March, 1920) shows that the wheat crop of 1919-20 in the Southern Hemisphere is estimated to be 3 per cent. less than the previous season, and about the same shortage compared with the average crop of the previous five seasons. The severe drought which visited Australia is reflected in the fact that the wheat crop there was about 46 per cent. less than in 1918-19 and 62 per cent. less than the average crop of the prior five seasons. The situation was saved, however, by a crop in Argentina far above the average, 16 per cent. more wheat being obtained than in 1918-19, and 43 per cent. more than the average crop of the five years 1913-14 to 1917-18. The 1919-20 Argentina crop is estimated at 58,280,000 quintals (220 lb.) and the Australian one 11,975,000 quintals. The Union's crop was estimated at 1,804,400 quintals.

The vast bulk of the world's wheat is produced in the Northern Hemisphere, and, basing calculations on the statistics published by the International Institute of Agriculture for the five wheat seasons of 1913-14 to 1917-18, the total annual crop of the world may be placed approximately as follows:—

Northern Hemisphere	1,010,000,000	quintals.
Southern Hemisphere	83,000,000	..
	<hr/>	
World's total ...	1,093,000,000	.. (220 lb.)

The world's wheat crop of 1919-20 is estimated to be about 3.5 per cent. smaller than the above average crop and 6.2 per cent. less than the crop of 1918-19.

## The Great Advance in Wool Prices.

The breeding of woolled sheep is the oldest and most important of the Union's agricultural and pastoral industries, and the unprecedented prices obtained during the past year, due chiefly to conditions set up by the war, will mark an epoch in the history of the industry in South Africa.

A review of the trend of prices between 1913 and 1919 at the four principal wool exporting ports, Durban, Port Elizabeth, Mossel Bay, and East London, shows that there was little difference in the average prices obtained at these markets. In each of the four centres the price of wool gradually advanced from 1913 to September, 1919, and then between September and December jumped 100 per cent. In Durban the average price advanced from 7d. in 1913 to 30d. in September, 1919. In Port Elizabeth the advance was 7½d. to 22d.; in East London and also Mossel Bay from 7½d. to 28d. Then, on to December, 1919, the price of wool throughout the Union beat all previous records. For some clips extraordinarily high prices were obtained; in Durban 60d. per lb. was touched, in Port Elizabeth 85½d. (the Union's record—for a clip of Mr. J. S. Minnaar), in East London 76d., and in Mossel Bay 64½d., the average during these months being about 45d. per lb.

In these averages the values of the fleece wool only have been taken into account and the prices of pieces, locks, and bellies omitted.

The following table gives the highest and average prices per lb. at each port for the years 1913 to 1919:—

YEAR.	DURBAN.		PORT ELIZABETH.		EAST LONDON.		MOSSEL BAY.	
	Highest.	Average.	Highest.	Average.	Highest.	Average.	Highest.	Average.
	d.	d.	d.	d.	d.	d.	d.	d.
1913 ... ..	12	7	12	7 $\frac{3}{4}$	12	8 $\frac{3}{4}$	—	11
1914 ... ..	13	10	11	7 $\frac{3}{8}$	10	8	—	9
1915 ... ..	15	12	14 $\frac{1}{2}$	6 $\frac{5}{8}$	14	9 $\frac{1}{2}$	—	11 $\frac{1}{2}$
1916 ... ..	25	19	25 $\frac{1}{2}$	10 $\frac{5}{8}$	26 $\frac{1}{2}$	19	—	19
1917 ... ..	32	24	29	15 $\frac{5}{8}$	30	20 $\frac{1}{2}$	—	24
1918 ... ..	29	21	31	17 $\frac{3}{4}$	30	21	23 $\frac{1}{2}$	22
1919 ... ..	60	30	85 $\frac{1}{2}$	22	76	28	64 $\frac{1}{2}$	39

The average price over the Union in 1913 was 8 $\frac{1}{2}$ d. per lb. In 1918 it was 20 $\frac{1}{2}$ d. per lb. Thus in five years wool had advanced 141 per cent. in value. Then in September, 1919, there was a sudden rise of about 100 per cent. on the 1918 values, and at the close of 1919 wool fetched between 240 per cent. and 250 per cent. more than in 1913.

Taking the total quantity of grease wool exported during the past ten years, we find that the average value for customs purposes was as follows:—

1910 ... ..	7.30d. per lb.	1915 ... ..	7.07d. per lb.
1911 ... ..	6.79d. per lb.	1916 ... ..	10.64d. per lb.
1912 ... ..	6.88d. per lb.	1917 ... ..	15.84d. per lb.
1913 ... ..	7.54d. per lb.	1918 ... ..	16.48d. per lb.
1914 ... ..	7.23d. per lb.	1919 ... ..	19.63d. per lb.

While the great advance in the value of wool was due to the war, prices were also influenced by the marked improvement in the quality of wool which South Africa has been producing during the last few years. A gradual improvement has been taking place for the last fifteen years, but it has become especially marked in recent years, and the present high value of wool should act as a stimulus to farmers in the continued improvement of their produce, so that the wool of South Africa may at no distant date be equal to that of any country.

---

We advise you to get each copy of the *Journal* and to keep it. A full index will be sent every six months to each subscriber. Experience proves the *Journal* to be a useful book of reference. It will be so in the future. Every farmer is asked to get the *Journal* and not to lose it. It is likely that some day, in answer to an inquiry, you may be referred to an article in the *Journal*. Keep your *Journal*!

## THE POULTRY YARD MONTH BY MONTH.

By J. J. JORDAAN, Lecturer and Instructor in Poultry, Glen, Orange Free State.

### June.

#### *Feeding.*

Good circulation is essential to good health; therefore provide exercise by digging all grain food into the ground 8 to 12 inches deep. Throwing it into chaff, leaves, etc., is not severe enough.

A good plan is to have a place dug, say, 6 feet square for the purpose.

The feeding of the breeding birds should be of the best and closely studied. Avoid warm mashies and all forcing foods. Good, sound, hard grain is best.

Green food, grit, and oyster shell or lime should be provided *ad lib.* If green food is scarce or unobtainable, oats, barley, mealies, kaffir corn, or any other available grain should be sprouted; the feeding values are excellent, and green food is essential to fertility. Cabbage, lettuce, barley, mangel wurzel, or dry lucerne hay soaked overnight in warm water are all good. To sprout grain, take as much as is required for a day, put it into a grain bag, tie fast and place in a bucket of water (warm is best) until saturated, and then place in a dark corner and keep moist and covered with old bags, etc. In a week or ten days, according to the weather, it will be fit for use. In feeding just throw the tangled mass of growth to the birds, they will soon shred it.

#### *Egg Production.*

Laying birds for table-egg production must have stimulating food. (See last month's notes and formula.)

#### *Breeding Pens.*

In the breeding pen do not be tempted into giving the male bird more hens than will ensure strong fertility.

#### *Showing.*

The show season is now at its height; be sure to attend at least one of the leading shows—the information to be gathered there is invaluable. If you are not clear upon any point, look up the judge and ask him; especially get him to explain that class in which you are interested or of which you are a breeder.

It is also wise to exhibit some birds of your own breeding to compare your stock with those of other breeders.

In sending your birds to the show see that the coop is well made, warm, and roomy. Such a coop lasts longer, and as the bird is comfortable whilst travelling its chances of winning are improved.

Two or three hours before sending the bird away, give it a pill the size of, say, a walnut, consisting of equal parts ground chalk and ginger; it will then be less likely to get sick or catch cold.

In replacing birds in the pens on their return from shows, do so at night; they are not so likely to fight.

A little Douglas Mixture in the drinking water for a day or two after arrival will assist greatly in getting them over the effects of the travelling and showing.

Douglas Mixture is made as follows:—

To 1 gallon water add  $\frac{1}{2}$  oz. sulphuric acid, pour this on  $\frac{1}{2}$  lb. sulphate of iron.

When the iron is dissolved and water is cool bottle and store for use.

The usual dose is one tablespoonful to each quart of drinking water.

Douglas Mixture must always be given in enamel or earthenware vessels.

#### *General.*

In the coastal districts (excepting Natal) rain and cold weather may be expected. Scratching sheds must be provided in these parts.

In inland districts the birds must be kept warm at night, but not at the expense of ventilation.

A few wheelbarrows full of ground or stable manure on the roof of the sleeping quarters will go a long way towards adding warmth to them.

All water vessels should be emptied at night and fresh water given the birds in the morning. Drinking water that has been frozen is liable to set up bowel trouble.

## THE VEGETABLE GARDEN.

June, 1920.

By H. B. TERRY, Cert. R.H.S., Lecturer in Horticulture, School of Agriculture, Potchefstroom.

THE opportunity should be taken to clean up the vegetable section, destroying by fire or burying any remnants of previous crops that may afford shelter for insect pests. While this is being carried on, and before the soil is turned over, apply liberally any stable or kraal manure obtainable, then, after resting until August or September, it will be in a condition to receive any crop.

**TURNSIPS** may still be sown for succession; thin out the young plants to about 6 inches apart; use the thinnings as spinach.

**CARROTS** should be kept well watered and cultivated; they will make very little growth otherwise.

**CABBAGE** and **CAULIFLOWER** require a similar culture, and both crops must be watched to see that they do not suffer from drought. The earliest heads should now be ready to cut. As cauliflowers come on it is as well to break down a few leaves over the heads to protect them from frost.

**KOHL RAB** is a much neglected vegetable, and only needs to be better known as an excellent substitute for turnips to cause it to be more extensively cultivated. It will grow where turnips have repeatedly failed, is easy to germinate, and quick to mature.

**PEAS** may still be sown for spring use if the position is not subjected to heavy frosts. All existing crops should be kept well watered, as a great strain is upon the plants when the pods are filling.

**RADISH** may continue to be sown. A good plan is to sow this in the same rows as lettuce; the radish matures early and leaves the lettuce to utilize the ground as a follow-on crop.

**ONIONS**.—Autumn seedlings should be planted out now and not delayed any longer. Set them out in straight rows, 15 to 18 inches apart. The soil should be well firmed after planting, and take care not to plant deeper than 1 inch.

**CELERY** should now be fully developed and available for use. A little dry grass spread over the plants will protect the leaves from frost bite; keep the plants earthed up and watered to make the stalks crisp.

**LEeks** are advancing well and only require a few waterings to maintain growth. Further planting may be made; treat like onions and give rich soil.

**BROAD BEANS** should be sown to pod during October and November. Progress above the ground may be slow, but the good root action below will be made good use of when the weather becomes warmer.

**ASPARAGUS**.—Clean off any old top growths and spread a covering of well-decayed stable manure over the beds. New crowns should be planted as soon as possible; the beds should not be raised, but sunk slightly for preference to facilitate irrigation during dry weather in spring. Set the crowns 4 inches deep and spread the roots well out; 2 feet 6 inches to 3 feet between the rows is required for cultivation.

**RHUBARB** of ordinary type will also require to be well manured after the rubbish has been cleaned away from the recent crop. Old crowns may be lifted, divided, and replanted if more plants are needed. Winter rhubarb (Topp's Crimson), if well watered and the soil kept loose around the plants, will supply unlimited quantities of this delightful pie-vegetable throughout the entire winter season.

**SHALLOTS and GARLIC.**—This is the best month for planting; most people bury the small bulbs too deeply; this is a mistake, the tops of the bulbs should be just under the surface. Shallots are always needed in the kitchen, and garlic as well when sauces and other condiments are being made.

**POTATOES** are best allowed to remain in the ground until required for use. If lifted for storing let the tubers be placed in a pit and cover them with fine soil or sand; if exposed to too much light they turn green and are not fit for human consumption.

**JERUSALEM ARTICHOKEs** are produced under ground similar to potatoes. They may be dug out now when required, and make a delightful change to the usual vegetable.

**SWISS CHARD**, as a substitute for spinach, will continue to make plenty of leaves if given liberal waterings and kept well hood.

It is hoped that where provision has not been made for the growing of vegetables on the farm, if only to supply the homestead with a change of vegetables several times a week, a start will now be made, as the most important sowing months are rapidly approaching, and if one is prepared the rest is simple.

## SOUTH AFRICAN PRODUCE ON THE OVERSEA MARKET.

### Extracts from Report of the Acting Trade Commissioner.

March, 1920.

**Wool.** During the March series of auctions about 4500 bales of South African free wool were catalogued. It was thought that the keen demand and high prices paid for Australian merino wools would have improved the market for South African wools. This was not the case, and during the first week of the series when some 2600 bales of South African wools were put up for sale the prices realized showed no change from those which were secured in February last.

	Current Prices.	Prices Current at February Sales.
	Per lb.	Per lb.
Snow white, extra super—none offered ... ..	—	80d. to 91d.
Snow white, super—par ... ..	70d. to 82d.	66d. to 79d.
Snow white, medium—par ... ..	58d. to 69d.	56d. to 65d.
Snow white, inferior—par ... ..	40d. to 57d.	40d. to 55d.
Grease combing, long—5 per cent. dearer ...	36d. to 75d.	34d. to 69d.
Grease combing, medium—par ... ..	24d. to 35d.	22d. to 33d.
Grease clothing, light—par ... ..	23d. to 35d.	23d. to 36d.
Grease clothing, heavy—par ... ..	18d. to 22d.	18d. to 22d.

**Mohair.**—The general trend of the mohair market during the past month has been very quiet and sales have been restricted to small parcels of fine quality hair. Hardly any transaction took place in South African mohair, prices for which remained nominal.

**Hides.**—At the auction sales held on the 30th March considerable quantities of South African hides, mostly from stock previously offered and not of a character suitable for present trade requirements, were submitted for sale. The demand was practically negligible, and only a few dry salted kips and calf skins were sold at a decline of 1d. to 2d. per lb. It is hoped that the market will improve after the Easter holidays.

**Sheep Skins.**—At the March auctions a good selection of Cape skins was offered. Good combing wools reached a higher level, but long wools declined 1d. to 2d. per lb. Capetown long wool skins fetched 24½d. to 29½d.; short, 18½d. to 19½d.; shorn, 18d. to 20d. Mossel Bay, extra long wool, 32d. to 34d. The market at the close of the month was quite firm, both for woolled and common skins with prices unchanged.

*Goat Skins.*—Public auctions were held on the 11th instant when 154,649 Cape goat and 120,654 Cape angora skins were offered, and 34,293 and 11,379 sold respectively.

There was a small trade for goat skins and an improved demand for angora standard qualities, heavy advanced 2d. per lb., medium 1d. per lb., light and extra light sold at prices varying from 1d. to 2d. per lb. above January auction prices. "Clipped" advanced 2d per lb., while "dry damages" were unchanged on average.

*Wattle Bark.*—The market price of wattle bark during the past month declined about £4 per ton, caused to a great extent by heavy shipments of bark during January and February, and there are now stocks on hand far in excess of market requirements. The trade considers that it will take a little time for these stocks to be absorbed before any increase in present prices may be looked for. Prices ruling to-day for chopped are from £18. 5s. to £18. 10s. per ton. On the other hand, ground bark is at present in small supply, and the price has been maintained round about £19. 15s. to £20. 5s. c.i.f.

*Sunflower Seed.*—The present London market price of sunflower seed for feeding purposes is about £60 per ton for small lots. It is recommended that any shipments should be on a small scale, as any large quantity would have an adverse effect on the market price.

*Ostrich Feathers.*—The demand for feathers throughout the past month has been on the quiet side. The principal inquiry is still for narrow wings and common coloured feathers. The better quality wing feathers have, however, been sold in limited quantities. The adverse rate of exchange still continues to restrict the Continental demand.

*Tobacco.*—Small consignments of South African tobacco continue to reach the London market, and according to reports received from the trade, the prices of Virginian type (Rustenburg) range from 1s. 3d. to 2s. 6d. per lb. according to the grade.

*Cape Aloes.*—There has been a fair demand and prices are firm. Fairly large supplies have been received from the Union but these are firmly held, and good firsts are selling privately at 82s. 6d. to 85s. per cwt., whilst anything below this grade is worth about 75s.

*Beef.*—Several consignments of South African beef have reached the London market during the month, and the average prices realized were 6s. 2d. for hind-quarters and 4s. for forequarters per stone (8 lb.).

---

## DATES OF AGRICULTURAL SHOWS STILL TO BE HELD.

(As notified 30th April, 1920.)

---

### TRANSVAAL PROVINCE.

Potchefstroom.—9th June.  
Rustenburg.—9th June.  
Pietersburg.—16th and 17th June.

Barberton.—18th June.  
Tzauenen.—9th July.  
Nylstroom.—29th and 30th July.

---

### NATAL PROVINCE.

Newcastle Agricultural Society.—2nd and 3rd June.  
Vryheid Agricultural Society.—8th June.  
Dundee Agricultural Society.—10th and 11th June.  
Klip River Agricultural Society (Lady-smith).—15th and 16th June.  
Umvoti Agricultural Society (Greytown).—16th and 17th June.  
Weenen Agricultural Society (Estcourt).—17th and 18th June.

Royal Agricultural Society (Maritzburg).—22nd to 25th June.  
Durban and Coast Agricultural Society (Durban).—29th June to 2nd July.  
Zululand Show Society (Eshowe).—7th July.  
Richmond Agricultural Society.—14th July.  
Dronk Vlei Agricultural Society.—14th July.  
Camperdown Agricultural Society.—21st July.  
Ixopo Agricultural Society.—22nd July.

## OVERSEA PRICES OF SOUTH AFRICAN PRODUCE.

April, 1920.

MARKET PRICES OF SOUTH AFRICAN PRODUCE IN THE UNITED KINGDOM,  
CABLED BY THE ACTING TRADE COMMISSIONER, LONDON.

- Wool.*  
South African No. 2 White Flat, offer 81s. c.i.f.
- Cape Oats.*  
Quoted Mark Lane, 52s. per quarter.
- South African Wool.*  
Approximately 3000 bales offered at auction, 5th May. Only 500 sold, owing high limit imposed. Best greasy combing made up to 1s. 2½d. per lb. Super Snow-whites, 7s. 2d. per lb. Prices show decline about 10 per cent. compared with March sales.
- Mohair.*  
Fine Kid Hair in request. No demands for ordinary class hair. Turkey selling from 2s. 2d. to 2s. 6d. per lb.
- Cape Hides.*  
Dry salted, 1s. 11½d.; nominal best heavy, 2s. 0½d.
- Hides.*  
Market dull.
- Sheep Skins.*  
Full-woolled skins, 2s. 6d. per lb. No demands for other class.
- Cape Angora Skins.*  
Prices nominal. Light, 2s.; Heavy, 1s. 8d. per lb. Market dull.
- Natal Wattle Bark.*  
Chopped, £17; ground, £18, 10s. c.i.f. Large stocks here; business neglected.
- Cotton (American Future May).*  
Highest, 25·50d.; lowest, 25·10d.
- Aloes, Bitter.*  
Price from 75s. to 85s. per cwt.
- Ostrich Feathers (cabled 5th May).*  
Auction 1500 lots offered. Only half sold. Fair quality wings good competition only declined 10 per cent., but common wings 20 per cent. lower. no demand, short sold badly, except black and drabs, spadonias cheaper.
- Fruit (cabled 7th May).*  
"Saxon" shipment. Grapes, somewhat wasty: price, 7s. 12s., up to 20s. Pears in good condition, 8s., 9s., up to 12s.



**STAFF: APPOINTMENTS, TRANSFERS, ETC.**

---

**(1) AGRICULTURE.**

DATE.	NAME OF OFFICIAL AND NATURE OF CHANGE, ETC.
1/3/20	Sheep Inspector F. F. Kolbe: Promoted Senior Sheep Inspector, Natal. <i>vice</i> J. Cheere Emmett, resigned.
25/3/20	R. E. Montgomery: Director of Veterinary Research, transferred to Uganda Administration.
1/4/20	Senior Veterinary Officer A. A. Goodall: Seconded to South-West Africa Administration.
13/4/20	District Veterinary Surgeon G. McCall, Barberton: Resigned.
8/4/20	Sheep and Wool Expert L. H. Visser: Transferred from Pretoria to Paarl.

**(2) AGRICULTURAL EDUCATION.**

10/4/20	E. G. L. Smith: Appointed Lecturer in Horticulture, School of Agriculture, Glen.
1/4/20	H. Cooke, B.S.A., Lecturer in Agriculture at Grootfontein School of Agriculture Appointed Acting Vice-Principal at same Institution. <i>vice</i> W. J. Lamont transferred to Principalship, Elsenburg.
1/5/20	E. Parish, B.Sc., Vice-Principal, Glen: Transferred as Technical Assistant to Head Office.
1/6/20	G. J. Bosman, B.S.A., Itinerant Instructor and Experimentalist, Potchefstroom: Appointed Acting Vice-Principal, Glen. <i>vice</i> E. Parish.
31/5/20	M. Lundie, Assistant Chemist, Grootfontein: Resigned to accept position under Pretoria Municipality in connection with Sewage Works.

---

**MOVEMENTS, ETC., OF OFFICERS.****ENTOMOLOGICAL DIVISION.**

The Chief of the Division of Entomology, Mr. C. P. Lounsbury, proceeded to England by the s.s. "Kinfauns Castle" on 7th May as the Union's official delegate to a conference of official entomologists of the British Empire, convened at London to discuss problems in Agricultural Entomology. The meeting will be held under the auspices of the Imperial Bureau of Entomology, an organization supported by the Union Government in common with other countries of the Empire. The conference was originally planned for 1914 and was postponed to 1st June of this year owing to the war. While overseas, Mr. Lounsbury hopes to find time to make observations and inquiries in respect of European natural enemies of the pustular oak scale, woolly aphis, and codling-moth, and in connection with these subjects may visit France and Italy after the conference.

**VETERINARY DIVISION.**

At the request of the Government of Mozambique the services of Mr. J. J. G. Keppel, Government Veterinary Officer, have been lent to that Government for six months, during the absence on leave of their Chief Veterinary Surgeon.

## NOTES FROM THE "GAZETTE."

Attention is drawn to the following matters of interest which appeared in the *Union Government Gazette*.

GAZETTE. (Abbreviations: "Proc." Proclamation; "G.N." Government Notice.)

No.	Date.	ITEMS.
1041	16/4/20	Owing to the absence of scab therein the Minister of Agriculture has, under the Diseases of Stock Act (No. 14 of 1911), declared protected the Districts of:—
1045	23/4/20	(i) Ladybrand, Senekal, Winburg, Ficksburg, Thaba 'Nehu, Smithfield, Edenburg, Wepener, and portions of Hoopstad, Kroonstad, Bloemfontein, Boshof, Zastron, the Sub-District of Venterstad and portions and farms in Albert and Carnarvon. (G.N. Nos. 647, 707.)
		(ii) Owing to the partial prevalence of scab the Minister of Agriculture has approved of semi-protection being extended to a new list of 43 districts or portions of districts in the Cape, Orange Free State, and the Transvaal. (G.N. Nos. 648, 649.)
1047	30/4/20	The compulsory dipping of sheep between 10th May and 30th June has been ordered for the Prieska District under the Scab Regulations. (G.N. No. 745.)
1041	16/4/20	Compulsory Dipping of Cattle in the three and five day dips has been ordered by the Minister for the Districts of Nqutu, Barberton, Ladysmith, Game Reserve (Barberton), and portions of Vryheid, Estcourt, Ixopo, Utrecht, Umvoti, and Camperdown Districts. (G.N. Nos. 650, 706, 760, and 792.)
1041	16/4/20	Unallotted farms in certain Natal districts are notified for disposal by the Secretary for Lands; applications to be made to the Surveyor-General, Pietermaritzburg, up to the 28th May. (G.N. No. 660.)
1015	23/4/20	Lot No. 8630, Vlake Rand, in the Montagu Division, is notified for disposal by public auction, at 3.30 p.m., Wednesday, 23rd June, at the residence of Mr. Joubert, of Warmwaterdrift. (G.N. No. 680.)
1045	23/4/20	The Great Fish River Irrigation District, with the definitions of its boundaries, has been proclaimed by Proclamation No. 63.
1045	23/4/20	Restrictions for the prevention and spread of Citrus Canker have been proclaimed under the Agricultural Pests Act (No. 11 of 1914), and the removal of citrus fruit and trees has been restricted in certain areas in the Districts of Rustenburg, Waterberg, and Pretoria. (Proclamation No. 67.)
1045	23/4/20	The appointment of W. J. J. Scheepers ( <i>vice</i> Mr. J. E. de Villiers) as an Itinerant Water Court Judge, with Headquarters at Capetown, is notified in G.N. No. 681.
1045	23/4/20	The appointment of members of the Land Board of the South-West Africa Protectorate under the Crown Land Disposal Ordinance (1903), as amended by Protectorate of South-West Africa Crown Lands Disposal Proclamation (No. 13 of 1920), is notified in G.N. No. 698.
1047	30/4/20	The conditions of lease, applying to unalienated Crown Lands in Natal and Zululand unsuitable for European settlement purposes, are amended in certain respects (maintenance, fencing, cost of dipping tanks, etc.). (Proclamation No. 70.)
1047	30/4/20	From the 22nd April certain railway tariffs, including those on live stock, have been increased, the special surcharge of 25 per cent. in the case of stock being increased to 33½ per cent.
1047	30/4/20	An allotment early in July of 1500 tons of guano to bona fide farmers and gardeners within the Union is notified. Further particulars as to conditions and manner of application appear in G.N. No. 288.
1050	7/5/20	The demarcation of The Kathu Forest Reserve, Block I, in the Division of Kuruman, is notified. (G.N. No. 794.)

**RECENT AGRICULTURAL LITERATURE.**

By PAUL RIBBINK, LIBRARIAN, DEPARTMENT OF AGRICULTURE.

## I.—UNION GOVERNMENT PUBLICATIONS.

MISCELLANEOUS REPORTS, ETC., OF INTEREST TO FARMERS.  
(Obtainable from the Government Printer, Pretoria.)

<i>Price per copy.</i>	<i>Number of Publication.</i>
1s. Summarized Report of the Proceedings of the Gold Conference held at Pretoria, 22nd October, 1919 ...	U.G.18—'20
1s. Interim Report, Cost of Living Commission ... ..	U.G.26

II.—THE AGRICULTURAL PRESS OF SOUTHERN AND TROPICAL  
AFRICA.

## SELECTED ARTICLES.

*Die Boer* (Bijvoegsel tot "De Volkstem"), Pretoria.

- 9/4/20 Dr. Hartig's Middel tegen Gallamziekte.  
 30/4/20 Ekonomiese Sij van Ons Boerderij. Lesing deur Dr. A. I.  
 Perold, gehou te Stellenbosch.  
 23 4/20 Krag op die Boereplaas, deur W. S. H. Cleghorne.

*Die Boerenvrou* (Posbus 984, Pretoria).

- 4/20 Ons Boerehuise in Transvaal en hulle Karakter, deur J. H.  
 Pierneef.

*Farmers' Advocate*, South African (P.O. Box 247, Bloemfontein).

- 4/20 War Farming in Germany.  
 Breeding Merinos, Milk and Cream Testing, by A. de Wet.  
 Heavy Horse *versus* Ox, by A. Taute.

*The Farmers' Journal* (Nairobi, B.E.A.).

- 25/3/20 Cotton Growing.  
 1/4/20 Native Labour; Cotton Growing for B.E.A.  
 8/4/20 Turmeric, Cultivation and Uses.  
 Hints to Tobacco Growers.  
 15/4/20 Flax Problem. Storing Rain-water, by H. F. Birchall. Tea  
 Culture.

*The Farmers' Weekly* (Bloemfontein).

- 7/4/20 Hand-rearing of Calves (2), by H. Cook, B.S.A.  
 14/4/20 The Cotton Crop, by W. B. Wilson, B.S.A.  
 Hail Insurance (Editorial).  
 21/4/20 The Agricultural Department, by "Veritas."  
 Export Fruit, by G. Alex. Barnes.  
 Construction on Diversion Weirs, by C. H. Warren,  
 A.M.I.C.E., M.I.M.E.  
 Restriction of Prices.  
 28/4/20 Liver Fluke, by F. G. Cawston, M.D.

*Die Landbouwer* (Posbus 1035, Pretoria).

- 28/2/20 Goedkoop Bouwe op die Plaas (vervolg uitgawe dd. 15  
 Januarie 1920).

*Die Landbouur II eekblad* (Posbus 267), Bloemfontein).

- 31/3/20 Bakteriële in die Landbou. II. Handelsopleiding vir Suid-afrikaners. Waterpasse, V, deur R. J. v. Reenen.  
 7/4/20 Wat is die Profijt op mij Plaas. Verbetering van Grond deur Groenbemesting, deur D. Potgieter, B.Sc.  
 11/4/20 Gesondheidsleer vir die Boerplaas, deur Dr. A. J. Stals, Garsverbouwing, deur G. J. Bosman.  
 21/4/20 Invloed van Klimaat op Tabak, deur Pieter Koch, B.Sc.  
 Hoe om 'n Vrugteboord uit te lê, deur O. S. H. Reinecke.

*The South African Dairyman* (P.O. Box 925, Durban).

- 3/20 The Milk Producers' Union Famous Breeds of Britain: Devons and South Devons, II, by Farmer George, Official Notes on Friesland Cattle. The Butter Position. Use of Starter in Cheese-making, by P. C. de Klerck.  
 4/20 Dairying Problems in Zululand. The Milk Producers' Union, Official Notes on Friesland Cattle.

*The South African Farm News* (P.O. Box 963, Johannesburg).

- 3/20 Horse-breeding in South Africa, by F. J. Finch-Smith, Cattle Industry, IV, Special Purpose Cattle. Lamziekte Investigation: A Visit to Armoedsvlakte, by J. F. Pentz, Bacteria and Butter-making, II. Timber in the Union.

*The South African Fruit Grower and Small Holder* (P.O. Box 3958, Johannesburg).

- 3/20 What Fruit Shall I Grow? by B. W. la Motte.

*South African Gardening and Country Life* (P.O. Box 3958, Johannesburg)

- 3/20 Our South Africa, 14: Stellenbosch, by Dorothea Fairbridge, Amateur's Attempt a Home and Garden: No. 12, Fruit, Practical Hints on Cutworm Destruction, by F. de Castelia, Native Plants, Plants of the Bible and Biblical Lands, VI.

*South African Journal of Industries* (Government Printer, Pretoria).

- 3/20 Economics of Wheat Production, by H. Wolfe, M.Sc. Power Applied to Agriculture, by W. S. H. Clegborne, Transport Methods in South Africa, by Sir Wm. Hoy (continued in April issue).  
 4/20 Eggs for Inland and Oversea Markets, by W. O. John, Fodder Trees and Shrubs for South African Farms, by H. D. Leppan, B.Sc., Agriculture. Tea Culture, by Hon. W. T. Clayton, M.L.A.

*South African Poultry Magazine* (Bloemfontein).

- 4/20 Poultry Products on the Railway. Exhibiting Table Poultry and Eggs, by "Utility."

*South African Poultry Review and Small Holder* (Johannesburg).

- 4/20 Co-operation. Utility White Leghorns. South African Poultry Association, Minutes of Executive Board Meeting held on 6th March, 1920.

*The South African Sugar Journal* (P.O. Box 925, Durban).

- 1/20 Restrictions on Sugar Prices. Notes on the Cotton Industry, by W. B. Wilson, B.Sc., Agric. Electrification of Cane-sugar Mills, by Chas. Griffith, O.B.E. Housing of Labourers on Sugar Estates.

*The Sun and Agricultural Journal of South Africa* (P.O. Box 634, Johannesburg).

- 4/20 The South African Grain Trade Association. Report on the Wheat Position, by C. E. Wilson, Secretary. The South African Maize Breeders', Growers', and Judges' Association: Report of Fifth Annual Meeting held on the 1st of April, 1920, in Johannesburg.

*Sunday Times, Farmers' Supplement* (Johannesburg).

- 4/4/20 A Planting Calendar, by G. J. Bosman.  
 18/4/20 Strawberry Culture, by H. B. Terry.  
 2/5/20 White Ants of South Africa, by C. Fuller. (Continued from previous issues.)  
 Rural Transport for Agricultural Industries, by Agricola. (Continued from previous issues.)

*The Week End* (P.O. Box 413, Pietermaritzburg).

- 17/4/20 Milk Fever, Kaffir Corn and other Sorghums, Fowl Cholera.  
 24/4/20 Mineral Needs of the Dairy Cow, Diseases of Swine, III.  
 1/5/20 Silos and Silage, Culture of the Potato, Liquid Manure.

## III. AGRICULTURAL PUBLICATIONS IN OTHER PARTS.

## REVIEWS AND EXTRACTS.

*Control of Humidity Conditions in Lemon Storage.*—This is dealt with by Mr. A. D. Shamel in an article appearing in the March, 1920, issue of the *Californian Citrograph*. A description is given of the instruments and means used for regulating humidity conditions in the storage rooms and among the numerous conclusions arrived at it is shown that uniformly high humidity gave the best results with the fruit, and that the rate of natural curing depends upon the temperature at which the fruit is held. At 93° F. the green fruit cured within nine days.

*Wart Disease of the Potato.*—The January, 1920, number of the *Scottish Journal of Agriculture*, issued by the Board of Agriculture for Scotland, deals with the scheme of certification of growing crops which are immune to the disease. The inspection of growing crops was terminated in September last and revealed that stocks of the older varieties are far more impure than those of the newer varieties. Mixed stocks are being weeded out, older varieties are being freed from admixture, and new varieties are being maintained in high state of purity. Planting from certified stock of immune varieties will ultimately lead to absolute pure stock reaching the market.

*Canadian Government Grain Elevator.*—We learn from the *Canadian Agricultural Gazette* of February, 1920, that the Canadian Government has created and is operating five large elevators in the Dominion. The elevators with fundamentally different functions to fulfil may be classified under three headings of "Public Terminal," "Interior Terminal," and "Transfer." The Public Terminal Elevator at Port Arthur was completed in 1913, cost \$1,500,000, and has a capacity of 3,250,000 bushels of grain with a workhouse capacity of 750,000 bushels. Two Interior Terminal Elevators at Moosejaw and Saskatoon, Sask., respectively, were completed in October, 1914, costing \$1,000,000 each, the capacity of each being 3,500,000 bushels with a workhouse accommodation of 112 bins for 500,000 bushels. Another elevator of the same type with a capacity of 2,500,000 bushels was completed in 1915 at Calgary, Alta., costing a little over \$1,000,000. The third class, or Transfer Elevator, was erected in 1916, at Vancouver, B.C., at a cost of \$800,000.

*Milk Products in America and Europe.*—Mr. W. Dempster, of the New Zealand Department of Agriculture, contributes a very interesting article to the February, 1920, *Journal of Agriculture of New Zealand*, on his trip to America and Europe investigating the manufacture and marketing of milk powder, sugar milk, and other branches of dairying as carried out in those countries. A review is given of the manufacture in the United States of skim-milk powder, butter, Swiss cheese, sugar of milk, "jack cheese," muriatic-acid casein, condensed milk, casein, etc. English and Scotch methods of milk powder production are dealt with, Holland being visited in the same connection. The author gives a detailed account of his finding concerning production and all factors influencing production and marketing.

## AT THE SCHOOLS OF AGRICULTURE AND EXPERIMENT STATIONS.

April, 1920.

CEDARA, NATAL.

*Climatic.*—The rainfall for the month (up to and including the 23rd inst.) was 1.37 inches. The mean maximum temperature was 71.2° F., and the mean minimum 52.08°. The days were mostly bright and warm with cool nights.

*Crops.*—The maize for grain has produced good cobs and the crop promises to be quite up to the average. Ensilage maize is now being cut and placed in silos. The cow-pea crop was badly affected with leaf rust and very few pods were formed. The crop was cut for ensilage. The turnips, rape, and kale have all very good stands and promise heavy yields.

*Field Experiments.*—The linseed planted in January has produced a heavy yield of seed, but the stalks are very short. Bimplipatam Jute, also planted in January, has made very poor growth, the stalks not exceeding an average height of 2 feet. The experimental maize plots are looking very well and a heavy yield is expected.

*Stock.*—The condition of the stock is good and the veld is still in good grazing condition. One Aberdeen-Angus heifer calf was born during the month. The nine Aberdeen-Angus cattle shown at the Witwatersrand Show secured eleven prizes, including the Dunne Challenge Cup, one reserve champion, and three firsts.

*Orchard.*—The autumn ploughing and turning in of the cover crop is now demanding attention. Citrus fruits are now beginning to ripen and manured trees showing a marked increase in the size of the fruit.

*Chemical Laboratory.*—Activities during the month were mostly confined to the investigations commenced in the previous month, viz., (1) on the composition and tanning properties of wattle bark, and (2) the composition and nutritive value of indigenous grasses.

*Apiculture.*—Two discoveries of great interest to bee-keepers were made during the month. First, it was found that the Isle of Wight disease, due to a parasite known as *Nosema Apis*, is present here in South Africa. Hitherto it was thought that European Foulbrood was the only serious bee disease in this country, but Isle of Wight disease has been found at Cedara and in some neighbouring apiaries during the month. This disease must have been present for some years past, but it has never been noticed before.

The second discovery is of a parasite fly, about the size of a house-fly, which enters the hives with impunity and parasitises adult worker bees. The maggot of this fly lives as a parasite in the abdomen of the bee and eventually kills it, the maggot then leaving the dead body of its victim and burying itself in the ground and changing into a chrysalis, which eventually gives rise to the adult fly. It is impossible to estimate the ravages of this pest as numbers of the parasitised bees must die out in the field. Both these pests are being made the subject of further studies.

*Students.*—There are sixty-four students in residence to date. Three are at present taking a special course at Winklespruit.

## ELSENBURG, MULDER'S VLEI.

*Climatic.*—The first rainfall of any account since the beginning of the year was on the 10th instant, when 0.82 inches was registered. Though not a very heavy fall, this was most useful as it softened the ground sufficiently to enable the pushing forward of field operations so long delayed by drought. The total rain for the month was 0.885 inches as against the normal average of 2.34 inches, and the weather on the whole was rather hot. The maximum temperature recorded was 92.5° F. on the 14th, and the minimum 48.3° on the 25th.

*Field Operations and Crops.*—Considerable field work was accomplished after the 10th instant, including the sowing of 50 acres of farm land to oats and 65 acres to soiling and grazing crops, additional ploughing and harrowing in both farm and experimental sections, and cultivation and fertilizing of lucerne lands. Approximately 100 tons of stable manure were spread and worked into the soil. The bulk of the Algerian oat crop was threshed, a yield of 600 muids being obtained from 85 acres; 35 tons of straw were chaffed for use as dry roughage during the winter.

*Viticultural Section.*—A portion of the vineyard was ploughed, manured, and lined during the month, and the wines were racked.

*Horticultural Section.*—The month of April completed the fruit season at Elsenburg. The rest of the Keiffer pear crop was picked, part being sold on the Johannesburg market and the remainder cut up for drying. The crop was not as heavy as in previous seasons, but the quality was good. A large amount of seed of several varieties was sown in the vegetable garden.

*Live Stock.*—The live stock on hand on the 1st April was as follows:—Cattle (Frieslands and Jerseys), 86; sheep (Suffolks, Murrays, and cross-breds), 212; horses and mules, 60; oxen, 6; donkey jack, 1; pigs (Large Black, Berkshires, and Tamworths), 213; poultry, 716. In addition there were at Mariendahl:—Cattle (grade), 101; oxen, 8; horses and mules, 17.

*Experimental and Investigational Work.*—Investigations relating to the preservation of eggs (by the lecturer in poultry) and the keeping qualities of various fertilizer mixtures (by the lecturer in chemistry) were started this month. Other experimental work in the various sections as previously described is progressing satisfactorily.

*Staff.*—During the month Mr. W. J. Lamont assumed duty as Principal at Elsenburg, *vice* Mr. T. G. W. Reinecke, and Mr. B. S. Parkin was appointed to the Lectureship in Veterinary Science. Mr. E. Baker, Lecturer in Botany, has sailed for Europe on six months' vacation leave.

## GLEN, ORANGE FREE STATE.

*Crops.*—The rainfall for the month was 1.44 inches. A slight frost was registered on the 27th ultimo. Although the rainfall was small, crops and grass continued to make normal growth. There is an abundant growth of grass, and the prospect for the winter, as far as bulk feed is concerned, promises well. Maize planted at the end of January will give a fair return for ensilage purposes, as no frost has been registered here during the month. A large quantity of hay was gathered during the month. As a large acreage of the veld is suitable for mowing it is proposed to cut a considerable quantity.

*Live Stock.*—All the live stock are in excellent condition. The Friesland cow D.O.A. 41 T, which gave the highest yield of butter-fat in the official test as a senior four-year-old, has just calved again. She is in good condition, and there is every chance of her performance coming up to expectations.

*Extension Work.*—A number of officers were absent on duty this month, principally at shows.

*School.*—Five more students were received for the one year course during the month. The accommodation for the diploma course is fully taxed. There are only a few vacancies at the one year hostel.

## GROOTFONTEIN, MIDDELBURG, CAPE.

*Students.*—The senior diploma course students attended the Port Elizabeth Show and acted as stewards in the various sections. They also acted in the same capacity at the Middelburg Show, which was attended by all the students.

*Judging Competition.*—The Inter-school Live Stock Judging Competition, held at Bloemfontein Show for the first time, was a matter of great interest to all the students and staff of the institution, and particularly those who were finally selected for the team which was to represent Grootfontein. Grootfontein won the competition, securing the highest marks as a team, and also the highest marks amongst all individual competitors.

*Staff.*—Various members of the staff judged at shows and also delivered lectures and demonstrations on various subjects.

*Sheep Course.*—Close on eighty applications and inquiries were received from applicants for the special course in sheep and wool. The course was opened on the 15th April; the twelve best candidates will be accepted after undergoing an entrance or test examination.

The first returned soldiers' course closed on the 15th April, and the new six months' course for returned soldiers open on the 30th.

*Special Short or Winter Vacation Courses.*—The following courses will be held in June and July:—

- (1) Nine days' sheep and wool course from 10th June to the 18th June.
- (2) Nine days' course in dairying, horticulture, and poultry from the 10th June to 18th June.
- (3) General course covering all subjects taught at this institution, with the exception of those enumerated in courses (1) and (2), and covering a period of three weeks, opening on the 21st June and closing on the 10th July.

## POTCHEFSTROOM, TRANSVAAL.

The weather during the month was dry, only 0.12 inches of rain being registered compared with 1.48 in April last year. The temperature was, however, very mild; no frost occurred during the month. The maximum temperature recorded was 86.6° F. on the 12th and the minimum 43.1° F. on the 18th. The dry weather following a comparatively dry March has resulted in a shrinkage of the maize crops, especially those grown for silage. The condition of the veld is also below normal.

*Farm Section.*—On account of the dry condition of the ground, difficulty was experienced in getting into good tilth the lands intended for winter cereals. Approximately 87 acres were ploughed and harrowed in preparation for winter cereals, 79 acres of teff and lucerne were mown, yielding hay of excellent quality; 100 tons of maize silage was made, and in addition a fair amount of cow-pea hay. It is estimated that the following foodstuffs will be on hand for the winter: Lucerne hay, 160 tons; teff hay, 40 tons; sweet grass hay, 30 tons; cow-pea hay, 6 tons; maize silage, 200 tons. In addition there are 26 acres of mangels and 2 acres of pumpkins.

*Experimental Section.*—Ranges of ground in the Experimental Division were prepared for the purpose of planting linseed, kale, rape, chic peas, susan peas, vetches, and winter beans. In the fertility plots the range which carried cow-peas this season as a hay crop was fallowed in preparation for the ensuing maize crop. Five acres of tepary beans and 1 acre of iron cow-peas were harvested for the seed of which there is a great demand. In addition to the silage and hay experiments, varieties of beans and kaffir corn were harvested, also sugar-cane, Napier fodder, and 'N Youti. In the variety trials of cow-peas and millets, the crops were harvested, and in addition the crops of buckwheat and linseed in the rotation experiments.



*Horticultural Section.*—The fruit season of 1919-20 again illustrated the suitability of the soil and climate to pears. The dry season proved a suitable one for grapes which is in accordance with previous experience. Some varieties of apricots, Japanese plums, and peaches gave excellent crops despite the late frost of 23rd September, 1919. Apples have proved extremely erratic in their blossoming in the past season, and the disease of bitter pit was very prevalent. The trees are stunted and diseased; many will be pulled out this coming winter. The cherry, nectarines, and domestic plum crops were failures. Great difficulty is experienced this season, owing to the absence of rain, in getting the orchards cleaned and cultivated. The ground is proving extremely hard. The apple trees are badly attacked by woolly aphid; the pest is being controlled by hand painting of the trees with paraffin emulsion. A pruning experiment to illustrate the effect of early normal and late pruning was commenced this month.

*Live Stock.*—Cattle have maintained their condition. The various herds will require heavy feeding, however, during the winter, owing to the poverty of the veld. Several young animals inoculated against spousiokte in December and January last died of the disease in this month. The young stock were all inoculated a second time against the disease. Twenty-four aged oxen and twelve head of mixed cattle, discarded for various purposes, were disposed of at prices ranging from £17, 12s. 6d. to £21, 12s. 6d. All the herds were carefully gone through with the object of reducing undesirable animals before winter sets in.

It is intended to abandon the crossing experiment of Sussex and Africander cattle on Mendelian lines, and to dispose of all the progeny in the second generation from cross-bred bulls; but before doing so observations are being taken on the animals of that generation in order to obtain data of scientific value. It is feared, however, that the number of individuals are not sufficient for the purpose. For this experiment it is proposed substituting grading work with pedigree Hereford and Sussex bulls on Africander females as foundation stock. This will yield data of practical value to ranchers who are attracted to these two breeds for purposes of beef breeding.

The supply of milk has been sufficient only to meet the domestic demands of the school and farm and for calves. The quantity of cream available is therefore not sufficient to supply the requirements of the hostels in respect of butter. For this purpose a certain amount of cream is being bought.

But for a few mild cases of blue-tongue, sheep have done well, although the Romney Marsh ewes put to the ram have fallen off somewhat owing to the condition of the veld. These ewes have apparently all been settled by the ram this month, as also the Suffolk × Persian and the Suffolk × Merino cross-breeds to the Suffolk rams. The Wanganella Merino stud ewes have commenced lambing.

A number of pigs, both of Large Black and Berkshire breeds, was sold to farmers for breeding purposes. The demand exceeds the available supply.

*Poultry Division.*—A small intensive house is being erected. The birds in the breeding pens have come through the moult very early this year, which made it possible to get an early start with incubation. Two hundred young chickens have been hatched thus far and by the end of August, at latest, it is hoped to have hatched 1000 head.

*Experimental and Investigational Work.*—Three years work on "adhesive washes designed to protect fruit trees from the attack of rodents" has been completed, and the result will be published. The entomologist has also under investigation the following:—(a) Potato tuber moth; (b) the angoumois grain bug; (c) the control of rats and mice. Investigations into nitrification and the lime requirements of soils is being continued by the chemist. The engineer made an inspection of water power installations in Natal in company with Brother Nivard, of the Mariamhill Monastery, who had installed these. A number of samples of agricultural materials (fertilizers, foodstuffs, brak waters required for dipping purposes) were analysed during the month.

*School.*—Forty-four students, including all the second year diploma men, and nearly all members of the staff, attended the Witwatersrand Agricultural Society Show and assisted at the Government exhibit and as stewards to the Society.

---

Keep your *Journals!* The contents will be indexed every six months and a copy of the index sent to each subscriber.

## MEAT STATISTICS.

### I.—RETURN OF BEEF INSPECTED AND PASSED FOR EXPORT, APRIL, 1920.

Place.	Cattle.			Carcasses.		
	Inspected.	Rejected.	Passed.	Inspected.	Rejected.	Passed.
Durban ... ..	3,171	—	3,171	3,171	299½	2,871½
Pietermaritzburg ...	1,018	—	1,018	1,018	26¾	991¼
Pretoria ... ..	—	—	—	4	—	4
Johannesburg ... ..	584	—	584	584	—	584
Bloufontein ... ..	—	—	—	—	—	—
Capetown ... ..	110	—	110	110	5¼	104¾
Port Elizabeth ... ..	—	—	—	—	—	—
Germiston ... ..	—	—	—	—	—	—
<b>TOTAL</b> ... ..	<b>4,883</b>	<b>—</b>	<b>4,883</b>	<b>4,887</b>	<b>331½</b>	<b>4,555½</b>

Beef actually exported during the month of April, 1920: Total 17,563 quarters. (*Ex* Durban 16,873 quarters; *Ex* Capetown 690 quarters.)

Total shipments of Beef in quarters—

1916 ...	115,992	1918 ...	123,354	*1920 ...	21,710
1917 ...	309,214	1919 ...	285,367		

II.—OTHER MEAT EXPORTED\*: Pork, carcasses 627; Bacon 79,160 lb.

### III.—RETURN OF CATTLE IMPORTED INTO THE UNION FROM ADJOINING TERRITORIES.

Territory.	Imported April, 1920.	Total from 1st January, 1920, to 30th April, 1920.
		No.
For Slaughter—	No.	No.
Rhodesia ... ..	1,962	6,854
Bechuanaland Protectorate	1,796	7,249
S.-W. Africa ... ..	1,232	5,066
Swaziland ... ..	15	623
Basutoland ... ..	—	—
For Breeding—		
Rhodesia ... ..	914	4,258
Bechuanaland Protectorate	2,474	6,209
<b>TOTAL</b> ... ..	<b>8,393</b>	<b>30,259</b>

### SUMMARY OF IMPORTS.

Calendar Year.	For Slaughter.	For Breeding.	Total.
	No.	No.	No.
†1916	26,580	—	26,580
1917	47,970	5,440	53,410
1918	36,767	13,286	50,053
1919	40,574	16,693	57,267

\* Total from 1st January to 30th April, 1920.

† 1st July to 31st December only.

## CROP AND LIVE STOCK REPORT.

April, 1920.

## MAIZE.

The condition of the crop in the Cape Province is reported to have slightly reduced the prospects, as also in the Orange Free State and Natal. On the other hand, no perceptible change has taken place in the Transvaal.

Taking the Union as a whole the crop remains at 20 per cent. below normal in condition as at the end of April and is estimated to yield 10,161,900 bags. As was to be expected, frosts were mainly responsible for the condition of crops, which owing to the late rains could not be planted earlier. In the Eastern and Central Transvaal the maize borer appears to have caused some damage as well as in the South-Eastern Districts in the Free State.

## KAFFIR CORN.

The reports received from correspondents disclose practically the same conditions as in respect of maize.

Where the prospects in the Cape Province have diminished from 38 to 41 per cent. below normal there has been on the other hand a slight improvement in Natal as well in the Free State. The condition of the crop for the Union is placed at 20 per cent. below normal, at the end of April, estimated to yield 1,131,400 bags.

## TOBACCO.

As compared with the previous month, the prospects of this crop have improved by approximately 5 per cent. over the Union. Improved conditions are reported particularly from Oudtshoorn and the Transkei. On the other hand a decline of 10 per cent. is reported from the North-West Free State. At the end of April the crop is estimated to be 19 per cent. below normal in condition, which should yield 8,949,600 lb.

## COTTON.

It is estimated that the 1918-19 season, under normal conditions, should have given 2,322,000 lb. of seed cotton. As compared with that season, it would appear that the area under cultivation in 1919-20 was as follows:—Transvaal, increase of 44 per cent.; Natal, increase of 8 per cent.

At the end of April, 1920, the information disclosed points to the fact that the condition of the present crop was not so satisfactory in the Transvaal, a decline of 19 per cent. being reported. In Natal, however, the prospects appear to be just about normal. The net result, therefore, is that the current season may be expected to produce in the Transvaal, 1,133,760 lb., and in Natal, 1,464,500 lb., or a total of 2,605,200 lb. of seed cotton.

## CONDITION OF LIVE STOCK.

Compiled from Reports furnished by Sheep and Stock Inspectors.

Area.	Large Stock.	Small Stock.
CAPE—		
South-West ... ..	<i>Medium to poor</i> ... ..	<i>Medium to poor.</i>
North-West ... ..	<i>Good to medium.</i> Fat in parts	<i>Good to medium.</i> Fat in parts.
South Coast ... ..	<i>Good to medium</i> ... ..	<i>Good to medium.</i>
Southern Karroo ... ..	<i>Good to medium.</i> Poor in parts	<i>Good to medium.</i> Poor in parts.
Central Karroo... ..	<i>Fat to good</i> ... ..	<i>Fat to good.</i>
Northern Karroo ... ..	<i>Good.</i> Fat in parts ... ..	<i>Good.</i> Fat in parts.
Eastern Karroo ... ..	<i>Good.</i> Fat in parts ... ..	<i>Good.</i> Fat in parts.
Bechuanaland ... ..	<i>Fat to good</i> ... ..	<i>Fat to good.</i>
Griqualand West ... ..	<i>Fat to good</i> ... ..	<i>Fat.</i> Medium in parts.
North-Eastern ... ..	<i>Fat to good</i> ... ..	<i>Fat to good.</i>
Border ... ..	<i>Good.</i> Fat in parts ... ..	<i>Good.</i> Fat in parts.
Transkeian Territories... ..	<i>Fat to good.</i> Medium in parts	<i>Fat to good.</i> Medium in parts.

Area.	Large Stock.	Small Stock.
TRANSVAAL—		
Eastern High Veld ...	<i>Good.</i> Fat in parts ...	<i>Good.</i> Fat in parts.
Central ...	<i>Good to medium.</i> Fat in parts ...	<i>Good to medium.</i> Fat in parts.
Western High Veld ...	<i>Good.</i> Fat in parts ...	<i>Good.</i> Fat in parts.
Low Veld ...	<i>Good.</i> Fat in parts ...	<i>Good.</i> Fat in parts.
ORANGE FREE STATE		
North-Eastern ...	<i>Fat to good</i> ...	<i>Fat to good.</i>
North-Western ...	<i>Good.</i> Fat in parts ...	<i>Good.</i> Fat in parts.
South-Eastern ...	<i>Fat to good</i> ...	<i>Fat to good.</i>
South-Western ...	<i>Good.</i> Fat in parts ...	<i>Good.</i> Fat in parts.
NATAL—		
High Veld or Highlands	<i>Fat to good</i> ...	<i>Fat to good.</i>
Middle Veld or Midlands	<i>Fat to good</i> ...	<i>Fat to good.</i>
Coast ...	<i>Good.</i> Fat in parts ...	<i>Good.</i> Fat in parts.

## Springhaas.

The following letter from Professor J. D. F. Gilchrist, University of Capetown, P.O. Box 594, Capetown, is published with the request that any one able to throw light on this matter of scientific research will kindly communicate direct with Professor Gilchrist, who will gladly give further particulars to those interested:—

"In an early description of the springhaas (*Pedetes*) in 1816, it was asserted that this animal had a pouch in the abdomen similar to that found in the kangaroo. At a later date this statement was repeated, but it was said that the pouch was not on the abdominal part but further forward in the region of the chest, and that it was rudimentary and not used for the shelter of the young as in the kangaroo. None of the stuffed specimens of the springhaas in the museums in Europe or the Cape show such a pouch, and it has been taken for granted that the original statement was founded on a mistaken observation. It may be, however, that the pouch only appears in the adult female.

"It may be that some of your numerous readers can throw some light on this problem. The discovery of a pouch in the springhaas would be of the greatest utility in determining the true nature of this peculiar rodent, and some one who has the opportunity of procuring or observing these animals may be able to solve this problem which is puzzling scientific men, viz., as to whether they are really a kind of hare or a kangaroo."

The *Journal* aims at keeping farmers informed of what the Department of Agriculture is doing, also of such matters affecting their interests as come under its purview. The *Journal* contains original articles for the guidance of the farmer on the many and diverse problems which face him. Every farmer should read it and keep it.

LOCAL MARKET PRICES.

RATES OF AGRICULTURAL PRODUCE AND STOCK RULING AT THE 15TH MAY, 1920.

CENTRE.	Wheat, Per 200 lb.		Wheat Flour, Per 100 lb.		Bar Meal, Per 200 lb.		Meaties, Per 200 lb.		Mealie Meal, Per 180 lb.		Barley, Per 150 lb.		Oats, Per 150 lb.		Out-bay, Per 100 lb.		Lucerne Hay, Per 100 lb.		Potatoes, Per 150 lb.						
	Min.	Max.	Min.	Max.	Min.	Max.	Min.	Max.	Min.	Max.	Min.	Max.	Min.	Max.	Min.	Max.	Min.	Max.	Min.	Max.					
<i>Cape Province—</i>																									
Alwal North†	60	0	60	0	62	0	36	6	37	6	37	6	10	0	10	0	14	6	13	0	32	6	35	0	
Beaufort West...	60	0	60	0	62	0	37	0	38	0	38	0	22	6	22	6	12	0	13	0	24	0	25	0	
Cape Town.....	70	0	72	0			32	0	37	0							12	0	13	0	12	0	39	9	
East London.....					32	0	32	0									14	6	16	0	27	0	45	0	
Grahamstown.....					32	0	33	0									14	6	16	0	27	0	45	0	
Kimberley.....	60	0	70	0	79	6	82	6	18	0	19	0	30	0	30	0	11	3	15	3	10	0	12	6	
Kingwilliamstown					31	0	39	6	31	0	33	0	26	0	26	0	15	0	17	0	15	0	17	0	
Port Elizabeth...	44	0	54	0	70	0	70	0	37	6	37	6	30	0	33	0	12	6	15	0	8	0	10	3	
Queenstown.....	68	6	70	0	43	0	70	0	37	6	37	6	38	6	38	6	15	0	15	0	35	6	35	6	
<i>Natal—</i>																									
Durban.....							26	0	32	0	23	0	30	6			10	0	13	0	9	0	11	6	
Pietermaritzburg†																									
Orange Free State—																									
Bloemfontein.....	60	0	80	0	82	6	95	0	30	0	36	0	32	6	37	0	10	0	15	0	30	0	35	0	
Barramouth.....	60	0	65	0	77	6	77	6	28	0	29	0	30	0	30	0	12	0	14	6	30	0	30	0	
<i>Transvaal—</i>																									
Pretoria.....					60	0	60	0	25	0	30	6	18	3	24	6	28	0	35	0	25	0	27	0	
Johannesburg.....	44	0	61	0	51	0	70	3	28	0	33	3	33	3	33	3	15	0	17	0	15	0	16	3	
<i>Other Centres—</i>																									
Onions, Per 120 lb.																									
	Min.	Max.	Min.	Max.	Min.	Max.	Min.	Max.	Min.	Max.	Min.	Max.	Min.	Max.	Min.	Max.	Min.	Max.	Min.	Max.	Min.	Max.	Min.	Max.	
<i>Cape Province—</i>																									
Alwal North†	15	0	15	0	100	0	100	0	0	9	1	1	0	9	0	10	3	6	1	0	15	0	620	0	
Beaufort West...	15	0	17	0	68	0	70	0	0	9	1	1	0	11	1	2	2	6	2	8	3	6	3	6	
Cape Town.....	16	3	27	6	20	0	77	0	0	9	1	1	0	11	1	2	1	1	1	2	0	13	0	27	0
East London.....					55	0	80	0	0	4	1	3	0	8	1	3	1	6	3	2	3	0	4	1	
Grahamstown.....	18	0	24	0	37	0	62	0	7	1	3	1	0	1	2	0	2	9	3	0	1	3	0	4	
Kimberley.....	5	0	21	0	20	0	30	0	6	10	0	9	1	2	0	2	1	2	5	2	6	3	0	3	
Kingwilliamstown	18	0	22	0	72	0	81	0	0	8	1	0	9	1	2	2	6	3	3	3	2	4	1	8	
Port Elizabeth...	12	0	21	6	0	6	0	6	0	11	0	11	0	1	0	1	2	3	2	3	1	0	1	8	
Queenstown.....																									
Durban.....	12	0	27	0	30	0	60	0	1	0	8	0	8	1	2	2	0	3	3	6	3	6	3	3	
Pietermaritzburg†																									
Orange Free State—																									
Bloemfontein.....	12	6	18	6	1	0	50	0	65	0	10	1	3	1	0	1	3	2	6	3	0	3	9	5	
Harrismouth.....																									
	19	0	23	6	0	51	0	53	0	1	8	7	2	1	1	2	2	3	2	9	3	3	3	3	
Pretoria.....	12	6	18	9	0	51	0	51	0	94	0	97	6	55	0	10	1	3	1	1	2	2	3		
Johannesburg.....																									
<i>Transvaal—</i>																									
Durban.....																									
Pietermaritzburg†																									
Orange Free State—																									
Bloemfontein.....																									
Harrismouth.....																									
Pretoria.....																									
Johannesburg.....																									
<i>Other Centres—</i>																									
Cattle (Slaughter), Each.																									
	Min.	Max.	Min.	Max.	Min.	Max.	Min.	Max.	Min.	Max.	Min.	Max.	Min.	Max.	Min.	Max.	Min.	Max.	Min.	Max.	Min.	Max.	Min.	Max.	
Sheep, Each.																									
	Min.	Max.	Min.	Max.	Min.	Max.	Min.	Max.	Min.	Max.	Min.	Max.	Min.	Max.	Min.	Max.	Min.	Max.	Min.	Max.	Min.	Max.	Min.	Max.	
Pigs, Each.																									
	Min.	Max.	Min.	Max.	Min.	Max.	Min.	Max.	Min.	Max.	Min.	Max.	Min.	Max.	Min.	Max.	Min.	Max.	Min.	Max.	Min.	Max.	Min.	Max.	
	30	0	40	0	40	0	40	0	40	0	40	0	40	0	40	0	40	0	40	0	40	0	40	0	

\* Live weight per bag. † Dressed weight, including hides, offal, etc., per 100 lb. ‡ Information not available.   
 NOTE.—The rates quoted for produce sold in bags include, as a general rule, an additional 3 lb. for weight of bag.

## DEPARTMENTAL NOTICES.

AN UNRESERVED SALE OF PURE-BRED STOCK WILL BE HELD AT  
THE SCHOOL OF AGRICULTURE AND EXPERIMENT FARM,  
CEDARA, ON SATURDAY, 26TH JUNE, 1920.

*Cattle.*—About seven Friesland bulls, nine Aberdeen-Angus bulls, eight Short-horn bulls, three Friesland cows and heifers, eight Shorthorn cows and heifers.

*Pigs.*—About twenty pigs of the Large Black and Berkshire breeds.

*Poultry.*—A number of pure-bred poultry.

All animals sold will be forwarded carriage paid to buyers' nearest railway station.

For catalogue and further particulars apply to the Principal at above address.

E. J. MACMILLAN,  
*Under-Secretary for Agriculture.*

### SHORT COURSES OF INSTRUCTION

will be held during the 1920 Winter Vacation at the Schools of Agriculture, as follows:—

*Grootfontein, Middelburg, Cape Province.*—10th to 18th June: Sheep and Wool. 10th to 18th June: Poultry, Dairying, and Horticulture. 21st June to 10th July: General Farmers' Course.

*Potchefstroom, Transvaal.*—17th to 26th June: Poultry, Dairying, and Horticulture. 29th June to 14th July: General Farmers' Course.

*Eisenburg, Mulders Vlei.*—21st June to 3rd July: General Course (including Poultry, Dairying, and Horticulture). 5th July to 17th July: General Farmers' Course.

*Glen, Orange Free State.*—30th June to 9th July: Sheep and Wool. 30th June to 9th July: Horticulture and Poultry. 14th July to 4th August: General Farmers' Course.

Women will be admitted to all the courses (except the General Farmers' Course at Glen), though the courses in Poultry, Dairying, and Horticulture are specially designed for them.

Candidates must be over eighteen years of age.

Fees (including instruction, board and lodging):—Nine days' course, £2. 5s.; two weeks' course, £3. 10s.; three weeks' course, £5.

Smaller charges are made for those who make their own arrangements for board and lodging.

Reduced railway fares, at single rate for return journey, will be granted.

Further particulars and conditions may be obtained from, and application for admission should be made to, the respective principals of the institutions above mentioned.

E. J. MACMILLAN,  
*Under-Secretary for Agriculture.*



PRICE 5/-  
PER ANNUM.

**Journal**  
of the  
Department of  
**Agriculture**  
ISSUED BY AUTHORITY OF THE  
MINISTER OF AGRICULTURE.

PRINCIPAL CONTENTS.

- Ticks found on Man and his Domestic Animals and Poultry in South Africa.
- Chemical Analysis of Soils.
- The Fruit Export Act.
- The Agriculture and Soils of the Cape Province—II. Along the Orange River.
- The Department of Agriculture during the War—III.
- Composition and Valuation of Fertilizers and Feeding Stuffs.
- Fundamental Principles of Co-operation in Agriculture.
- Experiments and Investigations—VI.
- Army Mystery Worm.

PRICE **6D** PER COPY

## STAFF.

### Department of Agriculture (including Agricultural Education).

In publishing the following abridged list of certain members of the staff, the public is notified that matters of an Administrative nature are dealt with by the Head Office in Pretoria or by the Chiefs of the Divisions located there or their representatives in the Provinces, and all correspondence should be directed accordingly. Matters concerning farm practice and advice on farming generally, should be referred to the Principal of the School of Agriculture serving the area of the Union concerned.

#### ADMINISTRATION.

(UNION BUILDINGS, PRETORIA, TEL. ADD.: "LANDBOUW".)

Secretary for Agriculture.—F. B. Smith, C.M.G.

Under-Secretary for Agriculture.—P. J. du Toit (at present on the Public Service Commission of Inquiry).

Acting Under-Secretary for Agriculture.—G. N. Williams, D.S.O.

Under-Secretary for Agriculture (Education).—E. J. Macmillan, B.S.A.

Acting Chief Clerk.—F. W. Green.

Bloemfontein: Inquiry Clerk.—G. F. Joubert. Tel. Add.: "Landbouw"

#### DIVISIONS.

Sheep.—Chief: B. G. L. Enslin, D.S.O., Union Buildings, Pretoria. Tel. Add.: "Merino".  
Principal Sheep Inspector.—W. Cronwright, Union Buildings, Pretoria. Tel. Add.: "Acarus".

Principal Sheep and Wool Expert: A. G. Michaelian, Union Buildings, Pretoria. Tel. Add.: "Wolox".

Veterinary Research. Director of Veterinary Education and Research: Sir Arnold Theiler, K.C.M.G., P.O. Box 593, Pretoria. Tel. Add.: "Microbe".

Veterinary Research Officer: E. M. Robinson, M.R.C.V.S., Allerton, via Maritzburg. Tel. Add.: "Bacteria".

Veterinary Research Officer: H. H. Curson, M.R.C.V.S., Grahamstown. Tel. Add.: "Institute".

Veterinary.—Principal Veterinary Officer: C. E. Gray, M.R.C.V.S., Union Buildings, Pretoria. Tel. Add.: "Privet".

Senior Veterinary Officer: A. Spreull, M.R.C.V.S., corner of Minnaar and Koch Streets, Pretoria. Tel. Add.: "Veterinus".

Senior Veterinary Officer: R. W. Dixon, M.R.C.V.S., Parliament Street, Capetown. Tel. Add.: "Veterinus".

Senior Veterinary Officer: W. Power, M.R.C.V.S., Colonial Buildings, Maritzburg. Tel. Add.: "Veterinus".

Senior Veterinary Officer: A. Grist, M.R.C.V.S., Government Buildings, Bloemfontein. Tel. Add.: "Veterinus".

Senior Veterinary Officer: G. W. Freer, M.R.C.V.S., Funtata. Tel. Add.: "Veterinus".

Dairying.—Superintendent of Dairying: E. O. Challis, Union Buildings, Pretoria. Tel. Add.: "Dairying".

Botany.—Chief: I. B. Pole Evans, M.A., D.Sc., F.L.S., P.O. Box 994, Pretoria. Tel. Add.: "Mycologist".

Mycologist: V. A. Putterill, M.A., Department of Agriculture, Capetown.

Mycologist: P. A. v. d. Bijl, M.A., D.Sc., F.L.S., Natal Herbarium, Berea, Durban. Tel. Add.: "Herbarium".

Tobacco and Cotton.—Chief: W. H. Scheffius, M.Sc., Union Buildings, Pretoria. Tel. Add.: "Tobacco".

Horticulture.—Chief: I. Tribolet, Union Buildings, Pretoria. Tel. Add.: "Hortus".

Viticulture.—Government Viticulturist: S. W. van Nickerk, Elsenburg, Mulders Vlei, Cape. Tel. Add.: "Viticulturist".

[Continued on page iii of cover.]



# CONTENTS.

JULY, 1920.

	PAGE
TICKS FOUND ON MAN AND HIS DOMESTIC ANIMALS AND POULTRY IN SOUTH AFRICA ... ..	317
CHEMICAL ANALYSIS OF SOILS ... ..	341
THE FRUIT EXPORT ACT: NOTES ON AMENDED REGULATIONS ... ..	349
THE AGRICULTURE AND SOILS OF THE CAPE PROVINCE ... ..	351
ALONG THE ORANGE RIVER ... ..	359
THE DEPARTMENT OF AGRICULTURE DURING THE WAR ... ..	363
COMPOSITION AND VALUATION OF FERTILIZERS AND FEEDING STUFFS ... ..	368
FUNDAMENTAL PRINCIPLES OF CO-OPERATION IN AGRICULTURE ... ..	383
EXPERIMENTS AND INVESTIGATIONS ... ..	388
ARMY MYSTERY WORM: ACTION IN CASE OF RECURRENCE ... ..	391
NOTES ... ..	394
<p>The Extent of the Union and the Area Cultivated—Date of Rains—Recent Outbreaks of East Coast Fever—Grain Elevators—Drying-out of Maize during Rail Transit—Export of Grain, etc. (page 346)—Plant Nurseries in Quarantine for Pests (page 348)—Cotton Export (page 350)—Afforestation (page 358)—Wheat and Flour (page 367)—Fencing (page 382)—Fruit and Vegetables: A Great Manufacturing Scheme (page 390)—Advice on the Farm (page 393).</p>	
THE POULTRY YARD MONTH BY MONTH ... ..	400
THE VEGETABLE GARDEN ... ..	401
NOTES FROM THE "GAZETTE" ... ..	402
RECENT AGRICULTURAL LITERATURE... ..	403
AT THE SCHOOLS OF AGRICULTURE AND EXPERIMENT STATIONS ... ..	406
MEAT STATISTICS ... ..	409
CROP AND LIVE STOCK REPORT ... ..	410
SOUTH AFRICAN PRODUCE ON THE OVERSEA MARKET ... ..	411
STAFF: APPOINTMENTS, TRANSFERS, ETC. ... ..	411
LOCAL MARKET PRICES ... ..	412

## DEPARTMENTAL NOTICES.

### FOREST DEPARTMENT.

#### TIMBER FOR SALE AT CEDARA PLANTATION.

Straight Gum Poles of various sizes from about six inches in diameter at the butt downwards may be purchased in small or large quantities from the Government Plantation, Cedara, Natal. Enquiries stating size of pole desired (length and smallest diameter under bark at the thin end) should be addressed to the Forester, Cedara, who will quote prices per pole put on rail at Cedara Station.

Firewood, fencing droppers, and fenceposts are also available.

#### GROOTFONTEIN SCHOOL OF AGRICULTURE.

The premises used as administrative offices at the Grootfontein School of Agriculture were destroyed by fire on the 21th May. As all records and correspondence were lost, applicants for entrance to courses, including the 1921 courses in Sheep and Wool and in Dairying, are asked to repeat their applications.

E. J. MACMILLAN,

*Under-Secretary for Agriculture.*

#### OLIVES.

A small quantity of Redding Olive Seeds is available for distribution in one lb. parcels, 1600 seeds to the lb.

The Redding is the best stock known on which to work the domestic varieties of olives. It is a rapid grower and makes a very fine root system. Trees grafted on the Redding will thrive over a bigger range of soil than if grafted on any other variety.

It is a advisable on planting, to remove the pointed end of the seed, taking care not to injure the kernel. This will tend to give a far better and speedier germination than if the seeds are planted whole.

Application should be made to the Chief, Division of Horticulture, Department of Agriculture, Union Buildings, Pretoria.

## DATES OF AGRICULTURAL SHOWS STILL TO BE HELD.

(As notified 30th June, 1920.)

#### TRANSVAAL PROVINCE.

Tzaneen. 9th July.

Nylstroom.—29th and 30th July.

#### NATAL PROVINCE.

Durban and Coast Agricultural Society (Durban).—29th June to 2nd July.

Zululand Show Society (Eshowe).—7th July.

Richmond Agricultural Society.—14th July.

Dronk Vlei Agricultural Society.—11th July.

Camperdown Agricultural Society.—21st July.

Ixopo Agricultural Society.—22nd July.

(NOTE.—The show at Vrijheid (Natal), has been postponed to 4th and 5th August, 1920.)





SCHOOL OF AGRICULTURE, CEDARA, NATAL.  
Students exercising Stud Bulls.



# JOURNAL OF THE DEPARTMENT OF AGRICULTURE.

VOL. I.

JULY, 1920.

No. 4.

Published monthly in English and Afrikaans by the Department of Agriculture,  
Union of South Africa.

SUBSCRIPTION: Within the Union and South-West Protectorate, **5s.** (otherwise **6s.**)  
per annum, post free, payable in advance.

Applications, with subscriptions, to be sent to the Government  
Printer, Box 373, Pretoria.

---

## TICKS FOUND ON MAN AND HIS DOMESTIC ANIMALS AND POULTRY IN SOUTH AFRICA.

By G. A. H. BEDFORD, F.E.S., Entomologist, Division of Veterinary  
Research, Onderstepoort, Transvaal.

TICKS, as a number of farmers in South Africa are only too well aware, play an important rôle in the transmission of certain diseases to domestic animals. Apart from this they also do a considerable amount of harm when at all numerous by sucking blood and setting up irritation, which causes their hosts to lose their appetites and fall off in condition, and may even cause the death of their host without transmitting a disease.

Sir Arnold Theiler recorded a case in a pamphlet he wrote, entitled: "Diseases, Ticks, and their Eradication" (now out of print), in which a horse, badly infected with Blue Ticks (*Boophilus decoloratus*), died from acute anaemia as a result of the tick infestation. No less than 14 lb. of Blue Ticks were collected from this animal in three days, and this amount only represented about half the number of ticks which had engorged on this animal.

The Spinose Ear Tick (*Ornithodoros megnini*), which has recently been introduced into this country from America, and has now established itself in many parts of the Cape Province and Orange Free State, has often been known to kill sheep, goats and calves by the irritation set up when feeding in the ears (it being only found in the ears of its host).

Owing to the fact that the diseases transmitted by ticks are only conveyed by certain species and not by all, and that it is necessary to adopt different methods for combating the different species of ticks, it is of the utmost importance that farmers should be able to recognize the different kinds of ticks found on their domestic animals and birds. Also, when introducing stock on to a farm from another district the farmer should know whether or not there are any disease-transmitting ticks on the animals, and whether there are any species present which

have not previously been found on his farm. Should any be found, he should have the animals isolated immediately they arrive, and the ticks destroyed.

In any case, it is advisable to have all animals dipped, both before they leave a farm and after their arrival on another farm, because animals may be badly infested with both larvae and nymphae of ticks, and these are almost bound to escape notice on account of their small size.

How many farms in South Africa have become infected with the Spinose Ear Tick during recent years through infected stock being transferred from one farm to another? In answering this question one may safely say hundreds, and the reason for this is because the owners of these farms did not know anything about the ear tick, and consequently did not have animals' ears examined and treated for ticks when they arrived on the farms. Therefore the importance to a farmer of knowing the kinds of ticks found on his farm and the kinds he is likely to introduce thereon, especially those kinds which are capable of transmitting diseases, cannot be overestimated.

It is with the object of acquainting the farmer with the different species of ticks known to be parasitic upon stock and poultry in this country that this short pamphlet has been written. In it will be found a short résumé of the classification of ticks, how to distinguish the different kinds, and notes on each species, such as their life-histories, the kinds of animals they are likely to be found on, the diseases they transmit, and any other notes of interest.

The larvae and nymphae of the majority of species are by no means easy to identify, especially without the aid of a microscope. Therefore, in this paper I have confined myself for the most part to giving short descriptions and figures of the adults only.

The adults of some species can be easily recognized with the naked eye by conspicuous coloured markings on the shields and by the colour of the legs; but others, especially some of the brown ticks, require to be examined under a microscope.

The males are usually easier to determine than the females, and in order to establish the correct species of the latter, it is often advisable to look for the males, which are often to be found attached to the under surfaces of the females, and to identify these.

Two other articles, it may be added, are also being published by the Veterinary Research Division, one on the eradication of ticks; and the other dealing with the diseases transmitted by ticks.

### CLASSIFICATION OF TICKS.

Ticks belong to the order Acarina, which also includes the mites. Ticks, and more especially mites, are often spoken of as insects, but they are in no way related to them, being as they are akin to the spiders and scorpions.

Ticks, mites and spiders can be distinguished from insects at a glance by the presence of four pairs of legs, at least in the adult and nymphal stages, whereas insects never have more than three pairs of true legs. Insects may also be distinguished by a pair of antennae (feelers) projecting forwards in front of the head, which are never present in ticks and mites, and by their bodies being divided into a number of distinct segments.

Ticks are not likely to be confused with mites, except perhaps their larvae, and there are few mites, none in fact, found on domestic animals, which are likely to be mistaken for ticks. However, ticks can always be distinguished from mites by the presence of a proboscis (hypostome) beset with small backward projecting spines on the false head or capitulum.

All ticks are blood-sucking parasites of mammals, birds, reptiles, and amphibia (frogs, toads, etc.).

Ticks, which belong to the super-family Ixodoidea, are divided into two groups called families, the Argasidae and Ixodidae. These two families may be readily separated by the presence in the Ixodidae of a scutum (hard chitinous plate) covering the upper surface of the body in the males and forming a small, round or oval plate on the front part of the body in the females, nymphae and larvae. In the Argasidae the bodies are more or less soft, without any chitinous plate, and the sexes can only be distinguished by the shape of the sexual opening which is situated on the ventral surface between the two front pairs of legs. Other distinguishing characters are to be found in the position of the false head and also the eyes when present. In the Argasidae the false head is situated on the anterior portion of the ventral surface, and in the adults and nymphae does not as a rule project beyond the anterior margin of the body. Eyes usually absent, when present, four in number, situated on the lateral margins of the ventral surface of the body: the first pair close to the first pair of legs, and the second pair between the third and fourth pairs of legs.

In the Ixodidae the false head is situated in front, and is always plainly visible when viewed from above. The eyes, when present, two in number, situated on the lateral margins of the scutum.

At least four stages occur in the development of ticks, namely, egg, larva, nymph, and adult. In the Argasidae there are usually two or more nymphal stages.

The eggs vary very slightly in the different species. They are very small ( $\frac{1}{2}$ —1 mm. in diameter) spherical or nearly so in shape, smooth, and yellowish brown to dark reddish-brown in colour.

The larvae have six legs, are very small when they first hatch, but their bodies become distended when engorged.

The nymphs of Argasidae resemble the adult females and males, and those of the Ixodidae the females only, except for the absence of the sexual openings and other sexual characters, and, as a rule, in size.

#### FAMILY ARGASIDAE.

This family contains about seventeen species, of which seven are known to occur in South Africa. Of these, only three need concern us here. They are the Fowl Tick, the Tampan Tick, and the Spinose Ear Tick.

##### (1) *The Fowl Tick* (*Argas persicus*, Oken).

This tick is often wrongly termed the Tampan. It is essentially a parasite of fowls, but has also been found on ducks, geese, turkeys, pigeons, ostriches and man. It is extremely common and widely distributed throughout South Africa, and is also found in other parts of the world.

The nymphae and adults can be distinguished from either of the other two species under consideration here by their shape (compare

figures 1, 2, 3, and 4), and in any case are not likely to be confused with them, as the latter are mainly parasitic upon man and animals, and very rarely attack birds.

This species is the chief transmitting agent of the fowl spirochaete (*Spirochaeta marchouxi*), which is usually fatal to birds. The ticks become infected by feeding upon infected fowls, and are then capable of transmitting the disease to susceptible birds for six or more months.

Apart from the fact that the ticks are able to transmit a disease to fowls, they do a considerable amount of harm to them, and if they are at all numerous they kill their hosts, the birds dying from loss of blood and from the irritating effects produced by the ticks.

*The Life Cycle* is as follows:—The female ticks usually lay their eggs in batches of about 20 to 100 in the cracks and crevices of walls of fowl-houses, etc., or under the bark of trees. The eggs hatch in about three weeks, and give rise to six-legged larvae which crawl about in search of a host. They remain attached to the skin of their host for five to ten days, according to the temperature, and then they drop off and moult into nymphae. The nymphae and adults, unlike the larvae, are only temporary parasites, attacking their hosts chiefly at night and hiding during the day in crevices of buildings or under the bark of trees. They are rapid feeders, taking 1½ to 2 hours to engorge themselves. The first nymphal stage lasts about three weeks, and then they moult into the second nymphal stage, and again, after some weeks, into adults. The adult females feed more plentifully than the males, and usually about once a month during the summer. After each meal they lay a batch of eggs. Lounsbury found that the complete life cycle from egg to egg stage occupied about ten months in this country. The larvae are only able to live for about seven or eight weeks without food, but nymphae have been known to live for a year without having had a meal, and the adults for two to three years.

(2) *The Tampan* (*Ornithodoros moubata*, Murray).

This tick is not nearly so widely distributed in South Africa as the Fowl Tick, but is usually plentiful in localities where it is found. It usually occurs in desert tracts in the shade of trees and rocks, and in native huts. It is mainly parasitic upon man and his domestic animals.

This species transmits African Relapsing Fever or Tick Fever to man in Central and East Africa, the Congo Free State, and Angola, and has also been proved experimentally to be able to transmit *Spirochaeta marchouxi* to fowls.

*The Life Cycle* is as follows:—The females lay their eggs in batches in sand or hollows in the ground excavated by the females. The total number of eggs laid by a single female varies from about 90 to 150. The larva develops inside the egg, and the young nymph hatches out in eight to twenty-three days. The first stage nymph is able to feed soon after hatching, and after gorging moults into a second stage nymph. There may be three or four nymphal stages in all before the ticks reach maturity. Like the fowl ticks they are able to survive for many months without food.

(3) *The Spinose Ear Tick* (*Ornithodoros Megnini*, Dugès).

This tick is a native of America, and was probably introduced into the Union with stock coming from that country.



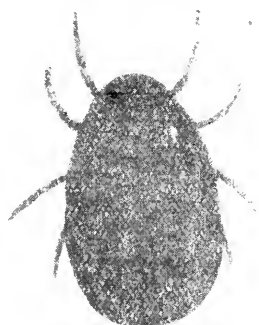

*Fig. 1*

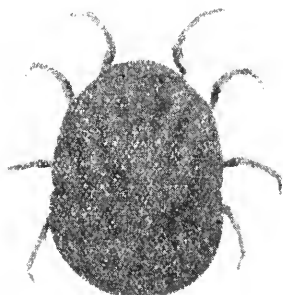

*Fig. 2.*



*Fig. 3.*

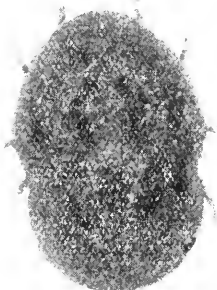

*Fig. 4*

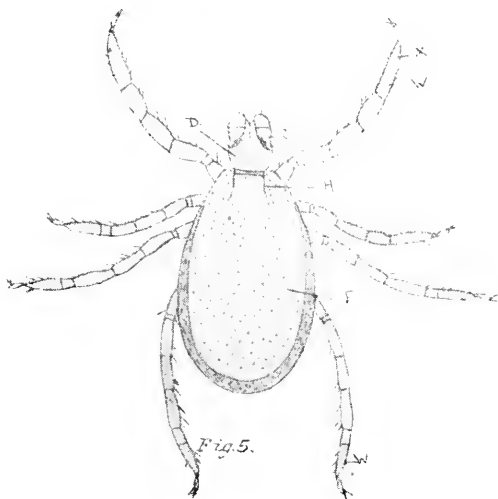

*Fig. 5.*

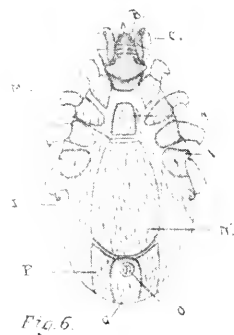

*Fig. 6.*

During the last few years it has spread rapidly throughout the Cape Province, Orange Free State, and Bechuanaland. It is also found in parts of Natal and the southern portion of the Transvaal.

The ticks are only found in districts where the rainfall is very low, and even in those districts become less numerous after heavy rains.

They are found only in the ears of their hosts, and usually find their way to the meatus of the ears. They are chiefly parasitic upon calves, sheep, and goats, but horses, donkeys, dogs, cats, and ostriches are also attacked, and so is man occasionally. The fluid these ticks inject into their hosts whilst feeding causes great irritation, and the result is that animals badly infected with these ticks fall off in condition and lose their appetite. Calves, sheep, and goats have been known to succumb when very badly infected.

The adults are fiddle-shaped, brown or slate in colour, with yellow legs, and without eyes. In general appearance they somewhat resemble the Tampan Tick, but can be distinguished from that species by the shape of their bodies, and also by the integument, which is pitted in this species and mammillated (covered with small pimples) in the Tampan.

The nymphae can be distinguished by the surface of their bodies being covered with small outstanding spines, which can be easily seen by the aid of a pocket lens.

The larvae are pale in colour when they first hatch out, but after engorging they become swollen, white or red in colour, and their legs and head can, as a rule, only be seen when the tick is examined with a pocket lens. These engorged larvae are unable to move, and are often mistaken by farmers for eggs.

*The Life Cycle* of this tick is as follows:—The female ticks lay their eggs under stones on the veld, in cracks and crevices of trees, gates or walls, or in any other place where they can get sheltered from the sun. These eggs hatch out in about twenty-two to fifty-six days, and give rise to six-legged larvae, which, as soon as they have hatched, crawl about in search of a host, and as soon as they find one they get into its ears and there commence to feed. The longest time the larvae are able to live without food is about two to four months. After engorging, which takes about five to 7 days, they become quiescent, and are then unable to move until they have cast their skins and become nymphae. The length of time the nymphae remain on their host varies considerably. The shortest time in which they can engorge themselves appears to be about a week, but may be considerably prolonged in some cases. Hooker, in America, has observed a nymph to abandon its host's ear thirty-five days after the larva had been introduced, and in other cases the nymphae remained attached after ninety-eight days had elapsed. Nymphae have also been observed at Onderstepoort to remain in the ears of their hosts for three months. When engorged they leave their host and crawl about in search of some sheltered spot where they can change into adults, which takes from seven to thirty-one days. They then fertilize, and then the females commence laying eggs, after which they die.

It is not necessary for the adults to nourish themselves before copulating and ovipositing, as they are able to store up enough food in the nymphal stage. Engorged nymphae collected from the ears of their hosts in November, 1916, and kept in the laboratory in wooden

boxes moulted into adults in seven to nine days. A number of them died about two to five months after they were removed from their hosts, whilst others, including a male which fertilized a female soon after it had moulted into an adult, still remained alive after six months.

Megnin states that he has kept some *O. megnini* alive for two years without food.

#### FAMILY IXODIDAE.

This is a large family comprising about 220 species. Of these, 30 are known to occur in South Africa.

Before proceeding to give a short account of each of the most important species, it will first of all be necessary to briefly describe the life cycles of these ticks, as they (the life cycles) are not only different from those of the species belonging to the family Argasidae, but also vary in some of these species, and this is a very important factor one has to take into consideration when exterminating ticks.

#### *The Life History.*

The engorged females after leaving their hosts search for some sheltered spot on the ground, such as under stones, where they can lay their eggs. The female, when she once starts to lay eggs, continues laying until her body becomes flat and empty, when she dies. The number of eggs laid by a single female varies according to the species, but usually several thousands of eggs are laid. The Blue Tick lays 1000-2500 eggs, the species of Brown Ticks from 3000 to 5700, the Bont-leg Tick may lay from 10,000 to 15,000, and the Bont Tick about 18,500.

The eggs may take anything from 18 days to a month or two, or even longer to hatch, the period depending upon the species and climatic conditions.

The larvae soon after they have escaped from the egg are ready to feed, and they then climb up a blade of grass or plant and wait patiently for a host to pass by. Should a suitable animal pass within their reach they promptly cling to it by means of their legs, which are provided with claws, and, having selected a suitable spot, insert their mouth-parts into the flesh and commence to feed. On the other hand, should the larvae be so unfortunate as to not meet with a host, which many, in fact the majority, which hatch in the course of a year undoubtedly do, they must of course eventually die of starvation.

The ticks belonging to this family may be classed into three groups—those which require only one host upon which to complete their life cycle, those requiring two hosts, and those requiring three hosts.

*Group 1.*—Ticks which, for the completion of their life cycle, require only one host. To this group belongs the Blue Tick. The larvae of this tick moults into a nymph on its host, and the nymph again moults into an adult on the same animal. Pairing takes place upon the host, and the females drop off when they have gorged themselves.

*Group 2.*—Ticks which require two hosts for the completion of their life cycle. To this group belongs the Red Tick. The larvae moults into a nymph on the host, and the nymph drops off when it has engorged. After remaining on the ground for about three weeks

it moults into an adult, which again has to find another host. Pairing takes place on the host, and the females drop off when they have gorged.

*Group 3.*—Ticks which require three hosts for the completion of their life cycles. To this group belongs the Dog Tick, the Brown Ticks (except *Rhipicephalus bursa*), the Bont-leg Tick, and the Bont Tick. The larvae of these ticks, having found an animal and gorged, drop off, and, after remaining on the ground for some time, moult into nymphs, which, in turn, have to find another host. Having done so, they engorge, and then drop off, and, after a lapse of time, moult into adults, which again have to seek another host. Pairing takes place on the host, and the females leave their host when they have engorged.

All the above ticks do not confine themselves to a single species of animal, and all the stages may be found either on the same kind of animal or on different kinds. In the case of the Bont-leg Tick, however, the larvae and nymphae are not, as a rule, found on the same species of host as the adults.

The males of the ticks belonging to this family remain on their host much longer than the females, and never, except in exceptional circumstances perhaps, drop off their host to find another one, or get on to another animal that may happen to come in contact with its host.

(1) *The Sheep Paralysis Tick or Russet Tick (Ixodes pilosus, Koch).*

This species, as one of its vernacular names implies, causes paralysis in sheep, especially in merinos. A single specimen is often capable of producing the malady, but by no means can all individuals of this species produce the disease, as the ticks are often found on perfectly healthy animals. The affection usually occurs in May and June, and is probably due to a toxin which is injected by the tick into the blood of its host when feeding. Animals struck do not often die, and usually soon recover after the ticks have been removed. In removing them care should be taken not to leave the proboscis of the tick in the flesh.

This species is a medium-sized tick (being roughly about the size of the well-known Blue Tick), and can be distinguished by the absence of eyes, and by the presence of a pregenital, a median, a pair of adanal and an anal plate on the ventral surface of the males (fig. 6), and in the female by the presence of an anal groove on the ventral surface.

The only ticks with which this species is likely to be confused are, with the exception of *Ixodes rubicundus*, Neu., the Dog Tick (*Haemaphysalis leachi*) and the Blue Tick (*Boophilus decoloratus*), which, apart from lacking the above-mentioned plates in the males and the anal groove in the females, differ in having a shorter proboscis and palpi.

The males and unengorged females are reddish-brown in colour, and the engorged females are slate-coloured, and of a peculiar shape—the body being larger behind than in front.

This tick is chiefly confined to the Cape Province, but has also been recorded from the Orange Free State. It is usually found in grass districts. A variety of this species (var. *howardi*) is known to

occur in the Transvaal, and has also been found in Durban, but it is by no means common.

The type has been found on sheep, goats, ox, mule, horse, cat, dog, pig, leopard, bushbuck and man, and its variety principally on dog, but Howard has also taken it on a cat, a hedgehog, and a bat.

The life history of this tick is unknown.

(2) *Ixodes rubicundus*, *Neumann*.

This tick is very similar to the foregoing species, from which it is distinguished by both the anal plate of the male and the anal groove of the female being parallel, whereas in *Ixodes pilosus* they are horseshoe shaped. It is by no means a common tick, and has only been found on sheep in the Cape Province. It is also capable of producing paralysis in sheep. I have received a female and male from Mr. H. W. Andrews of this Division, who took them off a paralysed sheep at Middelburg, Cape Province. They were the only ticks found on the animal, and it recovered shortly after the ticks had been removed.

*The Dog Tick* (*Haemaphysalis leachi*, *Aud.*).

*Characters*.—This is a small tick easily recognisable by the absence of eyes, the short hypostome and palpi, the latter of which are triangular in shape, and by the absence of plates and adanal shields on the ventral surface of the male.

The males and unengorged females are brown in colour, and the engorged females slate blue.

This tick is common and widely distributed throughout Africa. It is essentially a parasite of dogs and cats, and wild animals of the dog and cat tribes, e.g. jackal, lion, leopard, civet cat, etc. It has also occasionally been found on cattle and hedgehogs, and nymphs are sometimes met with on rats and mice. They attach themselves to the head and body of their host.

*The Life History*.—This species requires three hosts in order to complete its life cycle. The females lay on an average about 5000 eggs, which take about a month to hatch. After about a week the larvae are ready to feed, and when they have found a host they remain attached for 2-7 days. Having engorged, they drop to the ground and moult into nymphs in about a month's time. The nymphs, after finding a host, remain attached 2-7 days, and then drop to the ground, where they change into adults in about 10-15 days or so. The adults, after finding a host, remain feeding upon it for about twelve days, but the males remain much longer. The females usually commence to lay eggs in 3-7 days after leaving their host, the period varying according to the climatic conditions. This tick is not found in the Pretoria district of the Transvaal in winter—the cold period being passed in the egg stage.

*Relation to Disease*.—This tick is the principal transmitting agent of canine piroplasmiasis or biliary fever to dogs in South Africa. The organism causing the disease is imbibed by females when sucking blood of an infected animal; it then undergoes development in the tick and penetrates the eggs. The larvae on hatching, although infected, are not capable of transmitting the disease, nor are the nymphs, but the adults are. Infected adults have been known to transmit the disease after having fasted for seven months.

Dogs which have had the disease and recovered retain the infection.

*The Red Tick* (*Rhipicephalus evertsi*, *Neu.*)

*Characters.*—This tick, like all the others belonging to the genus *Rhipicephalus*, has a short proboscis and palpi, possess eyes and festoons, and the males have a pair of adanal and accessory adanal shields on the under surface of their bodies. The males can easily be recognized by their red legs, black shield (scutum), which is densely pitted, and by the under surface and margin of the upper surface of their bodies being also red. The females also have a dark scutum, and their bodies are dark brown when unengorged and reddish-brown when engorged.

This common species is found on all the domestic animals, except pigs, and also occurs on hares and various species of buck.

*The Life History.*—It is a two-host tick. The eggs hatch in about thirty days in summer. The young larvae on finding a host usually attach themselves to the ears and flanks, and after gorging moult into nymphs on the animal. After 10-15 days they drop off as engorged nymphae, and moult into adults on the ground in 22-25 days. The adults usually attach themselves to the anus or scutum of their host, the females remaining on 6-9 days, and the males much longer.

Larvae have been kept alive for seven months without food, and the adults for a year.

*Relation to Disease.*—The Red Tick is a carrier of one of the two organisms which produce equine piroplasmiasis or biliary fever in horses, and has also been proved experimentally to be capable of transmitting East Coast fever and a disease formally called "gall-sickness" (which is produced by the organism *Piroplasma mutans*) to cattle. However, the part played by this tick in the transmission of East Coast fever is probably insignificant. All the above diseases are transmitted by the larvae and nymphae feeding on infected animals and transmitting the disease to susceptible animals in their adult stage.

In addition to these, this tick has also been proved to transmit redwater to cattle and spirillosis, which occurs in horses, cattle, and sheep. Both these diseases may be transmitted to susceptible animals by larvae which have become infected through their mothers feeding on an infected animal, and also in the case of redwater, by adults which have derived their infection through feeding on an infected animal in their larval and nymphal stages.

*The Brown Tick* (*Rhipicephalus appendiculatus*, *Neu.*)

*Characters.*—This species differs from the Red Tick in having, like the remainder of the ticks belonging to the genus *Rhipicephalus*, brown legs. The males differ from the other kinds of brown ticks by the punctuation on the scutum being mostly small and not very numerous, especially on the margin. When fully fed the males have a long, pointed tail. The females also differ from the other brown ticks in the size and number of the punctuations on the scutum, but their determination is by no means easy. It is therefore advisable for the farmer to collect the males, which may often be found attached to the under surface of the bodies of the females, and to identify these.

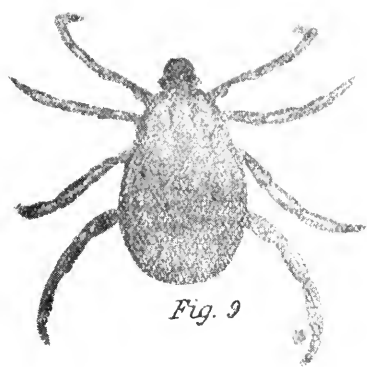
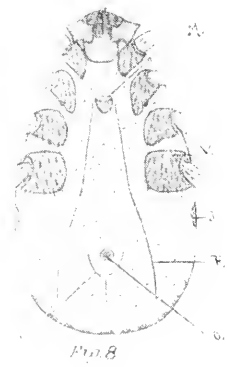

*Fig. 9*

*Fig. 10*

*Fig. 11*

*Fig. 12.*

This tick is common and widely distributed in South Africa. It is parasitic upon cattle, horse, mule, sheep, goat, dog, hares, and different species of buck. It is found on the head or body, or in the ears of its host.

*Life History.*—The Brown Tick requires three hosts in order to complete its life cycle. The females lay about 3000 to 5700 eggs, which take about twenty-eight days to hatch in summer, and from two to three months or more in winter. The larvae remain on their host from three to seven days, and after dropping off moult into nymphs in sixteen to twenty-one days. The nymphs also remain three to seven days on their host. They moult into adults on the ground after a period of about ten to eighteen days. The females usually remain on their host for about a week, but in some instances the period may be prolonged to about three weeks.

Larvae have been kept alive without food for seven to eleven months, the nymphs for six and a half months, and the adults for nearly twenty-six months.

*Relation to Disease.*—The Brown Tick is the chief transmitting agent of East Coast fever to cattle, and has also been proved to be capable of transmitting the disease formerly known as "gall-sickness" in cattle, which is produced by *Piroplasma mutans*, redwater in cattle and gastro-enteritis, or "Nairobi Sheep Disease," as it is commonly called, which occurs in sheep and goats in British East Africa.

East Coast fever may be transmitted either by the nymphs which become infected through feeding on an animal suffering from the disease in their larval stage, or by the adults which got infected in their nymphal stage. Infective nymphs and adults lose their infection after feeding on a clean animal. Redwater may be transmitted either by adults which have fed on an infected animal in their nymphal stage or by larvae whose mothers acquired the infection through feeding on an infected animal. There can be little doubt, however, that the Blue Tick is the chief carrier of the organism producing this disease in this country. "Nairobi Sheep Disease" was demonstrated by Mr. Montgomery in East Africa to be transmitted by the adults, which became infected through feeding on an infected animal in their nymphal stage. Fortunately, this disease does not occur in the Union.

*The Cape Brown Tick (Rhipicephalus capensis, Koch).*

This tick is by no means common in South Africa. It closely resembles the common Brown Tick, from which it is mainly distinguishable by the scutum or shield being more densely covered with small pits or punctations. It has also been proved to be capable of transmitting East Coast fever to cattle. Other hosts of this tick are the horse, goat, and dog.

The life cycle is similar to that of the foregoing species.

*The Black-pitted Tick (Rhipicephalus simus, Koch).*

This tick can be distinguished from the other brown ticks by the scutum being darker in colour, and by the punctations on its surface being fewer, and in the males they are usually arranged in longitudinal lines. The males when fed sometimes possess a tail. It is a fairly common species in South Africa, and is usually found attached



to the body or in the ears of the dog, ox, horse, goat, sheep, various species of buck, hares, and bush pigs.

This tick is also concerned in the transmission of East Coast fever to cattle, and has, in addition, been proved to transmit gall-sickness to cattle. Gall-sickness is transmitted by larvae whose mothers became infected through feeding on an infected animal.

The life cycle is similar to that of the Brown Tick.

*The European Brown Tick* (*Rhipicephalus sanguineus*, Latr.).

This species closely resembles the Brown Tick, from which it can be distinguished by its smaller size, and by the punctations on the scutum being more variable in size. The males, when fully fed, often have a small, stumpy caudal protrusion (tail). This tick is fairly common in South Africa. It is mainly parasitic upon dogs, but has also been found on cattle, sheep, and cats, and on wild animals, such as hares, animals of the dog tribe, etc. They are usually found on the bodies of their hosts.

*Life History.*—This tick, like the other brown ticks, requires three hosts in order to complete its life cycle. The females lay 1400 to 3400 eggs, which take about seventeen to nineteen days to hatch. The larvae remain four days on their host, and, after dropping off, take five to eight days to moult into nymphs. The nymphs also remain four days on their host, and take eleven to twelve days to moult into adults. The females remain on their host for seven to twenty-one days.

Unfed larvae have been kept alive for 253 days, nymphs for ninety-seven days, and adults for as long as 570 days without food.

*Relation to Disease.*—It has been proved to be a carrier of biliary fever or canine piroplasmosis to dogs in India, and probably plays a part in the transmission of this disease in South Africa, but not to the same extent as that of the Dog Tick (*Haemaphysalis leachi*, Aud.).

The piroplasm may be transmitted either by the nymphs of *R. sanguineus*, which have become infected through their mothers feeding on an infected dog, or by adults which have fed on an infected dog in their nymphal stage, whereas it is only transmitted by the adults of *H. leachi*, which have derived their infectivity through their mothers feeding on an infected animal.

There are three other species of Brown Ticks which have been recorded from South Africa, namely, the Eyed Tick (*Rhipicephalus oculatus*, Neu.), the Congo Brown Tick (*Rhipicephalus lunulatus*, Neu.), and *Rhipicephalus bursa*, Can. and Fanzago.

The Eyed Tick has, like the Red Tick, hemispherical eyes, whereas all the other brown ticks have flat eyes. It has been found on cattle in the Transvaal and East Africa, and on a hare in Damaraland. It is very rare.

The Congo Brown Tick is another rare species in South Africa, it having only been taken in the Zoutpansberg District, Transvaal. It can be distinguished by the shape of the adanal shields of the male, which are produced behind into two points. This tick is found on cattle, sheep, goat, dog, antelope, and hedgehog.

*Rhipicephalus bursa* has been recorded from the Transvaal and Cape Province, but it is not a common species in this country. It is

found chiefly in North Africa and Southern Europe. It is parasitic upon all domestic animals.

None of these three species has been known to be carriers of any disease, but it is probable that all are capable of transmitting East Coast fever.

*Argentine or Lounsbury's Tick* (*Margaropus withemi*, Karsch).

*Characters.*—The mules can easily be recognized by the fourth pair of legs being very much larger than any of the others, and by the abdomen having a distinct caudal protrusion (tail). On the under surface of the body there is a peculiar shaped plate in front of the anus. They are white in colour, with a brown shield which is often marked with dark lines, and the legs are pale with narrow, dark bands at the joints.

The females closely resemble the Blue Tick, from which they can be distinguished by their larger size, and by their legs being banded as in the male.

This is a South American tick, which was probably imported into this country during the Boer War with mules or horses from the Argentine. It is a common tick in many parts of the Orange Free State and Basutoland. It is mainly parasitic upon horses, and is occasionally found on cattle. It has occasionally been found at the Veterinary Research Laboratory, Onderstepoort, on horses from the Free State, but it very soon dies out here, no doubt owing to the climatic conditions being unsuited for it.

The life history of this species is unknown, and the tick is not known to be able to transmit any disease.

*The Blue Tick* (*Boophilus decoloratus*, Koch).

*Characters.*—Hypostome and palpi very short, anal grooves and festoons absent, eyes present, males and unengorged females very small, the latter with a small scutum.

The engorged females can be recognized by their blue colour and pale, yellow legs, and the males by their yellowish-brown colour and yellow legs, the presence of adanal and accessory adanal shields on the ventral surface of the abdomen, which are long and pointed behind, the tips being usually visible when the ticks are viewed from above, and finally by the abdomen terminating in a short, pointed tail behind.

This is the commonest tick found in South Africa: it is chiefly found on cattle and horses, but also occurs on sheep, goats, and dogs. They are usually found on the body and head of their host, and the immature forms are often very plentiful in the ears.

*Life History.*—This tick requires only one host in order to complete its life cycle. The females lay on an average 1000 to 2500 eggs, which take about three to six weeks to hatch. The larvae, after gorging, remain adhered to their host and moult into nymphs, which reattach themselves immediately; when fully engorged they remain *in situ* and moult into adults, which again attach themselves. The engorged females drop off in twenty-two to thirty-eight days (twenty-two days in summer and about thirty to thirty-eight days in winter) after they get on to their host as unfed larvae.

The unfed larvae have been kept alive for six months, but as a rule they will not live more than three months without food.

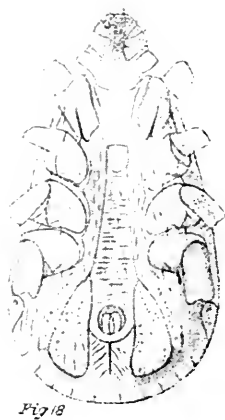
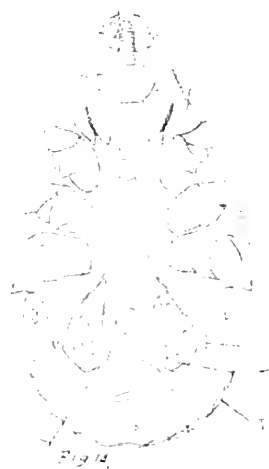

Fig. 17.

Fig. 18.

*Relation to Diseases.*—This tick is the well-known transmitting agent of the organisms producing redwater and gall-sickness in cattle in South Africa, and is also the transmitting agent of spirochaetosis to cattle, sheep, and horses in this country. The organism which causes redwater is known as *Piroplasma bigeminum*, that causing gall-sickness as *Anaplasma marginale*, and spirochaetosis is caused by *Spirochaeta theileri*. All these diseases are transmitted to susceptible animals by larvae which have become infected through their mothers feeding either on animals suffering from the disease, or on animals which have had the disease and recovered, the animals retaining the infection of any of these diseases for an indefinite period after they have recovered from them.

There is another species of Blue Tick found in South Africa, namely, the Australian Blue Tick (*Boophilus australis*, Fuller), which closely resembles the South African species in appearance. It is not a common tick in this country, having only been found in the southern parts of the Cape Province. Like its near relation, it can transmit redwater or bovine piroplasmosis to cattle, and will probably be found capable of transmitting gall-sickness and spirochaetosis.

*The Bont-leg Tick* (*Hyalomma aegyptium*, Linn).

*Characters.*—Hypostome and palpi long; eyes present; festoons absent; legs red, with pale bands. The males have white bodies, and the scutum is dark brown or black; on the under surface of the body there are a pair of adanal shields and two pairs of chitinized points, the first pair being situated on each side of the adanal shields, and the second pair beneath them.

This species is widely distributed throughout Africa, and is also found in Southern Europe and Asia. It is not often met with in South Africa, its place being taken in this country by the var. *impressum*, Neu., which is a common tick here; it may eventually prove to be a distinct species. The variety differs from the type mainly in the scutum or shield being much more densely punctated. It is found on all the domestic animals, and also on various species of buck, hares, bush-pigs, and birds, such as the ostrich, fowls, etc. They usually attach themselves to the anus and scutum of their host, but may also be found on the body.

*The Life History.*—The Bont-leg Tick requires either two or three hosts for the completion of its life cycle. The females lay on an average about 10,000 to 15,000 eggs, which take about a month to hatch. The larvae take four to fifteen days to engorge, at the end of which time they either drop off their host to moult, or they remain attached to the animal and moult *in situ*, in which case they engorge and drop off in three and a half to six and a half weeks after they get on to their host as larvae. The females remain about a week on their host.

Unfed larvae have been kept alive for a year; nymphs for three months, and adults for over two years without food.

*Relation to Disease.*—This tick is not known to transmit any disease, but Prof. Nuttall suspects that it may convey one of the two organisms which causes biliary fever in horses, the assumption being based upon the fact that the geographical distribution of one of the organisms which produces the disease and this tick coincide with one another.

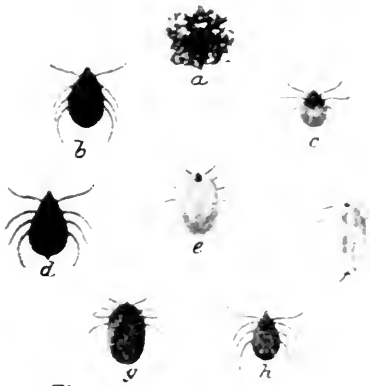

*Fig. 19.*

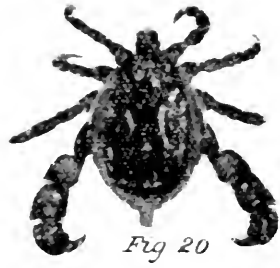

*Fig. 20.*

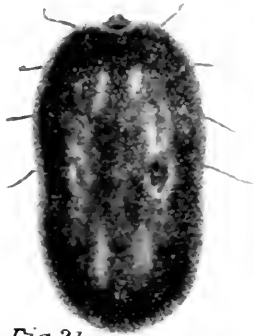

*Fig. 21.*

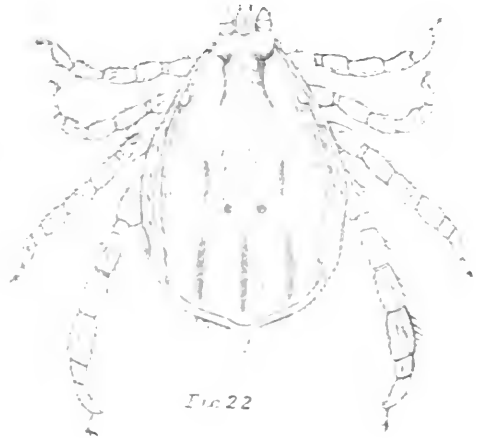

*Fig. 22.*



*Fig. 23.*



*Fig. 24.*

*The Bont Tick* (*Amblyomma hebraeum*, Koch).

*Characters*.—All the species of *Amblyomma* are as a rule easy to identify owing to characteristic coloured markings on the scutum, which differ in the different species. The following characters are common to all species belonging to the genus *Amblyomma*:—

Scutum generally ornamented and the legs banded; rostrum and palpi long; eyes and festoons present; males without adanal shields.

The males and females of the Bont Tick have the scutum yellowish with usually a red and green tinge, and with dark brown or black markings.

This tick is widely distributed in South Africa, but more frequently occurs on the low than on the high veld. It is parasitic upon all the domestic animals and upon a number of wild animals, also on fowls and ostriches. They usually attach themselves to the scutum and anus of their host, but also occur on the body.

*Life History*.—It is a three-host tick. The females may lay as many as 18,500 eggs, which takes about 7 to 10 weeks or longer to hatch. The larvae remain on their host from 4 to 20 days, and moult into nymphs in from twelve to four months after dropping off. The nymphs take from four to twenty days to engorge, and after dropping off usually remain on the ground 18-25 days before moulting into adults, but have been known to take 160 days to moult. The females take 6-25 days to engorge, and after leaving their host, remain on the ground from a week to ten weeks before they commence egg-laying. Larvae have been kept alive without food for almost a year, the nymphs for 180 to 250 days, and adults for nearly two years.

*Relation to Disease*.—The Bont Tick is the chief transmitting agent of heartwater to cattle, sheep and goats in South Africa. The disease is transmitted by either the nymphs which have fed on an animal suffering from the disease in their larval stage, or by the adults, which fed in their larval or nymphal stage on such an animal.

Nymphs which acquired their infection in the larval stage can feed on a non-infected animal without losing the infection.

*The Variegated Tick* (*Amblyomma variegatum*, Fabr.).

*Characters*.—This tick can be recognized by the scutum of the females and males being reddish-yellow bordered with green, and with black markings.

This species is found in parts of the Transvaal and Cape Province, but is by no means a common species. It is principally found on cattle, but also occurs on horses, goats, sheep, zebra and rhinoceros.

The life cycle is similar to that of the Bont Tick.

*Relation to Disease*.—We have recently proved by experiments that the Variegated Tick can transmit heartwater to goats. A number of nymphs, which had become infected in their larval stage through feeding on an animal suffering from the disease, were sent to us from East Africa by Mr. Montgomery. On arrival the majority were found to be dead, but 30 were placed in the ears of three goats, five in each ear, and two of the goats showed typical symptoms of the disease and died. Blood taken from these goats and injected into sheep produced the disease.

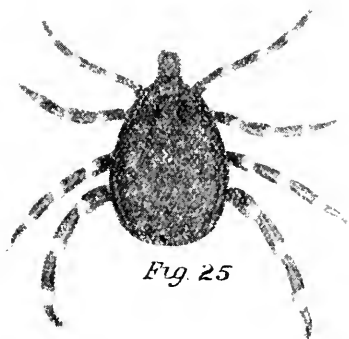

*Fig. 25*

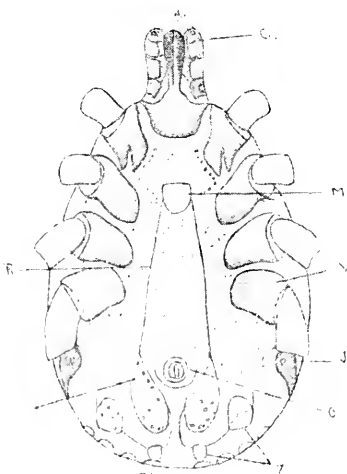

*Fig. 26*

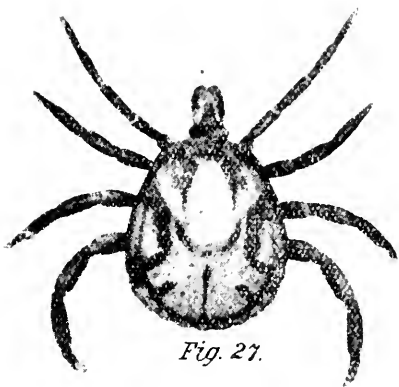

*Fig. 27.*



*Fig. 28.*

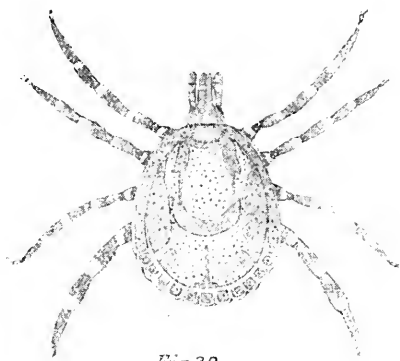

*Fig. 29.*

*The Tortoise Tick* (*Amblyomma marmoratum*, Koch).

This tick is a common parasite of tortoises in South Africa. Larvae and nymphs have been found on the ox and goats, upon which they feed readily. It also occurs on the rhinoceros, and has occasionally been found on birds, snakes and lizards.

The scutum of the females and males is dark with several pale yellowish markings, which are often more or less irregular, and in old specimens ill-defined.

The life history of this tick is unknown. It is not known to convey any disease.

## LIST OF THE TICKS WHICH HAVE BEEN FOUND ON MAN AND HIS DOMESTIC ANIMALS AND POULTRY IN SOUTH AFRICA.

## Man—

- Fowl Tick (*Argas persicus*, Oken).
- Bat Tick (*Argas respertilionis*, Latr.).
- Tampan Tick (*Ornithodoros moubata*, Murray).  
*Ornithodoros savignyi*, Aud  
*Ornithodoros pacimmentosus*, Neu.
- Spinose Ear Tick (*Ornithodoros meguini*, Dugès).
- Penguin Tick (*Ornithodoros talaje* var. *capensis*, Neu.)
- Sheep Paralysis Tick (*Ixodes pilosus*, Koch).
- Red Tick (*Rhipicephalus evertsi*, Neu.).
- Brown Tick (*Rhipicephalus appendiculatus*, Neu.).
- Black-pitted Tick (*Rhipicephalus simus*, Koch).
- Bont-leg Tick (*Hyalomma aegyptium*, Linn.).  
*Hyalomma aegyptium*, var. *impressum*, Neu.
- Bont Tick (*Amblyomma hebraeum*, Koch).

## Horse—

- Spinose Ear Tick (*Ornithodoros meguini*, Dugès).
- Sheep Paralysis Tick (*Ixodes pilosus*, Koch).
- Red Tick (*Rhipicephalus evertsi*, Neu.).
- Brown Tick (*Rhipicephalus appendiculatus*, Neu.).
- Cape Brown Tick (*Rhipicephalus capensis*, Koch).
- Congo Brown Tick (*Rhipicephalus lunulatus*, Neu.).
- Black-pitted Tick (*Rhipicephalus simus*, Koch).
- Brown Tick (*Rhipicephalus bursa*, Canes. and Fan.).
- Argentine Tick (*Margaropus withemi*, Karsch).
- Blue Tick (*Boophilus decoloratus*, Koch).
- Australian Blue Tick (*Boophilus australis*, Fuller).
- Bont-leg Tick (*Hyalomma aegyptium*, Linn.).  
*Hyalomma aegyptium*, var. *impressum*, Neu.
- Bont Tick (*Amblyomma hebraeum*, Koch).
- Variiegated Tick (*Amblyomma variegatum*, Fabr.).

## Ass—

- Spinose Ear Tick (*Ornithodoros meguini*, Dugès).
- Red Tick (*Rhipicephalus evertsi*, Neu.).
- Argentine Tick (*Margaropus withemi*, Karsch).
- Blue Tick (*Boophilus decoloratus*, Koch).
- Bont-leg Tick (*Hyalomma aegyptium*, Linn.).  
*Hyalomma aegyptium*, var. *impressum*, Neu.
- Bont Tick (*Amblyomma aegyptium*, Linn.).



## Mule—

- Spinose Ear Tick (*Ornithodoros megnini*, Dugès).  
 Sheep Paralysis Tick (*Ixodes pilosus*, Koch).  
 Red Tick (*Rhipicephalus eretsi*, Neu.).  
 Brown Tick (*Rhipicephalus appendiculatus*, Neu.).  
 Argentine Tick (*Margaropus withemi*, Karsch).  
 Blue Tick (*Boophilus decoloratus*, Koch).  
 Bont-leg Tick (*Hyalomma aegyptium*, Linn.).  
                   *Hyalomma aegyptium*, var. *impressum*, Neu.  
 Bont Tick (*Amblyomma hebraeum*, Koch).  
 Variegated Tick (*Amblyomma variegatum*, Fabr.).

## Cattle—

- Tampan (*Ornithodoros moubata*, Murray).  
                   *Ornithodoros savignyi*, Aud.  
 Spinose Ear Tick (*Ornithodoros megnini*, Dugès).  
 Sheep Paralysis Tick (*Ixodes pilosus*, Koch).  
 Dog Tick (*Haemaphysalis leachi*, Aud.).  
 Red Tick (*Rhipicephalus eretsi*, Neu.).  
 Brown Tick (*Rhipicephalus appendiculatus*, Neu.).  
 Eyed Tick (*Rhipicephalus oculatus*).  
 Cape Brown Tick (*Rhipicephalus capensis*, Koch).  
 Congo Brown Tick (*Rhipicephalus lunulatus*, Neu.).  
 European Brown Tick (*Rhipicephalus sanguineus*, Latr.).  
 Black-pitted Tick (*Rhipicephalus simus*, Koch).  
                   *Rhipicephalus bursa*, Canes. and Fan.  
 Argentine or Lounsbury's Tick (*Margaropus withemi*, Karsch).  
 Blue Tick (*Boophilus decoloratus*, Koch).  
 Australian Blue Tick (*Boophilus australis*, Fuller).  
 Bont-leg Tick (*Hyalomma aegyptium*, Linn.).  
                   *Hyalomma aegyptium*, var. *impressum*, Neu.  
 Bont Tick (*Amblyomma hebraeum*, Koch).  
 Variegated Tick (*Amblyomma variegatum*, Fabr.).  
 Tortoise Tick (*Amblyomma marmoratum*, Koch). Larvae and  
                   nymphae only.

## Sheep—

- Tampan (*Ornithodoros moubata*, Murray).  
                   *Ornithodoros savignyi*, Aud.  
                   *Ornithodoros parimantonus*, Neu., South-West Africa.  
 Spinose Ear Tick (*Ornithodoros megnini*, Dugès).  
 Sheep Paralysis or Russet Tick (*Ixodes pilosus*, Koch).  
                   *Ixodes pilosus*, var. *howardi*, Neu.  
                   *Ixodes rubicundus*, Neu.  
 Red Tick (*Rhipicephalus eretsi*, Neu.).  
 Brown Tick (*Rhipicephalus appendiculatus*, Neu.).  
 European Brown Tick (*Rhipicephalus sanguineus*, Latr.).  
 Black-pitted Tick (*Rhipicephalus simus*, Koch).  
                   *Rhipicephalus bursa*, Canes. and Fan.  
 Blue Tick (*Boophilus decoloratus*, Koch).  
 Bont-leg Tick (*Hyalomma aegyptium*, Linn.).  
                   *Hyalomma aegyptium*, var. *impressum*, Neu.  
 Bont Tick (*Amblyomma hebraeum*, Koch).  
 Variegated Tick (*Amblyomma variegatum*, Fabr.).

## Goat—

- Tampan (*Ornithodoros moubata*, Murray).  
*Ornithodoros sartigny*, Aud.  
 Spinose Ear Tick (*Ornithodoros megnini*, Dugès).  
 Sheep Paralysis or Russet Tick (*Ixodes pilosus*, Koch).  
 Red Tick (*Rhipicephalus crerisi*, Neu.).  
 Brown Tick (*Rhipicephalus appendiculatus*, Neu.).  
 Cape Brown Tick (*Rhipicephalus capensis*, Koch).  
 Black-pitted Tick (*Rhipicephalus simus*, Koch).  
 Bont-leg Tick (*Hyalomma aegyptium*, Linn.).  
*Hyalomma aegyptium*, var. *impressum*, Neu.  
 Bont Tick (*Amblyomma hebraeum*, Koch).  
 Variegated Tick (*Amblyomma variegatum*, Fabr.).  
 Tortoise Tick (*Amblyomma marmoratum*, Koch). Larvae and nymphae only.

## Pig

- Russet Tick (*Ixodes pilosus*, Koch).  
 Cape Brown Tick (*Rhipicephalus capensis*, Koch).

## Dog—

- Tampan (*Ornithodoros moubata*, Murray).  
 Spinose Ear Tick (*Ornithodoros megnini*, Dugès).  
 Sheep Paralysis or Russet Tick (*Ixodes pilosus*, Koch).  
*Ixodes pilosus*, var. *howardi*, Neu.  
 Dog Tick (*Haemaphysalis leachi*, Aud.).  
 European Brown Tick (*Rhipicephalus sanguineus*, Latr.).  
 Red Tick (*Rhipicephalus crerisi*, Neu.).  
 Brown Tick (*Rhipicephalus appendiculatus*, Neu.).  
 Black-pitted Tick (*Rhipicephalus simus*, Koch).  
 Cape Brown Tick (*Rhipicephalus capensis*, Koch).  
 Congo Brown Tick (*Rhipicephalus lunulatus*, Neu.).  
*Rhipicephalus bursa*, Canes. and Fan.  
 Blue Tick (*Boophilus decoloratus*, Koch).  
 Bont-leg Tick (*Hyalomma aegyptium*, Linn.).  
*Hyalomma aegyptium*, var. *impressum*, Neu.  
 Bont Tick (*Amblyomma hebraeum*, Koch).

## Cat—

- Spinose Ear Tick (*Ornithodoros megnini*, Dugès).  
 Sheep Paralysis or Russet Tick (*Ixodes pilosus*, Koch).  
*Ixodes pilosus*, var. *howardi*, Neu.  
 Dog Tick (*Haemaphysalis leachi*, Aud.).  
 European Brown Tick (*Rhipicephalus sanguineus*, Latr.).  
 Bont-leg Tick (*Hyalomma aegyptium*, Linn.).

## Ostrich—

- Fowl Tick (*Argas persicus*, Oken.).  
 Spinose Ear Tick (*Ornithodoros megnini*, Dugès).  
 Bont-leg Tick (*Hyalomma aegyptium*, var. *impressum*, Neu.).  
 Bont Tick (*Amblyomma hebraeum*, Koch).

## Fowls—

Fowl Tick (*Argas persicus*, Oken.).Tampar Tick (*Ornithodoros moubata*, Murray).*Ornithodoros savignyi*, Aud.*Ornithodoros parimentasus*, Neu., South-West Africa.Penguin Tick (*Ornithodoros talaje*, var. *capensis*), Cape Province.Bont-leg Tick (*Hyalomma aegyptium*, var. *impressum*, Neu.).Bont Tick (*Amblyomma hebraeum*, Koch).

## Turkeys, Geese, Ducks, and Pigeons—

The Fowl Tick (*Argas persicus*, Oken.).

TABLE OF DISEASES TRANSMITTED BY SOUTH AFRICAN TICKS.

Disease.	Host.	Organism causing Disease.	Transmitted by.
East Coast Fever or Rhodesian Fever	Cattle	<i>Theileria parva</i>	<i>Rhipicephalus appendiculatus</i> , <i>Rhipicephalus capensis</i> , <i>Rhipicephalus simus</i> , <i>Rhipicephalus eretsi</i> .
Redwater or Bovine Piroplassmosis	Cattle	<i>Piroplasma bigemium</i> &	<i>Boophilus decoloratus</i> , <i>Boophilus australis</i> , <i>Rhipicephalus appendiculatus</i> , <i>Rhipicephalus eretsi</i> .
Biliary Fever or Equine Piroplassmosis	Horse Mule Donkey	<i>Nuttallia equi</i>	<i>Rhipicephalus eretsi</i> .
Biliary Fever or Canine Piroplassmosis	Dog	<i>Piroplasma canis</i>	<i>Haemaphysalis leachi</i> , <i>Rhipicephalus sanguineus</i> .*
Gall-sickness (form of)	—	<i>Piroplasma mutans</i>	<i>Rhipicephalus appendiculatus</i> , <i>Rhipicephalus eretsi</i> .
Gall-sickness ... ..	Cattle	<i>Anoplasma marginale</i>	<i>Boophilus decoloratus</i> , <i>Rhipicephalus simus</i> .
Heartwater ... ..	Cattle Sheep Goats	<i>Uhrarisible virus</i>	<i>Amblyomma hebraeum</i> , <i>Amblyomma variegatum</i> .
Spirillosis ... ..	Horse Cattle Sheep	<i>Spirochaeta theileri</i>	<i>Boophilus decoloratus</i> , <i>Rhipicephalus eretsi</i> .
Human Tick Fever† ...	Man	<i>Spirochaeta duttoni</i>	<i>Ornithodoros moubata</i> .
Fowl Spirochaetosis ...	Fowls	<i>Spirochaeta marchouxi</i>	<i>Argas persicus</i> , <i>Ornithodoros moubata</i> .

\* This tick was proved to transmit the disease in India.

† This disease is not known to occur in the Union of South Africa.

## EXPLANATION OF PLATES.

- Fig. 1.—Fowl Tick (*Argas persicus*), adult.  
 Fig. 2.—Tampan Tick (*Ornithodoros moubata*), adult.  
 Fig. 3.—Spinose Ear Tick (*O. megnini*), nymph.  
 Fig. 4.—Spinose Ear Tick (*O. megnini*), adult.  
 Fig. 5.—Sheep Paralysis Tick (*Ixodes pilosus*), male (upper surface).  
 Fig. 6.—Sheep Paralysis Tick (*Ixodes pilosus*), male (under surface).  
 Fig. 7.—Dog Tick (*Haemaphysalis leachi*), male (upper surface).  
 Fig. 8.—Dog Tick (*Haemaphysalis leachi*), male (under surface).  
 Fig. 9.—Red Tick (*Rhipicephalus cvevtsi*), male (upper surface).  
 Fig. 10.—Red Tick (*Rhipicephalus cvevtsi*), male (under surface).  
 Fig. 11.—Cape Brown Tick (*R. capensis*), male (upper surface).  
 Fig. 12.—Black-pitted Tick (*R. simus*), male (upper surface).  
 Fig. 13.—Brown Tick (*R. appendiculatus*), dorsal surface of male (after Nuttall).  
 Fig. 14.—Brown Tick (*R. appendiculatus*), ventral surface of male (after Nuttall).  
 Fig. 15.—Brown Tick (*R. appendiculatus*), dorsal surface of female (after Nuttall).  
 Fig. 16.—European Brown Tick (*R. sanguineus*), dorsal surface of female (after Cumliff).  
 Fig. 17.—European Brown Tick (*R. sanguineus*), dorsal surface of male (after Cumliff).  
 Fig. 18.—European Brown Tick (*R. sanguineus*), ventral surface of male (after Cumliff).  
 Fig. 19.—Life-cycle of the Brown Tick (*R. appendiculatus*).  
 a. Eggs; c. unengorged larva; f. engorged larva; h. unengorged nymph; g. engorged nymph; d. male; b. unengorged female; e. engorged female.  
 Fig. 20.—Argentine Tick (*Margaropus withoni*), male (dorsal surface).  
 Fig. 21.—Argentine Tick (*Margaropus withoni*), engorged female (dorsal surface).  
 Fig. 22.—Blue Tick (*Boophilus decoloratus*), male (dorsal surface).  
 Fig. 23.—Blue Tick (*Boophilus decoloratus*), male (ventral surface).  
 Fig. 24.—Blue Tick (*Boophilus decoloratus*), engorged female (dorsal surface).  
 Fig. 25.—Bont Leg Tick (*Hyalomma impressum*), male (dorsal surface).  
 Fig. 26.—Bont Leg Tick (*Hyalomma impressum*), male (ventral surface).  
 Fig. 27.—Bont Tick (*Amblyomma hebraicum*), male.  
 Fig. 28.—Bont Tick (*Amblyomma hebraicum*), female.  
 Fig. 29.—Variegated Tick (*A. variegatum*), male.

## REFERENCE LETTERS.

- |  |                                 |
|--|---------------------------------|
| A.—Hypostome or proboscis.                                 | M.—Genital orifice.             |
| B.—Chelicerae or mandibles.                                | N.—Median plate.                |
| C.—Palpus (four-jointed).                                  | O.—Anus.                        |
| D.—Capitulum or "false head."                              | P.—Adanal plate.                |
| E.—Porose areas (only present in the females of Ixodidae). | Q.—Anal plate.                  |
| F.—Scutum or dorsal shield.                                | R.—Genital groove.              |
| G.—Eye.  | S.—Anal groove.                 |
| H.—Cervical groove.  | T.—Adanal shield.               |
| I.—Festoon.  | U.—Accessory adanal shield.     |
| J.—Epiracle or respiratory apparatus.                      | V.—Coxa (first joint of leg).   |
| K.—Pregenital plate.                                       | W.—Tarsus (sixth joint of leg). |
| L.—Caudal process.   | X.—Haller's sense organ.        |
|  | Z.—Chitinized points.           |

**Export of Grain, etc.**

The Chief Inspector of Grain reports that during May, 1920, there were exported (all from Capetown) 108 bags of beans and 139 bags of maize meal, while the stocks on hand on the 31st of that month were five bags lucerne seed at Capetown and 3641 bags of maize meal at Durban.

## CHEMICAL ANALYSIS OF SOILS.

By B. DE C. MARCHAND, B.A., D.Sc., Chief, Division of Chemistry,  
Department of Agriculture.

FARMERS in South Africa are apt to attach too little or too much importance to soil analysis. Those who do not submit samples of the soil from their farms for examination in the laboratories of the Department of Agriculture are not actuated, for the most part, by a disbelief in the value of such analyses, but apparently are merely neglectful or ignorant of the facilities offered. In many cases the farmer is satisfied with the yield obtained under his methods of cultivation and does not seek to obtain greater returns. Others, no doubt, are well aware of the capacity of their soils for crop production and of the most profitable manures to use, and have learnt by experience the most suitable crops to grow.

On the other hand, the belief in the value of soil analysis is by some carried to extremes. The soil chemist is credited with almost supernatural powers, such powers that if he really possessed them would enable him to become a millionaire in a short space of time, if he only had the land to farm on. Frequently in the Division of Chemistry we have a matchboxful of soil sent in, the sender writing from a box number in a big town, with the request that the soil be analysed and a report furnished as to manures required, crops to grow, trees to plant, or if tefl will do better than tall fescue, and so on.

Now if a soil chemist, say, in South Africa, were given a sample of soil coming from the West Indies, he would be able to determine the quantities of the various plant food constituents present in that soil and probably to give reliable advice on a scheme of manuring, but unless he knew where the sample came from, and were acquainted with conditions in that locality, he would be utterly at sea on the question of suitable crops or trees. The suitability of a particular crop to particular soils only holds provided other conditions are the same. Climate is one of the most important factors in the selection of the crop. It would be absurd, for example, to say that a soil from the high veld districts of the Transvaal was suitable for mangoes, yet *as a soil* it might well be exactly similar to soils on which mangoes are successfully grown in the low veld or Natal.

Yet many persons who submit samples of soil are positively annoyed when asked for more information or even for a sample of reasonable size.

The object of this article is to attempt to indicate the limitations as well as the value of soil analysis.

In the laboratories of the Division of Chemistry two types of chemical analysis of soils are carried out: (1) The so-called "complete analysis," and (2) a partial analysis.

We will briefly discuss these and endeavour to explain what is to be learnt from them.

## COMPLETE ANALYSIS.

1. The following is a statement of a "complete analysis" of a soil as carried out by the Division of Chemistry:—

	<i>Per cent.</i>
Stones, over 3 mm. diameter ... ..	1.5
<i>Composition of Air-dry Fine Earth.</i>	
Moisture ... ..	3.40
Loss on ignition ... ..	9.43
Insoluble matter ... ..	56.99
Iron oxide and alumina ... ..	28.65
Lime ... ..	0.09
Magnesia ... ..	0.14
Potash ... ..	0.12
Phosphoric oxide ... ..	0.04
Total ... ..	99.86
Containing—	
Nitrogen ... ..	0.106
" Available " potash ... ..	0.0078
" Available " phosphoric oxide ... ..	0.0007
Calcium carbonate ... ..	0.02

Such a statement can convey but little information to the average farmer so that some explanation is necessary:—

(a) *Stones.*—When the soil sample is received it is spread out to become air-dry, that is, to assume such a moisture content that no further moisture will be gained or lost while the sample is handled. When air-dry, the sample is lightly crushed, until all lumps are broken up, and passed through a sieve having round holes 3 mm. in diameter. The portion failing to pass this sieve, and which actually consists of stones of greater size than 3 mm. diameter, is weighed, the percentage calculated, and entered as "stones." This portion of the soil is of no use whatever as a source of nutriment for plants, though the presence of a considerable quantity of small stones may undoubtedly affect the texture of a soil. A sample of soil recently examined contained nearly 50 per cent. of stones greater than 3 mm. in diameter, almost all of which were less than 6 mm. The remainder of the soil consisted of still smaller pebbles and clay, and had it not been for the high proportion of stones, the soil must have been heavy to work whereas actually it behaved like a free working loam. Such cases are, of course, exceptional, and we may be satisfied by considering the "stones" as a measure of the inert valueless material present in a soil.

(b) *Moisture.*—The air-dry soil still retains some water. The percentage of this gives some indication of the water-retaining capacity of the soil. Loose, sandy soils retain less "moisture" than clays or loams or soils with much organic matter. In twenty-five sandy soils the average percentage of moisture in the air-dry samples was 0.72 while the average of twenty-five samples of "black turf," well known as a heavy soil which retains water well, was 8.42 per cent.

(c) *Loss on Ignition.*—This is the loss in weight which occurs when the dry soil is strongly heated. It represents chiefly organic matter, water of constitution, and carbon dioxide derived from the decomposition of certain carbonates when such are present. In the absence of large quantities of carbonates the “loss on ignition” is a measure, though a rough one, of the amount of organic matter present in the soil. Organic matter is largely derived from vegetable material which has once grown on the soil, the residues of previous crops, remains of native vegetation, and, if manuring has been practised, the products of decay of the manure, all go to make up the organic matter in soils. With the exception of certain peaty vlei soils and one or two others, South African soils contain but little organic matter as compared with the soils of more humid countries. This is due to the rapidity with which decay takes place under our conditions. The presence of organic matter largely influences the water retaining capacity of soils. It is also a carrier of plant food constituents. The organic matter is the store house in which combined nitrogen is held in the soil and from which it slowly becomes available to plants. Roughly speaking, the greater the amount of organic matter, the higher is the percentage of nitrogen. The organic matter in the soil is the source from which the micro-organisms, which are present in all soils, derive their energy. These micro-organisms play important parts in the changes which combined nitrogen undergoes in the soil, in nitrogen fixation, and in the decay of non-nitrogenous organic matter in the soil, liberating carbon dioxide.

(d) *Insoluble Matter.*—When the soil sample is analysed a portion is extracted, under certain definite conditions, with acid. That part which does not yield to the treatment, and is not dissolved, is termed “insoluble matter.” The quantity is of no significance as regards the fertility of the soil but gives some indication of the texture of the soil and is a valuable factor in soil classification. This insoluble matter still contains a certain amount of those elements, calcium, magnesium, potassium, and phosphorus (though seldom much of the last named) which are important as plant food constituents, but these are supposed to be present in forms of combination in which they cannot be assimilated by plants.\*

(e) *Iron Oxide and Alumina.*—The percentage of iron oxide and alumina in the acid extract of the soil has no practical significance. The amount is usually highest in heavy clay soils and lowest in sandy soils. Soils containing over 15 per cent. of iron oxide and alumina are usually heavy. The percentages of iron oxide and alumina either together or singly are of assistance in soil classification.

(f) *Lime.*—Lime is one of the essential plant food constituents without which a plant cannot thrive. There is usually sufficient lime present in a soil to satisfy the needs of the crop. Many of our soils contain very little lime of which much is of no value. The lime in a soil which is of real value is that present as carbonate. The figure given for “calcium carbonate” represents the total carbonates in the soil calculated as calcium carbonate. This is the form of lime which

\* Hopkins, C. G., Univ. Ill. Agric. Exp. Stat., Bulletin 182, has, however, shown that under suitable conditions plants are able to assimilate potash left in the “insoluble matter” after extraction with acid.

is necessary to prevent soil acidity, to promote bacterial action and to prevent certain diseases.

The figures for total lime are of less significance, but it must be remembered that soils containing a good quantity of total lime usually, though not always, contain adequate amounts of calcium carbonate. It is obvious that if the total lime be low the percentage of calcium carbonate cannot be high.

To illustrate the importance of the percentage of carbonate of lime in contradistinction to total lime it may be mentioned that some South African soils have been found to contain what would usually be regarded as high percentage of lime but have been found to contain little or no carbonate of lime. Three samples of soil analysed a few years ago contained 1.48 per cent., 0.79 per cent., and 2.37 per cent. of total lime but were actually acid.

(g) *Magnesia*.—Magnesia is one of the essential plant foods though, in general, soils contain sufficient magnesia for crop requirements. The assimilation of magnesia appears to be connected with that of phosphoric oxide. There is a certain amount of evidence to show that when magnesia is in excess over lime in a soil the amount of phosphoric oxide assimilated is greater than when lime is in excess over magnesia.

It is also considered that a large excess of magnesia over lime is detrimental. The whole question is obscure, but it may be accepted that it is preferable that a soil should contain more lime than magnesia.

(h) *Potash*.—This is one of the essential plant food constituents and is also one of those which it is customary to supply in the form of fertilizers. It is therefore necessary to determine whether a soil stands in need of potash manures or not. The question of the supply of potash to the plant by the soil is an extremely difficult one. Many of our soils contain enormous stores of potash, some of the granite soils of the Transvaal contain about 4 per cent. of total potash, that is, the potash extracted by hydrochloric acid together with that remaining in the "insoluble matter." As previously mentioned, Hopkins has shown that plants are able to assimilate potash from the acid extracted "insoluble matter" obtained in soil analysis. It is one of the most difficult problems in the interpretation of soil analysis to determine whether the soil stands in need of potash fertilizers or not.

There can be no question that the value of potash fertilizers is tremendously overrated. As an aid to intensive cultivation as practised in Europe potash manuring is necessary, but it is the writer's belief, based on an examination of the available data obtained in reliable manurial experiments, that potash manures are superfluous, in fact money wasted, in at least 90 per cent. of cases in this country. Yet according to the methods for the chemical analysis of soils used in South Africa (there are two) about 50 per cent. of our soils are reported as deficient in potash.

The "available potash," as determined by Dyer's citric acid method, seems to be a much more reliable guide to the potash requirements of South African soils.

(i) *Phosphoric Oxide*.—Phosphoric oxide is one of the most important plant food constituents. In South Africa it is perhaps of the greatest importance economically. In fact the chief manurial



problem in this country is that of the supply of phosphates to the soil. Of the South African soils, the analyses of which have been recorded, some 90 per cent. are deficient in this essential constituent. Not only is the deficiency indicated in the analyses but it is well known that markedly increased yields are almost invariably obtained when phosphatic manures are used. When the great deficiency in phosphoric oxide in the soils is coupled, as it is in South Africa, with a system of farming in which large quantities of grain and forage crops containing relatively enormous quantities of phosphoric oxide are sold off the farms it is obvious that the supply of phosphates is of prime importance. In one year's maize crop alone phosphoric oxide equivalent to about 35,000 tons of 16 per cent. superphosphate is removed from the soils of the Union. The greater part of this is not returned to the soil from which it was drawn.

(j) *Nitrogen*.—The nitrogen in the soil occurs chiefly in the organic matter, but before it can be utilized by plants it must be converted by micro-organisms into other forms, chiefly nitrates, which can be assimilated. Most soils deficient in organic matter and nitrogen are also deficient in nitrates. The amount of nitrogen which must be present in the soil in order to render the application of nitrogenous manures unnecessary is for South Africa rather lower than is supposed to be necessary in Europe. The problem of the supply of nitrogen in the soil is not one which should worry the farmer. In a good system of farming no nitrogenous manures need be bought since the supply in the soil can always be maintained by green manuring.

(k) “*Available*” *Potash and Phosphoric Oxide*.—These represent the quantities of these constituents which are supposed to be immediately available to, or assimilable by, plants. While the “total” potash and phosphoric oxide may be said to represent the reserve stocks present in the soil the “available” potash and phosphoric oxide represent what is at the immediate disposal of the plant and serve as an indication of the necessity or otherwise for the supply of these constituents in the manure.

#### PARTIAL ANALYSIS.

2. The partial analysis to determine manurial needs consists of the determination of lime, magnesia, nitrogen, available potash, and available phosphoric oxide. This partial analysis does not give much information as regards soil classification or on the ultimate potentialities of the soil. It merely serves to indicate the lines which manurial treatment should take.

The following is a statement of the results obtained by a partial analysis of a sample of soil:—

	<i>Per cent.</i>
Lime ... ..	3.65
Magnesia ... ..	0.45
Nitrogen ... ..	0.092
“Available” potash ... ..	0.0145
“Available” phosphoric oxide ... ..	0.0060

It should be noted that the information furnished by such a partial analysis is much less complete than that furnished by a complete analysis, and that on this account the interpretation is

practically limited to a knowledge of the manurial treatment which would be immediately beneficial.

3. Let us now consider the complete analysis given on page 2, and endeavour to learn what the figures teach us about the soil:—

(a) The percentage of stones is low and can have no effect, good or bad.

(b) The percentage of water retained is fair. The soil probably retains water reasonably well.

(c) The percentage of organic matter is good for a South African soil. (It must be noted that in this case the loss on ignition includes only a very small amount of carbon dioxide since the percentage of calcium carbonate is so small.)

(d) The percentage of insoluble matter is low while that of iron oxide and alumina is high. The conclusion drawn from this is that the soil is heavy.

(e) The percentage of lime is low and is lower than that of magnesia. The excess of magnesia over lime is, however, probably too small to have any effect. The percentage of calcium carbonate is very low. The soil may be sour or acid or if not at present acid may easily become so under cultivation. The general conclusion is that the application of lime would be beneficial, if not immediately, in the long run.

(f) The total percentage of potash is probably adequate. The amount of "available" potash is near the border line. In all probability the soil does not stand in need of potash manuring and the application of such manures will be unprofitable.

(g) The soil is woefully deficient in phosphoric oxide, more particularly in immediately available phosphoric oxide. Further, owing to the high percentage of iron oxide and alumina and the low percentage of lime and magnesia, it is probable that most of the phosphoric oxide present is locked up in a form of combination which will prevent it from becoming available in the future.

(h) The percentage of nitrogen would be considered to be barely adequate in Europe. Under South African conditions this soil would bear two or three crops without the application of nitrogenous manures, but thereafter the store of nitrogen would have to be replenished.

To summarize the information obtained about this soil from a consideration of the chemical analysis, we have:—

1. The soil is not stony.
2. The soil holds moisture fairly well.
3. The soil contains a good amount of organic matter.
4. It is probably heavy.
5. The application of lime will probably be beneficial.
6. Potash manures will probably have no effect.
7. Good increases should be obtained by the use of suitable phosphatic manures.
8. The soil does not stand in immediate need of nitrogenous manuring but is not inexhaustible in this respect.

It will be noticed that nothing has been learnt regarding the suitability of the soil for any particular crop or crops. There are other factors which must be known before any opinion can be expressed. Since the soil is probably heavy, and the samples analysed are also always examined as regards texture, when this will have been confirmed, it is probably well suited for cereals, including wheat. The farmer would, however, be rather annoyed if he were advised to grow wheat on the land from which this sample came as it is situated in the Transvaal, in the region of summer rainfall, and cannot, at least at present, be irrigated. If a soil sample can be identified as the same or as similar to one already well known, provided climatic conditions are similar, the most suitable crops can be suggested. This may occur in perhaps 10 per cent. of cases, one of the chief reasons why better information is not available being that farmers seldom trouble to determine what crops are most suited to the special conditions obtaining on their farms. As a general rule the South African farmer sets out to grow some crop or other, maize, let us say, and maize he grows, though it may pay him far better to grow something else. It is this lack of experiment on the part of farmers which renders it so difficult, verging on the impossible, to advise as to the most suitable crops. With some crops, and notably with forest trees, it is climate, not soil, which is the determining factor in the suitability for any particular locality. Not that soil conditions must be ignored, but they are in many cases only a secondary consideration.

To return to our soil, we may say that, quite apart from the irrigation question, it is unsuitable for lucerne on chemical grounds, owing to the small percentage of calcium carbonate; that it is probably too heavy for successful potato growing; and that the soil is suited to cotton and sugar-cane. It is to be noted that of the above conclusions only one, that the soil is unsuitable for lucerne, is deduced from the chemical analyses. The others are dependent on the texture. It must also be particularly noted that of the crops for which the soil is said to be suited the possibility of cultivating cane and wheat are also dependent on conditions quite extraneous to the soil itself, namely, climate and water supply.

Of course the soil is suitable for growing any of the commoner and less specialized farm crops: maize, teff, oats, barley may be successfully grown on a great variety of soils.

If the complete chemical analysis of a soil furnishes so little information as to crops it follows that a partial analysis will furnish less. The partial analysis carried out by the Division of Chemistry must not be expected to furnish any information other than a basis for suggesting a scheme of manuring. We learn from the foregoing partial analysis that the soil is well supplied with lime, with potash, and fairly well with both nitrogen and phosphoric oxide. Green manuring and the application of some phosphatic manure should form the basis of the system of maintenance of fertility.

#### THE FARMER'S PART.

It must not be supposed from what has been said that soil analysis is altogether without value. A value it certainly has if properly considered, but it must not be looked upon as a sort of magic touchstone

which has only to be applied in order to enable the farmer to take a short cut to prosperity. The necessity for experiment and trial on the part of the farmer still remains, though a knowledge of the chemical composition of the soil may prevent haphazard experiments on wrong lines and indicate the direction which experiments should take.

A quotation from a leading authority on soils may not be out of place:—<sup>o</sup>

In some cases it will be possible by a chemical analysis to pronounce a given soil to be unsuited to a particular crop: as a rule, however, it is not its chemical composition which fits the land for a particular crop, but its mechanical texture, water-bearing power, drainage, etc. In most cases the soil can be adjusted to the crop by manure, though the process may be unsound from an economic standpoint, but no expenditure can rectify unsatisfactory texture, e.g. convert a light sand into a good wheat land.

It is interesting to note, however, that the conversion of a light soil into a loam or of a clay into a soil of lighter texture by the addition of clay or of sand has actually been proposed in this country.

Farmers who wish to have soil samples analysed should remember the limitations pointed out above.

Those desirous of having soil samples analysed should first communicate with the officer concerned in order to obtain particulars of methods of taking samples, quantities to send, and the information to supply regarding the samples, *before sending such samples*, in order to avoid the disappointment and delay which is inevitable if small or improperly taken samples are forwarded.

It is highly desirable that samples should be submitted a reasonable time before the advice asked is to be acted on. It is naturally impossible for the laboratories of the Department of Agriculture to maintain staffs large enough to permit of all samples being dealt with immediately on receipt. The greater proportion of the soil samples received by the Division of Chemistry arrive at the beginning of the planting season, frequently accompanied by the request that a report be furnished at once as the sender wishes to plant next week. This is in any case quite impossible since even a partial soil analysis takes about a week to carry out. Farmers are, therefore, requested to submit samples of soil for analysis as early as possible in order to avoid disappointment. After all there is no reason why samples should not be taken and submitted immediately after a crop has been harvested instead of just prior to planting a new one.

---

### Plant Nurseries in Quarantine for Pests.

The nurseries published in last month's issue of the *Journal* (page 287) were still in quarantine on the 1st June, 1920. To their number must be added the Silverdale Nursery, Maritzburg, on which quarantine has been imposed for White Peach Scale and Red Scale on peaches.

<sup>o</sup> Hall, A. D., "The Soil," 2nd Edition, p. 167.

## THE FRUIT EXPORT ACT.

### Notes on Amended Regulations.

By I. TRIBOLET, Chief, Division of Horticulture.

AMENDED regulations under the Fruit Export Act appeared in the *Government Gazette* of 13th February, 1920, and some of the outstanding features are noted hereunder:—

*Oranges.*—The 26 in. by 12 in. by 12 in. box is adopted for oranges instead of the 26 in. by 12½ in. by 12½ in. The half box is therefore 26 in. by 12 in. Depth optional.

*Apple Box.*—The adoption of the 18 in. by 11½ in. by 16 in., inside measurement, is equal to one of 2070 cubic inches capacity, and as the Imperial bushel equals 2219 cubic inches the box is somewhat less than a bushel in capacity. This was done after communicating with the Governments of Australia and Tasmania who are working on the same lines. This box both here and in Canada is taking the place of the 20 in. by 11 in. by 10 in. one, the general idea being to make it the universal standard apple box.

*The Pineapple Boxes* are 27 in. by 16 in. and 27 in. by 14 in. Depths optional remain. These measurements may be found to be not entirely satisfactory, and it is quite possible that in the course of one or two seasons something better may be evolved.

*Marking Both Ends of the Boxes.*—At the urgent request of those handling our fruits on shipboard and overseas it was decided to have the shipping mark of the agent appointed by the exporter placed on the one end of the box. On the other end the marking in accordance with Section 6 (a), (b), (c), and (d), still obtains.

*Fruit Boxes.*—It almost seems that if some improvement in boxes does not soon take place the wood of which they are made will have to be standardized and included in the regulations. Such flimsy receptacles were turned out last season that they were hardly fit to carry fruit across the street, let alone a long railway and sea journey. This was especially noticeable in the citrus boxes, and accounts for a good deal of the wastage that was heard of. It is hoped, therefore, that this phase of the export trade will show improvement next season, otherwise a good deal of fruit intended for export will not get further than our own docks. This is given as a timely warning.

*Third Class Fruit.*—A change has been made in the terms designating the third class fruit. Previously it was known as "Graded," now it is known as "Choice," so that the grades are "Extra Selected," "Selected," "Choice," "Lowest Grade."

The pear "Idaho" has been added to the list of those that are not recommended for export.

The Methley plum has been sized as follows:—Extra selected, 1½ in.; selected, 1½ in.; choice, 1¼ in.; lowest grade below 1¼ in., 2 inches being considered too high for extra selected in this variety.

*Regrading.*—Under Section 16 of the regulations we have the following:—"Boxes of fruit marked so as to represent a grade higher than the correct grade shall be re-marked by the inspector, and if otherwise complying with the regulations shall be branded and stamped by the inspector as provided in section *four* of the Act."

If packers cannot get nearer the official grades than was the case last season, Section 16 will have to be altered somewhat in this manner:—"Boxes of fruit marked so as to represent a grade higher than the correct grade shall be degraded by the inspector and held over until such time as they can be re-marked, branded, or stamped by the exporter, his agent, or servant before being shipped, etc."

A certain amount of error is allowable and may occasionally take place in the marking of boxes, but an inspector cannot possibly devote his time to re-marking and correcting if the amount of wrong grading that happened last season is continued.

*Packing.*—A great many packers seem to have no sense of proportion as to the amount of wood wool to put in peach boxes. In some cases there is practically none, and in others again practically half the package is of wood wool, and instead of having twenty-eight fruits the package only runs to eighteen or so. In the first instance the scant wood wool packer seems to want to save wood wool on account of it being so expensive, and often says so. In the second case, the idea is often to give the peaches a chance of arriving at their destination in a better condition than they would otherwise do. Both methods are faulty, as in both instances the fruit arrives in worse condition than it should. The box with too much wood wool makes a loose pack and the fruit shakes and wobbles about in the box, and does so more and more as it is handled. Besides, it gives our packs a bad name. People who buy a box of fruit like to see it as full of fruit as it reasonably can be. They do not like to pay fruit prices for wood wool. The grape packs that I have seen are very good indeed. The outstanding fault with other fruits is that the packing is a little slack.

The regulations, although amended from time to time, cannot be looked upon as being anything like perfect, and my suggestions for improvements or beneficial amendments from growers, exporters, and shipping firms will always be welcomed and given due consideration by the Chief of the Horticultural Division, Department of Agriculture.

## Cotton Exports.

The following interesting figures give the total exports of cotton from the United States, British India, and Egypt, the countries from which the world's main supply of cotton is obtained:—

Season 1st September to 31st August.	Quintals (220 lb.)	Season 1st September to 31st August.	Quintals (220 lb.)
1913-1914 ...	30,841,900	1917-1918 ...	15,129,600
1914-1915 ...	27,228,200	1918-1919 ...	17,762,700
1915-1916 ...	22,057,300	1919-1920 ...	14,068,400*
1916-1917 ...	19,450,200		

\* Total for 6 months, 1st September to end of February.

## THE AGRICULTURE AND SOILS OF THE CAPE PROVINCE.

By ARTHUR STEAD, B.Sc., F.C.S., Research Chemist,  
Grootfontein School of Agriculture, Middelburg, Cape.

### WITKOP-BURGHERSDORP.

(Continued from page 158, May, 1920.)

#### GEOLOGICAL.

A FEW words in explanation of the selection of the soil samples are necessary because, owing to circumstances, it was not possible to follow a definite geological plan.

The writer had visited Witkop to speak at a farmers' meeting about the factors which are concerned in the growth of crops, including food supply. During the discussion at the meeting requests were made that samples of soil typical of the area should be analysed, and these having been agreed to, it became necessary to consider ways and means of obtaining representative samples.

No maps were available excepting the altogether unsuitable divisional maps.† It was therefore considered advisable to rely on the judgment of the farmers, who were accordingly requested to form themselves into a committee and decide which farms would furnish typical samples.

In every case, however, the actual spots sampled were selected by the writer. The following is a list of the farms from which samples were taken:—

Paardenverlies.	Kalkfontein.	Kraaifontein.	Lemoen Kraal.
Olivier's Rust.	The Willows.	Witkop.	

The topography and the geology‡ of the area, the farms, and the approximate localities from which the samples were taken, are indicated by the map on Plate III, which map has been reproduced from an adaptation§ of Dunn's Map of the Stormberg Coalfields.||

Du Toit in recent years revised a portion of Dunn's work, including the farms Wonderpoort, Dankfontein, and Vaalbank, which adjoin The Willows, Olivier's Rust, and Kraaifontein. That author states "the revision has necessitated only a few alterations in the boundaries of the sub-divisions of the strata building up the area, but great changes have been made in the course of mapping the dolerite sheets."¶

\* The existence of the out-of-print geological map of Dunn was then unsuspected and it was only through the courtesy of Dr. A. L. du Toit that one of the few existing copies became available subsequently.

† These maps are out of date and very lacking in topographical detail.

‡ The greatest use has been made of the Reports of the Geological Commission (Cape), and of "The Geology of the Cape Colony," by Rogers and Du Toit, while the writer is greatly indebted to the latter author for having read over these notes and made suggestions.

§ By my colleague, E. J. v. Meerten, Lecturer in Engineering.

|| E. J. Dunn. Report on the Stormberg Coalfields, G4—78, C.T.

¶ A. L. du Toit, Geological Commission, 16th Annual Report.

Dunn's map would therefore, excepting the dolerite-sheets, faithfully reflect the general geological features of the Witkop area. Dunn would, for instance, appear to have mapped as volcanic beds a dolerite sheet which occurs on the high ground in the neighbourhood of Vaalbank and Dankfontein; but since the chemical composition of the volcanic beds and dolerite seem to be very similar no great error will be made for soil purposes if Dunn's map be accepted as correct. It is, however, very probable that the volcanic beds weather more readily than dolerite.

Reference to the geological map (Plate III) shows that the strata of the Witkop area belong to the Stormberg series of the Karroo system of rocks, together with intrusive dykes and sheets of dolerite.

Proceeding downwards, the Stormberg series consists of the following groups:—

4. Volcanic beds.
3. Cave sandstone.
2. Red beds.
1. Molteno beds.

*Volcanic Beds.*—The volcanic lavas “are all basaltic in composition, varying from coarse-grained doleritic types to highly vesicular varieties, while there is a considerable development of volcanic ash. . . . At the boundary of Dankfontein with Vaalbank the cave sandstone is overlain by nearly 300 feet of volcanic ash, followed by an almost similar thickness of lavas.”\*

The actual chemical composition of these lavas would not appear to be known. They contain, however, the following minerals:—

Lime-soda Felspars.

Augite.	} Silicates of lime and magnesia with more or less iron.
Olivine.	
Enstatite.)	

Magnetite.

Apatite—Calcium phosphate with calcium fluoride or chloride.

Agates.

Calcite—Calcium carbonate.

Lime-soda zeolites.

(The last three are found filling the steamholes of the amygdaloidal lavas.)

The petrological descriptions of the volcanic beds afford no indication as to the amount of potash they contain, but probably they contain a similar quantity to dolerite, i.e. about 0.7 per cent.

Soils derived from these beds would be somewhat clayey, but well provided with phosphoric oxide, potash, lime, and magnesia. The abundance of these food elements will have led, in the course of time, to an abundant fixation of nitrogen by the soil. Soils derived from the volcanic beds should therefore be of high fertility, provided always that, in addition to food supply, the other factors necessary for plant growth are normally present. As a matter of fact the farmers of the area recognize the soils derived from the volcanic beds as among their best.

*Cave Sandstone.*—The cave sandstone is a massive fine-grained uniform rock, probably an aeolian deposit,† which consists very

\* A. L. du Toit, Geological Commission, 16th Annual Report.

† A. L. du Toit, in a private communication.



Plate 3.

MAP  
showing  
GEOLOGY AROUND WITMOP  
and  
POINTS AT WHICH SOIL SAMPLES WERE TAKEN  
(Adapted from Dunn's Geological Map of 1877)

Scale of English Miles  
0 1 2 3

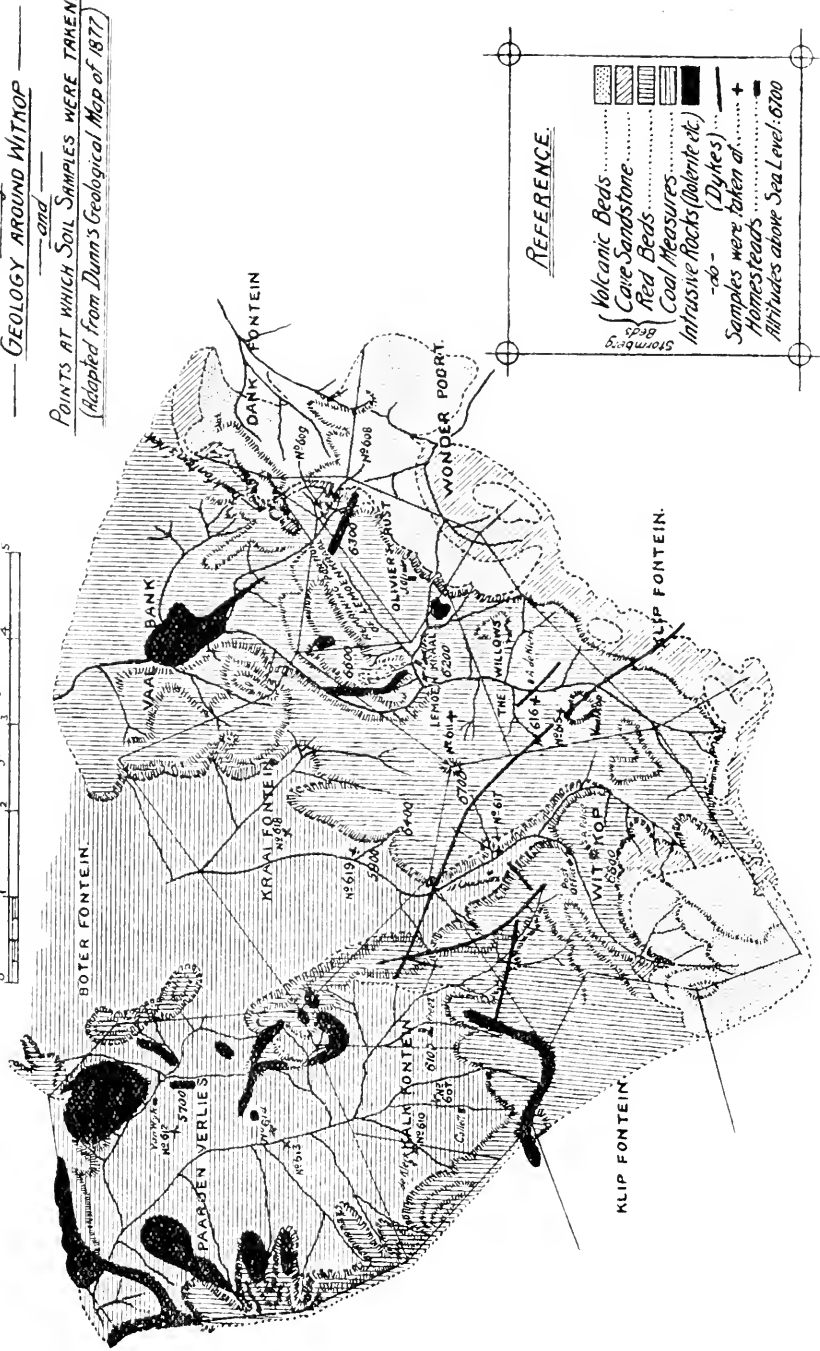

REFERENCE.

- Volcanic Beds
- Cave Sandstone
- Red Beds
- Coal Measures
- Intrusive Rocks (Dykes etc)
- do- (Dykes)
- Samples were taken at
- Homessteads
- Altitudes above Sea Level: 6700

largely of quartz grains which are rounded to only a small degree. It contains angular fragments of microcline and orthoclase (potash felspars), fragments of plagioclase (a lime-soda felspar), and a little white mica (a potash-magnesian mineral). There would not appear to have been made any number of chemical analyses of representative samples of this group, or indeed of any of the groups of the Stormberg series, but the following partial analyses taken from the 1902 report of the Geological Commission are quoted for what they are worth:—

- I. Cave sandstone from N'Quatsha's Nek.
- II. Greenish blue sandstone from red beds below the former.
- III. Typical red clay that occurs in the cave sandstone and red beds.

	I.	II.	III.
Silica ... ..	83.5	77.3	74.0
Calcium oxide ...	.67	2.33	2.28
Sodium oxide... ..	1.55	2.10	3.04
Potassium oxide... ..	1.44	2.58	2.36

One would have liked to find in the Geological Commission's Reports quantitative chemical analyses of typical specimens of rocks from several localities, and it is further a matter of great regret that no figures for the phosphoric oxide contents of the various rocks are available. No doubt the Director of the Survey recognized the desirability of such records; but in a new country many things have to wait. It should, however, be obvious that such quantitative data would considerably increase the value of the geological survey to agriculture.

Reference has already been made to the thickness of the cave sandstone at the boundary of Vaalbank and Dankfontein; on Wonderpoort it is about 150 feet thick, and no more than 40 feet in the neighbourhood of Dankfontein's Nek, a point near which samples Nos. 608 and 609 were collected.

The most remarkable feature of the cave sandstone is the fantastic shapes into which it weathers. Often the rock is hollowed out below so as to form shallow caves, in which the primitive Bushman artist-hunter lived, decorating the pale-coloured walls of his abode with characteristic paintings of men and of animals, done in red, yellow, and black pigment. Such paintings may still be seen near the head of the kloof that descends from the plateau down to the Witkop homestead.

Since cave sandstone consists mainly of silica in the shape of quartz grains, and since it would seem to be poor in all plantfood-containing minerals, it is to be expected that the soils derived solely from it will be of a rather poor, fine, sandy type; while it is also to be expected that conjointly with volcanic beds or dolerite it would give rise to a fairly fertile and easily worked soil.

*Red Beds.*—These beds are so called owing to their characteristic colour. The junction between them and the cave sandstone is well marked, but it is not always easy to draw the line which divides them from the lower Molteno beds.

The most characteristic rocks of the group are red, purple and blue mudstones and shales. Red sandstones and yellow and white fine-grained felspathic sandstones are also common. Calcareous

nodules are met with in some of the strata and would seem to be associated with fragments of bone.

The red beds weather easily, and for this reason are well covered

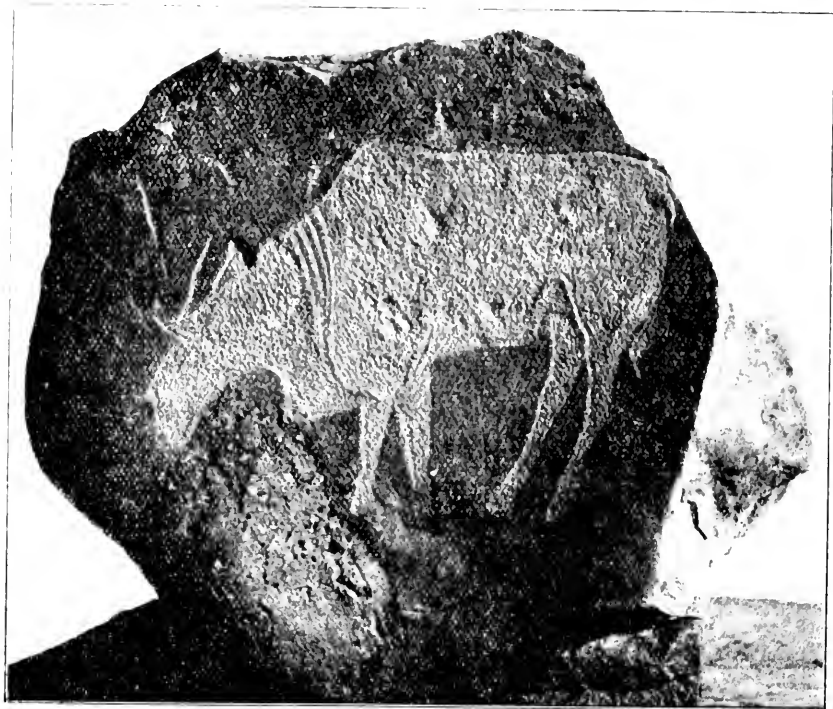

Specimens of Bushmen Carvings on Stone.

with soil on the flats: in this process their high colouring is destroyed, the product being yellow or brownish in tint. One would expect the soils to be of a sandy to fine sandy type, possessing a phosphoric oxide

and lime content that varies according to the presence or absence of calcareous nodules in the parent rock. If the analyses quoted under "Cave sandstone" higher up may be relied on as typical, the soils from the red beds should contain more potash than the soils from the cave sandstone, a point which appears to be brought out by the chemical analyses of the soils.

*Molteno Beds.*—These beds derive their name from the higher-lying ground of the Molteno Division. Reference to the map on Plate III shows that they occupy the flats on the farms Paardenverlies, Kalkfontein, and Kraaifontein, from which latter farm a tongue proceeds up the kloof which passes the homestead of Witkop. The flats of all of the other farms are occupied by red beds.

The Molteno beds consist of alternating grey or yellow shales and gritty sandstones. The latter frequently contain much potash-felspar and some mica, but calcareous nodules are never found. The finer-grained sandstones are loose in texture and weather easily. Nothing seems to be on record regarding the phosphatic contents of this group: a sample from the neighbourhood of Stormberg Junction was, however, found to contain 0.06 per cent. of phosphoric oxide—a very low figure. In other areas the Molteno beds have a poor reputation as soil producers, a reputation that is maintained in the sand-bult soils of Paardenverlies; the type of soil is sandy and of a degree of fineness that varies according as the soil is derived from sandstones or shales.

*Dolerite Intrusions.*—Dolerite is the name given to the heavy, dark, hard igneous rock which occurs in more or less rounded shapes on the boulder-strewn kopjes of the Karroo, or in massive form capping the hills and mountains. It must not be presumed, however, that dolerite is confined to the Karroo, for it is to be found from east to west of the central portion of South Africa. When freshly broken it is bluish black in colour, although the more acid varieties are somewhat paler. Typical dolerite contains the following minerals:—

Labradorite (lime-soda felspar).  
Augite.  
Olivine.  
Magnetite.

All of these minerals, it will be noted, occur in the volcanic beds described above. Several analyses of dolerite have been published, and according to Rogers and Du Toit\* the following may be taken as typical:—

	<i>Per cent.</i>
Silica ... ..	52.7
Alumina ... ..	11.4
Ferric oxide ... ..	9.0
Ferrous oxide... ..	3.7
Lime ... ..	11.6
Magnesia ... ..	7.1
Potash ... ..	0.7
Soda ... ..	2.3
Water ... ..	1.4

Added to these we have found 0.17 per cent. of phosphoric oxide in a sample of dolerite from the Stormberg area. It would appear that the phosphoric oxide occurs as needles of apatite.

\* "The Geology of the Cape Colony."

Dolerite gives rise to rather clayey soils containing rather more than average amounts of lime and magnesia, together with fair quantities of potash and phosphoric oxide. If not too clayey the soils are usually of high fertility, and, generally speaking, dolerite exercises a favourable influence on the fertility of the soils derived from the sandstones, mudstones, and shales of the Stormberg series of rocks. This influence is to be seen on Paardenverlies.

THE SOILS: THEIR DESCRIPTION, PHYSICAL AND CHEMICAL COMPOSITION, AND GEOLOGICAL ORIGIN.

In recording the data under this heading it has been thought advisable to proceed according to the farm of origin, as being the more interesting to the general reader, rather than according to geological origin.

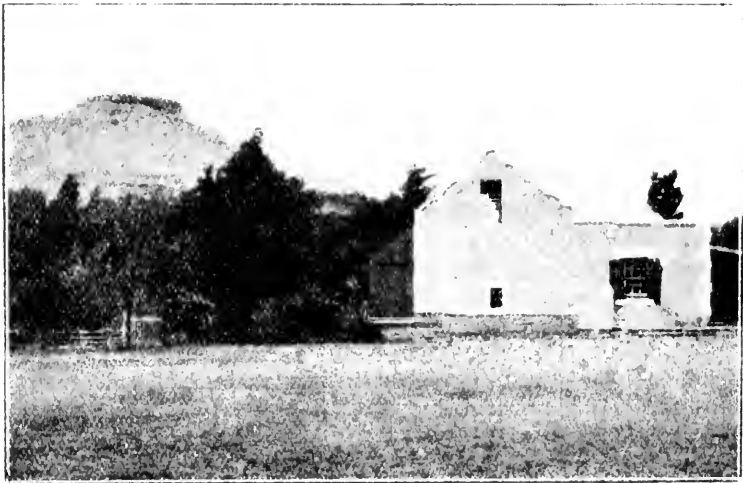

Plate IV.

The Homestead "Paardenverlies."

*Paardenverlies*—Mr. P. G. v. Wyk.

This farm is the nearest of the series to Burghersdorp, and, moreover, the lowest in altitude; its climate is therefore not quite so rigorous as that of the higher-lying farms. Mealies can be grown and many kinds of fruit and vegetables are grown with success and ease.

The homestead (*vide* Plate IV) is situated to the left of the road as one goes from Burghersdorp to Witkop Post Office, and lies under a characteristic kop which is built up of Molteno beds crowned with a dolerite sheet. This mountain is an outlier of a chain that runs northward towards Kommandant's Kop.

Black soils of reputed high fertility and suitability for wheat-growing lie at the foot of this range; their fertility is doubtless due to the effect of the dolerite sheet with which the range is capped, and which seems to have weathered considerably. These soils were not sampled.

On the opposite side of the road there is a large area of sand-bult soil of low fertility lying over the Molteno beds; it is light brownish

red in colour and sandy. Anthrills are conspicuous, pointing to good drainage and good aeration. The natural herbage consists of "rooi-zuur gras" (red sour grass) and "blauwsaad gras" (blue seed grass), and its distribution indicated uniformity in soil conditions. Soil of this type has the reputation of keeping moist during dry weather, a property doubtless due to its physical composition being such that allows of the ready movement of water in any direction. No matter what crops are grown on this type of soil the yields are poor, even when the soil is virgin. Seeing that the rainfall is good and that other factors are favourable, one cannot resist the conclusion that the poor yields are to be associated with an inadequacy of the food supply. Sample No. 612 was taken from this area and represents virgin soil.

Further from the road, nearer Kalkfontein and not far from the Brandziek Kraal Spruit, there is a blackish soil at the foot of a low dolerite-capped ridge of Molteno beds. It has the reputation of being a good soil and well suited to wheat culture; the farmer would call it a mixed sand and turf soil. The indigenous vegetation consists of "blauw saad" and "rooi plat blaar" (red flat leaf) grasses, a little Cape clover, and a few sour Karroo bosjes. It is representative of a soil derived from both Molteno beds and dolerite. Sample No. 614 was taken here, and may be considered representative of the virgin soil.

(Further instalments will be published in subsequent issues of the *Journal*.)

---

### Afforestation.

The great need for afforestation in South Africa is preached on all sides, both from an economic and a climatic point of view, and because a greater number of schemes for extensive tree planting are not being commenced throughout the country, many ascribe it to lack of enterprise on the part of the State. Like irrigation, the planning of an afforestation scheme calls for the consideration of many points of scientific importance and requires properly trained men to satisfactorily carry it out. The position in the Union to-day is that the Government is prepared to find the money for the purpose of putting into operation many more afforestation projects, but the additional trained staff, so essential to work of this nature, is not available. The Forest Department is working at its utmost capacity to cope with the many projects already in progress, and has a number of selected students in training abroad who should be available in the next few years to augment its personnel, when afforestation schemes to a wider extent than is now practicable can be dealt with.

While much has already been done for the country, as evidenced by the amount of local timber placed on the market during the war and subsequently to meet the shortage of oversea supplies, the Forest Department cannot do everything and the individual must also play his part. If every farmer sought the advice of the Forest Department and the facilities it is eager to dispense, and earnestly endeavoured to grow even a few trees, not only would he be the means of adding to the wealth of his country but he would also ensure to himself an additional income and at the same time beautify his farm. We reap to-day the benefit conferred on us by our pioneer tree-planters; let us continue the good work, each in his own way realizing that however small the beginning it is a step in the right direction.

**ALONG THE ORANGE RIVER.****A Trip to Upington, Louisvale, Keimoes, Friersdale, Cannon Island, Rooikop Island, Kakamas, and Marchand, 5th-20th November, 1919.**

By I. TRIBOLET, Chief, Division of Horticulture.

IN accordance with instructions to proceed to certain districts in the Cape Province for the purpose of giving advice to farmers on citrus culture as well as on other branches of agriculture, I saw Mr. Coetzee at his farm "Glen Allan," near Prieska, and with his assistance arranged an itinerary, etc. I reached Upington on Saturday afternoon, the 8th November last, and was met by Mr. Biggs and conveyed across the river to Louisvale, an irrigation settlement of some extent, on which are about 110 settlers, ranging from the raw Englishman to the Dutch bywoner, with some capable Dutch farmers interspersed. The Biggs Brothers appear to be the dominating factor in Louisvale. I met some of the farmers there, and visited the farms of the Biggs Brothers and the holdings of Maine, Kruis, and others, Upington. I spent Monday, the 10th, in looking round the plantations near Upington. The Mayor, Mr. Van Coppenhagen, accompanied me to several holdings and introduced me to a number of farmers. Mr. Wither, the magistrate, and Dr. Borchers also put me in touch with some of the principal men about here.

On Tuesday, the 11th, I took car from Upington to Keimoes, visiting some farms along the river. I also touched at Cannon Island, which is some 2000 morgen in extent. Six separate weirs, or shutter dams, are here being constructed under the supervision of Mr. Hawkes, of the Irrigation Department: some of these are well on towards completion, and, when the whole scheme is finished, will give a high-water level, taking in some land on the river banks and supplying the island with storage waters, as well as giving power for running a hydro-electric plant for pumping, lighting, etc. I did not make Keimoes that night, but camped at a farm known as Currie's Camp. From there I visited a few settlements on the islands in the river, notably those of Mr. H. Stein and the Jannasch Brothers. Their cultures are mostly lucerne and deciduous and citrus trees, the latter having been cut to the ground by frost, Stein losing over 1000 and Jannasch some hundreds of trees. The deciduous trees were also completely depleted of their fruit by the frost.

On Wednesday, the 12th, I was fortunate in getting a motor from Currie's Camp to Keimoes, and thence on to Rooikop Island, which belongs to a syndicate managed by Mr. Seipker. Grapes and lucerne are the principal cultures, both proving very profitable. From there I visited Mr. Sexton's farm on the outskirts of Keimoes. His plantations consist of vines and deciduous fruit trees of various sorts, citrus trees, and lucerne, everything looking very well and in good order. His place is, I should say, the show one of the district. Mr. Lenoff's citrus grove of 1600 orange trees was next visited. The

oldest trees not killed by frost are four years old. A great part of the grove is composed of replants put in year by year, as the trees were cut back by the frost, so that it has a very uneven appearance. The crop this year on the older trees was destroyed by frost. The soil is excellent, but Mr. Lenoff has not yet had any return from the citrus. Had the plot been under lucerne he would have had returns of from £1500 to £2000 for the four years, and very much more at the present price of lucerne.

I left Keimoes at 6 o'clock on the morning of the 13th, having been advised to take a cart and four horses instead of a car. The advice was quite sound, for the long distance and heavy sand through which we passed made it an almost

#### IMPOSSIBLE ROAD FOR A CAR:

at any rate with a car there would have been many stoppages and much pushing, which at a temperature of 104 in the shade is very undesirable exercise. I reached Kakamas, after breaking a spring, at about 1 p.m. I spent the afternoon in looking round and finding out who was in authority there. Unfortunately, both Mr. Conradie and Mr. Beyers were unavoidably absent, as well as the Rev. Mr. Shaw. One of the clerks, Mr. Marchand, offered to show me round the erven in the immediate vicinity, but having already had a good look round, and having had conversations with different plottolders as to prospects, state of crops, etc., I thought it better to take a car and run down the river, through Marchand, as far as cultivation extended, meet some of the plottolders, get what information I could, as well as give them any advice I thought might be useful to them. They all seemed very keen to pick up "tips," especially those growing fruit trees and vines, as they seem less informed on these lines than on the growing of wheat and lucerne. They have very little idea of the pruning of trees or vines, particularly in the earlier stages of growth. Most of the vineyards are established with ungrafted cuttings, which is somewhat risky, although they may run for many years in that sandy soil without any serious damage being done by Phylloxera. They find the establishment of a vineyard with grafted vines rather beyond their means, and before Phylloxera makes any headway, they will well be able to reconstitute their vineyards from what they have made from their cuttings.

On the 15th I returned to Keimoes, where a meeting had been advertised to take place at 4 p.m. The attendance was rather disappointing, as only ten of the most prominent men put in an appearance, all of whom I had already met. It was certainly a rather inopportune time to get an attendance at a meeting, as the wheat was just ripe, and those who were not reaping were scaring birds from the ripe grain. I visited a few more of the holders there, incidentally Father Fages, of the Catholic Mission, who, I believe, is the only one making wine in the district. I sampled his vintage, and found it only fair to middling. His vineyard, in fact the whole of the property, is in excellent order. He runs the school with 30 to 40 attendants, has a flour mill, teaches the scholars furniture making, etc. I also sampled some brandy on Rooikop Island made by the manager, Mr. Seipker, and consider it the best young brandy I have tasted in this country. It was made from Hanepoot grapes and is very high class indeed. Speaking to an ex-Excise officer, now a sergeant of police, I was told that the Brandy Board at



Capetown have set aside samples of the brandy as samples for Cape brandy farmers to work up to. I can quite believe that this might be so.

That night I started for Upington, got as far as Currie's Camp, and on Monday morning, the 17th, reached Upington and attended to correspondence which had been sent on from Pretoria. On the 18th I got a lift in the irrigation engineer's motor-car as far as Louisvale, where I held a meeting in a big store at 4 p.m. There was, considering the busy time with the wheat and the birds, a very good attendance, over 40 plottolders turning up, and they kept me busy for over a couple of hours. I had a very good translator, so that they got the lecture both in Dutch and English. I got back to Upington at 10 p.m.

On Wednesday, the 19th, during the morning I visited a few places near by, and in the afternoon held a meeting in the bioscope hall. The mayor, Mr. Copenhagen, presided and was also kind enough to act as translator. This meeting was extremely disappointing as far as attendance was concerned, only 15 farmers being present, although nine days' notice was given. The next morning I left for Potchefstroom on my way to Pretoria, which I reached on Sunday, the 23rd.

#### IMPRESSIONS AND POSSIBILITIES.

At first sight the country, excepting the strip of verdure on the islands and the margins of the river, struck me as being a desert waste and almost worthless even for stock, but on inquiry and observation I found that such was not the case. The farms, outside of the influence of the river moisture, with sandy soil and scattered bushes here and there seem almost unfit even for running goats, yet it was about the only place in the Union from which really fat stock off natural grazing were being sent to market, and, from the magistrate's statistics at that date, not one animal had been reported as having died from poverty or starvation through the prevailing drought. Farms that four years ago were bought for £3000, and considered dear at that figure, are now being sought after at from £9000 to £10,000, but no business doing. The lands commanded by water, such as the islands and the river bed, and the margins of the river are exceedingly fertile and sell at £100 per morgen in the rough and up to £180 per morgen, according to the amount of clearing and levelling that has been done on them. If laid down to lucerne £210 per morgen is the lowest at which they can be obtained.

The principal crops grown are wheat, lucerne, citrus, and vines, all under irrigation, and in the order set down. Very good crops of wheat are grown, the yield being about 20 bags per morgen; lucerne, at a low estimate, gives  $2\frac{1}{2}$  tons per morgen with six cuttings in the season, that is 15 tons per morgen per annum of lucerne hay; vines will give anything from 15 to 20 tons of grapes per morgen; oranges in frostless spots give heavy yields of first-class fruit, so I am told.

#### LUCERNE AND VINES

are the two cultures that should be encouraged, and from what I have seen of the place will prove the most remunerative and most stable. The whole trend of my lectures and conversations with plottolders was to that effect, although a great many other things, such

as vegetables, tobacco, dates, etc., might not also very profitably be grown. It is pathetic to learn that on an irrigation settlement, such as the one under consideration, Upington is supplied with vegetables from De Aar. With Windhuk on the one side and the big towns of the Union on the other, fortunes could be made with vegetables. How well they grow can be realized by considering that it takes 96 onions only to fill a muid sack.

In my addresses I demonstrated the prevailing practice of growing wheat. I let the audience give their own prices and figures, and wrote them down on the blackboard, and it was agreed that the following yields and prices were fair and average for normal times:—

Wheat, 1 morgen, 20 bags at 30s. per bag	£30
Lucerne, 1 morgen, 15 tons for 6 cuts, at £4 per ton	£60
Grapes, 1 morgen, 15 tons = 3 tons raisins at 3d. per lb.	
at £25 per ton	£75

The price for wheat was considered somewhat high and that of lucerne and grapes under the average. I pointed out that for every 1000 morgen under wheat instead of lucerne, they lose £30,000 per annum, and that for every 1000 morgen under wheat instead of vines for raisin making, they lose £45,000 per annum. In growing wheat instead of citrus they lose even more, but as they have had such a knock over the citrus business I could not think of recommending them to go on except very slowly. A few years ago they planted from 20,000 to 30,000 orange trees, and of these there are not 20 alive to-day. They covered them from the frost for the first three years, and this year took the covers off at about the usual time, but three frosts in succession cut them to the ground and destroyed most of the crop on the old trees. It is too risky in the river bed. I should say that

#### DATE PALMS

could most successfully be grown throughout this area, and there is no question as to their bearing, as the specimens I saw give prolific crops of very fine fruit. They might be grown on the banks of the channels and on the margins of the irrigated areas without breaking into the lucerne, vine, or other cultures. They are easy to grow and start bearing at anything from 3 to 5 years after planting the off-shoots, and Popenhoe considers that at a low yield and a low price 50 trees should give a gross return of about £200. The groves are planted at about 50 trees to the acre; the gross return would thus be about £200 per acre. Upkeep in the way of cultivation, etc., is very light, cost of water being the heaviest item. The palms are very deep-rooting, the roots being found at depths of over 20 feet; they also develop systems of lateral roots, which extend in masses around the stem, running out for over 20 feet. The trees are dioecious, that is, having the male and the female flowers on separate trees. Artificial fertilization is necessary to obtain good results. One good male tree will produce sufficient pollen to fertilize a hundred female trees, but to be safe the proportion is usually put at three to four.

The settlers generally along the river are very ignorant of horticultural matters, and visits should be made now and again by officers of the Department to put them right at any rate on general vital questions.

## THE DEPARTMENT OF AGRICULTURE DURING THE WAR.

[This article, which commenced in the May, 1920, issue, briefly reviews the work carried out by the various branches of the Department during the years of war, and records some achievements despite the many difficulties encountered through the abnormal conditions then existing.—ACTING EDITOR.]

### BOTANY.

THE Division of Botany is engaged in the investigation and control of diseases of plants produced by fungous and physiological causes and the study and collection of fungi of economic importance. It is also concerned with the investigation of the merits of indigenous plants of economic importance and of poisonous plants and noxious weeds, the identification of plants, the introduction and testing of economic plants from abroad, and the improvement of farm crops by breeding.

The principal work carried out at the Botanical Experiment Station, Pretoria, in 1914-15 was the testing under local conditions of a number of imported grasses and the cultivation of certain indigenous ones, and promising results were obtained with some. A good deal of attention was given also to experiments in connection with maize and potato diseases. "Rooibloem" (witchweed) investigations were continued: in connection therewith the action of certain chemicals on seed-infested soil was tried with negative results. Researches into certain bacterial diseases of plants were also conducted.

In 1915-16 the laboratory accommodation was increased and valuable presents of named and mounted plates of plants were received. The division worked in close conjunction with the Veterinary Research Division in the botanical investigations connected with gallamziekte and gouwziekte. The "rooibloem" investigations were continued and a practical method for dealing with the weed was discovered. The kikuyu grass obtained from British East Africa gave promising results and has since become very popular both as an ornamental and fodder grass. A disease affecting citrus fruit discovered in 1914 in the Drakenstein Valley, near Paarl, was since found to be present in a number of other places in the Cape south-western districts. Infected nurseries were quarantined and the disease was investigated, it being ascertained that it was due to an undertermined bacterial organism. At the same time also a great deal of routine and research work was performed in connection with plant pathology, though the work was handicapped by the lack of greenhouses.

During 1916-17 citrus canker was detected in the Union. It had apparently been introduced with a consignment of citrus trees from Japan about 1905, which was planted at Warmbaths Experiment Station. Every effort was made by the Department to stamp out the disease and prevent its spread, but for all that it was discovered to have spread to several other centres. The division is tackling this

serious disease, and all facts coming to light will be published. Investigations were also conducted into the bacterial blight of pear blossom, citrus verrucosis and mottling, blossom end rot in tomatoes, and early blight in potatoes. In conjunction with the Division of Veterinary Research extensive experiments were tried with the object of ascertaining the relationship between vegetation and certain obscure diseases of animals, and it was definitely established that two diseases (geeldikkop in sheep and jagziekte in horses) are caused by particular plants. Information of great scientific interest was obtained in the course of these inquiries calculated to lead to important discoveries in the future regarding diseases of live stock. Experiments as to the economic value of local and imported plants were carried out—flax, oil seeds, tanning materials, drugs, fibres, etc., useful for industrial or medical purposes, receiving attention. One of them, *Hibiscus cannibus*, gave promise of being suitable for grain bags, and if this proves to be the case it will be a matter of much importance to the country, as the plant grows prolifically in the Transvaal. The kikuyu grass was distributed to a large number of applicants, and there was also a keen demand for leaves of the spineless cactus.

The investigations into the relationship of flora with animal diseases was continued in conjunction with the Veterinary Research Division in 1917-18, and researches were conducted into a number of diseases that were causing damage to crops. The campaign against citrus canker occupied a great deal of the division's resources, the measures of dealing with the disease being continued, involving the close inspection of infected orchards and the destruction of infected trees, and the delicate matter of fixing a scale of compensation for trees destroyed was satisfactorily arranged. Although abnormal wet conditions favoured the spread of the disease, there was good reason to believe that it was well in hand and would ultimately be stamped out. Attention was given also to investigating plants of economic importance, and valuable reports, details of which are published in the Division's Annual Report, were obtained from the Imperial Institute, London. During the year steps were taken to organize a botanical survey of the Union. With a view to stimulating interest in the suppression of noxious weeds specimens of them were displayed at the chief agricultural shows and the issue of a series of popular leaflets on the weeds was commenced. The demand for kikuyu grass was keen, and the grass is likely to prove very useful both for pastures and lawns. The delay in connection with an experiment station greatly handicapped the division, preventing many important and pressing lines of investigation.

#### TOBACCO AND COTTON DIVISION.

As its name implies, this division is concerned with the promotion of the tobacco and cotton industries. Experiments are conducted in the breeding and growth of tobacco and in the curing, fermentation, and preparation of tobacco for the market. Approved varieties of tobacco and cotton seed are distributed amongst farmers, and advice is given to them personally and by correspondence and publications.

During the year 1914-15 the object of the division was steadily pursued. The tobacco crop was unduly affected by inclement weather in the Transvaal, and there was also a considerable reduction in the Turkish tobacco crop. Good prices were obtained for the better

grades of tobacco, and the co-operative societies at Rustenburg and in the districts near Capetown made good progress. Due to the results obtained at the Rustenburg Experiment Station and its influence among local farmers, cotton growing made satisfactory progress, and good hope was expressed at the possibility of marked development in the future. About 400,000 lb. seed cotton were produced in the District of Rustenburg and about 60,000 lb. in other parts of the Union, this being the highest quantity yet produced in the Union, and since then the production has constantly increased.

In 1915-16 much useful work was carried out at the various stations by experiments in breeding new varieties of cotton and tobacco, the use of fertilizers, methods of cultivation, and the curing of tobacco. In addition, the field officers of the Department devoted much attention to individual farmers by visiting them and giving advice and lecturing at farmers' meetings. Prices of tobacco during the year were good, and both the tobacco warehouses at Rustenburg and Paarl had a successful year and disposed of all their stocks. The two ginning plants in Rustenburg ginned and baled over 400,000 lb. of seed cotton, the entire crop being sold at prices varying from 7d. to 7½d. per lb. The year established cotton growing more firmly, and the pioneer work of the past was rewarded in the promise of a successful future for the industry, which, if fulfilled, will be of great benefit to the country. Cotton is a good drought resister and will furnish a useful additional crop in areas where the range of crop is at present somewhat limited; moreover, it is adapted for farmers in a small as well as a large way, and provides work suitable for native women and children. The quality of cotton grown in our country is excellent and usually realizes more in England than does the same variety from elsewhere.

In 1916-17 experimental and other work proceeded as usual at the Rustenburg, Elsenburg, and Piet Retief stations, but the station at Tzaneen was closed and transferred to the Lands Department for the purpose of its inclusion in a settlement scheme, for which it was considered to be better suited. The four field officers of the division were busily employed in instructing farmers and conducting field experiments, and their services were greatly appreciated and in much request. Unfavourable weather curtailed the tobacco crop, but prices were good and there was a ready sale for all classes of tobacco. A feature of the year was the fact that for the first time in the history of the industry the exports of tobacco from the Union exceeded the imports of manufactured and unmanufactured tobacco. The growing of cotton was further extended in the Transvaal and Natal, and the crop was estimated to be about one million pounds of seed cotton.

Good progress was made in 1917-18, the experiment stations continuing investigations and experiments in various phases of the industry, and the field officers disseminating useful knowledge in the cultivation, etc., of the two crops. Unfortunately, the tobacco crop was subjected for several seasons past to successive bad years owing to unfavourable weather; nevertheless, the industry continued to expand. The two tobacco associations at Rustenburg and Paarl again had a successful year and disposed of their holdings at good prices. Largely due to the efforts of Mr. Oosthuizen, who was in charge of the experimental and other work in the Orange Free State, a tobacco limited liability company was formed at Paris, Vredefort District, and its

existence is likely to prove of great advantage to the growers of that district. Another indication of the forward movement of the industry was the formation during the year of an association composed of tobacco organizations in the Union and Rhodesia, its objects being to co-ordinate the methods of handling and disposing of leaf tobacco and to bring growers and manufacturers of tobacco into closer relation to their mutual benefit. Cotton growing continued to expand and a greater crop than the previous season was expected. Owing to the war high prices were realized for lint, and prospects of a firm demand in the future encouraged the extension of the crop. The question of a cotton-seed crushing plant received attention, and if carried out will prove valuable, as the present method of crushing seed is wasteful and no benefit is derived from the oil, a very valuable by-product. Demands for tobacco and cotton seed supplied by the division were great and could not all be met. During the year several bulletins and articles on various subjects concerning the industry were published, and an exhibit of tobacco and cotton was placed on the principal agricultural shows held in the Union.

#### DIVISION OF HORTICULTURE.

The fruit industry of the Union depends in a large measure on the disposal of its fruit on oversea markets, and the year 1914-15 witnessed the commencement of a curtailment in the export of fresh fruit owing to the war and the consequent lack of suitable freight. For this reason the export trade showed a marked falling off as compared with the prior season, 1913-14. The deciduous crop of 1914-15 was, however, a small one. At this time also the exportation of meat began, which further aggravated the position caused by the limited cold storage accommodation through the withdrawal of many steamers for war purposes. During the year a Fruit Export Act, making compulsory the inspection of fruit exported for sale, was passed by Parliament. The provisions of the Act necessitated amended regulations, which have proved very satisfactory. Useful work was carried out by the Citrus Experiment Station at Warmbaths and by visits to farmers and demonstrations in various parts of the Union in connection with tree planting, pruning of trees, and the packing of oranges for export. Plantations of oranges and pines were extended in the localities suitable for them, and generally the excellent prices obtained oversea continued to encourage the growing of fruit in the Union.

In 1915-16 the division was busily employed as usual in advising fruit growers, grading fruit for export, and assisting the industry generally, and the services of its officers were in great demand. The industry suffered greatly through lack of freight caused by the war, but such fruit as could be exported fetched abnormal prices. Fortunately an extension by the Railway Administration of their refrigerator fruit service enabled much of the fruit, which in the ordinary course would have been exported, to be sold in the Union at remunerative prices. The quantity exported was 257,314 boxes, as compared with 319,829 boxes the previous year (1914-15). Statistics obtained showed a great extension in the number of fruit trees planted, and the question of providing additional cold storage on steamers received much consideration. There was a considerable increase in the production of dried fruit and jam in the Western Province of the

Cape; two fruit-drying concerns were established during the year and the industry made great progress.

A continuance of freight shortage in 1916-17 pressed heavily on many fruit growers, but the situation was relieved by the facilities for disposal of fruit locally, especially citrus fruit. The restriction in the exports of fresh fruit and the good markets obtainable for dried fruit, canned fruit, and jam resulted in a great extension of these branches of the industry. The Experiment Station at Warmbaths was maintained as usual, and the horticultural experiment stations at the agricultural schools were developed, experiments with sub-tropical fruits also being conducted at Winkel Spruit, Natal. Notwithstanding the serious position caused by the freight question, the year showed a forward movement in the industry, and the division's staff did useful work in the many directions calling for their attention, being largely instrumental also in the opening up of local markets for fresh fruit.

The conditions set up by the war continued during the year 1917-18, and though the prices obtained locally for the best fruit were not as high as would have been realized oversea, yet the prosperity in the Union brought satisfactory prices and the local market for fruit was extended. Dried fruit, canning, and jam-making made further progress, helped in a large measure by the existing conditions. During the year a conference of the officers of the division and of the lecturers in horticulture at the schools of agriculture and experiment stations, and of certain leading fruit growers and nurserymen, was held at Elsenburg, at which many matters of importance to the industry were discussed. Interest in all classes of fruit growing continued to increase and notable expansion in oranges, apples, and pineapples took place, pointing to the near approach of a considerable export trade, particularly in citrus fruits and pineapples.

(This review will be continued in subsequent issues of the *Journal*.)

## Wheat and Flour.

The following table shows the total exports of wheat and flour from the world's principal exporting countries, Canada, United States, British India, Argentina, and Australia. The exports from Russia and Roumania, which totalled 60,309,700 quintals in 1913-1914, are not included:—

Season 1st August to 31st July.	Quintals (220 lb.)	Season 1st August to 31st July.	Quintals (220 lb.)
1913-1914 ...	121,019,500	1917-1918 ...	127,280,400
1914-1915 ...	144,178,600	1918-1919 ...	150,893,600
1915-1916 ...	168,360,200	1919-1920 ...	89,854,300*
1916-1917 ...	152,158,600		

The *Journal* is the Department's medium of making known its activities. It contains information of value to every farmer in the Union. Keep it for reference.

\* Total for 6 months only (August-January).

## COMPOSITION AND VALUATION OF FERTILIZERS AND FEEDING STUFFS.

By C. O. WILLIAMS, B.Sc., A.R.C.S., Chemist, School of Agriculture,  
Cedara, Natal.

This article originally appeared in the various newspapers and journals circulating more particularly in Natal, but has been re-written and adapted for insertion in the *Journal of Agriculture* so as to be applicable to the whole Union. The object of the article more especially is to enable farmers and agriculturists generally to ascertain for themselves the comparative values of the various fertilizers and feeding stuffs on the market at the present time.

### FERTILIZERS.

It may be mentioned at the outset that the present condition of the fertilizer market is far from normal, and it is liable to so many sudden fluctuations that any figures given in this article are to be accepted as very approximate, and may have to be appreciably modified before the end of the season.

#### *Distinction between the Market Value and Agricultural Value of a Fertilizer.*

It should be pointed out that the commercial or market values dealt with in this article are different to the agricultural or real values of the corresponding fertilizing ingredients to the farmer. The *market value* of a manure is determined by the cost of the materials which enter into its composition and depends upon commercial conditions, i.e. on supply and demand; if the demand is great while the supply is small the price will be high, and conversely. The *agricultural value*, on the other hand, is the real value of a manure to the farmer in bringing about an increase in his crops and in building up "condition" in the soil. This agricultural value would be greater for some crops than for others, and would also depend largely upon the soil, locality, climate, etc. To further explain this distinction let us take an example:—Nitrate of soda during the war reached an exceptionally high price owing to its use in the manufacture of explosives, and even now it is over double the price asked for it a few years ago. Most soils in South Africa respond very poorly to nitrogenous fertilizing, so that nitrate of soda at the present high price is hardly an economical proposition to the ordinary farmer; that is, its market value is out of proportion to its agricultural value.

#### *The Constituents on which the Valuation of Fertilizers is Based.*

The three elements usually found deficient in soils for the healthy growth of plants are nitrogen, phosphorus, and potassium, so that compounds containing any of these three elements have often to be supplied in the form of manures or fertilizers.

The nitrogen must usually be combined with certain other elements, in the form of a nitrate, before it can be absorbed by the



roots of plants, but ammoniacal and certain organic compounds of nitrogen, if applied to the soil, will ultimately be converted by the aid of bacterial organisms into nitrates, so that any of the three classes of nitrogenous compounds mentioned above may be used as sources of nitrogen for plants. In valuing nitrogenous fertilizers it is the amount of the nitrogen in them that is ascertained as being the essential element common to them all. It must be observed, however, that there are other compounds of nitrogen, such as the sulphocyanides for instance, which are harmful to plants, so that they would be worse than useless for fertilizing purposes.

The element phosphorus cannot be used for application to the soil as a plant food, and there are some compounds of this element which are also strong plant poisons. Phosphorus in combination with oxygen to form phosphorous pentoxide or phosphoric oxide is an essential constituent of all phosphates, and these are the class of phosphorous compounds utilized as phosphatic fertilizers. Amongst the chief phosphates applied to the soil are the various phosphates of calcium, magnesium, iron, and aluminium, as they all contain phosphoric oxide—that is the constituent estimated in all analyses of such fertilizers and to which monetary value is attached. Potassium is a metal, and as such obviously cannot be utilized by plants as food, but compounds of potassium in the form of salts are usually very soluble, and when present in the soil can be assimilated by plants. For example, potassium combined with the element chlorine forms potassium chloride, and this salt is often applied as a fertilizer. Again, potassium when combined with oxygen forms potassium oxide or potash, and a combination of this oxide with sulphur trioxide gives us potassium sulphate (sulphate of potash), and this salt is also largely used as a potassic fertilizer. Potash combined with carbon dioxide (carbonic acid gas) produces potassium carbonate, which is present to a large extent in wood-ash, another substance applied to the soil very often as a source of potassium. Although the element potassium in the two last-mentioned compounds is present as an oxide (potash), the first mentioned, potassium chloride, does not contain the potassium as oxide at all, and the alternate name of chloride of potash for this compound is a misnomer. It is, however, the practice in analysing this latter substance, after estimating the amount of potassium present, to calculate from it the equivalent amount of potassium oxide and to give the result as so much potash.

#### *Definition of Unit Values.*

It has already been explained that the most important fertilizing constituents in a manure are:—

1. Nitrogen, which may be present either as a nitrate, as an ammoniacal compound, or as such organic compounds as the proteins or albuminoids.

2. Phosphorus, generally in the form of a phosphate, in which the amount of the phosphoric oxide always present is estimated.

3. Potassium, usually present as a soluble salt, and in which the equivalent amount of potassium oxide or potash is generally given. Therefore, when calculating the value of a manure, only these constituents are usually taken into account.

In valuing a fertilizer it would be possible to calculate, for instance, the price per pound of each of these fundamental constituents in it but the more convenient method is to ascertain the

price of a unit of each constituent, this unit consisting of 1 per cent. (or one-hundredth) of a ton, i.e. 20 lb. This unit value of a constituent may therefore be obtained by dividing the total of this constituent present in a ton of the fertilizer by the percentage amount of the constituent. For example, supposing the price of nitrate of soda (containing 15.5 per cent. of nitrogen) is £25 per ton, then the unit value of the nitrogen in it is £25, divided by 15.5, or 32s. 3d.

The unit values given below are the averages calculated from the retail lists of the chief dealers in the Union at the commencement of the present season. They are therefore based on the cash or short-credit prices quoted f.o.r. at the place of storage or manufacture, which is in almost all cases either Durban, Capetown, Johannesburg, or their immediate neighbourhoods. The more remote the farmer's place from the manure market the greater will be the cost of the fertilizer to him on account of the added cost of carriage and handling. In such cases the scales of unit values drawn up for the three main centres of the Union need not be altered, but after calculating the value of the fertilizer, f.o.r. Durban, say, by means of the lists given below, the cost of carriage and handling from the consignor's railway station to the district in question must be added in order to fix its cost to the farmer at its final destination.

The wholesale cost of the raw materials or the landed cost of the imported fertilizers would vary appreciably throughout the Union, so it would be manifestly unfair to fix a single scale of unit values to apply throughout the whole Union. For instance, the freight on imported fertilizers and raw materials would be greater from Europe or America to Durban than to Capetown; also, a manufacturer or merchant in Johannesburg would have to pay railage in addition to the freight charges to one of the coast ports. For this reason three scales of unit values have been drawn up. The first gives the averages of the prices quoted by the dealers in Durban and the Province of Natal, the second applies to Capetown and the Cape Province generally, while the third gives the average for fertilizers manufactured in Johannesburg and in the whole of the Transvaal. So far as the writer is aware there have been no brands of fertilizers registered by manufacturers or importers in the Orange Free State.

#### *Lists of Unit Values.*

When compiling such a list it is only the simple fertilizers that are taken into consideration, for in the case of a mixed fertilizer there is the additional charge, of varying amount, to cover the cost of mixing, handling, rebagging, etc. By taking the average of the values per unit in the case of each fertilizing constituent in all brands of simple fertilizers of the same nature placed on the market this year, the following lists of unit values were obtained. In most instances the number of simple fertilizers of any particular class offered for sale is so small that no true average is possible. There is no brand of nitrate of soda, for instance, quoted in Natal at the present time; only one brand of sulphate of ammonia, one blood meal, five quotations for superphosphates, two for dissolved bones, and none for potash compounds. In the Cape and Transvaal Provinces the number of quotations for the above-mentioned single fertilizers is even less. Again, owing to the unstable state of the market at present, the

calculated unit values of any particular constituent of the few fertilizers of the same nature differ so very widely that very anomalous results are obtained. As an illustration in the case of the most common class of simple fertilizers (bone meal), there are only seven brands known to the writer to be on the Cape market at the present day; the unit value of the citric acid-soluble phosphoric oxide in these varies from 7s. 6d. in the lowest case up to a maximum of 10s. 8d., giving an average all through of a little over 9s.

The unit value of the nitrogen is given separately for the different classes of nitrogenous fertilizers, for the rate of availability of this constituent varies in each and the applicableness of each class is not the same for all types of soils and crops. In the cases of nitrate of soda, sulphate of ammonia, and blood or meat meal the value per unit of the nitrogen was calculated direct. The nitrogen in the organic substance of bone is less readily available to plants than that in blood or meat meal, as owing to the tough nature of this gelatinous material it does not decompose so rapidly in the soil; for this reason the unit value of nitrogen in bone meals has been arbitrarily fixed at about four-fifths the unit value in blood or meat meal. In genuine dissolved bones, however, the organic matter has been partially decomposed and disintegrated by treatment with acid, and the nitrogen is reckoned as being of the same value as in dried blood. Very often such inferior organic materials as horn and hoof waste, hair, feathers, skin and leather waste, wool and silk waste or shoddy, tanning refuse, etc., are ground up for use as fertilizers, but the rate at which the nitrogen becomes available in such substances is very slow. These, however, are often used as a source of nitrogen in mixed fertilizers owing to their cheapness. When the guaranteed analysis of locally manufactured mixed fertilizer states that the source of the nitrogen in it is organic, it is fairly safe to assume that it is in the form of bone meal, unless it is specifically stated otherwise, although it must be stated that dried blood or meat meal is often employed in such mixtures.

The citric acid-soluble phosphoric oxide is assumed to be of the same value in all phosphatic fertilizers (except basic slag) as that calculated for bone meals. The insoluble phosphoric oxide is also arbitrarily assumed to have a unit value equal to half that of the citric acid-soluble phosphoric oxide, but, strictly speaking, the real value is far from being uniform. The insoluble phosphates in some materials become more readily available in the soil than others; also, the finer the material is ground the more readily available the insoluble phosphate in it becomes, and consequently the more valuable this constituent should be.

There is very little in the way of potash salts imported into South Africa at the present time, and there is absolutely none for sale separately. The unit values of the potash in the form of sulphate and chloride have been calculated from data supplied by one of the wholesale firms in Natal, and these figures should be taken as only approximate. The potash materials used mostly for fertilizing purposes at present are wood-ash, Karroo-ash, and kraal-ash, in all of which the potash is in the form of carbonate. One firm in particular states in its price list that all their fertilizers contain more than sufficient sulphate of lime to convert any carbonate of potash present almost entirely into sulphate of potash, producing at the same time carbonate of lime. It is true that such a chemical reaction takes

place readily when solutions of these two compounds are added one to the other, but this reaction would take place very slowly in the soil, and that only when the sulphate of lime is present in a large excess.

It should also be pointed out that in the case of some of the Provinces no data were available for calculating the unit values of some of the fertilizing constituents. For instance, in the case of the Cape Province, no trustworthy information could be obtained as to the probable unit value of the nitrogen in blood and meat meals. In such a case as this, the unit value obtained from data in one of the other Provinces (in this particular instance Natal) is given in the subjoined lists:—

1.—*Nitrogen.*

Constituent.	Unit Values for					
	Natal.		Cape.		Transvaal.	
	s.	d.	s.	d.	s.	d.
(1) Nitric nitrogen in nitrate of soda ...	31	3	31	3	31	3
(2) Ammoniacal nitrogen in sulphate of ammonia ...	34	6	34	6	34	6
(3) Organic nitrogen in blood and meat meals ...	25	6	25	6	25	3
(4) Organic nitrogen in dissolved bones...	25	6	25	6	25	3
(5) Organic nitrogen in raw bone products	20	0	20	0	20	0

2.—*Phosphoric Oxide.*

(1) Water-soluble phosphoric oxide in superphosphate ...	14	3	21	0	19	9
(2) Water-soluble phosphoric oxide in dissolved bones ...	15	0	20	9	20	9
(3) Citric-soluble phosphoric oxide in basic slag ...	14	3	14	3	14	3
(4) Citric-soluble phosphoric oxide in bone products, etc. ...	8	6	9	0	9	0
(5) Insoluble phosphoric oxide ...	4	3	4	6	4	6

3.—*Potash.*

(1) As carbonate ...	7	0	7	0	7	0
(2) As chloride ...	10	6	10	6	10	6
(3) As sulphate ...	14	0	14	0	14	0

NOTE.—In case of a fertilizer where figures are given for water-soluble, citric-soluble, and total phosphoric oxide the insoluble phosphoric oxide is the difference between the total and citric-soluble phosphoric oxide. Again, in valuing such a fertilizer it is only to that portion of the citric-soluble phosphoric oxide not included in the water-soluble part that the unit value for citric-soluble applies. For example, if a superphosphate contains 14 per cent. water-soluble, 16 per cent. citric-soluble, and 17 per cent. total phosphoric oxide, it will be necessary first to calculate the value of the 14 per cent. water-soluble phosphoric oxide, then the value of the remaining 2 per cent. citric-soluble, and, lastly, the 1 per cent. insoluble phosphoric oxide.

*Purposes of Unit Valuation.*

The list of unit values given above is useful from two points of view. First, it enables us to find whether a certain fertilizer is commercially worth the price asked for it or not. As an illustration, we shall take from one of this year's price lists the figures showing the guaranteed composition of a bone meal. They guarantee 18 per cent. of citric-soluble phosphoric oxide, 23 per cent. of total phosphoric oxide, and 4 per cent. of nitrogen. The price is £11. 15s. per ton f.o.r. at the factory. The calculation of the estimated market value is as follows, the unit values for Natal being applicable in this case:—

Value of nitrogen: 4 per cent., at 20s. ....	£4 0 0
Value of citric-soluble phosphoric oxide: 18 per cent., at 8s. 6d. ....	7 13 0
Value of insoluble phosphoric oxide: 5 per cent., at 4s. 3d. ....	1 1 3
	£12 14 3
Estimated market value ....	£12 14 3

It is seen from the calculation that the price asked for this bone meal is appreciably below the average market value for the season.

The list may also be employed to compare the commercial values of different brands of fertilizers of the same nature, thus enabling the buyer to select that brand which will give him the best value for the money spent. In connection with this it is hardly necessary to point out that the highest priced manure is not necessarily the dearest: in fact it is generally the other way about, in case of simple fertilizers especially. For instance, a certain firm is offering this season bone dust at £11. 15s. per ton and bone meal at £11. 5s., but on working out the values it is found that the former is the better value, without even taking into account the fact that the bone dust is the finer grinding, and therefore more readily available in the soil. Furthermore, in the case of the higher priced fertilizer, but which shows better value, there is less carriage to pay on worthless material so far as fertilizing the soil is concerned.

In connection with this point it may be mentioned that there is a tendency shown by firms to add a considerable amount of practically worthless material as a filler to the mixed fertilizers they turn out, chiefly in order to keep the selling price per ton down to a reasonable figure. This is due to the prejudice shown by the farmer against paying a high price for his fertilizer, no matter what its composition may be. For the reasons given above this is absolutely false economy, and before deciding which brand of fertilizer he should buy the farmer ought to find out the comparative values of all the suitable brands offered by means of the above list of unit values, giving the preference to the more concentrated fertilizers, everything else being equal.

To give an illustration of this second use of the unit values, let us compare two mixed fertilizers, supposed to be offered by different firms in the same town in Natal, say:—One quotes at £10 per ton, guaranteeing 10 per cent. citric-soluble phosphoric oxide, 15 per cent. total phosphoric oxide, 3 per cent. nitrogen, and 3 per cent. potash.

The calculation in the case of this first fertilizer is as follows:—

Value of nitrogen: 3 per cent., at 20s. ....	£3 0 0
Value of citric-soluble phosphoric oxide: 10 per cent., at 8s. 6d. ....	4 5 0
Value of insoluble phosphoric oxide: 5 per cent., at 4s. 3d. ....	1 1 3
Value of potash: 3 per cent., at 7s. ....	1 1 0
Cost of handling, mixing, rebagging, etc. ....	0 12 6
Estimated commercial value per ton ... ..	<u>£9 19 9</u>

The estimated value of this fertilizer is 100 per cent. ×  $\frac{£9. 19s. 9d.}{£10}$ , or 100 per cent. of the price asked for it; that is, the seller's price is the same as the estimated market value.

The second firm quotes at £12. 15s. per ton, with a guarantee of 10 per cent. citric-soluble phosphoric oxide, 16 per cent. total phosphoric oxide, 2.5 per cent. nitrogen, and 2.3 per cent. potash.

In this case we have:—

Value of nitrogen: 2.5 per cent., at 20s. ....	£2 10 0
Value of citric-soluble phosphoric oxide: 10 per cent., at 8s. 6d. ....	4 5 0
Value of insoluble phosphoric oxide: 6 per cent., at 4s. 3d. ....	1 5 6
Value of potash: 2.3 per cent., at 7s. ....	0 16 0
Cost of handling, mixing, rebagging, etc. ....	0 12 6
Estimated commercial value ... ..	<u>£9 9 0</u>

The estimated value of this fertilizer is 100 per cent. ×  $\frac{£9. 9s.}{£12. 15s.}$ , or only 74 per cent. of the price asked for it; that is, the real market value is only about three-quarters the seller's price.

Both fertilizers are supposed to be quoted for cash, f.o.r. at the same station, so the item of carriage would be the same in both cases and need not be taken into consideration.

There is no possible doubt in this particular case which is the better value to the farmer, for although the second fertilizer is quoted at £2. 15s. more per ton than the former its real commercial value is considerably less. Under normal conditions of the fertilizer market it is not usual to find such a big difference as that in the comparative values of two brands of fertilizers offered by different firms, but it serves as an extreme illustration to farmers to be careful always to ascertain whether they are getting the best value or not in the case of the particular fertilizer they propose buying.

It should be mentioned here that special or mixed fertilizers sold as suitable for certain crops are often considerably higher in price than their real commercial value warrants. They are also sometimes badly compounded, very inferior ingredients being used, and the proportions of the various fertilizing constituents may not be the best for that particular crop on normal soils in this country; in fact there may be some constituent present that is not needed at all for the particular soil on which it is proposed to empty the fertilizer, and the proportion that is best for one type of soil is far from being the best

for another type. Therefore, for several reasons, it is often preferable for the farmer to prepare his own mixtures. This can readily be done on a clean floor, taking care that the ingredients employed are in a fine state of sub-division and are thoroughly and uniformly mixed. Caution is to be shown in the choice of ingredients, for there are some substances which cause a deleterious chemical or physical reaction when intimately mixed, especially if the mixture is allowed to remain for some time before being sown, so that the resulting product deteriorates in value very considerably. For example, the mixing of a material containing lime, especially if caustic, with superphosphate would cause a partial reversion of the water-soluble phosphate to a less soluble and available form. It must, however, be admitted that many firms put their mixed fertilizers on the market at a reasonable cost and in a better mechanical condition than a farmer can hope to prepare his home-made mixtures. It therefore behoves every buyer to scrutinize each price list very carefully and calculate which is more economical, to purchase a particular brand of mixed fertilizer at a fair value, or to compound his own special mixture.

It must again be emphasized that the above unit values are not given for the purpose of indicating the agricultural value of a fertilizer or the return which may reasonably be expected from the use of it, for that is also largely controlled by (among other factors) the season, character of the soil, kind of crop, and method of applying the fertilizer.

#### *Other Considerations concerning the Value of a Manure.*

Another point to remember is that no attempt has been made when making the lists of unit values to differentiate between the quality of the ingredients of the same nature in different fertilizers. The mechanical condition of the ingredients in a fertilizer is an important consideration, and especially is this true of those fertilizing constituents which are insoluble. It may be laid down as a general principle that the availability of a given insoluble fertilizing constituent will vary with its fineness, and for this reason, in case of such fertilizers as bone meal and basic slag, the fineness of the material must be guaranteed to be within certain limits. As before mentioned, in the above list the insoluble phosphate in the coarsest bone meal is assumed to be of the same value as that in the finest bone flour, which in practice is far from being the case. Another thing in connection with the mechanical condition of fertilizers is to insist that all the ingredients present have an approximately equal degree of fineness, for if a heavy, finely-ground material (for example) is mixed with coarse, bulky material they will soon become more or less separated, and the result will be a fertilizer very variable in composition and from which it would be very difficult to obtain a representative sample for analysis, the coarser material preponderating at the top of the bag while the finer material will have worked its way down to the bottom.

#### *Analysis of Fertilizers to Farmers.*

The sale of fertilizers and farm foods throughout the Union is now regulated under the Act No. 21 of 1917, according to which "Every person who sells any fertilizer (or farm food) shall give or send to the purchaser at the time of delivery an invoice stating the quantity sold, the name or brand under which the fertilizer (or farm

food) is registered, and the chemical constituents thereof which have been registered as prescribed by regulations in respect of such fertilizer (or farm food). That statement in the invoice shall be deemed to be a guarantee that the article is as described therein." Should a buyer have reason to doubt the accuracy of the guarantee the regulations under the Act provide him with the means of having his consignment sampled and analysed. The exact procedure to follow can be ascertained from the Government regulations issued under the above-mentioned Act, copies of which can be obtained on application to the Secretary for Agriculture, Pretoria. An article on the subject was published in the April, 1920, number of the *Journal*.

The importance of thorough and careful sampling is not realized fully by many people. Out of a consignment of 50 tons, say, the proportion sent to the analyst is almost infinitesimal, therefore extreme care should be taken that this comparatively small amount is thoroughly representative of the whole bulk. We very often have only a fraction of an ounce forwarded to us for analysis, and that perhaps taken from the mouth of one of the bags. Further, this small quantity is generally sent loose in an envelope, paper-wrapper, or a coarse linen or canvas bag, with the consequence that a large proportion of the finer material will have escaped before the package has reached the laboratory. It is recommended that at least a couple of pounds of the material, after careful sampling, should be forwarded in a close-fitting tin or wooden box and sealed.

Should a bona fide farmer require an analysis to be done without making use of the machinery of the Act for the purpose the same care should be taken with the sampling, and a copy of the guaranteed analysis should accompany the sample in all cases. The fees laid down in the tariff of the Department of Agriculture for such analysis amount to ten shillings only, provided that no more than three determinations are involved in the analysis, otherwise the fee charged is fifteen shillings. This work is done in the laboratories of the various Schools of Agriculture throughout the Union.

In addition to the analysis of the fertilizers we are always ready to advise farmers with regard to the valuation and comparison of any particular fertilizers they seek information about, but it is difficult, however, to give definite opinion concerning the suitability of a certain fertilizer for a particular crop on the soil in question and to advise on the best amount to apply. This depends largely on the capabilities of the soil, and although a chemical analysis of the soil will very often help considerably in coming to a decision on the matter, the chemical composition of the soil as revealed by such analysis is only one of the many factors that govern its fertility; the climate, the aspect, the natural drainage, the physical structure and mechanical constitution of the soil, the mode of cultivation adopted, etc., have all, in addition to the composition of the soil, a great deal to do with its natural fertility.

#### LIME MANURES.

These include all the so-called "lime materials" that are applied to the soil chiefly for their ameliorative effect on its texture and acidity. The different forms of lime employed for this purpose are:—

##### 1.—*Calcium Oxide*.

This is applied chiefly in the form of quicklime or burnt lime, which is manufactured by heating some form of natural calcium



carbonate (or carbonate of lime), such as limestone, in order to decompose this compound and drive off carbon dioxide. Thus, calcium carbonate decomposes into calcium oxide and carbon dioxide. Quicklime or burnt lime ordinarily contains, besides free calcium oxide, small proportions of calcium carbonate and calcium hydrate, together with the mineral impurities originally present in the limestone, as well as a certain amount of ash from the fuel employed.

### 2.—*Calcium Hydrate.*

The commercial form of this is known as slaked lime, and is produced by adding the proper quantity of water to quicklime, these two chemically combining with the generation of a considerable amount of heat. Pure calcium hydrate would be a combination of approximately 76 per cent. of calcium oxide and 14 per cent. of water, but in ordinary slaked lime there would of course be present the original impurities of the burnt lime, and a portion of the calcium oxide would have changed to calcium carbonate.

The above forms of lime go under the term of caustic lime owing to their alkaline nature.

### 3.—*Calcium Carbonate.*

This is commonly known as carbonate of lime, and is found in nature as limestone, marble, chalk, coral, etc., but there is always a certain proportion of other substances present as impurities in these natural materials. In contradistinction to the caustic limes these forms are termed mild limes. Either of these natural forms of carbonate of lime may be ground up finely for applying to the soil as a manure, and this fine powdery product is sold under the name of agricultural lime, but the term "lime," strictly speaking, should only be applied to calcium oxide. When buying this agricultural lime it is very necessary to know how pure it is, that is, the percentage of calcium carbonate actually present. Pure calcium carbonate is a combination of 56 per cent. of calcium oxide with 44 per cent. of carbon dioxide, but no agricultural lime placed on the market is absolutely pure calcium carbonate. Therefore, supposing an agricultural lime is guaranteed to contain 55 per cent. of calcium oxide it is very essential to know whether all that calcium oxide is present in combination with carbon dioxide as calcium carbonate or not, for in such a material other combinations of calcium oxide may not be of so much use from a manurial point of view.

From the above explanations it is evident that in all the above forms of lime manures the essential constituent is the calcium oxide that is present, either in the free state or in combination with water (as hydrate), or with carbon dioxide (as carbonate). It is therefore customary to value a lime manure by the amount of calcium oxide present in it in any of these three forms. Lime manures do not come under the scope of the Fertilizers Act, therefore it is not compulsory on sellers to give a guaranteed analysis of such materials, but when buying any of them it is advisable that such a guarantee be insisted upon, for there is a very great difference in the composition and quality of the various agricultural limes, for instance, that are on the market at the present time.

*Unit Value of the Calcium Oxide in Lime Manures.*

It has been very difficult to obtain definite information from dealers with regard to the composition of the various lime manures that are being offered for sale, and the writer has found by actual analysis that the figures submitted in some cases are far from being reliable. Therefore the attempt to arrive at an approximate unit value for the calcium oxide has only been made in the case of the agricultural limes. From the price lists and pamphlets received from most of the dealers in such materials it has been calculated that the unit value of the calcium oxide (in the form of carbonate) in agricultural limes, works out to approximately 6d., supposing the consignment to be retailed per ton in bags, f.o.r. at the works, the price including cost of bags as in fertilizers.

*Comparative Valuation of Lime Manures.*

By the aid of the calculated unit value given in the preceding paragraph it is possible, as with a fertilizer, to ascertain whether a certain agricultural lime is being offered for sale at a fair value or not, for the estimated true market value could be calculated by multiplying the unit value by the percentage of calcium oxide present as a carbonate. But even without assuming the correctness of this unit value as applied to lime manures we can compare two agricultural limes, for instance, and find out which is the better value.

To take an example, suppose a certain agricultural lime containing 88 per cent. of carbonate of lime is quoted at £1. 2s. 6d. per ton, while another brand containing 95 per cent. of carbonate of lime is being offered for £1. 8s. 6d., the terms of the sale being identical in both cases. In the first brand every unit of carbonate of lime is worth £1. 2s. 6d. ÷ 88, or 3s. 1d., while in the second the price of carbonate of lime per unit works out to £1. 8s. 6d. ÷ 95, or 3s. 6d., which is decidedly greater.

Although the first agricultural lime works out to be the cheaper it may not really be so to a certain farmer when the item of carriage is also taken into consideration, for in the case of such cheap bulky materials as these this latter item is of great comparative importance. In fact, before comparing prices, it is better to add in each case the carriage and other incidental expenses of transport on to the dealer's price f.o.r. at the works, for the total cost of the consignment at the farmer's own door is the essential thing to know.

## FEEDING STUFFS.

The number of artificial farm foods on the South African market at the present time is so small that it is not out of the question to attempt making out a list of unit values for each of the food constituents, but a method will be explained of comparing different feeding stuffs with the view of ascertaining approximately their relative value commercially.

*The Constituents of Foods.*

The regulations under the previously mentioned Act requires that all dealers must give on their invoices a guarantee with regard to the composition of a farm food, stating the proportions present of the

following constituents:—Protein, fibre, moisture, and ash, the percentage of soluble carbohydrates being calculated by finding the difference between 100 and the total of the other percentages.

The *moisture* in feeding stuffs varies considerably, being as low as 8 or 9 per cent. in oil cakes and as high as 90 per cent. in roots. In the case of artificial foods it is better that the amount of water should be low, in order that the proportion of food constituents be correspondingly higher, for it is unnecessary and uneconomical to pay carriage on water in a foodstuff.

The *ash* is the mineral portion left after igniting the material in the open air until all the volatile and organic matter has disappeared. This mineral matter, although no money value is attached to it commercially, is an essential constituent in food, for it is necessary for the building up and the repairing of the skeleton and the various tissues of the body, and also for the proper performance of the digestive, respirative, and circulatory processes. Young animals especially are liable to suffer in development should their food be deficient in mineral constituents, and it very often becomes necessary to supplement their ordinary food with a ration of such mineral substances as bone meal and common salt.

The *crude fibre* is mainly made up of cellulose, one of the carbohydrates, and is usually regarded as being the portion of the food that would resist digestion if fed to an animal, and is therefore not given a value from a commercial point of view. Although it is not absorbed to any appreciable extent into the animal system it is a mistake to think that the crude fibre has no digestive value and is unnecessary in the animal's diet. During the process of digestion it is necessary that the digestive organs should be comfortably full in order to promote the desired movements of the organs and of the food contained therein. There must therefore be a large proportion of indigestible matter present, besides the digestible portion, in order to make up the necessary bulk.

The *soluble carbohydrates* comprise the sugars, starches, gums, and similar compounds. They are all composed of the element carbon, hydrogen, and oxygen. In the animal system they are oxidized and converted ultimately into water and carbon dioxide (carbonic acid gas), at the same time generating heat and other forms of energy in the animal body.

The *fats* and *oils* also comprise the same elements as the carbohydrates and have the same functions to perform in the body. Their power in this respect is nearly two and a half times that of the carbohydrates and are consequently so much more valuable as food constituents.

The *proteins* or *albuminoids* contain besides the above-mentioned elements nitrogen, sulphur, and phosphorus. The typical protein is albumen, of which the "white" of an egg is altogether composed; the gluteins are also proteins and are present in the seeds of the different cereals. With the exception of the mineral portion of the skeleton and the layers of fat in the body practically all the other tissues are composed of proteins.

#### *Food Units.*

For the purpose of the commercial valuation of a farm food it is always assumed that it is only the proteins, fats, and soluble carbohydrates that have a monetary value, and by adopting the same

procedure as in the case of fertilizers it would be possible to arrive at a list of unit values for each of these constituents, but, as previously explained, it is not proposed to do this.

It is, however, generally assumed that the comparative value of the protein and fat in all foods is approximately equal, and that each is equal to two and a half times the value of an equal weight of soluble carbohydrates. On this assumption 1 per cent. of the soluble carbohydrates in a ton, i.e. 20 lb., is taken as a unit, so that the total number of food units in the substance is found by multiplying the sum of the percentages of the protein and the fat by 2.5, and add to that sum the percentage of the soluble carbohydrates. Thus:

Number of food units = 2.5 (protein + fat) + soluble carbohydrates.

#### *Comparative Valuation of Feeding Stuffs.*

If we divide the price per ton of any food by the number of food units we get the monetary value of one food unit in it. By going through this calculation for all the different farm foods at present on the South African market it is found that the average value per food unit comes approximately to 2s. 3d., taking in every case the cash retail price per ton, in bags f.o.r. at the works or place of retail.

This calculated average unit value can be taken as a guide for estimating the commercial value of any particular feeding stuff offered for sale, and to see whether the retail price at which it is offered compares favourably or not with this estimate. To give an example, suppose a farm food was placed on the market at £15 per ton, having the following constituents guaranteed:—

Protein, 40 per cent.; fat, 10 per cent.; and soluble carbohydrates, 30 per cent.; total number of food units =  $2.5(40 + 10) + 30 = 155$ ; estimated value = 2s. 3d.  $\times 155 =$  £17. 9s.

This calculation shows that the retail price of such a food would be considerably below the average market value of these foods at the present time.

But, as shown in connection with lime manures, we can compare the value of two or more different foods without assuming the correctness of the unit value given in the previous paragraph. For instance, suppose two oilcakes were offered for sale, of which the particulars are as follows:—

No. 1.—Price, £11. 10s. per ton; guaranteed protein, 43.5 per cent.; fat, 8.5 per cent.; soluble carbohydrates, 26.0 per cent.; number of food units =  $2.5(43.5 + 8.5) + 26.0 = 156$ ; value of one food unit = £11. 10s.  $\div 156 =$  1s. 6d.

No. 2.—Price, £9 per ton; guaranteed protein, 43.8 per cent.; fat, 9.2 per cent.; soluble carbohydrates, 22.0 per cent.; number of food units =  $2.5(43.8 + 9.2) + 22.0 = 154.5$ ; value of one food unit = £9  $\div 154.5 =$  1s. 2d.

The second cake is therefore the better value to the buyer, as being 4d. per unit cheaper.

It must be pointed out, however, that it is not always the food that works out the cheaper per food unit that is the best for the stock

owner to buy. If, for instance, he requires the foodstuffs for the feeding of young stock, then the proportion of proteins should be high as compared with that of non-proteins, for the proteins are particularly concerned with the building up of tissues. On the other hand, for animals only moderately worked or for those in store condition it is better to have foods rich in fats and carbohydrates, the constituents which are sources of heat and energy in the animal system, for there is comparatively little waste of tissues in the body in cases like these, so the proportion of protein matter in the food can be appreciably lower.

#### *Other Factors Governing the Feeding Value of a Foodstuff.*

The value of a food depends very largely upon its chemical composition, but its mechanical condition, palatability, digestibility, method of preparation, etc., have all a great influence also upon its feeding value. To take the question of mechanical condition, for instance, mealie meal is far more thoroughly digested than the whole or partially broken grain, for the smaller the particles of the food are the larger is the surface exposed to the action of the digestive juices. Again, it is not of much use putting a highly nutritious food like some of the oilcakes before an animal if it has no taste for it and refuses to consume it, but it must be remembered, however, that palatability is greatly influenced and controlled by familiarity and habit with regard to food.

Concerning the question of digestibility, in some foods like hay and straw the proportion of the various constituents digested is low, whereas in the case of most of the cakes and meals practically all the food constituents are digestible. In the method of rough commercial comparative valuation given in this article the question of digestibility is ignored, so the comparison should only be made between foods which have approximately the same digestive coefficients for the corresponding food constituents. For instance most of the different brands of oilcakes might safely be compared in this way with one another, for approximately the same proportion of each corresponding food constituent would be digestible in all of them. As an example, it is found in most cases of this particular class of foods that the percentage of the total protein that is digested by stock is roughly the same. On the other hand, we could not compare in this way the commercial value of a certain sample of hay with any of the oilcakes, for instance, because the proportion of each food constituent digestible is much lower in the former.

#### *Manurial Value of Foods.*

Another factor of importance in determining the relative values of foods in their effect upon the quality and quantity of the resulting manure obtained from the animals that are being fed on them. A foodstuff may thus be of considerable value to the farmer after it has passed through the animal, yet the market price of a foodstuff often bears no relation to its manurial value, the commercial value being determined by its worth as a food simply and not as a manure in addition.

Oil or fat is one of the most costly constituents of a feeding stuff, because, as previously mentioned, it is a source of far more energy in

the animal body than the same weight of the soluble carbohydrates. Both of these food constituents owe their value almost entirely to the fact that they are sources of heat and energy, as well as promoting when in excess the formation of fatty tissue. On the other hand, the protein, besides being the constituent that builds up and replaces the worn-out muscular tissue of the body, is also the source of nitrogen in the resulting manure; it therefore has a considerable residual manurial value in addition to its value as a food constituent pure and simple. In the method given above of estimating the value of feeding stuffs by food units, the manurial value as well as the feeding value of each constituent is taken into consideration, although, as previously stated, the mineral matter of the food is not taken into account in this respect.

It would be beyond the scope of this article to deal exhaustively with this aspect of the subject and to attempt to give figures showing the probable proportion of the various fertilizing constituents from a food that would be found ultimately in the manure, but it is certainly a point that a farmer should bear in mind when buying artificial foods. Speaking generally, the oilcakes yield the richest manure, as they contain the largest proportion of nitrogen and phosphoric oxide, with a fair amount of potash. Next to these come the leguminous seeds and bran. The cereal grains are slightly inferior to the ordinary meadow or veld hay in this respect, while roots are the poorest of all.

In conclusion, the fact must again be emphasized that the unit values given in this article, owing to the abnormal conditions of the market, are only very approximate indeed. Also, since the prices of fertilizers and feeding stuffs fluctuate such a great deal at present, some of the unit values that were approximately correct for the beginning of the year may be very far out by now. For these reasons undue stress must not be laid on their correctness for comparing prices of fertilizers and feeding stuffs as the season advances, but the writer hopes to be able from time to time to correct these lists and to publish them in the *Journal*. Of course as the market becomes more stabilized more and more reliance can be placed on the list of unit values drawn up.

---

### Fencing.

The following fence is recommended for stock purposes:—Straining posts of iron in good, hard wood, to be placed not more than 400 yards apart. Standards of iron on good, hard wood, the latter to be not less than 6 inches in diameter at the thin ends, to be placed not more than 20 yards apart. Droppers not less than four between each two standards. Wire not less than four strands of barbed wire. Gates where necessary over public roads should be 15 feet long and constructed as laid down in Act No. 17 of 1912 (Section 28).

---

The *Journal* aims at keeping farmers informed of what the Department of Agriculture is doing, also of such matters affecting their interests as come under its purview. The *Journal* contains original articles for the guidance of the farmer on the many and diverse problems which face him. Every farmer should read it and keep it.

## FUNDAMENTAL PRINCIPLES OF CO-OPERATION IN AGRICULTURE.

By JOUS. RETIEF, Registrar of Co-operative Agricultural Societies.

THE success of farming, like that of all other producing businesses, depends not only upon the application of proper methods of production, but also upon the exercise of business acumen in marketing the products of the business.

During recent years much has been done to introduce improved methods of production, but if our farmers are to receive a reasonable return for their investment of capital and labour, they must resort not only to scientific methods of production and labour but must also find the shortest and least expensive route between the producer and the consumer. In other words, farmers must co-operate in placing their business on a proper organized basis.

Organization is generally admitted to be essential for success in practically every phase of industrial activity. It is the fundamental principle accepted by all business men in their operations.

In South Africa farmers are beginning to realize that they cannot proceed as heretofore, and that organization has become necessary for them also. Finding that individual efforts would be of little avail against the forces opposed to them, our farmers are beginning to see that, as farmers, their interests are identical, and that their only hope of success lies in co-operative effort, each helping the other, and all working together.

There is, however, a great deal of confusion in the use of the term "co-operation," as applied to agricultural efforts.

The true co-operative association, whether with limited liability registered under our Companies Acts, or with unlimited liability registered under our Co-operative Acts, is an association of farmers who unite in an effort to handle their common interests through an agency controlled by themselves on the principle of an industrial democracy, and exclusively for their own benefit.

The object of agricultural co-operation is to ensure that the farmer receives not only the profits due to him as a labourer, but also the profits which he may have earned as a business man by grading, developing, and marketing the products first raised by him as a labourer. The idea is to secure these extra profits for the farmers as a class, as well as to provide for their equitable distribution among individual farmers by dividing the profits on the basis of patronage instead of on the basis of capital.

Agricultural Co-operation simply means that the farmer takes control of all the branches of his own business—he must not only produce but must also, as far as possible, deliver his products to the consumer—i.e. he must get into closer contact with the consumer.

We have in the Union two forms of Co-operative Associations—those with limited liability and those in which the liability of members is unlimited.

The Co-operative Associations formed with unlimited liability, and registered under our Co-operative Acts, are, of course, *entirely* co-operative, in that they are associations formed exclusively for the benefit of the members, whose voting power is based on equality of membership, whose membership is confined exclusively to producers, and whose earnings are distributed on the basis of the product. This cannot be said of all the limited liability co-operative associations in the Union registered under the Companies Acts of the different Provinces. Some of these are masquerading as co-operative associations, but are in reality conducted for the benefit of the shareholders rather than for that of the producers, and cannot therefore be termed co-operative.

The true co-operative association formed with *limited liability* differs fundamentally from the ordinary joint-stock company *conducted for profit*, and nothing marks the difference between the two so clearly as the division of profits.

In an ordinary joint stock company a distribution of profits would take place in direct proportion to the capital invested if it should appear as the result of the year's business that there was a surplus after paying all just debts, and making proper allowance for depreciation of property, and also generally after an allocation of a proportion of the profits to the Reserve Funds. In a co-operative association with limited liability, on the other hand, such surplus is returned to the member in proportion to the volume of the business transacted by him with the association, after, of course, a fair rate of interest is paid for the use of capital actually employed in the business.

Another important point of difference between a limited liability co-operative association and an ordinary joint-stock company is the method of voting. In the latter the voting is conducted on a money basis, and the man with the largest monetary interests controls the affairs of the company, whereas in a co-operative association the voting power is based on the equality of membership, i.e. on the principle of "one man one vote," and no proxies are allowed to be issued. This serves as an effective safeguard against the concentration of power in the hands of one man or of a few. The history of the co-operative movement in Europe shows that this fundamental principle is sound.

These are two of the most important principles which distinguish a co-operative association from an ordinary joint-stock company.

The remarks which follow are applicable to both forms of co-operative associations, whether formed with limited liability or unlimited liability.

The history of co-operation in Europe and in the several other countries where co-operation means so much to the farmers to-day that they cannot possibly do without it, shows that, especially in the beginning, great difficulties are to be contended with. One of these difficulties is the strong opposition with which the co-operative movement is confronted wherever it is commenced. The co-operative association, as a rule, is called upon from the very beginning to compete with persons or organizations whose interests are affected by it. Every conceivable form of misrepresentation will be levelled against it, and every other weapon known to competition will be utilized to put it out of business.

This opposition we have experienced to a certain extent in this country also.



The fact that co-operative associations have to contend with such strong opposition should serve to prove to farmers that there is something radically wrong with their own business. Instead of disheartening them, it should be to them the deciding factor in answering the question whether or not co-operation is necessary for them.

The farmer, however, does not always view the matter in this light. In all countries he is difficult to move, and is naturally a strong individualist. He is averse to delegating authority over his affairs to any one, and when he is faced by some kind of adversity in his association, or is confronted with the skillful arguments of those who aim at destroying the organization and keeping him working as an individual, he is apt to weaken and finally to leave the organization, unless he feels the *need* of co-operation by reason of the fact that his existence as a farmer is threatened by existing conditions.

It follows, therefore, that to be permanently successful a co-operative association must be founded on economic necessity. The reason for its existence must lie in some vital service which it is expected to perform if it is to live in the face of the opposition to which it will be subjected.

It would, therefore, be well to begin to co-operate first of all in those lines of agricultural production in which it is felt that the greatest need for co-operation exists.

Necessity plays a great part in co-operation. It is one of the chief factors which lead to concerted action and loyalty amongst farmers in time of adversity.

As long as the foundation is sound, members should not become discouraged when the initial efforts of their society are necessarily small and inauspicious. It is very often advisable to begin in a small way and allow the business to extend in the degree that members gain experience and confidence in the society.

There are many large and powerful co-operative organizations in other countries to-day which began in the humblest of ways.

But it is important that a society should not be established prematurely. Before deciding on the formation of a co-operative organization, all the pros and cons should carefully be considered, and every precaution should be taken as would be done before commencing any other kind of business.

A point I would like to emphasize is that, whereas the causes of failure of any ordinary business are usually ascribed to bad management or something of that nature, the blame, in the case of a co-operative society, is generally put on co-operation itself. The *actual* cause of failure (in the majority of cases violation of the fundamental principles of co-operation) is lost sight of, and people jump to the conclusion that it is co-operation which is a failure. The result is that the failure of any co-operative society tends to discredit the movement throughout the country, and adversely to affect its progress.

In the preliminary stages of the movement, failures can, of course, hardly be avoided, and were experienced even in those older countries where co-operation has met with such a marked degree of success, but, for the reason just mentioned, it is essential that everything should be done to avoid them as much as possible.

In forming a co-operative society, care should be taken not to follow blindly the systems practised in other countries, however successful they may have proved there. It would be well to accept

the precept of proving all things and holding fast that which is good. Local conditions should carefully be studied and the systems in vogue elsewhere should be modified to suit our own requirements.

When once the society has been safely launched, the closest attention should be given to the management.

The individual producer is likely to gauge the requirements of management by the size of his own particular business, and very often falls short in his estimate when he is called upon to act on the board of directors and is charged with the responsibility of providing an efficient management for the successful handling of a collective business. It is, therefore, of the utmost importance that care should be exercised by the members in selecting from amongst themselves the men into whose hands the direction of the affairs of their association will be entrusted. It should be remembered that the success of a co-operative association depends very largely on efficiency in management and the only factor which should, therefore, be considered in selecting the members of the board should be "*fitness.*" There should be no "respect of persons" in the sense of a man and his relations.

The great difficulty, however, in most co-operative organizations is the lack of appreciation of the need for a high order of organizing and business ability on the part of the employees. This is very often noticeable in the appointment by the directors of the manager and other officials.

No business can ever become a success if the officials, and especially the manager, are incompetent, and a co-operative association is certainly no exception to this rule.

There is often also a tendency on the part of the members to rely too completely upon the directors for the proper conduct of their joint affairs, and, similarly, on the part of the directors to delegate their functions to the manager, or such other person as is charged with the performance of the practical business of the association. If, in such circumstances, the integrity of the manager is beyond reproach, and he is a highly capable person who has at the same time a clear conception of the underlying purpose of the organization, all may be well, but if this is not the case, then the co-operative association is bound to be short-lived.

One of the problems which the management always has before it is the keeping alive of the interest of the members, who should be encouraged to take an active part in the development and organization of their society. Their confidence should be gained by keeping them fully posted with the details of the business; the methods employed should be an open book to them, and there should be nothing mysterious about the management and control of the business.

The answer to the question as to the manner in which the management should proceed in putting the society's produce on the market covers a very wide field. Generally speaking, it becomes a matter of adaptability to local conditions and circumstances, while much depends on the particular kind of produce which the society has for disposal. It may be to the advantage of a society formed for the disposal of a certain kind of produce to establish depots and sell the produce by retail, in which case great care should be taken to secure the services of a manager who is thoroughly versed in that class of

trade, while the loyal and active support of the members would also be required in order to maintain a uniform supply.

Again, societies may find it necessary to combine and establish a central distributing and supply agency.

Whatever the conditions and circumstances may be, it should be made a fundamental rule that no risk whatever should be incurred. There should, for instance, be no speculation with members' produce by attempting to "rig" the market, or something of that nature, even if the society or combination of societies is strong enough to do so. The risk involved in such a procedure may not be very great, provided there is a steady, assured market for the kind of produce the society has for disposal, but it becomes quite a different matter when the kind of produce is generally an uncertain crop, and the consumption varies a great deal, so that prices are likely to be affected in a way not to be foreseen.

Coming now to the question of audit, the history of agricultural co-operation in other countries, and I may add in our own, furnishes a clear indication that regular and detailed investigations of the books and affairs of co-operative associations by persons thoroughly versed in the intricacies of the particular business transacted, are essential.

Auditing a co-operative society's accounts is a different matter altogether from auditing those of an ordinary business. The methods of business, the aims, the accepted practices, are different. Also the nature of the business transacted by some societies is such that the cumulative effect of the mistakes made is not immediately discernible, and it follows, therefore, that unless very special attention is given to this important matter, the results are sure to be disastrous.

I have already referred to the very important question of good management. I now wish to offer a few remarks on something equally essential, if not more so, namely, the loyalty of members. It is necessary that each member should bear in mind that the success of the organization depends upon the combined efforts of its members in giving every possible support to the movement. They should fully realize that the association's interest is *their* interest; its gain *their* gain; its loss *their* loss. There should be no yielding to the seductive blandishments of interested persons anxious, for obvious reasons, to break up their association, even at a temporary sacrifice.

No member should, in handling his crop, be interested only in his own immediate success, and look upon his association merely as a new shop at which he may deal or otherwise at his pleasure. The association must know definitely what it is expected to do. It is clearly impossible to form a correct estimate of the volume of the business to be handled, the expenses to be incurred, and the preparation to be made to transact the affairs in an orderly and economical manner if the loyalty of the members cannot be depended upon.

The surest way of procuring that loyalty is obviously for the association to offer some distinct and direct material benefit. The members must believe that the co-operative principle is sound, and this belief must be founded on the business results of the organization, as well as on its larger influence on the development of the industry as a whole.

## EXPERIMENTS AND INVESTIGATIONS.

### Work at the Schools of Agriculture and Experiment Stations and Sub-Stations.

[In the last two issues of the *Journal* the work in hand at Cedara, Grootfontein, Glen, and sub-stations was reviewed.—ACTING EDITOR.]

#### VI.—AT EISENBURG, MULDER'S VLEI, CAPE.

##### FIELD HUSBANDRY DIVISION.

*Manurial Experiments*—(1) To determine the most profitable fertilizer or combination of fertilizers for wheat and oats on the light sandy loams of the south-west Cape and with a rotation of crops. The rotation employed is:—(1) Fallow, with a cover crop of peas ploughed under, followed by (2) wheat, followed by (3) oats and vetches for hay, followed by (4) oats for grain. The fertilizers used and the amounts applied per acre are:—Basic slag 200 lb., superphosphate 200 lb., blood meal 140 lb., bone meal 200 lb., muriate of potash 30 lb., ground limestone 300 lb., Cape Cross phosphate 200 lb., fresh stable manure  $2\frac{1}{2}$  tons.

(2) This is an experiment with a similar object, but with a different rotation and different fertilizers. The rotation is (1) wheat for grain, (2) oats for grain, (3) peas for grain. The fertilizers used are:—Government guano, Saldanha Bay phosphate, gypsum, slaked lime, kraal manure. There are also green manure plots, in which the peas are not allowed to go to grain, but are ploughed under.

(3) This is a liming experiment to determine the best forms and the most profitable quantities of lime to apply, and whether lime is of any advantage without fertilizer being applied as well.

*Cereal Variety Trials*.—Seventy plots are under different varieties of wheat, oats, and barleys for a study of their characteristics and yield. Sixty plots are further used for acclimatization of seed of more promising varieties, and this seed is sent out to farmers for co-operative experiments. There are in addition 120 single-ear rows for selection work.

##### *Experiments with Green Manure Crops and Fodder Crops.*—

- (a) Different varieties of green manure crops followed by wheat and oats.
- (b) Testing a green manure crop of peas as against cultivated fallow, the succeeding crops being wheat and oats.
- (c) Vetch and oat-hay crop *versus* oat-hay, followed by wheat, to test the effect of the legume (vetch).
- (d) Feeding-off *versus* ploughed-under *versus* cut-for-hay, of a vetch and oat crop, to test the effect on the succeeding wheat crop.
- (e) Rate of seeding trial with oat and vetch for hay.
- (f) Variety tests of oat and vetch for hay.
- (g) Variety of clovers as a cover crop with oats.
- (h) Seed-production from vetches

## ANIMAL HUSBANDRY DIVISION.

Determining the relative efficiency of cross-breeding *versus* straight-breeding in the economical production of bacon pigs with ordinary farm foods. Data are collected as to quantities consumed per pig from weaning time till marketing, with costs of production, etc. This experiment is intended to last for three years. Berkshires, Large Blacks, and Tamworths are the breeds used. The Berkshires and Large Blacks are bred straight and also crossed both ways. Tamworth sows are crossed with both Berkshire and Large Black boars.

## CHEMISTRY DIVISION.

*Laboratory.*—(a) A study of the “ ammonification ” and “ nitrification ” processes under ordinary field conditions as related to the soil nitrogen problem.

(b) A study of the effect of liming of soils in the nitrification processes.

(c) A study of the effect of “ braaking ” (fallowing) land on the nitrification process.

*Pot Culture.*—Tests with Saldanha Bay phosphate on wheat.

*Field.*—Comparison of different forms of phosphatic fertilizers on limed and unlimed soils.

Further investigations are planned and will be carried out as soon as chemical equipment arrives from Europe.

## VITICULTURAL DIVISION.

- (a) Experiments in callusing and grafting.
- (b) The suitability of American stocks for different European vines in different soils.
- (c) Manurial trials in vineyard.
- (d) Investigations into fermentation of wines and the use of tannin and potassium metabisulphite; also into the clarification of wines by refrigeration and the use of isinglass and gelatine.

## HORTICULTURAL DIVISION.

- (a) Manurial experiments with pears.
- (b) Budding and grafting olives to determine best method and best time of year.
- (c) Propagation of olives by cuttings—time and method.
- (d) An attempt to find a more suitable apple stock than the Northern Spy now used.
- (e) Pruning experiments with apples and pears to force bearing of non-production trees.
- (f) Stock experiment with plums—plum stock *versus* peach.

## BOTANY DIVISION.

Investigation and experiments in the control of *fusicladium* in pears. Spraying at different times between the late winter and two weeks after the petals have fallen; 232 trees of different varieties are under treatment. The sprays used are Lime Sulphur and Bordeaux for spring and summer spraying, and Formalin for winter spraying.

## ENTOMOLOGICAL DIVISION.

Dusting and spraying trials in the orchard to determine (1) the effect of Bordeaux liquid on lead arsenate when the two are used in conjunction in the control of codling moth; (2) the relative efficiency of lead arsenate paste, lead arsenate powder, calcium arsenate paste, calcium arsenate powder, and arsenate of soda in the control of codling moth; the practicability of dusting in place of spraying in the control of codling moth and *fusicladium*.

## POULTRY DIVISION.

Investigation into preservation of eggs by cold storage and other methods. Investigation into the transmission of coccidiosis by inoculation.

---

**Fruit and Vegetables: A Great Manufacturing Scheme.**

Representatives of certain well-known British manufacturers have recently been touring the Union with a view to establishing a number of factories for jam-making and vegetable canning, commodities for which their firms are world-famous. Fully conversant with both the business and technical aspects concerning the numerous preserved food products dealt with, these representatives have visited a large number of centres, keeping in view the possibilities, present and future, of starting similar manufactures in the Union. Their first aim is to select centres, promising sufficient produce, labour, etc., to warrant the establishment of, say, four factories, mostly on the coast or at any rate in a big town, each factory to be on not less than a twenty acre stand so as to provide ample room for expansion. The chief products required are apricots, plums, peaches, apples, pine-apples, Seville oranges, vegetables (such as beans, tomatoes, etc.), and, in a lesser degree, tropical and sub-tropical fruits, such as mangoes and pawpaws.

When it is mentioned that such huge quantities as 10,000 tons each of apricots, plums, and Seville oranges—quantities far beyond the present capacity of the Union—could be dealt with by the projected factories, *as a start*, and that several millions of money will be forthcoming for investment in these operations, the magnitude of the scheme and its importance to the Union will be realized. Indeed, the firms concerned, it is understood, are prepared to face considerable initial financial loss, provided supplies of raw materials are in sight ensuring an annual expansion of the trade. Naturally the impetus to fruit-growing would be great. It is understood that the scheme provides for assisting growers to establish and maintain large areas of fruit, etc., provided that portion of their produce is supplied to the factories for a number of years, either at a contract price or prevailing market rates.

What the outcome of the visit will be is not yet known. That the required annual supply of fruit, etc., cannot be met in full for some years to come is certain, but we believe that as a result of their tour, the representatives are favourably impressed with the outlook and the possibilities of development for fruit-growing in South Africa.

## ARMY MYSTERY WORM.

### Action in Case of Recurrence.

THE summer of 1918-1919 will long be remembered for the extraordinary outbreaks of the Mystery Army Worm (*Laphygma cœmpta*) in various parts of the Union, and the consequent loss of grazing and teff-grass which would have been invaluable during the terrible drought through which the area affected has since passed. During the following summer little was heard of the insect. Early in March, 1919, a plant inspector of the Division of Entomology found larvæ rather numerous in a few localities in and near Durban. They were most abundant in swampy places at Umgeni, but three acres of young sugar-cane in a nearby plantation had been completely fed off by them, numerous parasites of a number of kinds were busy amongst them, and wilt disease was also observed. The presence of the insect elsewhere in the country was not confirmed, although in December, 1919, two official reports of outbreaks were made to the Division. The first of these came from Gqobonco, Engcobo district, Transkei, and the other from the Beaufort West district, where the caterpillar was observed in considerable numbers on certain farms shortly after the first rains fell.

Beyond these two early reports nothing further was heard, but the pest must have been present and breeding in the south-western districts, for on the 26th April, 1920, Mr. David Gunn, the Entomologist stationed at Port Elizabeth, reports: "I received an urgent request for assistance from farmers near Witteklip, on the Avontuur railway line (Uitenhage district). One farmer stated that millions of caterpillars were present in his fields, and were destroying all his crops. I proceeded to Witteklip on the morning of the 21st instant, and met a number of farmers who informed me that extensive damage had been done to potato, barley, and maize fields. In several instances large fields of barley had been completely destroyed, and would have to be resown. Upon visiting the farm Rocklands, I found that about ten acres of barley had been completely destroyed, and half of a large field of young maize plants which was grown as green fodder for dairy cows. About three-quarters of a field of potatoes had also been completely destroyed. Millions of caterpillars were present on this farm, and at the request of farmers in the neighbourhood I prepared a quantity of sweetened poisoned bait in order to save a field of young maize. As millions of caterpillars in all stages of development were feeding on the plants, two boys with large branches of trees were first sent through the field in the afternoon to brush the caterpillars on to the ground, and afterwards the sweetened poisoned bait was sown thinly throughout the rows. The field was examined the following morning, and the work was found to be successful, as every caterpillar which had been brushed off the plants had eaten the bait and had died in consequence. The farmers were fully satisfied with this demonstration, and proceeded to their farms to adopt the

same method. . . . I am fully convinced that the sweetened poison bait is the most effective method for controlling this pest. Before my arrival at Witteklip, one farmer had rolled part of a field of infested maize with a heavy roller to save this crop, but only a few caterpillars were destroyed. I was informed by several farmers that this insect pest had destroyed all the crops in Gamtoos Valley, Humansdorp district, and during my absence a telephone message was received from Hankey to the effect that the caterpillars were present in large numbers and were causing extensive damage.

“I made a careful investigation on the farm Rocklands, and found that the caterpillars had come from the veld near the cultivated fields. The owner of the farm informed me that the damage had been done so quickly that he had only noticed it three days before my arrival.”

The attack on potatoes is thought to be unusual. A newspaper account of the outbreak stated that large fields of cauliflowers were destroyed, but it appears that in this case the mystery worm was confused with the small cabbage worm. It is conjectured that the parent mystery worm moths came from the north-east. If the moths that result from the present caterpillars take the same direction in migrating, they will be carried out to sea.

#### ACTION IN CASE OF RECURRENCE.

If in future an outbreak of the insect should occur in any part of the Union, farmers whose crops or veld suffer should report at once to their magistrate in order that this Department may be put in possession of information by which the severity and extent and probable spread of the visitation may be judged. It is likely that the caterpillars escape observation, or at least fail to arouse apprehension, until they are nearly full-grown. Tefi and other sown grasses in which the caterpillars are abundant should be promptly mown in order to save them and to expose more fully the insects to their many natural enemies. The grass may be expected to grow again and yield a good cutting later unless frost interferes. So far as the veld is concerned, remedial measures are impracticable: but for the purpose of saving young maize, grain, or grass from worms which might migrate into the lands from the veld or from already infested crops, poisoned bait is efficient. The bait may be made of bran or other such food while still fresh. Grass is naturally the most convenient and cheapest bait on most farms. The other necessary ingredients are arsenite of soda (or other insecticidal form of arsenic), sugar or molasses, and water. The preparations recommended are one pound of arsenite, two pounds of sugar or two quarts of molasses, and 16 gallons of water with as much bran or finely cut grass as the liquid will thoroughly moisten. Sixteen gallons are sufficient for 150 lb. of bran or 200 lb. of green stuff. Bran bait is easy to prepare and to spread. The bran should be sprinkled and meanwhile turned over and over until it is uniformly moist, but not sloppy; when it is wetted to the right consistency, it can be broadcasted so thinly that no stock can pick it up. Green stuff is best wetted by immersing it in the liquid; it should then be drained. The bait can be spread over grass land or in grain crops, but it is not often that a farmer will care to go to the expense and trouble of baiting whole lands. However, the baiting of entire fields is not an uncommon practice in the United



States and Canada in combating grasshoppers. About a hundred pounds of bait should be spread to the acre. In general, baiting is most useful in checking the migration of the mystery worm from the veld or from ravaged lands into new lands. It is advised that a few furrows be ploughed immediately in front of the movement and heavily baited. The soil can be harrowed afterwards, and thus any danger to stock be removed. The baiting should be extended into the lands if many of the worms get past the barrier. If arsenite of soda is not available, it is recommended that any strongly arsenical cattle dipping preparation be tried in its stead, employing three times the strength of solution used in long-interval dipping.

---

### Advice on the Farm.

A well-known farmer in the Caledon district, commenting on an application by the Department for certain instructors and experimentalists, says that he strongly advocates the appointment of good practical men able to explain to the farmer *on his farm* the latest results of agricultural investigations and to demonstrate to him how to apply this knowledge, bearing in mind local conditions. He considers practical education on the farm by Government experts of greater value and cheaper than the establishment of numbers of experiment farms, but admits that specially selected stations for experimental work are indispensable. Referring to the wheat and wool industries of his district, he emphasizes the necessity for economy in production, and considers that wheat growing and sheep farming should go hand in hand in order to improve the fertility of the soil and increase its production. He advocates the use of suitable lands as sheep pasturage and the growing of green crops in rotation for the same purpose to provide for economy in production and aid in the improvement of soil fertility, green crops not consumed to be turned under as manure.

The policy of the Department follows closely the lines suggested above. Apart from the research and experiments of the various divisions, experimental and investigational work is being centred at the five schools of agriculture and experiment stations, and from these five points extension work is carried out, such as co-operative experiments on private farms and lectures and demonstrations throughout the country. Experiments in the feeding of sheep and the increase of soil fertility, very much of the nature outlined above, are now being conducted at certain of the experiment stations.

The Department is alive to the value of practical demonstrations on the farm by qualified instructors. The foundation of such advice is laid in the experiment stations and the lessons learned there will in the course of time reach the farmer. It must not be overlooked, however, that experimental work extends sometimes over many years and that suitable officers have to be trained. The country is vast and its problems many, so that time, patience, and money are necessary. As it is, the best that the men and money available can give is being put before the farmer, and year by year he reaps the benefit of investigations commenced long since.

## NOTES.

### The Extent of the Union and the Area Cultivated.

*The Extent of the Farm Lands.*—The Union is a high-lying country with more than 40 per cent. of its extent 4000 feet above sea-level, and covers 473,096 square miles, or 302,782,000 acres. The latest statistics (Census, 1918) regarding the manner in which the land is used show that in 1918 there were 76,149 farms, and that the area taken up in farming (including native locations, reserves, etc.) was 229,270,000 acres. Thus it will be seen that of the total extent of the Union 75 per cent. is taken up in farm lands.

*Land under Cultivation.*—In 1918 the area cultivated was as follows:—

Agricultural Crops ... ..	7,502,416	acres.
Fruit ... ..	181,762	..
Timber... ..	462,096	..
Fallow... ..	1,940,290	..
Native Locations, Reserves, etc. ...	3,769,588*	..
Total ... ..		
	13,856,152	acres.

In other words, 4.57 per cent. of the whole extent of the Union was cultivated in 1918.

For purposes of ascertaining the progress made in recent years reference to the 1911 Census shows that the area of land cultivated then was—

Under cultivation ... ..	3,282,971	morgen
Lying fallow ... ..	892,929	..
4,175,900		
morgen		

or 8,815,800 acres, being equal to 2.91 per cent. of the Union's total acreage. This shows that during the years 1911 to 1918 the extent of land under cultivation had increased by 5,040,352 acres, or 1.66 per cent.

*Acreage under Cultivation in Other Countries.*—It is interesting to observe the position in other countries, and the following table is compiled for the purpose of showing how the Union compares with other parts of the world in so far as cultivation of the soil is concerned. It must be borne in mind, of course, that in some countries where the percentage of cultivated land is low, arid or arctic conditions prevail over a wide area, and the proportion of productive land is very small. The percentages hereunder were classified

\* Not enumerated separately.

and reported by the International Institute of Agriculture, and in most instances give the position some years ago. The names of the countries are given in the order of the greatest acreage under cultivation.

*Proportion of Cultivated Land, including Fallow Land and Artificial Grass Lands, to the total area of the country.*

	Per cent.		Per cent.
1. United States ...	15.4	11. Canada ...	.8
2. British India ...	43.0	12. United Kingdom	23.2
3. Russia (European) ...	19.2	13. Japan ...	18.7
4. Germany ...	47.7	14. Australia ...	.8
5. Austria-Hungary ...	39.8	15. Roumania ...	46.1
6. France ...	45.2	16. Algeria ...	9.1
7. Argentine ...	6.1	17. Sweden ...	8.3
8. Spain ...	33.1	18. <i>Union of South</i>	
9. Russia (Asiatic)...	.8	<i>Africa</i> ...	2.9 (1910)
10. Italy ...	47.7		4.57 (1918)

The highest percentage published is that of 66.2 per cent. for Denmark. Belgium being next with 49.2 per cent., but of the total extent of these countries 94 per cent. and 88 per cent. respectively was productive land. The lowest percentage is .8 per cent. each in Canada, Australia, and Asiatic Russia, but the productive land in these countries is small, being only 2.6 per cent., 6.3 per cent., and 17.8 per cent. respectively of the total area.

## Care of Rams.

Mr. A. G. Michaelian, Principal Sheep and Wool Expert, gives the following advice:—

Every sheep farmer should have suitable ram paddocks in which he should run his rams when they are not working. If these paddocks contain plenty of good, sweet, nutritious feed in sufficient quantity all the year round, it should not be necessary to artificially feed flock or stud rams, veld bred or otherwise, which are to be used among ewes at the rate of 2 per cent. Of course, if you are not in good sheep country, where sufficient nutritious feed is available all the year round, it will be necessary to augment the rams' feed artificially whether they are intended to go to work or not. Should a special ram be required to serve, say, eighty ewes or more, he would require extra feeding whilst working, unless, of course, there is an abundance of good feed in the paddock and the farmer can see that the ram is holding his own. If it is found necessary to feed the ram while he is working he should be brought in and fed at, say, between 10 and 11 o'clock in the morning accompanied by two or three of his ewes to keep him from fretting. He must be turned out again at, say, four in the afternoon, when it is cool. The ram should have two feeds whilst inside.

It is not advisable to take the ram out from the ewes during the night. Generally speaking, rams should remain with the ewes from six to seven weeks. Rams should never run with ewes unless they are wanted to work. If rams are allowed to run with the ewes the whole year round they will never be fit. It should be the object of

sheep farms to get their rams into good hard working condition and not "hog" fat. To be fair to the rams they should not be asked to work with more than two months' wool on.

Various foods are used to feed sheep, such as crushed oats, crushed mealies, bran, lucerne hay, oaten hay, and also teff. It is not advisable to feed grain or hay independently. They should be mixed to get the best results. I have found the following a satisfactory sheep feed: 40 lb. crushed oats, 10 lb. bran, 50 lb. finely chopped good oat-hay. This is thoroughly mixed and a little salt can advantageously be added. A change can sometimes be made by adding or substituting crushed mealies and using the lucerne-hay and oat-hay in equal proportions. Bran should always be added. There is no hard and fast rule regarding the different proportions, but I have found the above very good. Sheep should only receive what they will clean up at one feed.

Powdered raddle is generally used to put on the ram to show which ewes he has jumped on. The raddle mark on the ewes' rump is, however, no guarantee that she has been tupped. I have seen rams repeatedly jump upon ewes and not serve them. Personally I never worry about raddling rams.

The farmer must remember that it is his business to see that the ewes are in good condition so that they may easily come in season. To my mind this is the only way to ensure a good percentage of lambs.

I consider it is a mistake to put ewes in full wool to the ram.

However fit the rams are, if the ewes do not come in season you cannot expect a good lambing.

## Recent Outbreaks of East Coast Fever.

Recent outbreaks of East Coast fever have given rise to considerable alarm and the following brief statement on the subject is made for general information. In Natal and the Transvaal the situation is not regarded as critical, though in the latter Province recent developments in certain areas are causing much anxiety. Outbreaks have occurred in parts of the Zoutpansberg, Barberton, and Piet Retief, and are being dealt with by the Veterinary Division, but public attention is centred on the occurrence of the disease as reported from various centres in the Pretoria District. The situation in this district is one of great difficulty, for hundreds, if not thousands, of cattle entering the bushveld for winter grazing must have traversed the infected areas. Every effort is being made to check the spread of the disease by increasing the police supervision in the district so as to prevent illicit movements of stock, and it is trusted that the measures adopted will have the desired result of stamping out the disease.

The adequate control of East Coast fever has been seriously hampered during the years of the war. Shortage of staff, high cost and lack of dipping and fencing materials, and, recently, the severe drought, have all combined to make the task of dealing with the disease a most formidable one, and it is feared that the position in the Union has not improved as much as it might have done under more favourable conditions. Indeed it is fortunate that under the circumstances more outbreaks have not occurred.

The Department is alive to the pressing necessity of extirpating East Coast fever, and attention is being given to further scientific research into tick destruction and a specific remedy for the disease. The fencing of infected areas is an important feature in controlling the spread of the disease and facilities for the speedier supply of fencing and dipping materials than at present obtains are being considered. But the success of any operations depends in a large measure upon the curtailment of the movements of cattle, and if the co-operation of the community could be obtained in the suspension of ox transport for a reasonable period in any infected district, the position could be manifestly improved. In like manner the quarantine period, although irksome to stock owners, will need to be rigorously enforced.

The regulations governing the control of East Coast fever are well known. In the April, 1920, number of the *Journal* an article was published giving practical hints for the prevention and eradication of the disease. That the ill-effects of the war have retarded the control of the disease is unfortunate, but that greater ills in extensive outbreaks have not followed is correspondingly fortunate. The alarming spread of the disease in Pretoria is an outcome of the disabilities occasioned by lack of men and materials and to some extent to public indifference to the requirements of the law respecting diseases of stock. The Department views the position seriously but does not consider that, generally, it is critical. By all means in its power will it grapple with the spreading disease, and it looks to the farming community, especially those in, or in the neighbourhood of, infected areas, to co-operate with it in stamping out the disease.

## Grain Elevators.

The attention of farmers is directed to the report\* of Mr. Wm. Littlejohn Philip on the subject of grain elevators, a matter of great public interest and far-reaching importance to farmers. The report states: "An elevator system may generally be described as follows: A system of handling grain in bulk instead of in bag; a system which deals with all kinds of grain, whether for local consumption or export and of handling the grain in the most economical manner; a system of providing safe storage and negotiable certificate; and a system which is particularly economical from a Railway and Harbour point of view." The report sets out plainly the many advantages of an elevator system which is devised not solely to facilitate export trade but for inland trade as well.

Mr. Littlejohn Philip's recommendations are substantially those of the Grain Elevators Committee, excepting that instead of three port elevators he advocates that two only (one at Durban and one at Capetown) should be erected at present, and instead of sixty-two country elevators seventy-one are considered necessary. The two elevators for the ports are proposed to have a storage capacity of 72,000 tons and the seventy-one country elevators 160,200 tons, the estimated total cost involved being £1,799,000. Against this outlay the net financial saving which will accrue to the country is estimated at £479,055 per annum.

\* "Grain Elevators for Union of South Africa." Obtainable from the Government Printer, Pretoria. Price 3s.

In a memorandum accompanying the report, Sir William Hoy, the General Manager of Railways and Harbours, supports the complete scheme of port and country elevators recommended by Mr. Littlejohn Philip but suggests that a commencement be made with seventeen country elevators to feed the port elevator at Durban and a like number to feed the one at Capetown, the remainder to be built later on as experience dictates. He states: "Assuming that steps are not taken to commence construction work until the necessary funds have been authorized by Parliament, say, until July or August next, it is certain that the elevators could not be erected in time for the 1922 crop. As a matter of fact, matters would require to be carried out expeditiously to have them ready for the 1923 crop."

The report points out that all costs, expenditure, losses, and expenses of sale incurred between production and ultimate sale, reduce the amount which the farmer gets for his grain. The elevator system is designed primarily to help the farmer in this respect; indeed it is estimated that as a result he should obtain from 1s. to 2s. more for every 200 lb. produced, and at the same time be relieved of all anxiety as to safe storage and forced sale. His position is sensibly improved, for when his grain is deposited in an elevator he will receive a negotiable certificate enabling him to raise money, if required, and to sell at an opportune time. But the benefits are by no means confined to farmers, for grain merchants, in the widest acceptance of the term, and storekeepers will materially be assisted as their risks in handling the grain are reduced and their business operations simplified; bankers, also, will have the advantage of holding excellent security for money advanced to the farmer. Altogether the economical handling of the trade will benefit both producer and consumer, and it is considered that present production will be doubled within five years after the system is fully established.

The matter is of great moment to agriculturists, and the report, which contains much interesting information regarding the Union's maize crop, should be in the hands of every farmer interested in the production and distribution of maize, wheat, and oats.

### **Drying-out of Maize during Rail Transit.**

In connection with the Grain Elevator Inquiry an interesting moisture test was carried out by the Chief Inspector of Grain in co-operation with the Railway Department, the object being to ascertain the extent to which maize dries out during rail transit to the ports. Great care was exercised in the matter. At certain stations samples were drawn from bags of maize consigned to Durban and Capetown about an hour before dispatch, three bags, duly marked, in each consignment being chosen, one at the top of the truck, another in the centre, and the third at the bottom, so as to check the influence of sun and atmosphere. These samples were forwarded in hermetically sealed tins by the station masters concerned to the Chief Inspector of Grain at Pretoria, who tested them for their moisture content. The same test was applied by the grain graders at the ports, who drew samples from the marked bags immediately on their arrival. The result of the test is set forth in the following statement from the Chief Inspector of Grain:—

RECORD OF MOISTURE TESTS FOR GRAIN ELEVATOR INQUIRY.  
Conducted by Chief Inspector of Grain.

Truck No.	Sending Station.		Port of Arrival.		Results of Tests at Pretoria.			Tests at Ports.			Class and Grade of Maize.	Consignee.	Consignor.	Weight per Bushel.			
	Date.	Time.	Name.	Date.	Name.	Date.	Time.	Top Bag.	Middle Bag.	Bottom Bag.					Top Bag.	Middle Bag.	Bottom Bag.
28346	7.10.19	p.m. 10.0	Kroonstad	13.10.19	Durban	9.10.19	2.0	10.0	11.6	Per Cent.	9.4	11.6	13.2	F.W. 3	60	Murray & Co.	Inland Products Co.
27757	17.10.19	12.30	Frankfort	21.10.19	Durban	20.10.19	2.0	11.0	10.0	Per Cent.	9.6	10.8	9.8	10.4	60	Murray & Co.	Frankfort P. Mart.
5529	27.10.19	—	Leeuwdoorn	4.11.19	Durban	29.10.19	2.0	7.7	8.2	Per Cent.	6.8	9.6	10.0	8.4	58	Murray & Co.	Bonner & Co.
3881	4.11.19	—	Bethal	10.11.19	Durban	6.11.19	2.0	10.5	10.4	Per Cent.	9.6	12.2	11.2	10.8	56	Morton & Co.	Postenstein & Co.
28502	6.12.19	a.m. 10.20	Leeuwdoorn	9.12.19	Cape town	9.12.19	2.30	9.3	9.7	Per Cent.	9.5	9.3	10.3	12.0	59	Liberman & Burski	Wolmaranstad Co
5763	12.12.19	8.20	Coligny	20.12.19	Durban	17.12.19	2.30	10.0	8.5	Per Cent.	9.5	10.4	10.2	10.2	56	Hayne & Co.	Mangelsdorf & Co.

## THE POULTRY YARD MONTH BY MONTH.

By J. J. JORDAAN, Lecturer and Instructor in Poultry, Glen, Orange Free State.

### July.

#### *Breeding Pens.*

In the breeding pens, one hen in the heavy and two in the light breeds may be added to the number if the fertility has been good, say 80 per cent. Do not neglect the male bird but continue his special feeding and keep him in good condition by feeding him separately from the hens.

#### *Feeding.*

Remember birds eat more in cold than in warm weather. Owing to the extreme cold, nature demands a good deal from the bird, to keep up its bodily heat and energy, and also to produce eggs; this all demands abundance of good food. Green food *must be fed* if eggs are to be forthcoming—see that they get it.

#### *Incubation.*

Incubation should be the order of the day, but in your eagerness for numbers of chicks do not become careless, but remember that the quality of the birds and eggs later on will be according to the care given the testing and grading of the eggs for incubation. Disinfect the machine each time a hatch comes off, thoroughly wash with some disinfectant, inside and out. Do not forget the drying box. Before putting in the fresh eggs also submit it to the formalin treatment. (See April notes.)

The colder the night the more reason why the incubator room and chick brooders should be visited before you retire to rest.

#### *Chickens.*

Chicks four weeks old and upwards, until they are eight weeks old, should now be taken off the oatmeal feeding and fed as follows (dry for preference and only moistened occasionally as a change):—

*Early morning mash*: 1 part oatmeal, 1 part mealie meal, 4 parts bran, and 6 parts lucerne-hay.

Every three hours following the mash, feed alternately:—Cracked wheat, cracked kaffir corn, cracked mealies, Japanese millet.

Grit, oyster shell, and fine charcoal should be before them constantly and green foods as often and as much as possible.

Keeping the brooder sleeping quarters well aired during the day, by opening the lid and letting the sun into the brooder, and keeping the floor scrupulously clean, will also ensure health.

#### *Runs.*

The ground in the chicken runs should be sown with some fast growing plant or shrub, such as rape or barley, to act as shade and windbreaks for the chicks when taken from the brooders. This will be found most necessary during August and September when wind will play havoc with the chicks unless they are protected.

#### *Disease.*

Roup and colds are most common now, especially if sleeping quarters are badly ventilated or overcrowded. A piece of asafoetida and camphor, each of the size of a walnut, tied up in a rag along with a small stone, and kept in the drinking water, will ward these off to a large extent.



## THE VEGETABLE GARDEN.

July, 1920.

By H. B. TERRY, Cert.R.H.S., Lecturer in Horticulture, School of Agriculture  
Potchef-stroom.

THIS is the coldest month of the year, and frosts may be expected every night, especially on the high veld. It will be practically impossible to raise seedlings in the open except in sheltered positions. Frames or pits should be used for raising a few early plants of cabbage, tomato, marrow, and cucumber. In tropical districts where frost is rare, French beans, marrows, cucumber, sweet corn, tomato, etc., are sown or transplanted for early or succession crops.

**ARTICHOKES.**—Jerusalem Artichokes may be planted now. The tubers should be planted as soon after lifting as possible as they do not keep well out of the ground.

**ASPARAGUS.**—New crowns should be planted this month: established beds should be well forked over and given a top dressing of well rotted stable manure or kraal manure if not already done.

**RHUBARB.**—Winter (Topp's Crimson) will continue to give a supply of stalks if kept watered; crowns of the summer varieties should be planted now. Established crowns may be forced by placing old cement barrels or paraffin tins with tops and bottoms knocked out over the crowns; pack stable manure around the covers and loosely cover over the tops. Give plenty of water.

**SEAKALE AND CHICORY** may be forced in a similar manner to rhubarb.

**HERBS** such as thyme, marjoram, sage, and mint, should be divided and replanted.

**BROAD BEANS** may still be sown. If the earlier sown plants become frosted do not despair; they will break out again. In warm localities where growth is rapid, it is often necessary to nip out the growing point to cause the pods to set.

**CABBAGE.**—Sow a little seed of such early sorts as Surthead, Webbs' Emperor, Enfield Market, St. John's Day, Winningstad. Give a little protection until germinated.

**LETTUCE.**—Continue to sow Cos varieties. In warmer districts cabbage varieties may be sown again: Curled Neapolitan, Boston, Iceberg.

**PEAS.** Sow Stratagem, American Wonder, Gradus, Black-Eyed Susan, Marrow-fat. Lettuce or raddish may be sown between the rows if the peas are sown 3 feet apart in rows.

**ONIONS** may be sown for salads: next month will be early enough to put in main crop for summer.

**RADISH** may be sown for succession: try sowing with lettuce between the rows of peas.

**TOMATOES.**—Under cover, or in a sunken pit sow a tin of some early sort such as Carter's Sunrise, Earliest-of-all, Earliana, Bonnie Best; germination may be slow but strong plants will be available for early transplanting should an opportunity occur. After germination give plenty of light and air to harden the seedlings off.

**TURNIPS.**—Continue to sow for succession; supply plenty of water, as a check will ruin the crop. Keep a sharp lookout for Bagrada Bug and endeavour to suppress it.

**KOHL RABI** is harder than turnips and often succeeds where turnips fail; both White and Purple Vienna may be sown.

**SHALLOTS.**—Get these planted during the present month. Let the rows be one foot apart, about 6 inches between each bulb.

**POTATOES.**—It is too soon to plant, but the ground should be prepared, the sets obtained, and placed in shallow boxes to begin sprouting.

## NOTES FROM THE "GAZETTE."

Attention is drawn to the following matters of interest which appeared in the *Union Government Gazette*.

GAZETTE. (Abbreviations: "Proc."—Proclamation; "G.N."—Government Notice.)

No.	Date.	ITEMS.
1051	14/5/20	Under the Diseases of Stock Act (No. 14, 1911) the compulsory dipping of cattle in the three, five, and sixty day dip has been ordered by the Minister of Agriculture for portions of the Zoutpansberg, Paulpietersburg, Heidelberg, New Hanover, Barberton, Pretoria, Piet Retief, Ngotshe, Umzinkulu, Umvoti, and Lions River Districts. (G.N. Nos. 822, 881, 930, and 962).
1054	21/5/20	
1057	28/5/20	Dipping of cattle for East Coast Fever in the five-day dip has been made compulsory for certain farms in the Pretoria District. (G.N. No. 409.)
1051	14/5/20	The proposed demarcation of the Pajane Plantation, Tabankula District, is notified in terms of the Forests Act (No. 16 of 1913). (G.N. No. 837.)
1054	21/5/20	The Poortfontein Irrigation District, in the Divisions of Swellendam and Ladismith, has been declared as such, with the definition of the boundaries, by Proclamation No. 85, and the Lower Kaap Irrigation District in the Barberton District, with the definition of its boundaries, by Proc. No. 86.
1054	21/5/20	In terms of Sub-section (1) of Section five of the Fencing Act (No. 17 of 1912), the Governor-General has declared that as from 20th May, 1920, contributions to the cost of fencing are obligatory in the surveyed portion of the District of Port St. Johns specially acquired for European occupation. (Proc. No. 87.)
1054	21/5/20	On the request of the Divisional Council of Mafeking, the Governor-General has declared that Section thirty-six of the Stock and Produce Theft Repression Consolidation Act of 1893, shall come into operation for the Division of Mafeking as from 21st May, 1920. (Proc. No. 89.)
1054	21/5/20	A limited number of Government Scholarships, and the conditions under which these will be awarded, are notified in G.N. No. 893.
1054	21/5/20	The Stock Regulations, as far as the reporting of Stock Diseases is concerned, have been amended by G.N. No. 846; and the persons to whom and the periods within which the reports have to be made (as provided for in G.N. No. 1703 of 1919) are determined by G.N. No. 963.
1060	4/6/20	
1057	28/5/20	Demarcations of the Forest Reserves of Zomeikomst Plantation in the Pietersburg District, and of Harland and Heathercliff in the Uitenhage Division, have been notified in G.N. Nos. 910 and 911.
1060	4/6/20	Harkerville Forest Reserve, Knysna Division, with its demarcation has been proclaimed by G.N. No. 946.
1057	28/5/20	On account of the resignation of Mr. E. R. Montgomery, the Minister of Agriculture has approved of the appointment in his stead of Sir Arnold Theiler, K.C.M.G., as a member of the Advisory Committee of the Botanical Survey of the Union.
1057	28/5/20	Certain portions of the Indwe Sub-Division of the Wodehouse District, are proclaimed as an East Coast Fever Area under the Stock Diseases Act (No. 14 of 1911) and stock movements therein are restricted. (G.N. No. 929.)
1057	28/5/20	Up to the 9th July applications will be received by the Department of Lands, Pretoria, for the disposal on conditional purchase lease of certain farms in the Heilbron District (G.N. No. 917), and by the Secretary for Lands, c/o the Surveyor-General, Pietermaritzburg, in respect of certain farms in the Klip River and Dundee Divisions. (G.N. No. 919.)
1060	4/6/20	Semi-protection under the Scab Regulations has been extended to certain areas adjoining the Steynsburg Division as defined in the Schedule to G.N. No. 951.
1060	4/6/20	The Educational Standard for Apprentices entering the Government Farm, Groot Constantia, will be Standard VI, as from 1st June, 1920, instead of Standard IV. (G.N. No. 426.)

## RECENT AGRICULTURAL LITERATURE.

By PAUL RIBBINK, LIBRARIAN, DEPARTMENT OF AGRICULTURE.

### I.—UNION GOVERNMENT PUBLICATIONS.

#### MISCELLANEOUS REPORTS, ETC., OF INTEREST TO FARMERS.

*(Obtainable from the Government Printer, Pretoria.)*

Price per copy.	Number of Publication.
3s. 6d. Agricultural Census, 1918 : Statistics of Agricultural and Pastoral Production ... ..	U.G. 53—'19
2s. Census of the European White Races—Part IV. Conjugal Condition ... ..	U.G. 52—'19
3s. Grain Elevators for Union of South Africa. Report of Wm. Littlejohn Philip, Esq., O.B.E. ... ..	U.G. 3—'20
9d. International Labour Conference at Washington. Report of South African Government Delegate ... ..	U.G. 27—'20
3s. 6d. Land and Agricultural Bank of South Africa. Report for the year 1919 ... ..	U.G. 33—'20
9d. Returned Soldiers. Reports dealing with the subject of returned soldiers and the assistance granted to them for period 1st September, 1918, to 31st December, 1919 ...	U.G. 22—'20
7s. 6d. Statistics of Production. Statistics of Factories and Productive Industries (excluding Mining and Quarrying) in the Union for the year 1917-1918 (3rd Industrial Census, 1919) ...	U.G. 17—'20

### II.—THE AGRICULTURAL PRESS OF SOUTHERN AND TROPICAL AFRICA.

#### SELECTED ARTICLES.

*Die Boer* (Bijvoegsel tot "De Volkstem"), Pretoria.

7/5/20 Dr. Theiler oor Gallamsiekte. Landbou in ons Leerplan : Lesing gehou deur Mnr. J. C. Faure.

14/5/20 Boerderij in 1919.

*Die Boerevrou* (Posbus 984, Pretoria).

4/20 Spesiale Mielienummer : "Die Mieliedogter." Die Mielies van Nooitgedag, deur E. N. Marais. Die gebruik van Mielies in die Nijwerheid. Mieliestrooihoede. Mielies als Voedsel. deur J. van Duyn.

*Farmers' Advocate, South African* (P.O. Box 247, Bloemfontein).

5/20 Conquering the Locusts. With Pen and Camera at Shows. How to grow Winter Food for Dairy Cows—IV : Hay, by W. Clarke.

*The Farmers' Journal* (Nairobi, B.E.A.).

22/4/20 A Flax Disease (Flax Wilt). Limestone, Lime and Cement, by Mancunian. Silkworm Rearing.

29/4/20 Citrus Nursery (*continued*) by E. Bester. Hydraulic Ram Pumps, by H. F. Birchall. Administration of Medicine to Animals, by L. H. Saunders.

*The Farmers Weekly* (Bloemfontein).

- 5/5/20 Farm Furniture, III, by "Waterberg". Tips on Irrigation—II, by C. H. Warren. Artificial Incubators, by Malcolm Macfarlane.
- 12/5/20 Home-Made Farm Appliances, by Geo. Morgan. The Cotton Crop, by W. B. Wilson. Plant-Poisons, by W. T. Mitchell, M.R.C.V.S.
- 19/5/20 The Conquest of Snake Venom, by F. W. Fitzsimons, F.Z.S. Plant-Poisons (*continued*).
- 26/5/20 Birds: Their Value to Man, by F. W. Fitzsimons, F.Z.S. Tips on Irrigation—III. The Curing Season. Farm Furniture—IV.

*Die Landbou Weekblad* (Posbus 267, Bloemfontein).

- 5/5/20 Die Friesland Ras.
- 12/5/20 Boeresaanwerk, deur A. P. J. Fourie. Turkse-Tabakbon, I, deur P. Koch, B.Sc.
- 19/5/20 Landbou-opvoeding in die Skole, deur Prof. A. M. Bosman.
- 26/5/20 Rogverbouwing, deur G. J. Bosman. Landbouwonderwijs in Middelbare Skole.

*South African Dairyman* (P.O. Box 925, Durban).

- 5/20 The Making of Cheddar Cheese, by B. L. de Klerk. Practical Pig-keeping.

*South African Farm News* (P.O. Box 963, Johannesburg).

- 1/20 Bacteria in Cheese. Spraying for Fungous Diseases.

*South African Fruit Grower and Small Holder* (P.O. Box 3958, Johannesburg).

- 5/20 Reminders for the Incoming Month, by H. B. Terry. Mistakes in Lemon Cultivation, by A. E. Bester. Why some Orchards are not Profitable.

*South African Gardening and Country Life* (P.O. Box 3958, Johannesburg).

- 5/20 South African Birds of Economic Value, by R. G. and E. Warren. Shrubs for Small Gardens. Some May Garden Suggestions, by Peter. Amateurs Attempt a Home and Garden, No. 13. Fruit, B.

*South African Journal of Industries* (Government Printer, Pretoria).

- 5/20 The Union's Trade in 1919, by H. K. Vere-Hodge. Wood-charcoal and its Manufacture, by J. J. Kotze. The Industries of Pretoria. Transport Methods in South African Rural Transport, by Sir Wm. Hoy, Kt., C.B. *Datura Stramonium*.

*South African Poultry Magazine* (Bloemfontein).

- 5/20 South of the Hex, another little Rock Argument, by L.A.C. Wm. A. Bartlett, Esq., R.E.S.S. South African Poultry Association: Official Minutes of the Sixteenth Annual Conference, Pretoria, November, 1919.

*South African Poultry Review and Small Holder* (Johannesburg).

- 5/20 Utility *versus* Fancy. A Hen's Egg-Producing Potentialities, Mr. Hogan's Mathematical System, by W. N. Horne. Hints on Rearing Chicks, by Sebright. Poultry Clubs and Shows: Suggestions for Organization and Conduct (*continued* from April issue), by P. H. Taylor. Fancy *versus* Utility, by Drastic.

*South African Sugar Journal* (P.O. Box 925, Durban).

- 5/20 The Increased Price for Sugar. Empire Sugar. A Fertilizer Transaction. Notes on the Cotton Industry, by W. B. Wilson, B.Sc. Agric.

*The Sun and Agricultural Journal of South Africa* (P.O. Box 634, Johannesburg).

- 5/20 The Hartebeestpoort Suspension Bridge. South African Maize Breeders', Growers', and Judges' Association: Report of General Meeting, 1st April, 1920. Fixing the Prices of Foodstuffs—II, by B. J. Bourke. South African Grain Trade Association, by C. E. Wilson. Makers of South African Agriculture: W. J. Palmer, B.Sc.

*Sunday Times* (Farmers' Supplement) Johannesburg.

- 9/5/20 Sudan Grass, by G. J. Bosman. Fruit Growing in Natal, by Spoorweg. Turkey Rearing, by Malcolm Macfarlane.  
 16/5/20 Farming and Stock Raising in Rhodesia, by Pioneer. Vegetable Oils and Oilseeds, by S. H. Doyle (*continued*). Importance of Spraying. How to Calve a Cow, by A. Hodder (*continued*).  
 23/5/20. What we Want from the Farmer—IV, Sheep. Planting Orchard Trees, by J. M. Sim. The Elevator System. Grain Production in South Africa, by M. Edward.  
 30/5/20 Sunflower as a Crop, by G. J. Bosman. Tobacco Culture in South Africa, by W. E. Leigh. The Rosella, by Delver. Some Facts about Goats.

*The Week End* (P.O. Box 413, Pietermaritzburg).

- 8/5/20 Glanders and Farcy. Water and the Wand. Problem of Desiccation.  
 15/5/20 Undesirable Stallions. Rotation of Crops. Chicken Production.  
 22/5/20 Facts about Fertilizers—IV. Breeding for Tick Immunity. Cultivation of Flax.  
 29/5/20 Organization of Farmers. Cultivation of Buckwheat. Making Cheddar Cheese.

### III.—AGRICULTURAL PUBLICATIONS IN OTHER PARTS.

#### REVIEWS AND EXTRACTS.

*The Mating and Breeding of Poultry*, by H. M. Lamon and R. R. Slocum. This is a new book published by the Orange Judd Co., New York (Kegan Paul & Co., London). The subject is one which has not yet been dealt with so exhaustively, and coming from two practical poultry men in the Bureau of Animal Industry of the United States Department of Agriculture, it should prove exceedingly valuable to all poultry breeders. The book aims at placing at the disposal of breeders a guide for the production of such types of birds as have been standardized in the *American Standard of Perfection*. Methods of the most successful breeders are given, and the most likely tendencies and defects which may prove troublesome are indicated and emphasized. The work is divided into the following chapters which sufficiently indicate its scope:—Definition of Common Breeding terms; Principles of Breeding; Breeding for Increased Production; and the following classes of Poultry. American, Asiatic, Mediterranean, English, Polish, Hamburg, French, Continental, Game and Bantam, Oriental, Ornamental Bantam; Miscellaneous, and Preparing Fowls for the Show. The book is profusely illustrated, contains 368 pages, bound in cloth, and costs \$2.50 net, from the Orange Judd Co., 315-321 Fourth Avenue, New York.

*Farming for South African Schools*—Book I, by Rev. W. G. Dowsley, B.A., published in English and Afrikaans, by De Nationale Pers Beperkt, Capetown, at 4s. 9d. per copy, is one of the most useful and needed books published in recent years. It is to be followed by other books of a similar nature and will not only comprise a complete course for the average scholar of the upper standards of the primary school, but will be invaluable to the teacher at primary schools and normal colleges, as well as to practical farmers. Book I introduces us to agriculture, treats on the soil, tillage, and implements, and additions to the soil. Further chapters deal with fruit trees, pruning, forest trees, and vegetables. A feature of the book is the numerous excellent illustrations, and it certainly should find a place on the bookshelf of every South African farmer and student.

## AT THE SCHOOLS OF AGRICULTURE AND EXPERIMENT STATIONS.

May, 1920.

CEDARA, NATAL.

*Climatic.*—The rainfall for the month was 0.56". The mean maximum temperature was 69.37° F. and the mean minimum temperature 47.94°. The highest maximum, 76.8°, was reached on the 9th and the lowest minimum, 32.5°, on the 28th.

*Crops.*—A large quantity of silage maize has been cut, and grain maize is being cut and stooked in the field. The crop is somewhat below expectations owing to the cold experienced in February. Cowpeas have been cut and made into hay, the yields being poor owing to leaf rust. The millet and sunflowers have been cut. Turnips, kale, and rape are making excellent growth and should provide much fresh feed during winter months. The veld grass is still yielding good grazing and a large quantity has been cut and made into hay.

*Field Experiments.*—The experimental plots of grass have been harvested. The Kikuyu gave an excellent yield and responded well to fertilizers. Tall fescue gave satisfactory results, and a fairly heavy yield of succulent fodder; cocksfoot yielded less than the others, being affected by rust. The experiment with cowpeas for rust resistance indicates superiority of the New Era variety.

*Stock.*—The stock as a whole are doing well owing to the mildness of the season and the good condition of the veld. The show and sale cattle are now receiving special attention. Eleven calves were born during the month, three Friesians (two bulls and one heifer) two Ayrshires (heifers) three Aberdeen-Angus (two bulls and one heifer) three shorthorns (one bull and two heifers).

*Dairy Conference.*—The Second Annual Dairy Conference was held on the 21st, and was well attended, about 200 visitors being present. After the stock was inspected the Principal gave a demonstration lecture on "Types of Dairy Cattle," typical examples of each being brought before the audience and the various points illustrated. After lunch the visitors inspected a display of dairy utensils and of various kinds of foodstuffs and fodder. The Dairy Instructor lectured on "Variations in Tests of Cream and Milk," the Chemist on "Fees and Feeding," and Mr. Angus on "Some Factors in Milk Production."

*Chemical Laboratory.*—The routine analytical work on samples sent in by the public was very heavy, being chiefly soils, tanning materials, and toxicological materials. The latter were almost all ingesta and organs of beasts, the cause of death in each case evidently being arsenic. The large number of such samples constantly received here for examination shows that comparatively large numbers of stock are lost from this cause, often due to criminal actions of servants, but also sometimes caused by the negligence of farmers themselves.

A consignment of Gerber Butyrometers manufactured by a British firm was tested for accuracy of graduations, in accordance with the regulations of the Dairy Act. Most of them were found to be very inaccurate and the dealer was advised to return the whole consignment to the manufacturers.

*Entomology.*—Complaints were received during the month from various parts of Natal of the depredations of certain species of caterpillars on vegetables, winter potatoes having suffered severely. The caterpillars closely resemble the army worms, and farmers are inclined to consider them the same, but, although nearly allied, they are not the army worms proper. Spraying with a mixture of 1½ lb. of arsenate of lead powder in 40 gallons of water is recommended.

## ELSENBURG, MULDER'S VLEI, CAPE.

*Climatic.*—Good soaking rains fell early in the month and also in the latter part, the total precipitation being 4.97 inches, one inch more than the normal average for May. Except for a few days, rather cold weather prevailed. The maximum temperature recorded was 84.3° F. on the 20th, and the minimum 42.6° F. on the 24th.

*Field Operations and Crops.*—Considerable ploughing, harrowing, and sowing were carried out during the month both at Elsenburg and Mariendahl, oats, rape, and vetches being the chief crops put in. It is anticipated that all the seeding operations will be completed within the first two weeks of June. Practically the entire seeding for the 1920 manurial and fodder experiments and variety trials, has been completed.

A large part of the horticultural area was ploughed, and the greater part of the main orchard was planted with field peas for green manure. About 1700 lb. of dried fruit was disposed of.

*Live stock.*—The condition of the live stock on both farms is satisfactory, except at Mariendahl, where the young stock are rather backward. The milk yield at Elsenburg showed a slight increase toward the end of the month.

Half of the new intensive poultry house is now in occupation, 118 hens and pullets having been placed therein.

*Experimental and Investigational Work.*—The 1920 field experiments are in full swing at present, also two manurial experiments in the orchard. A considerable amount of investigational work is in progress in the scientific and other sections of the Institution.

*Extension Work.*—Several external lectures were delivered by various members of the staff, and a number of farms was visited for the purpose of giving advice *re* crops, stock, etc. A party of Australian troops visited the Institution on the 13th instant, and was shown the different divisions.

*School.*—Student work, both theory and practical, is progressing very satisfactorily. At present the students are writing their second quarterly examinations.

## GROOTFONTEIN, MIDDELBURG, CAPE.

We regret to state that a disastrous fire occurred at the Grootfontein School of Agriculture on the night of the 24th May, 1920, when the building used as an office was destroyed. Unfortunately many valuable records were lost and the work of the Institution was greatly interfered with, so that the usual monthly notes will need to be left over this month.

## POTCHEFSTROOM, TRANSVAAL.

*Climatic.*—The weather during May was exceptionally mild. The minimum temperature did not reach freezing point until the 27th. This was followed by a cold snap on the morning of the 28th, when 8 degrees of frost were registered. Welcome rains fell between the 12th and 15th, totalling 0.63 inches. The rain was of great assistance in obtaining a good tilth on land intended for winter cereals and lucerne.

*Farm Section.*—Good progress was made in the preparation of land for winter cereals and next season's maize crops. In all, 112 acres were ploughed, 81 acres harrowed twice, and 81 acres rolled. Approximately 140 acres will be sown to winter cereals, viz., 54 acres to varieties of wheat, 54 acres to Algerian cats and 32 acres to other varieties of oats, emmer wheat, and early rye. Wherever possible, all land to be sown to maize and other crops in the spring is being broken up now. During the month 54 acres were sown to

Algerian oats, and 27 to huerne. The seeding of the wheat crop was, according to approved practice on this station, left over to the first week in June. Sixty tons of maize silage was made and 30 acres of the maize grain crop harvested. The whole crop of Potchefstroom Pearl, Eureka, and Chester County Mammoth will be selected by hand for seed. There is every promise that a fair quantity of first-class seed grain will be obtained this season.

*Live stock Section.*—Four aged cows and one cross-bred steer were disposed of to the butcher. Nine calves were born during the month including a few Herefords. Spring calves from the beef breeds have been weaned. Calves are all in good growing condition. Thus far 53 lambs have been dropped from the Waugatella stud flock, and are doing excellently. Thirteen pigs were disposed of for breeding purposes.

In connection with the cross-breeding experiments with Afrikander and Sussex Cattle, measurements of individuals of the two parental breeds and the two filial generations were taken. In the former instance, the original Afrikander dams, where still available, were also measured.

*Experimental and Investigational Work.*—Varieties of kaffir corn were harvested. Samples of pure seed from self-fertilized heads were cleaned and stored, and the seed of those heads hybridized by hand. The two acres of land under kaffir corn were ploughed and cleared of all stalks to prevent the spread of the maize stalk borer. Harvesting of maize in the rotation experiments was undertaken and also the cultivation, manurial, rates of seeding, and hybridization tests. Varieties of cowpeas, beans, and summer wheats (hybrids) were harvested. The latter are being tested in order to determine their rust-resisting qualities under our summer conditions. Velvet beans were turned in early in the month on certain ranges which were sown to varieties of wheat later in the month.

In the breeding cage, beds were prepared and sown to various crosses of wheat in their first and second generations. The extension to the plant breeding cage has nearly been completed.

Trials by the Entomologist on the eradication of ants in houses yielded results which showed that poisonous bait containing antimony potassium tartrate was fairly effective. A mixture containing 2 grammes of this substance and 30 grammes sugar to 100 c.c. water was used. Search for the maize stalk borer showed very few first generation larvae, but a heavy infestation of second generation larvae was found. The rooting out and burning of maize stalks before spring sets in with the object of reducing injury by this pest in the ensuing season, becomes yearly more necessary.

*Horticultural Section.*—The whole orchard has been cross-ploughed and brought into good order. It was found necessary, owing to the early dry weather, to irrigate all young trees.

*Poultry Division.* The output of eggs in the Egg Laying Competition was very gratifying, early in the month, but there was a reduction during the latter part. The explanation for this cannot be readily found unless it be the rain which fell at the middle of the month. Stock birds are doing well and the egg yield from these has been very good for this time of year. Chickens are coming along splendidly. Never in the history of the station has there been such a fine, well-grown crop of chickens at this time of year.

*Extension Work.*—Various members of the staff, officiating in most cases as judges, visited the following shows during the month:—

Klerksdorp, 18th and 19th; Lichtenburg, 21st; Zeerust, 20th and 21st; Wolmaransstad, 26th and 27th; Haenertsburg, 27th; Pretoria, 31st.

A representative exhibit of cattle was sent to the Klerksdorp show and the Crop Exhibit from the Farm and Experimental Sections, was staged at the Zeerust show.

---

We advise you to get each copy of the *Journal* and to keep it. A full index will be sent every six months to each subscriber. Experience proves the *Journal* to be a useful book of reference. It will be so in the future. Every farmer is asked to get the *Journal* and not to lose it. It is likely that some day, in answer to an inquiry, you may be referred to an article in the *Journal*. Keep your *Journal*!



## MEAT STATISTICS.

## I.—RETURN OF BEEF INSPECTED AND PASSED FOR EXPORT, MAY, 1920.

Place.	Cattle.			Carcasses.		
	Inspected.	Rejected.	Passed.	Inspected.	Rejected.	Passed.
Durban ... ..	3,956	—	3,956	3,956	229	3,727
Pietermaritzburg ...	1,570	—	1,570	1,570	65½	1,504½
Pretoria ... ..	—	—	—	—	—	—
Johannesburg ... ..	381	—	381	381	—	381
Bloemfontein ... ..	—	—	—	—	—	—
Capetown ... ..	282	—	282	282	47¾	234¾
Port Elizabeth ... ..	—	—	—	—	—	—
Germiston ... ..	—	—	—	—	—	—
TOTAL ... ..	6,189	—	6,189	6,189	342¼	5,846¾

Beef actually exported during the month of May, 1920: Total 12,938 quarters. (*Ex* Durban 11,985 quarters; *Ex* Capetown 953 quarters.)

Total shipments of Beef in quarters—

1916 ...	115,992	1918 ...	123,354	*1920 ...	34,648
1917 ...	309,214	1919 ...	285,367		

II.—OTHER MEAT EXPORTED\*: Pork, carcasses 1006; Bacon 79,160 lb.

III.—RETURN OF CATTLE IMPORTED INTO THE UNION FROM ADJOINING TERRITORIES.

Territory.	Imported May, 1920.	Total from 1st January, 1920, to 31st May, 1920.
		No.
For Slaughter—	No.	No.
Rhodesia ... ..	2,524	9,378
Bechuanaland Protectorate	1,633	8,882
S.-W. Africa ... ..	783	5,149
Swaziland ... ..	25	648
Basutoland ... ..	—	—
For Breeding—		
Rhodesia ... ..	917	5,175
Bechuanaland Protectorate	1,557	7,766
TOTAL ... ..	7,439	36,998

## SUMMARY OF IMPORTS.

Calendar Year.	For Slaughter.	For Breeding.	Total.
	No.	No.	No.
†1916	26,580	—	26,580
1917	47,970	5,440	53,410
1918	36,767	13,286	50,053
1919	40,574	16,693	57,267

\* Total from 1st January to 31st May, 1920.

† 1st July to 31st December only.

## CROP AND LIVE STOCK REPORT.

### May, 1920.

#### MAIZE.

Reports received from correspondents disclose a further decline of 2 per cent. in the condition of the crop at 31st May, 1920, and the estimated production for this season is expected to be 9,984,000 bags.

While an improvement of 1 per cent. is reported in the Transvaal there has been a decline in the Cape Province of 5 per cent., and 3 per cent. both in Natal and the Orange Free State. For the whole Union the crop is averaged at 22 per cent. below normal. Frosts in varying degrees of intensity have been reported from practically every part except the coastal and the low-lying regions. In the Border districts of the Cape Province droughty conditions were prevalent. As far as pests and insects are concerned these appear to be singularly absent, the only exceptions being a few isolated spots in the Transkei, and Standerton in the Transvaal.

#### KAFFIR CORN.

The condition of this crop at 31st May, 1920, is practically identical with that reported at the end of the previous month. The total production this season is estimated to be 1,132,500 bags.

#### TOBACCO.

As compared with the previous month, reports received show a further decline of 1 per cent. in the crop condition for the Union, the estimated production at 31st May, 1920, being placed at 8,897,200 lb.

#### BEANS.

According to the 1918 census which represented the actual production for the 1917-18 season, the quantity produced in the Union was 256,472 bags.

Taking these figures as a basis an estimate has been framed from which it appears that the Union is likely to produce this season 251,300 bags.

Taking the Union as a whole, the area under cultivation for 1919-20 as compared with 1917-18 (i.e. two years previously) showed a decline of 4 per cent. In the Transkei there was an increase of 4 per cent., and 3 per cent. in the Transvaal, whereas smaller quantities were cultivated in other parts of the Union.

### CONDITION OF LIVE STOCK.

Compiled from Reports furnished by Sheep and Stock Inspectors.

Area.	Large Stock.	Small Stock.
CAPE—		
South-West ... ..	<i>Medium to poor</i> ... ..	<i>Medium to poor.</i>
North-West ... ..	<i>Good to medium.</i> Fat in parts	<i>Good to medium.</i> Fat in parts.
South Coast ... ..	<i>Good to medium.</i> Fat in parts	<i>Good to medium.</i> Fat in parts.
Southern Karroo ... ..	<i>Good to medium</i> ... ..	<i>Good to medium.</i>
Central Karroo... ..	<i>Fat to good</i> ... ..	<i>Fat to good.</i>
Northern Karroo ... ..	<i>Fat to good</i> ... ..	<i>Fat to good.</i>
Eastern Karroo ... ..	<i>Good.</i> Fat in parts ... ..	<i>Good.</i> Fat in parts.
Bechuanaland ... ..	<i>Fat to good.</i> Medium in parts	<i>Fat to good.</i> Medium in parts.
Griqualand West ... ..	<i>Good.</i> Fat in parts ... ..	<i>Good.</i> Medium in parts.
North-Eastern ... ..	<i>Fat to good.</i> Medium in parts	<i>Good.</i> Fat in parts.
Border ... ..	<i>Good to medium.</i> Fat in parts	<i>Good to medium.</i> Fat in parts.
Transkeian Territories...	<i>Good to medium.</i> Fat in parts	<i>Good to medium.</i> Fat in parts.

Area.	Large Stock.		Small Stock.	
<b>TRANSVAAL—</b>				
Eastern High Veld ...	<i>Good.</i>	Fat in parts ...	<i>Good.</i>	Fat in parts.
Central ...	<i>Good to medium.</i>	Fat in parts	<i>Good.</i>	Fat in parts.
Western High Veld ...	<i>Good.</i>	Fat in parts ...	<i>Good.</i>	Fat in parts.
Low Veld ...	<i>Good.</i>	Fat in parts ...	<i>Good.</i>	Fat in parts.
<b>ORANGE FREE STATE—</b>				
North-Eastern ...	<i>Good to medium.</i>	Fat in parts	<i>Good.</i>	Fat in parts.
North-Western...	<i>Good.</i>	Fat in parts ...	<i>Good.</i>	Fat in parts.
South-Eastern ...	<i>Good.</i>	Fat in parts ...	<i>Fat to good.</i>	
South-Western ...	<i>Good.</i>	Fat in parts ...	<i>Good.</i>	Fat in parts.
<b>NATAL—</b>				
High Veld or Highlands	<i>Good.</i>	Fat in parts ...	<i>Good.</i>	Fat in parts.
Middle Veld or Midlands	<i>Good.</i>	Fat in parts ...	<i>Good.</i>	Fat in parts.
Coast ...	<i>Good.</i>	Fat in parts ...	<i>Good.</i>	Fat in parts.

## SOUTH AFRICAN PRODUCE ON THE OVERSEA MARKET.

April, 1920.

OWING to pressure of other duties, the Acting Trade Commissioner in London states that he is unable to furnish for the month of April, 1920, the usual detailed monthly report on South African produce on the oversea markets. He reports, however, under date of the 8th May, 1920, that a big slump has apparently set in in all classes of raw materials. For instance, wool has dropped 10 per cent.; hides have been offered on auction and elicited practically no bids; ostrich feathers have declined, and large stocks of wattle bark are on the market for which no offers can be obtained, or at prices which will show a loss. Mr. Canham states that general opinion in London is that speculation has taken place and prices early in the year reached such a level that the buyers now show no tendency to operate, while one of the principal factors in the depression prevailing is the adverse rate of exchange which practically debars Continental firms from purchasing supplies of raw materials in London.

## STAFF: APPOINTMENTS, TRANSFERS, ETC.

DATE.	NAME OF OFFICIAL AND NATURE OF CHANGE, ETC.
1/4/20	<i>Sir A. Theiler, K.C.M.G.</i> : Appointed as Director of Veterinary Education and Research.
20/2/20	<i>Professor P. R. Viljoen</i> : Lecturer in Veterinary Science at the Transvaal University College, reappointed to the Department as a Senior Research Officer.
16/4/20	<i>District Veterinary Surgeon G. W. Lee</i> (Seconded to the South-West Africa Protectorate Administration): Resigned.
7/5/20	<i>C. Fuller</i> : Appointed Acting Chief, Division of Entomology, during the absence on special duty of Mr. C. P. Lounsbury attending Conference of Entomologists in England.
31/5/20	<i>J. C. Faure</i> : Entomologist, Department of Agriculture, resigned to assume Professorship in Entomology at the Transvaal University College.

# LOCAL MARKET PRICES.

## RATES OF AGRICULTURAL PRODUCE AND STOCK RULING AT THE 15TH JUNE, 1920.

CENTRE.	Wheat, Per 200 lb.		Wheat Flour, Per 100 lb.		Boer Meal, Per 200 lb.		Mealies, Per 200 lb.		Mashed Meal, Per 150 lb.		Barley, Per 150 lb.		Oats, Per 150 lb.		Incerne Hay, Per 100 lb.		Potatoes, Per 150 lb.																	
	Min.	Max.	Min.	Max.	Min.	Max.	Min.	Max.	Min.	Max.	Min.	Max.	Min.	Max.	Min.	Max.	Min.	Max.																
	s. d.	s. d.	s. d.	s. d.	s. d.	s. d.	s. d.	s. d.	s. d.	s. d.	s. d.	s. d.	s. d.	s. d.	s. d.	s. d.	s. d.	s. d.	s. d.															
<i>Cape Province</i>																																		
Alival North†	70	0	75	0	80	0	36	0	35	0	35	0	33	6	21	0	21	0	12	6	30	0	30	0										
Beaufort West...	85	0	87	6	—	—	28	0	22	0	24	0	27	6	28	0	13	0	13	6	12	0	12	6										
Capetown.....	—	—	—	—	—	—	28	0	33	0	26	0	29	0	24	0	15	0	16	6	13	0	15	0										
East London.....	80	0	90	0	52	6	98	0	100	0	—	—	—	—	—	—	—	—	—	—	—	—	—	—										
Kimberley.....	—	—	—	—	—	—	25	6	30	6	—	—	—	—	—	—	—	—	—	—	—	—	—	—										
Kingsburgh.....	—	—	—	—	—	—	26	0	31	0	—	—	—	—	—	—	—	—	—	—	—	—	—	—										
Port Elizabeth.....	70	0	72	6	41	3	41	6	70	6	36	9	37	9	38	6	39	0	42	6	45	0	35	9										
<i>Valley</i>																																		
Durban.....	—	—	—	—	—	—	21	0	28	0	19	0	25	0	—	—	—	—	—	—	—	—	—	—	—									
Pietermaritzburg.....	—	—	—	—	—	—	25	0	26	0	28	0	29	0	—	—	—	—	—	—	—	—	—	—	—									
<i>Orange Free State</i>																																		
Bloemfontein.....	80	0	90	0	50	0	100	0	120	0	24	6	31	0	28	6	35	0	38	6	45	0	29	0	33	0	12	6	18	0	18	6	25	8
Harrismith.....	60	0	65	0	45	0	87	6	87	6	20	6	23	0	23	0	30	0	30	0	30	0	27	6	10	0	10	0	10	0	10	0	10	0
<i>Transvaal</i>																																		
Pretoria.....	75	6	75	6	—	—	21	9	22	9	21	6	21	6	23	0	25	0	25	0	25	0	25	0	25	0	25	0	25	0	25	0	25	0
Johannesburg.....	—	—	—	—	—	—	20	6	25	9	21	6	21	6	23	0	25	0	25	0	25	0	25	0	25	0	25	0	25	0	25	0	25	0

CENTRE.	Onions, Per 120 lb.		Tobacco (Boer Roll), Per lb.		Beans, Per 200 lb.		Boet, Per lb.		Mutton, Per lb.		Fresh Butter, Per lb.		Eggs, Per dozen		Cattle (Slaught- ter), Each.		Sheep, Each.		Pigs, Each.																	
	Min.	Max.	Min.	Max.	Min.	Max.	Min.	Max.	Min.	Max.	Min.	Max.	Min.	Max.	Min.	Max.	Min.	Max.	Min.	Max.																
	s. d.	s. d.	s. d.	s. d.	s. d.	s. d.	s. d.	s. d.	s. d.	s. d.	s. d.	s. d.	s. d.	s. d.	s. d.	s. d.	s. d.	s. d.	s. d.	s. d.	s. d.															
<i>Cape Province</i>																																				
Alival North†	30	0	30	0	1	6	1	9	0	9	0	11	2	9	3	6	4	0	9	0	20	0	15	0	60	0	240	0								
Beaufort West...	25	0	22	0	0	5	1	0	0	11	1	3	0	11	3	8	4	0	15	0	26	0	50	0	63	0	60	0	200	0						
Capetown.....	36	0	33	0	56	0	80	0	0	11	3	0	11	3	2	6	11	3	2	6	11	3	2	6	11	3	2	6	11	3	2	6	11	3		
East London.....	30	0	33	0	0	10	1	0	0	9	1	0	9	1	0	9	1	0	9	1	0	9	1	0	9	1	0	9	1	0	9	1	0	9	1	
Kimberley.....	15	0	20	0	1	0	2	3	40	0	42	0	7	10	0	9	1	0	9	1	0	9	1	0	9	1	0	9	1	0	9	1	0	9	1	
Kingsburgh.....	30	0	36	0	54	0	78	0	0	10	0	11	0	11	0	11	0	11	0	11	0	11	0	11	0	11	0	11	0	11	0	11	0	11	0	
Port Elizabeth.....	—	—	—	—	—	—	—	—	—	—	—	—	—	—	—	—	—	—	—	—	—	—	—	—	—	—	—	—	—	—	—	—	—	—	—	
Queenstown.....	—	—	—	—	—	—	—	—	—	—	—	—	—	—	—	—	—	—	—	—	—	—	—	—	—	—	—	—	—	—	—	—	—	—	—	
<i>Valley</i>																																				
Durban.....	15	0	26	6	30	0	60	0	1	0	9	0	6	1	0	2	6	3	6	3	6	3	6	3	6	3	6	3	6	3	6	3	6	3	6	3
Pietermaritzburg.....	—	—	—	—	—	—	—	—	—	—	—	—	—	—	—	—	—	—	—	—	—	—	—	—	—	—	—	—	—	—	—	—	—	—	—	—
<i>Orange Free State</i>																																				
Bloemfontein.....	16	6	22	6	0	6	1	0	52	0	10	1	3	1	0	1	3	2	6	3	6	3	6	3	6	3	6	3	6	3	6	3	6	3	6	3
Harrismith.....	—	—	—	—	—	—	—	—	—	—	—	—	—	—	—	—	—	—	—	—	—	—	—	—	—	—	—	—	—	—	—	—	—	—	—	—
<i>Transvaal</i>																																				
Pretoria.....	17	6	23	0	—	—	30	0	45	0	0	1	2	0	7	2	0	9	1	1	2	5	2	6	3	3	4	3	4	3	4	3	4	3	4	3
Johannesburg.....	19	0	27	0	—	—	28	0	62	0	42	0	58	6	0	9	1	2	2	2	6	2	6	2	6	2	6	2	6	2	6	2	6	2	6	2

\* Live weight per lb. † Dressed weight, including hides, offal, etc. per 100 lb. ‡ Information not available.  
 NOTE.—The rates quoted for produce sold in bags include, as a general rule, an additional 3 lb. for weight of bag.  
 ERRATA.—Owing to a typographical error the price of beet at Pretoria on the 15th May, 1920 (*vide June Journal*), was shown as 4s. 8d. to 7s. 2d. instead of 4 s. 8d. to 7 s. 2d. per bag.

PRICE 5/-  
PER ANNUM.



# Journal

of the

Department of

# Agriculture

ISSUED BY AUTHORITY OF THE  
MINISTER OF AGRICULTURE.

## PRINCIPAL CONTENTS.

- Methods of Fire Protection.
- Poisoning of Cattle by Feeding on Ergotized Paspalum.
- The Agriculture and Soils of the Cape Province—III.
- Rodent Injury to Trees.
- Lamb Fattening.
- The Department of Agriculture during the War—IV.
- Turkeys.
- Food Value of Willow Leaves.
- Cigar-Tobacco Investigations.
- Development of Agricultural Machinery.
- Experiments and Investigations—VII.

PRICE **6D** PER COPY

## LIST OF BULLETINS AVAILABLE FOR DISTRIBUTION.

### Application to be made to the Department of Agriculture, Pretoria.

Applicants for bulletins are requested kindly to quote the *full number* of each, as shown hereunder, and to enclose also payment for same. The cost of each bulletin is indicated; those not marked are issued *gratis*.

#### LIVE STOCK.

##### POULTRY.

- Caponizing. By R. Bourlay, Poultry Expert, Potchefstroom Experimental Farm. U.R. 21/1912.
- Chicken Rearing. By J. J. Jordaan, Glen, Orange Free State. id. L.S. 58.
- Ducks, The Management of. By T. B. Cross, Poultry Instructor, School of Agriculture, Cedara. id. L.S. 12.
- Egg-laying Competition held at the School of Agriculture, Potchefstroom, Report on the Second. id. L.S. 9.
- Egg-laying Competition held at the School of Agriculture, Potchefstroom, Report on the Third. id. L.S. 43.
- Egg-laying Competition held at the School of Agriculture, Potchefstroom, Report on the Fourth and the First at Cedara School of Agriculture. id. L.S. 70.
- Egg-laying Competition held at the School of Agriculture, Potchefstroom, Report on the Fifth. id. L.S. 89.
- First Duck Egg-laying Competition, Cedara. id. L.S. 88.
- Egg Production. By Arthur Little, Lecturer in Poultry Keeping, Grootfontein. id. U.R. 37/1912.
- Eggs, Handling, Packing, Storage, and Transport of. By W. O. John, School of Agriculture, Elsenburg. id. L.S. 42.
- Egg Societies, Model Regulations for Co-operative. By J. Retief. L.S. 51.
- Incubation in South Africa. By R. Bourlay, School of Agriculture, Potchefstroom. id. L.S. 47.
- Poultry, Common Household Remedies for. By A. Little, Lecturer in Poultry, Grootfontein. 40/1912.
- Poultry Pests and How to Deal with them. By W. O. John, Lecturer in Poultry, School of Agriculture, Elsenburg. id. 12/1916.
- Poultry Yard Month by Month, The. By J. J. Jordaan, Lecturer and Instructor in Poultry, School of Agriculture, Glen, Orange Free State. id. L.S. 32.
- Poultry on the Farm in South Africa. By J. J. Jordaan. id. U.R. 84/1915.

[Continued on page iii of cover.]

# CONTENTS.

AUGUST, 1920.

	PAGE
METHODS OF FIRE PROTECTION ... ..	413
POISONING OF CATTLE BY FEEDING ON ERGOTIZED PASPALUM ... ..	422
CIGAR-TOBACCO INVESTIGATIONS... ..	427
THE AGRICULTURE AND SOILS OF THE CAPE PROVINCE ... ..	429
DEVELOPMENT OF AGRICULTURAL MACHINERY ... ..	442
RODENT INJURY TO TREES ... ..	445
FOOD VALUE OF WILLOW LEAVES ... ..	456
LAMB FATTENING ... ..	458
THE DEPARTMENT OF AGRICULTURE DURING THE WAR ... ..	463
TURKEYS ... ..	472
EXPERIMENTS AND INVESTIGATIONS ... ..	478
NOTES ... ..	480
Ostrich Feathers—Prickly Pear and Jointed Cactus Extirmination—Butter and Cheese—The World's Crops—Rat Poisons—Marketing of Meat : Facilities for Farmers—Interesting Railway Figures (page 426)—Railage of Sheep to Fresh Pasturage (page 428)—The Union's Summer Crops, 1919-20 (page 428)—Plant Nurseries in Quarantine for Pests (page 444) East Coast Fever in the Pretoria District (page 455)—South African Pork and Bacon (page 457)—Sale of Live Stock at Cedara School of Agriculture (page 490).	
STAFF : APPOINTMENTS, TRANSFERS, ETC. ... ..	488
THE POULTRY YARD MONTH BY MONTH ... ..	489
THE VEGETABLE GARDEN ... ..	491
NOTES FROM THE "GAZETTE" ... ..	492
SOUTH AFRICAN PRODUCE ON THE OVERSEA MARKET ... ..	493
OVERSEA PRICES OF SOUTH AFRICAN PRODUCE ... ..	495
RECENT AGRICULTURAL LITERATURE... ..	496
AT THE SCHOOLS OF AGRICULTURE AND EXPERIMENT STATIONS ... ..	500
MEAT STATISTICS ... ..	504
EXPORT OF GRAIN, ETC. ... ..	505
CROP AND LIVE STOCK REPORT ... ..	506
LOCAL MARKET PRICES ... ..	508

## DEPARTMENTAL NOTICES.

### FOREST DEPARTMENT.

#### TIMBER FOR SALE AT CEDARA PLANTATION.

Straight Gum Poles of various sizes from about six inches in diameter at the butt downwards may be purchased in small or large quantities from the Government Plantation, Cedara, Natal. Inquiries stating size of pole desired (length and smallest diameter under bark at the thin end) should be addressed to the Forester, Cedara, who will quote prices per pole put on rail at Cedara Station.

Firewood, fencing droppers, and fenceposts are also available.

#### GROOFFONTEIN SCHOOL OF AGRICULTURE.

The premises used as administrative offices at the Grootfontein School of Agriculture were destroyed by fire on the 24th May. As all records and correspondence were lost, applicants for entrance to courses, including the 1921 courses in Sheep and Wool and in Dairying, are asked to repeat their applications.

E. J. MACMILLAN,

*Under-Secretary for Agriculture.*

#### OLIVES.

A small quantity of Redding Olive Seeds is available for distribution in one lb. parcels, 1600 seeds to the lb.

The Redding is the best stock known on which to work the domestic varieties of olives. It is a rapid grower and makes a very fine root system. Trees grafted on the Redding will thrive over a bigger range of soil than if grafted on any other variety.

It is advisable on planting, to remove the pointed end of the seed, taking care not to injure the kernel. This will tend to give a far better and speedier germination than if the seeds are planted whole.

Application should be made to the Chief, Division of Horticulture, Department of Agriculture, Union Buildings, Pretoria.

#### SCHOOL OF AGRICULTURE AND EXPERIMENT STATION, POTCHEFSTROOM.

The following varieties of seeds are for sale. Applications stating the quantities of seed required should be addressed to the Principal of the above Institution not later than 31st August, 1920. Applicants are requested not to forward remittance until they have been informed of the quantities of seed allotted to them:—

*Maize*.—“Potchefstroom Pearl.” Also limited amounts of “Caester County Mammoth” and “Red Cob Congo.” Price: 30s. per 100 lb.

*Cowpeas*.—“Iron,” a medium late variety which has proved the heaviest yielder of hay and grain at the above station. Price: 3d. per lb.

*Monkey Nuts*.—“Virginia Bunch” and “Tennessee.” Price: 6d. per lb.

*Beans*.—“Tepary,” commercially termed “Small Haricot.” A very prolific and drought-resistant plant, suitable for edible purposes as a dry bean only. Price: 6d. per lb.

*Spineless Cactus Leaves*.—Newest varieties. Price: 3d. per leaf.





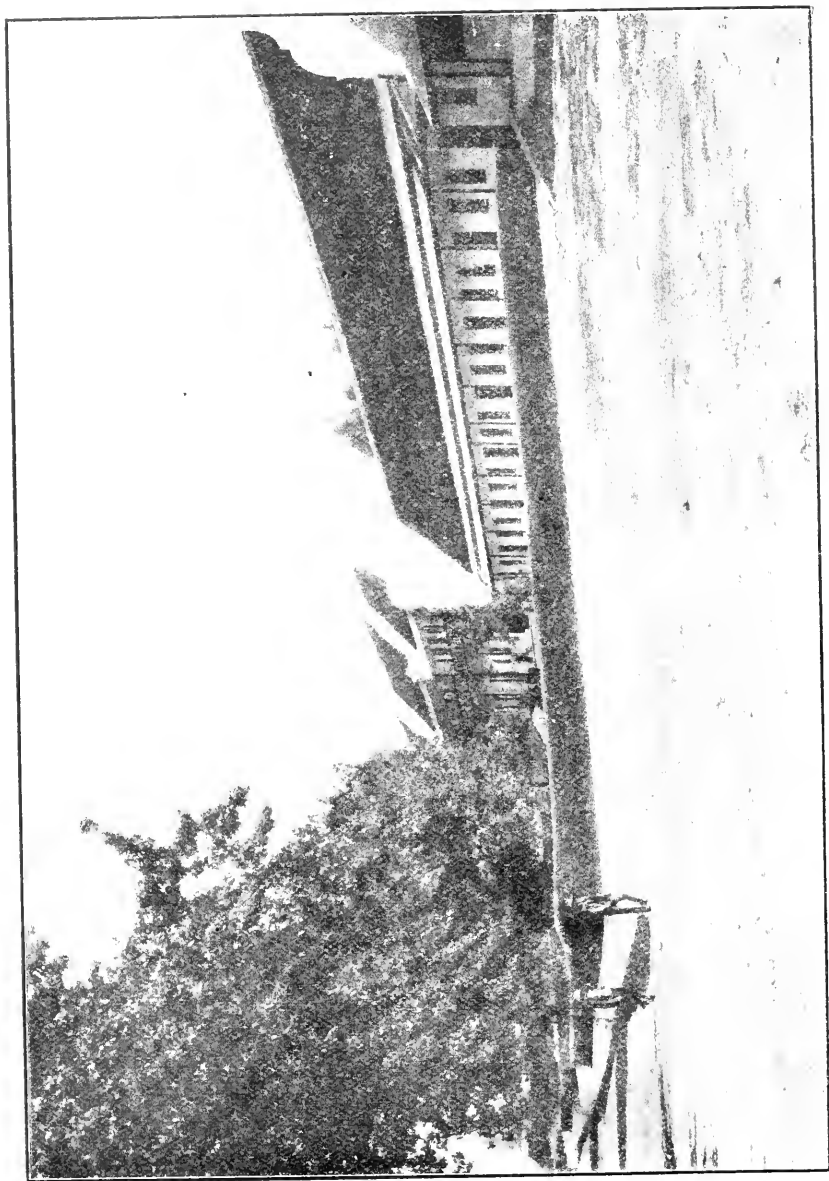

ELSENBURG SCHOOL OF AGRICULTURE, MULDER'S VLEI, CAPE.

Students' Quarters.



# JOURNAL OF THE DEPARTMENT OF AGRICULTURE.

VOL. I.

AUGUST, 1920.

No. 5.

Published monthly in English and Afrikaans by the Department of Agriculture,  
Union of South Africa.

SUBSCRIPTION: Within the Union and South-West Protectorate, **5s.** (otherwise **6s.**)  
per annum, post free, payable in advance.

Applications, with subscriptions, to be sent to the Government  
Printer, Box 373, Pretoria.

---

## METHODS OF FIRE PROTECTION.

With Special Reference to Fires caused by Sparks from  
Railway Engines.

By E. BAKER, B.Sc., Lecturer in Botany, Elsenburg School of  
Agriculture.

FIRE constitutes one of the greatest dangers to which our forests, plantations, and veld areas are exposed. The indigenous bush, the cultivated woods with their thick even-aged plantations, types of veld (including such areas as the bushveld with its masses of dead trees), the grain lands, and the sugar-cane plantations, are all subject to ravages by fire.

### CAUSES OF FIRE.

Before dealing with methods of control and prevention, it would be well to consider what are the chief causes of fire breaking out in the areas mentioned above. First among these are those fires due directly to sparks from railway engines.

A second cause may be put down to veld burning. In some instances the farmer wishes to burn a certain amount of veld, perhaps for his own protection or for securing early grazing, and the fire gets beyond his control, causing damage to his own and very often to his neighbours' properties.

Another cause may be put down to carelessness or malice. At certain times of the year when trekking through the bushveld, one

may reckon on seeing at least one fire each day. These fires burning out in many instances large areas, are impoverishing the veld and, in addition, are driving the game to more inaccessible localities. Many of the sweet annual grasses are disappearing, leaving the coarser, wiry, and tufted grasses to take hold of the land. Such fires are due also to the carelessness at times of hunters and others, who on leaving their camping grounds do not take sufficient precautions to extinguish their fires.

Empty or broken glass bottles, lying in the grass, may also be the direct cause of a fire breaking out. To guard against this, legislation, patrols, and the compulsory service of inhabitants in assisting to extinguish the fires would be of great value if these areas were more thickly populated, but at present the more important need is the permeation of every class of people in, or visiting, these parts, with the knowledge that it is necessary to save and preserve the forests, bush lands, etc. This, at the present time is probably of the greatest importance. All classes of inhabitants should be alive to the seriousness and evils of fire, so that in course of time fires as the result of carelessness will be reduced to a minimum. So stringent are the laws in some of the European countries that it is illegal even to smoke a cigarette or an uncovered pipe in certain areas. No veld burning should take place without the presence of a sufficient number of heaters to effectively control the burning. There is, however, in some parts of the country where railways pass through forests, an ever-present possibility of fire, and the Railway Department should not be blamed for their engines persistently coughing out glowing cinders, which may cause fires on lands adjoining the railway line, until the owners of such lands have taken proper precautions for minimizing the effects of any such fires.

#### DEVELOPMENT OF FOREST FIRES, ETC.

A fire always depends on the inflammability of the ground cover. If this consists of damp succulent growth or if the area is cleared of dry fallen twigs, so that the trees rise out of practically bare mineral soil, a fire is impossible. All forest fires originate from ground fires, which increase in size or die out, according to the quality of the inflammable material on the ground. If this is suitable to the growth of the fire, the flames sooner or later leap up into the crowns and convert the wood into a sea of flame. The flames in the crowns of the trees precede the ground part of the fire, scattering burning fragments, which may cross roads, streams, or bare places, and under such circumstances the fire assumes proportions which are only with great difficulty and expense got under control.

A fire in the crowns of trees can only spread when the ground fire follows it, feeding it from below. If, for some reason, the ground fire loses its fuel for some distance, the crown fire dies out of itself. On this principle, the methods adopted against forest fires are based.

A fire may easily be extinguished if one can commence operations immediately after its start, by sweeping closely over the ground towards the fire with wet sacks or with leafy branches of trees. This sweeping is more effective than beating, as beating the flames from above causes sparks to be scattered, initiating new small fires, which require additional help to extinguish. It nearly always happens, however, that the heat of a fire travelling with the wind is so great

that one cannot work before it. Attention should then be paid to the flanks of the fire, and an attempt made to gradually reduce its width down to a point where it may eventually be extinguished.

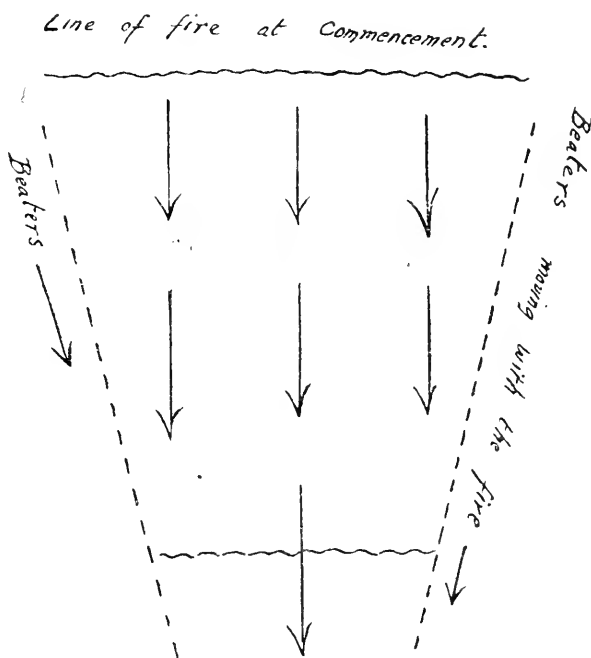

FIG. 1.—Indicating beaters moving in the direction of the wind along the flanks of the fire.

In the case of a forest fire, if the fire has risen to the crowns, this method is of no use, for a crown fire cannot be extinguished directly. In sugar-cane fields and mealie lands the nature of the crop is such that it is almost impossible to adopt this method of attack, and the only practicable course is that of lighting a counter-fire. The counter-fire is started where an opportunity is offered by lighting a continuous line of small fires across the front of the oncoming fire. The small fires are made to travel towards the main fire and checked from travelling in the opposite direction. Such opportunities are offered by roads, streams, swamp areas, or previously constructed breaks or paths.

The counter-fires, travelling against the wind, proceed slowly at first and, in the case of forests, do little damage to trees, except in young woods or plantations. As the counter-fires approach the main fire, they are caught in the wind current and move more rapidly until they unite with the main fire. This union causes both fires to die out, as there is no longer any ground covering to feed the flames in the crowns. Great care should be taken in making the counter-fire. The distance at which it may be started from the oncoming fire will depend on the nature of the crop and the strength of the

wind. If started too near the main fire, before it has spread sufficiently, the main fire will be on it, and, being thus assisted, will rage more vigorously than before.

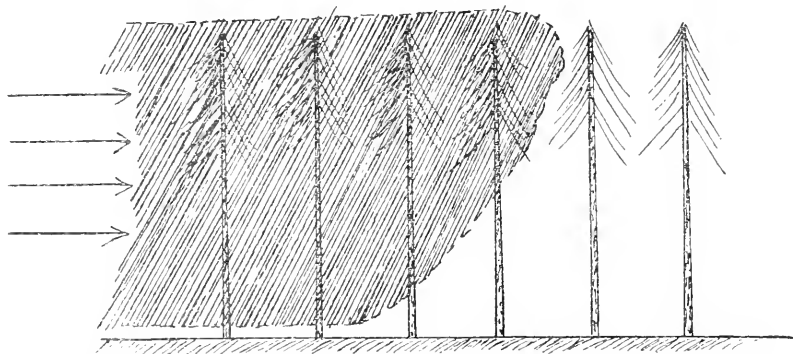

FIG. 2.—Showing the shape of the flame area, with crown fire preceding the ground fire.

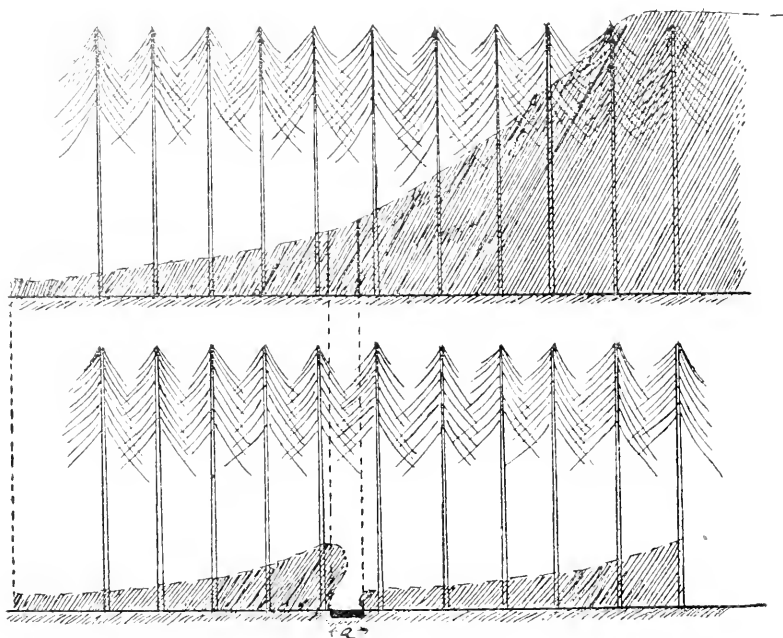

FIG. 3.—Indicating how the ground fire becomes a crown fire, and how at (a) a fire path reduces the possibility of the formation of a crown fire.

Where such natural opportunities as roads, streams, etc., for the lighting of a counter-fire are absent, suitable paths should be made at the time of planting, and in these days when farmers are planting larger areas to timber, it is advisable to divide such areas into 5 or 10 acre blocks, with surrounding borders at from 5 to 6 yards wide, free from vegetation.

In gum and coniferous plantations, the strips or borders should be cultivated during the years of greatest danger from fire. i.e. during

the first years of growth, up to the time of the first or second thinning of the trees. The loss of wood-growing space is not serious, for a strip 6 yards broad is nearly always overgrown by the crowns of the trees on its border. These strips also serve as roads for the transport of thinnings, etc. In Germany, a crop such as Seradella is sometimes raised on these strips, with the view to providing food for the forest animals, thus checking the damage they might otherwise do to the bark of the trees, while at the same time assisting in keeping the strips clean by eating down the growth.

Most of the cane fields and meadow lands are divided up into blocks, and if more of our farmers would adopt similar precautions for their veld areas, by ploughing strips where natural opportunities do not obtain and where the need for such strips is indicated, the constant recurrence of burnt areas as are now to be seen might appreciably be reduced.

As regards the

#### FIRES ORIGINATING FROM RAILWAY ENGINES.

the endeavours of railway engineers to remove the danger of fire by arrangements in the smoke stacks for preventing the scattering of glowing cinders from the locomotives, have met with little or no satisfactory results. The falling of the burning fragments from the ash boxes may be preventable to some extent, but those falling on the track are not responsible for much damage. At the same time it is not possible to stop the sparks which fly from the smoke stack, without affecting the draught necessary for the heat required by the engines. This does not perhaps apply to the engines for transportation of the sugar-cane to the mills, for here spark arresters are used, as the rapidity of locomotion is of secondary importance.

With the use of oil-fuel engines the danger would be obviated, but until such time some arrangement is required on both sides of the line that will in itself afford protection against the possibility of causing fires in the planted areas. On the knowledge that the breaking up of the ground constitutes a remedy against the spreading of fire, a strip kept free from vegetation should be provided on each side of the railway track.

The danger of causing a fire by engine sparks depends on—

- (1) The size of the glowing particles.
- (2) The strength and direction of the wind.
- (3) The inflammability of the ground cover.

The larger the cinders, the more easily may they start a fire. If the ground cover in a wood is but slightly inflammable, it may be sufficient to divide the railway track from the plantations by a strip, kept cultivated, so that a fire starting on the side of the railway line cannot run over into the wood. Under certain conditions, it has been proved that where a railway line passes through a forest, and the wood comes close up to the line, the danger of fire is smaller than when the woods are further off. If the wood is close to the line, the wind is diverted to follow the narrow passage along the track, whereas the sparks may be blown across broader openings into the wood.

Efficient protection is therefore afforded by having safety belts of trees along each side of and close up to the railway line, and land is used also for growing timber, which otherwise would lie idle and probably be a menace. Sparks have been observed to glow at

distances of 80-100 yards from the railway line, and if a strip 100 yards wide on each side of the line is to be kept bare for each mile of railway 72 acres of land must either lie idle or be used for some succulent crop, which is not likely to catch fire. In many instances it would be more profitable to grow timber on these strips, as the land may be too poor for agricultural purposes.

To protect plantations from sparks from railway engines, the safety belts of trees should be about 15 yards broad and separated from the main plantation by a path 5-6 feet wide and from the railway embankment by a strip about 4 feet wide. These two paths should be united every 20 yards or so by cross-paths, which should always be kept clean.

The following diagram indicates the method of laying out such belts, as practised in the pine forests of northern Germany:—

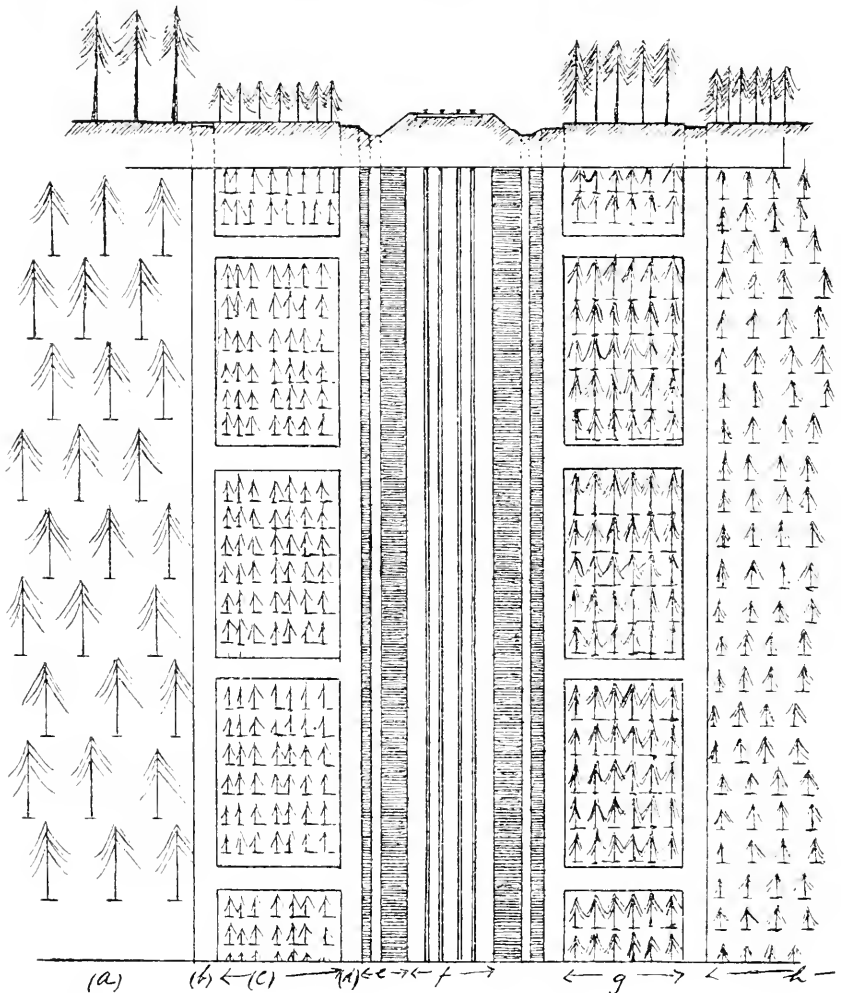

FIG. 1.—(a) High forest. (b) and (d) Clean strips. (c) Young protection belt. (e) Embankment with clean strip in centre. (f) Railway track. (g) Older protection belt for protecting young plantation (h).



Similar belts of trees might be used in the protection of sugar-cane areas or where there is great danger of veld fires being caused by sparks from railway engines. Where it is impracticable to plant trees through veld areas, rectangular patches may be made, and the litter from the paths thrown into these patches and burnt off when convenient.

Dry grass and bush growth on the sides of the railway line are often set on fire, and in order to check this fire from doing serious damage, a strip about a yard wide should be cleared in addition and running parallel to the 4-foot strip bordering the plantation.

The ground covering of dry inflammable material in

#### THE SAFETY BELT

should be removed. All dry branches, tufts of grass, heath, etc., should be cleared, and the trees—except the row of trees nearest to the railway line—should be pruned up to about 4 feet. The green branches on the borders of the belt should be retained down to the earth as far as possible. The closer the screen nearest to the railway track, the better does the protection belt fulfil its function of catching the flying sparks and of stopping them from flying over into the plantation. To attain this object, the arrangement of the trees in the safety belt must be continuous, without any great gaps. The trees should not be planted too closely, for the flames rise higher between close-standing stems than between those standing further apart; moreover, the crowns of the former do not develop so well.

As the trees in old plantations are wider apart than in young plantations, and because high trees may be a menace to the railway track and to telegraph wires, it is advisable to choose a short rotation for the protection belt. In settling this rotation, the purpose of the protection belt should first be considered. The question of the yield of timber is of secondary importance. The protection belt only becomes effective when it has reached a height equal to that of the smoke stack of the railway engine, and owing to the danger from sparks being carried by the wind, the protection belt should not be cut over on both sides of the line at the same time, but should, on one side at least, consist of high forest. Neither should the plantation behind the shelter belt be cut down and restocked so long as the protection belt in front of it is still so low that it cannot check the flying sparks successfully.

If it is impossible to avoid having a dangerous young growth behind an insufficiently soft protection belt, as in newly afforested areas, a second protection belt, similar to the first, should be laid down and maintained until the first belt can undertake the work of protection.

The danger is least where the railway runs through cuttings, so that the height of the smoke stack is less than that of the banks. In this case, only the strip, a yard wide, between the railway bank and the wood is necessary, but unless the cutting extends for some considerable distance it would be advisable to lay out the 15-yard broad shelter belts.

The danger is greatest on the convex side of curves, but if the protection growth is sufficiently close to form an effective screen, no damage will be done, for the sparks cannot form a direct kindling of the tree crowns.

The danger would also appear to be great where the metals lie on a high embankment, the locomotive funnel thus being exposed to the wind. The sparks certainly fly somewhat further than on open level ground, but they take a longer time to fall to the ground. At the same time, owing to the grade of the embankment, the safety strip is of necessity at a considerable distance from the metals, so that the trees of this belt can catch the sparks as well as if they stood close up to the line.

If a new railway line is to be laid through an existing plantation, the same type of protection belt may be adopted. It is only necessary to clear as broad a way as is required for the construction of the railway. On both sides of the line the protection belts may be formed as above described.

The crop remains, but the ground is cleared of all inflammable material, and if the trees are too widely scattered or devoid of branches for a considerable height, underplanting with some species of trees which will stand a fair amount of shade may be resorted to on the sides of the belt nearest the railway. If the trees of the shelter belt must be removed on account of age, the belt should immediately be restocked, and a strip of the main portion of the wood converted into a safety belt.

In the kind of

#### TREE SUITABLE FOR PLANTING,

the following qualities should be present:—

- (1) The tree must be suited to the soil so that it may flourish as well as possible.
- (2) It should form a thick or resistant bark as soon as possible, so that it may not be killed by a moderate ground fire.
- (3) Its crown must be thick enough to catch flying sparks and to shade the ground, so that a strong growth of grass and bush is impossible.

On first consideration, broad-leaved trees are more suitable than pines, but when broad-leaved trees, such as oak, etc., flourish, the ground is as a rule damper and danger from fire less than where pines may thrive.

On dry sandy soils, the common cluster pine is probably the most efficient kind for the construction of safety belts, and when planted as transplants, 4 feet by 4 feet, in preference to sowing, they soon develop a bark sufficiently resistant to small ground fires. At this espacement, a single horse-hoe can be used during the early life of the belt to keep the ground well cultivated, but if impossible the rows should be cultivated by hand. The hoeing should be done until the trees have reached a sufficient height to form a canopy, and thus prevent the growth of the ground vegetation. When the trees are about 4 feet high, the lower dry and suppressed branches should be pruned off, except on the outermost borders, where all live branches may be retained.

Blackwood (*Acacia melanoxylon*) and Black Wattle (*A. decurrens*) also form effective screens under suitable conditions. The accompanying illustration shows such a belt of Black Wattle, used on a hillside on the sugar estates at Mount Edgecombe, Natal.

The Blackwood, under suitable conditions, is an excellent tree for safety belt work. It has a fairly hard bark and retains its lateral branches well on the sides exposed to light, neither does it produce straggling branches, as other trees might.

During early life certain species of Eucalyptus might be quite efficient. Where soil conditions are good, they make rapid development, and when felled the regeneration due to coppice growth



provides an excellent screen at an early age. Unfortunately, however, many of the gums tend to produce bare stems for a considerable distance as they advance in age, and where gums are planted in the protection belts a mixture, using some shade-bearing tree with the gum, would probably be of greater value.

The cultivation of the strips is best done by means of a rubber adapted for forest work. If the strips are very long, the shape of the protection belt may be modified as shown in the following figure, so that an animal-drawn cultivator may be worked continuously.

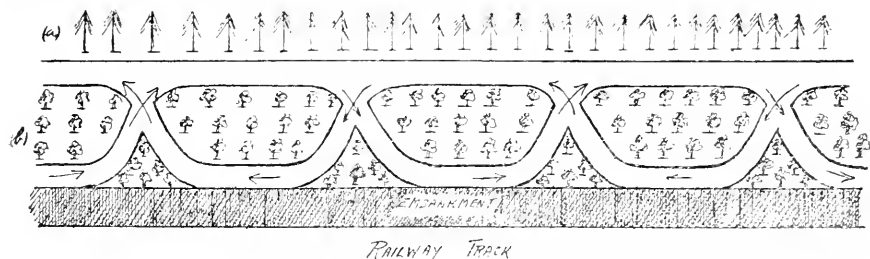

FIG. 5.—(a) Forest. (b) Modified protection belt to allow of cultivator working continuously.

## POISONING OF CATTLE BY FEEDING ON ERGOTIZED PASPALUM.

By D. T. MITCHELL, M.R.C.V.S., Veterinary Research  
Laboratory, Onderstepoort.

THE cultivation of paspalum on an extensive scale as cattle feed in the Province of Natal is of comparatively recent date, and although during the first few years the results justified the labour involved, in recent years it has been noted that in cattle which were allowed access to the paspalum lands at a certain season, symptoms of inco-ordination of movement appeared in a large percentage of them, which disappeared slowly on changing the grazing ground to natural veld. Serious outbreaks were reported from various parts of the Province, and, of these, four were investigated.

Two occurred in Umvoti County, one involving a large dairy herd and the other a number of young stock, heifers and oxen. A third outbreak was reported from the Town Hill, near Maritzburg, where clinical symptoms were found to be present in about 50 per cent. of the cows of a dairy herd. A number of young oxen and heifers at the Government Experimental Farm, Cedara, were inspected at an inquiry held there, and were found to be affected with characteristic symptoms identical with those noted in previous outbreaks.

In all these cases symptoms had appeared in the cattle grazing on paspalum pastures which were in the seeding stage, and in each case it was noted that a very large percentage of the heads of the grasses were infected with a fungus of the *Ergot* type. Specimens were collected and submitted to Dr. Pole Evans, Plant Pathologist, who reported that the fungus present was *Claviceps paspali*, which had been noted in other parts of the world to produce a similar train of symptoms to those shown by the cattle in the affected herds under observation. Of the species of ergot possessing definite poisonous principles producing pathological or functional alterations in man and animals, the best known is *Claviceps purpurea*, the ergot which infects grain and rye grasses. The distribution of this fungus is very widespread, and its toxic properties have been recognized since the earliest times.

Dissemination of the spores of the fungus *Claviceps paspali* has been noted to have been brought about by a species of beetle of the family *Carabidae*, which collects the spores from the germinating *Sclerotia* on the ground, and on climbing up the tall stems of the grass in order to get a high point to fly from, transmits the spores to the flowering heads of the grasses. Here a further development occurs. The pistil of the flower is attacked and a mycelium is produced, growing as a mass of thread between the glumes of the grass. Conidia result from this mass, and a sticky substance, popularly known as "honey dew," is found which materially assists in spore dissemination. These spores are transmitted from plant to plant in various

ways by insects which feed on the honey-dew, and by the movement of animals feeding in the infected pasture and by wind causing contact of infected with healthy heads. In cattle grazing on paspalum infected with ergot at this stage of its development, it will be noted that hairs in the lips, cheeks, upper parts of the legs, and along the abdomen are stuck together with this "honey-dew" exudation. From this mass of fungus threads the ripe *sclerotia* are formed.

The symptoms produced in cattle by feeding on ergotized grass vary according to the species of the infecting ergots. *C. purpurea* sets up a very definite train of symptoms, commencing with diarrhoea, lameness, and stiffness in the limbs, affecting particularly the lower joints, associated with coldness and in-sensibility of the parts affected. This is followed by sloughing of the part and separation of the dead tissue usually in the neighbourhood of a joint. Portions of a limb may be sloughed off, for example, a toe, or in some cases the slough may involve the fetlock joint resulting in separation occurring at this point. The ears and tail are frequently affected, partial or almost complete loss resulting.

Lesions may also be noted affecting the mucous membranes. Necrotic patches may appear on the buccal mucous membrane and hyperaemia affecting the intestinal mucous membranes is of frequent occurrence. Abortion very frequently occurs in animals which are pregnant. There is little systematic disturbance except in complicated cases, and temperature is not elevated.

The American investigators, Brown and Ranck, carried out a series of animal tests in 1914-15 to determine whether *C. paspali* was capable of producing toxic symptoms in animals. Positive results were obtained by feeding guinea-pigs on the ripe *sclerotia*. 40-80 *sclerotia*, when fed daily, produced symptoms of marked sensibility, and after a few days in-co-ordination of movement occurred, resulting in death after a period of complete paralysis. Commercial ergot extract (*C. purpurea*) was found to produce no distinct ill effects. The administration of  $\frac{1}{4}$ - $\frac{1}{2}$  c.c. on four successive days produced only temporary sluggishness.

The ripe *sclerotia* given to calves, *ad. lib.*, produced hypersensitiveness after two days, and, later, in-co-ordination of movement followed by frequent paroxysms, and, later, prostration and death.

In order to ascertain whether *C. paspali*, which is known to infect a high percentage of paspalum lands in this country, would reproduce the symptoms in experimental animals which were observed in America in animals feeding on infected pastures, a series of experiments were arranged at the Veterinary Research Laboratory. Six animals were selected for the tests, and the ergot-infected paspalum was collected from old paspalum lands at the Government Experimental Station at Cedara. The method of collection was by stripping the infected heads by hand, the material resulting being a mixture of portions of the seed heads and a fairly high percentage of ripe *sclerotia*. This material was fed within a few days after collection in a mixture of bran and a small quantity of chopped lucerne.

From the experiments it was noted that feeding with 9 lb.-12 lb. quantities of infected heads produces a definite and diagnostic train of symptoms. The initial symptoms appeared in each case on the second day after the infected heads were fed to the animals and were characterized by muscular tremors, hypersensitiveness, increased

glandular secretion, and increases in respirations and pulse rate. These symptoms were rapidly followed by in-co-ordination of movement, lack of tone of the leg muscles, loss of appetite, and constipation. Recovery was noted to commence about the fifth or sixth day, and from this onward slow improvement was shown. The animals on being turned out to graze were kept under observation for a further period, and it was noted that recovery could not be considered to be complete until at least two months had elapsed from the time the meal of infected heads was partaken of. Abortion did not occur. One animal calved normally three months later.

A short description of the disease as it appears under natural conditions in this country is here given, together with suggestions for preventive measures to be adopted.

*Cause.*—The causal agent of ergotism in South Africa has been demonstrated to be *C. paspali*, associated with paspalum lands which have been established for some years. So far, no cases of true ergotism due to ingestion of grass or grain infected with *C. purpurea* have been reported, and it is doubtful whether this latter fungus exists in any part of the Union to such an extent as to produce clinical symptoms in animals.

*Distribution.*—The infection is not very widespread, but it may be looked upon as general throughout the midland portion of Natal. Outbreaks which have been reported were limited to the midlands. No cases were reported from the northern portion adjacent to the Drakensberg range or from the coastal belt. In the latter area, however, this is understood as being owing to the absence of frosts and to the humid conditions which exist for the greater part of the year—natural grazing is plentiful and the necessity for providing additional grazing during the seasons when veld grazing is scanty is not felt. Paspalum has only been cultivated to a limited extent in this area. In the midlands the cultivation of paspalum had been undertaken on a fairly extensive scale in former years, and in seasons which favour the growth of the fungus, it is almost impossible to find an area under this grass which is not grossly infected. Even along the roadsides, where accidentally sown plants are to be found, these are almost constantly found to be infested.

*Occurrence.*—The occurrence of the condition among cattle feeding on paspalum lands varies each year, and is chiefly dependent on the extent to which the grass is infected. Like most fungi, warm humid conditions favour development and dissemination, and so, as is to be expected, the percentage of infected paspalum heads in a pasture is very much greater in seasons where a mild winter is followed by frequent rains during the spring and early summer. The stage of growth at which the fungus is able to set up the characteristic symptoms is limited to the period when the *sclerotia* are ripe, which coincides with the ripening of the grass seeds. During the "honeydew" period the cattle appear to be able to eat the infected grass with impunity. It was noted that cattle feeding on paspalum on which ripe *sclerotia* were present evinced a special fondness for the high standing diseased heads after a meal of the lower and more succulent foliage had been collected. This point has also been commented upon by Brown and Ranck. Symptoms are usually developed about a week after exposure in the infected pasture, and the percentage of animals

which show clinical symptoms varied from 5 to 60 per cent. in the outbreaks investigated.

*Animals Affected.*—The condition was only noted to occur in cattle, and young stock of from fourteen months to two years appeared to be more susceptible than adult cattle. Horses, donkeys, sheep, and goats grazed on the infected grass without developing any clinical symptoms. This apparent immunity may, to some extent, be due to the different method of grazing adopted by these animals by which little of the infected heads would be collected. No fondness for diseased heads, as observed in cattle, was noted in these animals.

*Symptoms.*—The symptoms in the affected animals vary in intensity from a slight in-co-ordination of movements to complete paralysis. Hyperaesthesia and increased respirations were not so marked in the cases which occurred under natural conditions as were noted in those produced experimentally.

In the majority of instances the natural cases were comparatively mild, the symptoms shown consisted of staring coat, high stepping movement of the front legs in walking, defective vision indicated by an absence of any attempt to avoid holes in the ground or obstacles, occasional stumbling, lateral swaying of the hindquarters, and a general lowering of muscular tone. Appetite is unimpaired in the early stages, but, later, there is loss of appetite, and in consequence the animal has a "tucked-up" appearance. The most acute cases were seen among some eighteen-month-old oxen which had been feeding on infected grass for some weeks. Few cases of partial paralysis were noted, and these affected animals exhibited marked symptoms of hyperaesthesia, hurried respirations, and a rapid thready pulse.

*Mortality.*—A few cases of deaths from the condition were reported, but in none of the outbreaks personally investigated did any mortality occur. This may have been due to the fact that in these cases the owners were advised to remove the animals at once and provide good nursing for badly affected ones, but in general it may be taken that in uncomplicated cases the mortality is almost negligible. The resulting loss of condition is the greatest economic factor to be considered, and though clinically affected animals recover from the acute symptoms fairly rapidly it requires a considerable time on a good nursing diet to recover from the effects of the intoxication, and the animal's general physique, especially in growing animals, suffers in consequence.

*Treatment.*—The treatment which was found to give most rapid results after the necessary removal from the paspalum lands consisted of a saline purge followed by a few days' rationing on green lucerne or barley, the idea being merely to prevent further ingestion and to assist in elimination of the unabsorbed toxic elements in the digestive tract.

Prophylactic measures consist of reaping and collection of the grass during the flowering season, at which time the material collected from the lands may be fed to cattle with perfect safety. Burning of unreaped lands during the winter will have the effect of destroying most of the resting forms of the fungus, but this procedure is not to be recommended on account of harmful effect of the fire on the grass roots. Heavy stocking at the commencement of the summer before the flowering season will be found to be effectual. By this means

the formation of flowering heads is prevented and infection of the pasture is rendered impossible.

In the outbreak at Cedara which involved a herd of young oxen, a number of deaths from redwater occurred after recovery was almost complete. The grazing ground on which these animals ran was "redwater veld," but as the animals had been reared in the area, and as no cases occurred in cattle of a similar age grazing in adjoining camps, it was considered that the mortality was due to a breakdown in immunity resulting from lowered vitality due to ergot intoxication. The absence of abortion in pregnant animals contracting the disease under natural conditions and also of any symptoms of necrosis or sloughing was noted in the outbreaks reported and investigated. The condition does not give rise to any immunity or distaste for the fungus, and animals again allowed access to lands in which the infection is present during the same or succeeding year will develop all the characteristic symptoms.

### Interesting Railway Figures.

In Bulletin No. 3, 1920, issued by the General Manager of Railways and Harbours, some interesting figures are published concerning the railway systems in other countries compared with that of the Union. It is shown that the average cost per mile of railway in Great Britain is £56,317; France, £30,789; Germany, £24,053; United States, £15,909; and Australia, £10,263; while in the Union it is lower than any of these countries, being £9823. Of course, the higher this cost becomes the more revenue will be required to meet interest charges.

The Union is a vast country with a small population, and has a far-reaching railway system. This is reflected in the following statistics showing the number of inhabitants per mile of railway line in the Union as compared with other countries:—

Country.	No of Inhabitants per Mile of Line	Country.	No. of Inhabitants per Mile of Line.
Russia in Europe ... ..	3360	France ... ..	1241
Italy ... ..	3162	Switzerland ... ..	1177
Holland ... ..	2880	Denmark ... ..	1105
Spain ... ..	1967	United States ... ..	404
Great Britain ... ..	1943	Australasia ... ..	257
Austria-Hungary ... ..	1792	Canada ... ..	200
Germany ... ..	1698	Union of South Africa (Europeans only) ...	147
Belgium ... ..	1356		

The *Journal* aims at keeping farmers informed of what the Department of Agriculture is doing, also of such matters affecting their interests as come under its purview. The *Journal* contains original articles for the guidance of the farmer on the many and diverse problems which face him. Every farmer should read it and keep it.



**CIGAR-TOBACCO INVESTIGATIONS.**

By W. H. SCHERFFIUS, M.Sc., Chief, Division of  
Tobacco and Cotton.

DURING my visit to the United States in 1919, I inspected the plantations, curing sheds, and warehouses of the American Sumatra Tobacco Company, Quincy, Florida. This company is making splendid progress in the production of cigar wrapper tobacco. Their methods are of the most progressive to be found anywhere. They have hundreds of acres of tobacco, all grown under cheese-cloth or lattice, and in some cases both cheese-cloth and lattice are used. The tobacco grown in this manner is used to cover high-class cigars. It is interesting to note that they commence harvesting the leaves when the first flowers appear. The flower-heads are broken out, but the suckers are not removed. The harvesting is complete three weeks after the plants are topped. The curing process is preferably a slow one, consisting of a slight drying during the day and absorbing some moisture during the night. When the leaves are thoroughly cured they are taken off the laths, packed in cases, and sent to the packing or rehandling warehouse. The tobacco remains in the cases for weeks, till the manager is ready to ferment it, when it is taken out of the cases and put into large bulks; if necessary, moisture is added to start fermentation. The temperature is raised to about 118-120° F. If the temperature begins to rise or fall before five or six days, the stack is pulled down and rebuilt. Stacks are usually pulled down and rebuilt three or four times; then the tobacco is put back in the cases to await sorting, grading, retieing, and rebulking in bale lots, one on top of the other. Here the process of fermentation is completed, and the tobacco is again put in the cases to hold its moisture till it can be made into bales. The bales are covered with Indian fibre and hessian, and the parcel is crated ready for shipping. The weight of the parcel is net 180 lb., gross 188 lb. The cost of producing an acre of this tobacco, approximately 1150 lb., is about \$600.00 or about 60 cents per lb. A good crop will give about 40 per cent. first-grade stuff.

**SANTIAGO DE LAS VEGAS.**

The methods employed in Cuba differ in many respects to those in America, but the underlying principles are the same. I visited the experiment station at Santiago, and saw their methods of preparing seed-beds, which are sterilized with steam, instead of the usual practices. Their soil is very similar in appearance to much of our red sandy and clay loam soils. My attention was called to the fact that many of their tobacco lands were surrounded and interlaced with palm trees or banana bushes. The seedlings are transplanted when they are about 8 inches long. The plants are topped, but not

suckered, similar to the American method. Harvesting begins about 45 days after the date of transplanting, and about 15 to 20 days are required to complete the harvest. Their curing sheds are board or plank walls with high heavy thatched roofs. After the tobacco is cured, it goes to the packing house, where it is fermented at 45 to 50° centigrade, sorted, graded, and baled; then it goes into the hands of the jobbers, and from them it is distributed amongst the manufacturers.

I visited some of the packing houses in Havana and saw the tobacco being prepared for distribution amongst the manufacturers. The Cubans cover their bales with heavy palm leaves or bark which serves the double purpose of keeping the tobacco from damaging and retaining the moisture in the leaf. The bales are made up of 4 hands to the carrot, 80 carrots to the bale, and the bale weighs 80 to 100 lb.

The finest grade of cigar wrapper sells for about £800.00 per bale or \$10.00 per pound.

The district Santiago de Las Vegas stands first in the production of cigar wrapper. The district Vuelta Abago leads in the production of fine filler.

---

---

### **Railage of Sheep to Fresh Pasturage.**

In Bulletin No. 6 of the General Manager of Railways and Harbours it is stated that 413,267 sheep were carried by rail to fresh pasturage during the year 1919 and the three months ended 31st March, 1920—a further illustration of the serious effects of the drought and the tax it imposed upon the Administration's resources in trucks and haulage. This is apart from ordinary live stock transport and takes no account of the large number of large stock removed to fresh pasturage. If all the sheep railed to fresh pasturage were returned they would total 826,534. The actual railage charges, at full ordinary tariffs for the forward journey, were £31,010. The animals are returned to original forwarding stations free of charge. On their return one-half the forward journey railage is rebated, so that if all the animals were returned, the Administration would only receive £15,505 compared with £62,020, had ordinary rates been applied. The reduced rates work out less than 1.28d. per truck per mile.

---

### **The Union's Summer Crops, 1919-20.**

The attention of readers is directed to the Department's Crop Report for June, 1920, published in this issue, which gives the final returns for this season's crops of maize, kaffir corn, and tobacco, showing the estimated total yield of each of these crops.

---

---

The *Journal* is the Department's medium of making known its activities. It contains information of value to every farmer in the Union. Keep it for reference.

## THE AGRICULTURE AND SOILS OF THE CAPE PROVINCE.

By ARTHUR STEAD, B.Sc., F.C.S., Research Chemist, Grootfontein School of Agriculture, Middelburg, Cape.

### I.

#### Witkop—Burghersdorp.

*(The previous instalments of this article appeared in the May and July numbers of the Journal.—Acting Editor.)*

OVER the spruit there is a turf-looking soil whose reputation for fertility is better than that of the adjacent higher-lying Molteno beds "zandbult" soil. Sample No. 613 was taken here. The natural vegetation of the soil consists mainly of "zuurgras"; but here and there is to be found a plant of "blauwzaadgras." The soil is probably alluvial to some extent, because in the spruit were a number of dolerite boulders, washed down, presumably, from the dolerite-capped red beds on Kalkfontein. At the time the sample was taken the land was being prepared for potatoes, a crop to which the soil is said to be well suited.

Before discussing the analytical figures of this report, it is considered advisable in the interests of the general reader to devote a few pages to a consideration of the several factors which are concerned in the growth of crops, giving at the same time some indication of the bearing of the analytical figures on the estimation of the fertility of the soil and its suitability for particular crops.

#### FACTORS IN PLANT GROWTH.\*

Six principal factors are concerned in the growth of crops. They are:—

1. Light.
2. Temperature.
3. Air supply.
4. Water supply.
5. Food supply.
6. Harmful factors.

The first five factors must all be present for growth to be possible; if any of these five factors is present to an inadequate degree only, crop yields will suffer accordingly.

*Harmful Factors.*—Should any harmful factor be present, the crop yields will be below normal in proportion to the intensity of the action of the harmful factor. Attacks by insect pests, diseases, and so on are harmful factors capable of untold damage to crops. For instance, rust now prevents the wheat crop from yielding grain in the

\* The following remarks are based to a considerable extent on the admirable account given by E. J. Russell, F.R.S., in "Soil Conditions and Plant Growth."

Alexandria district, while the same soil transported to Middelburg still yields excellent returns of that crop. Factors such as diseases and insect pests do not, however, come within the province of the chemist; it is therefore proposed not to deal with them further than drawing attention to them.

Among harmful chemical factors are the conditions known as soil acidity and "brak." Both conditions are capable of entirely preventing the growth of normal crops, no matter how favourable other factors may be.

The brak condition of soil is not at all likely to be met with in the area under consideration, so that subject need not be pursued further. Acidity of the soil, on the other hand, is likely to be very prevalent. Reference to all of the analyses recorded in this report will show that out of thirteen samples all, except two, are acid to litmus, viz., they turn blue litmus paper red.

Now the principal function of carbonates in the soil is to prevent the development of the acid condition, a condition which is not only harmful in a direct manner to cultivated plants, but also indirectly in that it prevents the normal activities of certain soil organisms whose function it is to prepare food for assimilation by the plant roots.

Owing to the importance of carbonates just indicated, it is usual to estimate the quantity present when analysing a sample of soil. Of all the samples, No. 616 alone is well supplied with carbonates.

Fortunately, it is a simple matter to correct a soil for acidity. This is best done by adding an appropriate quantity of ground limestone. So great have been the immediate benefits following such applications that they have been repeated in some cases too often, as witness the old saying:—

"Lime and lime without manure  
Will make both land and farmer poor."

*Light.*—Crops cannot be grown in the dark, because sunlight is necessary to the utilization by the plant of the food (carbondioxide) it obtains from the atmosphere. The farmer makes use of this fact when he grows a crop of teff grass to smother weeds. The teff grows so quickly that it soon shuts off the sunlight from the slower growing weeds.

*Temperature.*—The importance of temperature in crop production is perhaps too often overlooked. Everyone knows that if the weather is too cold there is no growth, and that certain crops may be killed by frost. So also if the weather is too hot growth comes to a standstill; but not in all cases, because some crops like hot weather best. The fact is that the temperature requirements of crops vary considerably.

Potatoes, for instance, require cool weather and a cool soil for best results: wheat likes cold weather at the start and a cool soil: thereafter it needs hot weather for ripening.

Maize, kaffir corn, pumpkins, melons, and cotton are crops for which hot weather is essential. The first-mentioned crops thrive in the cool climate of Witkop; the last-mentioned are either not grown at all or do badly.

It should be evident that if the temperature conditions are not right, the crop yield cannot be good, no matter how favourable the other factors may be.

The mechanical composition of the soil, taken in conjunction with the climate of a particular locality, enables one to form an estimate of the temperature suitability of that soil for a particular crop.

Reference to Table I hereunder will show that the mechanical analysis classifies the soil particles into groups of various sizes, the coarsest being sand and the finest clay. Now, the coarser the soil, the hotter it becomes during the heat of the day, while the greater the proportion of fine particles (viz., silt and clay) it contains, the cooler it will keep. Similar differences exist with reference to soil temperature changes as winter gives place to spring. The sandier the soil, the sooner it warms up to the general air temperature. Thus, under the temperate climatic conditions of, say, England, sandy soils are often valuable because they are "early," while clay soils are commonly known as cold and "late."

Speaking rather generally, the temperature properties of clay soils are undesirable in cool climates, but very valuable in hot localities; while the reverse holds with reference to sandy soils.

One must evidently therefore always consider climatic conditions and the mechanical composition of the soil in conjunction. To come to actual instances, a sandy soil which is just right for potatoes under Witkop conditions, would be too hot under Burghersdorp conditions; or a sandy soil situated in the Karroo would give only a poor crop of wheat, whereas the same soil situated in the Witkop district would return quite good yields. We have dealt with this matter somewhat lengthily, because in our experience the farmer often ascribes to a lack of plantfood in the soil what ought really to be ascribed to unsuitable climatic conditions, particularly temperature conditions.

*Air Supply.*—It is only below ground that the air (oxygen) supply is likely to be deficient, and then only in the case of soils which contain large percentages of finest particles, i.e. the loams and clays. Even the most compact soil contains a considerable quantity of air, the presence of which is revealed when a lump is placed under water; as the water enters the soil the air is driven out and escapes as bubbles.

Soil is therefore not to be regarded as a solid mass, but rather as a porous mass whose solid particles are packed more or less closely together. The particles touch one another at one or more points; between them are spaces which, if the soil is quite dry, are entirely filled with air. If, however, the soil is moist, part of the air-space, i.e. that contiguous to the soil particles, is taken up by water. (A fair picture will be obtained if one imagines the soil particles to be covered with a film of water whose thickness will depend on the amount of moisture in the soil.)

Since sand particles are relatively large (see sizes in Table I hereunder) the spaces between them are correspondingly big; there is therefore little friction impeding the movement of air in a sandy soil.

In the case of soils which contain large percentages of finest particles (i.e. silt and clay), the spaces between particles are so small that the movement of air is very much impeded.

Speaking generally, the movement of air is easy in sandy but difficult in clay soils; the renewal of the air of sandy soils is therefore accomplished much more readily than the renewal of the air of clay soils.

Now, the roots of plants and other living things in the soil require air for the oxygen gas it contains. They use this oxygen gas up; it is therefore necessary that the soil air be renewed from time to time. This is accomplished naturally by the movements of air which take place between the atmosphere above ground and that below ground.

If the air (oxygen) supply in the soil be deficient, one would expect the root system to suffer; one would expect to find a better developed root system in the sandy as compared with the clayey soil. Every farmer knows that this is so. A well aerated soil and a good root system go together, as do also a poorly aerated soil and a feeble root system.

Much can be done by skilful tillage and management to improve the air supply of the finest types of soil; the skilful husbandman is able to cause the finest particles of this class of soil to coalesce, the compound particles so formed then behaving much like the coarser sand particles. Calcium and magnesium carbonates are also able to bring about this desirable coalescence of the clay particles; that is another reason why "carbonates" figure in the mechanical analysis of the soil; the more carbonates the soil contains, the more clay it may contain and yet be tillable.

It will be obvious that the more extensive the root system, the better able will the plant be to obtain the food it requires from the soil. We shall see later that this means that less percentages of food suffice in the case of sandy soils than are necessary in the case of clayey soils.

If an animal be shut up in an air-tight box, it would not die immediately, but as soon as it had used up the oxygen of the air in the box (or, to be correct, a part of it only) it would die from suffocation. A plant will die from suffocation if the air supply available to its roots is sufficiently restricted.

This sometimes happens in practice when a growing crop is submerged for too long a period, either in a natural way or by irrigation.

Not only is it necessary to avoid the condition described in the preceding paragraph, it is also necessary for best results to keep the water supply in the soil below a certain limit.

According to King\* ideal conditions exist in the soil when of a cubic foot (= 100 per cent.) 44.24 per cent. consists of solid particles, 33.63 per cent. of air, and 22.13 per cent. of water. A larger proportion of water than that means a deficient air supply. These figures are not quoted with a view to suggesting that the farmer can maintain such conditions in his soil, but rather to point out that too much water is as much to be guarded against as a deficiency.

Soils that in their natural state contained so much water (and therefore so little air) as to be useless for the growth of crops have frequently been made highly productive through drainage which removes and prevents the subsequent accumulation of excess water.

We have seen that air supply is a very important factor in plant growth, and further that it is influenced by the mechanical composition of the soil, tillage, and water supply.

Since the air requirements of crops vary a good deal, the mechanical analysis of the soil is to be regarded as an aid in deciding

\* F. H. King, "Soil Management."

for what crops a particular soil is suited; crops which require good aeration cannot be grown on soils whose particles consist mainly of clay and silt.

*Water Supply.*—Water is to plant growth what a mainspring is to a watch; it is that which sets the processes of growth in motion and keeps them going. All crops need large quantities of water, some more than others, and they obtain all of it from the soil through their roots. Provided the amount of water in the soil is not so great as to interfere with the air supply, the crop yield, other things being equal, will be proportional to the water supply.

Not only must a certain quantity of water be available to the crop; it must be there when the crop needs it. Spells of drought are always liable to reduce crop yields, especially at certain critical periods of growth, as at the flowering stage.

A farmer can, therefore, only depend on the rainfall to supply the moisture factor when rains are sufficiently abundant and frequent. Given one and the same rainfall, however, soils of different types absorb and retain it to very different degrees.

Even violent rains are absorbed completely by sandy soils, but there would be a very considerable run-off in the case of the finest types of soil, because water can only penetrate a soil as quickly as air escapes from it.

On the other hand, sandy soils have very little power of *retaining* rainfall, so that much of which falls escapes as drainage. Clay soil, however, has very great power to retain water, and is therefore in this respect a more desirable type of soil than a sand. Since water sinks into a clay soil much slower than into a sand, the latter type of soil is ready for ploughing after rain much sooner than the clay, and because the latter type of soil remains wet at the surface longer there is a greater loss of moisture from it through evaporation.

Coarse sandy soils have very little power to lift water, so that although there may be ground water at no great depth, the sand above it may be quite dry. Clays, on the other hand, have very great water lifting power, but the water ascends very slowly; so slowly in the case of heavy clays that crops growing on them may suffer severely in times of drought, although there is plenty of moisture in the lower levels of the soil.

It is evident that both sands and clays have good as well as bad points. Neither type is a good one for farming on rainfall. The ideal soil for that purpose is one in which water moves readily up, down, and sideways, and one which, at the same time, is able to absorb and retain a fair amount of the rain that falls upon it. Since it is the finest particles which are responsible chiefly for the ability of the soil to retain moisture, and since these same particles are responsible for its water lifting power, for the slowness of movement of water in it, and for its slow absorbing properties, the ideal soil will be one which contains enough fine particles to make it retentive, yet not enough seriously to impede the movements of water in it. Such soils are the loams, particularly the fine sandy loams, a type of soil which contains from 10 to 15 per cent. of clay.

The mechanical analysis of the soil, by indicating the proportions of fine to coarse particles, therefore assists one in forming an opinion as to the water properties of it.

It will be noted that "humus" figures in the mechanical analysis. Humus is even more retentive of moisture than clay, and

generally speaking its properties with reference to the moisture conditions of the soil are similar to those of clay, excepting that it does not usually hinder the movement of water to anything like the same degree; indeed, humus, by causing the clay particles to aggregate, assists the movement of water in clay soils. A good humus content is invaluable in sandy soils, as it tends to bind the particles together as well as to increase the moisture-holding capacity of the soil.

Reference to the mechanical analyses will show that in some cases figures relating to the permeability of the soil to water are given. By permeability is meant the rate at which water passes downwards through the soil. These figures are to be regarded as complementary to the figures which give the proportions of various sizes of particles, but which do not indicate to what extent the particles are aggregated.

*Plate V.*

Showing the effect of a deficient food supply on the crop and the effect produced by applying the deficient food substance to the soil.



The mealies are growing on a virgin soil derived from the Molteno Beds. Where the growth is poor no manure was applied; but where the growth is fair a phosphatic manure had been sown with the seed.

The importance of water in plant growth will be manifest from the following four points:—

1. All plants contain considerably more water than any other substance. For example, about 90 per cent. of a mangel consists of water.
2. The presence of water in its tissues prevents the sun from drying it up and thereby killing it.
3. It forms the vehicle by which the plant obtains its food from the soil and thereafter distributes it throughout its tissues.
4. It plays a very great part, directly and indirectly, in the preparation of the food substances which the plant obtains from the soil.



It is evident that the importance of water to plant life is difficult to over-estimate, especially in this country of ours where the rainfall is both uncertain and light.

*Food Supply.*—If crop yields are consistently poor the farmer more often than not ascribes the bad yields to a deficient food supply in the soil. Sometimes he is right, but just as often wrong, for food supply is only one of several factors whose presence is necessary to plant growth. Before attributing bad yields to a lack of food, one should always make certain that none of the other factors is wanting.

Doubtless there are many instances on record in which soils have been deficient in plant food right from the start, also in which the supply of food has seriously diminished owing to long continued cultivation. Many also are the instances in which the yields of crops have been considerably increased by the addition to the soil of one or more plant foods.

It will have been gathered that there is more than one kind of plant food; as a matter of fact there are at least a dozen kinds. Of the foodstuffs required by plants one, i.e. carbondioxide, is obtained from the atmosphere. The plant takes this gas in through microscopical openings on its leaves, from which one may reasonably conclude that good leaf development is essential to good yields. The rest of the food substances are taken from the soil through the roots. There are, however, no openings on roots comparable to those on leaves through which the plant takes its food from the soil; but the food enters the plant by its roots. These latter are constructed of material which allows water to pass through it, carrying with it substances (including food substances) which it has dissolved from the soil. No matter how finely substances are divided they cannot pass through the roots of a plant unless they are soluble in water and are actually dissolved in it.

Water is therefore rightly regarded as the vehicle by which food is transported from the soil to the plant. It therefore follows that if the water factor is deficient, so must the food factor be in effect; also that no benefit can be expected from the artificial increase of the food supply (manuring) until the defect in the water factor has been remedied.

It should, however, be stated here that, given two soils identical in every respect, except that the one contains plenty of all kinds of available plant food, the other being somewhat deficient in that respect, the former will produce crops at a less water cost than the latter. This means that up to a point an abundant food supply economizes the water supply.

It was stated higher up that no plant food substance can enter the roots of a plant unless it be first dissolved in the water of the soil. Now, only a very small fraction of the plant food substances in the soil are soluble in water; that is, almost the whole quantity is insoluble and therefore unavailable for immediate use by the plant. Consequent on these facts, two groups of food substances are recognized in the soil, i.e.—

- (a) Dormant or unavailable food substances.
- (b) Water-soluble or available food substances.

The chemical analysis of the soil is usually designed to furnish the percentages of (a) + (b); hardly ever is it attempted to give particulars regarding (b), owing to manipulative difficulties. Frequently, however, an analysis furnishes figures which, on the average, indicate whether there is a sufficiency or not of water-soluble plant food in the soil, i.e. figures showing the percentages of plant food which can be extracted from the soil by means of a weak acid solution, such as a 1 per cent. solution of the acid of lemons, i.e. citric acid.

The analyses of this report give the figures for (a) + (b), and the percentages of potash and phosphoric oxide extractable by a 1 per cent. solution of citric acid, called "available" in the analysis.

It may be asked with fairness, "Why give the figures for (a) + (b) at all?" This is hardly the place to discuss the matter, except to say that the figures for (a) + (b) represent the "capital" of the soil in plant food, and that of this "capital" a very small percentage becomes available year by year. Naturally, the larger the "capital," the greater the output of available plant food to be expected, although the expected does not always happen.

The output of "available" plant food is governed by the action on the dormant plant food of those several natural processes which are grouped together under the term "weathering."

Anything that increases the intensity of the weathering processes in the soil increases the output of available plant food. The benefits derivable from thorough tillage are to be attributed in no small degree to the increased "weathering" effect thereby produced.

Further, by many comparisons of crop yields with the amounts of dormant plant food in the soil, it has been possible to arrive at certain standards of sufficiency and deficiency which, provided other conditions are normal, afford a useful guide.

Some dormant food substances become available less readily than others, however, a fact which sometimes leads to wrong deductions when the chemical analysis gives figures for (a) + (b) only; likewise also if the dormant plant food in a soil becomes available at a faster rate than usual. The geological origin of the soil and the figures obtained by extracting the soil with a 1 per cent. solution of citric acid afford a useful check in such cases; how useful will be apparent when we come to consider the analytical figures for the Paarden-veerlies soils.

It is now necessary to come to closer grips with the actual food substances the plant takes from the soil. Since of the large number required only three (one or more), are ever likely to be present in deficient amount, the discussion will be limited to these three only. They are suitable compounds of phosphorus, of nitrogen, and of potassium. For convenience these compounds figure in the analysis as phosphoric oxide, nitrogen, and potash; *it must, however, be remembered that it is always "compounds" of these substances which are being dealt with.*

*Nitrogen.*—Nitrogen is that food element whose effect is seen particularly in the foliage, etc. With a deficient nitrogen supply there is poor, sometimes yellowish, growth; if the nitrogen supply is adequate the foliage is abundant and of a bright healthy green colour; while, if the nitrogenous supply is excessive, the growth is rank, slow to ripen, does not seed well, and is particularly susceptible

to attacks by disease and insect pests. The nitrogen factor would not appear to be deficient in our average soil; on the other hand, it is doubtless often excessive.

*Phosphoric Oxide.*—Suitable compounds of phosphoric oxide exert a very beneficial effect on root development and on tillering (stooling). Its effect in this respect is particularly marked on soils of poor aeration; not so much on sandy soils. An abundant supply of phosphatic food shortens the period necessary for the plant to come to maturity, and, when this food factor is deficient in comparison with nitrogen, artificial additions result in a considerable increase in the yields of tubers to top, seed to straw, etc.

Further, an adequate supply of phosphatic food produces crops of much higher feeding value than if the supply is inadequate.

The average soils of the Union would seem to be more deficient in phosphatic food than in any other.

*Potash.*—Potassium is that food element which is responsible for the "filling out" of grain. Other factors being normal, an inadequate supply of potash leads to grain of dull appearance, "thin" and often of low germinating vitality. A plentiful supply of potash tends to keep the plant growing in droughty times, and confers on the plant a greater resistance to certain diseases.

Potatoes, beet, mangels, and tobacco are among the crops which require more potash than is usually found in average soil.

*Rectifying Deficiencies in Food Supply.*—If the food supply is deficient, matters may be improved by adding substances called manures or fertilizers to the soil.

Manures are substances which add water-soluble food substances to the soil or food substances which, when added to the soil, become readily soluble in the soil water. Superphosphate is an example of a water-soluble phosphatic manure, while basic slag and bone, if ground to a sufficient degree of fineness, are examples of phosphatic manures which are not water-soluble, but which become readily water-soluble when applied to the soil. Nitrate of soda and ammonium sulphate are examples of water-soluble nitrogenous fertilizers, blood and meat meal being insoluble, but becoming readily soluble in the soil. Sulphate of potash is a water-soluble potassic fertilizer, as are also certain plant ashes. These latter are, however, not generally usable owing to the fact that under certain conditions (deficient rainfall among them) their use would introduce a harmful factor, as well as food, into the soil.

Kraal manure, stable manure, Government guano, and bat guano are examples of fertilizers which supply all three food substances, and all of them contain water-soluble and water-insoluble food substances. Further, the amounts of plant-food substances present in these manures are not well balanced; phosphatic food substance, in which our soils are most deficient, is also most deficient in these fertilizers.

Manures are not to be used in any haphazard fashion; the correct choice depends not only on soil conditions, but also on the crop it is desired to grow and on climatic conditions. There is no such thing as a "best" fertilizer; what is best in one case may be worst in another.

The reader having perused the above sketch of factors in plant growth should now be able to appreciate the discussion of the analytical figures.

TABLE I.  
*Analysis of Soils from Paardenverlies.*

	No. 612. Zandbult.	No. 613. Over Spruit.	No. 614. Under Dolerite Ridge.
<i>Mechanical Analysis.</i>			
Colour	Light reddish brown.	Dark reddish brown.	Black.
	Per Cent.	Per Cent.	Per Cent.
Fine earth, below 1 mm.	100	100	100
Coarse sand, 1-0.2 mm.	21.24	15.25	8.38
Fine sand, 0.2-0.04 mm.	54.63	46.41	33.06
Silt, 0.04-0.01 mm.	3.66	10.95	14.08
Fine silt, 0.01-0.002 mm.	3.9	9.39	16.07
Clay, below 0.002 mm.	11.75	11.82	19.95
Soluble in N/5 Hydrochloric acid	0.56	0.67	0.71
Reaction to Litmus	Acid.	Acid.	Acid.
Carbonates	Nil.	0.005	0.005
Humus	1.93	1.96	3.6
Loss on Ignition	3.2	3.5	5.5
Moisture	0.83	0.82	1.96
Permeability to water	3.35	0.53	0.34
<i>Chemical Analysis.</i>			
Nitrogen	0.08	0.11	0.15
Insoluble inorganic residue	88.6	88.2	83.7
Lime	0.35	0.28	0.53
Magnesia	0.24	0.20	0.50
Potash	0.10	0.57	0.47
"Available" Potash	0.006	0.032	0.033
Phosphoric Oxide	0.053	0.048	0.100
"Available" Phosphoric Oxide	0.003	0.013	0.018

#### DISCUSSION OF ANALYTICAL RESULTS.

Particulars of the analytical processes by which the above results were obtained will form an appendix to this report.

#### *Mechanical Analysis.*

The analysis shows that the soil particles have been sorted out into five groups, i.e.—

- (1) Coarse sand, 1.0.2 mm.
- (2) Fine sand, 0.2-0.04 mm.
- (3) Silt, 0.04-0.01 mm.
- (4) Fine silt, 0.01-0.002 mm.
- (5) Clay, below 0.002 mm.

The figures which immediately follow the group name indicate the diameter of the particles in the group. For example, coarse sand, 1-0.2 mm., means that the diameter of particles classed as coarse sand varies between one millimetre\* and 0.2 millimetre.

A few words concerning the principal properties of the various groups will not be out of place.

It has already been indicated that the clay particles are the finest, the sand particles the coarsest, and the silt particles intermediate in size, also that the properties of the various particles

\* One millimetre is roughly  $\frac{1}{25}$  of an inch.

depend largely on their size. The coarsest particles (viz., coarse sand) are roughly the very opposite in properties to the finest (viz., clay), as will be apparent from the following parallel comparison:—

Clay.	Coarse Sand.
The individual particles are invisible to the eye, even when aided by the most powerful microscope.	The particles are plainly visible to the unaided eye.
When rubbed with water clay becomes very sticky and impervious.	Does not become sticky or impervious under similar treatment.
Clay is very plastic when moist, that is, it can be moulded into shapes; these shapes are retained when the clay dries and even when it is fired. Clay particles therefore possess the property of cohesiveness to a high degree. Clay in the soil binds the particles together—into clods if the soil has been badly worked, into granules or crumbs if properly tilled.	Coarse sand can be moulded into shapes when wet, but the particles fall apart as soon as the moisture evaporates, viz., the particles have no cohesion except when wet. Thus coarse sand tends to keep the soil open and powdery.
When dry clay is wetted it swells and gives out heat. On drying again it contracts. [A soil which contains much clay cracks open when it dries out.]	No such changes take place with coarse sand when similarly treated.
Clay impedes the movements of air and water.	Coarse sand permits of the free movement of air and water.
Clay retains much water.	Coarse sand retains very little water.

*Fine sand* unlike coarse possesses cohesiveness; the particles of this group tend to cake together. If a soil contains very much fine sand it usually "crusts" after irrigation or rain. Its power to retain water is only slightly better than that of coarse sand.

*Silt* is a very valuable constituent of soils; while fine enough to retard, it does not prevent the ready movement of water; it retains a fair quantity of water and possesses the power of lifting water well by the so-called capillary action.

*Fine silt* has great water-retaining power; it is, however, neither so impervious nor so plastic as clay. Fine silt hinders the movement of water and air in the soil and is a valuable constituent provided the soil contains little clay; should, however, the soil contain much clay, the presence of fine silt only serves to accentuate its undesirable physical properties.

*Humus* possesses many properties similar to those of clay; for example, it is highly retentive of moisture, it expands when wetted and it is very efficacious in binding particles of sand together, also particles of clay. Humus therefore improves the physical properties of both sands and clays.

*Carbonates*.—Under this head are included carbonate of lime and carbonate of magnesia. Both these substances are grouped together because their effect on the physical properties of the soil is similar. These carbonates have a very beneficial effect in making clay soils easier to work, owing to the fact that they dissolve in the soil water to a sufficient extent to produce a granulating or flocculating effect on clay. Chemically these two carbonates act in the direction

of preventing the soil from becoming acid or of correcting acidity, if such has already developed.

Coming to the analytical features of the samples, it is found that No. 612 contains a moderate quantity of clay, little fine silt and silt, much fine and much coarse sand; viz., it contains much material which allows of but little which prevents the movement of air and water. The soil should therefore be one of high permeability; the figure (3.35) in Table I shows that such is actually the case. Owing to the large percentage of fine sand (55 per cent.), this soil would probably harden at the surface on drying. No. 613 contains less of both grades of sand, the same amount of clay and about three times as much fine silt and silt; viz., the soil contains considerably less material which facilitates and more which hinders the movements of air and water. These facts find reflection in the analysis which gives the permeability as 0.53, or only one-sixth of that of No. 612.

Apart from permeability, owing to the high percentage of coarse particles in No. 612, the soil must be of low retentive power, both as regards moisture and plant food, while No. 613 with its higher percentage of finer particles will be more retentive. One would deduce from the analysis that No. 613 is the more desirable of the two, and that 612, unless it be underlain by a more retentive sub-soil, would be likely to suffer from drought unless the rains fell frequently.

We shall see presently that from the chemical point of view, No. 613 is also the better soil.

In No. 614, both clay and silt are considerably higher than in either of the preceding samples, and both coarse and fine sand are considerably less. The further fall in permeability shown by the analysis is therefore understandable; one might, indeed, have expected an even greater fall were it not that No. 614 contains about twice as much humus as No. 613, the effect of humus being to keep the clay soil in a granulated condition (*vide supra*).

The higher percentages of finest particles and of humus in No. 614 make it a more retentive soil than No. 613, much more retentive than No. 612.

In wet seasons, if such are ever experienced in the Witkop district, No. 614 would probably retain too much water; No. 612 no more than sufficient. In average seasons, crops might suffer from drought on No. 614, because that soil would be likely not to absorb a sufficiency of the rainfall, while No. 612 would also carry too little moisture, because it has no great power of retention. No. 613, by absorbing fairly well and retaining well what it absorbs, would probably be in a position in an average season to supply crops better with moisture than either of the others.

\*All three soils are deficient in carbonates and are acid; that is, they contain a harmful factor.

#### CHEMICAL ANALYSIS.

*Nitrogen.*—No. 614 contains twice as much nitrogen as No. 612, No. 613 occupying an intermediate position. So far as our experience goes, the nitrogen supply would seem to be ample in all cases.

*Lime.*—In no case does the supply of lime appear inadequate for food purposes. Note that the soil in No. 614 derived from the dolerite-capped sandstone ridge is the richest in lime.

*Magnesia.*—The remarks under "lime" apply here also. Note also that the mechanical analysis returns the amount of carbonates

(viz., lime and magnesia carbonates) as nil in the case of No. 612, and a mere trace in the other two cases.

*Potash.*—The figures for potash are similar in all cases and appear to indicate sufficiency; but they represent “capital” and not “available.” The “available” potash is ample only in No. 613 and No. 614; No. 612 contains only about one-fifth of the “available” potash contained by the other two soils, and is doubtless deficient in that respect.

*Phosphoric Oxide.*—No. 614 is well provided with this plant-food substance, and a fair proportion of it is available. The amounts of phosphoric oxide in Nos. 612 and 613 are low, but it should be noted that No. 613 contains much more “available” phosphoric oxide than No. 612 and nearly as much as No. 614. No. 613 contains a fair quantity of “available” phosphoric oxide, while No. 612 is deficient.

It is evident from the foregoing discussion that whether judged by the chemical or by the mechanical analysis, soil No. 612 is decidedly inferior to either No. 613 or No. 614.

#### RECOMMENDATIONS.

No. 612.—This soil is deficient in carbonates, in “available” potash and in “available” phosphoric oxide. The soil is also of low retentiveness. The first-mentioned deficiency can be corrected by the application of finely ground limestone. The deficiencies in plant food would be best met by the application of a suitable manure, as, for instance, a mixture of 250 lb. bone dust and 2000 lb. kraal manure (dry sifted material), these quantities being sufficient for a morgen for ordinary crops.

Green manuring is recommended for the purpose of increasing the amount of humus in the soil, as this would make the soil more retentive, thereby improving the moisture factor.

The mechanical composition of this soil would indicate that it is more suitable for potatoes than No. 613 on which that crop is grown. This would doubtless be the case were the seasons such that the crop did not suffer from want of moisture, and provided the farmer would supply the deficient plant food. Should it be attempted to grow potatoes on this land, the above-mentioned mixture should be applied to half a morgen, and the kraal manure could be doubled in quantity with advantage.

No. 613 would benefit by green manuring, the application of bone dust, and of agricultural lime. Good tillage would also prove of greatest benefit. The soil is, perhaps, rather fine in texture for potatoes, No. 612 being the more desirable type; but what it loses in that respect it more than gains over No. 612 by its other superiorities.

No. 614 requires good tillage more than anything else, and it would probably benefit from a dressing of agricultural lime. It is a rather heavy soil, and would appear to be well suited to wheat. Light dressings of superphosphate or dissolved bones at seeding time would doubtless improve the root development of crops and through that the yields.

[Further instalments will be published in subsequent issues of the *Journal*.]

## DEVELOPMENT OF AGRICULTURAL MACHINERY.

### A Movement to Promote Greater and more Economic Production.

THE insistent and universal demand for greater agricultural production brings into prominence one of the chief factors which will enable the world's producers to cope with the call for more foodstuff—the extended and intelligent use of agricultural machinery. It is common knowledge that with the passing of the years there has taken place a perceptible improvement in the various classes of machinery designed to aid the agriculturist, and labour-saving devices have steadily come into use. But agricultural machinery does not yet occupy the place it should in the economy of the farm, due chiefly, no doubt, to cheapness of labour and also to a measure of conservatism usual to the farming industry which moves deliberately where any change from farming methods of the past is concerned. It must be admitted, however, that the employment of agricultural machinery is fraught with many problems to the farmer. There are numerous classes and types of machinery on the market, and to a large extent the farmer is dependent upon the advice of the implement manufacturer or his agent in selecting any machine or implement he may be thinking of buying. It is true that he may have the advice of his neighbours or of the Department of Agriculture, and may have had the opportunity of seeing the particular machine or implement at work, but notwithstanding these aids, it is the experience of many farmers that they have often purchased machinery of little use to them, being of a type unsuitable perhaps to the locality, and agriculture has suffered as a consequence. Another cause retarding the more extended and efficient use of labour-aiding appliances to-day, is the lack of skilled workers. Owing to the facilities for raising and feeding oxen, and the use of native labour, South Africa has not hitherto felt a pressing need for certain classes of machinery, the adoption of which has consequently been slow.

The war has brought about a change in the attitude of many farmers, especially those in older countries, towards the use of machinery, one of the chief causes of this new outlook being the shortage of labour and the advance in the wages of farm workers. Alive to the altered conditions, the pressing need for increased production, and the great importance which the use of agricultural machinery and implements will hold in the future development of agriculture, the Ministry of Agriculture and Fisheries, London, appointed a Committee to inquire into the many phases of the subject, and we have before us a copy of the Committee's report\* dealing

\* Report of the Departmental Committee on Agricultural Machinery (Ministry of Agriculture and Fisheries), obtainable from His Majesty's Stationery Office, London. Price 1s. net (No. Cmd. 506).



particularly with advice as to the further steps which should be taken to promote the development of agricultural machinery.

The future prosperity of the Union is subject largely to the extension of its agricultural activities and the magnitude of any forward movement in the development of our resources will depend in a great measure on the proper and increased use of agricultural machinery by our farmers. Therefore the subject of the inquiry referred to above is of undoubted interest to the farmer of South Africa, and we give the following few extracts of the report, being recommendations of the Committee for adoption in the British Isles, which will outline the trend of the movement there, and may be of special application to our country.

*Testing.*—The committee recommends: “That provision should be made by the Ministry of Agriculture for the thorough testing of agricultural machines and implements, and for the publication of the results.” It is further recommended that a permanent organization be set up for the fulfilment of the above aims, and that any manufacturer or agent should have the right to submit for testing and report any machinery or implement already on sale or ready for sale. It should be a condition that the results of all tests be published and accessible to all persons interested. Any authorized person submitting a machine for test should have the privilege of obtaining any suggestions for possible improvements which may have occurred to the officers making the test.

These test conditions should be of as wide a range as possible. For example, tractors and ploughs might be under continuous test for a period little less than a year, whereas for a binder probably six or seven weeks would suffice. Field tests should be supplemented by laboratory and workshop tests, and the whole should be so devised as to enable the report to include a precise specification of the machine, its qualities and actual performance under the conditions recorded.

After expressing the opinion that the above work could not suitably be undertaken by the universities or by a public association of persons interested in agricultural engineering, the committee goes on to recommend that the Ministry of Agriculture itself should undertake the work, and that a Central Advisory Committee to the Ministry be appointed with representation by the agricultural engineering trade, and agriculture, and containing also a small official element. The actual work of testing should be in the hands of qualified technical officers.

As a beginning, it is proposed to use the facilities existing at Agricultural Institutions, or any other that can be made available elsewhere. At a later date a special testing station may be necessary.

*Trials.*—The committee recommends that State recognition should be given to properly conducted trials of agricultural machinery organized by Agricultural Societies or Trade Associations.

*Inventions.*—The Ministry of Agriculture should provide for advice to inventors of new agricultural machines and implements, and for assistance in selected cases in the preparation of drawings, working models, or experimental machines.

*Information.*—The Ministry of Agriculture should establish an information bureau for the collection, classification, and collation of information relating to agricultural machinery and implements.

*Education.*—Instruction in the principles of mechanics and in their practical application to agriculture should be given to youths above the age of fourteen. By means of short courses and extension lectures the needs of farmers and specialized workers who require more than a general knowledge of agricultural machinery could probably be met, and local authorities should be encouraged to provide instruction in such subjects as tractor driving and mechanics, and the principles of internal combustion engines.

The committee recognize the difficulty in securing efficient instructors. The type of instructor required is a combination of the engineer and the agriculturist. Instruction in engineering, including workshop practice, should form the basis of his training, and should be followed by instruction in agriculture.

Agricultural machinery should be given a more prominent place in the curricula of agricultural colleges and farm institutes, and in the case of the former there should be attached to the staff at least one specialist whose whole time would be available for teaching and advisory work on this subject.

Further, there should be available at each institution besides the machinery and implements used on the farm, a well-equipped machinery workshop, and an exhibition of the principal types of machines and implements on the market.

*Advice and Propaganda.*—Expert advice on the subject of agricultural machinery should be provided in all counties, and the Ministry of Agriculture should encourage and co-ordinate demonstrations of agricultural machinery in every county or area. Local lectures illustrated by the lantern and kinematograph should be encouraged, and for this purpose lantern slides and kinematograph films, illustrating the use and care of agricultural implements and machines, might be provided by the Ministry of Agriculture.

As to propaganda, the committee is of opinion that nothing promises such success as demonstrations conducted by persons of known impartiality and adequate technical knowledge. But not everything can be demonstrated, and there is also need of the above-mentioned lectures with kinema and lantern, and well-chosen and attractive posters and pamphlets. These, in turn, may be supplemented by attractively written and illustrated articles supplied to the local press.

---

---

### Plant Nurseries in Quarantine for Pests.

The nurseries listed in the last two issues of the *Journal* (pages 287 and 348) were still in quarantine on the 1st July, 1920, with the exception of the following, which have been released:—

E. Krohn, Esselen Street, Pretoria.

J. H. Laubscher, Graaff-Reinet.

Botanic Gardens, Graaff-Reinet.

---

---

Keep your *Journals*! The contents will be indexed every six months and a copy of the index sent to each subscriber.

## RODENT INJURY TO TREES.

### Cause, Prevention, and Repair.

By W. F. SCHLUPP, B.Sc. (Agr.), Entomologist, School of Agriculture and Experiment Station, Potchefstroom, Transvaal.

RODENT injury to trees is of frequent occurrence in certain parts of the Union. In this article the various ways and means of dealing with the problem are discussed. The farmer or fruit grower can select the method best suited to his own particular case.

The trees most commonly injured are those of the orchard, but occasionally shade trees and plantations are damaged. This article deals principally with the protection of fruit trees, but some of the methods described are adaptable in other cases.

The rodents responsible for the damage are hares, field mice and rats. In addition to rodents, small antelopes sometimes do much injury.

*Cause of Rodent Injury.*—The damage is nearly always done in winter and spring, and the immediate cause is a lack of green plants and other food. However, in most of the cases that have come to the notice of the writer the primary cause has been neglect of the orchard. By allowing a rank growth of grass and weeds to spring up, favourable conditions for rodents are produced; the vegetation affording the animals a shelter from hawks, owls, and other natural enemies.

*Preventive Measures.*—The best preventive measure is clean cultivation. By this we mean keeping the orchard free of weeds, etc., during the dry season, as it is in dry winters and springs that the trees are generally attacked. During the wet summer season a cover crop may be grown, but at the end of the rainy season this should be ploughed under and not allowed to remain on the ground over winter. Grass and other vegetation growing around trees should be destroyed. In addition to sheltering rodents, rank vegetation may sometimes increase the chance of damage by insects and fungi.

When all that is desired is protection of the trees from a few rodents that occasionally enter the orchard, the winter prunings are sometimes left lying on the ground until spring, in order that the animals may feed upon these instead of upon the trees. A few cabbages, mangels, etc., could also be placed about the orchard. This is sometimes successful in preventing injury, but is only a compromise measure and may at times result in attracting a few more rodents to the vicinity.

*Fencing.*—Rat and mouse proof fences are practically out of the question. For hares, poultry netting with  $1\frac{1}{2}$ -inch meshes is suitable. A height of 3 feet is suggested, although  $2\frac{1}{2}$  feet or even 2 feet would

probably be sufficient. Fencing against rabbits has been practised over immense areas in Australia, and to a less extent in Europe and America, but the present high price of material will prevent any extensive use of it in South Africa. For buck, a high and fairly rigid fence is required.

### MECHANICAL PROTECTORS FOR FRUIT TREES.

Mechanical protection is particularly adapted for small trees. It consists in enclosing the trunks in some suitable material. The practice that obtains in some farm orchards of allowing sprouts to grow from near the surface of the soil, thus forming two or three trunks instead of one, is objectionable from several standpoints, and renders the use of protectors difficult.

Plate I illustrates the use of different materials. Beginning on the left of the picture, these materials are: (a) Wire-netting, (b) maize stalks, (c) bagging, (d) paper.

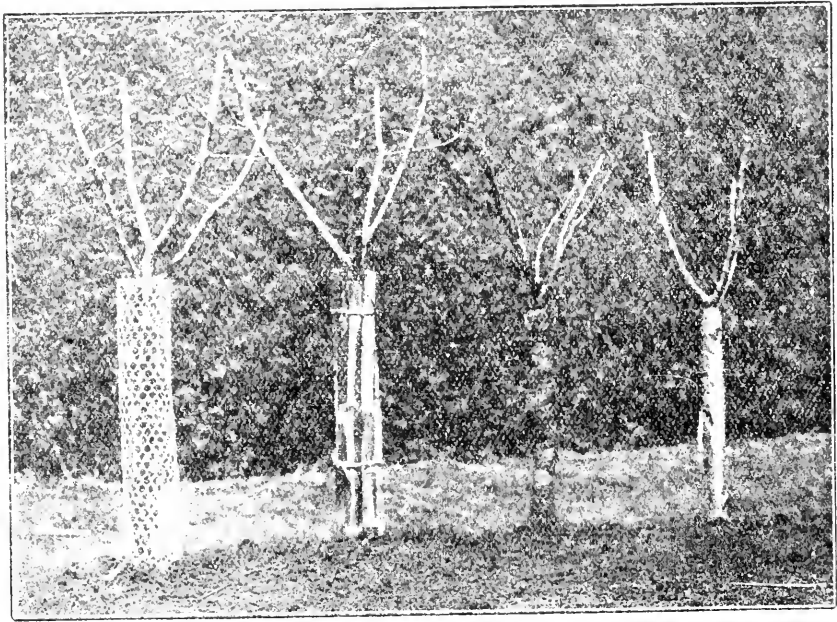

PLATE I.

*Photo by Caporn.*

(a) Wire-Netting.

(b) Maize Stalks.

(c) Bagging.

(d) Paper.

*Wire-netting.*—Galvanized netting is suitable. A piece wide enough to encircle the trunk very loosely (a piece about 1 foot wide is used for a small tree) is cut and bent to form a cylinder, and, after being placed in position is secured by twisting together the projecting ends of the wire. Stakes may be used to prevent the cylinders from being pressed against the tree trunk.

One-inch mesh will protect the trees against hares, but a mesh sufficiently small to keep out mice should always be used, if it can

be obtained. Even wire mosquito gauze can be used, but it is less durable than netting made from larger wire.

*Maize Stalks.*—Dry stalks are cut into suitable lengths and bound around the trunk. Unless the tree is perfectly straight, considerable trouble is experienced in getting them to fit properly. Splitting the stalks sometimes solves this difficulty. Reeds may be used as a substitute. Stalks and reeds furnish excellent protection and the material costs nothing, but they often prove rather expensive if the labour is taken into consideration.

*Bagging.*—This is a good material for use. Rodents do not gnaw through it; and in the case of large trees, or trees with branching trunks, protectors made of this material are practically the only ones that can be put in position easily. A few old bags are generally available on the farm, and others that will serve the object, such as old coal bags, can often be obtained at a cheap rate.

*Paper.*—Any strong paper, with the exception of that containing tar, will answer the purpose and will generally prove satisfactory as a wrapping material, provided, of course, that a proper thickness is used. It is said that in countries where the ground lies covered with snow for a long period rabbits will tear through paper, but hares are not so pressed here by hunger.

With regard to the comparative merit of the different materials, the netting has the most to recommend it. The cylinders can be put on the trees when the latter are small and left on until the trees are large; whereas protectors made from the other materials must be removed each summer, otherwise there is danger of insects and fungi finding shelter under them and injuring the tree.

#### REPELLENT SPRAYS.

In the United States of America lime-sulphur sprays have been found to be of considerable value in protecting trees from the attack of rodents. Their weak point is that the effect does not last throughout a season. However, as a precautionary measure late winter or early spring spraying with lime-sulphur can be recommended, as, in addition to having some value as a repellent for rodents, it is one of the very best "general winter clean-up sprays" known. It is fairly effective against most kinds of scale insects, helps to prevent the development of fungous diseases, and has an invigorating effect upon the tree.

To prepare lime-sulphur spray, heat 5 gallons of water, and to this slowly add 10 lb. of quicklime. Mix 20 lb. of sulphur to a thin paste with a little water, and stir it into the lime while the latter is still slaking. Add 5 gallons of water and boil until the sulphur is all dissolved, stirring continually. Add water when necessary, keeping the quantity in the cooking vessel up to 10 gallons. Boiling generally takes from 45 minutes to 1 hour. When cooking is completed, strain the liquid, add enough water to make 50 gallons of spray, and use. If there is doubt as to the purity of the lime, or if slaked lime is used, the quantity should be increased to 15 or 20 lb. Reliable brands of ready prepared lime-sulphur can be purchased in shops, either in a concentrated liquid form or as a dry powder.

## REPELLENT WASHES.

Repellent washes can be recommended, but it must be remembered that they are not absolutely infallible; occasionally they fail to save the trees from injury. They are applied to the trunks with a brush, and deter animals from gnawing the bark because of an objectionable taste or odour. A great variety of substances are used. Some are without any real value, but others are distinctly useful and generally fulfil their purpose.

Aloes and other bitter substances do not afford sufficient protection, as many rodents do not object to bitterness.

Coal-tar dips, carbolic acid, etc., lose their effectiveness very quickly, and have to be renewed at short intervals. Moreover, if used too strong they will injure tender young tissue. They cannot be recommended, except perhaps for emergency use.

Stockholm tar and coal-tar, though effective, should not be used, as they are very injurious to young trees. The effect does not always show at once. In the writer's experiments, tar preparations were applied during the last week of August, 1918, to seedling peach trees about the thickness of the thumb. The trees came into leaf and showed no injury for several weeks, but they died before autumn. Young shoots were killed very quickly. Even tarred roofing paper is said to produce severe injury to young trees.

Limewash has some merit, but it is not so effective as certain other washes, and it does not stick well. Salt is sometimes added to make it more adhesive, but on the farm Turffontein, Welverdiend, where it was tried, the hares injured the treated trees badly. The salt seemed to attract the rodents. The addition of soot does not appear to make much difference in effectiveness. Carbide lime soon loses its characteristic odour, and does not seem to be very much superior to ordinary lime. The Minnesota Station recommends that limewash be coloured a deep blue by the addition of copper sulphate (blue-stone), but, as will be seen later, such a wash did not prove to be very adhesive at Potchefstroom.

Blood has given very good results against hares. Judging by the antipathy that cattle have for it, blood should also be an excellent thing for use when fruit trees are attacked by buck. Probably the effectiveness could be increased by mixing it with water in which a little glue is dissolved, in order to make it more adhesive. If the trees are to be protected from mice, blood must not be used, as it attracts these pests instead of repelling them.

Sulphur is used in many storehouses as a repellent for rats and mice. The value of lime-sulphur spray has already been discussed. Everything considered, a tree paint containing sulphur seems to be the most promising deterrent for general use. Such paints are stated to have given good results in oversea countries. Aside from effectiveness, sulphur has the advantage of being beneficial rather than harmful to the tree.

## EXPERIMENTS WITH REPELLENT WASHES.

With the object of finding a wash that was sufficiently adhesive, experiments were conducted by the writer for the past three seasons

at the Potchefstroom Experiment Station. Most of the washes that were used contained sulphur. The mixtures were tested by painting them on young seedling peach trees, standard privets, oaks, etc., and on the back of large eucalyptus trees. Air-slaked lime was used in making up the washes, quicklime not being available.

In 1917 an experiment was conducted to test the reputed virtues of cactus juice as an adhesive. When sliced and soaked in water, at the rate of one pound to a gallon, spineless cactus yielded a thick gelatinous mixture. Washes were applied during the first week of August, and were of the following composition:—

1. Plain limewash, made with lime and water.
2. One part lime and one part sulphur, in cactus solution.
3. Two parts lime and one part sulphur, in cactus solution.
4. Three parts lime and one part sulphur, in cactus solution.

None of the washes proved to adhere satisfactorily. Although the cactus solution appeared to be very sticky, the washes prepared with it washed off the trees just as quickly as the plain limewash.

The following washes were applied on 24th August, 1918:—

1. Plain limewash.
2. One part lime and one part sulphur in dilute iron-sulphate solution.
3. One part lime and one part superphosphate in copper-sulphate solution.

Upon drying, No. 3 formed a coating that could not even be rubbed off, and it appeared that a wash of a most adhesive nature had been found. However, when heavy rains fell, No. 3 was the first to go. Results from No. 2 were not conclusive. As No. 3 at first gave much promise, the following tests were begun on 26th August:—

1. Plain limewash.
2. Lime, in copper-sulphate solution.
3. Two parts lime and one part sulphur in copper-sulphate solution.
4. Superphosphate in copper-sulphate solution.
5. Two parts superphosphate and one part sulphur in copper-sulphate solution.
6. One part superphosphate and one part lime in water.
7. Two parts superphosphate, two parts lime, and one part sulphur in water.
8. Two parts superphosphate, two parts lime, and one part sulphur in copper-sulphate solution.

The copper sulphate was present at the rate of 1 lb. in 8 gallons of the water used in making up the mixtures. It appeared to add slightly to the adhesiveness of the washes, but a heavy rain (1.68 inches) fell on 1st September, and the coatings on the trees were badly injured, and began to disappear. On 25th October not a coating was left. In the interval between the two dates mentioned the rainfall was 4.11

inches. This was distributed over eleven days, but most of it fell as heavy showers on three days.

Washes as listed were applied on 17th September, 1920:—

1. Plain limewash.
2. One part sulphur, one part lime, and one part tobacco dust, in thin glue.
3. Two parts sulphur, two parts lime, one part tobacco dust, in thin glue.
4. 1 lb. sulphur, 1 pint tobacco dust, and 1 lb. hard soap, in 1 gallon of water.
5. 1 lb. sulphur, 1 pint tobacco dust, 1 lb. soap, and 1 lb. lime, in 1 gallon of water.

On 25th September the following were added to the test:—

6. One part portland cement and one part sulphur, in sour skimmed milk.
7. One part portland cement, one part sulphur, and one part lime, in sour skimmed milk.

No rain fell until November, but by that time the limewash had peeled off the trees. The other washes withstood the November rains, consisting of six light showers, two of nearly one-half inch each, and two rains of 1.07 and 1.42 inches respectively, making a total of 4.02 inches. In December only 1.62 inches of rain fell, distributed over nine days.

In January, 1920, there were four days on which rain fell in amounts ranging from .46 to 1.31 inches, besides eight other days on which light showers occurred, making a total of 4.05 inches of rainfall for the month. The January rain washed away the mixtures prepared with glue, and injured the others.

In February there were six light showers, four ranging in amount from approximately one-half to one inch each, besides one heavy downpour in which 4.18 inches fell, most of it within a couple of hours. The total rainfall for the month was 7.98 inches. The February rains practically completed the work of the January ones, as at the end of the month very little except traces of the washes remained. Following the glue mixtures, Nos. 4 and 5 were the first to go, then 6, and finally 7.

No injury from any of the washes could be seen, except in one case when the mixtures 4 and 5 were boiled. The alkali of the soap evidently united with some of the sulphur, with the result that the washes injured leaves and tender young shoots. When there was no boiling, there was no injury. As regards the glue, it was used at the rate of 1 lb. in 4 gallons of water. It would probably be better to use a stronger mixture.

*Conclusions from Experiments.*—The washes used the third year were the only ones of much value. It is not always safe to form definite conclusions from one season's results; but, as the washes appeared to be perfectly safe, and as they withstood a much greater amount of rain than falls during the period when trees are liable



to injury by rodents, the following suggestions for repellent washes are advanced tentatively:—

- (a) Equal parts of portland cement, sulphur, and slaked lime, mixed with sour skimmed milk.
- (b) A mixture of 1 lb. each of sulphur, lime, and soap, in 1 gallon of water. The soap should be dissolved in hot water and the sulphur and lime stirred into the liquid. It mixes readily. Use while warm. If quicklime is used, it should be slaked in a little water, and then added to the soap and sulphur mixture.
- (c) A mixture of sulphur, lime, and glue. Dissolve 1 lb. of glue in 2 to 4 gallons of water, then, if slaked lime is used, mix the sulphur and lime together and stir into the glue solution.

Tobacco dust may be added to any of the above washes if desired. The mixtures should be applied to the trees whenever there is danger of rodent attack.

#### POISON WASHES.

The virulent soluble arsenical compounds such as arsenite of soda must never be used in washes, as serious injury or even the death of the tree will be the result. The extent of injury will depend upon the strength of the solution and the age of the tree. There are little data available regarding the use of insoluble arsenicals. One case has come to the notice of the writer in which fruit trees were painted with a fairly strong wash of lead-arsenate paste and water. The treatment did not prove to be very effective, as hares continued to attack the trees.

Strychnine washes have been used in Idaho, California, and other western States of America in recent years. A typical one is prepared as follows: Dissolve 1 ounce of strychnine sulphate (the hydrochloride could be used) in 3 quarts of boiling water and  $\frac{1}{2}$  lb. of dry laundry starch in 1 pint of cold water, and then mix the two solutions together. Boil until the paste is clear, and while boiling add 6 ounces of glycerine, stirring thoroughly. When cool enough, apply with a paint brush to the tree trunk.

The above quantity will do for a large number of small trees. It is said that rodents attacking the trees are soon killed by the poison, and that there is practically no injury to the trees by the wash.

It should be remembered that *strychnine is a deadly poison*, and must be handled with care.

#### POISON BAITS FOR THE DESTRUCTION OF RODENTS.

When rodent pests become numerous, destruction is always advisable, and in plantations it is the only practicable remedy, as applying washes to thousands of trees is out of the question. Poisoning is the cheapest method of destruction. Of the different poisons which might be used strychnine is by far the best, and is the only one that will be considered here.

*Hares.*—When these cannot be kept in check by shooting, they are sometimes poisoned by introducing a little strychnine into fruits or vegetables, and placing these about the orchard, either on the

ground or stuck on short sticks. Small twigs cut from fruit trees and dipped in a syrup or paste containing strychnine are at times successful as baits.

For extensive work a grain bait is generally used, and for this purpose "Colorado Formula No. 15" is recommended. Obtain from the chemist 1 ounce of powdered strychnine alkaloid. Be certain that it is the alkaloid, and that it is finely powdered. Mix the strychnine and 1 teaspoonful of saccharine in 1 quart of water, add  $\frac{1}{2}$  pint of fine salt and  $\frac{1}{4}$  pint of wheat flour, mix thoroughly (an egg beater is a good implement to use) and bring to a boil, stirring continually and making certain that the paste does not scorch. Then pour the paste over 10 quarts of grain (about 20 lb), mix thoroughly, and spread out to dry. This bait can be kept indefinitely.

A simpler bait, which, however, is hardly so effective, may be made as follows: Dissolve 1 ounce of strychnine sulphate or hydrochloride in a gallon of hot water, add 4 lb. of cheap sugar or  $\frac{1}{2}$  gallon of treacle and 20 lb. of grain, and simmer until the liquid is absorbed by the grain. This bait must be used at once, as it will soon ferment.

Different kinds of grain could be used, but maize is generally satisfactory. Before putting out the bait, the hares should first be fed for two or three nights with unpoisoned grain. If this grain is eaten, no feed should be given for a night, then on the following evening the poisoned bait should be put out, a tablespoonful in a place.

Best results are obtained by running a few shallow furrows through the lands and placing the bait in them.

*Field Mice and Rats.*—The following bait has given excellent results against South African veld mice: Dissolve a small cupful of laundry starch in a little cold water, add about 3 pints of boiling water, stir, and pour the paste over 40 lb. of crushed grain. Mix 1 ounce of powdered strychnine, 1 ounce of common baking soda, and a teaspoonful of saccharine (the latter is not absolutely necessary), place in a pepper box, and sift it over the grain. Mix thoroughly, let stand for a couple of hours, and then use, placing about a teaspoonful in a spot.

The United States of America Bureau of Biological Survey has used very successfully a simple convenient bait prepared by sifting the poison mixture from the pepper box on to dry crushed wheat. No paste is used. The same Bureau has had very good results in winter with a bait prepared as follows: Moisten 30 lb. of finely cut dry lucerne hay with water. Dissolve 1 ounce of strychnine sulphate (the hydrochloride can be used) in 2 gallons of hot water, and sprinkle it over the lucerne. This bait is cheap, convenient, less dangerous than grain to birds, and is well worthy of trial.

#### TREATMENT OF INJURED TREES.

Small irregular wounds should be trimmed, so as to leave smooth edges, and then covered with grafting wax to exclude the air and prevent drying out of the tissues. If wax is not available a plaster of fresh cow dung and clay should be bound over the wound.

For a grafting wax, Mr. R. A. Davis, late Chief Horticulturist for the Union, recommends the following as being suited to our conditions: Melt together in a suitable vessel, such as an iron kaffir pot, 6 lb. of crushed resin,  $\frac{1}{2}$  lb. of beeswax, and 1 oz. of raw linseed

oil. Stir while heating and do not let it boil. Apply with a brush while warm; it is too hard for use when cold.

### *Bridge Grafting.*

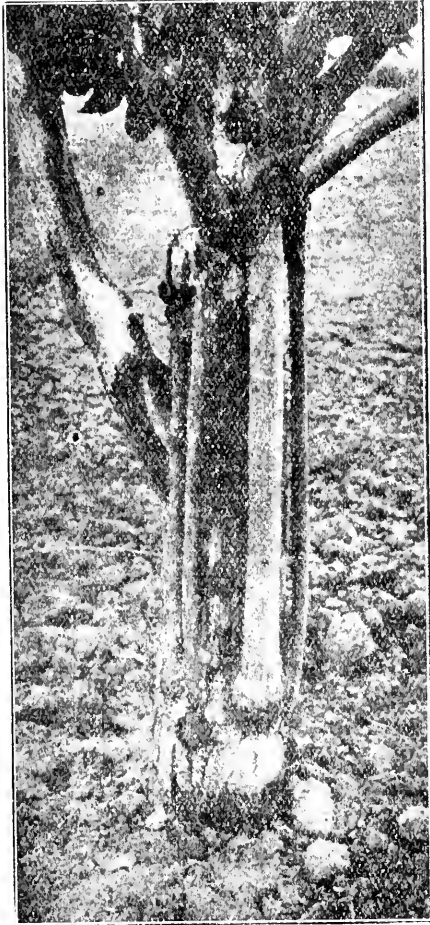

PLATE 2.

For large wounds other treatment is necessary. When small trees are badly injured, it is best to replace them with new ones; but the death of a large tree means a considerable loss. When such trees have been girdled or otherwise badly injured they can be saved by bridge grafting. Plate 2 shows a two-year old graft on a pear tree that had been girdled, and shows what may be done in the way of saving a tree. Plates 2 and 3; and also the following concise description, are taken from Farmers' Bulletin No. 710 of the United States Department of Agriculture ("Bridge Grafting of Fruit Trees," by W. F. Fletcher):—

"A bridge graft is made by using scions or small limbs to connect the two portions of the bark of a stock which have been separated by an injury; in other words, the injured area is bridged by a scion or scions, the ends of which unite with the uninjured parts above and below the wound in such a manner that a connection between the tissues is established.

"Bridge grafting may be used successfully on almost any kind of fruit tree that admits of being readily propagated by grafting. In practice there is

occasion to resort to it much more frequently with the apple than with any other fruit, but pear trees are often treated, at least in some sections. No reason is apparent why the method should not be successful on plums and cherries. Peaches graft less readily than the other trees mentioned and there may be some question as to the usefulness of the method in the case of this fruit.

"To be effective, bridge grafting must be done in the spring before growth starts, though sometimes it can be done after growth starts if dormant scions for that purpose can be secured. As rodents sometimes injure trees in late spring, the grafting must be done promptly.

"In preparing the wound to receive the graft, the injured part should be thoroughly cleansed; all dead tissue cut away. . . . The

irregular edges of the bark (plate 3, fig. A) at the upper and lower edges of the wound should be cut back evenly, as shown in fig. B.

“The scions which form the bridge should be selected from wood of the previous season’s growth. Either branches which grew the preceding season or water sprouts that are a year old may be used.

“It is important that the scions should be a little longer than the space that is to be bridged. This is in order that the middle portion of the scions when put in position shall arch slightly over the central part of the wound. This is illustrated in fig. D, where a longitudinal section of a bridge graft is shown.

“Before being placed in position, the scions are bevelled at each end, both bevelled surfaces being on the same side of the scion, as shown in fig. C. This bevelling should be done with a long sloping cut, so that the wedge-shaped ends thus formed will be relatively

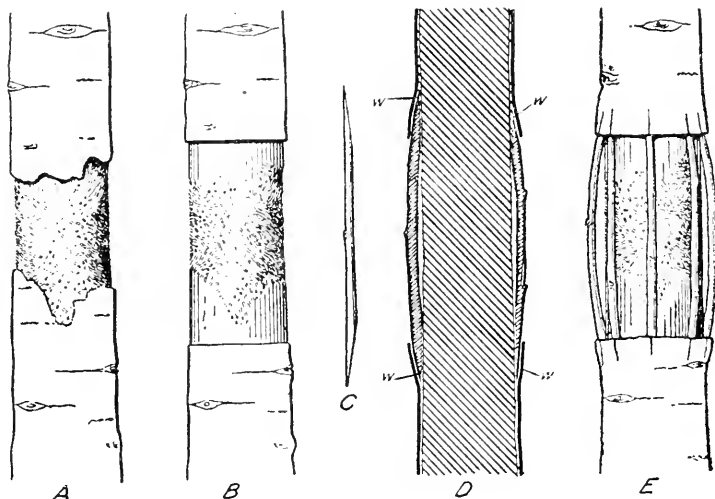

PLATE 3

Details of bridge grafting.—A, The trunk of a tree girdled by mice; B, the wound cleansed and the bark along the margins trimmed back to healthy, growing tissue; C, a scion with bevelled ends ready for insertion; D, longitudinal section of the trunk with scions in place, showing their insertion under the bark of the trunk (*w*); E, scions in place ready for waxing.

thin, to permit their being thrust well under the bark without danger of separating it unduly from the cambium at the point of insertion. Reference to fig. D illustrates this feature. The placing of the scions in position is facilitated if the bark at the margins of the wound is slit for a short distance at the points where the ends are to be inserted (fig. C).

“The number of scions required for a bridge graft will depend largely upon the size of the trunk. No fixed rule can be given. The larger the number, the more complete will be the restoration of the connection between the parts above and below the wound; but, if placed too close together, the bark at the margins of the wound between the scions will be raised. The starting of the bark, except at the immediate points of insertion of the scions, must be avoided.

“ In placing the scions, it is of the greatest importance that the cambium of the scions which is exposed in the sloping cuts at the ends be brought into intimate contact with the cambium that lies under the bark at the margins of the wounded area. The union of scion and tree can only occur where the cambium layers of the two come together. The scions may be secured in their proper positions, if need be, by driving a small nail through each end into the trunk. This will aid in drawing the cambium of scion and trunk closely together.

“ The operation is completed by thoroughly covering the area occupied by the ends of the scions and the margins of the wound with grafting wax, strips of waxed cloth, or some other means that will adequately prevent the parts from drying out.

“ When a valuable large tree has been badly injured, a method frequently adopted in western America is to plant two-year old seedlings around the base of the tree and graft their tops into the trunk above the girdled space. V-shaped vertical grooves extending through the cambium are cut just above the wounded area in the bark of the tree to be treated. The tops of the small trees are shaped to correspond with these grooves. The two are then accurately fitted together in such a manner as to bring the cambium of one in contact with that of the other. Small nails may be driven through the tops of the trees into the trunk, to hold the parts firmly together. . . . The wounds incident to joining the tops of the small trees to the trunk of the large one should be well covered with wax, to prevent drying out.”

---

### **East Coast Fever in the Pretoria District.**

In connection with the serious outbreaks of East Coast fever in the Pretoria District, the Minister of Agriculture—at Capetown for the Parliamentary session—visited Pretoria on the 17th June, for the purpose of holding meetings to discuss means of fighting the disease. Three meetings were held, two in Pretoria, and the third at the Premier Mine. The first was attended by members of the Pretoria Municipality, the Pretoria Society of Agriculture and Industries, prominent dairymen of Pretoria, and representatives from the western portion of the town; at the second meeting the situation was discussed with the Advisory Board (as then constituted) and representatives of the Police and the Veterinary Division. The third meeting held next day at the Premier Mine was attended by a large number of farmers. As an outcome of these meetings, it was decided to dissolve the existing Board, and elect one consisting of a representative each from each ward, the Pretoria Municipality, the west end of Pretoria, and the Innesdale Municipality, with the Magistrate of Pretoria as chairman. Representatives of the Police and Veterinary Division will attend meetings of this committee, sub-committees to be formed in each ward to represent matters to the central committee. The first meeting of the central committee, which has now been elected, has been called for the 7th July. The best possible steps are being taken to combat the spread of the disease, and it is trusted that the situation will very adequately be controlled as a result.

## FOOD VALUE OF WILLOW LEAVES.

Notes from the Chemical Laboratory, School of  
Agriculture and Experiment Station, Potchef-  
stroom.

By THOS. D. HALL, B.A., M.S.Agr.

WILLOW leaves are greatly sought after by cattle and other live stock, and it is often thought that it is only because this is the first green substance that appears on the dry, brown landscape; it will be seen, however, from the following analyses that willow leaves are highly nutritious. These figures are from the analyses of willow leaves of the "Weeping willow" variety containing also, besides leaves, the soft stems at the ends of the branches.

Substance.	Moisture.	Crude Protein.	Crude Fat.	Crude Fibre.	Carbo- hydrates N.F.E.	Ash.
Willow leaves—	Per cent.	Per cent.	Per cent.	Per cent.	Per cent.	Per cent.
Sample No. 1 (fresh)	68.46	5.32	1.47	5.01	16.93	2.81
"    "    2 ( " )	71.77	5.47	1.84	7.77	9.94	3.21
"    "    3 ( " )	62.56	5.55	2.36	8.15	17.77	3.61
Average ...	67.59	5.44	1.89	6.97	14.88	3.21
The same samples air-dried contain—						
No. 1 ...	9.68	15.25	4.54	14.37	47.12	8.08
"    2 ...	10.67	17.25	5.83	21.52	31.61	10.12
"    3 ...	9.94	13.62	5.68	19.61	42.47	8.68
Average ...	10.09	15.37	5.35	19.50	40.4	8.94

These samples were taken at intervals of more than a week apart during the feeding experiment on chickens conducted by Mr. R. Bourlay, of this Institution, comparing the value of green willow leaves with green lucerne. Those wanting more details of the experiment are referred to Press Circular No. 9, 1917, "Willow Leaves as a Green Food for Chicks." Mr. Bourlay summarizes his results thus: "It will be seen that in six weeks the chickens which were fed on willow leaves gained 2 lb. in weight over those fed on green lucerne, or an average gain of two and two-third oz. per chick."

Various inquiries about willow leaves have been received, so that it has been decided to publish these figures for general information. It is well to compare the analyses of dry willow leaves with lucerne hay, cowpea hay, and teff hay.

## COMPOSITION OF SOME IMPORTANT HAYS.

Hay.	Moisture.	Crude Protein.	Crude Fat.	Crude Fibre.	Carbo- hydrates N.F.E.	Ash.
	Per cent.	Per cent.	Per cent.	Per cent.	Per cent.	Per cent.
Lucerne ... ..	8.0	15.5	2.4	34.8	30.6	8.9
Cowpea ... ..	8.2	13.2	2.4	30.5	39.6	6.3
Teff... ..	8.2	6.0	1.1	34.8	43.2	6.7

Comparing the average composition of the dried willow leaves, we see that it is about equal to lucerne in quantity of protein, but it has not yet been determined whether the quality of the protein is better or worse than that of lucerne. It has more than twice as much crude fat, a little more than half as much crude fibre, and 10 per cent. more carbohydrates, and the same quantity of ash. The ash of these willow leaves was analysed by Mr. G. M. Hay, B.A., Assistant Chemist, and it will be noted that the mineral composition of the ash is excellent for growing animals or birds.

	Partial Composition of Ash of Willow Leaves and Twigs.	Partial Composition of Ash of Lucerne (Arms-by).
Silica... ..	3.268 per cent.	not given.
Iron oxide ... ..	3.692 ..	not given.
Calcium oxide ..	31.360 ..	22.96 per cent.
Magnesium oxide	12.620 ..	9.61 ..
Potassium oxide	9.926 ..	28.91 ..
Phosphoric oxide	5.040 ..	15.57 ..

This shows that in some respects the willow ash is better and in others the lucerne.

Actual feeding tests are, however, better than analyses, and Mr. Bourlay has shown that for growing chicks willow leaves give better results than equal quantities of lucerne.

### South African Pork and Bacon.

Reporting on a consignment of pork and bacon recently shipped from the Union to the London market, the Acting Trade Commissioner states that the pork arrived in extremely good condition, being a marked improvement on other consignments seen by him. The type of pig used is described as a useful butcher's pig, being of handy weights varying from 60 to 90 lb., but it is considered that the breed needs much improving, as the majority of the pigs were described as being half wild. It is pointed out also that the dressing of these pigs was not up to standard, the methods of scalding calling for improvement, the skins being very dark in colour and suffering in comparison with the clear white colour of English and American dressed hogs.

The bacon was considered extremely useful price meat, and both it and the pork secured the maximum controlled price.

## LAMB FATTENING.

---

By O. RIVERS, Officer in Charge of Sheep, School of Agriculture,  
Potchefstroom.

---

IN order to add to the data concerning the exact amount of feed and its cost for fattening winter lambs, an experiment was carried out at the School of Agriculture, Potchefstroom, from 1st July to 8th September, 1919, on slightly different lines to previous ones, and an accurate account kept of feed used during the ten weeks.

*Types Used.*—The lambs fattened were twenty first-cross by Suffolk rams from blackhead Persian ewes (Illustration I), and twelve second-cross by Suffolk rams from first-cross Suffolk-Persian ewes (Illustration II). Seventeen lambs of the above crosses, twelve of which were first-cross and five second-cross Suffolk-Persians, were kept as controls.

*Remarks on Types.*—It will be seen at once in Illustrations I and II that there is a great difference between the two crosses, the second-cross being much stouter built, with a fuller thigh, and altogether superior as a mutton sheep to the first-cross, carrying also a superior fleece of wool, and appearing to mature earlier.

*Controls.*—The seventeen controls were not given any grain, being entirely on green oats or lucerne during the whole time the experiment was being carried out.

*Ages.*—The lambs were dropped between the 10th April and the 26th April on veld at Brakspruit, and kept there until the 29th of May, being then of an average age of six weeks two days. They were then put on a lucerne paddock until the 30th June, when they were weighed and shifted on to Algerian oats to be fattened.

*Salt Lick.*—Salt lick, composed of 100 lb. salt, 4 lb. sulphur, and 3 lb. sulphate of iron was always obtainable.

*Worms.*—On 10th and 28th July and 11th and 18th August it was found necessary to dose all the lambs for tapeworms. Worm powder from the Government Laboratories was used. The lambs were weaned on 18th August at the average age of four months to save green feed, which was only sufficient to keep them going properly.

*Method of Feeding.*—The system of feeding was as follows: From the 1st July to the 8th September the lambs were yarded morning and evening and drafted off from their mothers into another yard with sufficient feeding troughs in it to allow room for all to feed at once. Sixty feet were used. During the first period of fourteen days a number of ewes were allowed to feed with the lambs to teach them, the ewes being daily gradually reduced in number until the lambs got





FIG. I. First-Cross Suffolk-Persians.



FIG. II.—Second-Cross Suffolk-Persians.

used to drafting themselves off and feeding alone. In this first period of fourteen days only 110 lb. of feed was used for thirty-two lambs and an average of ten ewes daily.

*Weighing.*—At intervals of fourteen days from 1st July to 8th September (five periods of fourteen days each) the lambs were weighed. The following chart shows the increases in weight:—

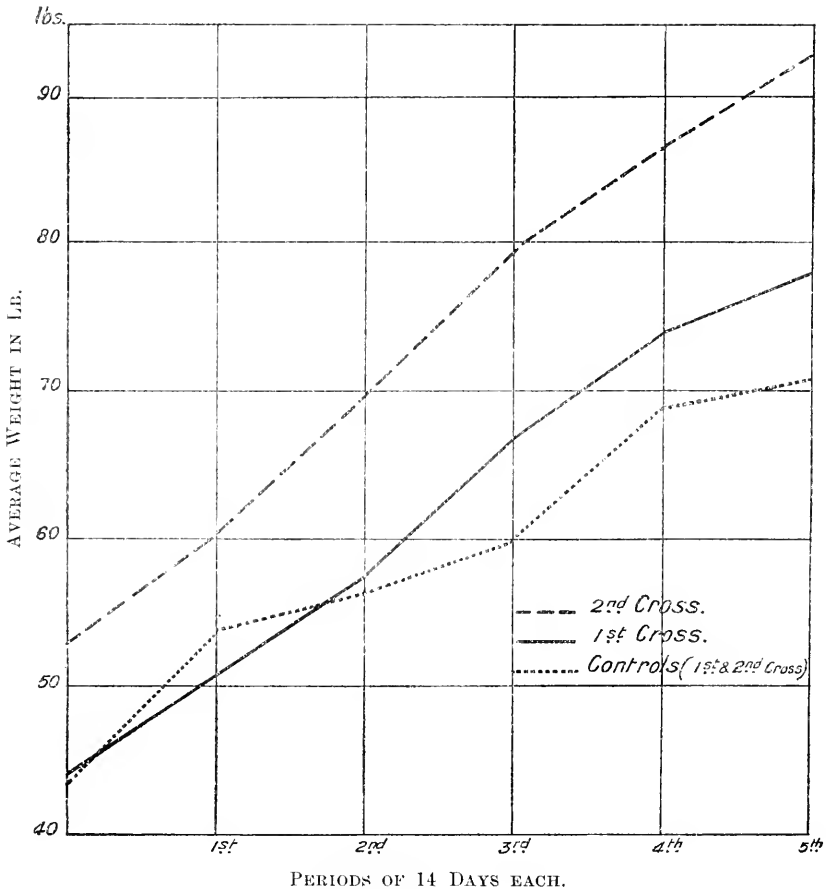

*Ration of Mixed Feed.*—As will be seen in Tables I, II, and III hereunder, the ration supplied seems very low in weight, but as the lambs would not eat up any more it appeared sufficient. They were tried with an increase frequently, but would leave a little unconsumed every time an increase was made.

TABLE I.

Type.	Average Starting Weight.	Average Fortnightly Weights (in lb.).					Average Daily Gain.	Total Gain.	Finished Weight in lb.	Gain on Starting Weight.
		1st.	2nd.	3rd.	4th.	5th.				
Second-Cross ...	53.00	60.33	69.75	79.58	86.66	92.91	.578	39.91	92.91	75.31
First-Cross ...	44.50	51.00	57.50	67.00	74.00	78.00	.478	33.50	78.00	75.27
Mixed Controls ...	43.75	53.75	56.28	59.78	69.18	70.94	.388	27.19	70.94	62.31

TABLE II.

Fortnightly ration for thirty-two lambs in pounds:—

Periods of 14 Days each.	Grazing on Algerian Oat Crop plus			Lambs' Daily Ration each.	Total Weight of Feed.
	Crushed Mealies.	Wheat Bran.	Crushed Oats.		
	lb.	lb.	lb.	lb.	lb.
1st ... ..	72	18	20	.245	110
2nd ... ..	91	31	31	.34	153
3rd ... ..	91	31	31	.34	153
4th ... ..	98	34	34	.37	166
5th ... ..	134	73	60*	.594	267
TOTALS ... ..	486	187	176	—	849

TABLE III.

Fortnightly ration of mixed feed for each lamb:—

Periods.					Total Weight.
First.	Second.	Third.	Fourth.	Fifth.	
lb.	lb.	lb.	lb.	lb.	lb.
3.44	4.78	4.78	5.19	8.4	26.59

*Averages.*—The average weight at starting was 47.69 lb. for each of the thirty-two lambs fed and for the seventeen mixed controls 43.75 lb. each. The average weight at the finish was 83.6 lb. each for the former, showing a gain on feed of 35.91 lb. each, and for the seventeen controls, fed on green feed only, 70.94 lb. each, showing a gain of 27.19 lb. each.

The average gain per cent. on the starting weight of the thirty-two fed lambs was 75.29 per cent. on their weight before feeding, and of the seventeen mixed controls 62.31 per cent.

\* Nut meal in place of oats.

*Values.*—Taking the value of the fed lambs before starting to feed at, say, 9d. per lb. on 50 per cent. of their live weight = 17s. 10½d. each, and their value at 10d. per lb. on 50 per cent. of their finished weight = £1. 14s. 10d. each, leaves a gain of 16s. 11½d. each. The controls valued on the same basis work out at the start = 16s. 4¾d., and finish at £1. 9s. 6½d., showing a gain of 13s. 1¾d. each.

	s.	d.
Gain on fed lambs ... ..	16	11½
Less cost of feed per head ... ..	2	2¼
Net gain on fed lambs ... ..	14	9¼
Gain on controls ... ..	13	1¾

Leaving on account of the fed lambs a gain of 1 7½ each.

*Comparisons.*—The lambs averaged 3.94 lb. more in weight than the controls at the start, and if they increased at the same rate as the controls, namely, by 62.31 per cent., would have ended at 6.45 lb.

	s.	d.
50 per cent. of 3.94 lb. = 1.97 lb. at 9d. =	1	5¾
50 per cent. of 6.45 lb. = 3.225 lb. at 10d. =	2	8¼
Showing a gain of ... ..	1	2½

This would reduce the gain on the fattened lambs (1s. 7½d. minus 1s. 2½d.) to 5d. each.

This result is obtained without taking into consideration any cost for labour or other preliminary expenses.

*Prices of Feed.*—Feed has been charged at current rates, viz., second or third grade mealies at 16s. per bag, bran at 7s. 6d. per 100 lb., oats at 4s. per bushel (10s. per 100 lb.), and nutmeal at 8s. per 100 lb.

Crushed mealies ... ..	486 lb. ...	£1 18 10½
Bran ... ..	187 lb. ...	0 14 0¼
Oats ... ..	116 lb. ...	0 11 10½
Nutmeal ... ..	60 lb. ...	0 4 9½
Total cost of feed ... ..		£3 9 6¾
Or, per head, on 32 lambs fed ...		<u>£0 2 2¼</u>

#### SUMMARY OF RESULTS.

At the current rates for foodstuffs, taking into consideration the extra labour and cost of grinding, and initial expenditure, the conclusions arrived at are that lambs of, say, 45 lb. weight at ten weeks old, if fed on plenty of green feed, such as oats or lucerne, will gain weight very rapidly, and if their feed is changed often will give results in net profits equal to, or even better than, fed lambs plus green feed.

As the unfed controls started at a disadvantage of about 4 lb. each in live weight, it is shown that it was a handicap which, all things being equal, would have given an even smaller gain on the fed lambs.

## THE DEPARTMENT OF AGRICULTURE DURING THE WAR.

[This article, which commenced in the May, 1920, issue, briefly reviews the work carried out by the various branches of the Department during the years of the war, and records some achievements despite the many difficulties encountered through the abnormal conditions then existing.—ACTING EDITOR.]

### VITICULTURE.

The Division of Viticulture is charged with the duty of advising farmers in all matters relating to the culture of the vine and the manufacture of wine, brandy, and vinegar. As was experienced in other divisions of the Department, the year 1914-15 saw a serious interference in research and other work owing to staff shortage caused by the war, and much that was contemplated, especially at the Oenological Institute, had to be curtailed. Routine work was satisfactorily disposed of and lectures were given to short-course students and at several farmers' meetings. Experiments in various districts as to the most suitable American vines for different soils were continued, and at the Paarl Experiment Station the experiments in regard to trellising, manuring, varieties, etc., were carried on. There was a considerable shortage in production of wine throughout the viticultural districts, and owing to unfavourable weather conditions during the ripening stage of the grapes the quantity of wine made at Groot Constantia Wine Farm was the smallest for many years. In 1914 the production reached 15,689 gallons, and in 1915 only 9,485 gallons. In 1915-16 the division was fully equipped, having the farm at Groot Constantia and the Experiment Stations at Elsenburg and Paarl to conduct the necessary research into the problems affecting the industry, but the work was hampered by lack of a sufficient number of scientific officers, who carried out, however, as much as was possible with useful results. Lectures were given to short-course students and also at farmers' meetings, many individual farmers were visited by the Government Viticulturist, experiments were carried on at the Paarl Viticultural Station with its collection of some 200 varieties of wine and table grapes, and generally the interests of the industry were catered for. A number of varieties of table grapes new to the Union were shipped to England during the season and valuable information was obtained as to their suitability to our country. Owing to the desire of the Manager of Groot Constantia Wine Farm to retire at an early date, an arrangement was made to initiate the incoming manager into the methods of wine-making found successful on the farm and other matters so as to ensure continuity in the successful management of the estate. The farm vintage produced 9899 gallons in 1916. The Union's vintage of 1916, although of good quality, was not large, and the price obtained for it as a consequence was satisfactory to the producers. While no marked progress was shown in the wine-making industry, the area under vines increased owing to the planting out of table grape varieties, for which the demand oversea is good and prices

very remunerative. The viticultural industry depends for expansion on the creation of an export trade. While the outbreak of war, with the consequent curtailment of cold storage accommodation, was a serious blow to exporters of table grapes, it caused a reduction in the production of wine in France, resulting in an opening for South African wines for which inquiries were made by English firms, and thus opening the way for a wider market than hitherto for our wines.

In 1916-17 some useful research and analytical work was performed in the laboratories; numerous inquiries were dealt with in regard to viticulture and wine-making; many visits were paid to farmers for the purpose of advising them or making observations; a number of lectures were delivered at different centres; and articles were published on certain aspects of viticulture. The demand for cuttings of vines true to name obtainable from the division was great. During the 1917 vintage 129 bottles of pure Levures were issued, and the use of these cultures, particularly by winemakers who had come under the influence of the division, was extensive. At Groot Constantia an apprenticeship scheme was inaugurated with the object of giving practical training in viticulture and horticulture to youths whose means and educational attainments would not permit of their attending one of the schools of agriculture. Accommodation was provided for twenty, but double that number applied for admission, and practically all the manual work on the farm was carried out by these students. The season was fair for wine-making. The quality of the wine was excellent, and the total farm vintage amounted to 15,402 gallons. The country's grape crop of 1916 would have been extraordinarily good but for a severe summer. The price for the average wine varied from £4 to £6 per leaguer, red wines being in greater demand than white. Grape brandy averaged about £16 per leaguer and wine brandy about £20.

Dr. Perold, who combined the duties of Chief of the Division of Viticulture with that of Principal of Elsenburg, resigned in 1917-18 in order to become Dean of the Faculty of Agriculture at the newly constituted University at Elsenburg, and Mr. S. W. van Niekerk was appointed Acting Chief of the Division. A limited staff owing to war conditions was just sufficient to cope with the most pressing of the technical work of the division, and much-needed scientific investigation had necessarily to be kept in abeyance, while it was not possible to do as much in the way of visiting farms as could have been wished. However, during the year lectures on wine-making were given at various centres, and some eighty farms were visited by the viticulturist. A successful short course was held attended by twenty-two, and evidence was shown of the advantages derived from these courses. The collection of grapes at the Paarl Experiment Station was enlarged by new varieties from England, Australia, etc. Mr. T. L. Watermeyer, who had been in charge of the Government Wine Farm, Groot Constantia, and universally recognized as one of the best wine-makers and foremost authorities on wine in the country, died on the 2nd November, 1917—a great loss to the country and the Department in particular. Owing to consequent staff changes it was arranged to include the farm, with Mr. S. van Renen as manager, with the Division of Viticulture instead of allowing it to remain as an independent unit as during the late Mr. Watermeyer's time of office. The system of training young men at Groot Constantia was successfully

carried on, and of the twenty apprentices there suitable positions for nine were obtained during the year. The farm vintage amounted to 13,400 gallons. A considerable amount of matured wine in stock from previous years was sold locally, the outbreak of war causing certain negotiations then in progress for the sale of the wine in England to fall through. The season's grape crop was fair; the market, however, was very irregular. With a view to steadying the market and ensuring fair prices, wine farmers and merchants formed a co-operative society, called the Co-operative Wine Farmers' Association of South Africa, Limited, which received wide support.

#### ENTOMOLOGY.

This division deals with the suppression of locusts, inspection of nurseries, restrictions on traffic in plants, fruit, etc. It disseminates advice on insect problems by publication and correspondence; it carries out experiments and demonstrations regarding the suppression of insect pests, and studies are made of the life-cycles, etc., of insects of economic importance.

In 1914-15, owing to the war, there was a large reduction in the importation of plants, fruit, and potatoes, imports of the last named being particularly free from serious disease. Codling-moth was discovered in certain districts, which were closed to the introduction of fruits liable to carry the pest. The brown locust appeared in parts of the Orange Free State. Investigational work covering a wide range of matters was carried out, including false codling-moth, bagrada bug, scale insects, white ants, wattle insects, parasites of the black scale, vine mealy bug, Argentine ant, house-fly, etc.

The Chief of the Division was absent for a considerable period of 1915-16, spending part of the time studying the developments of economic entomology in Australia, Canada, and the United States. During the year a quarantine station for imported varieties of sugarcane was established at Durban, the Natal Sugar Association bearing the whole of the cost involved. Investigation work was continued, and mention may be made of the success attending the method advocated by the division for dealing with the house-fly. The most noteworthy work of the division for the year was the campaign against locusts in the central and north-western portions of the Cape Province and the south-west of the Orange Free State. The outbreak was worst over an area of 20,000 miles in the south-western Orange Free State and Bechuanaland, stretching into Griqualand West and neighbouring Cape districts. In all 28,000 swarms were destroyed, the total cost of the campaign amounting to £10,000. This saved the country from what would certainly have been a dire calamity.

In 1916-17 the normal work of the division, such as the inspection of nurseries and of plants imported from oversea, etc., was carried on as usual. A number of articles and notes relating to entomological subjects of immediate concern were issued and several investigations were conducted. Following on the outbreak of locusts in 1915-16 it was found that the number of scattered locusts that remained had by rapid increase and grouping together assumed formidable proportions, and though the infestation was not as great as the year before, it was widely distributed and caused as much work to the officers of the division. The infestation occurred in remote, dry, and thinly inhabited

parts of the Union, and was therefore exceedingly difficult to deal with. Despite the obstacles encountered, the division was successful in accounting for most of the locusts before any great damage had been done to the crops. Valuable lessons in dealing with the plague were learnt from this campaign; unfortunately it had become evident that the prospect of eventually exterminating the pest within the Union was remote, and that constant vigilance was necessary in order to cope with future outbreaks.

During 1917-18 the division was chiefly occupied in suppressing locusts, in inspecting nurseries and imported plants, and advising farmers on matters relating to injurious insects. Attention was given to many insect pests, such as the maize stalkborer, pea and bean weevils, Argentine ant, antesia bug, vine mealy bug, white ant, scale insects, etc. A number of bulletins and articles were issued and numerous addresses delivered at farmers' meetings and at schools and colleges. Unfortunately, foul brood of bees was discovered in several parts of the south-western Cape Province, this being the first notice of this trouble in South Africa. Owing principally to the war, but also because many plants, formerly imported, are now being raised in the country, there was a decrease in the number reaching the Union from overseas.

Contrary to expectations, there was a severe outbreak of brown locusts, more extensive than any since the great visitation of a decade previous. The campaign to combat the plague was carried out on the same lines as in previous years. Hatching took place in the drier and more remote parts of the Union, over an area of approximately 200,000 square miles. This necessitated much arduous work, and credit is due to the officers who, as a result of their labours, compassed the destruction of 37,800 swarms of voetangers. Very few swarms escaped. Unfortunately, the campaign was attended by a number of deaths of live stock by poisoning, but this was due to abnormal climatic conditions in certain areas, coupled with carelessness in the use of the locust poison. A measure of compensation was given for losses of stock in cases where animals had died from grazing on veld on which locusts had been destroyed. The campaign is estimated to have cost £26,000, of which the Government's share, including compensation, was £16,500. The damage done by the locusts was comparatively light because they were quickly killed, but, had they been allowed to fly, the swarms would undoubtedly have caused enormous damage in the more fertile and closely settled parts of the country, and their descendants would have caused still greater havoc.

#### CHEMISTRY.

The Division of Chemistry investigates problems of general or special importance and, in conjunction with similar work carried out at the agricultural schools, undertakes the analysis for farmers of soils, manures, and foodstuffs.

During 1914-15 the officers of the division were fully occupied in coping with the analytical and other work relegated to it. The control of the sale of fertilizers in the Cape Province, the only Province where legislation in that respect was in force, was continued. Since then new fertilizer legislation for the Union has been introduced (Act No. 21 of 1917), which falls under the administration of the Chemistry Division.



The division was mainly occupied with the analyses of soils, manures, and feeding stuffs during 1915-16. Owing to lack of facilities and smallness of the staff, which conditions then prevailing prevented increasing, little research was possible. The situation was relieved to some extent, however, by work carried out at the laboratories at the agricultural schools and experiment stations. None of the soils analysed during the year presented any very striking features, the general characteristics being a poverty of lime and phosphates and a sufficiency of potash in available form. A large number of samples of bat guano were analysed; the manure was found to be variable in composition owing to the amount of sand or earth mixed with it, and usually of poor quality. Samples of limestone submitted showed that lime admirably adapted for agricultural purposes was available.

The year 1916-17 brought a heavy loss to the division in the death of its Chief, Mr. H. J. Vipond, who was killed in action in Flanders in February, 1917. Dr. Marchand acted as chemist, and the appointment has since been confirmed. During the year Dr. Juritz was transferred from the Department of the Interior to this Department as Agricultural Research Chemist. He is stationed at Capetown and conducts investigations and collects information on subjects of special or pressing importance.

The division was occupied almost entirely with analyses of various substances of importance from an agricultural point of view, of which soils and fertilizers formed the greater portion. The soils analysed proved to be very similar in type to those analysed in previous years, and were usually sufficiently supplied with potash, but deficient in lime and phosphates. It was pointed out that farmers do not inform the division of the results obtained from the treatment recommended by it in connection with soils analysed, nor do they take samples according to the method prescribed by the division, consequently the value to the country generally obtained from these analyses is not as great as it might be. The provision for chemical work at the agricultural schools and experiment stations was greatly improved, and while this helped to relieve the Division of Chemistry, much necessary work awaiting it could not be undertaken owing to lack of staff and laboratory facilities.

Insufficient accommodation and the situation created by the war prevented any extensions in 1917-18, the work undertaken by the division being chiefly of a routine character, consisting mainly of the analysis of soils and other substances. The analysis of soils for farmers as obtaining was, it was concluded, of little value to farmers or the division owing to the practical impossibility of determining the requirements of a soil from a bare analysis, and the neglect of farmers of carry out the instructions for the taking of samples and to inform the division of the results of its recommendations for manurial and other treatment of the soil analysed. It was considered that, instead, greater advantage would result from a systematic soil survey of the Union. Regulations to be enforced under the Fertilizers Act were drafted by a conference composed of the Acting Chemist, the Research Chemist, and the Lecturer in Chemistry at each of the schools of agriculture.

During the year the Research Chemist at Capetown was chiefly occupied in conducting inquiries into the possibilities and prospects

of paper-making within the Union and in investigating the supplies of fertilizers available in the country, at the request of the Scientific and Technical Committee. He also furnished the committee with reports on several other subjects and investigated a number of substances of importance to the country. The results of these investigations are discussed in his annual report.

#### THE LIBRARY.

The object of the library is to provide as complete a collection of agricultural literature as possible for the purpose of reference. The library is open to the public and books may be borrowed on certain conditions.

Owing to the situation arising through the war and the need for curtailing expenditure the publication of the *Agricultural Journal* was suspended in 1914, and the librarian was entrusted with the issue of all reports and bulletins, etc., printed. These publications were issued gratis to applicants up to 1st October, 1918, but with a view to preventing wastage of the bulletins a small charge was then placed on some of the more important ones. The following table shows the number of publications published and the number of copies issued to applicants each year:—

#### *Number of Publications.*

1915-16.	1916-17.	1917-18.	1918-19.
176	91	97	88

#### *Number of Bulletins, etc., Issued to Applicants.*

1915-16.	1916-17.	1917-18.	1918-19.
(Figures not available)	6,500	47,940	44,026

In view of the need for keeping expenditure within the lowest possible limits, the grant for the library for the period of the war was reduced. Progress was maintained, however, and the library was added to to the extent shown in the following table:—

#### *Additions to Library of Complete Bound Volumes.*

1915-16.	1916-17.	1917-18.	1918-19.
616	565	718	853

The scope of literature in the library may be gauged by its contents, there being at the 31st March, 1919, 8080 bound volumes and 5000 unbound volumes, with 13,700 bulletins and leaflets and 2000 periodicals. In addition to this, some 13,800 books are deposited with the divisions and schools. Mention should also be made of the acquisition at a cost of £500 of the Galpin Library, which is housed with the Division of Botany, Pretoria.

A feature of the year 1915-16 was the inauguration of the scheme to lend books from the library to farmers on payment of a deposit and postage, and on 31st March, 1919, some 233 farmers were availing themselves of the privilege.

## CO-OPERATIVE AGRICULTURAL SOCIETIES.

The Division of Co-operation is mainly concerned with the establishment and control of co-operative agricultural societies registered under the provisions of the Co-operative Agricultural Societies Acts in force in the Transvaal and Orange Free State.

Several changes took place on the staff of the division during 1914-15; the Registrar and Assistant Inspector resigned to take up posts in the Central Agency for Co-operative Societies. During the year the extent of the transactions of most of the societies was affected by drought, and several of them sustained loss on the year's working as a consequence. There were eighteen societies established in terms of the Co-operative Acts, and, while progress was made by many of them, others again were not conducted as satisfactorily as could be wished, the position of two or three being very unsatisfactory. On the whole, however, the societies showed a distinct improvement in the way in which the majority of them conducted their business, and as a result of the year's working had materially strengthened their financial position. A serious mistake made by many was the custom of giving indiscriminate credit to members in connection with the sale of farming implements.

In 1915-16 three more co-operative societies (in the Orange Free State) were in process of formation. Of the eighteen societies one was liquidated during the year, and the condition of four others was unsatisfactory, the finances of the remainder being considered sound. The membership was 10,825, their turnover being 919,891 bags of maize, 2,057,203 lb. of tobacco, and £107,039 worth of other produce, and farming requisites to the value of £139,052, the societies doing a great deal of good in assisting farmers to dispose of their mealies and tobacco and steadying the trade in these products. While there was progress in the general administration of the societies, it was evident that mistakes were made in credit sales and the holding of produce for a rise in the markets, matters contrary to the principles of co-operation. The troubles in which some of the societies became involved were due primarily to want of knowledge and supervision; carelessness in the admission of members to the societies, which have unlimited liability, and lack of attention and personal interest by members to the expenditure and affairs of the societies.

There were twenty co-operative societies in existence in 1916-17, most of them almost entirely occupied with the sale of maize and a certain amount of other produce and the purchase and supplying of agricultural implements and other farm requisites. One society, however, was devoted to the handling of tobacco, another maintained a threshing machine, a third dealt with the supply of dairy cows to its members and the sale of milk, and a fourth manufactured cheese. The societies had a total membership of 10,234, their turnover being 644,899 bags of maize, 1,544,076 lb. of tobacco, and £76,959 worth of other produce, and farming requisites to the value of £140,481. The turnover in produce for the year 1916 was less than that for 1915 owing to a poor harvest. The division was fully occupied in advising and inspecting the several societies under its aegis and generally in promoting the growth of co-operation. The benefits derived from these societies were many, both growers and consumers of the products dealt with being helped. The majority of the societies were in a

satisfactory condition, but in some there was room for much improvement. The country presents many difficulties in the firm establishment of co-operative societies, and the lack of interest taken by the members as a whole in the work of those in existence continued to be one of the chief weaknesses. Experience showed, however, that many of the troubles into which societies had fallen could be guarded against by strict supervision, and the division, in conjunction with the Land Bank, made every effort to control and guide the societies to their advantage.

Agricultural co-operation continued to expand, and in 1917-18 the number of societies had increased, there being sixteen in the Transvaal and seven in the Orange Free State. The number of members was 9818, and the total turnover £594,477. While the membership was not as large as two years previously, the stamp of members had improved considerably owing to the expulsion of useless ones and the admission of such only as were likely to be useful and loyal. A conference of representatives of the societies was held in Pretoria, at which important matters relating to co-operation were discussed. On the whole, a considerable improvement was manifested during the year, the well-managed societies continuing to progress and the weaker ones awakening to the methods ensuring success. The division exercised careful control, and every effort was made to guide the societies so as to avoid the mistakes and pitfalls of the past.

In addition to the societies registered under the Co-operative Agricultural Societies Acts in force, there are a number of others, formed and conducted by farmers and others interested in rural pursuits for their mutual benefit, which do not fall under any of the Acts referred to, and though they have not adopted the principle of unlimited liability they are essentially co-operative in character. These societies have been confined mainly to the Cape and Natal Provinces and deal with many matters concerning the preparation and sale of produce, purchasing of supplies, etc., and vary considerably, as might be expected, in size and in the extent of their operations. They have had their difficulties to contend with, and all have not been uniformly successful, but the majority have done well. The scientific and technical officers of this Department have assisted all types of society impartially, and have even been instrumental in establishing some of them.

#### DRY-LAND FARMING.

The Division of Dry-land Farming conducts experiments and disseminates information in regard to cultural methods of agriculture known as dry-farming.

In 1914-15 two of the subsidiary Dry-land Experiment Stations were closed down, the central station at Lichtenburg and the one at Pietersburg, conducted in co-operation with the municipality there, being maintained. While the Division's activities were curtailed in this direction, they were expanded by greater attention being given to co-operative experiments carried out on farms by farmers themselves, a policy adopted for the future operations of the division. Experiments were carried out and information disseminated during the year in regard to the improvement of the system of farming generally and to the proper methods of dry-farming particularly, and evidence continued to come to hand of greater yields per acre on

account of a growing knowledge of the system, better seed, and cultivation. Cultivation was extended in consequence, also the use of up-to-date agricultural implements. Some good results were obtained from experiments in wheat and oats tested for rust resistance.

Much work was done by the division during 1915-16 in spreading the knowledge of dry-farming and the suitability of certain tested crops for dry areas by letter, lecture, and co-operative experiments on the farm, as well as by experiments conducted at the stations. A great amount of interest in the better utilization of the soil in the drier (and generally more backward) parts of the Union was aroused, resulting in improved methods of farming in those areas. The system of co-operative experiments conducted by farmers on their farms under the supervision of the division was extended, and not only was the expense proved to be less, but the good to be accomplished greater than would be the case in experiments carried out at subsidiary stations as largely practised in the past.

The policy of co-operative experiments was further extended in 1916-17, and, owing to circumstances arising through lack of staff, necessity for curtailed expenditure, etc., arrangements were made for closing at the end of the year the Dry-land Station at Lichtenburg which had been established in January, 1909.

For purposes of co-operative experiments, £500 was set aside for the purchase of seed true to type. The small staff composing the division was fully employed in furthering its objects by encouraging farmers in the conservation of water and best methods of cultivating the soil, advocating, lecturing, and demonstrating the use of drought-resistant crops suitable for dry areas and in many other ways advancing the cause of the agriculturist. There was a marked awakening among many farmers in such matters as studying soils and climatic conditions, the value of experiments on the farm, the proper preparation of seed-beds, the use of up-to-date implements, the suppression of weeds, the value of sufficient humus and increasing the water-holding capacity and fertility of the soil, the need to ascertain the most suitable crop, and so on. While the principles of cultivation, etc., advocated by the Department were receiving an ever-widening circle of followers, the need for education therein was still very apparent, calling for much future effort.

Thus, during 1917-18, the division was continuously engaged in advising farmers on matters relating to dry-farming and in conducting experiments in various parts of the country in co-operation with them. Experiments were continued at the Experiment Station at Pietersburg; the one at Lichtenburg having been closed down, the administration of the division was centred in Pretoria. An idea of the extent of inquiry and advice conducted during the year by correspondence alone may be gauged by the fact that 4896 letters were received and 4486 dispatched. The principle of co-operative experiments met with success, evidence of the lessons learnt therefrom coming to hand.

[This review will be continued in subsequent issues of the *Journal*.]

---

Keep your *Journals*! The contents will be indexed every six months and a copy of the index sent to each subscriber.

## TURKEYS.

---

By T. B. Cross, Poultry Instructor, School of Agriculture,  
Cedara, Natal,

---

TURKEYS have been domesticated for a great number of years, but still may be found in their wild state in Northern America. Other denizens of the poultry-yard have greatly increased in size and weight, but not so the turkey. Wild males have been shot weighing as much as 60 lb., whereas the greatest weight obtained in the domesticated bird is about 46 lb. This is purposely mentioned, as in our experience we find that turkeys always thrive best if kept under the most natural conditions. Undoubtedly the most popular breed in South Africa is the American bronze, and this is not difficult to understand, as they are the largest, very hardy, and well adapted to this climate. White Austrian, or White Holland and Black Turkeys are not bred in large numbers, and from a commercial aspect do not compare favourably with the Bronze, though of late the White has improved considerably in size.

### AMERICAN BRONZE.

The general characteristics of this breed are as follows: *Head*, long and broad and carunculated (i.e. covered with fleshy protuberances). *Beak*, strong, curved, well set in the head. *Eyes*, full. *Throat wattle*, large and pendent. *Neck*, long, curving backward toward the tail, the top and most of the front carunculated. *Body*, long, deep through the centre, and well rounded. *Breast*, broad and full; the cock's beard long, bristling, and prominent. *Back*, somewhat curving, rising from the neck to the centre and descending in a graceful curve to the tail. *Wings*, large and powerful, carried well up and closely to the sides. *Tail*, long and drooping, the end almost touching the ground. *Legs*, long, stout and strong. *Toes*, straight and strong. *Carriage*, stately and upright. *Plumage*, hard and glossy. In the Poultry Club standard (English) the following weights are given for adult birds: Bronze cock, 36 lb.; hen, 20 lb. Black cock, 27 lb.; hen, 18 lb. White cock, 26 lb.; hen, 16 lb.

#### *Colour of the American Bronze.*

*Beak*, light horn at the tip and dark at the base. *Eyes*, dark hazel or brown. *Head* (including face, jaws, throat wattle, and caruncles), brilliant red, changeable to blue-white. *Legs and Feet*, black, approaching brown in young birds and of a pink or flesh-hue in adults. *Plumage of Cock*: *Neck*, light, brilliant bronze. *Beard*, black. *Back*, light brilliant bronze, each feather terminating in a narrow black

band extending across the end. *Breast*, dark brilliant bronze. *Body*, black, shaded with bronze, but not so brilliant as that of the breast. *Wings*: Bows, black, with a brilliant bronze or green lustre; coverts, rich bronze, the feathers terminating in a black band and forming a broad band across the wings when folded, and separated from the primaries by a glossy black ribbon-like mark formed by the ends of the coverts; primaries, black or dark brown, pencilled across with bars of white or grey, the more evenly the better; secondaries, similar to the primaries, the colours changing to a bronze brown as the middle of the back is approached, but with little admixture of white; an edging of white or brown on the primaries or secondaries is very objectionable. *Tail*, dull black, each feather regularly pencilled with narrow bands of brown, ending in a broad black band with a wide edging of dull white or grey, the coverts dull black or dark brown, each feather regularly pencilled with narrow bands of brown, ending in a wide black and bronze band extending across the feather, with a wide edging of white or grey. The more distinct the colours throughout the whole plumage the better.

*Plumage of the Bronze Hen*.—Similar to that of the cock (but not so brilliant nor so clearly defined), except an edging of white on the feathers of the back, breast, body, and wing-bows, the edging to be narrow in front and gradually widen as it approaches the rear.

#### THE WHITE.

*Beak*, pink or flesh-coloured. *Eyes and Head*, as in the bronze. *Legs and Feet*, white or pink-white. *Plumage*, pure white; the cock's beard, deep black.

#### THE BLACK.

*Beak*, dark horn or slate-black. *Eyes*, dark hazel. *Head*, as in the Bronze. *Legs and Feet*, dark lead or slate-black. *Plumage*, lustrous black.

In all breeds, crooked breast-bone, wry or twisted tail, or any deformity, are considered serious defects. For exhibition very small specimens or birds differing in colour of plumage from the standard should be passed over.

#### THE BREEDING STOCK.

In selecting the breeding stock great care should be taken that they are strong, vigorous, and, above all, healthy; very small or overgrown birds should on no account be bred from, the craze for size does much harm, especially if very heavy males are used. Let the "tom," as the turkey cock is generally called, be a typical specimen, unrelated to the hens, and not too heavy: 25 to 30 lb. for a stock bird in hard condition is quite enough; he should have good depth of body, with full rounded breast. The breast-bone should be long and perfectly straight, as turkeys are bred principally for the table; this is a most important point in both sexes. The thighs, long, stout, and well apart; shanks, large and strong, and toes well spread and perfectly straight. A turkey cock is better at two to four years old as a breeder than a year old bird; Bronze turkeys breed very true to

type and colour, so there is no need to inbreed to fix these or any other points. Up to ten or twelve hens may be mated to a vigorous tom; they should be at least twelve months old, but preferably two or three years, well grown, and vigorous, but not more than 20 lb. in weight; abnormally large hens may win in the show pen, but as breeders are invariably a failure.

To breed turkeys successfully free range is absolutely essential; they are naturally of a restless and roving disposition, and if closely confined quickly become listless and fall off in condition. Adult stock do not require any house or shelter, and remain in perfect health and condition if roosting out all the year round. The roosting place should, however, be enclosed by wire-netting to protect them from thieves and vermin. The perches, which can be erected between trees or substantial uprights, should not be more than 3 or 4 feet high, as turkeys are liable to injure their feet in flying down from high roosts; the perches, which can be of wattle or gum saplings sawn in half should be smooth of surface and not less than three inches broad. It is not advisable to keep other poultry with them, as both turkey cocks and hens are apt to bully and often severely injure other birds.

During the breeding season, turkey hens often suffer injury through the attentions of a vigorous male, and such hens should be removed until the back has healed.

#### FEEDING.

The breeding stock may be fed as follows: Mash in the morning consisting of equal parts of bran and pollard mixed to a crumbly consistency with water, or once or twice weekly in winter with soup; to this kitchen scraps of vegetables, meat, and bread may be added; if plenty of insect life is obtainable soup and meat may be withheld. In winter, when grass is scarce, cooked vegetables may with advantage be added to the mash, and chopped cabbage, etc., fed at noon. Mash should always be fed in troughs, and approximately one handful to each bird will be found sufficient. In the evening grain may be given; oats and wheat are excellent, but maize and kaffir corn should be fed with discretion, especially near the beginning of the breeding season. Flint grit and oyster-shell should always be available. The amount of food fed to a flock of turkeys must necessarily depend to a great extent on what they can find in the fields; for instance, if wheat stubble is close at hand they can be driven there in the morning and left until night, and feeding them is quite unnecessary.

#### HATCHING AND REARING.

The first eggs may be expected about the end of June, and the hens should be allowed to select their own nests, as they will seldom lay in nests prepared for them; at this period they exhibit great shyness and should on account be interfered with so long as the nest is in a safe and suitable place. As the eggs are laid they should be removed and safely stored in a cool room and turned daily; unless a nest egg is left in the nest the hen will probably desert it.

When broody, unless under exceptional circumstances, it is advisable to bring the hen in and set her in a suitable place where no dogs or vermin are likely to disturb her.



Turkey eggs incubate in twenty-eight days, and may be hatched out under ordinary hens, turkey hens, or in an incubator, but, generally speaking, poults, as the turkey chicks are called, thrive better with a turkey hen. Not more than fifteen or sixteen eggs should be given to a turkey hen to hatch, or more than ten to an ordinary hen. Turkey hens often sit too closely, especially if near a spot where many people pass, and settings are sometimes spoiled by over-brooding. The spot chosen for the nest should be on soft ground lined with hay and a roomy box put over it for shelter; needless to say, a site likely to be flooded should not be selected, and on no account should the nest be made up on a wooden floor. Food, water, and grit should be put down near the nest so that the hen can come off to feed, etc., at will; during the period of incubation small, yellow maize is the best grain to feed; mash should not be given. Until the hen is settled in her new nest it is advisable to give her a few nest eggs, otherwise valuable eggs may be spoiled. If possible, the nest should only be visited when the hen is off.

Twenty-four hours after the chicks are hatched they should be moved with the hen to the run or yard they are to occupy. Runs that have been used for other poultry will not do for poults; the ground must be sweet and clean, and if under short grass so much the better. Turkey hens, if given complete liberty with their brood, are likely to wander too far and run all but the strongest off their legs. Poults cannot stand any dampness, so on no account should they be allowed to get wet by rain or by running in long grass. It is better, therefore, not to give them free range until about fourteen days old. Milk in any form is excellent for them, not only mixed in their soft food, but also to drink. A sudden change, however, from sweet to sour milk must be guarded against, otherwise diarrhœa may result. For the first week dry bread, coarse oatmeal, boiled rice and bran slightly moistened with milk forms an excellent feed; to this can be added or fed separately finely chopped green food such as succulent green grass, lettuce, lucerne, or, better still, onion tops; only a little food should be put down at a time, just sufficient for them to clear up readily. Food or green stuff must not be allowed to lie about the run; after the first week a little meat food is necessary, finely chopped liver or green bone until the poults can get insect life for themselves. Fine grit or sand and vegetable charcoal should always be available; the latter may be dusted over the mash two or three times weekly with advantage. After the first week, and until three months old, four feeds daily should be given, the first morning feed to consist of mash, the basis of which should be wheaten bran, to which may be added household scraps boiled overnight, or one part of Sussex ground oats to two of bran, mixed with milk; in cold weather a little maize meal can be added to the above. At first all grain should be finely broken up as in chick mixtures, but whole grain, with the exception of maize, may be given when four or five weeks old; the latter should be crushed. When the turkey poults become red about the head and neck they may be taken from their parent; if not she will probably induce them to roost at night, which will spoil (i.e. dent or cause to become crooked) their breast-bones, a bad fault in a bird required for the table.

Until four months old, young turkeys are better at night if shut up in a roomy shed, the floor well covered with dry litter; during a

spell of dry weather they should be put out to roost in the open and allowed to remain out whatever the weather may be. As with the breeding stock the perches must not be more than three or four feet high, and at least three inches wide.

If flocks of young turkeys are inclined to hang about the house, it is advisable to drive them afield every morning in order that they get as much insect life as possible; they will quickly learn to go into the lands and forage for themselves. Young turkeys intended for the market in South Africa at Christmas time should not be too closely penned up to be fattened, in fact where the range is good and insect life plentiful it is unnecessary. Increase the feed and add milk to the mash; Sussex ground oats are a valuable addition to the latter and tend to whiten the flesh.

### KILLING AND PLUCKING.

Before killing, turkeys should be kept without food for eighteen to twenty-four hours and without water for eight; if they are killed with full crops the skin quickly becomes discoloured. To kill quickly it is advisable to hang the turkey by the legs to a strong hook in the wall or to a beam, so that the head is at a convenient height, the wings should be locked behind the back, open the turkey's mouth with a sharp narrow-bladed knife, cut the jugular vein on each side of the throat, then push the point of the knife up the roof of the mouth into the brain, slightly turning the knife before withdrawing it. Commence to pluck immediately before the body gets cold; do not remove the feathers by dipping the body into hot water, it may be quicker, but it spoils the look of the carcass and hardens the flesh. For home consumption the bird may be killed by dislocating the neck, but for market or export this gives it an unsightly appearance as the neck is swollen with congealed blood.

### DISEASES.

Turkeys are subject to most of the ailments and diseases which attack fowls, but are seldom anything but hardy after they are six months old. The following are most commonly met with in rearing poults.

*Colds.*—Young turkeys, from two to four months old, are rather subject to colds; it seldom affects those that are big enough to roost in the open, but poults housed in unsuitable quarters. The first symptoms are a swelling on one or both sides of the head, watery eyes and nostrils. First give a small dose of epsom salts, say, one teaspoonful in a tablespoonful of warm water. To reduce the swelling, bathe the head daily in warm water with a little boracic acid added. Give daily, until better, three or four drops of chlorodyne in a teaspoonful of sweet oil and add some chopped onion to the morning mash.

*Roup.*—In cases of roup the above-mentioned symptoms are often present and, in addition, an offensive smelling discharge from the nostrils. Treat as in colds, but wash the head, eyes, mouth, and nostrils daily with a solution of sulphate of copper. To make a suitable solution, dissolve 1 oz. of sulphate of copper in 10 oz. of rain or

soft water, add 1 tablespoonful to each quart of drinking water; double the strength for washing the head, etc. Roup is a contagious disease, and sick birds should be isolated; bread and milk is the best food for a sick bird.

In diphtheritic roup patches of yellowish matter appear in the mouth, throat, and frequently under the eyes; treatment is seldom satisfactory, and it is safer, if many birds are kept, to destroy and burn the body. As in all cases of a contagious nature, the remainder of the flock should be given a clean house and a change of ground without delay; a little permanganate of potash, sufficient to make it pinkish, should be put in the drinking water.

*Chicken-pox.*—This disease, sometimes known as warts, may be recognized by a number of small black sores or scabs about the head and sometimes on the bare skin under the wings. Wash the sores daily with a fairly strong solution of permanganate of potash or vinegar and warm water, carefully removing the scab or crust of all sores, which should be anointed with carbolized vaseline or flowers of sulphur and lard. Give daily two or three pills of equal parts of flowers of sulphur and lard, about half an inch in length, and the thickness of a pencil. Feed on soft mash only and allow plenty of green food. This is not a serious disease, but birds may become blind by the warts forming on the eyelids, as they frequently do, and may starve if not hand-fed. As a precautionary measure during the hot summer months, one ounce of flowers of sulphur may be added to the mash of every fifteen birds once a week.

*Scaly Leg.*—This unsightly ailment is not common among turkeys, but can easily be cured by washing the legs with soap and warm water and applying paraffin oil. Several applications are necessary to effect a permanent cure.

*Bumblefoot.*—A swelling on the sole of the foot caused by hard dry ground or by flying down from high perches. Keep the patient on soft litter and paint every other day with iodine. Should an abscess form, it is advisable to lance it and apply a bread or linseed poultice to withdraw the accumulated pus. Bandage the foot to keep out dirt and wash daily with a weak solution of permanganate of potash or bichloride of mercury.

*Leg Weakness.*—When growing rapidly, young turkeys, especially the cocks, are subject to this ailment; they squat on their hocks and generally appear weak on the leg. Give plenty of animal food, such as chopped liver or green bone, and a little Parrish's Chemical Food in the drinking water. Remove to another pen if the others are inclined to bully, a thing young turkey cocks are often guilty of.

---

We advise you to get each copy of the *Journal* and to keep it. A full index will be sent every six months to each subscriber. Experience proves the *Journal* to be a useful book of reference. It will be so in the future. Every farmer is asked to get the *Journal* and not to lose it. It is likely that some day, in answer to an inquiry, you may be referred to an article in the *Journal*. Keep your *Journal*!

---

## EXPERIMENTS AND INVESTIGATIONS.

---

### Work at the Schools of Agriculture and Experiment Stations and Sub-Stations.

---

[This article completes the series of reviews appearing in preceding issues of the *Journal*, on the work in hand at the Schools.—ACTING EDITOR.]

---

#### VII.—AT POTCHEFSTROOM, TRANSVAAL.

---

##### FIELD EXPERIMENTS.

In conjunction with the Chemistry Section, a manurial rotation experiment is being carried out on eight acres of dry-land.

*Grasses.*—Several plots of pasture and other grasses are under observation. Kikuyu, Natal, Fescue, and Phalaris grasses are doing remarkably well.

*Lucerne.*—Another ten one-twentieth acre plots of lucerne have been laid down to observe the variety, characteristics, difference in growth in local and imported seed, longevity, and frost and drought resistance.

*Clovers.*—Eight one-twentieth acre plots of clover have been laid down during the past year: all the varieties seem to suffer from severe frosts and heat.

*Peanuts.*—Five varieties of peanuts were grown as a variety trial, and two acres were planted for the purpose of increasing the supply of seed.

*Mangels.*—To produce seed bearing strains of mangels, several varieties have been grown for purposes of selection. A seed producing strain is now being fixed.

*Kale and Rape.*—These crops have been grown in a “distance trial” and seeding test.

*Beans.*—A large number of bean varieties have been grown, but were not successful, owing to the drought.

*Fibre Plants.*—Several of these were grown and samples have been sent to the Division of Botany, Pretoria, for the purpose of fibre extraction.

*Cowpeas.*—This pulse is doing remarkably well; eight varieties were included in the variety test. About one acre of the iron variety has been grown for seed.

*Soya Beans.*—Six varieties of Soya Beans were included in the Soya Bean Variety Trials.

*Maize.*—Experiments have been conducted in connection with “Cultivation,” “Varieties,” “Planting,” and “Rotations.” Results of these trials will be furnished later.

*Spineless Cactus.*—About one acre has been planted with varieties of Spineless Cactus. These are required for distribution later.

*Rotations.*—Experiments in connection with maize and wheat rotations are being continued.

*New Importations.*—Several new varieties of grasses, pulses, and root crops were introduced from various places and grown, in most cases, successfully. These included Sudan grass, Sesbania, Dahl bean, Arotalaria, and Jack beans.

*Horticulture.*—Spraying experiments for apple-bark blister, and plum bark-cracking disease. For the former, bordeaux mixture, followed by gargoyle red spraying oil has proved very efficacious.

Pollination tests for Wickson plum: Satsuma has proved to be the best pollinator.

Tests with Hycol for the control of Black Peach Aphis and Woolly Aphis.

Fertility and sterility tests by bagging of blossoms.

Experiments in retarding blossoming with peach, apricot, apple, and pear.

*Chemistry.*—Nitrification studies on the dry-land fertilizer rotation plots, and on fallow and virgin soils.

Glucose and starch yields of different varieties of maize.

The lime requirements of soils, qualitative and quantitative.

Methods of making tobacco extracts.

*Agricultural Engineering.*—Analyses of charcoals made from different timbers grown in the Union, together with engine trials.

*Entomology.*—The control of Mylabris beetles: Results prove that hand collecting is the most practicable and effective remedy.

The protection of seed maize from birds and vermin.

Storage of grain: Results show that weevils are not able to live in grain stored in an iron tank rendered air-tight by sealing with white lead.

Agonomois grain moth: Results indicate that carbon bisulphate and heat are the only effective killing agents.

Destructive birds: The effectiveness of poisons is being studied.

House flies: Dilute solutions of lime sulphur spray with a small amount of sodium arsenite, have proved very effective in destroying flies in stables, gutters, etc.

Rodents—Protective measures: A separate article on the subject appears in this number of the *Journal*.

*Plant Breeder.*—Hybridization and selection of wheat, kaffir corn, and maize for the improvement of existing varieties and the production of new ones.

## NOTES.

### Ostrich Feathers.

The ostrich feather industry of South Africa, which dates from the year 1865, has been subject to depressions and booms from time to time. It boomed in the late 'seventies and early 'eighties, while a few years later it collapsed, reviving again in the later 'nineties. From 1905 it made great progress which culminated in 1913, when the value of feathers exported was nearly 3 million pounds sterling. Then came another slump and the war, and for five years the industry sank, until in 1918 the export of feathers was lower than it was thirty years ago. However, the year just passed brought a revival in the trade, as will be seen from the statistics hereunder, the auctions of ostrich feathers being resumed in London before a large number of English and French buyers, Italy also being represented.

The following statement of the quantity and value of ostrich feathers exported from South Africa indicates the progress or otherwise of the industry. The average price per lb. for feathers in 1913, when the industry was at its zenith, was, it will be noted, only about half what it was in 1880, when the market was also booming:—

#### OVERSEA TRADE IN OSTRICH FEATHERS.

	Quantity Exported. lb.	Valued at £	Average Price per lb.
1870 ... ..	28,786	91,229	£3 3 0
1875 ... ..	40,569	304,933	6 3 0
1880 ... ..	163,065	883,632	5 8 0
1885 ... ..	251,984	585,279	2 6 0
1890 ... ..	212,276	517,009	2 8 0
1895 ... ..	353,626	527,742	1 10 0
1900 ... ..	412,832	879,751	2 2 0
1905 ... ..	471,024	1,081,187	2 5 0
1910 ... ..	741,078	2,272,846	3 1 4
1911 ... ..	826,992	2,253,140	2 14 6
1912 ... ..	999,704	2,609,638	2 12 2
1913 ... ..	1,023,307	2,953,587	2 17 9
1914 ... ..	755,325	1,342,717	1 15 6
1915 ... ..	948,945	743,772	0 15 8
1916 ... ..	452,080	486,362	1 1 6
1917 ... ..	219,048	175,019	0 15 11
1918 ... ..	108,924	88,628	0 16 3
1919 ... ..	904,611	1,646,014	1 16 4

The exports for the first three months of 1920 average £2. 5s. 10d. per lb.

*Number of Birds.*—The following table, showing the total number of ostriches in the Union at various dates, will serve to illustrate the advance of the industry between 1904 and 1913 and the effect of the ensuing slump:—

Year.	Cape of Good Hope.	Natal.	Trans- vaal.	Orange Free State.	Union.
1904 (General Census) ...	375,970	1,523	14	1,323	360,830
1911 (General Census) ...	728,087	4,111	5,441	9,097	746,736
1913 (31st December) ... ..	756,923	5,081	4,591	9,718	776,313
1916 (30th June) ... ..	379,427	4,259	8,927	6,415	399,028
1918 (Census of Agriculture)	300,906	6,022	3,110	4,227	314,265
1919* ... ..	273,490	1,900	2,820	3,860	282,070

### Prickly Pear and Jointed Cactus Extermination.

Eradication of jointed cactus and prickly pear has been a difficult and costly problem. Both weeds grow on good soils and their destruction and the prevention of their spreading are most important.

Many means for eradicating the pest have been tried. Mr. P. M. Rademeyer introduced an exterminator several years ago, which was tested but not found very effective. Convinced of the efficacy of his preparation, Mr. Rademeyer continued experimenting with and improving it, until in 1917, with the co-operation of the Agricultural Department, a further test was carried out on the farm Review, in the Bedford district. Two tracts of land with dense growth of jointed cactus and several large prickly pear trees were sprayed on the 2nd August, 1917. One portion was treated with Rademeyer's exterminator at the rate of 55 gallons per acre, diluted with luke-warm water to a strength of  $6\frac{1}{4}$  per cent., costing at that time £4. 2s. 6d. (or £2. 8s. 5d. pre-war cost). The other portion was sprayed with arsenite of soda at the rate of 440 lb. per acre, diluted with cold water to a strength of 5 per cent., costing at that time £22 (or £5. 10s. pre-war cost). Labour and spraying operations cost an additional 5s. per acre for Rademeyer's exterminator, as water had to be heated and applied warm to make it effective.

The great advantage of this exterminator over arsenite of soda is that it is harmless to man and beast. The spray can be handled without danger to skin or clothing; open sores and cuts on the hands are not affected by the spray. A number of oxen were each fed on one-third gallon of the spray mixed and well soaked with lucerne-hay and prickly pear fruit and came to no harm. On the other hand, arsenite of soda is poisonous to stock, and special care must be taken when it is applied and the area sprayed must be fenced.

Two and a half months after spraying (18th October, 1917), the plots were finally inspected and the results found most satisfactory, practically all the jointed cactus and prickly pear having completely rotted on the plot treated with Rademeyer's mixture. Where arsenite of soda had been used, however, a number of live cactus

\* Excluding Native Locations, Reserves, etc.

joints and bulbs, also prickly pear leaves, were found to have started growing again.

Of the two methods Rademeyer's extermimator proved to be more effective and less costly; in addition, handling was not dangerous, and no fencing was required.

The hand-spray pumps used for the test, it may be added, were not satisfactory, but improved hand-pumps are now obtainable, which will ensure a wider spray.

All applications for the Rademeyer extermimator should be made to the Provincial Secretary, Capetown. It is supplied in 3-gallon drums at a charge of twopence per gallon (plus 5s. per drum, which will be refunded, less 10 per cent., on return of empty drums). Directions for mixing and use are supplied with each consignment.

### Butter and Cheese.

The dairy industry in the Union has assumed a position of considerable importance, and whereas only a few years ago it was necessary to import large quantities of butter and cheese to supplement local requirements, such strides have been made in recent years that the Union, under normal conditions, is now able to export a considerable surplus of butter, while in cheese it is self-supporting.

The following statistics illustrate the extent to which South Africa in past years has been dependent on overseas supplies of butter and cheese, and how materially the position has improved. The marked decrease in the large quantities of condensed milk formerly imported will also be observed.

*Net imports (i.e. gross total, less quantity re-exported both as merchandise and ships' stores):—*

Year.	Butter and Substitutes.	Butter.‡	Cheese.	Condensed Milk.
	lb.	lb.	lb.	lb.
1911 ... ..	5,549,782	3,746,810	4,900,774	22,119,633
1912 ... ..	6,429,032	4,748,453	5,121,498	20,631,632
1913 ... ..	5,648,119	3,688,834	5,571,394	22,423,370
1914 ... ..	5,496,450	3,758,753	5,144,916	20,660,865
1915 ... ..	3,851,977	1,820,377	3,857,136	18,466,863
1916 ... ..	1,964,677	91,682	1,818,320	13,046,612
1917 ... ..	961,237	*	423,992	11,663,844
1918 ... ..	514,303	33,582	176,849	1,451,794
1919 ... ..	631,538	247,368	†	6,760,738

It will be seen that up to the date of the war, the importations of the above-mentioned commodities remained at a high and fairly constant level. But the outbreak of war and derangement of normal trade conditions, combined with the necessity and opportunity for increased local production, caused importations to fall considerably year by year.

\* Imported, 26,891 lb.; exported, 58,641 lb.: balance over imports, 31,750 lb.

† Imported, 20,334 lb.; exported, 25,088 lb.: balance over imports, 4754 lb.

‡ Included in first column.



While imports have dwindled, our exports have developed to such an extent that there is now a reversal of trade in our favour, as borne out in the following figures:—

*Exports of South African Produce (Ships' Stores included).*

Year.	Butter and Substitutes.	Butter.*	Cheese.
	lb	lb.	lb.
1916 ... ..	1,587,320	1,586,572	36,088
1917 ... ..	3,122,725	3,111,821	110,555
1918 ... ..	1,562,846	1,544,000	487,872
1919 ... ..	521,752	512,588	1,560,782

*The Union's Production.*

According to the 1918 Census, the production (exclusive of that produced in factories) during the year 1917-18 was butter 8,079,100 lb.; cheese, 1,754,500 lb.; and the last Industrial Census shows that during the year 1917-18 the total output of the factories in the Union was: Butter, 12,014,229 lb.; cheese, 4,277,227 lb.

Therefore the Union's total production in 1917-18 was: Butter, 20,093,300 lb.; cheese, 6,031,700 lb.

The development of dairying is illustrated also by the following estimates given by the Superintendent of Dairying:—

*Estimated Production in the Union.*

Calendar Year.	Butter.	Cheese.	Calendar Year.	Butter.	Cheese.
	lb.	lb.		lb.	lb.
1912 ...	10,441,000	—	1916 ...	16,014,000	1,975,500
1913 ...	10,741,000	520,809	1917 ...	19,412,000	4,266,000
1914 ...	10,682,000	605,700	1918 ...	19,221,000	6,816,000
1915 ...	13,407,000	1,098,800	1919 ...	14,288,300	3,703,600

The figures for 1919 are tentative and subject to revision upon receipt of further information, but they serve the purpose of demonstrating the serious extent to which our production of butter and cheese was reduced through the severe drought of 1919.

## The World's Crops.

Uncertainty and anxiety prevail as to the position of the world's production of foodstuffs and its ability to meet the great existing demand for the necessities of life. At a time when this vital matter is receiving more than the passing attention generally given to it, the work of the International Institute of Agriculture at Rome comes into prominence, for in addition to other important matters, the Institute is concerned with the careful collection and compilation of statistics showing the world's production of crops, and the figures hereunder are taken from the latest report of the Institute to hand,

\* Included in first column.

that for April, 1920. These figures are the summary of information received from all countries for which complete statistics for the last seven years are available, and give the position in these countries in the northern hemisphere for the crop season of 1919 and in the southern hemisphere for the 1919-20 season.

## SUMMARY OF CROP PRODUCTION.

Crop.	Estimated Percentage of the World's Total Yield represented.	Yield of 1919 and 1919-20 compared with	
		Season 1918 and 1918-19 (= 100).	Average of Five Years prior to 1918 and 1918-19 (Average = 100).
		Per Cent.	Per Cent.
Wheat ... ..	62	93.9	96.4
Rye ... ..	14	103.5	108.7
Barley ... ..	42	81.2	88.1
Oats ... ..	60	87.8	91.4
Maize ... ..	78	119.1	104.7
Rice ... ..	60	137.0	110.3
Potatoes ... ..	30	94.0	87.2
Sugar beet ... ..	25	106.0	88.0
Wine ... ..	75	105.4	109.4
Linseed ... ..	80	96.9	93.8
Tobacco ... ..	55	100.0	124.7
Cotton ... ..	96	103.6	95.8
Silk cocoons ...	86	104.3	123.4

It will be observed that in respect of several crops, the Institute has information covering a comparatively small portion only of the world's producing area. In the case of cotton, however, the information available is almost complete, as it concerns 96 per cent. of the world's production, and here we find that the past season's crop was 3.6 per cent. greater than the year before, but that it fell 4.2 per cent. below the average crop obtained during the five seasons previous to the last.

In over three quarters of the world's maize belt, the crop last year averaged 19.1 per cent. greater than the year before and also 4.7 per cent. greater than the average of the five seasons previous to the last one.

It is chiefly in regard to wheat, however, that the greatest moment attaches at present, and the figures disclose the fact that during the past season the crop reaped in certain countries, representing 62 per cent. of the world's total producing area, was 6.1 per cent. smaller than the yield of the prior season, and also 3.6 per cent. less than the average crop obtained from these countries during the five years previous to the last one. So much for the past, but what of the season facing us? The Institute's report does not, of course, contain information regarding wheat sowings in the southern hemisphere this 1920-21 season, but it publishes certain statistics of the

sowing of 1919-20 winter cereals in the northern hemisphere. Here it is found that in certain countries (Spain, France, Scotland, Roumania, Bessarabia, Canada, United States, British India, Japan, and Tunis) representing 40 per cent. of the average area under crop during the five years 1913-14 to 1917-18 the acreage under wheat shows a further downward tendency. In these countries the total area sown is 7.7 per cent. smaller than that of the last winter (1918-19) and 9 per cent. less than the average acreage under crop during the five seasons prior to the last. This falling off is caused principally by decreased sowings in the United States, where the acreage under wheat is as much as 23.2 per cent. less than the previous year and 3.5 per cent. less than the average of the five years' period. On the other hand, in British India the past winter sowings were 21.5 per cent. greater than those of the previous season, but are still under the five years' average to the extent of 9.4 per cent. Although, as will be seen, the position in certain important producing countries is not reported, the above figures should give some indication in respect of a large portion of the world's wheat supply.

In so far as the wheat production of the Union is concerned, certain figures were published in the May, 1920, issue of the *Journal* (page 190). Information in regard to the present season's sowings is now being obtained, and will be published in the Crop Report in next month's issue.

NOTE.—Since writing the above, a Reuter message, dated 2nd July from Rome, has appeared in the Press to the effect that, according to statistics issued by the International Institute of Agriculture, indications point to a good European harvest, the outlook for the coming year not justifying serious anxiety either for importers or exporters.

## Rat Poisons.

A recent issue of the "Tropical Diseases Bulletin" contains, in a discussion of plague, the information quoted hereunder in respect of rat destruction:—

The importance of rat-killing is beginning to be realized in England, as shown by experiments conducted at the Zoological Gardens, London, by Mr. E. Boulenger. The experience gained being, in chief part, as useful in the tropics as in temperate climates, the following account of results observed are reproduced from *The Times* (London):—

"Giving the conclusions he (Mr. Boulenger) had arrived at, he said that squill poison, the extract of the bulb of the common Mediterranean plant, *Scilla maritima*, which in the small quantities necessary for rat destruction is harmless to domestic animals, gave the most satisfactory results. It is best used by soaking bread in a solution of the poison mixed with milk. Barium carbonate, of which  $1\frac{1}{2}$  to 2 grains kills a rat, although 10-15 grains are harmless to a chicken and 100 grains to a dog, is next best. It should be mixed with tallow, and smeared on bread. It can be used effectively with squills. It has the effect of making the rats thirsty, and after it has been put down, bowls of squills and milk should be placed where the rats will go to drink.

“Strychnine was not used; it is known to be thoroughly effective, but it is too dangerous for general use. Phosphorus and arsenic, although effective are also very dangerous, and were found in practice less successful than the harmless squills and barium carbonate. Plaster of paris, magnesium sulphate, and croton were taken, even when thoroughly disguised, only when no other food was available, and therefore were inefficient as raticides. As to viruses, there was no doubt that these were sometimes successful, but a large body of evidence showed that their action was extremely unreliable, and that rat populations could acquire toleration of them. The gassing method kills not only adult rats, but the newly born in their nests.

“Very many different kind of traps, some of them of remarkable ingenuity were tested. Some, including those most commonly sold, were useless; others had occasional successes. The most successful type was that known as the ‘Brailsford,’ a long narrow wire cage, open at each end, but with a central platform with a bait acting on a spring, which closed both doors. The suspicions of the rats were not awakened if apparently there was a clear way.”

*Scilla maritima* (continues the article) has not, so far as the writer is aware, been generally recognized as a rat poison, but as the method which gave Mr. Boulenger the “most satisfactory results,” it will doubtless at once gain attention. Barium carbonate has long been employed in the United States, and has been regarded favourably. . . . In the Punjab, a satisfactory mixture of fish paste and a phosphorus compound is made locally under official auspices, and is reputed to yield good results. In experiments conducted with various recognized poisons for rats in the Madras Presidency in 1905, it was found that Danysz virus, even after careful culture, proved untrustworthy, and that the “common-sense rat exterminator,” a phosphorus preparation of Canadian origin, gave the most satisfactory effects. . . . In the matter of avoidance of the rat’s objection to human-handled baits, it is requisite that the bread or bananas used be manipulated by means of knife and fork, instead of direct handling; whilst traps may be made less obnoxious by the attempt to get rid of the human odour by dipping them into boiling water. According to some rat catchers in England, a trace of aniseed as a scent on traps is effective; but of this the writer has no knowledge in practice.

---

### **Marketing of Meat: Facilities for Farmers.**

The following particulars of the facilities provided at Johannesburg and Pretoria for the sale, under municipal control, of live stock are published for general information:—

#### **AT JOHANNESBURG.**

Live stock for sale may be consigned direct to the Director, Live Stock Market, Johannesburg, and will be sold by public auction to the highest bidder.

The railway consignment note may be marked “To Pay,” and the amount of railage will be deducted from proceeds of sale.

Stock should be consigned so as to arrive in Johannesburg on Tuesdays, Wednesdays, or Thursdays, and not on Saturdays, Sundays, or public holidays.

Commission charged on sales is 4 per cent. (four per cent.), which includes all market dues. All slaughter stock sold on the market is sold with a Johannesburg Abattoir guarantee, i.e. in the event of any stock being condemned for disease in the Abattoir, the buyer does not pay for these. To cover the vendor in the case of condemnation, all slaughter stock, forwarded to the Director for sale, is insured, as per following table showing premiums and indemnity:—

Description.	Premium per Head.	Amount of Indemnity.
Cattle (over 12 months) ... ..	1s. 6d.	Full price realized.
Calves (under 12 months) ... ..	3d.	Full price realized.
Sheep, Lambs, and Goats ... ..	2d.	Full price realized.
Pigs (up to 100 lb. live weight) ...	1s. 6d.	3d. per lb. dressed weight of carcass.
Pigs (over 100 lb. live weight) ...	2s.	3d. per lb. dressed weight of carcass.

As pigs are sold by live weight (with the exception of very small sucking pigs), a charge of 1s. per 25 pigs, or part of 25, is made for weighing, and a weight certificate issued. All weighing of pigs is done by municipal officials.

There are two methods by which stock may be disposed of:—

- (1) At so much per head "on hoof" in the live stock market by public auction.
- (2) Slaughter of the animals and the sale of the carcasses, hide, offal, fat, etc., separately.

For animals sold by No. 1 method, 4 per cent. commission on price realized covers all charges, and by No. 2 method, the following are the abattoir and slaughtering charges, in addition to 4 per cent. commission:—

	Abattoir Charge.	Slaughtering Charge.
Cattle ... ..	2s. 6d. per head	4s. 9d. per head.
Sheep ... ..	6d. " "	7d. " "
Goats... ..	9d. " "	—
Calves ... ..	1s. " "	1s. 6d. per head.
Pigs ... ..	1s. " "	1s. 6d. per 100 lb. and 6d. for each 100 lb. over.

In the event of a reserve price not being realized, animals may be slaughtered, the hide, offal, fat, etc., sold at once, and the carcasses placed in the Abattoir Cold Storage for sale at a later date, for which the charges would be as follows, *in addition to 4 per cent. commission and above-mentioned abattoir and slaughtering charges*:—

- For every quarter of beef, 1s. 6d. per week or part thereof.
- Sheep carcass, 6d. per week or part thereof.
- Calf carcass, 6d. per week or part thereof.
- Pig carcass, 6d. per 100 lb. per week or part thereof.

All pigs forwarded for sale are examined before sale in the Live Stock Market for visible infection of measles, and any found so infected

are not sold or insured, but are forwarded to the Abattoir to be slaughtered and dressed; the fat is then stripped off the carcass and sold on account of the vendor. In the event of this being done the vendor is debited with abattoir and slaughtering charges as under:—

Abattoir Charge.

Slaughtering Charge.

1s. per pig.

1s. 6d. per 100 lb. and 6d. for every additional 100 lb. or part.

In the event of any very poor pigs being found visibly infected, and from which no fat is available, they are destroyed without further charge to the vendor. *It is, therefore, advisable to examine all pigs for visible measles infection before sending for sale, and any found infected should not be forwarded.*

A weekly report of prices ruling on the Live Stock Market is published every Saturday, and farmers desirous of having these forwarded to them should make application to the Director for their names and addresses to be entered on the Mailing List.

#### AT PRETORIA.

The facilities and the scales of charges at Pretoria are about the same as those at Johannesburg, excepting that at Pretoria the scheme of insurance has not yet been introduced, but is now under consideration. The sales are held at Pretoria West on every Tuesday, Thursday, and Saturday, and animals should be consigned direct to the Manager, Live Stock Market, Pretoria West. All stock sent in by farmers will be off-loaded and penned, also grazed, free of charge, prior to being sold. All pens have arrangements for watering stock, and, if desired, the municipality will provide feeding for animals at a nominal charge. The municipal railway siding runs into the stock yards, and allows for expeditious handling of animals. The quarantine section is ample, and can deal with any number of stock from quarantine areas for sale by auction or for slaughtering and sale by dead weight. Connected with the Abattoir is an up-to-date chilling room where carcasses are thoroughly chilled prior to sale, and presented to buyers in the best possible condition.

---

### STAFF: APPOINTMENTS, TRANSFERS, ETC.

---

DATE.	NAME OF OFFICIAL AND NATURE OF CHANGE, ETC.
1/6/20	<i>Dr. J. P. van Zijl</i> : Chemist at Glen transferred to Veterinary Research Division, Onderstepoort.
12/6/20	<i>W. E. Footner, M.R.C.V.S.</i> : Appointed as District Veterinary Surgeon (temporarily stationed at Pretoria).
21/6/20	<i>A. V. M. Suter</i> : Sheep and Wool Expert, Fauresmith, Orange Free State, died.
1/7/20	<i>Dr. P. J. du Toit</i> : Senior Veterinary Research Officer, promoted to be Sub-Director for Research and Education and Professor of Hygiene.
1/7/20	<i>Dr. H. H. Green</i> : Physiological Chemist promoted Sub-Director for Research and Education and Professor of Bio Chemistry.
14/6/20	<i>Mr. G. v. d. W. de Kock</i> of the Transvaal University College: Appointed as Senior Research Officer and Professor of Anatomy.

## THE POULTRY YARD MONTH BY MONTH.

By J. J. JORDAAN, Lecturer and Instructor in Poultry, Glen, Orange Free State.

### August.

*Feeding.*—This is one of the difficult months of the year in which to obtain green food, and in no month is it so necessary for growing chicks, prospective show or laying-competition winners. They want a liberal allowance, and the breeding-pen also demands it, if health and fertility are desired. Soaked lucerne-hay should be available if nothing else is to be had, although sprouted grain should be possible to all. (See June notes.)

*Chickens.*—Separate all cockerels from the pullets; this helps in retarding early development of egg organs and tends towards increased size and rapid growth. While separating them examine each one for insects or nits around the head and under the throat, and if seen anoint with a little of the following: 4 parts salad oil, 1 part paraffin,  $\frac{1}{2}$  part creosote.

Watch for leg weakness and cramp amongst the cockerels, especially those of the heavy varieties, and if seen add a tablespoonful of bone-meal to the mash for each ten birds, or a tablespoonful of Parishes' Chemical Food to each quart of drinking water. An extra feed at night by lantern light will also help towards rapid growth. Remember that the chicken has a large body to build up in a comparatively short period, and requires abundance of food for this, and that the nights are long.

Cull strictly—all poor doers will later be poor producers, and therefore unprofitable. Culling also keeps down expenses otherwise necessary for labour, feeding, and housing, as well as leaving more room for the good ones. Unless you are a breeder with a large connection it will be found advantageous to dispose of the cockerels as "broilers"; South Africa is waking up to this trade.

*Disease.*—Eye roup and ordinary roup will show if sleeping quarters are draughty.

*Breedings-pens.*—Two or three hens may be added to the number in the breeding-pen, but do not neglect the male bird. The better he is the more attention he will pay to the hens and the more he will neglect his own feeding.

*Egg Production.*—This is one of the best months of the year for hatching light breed pullets for autumn and winter egg production.

*General.*—Wind in all its fury may be expected in the latter part of the month, and few things will be found more detrimental to the vigorous growth of chicks, or cause a more sudden drop in the egg output. Windbreaks or screens should, therefore, be made, if they have not been grown.

A useful windbreak screen can be made as illustrated below:—

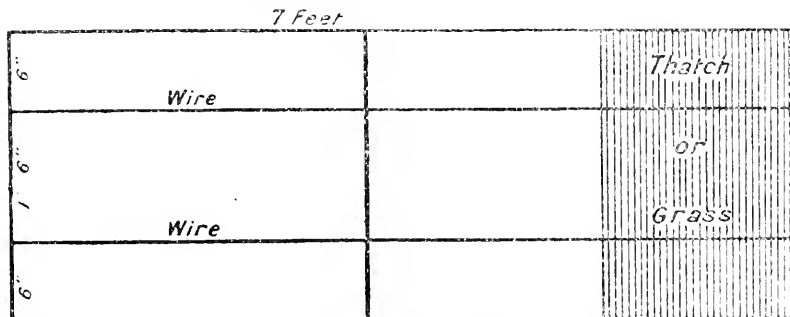

All that is required are: 3 7-foot iron standards, or other available posts; 6 3-inch bolts; 2 pieces of wire 8 feet long; 3 bundles stout grass or mealie stalks; a few pieces of tarred twine.

Cut one of the standards into three pieces 2 feet 4 inches long, have a hole drilled into each end of the standards for bolting and making frame as sketched. Frame might also be put together with wire instead of bolts. Fasten the two

lengths of plain wire to the three cross sections of the frame, and over this spread the three bundles of grass, and with tarred twine fasten to the frame and wires.

When complete, stand one on each side of the fence dividing the runs as shown below, with the grass on the outside of frame; they make excellent shades and windbreaks, and are cheap and durable.

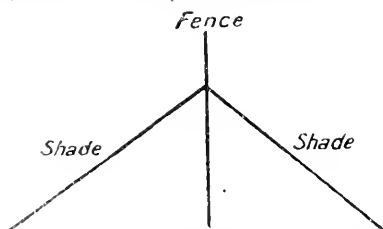

Ducks, goslings, and turkey poults should be hatched from now on.

New laid eggs will commence coming in, so dispose of all preserved eggs during this month.

Prepare ground for growing greenstuff during the summer.

Dip all the adult fowls in one of the commercial dips; the usual strength is 1 to 100 or 120 parts of water.

All houses, brooders, nests, etc., should be well sprayed with a strong solution of dip and then painted with solignum or carbolineum, preferably upon a hot day, in order to check the breeding of insects and preserve the wood.

Remove ground and manure, and whitewash the roof of the house both inside and out with lime, to which a liberal amount of salt has been added.

### Sale of Live Stock at Cedara School of Agriculture.

The annual sale of pure-bred live stock at Cedara was held on the 26th June, the day following the close of the Maritzburg show. There was a large attendance of buyers from all parts of the Union, and good prices were obtained. The following is a summary of the number of animals offered and the prices realized:—

No.	Kind.	Highest.	Lowest.	Average 1920.	TOTAL.
7	Friesland Bulls ... ..	£ 300 0 0	£ 135 0 0	£ 188 11 6	£ 1,320 0 0
3	„ Cows and Heifers	117 10 0	82 10 0	103 6 8	319 0 0
9	Shorthorn Bulls ... ..	160 0 0	70 0 0	110 5 6	992 10 0
6	„ Cows and Heifers	80 0 0	57 10 0	70 0 0	420 0 0
9	Aberdeen-Angus Bulls ...	150 0 0	100 0 0	121 2 3	1,090 0 0
1	Ayrshire Bul ... ..	—	—	41 0 0	41 0 0
2	„ Cows and Heifers	75 0 0	50 0 0	62 10 0	125 0 0
3	Berkshire Boars ... ..	9 5 0	7 10 0	8 8 4	25 5 0
5	„ Sows ... ..	9 0 0	6 10 0	7 4 0	36 0 0
9	Large Black Boars ... ..	6 10 0	2 10 0	3 13 4	33 0 0
7	„ Sows ... ..	8 10 0	3 5 0	5 18 7	41 10 0
36	Fowls ... ..	1 15 0	1 5 0	1 9 4	52 15 0
					£4,487 0 0

#### SUMMARY.

Cattle ... ..	£4,298 10 0
Pigs ... ..	135 15 0
Poultry ... ..	52 15 0
	£4,487 0 0



## THE VEGETABLE GARDEN.

August, 1920.

By H. B. TERRY, Cert. R.H.S., Lecturer in Horticulture, School of Agriculture, Potchefstroom.

As this month begins the sowing calendar for the spring and summer, all spare ground that has not been dug over and manured should be so prepared without delay.

Under cover for protection from frosts the following may be sown:—

**CABBAGE.**—Early Jersey, Wakefield, Surehead, Copenhagen Market, Castle. These are not mammoth varieties, but as they mature early they all help in giving successional crops.

**CAULIFLOWER.**—Early heading varieties are Early London, Gilt Edge, Snowball. An early crop and a late crop are all that can be successfully grown. The summer heat is too great for others.

**TOMATO.**—Earliana, Bonnie Best, Beauty, Sunrise, Matchless. It is best to sow these in tins or boxes and give a little bottom heat by placing the tins on a well tramped bed of stable manure.

**MUSTARD AND CRESS** should be sown in boxes and protected to cause the plants to grow quickly and stand erect.

In open ground, according to climatic conditions, there is a great variety of vegetables that may be sown in drills.

**BROAD BEANS.**—Further sowings may be made; they require fairly rich soil and at all times plenty of water.

**BETROOT.**—Eclipse, Egyptian, Turnip-rooted are good sorts to sow now. Thin out the young seedlings later on and transplant.

**CARROTS.**—Early Dutch Horn, Chantenay, and Model may be sown to mature during November and December.

**KNOL-KOHL (Kool Rabi).**—White Vienna, Goliath should be sown for succession. The young seedlings should be thinned early and transplanted.

**RADISH.**—All varieties excepting China Rose and Spanish.

**TURNIPS.**—A good sowing should be made for spring use.

**PEAS.**—Where severe frosts have prevented sowings the present is a good time to commence. Dwarf sorts such as Daisy, Gradus, American Wonder, Stratagem, Pride of the Market give the earliest yield. Late sorts may also be sown to follow on and prolong the season. Peas are not as a rule successfully grown if sown later.

**HERBS.**—Mint, Marjoram, Thyme, and Sage may be lifted, divided, and replanted.

**ASPARAGUS.**—No time should be lost in completing the planting of this delicious vegetable. The crowns commence to grow early and any check is disastrous.

**RHUBARB** may be divided and replanted. Old established crowns may be forced to provide early succulent stalks by placing half barrels, buckets, or paraffin tins over them and giving plenty of water. Care should be taken not to overdo the forcing, otherwise it weakens the plant.

**SCARLET RUNNER BEANS.**—These roots unless removed will break into growth this spring and give an early crop. The soil around them should be covered with manure and left. It is too early for other varieties of beans to be sown.

**LETTUCE.**—Both Cos and Cabbage varieties may be sown. If too crowded the seedlings may be transplanted and given copious supplies of water.

**CHICORY AND SEA KALE** will provide a beautiful lot of stalks for boiling as vegetables if treated in the same way as described above for rhubarb.

To grow vegetables successfully they must be kept continually on the move and never allowed to check. The soil should always be kept loose and moist. Don't keep on continually sprinkling the soil. Give a good soaking, then cultivate when dry enough. This keeps down weeds, saves watering, and allows air to get down to the roots.

## NOTES FROM THE "GAZETTE."

Attention is drawn to the following matters of interest which appeared in the *Union Government Gazette*:—

(Abbreviations: "Proc."—Proclamation; "G.N."—Government Notice.)  
*Gazette.*

No.	Date.	ITEMS.
1062	11/6/20	The regulations restricting the movements of cattle within the Indwe Sub-Division of Wodehouse district on account of East Coast fever, have been amended. (G.N. No. 929.)
1062	11/6/20	The appointment of certain gentlemen as officers of the Department of Agriculture for the purpose of imposing provisional quarantines on farms in the Pretoria District on which the presence of East Coast fever is suspected, is notified in G.N. No. 986.
1062	11/6/20	The Minister of Agriculture has approved of the withdrawal of the restrictions on public sales of cattle in the Mount Fletcher district. (G.N. No. 1000.)
1062	11/6/20	Compulsory dipping of cattle in the five-day dip in certain portions of the districts of Umvoti, Lions River, Umzimkulu,
1064	18/6/20	ixopo, Ladysmith, Krantzkop, Estcourt, Port Shepstone,
1068	25/6/20	Pietermaritzburg, Impendhle, New Hanover, Richmond, and
1071	2/7/20	Durban; in the three-day dip in portions of Zoutpansberg, Pretoria, Barberton, and Piet Retief; and in the seven-day dip in portions of Lydenburg, is required in terms of G.N. Nos. 1001, 1048, 1083, 1132.
1062	11/6/20	Crown lands in the Division of Kenhardt will be offered for sale by public auction on Saturday, 21st August, 1920, at 11 a.m., in front of the Magistrate's Office, Kenhardt. (G.N. No. 988.)
1064	18/6/20	The cutting and removal of rushes used by natives for the making of mats is prohibited in certain native locations in the district of Mqanduli, Tembuland. The period of such prohibition and other conditions are stipulated in G.N. No. 100.
1064	18/6/20	Both the "Thethlele" and "Chevy Chase" Plantations, in the Mount Fletcher district, are to be declared demarcated forests by the Minister in terms of Act No. 16 of 1913. (G.N. Nos. 1022 and 1023.)
1064	18/6/20	The districts of Riversdale, Ladismith, Swellendam, and portion of Bredasdorp, have been declared protected areas for purposes of the scab regulations framed under the Stock Diseases Act, No. 14 of 1911. The movement of sheep and goats within, into, and out of such areas are governed by the above-mentioned regulations. (G.N. No. 1036.)
1064	18/6/20	Under the Stock Diseases Act, No. 14 of 1911, the Minister has restricted the movements of cattle in respect of the Pretoria Municipal Area and Town Lands. (G.N. No. 1049.)
1064	18/6/20	For the purposes of the Stock Diseases Act, the Minister has declared the farms Jachtpad, Witumveloos, and Rusthof (Sub-division A of Onverwacht No. 63) to be in the Vryheid District.
1064	18/6/20	The Forest Department publishes the Prospectus of the School for Foresters and Forest Apprentices, giving full particulars as to purpose of the courses, the subjects they embrace, conditions of admission, etc. (G.N. No. 470.)
		A notification to intending students desirous of entering the courses referred to above is published in G.N. No. 471.
1068	25/6/20	The tariff for forest produce, as fixed by G.N. No. 1809 of 1914, issued by the Forest Department, has been amended to 2s. 6d. per wagon load of "grass" for thatch; and for "reed" for thatch to 10s. per 1000 bundles of not more than 10 inches in circumference. (G.N. No. 1067.)

(Abbreviations: "Proc."—Proclamation; "G.N."—Government Notice.)  
*Gazette.*

No.	Date.	ITEMS.
1068	25/6/20	The three-day interval for cattle dipping on the farm Hartebeestpoort, Pretoria District, has been extended to five days from 20th June, 1920. (G.N. No. 503.)
1062	25/6/20	The Public Service Commission has been authorized to nominate, subject to Government approval, from among South African scholars proceeding to or studying at the Forest Schools attached to the Universities of Oxford, Cambridge, Edinburgh, or any other forest school of equal standing, candidates for ultimate appointment in the Union Forest Department. Further particulars may be had from the Secretary of the Commission, Pretoria, and are published in Public Service Commission Notice, p. 643.
1071	2/7/20	The various areas comprising the Harkerville Forest Reserve, in the Division of Knysna, are defined in the Schedule to G.N. No. 946, which cancels previous notices regarding this reserve.
1071	2/7/20	An Advisory Committee on East Coast fever for the District of Pretoria has been appointed by the Minister of Agriculture, and the names of the members and consultative members published. (G.N. No. 1141.)
1071	2/7/20	Water Regulations for the Klipdrift Settlement, Potchefstroom, approved by the Governor-General, are published in G.N. No. 1140.
983	2/7/20	The High Commissioner notifies in the <i>Official Gazette</i> that under the Game Preservation Law for Swaziland (Game Preservation Ordinance, 1905, of the Transvaal), certain birds and animals mentioned in the Schedule to the Proclamation shall be protected in certain districts of Swaziland as from the date of publication (22/6/20) up to the 1st May, 1923. (Proc. No. 1.)

## SOUTH AFRICAN PRODUCE ON THE OVERSEA MARKET.

### Extracts from Report of the Acting Trade Commissioner.

May, 1920.

*Wool.*—At the wool auctions held on the 3rd June, about 2000 bales of South African free wools were offered. The market is described as being in a demoralized condition, and greasy wools were more or less unsaleable. While it is practically impossible to give a basis for prices, as far as any particular quotation can be made, greasy combings were from 25 to 30 per cent. below last sales rates. As regards Snow Whites, there was only a slight competition, and a few sales were effected on a basis of a decline of 10 per cent. on superior qualities, from 20 per cent. to 25 per cent. in the case of medium sorts, and from 10 per cent. to 15 per cent. as regards inferior descriptions.

*Mohair.*—The market is quite lifeless, and the tendency of the article is downward, probably in sympathy with wool. The price of the best quality Cape hair has been more or less maintained at about 28d. to 29d. per lb., and winter hair is quoted nominally at 21d. Other classes of mohair are for the moment practically unsaleable. Turkey hair is quoted at 26d. to 27d. per lb. for fair average quality.

*Hides.*—During the last six weeks there have been practically no buyers of raw hides, and the Cape hides catalogued for the public sales of the 13th May and 3rd June are nearly all still on hand, though a decline of 25 per cent. would be accepted by many holders.

*Skins.*—Goat and sheep skins are in the same position as hides, and no business of any importance has taken place. The few transactions recorded show a drop of about 33 per cent., but there are few buyers even at this reduction. The prospect is not encouraging, and a further fall in values of from 10 per cent. to 15 per cent. is expected.

*Wattle Bark.*—The market is at present very dull, and practically no business is being done. Large stocks have accumulated and sellers are willing to take £15. 15s. per ton c.i.f. for chopped. Ground bark is a little firmer at about £17. 10s. to £17. 15s. per ton c.i.f. I am informed that fairly large parcels are now afloat for the Continent, but the demand has fallen off considerably. The general slump in leather manufactured goods is naturally affecting the price of all raw materials used by the tanners, and the fact that there are large supplies of Valonia and other similar tanning materials available has also tended to depreciate the value of bark.

*Maize.*—During the past month no business has been done. Rhodesian No. 2 maize has been offered at 100s. per quarter c.i.f. on the basis of freight at 150s. per ton, but buyers will not pay this price. No. 2 South African is offered at about 105s. c.i.f. There is a good inquiry for all kinds of maize, but the trade is of opinion that the present level of prices, both of Argentine and South African maize, is too high to allow business. Argentine shippers are asking about 75s. per quarter c.i.f., which would make South African worth about 77s. 6d. to 80s. per quarter, but at present only about 72s. is obtainable for Argentine, and, therefore, it might not be possible to secure more than 75s. to 77s. 6d. for South African.

*Kaffir Corn.*—About 90s. per quarter is obtainable for this article for prompt shipment, but I am informed that shippers are not able to offer at less than 100s.

*Ostrich Feathers.*—Since the auction sales held on the 3rd May the market has shown no appreciable signs of improvement. The Whitsun holidays have also handicapped business to some extent. Inquiries have been made for Tipless and Medium quality sound Feminas and Femina Boos, but the demand for all other grades remains restricted owing principally to the unstable position of the foreign exchanges.

The Plumage Bill, which passed its second reading in the House of Commons during last month, is now being considered in committee, but owing to the congestion of business little progress has so far been made. I may state that the trade here and on the Continent strongly resent the proposed legislation, which they contend will not only fail in achieving any useful purpose, but, indirectly, will adversely affect the feather trade, ostrich and otherwise. The manufacturers of feathers in France have, through their association, protested against the proposed legislation, and have pointed out to the Feather Association in London that the position is very serious, for if the Bill is finally adopted the French Government may be called upon, as a matter of reciprocity, to prohibit the import of ostrich feathers. The position is being carefully watched, but in the opinion of the trade here the possibility of any such action on the part of the French Government as indicated, is considered to be very remote. I may say that the French Government has recently reinstated certain prohibitions of importation, the greater proportion of which are not actually indispensable to the requirements of the population. These include feathers, but only such as are ornamental, prepared, or mounted. Feathers in their natural state (which are what really concern us) are not in any way affected. The importance of the feather industry in France will, it is considered, be a sufficient safeguard against any undue interference with the ostrich feather as an article of export.

*Dried Fruit.*—The Food Controller has decided to decontrol dried fruits before the next season begins. In accordance with this decision the Dried Fruits (Restriction) Order, 1919, the Dried Fruits (Wholesale Prices) Order, 1919, and the Dried Fruits (Retail Prices) Order, 1918, will be revoked as from Monday, 2nd August. After that date there will be no restriction on the import of dried fruits into the United Kingdom by private traders, and the maximum wholesale and retail prices at present in operation will be withdrawn. The Ministry states that it holds sufficient stocks of dried fruits to enable it to prevent any attempts to raise prices unduly, not only during the remainder of the present season, but also throughout next autumn, when the new crops will be brought to this country.

## OVERSEA PRICES OF SOUTH AFRICAN PRODUCE.

May and June, 1920.

MARKET PRICES OF SOUTH AFRICAN PRODUCE IN THE UNITED KINGDOM,  
CABLED BY THE ACTING TRADE COMMISSIONER, LONDON.

*South African Wool.*

May, 1920. Greasy combing 25 per cent. to 30 per cent. below last sale prices. Snow-whites only slight competition. Prices showed decline 10 per cent. for superior qualities, 20 per cent. to 25 per cent. for medium, and 10 per cent. to 15 per cent. for inferior descriptions.

June, 1920. Wool auctions 8th and 10th only a small quantity changed hands. Greasy combing 25 to 30 per cent. below last sales prices. Snow-whites only slight competition. Prices showed decline 10 per cent. superior qualities, 20 to 25 per cent. medium, and 10 to 15 per cent. inferior descriptions.

*Mohair.*

May, 1920. Market shows tendency to decline in sympathy with wool. Best quality S. A. Mohair, 2s. 4d. to 2s. 5d. per lb.; Winters, 1s. 9d.; Turkey, 2s. 2d. to 2s. 3d.

June, 1920. Practically no transactions.

*Cape Hides.*

May, 1920. Market stagnant.

*Sheep Skins.*

May, 1920. Market stagnant for Cape Merino.

June, 1920. Cape Merino. Practically no buying since April; few transactions show general decline of about 25 per cent. since March. There is at present no prospect of any improvement.

*Natal Wattle Bark.*

May, 1920. Market dull. Chopped, £14 c.i.f. per ton.

June, 1920. £15. 10s. c.i.f. per ton chopped; £17 ground.

*Maize.*

May, 1920. South African No. 2 White Flat, worth about 77s. 6d. to 80s. per quarter, 480 lb.

June, 1920. South African No. 2 White Flat, market stagnant, 70s. to 72s. 6d. Argentine 59s. to 61s.

*Maize Meal.*

May, 1920. Practically no market.

*Kaffir Corn.*

May, 1920. 90s. per quarter, 480 lb., for prompt shipment.

*Ostrich Feathers.*

May, 1920. Unchanged.

June, 1920. Improved demand but no alteration in prices.

*Cotton.*

May, 1920. Highest, 25.45d.; lowest, 24.63d.

June, 1920. June future closed at 24.48d., July, 24d.; highest for last week 24.25d.; lowest, 23.65d.

*S.A. Oranges.*

June, 1920. Now arriving in good condition, meeting most favourable market, prices 35s. to 55s.

*Cape Fruit.*

June, 1920. Not satisfactory, being too coarse and light, fair prices obtained due to temporary shortage but only best fruit should be shipped.

## RECENT AGRICULTURAL LITERATURE.

By PAUL RIBBINK, Librarian, Department of Agriculture.

### I.—UNION GOVERNMENT PUBLICATIONS.

MISCELLANEOUS REPORTS, ETC., OF INTEREST TO FARMERS.

#### A.—DEPARTMENT OF AGRICULTURE.

*Bulletins obtainable from the Department of Agriculture, Pretoria.*

<i>Price per copy.</i>		<i>Number of Publication.</i>
Gratis.	Veterinary Research and Education in South Africa, Address by Sir Arnold Theiler, K.C.M.G.	5/1920
3d.	The South African Locust Poison, by Ernest Anderson, M.S., Ph.D.	Science Bul- letin No. 15.
2s. 6d.	Botanical Survey of South Africa, Phanerogamic Flora of the Divisions of Uitenhage and Port Elizabeth, by S. Schonland.	Memoir No. 1.

#### B.—MISCELLANEOUS REPORTS, ETC., OF INTEREST TO FARMERS.

*(Obtainable from the Government Printer, Pretoria.)*

3s. 6d.	Census of the European or White Races of the Union of South Africa, 1918, Part II, Ages.	U.G. 51—'19.
5s. 0d.	Census of the European or White Races of the Union of South Africa, 1918, Part III, Education.	U.G. 1—'20.
5s. 0d.	Report of the Under-Secretary for Education of the Union of South Africa, year ended 31st December, 1918.	U.G. 41—'19
1s. 0d.	Profiteering Bill: First Report of the Select Committee, June, 1920.	S.C. 8—'20.
—	Registration of Pedigree Live Stock Bill: Report of the Select Committee.	S.C. 13—'20.
1s. 3d.	South-West Protectorate: Report of the Administrator for the year 1919.	U.G. 40—'20.

## II.—THE AGRICULTURAL PRESS OF SOUTHERN AND TROPICAL AFRICA.

### SELECTED ARTICLES.

*Die Boer* (Bijvoegsel tot *De Volkstem*), Pretoria.

21/5/20 Dynamiet op die Plaas.

28/5/20 Soedangras, deur G. J. Bosman, Bosluispes en Omheining.

11/6/20 Lamsiekte of Gallamsiekte, uittreksel van lesing gehou deur  
Dr. Hartig.

18/6/20 Kunsnis en hoe om dit te gebruik, deur J. Fisher (*vervolg*).  
Daling mielieprijs.

*Die Boerevrou* (Posbus 984, Pretoria).

6/20 Die Werkvolk op 'n Boereplaas, deur oud-president F. W. Reitz.  
Kalkoene, deur J. J. Jordaan. Meubelwedstrijd. Bijboerderij  
vir Beginners, deur G. R. von Wielligh.

*Farmers' Advocate, South African* (P.O. Box 247, Bloemfontein).

- 6/20 Wheat Cultivation in South Africa: Results of Experiments with "Yeoman" Seed, by J. E. Donkin. With Pen and Camera at the Shows. Pig Management. Grazing, by D. P. MacDonald.

*The Farmers' Journal* (Nairobi, B.E.A.).

- 6/5/20 Humus, What can be done with the refuse of the farm. Diseases of Para, by W. Small.  
 13/5/20 Rearing the Calf, by J. F. de Vine. Diseases of Para (*continued*). Contagious Pleuro-pneumonia of cattle.  
 20/5/20 Impressions of the East African Flax Industry. The Citrus Nursery, by A. Bester (*continued*). Rats: What is being done in England.  
 27/5/20 Management of the Milking Herd.  
 3/6/20 Flax Unity.  
 10/6/20 Rules for Butter-making. Diseases of Dogs.

*The Farmers' Weekly* (Bloemfontein).

- 2/6/20 Tips on Irrigation, by C. F. Warren, A.M.I.C.E. (4). How to Throw a Horse, by A. Hodder, M.R.C.V.S. On Selecting a Tractor. The Shorthorn Breed. Monthly Review.  
 9/6/20 Birds: In Orchards and Grounds, by F. W. Fitzsimons, F.Z.S. Pig Breeding and Management, by "Granob." Farming in South America, by Dr. Eric Nobbs. Farm Furniture, by "Waterberg."  
 16/6/20 Income Tax, by "Accountant." Glanders and Farcy, by A. Hodder, M.R.C.V.S. Tips on Irrigation. The Soil Mulch.  
 23/6/20 Birds and Pasture, by F. W. Fitzsimons, F.Z.S. Thirstland Redemption, Editorial.  
 30/6/20 Stump Pulling (Special). The Sublime in Agriculture, by "J. M. G." Milk and Cream Tests, by J. Toens. Farming in South America (*continued*). Feeding of Dairy Stock, by C. Williams. The Season for Fluks Infection, by F. G. Cawston, M.D.

*The Independent* (Salisbury, Rhodesia).

- 21/5/20 (Vol. 1, No. 1). Cattle Dipping.  
 28/5/20 Well Waters, How to Purify. Control of Export Maize, by "Cereal."  
 4/6/20 Microbes and the Farm, by L. E. W. Bevan (*continued*). The Irrigation of the Kalahari, by A. Karlson (*continued*). From Farm to Factory, the Dairy Industry of Rhodesia, by F. D. Walker. The Kudzu Vine, by F. Eyles.  
 11/6/20 Maize: The Economical Value of Seed Selection, by "Ager."  
 18/6/20 Pisé Work, by D. L. McLachlan. Home-made Windmill, by A. C. Jennings.  
 25/6/20 The Ancient Ruins in Rhodesia, by F. Eyles. War Settlement: The work in Rhodesia, by R. C. Simmons.

*Die Landbouwer* (Posbus 1035, Pretoria).

- 15/3/20 Op water wag of lei. Vermeerdering van ons mielieproduksie (*vervolg*). Ons Hoenderpraatjie.

*Die Landbou Weekblad* (Posbus 267, Bloemfontein).

- 2/6/20 Mielies en Groente Inkuiling, deur G. J. Bosman. Die Kunsmis in Holland. Landbou-onderwijs in Middelbare Skole (*vervolg*).  
 9/6/20 Die Grondkombêrs. Plumveedag te Glen, O.V.S. Volstruisveer-industrie.  
 16/6/20 Suidafrikaanse Rijsmiere, deur Claude Fuller.  
 23/6/20 Kort Landboukursusse. Landboukunde in die Skool, vereistes vir Matriek na Junie 1920. Bestanddele van Portland Sement, deur "Meerkat" (*vervolg*).  
 30/6/20 Landbutoestande in Rhodesia, deur oom Gert. Dorre Suid-Afrika, deur J. D. Schonken. Landbou-onderwijs in die Skool, deur Dr. T. de V. Malherbe. Goeie Saad, deur G. Nel.

- South African Dairymen* (P.O. Box 925, Durban).  
6/20 Dairying Demonstration at Cedara, 21st May. Official Notes on Friesland Cattle. The Acid Test for Milk.
- South African Farm News* (P.O. Box 963, Johannesburg).  
6/20 Rand Cattle Farmers' Fight against Anthrax. Red Polled Cattle, by Farmer George. The 1920 Settlers.
- South African Fruit Grower and Small Holder* (P.O. Box 3958, Johannesburg).  
6/20 The Value of Superphosphate as a Fertilizer, by B. Wulf. French Gardening improved upon.
- South African Gardening and Country Life* (P.O. Box 3958, Johannesburg).  
6/20 How to Grow Vegetables. The Forming and Pruning of Fruit Trees. Points to Observe in Practical Pruning.
- South African Journal of Industries* (Government Printer, Pretoria).  
6/20 Fertilizer Production and Natural Fertilizers in the Union, by C. F. Juritz, M.A., D.Sc. Artificial Stock Foods and their Manufacture, by W. Jarvis Palmer, B.S.A. Vegetable Fats and Oils: IV.—Semi-drying Oils, by Prof. M. Rindl. The Iron and Steel Industry. Transport Methods in South Africa: IV.—Rural Transport (*continued*), by Sir Wm. Hoy, Kt., C.B. Products of the Peanut.
- South African Poultry Review and Small Holder* (Johannesburg).  
6/20 The Ancona, by W. G. Looney. Stick to your birds, no necessity for panic over price of food-stuffs. Poultry-keeping on Practical and Paying Lines, by W. C. Archibald.
- South African Poultry Review and Small Holder* (Johannesburg).  
6/20 Our Need. The Ancona, by W. G. Looney. The Goat, or Poultryman's Cow, by Geo. R. Vivyan. Hens in their third laying year; does it pay to keep them? by H. Curtiss. Roup, Contagious Catarrh.
- South African Sugar Journal* (P.O. Box 925, Durban).  
6/20 Annual General Meeting of the Natal Planters' Union, 7th June, 1920. White Sugar Manufacture in Natal, by Wm. Clacher. Notes on the Cotton Industry, by W. B. Wilson.
- The Sun and Agricultural Journal of South Africa* (P.O. Box 634, Johannesburg).  
6/20 Transvaal to Tangier, scheme for railway to Paris and London through the heart of Africa. Seed Selection of Tobacco, by Pieter Koch. Electric Light and Power from small streams (No. 2), by A. M. Daniels. Preparation and Packing of Produce for Market, by G. Bidwell. The South African Grain Trade Association.
- Sunday Times* (Farmers' Supplement), Johannesburg.  
6/6/20 Chemistry of Animal Nutrition, by J. S. Jamieson. Building an Incubator House, by Malcolm MacFarlane. Rat Destruction. Veterinary School.  
13/6/20 Milking. Velvet Beans. Irrigation and Cultivation of Orchards.  
20/6/20 Buying a Goat. The Soy Bean.  
27/6/20 Big Fortunes in Trees and Timber. Problems in Beef Production, by P. J. Naude. East Coast Fever, the necessity for hand-dressing. Winter Control of Fruit and Garden Pests, by "Entos."

### III.—AGRICULTURAL PUBLICATIONS IN OTHER PARTS.

(1) The following interesting extracts are taken from a series of papers entitled "The Biologist on the Farm," contributed by Prof. J. Arthur Thomson, M.A., LL.D., in the *Journal of the Scottish Board of Agriculture* for January, 1920:—

*Twins and Twins.*—We are not sure that many people are quite clear as to the two kinds of twins. When a sheep or a cow, or any animal ordinarily producing a single offspring gives rise simultaneously to two, these may be fraternal twins or identical twins. In the first case the two offspring develop from two distinct egg-cells; they are often dissimilar, and they may be of different sexes. In the second case the two offspring develop from one egg-cell; they are duplicates of one another, and they are always of the same sex. The



Nine-Banded Armadillo of Texas normally and habitually produces quadruplets from one ovum. These are enveloped in a common foetal membrane, and they are always of the same sex.

*The Mystery of Monsters.*—It is interesting to note some recent experiments on minnows which have thrown fresh light on monster-lambs, monster-calves, and the other ungainly things that sometimes crop up. From minnow to monster. What is the meaning of creatures with one eye instead of two, with one ear, with peculiar nostrils, and all that sort of thing? An old answer, which has a great deal of truth in it, pointed to the fact that when an animal is developing it has to some extent to retrace the path of racial evolution, and that if something goes wrong with the feeding of the embryo there may be what are called "arrests of development." Thus the no-trils may remain externally connected with the front of the mouth, instead of being separated off in the normal fashion. When the arrest or stoppage of development occurs and the creature is born with the part unfinished, we have what is called "hare-lip" in man. It is a minor monstrosity in man; it is normal in the hare! Now many monstrosities are cleared up when we regard them as due to arrests in development. But there are others on which this idea throws no light, and to us welcome a suggestion that comes from Dr. E. I. Werber's experiments on the American minnow. He subjected the developing eggs to various chemicals, such as butyric acid, and he got all sorts of monstrosities in eyes and ears, nostrils and mouth, heart and fins. The chemical intrusion seemed to have a dislocating and partially dissolving influence on the developing embryo, especially towards the head end. Hence monstrosities. But the question naturally rises: Is this more than a biological curiosity? How could any respectable embryo in natural conditions become subjected to butyric acid? But we must be patient. Part of the food of higher animals consists of carbohydrates, such as starch and sugar; when the chemical routine that goes on in the body in connection with carbohydrates goes "agley" in a certain way, one of the results of the disturbance is the formation of butyric acid. If this butyric acid was formed in the body of the pregnant mother it might affect the unborn offspring, her close partner, and might produce monstrosities. This seems to us to be a big contribution towards the solution of the mystery of monsters.

*The Control of Sex comes Nearer.*—It may be said with fairness, we think, that almost all the recent work on the determination of sex in birds and mammals points to the conclusion that the sex is settled when the egg-cell is fertilized, if not before that. Some very careful investigations on pigeons by Prof. Oscar Riddle force one to think. He makes it practically certain that pigeons lay two kinds of eggs, which differ from one another in the rate or intensity of their chemical processes. One kind of egg has a comparatively low storage capacity, a high oxidizing capacity, and a relatively higher intensity of chemical changes (or metabolism); and this type of egg *develops into a cock bird*. The contrasted type of egg, with higher storage capacity, relatively less intense metabolism, lower percentage of water, higher total percentage of fat and phosphorus, and greater energy-value in the yolk (as determined by the calorimeter), *develops into a hen bird*. It is very interesting to find also that an intermediate type of egg, produced early in the season, will develop into a female bird with a good many masculine features about her. Moreover, chemical analyses of the blood of full-grown male and female pigeons show that the constitutional differences which can be detected in the two kinds of ova persist in adult life. These experiments furnish a corroboration of the thesis worked out by Geddes and Thomson in *The Evolution of Sex* as far back as 1889, that femaleness is associated with a relative preponderance of constructive, or up-building or anabolic physiological processes; and conversely for maleness. In short, the sexes differ fundamentally in their physiological gearing, in the rate or intensity of particular vital processes.

(2) *Verlag en Mededeelingen van de Directie van den Landbouw in Nederland*, No. 1 of 1920, deals with the damage done to Agriculture, Horticulture, and Forestry by game and injurious animals. Figures are given of the estimated damage caused in the different provinces, and methods of combating the pests dealt with. The greatest damage is said to be caused by birds, especially sparrows, crows, and pigeons. The report recommends that, where necessary, land-owners or game licencees be instructed to eradicate such injurious game within a certain period, after which, if not sufficiently reduced, the State, in consultation with Provincial Commissions, will employ persons to complete the work.

## AT THE SCHOOLS OF AGRICULTURE AND EXPERIMENT STATIONS.

June, 1920.

CEDARA, NATAL.

*Climatic.*—From 29th May to 25th June (inclusive) the mean maximum temperature has been  $62.65^{\circ}$  F., and the mean minimum temperature  $39.33^{\circ}$  F. The highest maximum temperature,  $75^{\circ}$  F. was registered on 4th June, and the lowest minimum,  $31^{\circ}$  F. on 30th May. The total rainfall for the period was .07 inches. The days were bright and sunny and the nights frosty. There was a slight fall of snow on the hills on 23rd June.

*Crops.*—The cow-peas have been cut and cured for hay. Turnips, Kale, and Rape are now being cut and fed to dairy stock. During the month veld-hay and potatoes were harvested and oats planted.

*Field Experiments.*—The Kikuyu grass has been affected by the intense frosts and has dried off considerably, but growth is still vigorous just below the soil surface. In sheltered places the grass still retains its green colour. Tall Fescue has resisted the frosts well, only the growing tops being affected. The Cocksfoot has also been very little affected by the frosts and has retained its green colour. The Napier fodder has not withstood the cold well and has turned brown. Some new varieties of potatoes are being tried under winter conditions.

*Chemical Laboratory.*—A large number of samples were analysed in the laboratory during the month, nearly half being tanning materials of various kinds. A sample of ash from the spent bark was found to contain over 50 per cent. carbonate of lime, nearly  $3\frac{1}{2}$  per cent. phosphoric oxide, and 3 per cent. potash, so that it has quite an appreciable manure value. A bark of an indigenous tree was also analysed and found to contain 23 per cent. of tanning matter. It seems that there is an unlimited supply of this bark, and the sender is confident that extract could be manufactured from it at an appreciably lower cost than from the black wattle. The colour, however, is deeper than that of the wattle, although the objectionable red tint is not very prominent. Of three dipping fluids analysed, two showed that a very large proportion of the arsenite originally present had been oxidized to arsenate of soda, so that its presence could not be detected by the isometer and other similar methods that are often used by farmers for testing their dips. As the arsenate has been proved to have practically half the scalding and insecticidal effect that the arsenite of soda has, it is possible that grave errors often arise through trusting solely to the isometer, and not having a proper chemical analysis periodically made of the fluid in the tank, as a check on the isometer readings.

*Stock.*—The stock are all in excellent condition. Three calves were born during the month, one Friesland bull, one Shorthorn heifer, and one Aberdeen-Angus heifer. Fourteen head of cattle were shown at the Royal Agricultural Show, Pietermaritzburg, and these secured fourteen prizes, including a championship and three specials.

*Stock Sale.*—The Annual Stock Sale was held at Cedara on 26th June, when 37 cattle, 23 pigs, and 12 pens of poultry were sold, the total proceeds of the sale being £4487. The prices on the whole were good, the poultry, for example, being sold at an average of 30s. per bird.

## ELSENBURG, MULDER'S VLEI, CAPE.

*Climatic.*—The chief feature of the month was the exceptionally large rainfall, a precipitation of 7.625 inches being recorded up to the 25th instant. This is the greatest rainfall for the month of June since 1905, when 8.12 inches were received (during the entire month). The normal average for June is 4.55 inches. Strong northerly breezes and fairly cold weather were experienced, the maximum temperature recorded being 73° F. on the 2nd instant, and the minimum 33° F. on the 1st.

*Field Operations and Crops.*—The ploughing and seeding operations planned for early in June were seriously delayed by the excessive wetness of the lands. There still remain some 50 acres of farm land to be ploughed and 100 acres to be seeded. Cereal crops seeded before the wet spell are looking fairly well, though held back somewhat by the cold. Fields carrying rape and imported vetch show poor germination, in the latter case only about 20 per cent. Lucerne has grown well and is at present of great value to the lambing ewes. The pruning of fruit trees and vines was started during the month, but owing to bad weather not much could be done. Grafted vines are at present being transferred from the nursery to the main vineyard.

*Experimental Division.*—The greater portion of the field experiments had been planted under favourable weather conditions, but two ranges of "mixed fodder" experiments and one range carrying various green manures were held over pending the arrival of Hairy Vetch and English Winter Vetch seed. These three ranges were planted rather late in the month, under weather conditions anything but favourable. Three one-sixth acre plots were seeded to barley varieties, and some one hundred and fifty test rows of wheat and oats were also planted. The latter represent the end of single-ear selections made in 1918 and planted for the first time during 1919 season.

The heavy rains caused rather serious erosion in several of the experimental ranges.

*Live Stock.*—All live stock suffered more or less owing to the wet and cold weather. Natural grazing is still of very little value, and the grazing crops are not sufficiently advanced to be used as yet. The condition of the cattle is fair, but milk yields dropped considerably. The lambing season started at the beginning of the month. The percentage lambing is very satisfactory, but many losses occurred through exposure. The cross-bred lambs are fine and healthy on the whole, but the Murrays appeared very weak at birth, and deformities occurred in several cases. To date no Suffolk lambs have been dropped. Several sows farrowed during the month, and accommodation at Elsenburg is becoming too limited. For this reason a lot of young pigs were removed to Mariendahl.

*Investigational Work.*—Investigations in regard to the changes taking place in the mixtures of (1) superphosphate and bone-dust, (2) superphosphate, bone-dust, and Government guano, showed that the decrease in water solubility of the phosphoric oxide after six weeks is negligible (less than 1 per cent.), contrary to popular belief.

*Extension Work.*—Eight samples of fertilizers were analysed and reported upon in the chemical laboratory, and several veterinary specimens were examined to confirm suspicion of poisoning of stock.

A number of farms was visited during the month by different lecturers in order to advise the owners in regard to various matters.

*The School.*—The six-weeks' winter vacation for regular students started on 12th June, and the first general short course (two weeks) began on the 21st instant. The number of students attending this course is 34, of whom 23 are women.

## GLEN, ORANGE FREE STATE.

No rainfall during the month, and cold weather continued throughout.

*Crops.*—Owing to the cold weather, crops are not making any growth.

*Live Stock.*—In spite of the unfavourable weather all stock are doing well. The nucleus of an Africander herd was established by the transfer of 1 bull and 10 cows from Potchefstroom.

*School.*—The regular students left for their vacation on the 23rd, and the Sheep and Wool and Horticulture and Poultry Short Courses commenced on the 30th. Thirty-five students for the sheep and wool and eighteen for the horticulture and poultry course were admitted.

The dairy building is nearing completion and work on three staff houses is also proceeding.

### GROOTFONTEIN, MIDDELBURG, CAPE.

During the month the weather experienced was undoubtedly the worst ever recorded in this part of the country for this period of the year. The following are the minimum readings of over 10 degrees of frost since the 25th May: 27th May, 17 degrees of frost; 28th May, 13 degrees; 29th May, 11 degrees; 1st June, 12 degrees; 2nd June, 13 degrees; 7th June, 10 degrees; 24th June, 15 degrees.

This extreme cold has been accompanied by heavy windstorms, corresponding with the heavy rainstorms experienced in the Western Province.

*Field Operations and Crops.*—Twenty-one acres of land were prepared and laid down to oats; thirty acres of "beer manna" was harvested: the crop was very inferior. Many tons also of vlei hay were harvested.

*Live Stock.*—The condition of live stock, on the whole, is good. The stud sheep are lambing slowly, and the lambs are looking well. Cattle have, however, fallen off in condition, due to the excessive cold and high winds. Eighteen ostriches were sold at the local stock fair, and, considering the market, realized fair prices.

*Experimental and Investigational Work.*—A large number of experimental plots have been sown, and a considerable area for dry land experiments is in course of preparation. Investigational work is being carried out in connection with the liver tape-worm in sheep, etc.

*Buildings.*—On the 24th of May the office block of buildings, including the engineer's lecture-room, the agronomy laboratory, library, etc., was destroyed by fire, with all records. The students' quarters are at present being used, but it is hoped that permanent offices will be erected in the near future.

*Students.*—The special dairy course, sheep and wool course, six-months' soldier course, and diploma course students left for their holidays on the 5th June, and, with the exception of the diploma course men, the rest of the students resume duty on the 29th instant. On the 9th instant, the nine-days' sheep and wool course opened with 54 students, and the special nine-days' course in dairying, poultry, and horticulture opened on the same date with 10 students. These courses were completed on the 19th instant, and on the 21st instant the three-weeks' general course opened with 18 students. All the short course students have proved exceptionally keen at their work, and it is regretted that a number of applications had to be refused, due to lack of accommodation.

### POTCHEFSTROOM, TRANSVAAL.

Extremely cold weather was experienced during the whole month. Minimum temperatures of 19° were registered on four nights. The absolute minimum for the month was 18.4° F., which occurred on the 27th instant. No rain fell. The extreme cold weather, it is thought, will have a beneficial effect in destroying stalk borer on land ploughed after the maize crop was removed.

*Farm Section.*—The supply of irrigation water available has been adequate for irrigating the vegetable garden, and also 250 acres, including all the land under winter cereals. The following varieties of wheat were sown at the beginning of the month on large plots, varying from  $\frac{1}{2}$  acre to 6 acres: American No. 8, Gluyas Early, Spring Early, Black Don, Pusa No. 4, Pusa No. 12, Comeback, Bombay, Federation, and Lalkusawala.

Twenty acres were sown to the variety American No. 8, which is showing great promise in this section of the country. It is favoured by the miller, yields well, and is resistant to attack by birds. About 15 bushel lots were distributed free to farmers in this and other districts for co-operative experiments.

Harvesting of the maize crop is still proceeding. Chester County Mammoth yielded eight and three-fifth bags to the acre, and Yellow Cob Congo 10½ bags to the acre. The main maize crop, Potchefstroom Pearl, has not yet been thrashed.

The shortage of bedding this year necessitated cutting of veld-grass on neighbouring farms for this purpose. Carting of gravel for maintenance of roads and bridges is being proceeded with, also pruning of forestry trees and the thinning out of shelter belts.

*Live Stock.*—In spite of the severe winter conditions live stock are well maintaining their condition. Feeding of young breeding stock of the dairy breeds and weaner calves of all breeds took place during the month. The dairy cows are in good condition, but great difficulty is experienced in maintaining the supply of milk. Two calves were dropped during the month from the dairy herds. Nine aged cows, most of dairy breeds, out of the contagious abortion camp, were sold from the quarantine yards, Municipal Abattoirs, Johannesburg. The Afriander stud bull "Weeskind" and ten cows were transferred to the School of Agriculture, Glen. One Berkshire sow farrowed. One Berkshire and one Large Black boar were sold for breeding purposes.

*Experiment Section.*—Ranges of wheat in the rotation experiments were planted. The maize from the variety rotation, cultivation, manurial and seeding trials was thrashed. Varieties of beans and peanut were harvested and the former were thrashed.

The plant breeder spent some time in describing, classifying, and recording his wheat and kaffir corn crosses. Samples of grain of the various kaffir corns have been submitted to milling tests. Winter sowings of hybrids and selections of wheat were carried out in the breeding-cage.

*Horticultural Section.*—The vegetable crops suffered severely from frost. Bagrada Bug has been persistent in its attacks on cabbages, kohlrabi, and turnips; paraffin emulsion spray was used to combat this pest. Cabbages were sprayed with arsenate of lead against cabbage moth larvae and with paraffin emulsion against aphides. Several varieties of peaches blossomed out of season early this month.

*Poultry Section.*—The egg-laying competition has progressed favourably. The output of eggs was gratifying, showing an improvement on that of May, despite the cold weather. Young chicks in several cases succumbed to the severe cold. The stock birds continue to lay fairly well.

*Engineering Section.*—A ploughing demonstration was held with the Ransomes Demon plough. A report on the demonstration was prepared for publication.

Plans for moulds required in the construction of Pisé huts were prepared. A commencement will soon be made with the building of native huts in Pisé work.

*Entomological Section.*—Field experiments were carried out on the best methods of destroying birds with poison bait without endangering poultry and other farm animals. Wired crates and raised platforms were tried. Excellent results were obtained by the formula 3 parts antimony potassium tartrah, 60 parts granulated sugar, and 75 parts water, for the destruction of ants.

*Short Courses.*—The "small holders" course in dairying, poultry, and horticulture, along with the minor subjects, apiculture, entomology, and chemistry, which ran from 17th June to 26th July, is considered to have been an unqualified success: 55 students attended, of which number 31 were women. The keenness and attention of students was very noticeable compared with that shown in the same course last year. Most of them were farmers or prospective ones, and their wives and daughters.

The farmers' course opened on the 29th June, the attendance numbering 78 (64 men and 14 women), the large majority being farmers.

---

Keep your *Journals!* The contents will be indexed every six months and a copy of the index sent to each subscriber.

## MEAT STATISTICS.

### I.—RETURN OF BEEF INSPECTED AND PASSED FOR EXPORT, JUNE, 1920.

Place.	Cattle.			Carcasses.		
	Inspected.	Rejected.	Passed.	Inspected.	Rejected.	Passed.
Durban ... ..	3,188	—	3,188	3,188	153½	3,034½
Pietermaritzburg ...	521	—	521	521	16	505
Pretoria ... ..	—	—	—	—	—	—
Johannesburg ... ..	263	—	263	263	—	263
Bloemfontein ... ..	—	—	—	—	—	—
Capetown ... ..	—	—	—	—	—	—
Port Elizabeth ... ..	—	—	—	—	—	—
Germiston ... ..	—	—	—	—	—	—
<b>TOTAL ... ..</b>	<b>3,972</b>	<b>—</b>	<b>3,972</b>	<b>3,972</b>	<b>169½</b>	<b>3,802½</b>

Beef actually exported during the month of June, 1920: Total 1681 quarters. (*Ex* Durban 681 quarters; *Ex* Capetown 1000 quarters.)

Total shipments of Beef in quarters—

1916 ...	115,992	1918 ...	123,354	*1920 ...	36,329
1917 ...	309,214	1919 ...	285,367		

II.—OTHER MEAT EXPORTED\*: Pork, carcasses 263; Bacon 13,323 lb.

### III.—RETURN OF CATTLE IMPORTED INTO THE UNION FROM ADJOINING TERRITORIES.

Territory.	Imported June, 1920.	Total from 1st January, 1920, to 30th June, 1920.
For Slaughter—	No.	No.
Rhodesia ... ..	2,766	12,144
Bechuanaland Protectorate	2,047	10,929
S.-W. Africa ... ..	1,158	6,307
Swaziland ... ..	77	725
Basutoland ... ..	—	—
For Breeding—		
Rhodesia ... ..	1,476	6,651
Bechuanaland Protectorate	1,144	8,910
<b>TOTAL ... ..</b>	<b>8,668</b>	<b>45,666</b>

### SUMMARY OF IMPORTS.

Calendar Year.	For Slaughter.	For Breeding.	Total.
	No.	No.	No.
†1916	26,580	—	26,580
1917	47,970	5,440	53,410
1918	36,767	13,286	50,053
1919	40,574	16,693	57,267

\* Total from 1st January to 30th June, 1920.

† 1st July to 31st December only.

**EXPORT OF GRAIN, ETC.**

RETURN OF GRAIN, ETC., GRADED AND EXPORTED THROUGH THE VARIOUS PORTS DURING THE MONTH OF JUNE, 1920.

NOTE.—In this return the gross weight per bag of Maize is 203 lb., Maize Meal 183 lb., Hominy Chop 183 lb., Kaffir Corn 203 lb., Oats 153 lb., Barley 163 lb., Rye 203 lb., Beans 203 lb., Peas 203 lb., Lucerne Seed 193 lb., Millet (average) 220 lb.

Port.	Grain, etc.	No. of Bags Shipped during June, 1920.	Total No. of Bags Shipped from 1st July, 1919, to 30th June, 1920.	Stocks on Hand on 30th June, 1920.
CAPETOWN .. ..	Maize .. .. .	—	178,954	267
	Maize Meal .. .. .	—	327,349	—
	Hominy Chop .. .. .	—	5,825	—
	Kaffir Corn .. .. .	—	25,550	—
	Oats .. .. .	—	20,328	—
	Barley .. .. .	—	594	—
	Rye .. .. .	—	629	—
	Beans .. .. .	112	2,770	—
	Peas .. .. .	—	—	—
	Lucerne Seed .. .. .	5	4,751	—
Millet .. .. .	—	309	—	
DURBAN .. .. .	Maize .. .. .	—	255,672	—
	Maize Meal .. .. .	—	541,851	—
	Hominy Chop .. .. .	—	—	—
	Kaffir Corn .. .. .	—	6,215	—
	Oats .. .. .	—	3,648	—
	Barley .. .. .	—	—	—
	Rye .. .. .	—	945	—
	Beans .. .. .	—	8,284	—
	Peas .. .. .	—	500	—
	Lucerne Seed .. .. .	—	—	—
Millet .. .. .	672	1,469	—	
EAST LONDON .. .	Maize .. .. .	—	123,400	—
	Maize Meal .. .. .	—	114,298	—
	Hominy Chop .. .. .	—	—	—
	Kaffir Corn .. .. .	—	4,758	—
	Oats .. .. .	—	—	—
	Barley .. .. .	—	2,415	—
	Rye .. .. .	—	1,530	—
	Beans .. .. .	—	420	—
	Peas .. .. .	—	—	—
	Lucerne Seed .. .. .	—	—	—
Millet .. .. .	—	—	—	
PORT ELIZABETH ..	Maize .. .. .	—	160,493	—
	Maize Meal .. .. .	—	14,704	—
	Hominy Chop .. .. .	—	—	—
	Kaffir Corn .. .. .	—	3,587	—
	Oats .. .. .	—	—	—
	Barley .. .. .	—	5,465	—
	Rye .. .. .	—	—	—
	Beans .. .. .	—	450	—
	Peas .. .. .	—	—	—
	Lucerne Seed .. .. .	—	—	—
Millet .. .. .	—	—	—	
LOURENCO MARQUES	Maize .. .. .	—	16,376	—
	Maize Meal .. .. .	—	34,627	—
	Kaffir Corn .. .. .	—	—	—
	Beans .. .. .	—	400	—

SUMMARY.

	Exported June, 1920.	Total Exported 1st July, 1919, to 30th June, 1920.	Stocks on Hand at all Ports on 30th June, 1920.
	Bags.	Bags.	Bags.
Maize .. .. .	—	734,895	267
Maize Meal .. .. .	—	1,032,739	—
Hominy Chop .. .. .	—	5,825	—
Kaffir Corn .. .. .	—	43,110	—
Oats .. .. .	—	23,976	—
Barley .. .. .	—	8,984	—
Rye .. .. .	—	3,104	—
Beans .. .. .	112	12,921	—
Peas .. .. .	—	500	—
Lucerne Seed .. .. .	5	4,754	—
Millet .. .. .	672	1,778	—
<b>TOTALS .. .. .</b>	<b>789</b>	<b>1,871,186</b>	<b>267</b>

## CROP AND LIVE STOCK REPORT.

### June, 1920.

#### FINAL 1919-20 REPORT FOR MAIZE, KAFFIR CORN, AND TOBACCO.

The following statement shows the estimated production of the crops mentioned according to reports received from crop correspondents at the end of June, 1920.

The maize crop is estimated to yield 10,096,600 bags and under normal conditions the Union requires for its own consumption something like 9,500,000 bags. The country has, however, passed through a severe period of drought and it is not unlikely that the consumption of maize may be affected to some extent.

	Estimated Production. 1919-20 Season.		Crop Condition (Normal = 100).			
			Maize.		Kaffir Corn.	
	Maize.	Kaffir Corn.	Above Normal.	Below Normal.	Above Normal.	Below Normal.
	Bags (200 lb.)	Bags (200 lb.)				
<i>Cape Province—</i>						
South Coast ... ..	45,400	2,200	—	38	—	43
Bechuanaland ... ..	103,200	44,000	—	26	—	33
Border ... ..	94,800	9,800	—	34	—	50
North East ... ..	36,800	2,300	—	52	—	70
Transkei ... ..	492,400	61,900	—	37	—	43
Unrepresented districts	52,300	7,800	—	36	—	42
	824,900	128,000	—	36	—	42
<i>Transvaal Province—</i>						
Eastern High Veld ...	1,790,500	40,700	—	24	—	20
Central ... ..	1,253,100	144,900	—	28	—	27
Western High Veld ...	500,900	71,400	—	23	—	26
Low Veld ... ..	743,100	261,300	—	5	—	13
Unrepresented districts	3,600	5,600	—	22	—	20
	4,291,200	523,900	—	22	—	20
<i>Orange Free State—</i>						
North-East ... ..	1,892,600	45,200	—	17	—	27
North-West ... ..	535,400	15,900	—	21	—	22
South-East ... ..	508,500	7,300	—	34	—	44
South-West ... ..	11,600	3,500	—	57	—	60
Unrepresented districts	12,700	300	—	21	—	30
	2,960,800	72,200	—	21	—	30
<i>Natal Province—</i>						
High Veld ... ..	303,300	10,900	—	1	—	9
Middle Veld ... ..	299,300	125,000	—	8	—	7
Coast ... ..	1,411,200	263,500	—	6	—	1
Unrepresented districts	5,900	21,300	—	6	—	3
	2,019,700	420,700	—	6	—	3
<b>UNION ... ..</b>	<b>10,096,600</b>	<b>1,144,800</b>	<b>—</b>	<b>21</b>	<b>—</b>	<b>19</b>

Season 1918-19 ... Maize, 11,561,200; Kaffir Corn, 1,349,800 (Estimated Production).

" 1917-18 ... " 12,640,090; " " 1,801,415 (Production—Census, 1918).



## TOBACCO.

The average return of the Union's tobacco crop for the 1919-20 season is estimated to be 20 per cent. below normal, the total yield being estimated at 8,897,200 lb., viz.:—Cape Province, 3,215,000 lb.; Transvaal, 4,781,200 lb.; Orange Free State, 251,700 lb.; and Natal, 646,300 lb. The 1918-19 season's crop was estimated to be 12,429,000 lb. and that of 1917-18 is given as 14,931,153 lb. by the Census of 1918.

## CONDITION OF LIVE STOCK.

Compiled from Reports furnished by Sheep and Stock Inspectors.

Area.	Large Stock.	Small Stock.
<b>CAPE—</b>		
South-West ... ..	<i>Poor.</i> Medium in parts ...	<i>Poor.</i> Medium in parts.
North-West ... ..	<i>Good to medium.</i> Fat in parts ...	<i>Good to medium.</i> Fat in parts.
South Coast ... ..	<i>Good to medium.</i> Fat in parts ...	<i>Good to medium.</i> Fat in parts.
Southern Karroo ... ..	<i>Medium.</i> Fat in parts ...	<i>Medium.</i> Fat in parts.
Central Karroo... ..	<i>Good.</i> Fat in parts ... ..	<i>Good.</i> Fat in parts.
Northern Karroo ... ..	<i>Fat to good</i> ... ..	<i>Good.</i> Fat in parts.
Eastern Karroo ... ..	<i>Good.</i> Medium in parts ...	<i>Good.</i> Medium in parts.
Bechuanaland ... ..	<i>Fat to good</i> ... ..	<i>Fat to good.</i>
Griqualand West ... ..	<i>Good.</i> Fat in parts ... ..	<i>Medium.</i> Good in parts.
North-Eastern ... ..	<i>Medium.</i> Fat in parts ... ..	<i>Medium.</i> Fat in parts.
Border ... ..	<i>Good to medium.</i> Fat in parts ...	<i>Good to medium.</i> Fat in parts.
Transkeian Territories... ..	<i>Medium.</i> Good in parts ... ..	<i>Medium.</i> Good in parts.
<b>TRANSVAAL—</b>		
Eastern High Veld ... ..	<i>Medium.</i> Good in parts ... ..	<i>Medium.</i> Good in parts.
Central ... ..	<i>Medium.</i> Good in parts ... ..	<i>Good to medium.</i>
Western High Veld ... ..	<i>Good to medium</i> ... ..	<i>Good to medium.</i>
Low Veld ... ..	<i>Good.</i> Fat in parts ... ..	<i>Good.</i> Fat in parts.
<b>ORANGE FREE STATE—</b>		
North-Eastern ... ..	<i>Good to medium.</i> Fat in parts ...	<i>Good to medium.</i> Fat in parts.
North-Western... ..	<i>Good.</i> Fat in parts ... ..	<i>Good.</i> Fat in parts.
South-Eastern ... ..	<i>Good.</i> Fat in parts ... ..	<i>Good.</i> Fat in parts.
South-Western... ..	<i>Good to medium</i> ... ..	<i>Good to medium.</i>
<b>NATAL—</b>		
High Veld or Highlands	<i>Good to medium</i> ... ..	<i>Good to medium.</i>
Middle Veld or Midlands	<i>Good to medium</i> ... ..	<i>Good to medium.</i>
Coast ... ..	<i>Good to medium</i> ... ..	<i>Good to medium.</i>

Read the *Journal*! It acts as a link between you and the Department of Agriculture, which is charged with the furtherance of your interests. It publishes information for the most part of an official nature not otherwise readily accessible. An index will be sent you every six months, so keep the *Journal*. It will prove useful as a book of reference.

# LOCAL MARKET PRICES.

## RATES OF AGRICULTURAL PRODUCE AND STOCK RULING AT THE 15TH JULY, 1920.

CENTRE.	Wheat Per 200 lb.		Wheat Flour Per 100 lb.		Bar. Meal Per 200 lb.		Mealies Per 200 lbs.		Mealie Meal Per 180 lb.		Barley Per 150 lb.		Oats Per 150 lb.		Oat-hay Per 100 lb.		Lucerne Hay Per 100 lb.		Potatoes Per 150 lbs.		
	Min. s. d.	Max. s. d.	Min. s. d.	Max. s. d.	Min. s. d.	Max. s. d.	Min. s. d.	Max. s. d.	Min. s. d.	Max. s. d.	Min. s. d.	Max. s. d.	Min. s. d.	Max. s. d.	Min. s. d.	Max. s. d.	Min. s. d.	Max. s. d.	Min. s. d.	Max. s. d.	
<b>Cape Province—</b>																					
Alwal North.....	27 6	27 6	1 9	1 9	83 6	83 6	0 9	1 4	0 6	0 11	2 3	3 0	3 0	4 0	8 0	19 0	25 0	42 0	25 0	25 0	0
Beaufort West.....	16 0	23 0	0 6	1 0	57 0	88 0	0 9	1 2	0 9	0 11	2 3	3 6	3 6	4 0	15 0	26 0	28 0	45 0	60 0	200 0	0
Capetown.....	18 9	43 0	0 3	1 6	36 0	60 0	0 5	1 0	0 8	1 1	2 8	4 0	4 0	4 6	—	—	—	—	—	—	—
East London.....	21 7	30 0	0 9	1 3	55 0	80 0	0 6	1 3	1 0	1 3	1 10	2 9	2 6	3 0	14 10	19 0	25 0	50 0	—	—	—
Grahamstown.....	9 0	3 0	—	—	42 0	65 0	0 6	0 8	0 5	0 7	2 2	2 8	2 2	2 10	—	—	—	—	—	—	—
Kimberley.....	25 0	28 0	—	—	52 0	74 0	0 6	1 0	0 9	0 11	2 4	3 1	3 0	4 0	—	—	—	—	—	—	—
Kingwilliams-town	22 6	35 0	0 5	0 6	—	—	0 6	0 11	0 4	0 10	2 6	2 7	3 0	3 7	17 0	17 15	35 0	48 0	30 0	115 0	0
Port Elizabeth.....	—	—	—	—	—	—	—	—	—	—	—	—	—	—	—	—	—	—	—	—	—
Queenstown.....	—	—	—	—	—	—	—	—	—	—	—	—	—	—	—	—	—	—	—	—	—
<b>Natal—</b>																					
Durban.....	15 0	30 0	—	—	30 0	65 0	0 4	0 10	0 5	1 1	2 3	3 3	2 8	4 6	—	—	—	—	—	—	—
Pietermaritzburg.....	—	—	—	—	—	—	0 7	0 10	0 9	1 0	2 6	3 0	2 3	3 0	—	—	—	—	—	—	—
<b>Orange Free State—</b>																					
Bloemfontein.....	18 6	24 6	0 6	1 0	35 0	40 6	0 10	1 3	1 0	1 3	2 6	2 9	3 9	4 3	18 0	30 0	35 0	42 6	40 11	1 0	0
Harrismith.....	—	—	—	—	—	—	0 8	1 0	1 0	1 3	2 0	3 1	1 6	3 0	11 0	18 0	25 0	50 0	40 0	90 0	0
<b>Transvaal—</b>																					
Pretoria.....	25 0	30 0	—	—	26 0	42 0	4 2d.	7 5d.	0 9	1 3	2 6	2 6	2 1	3 3	3 10	32 10	33 6	57 6	40 5	0 10	0
Johannesburg.....	24 0	26 6	0 3	0 3	28 0	60 0	4 1d.	5 5 6	0 11	1 2	1 9	2 6	2 9	3 0	9 10	22 0	15 0	45 0	40 2	1 1	0

\* Live weight per lb. † Dressed weight, including hides, offal, etc. per 100 lb.  
 NOTE.—The rates quoted for produce sold in bags include, as a general rule, an additional 3 lb. for weight of bag.

PRICE 5/-  
PER ANNUM.



**Journal**  
of the  
Department of  
**Agriculture**  
ISSUED BY AUTHORITY OF THE  
MINISTER OF AGRICULTURE.

PRINCIPAL CONTENTS.

Karakul Sheep.

A Leaf Spot of the Pea-Nut or Monkey-Nut Plant.

Farming in the Early Cape Days.

The Dipping of Sheep in so-called Carbolic Dips.

Canning Clubs.

"Kudzu."

Grafted Vineyards.

South African Fibre Plants—Ambari or Deccan Hemp.

The Department of Agriculture during the War—V.

PRICE **6D** PER COPY

## DEPARTMENT OF AGRICULTURE.

## CHEMICAL ANALYSES OF AGRICULTURAL MATERIALS.

## Regulations and Tariff.

It is hereby notified for general information that **BONA FIDE FARMERS** may, until further notice, obtain analytical determination in accordance with the subjoined tariff of charges at the chemical laboratories of the Department of Agriculture. Samples taken within the areas defined below should be addressed as indicated hereunder :—

- (a) The coastal districts from Namaqualand to Knysna and extending inland to Ceres, Worcester, and Montagu : Principal, School of Agriculture, Elsenburg, Mulder's Vlei, Cape Province.
- (b) Transvaal, British Bechuanaland, Griqualand West : Principal, School of Agriculture, Potchefstroom, Transvaal.
- (c) Natal and Griqualand East : Principal, School of Agriculture, Cedara, Natal.
- (d) Remaining portion of Cape Province, i.e. portion south of Orange River (excluding Elsenburg area and Griqualand East) : Principal, School of Agriculture, Grootfontein, Middelburg, Cape.
- (e) Orange Free State : Principal, School of Agriculture, Glen, Orange Free State.

Samples may also be sent to the Chemist, Department of Agriculture, Pretoria. The Inquiry Officer in Capetown and the office of the Senior Veterinary Surgeon, Pietermaritzburg, will also receive samples for forwarding to Elsenburg and Cedara respectively.

The officers named should be advised of the dispatch of samples.

The conditions under which samples will be received are as follows :—

1. **In no case will a sample be accepted for analysis unless the full instructions as to taking it, which will be furnished by the Department on request, have been complied with, and all the particulars required concerning the sample supplied.**
2. The right is reserved of refusing such samples as may not be considered of sufficient public importance to warrant analysis.
3. **No sample will be accepted unless plainly labelled inside and outside the package with the name and address of the sender.**
4. Reports upon or results of analyses may only be used by the persons submitting the samples for private purposes.
5. The Department reserves the right to publish the results of analyses performed by it.
6. In case the examination of any article should prove to furnish, or be considered likely to furnish, results of sufficient general interest, it will be in the discretion of the Department to forego any of the charges in the subjoined tariff.
7. **Postage on carriage must be prepaid by the sender, who must also send remittance covering cost of analysis.**

[Continued on page iii of cover.]

# CONTENTS.

SEPTEMBER, 1920.

	PAGE
KARAKUL SHEEP ... ..	509
A LEAF SPOT OF THE PEA-NUT OR MONKEY-NUT PLANT ... ..	524
FARMING IN THE EARLY CAPE DAYS ... ..	531
THE DIPPING OF SHEEP IN SO-CALLED CARBOLIC DIPS ... ..	536
CANNING CLUBS ... ..	548
THE DEPARTMENT OF AGRICULTURE DURING THE WAR ... ..	551
"KUDZU" ( <i>Pueraria Thunbergiana</i> ) ... ..	578
GRAFTED VINEYARDS ... ..	561
SOUTH AFRICAN FIBRE PLANTS—AMBARI OR DECCAN HEMP ... ..	570
NOTES ... ..	581
<p>Index for the <i>Journal</i>: Railway Transport: Hints to Consignors—Prospects of Cereal Crops and of Supply—Productive Wealth of the Union—Western Province Fruit Crop—Fighting a Notorious Pest (page 527)—Employees on Farms (page 530)—Naphthalene for Fowl Lice (page 557)—Grain-eating Bees: A Poison (page 569)—South African Produce on Show (page 569)—Rhodesian Cattle and Maize (page 580)—Fruit Export, July, 1920: A Record Shipment (page 585)—Cotton Gins (page 588)—Export of Grain, etc. (page 589)—Plant Nurseries in Quarantine (page 590)—Sale of Cattle in Southern Rhodesia (page 596)—Cost of Production of Maize (page 600).</p>	
THE POULTRY YARD MONTH BY MONTH ... ..	585
THE VEGETABLE GARDEN ... ..	586
NOTES FROM THE "GAZETTE" ... ..	587
SOUTH AFRICAN PRODUCE ON THE OVERSEA MARKET ... ..	589
OVERSEA PRICES OF SOUTH AFRICAN PRODUCE ... ..	590
NOTES FROM THE DIVISIONS ... ..	591
CORRIGENDA ... ..	591
STAFF: APPOINTMENTS, TRANSFERS, ETC. ... ..	592
RECENT AGRICULTURAL LITERATURE... ..	593
AT THE SCHOOLS OF AGRICULTURE AND EXPERIMENT STATIONS ... ..	597
MEAT STATISTICS ... ..	601
CROP AND LIVE STOCK REPORT ... ..	602
LOCAL MARKET PRICES ... ..	604

## **DEPARTMENTAL NOTICES.**

### **AGRICULTURAL DEPARTMENT.**

#### **STALLIONS AT STUD.**

Horse and Donkey Stallions will stand at stud at the various schools of agriculture from 15th August, 1920, to 15th January, 1921.

Fees: £2 service of each mare. Grazing and feeding extra.

For further particulars apply to the respective Principals of the Institutions referred to, viz.:—Elsenburg, Mulder's Vlei, C.P.; Grootfontein, Middelburg, C.P.; Glen, O.F.S.; Potchefstroom, Transvaal; Cedara, Natal.

#### **SPINELESS CACTUS.**

A number of leaves of spineless cactus are available for disposal from the Schools of Agriculture at the undermentioned tariff. Applications should be made to the Principal. The minimum quantity supplied to any one purchaser is 10 leaves.

3d. per leaf from 10 to 100 leaves.

2½d. per leaf from 100 to 500 leaves.

2d. per leaf over 500 leaves.

#### **FREE ISSUE OF SEED.**

On application to the Principal, School of Agriculture, Potchefstroom, small lots of the following varieties of seed will be distributed free to farmers on a co-operative experimental basis:—

Cowpeas ("Taylor," "New Era"); Millets ("Golden," "Japanese"); Soya Beans ("Hollybrook," "Black"); Buckwheat; Australian Salt Bush ("Old Man"); Napier Fodder Roots; and Sugar Cane Roots.

### **FOREST DEPARTMENT.**

#### **TIMBER.**

Straight gum poles of various sizes from about six inches in diameter at the butt downwards may be purchased in small or large quantities from the Government Plantation, Cedara, Natal. Inquiries stating size of pole desired (length and smallest diameter under bark at the thin end) should be addressed to the Forester, Cedara, who will quote prices per pole put on rail at Cedara Station.

Firewood, fencing droppers, and fence posts are also available.

### **LANDS DEPARTMENT.**

#### **LAND FOR SETTLERS.**

All inquiries regarding settlement on Crown lands should be addressed to the Secretary for Lands, Union Buildings, Pretoria. Inquiries may, however, also be made at the Land Department, Branch Office, New Law Courts, Queen Victoria Street, Capetown, regarding land in the Cape Province, and at the Branch Office, Surveyor-General's Office, Pietermaritzburg, in so far as land in Natal is concerned. Inquiries regarding land in the South-West Protectorate should be addressed to the Secretary for Lands, Windhuk.

The Department of Lands, Pretoria, issues a booklet, "Land for Settlers" (June, 1920), gratis on application, which contains information regarding the main points of the Settlement Acts and other matters which every intending settler should know. The Department maintains a staff to deal with inquiries and applications for lands, and prospective settlers are advised to communicate direct with the Department.



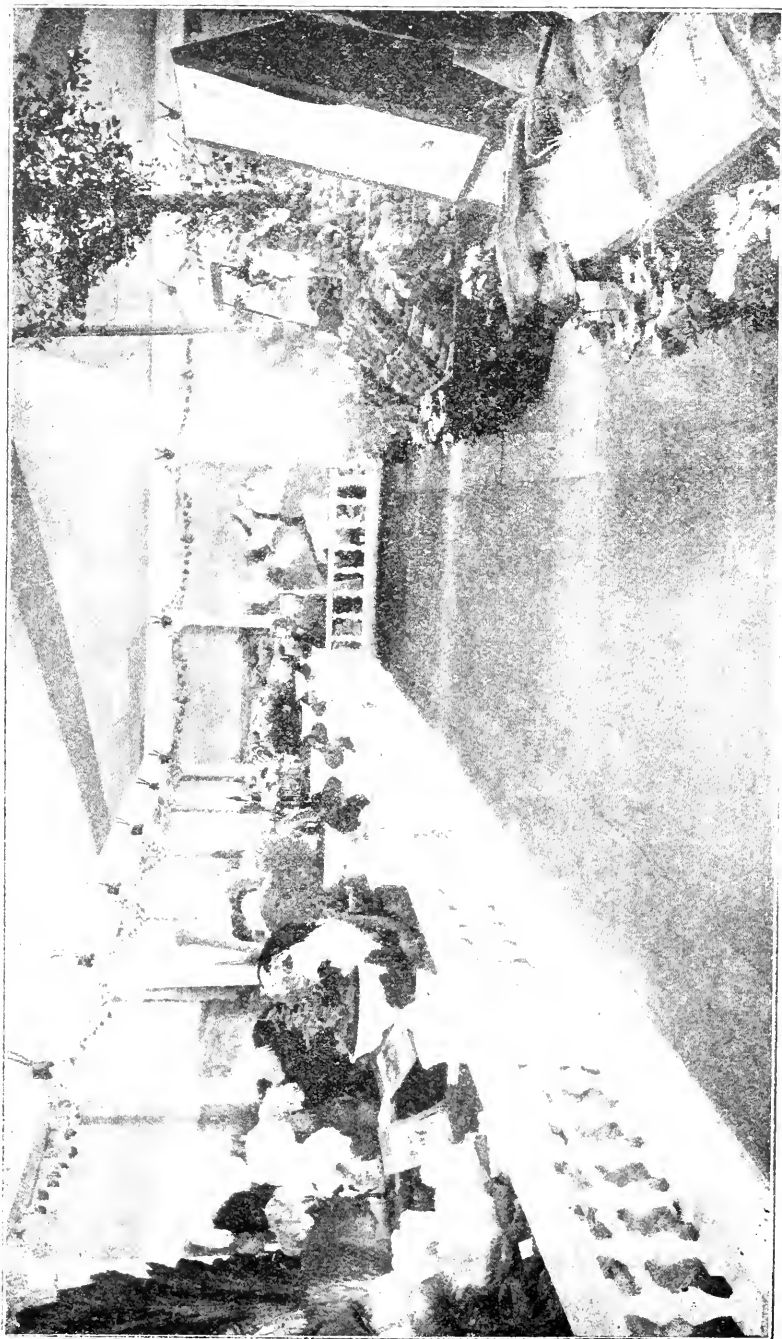

**SOUTH AFRICAN PRODUCE ON SHOW.**

A section of the Union Government's splendid exhibit at the 1920 Royal Agricultural Show, Darlington, England.

(See Note on page 549.)





# JOURNAL OF THE DEPARTMENT OF AGRICULTURE.

VOL. I.

SEPTEMBER, 1920.

No. 6.

Published monthly in English and Afrikaans by the Department of Agriculture,  
Union of South Africa.

SUBSCRIPTION: Within the Union and South-West Protectorate, **5s.** (otherwise **6s.**)  
per annum, post free, payable in advance.

Applications, with subscriptions, to be sent to the Government  
Printer, Box 373, Pretoria.

---

## KARAKUL SHEEP.

By R. OWEN WAHL, B.A. (HONS.), Lecturer in Zoology and  
Entomology, Grootfontein School of Agriculture, Middelburg  
(Cape), Officer in Charge of Karakul Sheep Investigations.  
(In consultation with A. D. Thompson, Manager, Karakul  
Stud Farm, South-West Protectorate.)

### I.

#### ORIGIN.

KARAKUL sheep produce the lambskins known to commerce chiefly as "Persian Lamb," from which various furs, such as astrakhan, broad tail, karakul, etc., are made. They are eastern sheep, their home being the arid region of Western Russian Turkestan, which includes the Kizil-Kum and Kara-Kum deserts and the Khanates of Bokhara and Khiva, districts situated east of the Caspian Sea and north of Afghanistan.

The word karakul means in Sarr "black lake," and refers to the lake and town of that name in Bokhara which is an important centre in the lamb-fur and sheepskin industry, and this name has been used by the European Russians to indicate the fur-producing sheep of those regions. In Central Asia, however, this term is not used, the names for the sheep being Arabi, Duzbai, and Shiraz.

Considerable difference of opinion exists as to the origin of these sheep, those who claim to be authorities on the subject differing

considerably among themselves in points of detail. Dr. C. C. Yeung, of America, maintains that all karakul sheep are descended from the black danadar, a long-tailed sheep, and the original fur-bearing stock of Central Asia. These danadars, crossed with fat-rumped sheep, give rise to the fat-tailed karakul of to-day. As the question is not one which concerns us in this article, nothing further need be said on the subject, except that, as indicated above, the karakul was originally a "made" sheep, i.e. brought into existence by crossing existing breeds.

#### CONDITIONS IN BOKHARA.

The desert regions in the native home of these sheep are "exceedingly barren, and consist of sand-dunes and saline steppes which support a thorny shrub (*Haloxylon ammodendron*, Bungl), and where there is no drifting sand and the soil is clayey in nature, a little grass in spring. During the summer it is very hot and there is very little rain, while in winter the temperature falls below zero. Under such trying climatic extremes it is little wonder that the karakul sheep have earned the reputation of being perhaps the hardiest of all domesticated animals." Duststorms in summer and snowstorms in winter are frequent, and, altogether, the conditions are such as would require an animal of exceptional hardiness to exist under them. In some respects the conditions which pertain in the Karroo and other areas of the Union and of South-West Africa are not greatly unlike those of their native land.

#### THE KARAKUL SHEEP INDUSTRY IN BOKHARA.

\* "The karakul sheep industry centres in the foothills of the mountains that form the southern boundary of Bokhara, the cultivated land in the valleys being utilized for gardens and orchards. The flocks are driven in the autumn, when the first snow falls, from their summer quarters on the high plateaux into the 'kishlaks' of the valleys. They are kept there until the lambing season is past, and in early spring they are driven back to the higher desert grazings which are unsuited to cultivation. The sheep are always kept in the open, and during winter more or less protected from the cold winds in the hollow of the mountains, and live mostly on dry stalks kept clear of snow by the wind.

"The lambing season is regulated by tying rags round the belly of the ram, and is timed for the best part of the year, when food is most plentiful. The lambs are weaned in midsummer, but the ewes are kept in milk until the late autumn, and a cheese, described as the 'pride of Southern Asiatic Russia' is made from it. The natives of Bokhara claim that the milk from karakul sheep is the richest and the most nourishing obtained from any living animal. It is also supposed to have properties which tend to cure tuberculosis.

† "Good fur-producing karakuls are found only in very limited numbers and on certain ranches owned by Bokhara noblemen, who.

\* Prof. R. Wallace in "Transactions of the Third International Congress of Tropical Agriculture."

† Quoted from an article on karakul sheep by Prof. Robert Wallace in "Transactions of the Third International Congress of Tropical Agriculture."

however, do not even make an attempt to prevent in-breeding or to secure the elimination from the breeding stock of Afghan blood, which is indicated by the fine downy wool underneath the hairy fleeces. The result is that good sheep and good lamb-furs are steadily decreasing in numbers and are believed to be within measurable distance of extinction."

#### IMPORTATIONS INTO OTHER COUNTRIES.

The ever-increasing demand for furs, and the ever-decreasing supply of furs owing to the destruction of fur-bearing animals, has led to the importation of karakul sheep into various countries. Through the efforts of Dr. Sinitzen, the Russian authority on these sheep, they were introduced into the Crimea, where they have done well. In 1902 Paul Thorer, the senior partner of one of the largest fur merchant houses in Leipzig, visited Bokhara, and on his return interested the King of Saxony and originated the idea of trying them in the German Colonies. This idea was taken up by the late Director of the Agricultural Institute at Halle, Professor Kuhn, who, in 1903, secured 4 rams and 26 ewes of what were believed to be pure karakuls from Bokhara. These sheep apparently did not do very well, and there is reason to fear that their selection had not been made with sufficient care to exclude the fine underwool so fatal to the production of high-class fur, for, in 1912, Dr. C. C. Young reported that "he examined 60 ewes descended from Thorer's flock and found only three of them devoid of the fatal down-like underwool." Professor Kuhn's flock was, it is said, purchased in 1910 by a Mr. Max Teinert, of South-West Africa. They do not appear to have thrived there either, as, when the author visited this gentleman's flock in 1917, there were not more than thirty pure-bred karakuls alive.

An attempt to establish these sheep in the Trans-Caspian district of Russia by the Agricultural Department of that country has also been a failure, owing to the wrong class of sheep being selected, and Dr. Young, after examining 1500 of these so-called karakuls, reports that he "did not find one fur-producing sheep, all being Arabi-Afghans," that is, having the fine woolled Afghan sheep blood in them.

The same wrong type seems to have been introduced in 1909 into Roumania. Before the European war karakul fur-breeding was reported to be a growing and successful industry in Austria, and in 1911 the Emperor of Austria presented the then President of the Argentine Republic with a flock of 20 karakul sheep. The result of this importation is unknown to us at present.

A much more important importation was made by Dr. C. C. Young, of the United States of America. In 1908 he imported 15 pure-bred karakuls (10 ewes and 5 rams), and in 1914 he succeeded, in spite of the existing prohibition against foreigners entering the country, in obtaining another specially selected flock of about the same size. It is understood that Dr. Young claims to have the best karakuls that ever left Bokhara.

One or two rams have also been obtained by Professor Wallace, of the University of Edinburgh, and are being used for experiments in crossing with various British breeds.

## INTRODUCTION INTO SOUTH AFRICA.

In February, 1907, a sheep breeder of Berlin drew the attention of the German Imperial Government to karakul sheep, and urged that these sheep should be given a trial in South-West Africa, as, in the opinion of others, including Professor Kuhn, of Halle, these sheep were of great value on account of the lambs' pelts, and that they required a dry country with dry grazing. The German Imperial Government decided to try the experiment: 22 Rams and 252 ewes were accordingly shipped to South-West Africa, and arrived at Swakopmund in February, 1909. These sheep were, according to the German records, and also to Professor Robert Wallace, of Edinburgh, "*selected with the greatest care in Bokhara from the best flocks in the country.*" It speaks well for the hardiness of the sheep that in the long journey by road and rail from Bokhara to Germany only one sheep died. On their arrival in South Africa they were sent to the Government farm Fürstenwalde, where, unfortunately, many died within a few months, chiefly from pneumonic and parasitic diseases, and in 1912 the flock consisted of 42 rams and 182 ewes, while some 82 sheep had been sold to farmers. In 1913 a further small importation was made, the sheep coming from Halle, and in 1914, a few months before war was declared, a large number of ewes were imported from Bokhara via Russia. It is worthy of mention that many of the best of the old ewes at present in the Government flocks are of this second Russian importation.

When the country was surrendered to the Union troops the pure-bred flock consisted of 80 rams and 360 ewes.

In 1916 this flock was moved to the Government farm Otjituesu, near Windhuk, and placed in the charge of Mr. Thompson, and there they have remained to date.

In 1916 also, the Minister of Agriculture agreed to allow the importation of part of this flock into the Union, and 3 rams and 84 ewes were transferred to the Grootfontein School of Agriculture, Middelburg (Cape). In 1917, 25 ewes, carefully selected by the writer, who had been put in charge of the investigations into the breeding of these sheep, were added to the flock, and since that date a few rams have also been transferred there. The Karroo conditions suited the sheep excellently, and, in spite of the recent years of drought and the sale of about 130 young rams and 75 ewes, the flock at Grootfontein numbers 150 ewes, exclusive of lambs, and 10 rams.

## II.

## DESCRIPTION.

*Conformation.* The karakul is essentially a hairy, fat-tailed sheep, not very unlike the africaander in conformation, although larger. The rams are usually horned, although hornless specimens are by no means uncommon, while the ewes are usually hornless, horned specimens being decidedly uncommon. The *head* is rather long and somewhat narrow, the nose markedly roman, especially in the rams, and tapering rather abruptly towards the muzzle. The nostrils are narrow and slit-like, with their lips folded in. This is probably a provision of nature to guard against the driving sand of their native country, and is a characteristic which can with advantage

be bred out in favour of wider nostrils. The head should be wide above the eyes and the bridge of the nose broad, bold and strongly arched transversely. Plate I, the ram "Edward," of the Grootfontein stud, shows a karakul of good appearance. The *ears* vary considerably in size, some sheep having practically no external ears, while in others they are large and drooping. This variation in the size of the ears is due to the fact that among the originally imported ewes some, said to belong to the "Arabi" strain of karakuls, possessed these short ears, and also one of the rams. As it was previously mentioned that "Arabi-Afghans" were useless as fur-breeding sheep, let it be clearly understood that the short-eared "Arabis" just mentioned are not "Arabi-Afghans," but high-class fur-producing karakuls; in fact, the ram referred to has, to date, proved the best sire of tight-curled lustrous lambs we have. He is the ram "Jacob" mentioned again later. The best breeding ewe at Grootfontein also has small pointed ears. The *crest* of the head should have hairy covering, the woolly crest so often seen being undesirable. The *head and face* is always covered with short black hair, which should be soft and lustrous. Often a grey-tipped nose occurs and a grey lower lip, but further no white should appear on the head or face except a white crest or white patches at the points from which the horns should spring. The *teeth* are large and strong, being rather superior to those of the merino, some of the ewes both in the South-West Protectorate Administration and in the Union Government flocks over ten years of age still having good teeth. The *chest* is only fairly deep and broad, and the heart girth is not large in comparison to that of a well-built merino; the ribs are often not well sprung, while the wither is high and inclined to be sharp. These features, combined with the drooping rump, due to the heavy tail, give the sheep an appearance of ugliness in the eyes of those used to merinos, but for all its apparent lack of constitution the karakul is the hardiest of hardy sheep; in fact, it has been stated that they are the hardiest of all domesticated animals. The best type of *tail* is broad U-shaped, and flat at the base, rather short and tapering abruptly to a characteristic twisted tip which starts to grow upward and then falls over and hangs down in a line more or less that of its central axis. Another type of tail, which is often seen, is much larger and tapers more gradually to the characteristic tip, while a bad type tapers gradually from its base and is without the curved tip at its end. The first type of tail mentioned is preferred to the others, as it is more shapely and does not drag the rump down to the same extent as the second type. In ewe lambs the tail is usually amputated at an early age, as its removal facilitates the process of mating. Tailless ewes have a much more pleasing appearance when grown, as the rump is much less drooping. (Process of tailing is described later.) The *legs* are rather long and have clean, hard, smooth bone. They are covered with soft, short, black, lustrous hair like the face. The hoofs are large, deep, hard, and black.

*Covering.*—The fleece should be of clean hair, free from soft woolly matter, and opening freely to the skin. This freeness from wool is a most important point in sheep about three years of age. The presence of wool in the lamb pelt spoils it for fur purposes, and consequently woolly parents are to be avoided. As the sheep grow older the majority of them become more and more woolly, until

very little of the true hairy covering is left. Some, however, remain free from this woolly undergrowth all their lives, and these are considered of special value. (The woolliness in the fleece will be further discussed later on.)

The quality of the hair is of great importance, as our investigations have shown more and more that, to produce lamb pelts having the desired lustre which gives the fur its extraordinary beauty and its value, the right quality of hair is essential in the parents. The quality may be soft, medium, or strong, but it must be kindly to the touch and have a lustre indicating an abundance of life in the hair. Harshness, almost always accompanied by fuzziness, is most undesirable.

On opening the fleece of a good karakul it will be noticed that there is a distinct *crimp* in the hair near the skin. This crimp is not at all like that found in wool, being infinitely larger and confined to that half of the staple nearest the animal's body. Its presence is a most desirable feature if it is of the right kind. Good crimp should be well defined, should commence close to the skin, should lie parallel with the surface of the body, and should give place to a wave at about half the length of the hair. A fleece having crimp of this nature opens freely to the skin. If the crimp lies at an angle with the body surface it is bad, and although there may be a great deal of it it is an indication in most cases that the animal at birth had a most undesirable type of curl. Crimp of this kind causes a matted fleece, difficult to open cleanly to the skin.

It is, of course, most desirable to have the crimp occurring evenly over the whole body, but this is very rarely the case. The best crimp is found on the shoulder and leg and the worst occurs on the ribs.

The *length* of the staple should be about 8 inches for twelve months' growth, while its *density*, which is correlated with type of curl and quality of hair, is poor as compared with the pure-bred woolled Persian. The covering of the tail and belly should be as similar to that of the body as possible.

*The External Appearance of the Fleece.*—Let it be emphasized at the commencement of these remarks that what follows is what the writer knows to be correct, but that there is much to learn with regard to the appearance of the fleeces of good and of bad sheep. The subject is one of considerable difficulty, and until more specially marked lambs attain to maturity we are not in a position to say in all cases by the appearance of the adult fleece what the sheep was like as a lamb, or, conversely, what sort of an adult fleece any particular lamb will have. Lambs of "A" type when matured sheep have a fleece of an even external appearance (see Plate 2A). There may be a distinct wave in the covering, but the hair is never twisted into locks like those seen in a well-bred Angora goat. Often beautifully curled lambs grow up to have perfectly plain fleeces externally, and especially is this the case when they are strong-haired as adults. Any sheep having a fleece really curly in appearance must be looked upon with suspicion, and if the hair is, in addition, fuzzy and harsh and shows much curl, the sheep is best culled. A curly,

\* For explanation of "A" and "B" types, see "Lambs: their pelts, etc."

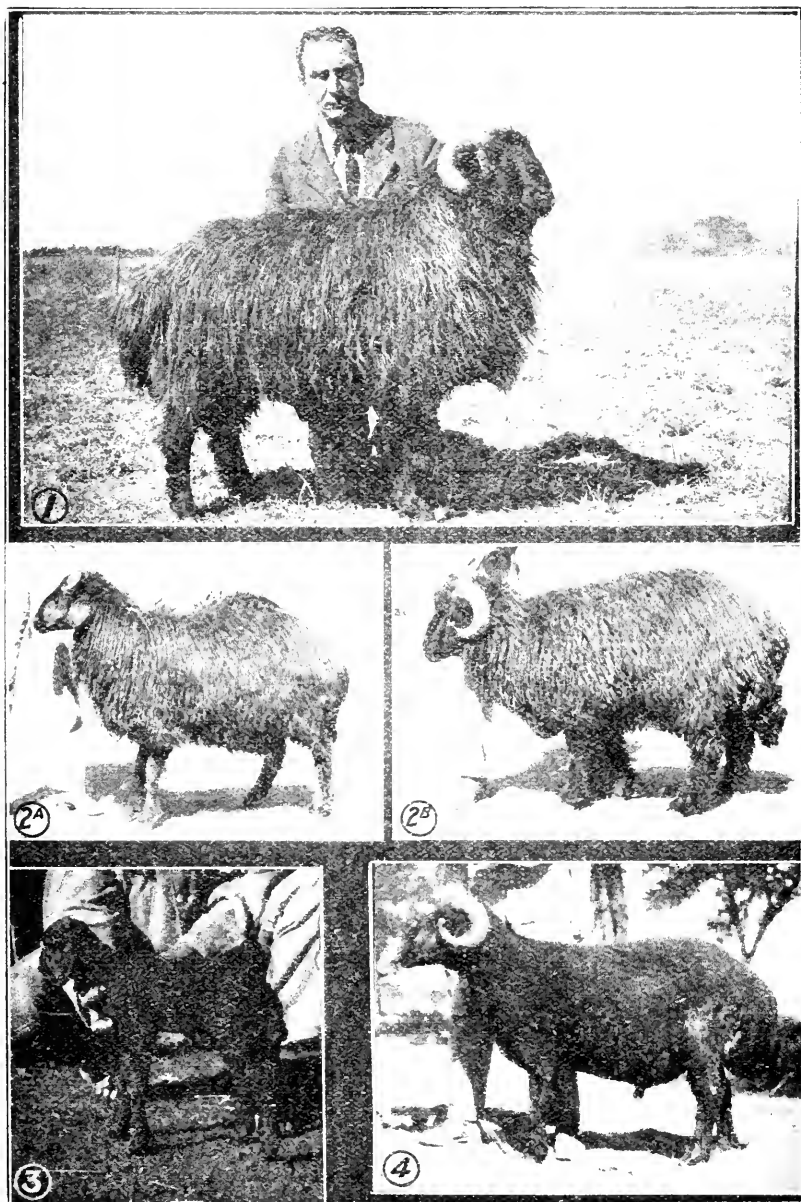

PLATE 1.—Typical Karakul Ram. Grootfontein Stud Ram "Edward." (Photo by N. H. Shaw.) PLATE 2A.—Yearling Ram of "A" type, with smooth external appearance of Fleece. (Photo by Author.) PLATE 2B.—Yearling Ram of "B" type, with curly and fuzzy external appearance of Fleece. (Photo by Author.) PLATE E 3.—Karakul Lamb, with good "Pipe" curl. (Photo by A. D. Thompson.) PLATE E 4.—Stud Ram "Jacob," with woolly Fleece due to age. (Photo by Author.)

fuzzy appearance of fleece (see Plate 2b) indicates that the sheep as a lamb had a "nigger" pelt (see Plate 7) or was, anyhow, of the "B" type (see Lambs: their pelts, etc.). Even if the external appearance of the fleece is plain, but the hair itself is of a harsh quality, the sheep was as a lamb of the undesirable "B" type. Such a fleece if opened would show strong crimp standing out at all angles from the body surface. Again, some sheep having an external superficial appearance of fleece much like that just described as resulting from lambs with "nigger" pelts, prove on handling to have good quality hair. Such sheep probably had as lambs a type of curl known as "walnut," and as this is a most desirable type of curl they are thus valuable sheep. We, however, require to know much more about this most important feature of these sheep.

The colour of the fleece varies considerably. On the new-born lamb it is a jet black, and continues so until it is first shorn, when the lamb is six months of age. The next fleece grown usually shows some grey hairs mixed with the black, which still predominates, though it often bleaches reddish-brown. After the age of twelve months is reached, there is an increase in the greyness of the covering, and when the sheep is from two and a half to three years old it has a fleece of the colour it will keep until it ages, when it again becomes brownish, due often, as mentioned above, to the presence of wool. Often the colour of the adult is so grey that the sheep appear white at a short distance, and, if this is due to hair and not to wool, it is not undesirable. While no colour is bad if the fleece has the desirable qualities indicated above, a bright blue-grey is preferred.

*The Presence of Wool.*—It was mentioned above that the presence of wool in the fleece was most undesirable, and it is felt that something more should be said about this most important factor. Experiments in crossing with wool sheep, such as the merino or high grades of woiled Persians, prove that even when a fair amount of curl is obtained the appearance of woolliness spoils the pelts for furs. This wool persists in the higher grades, and any person grading up a flock for pelt breeding should be most careful to avoid wool in any form. The total absence of wool in pure-bred stock is also greatly to be desired, and, as stated before, sheep which remain free from wool all their lives can rightly be considered of exceptional value. Most of the karakuls in South Africa, however, develop some woolliness with age, and yet produce lambs having the highest lustre and the most desirable type of curl. Even lambs which left nothing to be desired in lustre and but little in curl at birth often show an appreciable amount of wool after twelve months of age. As an instance, mention can be made of a ram lamb bred in the South-West Protectorate from an old ram "Jacob" imported with the first consignment in 1909. This sheep is, to date, the best lamb we have bred, having splendid "pipe" curl and lustre (see Plate 3). He is now decidedly woolly on his head. "Jacob" himself is a very old ram, being at least twelve years of age, and has now a fleece practically all wool (see Plate 4), although what hair he has shows that in his youth he must have had a splendid covering. He is, however, the best sire in South Africa for getting good curl pelts, and eight of his sons are or have been at stud on the two Government farms, while a grandson is shortly to be added to the Grootfontein stud. From many instances similar to the above it would appear that in many



karakuls the wool makes its appearance after the animal is beyond the age when its pelt is of value for the purpose of making furs, and is consequently of no account in breeding fur pelts. Many lambs do, however, show woolliness in their lamb covering, and as the wool present in the former cases may, for all we know, express itself earlier in the animal's life at any time, the best rule to follow is to avoid wool of any form in a karakul of any age.

It is sometimes difficult to find wool on a good karakul without the aid of a microscope. If any breeder thinks he has such an animal let him look carefully behind the head, round the bases of the ears, on the belly, and round the base of the tail. If he finds no woolly substance there, he can be satisfied that he has in his possession a most valuable sheep.

In judging the woolliness of the average karakul, however, allowance must be made for age. Almost invariably some hair will be found on the rump and upper leg, which will indicate what the fleece was like when the animal was at its best.

The value of the fleece is dealt with under the heading of "Management." The covering of the lambs is quite different from that of the adult, being jet black, lustrous, and curly.

### III.

#### LAMBS: THEIR PELTS AND THEIR CLASSIFICATION.

As karakul sheep are bred chiefly as fur-bearing animals, and as their value in that direction lies in the pelt of the young lamb, the greatest attention should be given to the study of the lambs when the pelts are at their best. This is when the lambs are from 3-4 days old, when the most desirable pelts should be jet black and exceedingly glossy. The quality of the hair should be kindly to the touch and fairly soft, and the tips of the individual hairs should be so curled so as to be tucked away out of sight, thus giving the pelt a smooth appearance. If these tips are not so hidden the pelt has a ragged appearance, which detracts greatly from its value as a fur. The curls should be tight, and much of the value depends upon the irregular arrangement of the curls all over the body. The most desirable kind of curl is that known as the *pipe* or caterpillar. Here the curls are caterpillar-shaped, about the thickness of an ordinary lead pencil in diameter, and of various lengths. Such curl is seen on the lambs in Plates 3 and 5. In classing young lambs with pipe-curl careful note is made whether the curl is heavy, medium, or light, depending upon the diameter of the pipe. These pipes vary considerably in length and may run in any direction, often forming most artistic designs. Another very desirable kind of curl is that to which the name *walnut* has been given. This curl is difficult to describe. It resembles the edible portions of a walnut which has been broken in half, and appears to be formed by the hair growing out in all directions from given points.

This curl rarely, if ever, appears over the whole surface of the body, being usually associated with pipe curls. A third valuable kind of pelt is that known as the "*watered silk*," in which clearly defined curls seldom occur, most of the pelt being covered with hair thrown into strong, firm, irregular corrugations. The highest lustre is found on skins of this type, which is indeed the nearest approach to the

“broad tail” or premature skins so highly prized by furriers. The corrugations and smooth, partially developed curls give an appearance of “shot” or “watered” silk to the pelt. Imitations of this type of fur are very numerous; in fact, most of the so-called astrakhan fur coats worn are imitations of these pelts (see Plate 6). Undesirable pelts all carry hair of quite a different quality and gloss to that just described. The quality is much harsher, and even if the curl is good the lustre is very inferior. Good quality of hair always gives a blue-black lustre like that seen on a black horse still wet from being washed, while bad quality hair gives a reddish-black lustre, or is dull. As lustre cannot be imparted to the fur by any artificial means, the value of the pelt depends largely upon it.

The most undesirable curl is that known as the “nigger” (see Plate 7). Here the curls are found like those on the head of a kaffir. The tips of the hairs are always exposed, giving the pelt a ragged, fuzzy appearance, and the lustre is very poor. Finally there is a curl which occurs in both the qualities of hair mentioned above. This curl is known as the “corkscrew” (Plate 8), and is much like that instrument in appearance if one imagines it compressed from above downwards. This curl has also been likened to a burr-clover seed-pod, and that term was used in the description of the 1916 lambs at Grootfontein. It has now been discarded for the term corkscrew. As the result of observations extending over four years the following classification of lambs, according to their pelts, has been evolved. Lambs having the quality of hair described as occurring in desirable pelts are classified as belonging to the *Type “A,”* and are then divided into classes, A1, A2, A3, and A4, depending upon the tightness of the curl, its evenness of distribution over the body of the lamb, the lustre of the pelt, and its freedom from raggedness. “Watered silk” lambs are classed as above, but the letters “Ws” are added to indicate their nature. *Type “B”* includes all lambs with the wrong quality of hair described under “undesirable pelts.” This quality of hair is always accompanied by a peculiar reddish lustre or by dullness. Classes B1, B2, B3, B4 are recognized as in A, for it is quite possible for a lamb of this type to have very definite pipe or walnut curls; in fact, the tightest-curved lambs got usually belong to this type, but the quality of the hair is undesirable, and the lustre is poor, and the pelts are consequently of much less value as furs.

Up to the present it has been customary in the South-West Protectorate flock to use type C and even D.

*Type C* is used for lambs having pelts in which the predominating curl is corkscrew, but as many of these lambs have hair of the A quality and others of B quality, it would seem that this type C might well be done away with, and the presence of the corkscrew curl indicated by the adding of the letters “Cs” to the letter indicating the type in which the corkscrew appears, thus 3ACs would indicate that the corkscrew is present but that the hair was of the A type. After all, A and B types refer to *quality* of hair and *lustre* and not to curl, and the corkscrew is only a kind of curl and often the result of mating two good sheep of A type, when, if the resulting lamb is too long-haired it either has very open curls, or, if much curl is present, it takes the form of a corkscrew.

*Type D* has also occasionally been used in the South-West Protectorate classifications, but no good purpose can be served by retaining it.

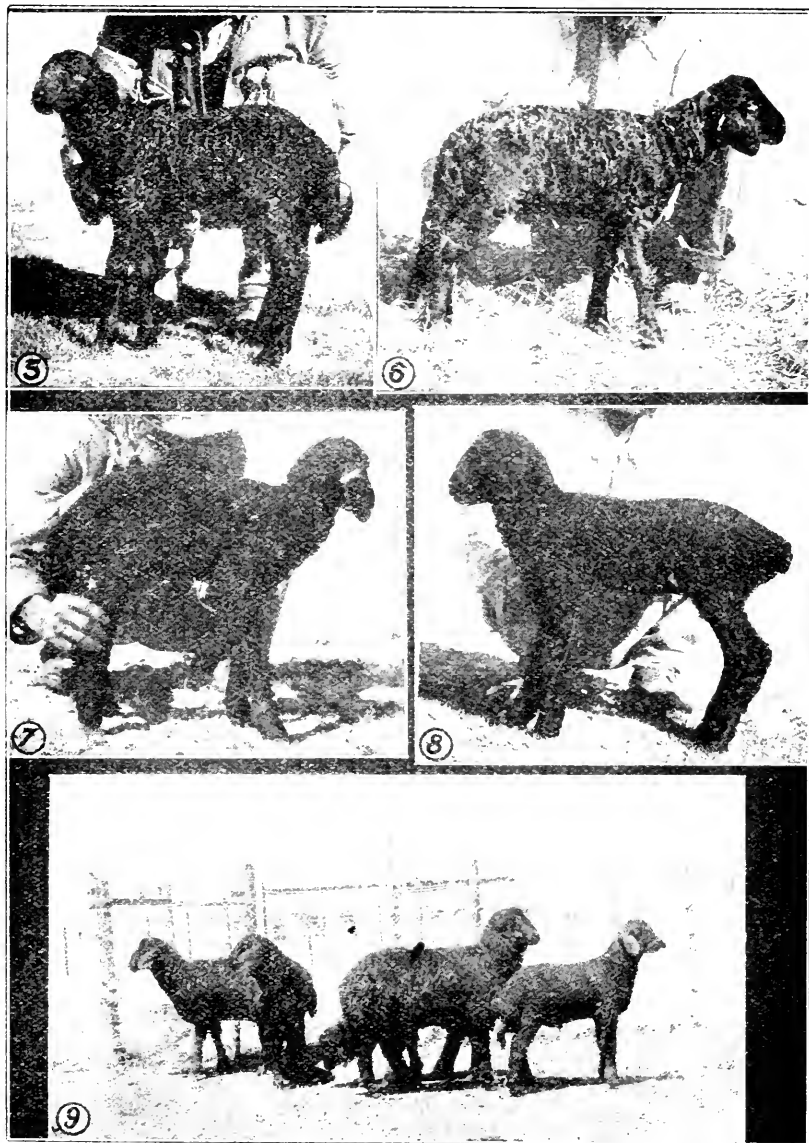

PLATE 5.—Karakul Lamb, with good "Pipe" curl and lustre. (Photo by A. D. Thompson.) PLATE 6.—Karakul Lamb, with "Watered-Silk" pelt somewhat over-developed. (Photo by A. D. Thompson.) PLATE 7.—Karakul Lamb, with "Nigger" curl having no lustre. (Photo by A. D. Thompson.) PLATE 8.—Karakul Lamb, with "Corkscrew" curl. (Photo by A. D. Thompson.) PLATE 9.—Karakul Lambs of same type of curl, with opening of curl due to age. (Photo by Author.)

In classing lambs, therefore, the types recognized are *A and B only*.

In classing lambs as above, physique, etc., is not taken into consideration at all, only the pelt, from a fur point of view, being judged. Any defect such as an overshot or an undershot jaw is, of course, noted, and the lambs killed, but if the pelt is all that is to be desired, such a lamb might still be classed as *A1*.

The best age to describe lambs to do them justice is when they are from three to four days old, but much depends upon the type of curl and the length of the hair, and only experience can tell the breeder when any particular lamb will be at its best. "Watered silk" lambs as a rule become very curly by the time they are seven days of age, and if they are then described such description would not be at all a correct record of what the lamb actually was at its best.

The curl and lustre and nature of the lamb pelt changes rapidly. For the first forty-eight hours after birth the hair has not yet taken its proper place and the pelt does not show at its best. After three or four days the curl opens considerably; the hair becomes too long, often the lustre lessens and the pelt is useless as a fur (see Plate 9).

At both the Grootfontein and the Otjituesu studs each lamb is carefully described under the headings shown hereunder (Fig. 10).

FIG. 10.

*Specimen page from Lamb Description Register showing method in which the lambs are described.*

G.K. 340 EWE.

Date of Description.	Sire.	Dam.	Class.
1st September, 1919	"L. Russel"	S.W.A. 68	1st A Sp. medium heavy.
Month: Good.			
Nose: Slight roman.			
Ears: Large, covering with slight wave.			
Covering of head: Wavy and glossy.			
Covering of face: Wavy and glossy.			
General appearance of head: Very good.			
Curl: Pipes, perpendicular, especially well defined on shoulders and lower neck.			
Short curved pipes on flank and hind leg, few walnuts.			
Type of curl: Medium heavy A.			
Lustre: Very good.			
Quality: Good A, medium soft.			
Density: Good.			
Length: Very slightly on long side.			
Belly: Very fair medium.			
Covering of legs: Slight wave and glossy.			
Tail: Good, rather long point.			
Bone: Good, well-built lamb.			
Class: 1st A special, medium heavy.			
Value: —————			
Remarks: Pipes very well defined and of various lengths and shapes. Entirely free from any raggedness; wet lustre; best lamb dropped this season, etc.			

Mate G.K. 340 to "Nimrod."

Mate S.W.A. 68 to "L. Russel" 1920.

Such descriptions are absolutely necessary, as the mating of the sheep depends upon the curl, etc., of the pelt. The mating of the ewe lambs is thus done with the lamb before the breeder, and it would seem that this method of mating will always have to be followed while the breeder's object is the improvement of the curl. We can never know sufficiently about the fleece of the adult to be able to tell exactly what the curl was like as a lamb, where it needed tightening up, etc., and in the case of ram lambs it is perhaps more important. If these lamb descriptions are not made and kept and used as the ultimate deciding factor, many a ram which had a very indifferent pelt will be kept for stud because of build, size, and other good points. It is our practice at Grootfontein to note at the time a lamb is described, in the case of rams, whether the sheep is good enough to watch with the possibility of using him at stud later. All the rams thus noted are carefully examined later and a final decision come to, but no other rams are ever considered for retaining no matter how well they grow out or how promising their fleece at ten or eleven months of age may seem.

Breeders are also strongly recommended to photograph all the ewe lambs born, except "niggers" or others having such faults so as to enable the owner to cull them, and also all the ram lambs which may possibly be retained at stud. It is impossible by means of description alone to recall the pelt of every lamb to mind, and when, after breeding for some years, the breeder has to decide which of two rams to keep for stud, reference to the photos of their dams and grand-dams will almost always enable the correct choice to be made. Such an instance actually occurred on Grootfontein during this lambing season, when it became necessary to select a son of one of the old stud rams. The choice lay between two lambs, one a class 1A and the other a 1-2A, i.e. just a shade looser in curl. Reference to the lamb photos of the dams decided the writer in favour of the 1-2A beyond all doubt. For these photos a postcard size camera is best, as the photos are quite large enough and they can easily be retained in postcard albums.

For the information of breeders a page out of the lamb book at Grootfontein is annexed. It will be seen that at the top of the page occurs the lamb's number and sex. On the first line the date of birth, parentage, and class, and then follows the description. Notice also that the future mating of the lamb is given at the foot of the page, and the mating of the dam for the following season. These matings are, of course, often changed when young rams are tried at stud, but the type of curl, etc., of each ram is, of course, known, and, should any change be necessary, a ram of the same type is used.

*Tagging Lambs.*—Every lamb, when its description is taken, should be tagged with a numbered tag. This is essential for purposes of keeping proper registers, for purposes of mating, etc. It is the practice in both the Government flocks to tag all pure-bred karakuls in the *right* ear only at present, and all grade karakuls in the left ear. This method has this great advantage, that it prevents any possible mistake arising if a tag is lost, as the tear will at once indicate whether the sheep was pure-bred or not. It has been found on Grootfontein that tagging close to the base of the front of the ear is much more satisfactory than tagging at the back, none of the tags in the former position having been torn out.

Arrangements are at present being made for the registration of pure-bred karakul sheep in the South African Stud Book, and when this has been accomplished further tags may be necessary. It is strongly urged, however, that breeders who purchased pure-bred sheep recently should continue tagging in the way suggested. The breeder's initials or the name of his farm might, with advantage, be stamped on the reverse side of the tag. In order to prevent confusion later, when the Stud Book regulations come into force, breeders should note that the letters "S.W.A." on the reverse side of the tag form the mark of pure-bred karakul sheep bred by the South-West Protectorate Administration, and that the letters "G.K." are used at Grootfontein. These combinations, therefore, should not be used by private breeders.

#### KILLING: SKINNING AND PREPARING THE PELTS FOR MARKET.

The lamb pelts, to be of any value for furs, necessitate the slaughtering of the lambs at the age when their curl is at its best. The throat must be cut to allow as much blood as possible to escape, and the skin must then immediately be removed. This is done by making a straight cut from the neck in the usual way. As every part of the pelt is of value, the cuts in it must be as few and as straight as possible. When the skin has been removed it should be carefully washed in clean water to remove blood, etc., which may be adhering to it, and then dipped into a weak solution of arsenite of soda in water for about half a minute. (This solution must not be stronger than 5 per cent.) After this precaution against moth has been taken the skin is gently stretched (taking great care not to overstretch) on a frame, and is dried *in the shade*. Drying is best done in a shady shed through which the air is constantly circulating. It is fatal to dry pelts in the sun, as they become "burnt" and lose most of their value, because burnt pelts will not stand the processes of working up into furs. When the skins are dry they are packed in flat bundles and shipped overseas to the furriers in that state. A small amount of salt may be put on the skin when it is ready to be dried.

Lambs born dead or prematurely born lambs should be bled at once, as if this is not done the pelts will not stand the working up into furs. In any case, however, the premature skins are more or less weak and do not wear nearly as well as the others. There appears to be a belief prevalent that it is necessary to kill the ewe to obtain the best type of skin from the unborn lamb. This is, of course, quite without foundation and wrong. The belief probably originated through the high value placed on the pelts of aborted lambs of a certain type, and also through the existence of a disease in Bokhara which causes the ewes to abort. As a matter of fact a considerable number of skins, in fact the great majority, would not be as valuable if their owners had been aborted lambs. Only certain types of curl would be better if aborted. Some, again, even if carried the full time, appear to have been born before their time, while curls like the "nigger" would never be really suitable no matter how soon or late the lambs were born.

## IV.

## KARAKULS IN SOUTH AFRICA.

As already stated, karakuls are very hardy animals, and are particularly well suited for the semi-arid regions which comprise a considerable portion of the Union of South Africa. Their hardiness is to be expected from their environment in their native country, and no effort has been spared to keep up this hardiness. In the Union Government flock at Grootfontein the lambs are turned out into the veld with their dams at about seven days of age, and the sheep never receive any additions to the food they find for themselves. (Even the stud rams are treated in this manner.) The ewes are exceptionally good mothers, cases of ewes refusing to "take" their lambs being almost unknown. They have further a very abundant supply of rich nourishing milk, and, as the lambs are big and strong at birth (the average weight being ten pounds), they thrive splendidly, and in the four lambing seasons at Grootfontein, during which some 380 pure-bred lambs have been dropped, there have not been a dozen deaths through what might be termed natural causes. In 1916 a small number of the ewe lambs died as the result of having their tails cut off, and an occasional lamb is still lost now through this operation, but otherwise it is seldom indeed that a lamb dies. The average weight of the veld-grown lambs in 1916 was just under 52 lb. at three months of age. In 1919 the weights were less favourable, but as no real rain ever fell from the time the lambs were born, and as consequently the grazing might have been much better when they were weaned, the results were really not bad. The average weight of 59 ewe lambs at weaning was 51 lb. The lowest weight was 30 lb., a lamb whose dam was killed by jackals, and the highest weight was 68 lb. The average weight of 54 ram lambs, grown under the same conditions, was 54 lb., the weights varying between 28 lb. and 77 lb. Ewes changing their milk incisors for their permanent teeth averaged 69 lb., varying from 34 lb. to 85 lb., while rams of the same age averaged 88½ lb., varying from 76 lb. to 109 lb. The average weight of 10 pure-bred wethers born September-October, 1918, was, on the 15th September, 1919, 87 1/5 lb., and that of the rams for the same age 93¼ lb., ranging from 84 lb. to 103 lb. Ewes with two incisor teeth up averaged 98 lb., varying from 82 lb. to 112 lb., while the 12 heaviest averaged 106 lb. Rams of the same age averaged 103 lb., the weights varying between 83 lb. and 127 lb. All the weights up to this point were of sheep which had had to contend with indifferent grazing due to droughty conditions. The following weights of ewes, taken February, 1919, were taken *just after* the lambs were weaned, when the ewes were in the lowest possible condition and not carrying much covering either. Four-toothed ewes averaged 88 lb., as against 98 lb. for two-toothed ewes. Six-toothed ewes averaged the same, i.e. 88 lb., while full-mouth ewes averaged 104 lb. A few dry full-mouth ewes weighed up to 135 lb., which is, however, still under what well-grown karakul ewes should weigh. The weight of the pure-bred *rams* are of less value, as rams, except those retained for stud or for special observation, are sold at twelve months of age, consequently the figures given refer to much smaller numbers than those available for the ewes. Four-toothed rams averaged 131 lb.;

six-toothed rams 138 lb.; and full-mouth rams 144 lb., the highest weight being 156 lb. If run on permanent pasture the weights would be much greater, but as it is our intention to keep these sheep under conditions as near those which exist on the majority of farms, the above weights are a truer indication of the size attained by them. The heaviest karakul the writer has seen was a ram sold in 1916, which weighed 206 lb. (For the convenience of readers the above weights are repeated with those given when dealing with grade karakuls. This enables a ready comparison to be made.)

Karakuls are great walkers and good climbers, going into stony kopjes much higher than the merinos or other sheep on Grootfontein. They cover the ground over which they are grazing rapidly, and, if in a flock with other sheep, soon separate themselves out and leave the others behind. If put into a lucerne paddock they graze up and down it, seldom remaining long in one place. They are markedly unsociable, and prefer the company of their own kind when mixed with other sheep, as indicated above. The ewes are most devoted mothers, even young ewes with their first lambs looking after their offspring most carefully, usually coming straight up to any one who has caught a lamb. As they are very heavy milkers they must be watched should they lose a lamb through any cause, as it is necessary to milk them dry a few times to prevent udder trouble.

As regards their *food*, they eat anything that can be eaten, and will thrive where many another breed would succumb to hunger. They are particularly fond of dry grazing, not necessarily droughty grazing, but dry grass, bush, etc. They have been seen on Grootfontein to relish and look for dried maize leaves which were ignored by the merinos in the flock. There does not appear to be a great craving for green grazing, and a flock of ewes have been seen to walk through a paddock of lucerne without attempting to feed.

Until the opportunity for further investigation occurs it would perhaps be too much to say that karakuls do not thrive on an entirely green diet, but certainly, when in 1916-17 the stud rams were run on lucerne and grass, one of them, while appearing in normal health and vigour throughout the period, lost 20 lb. in weight in about four months.

Karakul sheep have a great appetite for salt and should be freely supplied with this substance.

In the State-owned flocks the ewes are bred from only once a year. On Grootfontein the rams are paddocked with their ewes in late March or April, and the lambs are dropped in August to September. The ewes appear to come into use best at this time of the year, and an attempt made in 1917 to obtain autumn lambs resulted in very few lambs indeed. In the Protectorate flock there are two lambing seasons a year, namely, in April and November. This is necessary as the flock is too large to enable the officer in charge to do justice to all the lambs should they all be born in a month or six weeks. The rams run with the ewes for six weeks and are then removed.

As the lambs have to be killed to obtain the pelts the writer has often been asked how the flock increases in size. Two methods of getting over this difficulty are possible. In the first, only the ram lambs, except those retained for stud, are killed for pelts, and only those ewe lambs which are considered undesirable as breeding stock. In the second, two lambings a year, or three in two years, should be



attempted. If the grazing is good enough to lamb the ewes twice a year, and if the ewes will come into use, as they will if in anything like fair condition, the lambs born at the period most unfavourable for raising them would be killed, and those born at the better time of the year to add to the flock. When the breeder has once got his flock to the size at which he means to maintain it, he can go back to lambing his ewes once a year and kill off everything except what he wishes to retain to replace old ewes or to add better ewe lambs of exceptional curl and lustre as he improves his flock.

Many people express their repugnance at killing baby lambs, and yet this is done so often in South Africa that the argument is scarcely a sound one. In years of drought such as we are experiencing at present, one hears of the cutting of lambs' throats to save their dams, from all over the country, and the throats of thousands of lambs and sheep and other animals are cut daily for the supply of food. The operation is quick and practically painless, and there is no long lingering death in agony such as comes to so many of our wild animals from the rifles of our sportsmen, who, strangely enough, often talk about this cruelty to the lambs. Also it must be always borne in mind that it was the intention of the Department of Agriculture, and it is still the hope of those responsible, that karakul sheep will be bred in those regions of our country where droughts are more frequent than good years, and that farmers in such regions will, in the karakul, have an animal the lamb of which, should it be necessary to have its throat cut, will bring in a good return for breeding it, instead of being a dead loss as is the case with all other breeds of sheep.

Again, in *blood-pens areas*, where many lambs sicken and die yearly the karakul sheep offer such unique advantages as should make many farmers in such areas give them a trial. With these sheep, if the lamb sickens, its throat is cut and its skin is sold, say, for 20s., which is what any but a bad skin would realize, and the farmer has benefited to the extent of this sum.

Another great point in favour of karakul sheep is its resistance to "stekgras." Owing to the hairy covering these sheep are not affected by this grass to anything like the extent the woolled breeds are, and yet have a covering which brings in something when clipped.

The breeders who have been grading up sheep with pure-bred rams since 1916 speak highly of this resistance to "stekgras" and to the hardiness of even grade karakuls in resisting droughts, and the fact that some of them come back every year to purchase rams proves that they mean what they say.

---

## V.

---

### MANAGEMENT.

Under this heading the only points considered are those in which karakul sheep require treatment different from other breeds.

*Shearing.*—The lambs should be shorn for the first time when they are six months old; if left longer the weight or warmth of the fleece seems to be detrimental to their development. It is best to

shear every six months, as the fleece is inclined to mat if left for a whole year, and as the sheep undoubtedly do better if shorn twice in twelve months. Just after shearing, karakul sheep cannot stand wet cold, being like Angora goats in this respect, and should be treated in the same way. Every breeder should allow his adult sheep to go for a whole year without shearing once when they are still young, as this will enable him to find out much information as to the length of staple, which would help him with his mating and prevent many "corkscrew" lambs from being born. It will also show him clearly which are his really clean-haired sheep, as they will mate far less than those which have wooliness in their fleece.

*The Value of the Fleece.*—Before the war the fleece of the adult sheep realized about  $4\frac{1}{2}$ d. per lb., and was used for various purposes, such as stuffing saddles, etc. The war caused a considerable rise in the value of the fleece, and up to  $12\frac{1}{2}$ d. was obtained for the Grootfontein clip. The first hair of the lambs, and the second to an extent, appear to be the most valuable, as they are softer, less kempy, and more uniform in texture than the subsequent growths. The staple of the adult sheep, if allowed to grow for twelve months obtains a length of from 7 to 14 inches, while the weight of the fleece is about 5 lb. The heaviest clipped on Grootfontein weighed 9 lb.

*The Amputation of the Ewe Lambs' Tails.*—As the tails of the adult sheep are often of such a size as to interfere with the act of mating, some difficulty was experienced in getting some ewes in lamb when these investigations were first begun. Hand serving had to be done and much time expended. It was, therefore, decided to cut back the tails of all the ewe lambs, and after several methods had been tried the following, evolved in the South-West Protectorate flock, was finally adopted. The lamb is held in the usual way when tailing or castrating by an assistant and the tail is thoroughly washed with a disinfectant by the operator. The tail is then laid in the palm of the hand of the operator to allow the bony axis to assume its normal position, and is then firmly grasped at its base, right against the body of the lamb, by the assistant who is holding the lamb. The operator, holding the tail in his left hand, ligatures the arteries which run very close to the caudal vertebral column, as follows: A half-circle surgical needle, threaded with strong twine or plaited silk, which has been dipped in disinfectant, is passed from the one side of the bone, round the back of it, and out again on the other side of the bone. (The needle is inserted about one-third of an inch from the bone, and should reappear about the same distance from it on the other side; it need not appear outside the skin at the under side of the tail at all. The silk having thus been passed round the bone and arteries, is tied as tightly as the operator can tie it. This ligature prevents any bleeding from the only arteries which matter. The operator now feels for the second or third joint between the vertebrae of the tail, counting from its base, and, having found such a joint, he proceeds to cut through it and then cuts away the flesh and fatty matter on both sides. (A scalpel or castrating knife can be used for this operation, and all the operator has to be careful about is that he does not strike the bone itself, as the lambs seem to suffer from the bone shock, which is very often fatal.) Having cut off the tail three stitches are put in to draw the flaps of the skin together, one in the centre opposite the severed bony axis; and one about half-way between

this central stitch and the edge of the wound. The wound is then again washed with disinfectant and the lamb put back with its dam. It is best to keep it quiet in a shady place for the rest of the day, or for some hours at least. The following day the ligature round the bone is removed, and if there is a dry scab on the wound and there is any danger from blow-flies the scab should be painted over with stockholm tar. There is no necessity to remove the other three stitches.

Lambs to be operated on should always be brought to the place of operating the night before the tailing is done, and the cutting should take place early next morning, while it is yet cool and before the lambs have run about and got heated up.

By using this method the breeder can be sure that his losses through this operation will be so small as to be negligible.

*Weaning.*—Owing to the vigorous growth and early maturity of the young rams, it is necessary to wean them at the age of about 3½ months. If left longer than this there is danger of them tupping the ewes and consequently of having lambs born to unknown sires, coming on at all times of the year. The ewe lambs can be left somewhat longer if the condition of the veld permits it.

*[The second part of this article will appear, with illustrations, in next month's Journal. It deals with mating, cross-breeding, etc.]*

---

## Fighting a Notorious Pest.

The United States Department of Agriculture is striving hard to keep the "pink boll worm" out of its country. This notorious pest has proved a frightful scourge in Egypt, and it has spread to several distant lands, inclusive of Mexico. Amongst other measures to prevent its accidental introduction, all raw cotton imported into America is fumigated with cyanide gas. The fumigation is carried out in immense steel cylinders, somewhat like those used in creosoting timber. The bales of cotton are run into the cylinders on trucks, and by exhausting the air from the chambers and then admitting the gas, the poison is forced throughout the mass of cotton, carrying death to any insects that may be present. The growing of cotton is prohibited in a wide belt of country adjoining the infested area of Mexico, and aeroplanes are used to locate any fields that may be planted in ignorance of or in violation of the law. The disinfection of railway cars, etc., coming from Mexico is required, and for this purpose five special fumigation buildings have been erected, in which cars are treated bodily. Fifteen cars at once can be treated in the largest of these buildings. Specially designed apparatus is used for generating, distributing, and expelling the gas. It is expected that the cost of the chemicals for generating the gas in these buildings will amount to £20,000 a year. The pink boll worm is not known nearer the Union than Zanzibar on the East Coast. It is spread chiefly through the medium of seed, and even a small parcel of infested seed might suffice to get it permanently established in a new country.

## A LEAF SPOT OF THE PEA-NUT OR MONKEY-NUT PLANT.

Caused by the fungus *Septogloeum arachidis*, Rac

By PAUL A. VAN DER BIJL, M.A., D.Sc., F.L.S., Mycologist in Charge, Natal Herbarium.

THE object of this brief note is to call attention to the existence of a serious disease noticed especially along the coastal region of Natal on pea-nut or monkey-nut plants (*Arachis hypogea*).

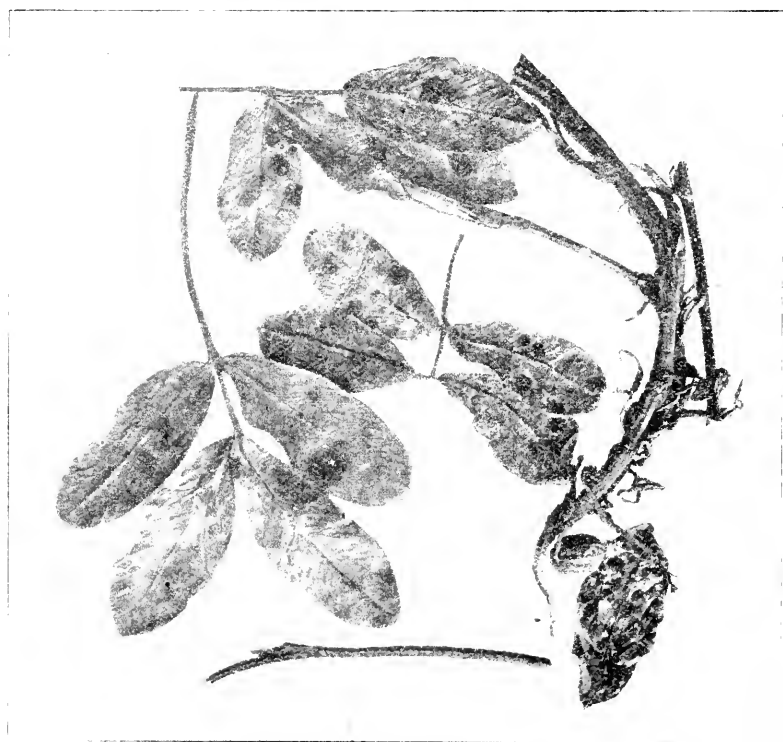

FIG. 1.—Photograph of Leaves and Stem of the Monkey-Nut Plant suffering from attack by the Fungus *Septogloeum arachidis*. Note the Black Spots.

The disease shows itself as black, circular to irregular spots or flecks which, though more prevalent on the leaves, occur also on the leaf stalks and stems (fig. 1). It is caused by a microscopic fungus, known scientifically as *Septogloeum arachidis*, which invades the tissues of the monkey-nut plant. The vegetative part or mycelium

of the fungus ramifies primarily in the air spaces between the cell tissue, and gives out sucking organs into the cells through which the fungus draws nourishment from the cells and ultimately kills them.

The attacked leaves die early and shrivel up or fall; a field badly infected presents a gloomy spectacle of plants, showing only a few newly formed leaves, the remainder being dead and shrivelled up, while some plants are in great part quite leafless.

When the fungus has killed a smaller or larger area of the plant tissues, it begins to show signs of fructifying, and forms in the black

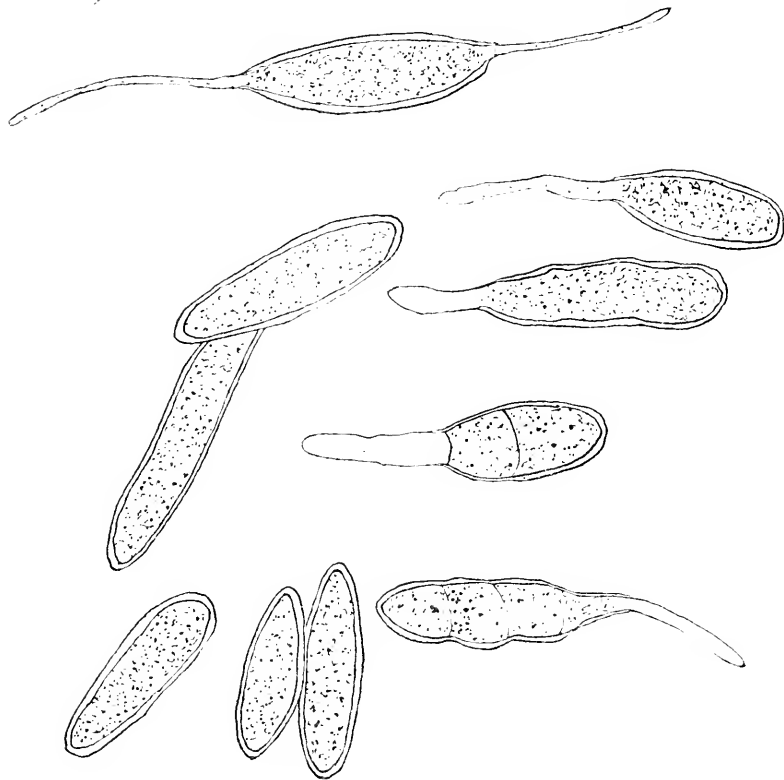

FIG. 2 (Highly Magnified).—Spores of the Fungus and showing some which Germinated in Water.

areas small dark dots or specks about the size of a pin-point and more or less concentrically arranged.

These dots are due to a cluster of fungal threads which break through the epidermis of the plant, and whose function is to form the spores of the fungus, and thus, much to the annoyance of the agriculturist, to ensure the spread and perpetuation of the disease.

The spore-bearing layer which thus breaks through the epidermis forms elongated, light-coloured, 1-5 celled spores (fig. 2),

The individual spores are microscopic in size and measure approximately  $.015 - .02 \times .004$  of an inch. They germinate readily in water (fig. 2), and should they land on the leaves of monkey-nut plants under conditions favourable for growth, would cause the black spots there within a few days. The spore layers form especially on the under surface of the leaves, where they are concentrically arranged in the black spots, but they also form, though less abundantly, on the upper surface and on other parts of the plant attacked.

Two fungi have been recorded as responsible for leaf spots in monkey-nut plants, viz., *Septogloeum arachidis* and *Cercospora personata*. These names, however, appear to be different names given to one and the same fungus, and as the South African one shows affinities with *Septogloeum* rather than *Cercospora*, we refer it to the former.

In South Africa this leaf spot is recorded from the Transvaal, British East Africa, and Natal. In foreign countries it is mentioned from Java, Ceylon, Phillipine Islands, and the West Indies.

The damage caused at times by the fungus is sufficiently serious to warrant the taking of steps to overcome its ravages. With this object in view, it is recommended that the material from diseased fields be burnt or else deeply ploughed in without chance of it coming to the surface before thoroughly rotted. Crop rotation should be resorted to in old lands. A protective or preventive spray with some fungicide may be applied in regions where the trouble is known to occur, and I would point out the necessity of spraying early before there are signs of the disease. Spraying will not benefit plants already badly diseased, though even in these cases it is a distinct advantage by reason of it killing the spores of the fungus through which the disease is disseminated.

## Employees on Farms.

According to the last census, the following was the average number, sex, and race of employees on farms in the Union during the year 1917-1918:—

Province.	Europea and other Whites.		Natives.		Indians and other Asiatics.		Other Coloured.	
	Males.	Females.	Males.	Females.	Males.	Females.	Males.	Females.
Cape of Good Hope	23,615	6,393	70,933	30,536	786	46	36,566	11,301
Natal... ..	2,281	576	54,084	12,960	18,405	3,920	334	65
Transvaal ...	7,863	2,497	69,968	25,117	436	78	524	231
Orange Free State	7,997	3,399	59,638	35,737	—	—	1,249	527
<b>TOTAL ...</b>	<b>41,756</b>	<b>12,865</b>	<b>254,623</b>	<b>104,350</b>	<b>19,627</b>	<b>4,041</b>	<b>38,673</b>	<b>12,124</b>

## FARMING IN THE EARLY CAPE DAYS.

By C. GRAHAM BOTHA, Chief Archivist for the Union.

[At this stage of our agricultural development when the future holds bright promise of continuing expansion, it is interesting and not without profit to ponder awhile over the early days of our history and the conditions under which the farmers of those times laboured. We welcome the following sketch from the pen of Mr. C. Graham Botha, who was recently appointed Chief Archivist for the Union and publish it as affording a comparison between the present and the distant past.—ACTING EDITOR.]

In looking through the records of several generations back there are many which throw an interesting light upon early farming at the Cape. In comparison with present-day conditions it is observed that while methods have improved, the trials and tribulations with which the farmer still has to contend were ever present in the years gone by. Drought, rust in wheat, cattle diseases, etc., were always the dread of the agriculturist. In the following paragraphs I wish to jot down a few facts of general interest which are to be found in the records of the seventeenth and eighteenth centuries. In 1652 the Dutch East India Company established itself in Table Valley solely with the object of having a refreshment station to supply fresh victuals to its ships passing to and from India. Its primary object was to trade in the East Indies and various sub-stations, of which the Cape was one. The first colonists to settle here were discharged servants of the Company, who had been given their freedom in 1657 and grants of land along the Liesbeek River at Rondebosch to grow corn and undertake farming. These were the first farmers of the Cape Colony. They were at first designated as freemen to distinguish them from those in the service of the Company, and the diary or official journal gives many references to their manifold difficulties. If it was not the failure of their crops then it was the devastation by the Hottentots. An entry like this: "The freeman all warned to be on their guard, in order not to be surprised, also not to go about unarmed; those unprovided with fire-arms to apply for some at the Company's armoury," gives a good idea of the troubles they encountered through the Hottentots.

At first the Company considered that it could supply its ships in the bay with fresh meat, vegetables, and grain by its own undertakings, but this was found to be very unsatisfactory and expensive. In the course of time colonists were encouraged to settle here, and help was given them in setting up for themselves. By the beginning of the eighteenth century a fair number of burghers had settled at the Cape, most of whom were engaged in farming. Between 1671 and 1685 a few families from Holland settled in South Africa as colonists, and a few years after came the French refugees. Before 1711 immigration had practically ceased, but the number of colonists was increased by the discharge of servants of the Company. The latter had no fixed idea of making this country a colony, the primary object being the maintenance of a refreshment station at the Cape. During the course of two or three generations it became apparent that the gradual extension and prosperity of the land was converting

it into an agricultural country. The change was imperceptible, and however much it was contrary to the wishes and expectations of the founders, was bound to come. In course of time the Company gave up its agricultural undertakings, both in corn-raising and cattle breeding, and looked to the colonists for its grain, meat, and wine.

#### EARLY LAND TENURE.

The majority of farms held during the seventeenth and eighteenth centuries were on loan tenure. A good pasturage was selected by the grazier, and he applied to the Government for permission to settle there for a year. If the place was suitable he had to renew his licence annually, but if it proved unsuitable he would abandon it in course of time and seek fresh pastures further afield, applying again for a new licence. The constant migration of the stock farmer gradually led to the extension of the colony's boundaries. The rights of the farmer in respect of the ground were those of a lessee; he had no *dominium* in the ground and could not sell it, but was entitled to dispose of the buildings (*opstal*) which he had erected thereon. The Government, if it so wished, had the right of resuming occupation of the land or of not renewing the lease, in which case it would pay out the farmer for the value of the *opstal*. This uncertainty of tenure did not as a rule perturb the farmer, whose lease as a general practice was always renewed. This early law of land tenure in the Cape Colony was altered by a Proclamation in 1813, which placed the issue of land grants on the footing it is to-day, land being given out either in freehold or on perpetual quitrent.

It must be of historic interest to farmers to-day to learn how a loan place (*leenings plaats*) was granted. After he had chosen his land, the agriculturist petitioned Government for the right of occupation, giving a name to some spring or spot round which the property was situated. In passing, it might be remarked that this explains the origin of many of the farm names in the old Cape Colony ending in *fontein*, as Springfontein, Matjesfontein, Grootfontein, Rheeboekfontein, etc. This petition was referred to the *landdrost* or magistrate of the district, and supporting evidence was obtained from the proprietors of the neighbouring ground that they had no objection to the grant being sanctioned. By instructions issued in 1805 the fieldcornet was directed to go to the selected spot and walk half-an-hour in every direction, provided it did not encroach on any land reserved by Government or already occupied. A central spot called the *ordonnantie* was chosen, and at half-an-hour's walk on every side from here were the points of the boundaries. As "walking off" the distance was somewhat uncertain in determining the extent, it was decided that a distance of 750 roods was to be equal to half-an-hour's walk. This gave an area of 3000 morgen. No objection having been raised to the issue of a permit to occupy the land on loan, the same was duly registered at the office of the secretary to the Council of Policy—later on at the Revenue Office.

#### THE FIRST EXPERIMENT.

Early attempts were made by the Government to produce such articles as cotton, indigo, olive oil, tobacco, silk, etc. In 1682 directions were given to cultivate flax, hemp, and indigo, but the experiments showed that it would not answer sufficiently well to



encourage the farmer to grow these plants. In 1719 a quantity of indigo seed was sent from Batavia with a man who understood its cultivation. After some years of trial it was found unsuitable as a general crop. In Van Riebeeck's days the olive was first planted, and for some years after was considered as a plant which would succeed. Simon van der Stel tried the cultivation of this tree and planted the trees in every kind of soil and in different positions, but the results do not appear to have been very satisfactory. Some of the French refugees made experiments with it by grafting on the wild olive of the country. Trial after trial was made, and it was found that while some of the trees grew well, many died off suddenly without cause. In others the fruit dropped off while still young. Trials were made in the growing of tobacco leaf, but were abandoned. A man who had experience in the cultivation and manufacture of tobacco was sent from Amsterdam in 1719. He travelled through what is now the Paarl district, through Stellenbosch, up to Tulbagh and Riebeeck Kasteel examining the soil. In the light of later events it is interesting to observe that he reported that everywhere the soil was unfit for the cultivation of the tobacco plant. It was heavy clay, he wrote, while the tobacco required black sandy soil. If planted in the summer it suffered from heat and drought, whilst the small sprouts were beaten off the stalk by the south-east winds. In the rainy season the plants did not thrive, and another drawback was that a shed had to be erected on every tobacco field to dry the green leaves, which, being young, could not be conveyed two or three miles from one place to another, owing to injury by the motion of the vehicles, and thus rendered useless. Several experiments in the manufacture of silk were made, but in 1735 the idea of making it pay was abandoned.

#### WHEAT GROWING.

The production of wheat, the making of wine, and cattle rearing would appear to have been amongst the principal pursuits of the farming community in the colony. The first agriculturists tilled the soil along the banks of the Liesbeek, and as the farmer pushed further inland areas in the Western Province, which are to-day well known as grain-raising centres, were recognized as such in the eighteenth century. In 1684 the first consignment of grain was exported from the country. The farmers were only allowed to sell their wheat to the Company, and it is interesting to see what prices they were paid. In 1666 they received 11s. 8d. per muid, and four years later the Company paid them 7s. 5d. per 100 lb., for there was not sufficient production to provide for the garrison and people, and it was considered that this price would encourage the farmer to produce more. From 1685, for a period of more than thirty years, the average price for wheat was 12s. 6d. per muid, and between that price and about 10s. seems to have been the amount paid during the eighteenth century.

The wheat was threshed in those days practically in the same manner as it is done in some parts of the country to-day. Within circular enclosure the ground was levelled and hardened, a mud wall being built round this. The sheaves were spread out, and either horses, oxen, or donkeys driven into the enclosure and made to go round and round until the ears had been separated from the stalks.

A man stood in the middle of this "floor" or "*trap vloer*" and kept the animals on the go by flicking a long whip. When the animals were tired the grain was collected by throwing up the trampled mass to the wind when the chaff was blown away and the seed fell on the floor.

#### WINE-MAKING.

In 1654 the vine was introduced into the colony from the Rhine provinces and within the next few years further consignments were received from there and France. Commander Simon van der Stel obtained different varieties of cuttings from France, Germany, and Spain, and a few years after Stellenbosch district had been constituted the vine was growing luxuriantly. In 1659 the first wine was made in South Africa from the muscadel by Commander Jan van Riebeeck, who appears to have been the only person possessing the knowledge to do so. The early efforts to induce the farmers to send their wine to Batavia were unsuccessful, as they wanted a local market and were unable to wait a whole year for payment of their goods. About 1718 the authorities of the Company in Holland thought that if the flavour of the Cape wine could be improved a market might be found in Europe and in India. They were then paying the farmer £6 per *legger* (leaguer) for ordinary wine for the use of their ships, and £8 for old wine for use in the hospital. The Constantia wine had already gained a reputation in Europe. In 1789 the colonists were given permission to export wine to Holland, provided it went in the Company's ships, and a freight of £1. 13s. 4d.—afterwards raised to £2. 3s. 4d. (per *legger*)—was paid. Towards the close of the eighteenth century the wine farmers of Stellenbosch, Drakenstein, French Hoek, and Wagenmaker's Vallei (now Wellington) lived in large substantially built houses, which had the aspect of ease and comfort as far as their interior fittings and furniture were concerned. The work of delving and cleaning the vineyard, pruning the vines, gathering the grapes, and pressing and storing them was undertaken by slaves under the supervision of Europeans.

One of the principal pursuits of the farming community was that of

#### CATTLE REARING.

In the first days of the settlement the cattle were obtained from the natives and trading parties were sent out by the Government for that purpose. The farmers, however, were strictly prohibited from bartering with the Hottentots. In 1700 this prohibition was withdrawn for a few years only as far as cattle trade was concerned, when severe penalties were again imposed to prevent the bartering of cattle. One of the first cattle sicknesses which appeared at the Cape was in 1659, when horned cattle and sheep died in great numbers. It is not known what the nature of the disease was, but the Government attributed the illness to the action of the Almighty, and believed that it was sent as a punishment for sins. It was resolved to hold a prayer meeting at 4 p.m. every Wednesday to pray that the Lord might withdraw his anger from the people, and assist them against their enemies. Again in 1714 an unknown cattle disease made its appearance and in 1723 tongue and hoof sickness broke out. Meat became scarce and a law was published which prohibited the sale of

fresh meat or vegetables to strangers under pain of being deported in addition to being fined nearly £70. The average price of meat sold to the inhabitants was from two to three pence per pound.

#### LIFE ON THE BORDER

of the colony during the eighteenth century was fraught with many difficulties. Drought, followed by excessive rain and cold, caused much stock mortality. Depredations by the wily and swift-footed Bushman made the farmer often abandon his farm. Robberies were of constant occurrence, and a reward of £3 per head was offered by the authorities for every Bushman thief, male or female, delivered at the Cape. Life was in danger, and the farmer had ever to be on the look-out. What the Kaffirs were to the Eastern Province farmer of last century, so the Bushmen were to the farmer living in the Graaff-Reinet during the prior century. This district at that time embraced virtually the whole of the Eastern Province of to-day, extended right up to Colesberg, and had as its western boundaries the Gamka River, Zwartbergen Range, and the Gamtoos River. Almost every farm household made its own soap and candles, very much on the same principle as they are still made to-day in some parts of the country. Soap was made from the fat of animals and mixed with the ashes of a shrub which grew in great quantities. Two kinds of candles were made, "vet kerse" and "water kerse." The former was made either from the pure tallow or tallow hardened with a vegetable wax obtainable in many parts of the country. The tallow while still soft was poured into tin candle moulds. The water candles were made by dipping alternately the wick into the softened tallow and water. In case of ailments every household depended upon their box of "Hallische medicamenten" or "huisapothek." Herbs and other medicinal plants were often used, such as the buchu plant, and the farmers' wives were adepts at giving "first aid" in cases of ordinary illnesses.

Once a year the farmer set off in his tented wagon for Capetown with his butter, candles, soap, hides, etc., which he would sell or barter for household necessaries, such as tea, coffee, sugar, rice, etc. Most of the crockery used on the farms was tin, as porcelain ware was liable to be broken on the long journeys.

#### WOOL PRODUCTION.

In closing this brief account of early farming life at the Cape, a word might be said about the attempts to produce wool. As early as the beginning of the eighteenth century the directors were anxious to procure sheep's wool from South Africa. Between 1700 and 1704 a small quantity was sent, and Governor Willem Adriaan van der Stel wrote to Holland for rams and ewes of good breed from Europe and sheep from Java and Persia. Some years later a quantity of wool was sent to Holland, but the quality proved bad. In 1713 we read that one man got 500 lb. of wool from his Persian sheep, and this was bought by the Government at 5d. per lb. Towards the last years of the Company's régime a fair quantity of coarse wool was produced. During the 1781 war some enterprising colonists formed the idea of manufacturing blankets and cloth, as there had been a great scarcity of blankets and rough cloth.

## THE DIPPING OF SHEEP IN SO-CALLED CARBOLIC DIPS.

### The Risk that may attend the Practice.

By ARTHUR STEAD, B.Sc., Research Chemist, Grootfontein School  
of Agriculture, Middelburg, Cape.

[Being the substance of a paper read by Mr. Stead at a meeting of the Technical Officers Association, Grootfontein School of Agriculture, on the 13th February, 1919, together with a note on the Physiological Action of the Phenols, by Mr. P. J. J. Fourie, M.R.C.V.S., Lecturer in Veterinary Science.]

WHILE sheep farmers would not seem to be in the habit of using this type of dip for the eradication of scab, it seems clear that such preparations are frequently used for the purpose of destroying keds, and that not a few valuable sheep have been killed in the process.

The dips are sold as non-poisonous; while that designation may be true under certain conditions, it is not so under others.

The common name for these dips would seem to indicate that they contain carbolic acid (viz., phenol,  $C_6H_5OH$ ), but usually this is not the case. Presumably the name has arisen from the "disinfectant" odour they possess, or possibly they have been so named because they are made from materials obtained in the course of the extraction of carbolic acid from coal-tar. Perhaps, however, the most likely derivation of the common name arises from the fact that phenol and creosols (these latter are higher members of a group of compounds which is called the Phenol Group, because of the many chemical similarities that exist between members of the group and phenol itself) have been in the past, when in admixture particularly, indiscriminately called "carbolic acid." Thus on page 177 of Wynter Blyth's "Poisons, their Effects and Detection," it is stated: "It must always be borne in mind that, with regard to statistics generally, the term 'carbolic acid' is not used by coroners, juries, or medical men in a strictly chemical sense, the term being made to include disinfecting fluids, which are almost wholly composed of creosols, and contain scarcely any phenol."

There are very many kinds of these dips on the market, and usually they are sold under proprietary names. The starting point of a great many of them is the "creosote oil" fraction of coal-tar from which naphthalene has been separated. This liquid contains creosols and other phenols, together with some pyridin and a large proportion of hydrocarbons, the composition and properties of many of which are very little known.

A much better name for these dips would be "coal-tar creosote dips."

Now, creosote oil is practically insoluble in water; it is therefore necessary to treat it so that when mixed with water it will give a permanent uniform fluid from which the oils will not separate. There are two directions in which this can be accomplished, i.e. (1) by treating the oils so that they will dissolve in water, and (2) by treating the oils so that they will form, when mixed with water, a permanent uniform emulsion. In the making of these dips a combination of these two methods is used. The phenols are changed into soluble substances by means of caustic soda, which soluble substances (cresylates among others) remain soluble on dilution of the dip with water; while the remaining oily compounds are dissolved in a rosin soap.

In making the dip the manufacturer takes the creosote oil and dissolves therein the requisite quantity of rosin, after which he adds a calculated amount of caustic soda solution. The mixture is then boiled to saponify the abietic acid, that is to produce rosin soap. If the operations have been properly conducted a clear, brownish, tarry-smelling liquid results which, on dilution with water, should form a whitish uniform emulsion from which no oily globules will separate on standing.

Having outlined the nature of the substances† with which this article is concerned, the circumstances surrounding two or three dippings which were attended with fatal results may now be recounted.

#### COAL-TAR DIP "A."

Early in 1917 the writer was asked to investigate a sample of dip, here called "A." for poisons. The owner of some valuable sheep had dipped them in a mixture of one part of "A" to 150 parts of water. The tank used had a capacity of about 300 gallons.

The dipping was carried out early one morning; the same evening the sheep appeared to be all right, but by the following morning two had died. Eventually 11 died out of a total of 68; all the casualties occurred amongst the first 33, i.e.: Of first lot of 12 dipped, 6 died; of second lot of 21 dipped, 5 died; of third lot of 35 dipped none died.

Veterinary Surgeon Simson saw the sheep and described their symptoms as follows:—

#### *Ante-mortem symptoms*—

Respiration accelerated, short and painful; there was a slight mucous nasal discharge; there was some swelling in the laryngeal region; there was, before death, slight tympanitis.

#### *Post-mortem symptoms*—

Pneumonia in all; nephritis in three; bile-stained mucus in the duodenum and mucosa appeared to be in a catarrhal state; the bladder was contracted and contained about a tablespoonful of white mucus;

\* Rosin consists chiefly of abietic acid which, on boiling with caustic soda, gives sodium abietate, a substance which possesses remarkable powers in emulsifying oily materials.

† There is another type of carbolic dip whose origin is coal-tar, i.e. the cresylic acid dip. This dip is made from somewhat impure coal-tar derived creosols, caustic potash, and linseed oil. Since the cresylates formed are soluble in water and since the materials used in the manufacture contain only very small quantities of hydrocarbons, this dip on dilution with soft water remains clear. Lysol is a member of this class of dip.

mucosa of abomasum, mouth, and pharynx were normal, and likewise other internal organs.

The veterinary officer ascribed death as being due to the absorption of some poison from the dip.

The Government Analyst at Bloemfontein, to whom the matter had been referred, suggested that the sheep had taken some of the dip down the windpipe; but this hypothesis did not explain why there was over 30 per cent. mortality amongst the first 33 sheep dipped and none amongst the last 35. Furthermore, the owner noticed no coughing or other early signs of distress amongst the animals.

The proprietors of the dip appear to have ascribed the mortality to pneumonia caused by a too cold dipping fluid; the absence of mortality amongst the last 35 dipped being due to the warming of the dip by the first 33.

That there have been numerous complaints from farmers who have dipped in this type of dip would appear to be obvious from the following extracts taken from a booklet of instructions issued by the proprietors of one of these "carbolic" dips:—

"Dip in a solution not weaker than 1 in 150 nor stronger than 1 in 125, and keep in the tank for two minutes **BY THE CLOCK.**"

(Presumably a greater concentration than 1 in 125 and a longer immersion than two minutes would be unsafe for that particular dip.)

The following comes under the heading "Two Warnings":—

"Every spring and early summer some farmers lose sheep after dipping. They choose a 'splendid dipping day,' but forget that the water is as cold as ice. The sheep that die are always among those first dipped. Before death they wheeze and rattle when listened to carefully. When the water is cold, the warmer the day the greater the shock to the sheep. The first forty or so warm up the water and take the chill off in a *small tank*,\* but don't forget, *they take the chill away with them.*" From one to eight days after this they are dying of pneumonia, while you curse the particular dip you used, and swear never to use it again, and to warn your neighbours about it. The dip was not at fault: plain water would probably have been a good deal worse, not containing any stimulating value to counteract the chill."

During the course of correspondence the owner of these sheep stated that he knew of six other cases in which sheep dipped in "carbolic dips" had died, and as in his own case the mortality was confined to the first sheep dipped; he also stated that Assistant Chief Sheep Inspector Fincham had expressed the opinion that the reason why the first sheep to be dipped die is owing to the water used being hard; and also that his experience of carbolic dips is that where they are mixed with hard water the first few sheep put through the dip suffer badly.

It would seem clear every one is agreed that, when "carbolic" dip is used, the first sheep dipped may suffer more or less, while the last do not suffer owing to some change which takes place in the dipping fluid.

Examination of dip "A" showed that it did not contain arsenic, that true phenol was practically absent, but that it contained higher phenols, pyridin, hydrocarbons, soda and water.

\* The italics are mine.—A. S.

Such a dip is usually described as non-poisonous, presumably because it contains neither the highly corrosive poison phenol nor the violently poisonous arsenic, or, perhaps, because if only moderate quantities of the dip be taken internally, fatal results will not follow.

Samples of the water actually used in the dipping were not available, because, in making the dip, a little rain-water from the dam was mixed with fountain water; quantities of the fountain water were, however, obtained. Since dam waters are usually softer than fountain waters it may be assumed that the water actually used in mixing the dip was somewhat softer than the fountain water. Analysis of the latter showed it to contain:—

	Grammes per 100,000 c.c.
Sodium bicarbonate ... ..	7.9
Calcium and magnesium carbonates ... ..	21.0
Sodium chloride ... ..	0.5
Free carbon-dioxide ... ..	1.87

The water would be described as a moderately and temporarily hard sodium bicarbonate water.

Experiments made with this water and dip "A" in the proportions 1 to 150 showed that it did not give a perfect emulsion; that there was a considerable separation of oily globules.

The following are some of the results of these experiments:—

*Mixtures of "A" and water in the proportion 1 : 150.*

Mixture.	Oils Separated.
(1) "A" to fountain water ... ..	13.5
(2) Fountain water to "A" ... ..	10.9
(3) "A" to distilled water ... ..	3.7
(4) Distilled water to "A" ... ..	3.1

The emulsions were made by thorough mixing and agitation; after they had stood 10 minutes the separated oils were removed and weighed, the removal of them taking about half an hour to accomplish. It will be observed that the amount of non-emulsified oils is very considerable in the case of the fountain water, and appreciable in the case of the distilled water mixtures. It is also obvious that the better emulsions were obtained by adding the water to the dip.

Seeing that the dip would not give a perfect emulsion with distilled water it appeared that "A" might be an imperfectly made dip; that, for instance, not enough soda and rosin had been used in its preparation. This would not appear to be the sole cause leading to the separation of the oils, for a mixture prepared by adding distilled water that had been recently boiled to an appropriate quantity of "A" gave a much less visible separation of oils.

Now, the boiling of the distilled water would have the effect of driving out any carbon-dioxide gas it contained. A further experiment, consisting in passing through the emulsion a stream of carbon-dioxide, was, therefore, made, and it caused a considerable separation of oils, showing that carbon-dioxide could destroy emulsions of "A." Its action in this respect would seem to be due, in part, to the fact that it has the property of decomposing cresylates; it has also another

possible effect, to which reference will be made later. Analysis of the distilled water showed that it contained rather more than 5 grammes of the gas in 100,000 c.c., which is quite an appreciable quantity. Since analysis of the fountain water showed it to contain only one-third of that amount, it is obvious that the vastly greater separation of oils from the mixtures made with fountain water must be due to some other cause than that of dissolved carbon-dioxide. It was also found that the separation of oils from the fountain water emulsions was not immediately complete, although it was practically so in the case of distilled-water emulsions.

Solutions of many salts, including common salt (as, for instance, "brak" water), have a very powerful effect in destroying these emulsions, but the amount of salt in the fountain water is not nearly sufficient to produce such a result. The fountain water, however, contains carbonates of calcium and magnesium; it is to them that we must look as the principal agents which render the fountain water so unsuitable for mixing with dip "A."

Let us now see how their action can be explained.

Earlier in this article it is stated that the emulsification of these dips on admixture with water is effected through the agency of sodium abietate, the active constituent of rosin soap. The abietates of calcium and magnesium are insoluble in water, so that, when rosin soap is mixed with water containing soluble compounds of these elements, it will be decomposed. Applying this to dip, it follows that if sufficient of its rosin soap is destroyed by the calcium and magnesium compounds contained by the water, a perfect emulsion cannot form or, if it does form, it will be broken down. It would therefore seem that Mr. Fincham's opinion quoted higher up is well founded. Still, other factors may operate in destroying these emulsions which, in some respects, are like colloidal suspensions, as, for instance, suspensions of clay. Sometimes these are very stable, sometimes not. Small quantities of salts, including common salt, calcium and magnesium chlorides, sulphates, and bicarbonates have a very powerful effect in upsetting permanent suspensions of this kind; there would seem to be little doubt that they are similarly effective in upsetting the equilibrium of the emulsoid suspensions formed by mixing coal-tar dips with water.

Salts break up clay suspensions by causing the ultra-microscopical particles of clay to aggregate, viz., they flocculate the clay particles. In an emulsion of dip one has, in place of solid particles, ultra-microscopical liquid oily particles in suspension; so exceedingly small are they that they pass readily through the pores of the finest filter papers, and, like deflocculated clay particles, are able to remain in uniform suspension throughout the water. When, however, the water is one that acts in a direction opposite to the dispersive action of the soap (such a water is one which contains appreciable amounts of any of the salts mentioned above), there is every possibility of the emulsion being flocculated, or broken up. Suspensions of clay in natural waters may be sometimes flocculated by carbon-dioxide; the possibility of this gas acting on dip emulsions in this manner must, therefore, not be overlooked.

In order to test whether the free carbon-dioxide in the fountain water exerted any appreciable effect in destroying the emulsion of



“A,” some of the water was placed in a chamber from which all air was pumped. This had the effect of extracting from the water a good proportion of its dissolved gases, including carbon-dioxide. The water was then used to make an emulsion with “A.” The result was a separation of 9.7 per cent. of oils, viz., 1.2 per cent. less than occurred when the untreated fountain water was added to “A.” It would, therefore, seem that one must not overlook the presence in them of free carbon-dioxide when judging of the suitability of a water for mixing with a “carbolic” dip.

The effect of removing both carbon-dioxide and calcium and magnesium carbonates was studied in the following way:—A water of the kind we are dealing with loses its free carbon-dioxide and deposits nearly all of its magnesium and calcium carbonates on being boiled. A quantity of water was, therefore, boiled until its original bulk was reduced to about one-half. The carbonates which separated out were then removed by filtration, and the original volume of the water restored by the addition of carbon-dioxide-free distilled water. The water was then cooled to room temperature, after which an appropriate quantity of “A” was mixed with it. The result was that only 4.7 per cent. of the oils separated.

Yet another experiment was made.

Every one knows that when soap is added to hard water, as in washing, a curdy precipitate is formed, and that the harder the water the more soap one requires to produce a lather. The calcium and magnesium salts of waters are those responsible for the formation of the curdy precipitate, and it is not until the maximum amount of curdy precipitate has been formed that the water will yield a permanent lather. Further, the curdy precipitate contains the calcium and magnesium that were responsible for the hardness of the water. In other words, soap softens water by removing calcium and magnesium salts from it as a curdy precipitate.

A quantity of water was, therefore, taken, and to it rather more than enough soap solution was added to produce a permanent lather on shaking. The curdy precipitate formed was separated by filtration, after which the water had added to it an appropriate quantity of “A.” Only 3.4 per cent. of oils separated out: another proof that the destruction of the soap of the dip is very largely responsible for the failure of it to form a true emulsion. It should, however, be observed that although there was in this experiment an excess of soap there was still an appreciable separation of oils; this means that the separation of the oils is not due to hardness of water alone.

The results of the experiments are now summarized:—

- (1) It was not found possible to obtain a true emulsion by mixing “A” with either fountain or distilled water; but distilled water mixtures contained very much less separated oils than the fountain water mixtures.
- (2) The most perfect emulsion was obtained by boiling the distilled water before mixing it with “A,” the explanation being that boiling expelled dissolved carbon-dioxide from the water.
- (3) A slightly improved emulsion was obtained with fountain water by placing it in a vacuum chamber (to remove carbon-dioxide) before mixing it with “A.”

- (4) An emulsion equally good as that made with unboiled distilled water was obtained by softening the water with soap prior to mixing it with "A."
- (5) An emulsion almost equal to that above described in (4) was obtained by partially softening the water prior to use by boiling it.

The conclusions drawn from the above five points are (1) "A" does not give a perfect emulsion with fountain water chiefly because the latter is somewhat hard, and (2) because it contains dissolved carbon-dioxide; (3) it is also possible that "A" had not been properly manufactured. There is another point that would seem to have considerable significance, which is that the full separation of oils from the untreated fountain water mixture took some time, although the major quantity separated within half an hour. Further, it was found that two or three filtrations through blotting-paper sufficed to free the emulsions from their separated oils. The questions that now must be answered are: "Why did the dip kill the sheep?" and "Why did all of the casualties occur amongst the first 33 dipped?"

The writer's conclusion is that the first sheep dipped took with them out of the tank, not a chill, as suggested by the pamphlet, but separated oils; that through this they were, in effect, dipped in too strong solution. It might be asked: "Why did not all the 33 die?" It should be remembered in this connection that the separation of the oils was found not to be an instantaneous process; but more important still is the well-known fact that, of human beings, some are much more resistant than others to the poisonous action of the constituents of this class of dip; it is only reasonable to presume that similar idiosyncrasies obtain amongst sheep.

#### DIP "B."

Before the end of that year another case came under the writer's notice, in which a coal-tar dip, used to destroy keds, was suspected of killing sheep as well. This dip is referred to as "B."

In this case the dip was mixed and used according to instructions, excepting that rather more water was used than prescribed.

The owner of the sheep stated that his sheep had been dipped a day or two previously, and that many of them had died. The writer visited the flock, and was fortunate enough to be accompanied by Mr. E. N. S. Warren, the Lecturer in Sheep and Wool at Grootfontein.

The method of dipping was described by the owner, and Mr. Warren was satisfied that the cause of mortality could not be ascribed to any fault in the handling of the sheep. The following are the particulars of the dipping:—

The dipping tank used was much larger than that used with dip "A"; its capacity was well over 600 gallons; 560 gallons of dip were actually used.

The sheep dipped numbered 285; they were dipped in four lots, i.e.:—

(1) 40 rams; (2) 180 ewes; (3) 15 ewes with lambs; (4) 50 ewe lambs, 7 to 8 months old.

*Deaths.*—Of lot (1), 14; of lot (2), 1.

No other deaths occurred, but on our arrival at the farm several sheep were in a very bad state, i.e. several of lot (1), 15 of lot (2), none of lot (3), and 3 of lot (4).

For these sick sheep, brandy and white of egg was prescribed, a treatment which proved efficacious.

The ante-mortem symptoms were described as follows:—

“The animals were noticed to stand panting a good deal; they were very short of breath; they got tired, went down and died. They passed water frequently, and there was a frothy discharge from the nostrils.”

On opening some of the sheep that had died the following appearances were noted:—

Lungs: Much inflamed and congested; tissue appeared to be soft.

Windpipe: Inflamed, and containing frothy matter right up to the nostrils.

Gullet: Normal.

Throat: Normal.

Mouth: Bluish, otherwise normal.

First, Second, and Third Stomachs: Normal.

Fourth Stomach: Somewhat inflamed.

Liver: Normal.

Bladder: Very contracted and hard, and containing a very little whitish coagulated fluid.

Intestines: Very much inflamed and containing whitish mucoid substance.

It will be observed that the above symptoms bear a considerable resemblance to those described by Veterinary Surgeon Simson in connection with dip “A.”

*Analysis of the Water* (grammes per 100,000 c.c.).

Sodium carbonate ... ..	1.59
Calcium and magnesium carbonates ... ..	25.50
Sodium chloride ... ..	2.94
Free carbon-dioxide ... ..	Nil.

This water would be described as a moderately hard one. It differs principally from that described above in that it contains less sodium carbonate, more salt, and no free carbon-dioxide. The dip was not analysed; it was obviously a coal-tar dip.

Experiments with water and “B” showed that on mixing them according to directions it was impossible to obtain a good emulsion. No quantitative measurements of the amount of separated oils were made, as it was not thought necessary.

Asked by the proprietors of “B,” the writer informed them that in his opinion the sheep had been killed by the absorption through the skin of the phenoloid substances of the dip, and that the mortality was almost entirely confined to the first lot of sheep suggested these had removed the separated oily globules in their fleeces, leaving the dip in a less dangerous condition for those that subsequently passed through it.

This view was not accepted; a test dipping made with another water, reputed to be "brak," seemed to show that the writer may have been mistaken. Some months after this test dipping, however, he was able to analyse the water; it contained:—

	Grammes per 100,000 c.c.
Sodium carbonate . . . . .	12.0
Calcium and magnesium carbonate . . . . .	29.0
Sodium chloride . . . . .	3.0
Free carbon-dioxide . . . . .	Nil.

The analysis shows the water to be very similar to that used at the farm where the fatalities occurred, excepting that it was a little bit harder: also that it contained a good deal more sodium carbonate, a point possibly in favour of a non-separation of oils from the emulsion. It is also necessary to state that between the time of the test dipping and the time the water was analysed, there had been several months of drought, which suggests that the water may not have been so hard at the time of the test dipping.

Another point in connection with the test dipping is that a less quantity of dip was made—less than half that made when the sheep were killed. This alone means that somewhere about half as much separation only occurred. It was stated, however, that although no sheep actually died from the test dipping, some were badly affected.

Wishing, however, to satisfy themselves by actual trial, the proprietors of "B" arranged for a test dipping in the tank and with the water used when the deaths occurred. The writer was asked to be present at the dipping, an invitation which was gladly accepted.

Dip of prescribed strength to the amount of 490 gallons was made, and through this 55 sheep were passed; of them four had died within a few days of the dipping; others would probably have died had they not been dosed with brandy and white of egg.

This test dipping left no doubt as to the harmfulness of the dip when used with that water.

It was noticed that when the dip was made there was a considerable separation of oils. A sample was taken of the well-mixed dip before the sheep were put through, and a further sample after the dipping had been completed. On placing these in separating funnels, it was found that there were, practically, no separated oils in the latter; but a considerable quantity in the former, proving that the sheep do take out the separated oils in their fleeces. This was also obvious from the very dark colour of the fleeces of some of them.

Further, a sample of urine taken from the bladder of one of the sheep that died was found to contain decomposition products of phenols. This was to be expected if the animal had died from phenolic poisoning, because the urine is the channel through which these poisons are eliminated. Since, from observation the sheep had not taken dip through the mouth, it would seem that there must have been absorption through the skin.

It may be added that medical literature abounds with cases where death has followed the extensive covering of the body with carbolic fluids. An instance is taken from Wynter Blyth's book, page 181. A surgeon prescribed for two joiners who suffered from scabies a

lotion which contained 33.26 grammes carbolic acid in 240 c.c. Each man was estimated to have used 13.37 grammes of carbolic acid. One of the men died: the survivor described his own symptoms as follows:

“ He and his companion stood in front of the fire and rubbed the lotion in; he rubbed it into his legs, breast, and front part of his body; the other parts were mutually rubbed. Whilst rubbing his right arm, and drying it before the fire, he felt a burning sensation, a tightness and giddiness, and mentioned his sensations to his companion, who laughed. This condition lasted from five to seven minutes, but he did not remember whether his companion complained of anything, nor did he know what became of him, nor how he himself came to be in bed. He was found holding on to the joiners’ bench, looking with wide, staring eyes, like a drunken man, and was delirious for half an hour.” He soon recovered. “ The other joiner seems to have died as suddenly as if he had taken prussic acid. He called to his mother, ‘ Ich habe einen Rausch,’ and died with pale, livid face after taking two deep, short inspirations.”

“ The post-mortem showed the sinuses filled with much fluid blood, and the vessels of the pia mater congested. Frothy, dark, fluid blood was found in the lungs, which were hyperaemic; the tissues of the epiglottis and air-tubes were reddened and covered with a dark, frothy slime. Both ventricles—the venae cavae and the vessels of the spleen and kidneys—were filled with dark, fluid blood. The muscles were very red; there was no special odour.”

It should be pointed out that the lotion used probably contained true phenols, as well as creosols, so that a comparison with the effects caused by carbolic dips would not be altogether just. It is, however, known that for some animals, at least, the higher phenols and crude creosols are just as poisonous, if not more so, than pure phenol. Moreover, reference to veterinary literature indicates that the application of coal-tar dip emulsion to the skin of cats and dogs is attended with considerable risk; I have, however, been unable to find any reference to their bad effect on sheep.

The question arises: Could anything be done to make these dips safe with all waters? This is a matter which requires investigation. It may, however, be pointed out that the first sheep that go through the dip—usually the farmer’s best, presumably because the dip is then clean—take the dangerous separated oils out with them. It might, therefore, be possible to free the dip wash of its separated oils by drawing absorbent material through it; for example, a framework bearing absorbent material could be drawn slowly upwards from the bottom of the tank and out; this would take out most if not all of the separated oils. Softening the water before use or adding more soap to the concentrated dip are also methods which suggest themselves. There is also good reason for believing that small tanks are safest. If the water is “ brak ” the separation of oils is so obvious that one cannot help noticing it and danger is avoided. It would seem to be the water that causes the separation of minute globules of oil which is so dangerous; of this type are the waters dealt with here. Tiny globules, unless specially searched for, may also be easily overlooked.

As to the remedial measures, stimulants are valuable. The animal could also be washed well with a solution of epsom salts in water; an hypodermic injection of a watery solution of glauber salts is also recommended.

Very recently another coal-iar dipping fatality, involving the loss of many valuable sheep, has come to notice. The dip, here called "C," for scab eradication, was directed to be used at a strength 1:70. The strength used by the farmer was 6 dip to 680 water, or, roughly, 1 to 113, his object being to destroy "keds." The water contained carbon-dioxide, and was moderately hard (26.5 grammes carbonates per 100,000 c.c.). It gave an imperfect emulsion with Dip "C"; but a mixture of the same water with storm water gave an emulsion from which practically nothing separated; the mixed water also contained carbon-dioxide, but was only about one-half as hard as the fountain water.

The result of the dipping was as follows:—

Of 1st lot of 26	8 died, or 30.7 per cent.
Of 2nd lot of 25	7 .. .. 28.0 ..
Of 3rd lot of 43	2 .. .. 9.3 ..
Of 4th, 5th, or 6th lot of approximately 20 sheep	1 .. .. 5.0 ..
Of last lot of 125	2 .. .. 1.6 ..
	—
Total	20 6.9 per cent.

The above figures show very pointedly the progressive decline in the toxicity of the dipping fluid as the sheep are dipped.

The following are the symptoms described by Government Veterinary Officer Simson, who saw some of the sheep before they died, and who also made post-mortems:—

*Ante-mortem*—

- (1) Respirations accelerated with occasional grunt, as if respirations were painful.
- (2) Odema between jaws and on face of one animal.

*Post-mortem* (3 rams)—

- (1) Subcutaneous odema and congestion, most marked in one with heavy folds on neck; the other two animals were of a plainer bodied type.
- (2) Lungs: Intense congestion or pneumonia.
- (3) Nephritis in one.
- (4) Bladders contracted and containing whitish mucoid material.
- (5) Blood smears; negative.

(These post-mortems were not made immediately after death.)

It may be stated that Mr. Simson's diagnosis in connection with the above mortality was that the "sheep had been poisoned in dipping by absorption of phenoloid substances through incomplete emulsion of dip and water."

The object in now publishing this paper is to warn both sheep farmers and dip proprietors that while these so-called carbolic dips are safe with some waters they are unsafe with others.

The most dangerous water would appear to be that which is moderately hard; because the oily globules separated under these conditions are very tiny and easily overlooked (as in cases "B" and "C" above).

Probably the most reliable test for the separation of dip oils, in cases of doubt, is to prepare some of the dip wash and pour it through a piece of blotting or filter paper folded so as to fit a funnel. Some, at least, of the separated oils should be retained by the paper. The risk that sometimes attends the dipping of sheep in these fluids has also been noted in America, and farmers have been warned accordingly (*vide* Farmer's Bulletin No. 798, U.S.A. Department of Agriculture).

---

#### NOTE ON THE PHYSIOLOGICAL ACTION OF CARBOLIC ACID.

---

By P. J. J. Fourie, M.R.C.V.S., Lecturer in Veterinary Science,  
Grootfontein School of Agriculture.

---

Wallis Hoare, in his *Veterinary Therapeutics*, ascribes to toxic doses of carbolic acid a special action on the nervous and circulatory systems.

"On the nervous system after primary stimulation it produces paralysis of the medulla and spinal cord."

This would account for the nervous symptoms which are described in connection with poisoning by this agent, i.e. "muscular tremors, staggering gait, accelerated respirations, convulsions succeeded by coma."

. . . "on the circulation after primary stimulation, it causes fall in blood pressure."

On this account one would expect to find on post-mortem examination great congestion of the lungs.

"The urine assumes a characteristic olive green or brown colour."

This was found in one of the cases referred to by Mr. Stead.

Why the bladder was usually empty and contracted may probably be explained on the ground that the poison which becomes excreted through the kidneys acted as a local irritant in the bladder, and caused the reflex contraction of this organ.

The subcutaneous hæmorrhages referred to in the paper are probably due to the toxic influence of the material on the capillary walls.

The post-mortem changes, according to Wallis Hoare are—

"patches of inflammation in the stomach and intestines, and the kidneys may show inflammatory changes."

## CANNING CLUBS.

By H. E. KING, Secretary, South African National Union.

THE world war called into being many new kinds of industrial activity, and the constantly increasing cost of living has revived forms of domestic handicraft which had fallen into disuse. The preservation of fruit in Great Britain had been to a large extent left to big packing establishments, which were able to turn out superior grades of tinned goods at very moderate prices. During the war, however, efforts were made to stimulate the manufacture of jam and the preservation of fruit in the home. In America, co-operative canning has been carried on with success for some time, and lately there has arisen a desire in South Africa to establish canning clubs on somewhat similar lines. It is well that in this country of widely separated markets there should be an organized movement to induce women to conserve, by means of home canning and preserving, fruit and vegetable products that would otherwise go to waste. While the production of such forms of food for use in the home is essential, it is desirable that they be prepared in such a manner and be of such a quality as will fit the surplus for sale as a commercial commodity. It may therefore be valuable to show how these clubs can be worked. They do not aim at production on a large scale, but rather at catering for those who have a preference for home-made products.

Canning clubs are groups of persons who buy co-operatively a canning outfit, and use it in common. In America the work is done by women, assisted by Government with expert advice, and, if wanted, expert supervision. Although many women in South Africa are adepts at preserving food in small quantities for the home, their methods are unsuited to the economical production of a commercial commodity. For that reason it is essential that they should *combine* so as to *reduce the cost of production* to the lowest possible figure and to ensure a uniform quality of article.

In every centre where fruit and vegetables are plentiful, and where there is a sufficient number of people living in close proximity, the women concerned should form themselves into a co-operative society, with a small capital, payable in calls of 5s., as may be required. A large room should be secured and fitted with the necessary equipment, a canner, peeling machines, soldering apparatus, bottles and tins, together with strong tables and chairs. The cost of all these need not exceed £25 to £30. A supply of sugar sufficient for the products it is expected to treat during the year should be purchased in bulk at wholesale rates, together with a stock of any other articles, such as cans, bottles, labels, etc., likely to be required during the season. This is one of the purposes for which capital is needed.

*The members of the society must secure all their supplies at the lowest prices, and therefore they must be in a position to buy for cash.*



Having equipped and stocked the premises, the club will be ready to receive from members supplies of fruit and vegetables. Additional quantities may be purchased if desired from outside sources. A record will be kept of each quantity sent in and the value thereof, which will be decided by a small committee appointed for the purpose. Members having agreed on the share of the work to be done by each will then meet daily and can the different products on lines to be decided beforehand. Some will attend to the peeling, some to the preparation of the fruit and vegetables, and others to the cooking and the packing. Efficiency will be increased by specialization in particular branches of work. Where it is necessary to hire labour, it will be paid from the common fund, but for economical reasons as little outside help as possible should be used. One member should be told off to keep records of cost, so that the amount expended on the production of any particular article can be readily ascertained. In the end the finished articles will be marketed in bulk and the profits distributed pro rata, i.e. according to the value of the fruit, etc., supplied by a member, or the amount of work done by her, which will be reckoned as worth so much per hour.

Women will be able to bring their fruit and vegetables to a common centre and can or bottle them by the most up-to-date methods and in the most expeditious manner. The cost will be reduced by the purchase of everything at wholesale rates. And by reason of the quantities produced on a uniform system sales on commercial lines will be possible. The quantities to be dealt with will be limited only by the supplies offering and the energy of the members.

Briefly the object of these clubs is to enable members to can or bottle their fruit and vegetables, and convert them into *saleable* articles. They may buy back any quantity they may wish to retain for their own use.

In its early stages each club will necessarily be on experimental lines, but in time as the work progresses and develops and the skill of the workers becomes assured, a definite scheme will be evolved.

The following are suggestions for the early operations of a club:—

1. One or two members to be appointed to take charge, and a secretary elected. The first year these posts should be honorary, but once the canning club is established and has proved itself, their services should be remunerated and included as part of the cost of production.

2. Products "put up" during the first year should be disposed of locally. In the second year, when greater efficiency has been attained, they may be put on the market, after due inspection, properly labelled, and with the club stamp, which should stand as a guarantee of excellence.

3. At the end of a fixed period profits to be divided, only *working members* to participate in this privilege.

4. A register to be kept showing time and labour put in by each member; members to benefit according to their share of the work, i.e. they will be credited with the cash value of such work.

5. All materials used, i.e. fruit, sugar, jars, tins, fuel, etc., to be purchased by the club.

6. An accurate account to be kept by the secretary of all expenditure and receipts.

7. Should any money be borrowed or advanced by members or others, interest must be paid thereon at a rate to be agreed upon.

Each club will require:—

- (a) A canning outfit, with a capacity of several hundred cans or jars daily; (b) a supply of jars and tins; (c) soldering outfit; (d) suitable workroom; (e) tables, chairs, and utensils.

Any woman can be a member of the club, but need not necessarily be a *working* member. Non-working members will pay a yearly subscription, and be entitled to purchase the articles made at the same rates at which sales to others are made. *Working members only share in profits.* Working members should be divided into groups and working days appointed. It is in order to avoid confusion and to arrive at actual costs, that all materials and work should be paid for, not necessarily at once, but at regular intervals.

Later, when the club has grown in size and efficiency, it can be reformed on larger lines, and registered under the Co-operative Societies Act.

In order to arrive at exact costs, it is essential that accurate records be kept. The following is an

#### EXAMPLE OF ACCOUNT.

Order No. 64.—Date of work 26-27-28 Dec., 1920.

Description and quantity of products treated: 5000 yellow peaches.

Received from Mrs. Smith, 1000 at 3s. ...	£1 10 0	
.. .. Prinsloo, 1000 at 3s. ...	1 10 0	
.. .. Jones, 1000 at 3s. ...	1 10 0	
.. .. P. Uys, 500 at 3s. ...	0 15 0	
Purchased, 1500 at 3s. ...	2 5 0	
		£7 10 0
Sugar used: 125 lb. at 5d. ...	£2 12 1	
Containers used: 500 at 8s. 6d. doz. ...	17 14 2	
Labelling, etc. ...	1 7 6	
Fuel and sundries ...	1 5 0	
Labour: Mrs. Green, 8 hours at 2s. 6d. ...	1 0 0	
Mrs. Swart, 8 hours at 2s. 6d. ...	1 0 0	
Mrs. Malherbe, 12 hours at 2s. 6d. ...	1 10 0	
Overhead charges (use of equipment, etc.).	3 5 0	
		£29 13 9
Total cost of production of 500 tins = 18s. per dozen tins ...		£37 3 9

This is the *kind* of account that should be kept, but the figures are only approximate.

## THE DEPARTMENT OF AGRICULTURE DURING THE WAR.

---

[This article, which commenced in the May, 1920, issue, briefly reviews the work carried out by the various branches of the Department during the years of the war, and records some achievements despite the many difficulties encountered through the abnormal conditions then existing.—ACTING EDITOR.]

---

### GUANO ISLANDS.

THE office of the Guano Islands undertakes the conservation, collection, shipment, and sale to the public of guano, seal skins, etc., obtained on the various islands belonging to the Union, and is charged with the administration of all matters connected therewith.

The crop of guano collected in 1914 was the highest on record, being 8133 tons, of which 7076 tons were distributed, the balance being left in reserve against possible shortage in the future. The sale price was increased from £5 to £7. 10s. per ton, operating from the commencement of 1915. During the season 4172 seal skins were secured; prices for skins ruled low, for some shipments only 9s. per skin being obtained. The erection of a sea-wall round a large part of Ichaboo, our principal guano-producing island, was proceeded with, the purpose being to increase the breeding area available for the birds and so ensure an increase in the guano yield.

During 1915-16 the demand for guano increased, notwithstanding the advance in the price, and exceeded the supply. The consumption was almost entirely confined to the south-western Cape districts. Compared with the prices charged for artificial fertilizers, even in normal times, the charge of £7. 10s. per ton for guano was very cheap. The practice, which had been in operation for a few years, of maintaining a reserve for the purpose of supplementing the supply in lean years, bore fruit at this time, and the reserve in hand was most useful on account of the dearth of fertilizers resulting from the war. The total yield (which was affected by abnormal weather conditions) for the year was 7220 tons, a decrease of over 900 tons on the record yield of the previous year, but still above the average annual yield. Over half a million eggs were collected and disposed of, but sealing operations were entirely suspended throughout the year owing to the slump then prevailing in the fur-skin market. Altogether this branch of the Department's activities brought in a profit of £41,961 for the year. Owing to the increase in the cost of freight, bags, supplies, etc., the cost of collection rose considerably.

A continuance of unseasonable weather and an absence of fish during part of the year, which affected the birds' breeding season, were the cause of a further decline in the guano output, which totalled 6900 tons for 1916. In consequence of rising costs following the war, it was necessary again to increase the charge for guano, which from the beginning of 1917 was £10 per ton, this being about the market value of the article in normal times. The demand continued to be far in excess of the supply, the quantity applied for in

1916 totalling 26,594 tons, while only 6118 tons were supplied, about 95 per cent. of which was absorbed principally by the Districts of Malmesbury, Paarl, Cape, Caledon, and Stellenbosch, the demand from other centres of the Union remaining very much as in former years. In how far the applications were affected by the high price of grain and of artificial fertilizers cannot be gauged, but every effort was made to allot the guano as fairly as possible and to guard against inflated individual orders. Over 544,000 eggs were collected, while a rise in the seal skin market brought a renewal of sealing operations, which resulted in 878 skins being obtained and shipped to London; they fetched very satisfactory prices. The net profit derived from the Guano Islands in 1916 was £19,663.

Similar conditions to those which prevailed during the previous year affected the yield of guano in 1917-18, the total being 6965 tons. The demand as usual exceeded the supply, and the guano was disposed of by allotment as before, but two changes were made in the sale of it. Owing to the necessity for growing as much wheat and other grain and potatoes as possible the use of guano was restricted to those crops, and with a view to preventing inflated applications and ensuring its use for the specified crops only the applications received from the chief consuming districts were, with the assistance of magistrates and field cornets, carefully scrutinized and after revision dealt with in the ordinary way. Nearly all the guano was sent to districts in the south-west of the Cape Province. In consequence of mortality among penguins it was decided to confine the collection of eggs to Dassen Island only, the number obtained in 1917 being 410,400, for which £2137. 10s. was paid. Sealing operations, in view of the rise in the market for skins and oil, were proceeded with, resulting in 7015 skins and 3846 gallons of oil for the year, the skins being sold in London at prices varying from 31s. 2d. to 37s. 6d. each. The year's working resulted in a profit (exclusive of free issues and services) of £37,120. In order to augment the supply of fertilizers, of which there was a serious shortage in the country, arrangements were entered into for collecting from certain islands what is known as "riddlings," that is the rubbish (nests, etc.) taken out of the guano collections in the process of cleaning, which, though not of course as valuable as guano, was useful for vines, fruit trees, and other permanent crops, and helped to relieve the situation. A quantity of approximately 4000 tons of guano phosphate from Cape Cross, in the South-West Protectorate, was purchased from a syndicate, who had previously been in the habit of shipping it to Europe, for £9. 10s. per ton f.o.b. Capetown. Then, also, a deposit upon Bird Island was investigated in the hope that it might be useful as a fertilizer, but upon analysis it was found to be of little manurial value.

#### GRAIN DIVISION.

This division is entrusted with the grading of grain, etc., exported from the Union.

The grading of maize in 1914-15 continued to give satisfaction in essential particulars both to buyers oversea and to shippers, the quantity of maize exported during the year being 1,156,247 bags, and the exports of oats (1914) totalling 83,357 bags. A small quantity of barley was shipped, this being the first occasion of barley in any

quantity being exported to Europe, due solely to war conditions. A few thousand tons of lucerne-hay were exported for account of the Imperial military authorities, and on the whole satisfactory reports were received as to the quality. The division undertook the inspection of the lucerne before shipment, and of the total quantity presented for export 149 tons were rejected by the inspector. The annual maize conference, at which merchants, producers, the Union-Castle Shipping Company, and the Government are represented, was held regularly each year and much benefit derived therefrom. Owing to the war the Union-Castle Company renounced its agreement with the Government to convey maize to Europe at 10s. per ton, and fixed the freight rate at 30s., which was subsequently raised to 52s. 6d. A drop at that time in the market price in England for the cereal meant small returns for the farmer, and the position was aggravated by lack of sufficient accommodation on steamers to dispose of our surplus, a matter which received the earnest attention of the Government.

The 1915 maize crop was the largest on record, being estimated at 10,250,000 bags, and the quantity exported was approximately 2,484,000 bags. Australia was a very big buyer, taking no less than 632,190 bags, most of the balance going to the United Kingdom. In addition, the division passed for export during 1915-16 3066 bags of barley, 85,466 bags of Kaffir corn (the latter for the first time in quantity), 50 bags of lucerne seed to Australia (the first shipment of this seed that had left the Union), 32,358 bags of oats (a reduction on the previous year's shipments owing to additional consumption in the Union for military purposes), and 229 bags of millet. The quality of the maize exported during the season was excellent and very little was rejected for unsoundness or other reasons. No complaints were received of the grading, which appeared to have given complete satisfaction. A large number of standard samples of maize and Kaffir corn was sent out by the division. The question of freight greatly exercised the Government, and active steps were taken to secure cargo space for our maize. The rate of freight was changed during the year, being fixed at 63s. on the 1st January, 1916, a favourable one compared with the rates paid by Argentine shippers.

The produce passed for export by the division during the year 1916-17 was 1,334,608 bags of maize, 11,871 bags of hominy chop, 772 bags of maize meal, 1842 bags of barley, and 5084 bags of Kaffir corn. There was a falling off in quantity as compared with that shipped the previous year owing to an unfavourable crop season. The quality and condition of the maize was good. The grading continued to give satisfaction both in this country and abroad. In the United Kingdom our maize has got an excellent name, the grader's certificates being said to be so reliable as to be as negotiable as bank notes. As a consequence of this excellent result very little grain or seed of any kind was exported without reference to the division, and many requests were made that the system of grading should be applied to the home as well as the export trade. The export grades for maize and Kaffir corn fixed in 1915 were maintained, and large numbers of samples were made up and distributed.

The maize crop reaped in 1917 was the largest yet grown, and during the year 1917-18 4,314,694 bags of maize and its products were exported. The quantity, moreover, would have been greater but for heavy rains which carried on into the ripening and harvesting period

and partially through the winter months: as a result the quality of the grain was not so good as usual. The inadequacy of proper storing facilities caused great loss through dampness, the present system of storing and handling being expensive in addition. Consequently a committee was formed for dealing with the maize traffic, and the report eventually submitted by it favouring the erection of elevators will have a far reaching beneficial effect on the trade. In the absence of elevators, and with a view to assisting farmers and traders and of preventing the shipment of damp maize to the ports, provision was made during the year for the grading of maize at railway stations in the chief maize-growing areas, four graders being appointed for the purpose. Another feature of the year was the purchase of practically the whole of our surplus maize by the Imperial Government at prices based on those paid for the maize already bought by merchants. Another new departure was the purchase by the Imperial Government of large quantities of maize meal in the Union for use oversea. This was the first occasion maize meal was exported in any quantity, and with one exception the meal arrived in good condition and gave satisfaction. Our maize is well grown, is sent over in good condition without being artificially dried, and its grading can be relied upon, and it is interesting to note that our No. 2 maize was recommended to farmers for growing maize for ensilage by the English Board of Agriculture. In addition to maize other products exported under the supervision of the division were Kaffir corn 2796 bags, barley 7384 bags, dried peas 3258 bags, dried beans 1119 bags. The purchasers of seeds exported from the Union all stipulate for certificates of quality and purity by the Government, and the division did its best to meet these demands. Standard samples of maize, etc., were made up on the standard set in 1915, and a large number of sets was disposed of to traders, farmers, and others interested in the export and local trades.

#### FENCING AND BRANDS.

The administration of the laws relating to fencing and brands, and the publication of the "Brands' Directory" required by the Transvaal Brands Act, are matters forming a separate section of the work of the Department.

*Fencing.*—This matter is governed by the provisions of the Fencing Act of 1912 (No. 17), and though the high prices of fencing material caused by the war retarded the extension of fencing which would otherwise have taken place, and the number of applications for advances in terms of Section 3 of the Act decreased year by year, there was nevertheless a forward movement and a smooth working of the Act, it being clear that with a return to better conditions fencing would be vigorously pursued, as its value was becoming generally recognized. The obligatory provisions of the Act were gradually extended to those parts of the Union in which compulsory contributions by adjoining properties were not already enjoined by law.

*Brands.*—Legislation varies in the different Provinces, and in Natal there is no Brands Act. The Orange Free State and Cape Acts leave the choice of brands and of their position on the animals to the applicants. The Transvaal Ordinance (No. 15 of 1904) limits the choice to such of a series of brands, arranged on the three-piece

system, as have not already been allotted, and also prescribes the position they are to occupy on the animal; this system proves to be the best in the interests of stock owners, and the need for uniformity throughout the Union based on the Transvaal system was freely expressed. Owing to scarcity of paper it was not possible to publish all the Brands' Directories, but the deficiency was met by the regular publication of quarterly returns and of lists showing the additions and amendments to the directories and the cancellations of brands. The number of brands registered steadily increased during the period of the war. This was specially noticeable in the Transvaal, where, owing to its Brands Ordinance, farmers have availed themselves of the benefits conferred by proper branding of stock, and registrations far exceeded those in the Cape and Orange Free State Provinces, notwithstanding that the Transvaal Act was of more recent date. On the 31st March, 1918, the total number of brands registered was 27,526, of which 20,350 were in the Transvaal, 5647 in the Cape Province, and 1529 in the Orange Free State.

#### CROP AND LIVE STOCK REPORTS.

The need of reliable and up-to-date information regarding the growth of the country's principal crops and their probable yield, together with the condition of live stock, becoming increasingly felt, the Department inaugurated a scheme of crop reports, and commencing with September, 1915, a Crop and Live Stock Report has since been published regularly every month. The principal crops of the country were dealt with, and in the face of many difficulties it was endeavoured to keep the public informed of the progress made by the crops month by month and to afford a means of arriving at an estimate of probable production. A comprehensive statement regarding the condition of large and small stock throughout the Union from a slaughtering point of view was also included. It is obvious that reliable forecasts of crops production are essential; farmers are benefited both directly and indirectly—directly by being kept informed of crop prospects and prices outside of their own immediate districts, and indirectly because the disinterested reports of the Government tend to prevent the circulation of false or misleading reports calculated to depress prices. Merchants in the distribution of their wares, the railways in arranging the handling and transport of produce, and the shipping companies in the providing of freight, are also benefited by reliable forecasts of crop production.

The following is a brief explanation of the system at present in operation:—

1. In each producing district of the Union a number of farmers, judiciously distributed, furnish gratuitously monthly crop reports. Each of these farmers, who is known as a crop correspondent, reports on the crops growing on his own farm and the farms adjoining it.

2. These reports are sent on a specified date to the Magistrate of the district, where they are scrutinized, weighed, and averaged, the result being telegraphed to Pretoria.

3. Two classes of reports (excepting in respect of fruit) are furnished by the crop correspondent, viz.:—

- (a) When sowings are completed he fills in a card showing the change (if any) in the area under crop as compared with

the previous year. For this purpose the figure 100 always represents the acreage under crop the previous season. Thus, for instance, if the acreage under maize in 1919 is the same as in 1918, he will report 100; if it is, say, 50 per cent. greater, he will report 150; or if it is, say, 10 per cent. smaller, he will report 90, and so on.

Upon receipt of this information the Department's estimate is made of the season's prospective normal yield.

- (b) After the above report has been furnished the crop correspondent sends in monthly during the growing season a report as to how the crop is progressing. If it is growing as he would expect to see it in an ordinary favourable season it is *normal*. Thus, if the crop is considered to be making normal growth (in other words, has such appearance as to promise a return per acre expected in an ordinary favourable season), he reports normal, represented by the figure 100. Variations from 100 indicate that the condition of the crop is either above or below normal, as the case may be.

Upon receipt of this information, the Department's original estimate of the yield is amended month by month as required should it be found that the crop growth is above or below normal. When the crop has reached maturity the estimate is finally fixed as a rule by accepting the latest monthly report (for example, June in the case of maize) as showing the final condition.

The success of the scheme depends upon the public spirited co-operation of the farming community. The service is small. It entails no letter-writing, but at the most a few minutes only in filling in once a month a few items on a post card. Since the introduction of the system the Department, with the assistance of Magistrates, has steadily been educating the farmer in the method of reporting, perfecting the proper representation of each district, and generally building up a system of crop forecasts which will be of great value to our country. There is evidence that the Crop Report is attaining its object and is becoming recognized as an indispensable adjunct of the machinery of State.

#### ADULTERATION OF WINES, SPIRITS, AND VINEGAR.

The administration of Act No. 15 of 1913, which prohibits the use of certain substances in wine, spirits, and vinegar and regulates their manufacture and sale, is carried out by the Department. A vigorous pursuance of the provisions of the Act is fraught with much importance to the viticultural industry, for it ensures the production of a good article, protects the consumer, and prepares this country for competition in the world's markets with the produce of other countries by insisting on a standard of excellence in our viticultural products. During 1914-15 770 samples of wine, brandy, whisky, gin, rum, and vinegar were analysed, and 13 per cent. (mostly rum and vinegar) were found to be adulterated, deficient, or not genuine. In addition 221 liquors were analysed on importation. In 1915-16 742 samples were analysed; again 13 per cent. (mostly vinegar and



brandy) being found adulterated, etc. The following year the number of samples analysed was 1036, the number found adulterated, etc., being 21 per cent., of which by far the largest number were brandies. During 1917-18 the number of samples taken increased to 1234, and 21 per cent. of those analysed were deficient or adulterated, again mostly brandies. Practically all cases of adulteration of spirits were caused through the addition of water. In addition, 121 samples of liquors were examined on importation. For contraventions of the Act a large number of prosecutions were instituted by the Department and many convictions followed, and generally satisfactory control of that part of the liquor trade falling under its jurisdiction was exercised.

[This review will be concluded in the next issue of the Journal.]

---

### Naphthalene for Fowl Lice.

In connection with the testing of proprietary insecticides, the Insecticide Board of the United States Department of Agriculture conducted a series of experiments to determine the value of naphthalene against fowl lice. Naphthalene is said to be a very common ingredient in proprietary lice powders, and to be also sold in the form of nest eggs. The experiments are reported in the October, 1919, issue of the *Journal of Economic Entomology*. The findings are summarized as follows:—

1. Powders containing 5 per cent. or less of naphthalene are of no value against lice.
2. Powders containing from 10 per cent. to 20 per cent. are very effective.
3. As little as 10 per cent. naphthalene may temporarily injure hens, if the powder is well rubbed in, and 60 per cent. or more may kill the treated fowls under the same conditions.
4. Naphthalene (60 to 100 per cent.) sprinkled over the backs of fowls at roost proved to be of considerable value against lice.
5. Naphthalene nest eggs are of no value against lice on laying or setting hens.
6. The data obtained indicate that setting hens, the eggs, and possibly any chickens hatched, are injured by these eggs.

The failure of naphthalene nest eggs to control the lice is ascribed to the fact that the vapour given off is over four times heavier than air, and consequently does not work up through the feathers. The nest eggs were also quite valueless against the common fowl mite. The dusting of the fowls at night had to be done without disturbing them much in order to be successful, and some failures were put down to the powder being shaken off.

## “ KUDZU ” (*Pueraria thunbergiana*).

By SYDNEY M. STENT, Botanist, Division of Botany, Pretoria.

DURING the last few months so much has been written and talked about the wonders of Kudzu, and so many letters of inquiry on the subject are received daily by this Department, that a short résumé of the information we possess about this plant will be useful to our readers, and we hope incidentally to ourselves, in reducing somewhat our increasing and voluminous correspondence on the subject.

Kudzu, known botanically as *Pueraria thunbergiana*, is a woody climber belonging to the bean family (*Leguminosae*). It is a native of Japan, and in that country has many uses—the thick roots contain large quantities of starch which is used for human food, the stems contain a fine fibre from which a certain kind of cloth is manufactured, while the foliage is used and valued as fodder for all kinds of stock, horses being especially fond of it. It is said to be one of the most rapid growers on record; in some cases the stems have been known to attain a length of 60 feet in three months. It forms a very ornamental covering for porches, verandas, or summer-houses, and has been cultivated in the United States for this purpose for some years, but it has recently only been exploited in that country as a forage crop.

Mr. C. V. Piper, of the Department of Agriculture, Washington, has published a short pamphlet on the subject of Kudzu, and he gives the following advice as to its culture:—

*Culture.*—Kudzu, when well established, covers the field with a dense mass of herbage. Seeding is too expensive to advise and is generally unsuccessful. Setting the rooted plants in the field where they are to be grown is the best method. The plants, however propagated, are set about 10 feet apart each way in the field. They succeed best if put out very early in the spring. During the first season the trailing runners cover the ground; the second season good crops are secured, but usually the largest crops are not obtained till the third season and subsequently. A crop of corn, soy beans, cowpeas, or peanuts can be grown between the rows of Kudzu during the first season, and thus avoid losing the use of the land. As Kudzu is a long-lived perennial it is advisable to plant it only where the field can remain in this crop for several years. Young plants are sometimes severely injured by rabbits.

*Seed.*—The seeds of Kudzu do not germinate very well. If used, they should be planted in a well-prepared seed bed and the plants transplanted very early in spring after they are well rooted.

*Cuttings.*—Kudzu may be propagated by cuttings, but under field conditions a large percentage fails, so the method can not be recommended. The best success with cuttings has been secured

by using well-ripened wood and setting out very early in the spring.

*Transplanting.*—A new field of Kudzu is best established by the transplanting of well-rooted plants.

*Grazing.*—Kudzu may be utilized as pasture, but should not be grazed too heavily; two fields should be provided to graze alternately. Some farmers allow the crop to grow until the dry season of the fall, when other pasturage is likely to be scant. There is some evidence that continuous light grazing will give more feed than alternate heavy grazing. The crop is best pastured by cattle, as hogs are inclined to dig out and eat the starchy roots; indeed, hogs may thus be used to eradicate a field of Kudzu when this becomes desirable.

*Soiling or Green Feeding.*—Kudzu is excellent for soiling, as was shown by the experience of the Louisiana Agricultural Experiment Station. During an extremely dry period the only green foliage available was furnished by the Kudzu fields.

*Hay.*—Some fields in Northern Florida, after becoming well established, have yielded three cuttings of hay a season, and yields as high as 10 tons per acre have been reported. In other fields the total yield has been smaller than that of velvet beans. At Arlington Farm, Va., Kudzu was harvested and cured in the same manner as cowpeas, and an excellent quality of hay obtained. Curing frames were used also, and if properly coked Kudzu-hay sheds rain without the use of any topping material. In fact some of the hay was left in cocks all winter, and when opened the following spring was in excellent condition; only the outside was brown and weathered, the forage within being of a bright-green colour. Kudzu can be cut readily with a mower. The hay cures more easily than most legumes, as the leaves are less juicy.

The first mowing of a field, however, is sometimes difficult, as the first crop is more tangled than succeeding ones. A good device to use in very tangled crops is an old scythe blade fastened vertically to the end of the cutter bar. The first crop produced is also likely to be difficult to rake, as the trailing stems along the ground are still strong; therefore it is often better to use a fork and make piles or rolls not too large to pitch on to a wagon. There is practically no shedding of the leaves in curing.

Kudzu is said to make excellent hay and its feeding value is about equal to clover and lucerne. Like most leguminous crops it is a splendid soil renovator, enriching the poorest land, but even in the United States it is only in the experimental stage, and Mr. Piper lays special stress on the fact that though the value of the plant both for hay and for grazing is acknowledged they have yet much to learn about its habits and behaviour under varying conditions before it can be pronounced on definitely.

In South Africa, Kudzu is little known and few experiments have been carried out with it. In 1915 the Division of Botany obtained a small quantity of seed from the U.S.A., and this was sown at the Experimental Station, Groenkloof. The seed germinated

fairly well, but the young plants were killed off by the frost before they had become well established.

Mr. McCallum, of Pigeonhole Farm, Tzaneen, obtained some seed from which he raised about 100 small plants. These he planted out, but only two survived, and he writes as follows:—"One plant has grown vigorously and has an abundance of foliage. I tried to dig it out but found this impossible as the roots penetrated over three feet. . . . It is too early to speak favourably or unfavourably about it. I have an idea that if I can establish it in my bushlands it will be a great help, but so far I have not succeeded."

Reports from Rhodesia state that Kudzu has been grown successfully on the Government Experiment Station outside Salisbury, where it is considered a useful grazing crop, but that the stems are too tough and fibrous to make good hay.

Another small quantity of seed has been obtained by the Division of Botany in order to carry out further trials with the plant, and the results of these will be reported on later.

Kudzu seldom matures seed away from its own country. Most of the seed is sent direct from Japan, the natural home of the plant, and as far as we know the only firms in South Africa who advertise seed or young plants are Distins (African Seeds, Ltd.), Johannesburg, and Carter Bros., Maritzburg.

---

### Grain-eating Birds: A Poison.

The following is recommended by the Principal, School of Agriculture, Potchefstroom, as a poison for grain-eating birds:—

A paste of two cups of starch or three of flour is made with cold water; boiling water is then added until the liquid measures three bottles. The whole is boiled for a short while until the liquid becomes translucent; now stir in thoroughly one ounce of finely powdered strychnine alkaloid; pour the liquid over 50 lb. of kaffir corn grain, or a mixture of kaffir corn and millet seeds, and stir so as to wet every grain. The grain is allowed to dry, then bagged, properly labelled and stored in a safe place until required.

To poison the grain-eating birds, patches of dry grass are burnt near the lands on which unpoisoned grain is thrown. As soon as the swarms of "finks" have cleaned these up, sow the poisoned bait. This method has been found most effective, and, if followed, there is little danger of destroying those species of birds which are of benefit to the farmer.

*Caution.*—Poison bait should not be distributed too near the homestead, unless the ground can be fenced in with wire-netting, otherwise poultry will be killed. The poisoned birds must not be allowed to be eaten.

## GRAFFED VINEYARDS.

Report of the Commission of Investigation, consisting of P. J. Cillie (C.'s son), A. I. Perold, B.A., Ph.D., and S. W. van Niekerk (Government Viticulturist).

## INTRODUCTION.

ALTHOUGH the reconstitution of our vineyards on American stocks—commenced some thirty years ago—has been more speedy and attended with greater success than in other wine-producing countries of the world, it must be acknowledged that in this connection there are numerous difficulties which still require elucidation. It would appear that this fact is recognized by the wine farmers themselves, and as a consequence of representations which were made to the Secretary for Agriculture by the Paarl and French Hoek Farmers' Associations, as well as by individual farmers, the present commission was appointed to inspect and report upon the condition of our grafted vineyards.

The report has been divided into three sections:—(1) Short description of the usefulness of American stocks; (2) summary of the results of the investigation; and (3) recommendations.

## (1) SHORT DESCRIPTION OF THE USEFULNESS OF AMERICAN STOCKS.

It was originally the general impression that any American stock was completely resistant to phylloxera. Experience has, however, taught us that this is not the case. Our wine farmers as a whole do not apparently realize all the factors which will determine whether any given American stock under certain circumstances will be phylloxera resistant. The commission has therefore considered it advisable to deal briefly with this phase of the question before giving the results of its findings.

In the first place it must be remembered that the success or failure of a grafted vine is governed by its capacity for growth on the one hand and the attacks of phylloxera on the other. Every circumstance which increases the former is to the advantage of the vine, and vice versa. So far as the attacks of phylloxera are concerned, it will be quite evident that everything which favours the attack is also a source of danger to the vine, and vice versa.

*Factors which Influence Growth.*

The stock.  
Soil.  
Climate.  
Cultivation and manuring of soil.  
Treatment of vine.

*Factors which Influence the Attacks of Phylloxera.*

The stock  
Soil.  
Climate.

*The Stock.*—It is well known that certain stocks are, speaking generally, more vigorous growers than others (e.g. Mourvedre × Rupestris 1202). It is also acknowledged that on the inherent characteristics of the stock will depend whether it will be attacked by phylloxera or not. (A similar occurrence which we find in animals, which on entering a vineyard will first devour the leaves and shoots of Hanepoot before they touch any of the other kinds.) Although phylloxera may be found on the roots of all types of American stocks (species and varieties), some are only lightly affected while others are completely destroyed.

If we plant two kinds next to each other in the same soil (let us say in the same receptacle) and then infect their roots with phylloxera, we will find after a while the roots of the one appreciably affected with phylloxera, while the other will for practical purposes be clean. It is of course understood that two varieties would be chosen which differed considerably in their power to resist phylloxera. From this we see that phylloxera will attack one kind of stock more readily than another. Moreover, the wounds caused by phylloxera are not equally serious to the roots of different kinds, and the various types of American stocks do not all possess the same capacity for closing up these wounds or of allowing them to heal. Here it must be explained that a stock is not killed because the phylloxera robs it of too much of its sap or because it becomes poisoned, but because certain organisms of decomposition present in the soil are enabled, through the wounds made by the phylloxera, to enter the roots and cause them to decay.

It will therefore be understood that different kinds of stocks will under similar conditions show a varying degree of resistance to phylloxera.

*Soil.*—The soil is of the greatest importance in relation to the growth of the vine as well as the attacks of phylloxera. In well-drained soils of good depth and possessing a fair supply of plant food ingredients (including water) a stock will make good growth. In light, shallow soils, which are usually too wet in winter and too dry during the summer, one cannot expect it to make satisfactory progress. Where the foregoing statement applies we find that American stocks exhibit great differences in their growth on different soils. We can understand then that the soil is one of the most important factors which we have to consider in making a choice of a suitable stock.

That the soil exercises a great influence on the attacks of phylloxera is evidenced by the fact that phylloxera destroys European vines much sooner in clay soil than in sandy soil, while in a deep fine sandy soil it either fails to destroy or infests only slightly. This is the reason why the coastal portion of France, bordering on the Mediterranean Sea, has been established on European stocks. In this area we find deep, fine sandy soils in which phylloxera has an almost negligible effect. In our own country there still exists old ungrafted vineyards, established on deep, fine sandy soils, which are deteriorating at a very slow rate. By a sound system of fertilizing, this deterioration may still further be retarded, and instances are known of old ungrafted vineyards which, by good manuring with

Government guano, etc., have been much improved and again brought to a productive condition after having become very poor.

*Climate.*—As the American stocks grow in North America, where they are indigenous, under very variable conditions of climate it was to be expected that, propagated under South African conditions, they would not all do equally well. This has also been the experience in Europe. As a clear example, one might instance Jaequez. This stock has long been regarded in France as unsuitable because of its insufficient resistance to phylloxera. In this country, as is correctly shown in the 1912 and 1914 reports on our grafted vineyards, on a great many soils Jaequez is an outstanding stock. Under certain conditions here, however, it has not proved sufficiently resistant, and for that reason must not be used as a stock. The explanation of this behaviour must undoubtedly be sought in our climate, which is responsible for stimulating the growth of the vine and enabling it to mature its wood better than is the case in Europe. The last-named factor, viz., the maturing of the wood, which is more particularly shown in the accumulation of reserve food (chiefly starch) in the roots, stem, and shoots of the vine exercises a very great influence on its growth and productiveness.

Climate, moreover, exercises a distinct effect on the life of phylloxera itself by providing more suitable conditions for the breeding of phylloxera in one season under a warm climate than in an area with colder climates. This is the reason why phylloxera will destroy the same stock grown under our climatic conditions more rapidly than in the cold climate of middle Europe. We can, therefore, understand why it is so often the case that a grafted vineyard, after a winter of low rainfall, followed by a dry summer, will suffer from phylloxera and visibly deteriorate.

It is true that the American stocks are much more susceptible to changes of climate than the European vines. Keeping this in view we must not accept blindly the results of experiments carried out in other countries with American stocks; it is necessary to test them under our local conditions in order to establish their degree of suitability.

*Cultivation and Manuring of the Soil.*—The soil must be well prepared (by trenching or deep ploughing) before the young vines are planted so that they have a good start, and will be able to develop their root system. If the soil is too wet it must be well drained before the vines are planted. Further, the vineyard soil must be worked in such a way that it is able to take up sufficient water and lose the moisture during the summer as slowly as possible. This may be accomplished by keeping the surface soil loose and free of weeds. The reason why these points are emphasized, although probably well known, is because the investigation has revealed that a large number of failures with grafted vineyards must be attributed simply to the bad preparation and improper cultivation of the vineyard soil.

It stands to reason that proper fertilizing will stimulate the growth of the vine and enable it to produce to a greater extent without weakening the plant and thus rendering it susceptible to the attacks of phylloxera. Poor soils particularly require a good dressing of manure each year. The practice which obtains among some

farmers of manuring their vineyards every second or third year is one which cannot be condemned sufficiently, especially where the soils are poor. The necessity for regular and proper manuring becomes apparent when it is remembered that the grafted vineyard comes into bearing sooner and produces more heavily than the ungrafted vines.

*Treatment of Vine.*—The vine must be kept healthy so that the leaves may have ample scope for discharging their normal functions. In pruning, the vigour of the vine must be kept in mind, and it must never be expected to do more than it can accomplish without injury. Young vineyards particularly must not be allowed to bear too heavily as this may be responsible for giving the vines a set back for a long time, and from which there is sometimes no recovery. The commission knows of an instance where Muscadel or Jacquez—in a deep, cool, reddish, gravelly soil—had begun in its fourth year to suffer from phylloxera and was beginning to deteriorate, yet in that type of soil Jacquez should have answered well. The reason was simply that the vineyard had been trellised and pruned long, which had had the effect of producing altogether too large crops in its second and third year, thereby weakening the vines to such an extent that they became easily affected with phylloxera. By advice of the Government Viticulturist at that time, the grapes of the weak vines were removed when quite undeveloped, and during the following winter the vines were so pruned (short and few bearers) that in the succeeding harvest they produced a very light crop, and to-day there is once more a nice looking vineyard.

## (2) SUMMARY OF RESULTS OF THE PRESENT INVESTIGATION.

The Commission instituted a careful inquiry into the grafted vineyards in the most important wine districts, and more particularly at certain places where it was known that the grafted vineyards were in a bad or unsatisfactory condition.

Up to the present most of the vineyards in our country are grafted on the following stocks:—Jacquez, Aramon, Metallica, Seed Rupestris varieties, Riparia varieties, and 1202. To a limited extent use is also made of Rupestris du Lot and the Riparia  $\times$  Rupestris hybrids 101-14, 3306, and 3309. The results of our investigation in connection with these stocks may be briefly summarized as follows:—

*Jacquez.*—Where there is a sufficient rainfall and irrigation is not practised, and where the soil is deep and open, this stock gives satisfaction. On the deep sandy soils of Goudini, Jacquez is by far the best stock for all kinds of grapes. On stiff clay soils, on shallow soils, and on all soils which become too dry during the summer, it is unsatisfactory and very often unsuitable, and must therefore not be used.

In areas where irrigation is practised Jacquez must only be used on deep open soils. It is essential that the soil should take up water readily and that the irrigation should be sufficient, so that the vine does not need to suffer from drought during the summer. The stock should also not be planted on stiff Karroo soils, which usually do not take up water readily.



*Aramon*.—What is understood here by *Aramon* is really a mixture of *Aramon* × *Rupestris* Ganzin Nos. 1 and 2. It is to be regretted that this is so, seeing that the two, on different types of soil, show great variation in growth and are thus responsible for uneven vineyards. It is also possible that the *Aramon* No. 1, as it is known to-day, is made up of two distinct kinds, and this question will receive further examination immediately.

In general, the Commission holds the view that *Aramon*, as mixed as it is, has in most cases proved a success, even though the majority of the vineyards are not uniform. In every case where the large vines had suckers they had either been grafted on *Aramon* No. 2 or on Seed *Rupestris*—never on *Aramon* No. 1. On the Karroo soils the vineyards grafted on *Aramon* are not so uneven. Those on *Aramon* No. 1 are, if anything, better than those on No. 2.

The Commission made a careful investigation of some instances of serious deterioration and actual failures of *Aramon*, both Nos. 1 and 2, in the Stellenbosch District. These consisted of *Hermitage* and *Stein Grape*, grafted on *Aramon* and five and ten years old respectively, on a light reddish brown, coarse, sandy hillside soil with a gravel layer as sub-soil, which is frequently cemented into an ironstone gravel. The soil is poor, very deficient in humus, and exceptionally porous, so that it retains its plant food with difficulty, and in 1916 the vineyard was weakened by the enormous crop which it bore. The poverty of the soil and the exceptionally heavy crop in 1916, coupled with only an average manuring, must be regarded as the chief causes of the vineyard's deterioration. Probably matters were accentuated by the bad winters of 1918 and 1919. The whole vineyard is very poor and gives one the same impressions as an ungrafted vineyard badly infested with phylloxera. Even the vines on the "heuveltjes" are deteriorating. The vines are small, the canes short and weak, while the roots are unhealthy and covered with phylloxera. Many of the roots are already dead.

That the fault here lies mainly in the soil is shown by the fact that *Aramon* on neighbouring farms was still doing well, but in such instances the soil was deep and more of a bluish, light sandy soil with more body in it, and thus better able to hold its plant food. In the soil where *Aramon* did so badly the sand grains were sharp and clean.

In the Robertson District there was an instance of *Hermitage* on *Aramon*, five years old, on stiff Karroo (heavy red loam) which had produced the previous year from 6 to 7 leaguers per 1000 vines (planted 3 feet 9 inches by 3 feet 9 inches), or 38 to 45 leaguers per morgen. Here there was a patch of vines doing badly, and in some cases the vines were actually dead. The roots of the weak vines were covered with phylloxera. The main cause was apparently the large crops, combined with the characteristic difficulty with which the soil is able to absorb water. In general we would like to point out that grafted vineyards which are irrigated are much more susceptible to the attacks of phylloxera when the soil absorbs water with difficulty, and where the vines therefore suffer from drought during the hot, dry months of summer, than in those cases where the soil readily absorbs water and the vines do not suffer from drought. In the latter case most stocks will answer well.

*Rupestris Metallica*.—The stock known here as *Metallica* is not the *Rupestris Metallica* of Europe, but was grown at Groot Constantia from imported *Rupestris* seed, and selected by the late Mr. J. P. de Waal when he was manager of the Government Farm, Groot Constantia, from which source it has spread over a wide area. The fact that it roots and grafts easily, grows vigorously, and comes into bearing soon, earned great popularity for it from the start, and it has in consequence been used as a stock on a large scale. It soon became apparent, however, that its grafted vines in most instances began to deteriorate after eight to ten years, and a few years after did not produce profitable crops. It does not stand drought, or rather damp conditions, and in wet sandy soils it is easily destroyed by root eels. It is therefore, quite correctly, seldom used as a stock.

*Seed Rupestris Varieties*.—Under this heading is understood all *Rupestris* varieties which are found in our grafted vineyards and which have not so far received a definite name, but which have been propagated here from imported *Rupestris* Seed. Such varieties as *Rupestris du Lot*, *Rup. Martin*, *Rup. Mission*, etc., were also originally grown from seed but have since been kept pure, described, and propagated by cuttings. Amongst the *Seed Rupestris* varieties we come across such names as “Donkey or Le Roux *Rupestris*,” “Appelkoosblaar” *Rupestris*, “Blinkblaar” *Rupestris*, Large Leaf *Rupestris*, etc., but these have never been studied and written up. The investigation clearly showed that there are amongst these useless as well as outstanding varieties. The old grafted vineyards (twenty years and more) are very patchy, because at the time of planting a mixture of varieties were used. In such vineyards one finds some excellent large vines on *Rupestris* varieties, of which a special study has never been made and whose identity has therefore not up to the present been established. It would seem that there are about three varieties which produce such good results. From these it is proposed to plant out cuttings in experimental plots in order to establish their identity and to enable them being more closely studied. It is quite possible that one or more of these varieties might turn out to belong to our best stocks, but then they must be propagated pure (along pure lines).

*Riparia Varieties*.—Of these we have *Riparia Gloire de Montpellier*, and another *Riparia* variety which very closely resembles the first named, but which has not been grown pure, and another mixture of *Riparia* varieties which is known as “Ou *Riparia*.” All the *Riparia* varieties have resisted phylloxera well, but the so-called “Ou *Riparia*” usually produces small grafted vines. The two first-named varieties are good, particularly the *Rip. Gloire de Montpellier* (usually called “Montpiljé”), which unfortunately has in very few instances been kept pure. The following remarks apply to *Rip. Gloire de Montpellier*:—It seems as if it is a suitable stock for all grape varieties, including Hanepoot. It induces the production of good crops and is responsible for the grapes ripening eight to ten days earlier than those on *Jacquez* planted on the same soil. The Commission received no complaints against it where it had been used as a stock, except that the vines might have been larger on the less suitable soil, though even then it has regularly produced satisfactory crops. Although it is particularly suitable on deep river or “kloof”

soils it appears that it also gives excellent results on decomposed granite (hillside), resting on Malmesbury slate as we find at Elsenburg. In one instance in Agter Groenberg, Hanepoot grafted both on this stock and on Jacquez stood side by side on the same deep, cool, mountain land and were trellised; the former showed more vigorous growth, better wood, had a much better colour (late in January, 1920), and had a better crop than the vines grafted on Jacquez, although the latter was by no means poor.

Near Robertson we came across an interesting instance where Hanepoot on Riparia Gloire de Montpellier, twelve years old, has proved an immense success on stiff red Karroo soil. The surface soil is a heavy red loam, only 5-10 inches deep, and resting on a hard lime bank, which, however, does not contain sufficient lime to produce chlorosis (leaf yellowing). This vineyard is irrigated in the summer. At the time of the inspection (about the middle of January) the vineyard had last been irrigated a month previously, and the vines were still shooting and in the pink of condition. They were laden with well developed grapes with sweet fleshy berries, which were ripe eight to fourteen days earlier than the Hanepoot on Jacquez. The vineyard on Jacquez, on the same type of soil, had a much worse colour and was showing no signs of sprouting, although it had been irrigated after the Hanepoot on Riparia. Complaint is sometimes made that Riparia does not support its scion because of its comparatively slower growth and the tendency to produce top-heavy vines. Although there is something in this statement it applies to Rip. Gloire de Montpellier only in its first few years, that is when it is planted on suitable soil.

*Mourvedre and Rupestris No. 1202.*—This is probably the most luxuriant grower amongst the American stocks in use here. It is only during the past ten years that it has been grown to any appreciable extent, and more particularly as a stock for Hanepoot. It is used mostly in the Constantia area and in the Districts of Robertson, Montagu, and Worcester. The oldest established Hanepoot on 1202 which the commission encountered was fifteen years old, and was still doing well. Because of its vigorous growth Hanepoot grafted on it has a tendency towards non-setting. The grapes usually ripen eight days later than those grafted on Jacquez when planted on the same soil. During the first three years Hanepoot grafted on the stock will show odd failures, but later, however, the vines do well. It is not regarded as a very suitable stock for Hanepoot, but with other varieties of grapes this difficulty is not experienced. On most soils it generally does well, excepting in sandy soils, especially those which are damp, in which it is easily destroyed by root eels. On clay soils and Karroo soil it is a very suitable stock. On account of its vigorous growth it is very useful for poor soils, although in such a case it must receive a liberal treatment of manure in view of the fact that, according to European experience, it is less able to withstand phylloxera than Aramon, but is better in this respect than Jacquez.

101-14, 3306, 3309.—These three hybrids of Riparia and Rupestris are not used to any great extent. 101-14 is the best, and up to the present is most popular. In a large measure it has a Riparia character. In the Commission's experience it was a complete success everywhere. Hanepoot (ten years old and sometimes older) on this

stock was excellent, bore a good crop and ripened its grapes early. It answers well on a large variety of soils. On moist as well as fairly dry soils and on light sandy soils, as well as in heavy clay and Karroo soils, it has grown well and appears to have been a success as a stock. It has in all probability a very good future, particularly as a stock for Hanepoot, on soils where Jacquez cannot be relied on. In the same vineyard in the Stellenbosch District, where Aramon was such a failure, it is the best stock (eight years old) in the experimental plot, much better in fact than both varieties of Aramon.

3306 and 3309 very often give successful results, particularly the latter, for Hanepoot on moderately dry heavy soil. As 101-14 is, however, superior to both these stocks there is at present no reason for their propagation as well, but the existing experiments will nevertheless be continued. All three are usually sufficiently resistant to phylloxera.

*Rupestris du Lot*.—This is generally a very vigorous grower and most varieties of grapes, including Hanepoot, may be grafted on the stock with successful results. Its flourishing growth is the reason for its vines not bearing much during the first five years; it is liable to non-setting, and ought, therefore, to be pruned longer. It should not be planted on shallow soils, excepting Karroo soils, on which it thrives in spite of there being a lime bank near the surface. It is suitable for heavy clay and loam soils, but is not a desirable stock for sandy soils. It is one of the stocks that are most resistant to phylloxera, and should be used to a greater extent on soils for which it is suited, viz., deep clay soils and Karroo soils.

### (3) RECOMMENDATIONS.

*Varieties which are Recommended or Condemned*.—According to the findings of the Commission, it is recommended that the following stocks should receive preference when a selection is being made:—101-14, 1202, Aramon No. 2, Rup. du Lot, Rip. Gloire de Montpellier, and Jacquez. Further selections from amongst these varieties will be determined by local considerations, as described in Part II of this report.

On many soils in the Western Province Aramon No. 1 is still suitable, but it is always inferior to Aramon No. 2. On Karroo soil No. 1 is if anything better than No. 2, and thus the mixed Aramon may therefore still be used on these areas.

Some of the best Seed *Rupestris* varieties ought to be grown when they have been further investigated, and so long as they are propagated pure.

*Metallica* and the old *Riparias* should not be cultivated any longer.

*Registration and Inspection of Nurseries*.—As it appeared during the course of the investigation that most of the grafted vineyards showed unevenness because the stocks used were of more than one variety, and that most of the nurseries for the production of American stocks for grafting purposes contained mixed varieties, the Commission strongly recommends that all nurseries for propagating American stocks and grafted vines should be inspected annually and registered. In this connection it may be pointed out that inspection should

include purity of mother plantations or stocks, purity of scions (e.g. Crystal must not be found amongst Hanepoot), and in addition the all-round good care of the nursery. The Commission recommends further that the Secretary for Agriculture should appoint a capable officer to undertake this work, and that from time to time a complete list should appear in the Department's *Journal* showing all nurseries regarding which the inspector has made a satisfactory report.

*Experimental Plots (Vineyards).*—The existing experimental areas, now mostly eight years old, which are fairly well distributed over the wine districts, and are now already giving useful indications regarding the stocks used, should be still further extended.

*Future Commissions of Investigations.*—In order to solve in a satisfactory manner the problem of our grafted vineyards, the Commission recommends that similar commissions of inquiry should be appointed at least every five years, and that if possible one or more of the members of the previous commission should be on the succeeding one in order to be better able to note the change which the grafted vineyards have undergone in the intervening period.

---

## South African Produce on Show.

An appreciative article on the display of South African produce at the recent show of the Royal Agricultural Society, held at Darlington, England, appears in the July, 1920, issue of "The British and South African Export Gazette." Admirably staged under the general supervision of the Union's Trade Commissioner in London, Mr. A. Canham, there was a remarkably comprehensive exhibit of South Africa's produce, including wool and mohair, hides and skins, leather, wattle bark and extract, ostrich feathers, cotton, tobacco, various cereals and fruits, wines, jams, dried fruit, meat, butter, bacon, eggs, cheese, canned crayfish, minerals, timbers, and fibres. There was evidence of extreme care and judgment in the selection and preparation of each item, everything being most attractively displayed. Altogether the exhibit is stated to have constituted the most effective publicity effort hitherto attempted by the Union Government. The Royal Show is the largest of its kind in England—perhaps in the whole world—and it is gratifying to learn that this great opportunity of advertising the Union's resources has been used with so much success. Following the outstanding victory of South African cheese exhibits at the London Dairy Show last year (reference to which was made in the April, 1920, number of the *Journal*), the attractive display of our products at the Royal Show is calculated to advertise the Union to good effect, for, as the article referred to mentions, more than one manufacturer has discovered a new source whence to draw his raw materials.

---

**SOUTH AFRICAN FIBRE PLANTS.**

---

**Ambari or Deccan Hemp: *Hibiscus Cannabinus*, L.**

---

By I. B. POLE EVANS, M.A., D.Sc., F.L.S., Chief, Division of Botany and Plant Pathology.

---

(This article appeared originally in the *South African Journal of Industries*, Vol. I, No. 3, and, owing to the widespread interest in the subject, is now reprinted.—ACTING EDITOR.)

---

SINCE the outbreak of war more than usual interest has been displayed by the public in the resources of South Africa as regards fibre plants, oil-producing plants, medicinal plants, tanning plants, and dye plants, with the result that numerous inquiries, often accompanied by specimens, have been submitted to the Division of Botany. Much valuable information relating to these economic plants and their distribution throughout the Union has thus been obtained.

In the present article one of these plants, which would seem to deserve some attention, not only from botanists, but also from the merchant and farmer, will be dealt with. The plant is known botanically as *Hibiscus cannabinus* L. It is also called Ambari Hemp, Deccan Hemp, Gambo Hemp, and Bimlipatam Jute. Locally it has been referred to as "The Wild Stock Rose." *Hibiscus cannabinus* produces a textile fibre which can be used for the manufacture of coarse woven articles, such as bags and sacks, hessians, and horse-cloths. It can also be employed for cheap cordage and yarns. The fibre is bright and glossy, but coarse and harsh.

The plant is a native of Africa, but now widely distributed throughout India, Asia, and Australia.

In India it is very largely cultivated for local use, but from investigations which have recently been given to it by the two Imperial economic botanists, resulting in the production of improved varieties from which the best specimens of fibre yet submitted to London merchants have been obtained, there is reason to believe that this plant will become more extensively grown for export trade.

In South Africa at the present time *Hibiscus cannabinus* L. as a fibre plant is practically unknown. It is certainly not cultivated, but in many places is looked upon as a most noxious weed.

In India, where its cultivation is firmly established, two spinning mills have been erected for some years for specially dealing with this fibre. From it practically all the agricultural cordage used in India is manufactured locally. It is also employed in making gunnies, coarse sack cloth, canvas, fishing nets, and paper.

*Hibiscus cannabinus* is an erect annual plant, attaining in South Africa an average height of 5-11 feet. In the veld it exhibits considerable variation as regards its habit of branching, time of maturity, and robustness—points which all need careful attention when seed

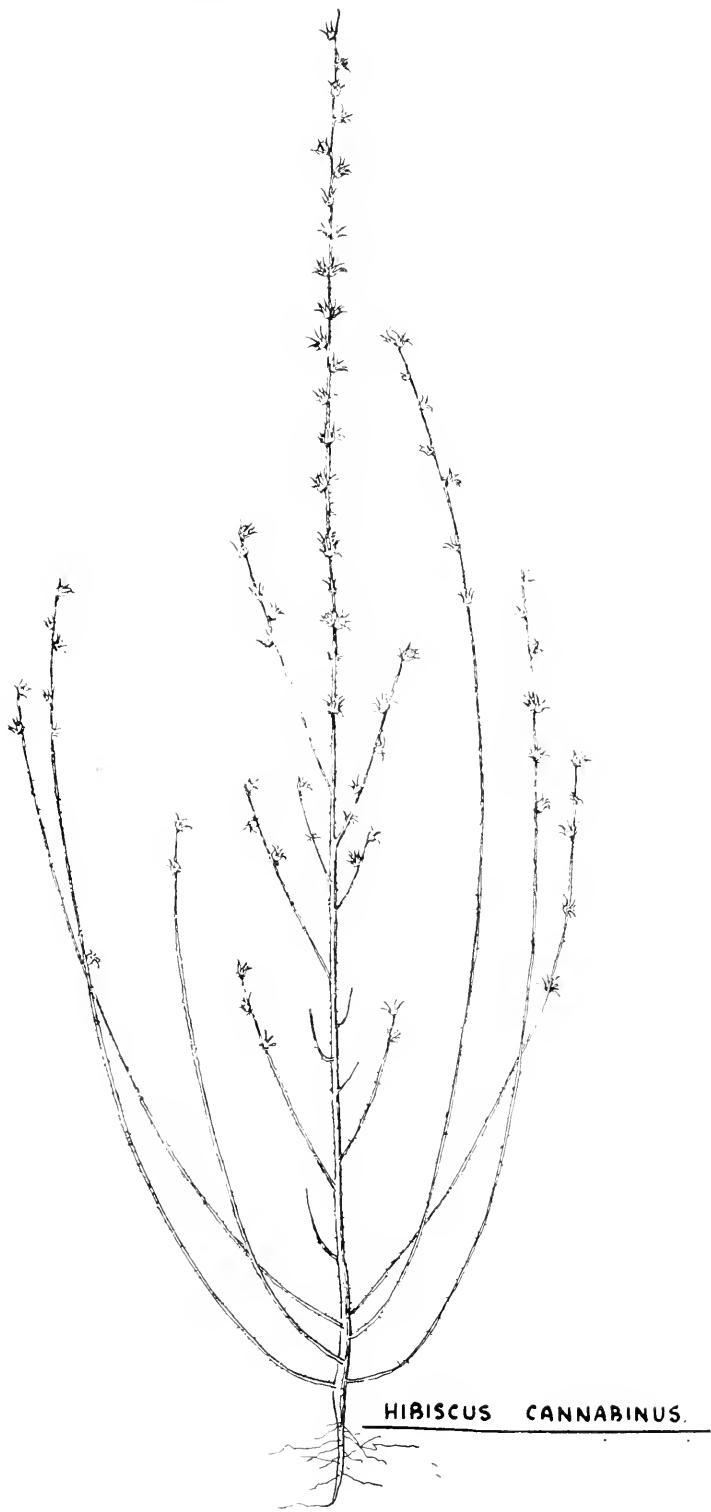

Plate I.]

Fig. 1.

Fig. 2.



Fig 2.



Flower.

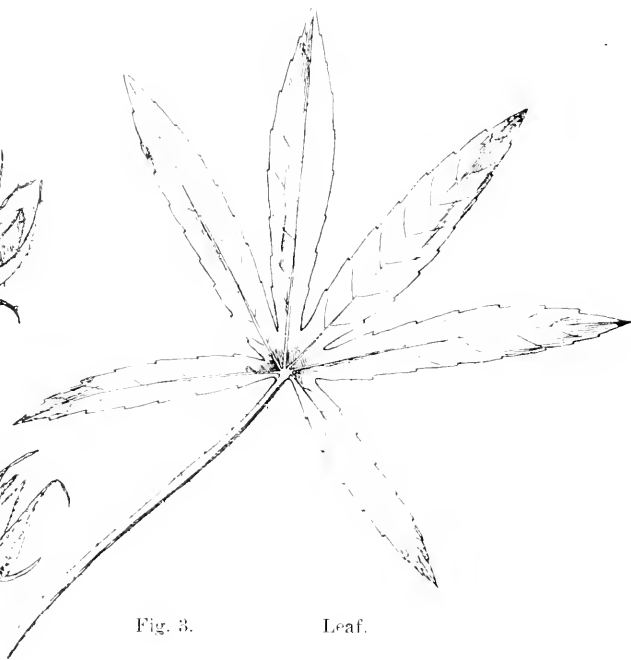

Fig. 3.

Leaf.

Fig. 1.

Plate II.]

Portion of Stem, showing Capsules.

*HIBISCUS CANNABINUS.*

K. A. LANSDELL *Division of Botany.*



is harvested. Some plants, when growing in the open, branch profusely (Plates I and IV), others frequently show no tendency to do so even under similar conditions.

The stem and leaf-stalks are prickly. The leaves are deeply divided and usually composed of 5-7 lobes (Plate II, Fig. 3).

The flowers are borne on the main stem and branches on a very short stalk in the axil of the leaf and open singly from below upwards, in the early hours of the morning. The flowers are creamy-white to yellow, with a dark purple eye (Plate II, Fig. 2).

The seed capsule when ripe is globose, pointed, and bristly (Plate II, Fig. 1).

The plant has been observed by the writer as a common weed in all the warmer parts of the Transvaal, especially in the Barberton, Waterberg, and Zoutpansberg Districts. It also occurs fairly plentifully in Zululand.

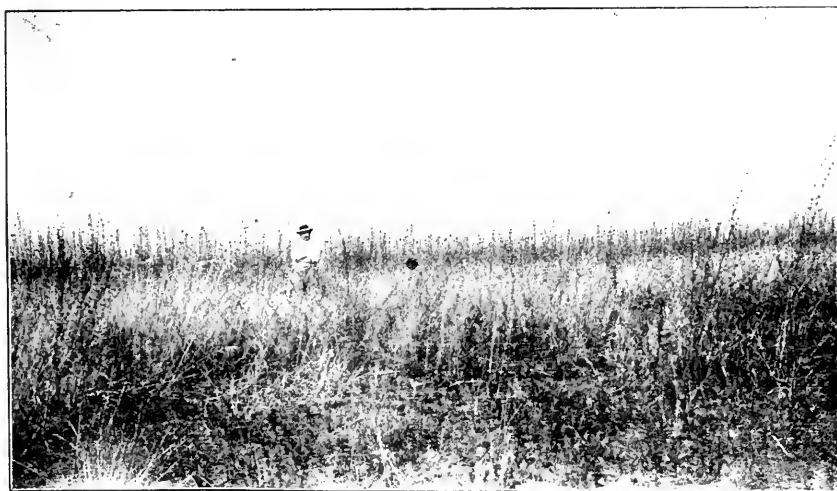

Photo by I. B. Pol-Erasmus.]

Plate III.—*Hibiscus cannabinus* growing in old mealie lands on the farm Waterval, Duivels Kloof, Transvaal.

Plate III illustrates a typical invasion of mealie lands by this plant in the Zoutpansberg District. At the time when the photograph was taken (10th September, 1917) practically all the seed capsules were ripe and had shed their seed.

Plate V depicts some plants taken from this heavily-infected tract of land and tied into bundles ready for fibre extraction. These plants were gathered, bundled, and forwarded to the Botanical Laboratories, Pretoria, by Mr. Closterschulte, of the Westfalia Estates, Duivels Kloof. In spite of their age an excellent sample of fibre has been obtained from them.

In some of the areas mentioned above the plant thrives to such an extraordinary extent that the writer has seen large patches, both of virgin veld and "lands" so completely covered that it was almost

impossible to walk through it, so dense was the growth of these plants. The plants thrive best on dry, sandy, well-ventilated soils.

In India about 20 lb. of seed are sown to the acre and it is put in broadcast. The crop usually takes 5-6 months to mature. The plants are either reaped with a mower or pulled out by the roots as soon as the first seed-pods are ripe and while the upper portion of the plant is still in flower.



Photo by I. B. Poole Evans.

Plate IV.—A much-branched plant of *Hibiscus cannabinus*, growing on the farm Waterval, Duivels Kloof, and undesirable for seed purposes.

After reaping, the plants are tied into bundles and then retted in water for ten days or more. Running water, if obtainable, is preferable for this operation. The bundles are first placed in an upright position in water so that the thicker root ends may be thoroughly soaked. After a couple of days the bundles are laid horizontally and entirely immersed.

As soon as the retting has advanced sufficiently the fibre is stripped off by hand and cleaned by dashing it against the surface of the water or a board erected for the purpose. After washing, it is wrung out and hung up to dry for a day. It is then twisted into hanks and pressed into bales of some 400 lb. weight.

The yield of fibre per acre in India is said to be from 1-2 tons; no statistics regarding the yield per acre in South Africa are yet available.

Samples of fibre from this plant growing in the Transvaal have been submitted by the Department of Agriculture to the Imperial Institute in London for analysis and report, on several occasions. As far back as June, 1909, a small sample of this fibre, weighing

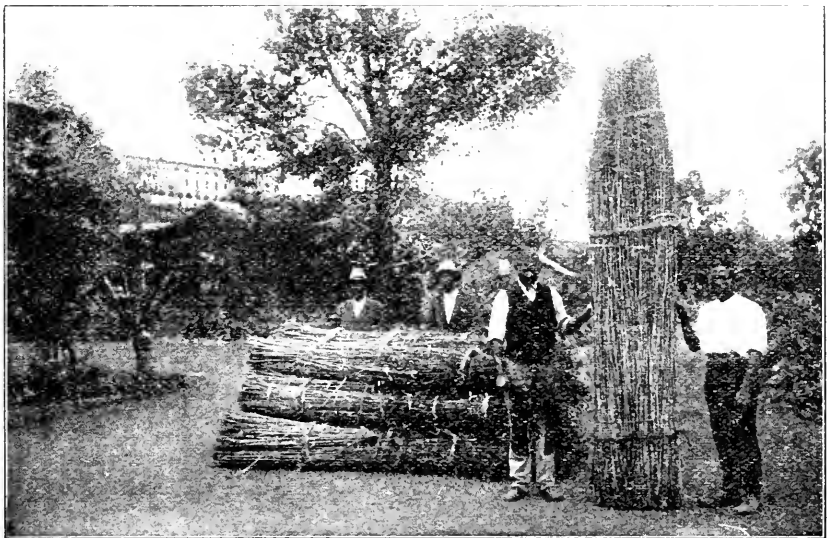

Photo by I. B. Polk Evans.]

Plate V.—Bundles of *Hibiscus cannabinus* from Westfalia Estate, Duivels Kloof, Transvaal.

10 $\frac{1}{4}$  oz., and obtained from Duivels Kloof in the Transvaal, was reported upon by the Imperial Institute as follows:—

“The sample consisted of two bundles of nearly white, clean fibre, of fair lustre, with a slight greenish tint. One bundle consisted of much harsher and more strappy fibre than the other. In both cases the fibre was gummy and insufficiently retted. Strength, good; length of staple, 3 feet 6 inches. The fibre was unsuitable for chemical examination.

“*Commercial Value.*—If properly prepared these fibres would command a fair price, as they are of excellent colour and have good strength. But in their present insufficiently retted, strappy condition, they would be of little or no commercial value, since they could not be employed for spinning purposes.

“The well-prepared fibre of *Hibiscus cannabinus* is exported from India under the name of ‘Bimlipatam jute,’ and finds a market as a jute substitute at approximately the same price as the medium qualities of jute. A specimen of this Indian Hibiscus fibre is sent herewith, which is worth about £15 per ton at the present time (September, 1909).”

A further sample of this fibre, weighing 2 lb. 1½ oz., was obtained from Mr. M. Macpherson, of Barberton, Transvaal, and submitted



Photo by I. B. Pole Evans.]

Plate VI.- Bundle of *Hibiscus cannabinus* ready for retting and two lots of fibre extracted from similar sized bundles.

to the Imperial Institute in July, 1909. The Institute reported as follows:—

“The fibre had a fair lustre and an irregular pale greyish-brown colour. It had not been well prepared, but the whole of the material was gummy and some parts were strappy and contained a good deal of adherent barky matter; these defects were

probably due to insufficient retting. Strength, good. Length of staple about 6 feet. The fibre was not submitted to chemical examination.

“The tangled state of the sample would also depreciate its value, as it could not be used for spinning purposes without the expenditure of much labour. Well-prepared Hibiscus fibre could be used as a substitute for jute, and would probably be worth about the same as ‘medium jute,’ which is now selling at £15 per ton in the London market.”

Recently the fibre was brought more prominently to the Department's notice by Mr. W. R. Pedley, of Nylstroom, Transvaal.

Mr. Pedley, in a letter to the Government Botanist, dated the 19th June, 1916, in asking for advice on the subject, wrote as follows:—

“The plant from which this fibre is taken grows exceedingly well in the sandy soil of the Northern Districts, and, should it prove of commercial value, would make a very payable crop, as it can be grown in our poorest soil with a minimum rainfall.

“The chief difficulty, I fear, is the length of time it must remain in water to clear it of vegetable matter.

“The sample I am sending has been in water for over eight weeks and still has a certain amount of vegetable matter adhering.

“The vegetable matter can be got rid of by boiling, but that process discolours the fibre to some extent, in addition to which it would hardly be practicable to treat large quantities in that way.

“I shall be glad of your opinion at an early date with a view to collecting and distributing seed, which must be sown early in the spring, as it takes some five or six months to mature.

The identity of the fibre was soon established, and all the available information regarding the plant and preparation of the fibre placed at Mr. Pedley's disposal.

On the 26th of June, in a further letter on the subject, Mr. Pedley communicated the following interesting notes:—

“This plant, or rather weed, has been a curse to me since I have been farming here, and not alone to me but to every farmer around; in fact some have given up lands on account of it. It grows stoutly to the detriment of everything else. It has taken me three years to clear one of my lands of it sufficiently to raise a crop of mealies, and even now I anticipate a good germination with the first rains.

“To give you some idea of the durability of the fibre I enclose with other specimens a small sample taken from the upholstery of my cart, where it has been for the last six months, prior to which it was lying on a ‘land’ for about eighteen months, from whence I carted about two wagon loads to my cattle kraal, where the cattle trampled it to its present state.

“I am also forwarding you another sample of the fibre which was cut green, cured, and then placed in water. The other sample I sent you was from plants cut green (before seedpods opened) and put straight into water.

“I should like to know which you consider the better sample and I will on receipt of your reply send you about 4 lb. I have

a quantity of each in water, and will take the fibre from whichever you may think the best. Personally, I see little or no difference.

“The plant grows to an average height of 5 or 6 feet and, where allowed to grow unmolested, grows so densely that it is extremely difficult to get oxen to face it when ploughing.

“Also, owing to its spiny nature it is a difficult plant to handle, but that could be overcome by using a reaping and binding machine. After about two days in water the spines cease to be troublesome.”

In August Mr. Pedley forwarded two bundles of fibre, each weighing about 4 lb. The fibre in one bundle was stated to have been taken from plants which were cut green and cured, and then immersed in water for about nine weeks. The fibre in the other bundle had been extracted from plants which had ripened their seeds and had dried out on the land. This had been immersed in water for some 27 days.

These two samples were forwarded through the Department of Industries to London for analysis and report, but were unfortunately lost in transit between the Trades Commissioner's Office and the Imperial Institute.

Fortunately, Mr. Pedley was able to furnish a further supply of each sample, and this in due course reached the Imperial Institute.

The reports on both samples are as follows:—

#### IMPERIAL INSTITUTE.

*Report No. 1.—Results of the Examination of Hibiscus cannabinus fibre from South Africa.*

Imperial Institute No. 1679/17/1; date 26th July, 1917.

*Reference.*—Letter No. T.C.85/16, dated 31st March, 1917, from the Trades Commissioner.

*Number or Mark and Weight of Sample.*—“Fibre of *Hibiscus cannabinus*, cut green and immersed in water for 9 weeks. No. 141.” Weight 3½ lb.

*Description.*—This fibre was of very variable character and colour. It was rather harsh, and a considerable portion of the sample was stiff and gummy, and had bark adhering to it. The better cleaned portions were dull and weak and evidently over-retted. On the whole the material was not well prepared.

*Strength.*—Uneven, but fair on the whole.

*Length of Staple.*—From 2 feet 6 inches to 4 feet 6 inches, mostly about 3 feet.

*Results of Examination:*—

	Present sample.	“Binlipatam Jute” ( <i>H. cannabinus</i> ).
Moisture, per cent. . . . .	8.9	12.5
Ash, per cent. . . . .	0.7	1.3
(a) Hydrolysis, loss, per cent. . .	13.1	11.8
(b) Hydrolysis, loss, per cent. . .	19.7	15.1
Acid purification, loss . . . . .	3.0	—
Loss on washing in water . . . . .	2.3	75.4
Cellulose . . . . .	73.0	75.4

*Commercial Valuation.*—The fibre was submitted to a firm of fibre merchants who stated that it was of similar quality to Bimlipatam jute and suitable for use by jute spinners. Its value in the open market (i.e. if saleable without official control) would be about £45 to £50 per ton at the present time (July, 1917). The pre-war value would have been £15 to £18 per ton.

#### IMPERIAL INSTITUTE.

*Report No. 2.*—*Results of the Examination of Hibiscus cannabinus fibre from South Africa.*

Imperial Institute No. 1679/17/2; dated 26th July, 1917.

*Reference.*—Letter No. T.C. 85/16, dated 31st March, 1917, from Trades Commissioner.

*Number or Mark and Weight of Sample.*—“Fibre of *H. cannabinus*, cut after the seeds have ripened, and immersed 27 days. No. 142.” Weight, 3½ lb.

*Description.*—Harsh fibre, of dirty grey colour, but fairly lustrous. The material was gummy in parts and some adherent bark was present, but it had been more evenly and carefully retted than the preceding sample No. 141.

*Strength.*—The fibre was of fairly good strength, and stronger on the whole than sample No. 141.

*Length of Staple.*—From 3 feet to 5 feet: average, 4 feet.

*Results of Examination:*—

	Present Sample.	“Bimlipatam Jute” ( <i>H. cannabinus</i> ).
Moisture, per cent. . . . .	10.4	12.5
Ash, per cent. . . . .	1.2	1.3
(a) Hydrolysis, loss, per cent. . .	13.5	11.8
(b) Hydrolysis, loss, per cent. . .	16.3	15.1
Acid purification, loss, per cent. . .	1.0	—
Cellulose, per cent. . . . .	72.0	75.4
Loss on washing in water . . . . .	1.2	—

*Commercial Valuation.*—The fibre was submitted to a firm of fibre merchants, who stated that if properly prepared it would be quite suitable for spinning with jute. They stated that its present value in the open market would be about £45 per ton, and that its pre-war value would have been about £15 per ton.

*Remarks.*—This fibre is of better strength than sample No. 141, although inferior to it in colour. Both samples are short in staple and not of very good quality, but similar fibres would be readily saleable. The merchants who valued the samples desired to be informed when commercial supplies of the fibre become available.

While these samples were under investigation at the Imperial Institute, the extraction of the fibre has received some attention at the Botanical Laboratories, Pretoria, with such facilities as are at present available, and it has been proved conclusively that there is no difficulty in retting the fibre under South African conditions.

With the temperature of the water varying from 18° C.-26° C., the length of time required for immersion has been 10-14 days. The yield of fibre from the bundles shown in Plates V and VI has been

from 10.7-11.9 per cent., and fibre of excellent quality has been obtained.

There is, however, much yet to be learnt regarding this plant before it can be recommended to growers in South Africa for cultivation.

The main points deserving of consideration and worth further attention are:—

1. Is there a market in South Africa for this class of fibre?
2. Can the fibre be produced in sufficient quantity and as a payable proposition to supply a local demand or build up an export trade?
3. Of the many varieties of *Hibiscus cannabinus* at present in South Africa, which are the most suitable for cultivation as regards yield and quality of fibre?

The only possibility of establishing a permanent industry with crops of this kind is through the medium of science and careful organization. The scientific botanist is necessary for the study and improvement of the plants in the field, while the technologist is required for the investigation of the fibre in the laboratory.

No results of any value from a field study of this crop could be expected for at least five years, and such an investigation to be properly carried out would require the whole time of one or more qualified investigators.

*Hibiscus cannabinus* thrives naturally in many parts of South Africa. The crop is an easy one to grow. It produces a heavy yield of fibre of excellent quality. The plant certainly has possibilities, but until these have been thoroughly investigated on scientific lines it cannot be recommended for trial on a commercial scale. Much has already been achieved from the botanical study of this plant in India, and there is no reason to suppose that similar results could not be obtained in South Africa if the proper organization and machinery were set in motion.

Specimens of *Hibiscus cannabinus* L. and its fibre may be seen on application at the Botanical Laboratories, Pretoria.

---

## Rhodesian Cattle and Maize.

The success of the exhibits of cattle and maize from Rhodesia at the last Fat Stock Show at Johannesburg is commented upon by the Director of Agriculture for Southern Rhodesia in his Annual Report for 1919, as being an event of far-reaching consequence, demonstrating the potentialities of both Matabeleland and Mashonaland. The twenty cattle exhibited secured five first prizes, three seconds, and one third, one award being the championship for the best ox in the show. This achievement, it is stated, created a deep impression on the minds of many South African stockmen. Added to this success was that of the maize exhibited on the same occasion, which, it is considered, will benefit not only the farmers concerned, but their districts and the country at large. "Great fillip," says Dr. Nobbs, "has thus been given to the production of maize of high quality, which must react on the whole crop as better seed is sought out and used and the average standard improved."



## NOTES.

---

### Index for the "Journal."

This number of the *Journal* is the sixth of the revived publication, the first number of which was published last April. In the ordinary course it is proposed, as in the past, to issue an index for every six numbers of the *Journal*, such six monthly numbers to comprise one volume. In the present instance, however, we propose to close the first volume at the end of the year, so as to allow future volumes to cover the calendar year, from January to June, and from July to December. Consequently the first volume and index of the revived *Journal* will comprise nine numbers, from April to December, 1920. Each subscriber will receive a copy of the index, and occasion is again taken to impress on subscribers the necessity of carefully keeping each number of the *Journal*, together with the index which will be issued from time to time, for the purpose of reference.

---

### Railway Transport—Hints to Consignors.

The Railway Department urges the necessity of exercising every care in the baling, bundling, tying, marking, and numbering of bales and bundles of wool, hair, skins, and hides, and states that a little extra labour and supervision would result in better handling of goods and be well rewarded.

Bales of wool should in every case be marked with consignee's initials or marks, the destination station's code mark, and the bale number. In the case of skins and hides, where this is not practicable, metal or wooden labels should be affixed. Bales of hides should be secured with strong rope and not pieces of wire or string.

Compliance with the following regulations will prevent much unnecessary delay in the delivery and transport of goods:—

#### CONSIGNMENT NOTES.

Every wagon load of goods tendered for transport must be accompanied by a separate consignment note of its contents. When a consignment is not brought to a station in one load, or at one time, the consignment note accompanying each wagon load must be marked "More to follow, and part lot of" (here specifying the total consignment), with the exception of that accompanying the last load, which should be marked "Balance." Each consignment note must be complete in itself, and bear or be supported by all necessary certificates, such as "South African Produce."

#### DELIVERY TO OTHER THAN THE ACTUAL CONSIGNEE.

Goods will not be delivered to other than the actual consignee, unless the applicant produces the advice note issued by the Administration, with the consignee's endorsement thereon authorizing

delivery to the applicant, or unless, before the issue of an advice note, written instructions are received from the consignee authorizing delivery to the applicant, or unless the applicant is a third party through, or to the care of whom, the goods are consigned. Any such authority will be retained by the Administration as an order by the consignee to deliver to the applicant. Consignees may leave with the Administration a general delivery order in the prescribed form instead of a delivery order for each consignment.

---

### Prospects of Cereal Crops and of Supply.

According to the June, 1920, Bulletin of Agricultural and Commercial Statistics, just published by the International Institute of Agriculture, Rome, the official estimate of the winter wheat crop of the United States of 1920 is 13.7 million tons, and that of the spring crop 7.5 millions, a total of 21.2 million tons, or 27 per cent. below that of last year, though only 4.9 per cent. less than the average of the five years 1914 to 1918. It should be remembered, however, that the actual quantity exported from the United States during the current season is below the available surplus, so that stocks at the end of this period will be greater than those held last year.

Canada reports an area under wheat 17 per cent. above the average from 1914 to 1918, also an excellent crop prospect, and it is therefore permissible to estimate that the yield will be equal to the average of the period mentioned, and much larger than it was in 1919.

On the basis of these statements, it is reasonable to expect that the North American exportable surplus of wheat for the season 1920-21 will be larger than the exports during 1919-20.

Government control of wheat ceased in the United States on 1st June.

Crop conditions for wheat are favourable in Germany, Bulgaria, France, England, Wales, Ireland, Luxemburg, Sweden, Egypt; and average in Scotland, Italy, Poland, Switzerland, and Czecho-Slovakia. In Hungary injury has occurred owing to great heat in May.

The estimates of the recent wheat crops in British India have been increased to 10.2 millions, and the new season is reported as developing normally.

The rye crops are favourably mentioned in France, Sweden, and Switzerland, as in average condition in Germany, Italy, and Luxemburg, and as poor in Poland and Czecho-Slovakia.

Vines and olives promise well in Italy.

Referring to the crops of the Southern Hemisphere for 1919-20, the Bulletin for May, 1920, states that the maize crop in Argentina is estimated at 32 per cent. over the average for the five years 1913-14 to 1917-18. This large yield may be an important factor in the cereal resources of the coming season.

---

### Productive Wealth of the Union.

The three great sources of production in the Union are from agriculture, mining, and factories. No official statistics have yet been published on the valuation of our agricultural production, but the matter

is under consideration at present, and it is hoped to have this information at no distant date. While no definite figures, therefore, can now be given, this much may be said that it is the opinion of those who have devoted much thought to the subject, that our agricultural production is of greater value than either our minerals or factory output. We have statistics to show that the value of our mineral products during the past decade has fluctuated between the vast sums of forty-three and fifty-three million pounds sterling per annum. But the value of the third source of productive enterprise in the Union—that of our manufacturing industries—was unknown until a few years back, when the first industrial Census was carried out by the Director of Census. This revealed a source of wealth not fully realized until then, as will be seen by the statistics given hereunder for the three years 1915-16 to 1917-18.\* In studying these figures special attention is directed to the second statement, and the column showing the value added by manufacture to the materials used, a sum rising from eighteen million to twenty-six and a half million pounds sterling, this being the true indication of the value of our manufacturing industries. It must be borne in mind also that the materials used are not all of South African origin, to what extent will be gauged by the fact that of the value of all materials used in 1917-18. £34,248,000, slightly over half only was the produce of South Africa. A gratifying feature in this respect, however, is that the proportion of South African materials used is steadily rising.

## MANUFACTURING INDUSTRIES IN THE UNION.

### *I.—Gross Value of Output.*

Class of Industry.	1915-16.	1916-17.	1917-18.
	£	£	£
I. Raw Material ... ..	363,904	531,123	1,126,801
II. Stone, Clay, etc. ... ..	822,135	1,066,242	1,385,405
III. Wood ... ..	1,078,892	1,291,683	1,757,693
IV. Metal, Engineering, etc. ... ..	7,566,728	8,106,748	10,094,404
V. Food, Drink, etc. ... ..	15,814,270	19,412,014	22,941,652
VI. Clothing, Textiles, etc. ... ..	1,301,298	1,744,456	2,416,444
VII. Books, Printing, etc. ... ..	1,376,420	1,991,291	2,366,267
VIII. Vehicles, etc. ... ..	768,465	1,025,564	1,289,177
IX. Shipbuilding, etc. ... ..	58,874	46,129	85,445
X. Furniture, etc. ... ..	552,829	831,297	1,015,640
XI. Chemicals, etc. ... ..	4,289,989	5,304,415	6,854,019
XII. Surgical Instruments, etc. ... ..	10,691	20,969	27,847
XIII. Jewellery, etc. ... ..	54,157	76,601	83,811
XIV. Heat, Light, and Power ... ..	2,855,393	3,181,003	3,454,366
XV. Leather and Leatherware ... ..	1,239,888	1,652,829	2,281,425
XVI. Building and Contracting ... ..	2,077,936	2,803,744	3,348,253
XVII. Other Industries... ..	203,013	368,306	299,791
<b>TOTAL</b> ... ..	<b>40,434,882</b>	<b>49,457,414</b>	<b>60,828,440</b>
Average Value of Output per Employee	399	399	453
Average Value of Output per head of Mean White Population ... ..	29	35	42

\* Quarterly Abstract of Union Statistics, No. 1, 1920,

*II.—Summary.*

Year.	No. of Establishments.	Hands Employed.	Salaries and Wages Paid.	Value of Plant, Machinery, Land, and Buildings.	Value of Materials Used.	Value added by Manufacture.	Value of Output.
			£	£	£	£	£
1915-16	3,998	101,178	8,912,857	24,537,419	22,315,587	18,119,295	40,434,882
1916-17	5,305	123,842	10,436,694	28,598,521	28,023,948	21,433,166	49,457,414
1917-18	5,918	134,211	12,227,700	35,133,505	34,248,331	26,580,109	60,828,440

**Western Province Fruit Crop.**

According to figures furnished by the Railway Administration it is estimated that the annual grape crop of the Western Province is not far short of 100,000 tons, produced in the following districts, viz.:—

Paarl ... ..	25,000 tons.
Worcester ... ..	22,000 „
Stellenbosch ... ..	18,500 „
Robertson ... ..	10,000 „
Montagu ... ..	9,500 „
Malmesbury ... ..	6,000 „
Tulbagh and Ceres ... ..	4,500 „
Capetown and Wynberg ... ..	3,000 „
Caledon ... ..	1,500 „
<b>Total ... ..</b>	<b>100,000 tons.</b>

With the price of wine averaging £20 a leaquer, and about 90 per cent. of the total grape crop bought up by the distillers, it followed that table grapes were worth more than 10s. per 50-lb. basket during the 1919-20 season, as compared with 2s. 6d. before the war.

Upwards of 20,000 tons of fresh fruit were carried over the South African Railways during the 1919-20 Western Province deciduous season, a slight reduction on the figures of the preceding three seasons, due, chiefly, to a larger quantity of grapes than usual being pressed on the farms on account of the abnormal price of wine. Of this total, about 9000 tons went to the jam and drying factories, 6000 tons to the markets in the Transvaal, Free State, Natal, Rhodesia, South-West Africa, and the Cape Eastern and Border Provinces, 3000 tons to Capetown and other local markets, and 2000 tons to the Docks for export.

The annual production of Western Province deciduous fruits is not far short of 130,000 tons, of which upwards of 90,000 tons of grapes are pressed into wine, and about 15,000 tons of stone fruits and grapes are dried on the farms, the remaining 20,000 or 25,000 tons of stone fruits and grapes being transported by rail to the jam factories, the fresh fruit markets throughout South Africa, and to Capetown Docks for export overseas.

## THE POULTRY YARD MONTH BY MONTH.

By J. J. JORDAAN, Lecturer and Instructor in Poultry, Glen, Orange Free State.

### September.

*Chickens.*—The chickens must be closely watched and kept comfortable and warm at night; take care that they do not sleep in cold or damp quarters or roup is sure to follow, as night follows day. Weariness must not be allowed to overcome one in giving them their regular and constant feeding. Continue separating cockerels and pullets and also culling. In culling, go over those again that appeared "good enough" last month.

The number of brooders, no doubt, will want increasing with the growth of the chicks. Two lots of 25 chicks will always do better than one lot of 50. Examine the small chicks frequently on the head, throat, and fluff, under wings, and tail for insects; these are most troublesome from this month onwards. As the weeping willows are now in leaf, the leaves from these trees may be given to the chicks as a green food; they should be finely chopped before being fed to the birds.

*Showing.*—Exhibition breeders should have the birds intended for exhibition rung at once, if this has not already been done. The most likely looking birds should be separated and given special attention; it is from now on that the winner is made and not during the two weeks before the show.

As a rough outline:—*Heavy breeds* will want bone-forming feed; *Tight-feathered breeds* need hard grain and pea and bean meal in the mash, which is best dry; *Loose-feathered and fluffy birds* want plenty of slightly moist mash, with a small quantity of sulphur, linseed meal, and ground sunflower added.

*Incubation.*—This is the last of the good months for incubation, so if the number of chicks hatched is not the number desired, set all eggs possible that pass the test.

*General.*—This is the month in which the greatest and most sudden changes take place both in weather and in temperature; seldom are three successive days the same. Therefore, be on the alert and prepared for any such change suddenly taking place. Adult birds will be inclined to lay on fat; keep them down in condition with a fortnightly dose of epsom salts just to taste, in their drinking water, and by digging the grain into the ground. Fresh drinking water should be given at least twice a day and kept shaded.

From now on to March dip all fowls monthly for insects and spray all nests, houses, and brooders. Insects must be fought; a little of the following powder sprinkled in the nest fortnightly will do a lot towards this:—1 part naphthalene (flaked), 20 parts sulphur.

---

### Fruit Export, July, 1920: A Record Shipment.

There were four shipments of fruit during July, 1920, totalling 33,390 boxes oranges, 2565 boxes naartjes, 1231 boxes grape fruit, and 252 boxes pineapples. Included in these figures is the shipment of fruit per the "Balmoral Castle" on the 9th of the month amounting to 16,894 boxes, of which 15,477 were oranges; this is the record shipment of fruit, either citrus or deciduous, that has left South Africa, the previous largest consignment being about 11,000 boxes of citrus fruit by the same steamer last season.

## THE VEGETABLE GARDEN.

September, 1920.

By H. B. TERRY, Cert. R.H.S., Lecturer in Horticulture, School of Agriculture, Potchefstroom.

THE risk of frost is now much less, and tender crops may be sown in all but the coldest localities. It is always worth while planting a few early seedlings or sowing seed and taking a risk, if by such means an early crop is to be secured, for vegetables are less plentiful during the next two months than at any other time of the year.

**TOMATO.**—Plants should be transplanted where no danger from frosts exist; a few branches of macrocarpa or gum trees not only protect the plants from heat and cold, but also from hail.

**DWARF FRENCH BEANS.**—Canadian Wonder, Refugee, etc., should be sown in drills 15 to 18 inches apart; place the beans about 6 inches apart in the rows. Some growers prefer to sow beans in hills 1 foot apart, placing four to six beans in each hill. Do not cover deeper than 1 inch.

**TABLE MEALIES.**—Make a good sowing in most localities; use Early Evergreen, Golden Bantam, Bothma Bread, Maizena. These varieties are not harmed should the outer leaves be slightly touched by frost.

**MELONS.**—Water-melons prefer a warm rather sandy soil and plenty of manure. Make holes six feet apart each way, dig in the manure, and in each hole place four to six seeds; later on select the best three and pull the others out. Musk or Sweet Melon (Spanspek) is grown in a similar manner to water-melons. Provision should be made for irrigation during drought.

**ONIONS.**—Sow Prizetaker, Golden Globe, Danver's Yellow, James Long, Ailsa Craig. It is less work to sow in beds and transplant later on. Weeds must be kept down at all costs.

**CARROTS.**—Early Dutch Horn, Model, James' Intermediate, and Altringham are useful early sorts to sow now. Let the drills be 15 inches apart to facilitate weeding and thinning.

**CUCUMBERS.**—Sowings may be made this month in favoured districts. Forkhook Famous, White Spine, Long Green are useful sorts. Make holes about 4 feet apart and place four to six seeds in each hole, water freely, and, later on, retain only the three strongest plants.

**KOHL RABI** is a good substitute for turnips in summer; it stands dry weather very well.

**LETTUCE.**—Sow cabbage varieties such as Boston, Neapolitan, Iceberg, etc.; do not allow the plants to want for water, as they will run to seed. Young seedlings may be transplanted.

**VEGETABLE MARROW AND SQUASHES** may be sown in hills or holes 4 feet apart each way in fairly rich soil; the earliest sorts are Custard Squashes, closely followed by Long White, Long Green. It is always advisable to grow the bush type; the yield is greater and less space is required.

**CELERY.**—Sow seed in tins or boxes under shelter.

**CAPSICUM OR CHILLIES.**—Sow large round for cooking and long chili for pickling. Sow the seed in boxes and transplant later on.

**BETROOT.**—Early roots may be obtained by sowing Eclipse, Egyptian Turnip Rooted; thin out when strong enough. The tops when young make an excellent substitute for spinach.

**LEEKs.**—Seeds may still be sown in beds for transplanting; the soil may be prepared meanwhile; make it fairly rich to push growth on.

**RHUBARB, JERUSALEM ARTICHOKEs, HERBS** of all sorts should be divided and transplanted.

**POTATOES** may be planted when no danger of late frosts is feared.

## NOTES FROM THE "GAZETTE."

Attention is drawn to the following matters of interest which appeared in the *Union Government Gazette*:—

(Abbreviations: "Proc."—Proclamation; "G.N."—Government Notice.)

*Gazette.*

No.	Date.	ITEMS.
1073	9/7/20	Under the Fencing Act (No. 17 of 1912), contributions towards the cost of dividing fences are obligatory as from the 9th July, 1920, in the Hex River Ward, Rustenburg District. (Proc. No. 113.)
1073	9/7/20	Compulsory dipping of cattle in the three-day dip for portions of the Districts of Zoutpansberg, Pietersburg, and Pretoria; in the five-day dip for portions of the Districts of Estcourt, Idutywa, Lions River, Weenen, Pinetown, Babanango, Umvoti, Inanda, Dundee, Ngotshe; and in the seven-day dip for portions of the District of Pretoria, has been ordered by the Minister. (G.N. Nos. 1166, 1218, 1294, 1345, 1381.)
1075	16/7/20	
1077	23/7/20	
1079	30/7/20	
1081	6/8/20	
1073	9/7/20	By-laws of the Prins River Irrigation Board, Division of Ladismith, under the Irrigation and Conservation of Waters Act (No. 8 of 1912), are published in G.N. No. 1150.
1075	16/7/20	Under the Stock Diseases Act, the Minister of Agriculture has prohibited, on account of East Coast Fever, the removal of cattle into the south-western and north-western paddocks of the Richmond Commonage, unless such movement is by permit. (G.N. No. 1217.)
1075	16/7/20	In terms of Act No. 16 of 1913, the Minister of Agriculture intends declaring certain areas in the district of Kentani as demarcated forests. (See Schedule, G.N. No. 1222.)
1077	23/7/20	Proclamation No. 76 of 1919, under the Fencing Act, 1912, regarding fencing of locations, has been amended in respect of the rate to be levied from each male inhabitant, and also as regards the date by which the rate levied is to be collected. (Proc. No. 126.)
1077	23/7/20	A Minister's Order regarding the removal by rail of scab-infected sheep, in contravention of the Stock Diseases Act (No. 14 of 1911), is contained in G.N. No. 1229.
1077	23/7/20	Brands applied for by Europeans and natives up to 21st July, 1920, under the Brands Registration Acts, Nos. 12 of 1890 and 4 of 1897 (Cape of Good Hope), are published in G.N. No. 1289.
1077	23/7/20	Brands, both European and native, allotted and registered in terms of the Great Stock Brands Ordinance (No. 15 of 1904, Transvaal), for the quarter ended 31st March, 1920, are published in G.N. No. 1292.
1077	23/7/20	A list of brands registered in the Orange Free State in terms of the Orange Free State Brands Regulation Ordinance of 1903 is published in G.N. No. 1293.
1077	23/7/20	Regulations governing the introduction into the Union of dogs from Great Britain are published in G.N. No. 1295.
1077	23/7/20	Crown lands in the Malmesbury Division will be offered for lease by public auction at Vredenburg, at 11 a.m., Tuesday, 14th September, 1920. Further particulars are contained in G.N. No. 1265.
1078	28/7/20	The Act for the incorporation of the South African Stud Book Association and affiliated Societies, and other matters incidental thereto, having the assent of the Governor-General, is published in G.N. No. 1297.

(Abbreviations: "Proc."—Proclamation; "G.N."—Government Notice.)  
*Gazette.*

No.	Date.	ITEMS.
1079	30/7/20	Under the regulations for the administration of the Transkeian Territories General Council (Proc. No. 143, 1915), the Governor-General has imposed levies on stock (and a poll rate) in certain Transkeian districts. The amounts payable and dates when they fall due are published in G.N. No. 1305.
1079	30/7/20	The Minister of Agriculture has declared the Frankenwald Estates (portions of Bergvallei No. 1 and Klipfontein No. 88) to be in the Germiston District for purposes of paragraph <i>sixteen</i> of the Diseases of Stock Act (No. 14 of 1911). (G.N. No. 1308.)
1079	30/7/20	The Minister of Agriculture has approved of certain gentlemen in the Pretoria District as officers of the Department of Agriculture for the purpose of empowering them to administer regulations under the Stock Diseases Act. (G.N. No. 1319.)
1079	30/7/20	Applications for Crown lands, to be disposed of on conditional purchase lease, in the Waterberg District, will be received by the Department of Lands, Pretoria, up to the 10th September. (G.N. No. 1307.)
1079	30/7/20	Crown lands in the Divisions of Paarl, Kenhardt, and Tarka, and the districts of Willowvale and Umzimkulu, will be offered for sale by public auction on various dates in October and at certain places mentioned in G.N. Nos. 1347 and 1348.
1081	6/8/20	The redemarcation of the Xorana Plantation, Mqanduli district, is notified in G.N. No. 1372.
1081	6/8/20	For purposes of the administration of the Revised Scab Regulations (G.N. No. 1703, 1919), the Minister has ordered that the native areas referred to therein shall be as defined in the Schedule to Act No. 27 of 1913. (G.N. No. 1362.)
1081	6/8/20	Crown lands available in terms of Proc. No. 102 of 1911 are notified as being for disposal in the Divisions of Weenen, Impendhle, and Estcourt. Applications will be received by the Secretary for Lands, Pietermaritzburg, up to the 6th September, 1920. (G.N. No. 1361.)
1081	6/8/20	Up to the 17th September applications will be received by the Department of Lands, Pretoria, for Crown lands in the Kenhardt Division that are to be disposed of on conditional purchase lease. (G.N. No. 1398.)
1081	6/8/20	Crown lands in the Heilbron District will be disposed of under similar conditions as referred to above. (G.N. No. 1399.)

## Cotton Gins.

The two cotton gins situated at Durban and at Rustenburg are being reopened for the purpose of ginning small parcels of specially selected seed cotton for farmers. The gin at Rustenburg is now open, and any farmer wishing to take advantage of this offer may send parcels to the Manager of the Experiment Station, Rustenburg. The Durban gin will be opened for similar work next season. Farmers sending parcels of cotton must prepay freight and give instructions as to where the seed and lint are to be forwarded after being ginned. A charge will be made to cover the cost of ginning and of returning the products to the farmer. It must be clearly understood that the Government will in no case do commercial ginning.



## SOUTH AFRICAN PRODUCE ON THE OVERSEA MARKET.

### Extracts from Report of the Acting Trade Commissioner.

June, 1920.

*Wool.*—Auction sales were held on the 3rd, 8th, and 10th of June, but only a small quantity of South African wool changed hands out of the 4400 bales offered. The bulk of the offerings did not obtain satisfactory bids and were consequently withdrawn. A few parcels of greasy wools were purchased by the manufacturers, but ordinary topmaking wools were passed over by the Continental buyers as well as Home trade. It is very difficult indeed to give a basis for prices, but the trade state that greasy combings at the above auctions were from 25 to 30 per cent. below those ruling at the April-May auctions. Snow Whites have not been so seriously affected, but superior qualities have declined 10 per cent., medium sorts 20 to 25 per cent., and inferior descriptions 10 to 15 per cent.

*Mohair.*—The market for this article is very quiet, and no transactions of any importance have been recorded. The nominal prices given in my previous report more or less apply to-day.

*Hides and Skins.*—The hide market is lifeless and buyers show no inclination to purchase. The few transactions that have taken place show a general decline. According to the reports received from the trade here there is hardly any prospect of an improvement for the next three months.

Sheep and goat skins are in a similar position to hides, and all descriptions are neglected.

*Wattle Bark.*—The market continues dull, and with the large stocks at present on hand an improvement cannot be expected for some time. The position at the moment is that tanners are overstocked with raw materials and have large supplies of leather on hand, with the result that short time is being worked in the tanneries. The Continental demand has declined and prices have fallen. Shipments from the Union have fallen off, but this may help the situation later on, and it is hoped that the market will improve within the next two months. At the moment £17. 10s. per ton for ground and £15. 10s. for chopped, on the spot, is being asked, but these quotations are nominal.

*Ostrich Feathers.*—During the past month the market for ostrich feathers has shown no appreciable improvement in prices, but the demand for the Home trade has to some extent improved. Continental buyers are, however, still holding off, hoping for a further improvement in the exchanges. Wing feathers of medium quality and short coloured feathers in hard and floss have been principally in request.

*South African Maize.*—Here, again, the market is stagnant, and only 70s. to 72s. 6d. per quarter c.i.f. is being offered for South African White Flat No. 2. Argentine maize is quoted at 59s. to 61s. per quarter c.i.f.

---

### Export of Grain, etc.

In last month's issue we published a statement (page 505) showing the quantity of grain, etc., exported from the Union during the seasonal year 1st July, 1919, to 30th June, 1920. For July, 1920, the first month in the new seasonal year, returns show that 2763 bags maize, 420 bags maize meal, and 138 bags beans were exported, while the stock on hand at the end of the month consisted of: maize, 2367 bags; maize meal, 29 bags; and lucerne seed, 35 bags.

## OVERSEA PRICES OF SOUTH AFRICAN PRODUCE.

July, 1920.

MARKET PRICES OF SOUTH AFRICAN PRODUCE IN THE UNITED KINGDOM,  
CABLED BY THE TRADE COMMISSIONER, LONDON.

### South African Wool.

"7000 bales South African wool offered July auction, but bidding poor. Large proportion withdrawn. Few snowwhites. Greasies sold at 10 to 15 per cent. below last sale prices."

### Combing Wool.

1s. 5d. short, 1s. shorn, 10d. nominal.

### Mohair.

Unchanged.

### Cape Hides.

Dry salted, best heavy, 1s. 7½d. Wet salted, 1s. 2d.

### Cape Merino Sheep Skins.

Market is stagnant. Nominal prices.

### Cape Goat Skins.

Almost unsaleable.

### Natal Wattle Bark.

Market dull. Chopped offered at £15 *ex* Store.

### South African Beef.

Hinds, 5s. 8d. to 6s. 8d. per 8 lb.; Fores, 3s. 4d. to 4s. 4d. per 8 lb.

### Ostrich Feathers.

Market dull with fair business at about previous rate for medium quality wing and coloured feathers.

### South African Cotton.

July futures closed 29th July, 2s.; highest, 25.04; lowest 2s.

### La Plata Maize.

Parcels *ex* Store, 66s. per quarter; August-September shipments, 60s. 6d. per quarter; September-October shipments, 60s. per quarter, *e.i.f.*

(NOTE.—A Reuter message from London, dated 13th August, appearing in the Press, advises the following quotations for maize:—August-September shipment: White Flat, 80s., nominal; La Plata, 63s. paid.—ACTING EDITOR.)

## Plant Nurseries in Quarantine.

No new quarantines on nurseries have been imposed since 1st June last. The list of quarantines in force on 1st August, 1920, is as follows:—

Name of Nurseryman.	Address.	Cause of Quarantine.	Extent of Quarantine.
D. A. English & Co. ...	Pietermaritzburg	Red scale ...	Portion of citrus.
F. Grace ...	Berlin, C.P. ...	" " ...	" " "
P. C. S. Gaylard ...	" " ...	" " ...	" " "
Municipal Nursery ...	St. George's Park, Port Elizabeth	Circular purple scale	Palms. " "
J. Hobson & Co. ...	Kingwilliamstown	Red scale ...	Portion of citrus.
W. T. Atwood ...	Observatory, Cape- town	" " ...	Whole nursery.
C. F. Marais ...	Wellington ...	" " ...	All citrus.
E. Krohn ...	Mare Street, Pre- toria	Pernicious scale and other pests	Whole nursery.

## NOTES FROM THE DIVISIONS.

### VITICULTURE.

OWING to the dry summer months of October, November, and December last, with two inches less rainfall than in 1918, the general opinion was that the 1920 grape crop would be far below normal—in certain areas as much as 50 per cent. less. It was remarkable, however, that although considered an exceptionally dry season, the climate was very mild. To this must be attributed the fact that, when the vintage started, farmers were pleasantly surprised in obtaining far bigger crops than anticipated. Further, the 1920 vintage will probably exceed the 1919 crop by about 10,000 leaguers (127 gallons per leaguer). This increase may be put down to new vines coming into bearing and also the fact that the price of wine was so high that less raisins were made. Whereas the highest prices in 1919 were £20, and the average £10, they rose in 1920 to £30, with an average of £20. These prices naturally gave an impetus to the laying out of new vineyards. The result is that grafted vines are being sold at very high prices; formerly a 1000 grafted vines cost from £5 to £12, to-day they are sold at £12. 10s. to £25. According to one of the largest vine nurserymen, 75 per cent. of the vines sold is Hermitage. This is not a good sign, as it shows that quantity is the chief object. High prices enabled farmers better to manure their vines, and this was reflected not only in increased crops, but complaints of deteriorating vineyards have considerably decreased. On the other hand they have had a bad effect on the quality of wine, as anything resembling wine demanded a ready sale. The practice of buying wines long before vintage, regardless of quality, cannot be too strongly condemned. It leads to carelessness on the part of the farmer, and consequently very inferior quality wines are made.

The "Ko-operatieve Wijnbouwers Vereniging van Zuid-Afrika, Bkt." has appointed an expert to assist all farmers who are anxious to improve the quality of their wines, but as this gentleman can only supervise a small quantity, and most of the crop was sold before the vintage, the bulk of the 1920 crop is known to be of poor quality. That the production of quantity, which is chiefly turned into spirits, is not desirable is recognized by the farmers. With a view, therefore, of encouraging the export trade, which is bound to lead to quality wines being in demand, a proposal has been made that merchants wishing to export wine, and on account of high local prices finding the profit too small, shall be assisted by their Society, who will contribute 6d. per gallon on condition that such wine must be bought direct from the farmer as suitable for export and should not be manipulated wines. This suggestion has passed the preliminary stages, and it is hoped will be confirmed at the next meeting of the Society.

During the last six months many wine farms have changed hands, and some at fancy prices; quite a number of the buyers are men from overseas, who are keen on growing grapes for export. We are now daily dealing with queries as to best grape varieties for export, etc.

From figures that I have seen, it appears that a ton of grapes exported netted £100 after deducting all expenses. (A ton of grapes is usually taken to represent 1 leaguer of wine.)

The wine market has dropped lately and prices are now between £12-£16.

The farmers are busy pruning and manuring their vineyards. Grafting operations have also commenced. (S. W. van Niekerk, Government Viticulturist, July, 1920.)

---

## CORRIGENDA.

July, 1920, issue of the *Journal* (Vol. I, No. 4).

Page 378, *Comparative Valuation of Lime Manures*. In the second paragraph the items 3s. 1d. and 3s. 6d. should read : 3·1d. and 3·6d. respectively.

Page 382, *Fencing*.—The word "in" in second line and the word "on" in third line to read "or" in each instance.

August, 1920, English issue, page 498. Owing to an inadvertent error in setting type, the title of the publication *South African Poultry Magazine* (Bloemfontein), having articles on the Ancona, etc., was erroneously substituted by that of another publication.

**STAFF: APPOINTMENTS, TRANSFERS, ETC.****(1) AGRICULTURE.**

DATE.	NAME OF OFFICIAL AND NATURE OF CHANGE, ETC.
1/7/20	<i>C. R. v. d. Merwe</i> : Appointed as Assistant Chemist, Pretoria.
3/8/20	<i>E. F. English</i> : Assistant Chemist, resigned to take up Government Bursary in America.
3/5/20	<i>W. Cronwright</i> : Appointed Principal Sheep Inspector, <i>vice</i> Major W. L. Currie, retired on pension.
3/5/20	<i>M. Truter</i> : Appointed Senior Sheep Inspector, Calvinia District, Cape Province, <i>vice</i> W. Cronwright, promoted.
1/8/20	<i>J. G. Brandsen</i> : Appointed District Veterinary Surgeon for the Transkei.

**(2) AGRICULTURAL EDUCATION.**

24/7/20	<i>A. R. Oliver</i> : Appointed Itinerant Poultry Instructor, School of Agriculture, Glen.
1/8/20	<i>C. C. Rhodes</i> : Appointed Itinerant Poultry Instructor, School of Agriculture, Potchefstroom.
1/7/20	<i>D. McLoughlin</i> : Appointed Assistant Chemist, School of Agriculture, Grootfontein.
27/7/20	<i>Miss M. E. Cairncross</i> : Appointed Matron at School of Agriculture, Cedara.
31/7/20	<i>A. St. C. Caporn</i> : Plant Breeder, School of Agriculture, Potchefstroom, resigned.

**MOVEMENTS OF OFFICERS.****ENTOMOLOGICAL DIVISION.**

*Mr. C. P. Lounsbury*, Chief, Division of Entomology, resumed duty on the 12th August, on his return from the Imperial Conference of Entomologists in London.

**VETERINARY EDUCATION AND RESEARCH.**

*Sir A. Theiler, K.C.M.G.*, Director of Veterinary Education and Research, has been granted six months' vacation and proceeds to Europe in September. He intends to visit research institutes in Europe and probably also in America. During his absence *Dr. P. J. du Toit* will act in his stead.

**TOBACCO AND COTTON DIVISION.**

The Chief of the Tobacco and Cotton Division, *Mr. W. H. Scherffius*, and the Manager of the Experimental Station, Rustenburg, *Mr. J. du P. Oosthuizen*, propose making a tour of the Rustenburg District, lecturing at the centres and on the dates as shown hereunder. All interested in tobacco and cotton culture are invited to attend the lectures:—

Rustenburg Experiment Station, 13th September, 2 p.m.; Rooiwal, Mr. Camphor, 14th September, 10 a.m.; Kameeldrift, Mr. Hahn, 14th September, 3 p.m.; Zoutpansdrift, Mr. Jan du Plessis, 15th September, 10 a.m.; Middelfontein, Mr. Hendrik Botha, 16th September, 10 a.m.; Steinbokfontein No. 520, Mr. Mackay, 16th September, 3 p.m.; Groot Marico, Markson's Hotel, 17th September, 10 a.m.; Lindleyspoort, Mr. Andries Macdonald, 17th September, 3 p.m.; Boshhoek, Mr. Gert Kirsten, 20th September, 10 a.m.; Pilansberg (Buffelspan), Mr. Smit, 20th September, 2 p.m.; Mackayskraal, Mr. H. T. Russell, 21st September, 10 a.m.; Rietfontein No. 826, Mr. Stander, 21st September, 3 p.m.; Klipgat, Mr. Jacobus v. d. Venter, 22nd September, 10 a.m.; Drievierboom, Mr. Crowthers, 23rd September, 2 p.m.; Beaufort, Mr. S. Visser, 24th September, 10 a.m.; Uitlanderskraal, Mr. J. L. Coetzee, 24th September, 3 p.m.

**DRY-FARMING DIVISION.**

*Mr. H. S. du Toit*, Government Agronomist, intends visiting Ladybrand and Kopjes in the beginning of September with a view to lecturing to farmers.

**RECENT AGRICULTURAL LITERATURE.**

By PAUL RIBBINK, Librarian, Department of Agriculture.

**I.—UNION GOVERNMENT PUBLICATIONS.****A.—DEPARTMENT OF AGRICULTURE.***(Bulletins obtainable from the Department of Agriculture, Pretoria.)*

<i>Price per copy.</i>	<i>Number of Publication.</i>
1d. Preliminary Studies on some Fungi and Bacteria responsible for the Deterioration of South African Sugars, by P. A. van der Bijl, M.A., D.Sc., F.L.S.	Science Bulletin No. 12.

**B.—MISCELLANEOUS REPORTS, ETC., OF INTEREST TO FARMERS.***(Obtainable from the Government Printer, Pretoria.)*

1s. 0d. Native Affairs: Second Report of the Select Committee	S.C. 10A—'20.
1s. 0d. Union Statistics, Quarterly, Abstract No. 3, July, 1920, issued by the Office of Census and Statistics of the Union of South Africa.	S.P. 17.
2s. 6d. East Coast Fever in the Union: Select Committee's Report.	S.C. 3—'20.
5s. 6d. Public Accounts, First and Second Reports of the Select Committee, July, 1920.	S.C. 1—'20.

**II.—THE AGRICULTURAL PRESS OF SOUTHERN AND TROPICAL AFRICA.****SELECTED ARTICLES.**

- Die Boer* (Bijvoegsel tot *De Volkstem*), Pretoria.  
 25/6/20 Turkse Tabakbau. Kikoejoegras. Lusern.  
 9/7/20 Stamboek Vee-Wetsontwerp.  
 16/7/20 Ko-operatie.  
 23/7/20 Ko-operatieve Kongres (Vervolg van Uitgawe van 25 Junie 1920).
- Die Boerevrou* (Posbus 984, Pretoria).  
 7/20 Iets oor Bije en Heuning. Vergroting van die Derdé Mangel. Bloem- en Groentetuin in Augustus. Lemoenvrugtekonfijt. Onse Lemoenvrugte.
- Farmers' Advocate, South African* (P.O. Box 247, Bloemfontein).  
 7/20 The Wheat Stringency. Our Agricultural Schools: Are they on right lines?. Reclaiming the Kalahari. Farm Devices: Simple and Useful.
- The Farmers' Journal* (Nairobi, B.E.A.).  
 17/6/20 The Veterinary Department of B. E. A. Flax Caterpillars, by F. W. Dry.  
 24/6/20 Oil Resources. African Attractions, by Mysterex. Maturing Young Bulls. Calving Diseases. The Motor Spirit Extremity: East Africa's Opportunity.  
 1/7/20 Flax (concluded from issue of 17/6/20). Citrus Nursery (concluded).  
 8/7/20 The Agricultural Census (B. E. A.). Flax Caterpillars. Notes on Roping, by F. W. Dry. Veterinary Report of May, 1920.  
 15/7/20 The Farmer's Taxes. Incubators. Flax Growing, by Geo. M. Hamilton.

*The Farmers' Weekly* (Bloemfontein).

- 7/7/20 Maize Production Costs. Birds and Forests, by F. W. Fitzsimons. Farming in South America. Meat Freezing and Packing, by E. A. Nobbs, Ph.D., B.Sc.
- 14/7/20 Bilharzia and Fluke. Farmers' Party Ideals. The Durban Show. The White Ant Trouble, by J. Cole Rous. Gall-sickness (*Anaplasmosis*), by A. F. Harber, M.R.C.V.S. The Ayrshire. S. A. Stud Book Association Annual Meeting.
- 21/7/20 A Bacon Factory, by C. Handley. Birds and Health, by F. W. Fitzsimons. Lamsiekte: Lecture by Sir Arnold Theiler at Vryburg. Agriculture in Rhodesia: The Director's Report for 1919 (continued from the issue of 7/7/20). East Coast Fever Problems: Some Rhodesian Recommendations.
- 28/7/20 Maize and Price Fixing. Educating our Boys, by C. W. Smith. Milk Fever in Cows, by A. Hodder. National Botanic Gardens. Red Polls. Windmills, by H. H. Murray. Transvaal Agricultural Union, 18th Annual Conference, Barberton, 21/7/20. Farming in South America: IV, by E. A. Nobbs, Ph.D., B.Sc.

*The Independent* (Salisbury, Rhodesia).

- 2/7/20 A Vital Report (East Coast Fever Committee). Grain Elevators.
- 9/7/20 Grain Elevators (*continued*).
- 16/7/20 Planting for Profit: Advice to Sellers.
- 23/7/20 Bombing Beetles, Insect Mustard Gas. Cattle for the Congo.

*Die Landbouwer* (Posbus 1035, Pretoria).

- 30/7/20 Ondergrond Losmaak met Dinamiet. Vermeerdering van Ons Mielie Produkcie. Kalverrekte (*vervolg* van uitgawe van 29/2/20). Kaasmaak in die Algemeen en in Besonder op die Plaas, deur J. Kruyswijk.

*Die Landbouer Weekblad* (Posbus 267, Bloemfontein).

- 7/7/20 Veeversorging in Holland en Amerika. Sement en Konkreet, deur Meerkat (*vervolg*).
- 14/7/20 Landbutoestande in Rhodesia, deur G. Jordaan (*vervolg*). Sement en Konkreet (*vervolg*). Landbouonderwijs in die Skool, deur Dr. I. de V. Malherbe (*vervolg*). Aanlegging van Boomgaarde, deur H. B. Terry. Melkboerderij, deur G. J. Bosman.
- 21/7/20 Beurse vir Landboustudie Oorsee. Dorre Suid-Afrika, deur J. D. Schonken (*vervolg*). Die Bou van Damme, deur W. S. H. Cleghorne.
- 28/7/20 Die Geskiedenis van Landbou, deur P. L. Kriek. Skaapboerderij in Australie (*vervolg*). 'n Wolfabriek.

*The Rhodesia Agricultural Journal* (Department of Agriculture, Salisbury).

- 6/20 Cream and its Production, by T. Hamilton. Measurement of Land, by F. Eyles. Forestry in Rhodesia, by J. S. Henkel. Cultivation of Rice in Southern Rhodesia, by H. G. Mundy. Regulations governing Sale of Fertilizers and Farm Foods, by E. V. Flack. Hints on Dips and Dip-Testing, by A. W. Facer. A Mazoe Irrigation Scheme, by A. C. Jennings. Rainfall Season 1919-1920, by C. I. Robertson.

*South African Dairyman* (P.O. Box 925, Durban).

- 7/20 Modern Dairy Farming, by Farmer George (*continued*). Official Notes on Friesland Cattle. The Milk Producers' Union: Meeting of Central Governing Board. Milk and its Care, by P. L. de Klerk.

*South African Farm News* (P.O. Box 963, Johannesburg).

- 7/20 Farmers' Party. Old British Breeds, "Sussex Cattle," by Farmer George. Bacteria in relation to Cheese-making.

*South African Fruit Grower and Small Holder* (P.O. Box 5958, Johannesburg).

- 7/20 Minimum Quantity of Moisture Necessary for Crops, by H. S. du Toit. Mistakes in Lemon Cultivation: Some Observations in British East Africa, by A. E. Bester. Tree Planting in Community, by H. E. King. Agriculture Elsewhere: the ex-German Colonies, by F. H. Cooper.

- South African Gardening and Country Life* (P.O. Box 3958, Johannesburg).  
7/20 New Varieties of the Queen of Summer (Roses). Some Useful Hints on Rose Pruning. The National Botanic Gardens. In a Free State Garden. South African Birds of Economic Value, by R. G. & E. Warren.
- South African Journal of Industries* (Government Printer, Pretoria).  
7/20 Power applied to Agriculture: II.—Water Power, by W. S. H. Cleghorne. Glucose and Starch from Maize, by T. D. Hall. South African Federated Chamber of Industries: Annual Convention of Manufacturers. Fertilizer Production and Natural Fertilizers in the Union: II., by Chas. F. Juritz. Iron and Steel in the Union of South Africa: II.—The Technical Aspect, by Prof. G. H. Stanley. The Geological Survey: Annual Report of the Director. Transport Methods in South Africa: V., by Sir Wm. Hoy, Kt., C.B.
- South African Poultry Magazine* (Bloemfontein).  
7/20 The Term Utility. Exhibition Poultry, by S. J. Hocking. Farmers and Poultry Clubs. Poultry Keeping on Practical and Paying Lines, by W. C. Archibald. Wyandottes, by H. Moore.
- South African Poultry Review and Small Holder* (Johannesburg).  
7/20 On Conferences. South African Poultry Association: Monthly Meeting of Executive Board, 12th June. The Championship (12th Annual Show, Pretoria).  
8/20 Long-Faced Tumblers, by W. B. Choles. Why Farmers should become Members of Poultry Clubs.
- South African Sugar Journal* (P.O. Box 925, Durban).  
7/20 The Ethics of Sugar Control, by A. Mortifee. Notes on the Cotton Industry, by W. B. Wilson. The Arrowing of Sugar-cane. Bagasse as a Paper-making Material. The Normal Weight of Sugar.
- The Sun and Agricultural Journal of South Africa* (P.O. Box 634, Johannesburg).  
7/20 Practical Talks with Farmers, by S. R. Forbes. The South African Maize Breeders', Growers', and Judges' Association. Cattle: The Kerry and the Dexter.
- Sunday Times* (Farmers' Supplement), Johannesburg.  
4/7/20 Tobacco Planting: II, by W. E. Leigh. Growing Cabbages for Market, by H. B. Terry. Afrikaner Cattle, by Prof. A. M. Bosman. Animal Nutrition, by J. S. Jamieson.  
11/7/20 Milk, by E. P. Berlyn. Rotation of Crops, by P. J. Naude.  
18/7/20 Tobacco Growing, Seed Selection, by W. E. Leigh. Foods and Feeding, by E. P. Berlyn. Feeding Farm Animals, by P. J. Naude. Transit of Live Stock, by "Sporweg" (continued).  
25/7/20 What we want from the Farmer: III.—Marketable Vegetables. Feeding of Farm Animals, by P. J. Naude. Veterinary Medicines, by J. S. Jamieson. Transport of Dead Meat, by "Sporweg."  
1/8/20 Caprification of Smyrna Figs, by I. Tribolet. Castration of Domestic Animals: I, by A. Hodder. Transport of Dead Meat, by "Sporweg."

### III.—AGRICULTURAL PUBLICATIONS IN OTHER PARTS.

(1) "*Het Eerste Jaarboek van de Veeartsenijkundige Hoogeschool te Utrecht (Holland), 1918-19*" is of particular interest at present in view of the recently created College of Veterinary Education at Onderstepoort, Pretoria. The year-book gives the speech of the "Rector-Magnificus," J. Wester, on the occasion of the presentation of the rectorate, appropriately entitled *Animalium hominum que Saluti* (To the welfare of animals and man). The inaugural speech of Dr. H. Schornagel on the "Meat Hygiene" from an historical view-point, and various biographical notes of new professors of necrology, lists of students, successes at examinations and degrees conferred, together with title of thesis, etc., bursaries and grants in aid of study, etc., are also included.

(2) The following is a further part of Professor J. A. Thomson's paper entitled "The Biologist on the Farm," as appearing in the *Scottish Journal of Agriculture* of January, 1920, and of which an abstract appeared in the previous issue of this *Journal*:—

"*Free-Martins.*"—A great deal has been said and written about "free-martins," but, so far as we can see, there is no longer any room for doubt as to what a "free-martin" is. When a cow has two calves of different sexes, one may be a normal male and the other a "free-martin"—a sterile and abnormal female. We have studied several. Externally and in its udder the "free-martin" is distinctly a female, but the internal organs of reproduction are more or less of the male type. We know that several good authorities have maintained that the "free-martin" is a disguised male, but we have been convinced by Prof. Frank R. Lillie's arguments that it is rather of the nature of a female. What, then, is the explanation of the predominantly male character of the internal reproductive organs? Prof. Lillie's ingenious theory is that there is a secondary fusion of the foetal membranes of the twin calves, and that the development of the female twin is badly disturbed by sex-hormones or chemical messengers which are carried in the blood that has been circulating in the male twin. The "free-martin" and its male co-twin are, of course, the products of two distinct ova.

"*Runts.*"—This is an ugly word for an ugly thing. It is technically applied by breeders to undersized and abnormally light new-born mammals, which are produced when the mother is not in good condition during the time of gestation, or sometimes when an unusually large number of young ones are born at once. True "runts," which have been recently studied by Miss Helen Dean King in the case of rats, are to be distinguished from small-sized offspring which are born a little too soon or in unpropitious conditions. For in these cases it is found that there is nothing radically wrong, and that careful nurture can be made to counteract the birth-handicap. With true "runts," however, the case is different. They are born with a growth-capacity so impaired that they seldom grow beyond a certain stage. They may be said to be born old. If they manage to grow up they tend to have an abnormally small nervous system, and they are lacking in reproductive vigour. Fortunately, therefore, they are in most cases unable to multiply after their kind. No one would be so foolish as to try to breed from "runts." They are better dead.

---

## Sale of Cattle in Southern Rhodesia.

In the course of his Annual Report for 1919, the Director of Agriculture for Southern Rhodesia states: "An interesting innovation in the usual methods of selling cattle in this country was initiated in April by the Farmers' Association of Plumtree, and has since proved a most complete success. The association constructed its own stock-yards, dipping-tank, and watering-troughs, appointed an auctioneer, and arranged a series of sales. The cattle are marked, cared for, and taken in charge for delivery by the society, and the fees compare favourably with those of other sales, yet the prime costs have been recovered, and future profits will be used for local public purposes. Other very important advantages are that the local cattle owner, including natives, soon acquire a true idea of the value of their cattle, removing illusions, and helping them to do sound business, whilst if dissatisfied with prices they can take the cattle back to their farms without serious loss. A similar scheme has also been adopted by the Sinoia Farmers' Association, and the plan is worth widespread imitation."



## AT THE SCHOOLS OF AGRICULTURE AND EXPERIMENT STATIONS.

July, 1920.

CEDARA, NATAL.

*Climate.*—The rainfall from 26th June to 28th July was .009 inches. The mean maximum temperature was 65.94° F., and the mean minimum temperature 41° F. The highest maximum temperature, 77.5° F., was experienced on 16th July, and the lowest minimum, 35.3° F., on 7th July. During the month frost was registered on nine days. The days were fine and bright, and the nights cold.

*Crops.*—The maize has yielded satisfactorily. The *Brassica* crops are looking well, but the grasses have been badly affected by severe frosts.

*Field Experiments.*—In the experimental plots of grasses, cocksfoot has proved more frost resistant than tall fescue or Kikuyu. It still maintains its green colour, whereas the others have turned yellow. The maize experiments have now been harvested, and satisfactory data obtained. This crop has responded vigorously to the application of phosphatic manures. Some new varieties of potatoes are being tried and are showing up well, and should produce seed suitable for summer planting.

*Stock.*—Ten calves were born during the month: Ancona, the champion South African bred heifer (Johannesburg and Royal Shows) gave birth to a fine bull calf. The other calves were four Shorthorns (three bulls, one heifer) and five Frieslands (three bulls, two heifers). Three cases of gall-sickness were treated by the Harber method with satisfactory results. All the stock is in excellent condition. The following prizes were gained at the Pietermaritzburg and Durban Agricultural Shows:—

Royal Show, Pietermaritzburg.—Champion, Aberdeen-Angus bull; special, Aberdeen-Angus bull, South African bred; Drysdale Cup for family group; also 1 first, 4 seconds, 2 thirds, and 3 highly commended.

Durban Show.—Champion, Aberdeen-Angus bull; reserve champion, Aberdeen-Angus cow; also 6 firsts, 2 seconds, and 1 commended.

*Students.*—There are now 57 students in residence at Cedara and 6 at Winkle Spruit.

ELSENBURG, MULDER'S VLEI, CAPE.

*Climate.*—Soaking rains to the extent of 3.335 inches fell during the month, the normal average being 4.04 inches. The maximum temperature recorded was 74.8° F. on the 12th instant, and the minimum 39.5° F. on the 7th instant.

*Field Operations and Crops.*—The seeding of all winter cereal crops was completed during the first week of the month, rye being the last crop sown. The crops on the low-lying lands are rather backward, due to the excessive wetness of the soil, but those on the higher lands are looking very well. The

total areas of farm land sown to various crops between April and 10th July are as follows:—

	<i>Elsenburg.</i>	<i>Mariendahl.</i>
Wheat (variety plots) .....	33 acres.	—
Algerian oats .....	170 ..	164 acres.
Burt oats .....	4 ..	20 ..
Texas oats .....	30 ..	—
Oats (variety plots) .....	11 ..	—
Barley .....	2½ ..	—
Rye .....	10 ..	20 ..
Oats and vetches (for ensilage) .....	40 ..	34 ..
Grazing crops (rye, barley, oats, and rape)	114 ..	46 ..
Kale and rape (in rows) .....	12 ..	—
<b>TOTAL .....</b>	<b>426½ ..</b>	<b>284 acres.</b>

In addition there are 20 acres of established lucerne at Elsenburg, and approximately 100 acres of land sown mainly to cereal crops in the experimental division.

About 40 acres of orchard and vineyard were ploughed during the month, and most of the pruning was completed.

*Development.*—2000 forest trees were planted, and 8 acres of land prepared for the sowing of pine seed and the plating of gums. A considerable amount of road construction and repairing was effected at both Elsenburg and Mariendahl, and a good deal of fencing erected.

*Live Stock.*—The condition of all live stock is satisfactory at present, and the milk yield of the dairy herd increased during the month. Green barley and lucerne grazing was of great value to stock, though natural grazing is improving.

*Extension Work.*—A number of samples of agricultural materials was analysed for farmers in the chemical laboratory, and a considerable amount of outside work was done by officers in charge of the various sections, particularly the veterinary.

*The School.*—The first winter vacation course ended on the 3rd July; the second began on the 5th and ended on the 17th. Attending the second course ("Farmers' Course") were 12 women and 15 men. Though handicapped by lack of instructors in certain subjects, both courses were very successful.

The school reopened for regular students on the 26th of the month.

### GLEN, ORANGE FREE STATE.

*Climatic.*—Cold and dry weather continued throughout the month. No rain was registered.

*School.*—Two short courses were held during the month, the horticulture and poultry course and the sheep and wool course, running concurrently, from 30th June, 1920, to 9th July, 1920. Seven students were admitted for the former course and 38 for the latter.

The three-weeks' general farmers' course is now in progress and 16 students were admitted.

The ordinary students are due back on the 10th August.

*Extension Work.*—Owing to the short courses, practically no extension work was performed. During the month, Mr. H. R. Oliver, who was appointed Itinerant Instructor in Poultry, assumed duty. His time will be devoted mostly to extension work.

*Farm.*—Crops made very little growth during the month owing to the cold weather. Stock are not affected to any extent by the weather, as grazing is still plentiful. Green feed continues to be expensive.

The stud season opens on the 15th of next month. Two Catalonian Jacks and one Percheron stallion will stand at stud at Glen, and farmers may book mares to them. Full particulars may be obtained on application.

## GROOTFONTEIN, MIDDELBURG, CAPE.

*Climatic.*—During the month no rain fell, and drought conditions are becoming severe in parts. High winds and cold have been prevalent; in fact, the wind experienced is unparalleled for this month. The springs in the Karroo are unusually strong, and, in many instances, are far stronger than they have been since the big snowstorm at the close of the Anglo-Boer war.

Temperature recorded: Maximum, 73° on the 20th; minimum, 18° on the 18th.

*Field Operations and Crops.*—Considerable field work was carried out during the month; 30 acres of land were ploughed, levelled, bedded, and sown to oats. Approximately 70 acres of lucerne and oats were irrigated from the springs and conservation dam, and some 30 tons of vlei-bay were stacked.

*Live Stock.*—In spite of the inclement weather the live stock at the institution are in good order. Stud sheep are lambing and the lambs are exceptionally fine. The veld cattle, Herefords and Africanders, are in splendid condition, but the working cattle are rather lower than usual at this time of the year. In the area falling under Grootfontein there has been a number of outbreaks of diseases amongst sheep, which, in some instances, are causing serious losses. It is hoped to report further on this at a later date.

*Field Experiments.*—Many of the cereal experiments sown last month are now looking well, and the sheep-feeding experiment is showing some striking results with regard to the effect of grazing different varieties of oats, wheats, and barleys, etc.

*Students.*—The short courses terminated on the 21st of this month (July). For the nine-days' sheep and wool course 83 applications were received, but owing to lack of accommodation only 62 were accepted, of which 58 finally took the course. The nine-days' course in poultry, horticulture, and dairying was attended by 10 students, and the three-weeks' general course by 21. All these students were particularly keen on their work. The special dairy, sheep, and wool course students and returned soldiers came into residence on the 1st July, and the diploma course students resumed duty on the 21st July.

## POTCHEFSTROOM, TRANSVAAL.

*Climatic.*—Cold weather was experienced during the month. The absolute minimum temperature registered was 27.0° on the 6th, and the absolute maximum 76.8°. No rain fell during the period.

*Farm Section.*—The main farm operations consisted of harvesting maize, sorting and classifying the crops for seed purposes. A good crop of Potchefstroom Pearl seed is being obtained. Three hundred and sixteen bags of maize were thrashed for feeding purposes. About 160 acres of land were irrigated during the month, which include the 140 acres sown to winter cereals. The windbreak of eucalyptus trees along the main irrigation canal has been thinned to supply the farm with timber. A considerable amount of gravel was carted to repair the roads of the institution. Stones were removed from 28 acres of lucerne land.

*Live Stock.*—Cattle are in good condition considering the time of the year and the bad season. The Hereford, Sussex, and Africander breeding herds were brought in from Brakspruit and put to the respective bulls during the month. The two former herds were allowed to run on mealie stalks in temporarily fenced fields in the arable section of this farm; both are in good condition. The Africander herd was run in the far railway camp; the animals are in fair condition only, as the grazing is poor. The object of running bulls of the beef breed with the respective herds during the month of July is to obtain April calvings from those cows which were not settled during the summer.

Six cross-bred Sussex-Africander cows and heifers were sold at a local sale in accordance with the arranged plan of abandoning the cross-breeding work on Mendelian lines. Two Large Black boars were sold for breeding purposes. 324 head of cattle were tested for tuberculosis, and all sale bulls were inoculated for red-water and gall-sickness, which caused the animals to drop somewhat in condition. 71 Wanganella lambs were born during the month.

One Fries calf died of sponsiekte, although inoculated on two distinct occasions within twelve months against this disease. Cases of metritis, several of ophthalmia, and a few cases of diarrhœa in dairy calves have to be reported. These were successfully treated. One valuable Ayrshire cow died of abscesses in the uterus.

*Experimental Section.*—Work done in this section consisted of harvesting and weighing one acre of potatoes grown on dry land, in connection with liming and manuring experiments; harvesting and weighing of all the remaining peanut plots, two acres; planting of winter legumes, such as beans, peas, etc., one acre.

One and one-third acre of land was laid down to barley on calcium nitrate fertilized plots. One-half acre was planted with Berseem clover. Cleaning and grading various varieties of seeds was carried out. Plots under fallow and stubble were ploughed and winter cereals irrigated when necessary.

*Horticulture Section.*—The work of pruning has made good progress. Black peach fly made an appearance, but only in small isolated colonies. Everything is kept in readiness for spraying the fruit trees during August. To maintain a continuous supply of vegetables, sowing and transplanting are done at regular intervals.

The Lecturer in Horticulture delivered lectures in the Pretoria, Witwatersrand, and Vereeniging Districts, which were well attended by growers and others interested.

*Poultry Section.*—The stock birds were in good health during the month, and the egg production for the breeding pen has been satisfactory.

*Articles for Publication.*—Articles on the "Destruction of Rodents" and "Glucose and Starch from Maize" were prepared (for the *Journal of Industries*), and one on "Die Bou van Damme."

*School.*—The "Farmers' Course" terminated on the 15th July. Of the 78 students enrolled, 73 were accommodated in the hostel here and 5 in Potchefstroom town. A certain number of teachers attended the course. Sixteen of the students were women.

The school reopened for ordinary students on the 27th July.

*Staff.*—Mr. Mackinnon assumed duty here as an additional foreman and field instructor on the 7th July. The plant breeder, Mr. A. St. C. Caporn, resigned and relinquished his post at the end of the month.

It is with deep regret that the death of Mr. J. R. Stenning, first grade and senior clerk at the school, is reported. The deceased rendered valuable services to this institution for fifteen years.

---

## Cost of Production of Maize.

The Department is undertaking an investigation of the cost of production of maize in various parts of the country. The investigations will extend through some years, beginning with the coming season. The scheme is, briefly, to submit a carefully prepared schedule to growers, who will fill it in at the close of the season after having kept an exact record of all labour involved in growing, harvesting, and marketing the crop. From this record, as well as other information supplied in the schedule, the total cost of production as well as a comparative analysis of costs, for different parts of the country, will be worked out. All growers willing to participate in this work are invited to send their names and addresses to The Secretary for Agriculture, Pretoria. All information supplied in connection with this investigation will, of course, be treated as strictly confidential.

## MEAT STATISTICS.

## I.—RETURN OF BEEF INSPECTED AND PASSED FOR EXPORT, JULY, 1920.

Place.	Cattle.			Carcasses.		
	Inspected.	Rejected.	Passed.	Inspected.	Rejected.	Passed.
Durban ... ..	565	—	565	565	55	510
Pietermaritzburg ...	227	—	227	227	$\frac{1}{4}$	226 $\frac{3}{4}$
Pretoria ... ..	—	—	—	—	—	—
Johannesburg ... ..	528	—	528	528	—	528
Blomfontein ... ..	—	—	—	—	—	—
Capetown ... ..	50	—	50	50	2 $\frac{1}{4}$	47 $\frac{1}{4}$
Port Elizabeth ... ..	—	—	—	—	—	—
Germiston ... ..	—	—	—	—	—	—
<b>TOTAL</b> ... ..	<b>1,370</b>	<b>—</b>	<b>1,370</b>	<b>1,370</b>	<b>58</b>	<b>1,312</b>

Beef actually exported during the month of July, 1920: Total, 1100 quarters (*ex* Durban, 850 quarters; *ex* Capetown, 250 quarters).

Total shipments of Beef in quarters—

1916 ...	115,992	1918 ...	123,354	*1920 ...	37,429
1917 ...	309,214	1919 ...	285,367		

II.—OTHER MEAT EXPORTED \*: Pork, carcasses inspected and passed, 1502.

III.—RETURN OF CATTLE IMPORTED INTO THE UNION FROM ADJOINING TERRITORIES.

Territory.	Imported July, 1920.	Total from 1st January, 1920, to 31st July, 1920.
		No.
For Slaughter—	No.	No.
Rhodesia ... ..	3,525	15,669
Bechuanaland Protectorate	1,099	12,028
S.W. Africa .. ..	924	7,231
Swaziland ... ..	254	979
Basutoland ... ..	8	8
For Breeding—		
Rhodesia ... ..	1,564	8,215
Bechuanaland Protectorate	1,185	10,095
<b>TOTAL</b> ... ..	<b>8,559</b>	<b>51,225</b>

## SUMMARY OF IMPORTS.

Calendar Year.	For Slaughter.	For Breeding.	Total.
	No.	No.	No.
†1916	26,580	—	26,580
1917	47,970	5,440	53,410
1918	36,767	13,286	50,053
1919	40,574	16,693	57,267

\* Total from 1st January to 31st July, 1920.

† 1st July to 31st December only

## CROP AND LIVE STOCK REPORT.

July, 1920.

### CONDITION OF LIVE STOCK.

Compiled from Reports furnished by Sheep and Stock Inspectors.

Area.	Large Stock.	Small Stock.
<b>CAPE—</b>		
South-West ... ..	<i>Poor.</i> Medium in parts ...	<i>Medium to poor.</i>
North-West ... ..	<i>Good to medium.</i> Fat in parts	<i>Good to medium.</i> Fat in parts.
South Coast ... ..	<i>Good to medium</i> ... ..	<i>Good to medium.</i>
Southern Karroo ... ..	<i>Good</i> ... ..	<i>Good.</i>
Central Karroo... ..	<i>Good</i> ... ..	<i>Good.</i>
Northern Karroo ... ..	<i>Good</i> ... ..	<i>Good.</i>
Eastern Karroo ... ..	<i>Good</i> ... ..	<i>Good.</i>
Bechuanaland ... ..	<i>Good</i> ... ..	<i>Good.</i>
Griqualand West ... ..	<i>Good</i> ... ..	<i>Good.</i>
North-Eastern ... ..	<i>Medium</i> ... ..	<i>Medium.</i>
Border ... ..	<i>Good to medium</i> ... ..	<i>Good to medium.</i>
Transkeian Territories... ..	<i>Medium</i> ... ..	<i>Medium.</i>
<b>TRANSVAAL—</b>		
Eastern High Veld ... ..	<i>Medium</i> ... ..	<i>Medium.</i>
Central ... ..	<i>Medium.</i> Good in parts ...	<i>Medium.</i> Good in parts.
Western High Veld ... ..	<i>Good to medium</i> ... ..	<i>Good to medium.</i>
Low Veld ... ..	<i>Good to medium.</i> Fat in parts	<i>Good to medium.</i> Fat in parts.
<b>ORANGE FREE STATE—</b>		
North-Eastern ... ..	<i>Good to medium</i> ... ..	<i>Good to medium.</i>
North-Western... ..	<i>Good</i> ... ..	<i>Good.</i>
South-Eastern ... ..	<i>Good.</i> Fat in parts ... ..	<i>Good.</i> Fat in parts.
South-Western... ..	<i>Good to medium</i> ... ..	<i>Medium.</i> Good in parts.
<b>NATAL—</b>		
High Veld or Highlands	<i>Good to medium</i> ... ..	<i>Good to medium.</i>
Middle Veld or Midlands	<i>Good to medium</i> ... ..	<i>Good to medium.</i>
Coast ... ..	<i>Good to medium</i> ... ..	<i>Good to medium.</i>

### THE 1920 WHEAT, OATS, AND BARLEY SOWINGS.

The Department's crop correspondents were requested to report this month on the area put under wheat, oats, and barley this 1920 season. For the purpose the figure 100 is taken as representing the acreage last season, and any change this season is shown by variations from that figure. The accompanying statement, shows the position as revealed by these reports. While the main wheat producing districts of the Union report an increase in acreage under this crop, the prevalence of drought principally is responsible for a considerable shrinkage in certain other parts of the country, particularly those subject to summer rainfall, so that the total acreage under wheat in the Union this season is estimated to be 2 per cent. less than it was last year. Given an ordinary favourable season the crop from the reduced acreage is estimated to yield 2,702,300 bags of wheat. On the other hand the Union's requirements normally are estimated to be about 3,800,000 bags annually, consequently there is likely to be a shortage of nearly 1,100,000 bags of wheat which will need to be made good by importation from other countries.

The following statement gives the estimated production, *provided the season proves to be an ordinary favourable one* and the crops make normal growth. For purposes of comparison it may be added that last season's crops were considerably below normal in growth (*vide* Crop and Live Stock Report, November, 1919) and it is estimated that the yield was approximately 1,989,100 bags wheat, 1,604,100 bags oats, 36,357,800 bundles oat hay, and 347,900 bags barley.



## LOCAL MARKET PRICES.

## RATES OF AGRICULTURAL PRODUCE AND STOCK RULING AT THE 14TH AUGUST, 1920.

CENTRE.	Wheat— Per 200 lb.		Wheat Flour— Per 100 lb.		Boer Meal— Per 200 lb.		Mealie Meal— Per 150 lb.		Barley— Per 150 lb.		Oats— Per 150 lb.		Out-hay— Per 100 lb.		Lucerne Hay— Per 100 lb.		Potatoes— Per 150 lb.	
	Min. s. d.	Max. s. d.	Min. s. d.	Max. s. d.	Min. s. d.	Max. s. d.	Min. s. d.	Max. s. d.	Min. s. d.	Max. s. d.	Min. s. d.	Max. s. d.	Min. s. d.	Max. s. d.	Min. s. d.	Max. s. d.	Min. s. d.	Max. s. d.
<i>Cape Province—</i>																		
Alwal North.....	80 0	71 0	50 6	51 6	70 0	90 0	28 0	29 0	27 0	30 0	31 0	32 6	13 6	13 9	11 0	13 6	35 0	35 0
Beaufort West.....	70 0	71 0	50 6	51 6	70 0	90 0	28 0	29 0	27 0	30 0	31 0	32 6	13 6	13 9	11 0	13 6	32 6	35 6
Capetown.....	70 0	71 0	50 6	51 6	70 0	90 0	28 0	29 0	27 0	30 0	31 0	32 6	13 6	13 9	11 0	13 6	22 0	38 0
East London.....	72 0	82 0	51 0	54 0	95 0	97 6	20 0	22 6	37 0	39 0	19 0	20 0	15 0	16 0	11 6	13 6	27 0	37 6
Grahamstown.....	70 0	70 3	52 6	84 6	62 0	64 6	24 0	28 0	40 0	41 6	33 6	34 0	8 0	11 6	9 0	9 9	25 0	45 0
Kingberley.....	75 0	80 0	47 6	47 6	90 0	90 0	18 0	19 0	30 0	30 0	25 0	30 0	11 6	17 0	11 0	11 0	20 0	23 0
Kingwilliamstown	65 0	65 0	47 6	47 6	90 0	90 0	18 0	19 0	30 0	30 0	25 0	30 0	11 6	17 0	11 0	11 0	20 0	23 0
Port Elizabeth.....	62 0	65 0	47 6	47 6	90 0	90 0	18 0	19 0	30 0	30 0	25 0	30 0	11 6	17 0	11 0	11 0	20 0	23 0
Queenstown.....	75 0	80 0	47 6	47 6	90 0	90 0	18 0	19 0	30 0	30 0	25 0	30 0	11 6	17 0	11 0	11 0	20 0	23 0
<i>Natal—</i>																		
Durban.....	55 0	64 0	—	—	—	—	19 3	21 6	28 9	34 6	27 6	28 9	7 6	15 3	12 3	13 4	15 0	38 9
Pietermaritzburg.....	—	—	—	—	—	—	21 0	25 0	—	—	20 0	25 0	9 0	15 6	4 0	10 0	12 0	43 0
<i>Orange Free State—</i>																		
Bloemfontein.....	65 0	75 0	68 6	90 0	93 6	95 0	18 9	21 6	30 0	45 0	25 0	35 0	11 6	17 0	9 6	12 0	27 6	33 0
Harrismith.....	62 0	65 0	47 6	47 6	90 0	90 0	18 0	19 0	30 0	30 0	25 0	30 0	9 6	11 6	12 6	12 6	26 0	26 0
<i>Transvaal—</i>																		
Pretoria.....	75 0	80 0	—	—	—	—	19 1	23 3	28 9	34 6	27 6	28 9	11 6	15 0	10 0	13 4	15 0	38 9
Johannesburg.....	55 0	64 0	—	—	—	—	19 3	21 6	28 9	34 6	27 6	28 9	7 6	15 3	12 3	13 4	15 0	38 9

CENTRE.	Onions— Per 120 lb.		Tobacco (Boer Root), Per lb.		Beans— Per 200 lb.		Beef— Per lb.		Mutton— Per lb.		Fresh Butter— Per lb.		Eggs— Per dozen.		Cattle (Slaught- er), Each.		Sheep— Each.		Pigs— Each.	
	Min. s. d.	Max. s. d.	Min. s. d.	Max. s. d.	Min. s. d.	Max. s. d.	Min. s. d.	Max. s. d.	Min. s. d.	Max. s. d.	Min. s. d.	Max. s. d.	Min. s. d.	Max. s. d.	Min. s. d.	Max. s. d.	Min. s. d.	Max. s. d.	Min. s. d.	Max. s. d.
<i>Cape Province—</i>																				
Alwal North.....	23 0	27 6	1 6	1 9	40 0	90 0	0 9	1 0	0 10	1 1	2 6	3 1	2 0	2 6	—	—	—	—	—	—
Beaufort West.....	16 0	23 0	0 5	1 0	50 0	55 0	0 10	1 3	0 9	1 2	3 0	3 9	2 7	2 10	7 0	0 25	0 25	0 45	0 25	0 240 0
Capetown.....	33 7	33 7	—	—	—	—	—	—	—	—	1 6	3 6	1 3	2 1 1/2	14 0	0 27	0 30	0 47 0	60 0	200 0
East London.....	25 0	30 0	1 0	1 3	60 0	80 0	0 4	1 1	0 8	1 2	2 6	4 0	1 8	2 4	12 10	0 22	0 25	0 40 0	* 0 4 1/2	* 0 8
Grahamstown.....	15 0	31 0	0 8	1 4	32 0	66 0	0 7	1 0	0 6	1 0	3 3	4 8	2 3	3 0	—	—	—	—	25 0	135 0
Kingberley.....	25 0	28 0	—	—	—	—	0 8	1 0	0 8	1 0	2 0	3 4	2 0	2 7	—	—	—	—	* 0 4 1/2	* 0 6 1/2
Kingwilliamstown	26 6	36 0	—	—	56 0	80 0	0 4	0 10	0 3	0 10	2 6	2 9	1 3	1 9	17 10	0 17	11 6	32 6	33 0	—
Port Elizabeth.....	—	—	—	—	—	—	—	—	—	—	—	—	—	—	—	—	—	—	—	—
Queenstown.....	12 0	31 0	—	—	30 0	70 0	0 5	0 10	0 6 1/2	0 10	2 0	3 4	2 0	3 9	—	—	—	—	—	—
<i>Natal—</i>																				
Durban.....	—	—	—	—	—	—	—	—	—	—	—	—	—	—	—	—	—	—	—	—
Pietermaritzburg.....	—	—	—	—	—	—	—	—	—	—	—	—	—	—	—	—	—	—	—	—
<i>Orange Free State—</i>																				
Bloemfontein.....	27 6	32 6	0 6	1 0	35 0	47 6	0 10	1 3	1 0	1 3	2 6	3 6	1 6	2 0	15 0	0 20	0 35	0 70 0	* 0 11	* 1 0
Harrismith.....	—	—	—	—	—	—	0 10	1 0	0 10	1 0	2 6	3 6	1 3	1 8	12 0	0 25	0 25	0 30 0	30 0	50 0
<i>Transvaal—</i>																				
Pretoria.....	29 3	33 0	—	—	39 0	57 0	4 8d.	7 6d.	0 11	1 3	1 10	2 4	1 6	2 6	4 10	0 19	10 0	27 6	45 0	* 0 9
Johannesburg.....	23 0	24 6	0 5 1/2	0 5 1/2	30 0	56 0	4 11 6	15 6	0 10	1 0	1 8	2 0	1 6	1 10	9 10	0 22	10 0	15 0	42 6	* 0 11 1/2

\* Live weight per lb. † Dressed weight, including hides, offal, etc. per 100 lb.  
 NOTE.—The rates quoted for produce sold in bags include, as a general rule, an additional 3 lb. for weight of bag.



*Continued from page ii of cover.*]

TARIFF OF FEES FOR ANALYSIS.

SOILS :—	£	s.	d.
Lime ... ..	0	5	0
Partial analysis (to determine manurial needs) ... ..	0	15	0
Analysis for "brak" or "alkali" ... ..	0	15	0
<b>LIMESTONE AND LIME :—</b>			
Lime ... ..	0	5	0
General analysis ... ..	0	15	0
<b>SALT AND BRINE :—</b>			
Chlorine ... ..	0	2	6
General analysis ... ..	0	10	0
<b>WATER (for agricultural purposes only):—</b>			
Partial analysis (involving not more than three determinations) ... ..	0	10	0
General analysis ... ..	1	10	0
<b>MILK AND CREAM :—</b>			
Total solids ... ..	0	2	6
Specific gravity ... ..	0	1	0
Fat (by ether extraction) ... ..	0	5	0
Fat (by butyrometer) ... .. (see other tariff).			
Partial analysis (total solids, specific gravity, and fat by ether extraction) ... ..	0	7	6
General analysis (fat, total solids, specific gravity, ash, and protein) ... ..	0	12	6
Qualitative test for boric acid ... ..	0	2	6
<b>CHEESE AND BUTTER :—</b>			
Moisture ... ..	0	2	6
Fat ... ..	0	5	0
Ash or salt ... ..	0	2	6
General analysis ... ..	0	12	6
<b>GRASSES, FODDERS, SILAGE, AND FEEDING STUFFS IN GENERAL (other than the registered commercial farm foods):—</b>			
Moisture ... ..	0	2	6
Protein ... ..	0	5	0
Fat (by ether extraction) ... ..	0	5	0
Crude fibre ... ..	0	5	0
Ash ... ..	0	2	6
General analysis ... ..	0	17	6
<b>SUGAR-CANE AND SUGAR BEET :—</b>			
Cane-sugar and glucose ... ..	0	10	0
General analysis (moisture, ash, protein, cane-sugar, and glucose) ... ..	0	15	0
<b>SULPHUR :—</b>			
Fineness ... ..	0	2	6
Full examination as to purity ... ..	0	7	6

*[Continued on back of cover.*

## TARIFF OF FEES FOR ANALYSIS—(continued).

DIPS, INSECTICIDES, AND FUNGICIDES :—		£	s.	d.
Nicotine ... ..	0 10 0			
Total sulphur ... ..	0 7 6			
Lime ... ..	0 5 0			
Arsenic (arsenites and arsenates) ... ..	0 5 0			
Fractional separation of carbolic dips ... ..	0 10 0			
Estimation of phenols (approximate)... ..	0 2 6			
General analysis of insecticide or fungicide ... ..	0 10 0			
TANNING MATERIALS AND TEA :—				
Tannin ... ..	0 5 0			
General analysis of wattle bark or other tanning material ... ..	0 7 6			
Colour (by tintometer)... ..	0 1 0			
CRUDE RUBBER :—				
General analysis ... ..	1 0 0			
TOXICOLOGICAL MATERIALS (Ingesta, etc.):—				
Qualitative tests for arsenic or other mineral poison ... ..	0 5 0			

The valuation of a manure will be furnished on particulars of guaranteed analysis being submitted by the inquirer. For this information no fee will be charged.

---

 QUANTITIES WHICH MUST BE SUBMITTED FOR ANALYSIS.
 

---

Soils ... ..	at least 9 lb.
Limestones and Lime ... ..	5 "
Salt ... ..	2 "
Brine ... ..	1 pint.
Water ... ..	$\frac{1}{2}$ gallon.
Milk ... ..	1 pint.
Cream ... ..	$\frac{1}{2}$ "
Butter ... ..	8 oz.
Cheese ... ..	8 "
Grasses, Folders, etc. ... ..	5 lb.
Sugar-cane ... ..	3 canes.
Sugar Beet ... ..	10 lb.
Sulphur... ..	4 oz.
Dips (wash from dipping-tanks) ... ..	1 pint.
Insecticides and Fungicides ... ..	1 lb.
Wattle Bark and other tanning materials ... ..	1 "
Tea ... ..	$\frac{1}{2}$ "
Crude Rubber ... ..	4 oz.
Ingesta and similar toxicological material ... ..	2 lb.

Charges for articles not enumerated in the above tariff and any further information may be obtained on application to the officers above mentioned.



PRICE 5/-  
PER ANNUM.

**Journal**  
of the  
Department of  
**Agriculture**  
ISSUED BY AUTHORITY OF THE  
MINISTER OF AGRICULTURE.

PRINCIPAL CONTENTS.

- Cotton Culture.
- Karakul Sheep—II.
- The Spinose Ear-Tick.
- The Agriculture and Soils of the Cape Province—IV.
- The Pig as an Economical Producer of Food.
- The Department of Agriculture during the War—VI.
- The Menace of Anthrax.
- Meat Supplies for the United Kingdom.
- Irrigation in the Union.

PRICE **6D** PER COPY

STEWARTS AND LLOYDS (SOUTH AFRICA), LTD.

# TUBES AND FITTINGS.

P.O. Box 1195,  
JOHANNESBURG.

P.O. Box 74,  
PRETORIA.

P.O. Box 131,  
DURBAN.

P.O. Box 296,  
MARITZBURG.

AGENTS FOR :

National Gas Engine Co.,  
Gas, Oil, and Petrol  
Engines.

Eagle Engineering Co.,  
Ltd., Petrol Paraffin  
Engines.

Davey Paxman & Co.,  
Steam Engines and  
Boilers.

Gilbert Gilkes & Co.,  
Water Turbines and  
Centrifugal Pumps.

Mirrlees, Bickerton &  
Day, Diesel Oil Engines.

IRRIGATION  
AND WATER  
SUPPLY OUR  
SPECIALITY.

PUMPING PLANTS,  
PIPE LINES,  
AND  
POWER UNITS  
OF EVERY  
DESCRIPTION.

*ESTIMATES AND ADVICE  
FREE OF COST.*

AGENTS FOR :

John Blake, Ltd.,  
Hydraulic Rams.

Thomas & Sons,  
Windmills and Pumps.

Bell Bros., Ltd., Filter  
and Water-Softening  
Plants.

Glenfield & Kennedy,  
Hydraulic Specialities.

Clydesdale Steel Plates.

# CONTENTS.

OCTOBER, 1920.

	PAGE
NOTES ... ..	605
Retirement of the Secretary for Agriculture—The Local Market—Export of Butter and Cheese—A Successful Entomological Conference—The Position of the World's Cereals—Advice to Consignors of Produce—The Wool Industry—The World's Wheat: A Forecast—"Prinshof": Land for Experiments—New Chemical Laboratories—Dip-testing Apparatus—The Drought Commission—Sale of Live Stock, Grootfontein—Export of Eggs—East Coast Fever: Pretoria District in August, 1920—Lung-sickness: An Outbreak—Bacon and Ham—Egg-laying Competition—Citrus Export: Experiments (page 622)—Fruit Export (page 625)—Peanut Growing (page 642)—Fencing Material (page 642)—Orange Stocks used in California (page 654)—Sunflower Seed Export (page 659)—Plant Nurseries in Quarantine as at 1st September, 1920 (page 670)—The Union's Timber Resources (page 675).	
COTTON CULTURE ... ..	615
THE PIG AS AN ECONOMICAL PRODUCER OF FOOD ... ..	623
KARAKUL SHEEP ... ..	626
THE DEPARTMENT OF AGRICULTURE DURING THE WAR ... ..	643
THE TOLL OF THE WAR ... ..	646
THE SPINOSE EAR-TICK ... ..	647
MEAT SUPPLIES FOR THE UNITED KINGDOM ... ..	655
THE AGRICULTURE AND SOILS OF THE CAPE PROVINCE—I ... ..	660
THE MENACE OF ANTHRAX ... ..	671
IRRIGATION IN THE UNION ... ..	676
PURE-BRED STOCK IMPORTED ... ..	678
THE POULTRY YARD MONTH BY MONTH ... ..	679
CORRIGENDA ... ..	679
THE VEGETABLE GARDEN ... ..	680
NOTES FROM THE "GAZETTE" ... ..	681
SOUTH AFRICAN PRODUCE ON THE OVERSEA MARKET ... ..	683
OVERSEA PRICES OF SOUTH AFRICAN PRODUCE ... ..	684
NOTES FROM THE DIVISIONS ... ..	685
RECENT AGRICULTURAL LITERATURE... ..	687
AT THE SCHOOLS OF AGRICULTURE AND EXPERIMENT STATIONS ... ..	690
STAFF: APPOINTMENTS, TRANSFERS, ETC. ... ..	694
MEAT STATISTICS ... ..	695
CROP AND LIVE STOCK REPORT ... ..	696
LOCAL MARKET PRICES ... ..	698
THE LOCAL MARKET ... ..	699

DEPARTMENT OF AGRICULTURE.

---

CHEMICAL ANALYSIS OF AGRICULTURAL MATERIALS.

---

Methods of Taking Samples.

---

NOTE.—If the sample is not representative of the bulk, the results of the analysis may be of little or no value. The accuracy of the sampling depends on the person taking the sample, and no means are known whereby an absolutely correct sample may be taken by following certain procedure. It is essential, therefore, that the person taking the sample should be thoroughly satisfied that it is as representative as possible. The analyst can only report on the same as received by him.

**Feeding Stuffs—**

(a) **Grains, Meals, and Similar Feeding Stuffs** (other than registered commercial farm foods).—For each ton of the quantity held up to 6 tons take two bags; if it exceeds 6 tons, take one bag for every additional ton over 6. Each bag should be emptied separately on a clean, dry floor, be well mixed with a spade, and one spadeful then set aside. The different spadefuls from each bag should then be mixed together, and a sample of about 4 lb. taken from the heap.

(b) **Green Fodders and Roughages.**—Standing crops should be sampled by cutting 10 to 20 or more handfuls from different parts of the field; if too large a quantity be so obtained, it should be thoroughly mixed and a portion weighing about 10 lb. taken as the sample. Cut green fodders and hays should be well mixed if possible, and 10 to 20 or more handfuls taken from different parts of the whole bulk; or handfuls should be taken from 10 to 20 or more sheaves or bales.

(c) **Roots and Tubers** should be sampled by selecting average specimens of the large, medium, and small roots forming the quantity, as far as possible in the proportion in which these are present. The number of individual roots or tubers comprised in the sample should be 20 to 30 if they are small, or 9 to 12 if large, according to size.

**Water—**

In taking samples of water great cleanliness is essential. Bottles used for water samples must be thoroughly cleansed by washing, and on no account must any bottle, which after washing retains the smell

of the previous contents, e.g. spirits or paraffin, be used. The bottle should be mixed with the water which is to be analysed before being filled. Bottles should be nearly but not quite filled and should for preference be closed with a glass stopper. Failing glass stoppered bottles, clean new corks should be used. In order to get a fair sample from any running supply, such as the water pumped from a borehole or that drawn in pipes from a reservoir, the water should be allowed to run for about an hour before collecting the sample.

If the sample is to be drawn from a stream or pond, the stoppered or corked bottle should be immersed some little distance from the bank and the stopper or cork withdrawn well below the surface. The stopper or cork should be tied over with a piece of clean cloth.

In the case of wells, boreholes, and, as far as possible, springs, the situations, depths, and nature of strata should be stated.

### **Liquids other than Water—**

In sampling liquid substances, care should be taken to thoroughly stir the contents of each package or drum before taking a sample.

### **Ingesta and Similar Toxicological Materials—**

The advice of a veterinary surgeon should, if possible, always be sought before a sample of this nature is forwarded for analysis, and precise information be given as to the nature of the poison suspected. In the case of arsenical poisoning of stock, portions of those organs showing marked inflammation should be included with some of the ingesta. These samples should always be most carefully packed in a screw-topped fruit jar or bottle.

### **Milk and Cream—**

*Mixed.*—In taking a sample of mixed milk from a number of cows, the milk must be poured from one vessel to another several times, and the sample must be taken immediately before the milk is allowed to settle. If the sample is made up from mixed milk from several vessels, it should contain the quantity from each vessel which will ensure that the completed sample is an average of the whole bulk. The stirring of the milk is in each case not sufficient.

*One Cow.*—The cow must be stripped thoroughly, the milk strained and well mixed by pouring from one vessel to another several times, and the sample must be taken immediately after, before the milk is allowed to settle.

*Cream* samples should be prepared by stirring thoroughly and by pouring the cream from one vessel to another several times, and the sample must be taken immediately after.

(NOTE.—If it is desired to take composite samples of milk or cream application should be made for full information and instructions, which will then be given.)

*Bottles.*—The sample bottles should contain about  $\frac{1}{4}$  pint of milk or cream. They must be thoroughly cleaned, and each sample must be labelled with the name of the owner; if it is taken from the mixed milk of a herd it must be marked "mixed." In the case of samples of individual cows each sample must, in addition to giving the name of the owner, be marked with the name, number, or other identification mark of the particular cow. Particulars of the breed of the cow or herd must also be stated. If in the case of samples of mixed milk the animals are not all pure bred, the particulars should be given as "cross-bred" or "mixed breeding." Labels will be supplied on application. Care should be taken to have the bottles well corked and sealed before dispatch.

*Preservatives.*—To each sample bottle of milk should be added four to six drops of formalin (not more) and to each cream sample five grains of powdered potassium bichromate, or just as much as can be carried on a threepenny piece.

In offering these facilities it is desired to place farmers in the position of being able to determine the butter-fat content of the milk of their herds and the percentage of butter-fat in the cream, to check the working of the separator by testing samples of the separated milk, and, lastly, to encourage the keeping of milk and butter-fat records. In the latter instance, samples should be submitted at regular intervals, either fortnightly or monthly. For any further particulars or information inquiries should be addressed to the Principals of the Agricultural Schools or the Superintendent of Dairying.

The result of these tests may only be used by the owner of the samples for his private purposes, and must not be made use of in the case of any dispute or legal action between contracting parties.

---

### Sending of Samples.

---

Ordinary materials, manures, feeding stuffs, etc., should be sent in a tin or glass fruit jar (suitably packed to prevent breakage) with closely fitting lid. Liquid samples must be sent in bottles, which will be provided on application.

#### Soils—

Apply for special form.

#### Regulations and Tariff—

Particulars were published in last month's issue of the *Journal*.







F. B. SMITH, C.M.G.,

THE RETIRING SECRETARY FOR AGRICULTURE, UNION OF SOUTH AFRICA.



# JOURNAL OF THE DEPARTMENT OF AGRICULTURE.

VOL. I.

OCTOBER, 1920.

No. 7.

Published monthly in English and Afrikaans by the Department of Agriculture,  
Union of South Africa.

SUBSCRIPTION: Within the Union and South-West Protectorate, **5s.** (otherwise **6s.**)  
per annum, post free, payable in advance.

Applications, with subscriptions, to be sent to the Government  
Printer, Box 373, Pretoria.

---

## NOTES.

---

### Retirement of the Secretary for Agriculture.

At the end of August last Mr. F. B. Smith relinquished the post of Secretary for Agriculture, proceeding on leave prior to retiring on pension after nearly eighteen and a half years' service in South Africa. The son of a farmer and educated privately and at Cambridge, Mr. Smith has always been interested in the relations of State to agriculture. He held various posts in England, his last being Professor of Agriculture and Vice-Principal at the South-Eastern Agricultural College, Wye, Kent, an institution with which the names of eminent men in the agricultural world are connected, and in the building up of which Mr. Smith was prominently concerned. In 1900 he made an extensive tour in the United States and Canada, where he investigated the system of agricultural education in vogue, publishing the result of his observations in a book entitled "Agriculture in the New World."

Mr. Smith's first connection with South Africa dates from the 26th April, 1902, when he came out from England to the post of Agricultural Adviser to the Governor of the Transvaal, under Crown Government, subsequently changed to Director of Agriculture in September, 1902. Soon after his arrival he wrote a report to Lord Milner regarding the organization of agriculture in the Transvaal, and its recommendations were adopted almost entirely. Mr. Smith was a member of the Transvaal Legislative Assembly in Crown Colony days, and was also a member of the Transvaal Indigency Commission, the report of which is so well known. He was an original member of the Council of the University College in Johannesburg, and on its division into the School of Mines and the Transvaal University College in Pretoria, became a member of the Council of

the latter. He was also a member of the Committee of the Government Library, Pretoria, and up to Union was a member of the Committee of the Transvaal Zoological Gardens.

In addition to the book referred to, Mr. Smith has written various papers on agricultural subjects, one on agricultural education being read before the British Association in Johannesburg, and another, "Some Observations on the Probable Effect of Closer Union of South Africa upon Agriculture," before the South African Association for the Advancement of Science.

At Union, Mr. Smith was appointed to his late position as Secretary for Agriculture, when he had to undertake the great task of forming an Agricultural Department for the Union in place of those which had previously existed in the four component Colonies.

In the course of a letter to the *Journal*, written immediately prior to his departure for England, where he has accepted a readership in Estate Management, offered him by the University School of Agriculture, Cambridge, Mr. Smith writes: "I have endeavoured to make the Department a professional one, and to organize it so that each branch of its work was entrusted to men who had specialized in these particular lines, and could devote their whole attention to them and in such a way that the workers should be as closely in touch with their work on the one hand and with the public on the other as it was possible for them to be. My one aim has been to help the agriculture of the country by every means within my power and particularly to build up the Department as the most powerful instrument possessed by the State for assisting it."

Mr. Smith has been associated with South Africa during a time of transition and remoulding and of marked progress, and he takes with him our good wishes for success in his new sphere of work.

#### TEMPORARY STAFF ARRANGEMENTS.

Until a permanent successor to Mr. Smith is appointed and in the absence of Mr. P. J. du Toit, the Under-Secretary, who is at present engaged on the Public Service Commission of Inquiry, the duties of the Secretary (excluding those pertaining to agricultural education) will be carried on by Mr. G. N. Williams, who has been acting as Under-Secretary for some considerable time in Mr. Du Toit's absence.

Similarly, Mr. E. J. Macmillan, the Under-Secretary for Agriculture (Education) will control the section of the Department concerned with matters of agricultural education.

### **The Local Market.**

In addition to the local market prices of agricultural produce and stock which are published monthly in the *Journal*, we propose, commencing with this number, to include in future a brief review under the above heading of the local market conditions and prices concerning wool, mohair, hides, skins, and ostrich feathers. With this additional information there will be available very necessary intelligence regarding the prevailing market rates of the principal agricultural products of the Union which should prove useful to farmers in respect both of current prices and, in the course of time, as a record of past prices,

## Export of Butter and Cheese.

The wonderful recuperative powers of South Africa have again been strikingly demonstrated. The severe drought experienced throughout the Union during last spring and early summer practically brought dairying to a standstill, for farmers, barely able to keep their cattle alive in some districts, found feeding for milk production out of the question, with the result that there was an acute shortage both of butter and cheese. The break of the drought about mid-February brought a remarkable change, however, and the hitherto idle creameries were soon working at high pressure.

The consumption of butter and cheese was greatly reduced during the period of scarcity, owing to difficulty in obtaining supplies and high prices. Butter and cheese have, however, been plentiful all through the winter, but consumption has not yet returned to normal. Statistics recently collected by the Division of Dairying show that considerable quantities of butter and cheese manufactured last season are still held by factories, and at the present rate of consumption there is no likelihood of these stocks being disposed of in the Union before the new season commences unless, of course, another drought, such as occurred last year, delays the season.

Cheese supplies have been affected by the importation of quantities of Australian cheese, a good deal of which still remains unsold.

The prospects for the new season are favourable, and an early commencement is expected, although production may at first be somewhat retarded in certain areas owing to late calvings.

---

## A Successful Entomological Conference.

In view of the importance of economic entomology and the established fact that the control of insect life spells success in the treatment of disease and in the production of food and other crops, it is gratifying to learn of the satisfactory results of the recent Imperial Entomological Conference held in London in June, 1920. Delegates from the British Dominions, Colonies, etc., attended the conference, the Union being represented by Mr. C. P. Lounsbury, Chief, Division of Entomology, and many matters of great importance, both of an economic and scientific nature, were discussed. Among the resolutions passed, and evidencing the success of the conference, is one advocating the holding of similar conferences every five years. Another resolution recommended that the Imperial Bureau of Entomology—an institution which, since its inauguration seven years ago, has played such a prominent and valuable part in the entomological world—should be established on a permanent basis. Of special interest at a time when there is such an insistent demand for expert officers, is the finding of the conference “that the provision of an adequate number of trained men to carry into effect existing plant import legislation is of more immediate importance than the revision or extension of such legislation.”

Altogether there is every reason to believe that much benefit will result from the deliberations of the conference, and that Mr. Lounsbury's association with it will be of direct gain to the Union.

## The Position of the World's Cereals.

In regard to that question of surpassing interest—the world's grain supply—to which reference has been made in previous issues of the *Journal*, most opportune information is published by the International Institute of Agriculture, in the shape of a pamphlet entitled "Statistical Notes on Cereals." After furnishing an accurate statement of the cereal situation during the current season, and collating in tabular form all available data as to yield, trade, consumption, prices and rates of ocean freight for wheat and rye, conclusions of great value are brought out as to the supply of wheat and rye. Taking into account the requirements of importing countries and the available supply of exporting countries, the Institute estimates that after furnishing all demands there should be in the latter countries on the 1st August, 1920, a stock on hand of at least 24 million quintals (10 quintals = 1 ton app.).

The "Statistical Notes" include also the following forecasts regarding the coming season, based upon such factors as are already available:—

(a) Importing countries: The generally favourable character of the summer points to a good harvest in Europe. If that promise is realized, it may be assumed that the aggregate requirements of the large importers will be appreciably less than in the past year.

(b) Exporting countries: It is doubtful whether Roumania can do anything material towards the world's supply next season, owing to the seriously reduced area sown last autumn. As regards Russia, there is no means of forming a definite opinion. British India has had a larger crop than last year and over the average. It therefore seems probable that exports now prohibited will recommence next season. The United States expect a crop falling short of that of 1919, but above the average of pre-war seasons. There are no official Canadian estimates yet available, but it is stated that the crop is doing well and the yield may be considerably larger than last year's.

Taking into account the old crop stocks remaining on hand at the opening of the new season, it may be assumed that the available exportable surplus of wheat and rye from North America during the season 1920-21 will be greater than the quantity exported in the current season. The outlook for the coming year, therefore, does not appear to justify any serious anxiety, either with respect to the needs of the importers or to the extent of available supplies in the exporting countries.

---

## Advice to Consignors of Produce.

Farmers forwarding produce to the coast should see that the bales are properly marked with their initials, as well as those of the broker to whom it is consigned. The contents of the bales should also be marked thereon. Farmers are warned against the use of inferior or second-hand woolpacks, as the wool so packed cannot be pressed to comply with the present requirements of the shipping companies, and consequently has to be repacked into new bales at the coast, which means extra expense to the consignor.

## The Wool Industry.

We draw the attention of readers to the recently published report of Mr. B. G. L. Enslin, Chief, Division of Sheep and Wool, on his investigations in the Wool Industries of Great Britain and the United States of America. Mr. Enslin, who travelled oversea for the purpose, had unique opportunities of getting to the heart of things, and that he did so very thoroughly is evident in the comprehensive nature of his report, which deals with the following matters, viz.:—

- (a) The uses to which different kinds of wool are put and the substitutes used.
- (b) The most likely markets for South African wool, having regard to the changed market conditions brought about by the war.
- (c) The present wool situation of the world.
- (d) The prevailing methods of selling and buying in different countries.
- (e) The most satisfactory method for farmers to get up their wool and market it.
- (f) In what respects South African grown wool and mohair fail to meet the requirements of manufacturers and how defects may be remedied.
- (g) The possibilities of starting factories in South Africa.

Dealing with the most important pastoral industry of the Union, the report is of absorbing interest to a large number of farmers and others concerned in the growing and selling of wool, and should certainly fulfil its purpose—the betterment of the industry in South Africa.

It is published as Bulletin No. 4, 1920, under the title "The Wool Industry" and may be obtained at a cost of 1s. (prepaid) from this office.

---

## The World's Wheat: A Forecast.

Sir James Wilson, K.C.S.I., who at one time was delegate for Britain and the Dominions at the International Institute of Agriculture, Rome, is a recognized authority on the economics of crop production, and we are in receipt of an exhaustive review by him on the position of the world's wheat supply. In summarizing the various statements and estimates set out in his review, Sir James comes to the interesting conclusion that all the exporting countries of the world, which on the pre-war average exported 170 million quintals (ten quintals are approximately equal to one ton), are likely to be able to spare for export during the year ending July, 1921, something like 276 million quintals, while, on the other hand, the importing countries of the world may not require to import more than 150 million quintals, leaving a surplus in the exporting countries of 126 million quintals of old wheat. He is further of opinion that even if India, Roumania, and Russia export no wheat during the year ending with July, 1921, the other exporting countries will probably meet all the requirements of importing countries until then, and yet have a surplus of 38 million quintals on the 1st August, 1921.

### **“Prinshof”: Land for Experiments.**

The property “Prinshof,” situated to the west of, and in the near vicinity of the Union Buildings, Pretoria, has been placed at the disposal of the Department of Agriculture for purposes of carrying out experimental work. The property was being temporarily used by the Faculty of Agriculture of the Transvaal University College, who are in process of vacating it, and the Department will enter into possession at an early date. In consequence of “Prinshof” being taken over, the botanical station of the Department at Groenkloof, near Pretoria, will be closed and transferred to “Prinshof.” This will not, however, interfere with the veld-burning experiments under the direction of Dr. Phillips, which will be continued on portion of Groenkloof.

### **New Chemical Laboratories.**

The new chemical laboratory buildings on the western slopes of Meintjes Kop are nearing completion, and will afford a welcome aid to the Department in its activities. The buildings present a fine appearance, are fitted with all the latest appliances, and will house the Division of Chemistry which for many years has been labouring under adverse conditions in inadequate quarters. The Division will take possession at an early date, and the situation of their new quarters near “Prinshof” will be of great convenience for carrying out experiments on the newly acquired land for that purpose, facilities which were sadly needed by the Division and the lack of which proved a great handicap in the past.

### **Dip-testing Apparatus.**

Referring to the evidence given on the value of dipping, the Select Committee on the spread of East Coast fever in the Union states, in the course of its report, that the proof is overwhelming as to dipping and hand-dressing being the only antidote to effect the eventual eradication of the disease, and urges that no pains should be spared in killing off the tick, which is proved to be the carrier of nearly every known cattle disease throughout the Union. The report brings out also the importance of dip testing, and recommends that all dipping tanks should be tested regularly at least once a month. The evidence is strong on this point, for, as one witness stated in affirming the absolute necessity of testing the solution, “It is no good dipping unless you have the right strength of dip. . . . What is the use of dipping if your dip is not in order?” In this connection we wish to point out, in view of the importance of farmers being in possession of an efficacious dip tester, that a suitable apparatus has been devised by Dr. Green, Biochemist at the Government Veterinary Laboratory, Onderstepoort. A clear and full description of the instrument, etc., is published in the Third and Fourth Reports of the Director of Veterinary Research (November, 1915). The instrument is not on the market, nor is it patented, and the attention of those interested in the matter is directed to the publication referred to.



## The Drought Commission.

Following a resolution by Parliament last session, the Government has decided to appoint a Commission to inquire into the best means of avoiding losses by drought. The scope of inquiry will be wide, the terms of reference being as follows:—

1. The methods by which losses to farmers owing to periodic droughts in the drier parts of the Union may be prevented, either by public or private action; and in particular whether any changes in farming methods are necessary for this purpose.
2. Any improvements in farming conditions generally such as the provision of more water, prevention of soil erosion, and any other matters which have a close bearing on point 1.
3. The methods by which indigency arising among the farming community in consequence of such losses could best be dealt with.
4. Thorough investigation into the different ways of producing feeding by the cultivation of various grasses, etc.

The Commission will consist of Mr. H. S. du Toit, Dry Land Agronomist, as chairman, together with a chemist of this Department and an officer of the Irrigation Department. There will be also two private members, namely Messrs. Gadd, of Middelburg, Cape, and Kolbe, of Bloemfontein.

The Commission proposes to visit the drier parts of the Union which are subject to recurring droughts, and in view of the great importance of the matter, it is trusted that farmers and others will render the Commission all assistance possible (when in their particular part of the country) by placing before it their views and experiences, which will be most welcome. It is hoped that with the co-operation of the farming community, the Commission's inquiries will have beneficial results of the highest moment to farmers, and mark an epoch in the advancement of agricultural South Africa.

---

## Sale of Live Stock, Grootfontein.

Despite most inclement weather, the sale of live stock at the Grootfontein School of Agriculture, Middelburg, Cape, on the 26th August, resulted in fair prices being obtained. There were sold 4 donkeys, 4 Friesland bulls and 8 cows, 3 Hereford bulls, 3 Shorthorn bulls, 3 Tasmanian rams and 2 ewes, 20 Wanganella rams and 13 ewes, 3 Angora rams, 2 Karakul rams and 15 ewes, and a number of poultry, totalling £2596. 12s. 6d.

---

## Export of Eggs.

The quantity of eggs exported last year amounted to 16,180 cases, and provision is being made for the export of a limited number again this season. Owing to the high cost of poultry feeds it is not anticipated that the trade can be increased to any extent in the immediate future, but it is important that an oversea outlet should be provided for the surplus, and also that the trade already established should be maintained.

### East Coast Fever: Pretoria District in August, 1920.

Fresh outbreaks occurred on the farms Kameelpoort No. 278, Papkuilfontein No. 575, Zandspruit No. 109, Mooiplaats No. 502, and Hartebeestfontein No. 555. None of these outbreaks, serious though they are, need cause great alarm, as with the exception of Hartebeestfontein No. 555 they are extensions of the already infected area. Hartebeestfontein is, however, in the clean area, but as the disease was fortunately detected in its early stages, it is hoped that the prompt steps taken to deal with it will be the means of preventing its further spread in that area. In the case of the other new outbreaks referred to above, every endeavour is being made to expedite the erection of tanks.

### Lung-sickness: An Outbreak.

It is most regrettable that after being free from lung-sickness in the Union for a considerable number of years, this disease has broken out in the Transvaal, where, in spite of the precautions continuously taken by the Department to prevent its introduction from the Bechuanaland Protectorate, an outbreak of lung-sickness has occurred on the farm Simson, on the Magalakwin River, in the northern portion of the Zoutpansberg District. The disease was undoubtedly introduced through the illicit movement of fifteen head of cattle by a native from the Tuli Block, in the southern Bechuanaland Protectorate. Immediately the outbreak was discovered and reported by the police, it was decided to destroy all sick cattle and those in immediate contact therewith, to the number of 110. Of these, 46 showed symptoms of the disease on post-mortem examination. Prior to the discovery of the disease, 13 head had died, of which 8 were among the cattle illegally introduced, the other 5 being cattle previously on the farm. The farm Simson has been placed under quarantine, and all the cattle in the neighbourhood are being inspected with a view to deciding what further action, if any, is necessary.

### Bacon and Ham.

We publish in this issue a short article by the Lecturer in Animal Husbandry at Elsenburg on "The Pig as an Economical Producer of Food," and as complementary thereto we offer the following statistics on the production of bacon and ham in the Union. As is the case with several of our products, the past few years have shown a marked and gratifying change in our economic position, for whereas formerly imports exceeded exports the reverse is now the case. Our imports, which at one time were considerable, have now dwindled to a negligible quantity, and the exports of bacon and ham have increased.

According to the Census the number of pigs in the Union was as follows:—

1904 ... ..	679,084
1911 ... ..	1,081,600
1918 ... ..	1,043,224

Although these statistics disclose a decrease of 38,000 in our pigs between 1911 and 1918, the class of pig bred in recent years has greatly improved; and while we have no statistics as to the proportion of our pigs suitable for bacon, it is certain that the number of "bacon" pigs in 1918 far exceeded the number in 1910, and as pigs increase rapidly and breeders are improving the quality of their stock, we can expect a perceptible forward movement in the number and standard of our pigs during the coming years.

According to Industrial Census returns the quantity of bacon and ham put out by factories in the Union was as follows:--

1915-16: 2,021,475 lb.: valued at £107,524.

1916-17: 2,803,190 lb.: valued at £176,349.

1917-18: 4,772,461 lb.: valued at £291,614.

In addition to the above, large numbers of pigs are slaughtered on the farm or elsewhere and cured for home consumption. The 1918 Census shows that 2,313,000 lb. of bacon and ham were so produced during 1917-18.

As will be observed hereunder, the balance between imports and exports of bacon and ham during the calendar years 1917 and 1918 was comparatively small and leaving this factor out of account, and not allowing for stocks on hand and stocks carried over, it is estimated that the Union's consumption of bacon and ham in the year 1917-18 was approximately 7,100,000 lb. Indeed, that year would seem to mark an epoch in the history of the industry, for, in view of the small quantities of our imports, it may be taken that we had at last reached the position of being able to meet our own requirements in bacon and ham. In the absence of statistics of production for the year 1918-19, we turn to the published figures of imports and exports for the calendar year 1919, which show that imports had dwindled to as low as 41,258 lb., while exports of South African bacon and ham reached 1,393,614 lb. When it is remembered that the country suffered during 1918-19 from one of the severest droughts in its history the trade returns are gratifying, and point to the continued expansion of our production in these commodities.

While statistics of production are available in respect of recent years only, the Customs returns hereunder indicate clearly the trend of our production since Union. There is nothing to show that during the past decade our consumption of bacon and ham has not been at a more or less uniform rate. On the other hand, it will be observed that it was necessary at one time to augment our local production by considerable importations. During the four years prior to the war (1911-14) our average annual importations were nearly 6,000,000 lb. This quantity, which indicates the small amount formerly produced in the Union, has to-day been supplanted by South African bacon and ham, a striking example of progress. While, therefore, our production now appears to be sufficient for our present needs, there awaits us a wide market overseas which has already favourably received some of our bacon and is able to absorb our surplus.

## BACON AND HAM.

Year.	Importation into the Union.		Exports of S.A. Produce (including Ships' Stores).	
	lb.	Value.	lb.	Value.
1910	5,465,965	£231,203	1,502	£77
1911	6,072,066	229,134	1,674	83
1912	5,983,675	223,384	4,228	192
1913	6,187,229	264,429	2,104	117
1914	5,526,887	229,517	7,106	328
1915	4,488,447	211,174	5,743	345
1916	3,060,263	169,152	27,686	1,627
1917	422,622	27,154	87,239	6,587
1918	142,258	10,989	185,601	15,554
1919	41,258	3,865	1,393,614	90,454

NOTE.—Importations, including "salted and cured," averaged annually about 3,450,000 lb. in 1897 and 1898, and 3,960,000 lb. in 1903 and 1904.

### Egg-laying Competition.

The Sixth Egg-laying Competition, held at the Potchefstroom School of Agriculture during the six months 1st June, 1919, to 30th November, was productive of interesting and valuable data, as will be seen from the following summary of results, viz.:—

Number of pens, 48 (five birds); total number of birds, 240; total number of eggs laid, 26,249, plus 112 unmarketable (not included in calculations); value of eggs laid, £233. 6s. 7½d.; cost of feeding, £81. 17s. 11d.; profit over cost of feeding, £151. 8s. 8¼d.; average market price of first grade eggs, 2s. 3½d. per dozen; average market price of second grade eggs, 1s. 10d. per dozen; average cost of feed to produce 1 dozen eggs, 9.02 pence; average number of eggs laid per pen (light breed), 568.9; average number of eggs laid per hen (light breed), 113.8; average number of eggs laid per pen (heavy breed), 510.2; average number of eggs laid per hen (heavy breed), 102.03; average profit over cost of feed per pen (light breed), £3. 6s. 10d.; average profit over cost of feed per hen (light breed), 13s. 4½d.; average profit over cost of feed per pen (heavy breed), £2. 16s. 9d.; average profit over cost of feed per hen (heavy breed), 11s. 4½d.; average cost of feed per pen, £1. 14s. 2d.; average cost of feed per hen, 6s. 10d.; eggs laid by winning pens: heavy breed, 528 full weight, 2 under weight, 2 unmarketable; light breed, 608 full weight, 12 under weight, 3 unmarketable; profit earned by winning pen: heavy breed, £3. 2s. 3¼d.; light breed, £4. 0s. 2½d.; highest value of eggs laid by any pen: heavy breed, £5. 11s. 11½d.; light breed, £5. 17s. 3d.; lowest valuation of eggs laid by any pen: heavy breed, £3. 3s. 10½d.; light breed, £4. 0s. 6d.

---

**COTTON CULTURE.**

---

By PIETER KOCH, B.Sc.Agr., Manager, Tobacco Experiment Station, Elsenburg, Mulder's Vlei.

---

THE cotton plant is one of the most important, if not *the* most important, fibre plant cultivated. From its products hundreds of necessaries are manufactured. For instance, from the fibre, clothes, explosives, etc., are made; from the seed, oil, soap, a kind of butter, and many other articles; and from the seedmeal, animal foods, fertilizers, and dyestuffs.

The normal world production of cotton lint is about twenty to twenty-five million bales of 500 lb. each, and of this amount South Africa produces very little. The farmers of our country have been trying to grow cotton for many years, but until a few years back their efforts have met with failure through lack of knowledge of cultural methods and want of gins and means of conveyance. Cotton culture has, however, made rapid progress in recent years (since 1912), especially in the warmer parts of the Transvaal and also in Natal, and its future is very promising. Every year sees an increasing acreage under cotton, so that at present some thousands of acres are devoted exclusively to this purpose.

*Botany.*—Botanically cotton belongs to the *Malvaceae*, and falls under the genus *Gossypium*. Cotton is generally divided into two groups, namely the American and the Asiatic group. In South Africa the first group only is grown, which includes the Upland varieties (or *Gossypium hirsutum*), Sea Island (or *Gossypium barbadense*), and Peruvian Cotton (or *Gossypium peruvianum*). The first of these three includes all the short and some of the long-staple varieties, and is grown mostly in the Transvaal and Natal; the second named produces the best, longest, and most valuable lint, and is grown on a small scale along the coastal regions of Natal and Kaffraria; the third is the most important cotton of Egypt, and has a beautiful, glossy appearance and a yellowish colour. This variety is still under experiment, and it has not yet been proved whether it will thrive in the Union.

Experiments have also been made with a tree cotton (*Caravanica*), but with unsatisfactory results.

Nyasaland Upland is being grown in the coastal regions on a small scale.

The difference between Upland and Sea Island is that the former is taller, with longer and thinner branches, much longer leaves, and small pointed bolls, and it ripens much later. Further, the fresh flower is more yellowish in colour, with red spots at the base, longer

and finer fibres, and black smooth seeds. Some Upland varieties, e.g. Peterkin, however, also possess smooth black seed. The fibre of Upland measures from  $\frac{3}{4}$  to  $1\frac{1}{2}$  inch in length, and that of Sea Island from  $1\frac{1}{2}$  to 2 inches.

Under cultivation cotton is generally considered to be an annual, and is usually replanted every season, with the exception of the tree variety. It is not yet possible to say whether ratooning will be practised permanently in future. (By ratooning is meant the method of cutting off the first crop close to the ground, when a new plant or "volunteer" takes its place the following year, re-seeding thus being eliminated.) Authorities state that, after the second year, the lint of such plants deteriorates greatly by losing its gloss and strength—two of the most important and desirable qualities of cotton fibre.

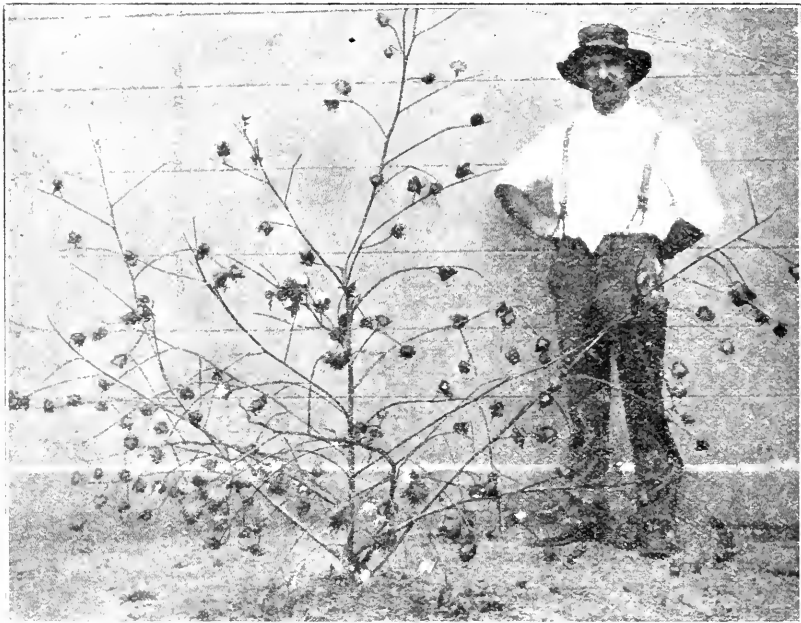

Plate I.

Photo by W. H. S.

"Sea Island" cotton plant with the leaves removed to show the bolls,—  
Big Umgazi, Port St. Johns.

*Climate.*—Cotton is eminently suited to warm regions. One of the essential climatic conditions is a summer rainfall of not less than 18 to 20 inches, fairly well distributed over the whole period of growth. During the first five or six weeks the plant is very delicate and weak; consequently the soil should not be allowed to dry out too much during that time. Thereafter the plant can withstand much drought, the taproot being long and shooting well down. The plant being very sensitive to frost, it is necessary that no frost occurs for six or seven months where cotton is grown. In localities which are subject to frost, planting should not be done before October, but also not much later than November.

During harvesting time it is desirable that the weather should be dry and sunny. The plant reaches full maturity in about six months.

*Soil.*—This crop can be grown on nearly every kind of soil where mealies grow, though the most suitable are clayey and sandy loams. Clay soils also give good results provided they are well cultivated and the seed is sown early. Light, sandy soils, however, should be manured judiciously, otherwise the growth will be poor and a light crop reaped. Under favourable weather conditions turf soils will occasionally yield excellent results. If the soil is very fertile branches and leaves are formed at the expense of fruit.

*Seed Selection.*—The selection of seed plays a highly important part in cotton culture. It is essential that good seed be planted, and, as the cotton plant is very sensitive to climatic and soil conditions, the greatest care should be exercised in selecting seed plants. A variety yielding the best results in one particular locality is very often unsuited elsewhere. The farmer is therefore advised to experiment personally with the different varieties and keep the seed from the most suitable plants for the following season's planting. Seed should be kept only from those plants which show uniformity of type and at the same time produce a great number of well-developed bolls.

It is further important that the seed matures normally and is dried properly prior to its being stored. If it is stored in a heap in a damp condition over-heating takes place and the power of germination is partly destroyed.

*Most Suitable Varieties.*—It is not yet possible to determine which are the most suitable varieties for the different localities of our country. The only reliable method would be for a number of seasons to test the most promising varieties. Only those giving the best results are then grown. The height of a plant is not always an indication of its suitability. There are varieties of cotton which, under very favourable conditions, attain a height of from eight to nine feet, but those of about three feet usually give the highest yield.

For Transvaal conditions the large-boll varieties, such as Bohemian, Bancroft, Russell, Cleveland, and others are to be recommended. King, a small-boll variety, but very prolific, also gives excellent results. Cook's Long Staple can be grown with success in the warmest and most fertile parts of northern Transvaal. Along the coastal regions of Natal and Kaffraria Cook's Long Staple, Griffin, Bancroft, Toole, Nyasaland and Peterkin thrive well. The small-boll varieties mature earlier than the large-boll varieties.

*Soil Fertility and Rotation.*—It is unnecessary to enlarge here on the subject of improving the fertility of the soil and of practising crop rotation, the subject having been discussed in detail in Bulletin No. 6, 1917, of the Tobacco and Cotton Division. It is only necessary to point out that the cotton plant requires far more nitrogen than phosphorus or potash. Nitrogen can easily and economically be supplied to the soil by the use of leguminous crops, such as cowpeas, velvet beans, and field peas. If the growth is poor and the plants are yellowish the soil is deficient in nitrogen; if the plants mature late and the bolls do not open well the soil is in need of phosphoric acid; and if the leaves contract rust and fall off there is a deficiency in potash.

Among the principal field crops grown commercially in South Africa the cotton plant is the least exhausting. The following table, taken from "Burkett's Cotton," is interesting:—

*Plant Foods Drawn from the Soil by Crops.*

Crop.	Nitrogen.	Phosphates.	Potash.	TOTAL.
	lb.	lb.	lb.	lb.
Cotton—				
300 lb. of lint...	1.02	0.30	1.37	2.69
650 lb. of seed	20.34	10.67	7.84	38.85
	21.36	10.97	9.21	41.54
Mealies—				
8½ bags	32.14	12.36	7.06	51.56
4000 lb. of stover	41.60	11.60	56.00	109.20
	73.74	23.96	63.06	160.76
Wheat—				
3½ bags	19.75	7.44	5.10	32.29
2300 lb. of straw	13.57	2.76	11.73	28.06
	33.32	10.20	16.83	60.35
*Tobacco—				
1000 lb. leaves	44.00	5.00	52.00	101.00
353 lb. of stalk	12.00	2.00	17.00	31.00
	56.00	7.00	69.00	132.00

We leave it to the reader to make comparisons and draw his own conclusions from these figures.

The farmer should endeavour to obtain the greatest yields at a minimum cost by methodical and scientific cultivation of the soil. This we may call intensive cultivation as contrasted with extensive cultivation. It is far better to grow 50 morgen of cotton yielding 1600 lb. of seed cotton per morgen than to grow 100 morgen yielding 800 lb. per morgen. It is self-evident that intensive cultivation is by far the better method for the development of the country.

*Preparation of the Soil.*—It is impossible to state with certainty when and how the soil should be cultivated, as so much depends on the class of soil and weather conditions. Where possible the lands should be ploughed in autumn or the early winter, and as deep as possible—9 to 12 inches, depending on the nature and kind of soil utilized. As soon as the first spring rains set in the lands should be either ploughed again, if necessary, or rolled and harrowed to a fine tilth. As soon as all danger of frost has disappeared the seed may be planted. The earlier the planting the greater the chance for the plants to come to full maturity and the higher the yield.

The seed germinates in from seven to twelve days. When the plant is about forty to fifty days old the first squares appear; after that it takes about three weeks for the buds to open. From the open flower till the boll opens it takes another fifty days. The warmer the weather the sooner the bolls open.

\* Taken from "Killebrew and Myrick's Tobacco Leaf."



*When and How to Plant.*—Seeding should be done between October and the middle of November. In the remote, warm low veld planting may be done till the end of November. In fertile soil the distance between the rows should be 4 feet, but in poor soil not wider than about 3 feet. In sticky or heavy soil the seed should be planted thicker than in sandy, light soil. The young plants emerge from the ground similar to bean plants, and being, moreover, covered with fuzz, which impedes germination, the depth of seeding should not be greater than from 1 to 2 inches, otherwise the cotyledons are unable to burst through the hard crust of earth which is formed after rain.

Forty lb. of seed per morgen is sufficient if a cotton planter is used. (In the U.S.A. the rate of seeding is from 60 to 80 lb. per morgen.) When the plants have reached a height of about 5 inches they should be thinned out to a distance of 12 or 15 inches. Thinning is done with hand-hoes, or if the soil is soft and moist, by hand.

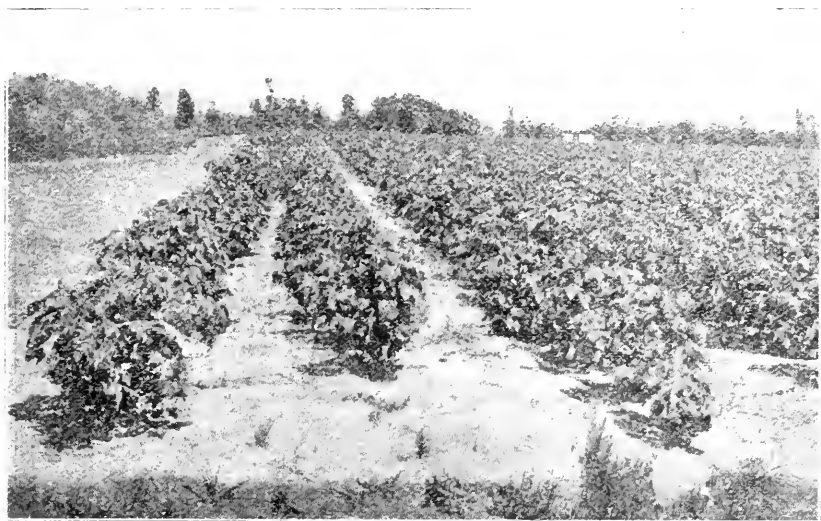

Plate II.

Photo by H. W. T.

Cotton-field not requiring further cultivation.

*Cultivation.*—The object of cultivation is to destroy weeds which would otherwise damage and perhaps choke the crop, to break the crust of earth formed after rain followed by sunshine, to impede capillary attraction and thus improve the moisture-holding capacity of the soil, and to facilitate the penetration of air into the soil. Proper cultivation of the soil also improves the growth of useful bacteria and the chemical solution of the plant foods.

As soon as the plants are well above the ground cultivation should be proceeded with and continued after each rain. At first the cultivation may be deeper than afterwards, especially when a heavy rain has caused packing of the soil. But when the plants have attained a height of 10 to 12 inches the cultivator should not be set deeper than 2 to 3 inches. The feeding roots of the cotton plant spread from 3 to 9 inches under the surface of the ground; deep

cultivation would consequently result in the breaking of the roots and the plants would suffer. Cultivation should be continued until the flower buds or squares make their appearance. Shortly afterwards this should be discontinued, otherwise the squares may be bruised and the yield diminished accordingly.

*Picking.*—As soon as the cotton fields are white with open bolls, or when about half of the bolls are open, harvesting may be begun. It takes about three pickings before the whole crop is gathered. When cotton is wet after rain or heavy dew harvesting should not be proceeded with until it is dry. If it should be found that moist seed cotton has been picked it should be spread open on the ground to dry and then stored in a clean, dry, protected shed or on the loft.

Care should be taken to pick only clean seed cotton; all leaves, pieces of boll, and other foreign matter are to be discarded, as such impurities only detract from the value of the product. Soiled cotton



Plate 111.

Courtesy E. Löffler.

Cotton-field ready for picking.

should be picked and ginned separately. The employment of native women and children for harvesting is the most economical. It is light, clean, and attractive work. An active woman can collect as much as 75 lb. per day if the plants are rather full of open bolls. The average is, however, about 50 lb. per day. Some natives who have become skilled in the work can pick as much as 100 lb. per day.

Mud sacks are mostly used in this country for harvesting. On either side of the opening a riem or cord is fastened and then hung over the neck and shoulders of the picker.

The picking costs work out at about a farthing to halfpenny per lb. of seed cotton.

*Ginning and Preparation for the Market.*—The cotton is conveyed loose in wagons or in wool packs and bags to central establishments for ginning. This consists in separating the lint from the seed.

About one-third of the weight of seed cotton is lint and the remainder seed.

There are two kinds of gins in general use, namely, roller gins and saw gins. The former is used for the long-staple cottons, thereby avoiding breaking or knotting of the fibres; the latter almost exclusively for ginning the short-staple cottons with fuzzy seeds. The greater majority of gins are saw gins, as they do much quicker and cheaper work. An ordinary roller gin requiring 2 horsepower can treat about 35 lb. of seed cotton per hour, whereas a saw gin with the same horsepower can gin 180 lb. per hour. The saws of the latter have a velocity of approximately 450 revolutions per minute, and the teeth of the saws pull the lint from the seed, while a brush revolving at high speed again removes the lint from the saws.

Before the invention of the roller gin in 1792 by Whitney and Holmes in America, it took a man a whole day to separate 1 lb. of lint with his fingers (the general practice followed at that time). After the machine had come in use the growing of cotton in North America made enormous strides. The demand for gins in the Union is being increasingly met, and to-day there are several gins permanently established in various parts of the Transvaal and Natal, where the cotton industry is developing rapidly.

In South Africa, where manual labour is still in vogue, the ginning costs are halfpenny per lb. lint, and in the U.S.A., where the pneumatic system is in use, it amounts to only one-eighth of a penny, or one-fourth of what it is here.

After being ginned the cotton is pressed by means of a strong press into bales of 54 in. by 27 in. by 27 in., and weighing 500 lb. each. The bales are covered with hessian or sack cloth and fastened with iron hoops to prevent them from expanding. South African cotton bales are, as a whole, far neater and more attractive than American bales.

*Costs of Cultivation and Profits.*—The costs and profits naturally depend largely on the value of the ground, the weather conditions, and the distance from the gineries and the market. But even if these conditions should be quite favourable sufficient labour must be available at reasonable wages. Without sufficient cheap labour it is practically impossible to grow cotton profitably. Fortunately most parts of the Union suitable for the growing of cotton are well supplied with natives with large families.

The costs work out at about £4 to £6 per morgen, and the profits, under normal conditions, at £6 to £18. Since the world-war prices have risen enormously and the profits are therefore much greater. It is not possible to give definite figures, as so much depends on the farmer himself and on circumstances. This, however, may be said with certainty that, where conditions are favourable and the farmer does his duty, cotton is a profitable crop and pays better than mealies. Moreover, the cotton plant in South Africa is not yet so subject to insect pests and diseases as, for instance, it is in America, where the profits of the cotton grower are greatly reduced by the depredations of the cotton-boll weevil, the bollworm, fungus diseases, etc. If cotton were to be grown here on a more extensive scale more pests would most likely make their appearance, but in such contingency means would no doubt be devised to combat them. Bollworms are at

present the greatest pest the South African cotton grower has to contend with.

Cotton lint has also the advantage that it can be kept many years without any danger of deterioration or being damaged to any extent by moths and mice, and there is an ever-increasing demand for it.

#### CONCLUSION.

North America produces about 60 per cent. of the world's cotton. In other countries, where cotton is grown to any appreciable extent, e.g. Egypt and India, the possibilities of greater production are, as far as we at present know, more or less limited. The only countries where cotton can still be grown extensively are Africa and a few South American Republics, especially Brazil. The future for cotton culture in Mesopotamia appears to be good. Much is being done by European commercial bodies to further cotton growing in Africa, as it is a matter of life and death for the cotton factories on which hundreds of millions of pounds have been invested, and on which millions of people are dependent for their daily bread.

Every year the United States of America manufactures more of its cotton, and more textile buildings are continually being erected, with the result that the manufacturers in England and on the Continent are unable to obtain supplies for their own factories. The demand is increasing much faster than the supply. Of the world's population about 500,000,000 are properly clad, 750,000,000 partly dressed, and 250,000,000 practically naked. The population of the world is getting more civilized, and the first requirement next to food is clothing in some form. The production of wool, camel hair, and other fibre suitable for clothing is so limited that at present the only solution seems to be in a very much greater production of cotton.

The tendency is for prices still to rise, and the farmer need have no fear whatever of over-production. In 1764 North America exported eight bags of cotton to Liverpool, and this probably represented the whole amount exported during that year, whereas to-day the export runs into millions of bales. The amount of cotton grown here at present and exported to other countries may not be great, yet it is most encouraging if one considers that the culture of this crop is of recent date and practically unknown to most farmers of South Africa, and, further, that the northern and eastern parts of the Union, where cotton is successfully grown, are still sparsely populated by whites. The prospects of the man who goes in for cotton growing are decidedly good, and there is not the slightest reason why thousands of farmers in the low veld should not give attention to this very promising crop.

---

### Citrus Export: Experiments.

A number of experiments are being carried out by the Government Mycologist and the Chief, Division of Horticulture, in regard to the carriage and keeping qualities of South African oranges from various farms to the London market. Reports are being furnished on each experiment, and it is hoped that valuation information will be obtained by this means.

## THE PIG AS AN ECONOMICAL PRODUCER OF FOOD.

By W. A. K. MORTEL, M.Sc., Lecturer in Animal Husbandry,  
Elsenburg School of Agriculture.

IN Denmark, Ireland, America, and many other countries the pig has justly earned such popular titles as "The Small Holder's Friend" and "The Mortgage Lifter." Why? Because next to the dairy cow he has proved himself to be the most economical animal machine for converting the common feeding stuffs usually available on the farm into edible animal products of the most desirable kind; and where unmarketable produce, such as kitchen garbage and spoiled feed, is concerned he is easily the most efficient of all our domestic animals for converting it into marketable food.

It is a well recognized fact to-day that as the population of a country increases so the pig industry is more and more realized. In this respect the United States of America stands out as a typical example, and there is no doubt in the writer's mind that, with closer settlement steadily taking place in South Africa, our farmers, before the close of another decade, will have built up the pig industry of the country to that position to which it is entitled. And with its favourable conditions in respect of water, shade, productive capabilities of the soil, and comparatively small farms, Natal should become the most prominent of all the Union Provinces in the building up of our pig industry.

The relative efficiency of pigs as compared with sheep and oxen in converting feeding stuffs into body gains, is clearly brought out in the following figures by Lawes and Gilbert\* :—

### COMPARATIVE RETURNS FROM THE STEER, SHEEP, AND PIG.

	Oxen (Steer).	Sheep.	Pigs.
	lb.	lb.	lb.
Average light weight ... ..	1200	130	175
<i>(a) Per head per week—</i>			
Total dry feed eaten ... ..	151	21	48
Increase in live weight ... ..	13.6	2.3	11.3
<i>(b) Per 1000 lb. l.w. per week—</i>			
Total dry feed eaten... ..	125	160	270
Increase in live weight ... ..	11.3	17.6	64.3
<i>(c) Required for 100 lb. increase—</i>			
Total dry feed eaten ... ..	1109	912	420

\* Warrington: "Chemistry of the Farms."

From the above table it will be seen that the feed consumption and gain per capita made by the sheep and the pig are less than that made by the steer (oxen), due to their smaller size. When, however, we consider the feed consumption and gain on the comparative basis of a 1000 lb. live weight, it will be seen that while pigs consume about  $2\frac{1}{4}$  times as much feed as steers, their gain in live weight is nearly six times that of steers, which more than balances the greater consumption of feed. The feed of pigs is in a more concentrated and digestible form, and for this reason they utilize less in digestion and assimilation and thus have a large amount of feed over and above the bodily needs for the production of gain than either steers or sheep. In considering the amount of feed suitable for man returned by our different kinds of animals on the basis of 100 lb. of digestible matter consumed by each, we find, according to Jordan, the following:—

HUMAN FOOD PRODUCED BY FARM ANIMALS FROM 100 LB. OF  
DIGESTIBLE MATTER CONSUMED.

Animal.	Marketable	Edible
	Products.	Solids.
	lb.	lb.
Cow (milk) ... ..	139	18
Pig (dressed) ... ..	25	15.6
Cow (cheese)... ..	14.8	9.4
Calf (dressed) ... ..	36.5	8.1
Cow (butter) ... ..	6.4	5.4
Poultry (eggs) ... ..	19.6	5.1
Poultry (dressed) ... ..	15.6	4.2
Lamb (dressed)... ..	9.6	3.2
Steer (dressed)... ..	8.3	2.8
Sheep (dressed)... ..	7.0	2.6

According to this table the dairy cow ranks far above all our domestic farm animals in her power to convert the *ordinary* feeding stuffs available on the farm into human food. The pig is a close second and sheep are indisputably last. However, pig farming can more often than not be regarded as a side line of the main farming business, that is, the pig is the medium of marketing the by-products of the farm and is easily the best of all animals for this purpose. Where cattle are being fattened we find the pig utilizing the undigested feed in the droppings which would otherwise have been mere waste. On a dairy farm the best value for the farmer's separated milk, butter-milk, or whey may be obtained by letting the pig convert it into a saleable product. Then, again, where mixed farming is practised, and it is typical of many districts in South Africa, the pig will not only economically utilize all the available dairy by-products, but also all the unmarketable products, such as undersized potatoes, spoiled grain (when cooked), waste fruit, and kitchen refuse. Particularly in the Western Province the pig is most useful for gleaning the stubble fields and converting this otherwise wasted grain into ready cash. It is in these respects that the pig shows up to the best advantage and has no rival as a profit producer. In addition, pig

farming ordinarily enjoys the following advantages over other kinds of live stock farming:—

(1) It requires a comparatively small outlay of capital for breeding stock and housing equipment in order to get into the business, and it is also comparatively easy to get out without much, if any, financial loss.

(2) No other kind of live stock farming offers such quick returns as does pig farming. This is due to the early age at which the pig will reproduce. Thus a young sow is able to have her first litter at about 12-14 months of age, and her second litter within 6 months of her last farrowing. In other words, by the time she is 18-20 months of age she is able to return to her owner on the average about 15 pigs, and will then begin to give him a steady income from month to month. In cattle farming, on the other hand, the breeder would just be thinking of having his heifers at 20 months of age served, and he would have to wait for the best part of another year before getting his first return. The sow by that time would have raised another 15 pigs. Thus the prolificacy of pigs—an average of about 8 pigs per litter, depending upon the breed—and the fecundity of pigs, that is, the production of two litters within the year (if under proper management), are very significant advantages to the tenant farmer and the small holder.

(3) In South Africa we appear to have a few additional advantages in so far as pig diseases, feeds, housing, and labour are concerned. In disease, the greatest of which is "hog cholera"—the swine scourge of America and Europe—South Africa is comparatively free. Outbreaks have occurred, but have not been frequent, nor of such a severe nature as has been the case in England or America. Owing to the mildness of our climate, the cost of housing is comparatively small, particularly where the system of having portable pig-houses is adopted. These will provide sufficient protection from the cold in winter and the heat in summer. The cheapness of our native labour makes pig farming more profitable in South Africa than it is in other countries where only white labour is available. However, cheap labour becomes efficient labour only where strict supervision is practised. And last, but not least, maize and lucerne, perhaps the two most highly valued pig feeds, can be economically produced in many parts of the Union, as well as other crops making excellent pig feed, such as rape, sweet potatoes, Jerusalem artichokes, etc.

In the past there has been, and even at the present time there is still, an inherited kind of prejudice against the pig, much of which may probably be put down to ignorance of the possibilities of pig production, and it is trusted that once the above facts are brought home to our farmers many of them will at least give pig farming a fair trial

---

### **Fruit Export.**

There were three shipments of fruit during August, 1920, totalling 27,260 boxes oranges, 1668 boxes naartjes, 416 boxes grape fruit, and 21 boxes pines.

## KARAKUL SHEEP.

By R. OWEN WAILL, B.A. (HONS.), Lecturer in Zoology and Entomology, Grootfontein School of Agriculture, Middelburg (Cape). Officer in Charge of Karakul Sheep Investigations. (In consultation with A. D. Thompson, Manager, Karakul Stud Farm, South-West Protectorate.)

(Continued from page 527.)

### VI.

#### MATING OF KARAKUL SHEEP: GROOTFONTEIN SCHOOL INVESTIGATIONS.

Mention has been made of the practice of deciding upon the mating of the ewe lamb at birth, and in connection with the very vexing question of the mating of karakuls, it is felt that a short account of the results of the investigations at the Grootfontein School of Agriculture may be of assistance to breeders. Some of the readers of this article will have purchased pure-bred ewes at the recent stad sale at Grootfontein, and will in many cases have some of the same ewes with which the investigations were begun.

The first lambing season, of the then recently acquired pure-bred karakuls, at Grootfontein, was a great disappointment. We had seen very beautiful skins and expected the lambs to resemble them, but as lamb after lamb was born dull of coat, fuzzy, or ragged, or a mass of corkscrews, this was difficult to believe. Practically all the ewes were put to one ram (No. 10/11, and named "MacPherson"), and many of the lambs were "B" type (see Plate 11), and most of the rest had a great amount of corkscrew in their pelts, giving them a poor lustre and very ragged appearance (see Plate 12). A few lambs from another of the original stud rams at Grootfontein, namely, "Edward" (No. 68/68) (see Plate 1), were rather lacking in the development of the curl, but were not ragged and had good lustre (see Plate 13). This decided us to use "Edward" extensively in 1917. The result of the 1916 lambing was: *First class*, 5, of which 4 were of the border line between classes 1 and 2 and would have been classed in second in 1917; *second class*, 18, of which 12 would have been in third in 1917; *third class*, 42, of which 11 would have been in fourth in 1917; and *fourth class*, 5.

Information as to the lines along which to work was not forthcoming from the Germans for the very good reason, as their records show, that they had no definite system of mating, and that, while numerous registers of various kinds were provided, none of them were kept accurately. (Even their family registers are very inaccurate.) The greatest problem, of course, was the improvement of the curl of the pelts and how to set about this by mating adult sheep about which nothing was known, except that woolliness was undesirable and crimp was very desirable, was the cause of much thinking. A detailed



description of every ewe in the flock, then 83 in number, was taken, and any showing much crimp of any kind was especially noted. The rams were examined again and again, and, in consequence, in

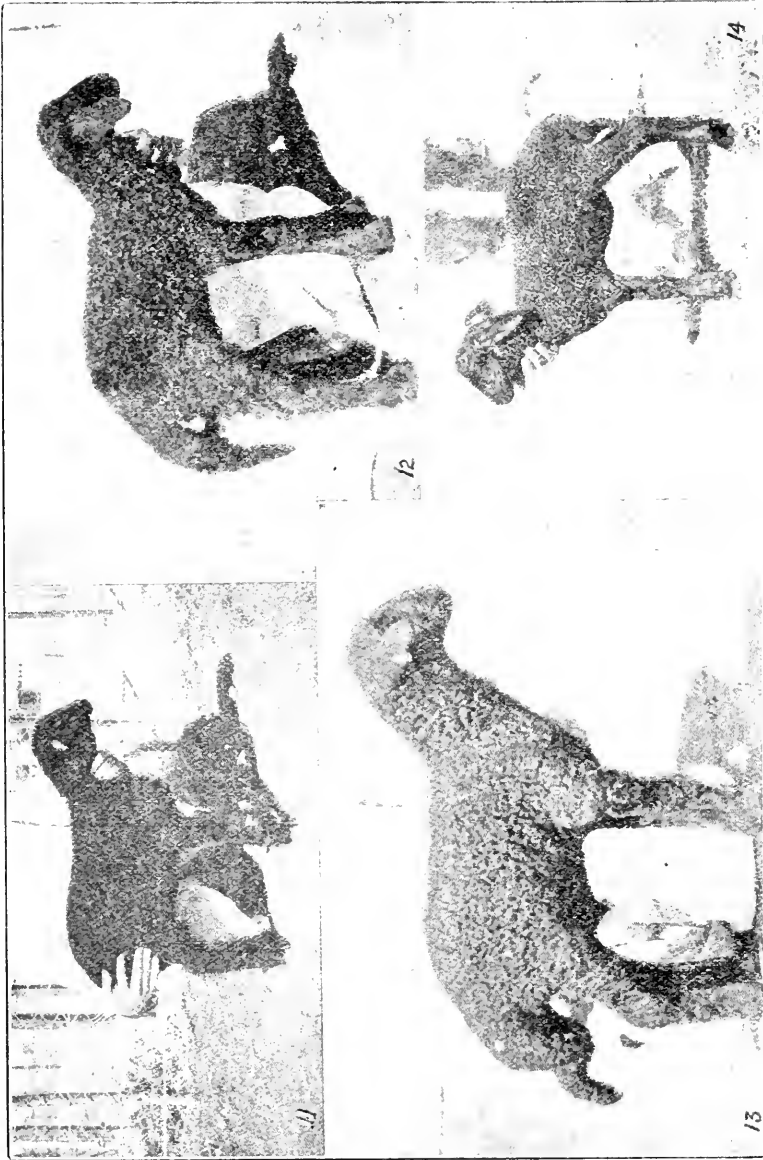

PLATE 11.—Typical "Nigger" Lamb of 1916 drop. (Photo by Author.) PLATE 12—Karakul Lamb, with ragged lock of "A" quality, 1916 drop. (Photo by Author.) PLATE 13.—Karakul Lamb, with good lustre and style, but rather open curl. There is no raggedness. (Photo by Author.) PLATE 14.—Karakul Ram Lamb of "A B" type. Note harsh hair below lock. This ram is to be used in the experiment referred to in text. (Photo by Author.)

1917 "MacPherson" was discarded and the other two rams, "Edward" and "Blackie" (No. 117) were used to great extent. It was noticed in the 1917 lambs that a great improvement in lustre

was obtained, and some lambs with good curl were also got, but on the whole they were too loose in curl, and some "watered silk" lambs were bred from "Edward." (This ram has since proved clearly that he has a great tendency to get lambs of that nature, and has, consequently, been of the greatest use in stamping out "nigger" curl and introducing quality into the flock. He also had the advantage of being the best built of the rams first imported into the Union.) It was decided to use this ram extensively in order to break down the "nigger" curl tendency in many of the 1916 ewe lambs when they were mated in 1918, and meanwhile (1917) he was mated to those ewes which had dropped lambs in "B" in 1916.

Considerable disappointment was experienced when it was noted that many of the ewes, especially noted as being very crimp, were the dams of the worst "nigger" lambs. It has since been found that crimp correctly placed is a very desirable feature, but that if it is wrongly placed it is about the worst feature one can have in the fleece of a karakul to be used for breeding.

Early in 1917, 25 ewes selected by the writer from the Protectorate flock were transferred to Grootfontein with an adult ram "Douglas" (No. 44), together with a ram lamb of the Arabi or short-eared strain and a son of "Jacob." These ewes were put to certain rams before leaving Otjitesu, and from the drop which took place from October, 1917, to January, 1918, two of the rams at present at stud, namely, "L. Russel" (G.K. 142) and "Llama" (G.K. 151), were obtained. Both these rams are sons of an old, very clear-haired ram named "Langman" (No. 25), of the South-West Protectorate stud, who has done for that flock much the same work as "Edward" has done at Grootfontein. Excluding the lambs from the selected ewes, the result of the 1917 mating was: *First class*, 10; *second class*, 22; *third class*, 22; *fourth class*, 8. This was a great improvement of the previous year's drop, especially as the standard of classing was raised somewhat. There was still, however, much room for improvement, and much to be learnt, and for the 1918 mating the ewe lambs of the 1916 drop were also available. It was essential that all those of "B" type, especially the "niggers," should be mostly mated to "Edward" to flatten out the curl and to introduce quality; consequently, many plain lambs in classes 3 and 4 were expected. Some of "MacPherson's" plainer A-type lambs were put to the ram "Douglas," a ram of much curl and at birth a first, with a very highly valued pelt according to German records, and two of "MacPherson's" rams were also tried at stud, although they were only class 2-3A at birth. "Edward's" lambs were plain as expected, and as the summary shows by the size of classes 3 and 4. The lambs from "Douglas" on the "MacPherson" ewes were all in B, or had corkscrew in A, and "MacPherson's" sons were, as expected, failures, although one of them, "McTavish" (No. K 2) got a ram lamb which promises very well, and which will be tried at stud in 1920. The other son, "McNab" (No. K 44), was too hard-haired and was a failure. "Douglas" was also a failure, but perhaps the ewes did not suit him. (NOTE.—The rams are purposely named to enable the breeders to trace the pedigrees of their stock to a degree, and also for the sake of leaving some record of these, the founders of the karakul flock in the Union;

see also remarks further on on the naming of rams.) The result of the 1918 season was: *First class*, 23; *second class*, 28; *third class*, 39; *fourth class*, 16. Although there were 16 in *class four* the results were very satisfactory, as was expected that this would be the result of the mating. The increase in the number of first class lambs showed that in that direction also the work was proceeding along the right lines. The drop in the number of second class lambs is partly to be accounted for by the fact that some of the better ewes were put to the untried rams to give them a fair chance of proving themselves. Much information was gained from this season's lambing. It showed clearly that a plain A-type ram, or better still a "watered silk" ram, could break down much of the undesirable curl and quality of B and "nigger" lambs, and that with patience and using the right stamp of sire a fur-bearing flock could be built up from what at first appeared to be very hopeless beginnings. Another lesson learnt was that it was exceedingly dangerous to introduce too much curl through the ram without knowledge of the exact breeding of the ewes with which he is mated.

For the 1919 mating 6 rams were used, including the 2 young sons of "Langman" mentioned above. One of these, "Llama," a first A "watered silk" at birth, was used to take much of the stamping out work from "Edward," and was given almost all bad ewes of B type or "niggers." Their lambing from this tup has just finished, and has been by far the best, for, although many third classes were got, fourth classes were scarce, and the lustre and quality of the hair generally was of a much higher order than in 1918. This was expected, as 3 of the 6 rams used were born on Grootfontein, and the officer in charge saw the other when it was a lamb. "Blackie" and "Edward" were the two others. Also, all the 1917 ewe lambs had their mating notes made when they were born, and this method of mating, put into practice for the first time, proved itself at once. The result was as follows: *First class*, 25; *second class*, 37; *third class*, 40; *fourth class*, 6. It will be noted that there is an increase in the number of first class lambs, an appreciable increase in the second class, an increase in the number of thirds, but at the expense of the fourth class, which contained only 6. Of the 40 lambs in the third class only 6 showed a B quality, and only one of these was a true B. None of the 6 fourth class lambs were in B.

For the convenience of readers the percentages for the four years are reprinted together:—

Season.	1st Class.	2nd Class.	3rd Class.	4th Class.
1916 ... ..	7.14	25.71	60.00	7.14
1917 ... ..	16.12	35.48	35.48	12.90
1918 ... ..	21.69	26.41	36.79	15.09
1919 ... ..	23.14	34.25	37.03	5.55

From the above results it can readily be seen that considerable improvement can be made in the space of four years. In 1916 the first and second class skins, that is the pelts, valuable as furs, together totalled to 32.85 per cent. of the drop, while in 1919 it is 57.39 per cent., or nearly 60 per cent. of the drop.

## VII.

## POINTS FOR THE BREEDER.

From the lessons learnt from the above results the following points are strongly recommended to the breeder. Treat the first lambing season you have as experimental, and correct your mistakes from that. Find out from the Government all the information you can about your ewes, and particularly what the investigators think your rams are likely to do and what sort of ram they would recommend you to buy. All B-type lambs, especially "niggers," must be mated to an A-type ram, as plain as possible, and one whose immediate parents at the very least were also both of A type. This is very necessary, as often a lamb born of A type and classed as such is out of a B or even a "nigger" ewe by a good ram, and consequently has lots of B in his nature, which is certain to find expression in the great majority of his progeny if put to B-type ewes. It will be of great assistance to every breeder to arrange his lambing for 1920 so as to have it over by the time the annual sale of karakul sheep takes place. By so doing he will be able to see whether the ram or rams he has are giving good results with his ewes, and if he desires to purchase one more suitable he will then have time to communicate with the writer at Grootfontein and find out if such a ram is available. (About 20 yearling rams will be for sale, the majority suitable for fur-pelt breeding.) Breeders are also strongly advised to purchase such rams even if they have to pay a good price for them, and not to be tempted into buying some animal which is unsuitable but which is being sold at a low figure. Bad quality of hair and poor lustre in a flock, and, above all, "nigger" curl, can only be eradicated by using good A-quality rams bred from A-quality parents on both sides, and "watered silk" rams with the proper length of staple are the best for this purpose. Until quality and lustre are firmly established a third class A "watered silk" ram bred correctly is of infinitely greater value to any breeder of pure-bred karakul sheep than any first class animal in AB or B, over even in A if one of his parents has any tendency to produce B-type lambs, when correctly mated to A-type stock, or was itself of that type as a lamb. It is best to use plain "watered silk" or good A-curl rams for at least three generations on B's and "niggers," and only then to begin tightening up the curl, still using A-type rams but with more definite curl (see Plates 3 and 5). This point about introducing lustre and quality into a flock before attempting to build up tightness of curl cannot be too strongly emphasized. Once these essentials are established, tightness of curl and strength of hair can be considered in the matings, and also the length of staple. Lambs which have long soft hair at age of description should be mated to rather strong-haired rams which were rather short-haired as lambs, and so on as one would mate any other class of stock to improve various weaknesses.

It will often be found that there is a great difference in the lambs produced by the same parents: some may even be in A and others in B. Professor R. Wallace, in the article quoted from earlier, mentions this fact, and says that "by some this has been attributed to feed, though, like the colour and quality of the hair of some of our domestic animals in this country, it is probably due to natural

constitutional variations." It appears to the writer, as he has already clearly indicated, that this variation is due mostly to the breeding of the parents; certainly when such big variations occur as between "A" and "B" types. In all cases when we know the breeding of two sheep for a few generations back we can predict approximately what the lamb's pelt will be like. Of course no two lambs are alike, but type of curl, lustre, and quality can be predicted under the conditions mentioned. It has already been shown that big variations in lambs from an "A" type ram can often be explained by the fact that although he, himself, is of "A" type, one of his parents was not, and even in a pure-bred "A" ram, one of whose parents was a "watered silk," and the other a tight-curlled lamb, both kinds of curl are transmitted by him. Such a ram, "L. Russel," is at present at stud at Grootfontein. He was a first A Special, medium tight curl. His sire was "Langman," who gets many "watered silk" lambs, and his dam was a first A of good definite curl. Many of his progeny are curly, but a fair number are too open, due to the "watered silk" blood he has in him. The curl of the ewe must, of course, also be taken into consideration, but the ram appears to have much the greater influence on the pelt.

As more is known about these sheep more will be published. For the present what has been written is what has been found and proved to be true, and will not cause any breeder to lose ground or time in obtaining good results. Other investigations, such as the value of rams with good tight curl and good lustre but with some "B" in them, are being conducted in the near future at Grootfontein. (Such a ram as a lamb is figured in Plate 14. Note the hard hair below the hock.) It may be that such an animal will be of great value when put to soft open curled ewes, but until this has been proved breeders are advised to keep away from B-type rams even if they can be bought for £2 and are classed 1B.

As, for some years to come, karakul sheep will be more or less a side-line with breeders and will probably not have the time devoted to them required to make full descriptions of the lambs, and as many will be unwilling to keep several rams to suit the weaknesses of small numbers of ewes, breeders should use only A-type rams and mate everything to them. Nothing can be lost by so doing, except perhaps that some corkscrew may appear in some of the lambs. If such is the case, a shorter stapled ram should be used on the dams of such lambs and on the lambs themselves, as corkscrew appears to be the result of too great length of staple.

As the purchasers of pure-bred karakuls are in a position to obtain the pedigrees of the rams and ewes they have purchased, it might be mentioned for their information and to enable them to avoid introducing too much blood from one ram, that both in the Protectorate and at Grootfontein a certain system of naming rams is followed. It is this: When a ram is used at stud it is named, the name beginning with the same letter as his sires, or having this letter placed in front of it. Thus the stud sons of "Jacob" are named "James," "Jubilee," "Jacobus," etc.; or, again, "Nineteen's" stud sons are "Nimrod" and "N. Lustre"; and "Langman's" are "Llama" and "L. Russel." The rams from which male lines can at present be established are: "Jacob," "Nineteen," "Langman," "Swartbooi," "Owen," "Robert," "George," "Blackie," "Edward,"

and "MacPherson." The rams descended from the other of the imported rams have either been disposed of or have not got sons good enough for stud purposes.

Before leaving the subject of mating some mention should be made of the number of ewes which should be mated to one ram for any given season. Owing the nature of the work at Grootfontein, where there is only a small flock, the greatest number of ewes mated to any ram has usually been between 30 and 40, but in April this year just over 100 ewes were put to "Edward," and the tup worked very well indeed, over 80 ewes lambing, and this does not include all the ewes which were in lamb to him as some were sold before lambing at the annual sale of this institution on the 5th September. "Edward" was born in 1913.

---

## VIII.

---

### THE KARAKUL AS A MUTTON SHEEP.

Built as it is to-day the karakul is by no means an ideal mutton sheep, being too flat-ribbed, not deep enough in the chest and heart girth, and having rather a small leg for its size. It compares very favourably with any of our native sheep, however. The mutton itself is of an excellent quality, being fine-grained and having an excellent taste. It is thought very highly of in Europe, where, indeed, it is a delicacy. At present the karakul is distinctly smaller than the pure-bred woolled Persian, but the two breeds are so alike in most of their points that there is no doubt that if it were desired, they could be built up to be quite as large in every respect. As it is, when grade karakuls and grade woolled Persians are mixed together, it is often very difficult to tell them apart. Where a quick maturing, hardy sheep, dressing a good weight, is required, the karakul presents strong claims for recognition. (As evidence of their early maturity the individual weights of ten yearling pure-bred wethers, all still in possession of their milk incisors, are given in pounds. They are: 90, 88, 87, 95, 84, 95, 82, 66, 100, 85; total, 872 lb., or 87 lb., as an average weight.) These wethers were run on the veld all their lives after they were a week old. Young pure-bred rams run with them, and of the same age, averaged 93½ lb., the highest weight being 103 lb. As already indicated, the hardiness of this breed, their ability to cover wide areas in search of food, the nature of the food they can exist on, and their resistance to "stekgras," all help to make this claim a very strong one in the arid regions of the Union. Again, as well be seen in the section dealing with grade karakuls, even the first cross with such sheep as the Namaqua and black-head Persian results in a considerable increase of weight as compared with their dams, at an early age, although in no case are the weights obtained equal to those sealed by the pure-bred karakul of similar age.

As a mutton sheep, therefore, the karakul is superior to any of our native sheep or to the merino, and, while it does not grow out as big as the woolled Persian, its flesh is of the same excellent quality. For the arid and semi-arid regions of the Union it is difficult to imagine a more suitable sheep, and, besides gaining weight and early maturity, and in almost all cases hardiness as well, the farmer who

uses good A rams to grade up his flock is also improving the fur-pelt qualities of his sheep, so that eventually he can farm pelts if he so desires, or in any case he will get good compensation for the lambs he so often has to kill to save the ewes in years of drought.

The karakul can doubtlessly be developed into a good mutton sheep, but such is not the present intention, as every effort is being concentrated on improving the fur-bearing qualities of this grand breed without losing any of its hardiness.

## IX.

### CROSS-BREEDING.

As the experiments in cross-breeding, or rather in grading up from various native breeds by the use of pure-bred karakul rams, were begun in the South-West African Protectorate before that country was surrendered to the Union, more information is available from the flocks there, and Mr. A. D. Thompson is responsible for the information given, except for that under the heading "Cross-breeding at the Grootfontein School of Agriculture." Mr. Thompson says: "To start a cross-bred flock select the required number of ewes, either of Afrianders or black-head Persians, whichever are the cheaper or the easier to obtain. As foundation stock there is little to choose between them, what difference there is being in favour of the latter breed. Should it be desired to start with Afrianders, as even a flock as possible should be selected, giving attention in this selection to those most resembling black-head Persians. An Afriander is not a Namaqua, the latter being a pure breed of sheep, having much finer hair and far more woolly matter and in some cases showing more lustre. It is, however, found that the gloss of the foundation ewes has little influence on the first crosses, and still less on the higher grades. They seem to inherit a sufficiently good gloss from their karakul sire.

"After selecting the ewes, mate them to an "A" type sire of any class in preference to one in "B" type, but, should such a ram be unprocurable, use as good a "B" as possible. After the first cross "B" sires should never be used. During the first ten days of the lamb's life it should be classed, and, if it does not come up to a certain standard, it should be culled, together with its dam. Ewes thus culled should be replaced by others until a sufficiently large number of good producing ewes is obtained. Very little describing is necessary with the first cross, but gloss and kind of curl or suggestion to curl should always be noted. From the second cross, where a fair amount of curl should be found, a careful description should be made. It has been found that some third-cross lambs are not as good as the second cross, and this is, no doubt, in most cases due to the exaggeration of weakness in the second cross, caused by using rams having the same faults.

"Afriander and black-head Persian ewes gave approximately 36 per cent. first class lambs, while the Namaquas gave only 7 per cent. These ewes were mated to the same rams running in the same flock.

At the second crossing all classes mated the same way gave practically the same proportionate results. The results obtained at a later mating, when ewes were mated according to their class, quite different results were obtained, namely, Africanders and black-head Persians gave approximately 53 per cent. first class, and Namaquas 50 per cent. The class of lamb they produced at the previous mating was also taken into consideration. (NOTE.—When Mr. Thompson speaks of Classes 1, 2, etc., in cross-breeding, he naturally does not mean that the pelts in these classes are of the same standard or value as in the corresponding classes used in judging pure-bred pelts. The practice of having different standards for the different crosses appears to me to be needless, and apt to give rise to confusion, and is not followed at Grootfontein.)

“It is, therefore, quite clear that classing the lambs and mating the dams accordingly will lead to success, and it is quite certain that if a certain amount of culling has been done the results would have been still better. This system also shows that Namaqua ewes may also be used successfully provided rams of the necessary types and classes are obtainable when required.

“For the above results three types of rams were used, namely, very highly developed ‘A,’ good ‘B,’ and ‘watered silk.’ ‘B’ type rams appear to do better on the Namaqua ewes than on the black-head Persians, due probably to the fineness and softness of hair of the first-named breed.

“Owing to the limited number of ‘A’ type rams, the following suggestion is made: Use ‘A’ type of any class for at least the two first crosses, then use a good ‘B’ to increase the development of the curl, then again use ‘A’ and then ‘B,’ and so on. In all cases the type of curl of the ewes to be mated should be taken into consideration, and ‘B’ type rams should never be used on ewes which showed signs of ‘nigger’ curl as lambs. Such ewes should either be culled or the ‘nigger’ tendency eradicated in their lambs, and in these lambs’ progeny until a plain fourth class ‘A’ or a ‘watered silk’ is obtained. In this way ‘B’ rams could be used either for first crossing or on third and fifth crosses. By that time there should be considerably more ‘A’ type rams, and ‘B’ could be done away with. If careful mating and culling are exercised it is certain that high-class lambs may be expected from the third cross upwards, equal and better than many pure-bred lambs, always providing that pure-bred rams of superior quality are used. Taking all things into consideration, therefore, the safest, if not the most economic, line to follow is to use Africander or black-head Persian ewes and ‘A’ type rams throughout. This is especially recommended on farms where the almost indispensable small camps required for mating small lots of sheep are not available, for if the separate lots are to be herded there is almost certain to be some mixing up of the lots through the carelessness of herders.

“Other experiments, such as the merino and heidschrucken crosses, are of no consequence. In the former case the wool renders the sheep unsuitable, the karakul being essentially a hairy sheep. The heidschrucken gives fair results, especially in B, but, being a foreign sheep, they would have to be imported, there being only about six pure-bred ewes in the country. They are, besides, inferior to the Africander and black-head Persian as foundation stock.”



## USE OF CROSS-BRED RAMS.

“ This practice is not recommended at all except for the production of sheep to be slaughtered for mutton, when seven-eighths and higher grade rams can be used to advantage on Africander and Namaqua ewes.

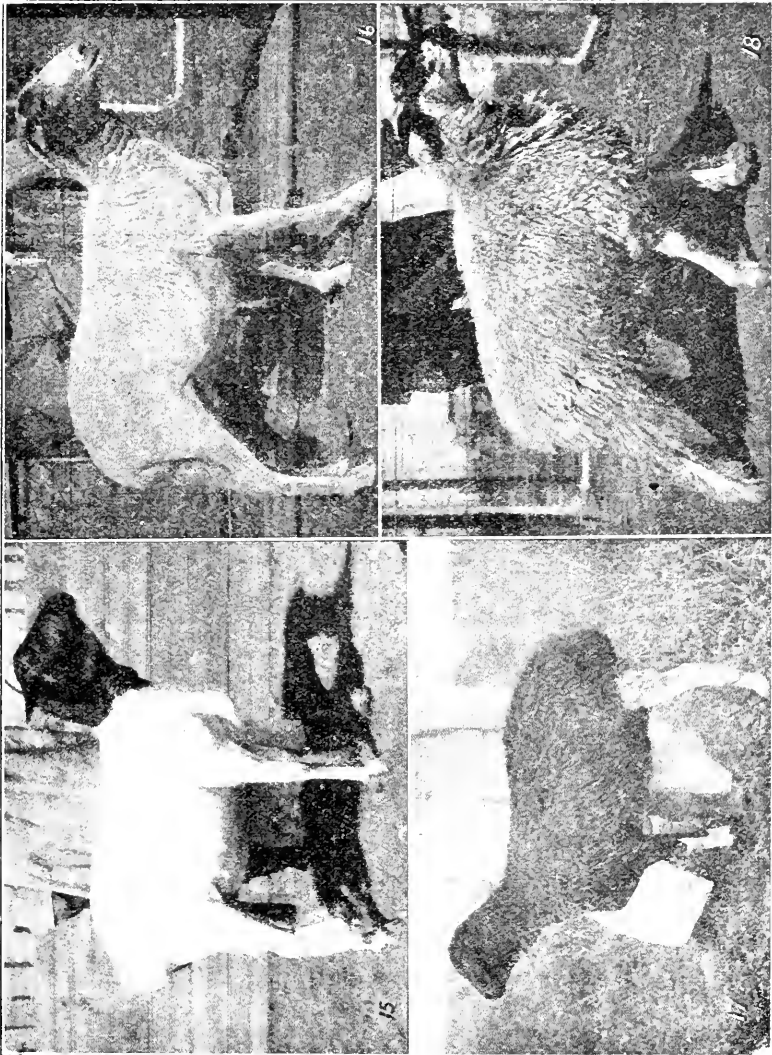

PLATE 15.—Black Head Persian Foundation Ewe. (Photo by Author.) PLATE 16.—Namaqua Foundation Ewe. (Photo by Author.) PLATE 17.—Low Grade Woolled Persian Foundation Ewe. (Photo by Author.) PLATE 18.—High Grade Woolled Persian Foundation Ewe. (Photo by Author.)

“ As experiment, still under observation, has revealed the fact that cross-bred rams on foundation ewes give very poor results, rams respectively three-quarters, seven-eighths, and fifteen-sixteenths karakul are being used, but for the present nothing definite can be

stated as to which grade is best. Instances are on record where three-quarter-bred rams gave better lambs than either the seven-eighths or fifteen-sixteenths; while others were very little better than the original foundation ewes, except for a little colour. In no case has a lamb by a cross-bred ram been as good as one by a pure-bred ram from the same ewe. Examination of stock where farmers have been using cross-bred rams for several crossings have shown very unsatisfactory results as far as the covering is concerned, although there is an improvement in carcass."

#### PROGRESS OF CROSS-BREEDING IN SOUTH-WEST AFRICA.

"Outside the Government sheep or flocks very little is known regarding the progress in quality of fur excepting on the farms in the neighbourhood of the Government Stud Farm. Further than that pure karakul rams are still in good demand, and are bought more or less by breeders of long standing. New breeders are, however, added to the list at almost every sale. The fact that the older breeders repeatedly come back to make further purchases should suffice to show that they have confidence in the future of the breed. In spite of being unable to dispose of the pelts for practically the last five years they are still spending money on them. On the majority of farms yet visited it is found that very little is done to establish any particular type of curl, and on many not even the grade is distinguished by any mark. Indiscriminate mating is found on every farm, irrespective of class, grade, or type of either ram or ewe. So long as a ram is pure he is bought and used. Odd breeders ascertain the type or class and endeavour to purchase on the same line. Grading with cross-bred rams has been largely done, and the results outside the mutton point of view, as already mentioned, are anything but satisfactory."

#### CROSS-BREEDING AT THE GROOTFONTEIN SCHOOL OF AGRICULTURE.

The object in view in undertaking the cross-breeding experiments, or, rather, the grading-up experiments, at this institution were two-fold: (a) To determine which of the easily procurable classes of ewes in the Union would be most suitable for pelt-breeding, and (b) whether karakul rams could with advantage be used for obtaining bigger and heavier sheep for mutton purposes, using the same ewes as in (a), and whether the covering of the adult grade sheep would have any commercial value.

With these objects in view the following types of foundation ewes were purchased; (1) Blackhead Persians (see Plate 15); (2) Namaquas (see Plate 16); (3) low-grade woolled Persians (see Plate 17); (4) high-grade woolled Persians (see Plate 18); (5) a few ewes graded from merinos by pure woolled Persian rams (see Plate 19).

Unfortunately we did not then possess the knowledge we now have about the relative values of A and B type rams, and the use of any pure-bred rams available has introduced some undesirable features into the first crosses, i.e. half-bred karakuls, in the first two years of the experiment. Since then only high quality A-type rams have been used,

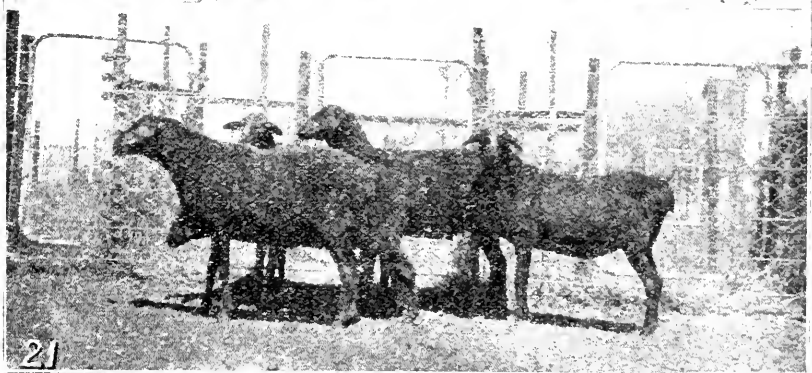
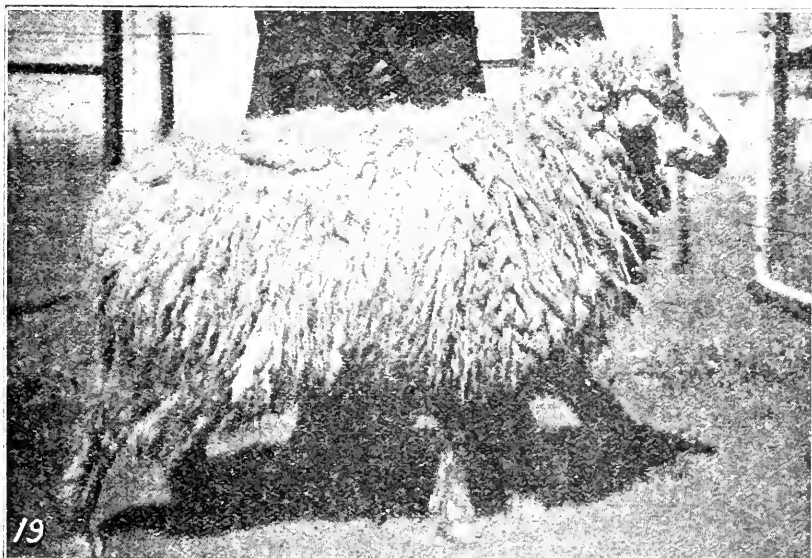

PLATE 19.—Grade Woolled Persian Merino Foundation Ewe. (Photo by Author.)

PLATE 20.—Second cross Karakul Black Headed Persian Lamb. (Photo by

Author.) PLATE 21.—(Group of first cross Karakul Black Headed Persian Yearling Ewes. (Photo by Author.)

The first-grade lambs born showed the following results: The best stapled and curl pelt lambs were obtained from the low-grade woolled Persian ewes, due, doubtless, to the length of staple of these ewes. The next best were from Namaquas, and the third from black-head Persians. The half-bred Namaqua-karakuls had better lustre due to the softness of the dam's covering, while that of the kempy black-head Persians was not as good. The high-grade woolled Persian ewes all dropped either white lambs with black points, or black "nigger" curl lambs, while the grade Persian-merinos all had "nigger" curl lambs. By far the greater majority of the first-cross lambs were black or piebald. In the Namaqua crosses the characteristics of the karakul were much more plainly stamped than in the black-head Persian crosses. In this latter breed the lambs are in physique exceedingly like their dams, but are bigger, and black instead of white. The shape of the head is much more that of the dam's breed, and even in the second cross this is usually the case (see Plate 20). The first cross from woolled Persians are very like the pure karakul in both body and head, due to this sheep being very similar to karakuls in conformation. The resemblance to the pure karakul is even more marked when these crosses are full-grown, when they can easily be mistaken for pure-bred karakuls at a casual glance.

The three-quarter bred or second-cross grades show that the Namaquas or black-head Persians are must better as foundation stock for pelt-breeding than the other more woolly breeds, although some of the lambs from the low grade Persians have pelts quite equal to those of woolly pure-bred karakul lambs. There are indications, however, that the black-head Persians are better than the Namaquas, and the conformation of these sheep is also better than the latter breed. Plate 21 shows a group of first-cross karakul-black-head Persian ewes just cutting their first permanent incisors.

It would, therefore, appear that the black-head Persian ewes are the best of the breeds, tried to date, to use as foundation stock for grading up lambs with fur pelts. As Mr. Thompson has already dealt with how to set about building up a flock, there is no occasion to add anything on that subject, except that our experience leads us to recommend the use of A-type rams only, and that tightness of curl can well be left until quality of hair and lustre are thoroughly established in a flock. If it is found that good prices are not obtained, due to lack in tightness of curl, while quality and lustre are being established, the male lambs should be castrated and sold as slaughterstock in the usual way. Later, when the curl is tighter, still through the use of tight A rams, the high prices will come, and by that time the breeder will have sufficient experience to know whether he can risk using a good AB ram to tighten the curl yet more. In the meantime the investigations at Grootfontein and Otjituesu will have yielded some definite results, which will also be at the disposal of the breeder.

A breed with which grading experiments have not yet been made, but which appear in many respects the most likely for the production of pelts of high value, is the "ronderib Africander," and it is hoped to obtain sufficient ewes of this breed very shortly to commence an investigation into their possibilities as foundation stock.

When we come to the second portion of the investigation, namely, the influence of karakul sires in producing offspring which mature quickly and which show an appreciable increase in weight over their

dams, we have very encouraging results. To make this investigation complete the flocks used should have been double the size, so that half the ewes of each breed could have been put to karakul rams, and the other half to rams of their own breed, and all the lambs dropped should have been raised under the same conditions. It was, however, impossible to obtain permission to do this, although it is still hoped that now that sufficient first-cross lambs have been obtained from the foundation ewes, permission will be granted to mate these ewes to rams of their own breed. These lambs should, on the same veld, give some valuable information on the points required.

All the weights given below were taken in February, 1919, after a dry spring and summer, and none of the sheep had had any additional feeding. The weights refer to half-bred or first crosses only, i.e. the progeny of foundation ewes put to pure-bred karakul rams, except where otherwise stated. The foundation ewes, i.e. the dams of the cross-breeds, were all, at the time of weighing, ewes having six or eight permanent incisors. The average weights were as follows:

*Foundation ewes—*

(1) Grade woolled Persians from merinos ... ..	84½ lb.
(2) Grade woolled Persians ... ..	86½ lb.
(3) Pure-bred black-head Persians... ..	74 lb.
(4) Pure-bred Namaquas ... ..	78 lb.

*Pure karakul and grade lambs 4½-5½ months old—*

PURE KARAKULS.		WOOLLED PERSIANS.		B. H. PERSIANS.		NAMAQUAS.	
Ewes.	Wethers.	Ewes.	Wethers.	Ewes.	Wethers.	Ewes.	Wethers.
51 lb.	56 lb.	58 lb.	62½ lb.	56½ lb.	57½ lb.	63 lb.	56 lb.

*Average weights at changing teeth—*

69 lb.	87½ lb.	No sheep.	73 lb.	64½ lb.	64 lb.	64½ lb.	69 lb.
--------	---------	-----------	--------	---------	--------	---------	--------

*Average weights two permanent incisors—*

98 lb.	103 lb.	89½ lb.	None.	88¾ lb.	None.	83 lb.	None.
--------	---------	---------	-------	---------	-------	--------	-------

It will be seen from the above weights that in every case the average weight of the first-grade sheep at two teeth up was greater than that of their dams as fully grown sheep.

No information as to the value of the adult fleece of the first grade is at present available. As will be seen in Plate 21 even the first-cross progeny from the kempy black-head Persian have quite decent coverings, and in the case of the other classes of grades this covering is longer and of better texture.

---

X.

---

TRADE IN KARAKUL SKINS.

The following is taken from an earlier bulletin on karakul sheep by Mr. Alex. Holm: "Much interesting information with regard to the trade in, and value of, karakul skins is given in the report made

by M. Karapov to the Russian Government. This report has been translated and published by the Union Department of Agriculture (Bulletin No. 17 of 1914). It states that from the Khanate of Bokhara there are exported from one and one-fifth to one and a half million skins per annum, valued at nearly £1,000,000, and that there has been a steady advance in price for many years past. About fifteen years ago the highest price was 8 roubles (about 16s.) per skin, and it is stated that in recent years this price has been almost doubled. During his visit to Bokhara in 1910, the best ram-skins were sold at about 24s. each. Dealing with the trade in 'hundreds of thousands of pieces to the value of millions of roubles' (note, a rouble about 2s.) he gives the following average prices:

1895	...	...	...	3.91 roubles (about 8s.).
1902	...	...	...	6.63 roubles (about 13s. 3d.).
1909	...	...	...	8.70 roubles (about 16s. 9d.).

"In this way the price has risen by 70 per cent. in the first eight years, and by 31 per cent. in the second eight years, or by 122.5 per cent. in the whole period of fifteen years. Add to this the rise since 1909, which amounts to 25 to 30 per cent., and we have, in comparison with 1895 a total rise of 180 per cent. These prices refer to raw undyed skins. The chief markets for their sale are Nijni-Novgorod and Moscow. At the former it would appear that about one million skins are sold annually, of a value over £500,000. Before being manufactured into garments the skins are tanned and dyed. The dyeing process has been chiefly done at Leipzig, from which the skins are exported largely to Russia. Leipzig handled annually about 385,000 skins, valued at six million marks (£300,000), or an average of 16s. per skin."

Since the above bulletin was written there has been a further increase in the prices paid for skins. This is due to several causes, such as the large amount of money spent by munition and other war workers in England and France, the shutting out of Bokhara from the European markets, etc. That country, however, is still the scene of severe fighting, and the fur-bearing flocks are probably greatly decreased in number, and this is also the case in Bessarabia. Further, the natives of Bokhara have for years past been slaughtering their best lambs for the sake of the prices obtained, and they have never bred karakuls on scientific lines or even taken any precautions against in-breeding or contamination with foreign blood. There has, of course, been no attempt made at any method of mating. We have thus in South Africa every chance of building up an industry in these pelts which will put it ahead of any other country, especially as our native sheep, and others readily obtained, are splendidly suited for grading up flocks for the production of pelts of high value.

In order to obtain some idea of what could be expected for grade karakul pelts, a small consignment of twenty skins was sent to London to the Trades Commissioner, who submitted them for valuation to Messrs. Martin & Sons, Ltd., 68 Upper Thames Street, London, E.C. Unfortunately the pelts were shipped on the "Kenilworth Castle" on her ill-fated voyage, and the pelts were consequently considerably damaged by salt water. In their report Messrs. Martin & Sons, Ltd., stated that in valuing the pelts they had, as far as possible, regarded them as if undamaged. Grade pelts of all classes were sent, even

although we knew that some were very inferior, and the values placed on them were clear proof that the opinions formed as to what constituted good pelts were correct. These valuations varied from 1s. to £2. 10s. per skin. The two skins valued at 50s. each were from seven-eighth karakul lambs, i.e. the third-cross karakuls on Africander foundation ewes.

As many pelts, far superior to those sent, are obtained every year in the Government pure-bred flocks, it can safely be assumed that £3 each could be readily obtained for pelts of good quality. At the above valuations the pelt of a lamb as described in Plate 10 is worth at least £4 to £4. 10s.

With reference to the actual marketing of skins, nothing definite can be said at present, except that the market exists, and that breeders, by communicating with the firm mentioned above, can make their own arrangements. The Department of Agriculture is at present inquiring into this matter, and the result of these inquiries will be made known in due course. We may add that in 1917 we saw the report on some skins sent from South-West Africa to the United States of America. The skins were purchased by the firm to whom they were sent at prices varying between 16s. and 23s. each, and an order was placed for 4000 skins of the same quality. Some skins, somewhat superior to those sent to the United States of America, and supplied by the same breeder, were sent to London in the consignment mentioned above, and were valued as high as 30s. each. These skins were all seven-eighth karakul.

#### GENERAL.

Breeders of karakul sheep will be interested to learn that at the conclusion of the annual stock sale at the Grootfontein School of Agriculture, held on 5th September, 1919, a meeting of owners of pure-bred karakuls was held. Mr. Alex. Holm, the Under-Secretary for Agriculture, to whose energy the Union owes the introduction of this breed of sheep, presided. At the request of the meeting Mr. Holm promised to bring before the Council of the South African Stud Book Association the desirability of providing for the registration of *pure-bred* karakul sheep. That is sheep whose parents on both sides can be traced back, without the introduction of any foreign blood, to the original importations into South-West Africa. At the time of writing no further information is available on this subject, but there is little doubt that such a register will be opened, as it is most imperative, if only for the protection of owners of pure-bred stock. Many grade karakuls appear to have been disposed of already as pure-bred stock, and intending purchasers are warned against the great danger of purchasing alleged pure-bred karakuls without making certain that they are absolutely pure-bred.

A certain number of pure-bred karakuls, both rams and ewes, will in future be offered annually at the sale at Grootfontein, and it is only at this sale that Government-bred sheep can be obtained, always excepting any other sales arranged by the Administration of the South-West Protectorate, of pure-bred stock of their breeding.

Inquiries from breeders in the Union relative to these sheep should be addressed to the Principal, Grootfontein School of Agriculture, Middelburg, Cape.

### CONCLUSION.

While the writer is aware that much has been left unsaid, it is hoped that this article will be of use to those breeding either pure karakuls or grades.

Where merino sheep thrive it would be a great pity to displace them with karakuls or any other breed of sheep, but for the large areas which at present support only "bastard" sheep, or which have much "stekgras," or are areas liable to outbreaks of "bloodpens" or to prolonged droughts, there is no sheep equal to the karakul, and farmers would do well to give this magnificent breed a trial.

---

### Peanut Growing.

Many inquiries on peanut growing are received and the following few points are given as a guide to those who contemplate going in for the crop.

One of the most important points is the selection of seed. Farmers should see that the seed is uniform, as it often happens that the planting of a miscellaneous collection of seed means an indifferent stand and results in a poor yield. It is the general practice to use shelled nuts for planting, although equally good results have been obtained by planting unshelled seed 3 to 3½ feet apart. Peanuts can be grown on almost any soil containing a fair proportion of lime, but it is advisable to plant, if possible, on a sandy loam soil; about 28 to 30 lb. per acre is required. It is very necessary to plant the seed early in the summer, as it takes fully five months to mature, and is rather sensitive to frost. As a soil renovator the peanut is rich in nitrogen and contains a considerable amount of phosphoric acid and potash, comparing favourably with the constituents of cotton seed, and as a fertilizer the vines are nearly as valuable as the cowpea itself.

The peanut is fast becoming a staple commodity. Already large quantities are being used as roasted nuts for eating and other purposes. Peanut butter is being recognized as an excellent substitute for ordinary butter. It is also used largely in the manufacture of soap, and contains a most valuable oil, for which there is a large demand.

---

### Fencing Materials.

The Department has no fencing materials for disposal, but owners of farms or lessees or allottees from the Government with the option of purchase, can obtain loans from the Land Bank, in terms of Section 3 of the Fencing Act, No. 17 of 1912, for the purpose of purchasing materials to fence the outside boundary lines of their holdings and to cover the other costs incidental thereto. Such loans are repayable by annual instalments over a period of 10 years, bearing interest at the rate of 4 per cent. Further particulars and application forms are obtainable from every magistrate or direct from the General Manager of the Land Bank, Pretoria.



## THE DEPARTMENT OF AGRICULTURE DURING THE WAR.

[This article, which commenced in the May, 1920, issue, and is concluded in this, briefly reviews the work carried out by the various branches of the Department during the years of the war, and records some achievements despite the many difficulties encountered through the abnormal conditions then existing.—ACTING EDITOR.]

### AGRICULTURAL EDUCATION.

THE foregoing outline of the work carried out by the various divisions of the Department does not deal with that important part of its activities known as "agricultural education," details of which are published in its annual reports. The functions falling under this branch of the Department are many, including the teaching and training of students at the five agricultural schools and experiment stations, agricultural research, experiments and investigations, extension work, lectures and demonstrations, improvement and management of stock and crops, etc. Agricultural education, therefore, is concerned with a large number of measures taken to improve our knowledge of the agricultural conditions of the country and the dissemination of that knowledge among the farming population. The staff at the agricultural schools and experiment stations collaborate and co-operate with the officers of the different divisions at headquarters (referred to earlier in this article) engaged in research and investigational work. The combined effort is bearing fruit in an increase of our knowledge of agricultural conditions, practice, and problems, as witnessed in the position of agriculture to-day compared with not so many years ago. It is not possible to include in this article all the many and diverse matters which were dealt with by the agricultural education section, with its five agricultural schools and experiment stations (each in itself a miniature department of agriculture for the area relegated to its sphere of operations), and brief reference only will be made of certain main subjects, common to all the institutions, which came under purview during the time of the war.

As has been referred to in connection with other divisions the outbreak of war, with its trail of consequences such as staff shortage and financial stringency, was the cause of arresting to a large extent the steady forward progress of agricultural education. Nevertheless, in the face of many difficulties, the work accomplished in 1914-15 and since has brought many benefits to the farmer, who has come to rely more and more on the services of Government officials. The number of students in residence at the various schools was affected by the large number which left to join the military forces, as clearly shown in the following table, viz.:—

#### *Attendance in Regular Courses.*

	No.		No.
1914 ... ..	205	1917 ... ..	109
1915 ... ..	104	1918 ... ..	126
1916 ... ..	130		

The staffs of the different schools were strengthened from time to time by the appointment of a number of Government students who had completed their studies abroad, but the country is so vast and the demands so great that many more additions are necessary. It is interesting to note here that forty-five scholarships for study oversea have been granted since Union, previous to which thirty-three had been granted. Thirty-two returned scholars are in Government service, thirty are still engaged in studying; eleven others, who were appointed to posts, have left the service.

The suspension of the *Agricultural Journal* at this time meant that effective publication could not be given to the work of the officers of the Department. However, during 1914-15 twenty-three articles dealing with agriculture and agricultural science, and giving the results of experiment and research work, were published, and by other means also the public was kept informed of the work being done at the schools. In addition to work at the schools 190 lectures and demonstrations at various centres, attended in all by 7000 people, were given; fifty-two agricultural shows were assisted in connection with judging, and an exhibit portraying agricultural educational activity was sent to eleven of them; 440 farms and poultry yards were visited for purposes of giving advice; and 8000 letters of an advisory nature were written. There were six different courses in operation during the year embracing a wide range of subjects and attended by the various grades of students for which they were intended. In 1915 there were 104 students at the schools, and in addition 136 men and 81 women attended the short courses.

A great deal of experimental work was carried out on the experiment farms attached to each school, the results being published, and progress was made in conducting co-operative experiments either with farmers on their own farms or in conjunction with agricultural societies. Apart from the ordinary variety trials and manurial experiments upon different crops, notable results were obtained in chemical investigations in the tannin contents of wattle bark, feeding experiments concerning the production of beef, ostrich breeding and management, life histories of insect pests and methods of control, plant breeding, etc.

Arrangements were made for the chemical analyses for farmers of agricultural soils, manures, feeding stuffs, etc., and 617 such analyses were completed during the year. Also 99 samples of milk and cream were tested for butter-fat contents. Five sub-experiment stations and stud farms were closed down and their activities transferred to the agricultural schools. The different breeds and numbers of pure-bred stock to be maintained at each agricultural school were decided upon, all surplus stock being disposed of during the year.

Development in regard to buildings and implements was arrested by the war, but a number of minor works were carried out by the staff of the schools concerned.

While the conditions set up by the war continued to exert a disturbing influence upon the agricultural schools and experiment stations, it was possible nevertheless to carry on with much useful work, and during the year 1915-16 members of the staff of the schools gave 301 lectures and demonstrations attended by 9684 people, visited 1019 farms, were in attendance at 121 agricultural shows (at certain of which carefully prepared educational exhibits were placed and live

stock representative of various breeds exhibited, and disposed of 9621 inquiries by correspondence, and the Lecturer in Household Science carried out very useful extension work. In addition to the instruction given the 130 students at the schools, the short courses proved to be very popular and were attended by 185 men and women, the attendance increasing to 300 during the next two years. Conferences on poultry-keeping, wheat growing, and other subjects, and likewise the annual stock sales, were well attended, while large numbers of farmers visited the various institutions.

A number of bulletins were published and articles written for the Press, and despite the depletion of the staffs some very interesting investigations were conducted, also a great many experiments and demonstrations with crops, manures, animal feeding, etc., and a large number of analyses of soils, fertilizers, foodstuffs, etc., were undertaken for farmers.

The sales of surplus stock during the year realized £7304, and arrangements made for the use of stallions at the institutions were availed of to the extent of 149 mares. The total area of land under cultivation to provide for the live stock maintained and to enable a proper training (suitable for South African conditions) to be given to students was 2810 acres.

In like manner, though hampered and retarded by the war and the shortage of staff, the many and various branches of work were continued during the ensuing years (1916-17 and 1917-18). An indication of what was accomplished in certain directions is given in the following figures:—

Year.	Inquiries replied to.	Lectures and Demonstrations given.	Attendance at Lectures, etc.	Shows Attended.	Visits to Farmers.
1916-17 ...	10,981	316	13,602	120	914
1917-18 ...	11,377	389	15,461	144	889

The amount of research and experimental work, analyses and reports for farmers, itinerant instruction, etc., continued to increase, the demands on the services of the staff showing a growing appreciation by farmers of the value to be derived from the agricultural schools in the many directions in which practical help was forthcoming from them. Statistics show that during the past five years 100,000 persons received advice and assistance from the schools either by means of lectures, correspondence, or visits.

During the two years ended 31st March, 1918, ninety-seven articles were written by the staff. The arrangements for the use of stud stallions were continued and largely availed of; the sales of pure-bred stock realized £11,882 in 1916, £17,399 in 1917, and in 1918 reached £28,251. 16s. 9d.; and the area maintained under cultivation was approximately 3120 acres.

Altogether, evidence was abundant of the influence and value of the agricultural schools and experiment farms connected with them in the agricultural life of the country. The gratifying progress made in agriculture and stock breeding was undoubtedly assisted by the officers of agricultural education, who took an active and leading part therein, and had the war not set up many obstacles and difficulties it is certain that the Department's activities would have extended considerably further and have contributed in no small degree to the greater development of scientific agriculture in the Union.

## THE TOLL OF THE WAR.

In an article entitled "The Department of Agriculture during the War," which appeared in the May, 1920, and subsequent issues of the *Journal*, and is concluded in this issue, a short review is given of the work carried out by the various branches of the Department during the stress of the war.

We wish, also, specially to record the number of officers of the Department who were on military service in various capacities during the war, and to name those who lost their lives in the fulfilment of their duty.

1. Total number on active service: Agriculture, 253; Agricultural Education, 55; total, 308.

2. The following particulars are given of those who lost their lives:—

Name.	Post.	Period.	Rank and Unit.	Theatre.
Brenchley, J. M.C.	Clerical Assistant	Oct., 1914-July, 1915; Sep., 1916-Oct., 1917	Tpr. 1st Mounted Rifles; 2nd Lieutenant Coldstream Guards	South-West Africa; France.
De Villiers, D. J.	Sheep Inspector	Oct., 1914-Nov., 1914	Comdt. Col. Mentz's Column	Rebellion.
Howell, S.	Clerical Assistant	Aug., 1914-June, 1915; March, 1916-Oct., 1916	Pte. 1st Eastern Rifles; Pte. 1st S.A.I.	Rebellion; South-West Africa; Europe.
Kinlay, J. A.	Clerk	August, 1915-July, 1916	Pte. 4th S.A.I.	Europe.
Lambert, M.	Stock Inspector	Oct., 1914-Jan., 1915; Jan., 1915-May, 1915; Oct., 1916-April, 1917	Tpr. Southern Rifles; Pte. Hartigan's Horse; Pte. 2nd S.A.I.	South-West Africa; Do.; Europe.
Lundie, W. A.	Clerical Assistant	Aug., 1914-Aug., 1915; Sep., 1915-July, 1916	Pte. 12th Pretoria Regt.; Pte. 3rd S.A.I.	German East Africa; Europe.
Payer, F. Y.	Stock Inspector	Sep., 1916-Nov., 1916; Nov., 1916-Oct., 1917	Tpr. 2nd Mounted Brigade; Gunner S.A.H.A.	German East Africa; Europe.
Parsons, C. B.	Assistant Horticulturist, Elsenberg School of Agriculture	Dec., 1914-July, 1916	Pte. D.E.O.R.; Lieut. 1st S.A.I.	Rebellion; South-West Africa; France.
Serooby, M. J.	Stockman, Veterinary Research Division	July, 1917-Dec., 1918	Driver S.A.S.C. (M.T.)	German East Africa.
Shaw, C. M. G.	Sheep Inspector	Aug., 1915-Sep., 1917	Pte. 4th S.A.I. Brigade	Europe.
Sunshine, A. J.	Stock Inspector	Sep., 1916-Nov., 1916; Nov., 1916-Sept., 1917	Tpr. S.A.H. (M.G. Section); Pte. 2nd S.A.I. Brigade	German East Africa; Europe.
Vipond, H. J.	Chief Chemist	July, 1915-Feb., 1917	Pte. Coldstream Guards	France.
Worsley, J. A.	Govt. Veterinary Officer	August, 1914	Capt. S.A.M.R.	South-West Africa.

---

## THE SPINOSE EAR-TICK.

---

### Practical Suggestions for Suppression.

---

By COLIN STORY, Baddatord, Fort Beaufort.

---

*Reprinted from the Farmer's Weekly, 10th December, 1919, p. 1977, with comments by C. P. Lounsbury, Chief, Division of Entomology, Department of Agriculture.*

---

WHILE spending some time in the Aliwal North District last year the writer amused himself with the study of the spinose ear-tick, a comparatively recent introduction into this country and a most obnoxious stock pest. As this tick and its habits are not so widely known as our common cattle ticks the following notes may be of interest:—

The spinose ear-tick must not be confused with the red tick, whose first two stages are passed in the ears of cattle. It takes its names from minute bristles, or spines, which cover the body when a nymph, the form most familiar to those who know the tick. (For those who have forgotten, a tick's life is divided into three stages—the larval, the nymphal, and the adult). The tick is unlike other cattle ticks in that there is no shield on the back. It resembles the tampan in appearance, and has its mouth parts on the underside of the body at the extreme forward end. It is found on cattle and sheep, and less commonly on other domestic animals; its feeding ground is the ear only and nowhere else.\* Boys who come much in contact with cattle and the cattle kraal are also liable to infection, and during my short experience with the tick two young natives had to be treated. The tick causes considerable discomfort within the ear and may be so deep seated as to be out of sight. If not suspected, the pain and subsequent abscess would be difficult to account for. The larva being extremely small and greyish-white in colour can easily gain access to the ear unnoticed and unfelt, and it may be several days before its presence is suspected.

---

\* Mr. Story has since learned that an occasional specimen attaches and feeds on the skin, at least in the case of woolled sheep. When visiting a Colesburg District farm, he found in two instances a nearly full-grown nymph to be the cause of a sheep biting at its side as if irritated. His examination disclosed no swelling where the tick was attached but the presence of excrement in the surrounding wool indicated that the specimen had been located for some time where it was found.—C. P. L.

## WHERE INFECTION LIES.

As in appearance, so in life-history, the spinose ear-tick is different from all other cattle ticks. It is a pest of the kraal and the veld much more than the stable. Where the tick has lately made its appearance the milk cows in the kraal, particularly if they sleep there, may be heavily infested while the dry cattle in the veld are clean, a fact no doubt due to a peculiarity in the life-cycle of the tick to be later noted. The females are said to lay their eggs in cracks and crevices of fencing posts, in stone walls, and under stones in the veld. Personally, however, the writer was not successful in finding adult ticks in any of these places. The favourite place would appear to be the loose, dry manure which fills the spaces between the stones at the bottom of the kraal wall and some distance in—six to nine inches. Here numerous adults, male and female, were found, and large numbers of newly hatched larvae. These are remarkably active six-legged little creatures, and resemble the colour of their surroundings so much that they are hard to find. They are present in greatest numbers close to the base of the wall, and rapidly diminish in numbers with each yard of distance from the wall. The farthest distance from home where odd larvae were seen was six yards. Like "seed" ticks in the veld, the ear-tick larvae become greatly agitated and extraordinarily active on the approach of a host and move relatively at a great rate. Any one standing for a minute or less within the precincts of a colony will notice on close observation ticks making towards him from all directions. Cows and calves lying near the walls of an infected kraal are practically certain to have a number of larvae in their ears next day, although they will not be seen for several days, when the ticks are partially engorged.

## STAGES OF DEVELOPMENT.

In the case of a sheep that was infected for experimental purposes larvae took from six to ten days to get through the moult. The fed larva before moulting is milk-white in colour; a few are bright pink. The legs cannot be distinguished unless under low power of the microscope, neither is any movement to be seen; the fed larva has about eight times the bulk of the unfed form. The emerging nymph is somewhat leggy, wrinkled, and thick skinned, the latter allowing for abundant expansion and the former providing for the easy transport of a very much bulkier body. This is now the unfed form of the familiar spinose ear-tick, although it would never appear so, so great is the difference in size between the newly moulted and the fully fed forms. Without leaving the ears the nymph settle down to feed again, and in the case under observation all the ticks had left the ears in thirty-six days. This feeding period varies greatly, however; according to Mr. Bedford, of the Division of Veterinary Research, it varies from one week to three months. The nymphs moult in about three weeks—this time also varies—and in another four weeks females may be seen laying eggs. When the nymphs leave the ears they do not return to a host again, but, crawling to some sheltered spot, they moult and pair without further nourishment. The adult ticks are the same size as the fed nymphs, and differ in having a minutely pitted skin and no spines. They also show genital orifices, which are absent in the nymphal forms.

## THE ONLY REMEDY.

The ear-tick is a difficult tick to kill. Tank dipping does not affect it, as its feeding ground within the ear is beyond the reach of the dip. Cattle must be caught and the ears hand-dressed. Ordinary dips are not satisfactory, as the tick has extraordinary resisting powers. Petrol has no effect on them, and pure paraffin kills only on the second day, and sometimes not even then. The mixture recommended by Mr. Bedford—Stockholm tar, oil (any kind), and turpentine, 2: 2: 1—is an excellent killer, but care must be taken not to smear the hair in the ear, otherwise when the ear is flapped the mixture reaches the eye and causes rather severe irritation. Cooper's have a special preparation for the spinose ear-tick which has been found most satisfactory. It is a thin fluid mixture which soon dries, and therefore does not gain access to the eyes. As the tick leaves its host a sexless nymph there is not the same chance of males and females meeting in the open veld as there is in the kraal. This, together with the fact that larvae do not appear able to survive five months' starvation, doubtless accounts for the mild veld infection. The source of serious infection is therefore the kraal and cow-stable, and cattle can be used in those places as a means of getting rid of the tick. It is not feasible to exterminate the tick by burning or spraying, as the moulting nymphs and laying females are protected by the kraal wall and by a covering of kraal manure.

## HOW TO CLEAN A FARM.

Infected kraals and cattle may be cleaned by systematic ear-dressing, say, once a fortnight. The cattle attract the larvae, and provided every beast in the kraal is treated with an effective mixture few ticks can escape. The wash should be allowed to run well down into the ear, and the ear worked with the hand as the tick is very deep-seated and many of them far out of sight. In post-mortem cases many ticks were found in places that could only be reached by cutting to the extreme base of the external ear, and in one instance on opening the ear to the osseous tube, which projects from the skull, one or two nymphs were found within it. In heavily infected kraals cows and calves will be found to have the hollows and grooves of the ear, and also the passage to the middle ear, packed with ticks in all stages from newly attached larvae to large mature nymphs. The ear presents a very dirty and messy appearance, due to discharges from the bitten places, together with numerous moulted skins, and it is difficult at first glance to distinguish any but the larger nymphs. Fed larvae, owing to their whiteness, their invisible legs, and their immobility, are sometimes mistaken for eggs, while the fed nymphs are taken for females. Young calves up to three months suffer most from the ear-tick. Its bite seems to be highly poisonous, resulting in swellings at the base of the ear, at the point of the jaw, and in the throat. There is often a copious discharge from the ear, and the calf rapidly goes off condition, ceases to feed, and ultimately dies. On one farm where the ear-tick had only recently made its appearance the owner lost eight calves in as many weeks. In every case abscesses were present. Before the advent of the tick a calf dying from disease was practically unknown. After one or two fortnightly dressings the cows and calves were entirely free from nymphs, the swelling began

to disappear, and the animals returned to normal condition. There is no doubt if this treatment were kept up it would not be long before the ticks were so reduced as to be of little account.

#### PRECAUTIONS NECESSARY.

Farmers bringing cattle from a known ear-tick area to a clean district should have all animals hand-dressed immediately before leaving, whether ticks are evident or not, and in case some ticks may still be present on arrival at their destination it would be advisable to hand-dress again at least once and to keep the animals under observation for a week or two. A great risk of introducing this tick to a clean area lies in the fact that the tick may quite commonly be present and its presence impossible to detect. Apparently clean ears are no guarantee that ticks are not present.

#### Comments by C. P. Lounsbury.

The writer of the foregoing article, Mr. Colin Story, is a graduate of the Elsenburg School of Agriculture, and was an officer of the Department of Agriculture for a number of years before he took up farming about 1906. When with the Department he was concerned with stock dipping experiments for the destruction of ticks, and in the years that have intervened he has maintained his old interest in ticks. It was therefore but natural that when considerations for health necessitated his leading a rather inactive outdoor life in the Aliwal North District for several months he should divert himself with a study of the ear-tick, a species new in his experience. He had no account of the tick by any previous student to influence his observations, and hence his conclusions are quite unbiassed and those of a practical farmer with an unusually sound general knowledge of ticks. Later he received from me a copy of Mr. G. A. H. Bedford's paper which was published as Local Series Bulletin No. 18 of the Department of Agriculture. Believing that a simple, straight forward article on the ear-tick, such as he would write, would find particular favour with the farmers of the country who have the misfortune to have the tick on their stock, I urged Mr. Story to write up his observations and get them published in the *Farmer's Weekly*. He acted on my advice, and now, with his permission, the article is here reproduced. The opportunity is taken to offer a few comments and to draw attention to points on which Mr. Story's observations are not fully in accord with the statements given in the leading American account of the tick (U.S.D.A. Bur. Ent. Bull. 106).

*Relation to Other Kinds of Ticks.*—The common stock-intesting ticks, that is the bont, bont-leg, blue, red, brown, Cape brown, black-pitted, and russet ticks, are all *Ixodid* ticks, and have many features in common not found in the spinose ear-tick. The latter is an *Argasid* tick along with the true tampan that attacks man, the fowl-tick (often called tampan), the bat-tick, and the penguin-tick. The *Argasid* ticks all lack the firm, non-stretching "shield" present on the back



of all the Ixodid ticks and have tougher, more leathery, skins. They vary in their feeding habits much more than do the Ixodid ticks, all of which, so far as known, have three active life-stages—larval, nymphal, and adult—during each of which they attack the animal. The spinose ear-tick also has three active stages, and only three apparently, but the adult stage does not take food. The true tampan has six active stages, but it does not take nourishment in the first, while the fowl-tick has four and attacks the host in all of them. In appearance the adult spinose ear-tick most resembles the true tampan, but it is distinguished by a slight constriction of its body behind the middle which has led to it being called fiddle (violin) shaped. The nymph, the stage most commonly seen, is the only tick, so far as known, that has a spiny skin.

Many kinds of ticks attach themselves to the ears of animals, but the larvae and nymphs of the spinose ear-tick and the larvae and nymphs of the red tick are the only kinds, in South Africa at least, known to attach deep in the ear. The red tick is one of the most widely distributed ticks in the country. Its young are quite common in the ears of farm stock; in fact they seem to feed almost exclusively there, but they are not known to cause serious distress, and their similarity in appearance to the common blue cattle-tick is sufficient to enable farmers to distinguish them from the very different spinose ear-ticks.

*Hiding Places of Adult Ticks.*—Mr. Story's observations that the favourite place for the females to lay in "would appear to be the loose dry manure which fills the spaces between the stones at the bottom of the kraal wall" may be thought somewhat difficult to reconcile with the American statement that the ticks "crawl up several feet from the ground and secrete themselves in cracks and crevices of the boards and timbers near the mangers, in the bark of trees, etc." But Mr. Story's conclusions in this connection are probably quite correct for the ordinary South African conditions. The ticks evidently have no need to crawl high, and are well content to come to rest in loose dry dung, filling a dark hole near the ground level. Such situations are generally readily available in kraals, calf-sheds, and the like. Mr. J. C. Faure, of the Division, in January of the present year spent a couple of days at a Kimberley District farm in studying the habits of the species in the light of Mr. Story's observations. At this farm there is a cow kraal with a connecting calf kraal and a connecting milking-shed. The walls are of rough stones set in dagga (puddled mud), and only the milking-shed is roofed. In the shed there are partitions to keep the cows separated, each formed of a few upright and a few horizontal eucalyptus poles, from which the most of the bark has been removed. The poles have cracked deeply in drying and thus afford numerous crevices in which ticks may secrete themselves. A considerable number of the ticks were dug out of holes in the wall both of the open calf-shed and of the covered milking-shed, the majority at or close to the surface level and sheltered in the pulverized manure that had accumulated there. Several were found in two crevices about two feet up from the ground. None was found higher, yet there may have been some out of reach or in holes that were not probed. But hours spent in probing the cracks in the partition poles in the covered shed disclosed about twenty adults, many nymphal skins, and egg shells from ten inches

to six feet above the ground and more or less hidden in dust, old cobwebs, etc. Many more were found in the vertical poles than in the horizontal ones. About a dozen adults and nymphs were also found in deep dust amongst the cobble stones of the floor of the shed under feeding-boxes suspended about three inches above the floor. A long search under stones in the part of the extensive calf pasture nearest to the kraals, and where the animals appeared to congregate most when at liberty, failed to reveal even a single tick: but five adults were found in the dust beneath a corrugated-iron water-trough in this enclosure several hundred yards distant from the kraal, and twelve more were found in the dust underneath a salt-trough, although none under near-by stones. Similarly no trace of the pest was found under stones in the adjoining camp for grown cattle, but the first scratch in the dust under a water-trough there brought an adult to light, while another adult was found beneath a salt-trough.

*How do the Sced Ticks get to Stock?*—Larvæ of all kinds of Ixodid ticks, so far as known, cluster on the grass or on other support, generally at the tip of a projection, and there wait for an animal to brush them off in passing by the place. Only a slight disturbance is required to excite them and to cause them to stretch out their front legs in readiness to scramble on to an animal. The American account of the ear-tick seems to suggest that it behaves in much the same way, for after telling that adults, eggs, and larvæ are found several feet above the ground it goes on to say:—"Such a habit is of advantage to the larvæ in finding their way to the ears of the host, as cattle using infested stalls or rubbing against infested trees and fences undoubtedly pick up large numbers." Mr. Story's observations, on the contrary, are to the effect that the larva crawls to the animal. Mr. Faure's observations at the Kimberley farm are in keeping with Mr. Story's, except that he was unable to notice the larvæ "making towards him from all directions." Mr. Faure, however, did not find a great number of eggs and larvæ, and it may be that he was rather early in the season to see them in greatest abundance. Mr. Story studied the tick chiefly in March. Mr. Faure saw only a few of the larvæ on the ground or elsewhere than at places where he raked out adults. Half an hour's watch of the ground in the milking-shed brought only three to his sight. One of the three was walking away from him, but when he laid a finger on the ground about an inch behind it it turned back and crawled on to his hand. The other two were only six to nine inches off when first seen, and they were moving away: he put his hand down an inch or so behind one of them, but it kept its direction. At another place in the shed he got a weak calf to lie on the ground a foot or two out from the nearest poles, and he then watched closely for larval ticks for about an hour. During the period three larvæ were seen, and all three went straight to the calf and climbed on to it—one on to its tail and two on to its legs. They were soon lost to sight in the hair. When first seen these larvæ were, respectively, about eight, twelve, and eighteen inches away from the calf. At another time four were noticed on the ground near poles in the shed, and one of these was seen to move over the dry manure and dust about four feet in a few minutes; it seemed unaware that a potential host was near it, and merely walked around a finger placed in its way. Other larvæ were also observed wandering about aimlessly on the ground, and one was observed on

the back of a calf. The largest number of larvae seen together was under the salt-trough in the calf camp. These larvae were very active when disturbed, but they evinced no tendency to make for Mr. Faure nor to get on to his hand, which he put on the ground a few inches from them—they rather seemed to want to get out of the sunlight. It evidently does not take the larvae long to find the ears and to settle down to feed. One calf that was born about 8 o'clock in the morning was examined at 3 o'clock in the afternoon of the next day, and already ten larvae were seen to have started to feed in its ears.

*Longevity of the Tick.*—The unfed larvae appear to be short lived compared with the larvae of Ixodid ticks. Most of those hatched under casual observation at the Division's office have died within a month. In the American account alluded to it is stated that under favourable conditions they may live for eighty days, but there is reason to assume few live as long as that, while Ixodid larvae live far longer waiting for an animal. It follows that the chances are very much against the very small larvae succeeding in getting on to an animal in the open veld. Then while Ixodid ticks mate before they feed up and the females are therefore ready to lay eggs when they drop, the females of the ear-ticks must find mates off the animal, and hence the chances are heavily against the ear-ticks that are dropped in the open veld becoming mated. It is for these reasons that the ear-tick is far more common in kraaled stock than in animals that roam at large in the veld day and night.

The female ear-tick does not lay her eggs until she has mated, and she seems able to wait a very long time for a mate. Under date of 10th January, 1919, a nymphal tick taken from the ear of a man at Capetown was sent to the Division. In a few days it molted and proved to be a female. It was kept alone in a glass tube until 25th November, or for nearly eleven months after it would have mated had it had an opportunity. A male that had shed its nymphal skin on 20th November was then placed in the tube, and a few days later, on the 29th, the two ticks were seen to be together. Eight days later, 6th December, the female began busily to lay eggs. The American bulletin referred to above tells of one unmated female that remained alive for eighteen months. Mr. Faure has had one female live still longer. It was one of a number of specimens confined together in a small box, and it was seen to be alive twenty-two months from the time it was taken from the ear. Whether it mated and laid eggs or not is unknown. The ear-ticks do not lay all their eggs at once, another respect in which they differ radically from Ixodid ticks, but lay intermittently for months. The American bulletin states that one female, given a mate as soon as she had moulted the nymphal skin, did not finally cease laying until 191 days from the moult; she had spread the laying of her eggs over six months. These facts are of interest because they indicate how infection might be kept up on a farm even were remedial and preventive measures that effectively prevented the maturing of any ticks and the introduction of any fresh infection kept up for a full year or even nearly two years. A few treatments in summer, as recommended by Mr. Story, however, should show a marked diminution in the severity of the pest; and it stands to reason that in the construction of new kraals and sheds, and in the

reconstruction of old ones, the advantage there would be in having them as tick-proof as practicable should be given full consideration.

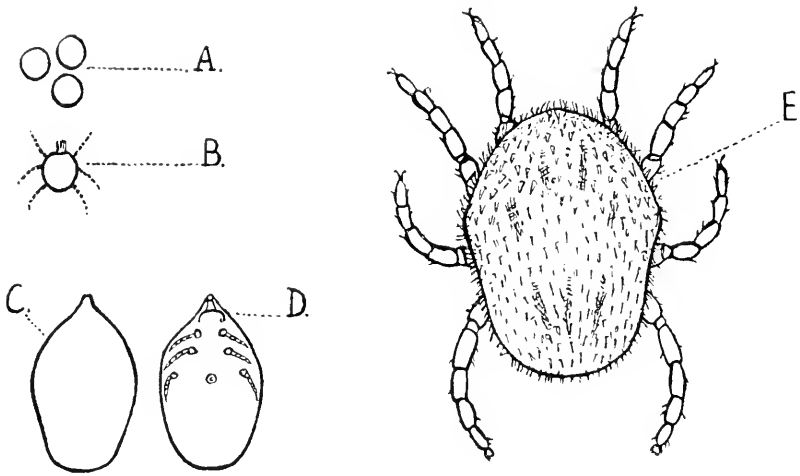

SPINOSE EAR-TICK.—A, eggs; B, the unfed six-footed larva that climbs on to the animal; C, D, the fed larva seen from above and the underside, which shows its legs; E, the fed nymph as it leaves the ear. All figures much more than life-size: the actual size of the fed nymph is about that of figure B.

### Orange Stocks used in California.

In a recent letter received by the Chief of the Division of Entomology from Washington the following information, on the authority of Professor A. D. Shamel, is given in regard to the source of the citrus seed used for the production of stock for budding oranges in California. It is to be noted that the kind of stock used almost exclusively, i.e. "sour" stock, has never been a success in South Africa. The paragraph reads:—

"The source of seed used for orange stocks for citrus in California is primarily the sour orange seed imported into California from Florida. We raise a small quantity of sour stock seed in California, but probably 99 per cent. of this seed used by nurserymen comes from Florida. We are now experimenting with some seed of the Seville orange which we secured from a Canadian marmalade manufacturing establishment which uses imported Spanish Seville oranges for making marmalade. It may be that source of supply will supplant that of Florida, because we have had great difficulty during the past year in securing adequate supplies of Florida seed. This condition has resulted in a shortage of stock in California at this time. In the past year about 100 bushels of Florida sour orange seed was received from Florida and planted in California. I remember that one year before the war 1000 bushels of Florida-grown stock seed was planted by citrus nurserymen in southern California."

## MEAT SUPPLIES FOR THE UNITED KINGDOM

## The Union's Share in the Beef Trade.

WE have received a copy of Parliamentary Paper (Cmd. 456) containing the report of the Committee appointed by the Board of Trade to consider the means of securing sufficient meat supplies for the United Kingdom, and in view of the future meat export trade of the Union and its interests in the United Kingdom market, the report (which, it may be mentioned, is not concerned with pork, bacon, and ham) contains valuable information to those concerned in the production and export of meat in South Africa.

The Committee held 30 meetings and interviewed 63 representative witnesses covering many phases of the matter, especially in regard to the development of meat production in the United Kingdom and in the British Oversea Dominions and to the protection of British markets and of producing countries within the Empire from domination by foreign organizations.

The position of the United Kingdom regarding supplies is summarized as follows:—

	Beef and Veal.	Mutton and Lamb.	Total.
	Per Cent.	Per Cent.	Per Cent.
<i>Average 5 years ended June, 1914—</i>			
Home-raised ... ..	61.5	54.2	59.1
Imported ... ..	38.5	45.8	40.9
	100	100	100
<i>Year ended June, 1914—</i>			
Home-raised ... ..	59.7	50.3	56.8
Imported—			
British Dominions ... ..	7.8	37.8	17.2
Foreign Countries ... ..	32.5	11.9	26
	100	100	100

The estimated meat consumption of the United Kingdom requires an importation annually of from 750,000 to 800,000 tons of beef and

mutton in the near future, while the depletion during the war of the flocks and herds of the belligerent countries and an increased habit of meat-eating point to an importation by the continent of Europe, for some years at least, that will be limited only by the means of transport and the capacity of the importing countries to pay for the meat. France, Italy, and Belgium alone require at least about 450,000 tons annually, to say nothing of other European countries. Then also a resumption of importations by the American meat companies is likely. Altogether the demand for imported chilled and frozen meat is estimated at from 1,350,000 to 1,450,000 tons annually.

The quantity the oversea Dominions are expected to have available for export during the next few years is estimated to be as follows:—

	ANNUAL SURPLUS.	
	Beef. Tons.	Mutton. Tons.
Canada .....	25,000	—
Australia .....	120,000	70,000
New Zealand .....	40,000	160,000
South Africa .....	25,000	—
<b>Total ...</b>	<b>210,000</b>	<b>230,000</b>

The effective meat-exporting capacity of foreign countries, not taking into account China and other possible contributors, is shown in the following table:—

	Beef. Tons.	Mutton. Tons.
Argentine and Uruguay .....	600,000	70,000
Patagonia (Argentine and Chili)	—	30,000
Brazil .....	250,000	—
Venezuela .....	8,000	—
Paraguay .....	5,000	—
Madagascar .....	8,000	—
	<b>871,000</b>	<b>100,000</b>

In the course of their report, the Committee deals with many phases of the subject, such as the control of British insulated shipping, the United States meat companies, production in the United Kingdom and in the oversea Dominions, distribution in the United Kingdom, general anti-trust measures, etc. Of special interest to the Union are the proposals for insuring, protection from foreign competition, and the question of guaranteed purchase by the Imperial Government, which are discussed at length. Under the subject of

production by the oversea Dominions, the following statement is made:—

“38. We are impressed by the way in which production in the Dominions has developed without any artificial stimulus. The real problems are those of improving quality, extirpating disease, and providing against the risk of drought, and these can only be dealt with locally, and not from the United Kingdom.

“As far as regards beef, the future lies with the chilled variety, and the prospect of bringing it from Australia and New Zealand continues to be remote, but the possibilities of development of trade from Canada and South Africa were laid before us by witnesses. So far as Australia (except Queensland) and New Zealand are concerned, the future lies with the production of mutton and lamb, and the development in the recent past has been continuous and vigorous. The demand in the United Kingdom is increasing and the prospects of developing new markets in the United States and on the continent of Europe are bright. The Imperial Government may usefully help by diplomatic action in securing the removal of unjustifiable restrictions on importation and in obtaining for the Dominions a fair share of the European and American trade.”

The

#### CONCLUSIONS AND RECOMMENDATIONS

of the Committee of special interest to the Union are given hereunder; the other matters dealt with are shipping, taxation, and the control of meat trade:—

“The evidence laid before us shows, in our opinion, that, apart from the exigencies arising out of war conditions, there is little risk of a shortage of the quantity of imported meat required to supplement our home production. So far, indeed, as mutton and lamb are concerned we are satisfied that the Empire can become self-supporting within a few years, but the case is different with beef, as this country must for a considerable time be dependent on South America for the bulk of its imports. In view of the strong position held by American companies in the South American meat trade, the witnesses, with few exceptions, were agreed that some action was desirable and necessary to safeguard the interests of British producers and traders at home and abroad, and by so doing to protect consumers from the menace of a monopoly, but there was no general agreement amongst them as to the best measures to be taken in order to secure this end.

We believe that the stimulation of supplies from within the Empire and the protection of British interests outside the Empire form the best basis for ensuring sufficient supplies for the United Kingdom, and we are strongly of opinion that this should be accepted as the permanent Government policy. The specific measures that may from time to time be required can be determined when occasion arises, but the public adoption of this policy will give confidence and encouragement to British producers at home, in the Dominions, and in foreign countries.”

#### PRODUCTION IN THE UNITED KINGDOM.

The Committee makes several recommendations with the object of ensuring an increase in the total quantity of meat production in the United Kingdom, such as (a) the provision of bulls and rams of

good quality of easy access to farmers; (b) prevention of the introduction of contagious disease among live stock, also inquiry into a scheme of national insurance against tuberculosis; (c) the spread of knowledge among farmers as to the best methods of feeding stock; (d) the provision of slaughter-houses and auction marts and sale-yards under the direct control of farmers and the sale of stock by dead-weight at co-operative slaughter-houses; (e) where cattle are not sold by dead weight, but on the basis of live weight, all cattle exposed for sale to be weighed and the weights notified before sale; (f) better sanitation for markets, slaughter-houses, and shops, and better provision for transport, etc.

#### PRODUCTION IN THE OVERSEA DOMINIONS.

“ We regard the control or supervision of meat production in the Dominions as a matter for them alone, but in order to ensure unity of action by the several Governments, we advise that there should be frequent inter-communication on this subject by conference or otherwise. As an example of action in regard to which general consideration might be desirable, we would refer to the recent New Zealand Act for the licensing of meat exporters.

“ Meat production in the Dominions may be expected to continue to progress rapidly, and the existence of a ready market in the United Kingdom for the bulk of their exports is the best guarantee of such development. Some further aid can, however, be given by assisting them to secure new markets.

“ (a) We recommend that diplomatic action be taken to obtain the removal of all unjustifiable restrictions on the importation of Dominion meat into foreign countries, including the *surtaxe d'entrepôt* on meat transhipped from the United Kingdom. Further, if any action is to be taken for the feeding of the countries ravaged by the war, we consider that every effort should be made to secure a share of the trade for the Dominions.

“ (b) We also recommend that Government contracts for meat should be confined to British producers in the United Kingdom and in the Dominions.”

#### THE UNION'S RESPONSE.

The beef export of the Union is still in its infancy, and much has to be learnt from our own and also the experience of other exporting countries regarding the requirements of the oversea market, involving such weighty considerations as breeding, feeding, slaughtering, preparation for market and shipping. Other British Dominions have established their market, but the Union is still a pioneer, and has yet to create a trade in beef of a quality and attractiveness equal or superior to that of other exporting countries, where the meat industry has become a highly specialized one. In the building up of such an industry the farmer has to lay the foundation. The country looks to him to produce the article of best quality by the carefully considered breeding and feeding of his stock. This is the first and greatest essential, but its ultimate success depends upon the slaughterer and the packer, branches of the industry which call for special knowledge and experience. Haphazard methods on the part



of either the producer, butcher, or packer mean discouragement and delay in the forward movement of our meat export trade, and it is our duty to draw attention to the pitfalls which must be avoided and the ideal which must be striven after to enable us to attain the standard we desire.

In a pamphlet issued by this Department (L.S. 83)—“The South African Export Trade in Beef”—is set out briefly overseas reports on some of our early shipments. From them we learn with pleasure that the quality of the meat was better than might have been expected from a country where breeding was largely confined to the production of animals for draught purposes, and that it compared favourably with that of the pioneer shipments from either Australia or the Argentine. The criticism of an Italian expert on a consignment unloaded at Spezzia in Italy is of special interest to farmers, for, in dealing with the characteristics and quality of the meat, he comments most favourably on its taste and tenderness, which are the main attributes of a table meat, and expresses the opinion that our meat is assured of successful penetration into European markets when certain defects in the article are removed. This improvement, however, will never come about so long as we breed an animal first for transport and then for the butcher. We have yet to reach the stage where the specialization of our product will enable us to compete with the highly improved cattle of other countries. This Department is concerned primarily with the fostering of an industry in breeding the right class of cattle for the special purpose of beef export. It looks confidently to the farmer to work with it and avail himself of its assistance in an earnest endeavour rapidly to achieve this end.

---

### **Sunflower Seed Export.**

As reflecting the general opinion of buyers oversea, the Acting Trade Commissioner draws attention to a letter received by him from a prominent London firm recommending South African shippers to grade sunflower seed to colour, for at present it is the usual experience that parcels exported contain black, white, grey, and striped seeds. It is also suggested that, failing grading in the above manner, business will considerably be facilitated if the seed could be thoroughly bulked, so that the seed is uniform, and sold overseas on sample as “mixed sunflower seed.”

It may be mentioned that the Government graders at the Union ports are prepared to inspect sunflower seed for good marketable condition only and to certify accordingly. Beyond this they are not able at present to do anything, as no grading regulations for sunflower seed have yet been issued.

## THE AGRICULTURE AND SOILS OF THE CAPE PROVINCE.

By ARTHUR STEAD, B.Sc., F.C.S., Research Chemist, Grootfontein School of Agriculture, Middelburg, Cape.

### I.

#### Witkop—Burghersdorp.

[The previous instalments of this article appeared in the May, July, and August numbers of the *Journal*.—ACTING EDITOR.]

KALKFONTEIN: MR. C. S. COLLETT AND MR. DE KLERK.

UPSTREAM from Paardenverlies the country rises gradually until at Mr. Collett's homestead—the homestead of the original Kalkfontein—the altitude is some 400 feet higher than that of the homestead of Paardenverlies.

For the most part Kalkfontein overlies Molteno Beds, which are flanked on three sides by heights of Red Beds, these latter on the western side forming part of the mountain chain known locally as the Kapok Hoogte, viz., the Snow Hills. Surmounting the Red Beds, particularly on the mountains above Mr. Collett's homestead, there are considerable masses of dolerite, the leachings from which have doubtless given rise to the "lime" spring which gave the farm its name.

Around the homestead there is a goodly number of splendidly grown trees, including oaks, poplars, and gums; specimens of the elder shrub are also to be seen there in a thriving condition. Noticeable also around the homestead are outcrops of reddish-tinted, glittering sandstone of very coarse grain.

From just below the homestead a vlei runs in the direction of Paardenverlies. From the central portion of it No. 607, a composite sample of virgin soil, was taken. The vegetation of the vlei consists of koel biesjes, rooi platbaar, en blauw and rooi ruigte grasses—both much relished by cattle—with kweek grass and, in places, tulp. There is also an abundance of a yellow-flowered legume (a trefoil), whose roots were found to be well covered with nodules of nitrogen-fixing bacteria. The kweek grass occurs only where the vlei soil is covered with an inch or so of reddish sandy "wash" from a flanking outcrop of Molteno Beds: it would therefore seem that the sandy covering has a great deal to do with the presence of the kweek grass. The occurrence of koel biesjes points to the presence at no great depth of a plentiful supply of underground water.

No. 610 represents a composite sample of virgin soil taken at the boundary of Mr. Collett's and Mr. de Klerk's lands, and is representative of a "vlakke" soil\* which overlies Molteno Beds, but which doubtless also to a considerable extent has been derived from

\* A "vlakke" is a "flats."

the flanking dolerite-capped Red Beds. The vegetation of this area consists of a mixture of sweet and sour grasses, including rooi platblaar and rooi ruigte, but adjoining the spruit which runs through the flat a fair number of Karroo bosjes is to be seen.

TABLE II  
*Analysis of Soils from Kalkfontein.*

		No. 607.	No. 610.
<i>Mechanical Analysis.*</i>			
Colour	...	Black.	Dark brown.
		Per Cent.	Per Cent.
Fine earth	...	100	100
Coarse sand	...	20.62	9.15
Fine sand	...	26.21	31.49
Silt	...	8.06	2.53
Fine silt	...	9.86	26.35
Clay	...	19.95	23.80
Soluble in N/5 hydrochloric acid...	...	2.20	1.37
Reaction to litmus	...	Alkaline	Acid
Carbonates	...	9.10	0.025
Humus	...	5.60	3.20
Loss on ignition	...	8.37	1.00
Moisture	...	1.70	1.18
<i>Chemical Analysis.</i>			
Nitrogen	...	0.23	0.11
Insoluble inorganic residue	...	76.97	81.51
Lime	...	1.09	0.54
Magnesia	...	0.66	0.45
Potash	...	0.57	0.58
“ Available ” potash	...	0.019	0.022
Phosphoric oxide	...	0.114	0.053
“ Available ” phosphoric oxide	...	0.021	0.019

Vlei soils are frequently very clayey, but No. 607 is only moderately so and, furthermore, contains a large quantity (20.6 per cent.) of coarse sand, the presence of which—due no doubt to some extent to the “wash” from the frequent outcrops along its margins of coarse-grained sandstones—will assist materially in counteracting the undesirable properties of the clay. No. 607 also contains an admirable quantity of humus, so that although it contains as much clay as No. 614, Paardenverlies, the effect of the coarse sand and humus will be to make it an easier working soil than No. 614, and, moreover, should make it better able to resist drought.

Chemically, the soil is a good one also. It contains a very adequate supply of nitrogen—probably too much for oats and barley—and quantities of potash and of phosphoric oxide which, for South African soils, are, in the total, considerable, and, moreover, satisfactory as regards availability. The soil is alkaline owing to the fact that it contains 0.1 per cent. of calcium carbonate.

Judging from the mechanical analysis, No. 610 shows a considerable resemblance to No. 614—the figures for coarse and fine sands are almost identical in both soils, while the totals for the silts, plus clay, are also nearly the same. They differ, however, in that No. 610

\* For sizes of particles see under “Paardenverlies,” above.

contains much less silt than No. 614—more fine silt and a little more clay. No. 610 contains rather less organic matter than No. 614 and rather less humus. One concludes that although there is a resemblance between the two soils No. 614 has the better physical make-up.

Considered chemically, No. 610 and No. 614 also show close agreement, excepting that No. 610 contains much less total phosphoric oxide. Considering the fineness of the texture of the latter soil one is inclined to think that, notwithstanding the fair amount of available phosphoric oxide it contains, it would respond to phosphatic manuring. [See remarks on page 437 concerning the action of phosphoric oxide on the development of roots.] Like most of the soils of the Witkop area, No. 610 is acid to litmus, a condition that may be corrected by the application of agricultural lime.

A comparison of the figures for insoluble inorganic residue in soils Nos. 610 and 607 is not without interest, for, if due allowance be made for their different content in moisture and in organic matter, the figures are nearly identical (viz., 89.1 per cent. and 88.5 per cent.), which suggests that the mineral skeleton of the soils has a common origin and that the present mechanical and chemical differences revealed by analysis originate in the steeper gradients around No. 607, and in the presence under the latter at no great depth of a calcareous water which has given the soil an alkaline reaction and has led to the accumulation of a valuable quantity of humus. While it can be expected that liming, phosphatic manuring, and green manuring would do much to improve No. 610, it is not to be expected that there is any practicable method by which it could be made to equal No. 607.

---

#### WITKOP AND KRAAIFONTEIN: MR. D. V. KANNEMEYER.

---

Reference to the geological map on page 353 will show the positions of Kraaifontein and Witkop relative to Kalkfontein, as well as their geological characteristics.

The portions of Witkop and Kraaifontein with which we are concerned are in the kloof, reference to which was made on page 356.

The kloof bottom is of Molteno Beds, while its head and cliffs are of Red Beds. It is to be noted that the spruit which passes down the kloof drains an area of volcanic beds situated at the southern corner of Witkop; also that dolerite dykes occur on both sides of the kloof, one of them passing through the kloof.

The homestead of Witkop is situated in the kloof at a distance of less than a mile from its head and at an altitude some 250 feet lower than the plateau on which Witkop Post Office stands. Near the head of this kloof are some caves which contain some fine samples of Bushman art.

The soil of the upper part of the kloof, viz., from the homestead upwards is of a rich black colour near the spruit, becoming browner the further one gets away from the water-course. No. 617, a composite sample of virgin soil, was derived from a land close to the spruit, and not far above the homestead.

The vegetation of the neighbourhood consists of kamfer bos, blauwsaad, and kweek grasses, together with, here and there, a clover plant. If left undisturbed the land becomes quickly covered with

reeds, from which one may conclude that there is plenty of underground moisture.

When sampled the soil was very dry, but it has the reputation of retaining water well, a property we have confirmed in the laboratory.

Potatoes and wheat are said to grow well on this soil, but no precise details of yields were available.

Samples No. 618 and No. 619 are from Kraaifontein lands worked from Witkop homestead. No. 618 is a composite sample from Kraaifontein New Land. This land is situated near the mouth of a short, wide kloof in the Red Beds on the eastern side of the spruit which comes down from Witkop. The soil is dark brown in colour and fine in texture.

The natural vegetation of this area consisted of kweek and blauwsaad grasses, plenty of clover, a yellow-flowered aster, and tulip.

No. 619 is a sample from a 10-year old land situated between Kraaifontein New Land and Witkop homestead. The land is decidedly high-lying; in fact it might be called a bult land. The soil is sandy, reddish brown in colour, and in every way much like the sandbult soil from Paardenverlies.

The vegetation of this area was originally zuur rooigras.

Precise details of yields from this land were not obtainable. Wheat, oats, and potatoes had been tried on it, the first-mentioned crop yielding at the rate of fifteen from one on a recent occasion.

TABLE III.

*Analysis of the Soils from Witkop and Kraaifontein.*

	No. 617.	No. 618.	No. 619.
<i>Mechanical Analysis.</i>			
Colour	Dark black.	Dark brown	Reddish brown.
	Per Cent.	Per Cent.	Per Cent.
Fine earth	100	100	97.70
Coarse sand	13.69	6.61	13.30
Fine sand	29.95	32.22	55.35
Silt	13.53	18.25	7.11
Fine silt	9.89	19.30	6.40
Clay	20.67	14.96	12.93
Soluble in N/5 hydrochloric acid	1.21	1.89	0.90
Reaction to litmus	Acid	Acid	Acid
Carbonates	0.042	0.025	0.025
Humus	5.50	2.96	0.77
Loss on ignition	7.70	4.90	2.68
Moisture	3.10	1.58	0.90
Permeability to water	0.43	0.30	2.56
<i>Chemical Analysis.</i>			
Nitrogen	0.21	0.12	0.08
Insoluble inorganic residue	74.40	87.50	96.20
Lime	0.87	0.42	0.21
Magnesia	0.52	0.35	0.23
Potash	0.55	0.51	0.46
“Available” potash	0.013	0.027	0.022
Phosphoric oxide	0.082	0.047	0.042
“Available” phosphoric oxide	0.013	0.008	0.003

Under the climatic conditions of Witkop it is to be expected that a soil containing 20 per cent. of clay will be difficult to till, provided no factors are present to modify the colloidal influence of the clay. That No. 617, containing 20.6 per cent. of clay, possesses a physical structure suitable for potato culture must then be ascribed to the "lightening" influence of the considerable quantities of coarse sand and clay it contains and to the absence of any considerable quantity of fine silt.

Now No. 618 contains 5.7 per cent. less clay than No. 617. May one, therefore, conclude that it is an easier soil to work? If the proportions of humus and coarse sand were the same as those of No. 617 such a conclusion would be justified, provided also that the proportion of fine silt was not greater. Reference to the analysis will show that these conditions are not fulfilled, that No. 618 contains less of both coarse sand and humus together with a larger proportion of fine silt. What No. 618 appears to gain in physical make-up in comparison with No. 617 it probably more than loses in the other indicated directions, a view that is supported by the permeabilities of the two soils to water, No. 618 being only three-quarters as permeable as No. 617.

Physically considered No. 617 is therefore the better soil of the two, while both should respond well to intelligent methods of tillage.

From a chemical point of view No. 617 is superior to No. 618 in almost every respect: but although that is so, No. 617 is by no means as good as it could be—it is not, for example, so well provided with phosphoric oxide as the soils of Kalkfontein and stands in need of phosphatic manuring. No. 618 is very deficient in available phosphoric oxide.

No. 619 is a very poor soil indeed and very much like the zandbult soil from Paardenverlies.

---

#### THE WILLOWS: MR. ANDREW DE KLERK.

---

The farm Willows lies to the east of Witkop. Samples Nos. 615 and 616 were taken here.

The homestead is situated on the eastern side of the stream which comes down past Vaalkop from the volcanic beds about four miles distant. At it are to be seen some rather young specimens of the macrocarpa cypress, English gooseberry, and red currant: there are also some poplars.

Sample No. 615 represents a mixed sand and turf soil situated on the slope at the foot of Vaalkop and facing about north. The natural vegetation of this area consists of rooigras and rooi platblaar grass, together with plenty of clover, which grows quite tall if protected from stock. The roots of the clover are well covered with bacterial nodules. The data regarding crops given on page 158 apply particularly to this soil. Vaalkop is built up of red and white sandstones, which figure in Dunn's map as Red Beds. The map shows that a dolerite dyke passes through the kop. No. 616 was taken from the vlei at a point opposite the homestead and over the stream referred to in the foregoing paragraph. Underground water is hereabouts about three feet below the surface.

Lucerne is growing on a part of this land, and in the opinion of the owner is doing quite well: this soil is, however, better suited to wheat than to any other crop.

The natural vegetation of this vlei consists for the most part of rooi platblaar grass, together with a fair amount of clover, the roots of the latter being well infested with bacillus *radicicola*.

TABLE IV.  
*Analysis of Soils from The Willows.*

	No. 615.	No. 616.
<i>Mechanical Analysis.</i>		
Colour	Dark brown	Black.
	Per Cent.	Per Cent.
Fine earth	100	100
Coarse sand	8.66	4.90
Fine sand	56.24	28.77
Silt	9.21	7.80
Fine silt	6.30	11.33
Clay	13.22	24.78
Soluble in N/5 hydrochloric acid	0.76	7.59
Reaction to litmus	Acid	Alkaline
Carbonates	0.025	5.80
Humus	3.62	5.60
Loss on ignition	4.20	9.50
Moisture	1.10	3.30
Permeability to water	1.31	0.116
<i>Chemical Analysis.</i>		
Nitrogen	0.13	0.26
Insoluble inorganic residue	87.56	70.67
Lime	0.35	3.80
Magnesia	0.30	0.97
Potash	0.52	0.54
“ Available ” potash	0.025	0.034
Phosphoric oxide	0.078	0.117
“ Available ” phosphoric oxide	0.012	0.028

No. 615 contains a moderate amount of clay and a fair quantity of humus. It is quite permeable to water and, unless underlain by a more impermeable stratum, would probably need rain at fairly frequent intervals. It contains a very large percentage of fine sand which would tend to make it dry hard at the surface. Chemically, the soil is somewhat deficient in total phosphates, from which one would conclude that phosphatic manuring would give a good response after the land had been cropped several times. That this soil is suited to potato culture is evident from its mechanical composition and the climatic conditions; the chemical composition is also favourable to potato culture, excepting that the soil is rather deficient in phosphates, both total and available.

No. 616, the vlei soil, is a very strong calcareous loam containing plenty of organic matter and a very large quantity of calcium carbonate. It would appear to require no manurial treatment other than such as may be required for special crops. Oats grow too rank and barley and some varieties of wheat get laid if grown upon this soil.

The rank growth<sup>2</sup> is doubtless due to the high nitrogen content and the abundant supply of underground water. It may here be mentioned that this type of soil is first and foremost a wheat soil. Rietti being the best variety to sow. Rooi Lama (the local name, apparently, for a much sown wheat) also does well on this type of soil, but Egyptian Red, also a variety frequently sown in the Witkop district, grows rank and gets laid.

Beyond skilful cultivation, it would appear that this soil requires no other treatment; it still yields very good crops after many years of cultivation. According to the farmer's classification this soil belongs to the black turf class.

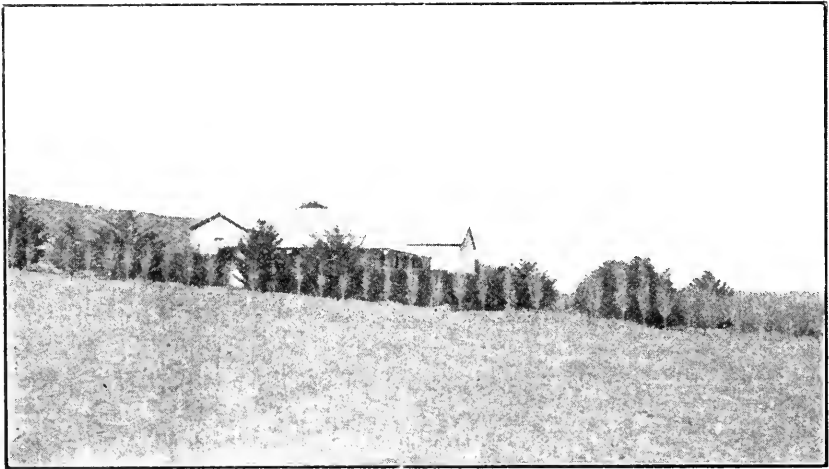

Plate VII. THE HOMESTEAD "THE WILLOWS."

The trees without leaves are poplars; the willows are hidden by the house. The hedge is of the macrocarpa cypress. Pines of several varieties have been planted here and are doing splendidly; they are 8 years old, at least 15-18 feet high, and their trunks about 10 inches in diameter.

#### LEMOEN KRAAL: MRS. DE KLERK.

The homestead of Lemoen Kraal lies almost direct north of The Willows homestead. Only one sample was taken from this farm, i.e. No. 611. The geological map (p. 353) will show that the bult from which this sample was derived is far removed from any influence by dolerite or by lava. It would therefore seem that it may be taken as representing a true Red Beds soil.

The soil is decidedly sandy and, moreover, very poor; it yields not more than ten from one in the case of wheat and six from one in the case of potatoes. Some peas were growing on the land at the time it was sampled; they were very unhealthy in appearance and their roots bore no nodules.

\* See remarks under Nitrogen, page 436.



The natural vegetation consisted chiefly of rooi zuurgras with some blauwsaad gras.

TABLE V.  
*Analysis of the Soil from Lemoen Kraal.*

										No. 611.	
<i>Mechanical Analysis.</i>											
Colour...	...	...	...	...	...	...	...	...	...	...	Reddish brown, Per Cent.
Fine earth	...	...	...	...	...	...	...	...	...	...	100
Coarse sand	...	...	...	...	...	...	...	...	...	...	24.55
Fine sand	...	...	...	...	...	...	...	...	...	...	54.06
Silt	...	...	...	...	...	...	...	...	...	...	4.27
Fine silt	...	...	...	...	...	...	...	...	...	...	3.89
Clay	...	...	...	...	...	...	...	...	...	...	8.88
Soluble in N/5 hydrochloric acid	...	...	...	...	...	...	...	...	...	...	0.68
Reaction to litmus	...	...	...	...	...	...	...	...	...	...	Acid
Carbonates	...	...	...	...	...	...	...	...	...	...	0.03
Humus	...	...	...	...	...	...	...	...	...	...	1.83
Loss on ignition	...	...	...	...	...	...	...	...	...	...	2.90
Moisture	...	...	...	...	...	...	...	...	...	...	0.41
Permeability	...	...	...	...	...	...	...	...	...	...	3.36
<i>Chemical Analysis.</i>											
Nitrogen	...	...	...	...	...	...	...	...	...	...	0.08
Insoluble inorganic matter	...	...	...	...	...	...	...	...	...	...	91.13
Lime	...	...	...	...	...	...	...	...	...	...	0.26
Magnesia	...	...	...	...	...	...	...	...	...	...	0.20
Potash...	...	...	...	...	...	...	...	...	...	...	0.28
" Available " potash	...	...	...	...	...	...	...	...	...	...	0.015
Phosphoric oxide	...	...	...	...	...	...	...	...	...	...	0.05
" Available " phosphoric oxide	...	...	...	...	...	...	...	...	...	...	0.003

The mechanical analysis shows that the soil is rather more sandy than the sandbult soil from Paardenverlies, i.e. No. 612. Chemically it is slightly different, in that it contains a notable quantity of available potash and a very small quantity (0.03 per cent.) of calcium carbonate. The soil is poorly retentive of water, but, since water moves through it readily, it will always be moist near the surface so long as the sub-soil has not dried out.

The manurial treatment recommended for this soil is the same as that recommended for the Paardenverlies sandbult soil. (See page 441.)

Complaint was made that the use of water from a borehole near the homestead made the soil hard. A partial analysis of the water was made with the following results:—

Total solids	...	...	...	...	...	35.2	grams per 100,000 c.c.
Chlorine	...	...	...	...	...	4.6	.. ..
Calcium and magnesium carbonates	...	...	...	...	...	21.75	.. ..
Sodium carbonate	...	...	...	...	...	5.56	.. ..

It is possible that the effect complained of was caused by the sodium carbonate. The origin of the carbonates in this water would appear to be, in part at least, the felspar of the dolerite and lava which occurs in the vicinity.

## OLIVIER'S RUST: MR. J. H. OLIVIER.

The remaining two samples of the series, i.e. No. 608 and No. 609, were taken from the land called Bo'Land, which is situated only a short distance from Dankfontein's Nek. The close proximity of the large mass of lava overlying exposed cave sandstone is worthy of note. There is also what appears to be a dolerite dyke to the south, while the soils themselves lie above Red Beds.

From the hills the land slopes down to the stream at the bottom of the valley where the soil is very black; nearer the hills it is lighter in colour and, moreover, is not uniform in tint, some areas being much lighter than others.

No. 608 is a composite sample of the soil nearer the hills; No. 609 a composite sample of the black soil. No. 608 is underlain by a

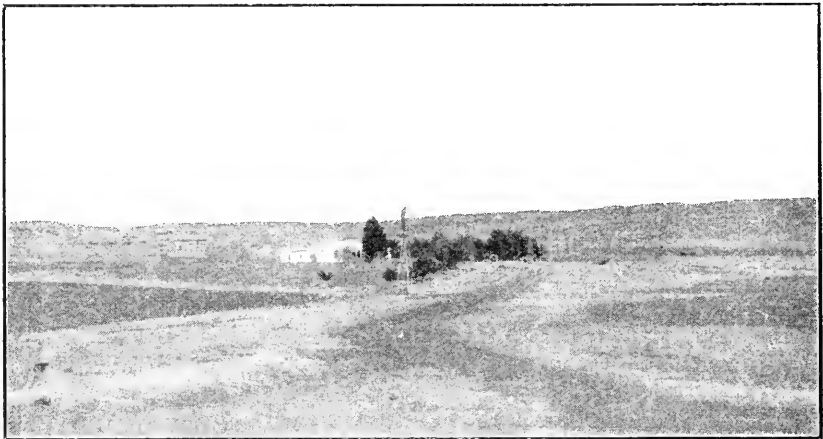

Plate VII.

THE HOMESTEAD "OLIVIER'S RUST."

The hills in the background are of cave sandstone, covered with volcanic rock, which is weathering readily. The macrocarpa cypress trees on the right are 25 years old, about 25 feet high, and their trunks from 10 inches to 15 inches in diameter.

reddish sandy sub-soil, below which is "potclay." No. 608 would seem to be regarded as a mixed sand and turf soil; it is suitable for potatoes and wheat.

The natural vegetation consists of *zuur rooigras* for the most part, together with some *rooi platblaar* grass.

No. 609 is reckoned amongst the black turf soils; it is clayey and at a depth of about 12 feet ground water occurs. The soil is not a good potato soil, but excellent for wheat, *Rooi Koren* and *Rooi Lama* being the varieties best suited to it. The natural vegetation consists of the same grasses found on the higher-lying land, but *rooi platblaar* predominates, and in addition there is a good proportion of *blauwblommetjes*.

An attempt was being made to establish lucerne on this lower-lying land. At the time the samples were taken the plants were very young, so that it is not possible to state whether or not the land is suitable for lucerne culture.

Regarding the patchy colour of the area from which No. 608 was taken it is impossible without further investigation to say what the variability originates in; it may be connected with the variable thickness of the exposed beds of cave sandstone which lie above it.

TABLE VI.  
*Analysis of Soils from Olivier's Rust.*

	No. 608.	No. 609.
<i>Mechanical Analysis.</i>		
Colour ... ..	Dark brown.	Black.
	Per Cent.	Per Cent.
Fine earth ... ..	100	100
Coarse sand ... ..	2.08	2.22
Fine sand ... ..	51.62	31.04
Silt ... ..	10.81	13.08
Fine silt ... ..	11.34	13.96
Clay ... ..	12.78	25.18
Soluble in N/5 hydrochloric acid ... ..	0.87	2.59
Reaction to litmus ... ..	Acid	Acid
Carbonates ... ..	0.035	0.045
Humus ... ..	3.19	6.00
Loss on ignition ... ..	5.70	9.30
Permeability to water ... ..	0.58	—
Moisture ... ..	1.41	2.21
<i>Chemical Analysis.</i>		
Nitrogen ... ..	0.16	0.20
Insoluble inorganic matter ... ..	85.90	79.19
Lime ... ..	0.58	1.20
Magnesia ... ..	0.44	0.85
Potash ... ..	0.40	0.63
“ Available ” potash ... ..	0.028	0.025
Phosphoric oxide ... ..	0.055	0.055
“ Available ” phosphoric oxide ... ..	0.019	0.021

The mechanical analysis shows that these two soils contain very much less coarse sand than any of the other soils of the series. This feature is to be associated with their origin from rocks built up of fine particles, particularly the fine-grained cave sandstone.

No. 608 bears considerable resemblance to the mixed sand and turf soil from The Willows (No. 615), both chemically and mechanically. The chief mechanical differences are that No. 608 contains less than a quarter as much coarse sand as No. 615, slightly more silt, 5 per cent. more fine silt, and about the same quantity of clay. The net result is that No. 608 has a somewhat finer texture, which is reflected in the greater permeability to water of No. 615. Chemically, No. 608 is somewhat superior to No. 615 in every respect. Bearing these differences in mind the remarks made higher up in connection with No. 615 also apply to No. 608.

Comparing No. 609 with the black turf soil of The Willows one finds considerable differences. While the amounts of clay in the two soils do not differ materially, and No. 609 contains no more than 8 per cent. more silt and fine silt, one would expect a considerable

difference in the working properties of the two soils owing to the fact that No. 609 contains very little carbonates, while No. 616 contains nearly 6 per cent., the presence of which has a very profound influence in making the clayey soils workable. No. 616 is also much better stocked with plant food materials. The presence of so much carbonate of lime in No. 616 doubtless also is responsible for the fact that lucerne has been found a suitable crop for it. For lucerne to thrive on No. 609 it would be necessary to apply lime to the soil or to irrigate it with a water which contains plenty of lime. There is no doubt, however, that No. 609 is a good wheat soil.

(To be concluded.)

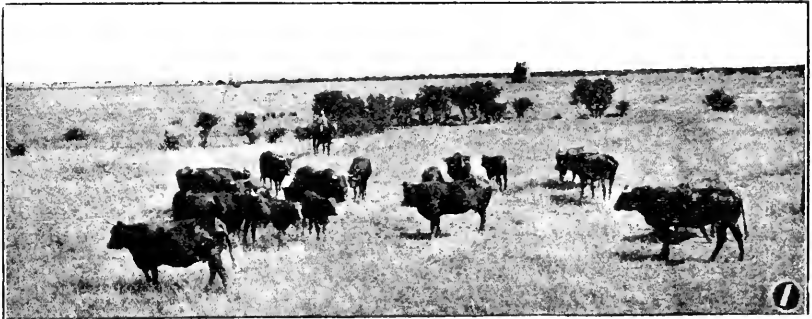

Cross-breds (Sussex and Africanders).

### Plant Nurseries in Quarantine as at 1st September, 1920.

Name of Nurseryman.	Address.	Cause of Quarantine.	Extent of Quarantine.
Mrs. A. W. Godwin ...	Durban ... ..	Red scale, <i>Dietyospermi</i> , <i>Eriococcus araucariae</i>	Palms, Araucarias, Roses.
D. A. English & Co. ...	Pietermaritzburg	Red scale ...	Portion of citrus.
W. T. Attwood ...	Capetown ...	" " ...	Whole nursery.
E. Krohn ... ..	Mare Street, Pretoria	Pernicious scale and other pests	" "
C. F. Marais ... ..	Wellington ...	Red scale ...	All citrus.
Municipal Nursery ...	St. George's Park, Port Elizabeth	<i>C. ficus</i> ... ..	Palms.
F. Grace ... ..	Berlin, C.P. ...	Red scale ...	Portion of citrus.
P. Gaylard ... ..	" " ...	" " ...	" " "
J. Hobson & Co. ...	Kingwilliamstown	" " ...	" " "

## THE MENACE OF ANTHRAX.

### The Spread of the Disease and How it may be Arrested.

THE attention of the public is centred to-day on the alarming outbreaks of East Coast fever that have recently come to light, a serious matter which is being combated by all the power this Department possesses. At a time, therefore, when we stand on the brink of perhaps enormous losses through the ravages of this disease (for the future trend of infection is still obscure and the situation is fraught with anxiety), and the public can realize the dangers from disease which attend the live stock industry of the Union, we wish to draw special attention to the ever-present menace which faces us in the presence of anthrax. The animal diseases in the Union demand the constant vigilance and unremitting research of this Department, and call for the co-operation of the farmer which, in this vast country, is the hinge on which depends either progressive improvement or recurring setbacks in the campaign to free the Union from the thrall of animal disease and hasten the achievement of that goal towards which our eyes are set—South Africa, a great meat producing country. The road to this end is beset with difficulties, and the one transcending all (East Coast fever included) is the danger which lurks in the spread of anthrax. This disease is not only the cause of serious mortality in live stock, but is also a menace to human life in which it continues to exact its toll. Here is a matter which concerns not only the farmer but the whole community, for the interests of public health as well as those of the stock owner are involved.

#### DESCRIPTION OF THE DISEASE.

Anthrax is a contagious disease caused by a microbe, *Bacillus anthracis*.

Human beings and all animals are liable to the disease, which is seen chiefly in cattle, pigs, and sheep, but not uncommonly in horses.

It shows itself suddenly and is very fatal, usually lasting forty-eight hours. In South Africa it does not often spread with rapidity from animal to animal, but may affect a number of swine at the same time if they have been fed on anthrax flesh or organs.

A beast which a short time before appeared to be well is found dead or in a dying condition; frequently blood oozes from the nostrils and the anus. In cattle there are no typical symptoms, but in horses and pigs the throat is often found to be swollen.

The carcass is swollen. Blood is found around the nostrils and anus. The muscles are often infiltrated with blood at certain points. The lungs and glands are congested. The spleen is very much enlarged; it is softer and darker than normal and its substance usually resembles tar.

In equines, anthrax infection not infrequently manifests itself by the appearance of extensive subcutaneous swellings, frequently involving the brisket or the lower surface of the abdomen. In this

form the progress of the disease is less rapid and animals occasionally recover.

In South Africa the enlargement of the spleen as a diagnostic sign has not the same value as in many other countries, for the red-water type of disease also gives rise to enlargement of the spleen. In the latter type of disease, however, the spleen is not so soft nor is it so tar-like as in the case of anthrax. The flesh is very dangerous to animals and human beings.

#### THE PRESENT POSITION.

It is of great concern that anthrax is becoming increasingly serious in the Union. The Principal Veterinary Officer reports that in many areas the veld has become so severely contaminated that heavy losses are frequently sustained even when stock owners are prompt in inoculating their stock, and repeated inoculations (and that through no fault in the vaccine) become necessary to check the mortality. There is no doubt that the disease is being perpetuated through carcasses of animals dying of anthrax left to lie on the veld or, worse still, being cut up for the sake of meat and the hide, and no abatement in the scourge can be expected until these practices are rigorously suppressed. That there are not more deaths among human beings on account of the careless manner in which anthrax carcasses are handled is surprising, unless it is that the native community, who are the greatest offenders, enjoy a considerable degree of immunity from the disease. The fact remains, however, that great care is needed in disposing of infected animals, and failure in this respect is fraught with imminent danger to man and beast. And the disease continues to spread. From reports covering the period of twelve months ended 31st March last, it appears that anthrax is prevalent everywhere in the Cape Province, except in the Karroo, but that only a small proportion of the cases are brought to the notice of the authorities; during this period 54 outbreaks were reported, 456 animals died, and 1162 were inoculated. In the Transvaal the mortality was 1300 head, 803 outbreaks having been reported, and 83,300 animals inoculated. The report for Natal shows 75 outbreaks, 375 deaths, and 35,173 head inoculated. Anthrax is by far the most serious of all the scheduled diseases in the Orange Free State, where the number of outbreaks has increased greatly during the period under review, being 315 as compared with 122 the previous year. There were 2788 deaths, while 65,910 head were inoculated. To control the disease in the native territories is a matter of great difficulty owing to the indifference of the native to the risks incurred in cutting up anthrax carcasses and the consumption thereof, a matter of frequent occurrence. Added to this the native is not easily induced to get his cattle reinoculated when the disease occurs within a short time of inoculation. During the year 211 outbreaks in the Transkei were diagnosed by this Department and 52,887 animals inoculated, and the prevalence of the disease in this part of the Union is causing much anxiety.

#### HOW THE SCOURGE MAY BE OVERCOME.

The figures given above demonstrate the loss in animals, and when the imminent peril to human life is taken into account the need

for strong action in removing the danger from our midst must appeal to all, and we earnestly hope that, with this end in view, the few simple measures given hereunder will be carried out scrupulously and honestly:—

1. On no account should the carcasses of animals found dead, or dying suddenly without showing any previous illness, be opened or skinned. Many such deaths are undoubtedly due to anthrax, and the risks run by any one handling such carcasses, either for the purpose of making post-mortems, removing the meat, or taking off the skins, are very great. Human beings are readily infected and the illness which ensues is rapid and frequently fatal, and the contamination of the veld, which follows the opening of an anthrax carcass, tends to perpetuate infection and almost inevitably leads to further losses of stock.

2. All carcasses of suspected animals—and all animals dying suddenly should be regarded as suspects—must be buried intact after taking a blood smear. This is done by cutting into one of the superficial veins of the ear which only permits the escape of a drop or two of blood, care being taken after the operation is completed to disinfect the knife used for this purpose by placing it in a 10 per cent. solution of Jeyes' fluid or other disinfectant, or by boiling it in water for ten minutes. The animal should be buried at a depth of not less than six feet, preferably in quicklime, as near the place where it died as possible, but away from any spot where it might contaminate water supply. After burial, if the report received of the result of the examination of the blood smear shows that the disease has been anthrax, the grave should be bushed over or enclosed in a rough fence to prevent animals from grazing over it. In handling carcasses great care should be taken not to allow any discharge from it to get on the clothes or person of any one touching it, and the ground where the animal has lain should be soaked in a 10 per cent. solution of Jeyes' fluid, and any discharges should be scraped up and thrown into the grave in which the animal is buried, while the hands should be thoroughly washed with disinfectant.

3. The Veterinary Division will be greatly aided in its efforts to control this disease if all suspicious deaths are reported at the nearest police post and blood smears are taken by owners. The division will then advise owners as to the precautions to be taken to reduce the risk of further loss and to check the spread of infection.

Blood smears should be made preferably on special glass slides (generally obtainable from the nearest police post), otherwise on any small slip of glass, which should first be thoroughly cleansed with hot water and wiped dry with a clean cloth. Blood for the smears should be obtained by incising one of the small superficial veins on the outer surface of the ear which will allow the escape of a drop or two of blood; of this a small quantity should be placed on the slide, either with a piece of clean dry glass or with the point of the knife, then the edge of a second slide or the edge of the knife should be placed at an acute angle on the slide on which the blood has been put, and the edge of the slide or knife gently drawn across the slide so as to spread the blood into the thinnest possible film. The blood smear should then be dried by waving it in the air, and each smear should be wrapped in a separate piece of paper and packed for posting, together with a

note giving the name and address of the owner, the species of animal from which the smear was taken, and stating the disease which is suspected. In posting the smear the address should vary with the Province—in the case of the Orange Free State it should be sent to the Senior Veterinary Officer, Bloemfontein; in the Cape it should go to the Senior Veterinary Officer, Capetown, or to the Director of the Veterinary Institute, Grahamstown; in Natal to the Assistant Director of Veterinary Research, Allerton Laboratory, Maritzburg; in the Transkei to the Senior Veterinary Officer, Umtata; and in the Transvaal to the Director of Veterinary Research, P.O. Box 593, Pretoria.

4. In the event of the disease turning out to be anthrax all in-contact cattle should be inoculated as soon as possible. The Veterinary Division will assist farmers by arranging for a veterinary officer to demonstrate the method of inoculation whenever practicable. The vaccine for inoculating can be obtained on application from the Director, Veterinary Institute, Grahamstown, the Assistant Director of Veterinary Research, Allerton Laboratory, Maritzburg, or from the Director of Veterinary Research, P.O. Box 593, Pretoria; cash should accompany all orders. The price of the vaccine is 5s. for twenty-five doses for cattle, and 5s. for fifty doses for sheep. Full instructions as to how to inoculate are issued with the vaccine, and suitable syringes for the operation can generally be obtained through local chemists or direct from any surgical instrument-maker.

#### ANTHRAX MAY SERIOUSLY DAMAGE THE UNION'S TRADE.

The prevalence of anthrax in a country is viewed with mistrust by other countries importing its products, and in addition to the Union's first concern already referred to, that of protecting human life and preserving our live stock, it is of great moment at this period in our history that no suspicion of taint from anthrax should be attached to any of our products. In the April issue of the *Journal* (p. 79) we drew attention to the stringent measures adopted by the Imperial authorities to prevent the introduction into the United Kingdom of any goods infected or likely to be infected with anthrax. And it is certain that a spreading of the disease in the Union will retard our overseas trade. This would result in a serious set back to our meat export trade which is only in its infancy, and which therefore has to be nursed and built up with the greatest care, for no country will receive our exports with open arms unless effectual measures are taken for their protection. Other animal products, such as wool, hides, and skins are affected in like manner, and any restriction in the export of these articles would be a calamity.

It is forbidden to dissect the carcass of an animal known to have died of anthrax, and there are regulations, with pains and penalties for their non-observance, for the purpose of controlling and stamping out this fell disease. It may be that in a measure the disease continues to spread because the penalties inflicted for disregard of the law are not sufficiently heavy. That there are other countries where infringements of the regulations dealing with the control of cattle disease are more severely dealt with than in South Africa is well known. As an example of this rigour there appeared recently in the Press a message from London that two Norfolk farmers have been



fined 500 guineas for not notifying foot and mouth disease among their sheep and moving them on the main road. This message has its own significance to stock owners in the Union, where the penalties prescribed and inflicted are smaller, yet where the industry at stake is of vital importance to the country. It is not, however, the fear of the law which is likely to rid the country of anthrax, but the whole-hearted co-operation of stock owners in the proper disposal of infected carcasses, which has been proved to be the most important factor in arresting the spread of the disease. It is regrettable but true that in our experience the stock-owning community appear to be indifferent to the great danger in carelessly handling anthrax carcasses. Yet the effective eradication of the disease depends more upon the efforts of the individual farmer than upon any action which can be taken by this Department, and so long as this indifference on the part of stock owners to their legal and moral obligation exists we run the grave risks attending the disease. We repeat, therefore, that anthrax is an ever-present danger and fraught with greater possibilities for evil than any of the other animal diseases which beset our land, and it is the bounden duty of every true citizen of South Africa to do his share, however irksome it may be, in freeing the country of this plague.

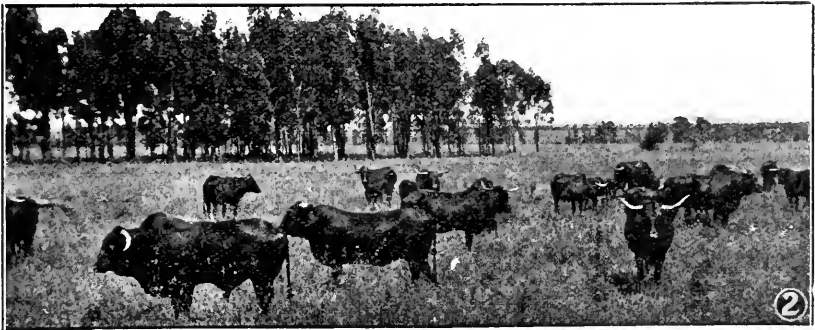

Herd of Pedigree Africanders.

### The Union's Timber Resources.

The Forest Department states that the more accessible forests of the Union will in the next ten or fifteen years have been more or less worked over and the supplies of virgin timber extracted. After that the yield from the indigenous forests can be expected to drop very considerably, probably to a half of the present output.

It is difficult, of course, to forecast how the country will be opened up in the meantime, and it is just possible that some of the forests, now remote, may become accessible, and thus enable the present output to be maintained for a further period of years. On the other hand, the plantations of exotic species may be expected to develop and the output from them can be relied upon to increase steadily. At present, however, and for some years yet, these plantations will yield only preliminary thinnings in the shape of mining timber, poles, fuel, etc., but as they grow older a regular and gradually increasing amount of saw-timber will be produced.

## IRRIGATION IN THE UNION.

THE report of the Director of Irrigation for the year ended 31st March, 1919,\* is a document of great public interest, for the future of the country is closely associated with the trend of its irrigation policy, and the report includes a valuable review of what has been done in the past in this respect, leading up to the present establishment of the Irrigation Department and determination of the policy devised for its future operations. Mr. Kanthack states in the course of his report that, notwithstanding the disability generally associated with the war, the Irrigation Department has, since 1916, been engaged in a most active policy of progressive development, and year after year Parliament has not hesitated to vote large sums of money for this purpose. But no matter how lavish the Government may be in supplying funds for the furtherance of a matter of such vital importance to the country, progress is limited by the available staff to devise and carry out the irrigation projects, and the Department has now reached a stage where enlargement is imperative if the same rate of progress as in recent years is to be maintained.

The report outlines the evolution of our irrigation policy which, based primarily on methods of flood irrigation in vogue in the Cape Colony, was completely changed by later happenings. The drought of 1913-15 and the slump in ostrich feathers—an industry responsible for the early inception of irrigation enterprise in South Africa due to the necessities of lucerne cultivation—followed by the war, brought home to farmers the fact that their future lay in the production of agricultural staples for which there was firm demand, and with this came the conviction that the prevailing method of flood irrigation would not suffice, and that a more secure supply of water must be assured during critical seasons of the year. This certain supply could only be attained by the conservation of water in large storage reservoirs. Foreseeing the inevitable change in the country's requirements, the Government was prepared in a measure to meet the position thus created, and in spite of the many adverse conditions caused by the war it made

### CONSERVATION THE KEYNOTE OF ITS POLICY.

To this end it was necessary, in the first instance, to give preference to areas already served by large flood irrigation schemes constructed by Irrigation Boards with Government money, and, secondly, to such of these areas not hitherto controlled by Irrigation Boards, such as the Olifants River Valley in Oudtshoorn. Finally, new areas, in which little or no previous irrigation development had taken place, received attention, all such schemes being, however, brought under the control of

\* Obtainable from the Government Printer ; price 7s. 6d.

Irrigation Boards, for which purpose a number of new and very large districts have had to be constituted.

The extent to which the Government's policy of conservation has been developed is gauged by the fact that there are at present eleven large conservation projects launched on the co-operative principle (that is, co-operative groups of farmers under the control and supervision of the Irrigation Department), which are either under construction or about to be commenced, and all are to be built by means of loans approved by Parliament. These loans aggregate  $2\frac{1}{4}$  million sterling, and the rateable area of irrigable land to be served by these schemes amounts to 88,000 morgen. Altogether the total amount of public money which, since 1914, Parliament has agreed to invest in conservation schemes of this nature is  $3\frac{1}{2}$  million sterling, and the total area which will be irrigated by them is approximately 120,000 morgen.

#### ASSISTANCE TO FARMERS.

Further in the course of his report, the Director refers to the large number of cases in which informal advice on irrigation matters is given to farmers by circle engineers, which bears much indirect fruit tending generally to promote irrigation development. Reference is also made to the provision under Section 6 of the Irrigation Act for the furnishing of advice to bona fide farmers at very low fees. Since 1914 the number of cases in which professional advice was given to farmers and public bodies was 1062.

The enhanced price of material and the higher prices paid to drillmen have raised considerably the cost to Government of drilling, and it must be recognized that under existing conditions the assistance rendered to farmers (for which no increased charge is made) in this very important matter is substantial. Generally, the operations of the boring branch were adversely affected during the year by shortage of technical staff and the high cost of tools and consumable stores. The influenza epidemic, combined with comparatively early rains in September 1918, was principally responsible for a diminished demand for boring from farmers, but nevertheless during the year 252 boreholes were completed for farmers, municipalities, and the Railway Administration, the average depth being 138 feet, an increase of 21 feet on the previous year; the average daily yield per borehole increasing from 19,000 to 24,800 gallons, indicating that better results may generally be expected from deeper boring.

It may be mentioned that, according to information received from the Irrigation Department, the interesting fact is established that the success of the boring branch has been marked, for of all the drilling operations undertaken by it something like 10 per cent. only have been failures.

The report deals in detail with the various matters falling under the jurisdiction of the Irrigation Department and with the many schemes on which it is now employed. It affords a comprehensive view of irrigation enterprise in South Africa, a subject of arresting interest to a country of uncertain rainfall and of vast extents of arid land.

---

### PURE-BRED STOCK IMPORTED.

The following is a return of pedigree stock imported (freight free) in terms of the S.A. Ocean Mail Contract since its commencement in October, 1912, to 30th June, 1920:—

BREED.	<i>Cattle.</i>				TOTAL.
	PERIOD.				
	Oct., 1912— 31/3/17.	1/1/17— 31/3/18.	1/4/18— 31/12/18.	1/1/19— 30/6/20.	
Shorthorn ... ..	1057	129	81	22	1289
Devon ... ..	434	14	3	12	463
Ayrshire ... ..	268	13	17	—	298
Aberdeen-Angus ... ..	228	70	40	4	342
Friesland ... ..	247	—	—	—	247
Hereford ... ..	87	36	15	4	142
Lincoln ... ..	80	8	1	—	89
Red Poll ... ..	66	9	5	1	81
Sussex ... ..	29	13	2	2	46
Jersey ... ..	29	1	—	—	30
Holstein ... ..	26	—	—	—	26
Kerry ... ..	12	—	—	—	12
Brown Lewis ... ..	14	—	—	—	14
Longhorn ... ..	9	2	—	—	11
Netherlands Horned... ..	6	—	—	—	6
Galloway ... ..	—	—	5	—	5
Guernsey ... ..	—	1	—	—	1
Swiss and others ... ..	26	—	—	—	26
Totals ... ..	2618	296	169	45	3128

### *Other Animals.*

HORSES.		SHEEP.		PIGS.	
Breed.	No.	Breed.	No.	Breed.	No.
French ... ..	19	Cotswold ... ..	2	Large Black ... ..	95
Clydesdale ... ..	74	Shropshire ... ..	127	Berkshire ... ..	98
Suffolk ... ..	11	Suffolk ... ..	42	Tamworth ... ..	6
Hackney ... ..	79	Wensleydale ... ..	58	Royal Ulster ... ..	3
Hunter ... ..	11	Hampshire ... ..	8	Lincoln ... ..	2
Shire ... ..	22	Lincoln ... ..	43	Other Breeds ... ..	23
Percheron ... ..	16	Dartmoor ... ..	4		
Oldenburg ... ..	2	Oxford Down ... ..	12		
Welsh ... ..	11	Dorset Horn ... ..	22		
Yorkshire Coach ... ..	8	Blackface ... ..	5		
Cleveland ... ..	1	Romney Marsh ... ..	157		
Other Breeds ... ..	94	Cheviot ... ..	2		
Jackasses ... ..	4	Border Leicester ... ..	14		
		Byeland Flock ... ..	10		
		Radfield ... ..	6		
		Coombe Dark ... ..	1		
Total ... ..	352	Total ... ..	513	Total ... ..	227

## THE POULTRY YARD MONTH BY MONTH.

By J. J. JORDAAN, Lecturer and Instructor in Poultry, Glen, Orange Free State.

### October.

*Incubation.*—This is the last month of the year in which it is advisable to hatch chickens. Goslings, turkeys, and ducklings may still be hatched, but young ones must have ample shade and dry sleeping quarters. Infertility and an over large percentage of "dead in shell" may be accounted for, to a large extent, by the male bird being exhausted. Try replacing him with the reserve bird in the breeding pen.

*Eggs.*—Sell all the settings of eggs possible; a reduction in price will often help in this direction. Although some of the poultry breeders who sell at fancy prices condemn this method, it certainly pays better to sell settings at half-price than at the price of new-laid eggs at this time of the year. The industry is, as a matter of fact, advanced by such sales at a reduced price to farmers and others who, availing themselves of the reduction, obtain a better class of poultry and thereby increase their egg output, yet do not become serious competitors to the breeder later on. Waterglass all supplies of surplus eggs if prices are unreasonably low.

*Feeding.*—See that all food and drinking vessels are kept scrupulously clean. Add just enough permanganate of potash to the drinking water to make it slightly pinkish in colour. Heating and stimulating foods, such as mealies, kaffir corn, and barley, affect the liver, and should, therefore, be fed sparingly.

*Chickens.*—Before retiring to rest see that your small chicks are safe and in no danger of being flooded out during the night. Thunderstorms come up unexpectedly at this time of the year. Dampness, chill, and sudden changes in the temperature are liable to set up white diarrhoea in small chicks.

*Disease.*—Be on the lookout for chicken-pox and roup, and on the first signs of any outbreak take stringent measures. In the case of chicken-pox isolate the sick bird at once. Give each of the other chicks a small sulphur pill as large as an ordinary size bean. Spray the sleeping quarters, and, if possible, remove the birds to a fresh run. Give liberal supply of green food. The sick bird should have the sulphur pill and a dose of epsom salts besides; feed on soft food and greens. In giving epsom salts, 1 teaspoonful to a tablespoonful of water is the dose for all adult birds; young birds in proportion.

Wash the face and head or affected part with a strong solution of permanganate of potash; break off the crust from the wart and drop in one or two permanganate crystals. Another treatment is to wash head and face, etc., with a mixture of equal parts vinegar and water and rub on carbolic vaseline. In two or three days the bird is usually fit to be returned to the run. The treatment in regard to roup is similar as regards feeding and isolation. In addition, night and morning give the sick bird one grain tabloid of "ammoniated quinine," wipe the face and nostrils with an old rag, and wash with sulphate of copper solution (one ounce dissolved in a pint of water). If it does not recover by this treatment in four or five days then destroy it.

*Breeding Pens.*—In many cases breeding pens can still be sold, especially tested ones; these should be advertised for sale. Beginners should watch for these chances and buy proved breeding pens.

---

## CORRIGENDA.

August, 1920, issue of *Journal* (Vol. I, No. 5), page 508.

The Market Master, Kingwilliamstown, states that the market prices for beef and mutton at that centre should read Beef 7d. to 10d., and Mutton 9d. to 1s., instead of as advised and printed originally.

## THE VEGETABLE GARDEN.

October, 1920.

By H. B. TERRY, Cert. R.H.S., Lecturer in Horticulture, School of Agriculture, Potchefstroom.

TAKEN on an average the present spring season may be considered an early one; sowings may be made of all summer crops, though it would be wise to omit Broad Beans, Turnips, and Cauliflowers at this stage.

**BEANS (DWARF).**—Canadian Wonder, Wax Podded, Everbearing, Sugar Beans, Stringless, Natal Red, White Kidney, etc., may be sown in drills 15 to 18 inches apart; 5 to 8 lb. of seed required per acre. These dwarf kinds are usually ready for table in eight weeks. Soaking the seed hastens germination.

**BETROOT.**—Make a good sowing of Eclipse, Egyptian, Crosby's. The rows need only be 20 inches apart; thinning the seedlings out to 6 inches in the rows materially assists the crop.

**CABBAGE.**—Sow Surehead, Castle, Mammoth, Early Offenham, to transplant end of November for first crop. Grow seedlings in rich soil to force them along all the time and so ward off attacks of aphids.

**CARROT.**—Continue to sow for succession; water freely, and keep down weeds to ensure a tender crop.

**CELERY.**—Early plants may now be planted in trenches.

**CUCUMBER.**—General sowings may now be made, either in clumps of three or singly in rows.

**EGG PLANT.**—Should be sown or transplanted 3 feet apart each way. This is a delicious vegetable when sliced, fried in butter, and served with raw tomatoes.

**LEEKs.**—Transplant all available seedlings and sow another small lot to follow on.

**LETTUCE.**—To be successful this must now be grown quickly. Iceberg, Neapolitan, Continuity, Boston, etc., are suitable cabbage varieties.

**MELONS.**—Sow Watermelons and Sweet Melons. Keep the soil moist and clean; watch for cutworms.

**MEALIES.**—Sweet Corn should be sown largely; do not put in too much at one time; sow fortnightly.

**ONIONS.**—Plant out all available seedlings. Autumn-sown crops should now be forming bulbs; plenty of water is necessary to enable them to develop fully. Sow Early Golden Globe, Prizetaker, Australian Brown, Ailsa Craig.

**PARSNIPS.**—Hollow Crown, Student, Gearnsy are useful sorts to sow now. The soil must be deep and well worked.

**PEAS.**—Sow a main crop of Black-Eyed Susan. As a rule the summer heat is too great for other varieties.

**PUMPKINS.**—Make a large sowing of good long-keeping varieties.

**SQUASHES,** such as Custard, Long White, Long Green, Bush, and Hubbard are useful summer sorts.

**TOMATOES.**—Early raised plants may now be transplanted in almost every district. The plants come into bearing much earlier if staked and the laterals are pinched out from the axis of the leaves.

**RADISH.**—Sow French Breakfast, Turnip Rooted for succession; grow these quickly and use when ready, otherwise they bolt to seed.

**POTATOES.**—Plant tubers for main crop now; give liberal supplies of manure; keep a lookout for any sign of leaf blight and spray with bordeaux mixture.

**HERBS.**—Herbs of all sorts should be divided and replanted without further delay.

**SPINACH.**—Where the ordinary sorts are difficult to cultivate, New Zealand spinach will be found very successful. It should be sown 2 feet apart in drills; later, thin out seedlings to 1 foot apart. The young growths may be continually cut for use throughout the summer.

## NOTES FROM THE "GAZETTE."

Attention is drawn to the following matters of interest which appeared in the *Union Government Gazette*:—

(Abbreviations: "Proc."—Proclamation; "G.N."—Government Notice.)

*Gazette.*

No.	Date.	ITEMS.
1084	13/8/20	Under the Scab Regulations, the Matatiele Commonage has been withdrawn from the restriction of movements of sheep imposed by Government Notice No. 1268 of 1914, as from 9th August, 1920. (G.N. No. 1414.)
1084	13/8/20	The protection granted to portions of the districts of Middelburg and Richmond under the Scab Regulations (G.N. No. 619 of 1919) has been extended to include a number of farms in the Murraysburg and Graaff-Reinet districts. (G.N. No. 1415.)
1084	13/8/20	A portion of the Lusikisiki Forest Reserve, called the Ntsubane (6.2) Extension, is to be a demarcated Forest. (G.N. No. 1417.)
1084	13/8/20	Mr. I. P. J. du Plessis, B.A., M.Sc., of the Grootfontein School of Agriculture has been appointed, in terms of the Dairy Industry Act (No. 16, 1918), to test, for accuracy, all test bottles, pipettes, and measuring glasses used in connection with the testing of milk and cream. (G.N. No. 1422.)
1084—	13/8/20	Mr. Thos. Douglas' portion of the farm Witkoppen No. 141 has been declared by the Minister of Agriculture, for purposes of paragraph (a), Section 16, of the Diseases of Stock Act, to be in the Witwatersrand District. (G.N. No. 1448.)
1084	13/8/20	Compulsory dipping of cattle in the three-day dip has been ordered by the Minister of Agriculture for portions of the Barberton, Pretoria, Piet Retief Districts, and in the five-day dip for portions of the Paulpietersburg, Estcourt, Babanango, Richmond, and Umvoti Districts. (G.N. Nos. 1450, 1491, 1554, 1593.)
1088	20/8/20	
1090	27/8/20	
1092	3/9/20	
1084	13/8/20	On account of outbreaks of East Coast fever thereon, various farms in the Districts of Barberton, Pretoria, Paulpietersburg, Weenen, Estcourt, Umzimkulu, Richmond, Umvoti, and Piet Retief have been declared infected areas. (G.N. Nos. 1451, 1493, 1555, 1592.)
1088	20/8/20	
1090	27/8/20	
1092	3/9/20	
1084	13/8/20	Stock brands allotted and registered during the quarter ended 30th June, 1920, in terms of Great Stock Brands Ordinance (No. 15 of 1904, Transvaal), are published. (G.N. No. 1454.)
1084	13/8/20	Crown lands in the Divisions of Malmesbury and the Cape will be offered for sale by public auction at Malmesbury, in front of the Public Offices, at 11 a.m., 22nd October, 1920, and at Capetown, outside the Civil Commissioner's Office, Adderley Street, at 10 a.m., 15th October, 1920, respectively. (G.N. No. 1429.)
1087	19/8/20	The Land Settlements Acts (Nos. 12 of 1912 and 23 of 1917) have been amended in regard to advances to groups of lessees for implements, stock, etc., cost of boring operations, and in other respects. (Act No. 28 of 1920.)
1088	20/8/20	A stock rate has been imposed by the Governor-General on every native person in the District of Tsolo in respect of each head of cattle in his charge on 1st July, 1920. (G.N. No. 1460.)

(Abbreviations: "Proc."—Proclamation; "G.N."—Government Notice.)

*Gazette.*

No.	Date.	ITEMS.
1088	20/8/20	Semi-protection, under the Scab Regulations, has been extended to certain locations in the Mount Fletcher District, and for which purpose they have been added to the Maclear District. (G.N. No. 1484.)
1088	20/8/20	A further list of brands registered in the Cape Province is contained in G.N. No. 1492.
1088	20/8/20	The proposed resumption of possession by the Government of Gertsakraal Outspan, in Steytlerville, and of Compagniesdrift Outspan, in Stellenbosch, is notified in G.N. Nos. 1468 and 1488.
1090	27/8/20	The private forests or plantations, the property of the Potchefstroom Municipal Council, and situated in the Potchefstroom town lands, are to be brought under the operation of certain portions of the Forest Act, No. 16 of 1913 (G.N. No. 150), as are also the forests and plantations on the private property known as Kraaibosch, in the Division of George (portions A, B, C, and D). (G.N. No. 151.)
1090	27/8/20	The Gwatju Ward of the Queenstown district has been withdrawn from the list of East Coast fever areas published in G.N. No. 558 of 1912. (G.N. No. 1533.)
1090	27/8/20	Agricultural lots in the township of Douglas, Division of Herbert, will be offered for sale by public auction on Saturday, 6th November, 10 a.m., in front of the Court-house, Douglas. (G.N. No. 1535.)
1092	3/9/20	Regulations under the Dairy Industry Act (No. 16, 1918), for the proper branding of butter, butter substitutes, and margarine in cases or packets, and of cheese in crates or boxes, are contained in the Schedule to G.N. No. 1565.
1092	3/9/20	Under the Agricultural Pests Act, No. 11 of 1911, the regulations, published in G.N. No. 366, 1912, have been amended by the inclusion of seed maize and seed barley, as far as the fees in respect of disinfecting consignments from overseas are concerned. (G.N. No. 1575.)
1092	3/9/20	An amendment of the regulation of the size of boxes to be used in the export of naartjes is published in G.N. No. 1577.
1092	3/9/20	Owing to the retirement of Mr. F. B. Smith, C.M.G., Secretary for Agriculture, and the absence of Mr. P. J. du Toit, Under-Secretary for Agriculture, on the Civil Service Commission of Inquiry, the following temporary appointments are published: Mr. G. N. Williams, D.S.O., to perform the functions of Secretary for Agriculture in regard to Vote 27, "Agriculture," Mr. F. W. Green to act as Under-Secretary for Agriculture, and Mr. M. v. Niekerk to act as Chief Clerk. (G.N. No. 1501.)
1092	3/9/20	Compulsory dipping of sheep and goats for portions of the Williston and Kenhardt districts, and the period within which such dipping is to be completed, is published in Government Notice No. 1594.
1092	3/9/20	Special regulations for the control and management of the Crown forests in the Transkeian Territories, involving the removals of forest produce, depasturing of cattle, areas closed to grazing, etc., are published in G.N. No. 1605.
1092	3/9/20	The Minister of Agriculture has declared the area described in the Schedule to G.N. No. 358 of 1920 as a proposed demarcated forest, to be now the demarcated Tonti Forest. (G.N. No. 1606.)
1092	3/9/20	Applications for Crown farms in the Divisions of Kuruman and Gordonia will be received by the Secretary for Lands, Pretoria, up to the 15th October. They will be disposed of on conditional purchase lease. (G.N. No. 1607.)
		Crown holdings in Ermelo, Standerton, Bethal, and Vrede Districts are also to be disposed of on conditional purchase lease, to be applied for before 15th October, as above. (G.N. Nos. 1608 and 1609.)



## SOUTH AFRICAN PRODUCE ON THE OVERSEA MARKET.

Extracts from Report of the Trade Commissioner.

July, 1920.

*Wool.*—The wool market during the past month has been very depressed, and of the 7000 bales of South African wools offered at public auction on the 19th July only 430 bales were sold, although I understand a few hundred bales were disposed of privately after the auctions. At the auction of Government-owned Australian wools on the 6th to 16th July, want of confidence on the part of buyers was most noticeable, and withdrawals were frequent, medium and inferior wools at times being quite unsaleable. Since the London auction sales of Government-owned wools have been held at Liverpool, Hull, and Antwerp, but large quantities were withdrawn, and the market still shows a downward tendency.

*Mohair.*—According to brokers' reports, the demand during the past week has shown no signs of improvement, and very few transactions have taken place. Many holders appear anxious to reduce their stocks, and consequently prices tend to weaken. There is a complete absence of mohair yarn orders, with little to no likelihood of any improvement in the near future.

*Hides and Skins.*—Auction sales were held during the past month, but the result was most disappointing, and hardly any transactions took place. At the time of writing the market is stagnant. The situation on the Continent is having an adverse effect on the trade, and supplies of hides now in the United Kingdom are more than the home trade can absorb.

*Sheepskins.*—The market is, to some extent, affected by the wool position, and transactions are few and far between, and any demand is mainly for combing wools, at a basis of value equivalent to about 2d. per lb. below that of the May auctions. At the auctions held on the 16th July, combing wools were in request at the above rate, but long wools were not wanted and declined about 3d. per lb., or even more.

Short and shorn were very weak, whilst lambs damaged wools and coarse-woolled skins were not in request.

There was only a very small demand for Common Cape Glovers Skins at the recent auctions. A few of the better grades were sold, but by-sorts and damages were neglected. The nominal decline, according to brokers' reports, was from 40s. to 50s. per dozen.

*Hattle Bark.*—The market is very quiet, and chopped bark is being offered at £15 per ton *ex* store. Large quantities, I understand, are in store either at London, Southampton, or Liverpool, and until these are worked off there does not appear any immediate likelihood of prices showing an upward tendency.

*Ostrich Feathers.*—The market during the month was on the quiet side, but a small amount of business was transacted at about previous rates. According to the brokers the demand generally has been for medium quality wings, which are needed for present requirements, whilst there has been some inquiry for coloured feathers of all descriptions.

*Maize, Barley, and Outs.*—The following "Baltic" report of the 5th August indicates the position of the market: "Maize opened easier, but closed steadier, the market having a better feeling in view of the fairly good demand for Government stock, La Plata *ex* store selling at 66s., and to South Coast ports at 65s. For parcels of La Plata *c.i.f.* August-September 60s. 6d. has been paid, and 60s. for September-October. A cargo of Galatz/Foxanian, August-September, is held for 67s. Bristol Channel is bidding 62s. 6d. for La Plata parcels July-August. Barley quiet and easier, with only a small trade done in No. 3

Canada Western to Glasgow and No. 4 to Avonmouth at 76s. for the former port July-August, and 68s. the latter August-September. Oats firm, and again dearer owing to scarcity. La Plata 42 lb. June-July made 52s., while for f.a.q. afloat 52s. 6d. and 53s. has been paid, 48s. 9d. for July-August and 47s. 9d. for August-September."

NOTE.—Prices quoted as per quarter.

*Meat.*—Shipments of South African meat continue to reach the market here, the condition on arrival being good, but the quality continues mixed. The trade during the past month has been rather slow, and prices for hind-quarters have ranged from 5s. 8d. to 6s. 8d., whilst forequarters have made from 3s. 4d. to 4s. 4d. per stone (8 lb.), according to quality.

*Raisins.*—The new crop of Valencias is estimated at some 6000 tons, but this is subject to modification. A few parcels of Australian and Cape arrived during the last few weeks, and the quality is excellent, but the demand is a little checked by the high prices. Cape raisins are quoted at 120s.

*Jam.*—Shipments of this season's South African jam have for some time past been reaching this market, and from reports received the condition and quality are quite satisfactory, and the demand is steady.

*Crayfish.*—Shipments of crayfish have recently arrived in good condition and are meeting an improved market. Prices range from 90s. to 105s. per case. The bulk of the supplies have, as usual, gone forward to France.

---

## OVERSEA PRICES OF SOUTH AFRICAN PRODUCE.

---

### MARKET PRICES OF SOUTH AFRICAN PRODUCE IN THE UNITED KINGDOM, CABLED BY THE TRADE COMMISSIONER, LONDON, ON 10TH SEPTEMBER, 1920.

---

*Wool.*—5955 bales free South African wool offered August sales. Competitions much better than two previous sales. Prices showed advance from par to 5 per cent. on considerable quantities offered.

[A Reuter message dated 4th September, appearing in the Press, states that the seventh series of Colonial wool sales closed that day. Of 94,000 bales catalogued 25,000 were withdrawn, 25,000 were exported to the Continent, and 2000 went to America. The attendance was good throughout, and there was strong competition for all Merinos showing quality.]

Continental buyers operated much more freely as compared with the July sales. Merinos were 5 to 15 per cent. higher.

Fine cross-breds were in good demand at an average advance of 5 per cent. at the beginning of the series; they weakened somewhat later, and are now quoted at par for better sorts, while top making styles are 5 per cent. lower.

Of Cape wools 6000 bales were offered on importers' account. The best combing grease wools were quoted 5 per cent. higher, while other grades were nominally unchanged.

The prices of Australian scoured ranged from 15d. to 82½d., grease, 13d. to 72½d. Cape snow whites, 31d. to 80d.; and greasy, 12d. to 34d.—ACTING EDITOR.]

*Mohair.*—Transactions still few. Price favours buyers.

*Cape Hides.*—Dry salted, 1s. 0½d. to 1s. 9d. per lb.; Wet salted heavy, 1s. 2d. to 1s. 3d. per lb.; Light, 1s. 2d. to 1s. 2½d. per lb. nominal.

[A Reuter message of the 11th September states that hides at the Bermoudey auctions were firmer. At the sale of Cape hides 16,000 were offered but were not sold, although the sellers were willing to entertain reasonable offers. The leather trade has slackened.—ACTING EDITOR.]

*Cape Merino Sheep Skins.*—Combing wool, 1s. 3½d. to 1s. 7d.; long, 1s. to 1s. 2½d.; short and shorn, 9d. to 1s. per lb. nominal.

*Common Cape Glower Sheep Skins.*—Large, £6; medium, 90s.; light, 80s. nominal.

*Natal Wattle Bark.*—Chopped, £13. 10s.; ground, £15. 10s., stores, London.

*Astrich Feathers*.—Auctions held 6th and 7th September. Outstanding feature was sale of 320 cases Western Feathers without reserve; 1700 cases offered, 1000 sold, realizing approximately £81,900. Paris largest buyer, which should promise well for the future fashions. America demand small. Best quality white and feminas remain practically unchanged, seconds and thirds declined 10 per cent. to 15 per cent., common much cheaper. Byocks, 10 per cent. to 15 per cent. lower; Spadous, light, very firm; coloured, easier; Boos, blacks, drabs, floss, declined 15 per cent. to 20 per cent. Next sales, 7th February.

*Maize*.—South African No. 2, White Flat. Parcel 77s. 6d. to 80s. per quarter offered United Kingdom or Continental Ports. *La Plata Maize*.—August-September shipments 67s. 6d.; September-October shipments, 66s. 3d.

*Maize Meal*.—£18. 10s., possibly £18. 15s. can be obtained.

*Kaffir Corn*.—90s. per quarter offered.

*South African Beef*.—Hinds, 5s.; Fores, 3s. per stone 8 lb.

*Dried Fruit*.—[A Reuter cable dated 11th September states that dried fruit was selling well. The demand for Cape raisins was good, little remaining unsold.—ACTING EDITOR.]

---

#### MARKET PRICES FOR OTHER PRODUCE OF INTEREST TO SOUTH AFRICA.

*Cotton*.—August future closed at 20·33; September future, highest 21·18; closed 2nd September 18·98.

*Cotton Seed*.—Quiet. Bombay to Hull August-September shipments, £14 paid.

*Cotton Seed Oil*.—Spot Hull quoted Egyptian crude, 70s.; Bombay crude, 60s.

*Eggs*.—English, 45s.; Irish, 38s. to 40s.; Danish, 38s. to 42s.; Chinese, 31s. to 32s.; Canadian, 35s. to 36s. per long hundred.

*Bacon*.—Still controlled. Maximum prices £10. 4s. per cwt. for green Wiltshire sides in bales.

*Pork*.—Good market for imported frozen: worth approximately 10s. per stone.

---

## NOTES FROM THE DIVISIONS.

---

### VITICULTURE.

JULY being a wet month outside work was handicapped, but August was better, although we had a shower nearly every week-end. Many farms in the Darling, Malmesbury, Paarl, and Stellenbosch districts were visited on extension work. Thousands of American stocks and scions were distributed from Constantia, Paarl Viticultural Station, and Elsenburg. Of the table grapes over fifty varieties were distributed, "Rosaki" and "Gros Colman" being the chief grapes in demand. There was quite a demand for the "Donzillinho de Castallo" and "Donzillinho de Gallego," although really grapes for port wines: on account of their ripening very early and having a pleasant taste, with a faint "Muscadell" flavour, they may yet prove valuable as table grapes for the local market. I should like to draw exporters' attention to the "Barlinka," as there was only a small demand for them. This grape is late, and can be left long on the vine. It is known to travel well. On account of its dark colour it has a better chance on the London market than the "Raisin Blanc," which is a white grape, and mostly planted to have something late. Export agents point out, also, in their circulars that our white grapes did not do so well late in the season because they had to compete with the coloured hot-house grapes.

The cultivation of vineyards is now in full swing. The pruning was finished early in August. Grafting is also going on. At Elsenburg some grafted vines were stratified in boxes, into which the vines were packed with a mixture of two-thirds sawdust and one-third charcoal. These boxes were placed in a stable, and after three weeks they were nicely callused at the place of union between scion and stock, whereas those stratified in the ordinary way outside showed no signs of callus.

Seven new experimental plots of grafted vines were laid out in the Robertson, Worcester, Stellenbosch, Paarl, and Malmesbury districts. In co-operation with farmers, certain grapes grafted on "10-12" varieties of American stocks, were planted on the farms to ascertain which stock is the best for certain soils, climate, etc.

### HORTICULTURE.

Everything augurs well for a bumper crop of all kinds of fruits in the Western Province. The ground has received the best soaking it has had for years, and deep-rooted cultures will benefit greatly if good cultivation is practised. Boxwood supply is the bugbear of the situation, and large numbers of pine trees are being cut down for the purpose. Hugh areas of fruit trees and vines are being planted, especially in the Stellenbosch, Paarl, Wellington, Ceres, Drakenstein, and French Hoek areas. Apricot culture is receiving special attention. Practically all the nurserymen are sold out of this particular line. Farms are changing hands at a rapid rate in the above-mentioned districts at almost fabulous prices. A prominent fruit grower is turning out first-class fruit export and lug boxes from his own forests planted twenty years ago. He has also nullified the effects of lemon rot by regularly spraying packs, houses, and boxes with an effective solution of formalin.

At the Docks citrus export is in full swing. That some of the packers of oranges have still much to learn is evident when one sees the loose packs, the excessive bulges, and the absence of hoop-iron strapping round the centres of the boxes.

A great many of the earlier oranges shipped should not be picked for export, and something will need to be done next season to prevent them going overseas. A considerable amount of fruit from certain areas were frosted and a good deal dried out. Some of the Rustenburg packs which came forward in bad condition last season were first class this season, owing to more supervision exercised in orchard and pack-house. A large proportion of the celebrated Clanwilliam oranges showed ten to twenty per cent. waste on arrival at docks, the reason probably being excessive winter rains.

With an ample supply of boxes and available shipping for next season, the citrus export should make a big forward movement.

### AGRICULTURAL CO-OPERATION.

At no period in the history of the co-operative movement in this country has such keen interest been displayed in the subject of agricultural co-operation as at the present time.

Although the operations of this Division are as yet confined to the establishment, registration, and control of co-operative agricultural societies in the Transvaal and Orange Free State Provinces only, letters are received from all parts of the Union, requesting information as to the steps to be taken for establishing co-operative societies, and the general principles underlying the formation of such organizations. During August last no less than six applications were received for the registration of societies in different centres of the Transvaal and Orange Free State Provinces. One new society, having as its main objects the disposal of members' produce and the supply of agricultural implements, was registered in the Orange Free State during August, with an initial membership of 52. This society is established in one of the best wool districts of the Province, and it is expected that before long many more farmers will join; with good management there is every reason to believe that the society will prove a success. Another recently established general produce and supply society commenced active operations in the beginning of the month, and its prospects, too, are very promising. Meetings have already been convened for the formation of three other similar societies, which will probably also be registered in the near future.

As an indication of the development of the movement, it may be mentioned that during August 523 farmers were enrolled as members of the existing societies operating in the Transvaal and Orange Free State.

From information to hand it may safely be said that the total turnover in maize of the existing societies during the present season will be far greater than that of any previous season.

## RECENT AGRICULTURAL LITERATURE.

By PAUL RIBBINK, Librarian, Department of Agriculture.

### I.—UNION GOVERNMENT PUBLICATIONS.

#### A.—DEPARTMENT OF AGRICULTURE.

(Bulletins obtainable from the Department of Agriculture, Pretoria.)

<i>Price per copy.</i>		<i>Number of Publication.</i>
1s. 6d.	The Wool Industry. A Report on Investigations in the Wool Industries of Great Britain and the United States of America, with a view to the Betterment of the Industry in South Africa.	Bulletin No. 4/1920.

#### B.—MISCELLANEOUS REPORTS, ETC., OF INTEREST TO FARMERS.

(Obtainable from the Government Printer, Pretoria.)

3s. 6d.	Advisory Board of Industry and Science: Report for the Year 1919.	U.G. 43—'20.
10s. 6d.	Estimates of the Expenditure to be defrayed from Revenue Funds during the Year ending 31st March, 1921 (excluding Railways and Harbours).	U.G. 6 & 49—'20.
3s. 0d.	Factories and Labour Divisions of the Department of Mines and Industries: Annual Report for the period 1/5/1919 to 31/12/1919 and 1/1/1919 to 31/12/1919, respectively.	U.G. 42—'20.
6s. 6d.	Police: Report of the Commissioner for the Year 1918...	U.G. 2—'20.
3s. 0d.	Postmaster-General: Report for the Year 1919 ...	U.G. 38—'20.
2s 6d.	Surveyors-General of the several Provinces of the Union: Reports for the Year 1918.	U.G. 41—'20.

## II.—THE AGRICULTURAL PRESS OF SOUTHERN AND TROPICAL AFRICA.

#### SELECTED ARTICLES.

*Die Boer* (Byvoegsel tot *De Volkstem*), Pretoria.

- 13/8/20 Dr. Theiler oor Lamsiekte.  
 20/8/20 Skapetentoonstelling, Sydney, Australië. Boer en Handel.  
 27/8/20 Kunsmissiowwe, deur C. R. van der Merwe.  
 3/9/20 Gallamziekte. (Polemiek tussen Dr. Hartig en Sir Arnold Theiler.)

*Die Boerevrou* (Posbus 984, Pretoria).

- 8/20 Iets oor Bye en Henning, deur G. R. von Wielligh. Hoe om Hoenders te Voer. Die Gemmerplant en wat daarvan kan gemaak word, deur Mev. Dr. van Wyk. Huismeubiler, deur Jeanette van Duyn.

*Farmers' Advocate, South African* (P.O. Box 247, Bloemfontein).

- 8/20 Official Milk Records. Industries and Agriculture. Dry-land Farming in Utah, by H. W. Turpin. The Holstein-Friesian of America, by W. A. K. Morkel.

*The Farmers' Journal* (Nairobi, B.E.A.).

- 22/7/20 Farmers' Taxes. Housing the Pig.  
 29/7/20 Farmers' Taxes. Milk Recording.  
 5/8/20 Notes on Sugar-making Machinery. Ramie Fibre Culture. How to Preserve Skins and other Trophies.  
 12/8/20 Agriculture in Rhodesia. Stump-pulling with Home-made Apparatus. Herd Testing in Australia. Natives' Work and Wages.

*The Farmers' Weekly* (Bloemfontein).

- 4/8/20 Vindication of the Dip. Birds as Scavengers, by F. W. Fitzsimons. Agriculture in our Schools, by G. Otto. East Coast Fever Inquiry.
- 11/8/20 Wool Manufacturing in South Africa, by J. P. MacLaren. Farming in South America: V, by E. A. Nobbs.
- 18/8/20 Johannesburg Municipal Market: Trading Results for Year ended 30/6/20. Agriculture in the South-West Protectorate. Grass Farming. Birds and the Balance of Nature, by F. W. Fitzsimons.
- 25/8/20 Notes on Cotton Growing, by Gossypium. Federated Farmers' Co-operative Association: Report on Meeting of 1st July, 1920, at Durban. Farming in South America: VI. Meat Packing, by E. A. Nobbs. Export of Frieslands.
- 1/9/20 Droughts and how they are Caused, by C. K. Hall. A Farm Dwelling-house, by W. S. H. Cleghorne.

*The Independent* (Salisbury, Rhodesia).

- 30/7/20 The Maize Outlook, by "Ager." Handling Cattle.
- 6/8/20 Insure the Cattle Industry. Beef for Export, by C. S. Jobling.
- 13/8/20 Be Up and Doing (on the Establishment of a Veterinary Research Laboratory for Rhodesia). Beef for Export (*continued*). The Salisbury Show: Amazing Maize.
- 20/8/20 Nature Study, by F. Eyles. The African Cattle, by A. G. S. R. The £15,000 Scheme. A Bacteriological Laboratory for Rhodesia. Veterinary Research Address, by Mr. Bevan.
- 27/8/20 The Meat Industry. Food Preserving. Veterinary Research: Address by Mr. Bevan (*continued*). Grow Wheat. The Old Days (*continued*). The 1890 Column.

*Die Landbouwer* (Posbus 1035, Pretoria).

- 8/20 Onse Landboutentoonstellings. Die Skaapboerdery, deur T. P. van der Walt. Bewerke van Teffhooi. Losmaak van ondergrond met Dinamiet (*vervolg*).

*Die Landbou Weekblad* (Posbus 267, Bloemfontein).

- 4/8/20 Die Heilige Aarde, deur L. H. Bailey. Dorre Suidafrika, deur J. D. Schonken (*vervolg*). Tjikorie Verbouing, deur G. Bosman. Die Kunsmatige Vermeerdering van Byekolonies (*vervolg*). Landbouonderwys in die Skool, deur G. J. Otto.
- 11/8/20 Landbouteostande in Rhodesië: V, deur G. Jordaan. Dorre Suidafrika, deur J. D. Schonken (*vervolg*).
- 18/8/20 Skaapboerdery in Australië, deur T. P. van der Walt (*vervolg*). Dorre Suidafrika, deur J. D. Schonken (*vervolg*). Lamsiekte, deur Dr. Arnold Theiler.
- 25/8/20 Profyt in Boerdery in Suidafrika. Ko-operasie, deur Dr. J. E. Holloway. Landbouopvoeding in die Skool, deur F. Geldenhuys. Suidafrikaanse Rysmiere, deur C. Fuller.
- 1/9/20 Landbouteostande in Rhodesië: VI, deur G. Jordaan. Dorre Suidafrika, deur J. D. Schonken (*vervolg*). 'n Boek oor Boerdery in Afrikaans: II (*vervolg*). Voedsel vir die Plaasdier.

*Mitteilungen der Farmwirtschafts-Gesellschaft für Suedwestafrika* (Post-sach 128, Windhuk, S.W.A.).

- 10/7/20 Eine Landplage, Paul Ritter. Karakuls, Gustav Voigts. Jahresbericht des "Verbandes" für 1920.
- 20/7/20 Der Wassermangel der Brunnen und seine Abhilfe, G. Dresselhaus. Ueber den weiteren Weg unserer Landesrinderzucht, H. Huettenhain. Lahmseuche oder Gallanziekte, Dr. R. Hartig.
- 1/8/20 Erfahrungen mit der Wunschelrute, R. Sarnow.
- 15/8/20 Tatsachen zur Eingeborenenfrage II. Die Kennzeichnung des Kleinviehs, Otto Henning. Harnsteine bei Ochsen, Dr. G. Schmid. Verwertung von Rückständen bei der Herstellung vom Fleischextrakt, Fr. Hirsch.

*The National Bank of South Africa, Ltd., Monthly Trade Report.*

- 31/8/20 South African Business and Prospects. Crops and Live Stock.

*The Rhodesia Agricultural Journal* (Department of Agriculture, Salisbury).

- 8/20 Statistics of Live Stock and Animal Produce for 1919. The Shows. Report of the Chief Veterinary Surgeon for 1919. Cultivation of Rice (*continued*). Report of the Veterinary Bacteriologist for 1919. Forestry in Rhodesia, by J. S. Henkel. Development of Flavour in Butter, by T. Hamilton. Manuring of Maize, by G. N. Blackshaw. Roundworm Infection of Calves, by H. E. Hornby. Poultry Husbandry, by A. Little.

*South African Dairyman* (P.O. Box 925, Durban).

- 8/20 Maritzburg and the Price of Milk. Feeding of Pigs. Simple Book-keeping. A Guide for Farmers.  
9/20 The Milk Producers' Union. The Neutralization of Acids and Alkalies, by P. L. de Klerk. Notes on Silage Making, by Farmer George. The Jersey Breed, by M. Sackville-West.

*South African Farm News* (P.O. Box 963, Johannesburg).

- 8/20 Farmers' Party.—Boere Party. S.A.U. Farmers' Party.—S.A.U. Boere Party. Herefords, by Farmer George. The Cattle Industry: V, by Bos.

*South African Fruit Grower and Small Holder* (P.O. Box 5958, Johannesburg).

- 8/20 Anthracnose or Zwart Roest of the Grape. Agriculture Elsewhere: the ex-German Colonies (*continued*), by F. H. Cooper. Mistakes in Lemon Cultivation (British East Africa), by A. E. Bester.

*South African Gardening and Country Life* (P.O. Box 3958, Johannesburg).

- 8/20 Carnation Growing in South Africa, by A. G. Murray. The Gables of Holland and the Cape, by Dorothea Fairbridge.

*South African Journal of Industries* (Government Printer, Pretoria).

- 8/20 The Prickly Pear (*Opuntia*): I, by Chas. F. Juritz, M.A., D.Sc. The South African Fisheries Survey, by H. Warington Smyth, C.M.G., M.A. An Oilshale Industry for South Africa, by T. G. Trevor. Sugar and Sugar Products, by W. Jex. Water-power in the Union of South Africa: I, by F. E. Kanthack, C.M.G. Iron and Steel Industry in the Union of South Africa: III, by Professor G. H. Stanley. Vegetable Fats and Oils: V, by Professor M. Rindl. South African Federated Chamber of Industries: II.

*South African Poultry Magazine* (Bloemfontein).

- 8/20 Poultry Keeping on Practical Paying Lines, by W. C. Archibald. The Breeding Season, by Utility. The Jungle Fowl and its Descendants, by Geo. R. Vivyan.

*South African Poultry Review and Small Holder* (Johannesburg).

- 9/20 An Embargo on Egg Export? All Utility and all Fancy: An American View. S. A. Poultry Association: Monthly Meeting of the Executive Board. Egg-laying Competitions: Results for July, 1920.

*South African Railways and Harbours Magazine* (Publicity Department, South African Railways, Johannesburg).

- 9/20 A Visit to the Belgian Congo, by P. A. Masters, South African Railways. Poultry Club: A Successful Week.

*South African Sugar Journal* (P.O. Box 925, Durban).

- 8/20 Sugar Raised to £51 per ton. A New Sugar Milling Company for Natal. Recent Aspects of the Natal Sugar Position. Sugar Industry in the Fiji Islands. Cotton on the South Coast.

*The Sun and Agricultural Journal of South Africa* (P.O. Box 634, Johannesburg).

- 8/20 Transvaal to Tangier: III. The Industries of Durban: Match-making. Maize Exhibits on Durban Show, by W. H. Scherffius. Cotton in Natal. Fertilizers for the Farmer. The Safco Factory. Maize Growing. The South African Maize Breeders', Growers', and Judges' Association.

*Sunday Times* (Farmers' Supplement), Johannesburg.

- 8/8/20 Cheddar Cheese, by D. Deenink. The Werribee Research Farm, by F. T. Nicholson. Castration of Domestic Animals: II, by A. Hodder.
- 15/8/20 The Apple, by J. M. Sim. Caprification of Smyrna Figs (*continued*), by I. Tribolet. British East Africa Coffee Growing, by W. S. Bromhead. Silo Construction, by S. G. Carlyle and J. McCaig. Maize Growing, by G. J. Bosman.
- 22/8/20 British East Africa Flax Growing, by W. S. Bromhead. Inbreeding, by J. H. R. Bisschop. The Mammary Glands of the Cow, by A. Hodder.
- 29/8/20 Tsetse Fly Disease, by A. Hodder. Caprification of Smyrna Figs, by I. Tribolet (*continued*). The Wheat Situation, by F. T. Nicholson.
- 5/9/20 Cultivation of the Osier. Planting Mealies, by G. J. Bosman. The South-West Protectorate: Farming and Ranching Prospects, by J. H. Hume. Exhibition of Maize, by P. J. Naude. Sheep in Australia, by F. T. Nicholson.

### III.—REVIEWS.

"*Farming for S. African Schools*," Book II, by the Reverend W. G. Dowsley, B.A., is among new publications received. This part deals with the Life of Farm Plants, Tobacco, Cotton, Sugar-cane, Insects, Bee-keeping, and Internal Parasites. The book is excellently illustrated and should be in the possession of every one interested in South African agriculture. It is published by De Nationale Pers, Bepkerk, Capetown.

*The Herd Book of the Friesland Cattle Breeders' Association of South Africa*, Volume I, has just made its appearance, and contains a record of all Friesland cattle approved and admitted for registry since the publication of Volume 12 of the S.A. Stud Book up to 30th June, 1919. The volume contains, besides the ordinary subject matter of a Herdbook, useful information on the constitution and rules of the association and an index to names of owners and breeders.

*The South African Shorthorn Herd Book*, Volume I, 1919, containing the pedigrees of C.H.B. and Lincoln Red males and females entered up to 30th June, 1919, is published by the Shorthorn Society of South Africa under the authority of the S.A. Stud Book Association. It includes, in addition to pedigrees, etc., the articles of association, rules, regulations, etc., and other useful information for breeders.

## AT THE SCHOOLS OF AGRICULTURE AND EXPERIMENT STATIONS.

### August, 1920.

#### CEDARA, NATAL.

*Climatic.*—The rainfall for the month (29th July to 26th August) was .05 inches. The mean maximum temperature was 67.92° F., and the mean minimum 43.95° F. The highest maximum temperature, 83° F., was registered on 26th August, and the lowest minimum, 37.8° F., on 4th August. Slight frosts were experienced on the 4th and 5th of the month.

*Crops.*—The oat forage crops are showing up well. The *Brassica* crops are being cut for green food. At present the veld looks parched, but is showing signs of fresh growth. Farming operations are now centred on the preparation of lands for the coming planting season.

*Field Experiments.*—Data for last season's experiments are now to hand and are being prepared with a view to the publication of results. The kikuyu grass is now showing rapid growth owing to the improving daily temperature and light rains. The tall fescue and cocksfoot have been adversely affected by the severe winter, but they promise renewed growth. *Rottboelia compressa*, an



indigenous grass, has wintered well in a dry area, and is now quite fresh and vigorous. Some new varieties of potatoes have been carefully nursed through the winter and are now responding well to improved weather conditions.

*Stock.*—Three Shorthorn calves were born during the month, one of these being a fine bull calf from the champion cow 32S. One of the calves was deformed and died shortly after birth. All the stock are in fairly good condition. The majority are being fed with silage.

*Horticulture.*—Pruning is now completed, and the trees have been given a dormant spray of lime-sulphur, 1 in 8. The pears were sprayed with a 1 in 30 mixture, as the buds are already expanding. Many of the peaches and the Keiffer and Le Comte pears are already well in bloom. The plums are just breaking. An experimental orchard for the testing of different varieties has been started, varieties showing greatest resistance to woolly aphis having been worked on French crab stocks.

*Chemical Laboratory.*—Most of the samples analysed in the laboratory this month were soils forwarded by farmers in order to ascertain the manurial needs. As usual, all the soils were distinctly acid in reaction and contained but a minute proportion of carbonate of lime. This shows that lime is a very important manure to supply the needs of Natal soils, and, although no startling improvement may be seen in the crop production in the first season, the beneficial effects of the continued application of lime will be apparent after a few seasons. It must be remembered, however, that the application of lime will not make up for the deficiency of any other constituents, such as phosphate or potash, but it will undoubtedly assist in rendering available any of these constituents that may be present in an insoluble form.

*Students.*—There were 59 probationers in residence at Cedara and 5 at Winkle Spruit at the end of the month.

---

#### ELSENBURG, MULDER'S VLEI, CAPE.

---

*Climatic.*—Mild weather prevailed practically throughout the month, and the rainfall was comparatively small—1.64 inches (26th July to 25th August), the normal average being over 4 inches. The maximum temperature recorded was 81.4° F. on the 24th instant, and the minimum 39.4° F. on the 12th.

*Field Operations, Crops, etc.*—The only crop sown during the month was rape, an additional 22 acres being put in. A large amount of "braaking" was effected, and about 150 acres of growing crops cultivated. The cereal crops, on the whole, are looking well. Approximately 60 acres of land were prepared for the sowing of mealies. The manuring, ploughing, and pruning of the vineyards were completed. At Mariendahl a further area of 8 acres was ploughed and subsoiled for the planting of vines. Pruning operations in the orchards were completed. All the deciduous fruit trees were sprayed with lime-sulphur, 1-15 and 1-10. About 3000 Redding olive seeds, 60 almond stocks, a number of fig cuttings, and plum and almond-rooted seedlings were planted.

*Live Stock.*—With the improvement of natural pastures the condition of the stock in general is improving, and the milk yield of the dairy herds shows a further increase. Thirteen cows of the Friesland herd are entered for the Advanced Registry. Orders for pure-bred pigs are increasingly numerous from all parts of the Union, and eight Large Blacks will shortly be dispatched to the South-West Protectorate.

*Experimental and Investigational Work.*—The experimental ranges, on the whole, are looking very well, particularly the "variety" plots. But certain ranges which were unavoidably planted rather late, notably the "Mixed Fodder" experiments, are backward, due to late planting and to the cold, wet nature of the soil.

Interesting observations are being made in regard to the following crosses: Berkshire boar-Tamworth sow, Berkshire boar-Large Black sow, Large Black boar-Tamworth sow, Large Black boar-Berkshire sow. In addition, many Berkshires and Large Blacks are being kept for straight breeding. Accurate records are being kept in regard to the prolificacy of the various crosses and pure-breds, the gestation and oestrus periods, and also the weights and feed consumption of all animals from time of weaning until of marketable age. The relative efficiency of the various types as "baconers" will also be determined.

Other investigations in regard to spraying, and soil and fertilizer problems are progressing satisfactorily.

*Extension Work.*—During the month there was the usual large demand upon the time of most of the officers in charge of the various sections for external work, mainly visits to farms in advisory capacity.

A number of soils was examined in the chemical laboratory in regard to the growth of Turkish tobacco, low productivity, "alkali" problem, etc.; a number of fertilizer and other materials was also analysed.

*The School.*—A new course in Apiculture has been started for both junior and senior students.

#### GLEN, ORANGE FREE STATE.

*General.*—The month was comparatively mild. A few duststorms were experienced; .65 inch of rain was registered on the 20th. There is still an abundance of grass, and the young grass is appearing as a result of the rain.

*School.*—The regular students returned from their midwinter vacation on the 10th. The total number of students in residence is 66.

*Building Operations.*—The new dairy will soon be completed, also three residences for the staff. Minor buildings, such as storeroom, bathroom, and calf pens were erected by the farm.

*Farm.*—Crops have improved considerably during the month. The greater area of the land intended for summer cultivation has been ploughed. Considerable maintenance work is just now being performed on the irrigation furrows.

*Live Stock.*—The stock all maintain their condition. Many animals are now stabled, including those which are to be offered for sale on the 14th proximo. Another heifer, "Glen Geertje," qualified for the Advanced Registry.

*Experimental.*—Winter experiments have been limited this year to variety tests only, and are looking very promising. The summer experiments will be extended to embrace various phases of the work.

*Entomological.*—This officer, together with the Lecturer in Horticulture, visited the orchards and gardens at Warrenton and Ritchie Settlements. As the plowholders at these places make their living almost exclusively by producing fruit and vegetables a considerable amount of useful work can be performed in the direction of proper pruning of trees and combating insect pests. It is proposed to follow up this work, and, in addition, include other settlements. The feeding habits of meerkats are also being investigated.

*Horticulture.*—The last of the pruning was done shortly after the return of the students. A considerable area has also been sown to vegetables.

#### GROOTFONTEIN, MIDDELBURG, CAPE.

*Climatic.*—Excessive drought conditions continue, high winds alternating with cold, and the condition of stock in parts is not what it should be at this season of the year. Heavy mortality in sheep is taking place on some farms, due to intestinal worms.

*Horticultural Section.*—Both orchards have been pruned during the month by the senior and the returned soldier students. Irrigation has also been conducted with a view to retarding the blossoming of the trees.

The diversity of opinion that exists as to the advisability of irrigation before blossoming of fruit trees has led to the following experiment this season to provide data as to the stage when most damage is sustained from late frosts:

Two plots containing trees of the same varieties of fruit have been treated thus: Plot 1.—Irrigated (flood method) when the buds started to swell. Plot 2.—Check plot not irrigated.

Soil thermometers have been placed in each plot, one each 2 feet, and one each at 4 feet below the surface of soil, to find the difference of temperature, for the lower the temperature the less likelihood of the trees blossoming. A blossoming record will be kept of the two plots, also percentages of fruit that set on selected branches of each of the varieties of fruit. These branches have been selected and the fruit buds counted.

*Farm Crops.*—Notwithstanding the adverse conditions that prevailed during the last two months in the form of high winds and severe frosts, fodder crops, consisting of 85 acres sown with various kinds of oats, made satisfactory progress.

*Agricultural Experimental Section.*—An area of 8 acres of the above is devoted to an experiment conducted with the view to establishing the relative values of (a) sowing in wet soil, with the proper dry surface mulch, and sowing

in dry soil and wetting afterwards to obtain germination. Both methods are to have the same treatment subsequently as to watering, etc.; (b) broadcasting *versus* drilling; (c) guano *versus* no guano. The soil contains a high percentage of lime, and owing to negative results in the past it is thought possible that the lime might neutralize the otherwise beneficial effect of the fertilizer; hence the comparative experiment.

All wheat, oats, and barley experiments are making good growth, a bird-resisting variety of wheat being foremost. Several root selections were made from the Chinese variety of lucerne; this variety is now about a foot high, and, although heavy frosts were experienced during the month it has not been affected. In the sheep-feeding experiment the Durum wheats and Cape rye are giving the most growth; cold weather has retarded (and in some cases killed) the barleys, rape, kale, and oats. Thousands of spineless cactus leaves have been cut for delivery in September.

*Dairy Section.*—The special dairy course students of this institution paid a visit to the Tweespruit Dairies and the Bloemfontein Creamery. Practical instruction was given in the manufacturing of cheddar and gouda cheese, the judging and grading of cheese, and the grading of cream. The visit was of great educational value to the men, who intend qualifying for responsible positions in factory dairies. The students also paid a visit to the municipal sewage farm. The operations dealing with the disposal of the sewage were closely followed, and information was elicited dealing with the crops raised, yield, etc.

*Chemical Section.*—Arrangements are in hand for the conduct of irrigation experiments at this institution, the chemical section collaborating with other sections interested in the work. During the last few months several samples of water have been submitted for analysis, with the complaint that they had proved injurious to crops. In every case the water was found to be "brak."

*Sheep Section.*—On the 26th of July thirteen special sheep and wool students accompanied Mr. Mellet, Government Sheep Expert, on the annual tour arranged in conjunction with this course, visiting various farms and the Stud Ram Sales at Bloemfontein.

*Poultry Section.*—Organized by the S. A. Railways Poultry Club, a highly successful "Poultry Week" was held at Johannesburg, from the 9th to the 14th of the month. It was the annual exhibition of poultry appliances and commercial products. Lectures and practical demonstrations were given daily by the Lecturers in Poultry from the Agricultural Schools at Potchefstroom, Glen, and Grootfontein. Some 3300 people attended, evidence of the public's interest.

#### POTCHEFSTROOM, TRAFSVAAL.

*Climatic.*—Mild weather was experienced during the month, the absolute maximum temperature registered amounted to 83.5° on the 29th. The absolute minimum reached 27° on two days, the 5th and 16th respectively. A few degrees of frost were registered on five nights only during the early part of the month. The weather was overcast on several days, but no rain fell. Severe winds from the north-west were experienced during the latter stages of the period under review. Scarcity of irrigation water has become apparent very early this season.

*Farm Section.*—Some 12 acres of black soil were ploughed, disk-harrowed, sown to oats and vetch, and rolled. This crop was sown as an experiment to provide grazing for sheep in the early spring. This black soil has broken down remarkably well; 60 acres under lucerne have been cultivated with Lucerne King Cultivator.

Top-dressings of Government guano were applied early in the month to the crops of wheat and oats. All the winter cereal crops have been irrigated and subsequently harrowed. A small piece of ground near the farm buildings, to be sub-divided and fenced in for pig camps, has been sown to lucerne. There is promise of a good stand. 160 bags of maize were thrashed. Owing to the scarcity of bedding a large quantity of veld grass was cut on a neighbouring farm. Other farm operations consisted of fencing, road-making, sorting and grading of seed maize.

*Live Stock.*—Cattle are maintaining their condition well. Breeding cows of beef breed have run on mealie stalks and have been fed on mangels. They are in good condition, but, unfortunately, owing to the drought of last year, a poor crop of spring calves is expected.

A consignment of 4 gelts and 1 boar of the Large Black breed was received from Elsenburg School of Agriculture, and also 2 sows and 1 Berkshire boar from the Laurenceford Estate, Somerset West, and the Tokai Reformatory Retreat. With this new blood it is hoped to considerably improve the class of pig bred here.

One cross-bred and three pure-bred calves were born during the month. One pure-bred calf died of sponsiekte, in spite of the fact that the animal was inoculated in December and again in April last. Since the above occurrence all young cattle have been reinoculated with double vaccine for sponsiekte.

*Experimental Section.*—The work consisted chiefly in irrigating, harrowing, stragening, and labelling of wheat plots in the variety trials.

*Staff.*—Mr. Dawson, a graduate from the Ohio University, assumed duty here as Experimentalist and Lecturer in Field Husbandry. The temporary services of Mr. F. J. Gibb have been obtained as Lecturer in Botany. A travelling instructor for the Transvaal Province, in the person of Mr. C. C. Rhodes, has been added to the staff of the Poultry Division.

## STAFF: APPOINTMENTS, TRANSFERS, ETC.

### (1) AGRICULTURE.

- 12/8/20 *S. T. Jackson, M.R.C.V.S.*: Appointed District Veterinary Surgeon and for the present stationed at Pretoria.
- 17/8/20 *Lloyd Worrall*: Appointed on three years' agreement as Instructor in the Tobacco and Cotton Division and stationed at Barberton.
- 3/9/20 *G. N. Williams*, Acting Under-Secretary, to act as Secretary for Agriculture; *F. W. Green*, Acting Chief Clerk, to act as Under-Secretary; and *M. van Niekerk*, Principal Clerk, to act as Chief Clerk.

### (2) AGRICULTURAL EDUCATION.

- 4/8/20 *Max Edelman*: Appointed Assistant Lecturer in Field Husbandry and Experimentalist, School of Agriculture, Cedara.

## MOVEMENTS OF OFFICERS.

*Mr. C. E. Gray*, Principal Veterinary Officer, has been granted three months' leave. During his absence *Mr. J. D. Borthwick*, Assistant Principal Veterinary Officer, will act as Principal Veterinary Officer.

Senior Research Officers *P. R. Viljoen* and *G. M. Robinson* sailed for Europe on the 17th September for purpose of special study.

*Mr. C. van Foreest*, Live Stock Officer, proposes visiting the Eastern Province of the Cape during the month of October for the purpose of lecturing to and advising farmers on cattle breeding. His itinerary will embrace Sterkstroom, Imvani, and other places on the railway line to East London.

*Mr. W. G. Mason*, Director of Training Farms, has been requested to pay a visit of inspection to the Government Experiment Farms in the South-West Protectorate, with a view to advising as to their organization and management. He will leave for Windhuk on the 3rd of October.

*Mr. W. O. John*, Lecturer in Poultry at the School of Agriculture, Elsenburg, has been seriously indisposed for some time, and is unable to attend to his usual duties. In the meantime *Mr. R. Bourlay*, Poultry Lecturer at the Potchefstroom School, will carry out the inspection of eggs for export, and has been seconded temporarily to Capetown for this purpose.

*Miss Rosalie Oosthuisen*, Government Overseas Scholar in Domestic Science, having completed a two-years' course in Canada, has returned to South Africa.

*Mesdames M. van Duyn*, *I. van der Merwe*, and *E. Ferguson*, who were granted Government Scholarships in Domestic Science at the same time as *Miss Oosthuisen*, are also expected to return shortly.

*Miss M. Davidtsh* and *Miss R. Fouché* have been offered an extension of their scholarships and will probably continue their studies in America for a year or two longer.

## MEAT STATISTICS.

### I.—RETURN OF BEEF INSPECTED AND PASSED FOR EXPORT, AUGUST, 1920.

Place.	Cattle.			Carcasses.		
	Inspected.	Rejected.	Passed.	Inspected.	Rejected.	Passed.
Durban ... ..	942	—	942	942	24½	917½
Pietermaritzburg ...	721	—	721	721	11	710
Pretoria ... ..	—	—	—	—	—	—
Johannesburg ... ..	255	—	255	255	—	255
Bloemfontein ... ..	—	—	—	—	—	—
Capetown ... ..	—	—	—	—	—	—
Port Elizabeth ... ..	—	—	—	—	—	—
Germiston ... ..	—	—	—	—	—	—
<b>TOTAL ... ..</b>	<b>1,918</b>	<b>—</b>	<b>1,918</b>	<b>1,918</b>	<b>35½</b>	<b>1,882½</b>

Beef actually exported during the month of August, 1920: Total, 4715 quarters (e.e Durban, 4305 quarters; e.e Capetown, 410 quarters).

Total shipments of Beef in quarters—

1916 ...	115,992	1918 ...	123,354	*1920 ...	42,144
1917 ...	309,214	1919 ...	285,367		

II.—OTHER MEAT EXPORTED\*: Pork, carcasses inspected and passed, 3169.

### III.—RETURN OF CATTLE IMPORTED INTO THE UNION FROM ADJOINING TERRITORIES.

Territory.	Imported August, 1920.	Total from 1st January, 1920, to 31st August, 1920.
	No.	No.
For Slaughter—		
Rhodesia ... ..	4,352	20,021
Bechuanaland Protectorate	1,696	13,724
S.W. Africa ... ..	1,757	8,988
Swaziland ... ..	180	1,159
Basutoland ... ..	—	8
For Breeding—		
Rhodesia ... ..	353	8,568
Bechuanaland Protectorate	3,503	13,598
<b>TOTAL ... ..</b>	<b>11,841</b>	<b>66,066</b>

#### SUMMARY OF IMPORTS.

Calendar Year.	For Slaughter.	For Breeding.	Total.
	No.	No.	No.
†1916	26,580	—	26,580
1917	47,970	5,440	53,410
1918	36,767	13,286	50,053
1919	40,574	16,693	57,267

\* Total from 1st January to 31st August, 1920. † 1st July to 31st December only.

## CROP AND LIVE STOCK REPORT.

August, 1920.

### CONDITION OF LIVE STOCK.

Compiled from Reports furnished by Sheep and Stock Inspectors.

Area.	Large Stock.	Small Stock.
<b>CAPE—</b>		
South-West ... ..	<i>Medium to poor.</i> Good in parts	<i>Good to medium.</i> Poor in parts.
North-West ... ..	<i>Good to medium.</i> Fat in parts	<i>Good to medium.</i> Fat in parts.
South Coast ... ..	<i>Good to medium.</i> Fat in parts	<i>Good to medium.</i> Fat in parts.
Southern Karroo ... ..	<i>Good.</i> Fat in parts ... ..	<i>Good.</i> Fat in parts.
Central Karroo... ..	<i>Good.</i> Fat in parts ... ..	<i>Good.</i> Fat in parts.
Northern Karroo ... ..	<i>Good</i> ... ..	<i>Good.</i>
Eastern Karroo ... ..	<i>Medium.</i> Good in parts ... ..	<i>Medium.</i> Good in parts.
Bechuanaland ... ..	<i>Good to medium.</i> Fat in parts	<i>Good to medium.</i> Fat in parts.
Griqualand West ... ..	<i>Good</i> ... ..	<i>Good.</i>
North-Eastern ... ..	<i>Medium</i> ... ..	<i>Medium.</i>
Border ... ..	<i>Medium.</i> Good in parts ... ..	<i>Medium.</i> Good in parts.
Transkeian Territories... ..	<i>Medium.</i> Poor in parts ... ..	<i>Medium.</i> Poor in parts.
<b>TRANSVAAL—</b>		
Eastern High Veld ... ..	<i>Medium</i> ... ..	<i>Medium.</i>
Central ... ..	<i>Medium</i> ... ..	<i>Medium.</i>
Western High Veld ... ..	<i>Good to medium</i> ... ..	<i>Good to medium.</i>
Low Veld ... ..	<i>Good to medium</i> ... ..	<i>Good to medium.</i>
<b>ORANGE FREE STATE</b>		
North-Eastern ... ..	<i>Medium.</i> Good in parts ... ..	<i>Medium.</i> Good in parts.
North-Western... ..	<i>Good</i> ... ..	<i>Good.</i>
South-Eastern... ..	<i>Medium.</i> Good in parts ... ..	<i>Medium.</i> Good in parts.
South-Western... ..	<i>Good to medium</i> ... ..	<i>Medium.</i> Good in parts.
<b>NATAL—</b>		
High Veld or Highlands	<i>Medium.</i> Good in parts ... ..	<i>Medium.</i> Good in parts.
Middle Veld or Midlands	<i>Medium.</i> Good in parts ... ..	<i>Medium.</i> Good in parts.
Coast ... ..	<i>Medium.</i> Good in parts ... ..	<i>Medium.</i> Good in parts.

### CONDITION OF CROPS.

According to reports from crop correspondents, weather conditions were generally favourable during August in the principal wheat producing area of the Union, and the crop there is estimated to be in very good condition. Outside of this area, which is subject to winter rainfall, the crop is reported to be suffering, very severely in some districts, from drought. In the south-eastern Orange Free State, wheat louse and birds are troublesome.

The following Statement shows the estimated production of wheat, oats, and barley and the condition of these crops as compared with normal, as at 31st August, 1920.

PROVINCES.	Estimated Production based on indications as at 31st August, 1920.						Crop Condition Above or Below Normal, on 31st August, 1920.					
	Wheat.		Oats (Grain).		Barley.		Wheat.		Oats (Grain).		Barley.	
	Bags (200 lb.)	Bags (150 lb.)	Bundles (7 lb.)	Bags (150 lb.)	Bags (150 lb.)	Bags (150 lb.)	Above.	Below.	Above.	Below.	Above.	Below.
CAPE PROVINCE.												
South-West.....	1,171,200	1,302,000	11,997,600	—	—	190,600	1	—	—	—	—	3
North-West.....	398,200	27,000	397,300	—	—	21,500	8	—	8	—	6	1
South Coast.....	112,000	2,073,700	61,100	—	—	61,100	4	—	4	—	15	29
Southern Karroo.....	129,400	47,100	1,428,500	—	—	51,800	4	7	—	4	—	7
Central Karroo.....	39,300	2,800	279,400	—	—	5,200	—	—	—	—	18	10
Northern Karroo.....	19,400	—	—	—	—	—	8	—	0	—	—	—
Eastern Karroo.....	15,200	1,400	149,300	—	—	2,100	—	19	—	—	37	38
Beechmanland.....	24,500	—	—	—	—	—	—	3	—	—	—	—
Border.....	40,400	13,700	822,800	—	—	6,700	—	34	—	—	48	41
North-East.....	76,900	18,100	1,335,500	—	—	2,600	—	42	—	—	22	43
Transkei.....	16,500	8,200	720,800	—	—	7,700	—	37	—	—	42	41
Unrepresented Districts...	120,000	31,000	3,193,100	—	—	27,900	—	—	—	—	—	—
	2,163,900	1,528,600	22,400,000	—	—	371,200	—	2	—	—	14	10
TRANSVAAL PROVINCE.												
Eastern High Veld.....	25,000	34,400	2,482,800	—	—	—	—	7	—	—	19	—
Central.....	153,400	32,200	4,757,400	—	—	—	—	7	—	—	10	—
Western High Veld.....	39,200	1,800	267,500	—	—	—	—	3	—	—	10	—
Low Veld.....	57,400	22,900	1,389,800	—	—	4,000	—	5	—	2	—	9
Unrepresented Districts...	10,800	2,700	1,030,900	—	—	7,600	—	—	—	—	—	—
	294,800	94,000	9,928,400	—	—	11,600	—	6	—	—	11	9
ORANGE FREE STATE PROVINCE.												
North-East.....	22,000	40,400	3,622,600	—	—	—	—	34	—	—	41	—
North-West.....	—	—	179,700	—	—	—	—	—	—	—	10	—
South-East.....	83,000	33,100	904,100	—	—	600	—	23	—	—	34	45
South-West.....	1,400	—	—	—	—	—	—	9	—	—	—	—
Unrepresented Districts...	24,900	2,400	484,800	—	—	3,000	—	—	—	—	—	—
	131,300	77,700	5,191,200	—	—	3,600	—	25	—	—	28	45
NATAL.												
Unrepresented Districts...	4,700	10,100	859,700	—	—	1,300	—	—	—	—	—	—
	2,594,700	1,710,400	38,379,300	—	—	387,700	—	4	—	—	16	10

## SUGAR-CANE.

The Natal Sugar Association reports as follows for July, 1920:—A further fall in condition of cane crop is reported for July. Empangeni which was reported normal last month has fallen to 80 and in every other area a fall is recorded. This definitely places the crop 20 to 25 per cent. below normal. Weather has been very dry. Empangeni area had an inch of rain, the Tugela area from 0.25 to 0.4 inch, Umvoti area 1 inch, and elsewhere from 0.5 to 0.4 inch.





## THE LOCAL MARKET.

August, 1920.

(NOTE.—The local market prices of certain other agricultural produce and of stock, are published elsewhere in this issue.)

## WOOL.

The market continues exceedingly dull and very little business has been done during the past month. A few sales of extra super combing wool of good length and quality are reported at prices ranging from 17d. to 20d. per lb. and medium super wool at 13d. to 16d. per lb. The prices paid for these types of wool prior to the decline of the market in February last, was from 50d. to 60d. per lb. for the former type and from 25d. to 30d. per lb. for the latter. Large stocks principally of medium and short wools, are now lying at the Coast, and seeing that the forwarding of the new season's clip to the ports will commence at the end of September, it is feared that buyers will not show any interest in the old stocks, unless these are obtainable at a very low figure.

Cable advices from London report that the Government Wool sales opened with improved tone and that prices advanced 5 per cent. This is due to more competition mainly from continental buyers and should help to relieve the present severe depression in the market.

Owing to the slight demand for wool at the ports of the Union it is impossible to give reliable figures as to present value and the following quotations must be regarded as nominal and do not indicate prices actually obtained at sales during the past month. The classification is that recommended by the Central Wool Committee:—

## GREASE WOOL.

	d.	d.		d.	d.
1. Choice superfine sound combing, well skirted, of good regular length ... ..	23	to 26	11. Inferior medium, 8 to 9 months	9	to 10
2. Superfine sound combing, well skirted, similar in quality but not of such good length as type 1 ... ..	20	„ 22	12. Choice superfine shorts, well skirted ... ..	12	„ 14
3. Extra super combing, deep stapled, sound, well skirted, of less fine quality than type 1 ... ..	18	„ 20	13. Superfine shorts, skirted ... ..	10	„ 11
4. Super combing, skirted ... ..	14	„ 17	14. Good bulky shorts (6 to 8 months)	9	„ 10
5. Good average combing ... ..	12	„ 13½	15. Average shorts... ..	8	„ 9
6. Average combing ... ..	10	„ 11	16. Inferior shorts ... ..	6	„ 7
7. Inferior combing, irregular, very tender or otherwise deficient ... ..	8	„ 9	17. Native super ... ..	9	„ 10
8. Extra super medium choice (9 to 10 months), well skirted ... ..	14	„ 17	18. Native medium ... ..	8	„ 9
9. Super medium (9 to 10 months), skirted ... ..	12	„ 13½	19. Native inferior... ..	7	„ 8
10. Average medium (8 to 9 months) of not such good style as type 9	10	„ 12	20. Bellies and good pieces, combing	10	„ 11

The above prices are for wool free from seed and burr.

## SNOW WHITES.

	d.	d.		d.	d.
1. Extra super snow white, good bulk, free ... ..	40	to 48	3. Average snow whites, shorter and faulty ... ..	27	to 30
2. Super snow whites, fair bulk, free ... ..	33	„ 39	4. Inferior ... ..	16	„ 20

## MOHAIR.

The market has for some time been in a very unsatisfactory position and prices have gradually declined. Buyers at the Ports are at present without orders and expect a further drop in values. The following are nominal quotations:—

	d.	d.		d.	d.
Summer firsts, average ...	18	to 20	Winter kids, special ...	27	to 32
Mixed hair ...	15	„ 18	Winter hair, average ...	14	„ 16
Basuto hair ...	15	„ 18	Coloured hair ...	6	„ 7

## HIDES AND SKINS.

There is little demand for hides and skins and prices have declined accordingly. Towards the end of the month the market became somewhat easier, with goatskins firm, and the following prices were obtained:—

	per lb.		per lb.
Sound long woolled sheep skins ...	10d.	Damaged coarse and coloured ...	4d.
Sound short ...	7d.	Goatskins ...	22½d.
Damaged long... ..	7½d.	Angora skins ...	9d.
Damaged short ...	4d.	Damaged goats and bastards ...	11½d.
Sound long, lambs ...	6d.	Damaged Angoras ...	3d.
Damaged ...	3d.	Hides, sundried ...	12½d.
Sound pelts ...	8d.	„ „ damaged ...	8d.
Damaged ...	2½d.	„ dry salted ...	13½d.
Coarse and coloured ...	5d.	„ „ damaged ...	10½d.

## OSTRICH FEATHERS.

THREE public sales of feathers were held in Port Elizabeth during the month, viz., 2nd, 9th, and 16th August. The total quantity of feathers disposed of was 8578 lb., which realized the amount of £12,154. The weight of feathers withdrawn or declared “not sold” was 2400 lb., valued at £3052.

It must be borne in mind when considering the weight and values of feathers sold or “not sold” that, under present conditions, a fair proportion of the goods change hands weekly amongst speculators. These goods handled by speculators—as distinct from shippers—are sold and resold upon the markets, which makes the totals rather misleading when considered from the producer’s point of view. The average price realized per pound for the three sales under review was £1. 17s. 11d. This price represents all lines, from primes, which would probably average about £7 per lb., to the very poorest of drabs, etc., which would only realize about 5s. per lb.

Prices remained comparatively steady, with the exception of the sale held on the 9th, at which wings went considerably lower, while shorts were also easier. At the sale on the 16th prices recovered to the level ruling at the beginning of the month. This fall in prices may be ascribed as almost entirely due to the poor average quality of the goods offered for sale. There was a very large proportion of “speculators’ lots” and “made-up” parcels, and competition on these lots is naturally always restricted.

The rise and fall in prices during the past three years has been due, in a great measure, to the speculation in ostrich feathers, and the low prices ruling at present are largely due to speculators having invested at fairly high prices and now unwilling to part at lower rates. In this way the same parcels of feathers are continually being offered for sale with a little re-sorting and changing on each occasion.

All advices from England point towards business being very restricted and prospects not too promising. The Continent is naturally handicapped by exchange rates, and there would appear to be very little business taking place.

From the farming point of view this is considered one of the worst months. The pinch of the dry season is beginning to be felt, necessitating extra feeding, which at present is costly. Most reports indicate that the breeding season is proceeding satisfactorily, and a fairly large number of chicks are being hatched.



PRICE 5/-  
PER ANNUM.

# Journal

of the

## Department of

# Agriculture

ISSUED BY AUTHORITY OF THE  
MINISTER OF AGRICULTURE.

### PRINCIPAL CONTENTS.

- Wheat-Straw and its Value to the Land.
- A Tomato Canker.
- Representative Transvaal Soils—I.
- Factors that Affect the Growth, Reproduction, and Maturity of Tobacco.
- Geese.
- The Crossing of North African and South African Ostriches.
- Mylabris Beetles.
- The Effects of Storms on Certain Forests in the Tsolo District, Cape Province.
- Building up the Fertility of the Soil.
- Pappea capensis* Seed.
- Calcium Cyanamide.

PRICE 6D PER COPY

STEWARTS AND LLOYDS (SOUTH AFRICA), LTD.

# TUBES AND FITTINGS.

P.O. Box 1195.  
JOHANNESBURG.

P.O. Box 74.  
PRETORIA.

P.O. Box 131.  
DURBAN.

P.O. Box 296,  
MARITZBURG.

AGENTS FOR :

National Gas Engine Co.,  
Gas, Oil, and Petrol  
Engines.

Eagle Engineering Co.,  
Ltd., Petrol Paraffin  
Engines.

Davey Paxman & Co.,  
Steam Engines and  
Boilers.

Gilbert Gilkes & Co.,  
Water Turbines and  
Centrifugal Pumps.

Mirrlees, Bickerton &  
Day, Diesel Oil Engines.

IRRIGATION  
AND WATER  
SUPPLY OUR  
SPECIALITY.

PUMPING PLANTS,  
PIPE LINES  
AND  
POWER UNITS  
OF EVERY  
DESCRIPTION.

**ESTIMATES AND ADVICE  
FREE OF COST.**

AGENTS FOR :

John Blake, Ltd.,  
Hydraulic Rams.

Thomas & Sons,  
Windmills and Pumps.

Bell Bros., Ltd., Filter  
and Water-Softening  
Plants.

Glenfield & Kennedy,  
Hydraulic Specialities.

Clydesdale Steel Plates.

# CONTENTS.

NOVEMBER, 1920.

	PAGE
NOTES ... ..	711
Death of Mr. W. O. John.—Compensation for Native Workers.—Exportation of Cinematograph Films Defining South African Agriculture.—Representative Transvaal Soils.—Overseas Soils in Agriculture.—New and Animal Insects.—The Flowering Plants of South Africa.—Mallet and Wattle Bark.—Woolfs' Poultry Congress.—Egg-laying Competition, Odara.—Export of Butter and Cheese.—Control of Livestock.—Fogee Leaf-Slug.—Importation of Fruit Seed.—Registration of Karakul Sheep.—The Woolfs' Crops.—Mr. C. G. F. Foster's Report.—Notice to Viticulturists and Vine Nurserymen.—Inspection of Vines.—Valuable Exhibit of Manufactured Wool and Mohair (page 717)—Fruit Export (page 721)—Maitland Market (page 731)—The New Apple-box (page 736)—Citrus Export (page 749)—Pear Nurseries in quarantine as at 1st October, 1920 (page 746)—Offer of Turkeys (page 742)—Export of Grain, etc. (page 754)—The 1920 Vintage of South Australia (page 744)—The Poultry Workers' Problem (page 764).	
WHEAT-STRAW AND ITS VALUE TO THE LAND ... ..	712
A TOMATO CANKER ... ..	718
REPRESENTATIVE TRANSVAAL SOILS ... ..	722
FACTORS THAT AFFECT THE GROWTH, REPRODUCTION, AND MATURITY OF TOBACCO ... ..	728
GEESE ... ..	732
THE CROSSING OF NORTH AFRICAN AND SOUTH AFRICAN OSTRICHES ... ..	737
MYLABRIS BEETLES ... ..	741
THE EFFECTS OF STORMS ON CERTAIN FORESTS IN THE ISOLDI DISTRICT, CAPE PROVINCE ... ..	750
BUILDING UP THE FERTILITY OF THE SOIL ... ..	757
"PAPPEA CAPENSIS" SEED... ..	760
CALCIUM CYANAMIDE ... ..	765
THE POULTRY YARD MONTH BY MONTH ... ..	770
THE VEGETABLE GARDEN ... ..	779
NOTES FROM THE "GAZETTE" ... ..	772
SOUTH AFRICAN PRODUCE ON THE OVERSEA MARKET ... ..	774
OVERSEA PRICES OF SOUTH AFRICAN PRODUCE ... ..	776
NOTES FROM THE DIVISIONS ... ..	777
OUTBREAKS OF ANIMAL DISEASES IN THE UNION ... ..	779
RECENT AGRICULTURAL LITERATURE... ..	780
AT THE SCHOOLS OF AGRICULTURE AND EXPERIMENT STATIONS ... ..	785
STAFF: APPOINTMENTS, TRANSFERS, ETC. ... ..	789
MEAT STATISTICS... ..	790
CROP AND LIVE STOCK REPORT ... ..	791
LOCAL MARKET PRICES ... ..	793
THE LOCAL MARKET ... ..	794
CORRIGENDA ... ..	795
ANALYSIS OF SOILS—METHODS OF TAKING SAMPLES ... ..	796

## DEPARTMENTAL NOTICES.

### AGRICULTURAL DEPARTMENT.

#### GOVERNMENT GUANO.

It is hereby notified that an allotment of guano will be made early in February next.

The total quantity of guano which will be available for distribution in this allotment cannot yet be determined, but all collections, ready in time for the forthcoming sowing season, will be disposed of and delivered with as little delay as possible.

The distribution of the guano will be limited to bona fide farmers and gardeners only, within the Union, who are requiring supplies for use during the period from February to June, 1921.

Applications must be made on the *prescribed form* obtainable from the Superintendent, Government Guano Islands, 69 Strand Street (P.O. Box 251), Capetown, and these will be received and booked up to and including noon on Saturday, the 18th December, 1920, after which date no further applications will, under any circumstances, be accepted or entertained in respect to this allotment.

Applicants are warned that, in making applications for guano, the purposes for which this fertilizer is required must be distinctly stated on the form of application and that *only the quantity actually needed for those purposes must be asked for, as all inflated orders will be liable to be disallowed.*

No application will be accepted, or considered, from any person who is not actually farming on his own account, and only one application will be accepted in respect to any one farm, portion of a farm, or group of farms under one ownership, or partnership, as the case may be.

All applications must be signed by the individuals requiring the guano and in no case will this fertilizer be supplied to or consigned to any persons other than those for whose use it is actually required.

The price of guano will be £10 per ton of 2000 lb., or 20s. per bag of 200 lb., including bags, and delivered on rail at Capetown, or on board ship in Table Bay Docks, but no remittances will be accepted until after allotments have been made.

Railage in all instances is payable by the consignee and must be prepaid where guano is to be consigned to railway sidings.

All inquiries and applications for guano must be sent direct to the Superintendent, Government Guano Islands, Capetown.

#### STALLIONS AT STUD.

Horse and Donkey Stallions will stand at stud at the various schools of agriculture from 15th August, 1920, to 15th January, 1921.

Fees : £2 service of each mare. Grazing and feeding extra.

For further particulars apply to the respective Principals of the Institutions referred to, viz.:—Elsenburg, Mulder's Vlei, C.P. ; Grootfontein, Middelburg, C.P. ; Glen, O.F.S. ; Potchefstroom, Transvaal ; Cedara, Natal.

#### FOREST DEPARTMENT.

Farmers and others interested in treeplanting are invited to apply to the Forest Department for advice as to the most suitable trees for growing in the various climates and soils of the Union, and on the best methods to adopt in the formation of plantations, wind-breaks and shelter-belts. Applications for such advice should be addressed to the Forest Officer nearest to the locality where it is intended planting should be done or to the Conservators of Forests, Capetown, Knysna, Kingwilliamstown, Umtata, Maritzburg, Pretoria, or Bloemfontein.

To encourage treeplanting, transplants of forest trees may be obtained from the Forest Department Nurseries of which there are 26 situated throughout the Country and forest tree seeds from the Conservator of Forests, Capetown, who has charge of the Department's Seed Store.

Copies of the latest price-list (No. 642 of 1920) for both transplants and seeds are obtainable from the Forest Officers mentioned in the foregoing or from the Chief Conservator of Forests at Pretoria. This publication contains a considerable amount of information useful to farmers and others desirous of planting trees and it also indicates that the average price for young trees ready for planting out is only 6s. per 100. These are sold firmly established in half paraffin tins, each tin containing about 25 transplants.



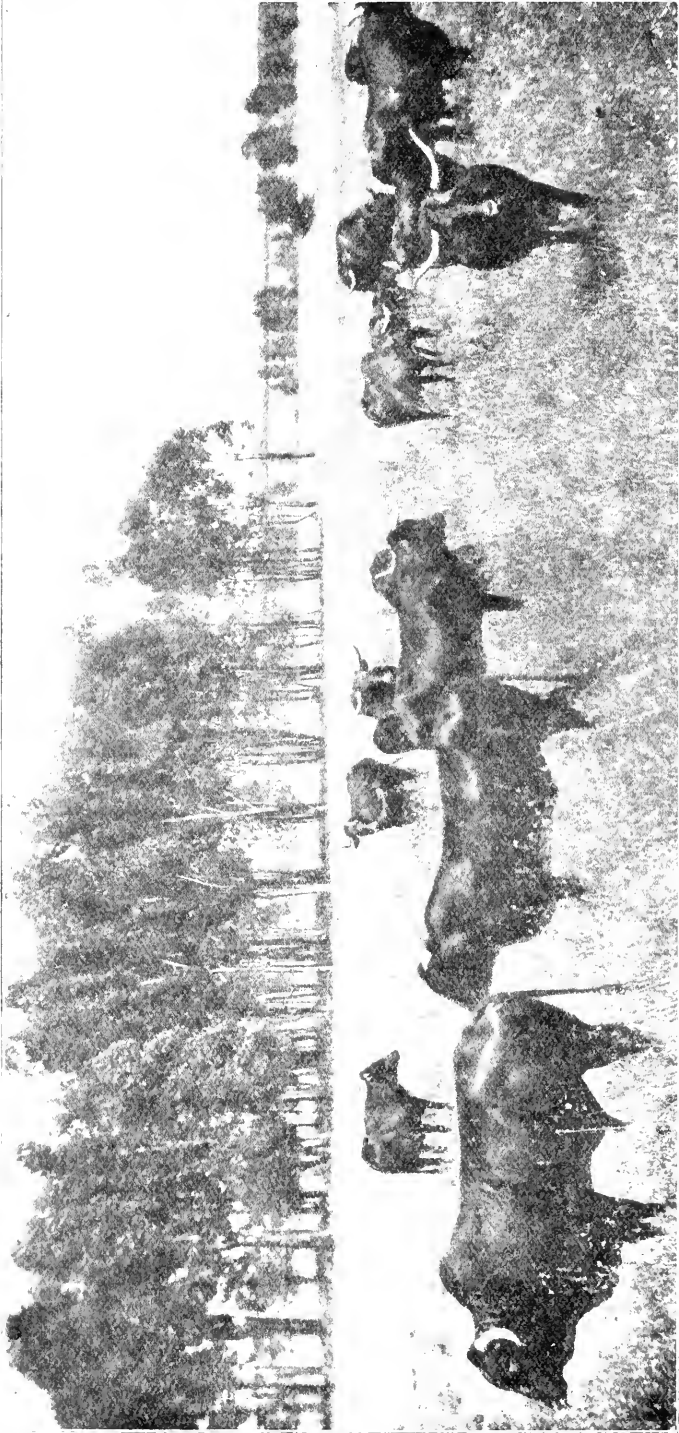

HERD OF PEDIGREE AFRICANDERS.  
Potchefstroom School of Agriculture.





# JOURNAL OF THE DEPARTMENT OF AGRICULTURE.

VOL. I.

NOVEMBER, 1920.

No. 8.

Published monthly in English and Afrikaans by the Department of Agriculture,  
Union of South Africa.

**Editor: G. W. Klerck.**

SUBSCRIPTION: Within the Union and South-West Protectorate, **5s.** (otherwise **6s.**)  
per annum, post free, payable in advance.

Applications, with subscriptions, to be sent to the Government  
Printer, Box 373, Pretoria.

---

## NOTES.

---

### Death of Mr. W. O. John.

The Department has sustained a great loss in the death on the 23rd September last of Mr. W. O. John. Mr. John's service in the Department dates from 1913, and at the time of his death he was the Lecturer in Poultry at the Elsenburg School of Agriculture, Mulder's Vlei, Cape. He came to South Africa many years ago with a sound, practical knowledge of poultry farming, and during the succeeding years devoted all his energy to the development of the industry in this country. He was a zealous, enthusiastic colleague, and his striking personality, combined with an aptitude for making his lectures interesting and impressive, stamped him as a valuable officer, while his kindly and straightforward nature endeared him to all who knew him. It follows, therefore, that his services were in constant demand, and he devoted himself unstintingly to his duties. Among his many activities mention may be made of the prominent part he took in the establishment of egg circles and the supervision of the egg-laying competitions at Rosebank; from the first he superintended the building up of the export trade in eggs and poultry, his last report on the subject appearing in the June, 1920, issue of the *Journal*. He is the author of several articles of much value to poultry farmers, and one of them, received shortly before his death, appears in this issue of the *Journal*. Emerging from obscurity, the poultry industry has taken a prominent place in recent years in South African agriculture, and the name of Mr. John is closely associated with its marked progress; indeed, he has been described as the "Father of the Poultry Industry in South Africa." It is with very deep regret, therefore, that we record the death at the early age of fifty-two of a valued and much respected colleague, a loss to the Department and to the community.

## Composition of Natal Wattle Bark.

The first of a series of articles on the above subject by Mr. C. Williams, B.Sc., A.R.C.S., Chemist, School of Agriculture, Cedara, appeared in the *Agricultural Journal* for July, 1914, and afterwards was published by the Department of Agriculture as a separate bulletin (No. 59, 1914). This article dealt with the composition of wattle bark from trees of various ages felled in the spring and early summer in the neighbourhood of Cedara, situated in the midlands of Natal.

The second article was also published as a bulletin (No. 72, 1915), and contained a *résumé* of the results obtained in case of bark stripped from trees in the same plantations during the subsequent winter months. It also dealt with the tannin content of leaves and twigs from wattle trees, and with the composition of the kino exuded by the trees under certain conditions of growth.

A third article by Mr. Williams has now been published as Bulletin No. 1, 1920 (obtainable on application from this office), in which there is summarized the results of the investigation carried out on the composition of the bark of trees from plantations on the north coast of Natal, in order to ascertain whether there is any marked difference or not in the tannin content and maturity as compared with trees of corresponding ages grown in the midlands. The colour of the infusion from the bark has also been estimated in each case and compared with the colour of other tanning materials.

The article contains, in addition, the results of an investigation conducted concerning the effect of keeping the wattle tannin liquor for a length of time, and also the effect of boiling it for some time. This was carried out in order to assist extract manufacturers to find out at what stages they may expect any loss or deterioration in the liquor.

Lastly, the composition and colour of commercial samples of various wattle extracts manufactured in Natal are tabulated.

The conclusions drawn from the investigations, as described in the three articles, are summarized as follow:—

1. Mature wattle bark when being thoroughly dried under natural conditions in the open air loses slightly under half its weight, on an average.

2. In the case of wattle trees, the total amount of bark and of tanning matter obtained from a tree increases fairly regularly with the age, but the percentage of tanning matter was approximately the same at all the ages examined from three up to seven years.

3. The development of the trees, and the weight of bark obtained per tree, are very much inferior in case of those from the coast plantations investigated than those from the higher altitudes of the midlands of Natal. The coast trees seem to mature more rapidly, and the percentage of tanning matter is generally higher for trees of corresponding ages, but the total weight of tanning matter obtained per tree is on the average less than half that from trees of similar age in the midlands.

4. There is a decided and continuous decrease in the percentage of tannin in the bark as we ascend the tree.

5. Individual trees of the same size, and from the same plantation even, differ considerably in the thickness of their bark from corresponding sections, showing that this factor depends very largely on the conditions under which the tree has been growing.

6. The thickness of the bark is a fairly safe criterion of its richness in tanning matter, no matter what the age of the tree is, provided no "corkiness" has developed in the bark.

7. The colour of the infusion from the bark deepens slightly with the age of the tree.

8. In the case of mature wattle bark that has been carefully harvested and dried in the open air, the depth of the red colour in the infusion of standard strength obtained from it varies from 3 up to 5 units, and the yellow colour usually varies from 3.5 to 7 units. This compares favourably with most natural tanning materials.

9. When a weak extract from wattle bark is cooled and allowed to stand, a large proportion of the difficultly soluble bodies are soon precipitated, with a corresponding loss of soluble non-tanning matter, while the proportion of tanning matter slightly and gradually increases.

10. When a weak extract is boiled for a moderate length of time, there is only a slight loss of tanning matter with a corresponding increase in the proportion of soluble non-tanning matter. There is, however, a marked deterioration with regard to the colour of the infusion.

11. In the commercial samples of solid wattle extracts manufactured in Natal, the proportion of tanning matter usually varies from 59 up to 67 per cent.

---

## **Exhibition of Cinema Films depicting South African Agriculture.**

In connection with the Government's scheme for advertising the Union and its resources, the Department of Mines and Industries, in collaboration with this Department, is preparing a number of films depicting farming scenes and operations in South Africa. The films, which are to be shown first throughout the Union and subsequently in a number of oversea countries, will illustrate the following: Tobacco growing and manufacturing, fruit growing, fruit drying and exporting, wine and brandy, dairying, cotton, forestry, ranching, maize, land settlement in the Union, development of irrigation and the water-power resources of the Union, wool, mohair, the Government's share in promoting scientific agriculture (including work at the schools of agriculture, experiment stations, and laboratories), transport and communications, etc.

This is an age of advertising, and the Union is falling into line with other countries in making known our many resources. High hopes are entertained that, as a result of the publicity campaign and the attraction of capital and other advantages which are expected to ensue, material benefit will accrue to the agricultural life of the Union.

## Representative Transvaal Soils.

In this number we publish under the above heading the first of a series of articles describing certain well-known soil types occurring in the Transvaal, their chemical and physical composition, and their behaviour under cultivation. These articles will set out also the results obtained by the use of various manures and put forward suggestions for the treatment of the soil. The Division of Chemistry possesses valuable data concerning the more important soil types which have never been systematically written up, and these articles, from the Chief and other officers of the Division, will serve this purpose and place before the farmer information of a valuable nature.

---

## Oversea Scholarships in Agriculture.

The following were the successful applicants for the scholarships recently advertised by the Department of Agriculture: *Field Husbandry*: J. D. Osborn, T.U.C., Pretoria; A. R. Pullen, T.U.C., Pretoria; D. Moses, School of Agriculture, Potchefstroom; A. R. Saunders, Boshoff, Orange Free State. *Tobacco and Cotton*: L. J. Henning, T.U.C., Pretoria; P. J. Naude, T.U.C., Pretoria. *Horticulture*: R. J. du Toit, Elsenburg School of Agriculture; R. J. Blatt, Johannesburg. *Dairying*: P. Toens, Cedara School of Agriculture; H. L. Neethling, Bloemfontein, Orange Free State. *Entomology*: J. T. Potgieter, Stellenbosch University. *Mohair*: C. W. van der Merwe, University of Capetown.

---

## Nagana.

The outbreak of mortality among cattle in Zululand caused by the tsetse fly which, following game recently protected in the near vicinity of settlers, has found its way to the live stock of the settlers, has been receiving the careful consideration of the Government. The throwing open of the game reserves is one of the steps taken with a view to removing the danger. It has also been decided to carry out extensive fencing in the Empangeni District, where the outside boundary of Ntambana is to be fenced by the Lands Department. A fence is also to be erected along the southern bank of the White Umfolozi River, but this presents certain difficulties which are receiving attention, and in connection therewith a scheme is being considered for the provision of motor transport for the use of the settlers. The Provincial Administration of Natal will undertake the patrolling of the zone between the two fences for the purpose of destroying any game breaking through. It has been decided that there is to be no slaughter of stock infected with Nagana.

Government Veterinary Officer McIntyre is now stationed at Empangeni, and his presence should be of much assistance to the settlers.

Of special interest to farmers in the areas where the tsetse fly abounds is the decision of the Government to participate in a proposed scheme for an investigation throughout Africa of the binomics of tsetse fly, by undertaking investigations in Zululand at the expense of the Union. The matter will be in the hands of the Division of Entomology, and steps are being taken to commence operations at once.

## Animal Disease.

The Acting Principal Veterinary Officer states that there is no change in the position of East Coast fever in the Pretoria District; the disease is still present, and, while the matter is viewed seriously, every effort is being made to prevent the spread of the disease and eventually to eradicate it. The outbreak of lung-sickness in the Zoutpansberg District, referred to in last month's *Journal*, has apparently been dealt with successfully, for further outbreaks have not been reported. During the month of September last nothing of special significance occurred, according to reports received from the Department's veterinary officers, in the matter of outbreaks of animal disease.

## The Flowering Plants of South Africa.

There is to be published this month Vol. I, No. 1 of "The Flowering Plants of South Africa," the foundation of a work destined to occupy an important position in the botanical science of this country. Edited by Dr. I. B. Pole Evans, Chief, Division of Botany, Pretoria, and Director of the Botanical Survey of the Union of South Africa, the publication is the commencement of a series which will be issued every three months, and being a new departure in works of this nature will largely contribute to a greater interest in the study and cultivation of our indigenous plants. Each number will contain ten coloured plates, with full descriptions of the plants illustrated. The first part of the work includes the following plants:—

- The African Agapanthus or Blue Lily (*Agapanthus umbellatus*), Pl. 1.
- M'Pahlela's Aloe (*Aloe globuligenma*), Pl. 2.
- Foster's Namaqualand Daisy (*Arcotis Fosteri*), Pl. 3.
- The Pretoria Cyrtanthus (*Cyrtanthus contractus*), Pl. 4.
- The Barberton Daisy (*Gerbera Jamesoni*), Pl. 5.
- The Natal Gladiolus (*Gladiolus Psittacinus*, var. *Cooperi*), Pl. 6.
- Stoke's Leucadendron or Sugar Bush (*Leucadendron Stokoei*), male, Pl. 7, female, Pl. 8.
- The Wild Garlic—Wilde Knoblook (*Tulbaghia violacea*), Pl. 9.
- The Yellow Arum (*Richardia angustiloba*), Pl. 10.

While not an official publication of the Division of Botany, the illustrations and descriptions are the work of members of the staff, and sole credit for the initiation of this valuable work belongs to the Division, and, it is pleasing to add, the funds making the publication possible were donated by private individuals. This laudable object of stimulating interest in our unique South African flora and of ensuring for all time a carefully prepared record thereof, depends upon public support through subscription, which it is trusted will be forthcoming. "The Flowering Plants of South Africa" is published by Messrs. L. Reeve & Co., Ltd., 6 Henrietta Street, Covent Garden, London, the South African agents being The Speciality Press of South Africa, P.O. Box 3958, Johannesburg, and P.O. Box 388, Capetown. The annual subscription is 60s. (postage 2s.).

### Mallet and Wattle Bark.

The Principal of the Cedara School of Agriculture reports that some samples of mallet bark growing on a Natal farm were found on analysis to have a tannin content that compared very favourably with that of mature black wattle bark, though the total yield of bark per acre would be much lower. The amount of tannin matter in the air-dried bark from the base of the tree was 41 per cent., and from the bark from the top of the tree the amount was 29 per cent. The yellow greatly predominated in the colour of the infusion, and in this respect it is probable that it would make a good mixture with wattle bark as a tanning agent.

Experiments to ascertain the rate at which green wattle bark loses its moisture when allowed to lie in the shade in hurdles away from the influence of sun and weather, showed that on an average 28 per cent. of the weight was lost in forty-eight hours. To the many extract factories in this Province who buy bark largely in the green state these figures should be useful.

---

### World's Poultry Congress.

Upon the initiative of the International Association of Poultry Instructors and Investigators, arrangements are now in process for the holding of a World's Poultry Congress. At the invitation of the Netherlands Government the Congress, the first of its kind, will be held at the Hague in the early part of September, 1921. Matters of the highest interest to the poultry industry will be discussed at this Congress, as will be seen from the range of subjects already set down, viz.: (a) State and other official action, including reconstruction; (b) the training and necessary qualifications of poultry instructors for educational and demonstration work; (c) science of breeding and its practical application; (d) experiments and investigation; (e) egg and poultry production as separate industries and in connection with cultivation; (f) opportunities for women in the poultry industry; (g) hygiene and disease; (h) organization and influence of exhibitions and laying trials; (i) general management and systems of incubation and rearing; (j) international and national trade in eggs and poultry, inclusive of co-operation and organization of poultry societies.

During the Congress it is proposed to hold an exhibition of breeds of poultry from all parts of the world, also of poultry houses and appliances used in different countries.

The Congress is arousing a great deal of attention, and in England, France, Belgium, Denmark, the United States, and Canada influential committees have been formed for the purpose of assisting the objects of the Congress and of electing representatives and collecting exhibits. In the Union also the matter is receiving the attention of those interested in the poultry industry, and, while it is not probable that this Department will be able to spare any of its poultry experts for attendance at the Congress an endeavour will be made for a delegate representing the Department to be present. The question of forming a committee for arranging the representation of South Africa at the Congress will be discussed at the forthcoming conference of the S.A. Poultry Association to be held at Bulawayo on the 9th November, 1920.

### Egg-laying Competition, Cedara.

The Third Egg-laying Competition commenced on the 1st June, 1919, and terminated on the 30th November, 1919, a period of 183 days. The accommodation available was the same as in the two previous competitions, viz., 120 single pens. A full description of the houses, runs, etc., is given in Bulletin Local Series No. 70, published by the Department of Agriculture.

Twenty competitors made entries of 24 pens, each pen containing 5 birds. Of these pens, 17 were from Natal breeders, 3 from the Transvaal, 3 from the Orange Free State, and 1 from the Cape Province. Of the 24 entries, 15 pens were Utility White Leghorns, 6 White Wyandottes, and one each of the following breeds: White Orpington, Brown Leghorn, and Black Leghorn.

As in the previous competition, only 2-oz. eggs were counted from the commencement. The majority of birds were not much handicapped on this account, as the competition did not begin until June. The weather during the six months under review was not ideal for egg production, being for the greater part very dry, and consequently a large percentage of underweight eggs were laid.

The quality of the green food obtained was naturally not of the best owing to the drought, and this, no doubt, was adverse to heavy egg production.

Utility White Leghorns occupied the eight leading places at the termination of the competition, and, on the whole, the White Wyandottes did badly, chiefly owing to underweight eggs.

The silver and bronze medals presented by the South African Poultry Association for the pens laying the greatest number of standard-weight eggs during the competition were won by Pens Nos. 12 and 5 (both Utility White Leghorns), the property of Mr. J. C. Randles, Otto's Bluff, Natal, and Mr. R. Porritt, Pietermaritzburg, Natal, respectively.

Pen No. 12 laid 530 full-weight eggs and 13 underweights, and Pen No. 5, 511 full-weight eggs and 28 underweights in the period of 183 days. The best individual record was made by hen No. 21, Pen No. 5, with 123 full-weight eggs, no underweights, the property of Mr. R. Porritt, Pietermaritzburg, Natal.

The total egg yield for the six months was 11,400, which includes 1811 eggs under 2 oz., but over  $1\frac{3}{4}$  oz. This gives an average of 95 eggs per bird. The value of the eggs laid during the competition was £96. 5s. 11 $\frac{1}{4}$ d.

The cost of feeding during the competition amounted to £44. 8s. 7 $\frac{1}{2}$ d., which, deducted from the value of eggs laid, gives a profit over cost of feeding of £51. 17s. 3 $\frac{1}{4}$ d., or, approximately, 8s. 8d. on each bird.

As in the previous competitions, wet mash was fed in the morning, green food at noon, and grain in the afternoon. All grain was fed in scratching litter in order to make the birds exercise themselves and keep them occupied. The average amount of mash consumed per bird during the competition was 2.52 oz. per diem, and of grain 2.41 oz.; this does not include green food at noon, or grit, oyster-shell, and charcoal.

Eight deaths occurred, four being indirectly due to ovarian trouble.

## Export of Butter and Cheese.

Referring to the question which has arisen regarding the advisability of permitting the export of butter and cheese, the Superintendent of Dairying states that as an outcome of the past drought and other material drawbacks, prices paid to the farmer for cream and milk were far in excess of those reasonably obtained in fairly good seasons, added to which wages had increased and also the cost of manufacturing the raw products into butter and cheese. Therefore, the consumer had to pay a higher price for the finished article, though the difference between the wholesale and retail prices of these commodities needs adjustment—a matter outside the province of the Department.

The high selling prices caused a decreased consumption to the extent of at least 50 per cent., compared with previous years, and an outlet had to be found elsewhere for surplus stocks. Payments to farmers for milk or cream are made monthly by the purchasing bodies, and, if they cannot dispose of the manufactured products locally, an alternative must be found, in order to ensure regularity in such monthly payments, and at prices consistent with those obtained for the finished article. This can only be accomplished by permitting the manufacturer to dispose of his wares to the best advantage.

With reference to cheese, it is pointed out that the world's markets for this commodity are entirely open, and manufacturers in the Union are faced with a world-wide and keen competition, yet notwithstanding, more than 50 per cent. of the known surplus stock, after allowing for local requirements, is being withheld from export to meet any unforeseen local demand, though such is not anticipated.

The position regarding the export of butter is also clear, for only 25 per cent. of the stocks in the Union will be permitted to be exported, and even assuming that the export of this quantity proves to be excessive, provision has been made for supplementing stocks from elsewhere, so that there need be no fear of a local shortage.

---

## Control of Locusts.

At the recent conference of the Orange Free State Agricultural Association, a resolution was passed "that this conference appreciates the very satisfactory results achieved in connection with the extermination of locusts, and urges the Government to make every endeavour, in view of the approach of the breeding season, to locate and destroy any possible new swarms before they reach the flying stage." We are pleased to say that the Division of Entomology has been keeping the situation under keen observation and is ready to deal with any developments. Large stocks of locust poison have been prepared, and these together with the necessary pumps, are now distributed and held in readiness for use at convenient centres. Special inspections have already been made of areas where trouble may arise, and altogether the public need have no apprehension of the Department being found in a state of unpreparedness. But the Department looks to the farmer for his co-operation. When voet-gangers are seen and egg deposits known of, the matter should immediately be reported, so that the occurrence may not be overlooked. In this manner the farmer may be the eyes of the Department and help very materially in controlling the locust.



### **Tobacco-leaf Slug.**

Mr. C. P. van der Merwe, Entomologist, Durban, reports that the tobacco-leaf slug has put in an appearance in the tobacco seed-beds in the Piet Retief District. At the beginning of October eggs and larvae, in all stages up to apparently full grown, were present, and, according to reports from some farmers, were already very destructive. The insect appears to be showing up earlier this year than last, possibly because a greater number of adults have hibernated. The later generation may also be expected to be more numerous and serious loss to tobacco growers will ensue unless steps are taken to control the pest by spraying with arsenate of lead.

### **Importation of Cotton Seed.**

Cotton growers and others concerned are reminded that the introduction of any cotton seed whatever into the Union is illegal unless the Department of Agriculture has issued a permit for it. A permit is only given in the case of cotton seed intended for sowing, and then only at the discretion of the Department, which considers every application on its individual merits. The precaution is taken because of the very grave danger of most devastating pest insects getting into the country through the medium of seed. The notorious Mexican boll weevil, an introduced insect causing appalling losses in the United States of America, the cotton phytotid mite, one that has destroyed whole crops in some of the West India Islands, and the even more feared pink boll-worm, the pest that reduced Egyptian cotton production by half a few years ago, all spread from country to country with seed. The widespread establishment of any one of these pests in South Africa would paralyse and perhaps entirely stop our cultivation of cotton. Every one concerned is urged to assist in making known the dangers of introducing seed and the necessity of obtaining a permit before cotton seed is shipped to this country. There is always a risk that in ignorance of the law seed may be brought in a passenger's luggage and so escape detection by customs examiners. There is also the risk of seed coming in by post through not being declared. Moreover, the boll weevil and the pink boll-worm moth may escape from infested seed brought to a port, although the consignee may not be allowed to take delivery of the seed. Therefore it is important that no cotton seed should arrive except special lots for which permits have been arranged. A person responsible for introducing cotton seed in the absence of a permit is liable to a heavy fine.

An illustration of the risk of pink boll-worm coming with seed recently occurred in connection with a parcel of Egyptian seed obtained from the British Cotton Growing Association. The seed was in the possession of a passenger who landed at Durban en route for the district of Lourenço Marques, where he intended to sow it. A customs officer detained the parcel, and it was ultimately sent unopened to the Entomologist of the Department of Agriculture at Lourenço Marques for inspection and fumigation. The inspection disclosed living pink boll-worm larvae. The presence of many dead larvae suggested that the seed had previously been treated for the destruction of the pest, but evidently not with proper thoroughness.

The same pest was found in a small parcel of Egyptian seed sent to this Department by our own Trade Commissioner in London.

A tag label on the bag bore the imprint "from the Imperial Institute, South Kensington." About 60 per cent. of the seed was damaged by the insect, and amongst the many dead larvae found were a number of active ones. This is mentioned to show how seed coming from high-class institutions must be viewed with suspicion as well as seed obtained in a commercial way.

---

### Registration of Karakul Sheep.

It has been decided by the S.A. Stud Book Association to open a Stud Register for Karakul Sheep. Only imported Karakuls of fur-bearing type or the progeny of such on both sire's and dam's side are eligible for registration, and all animals must be passed by the association's inspector before being accepted for registration.

Mr. R. Owen Wahl, who, in consultation with Mr. A. D. Thompson, is the author of that interesting article "Karakul Sheep," which appeared in the last two issues of the *Journal*, has been appointed inspector for the Cape Province, and Mr. Thompson for the South-West Protectorate.

Breeders desiring to register their flocks should make application to the Secretary, South African Stud Book Association, P.O. Box 703, Capetown.

---

### The World's Crops.

The August Bulletin of Agricultural and Commercial Statistics of the International Institute of Agriculture announces that the winter wheat crop in the United States improved during July, but the estimates of spring wheat show a decline. The wheat crop in Canada, where the harvest was in progress, shows a reduction on the original estimate. The aggregate of North American wheat crops is, therefore, now estimated at 28.9 million metric tons (1 metric ton = 2204.6 lb. avoirdupois) against 30.9 in 1919, and 29.3 during the five war years 1914 to 1918.

In Belgium, Spain, Italy, Switzerland, Canada, United States, British India, Algeria, Egypt, Morocco, and Tunis the wheat crop of 1920 is estimated to produce 48.9 million metric tons, as compared with 49.0 millions in 1919, and an average of 50.1 millions during the five years 1914 to 1918.

No definite estimates are to hand from other countries, but the wheat crop is reported as good in Bulgaria, Denmark, France, Luxemburg, Netherlands, Roumania, Serbia-Croatia-Slavonia, and Sweden, average in Germany, Scotland, Ireland, Poland, and Czecho-Slovakia, below average in England and Wales.

The area under wheat in Australia is reported to be 55 per cent. larger than last year and 11 per cent. above the average 1914-15 to 1918-19. Information under date of 17th August reports weather and crop conditions as good.

The aggregate wheat shipments from Argentina have exceeded all estimates of available surplus during 1920.

The cotton crop of the United States is estimated at 2.7 million tons, being 10.5 per cent. larger than last year and 1 per cent. above the five years' average. The sugar beet crop is estimated at 8.1 million tons, which is 39.4 per cent. larger than last year's yield and 52.3 per cent. over the average.

### Mr. Claude Fuller: A Recognition.

We are pleased to notice that the South African Biological Society has awarded the Captain Scott Senior Medal for Research in South Africa to Mr. Claude Fuller, Assistant Chief of the Division of Entomology. We are given to understand that our colleague was elected unanimously for this award by the Special Medal Committee of the Society, of which Sir Arnold Theiler, Professor Ernest Warren, Professor F. B. Fantham, Dr. R. B. Marloth, and Dr. H. H. Green are the members. The decision of the Medal Committee is a great tribute to the recipient of the medal and most gratifying to the Department of Agriculture and particularly to the Division of Entomology.

The award was made more especially for Mr. Fuller's researches upon white ants in South Africa. His investigation as an economic entomologist, his horticultural work in pioneering the export of citrus fruit and pineapples from Natal, and his devising and carrying into effect in Natal, during the progress of the Boer war, of the system of destroying locusts under State control, also weighed with the Medal Committee. We feel sure that the farming community will appreciate the honour conferred upon an officer who has done so much to help solve our problems of insect control and contribute to the advancement of agriculture in the Union.

### Notice to Viticulturists and Vine Nurserymen.— Inspection of Vines.

According to the recommendation made by the Commission on Grafted Vines, as published in the September number of the *Journal*, this Department has arranged to inspect all mother-plantations of American vines and nurseries of grafted vines, whose owners, whether farmers or nurserymen, desire to avail themselves of such inspection.

If a mother-plantation of American stocks is found to be true to name, the inspector will give a certificate to that effect, or after the party concerned has uprooted such plants as are not true to name. In case of a nursery of grafted vines, a certificate will be given as to the state of cultivation, growth, purity of scion and whether stocks were obtained from a registered mother-plantation. The name of the holder of such a certificate will be published in the *Journal* from time to time. All those who wish to avail themselves of this inspection are invited to communicate with the Government Viticulturist, Elsenburg, Mulder's Vlei, stating clearly the nearest railway station as well as the best road for a motor-car to reach the farm.

It is urged that all nurserymen, as well as farmers who have mother-plantations for their own use, will avail themselves of this opportunity of securing a Government certificate. It will prove that nurserymen are anxious to help the Department to supply to the public only stocks true to name, which the public now demand and Government officials advocate. To the farmer it will be a means of enabling him to be quite sure that his stocks are true to name and not a mixture of varieties very closely related and difficult to distinguish. The economic advantages of establishing a vineyard on stocks true to name are too well known to need any elaboration.

The Department is appealing to farmers and nurserymen in their own interests to respond to this invitation, and trusts that they will extensively avail themselves of the facilities afforded.

## WHEAT-STRAW AND ITS VALUE TO THE LAND.

By CHAS. F. JURITZ, M.A., D.Sc., F.L.C., Agricultural Research  
Chemist, Capetown.

THE fact that straw possesses a value as fodder was patent as far back as Biblical times, but even its worth as manure has been known for a considerable period. Centuries ago it was customary for land-owners to place an embargo on the removal of straw from their lands by tenants. The latter were bound to consume on the farm all the straw that they produced and to return it to the land.

The Departmental Committee on wheat-growing, whose report, with summaries of evidence taken in practically every district where wheat is grown within the Union (U.G. 42—19), was recently presented to Parliament, took occasion on its tour through the Union to inquire of various gatherings of farmers what the practice in their respective areas was with regard to utilizing the straw which accumulates at every harvest from the cereal crops. The committee repeatedly impressed on wheat-growers, particularly where it was found that the grain lands were lacking in humus, the desirability of returning the straw to the land, either directly by ploughing it in, or indirectly by feeding to the live stock or using it as bedding for the cattle and then applying the manure to the soil.

Below will be found a summary of the evidence given in this connection, in respect of most of the divisions of the two extensive areas in respect of which the committee considered inquiries of the above character specially necessary, namely, the south-western part of the Cape Province and the main area of the Transvaal. The districts most concerned in the south-west Cape are Ceres, Tulbagh, Caledon, Malmesbury, Swellendam, and Riversdale; and in the Transvaal the same question was raised in the Districts of Marico, Rustenburg, Potchefstroom, and Middelburg.

In the Malmesbury district good results have in several cases resulted from returning chaff to the land before fallowing. Evidence was given before the committee to the effect that this practice had restored lands which had become too exhausted to grow wheat. In addition to the chaff long straw was being returned to the soil, and was found better suited for the heavier than for the lighter soils. The rate at which chaff or straw is applied to the soil in this district is about one ton per acre. The surface of the land is first pretty well covered with the straw, which is then allowed to dry on the land before being ploughed in. This practice is becoming more and more common throughout the district. In the sub-district of Darling, a part of the Malmesbury district, all the straw, the committee was informed, goes back on the land in the form of kraal manure. The evidence given in another part of the same division, namely, in the Moorsburg district, was to the effect that the application of straw and chaff to the land, both directly and through the kraals, is a

general practice. At Hopefield the committee was told that no hay or chaff is sold off the farms in the Saldanha Bay district, but all goes back to the soil. In some districts the straw is returned to the land by way of the kraals; in that of Ceres, for instance, although some of the farmers are in the habit of selling their chaff, obtaining a price of about 1s. 6d. per bale of approximately 60 lb., most grain farmers put their straw in the kraals and subsequently, when mixed with manure, return it to the grain lands. A similar procedure is adopted in the adjacent Tulbagh district, where the straw which has passed through the kraals is first of all put on the orchards and vineyards, and any surplus given to the grain lands. The experience in this district is that the application of straw to lands which have lain fallow is sound practice, but application just before sowing means introduction of weeds and noxious insects.

At Caledon the gathering of agriculturists expressed the view that if the straw could be put on the land without much expense it would be of assistance, and it was thought that a stripping machine which would remove the ears and leave the straw on the land might solve the difficulty.

The above summarizes the practice said to be followed in the more south-westerly districts, which contain soils that are chemically amongst the poorest of all the grain lands in the Union, although climatically better suited for winter wheat than any other areas.

On passing eastwards along the southern coast belt the committee found that in the Swellendam district it is the general custom to burn most of the wheat straw produced on the farms; a little of the straw is made into kraal manure, and only some of the kraal manure is put on the grain lands, most being used for kitchen gardens. In the district of Riversdale the straw is sometimes burnt. In dry seasons it is generally fed to the stock, but not in wet seasons. Some farmers have been in the habit of ploughing in rotten straw and found this to give good results. The straw is put into the kraals for kraal manure, but it is not often that kraal manure is made in this district.

On the way to the Eastern Province, while in the Long Kloof, the committee was told at Joubertina that the straw is generally burned; and at Misgund, although it is usual for many farmers to put it through the kraals, it is also very largely burned. In the Uitenhage district we were informed that most of the straw is left to rot and wasted, although some of it is put into the kraals. Such are the varieties of practice in the south-western and southern districts of the Union, where the deficiency of humus in the soil is most noticeable.

In the Transvaal similar evidence was given. In the Groot Marico District, the evidence was to the effect that most farmers put kraal manure on their lands once in three years, and thus make indirect use of the cereal straw, which is generally either put in the kraals or fed to the cattle. In the Rustenburg District care is taken that none of the straw is lost; directly or indirectly it all goes back to the land, as much as possible being fed to the stock. The straw is chiefly made use of as a winter feed, what is left at the end of the winter being put into the kraals. In the Potchefstroom District, according to evidence given at Ventersdorp, the wheat-straw is all put into the kraals after the cattle have had a turn at the

heap. In the Middelburg District, the committee was assured by farmers who gave evidence at Rooikraal, the value of returning the straw to the soil is realized, and it is so applied, either directly or indirectly through the kraals.

The committee, dealing in its report (pars. 23 and 24) with the grain lands of the south-western region, pointed out that the outstanding deficiency of these soils is humus or decayed organic matter, which is valued as much for its quality of keeping soils in good physical condition as for its chemical constituents and properties. The report proceeds to advise that no economical means of supplying humus to those soils should be omitted, and states that a very ready and cheap method of assisting in this object is that of returning the straw to the land after the grain has been thrashed, either as such, or through the kraals or stables. The straw, it is pointed out, is a valuable by-product, of which the fullest use should be made, instead of its being left to waste on the farms, or being burned as undesirable material, a proceeding which the committee, in its report, characterizes as "a thoughtless process of soil-exhaustion, which leaves the farmer in deeper debt each year to his soils." Knowing what we do of microscopic ferments, we can the more readily understand how the organic matter of straw, that is to say the part which can be burnt off, is useful in forming food for the micro-organisms that help the crops by causing fermentation and decay.

The report mentions three important directions in which the addition of organic matter would improve the grain soils of the south-western districts; it would give them body; it would improve their physical texture; it would render them more absorptive and retentive of moisture without being wet or boggy: a soil which contains much organic matter is very porous and possesses considerable capillary power. But the addition of organic matter would do more than this. "The chief value of straw considered as a fertilizer," says Storer, "must be attributed to the ash ingredients which are contained in it." The grain farmers were rightly told, over and over again, during their meetings with the committee, that the two main needs in making up wheat-fertilizers are nitrogen and phosphates. During its growth a wheat crop takes large quantities of nitrogen and phosphoric oxide and a smaller proportion of potash out of the soil, but a wheat crop can no more come to perfection without potash than it can without nitrogen or phosphates. When straw is burned, the potash, lime, and phosphoric oxide which it contains are left behind in ash, but even when straw is not burned but applied to the land either direct or through the kraals, all the ash-ingredients remain in it and so get back into the soil. If the straw is returned to the land every season the farmer thus uses these ash-ingredients over and over again, and is saved the necessity of purchasing artificial fertilizers which he would have to do in large quantities if he does not wish his ancestral source of income, as the Departmental Committee phrased it in its report, to present an overdrawn account for immediate attention; in other words, if he does not want his soil to become utterly exhausted; the committee, in no uncertain terms, warned the farmers in the country's most extensive wheat areas of "the natural infertility of the soils and their steady impoverishment under the present cereal-cropping system."

Professor F. H. Storer, in his work on "Agriculture in some of

its relations with Chemistry" (Vol. 3, p. 63), quotes from S. W. Johnson some very instructive figures regarding the materials removed from the soil by an acre of wheat. He found the total weight of the crop—grain and straw together—to be 6440 lb. Of this 1840 lb. was grain and 4600 straw. The entire crop takes out of the soil 120 lb. of potash, nitrogen, and phosphoric oxide; of this 120 lb., 59 lb. goes into the grain and 61 lb. into the straw. Moreover, of the 120 lb., 48 lb. consists of nitrogen, 23 lb. of phosphoric oxide, and 49 lb. of potash. That is to say, the wheat crop, *taken as a whole*, needs roughly half as much of phosphoric oxide as of either nitrogen or potash. It is, however, when we consider the composition of the grain and straw separately that we notice the striking difference. Of the 48 lb. of nitrogen 34 lb. pass through the straw into the grain, and only 14 lb. remain permanently in the straw; of the 23 lb. of phosphoric oxide, 15 lb. pass over into the grain and only 8 lb. remain in the straw; with potash, on the other hand, the conditions are reversed: out of the 49 lb. no less than 39 lb. are ultimately found in the straw, while only 10 lb. are transferred into the grain. The fact is that, as the grain of the maturing crop ripens, most of the phosphoric oxide and nitrogen pass up out of the stalk and lodge in the grain.

Consider now what it would mean if all the grain were sold off the farm and all the straw got rid of by burning or otherwise; every acre of cultivated soil would, under the above conditions, lose about 48 lb. of nitrogen, 23 lb. of phosphoric oxide, and 49 lb. of potash, all of which would have to be returned to the soil in the form of fertilizers. If only the grain were sold off and the straw put back into the soil, the yearly loss per acre to be made good would amount to 34 lb. of nitrogen and 15 lb. of phosphoric oxide, but only 10 lb. of potash. In other words, the quantity of potash lost to the soil by disposing of both grain and straw is five times as great as when only the grain is disposed of.

Of course the latter argument would not apply if the straw were burnt and the ashes uniformly distributed over the stubble lands, but such a course presents some practical difficulties, and even then the loss of humus and nitrogen would still occur.

The manurial value of straw has of late been the subject of investigation in some of the United States experiment stations, particularly those of the States of New York, South Dakota, and Illinois. At the first-named station straw has been valued for purely fertilizing purposes at from 16s. 8d. to 25s. per ton, while South Dakota valued it at from 8s. 4d. to 20s. 10d. per ton. In this connection the *American Fertilizer* remarks that to burn or to waste straw is like burning real money, seeing that straw is a richer fertilizer than stable manure, containing more nitrogen, two and a half as much times as much phosphorus, more potash, and three times as much humus-making materials. In support of this statement the following percentage composition of straw and of stable manure is quoted:—

	Straw.	Manure.
Nitrogen ... ..	.50	.48
Potash ... ..	.30 to .90	.40
Phosphorus ... ..	.25	.10
Moisture ... ..	25.00	74.00

It has been estimated by Professor Mosier, of the Illinois Experiment Station, that the nitrogen and phosphorus contained in the stacks of straw scattered over the State of Illinois are sufficient for the production of about  $11\frac{1}{2}$  million additional bushels of wheat. The quantity of phosphorus contained in these stacks of straw is equivalent to that in three-quarter million dollars' worth of superphosphates.

The chemical composition, and consequently the value as manure, of straw varies considerably with the degree of maturity of the crop when cut. When perfectly mature the straw contains less nitrogen than the green stalks, and, furthermore, when the season has been moist the nitrogen may be considerably increased. The analytical results consequently depend largely on the condition and maturity of the straw.

Ingle, formerly Chief Chemist of the Transvaal, gives the following as the average of manurial constituents of wheat straw:—

Nitrogen ... ..	.48 per cent.
Potash ... ..	.90 ..
Phosphoric oxide ... ..	.25 ..
Lime ... ..	.31 ..

In another place the same writer records the following composition for wheat-straw as given in *Bulletin of the United States Office of Experiment Stations*:—

Nitrogen ... ..	.59 per cent.
Potash ... ..	.51 ..
Phosphoric oxide ... ..	.12 ..
Moisture ... ..	9.60 ..

These last figures are evidently the results of analyses of air-dried straw, while those in the first table, where a comparison is made with stable manure, are based upon an article still containing a considerable proportion of moisture. Stöckhardt gives the following results for absolutely dry wheat-straw:—

Nitrogen... ..	.4 per cent.
Potash and soda ... ..	.6 ..
Phosphoric oxide... ..	.2 ..
Lime and magnesia ... ..	.3 ..

Ordinary straw, he adds, contains from 8 to 12 per cent. of moisture.

There is another side to the question which must not be lost sight of: I give it in Professor Storer's words:—

"Formerly, when there were no means of compressing straw for sale, or transporting it when compressed, it was almost everywhere regarded as an important resource for keeping up the fertility of farms. But in modern times there are numberless situations where straw is as readily saleable at a profit as any other crop, and in such cases, i.e. wherever there is a market within reach, it is evident that the straw should be sold as such, and the price of it expended, if need be, in buying some other form of manure. For packing fragile articles, and for bedding men and animals in cities, straw usually commands a price which takes it out of the category of manures. It should be seldom, if ever, thought of as a manure nowadays in regions where it is saleable."



Elsewhere Storer observes that it may be possible to purchase with the proceeds of the sale of straw four times as much manure as the straw itself actually contains.

It will be seen that the above paragraph lays down two conditions; one has to do with the existence of suitable means for compressing and transporting, and the availability of a ready market; the other refers to the employment of the proceeds of the sale of straw in the purchase of other fertilizers. It would certainly be worth while selling the straw under such conditions as these, but for the average South African grain farmer virtually they do not exist.

Many South African farmers are themselves fully aware, as we have seen above, of the advantage of returning cereal straw to the land; the pity is that it is not realized more extensively and that there is not a more widespread adoption of a practice which will go far not only to maintain our principal grain lands in good physical condition, but will also render them more retentive of moisture and thus better fitted to produce sturdy crops and vigorous ears of corn.



A SUSSEX GROUP.

### Valuable Exhibit of Manufactured Wool and Mohair.

The Department is greatly indebted to Mr. Chas. Mallinson, who, it will be remembered, was at one time Principal Sheep and Wool Expert for the Union, for his services in collecting in England for the Sheep Division a most comprehensive exhibit showing the different stages through which wool passes from the grease to the finished article, both in worsteds and woollens, also one of mohair in the different stages of manufacture. Mr. Mallinson experienced considerable difficulty in obtaining the various samples, but writes that the collection is much more elaborate and valuable than any that has hitherto been seen in South Africa, and, of its kind, is unique. It is proposed to house the exhibit in Pretoria and send it also to the leading agricultural shows, where it will serve a valuable educative purpose.

## A TOMATO CANKER.

By E. M. DODGE, M.A., D.Sc., F.L.S., Assistant Chief,  
Division of Botany.

### INTRODUCTION.

A DISEASE which may be described as a canker of tomatoes was first noticed in fruit on the Pretoria market during the summer of 1914. It is most prevalent from January to March, and during that period each year (1914-1920) a large percentage of the fruit offered for sale is disfigured, and rapidly becomes attacked by soft rot organisms which enter the fruit through cracks caused by the scab lesions, and destroy it within a few days.

The incidence of the disease has a direct relation to the rainfall. Tomatoes which ripen in the early summer are seldom attacked, being grown under irrigation, and the disease is seldom observed up to the end of November. From November to January the temperature is high, and there is usually a considerable amount of rain; moist, humid conditions are favourable to the development of the disease. The fruit can only become seriously scabbed when it is attacked by the organism in the early stages of its development: this would account for the non-appearance of the disease before December or January. A few lesions are to be found on fruits as late as June, but the disease can be recorded as serious only during the summer months.

The occurrence of canker in fruit on the Pretoria market was suggestive of the fact that the disease occurred in market gardens in the district; several tomato growers were visited and the surmise was found to be correct. Canker is a very common trouble in market and private gardens in the Pretoria District; it is reported to occur also in the Rustenburg District, but I have seen no specimens from there, and beyond this nothing is known of the distribution of the disease. It is not regarded as being of a very serious nature, but a large percentage of the fruit is disfigured, and much of it decays if it is kept for a few days after ripening. The summer of 1919-20, when most of the observations were made, was exceptionally dry; during another season with heavier or more continuous rainfall the losses would probably be far more serious, and the disease might ruin the whole crop.

The "canker" lesions differ from those caused by other tomato diseases attributed to bacteria. The wilt disease caused by *Bacterium solanaccarum* Erw. Sm. is a distinctly vascular trouble, and causes a characteristic wilting of the plants. *Aplanobacter michiganense* is also found in the vessels. "Streak," described by Paine and Bewley

as caused by *Bacillus lathyri*, is characterized, as the name suggests, "by the formation of dark brown or black sunken patches on the stem, varying from small spots to long furrows or blazes." On the fruit it forms light or dark brown sunken patches, with round or irregular outline.

The effects of the canker organism on leaf stem and fruit are widely different from any of these, as will be evident from the detailed description given later.

#### SYMPTOMS OF DISEASE.

On the leaves the first indication of infection is the appearance of numerous dark green, semi-translucent, water-soaked points on the under surface. In cases of artificial infection in autumn weather this occurred 7-8 days after inoculation; under summer conditions the

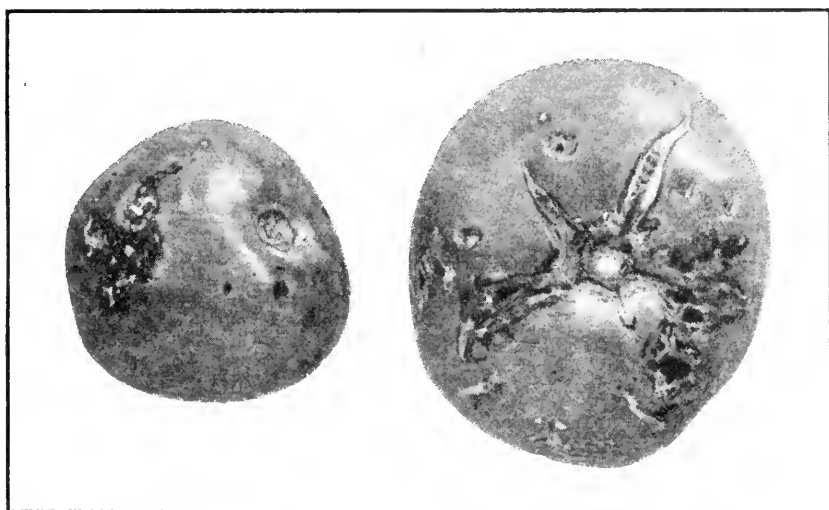

Tomatoes showing Typical "Cankers."

progress of the disease may be more rapid. The spots increase in size and become round or irregular, and about 2 mm. in diameter; they are slightly sunken and are often present in such numbers in the neighbourhood of the lateral veins and leaf margins that they coalesce, and produce irregular, discoloured streaks. The colour soon changes from dark green to a purplish grey. The discoloration penetrates to the upper surface, and the spots eventually consist of a smoke-grey centre, which is thin and membranous, and surrounded by a deep brown margin.

Where the spots are numerous the intervening leaf tissue becomes dry and brown. In this way the affected portions of the leaf, especially the edges and the tips, become dead and dry, and break away, giving the leaves a very raggy appearance; and many of the smaller leaflets

are altogether destroyed. Affected leaves show a tendency to curl inwards, and are more or less twisted and distorted.

Spots on calyces, pedicels, and young parts of the stem are similar in character to the leaf spots. On the calyx they may be numerous, but very minute and scattered, or less numerous and up to the 2-3 mm. diameter; or they may form elongated streaks up to 5 or 6 mm. long.

Cankers are produced on older parts of the stem, especially where the tissues have been somewhat injured by friction or otherwise. At first there appear irregular, dark green, water-soaked areas, which later become corky-looking, slightly raised, roughened, and with numerous small longitudinal cracks.

The surface has the appearance of having become blistered or raised by abnormal tissue development underneath, with subsequent cracking of the blistered areas. Cankers of irregular form and 1-2 cm. in diameter are not uncommon. The discoloration does not penetrate with the wood; it is apparently confined to the cortex and quite superficial.

In the field infected fruits are usually found immediately below diseased leaves, and are doubtless infected during rainy weather by rain-drops which fall on infected leaves and subsequently drip on to the young fruit. The majority of the fruit spots are at the stalk end, but they are also found scattered over the sides and less frequently on the blossom end.

A very minute green or brownish blister is the first indication of infection; this blister may remain minute, about 1 mm. diameter, or may increase in size up to about 3 mm., and become considerably raised above the normal fruit tissue. Occasionally, presumably when weather conditions are unfavourable, infection does not proceed further, and when the fruit is ripe these minute blister-like spots have almost the appearance of fly-specks.

In the large majority of cases the point of infection becomes surrounded by a dark green water-soaked area which spreads considerably, and then begins to discolour from the centre. The centre becomes dark brown, a water-soaked margin about 1 mm. wide is still apparent, whilst the organism is active. Finally the epidermis ruptures in the centre, showing whitish-brown over the discoloured tissues like the broken edges of a blister. The spots are hard and scabby in texture, and usually slightly convex, although in mature fruit they may lie in slight depressions owing to arrested growth at the point of infection.

Single scabs are usually not more than 5 mm. diameter, but they are often so numerous and close together that they coalesce, forming large, scabby areas several centimetres in extent. As the fruit ripens the tissues round the infected areas remains green, forming a green rim round the scabs, which is conspicuous on the red fruit. The rifts in the epidermis become extended in cases of severe infection and whitish-brown cracks are formed, many of them over 1 cm. in length, and extending into unaffected tissues. These open the way for putrefactive organisms, and the fruit usually rots in a few days after ripening.

Thus the disease not only disfigures the fruit and reduces its market value, but seriously affects its keeping qualities.

## THE CAUSE OF THE DISEASE.

The cause of this disease is a yellow bacterium belonging to the same group as the organisms causing citrus canker, walnut blight, black rot in cabbage, etc. It is not identical with any of these, and in a number of cross inoculation experiments it failed to infect any of these hosts; it only attacks the tomato and a few closely related plants. The bacterium appears to be one hitherto undescribed, and will be described in detail elsewhere under the name *Bacterium vesicatorium* n. sp.

## CONTROL OF THE DISEASE.

The organism is not very sensitive to the fungicides usually employed in spraying solutions, and experience has shown that spraying is of little use in combating plant diseases caused by bacteria. This is particularly the case with organisms disseminated chiefly by rain-splash and infecting the plant through the stomata.

It appears to be the custom of the market gardeners in the Pretoria District to save seed from their own plants for the following season; this custom is probably in part responsible for carrying over the disease from one season to another. Certain varieties are more susceptible than others, but it has been found practically impossible to discover the names of the varieties usually grown. The following methods are therefore suggested for the control of the disease:—

- (1) Selection of resistant varieties.
- (2) Sterilization of the seed by means of formalin or mercuric chloride.
- (3) A long crop rotation.
- (4) Destruction of diseased fruit and of affected plants at the end of the season.

In connection with (3) it will also be of importance that the irrigation furrows shall not be allowed to flow through the old tomato bed to the site selected for tomatoes in the following season.

---

**Fruit Export.**

The following is a return of fruit shipped overseas during the month of September, 1920:—

Variety.	<i>Er</i> Durban. Boxes.	<i>Er</i> East London. Boxes.	<i>Er</i> Port Elizabeth. Boxes.	<i>Er</i> Mossel Bay. Boxes.	<i>Er</i> Capetown. Boxes.	Total. Boxes.
Oranges ... ..	1058	151	4568	81	17,991	23,849
Naartjes ... ..	—	—	—	—	172	172
Lemons... ..	—	—	—	—	50	50
Grape fruit ...	—	—	—	—	441	441
Pineapples ...	—	—	304	—	—	304
<b>TOTAL ... ..</b>	<b>1058</b>	<b>151</b>	<b>4872</b>	<b>81</b>	<b>18,654</b>	<b>24,816</b>

The total shipments from all ports during July and August, 1920, were 37,438 and 29,365 boxes respectively.

## REPRESENTATIVE TRANSVAAL SOILS.

### I.

#### The Koedoespoort Red Loam.

By B. DE C. MARCHAND, B.A., D.Sc., Chief, Division of Chemistry.

---

*Occurrence.*—This soil type has been given the above name owing to its occurrence on the farm Koedoespoort No. 299, near Pretoria, where it has been the subject of considerable study. The type is widely distributed, being found in the Pretoria, Rustenburg, Marico, Krugersdorp, Potchefstroom, Heidelberg, Middelburg, Lydenburg, Barberton, and Zoutpansberg Districts. This list does not pretend to exhaust the possible occurrences; the type is probably to be found in other parts. Very similar soils occur also in Swaziland, in Natal, and in Rhodesia.

*Nature and Origin.*—The Koedoespoort loam is a brick-red to red-brown sandy clay soil, usually deep and easy to work in spite of its apparent heavy texture. The sub-soil is usually a brighter red than the surface soil, and is always stiffer. In some cases yellow patches may be observed a short distance down, usually at from 18 inches depth onward. The brown varieties contain more organic matter than the red, hence the difference in colour.

The typical soil is sedentary and is derived from the diabase\* intrusive in the Pretoria series, but may be influenced in some cases by the shales of the same series. One or two other basic igneous rocks also give rise to this soil type, of which the dolerite and the diabases of the Waterberg system may be mentioned. The shales of the Pretoria series do not, by themselves, give rise to the Koedoespoort loam. It is not possible at present to give a detailed account of the distribution of this soil type. Two very similar soil types must not be confused with the one under discussion, viz., certain heavy red soils overlying the norite, and the amygdaloidal basalt of the bushveld, since these differ from the former type in an important respect, they contain considerable quantities of lime.

---

\* For the sake of simplicity no distinction is made between the intrusive diabase and the contemporaneous amygdaloidal lava.

*Chemical Composition.*—To illustrate the chemical composition of the Koedoespoort loam, the following analyses of samples from various parts of the Transvaal are quoted:—

No. ...	1154.	1977.	1935.	2034.	2039.	2170.
Farm ...	Koedoespoort No. 299.	Koedoespoort No. 299.	Witpoort No. 26.	Schaapkraal No. 205.	Hekpoort No. 122.	Wonderfontein No. 41.
Ward ...	Aapies River.	Aapies River.	Mapoch.	Steenkampsberg.	—	Groot Marico.
District ...	Pretoria.	Pretoria.	Middelburg.	Lydenburg.	Kingsdorp.	Marico.
	per cent.	per cent.	per cent.	per cent.	per cent.	per cent.
Stones over 3 m.m. diam.	Nil.	1·5	Nil.	1·5	Nil.	Nil.
Moisture ...	6·60	3·40	3·52	2·25	4·04	4·06
Loss on ignition ...	8·86	9·43	7·78	12·12	9·33	8·30
Insoluble matter ...	60·20	56·99	61·77	52·52	53·55	56·73
Iron oxide and alumina	23·35	28·65	23·98	32·66	33·67	30·44
Lime ...	0·35	0·09	0·16	0·23	0·14	0·21
Magnesia ...	0·46	0·14	0·17	0·11	0·14	0·14
Potash ...	0·27	0·12	0·15	0·13	0·08	0·19
Phosphoric oxide ...	0·08	0·04	0·08	0·06	0·06	0·08
Total ...	100·17	99·86	100·61	100·08	101·01	100·15
Nitrogen ...	0·152	0·174	0·066	0·122	0·115	0·134
“Available” Potash	0·0096	0·0078	0·0186	0·0069	0·0086	0·0036
“Available” Phosphoric oxide	0·0027	0·0007	0·0011	0·0005	0·0014	0·0009

Chemically these soils are characterized by a high percentage of iron oxide and alumina, the ferric oxide usually being in excess as shown by the following:—

	No. 1935.	No. 1977.	No. 2034.
	per cent.	per cent.	per cent.
Ferric oxide...	10·16	18·59	18·99
Alumina ...	13·82	10·06	13·67

while a comparatively large proportion of this ferric oxide is present in a very finely divided state; an inadequate amount of lime, reasonable percentages of potash (including “available” potash) and nitrogen, and a great deficiency in phosphoric oxide, and particularly in available phosphoric oxide.

A large proportion of the phosphoric oxide in these soils is locked up in the larger particles, as the following figures show:—

	No. 1977.	No. 2039.
	per cent.	per cent.
Fine gravel ...	8·80	10·80
Phosphoric oxide ...	0·04	0·06
Phosphoric oxide in fine gravel ...	0·014	0·015

This phosphoric oxide, amounting to one-third of the total in sample 1977 and one-quarter in sample 2039, cannot be in any way available to plants (2).

*Mechanical Composition.*—The predominant mechanical fractions in soils of this type are the clay, the sand, and the fine sand, the silt fractions being subordinate, as is illustrated by the following mechanical analysis:—

	No. 1977.	No. 2031.	No. 2039.
	per cent.	per cent.	per cent.
Moisture ... ..	3.40	2.25	4.04
Loss on ignition ... ..	9.43	12.12	9.33
Fine gravel ... ..	8.80	3.37	10.80
Sand ... ..	15.82	18.50	13.97
Fine sand ... ..	12.92	11.80	15.89
Silt ... ..	6.80	1.73	6.19
Fine silt ... ..	9.29	9.50	8.60
Clay ... ..	33.20	36.00	30.96

The clay is usually in a highly flocculated condition, owing to which fact a good tilth can be obtained after a short period of cultivation. The flocculating agent is finely divided ferric oxide, which is found in considerable amount in the clay fraction:—

	No. 1977.	No. 2034.
	per cent.	per cent.
Total ferric oxide* ... ..	18.59	18.99
Ferric oxide in clay fraction ... ..	8.48	7.00

Apart from its flocculating action on the clay, this fine ferric oxide is the cause of the colour of these soils, the browner varieties being also partly coloured by organic matter.

Under continued irrigation the Koedoespoort loam is apt to puddle after a time and to form hard crust on the surface. These conditions can easily be avoided by good cultivation and reasonable care. The soil is easier to handle than one would expect from the clay content, and would be called a stiff loam by the farmer rather than a clay. The sub-soil is generally rather heavier than the surface soil. The depth is variable, from 2 feet to well over 4 feet is usual. The drainage is fairly good considering the amount of clay. On no account should the sub-soil be brought to the surface by trenching or otherwise. For some reason, at present uncertain, the sub-soil is unfertile, and if brought to the surface will cause trouble which can only be rectified at great expense. If it is considered necessary to trench, the method known as "false trenching" must be adopted.

The occurrence of brak (alkali) in the Koedoespoort loam has not been observed or reported.

\* The figures for both total ferric oxide and ferric oxide in the clay refer only to such as is soluble in boiling concentrated hydrochloric acid.



*Manurial Experiments.*—The following results were obtained in an experiment on Koedoespoort No. 299 with potatoes in 1908 (1). Sample No. 1154 was representative of the plots:—

Plot.	Manure.	Application per Acre.	Yield per Acre.		Increase (Saleable only).
			Saleable.	Small.	
I	Nitrate of potash ... ..	200 lb.	4,211 lb.	416 lb.	486 lb.
II	Superphosphate ... ..	400 "	6,264 ..	416 ..	2,536 ..
	Nitrate of soda ... ..	200 ..			
III	Superphosphate ... ..	400 "	6,232 "	608 "	2,504 ..
	Sulphate of potash ... ..	200 ..			
IV	Nothing ... ..	—	3,728 ..	512 "	—
V	Superphosphate ... ..	400 "	6,176 ..	608 ..	2,448 ..
	Nitrate of potash ... ..	200 "			
VI	Stable manure... ..	10 tons	5,358 ..	313 ..	1,630 ..
VII	Stable manure... ..	10 tons	6,411 ..	684 ..	2,686 ..
	Superphosphate ... ..	400 lb.			
	Nitrate of potash ... ..	200 ..			

It will be noticed that in every case in which superphosphate was applied an increase in saleable crop of about 2500 lb. was obtained. It is unfortunate that there was no plot manured with superphosphate alone. The indications are that all the increase on these plots was due to the superphosphate alone, and that the potash and nitrogenous fertilizers applied had little or no effect. Otherwise it would be curious if nitrate of soda, nitrate of potash, and sulphate of potash had almost exactly the same effect. It will also be noticed that the application of ten tons per acre of stable manure did not give as heavy a crop as the superphosphate mixtures.

In an experiment on maize on the same farm during 1910-1912 the results were (3):—

First series: Mixed maize and velvet beans.

Plot.	Manure.	Application per Acre.		Yield of Maize per Acre.		Increase.	
		1910 11.	1911 12.	1910 11.	1911 12.	1910 11.	1911 12.
1	Slaked lime ... ..	600 lb.	Nil.	625 lb.	1,062 lb.	186 lb.	460 lb.
2	Slaked lime ... ..	600 "	Nil.	898 "	1,993 ..	459 ..	1,391 ..
	Superphosphate... ..	200 "	200 lb.				
3	Weenen phosphate	1,000 "	Nil.	837 "	1,872 "	398 "	1,270 "
1	Superphosphate... ..	200 "	200 lb.	813 "	1,822 "	374 "	1,220 "
5	Basic slag ... ..	400 "	Nil.	1,106 "	2,220 "	667 "	1,618 "
6	Nothing ... ..	—	—	439 "	602 "	—	—

## Second series: Maize alone.

Plot.	Manure.	Application per Acre.		Yield per Acre.		Increase.	
		1910 11.	1911 12.	1910 11.	1911-12	1910 11.	1911 12.
7	Weenen phosphate <sup>c</sup>	1,000 lb.	Nil.	1,224 lb.	2,217 lb.	562 lb.	1,733 lb.
8	Nothing ...	—	—	662 ..	184 ..	—	—
9	Slaked lime ...	600 ..	Nil.	896 ..	×	234 ..	—
10	Slaked lime ...	600 ..	Nil.	1,214 ..	×	552 ..	—
	Superphosphate...	200 ..	200 lb.				
11	Basic slag ...	400 ..	Nil.	1,497 ..	2,133 ..	835 ..	1,949 ..
12	Superphosphate...	200 ..	200 lb.	1,199 ..	×	537 ..	—
13	Bone-meal ...	400 ..	Nil.	1,612 ..	1,731 ..	950 ..	1,250 ..
14	Superphosphate...	200 ..	200 lb.	1,459 ..	×	797 ..	—
	Nitrate of soda ...	150 ..	100 ..				
15	Bone-meal ...	200 ..	Nil.	1,305 ..	2,016 ..	643 ..	1,532 ..
	Superphosphate...	100 ..	100 lb.				
16	Superphosphate...	200 ..	200 ..	1,336 ..	×	674 ..	—
	Nitrate of soda ...	150 ..	100 ..				
	Sulphate of potash	100 ..	50 ..				

Sample No. 1977 is representative of the soil of the experimental plots. The plots marked × were, unfortunately, spoilt during the season 1911-12.

The beneficial effect of phosphatic manures, and particularly of the insoluble phosphates basic slag and ground Weenen phosphate, is evident. The application of superphosphate to soils of this type must result in a partial combination of the soluble phosphoric oxide with the finely divided ferric oxide, whereby the activity of the phosphate may be decreased. That this view is correct is substantiated by the results obtained on Plots Nos. 2 and 4 in both years and Plots Nos. 10 and 12 in the first season. The efficacy of the insoluble phosphates applied in the first season on the second crop is most marked. A slight increase, due to the nitrate of soda on Plot No. 14, is indicated, while the addition of sulphate of potash resulted in a decreased yield. The bone-meal plots deserve some remark, since the consignment used was partially rotted and quickly available, to which fact the big yield in the first season and comparatively low yield in the second were due.

From a consideration of the chemical and physical composition of the Koedoespoort loam and the results of the above-quoted manurial experiments the following conclusions may be drawn:—

1. That the application of phosphates is essential in order to raise good crops.
2. That nitrogenous and potassic manures are of little use.
3. That insoluble phosphates will give the best results, if not immediately, at any rate in the long run.
4. That in order to maintain tilth and to maintain the native supply of nitrogen in the soil, the incorporation of organic matter is desirable.
5. That if superphosphate be used, lime should also be applied.

<sup>c</sup> This phosphate is no longer obtainable; the results are given in order to show the effect of a very insoluble phosphatic manure.

This leads us to the question of treatment which is the one of most interest to the farmer. It is surprising, however, to find how few farmers work on any system as far as manures are concerned; we have apparently not got as far as schemes for building up fertility. A rotation is desirable on all soils, and the manures should be adjusted to the crop grown. The Koedoespoort loam is suited to most crops; in spite of its clayey nature good if not extraordinary crops of potatoes may be grown. It is unfortunate that rooibloem is prevalent and at times ruinous to the maize crop. A proper rotation should include a leguminous crop, ploughed under if necessary, or cropped by cattle, or even cut for fodder. The scheme suggested is, therefore:—

1. Basic slag 300-500 lb. every other year; *or* bone-meal 300-500 lb. every other year; *or* superphosphate 150-300 lb. every year.
2. 500-1000 lb. slaked or quicklime *or* 1000-2000 lb. "agricultural lime" (ground limestone) every two or three years.
3. A leguminous crop (cowpeas will probably be best) ploughed under every third or fourth year. *or* ten tons dung every third year.

The treatment should be so arranged that one stage be carried out each year somewhat after the following scheme for maize alone:—

	Crop.		Treatment.
1st year ...	Maize ...	...	Phosphatic manure.
2nd year...	Cowpeas ...	...	Ploughed under.
3rd year...	Maize ...	...	Lime.

Or,

a rotation suitable for a stock farmer:—

	Crop.		Treatment.
1st year ...	Teff ...	...	None.
2nd year...	Cowpeas ...	...	Lime and phosphatic manure.
3rd year...	Maize ...	...	None.
4th year ...	Maize ...	...	Phosphatic manure.

Or,

a rotation adopted at the experiment stations of the Tobacco and Cotton Division (4), and for which the manurial treatment suggested is:—

	Crop.		Treatment.
1st year ...	Tobacco ...	...	Phosphatic manure.
2nd year...	Cotton ...	...	Lime.
3rd year ...	Legume ploughed under		Phosphatic manure.
4th year ...	Maize ...	...	None.

If necessary a light dressing of sulphate of potash may be applied to the tobacco crop or a dressing of nitrate of soda to the cotton crop, though in most cases such additional manuring will hardly pay.

#### REFERENCES.

- (1) Watt, R. D., *Transvaal Agricultural Journal*, VII, 27th April, 1909.
- (2) Vipond, H. J., Annual Reports, Division of Chemistry, 1910, pp. 409-410; 1910-11, p. 376; 1913-14, pp. 225-226.
- (3) Vipond, H. J., *Union Agricultural Journal*, II, 5, p. 618; IV, 4, p. 529; and VI, 3, p. 493.
- (4) Scherffius, W. H., *Union Agricultural Journal*, VII, 6, p. 825.

## FACTORS THAT AFFECT THE GROWTH, REPRODUCTION, AND MATURITY OF TOBACCO.

By W. H. SCHERFFELUS, M.S., Chief, Division of Tobacco and Cotton.

THE various factors that affect the development of a crop of tobacco are numerous. Probably the most important are light, temperature, moisture, chemical changes, and fertility of soil.

*Light.*—I have purposely mentioned light first, as too frequently we attach more importance to the other factors mentioned and leave light out of consideration. A number of investigators have given especial attention to this phase of plant life, and their results have indicated that light plays a most important part in the growth and reproduction of plants. This topic might be viewed from three directions, namely: (1) Intensity of the light; (2) the quality, that is, the wave lengths of the radiation; and (3) the duration.

As regards intensity of the light, there seems to be an optimum amount suited for each plant species, and that optimum may be more or less than the full intensity of the sun's light on a clear day in a particular quarter of the globe. Within certain limits a reduction of the intensity of the light has a tendency to lengthen the axis and branches and also to increase the superficial area of leaf surface of a good many species of plants.

The effects produced by different spectrum rays are very marked, though nothing very decisive can be stated at present. Under the influence of red rays of light certain species of plants show an abnormal elongation of the axis, while under green and blue rays the length of the axis is markedly reduced. Some plants show the greatest growth under white light.

The duration of daily exposure to light seems to have an important bearing on the period of vegetative growth of certain species, the lengthening of the daylight period, showing a considerable shortening of the period of vegetative growth, larger seeds produced, and an increase in the flavour and aroma. The exclusion of light prevents the development and functioning of the seed-forming agents, or sexual reproduction; on the other hand, the length of the seasonal daylight, or if supplemented by artificial light, is a dominant factor in developing the staminate and pistillate reproductive organs, and, therefore, the existence of the species.

Only moderate shortening or lengthening of the daylight period tends to retard or accelerate, as the case may be, the sexual reproduction. If the daylight period is too short for production of seed the plant tends to gigantism or indefinite vegetative development. While under the influence of the correct length of daylight for a particular species an abundant flowering and fruiting may be expected. Thus certain varieties may act as late or early maturing, depending on the

amount of daylight they may be exposed to as compared to the optimum requirements of that species or variety.

Annuals, biennials, and perennials may also be the results of seasonal range of daylight, as many species are, in a measure, governed by length of daylight rather than the retarding influence of winter. Therefore, certain annuals may complete two cycles of reproduction in a single season by subjecting the plants to a suitable length of daylight or artificial light. Similarly, under certain reduced light exposures, some annuals behave like non-flowering perennials.

Apparently the rate of growth is directly proportionate to the length of daily light exposure.

From the above one would conclude that the proper time for seeding in order to get the correct amount of sunlight is important, and that the seasonal range of daylight is an important factor in controlling the natural distribution of plants.

*Temperature and Moisture.*—The various factors mentioned previously are so vitally dependent one upon the other that it is important to bear in mind that one of these factors, such as temperature, will not give results approaching perfection without the other conditions being favourable to the production of the crop. Tobacco is a plant which is very sensitive to its surroundings, and we must not expect a good development if the conditions under which we compel the plant to grow are unfavourable. To obtain the fullest development in growth the plant requires a humid atmosphere and a fairly high temperature, though in my opinion it attains its greatest perfection in temperate zone heat. It has, however, been very clearly demonstrated that certain varieties or types of tobacco will make good development under the influence of high temperature, while others show poor development. A notable example of this is found in the White Burley types. They seem to reach the highest degree of perfection in the Blue Grass Region of Kentucky; there is, however, another factor which plays a vital part in this connection which will be mentioned later. White Burley tobacco, when planted in this country, with occasional exceptions, seems to become somewhat dwarfed, and the different individuals show a lack of uniformity in their growth, and not infrequently the leaves show a parched or dried condition during the growing period. It seems to thrive best in rather a humid atmosphere and with a moderate temperature.

Cigar wrapper tobacco, which is probably the most highly specialized type grown, seems to thrive best and reach the highest degree of perfection in growth, flavour, and aroma, in a high temperature with a fair amount of humidity. During the curing or drying stage, to obtain the best results, the tobacco planter must use his best judgment in this process, as the method of handling his crop depends largely on the type of tobacco he is attempting to produce. For example, in the production of cigar wrappers the curing process is an alternating one, in which the tobacco should partially dry during the day and at night it should absorb a certain amount of moisture—this process is called “running,” i.e. the cured portion of the tobacco gradually changes from a yellow or green colour to a light mahogany brown. In the production of so-called Virginian tobacco the process is somewhat different; to secure the greatest amount of light-coloured leaf the planter must for the first few days during the yellowing process prevent curing, by keeping the atmosphere humid, till the

tobacco is properly yellow; then the curing process is commenced and is continued constantly to prevent "running" till the tobacco is thoroughly dried. The relative amount of humidity and heat necessary both during the yellowing period and the curing period are highly important, as the results obtained depend largely on these factors.

The ageing or fermenting process should not be attempted by the farmer where a warehouse is available, as it is purely a warehouse operation and can only be done properly where large quantities of tobacco are brought together and where suitable buildings are available.

*Chemical Changes.*—During the growing period there are certain plant foods which become water soluble and are drawn into the plant by means of fine root hairs on the plant. These plant foods, nitrogen, potash, and phosphorus, in addition to certain other minerals such as lime, magnesium, sulphur, iron, and carbon, are essential in building up the cell-structure of the plant. During the growth, curing, and fermentation of a crop of tobacco there are complex chemical changes constantly going on; starches are converted to sugars, alkaloidal poisons are built up and broken down, nitrogen is probably used up in this process and again liberated in the fermentation process. This continuous chemical change is illustrated by the varying amounts of nicotine found in tobacco at different stages. Generally speaking, as a plant develops, there is a gradual increase in the nicotine. Seedlings at transplanting time will show approximately .25 per cent. of nicotine, and at full maturity the plant may show 4 per cent. of nicotine; if allowed to stand longer in the field and become over-ripe it will show a slight falling off in the nicotine content. Likewise, during the fermentation process, there is a reduction in the nicotine content.

If one follows these changes, we see starch form and disappear, sugar form and disappear, nitrates and nicotine increase and again decrease. Citric, oxalic, and malic acids are present in the growing plants, and these partially disappear in the cured leaf. Butyric and acetic acids are present in fermented leaf. During the fermentation process gases are formed by the breaking down of certain compounds; ammonia is one of these gases, which is easily detected by the odour in the fermenting room. Thus it is apparent that after a crop of tobacco reaches the curing-shed it is highly important that the curing and fermenting be carried out with the greatest care in order that the best qualities may be obtained.

*Fertility of Soil.*—The question of the fertility of the soil is one which, though often discussed, is of such importance that I feel justified in making a few comments on it before closing. I would first like to impress the fact that the quantity of plant food in the agricultural zone of the soil is a definite quantity, and every crop grown on that soil takes away a portion of that definite quantity. So it becomes a simple matter of reasoning, that if one continues to draw on that stock of plant food without replacing it by means of fertilizers or by growing deep-rooted manuring crops, he must expect in a few years to see a falling off in yields. Again, constant cropping without ploughing under manuring crops will reduce the humus or decaying vegetable matter in the soil to such an extent that, although there may be sufficient nitrogen, potash, and phosphorus to produce crops, the soil may be lifeless. This decaying vegetable matter acts like a

sponge in holding moisture in the soil and also provides a habitat for the soil bacteria, which is so essential to plant life.

Tobacco, which is sometimes spoken of as a potash plant, requires a fair amount of plant food; therefore, if a soil is not giving good yields, for lack of plant food, it is probably advisable to apply a complete fertilizer carrying, say, 4 per cent. of potash, 3 per cent. of nitrogen, and 8 or 10 per cent. of phosphoric oxide. I would, however, advise caution in the use of nitrogen, especially in attempting to produce yellow tobacco. Nitrogen has a tendency to produce a stronger, heavier, and darker tobacco. Potash should not be used for tobacco in the form of a chloride, as chlorine is generally conceded to be injurious to the burning quality of tobacco. Phosphoric oxide seems to give an earlier maturity and a lighter coloured leaf. Previously we mentioned the Blue Grass Region of Kentucky as the favourite home of the White Burley tobacco. Underlying this area is a stratum of limestone, and the surface soil contains decomposed limestone, and incidentally this soil shows a high percentage of available phosphoric oxide. It is probably the phosphorus or the combination of phosphorus and lime together with a temperate heat that makes this section ideal for the production of this particular type of tobacco.

(*Acknowledgment.*—Article by Garner and Allard was consulted for certain facts and expressions.)



GROUP OF HEREFORDS.

### Mohair Market.

The Department has instituted inquiries into the position of the mohair market overseas with a view to an expansion of trade in this article. The weak state of the market at present is causing much anxiety, and while the future is obscure it is trusted that some relief may follow as a result of the inquiries.

## GEESE.

By the late W. O. JOUX, Lecturer in Poultry, Elsenburg School of Agriculture.

*Historical.*—There are several breeds of geese spread over various portions of the world, especially Europe, northern Asia, and America. The wild variety is known as the Grey-Lag, or ornithologically as *Anser cinereus*. The commonest offshoots of the Grey-Lag are the dark-grey "Brent goose," the "Barnacle goose," and the "Canada goose."

There is no doubt that all domesticated geese are descendants of the common Grey-Lag (wild goose), and that the present difference in general appearance, character, etc., is due to centuries of breeding for the particular shape, colour, type, etc., that we now associate with such well-known breeds as Toulouse geese or Embden geese. These breeds are probably the oldest domestic fowls in history, as we find, long prior to the Christian era, well-defined laws were followed in selecting breeding stock.

*Emden Geese.*—Pure white in body; eyes, bright blue; beak, orange coloured; legs and toes, deep orange. Male weighs 20-25 lb., female 16-20 lb.

*Toulouse Geese.*—Colour of head, neck, breast, and back is grey; wing and thigh feathers laced faintly with white; paunch and stern, white; tail, dark grey, almost black; each feather is laced with white; legs and toes, dark orange; bill, pale orange; eyes, dark brown or hazel. Male weighs 20-26 lb., female 16-20 lb.

*Chinese Geese.*—Two varieties, known as Brown Chinese and White Chinese. These are a very beautiful breed; they are hardy, good foragers, good layers, and the young thrive well. *The White Chinese.*—Colour of both gander and goose: plumage, pure white; shanks and toes orange-yellow; eyes, light blue; beak, orange-yellow; knob at base of beak, orange. Gander weighs 12-14 lb., goose 8-10 lb. *The Brown Chinese.*—Colour of gander and goose: head, brown; knob, dark brown or black; bill, black; eyes, hazel or brown; neck, light brown or greyish brown, with dark brown stripe down back of neck from head to body; wing, greyish brown; back, dark brown; tail, greyish brown; breast, greyish brown; body, greyish brown, lighter in shade on under parts; legs and toes, dark orange.

*The Cape Goose.*—A very hardy breed, found chiefly in the districts of Clanwilliam, Carnarvon, and such outlying areas. At present it is not possible to state definitely how this bird has been bred. It has characteristics so entirely its own that some considerable investigation will have to be made prior to attempting to fix its origin. The colour of the male is pure white; eyes, pale or dark blue; legs, orange; and beak, dark orange. The female is grey coloured (very like Toulouse); eyes, dark blue; beak, orange with well-defined line



of white around beak where it joins on to head; body, medium grey; back, wing, and thigh feathers finely laced with very light grey (almost white); legs and feet, dark orange. The gander weighs 10-12 lb., goose 6-8 lb.

(It will be noticed that male and female are entirely dissimilar in colour. This, of course, is an advantage, as it makes the selection of the sex very easy.)

#### MANAGEMENT OF THE BREEDING STOCK.

The gander will mate with several females. It is better to have as few males as possible in the flock, as this avoids quarrels. In the smaller breeds of geese one gander to three geese would be sufficient, and in heavier breeds, such as Embden and Toulouse, one gander to two geese. It is necessary when changing matings to do so in November or December, as ganders do not change affections readily.

*Age for Mating.*—Goslings, or yearling geese, should never be bred from; two-year-old birds are far better. If the female be three or four years old it is sometimes an advantage to mate a young gander of fifteen to eighteen months to such old geese.

The goose family live to a great age, and good specimens may be bred from up to their tenth year, or even later, but, speaking generally, geese are at their best breeding condition at from three to five years.

*Housing.*—Houses for geese need not be expensive structures; the lean-to is best suited to their requirements. It must be built of a size to accommodate the required number; approximately 4 feet floor space should be allowed for each adult bird. The house should be open-fronted, having two ends, back, and roof, the front covered with wire netting and facing sunrise; the floor should stand about 4 inches above surrounding soil, and should be constructed of material easily kept clean and, above all, dry. Geese contract disease if allowed to sleep on a damp floor. To avoid this the floor should be covered with deep litter, which should be changed from time to time. Geese delight in cleanliness, and will not enter a filthy house if they can avoid it.

*Situation.*—Geese can best be kept in places adjacent to grasslands, vleis, or along the banks of rivers where short succulent grass is easily obtainable. Water, while beneficial, is not absolutely essential; a running stream, natural vlei, a river, dam, or small artificial pond will serve their purpose. Geese keep in better condition when swimming water is within reach.

*Feeding adult birds.*—Variety should be observed in feeding. Geese have a special liking for grass, and a quantity of this will have a particular bearing on the amount of other food given; where short succulent grass is plentiful for the greater portion of the year geese need be fed in the evening only, but where grass is scarce it will be necessary to feed them twice daily. Where this is practised, a mash consisting of bran one part, mealie half part, should be mixed with boiled vegetables and fed at the rate of 3 oz. per bird in the morning; the geese should then be driven on to the land and kept there during the day. The evening feed may consist of any usual

South African grain, such as cracked mealies 1 part, oats 1 part, barley 1 part, and, if available, kaffir corn 1 part. These to be mixed together and fed in water in shallow vessels. During harvesting period on grain farms geese should be driven on to the stubble land, where they will find practically all the food they require, thus economizing the food bill and cleansing the farm of fallen grain and seed, a double advantage to the farmer.

*Laying and Incubation.*—As the laying season approaches the females will be seen walking around in search of suitable nesting-places; frequently they carry straw or grasses in their mouths, a sure indication. A nest should be provided for each goose. It may be made with half-a-dozen round sticks planted in the ground in a circle with the top ends tied together, wigwam or tent fashion, covered with grass, reeds, or sacking, with an opening on one side; the width of the nesting place should be  $2\frac{1}{2}$  to 3 feet and the height  $3\frac{1}{2}$  feet. A good handful of straw or hay should be placed in each nest; the goose will see to the rest. Geese carefully hide their eggs. It is, however, better to remove the eggs as they are laid. To do this without rousing suspicion, mark the first egg with an indelible pencil and leave in the nest; remove the second and all subsequent eggs, otherwise they may become over-heated, chilled, or stolen. When the goose becomes broody, remove the first egg and give her all the other eggs to sit upon; she will usually cover from ten to fifteen eggs, according to the size and breed of the goose. When setting she must be kept as quiet as possible; to this end it is an advantage to remove the gander and place him in another paddock. The sitting goose should have pure water within reach, also grain and green food. During the last few days of incubation it is sometimes necessary to remove the goose, otherwise she will neglect feeding. Her removal must be carried out most carefully, otherwise the eggs may be broken, and should not be attempted unless it can be done without injury to goose and eggs. The period of incubation is from thirty-three to thirty-five days; actual hatching period is forty-eight hours. Experience has shown that goslings should be allowed to hatch unaided; any attempt at helping them usually ends fatally through the membranes being prematurely ruptured, causing death by bleeding. Experience also teaches that a gosling unable to hatch unaided is not worth the trouble of rearing.

*Rearing Goslings.*—Goslings should be removed one by one as they hatch so as to prevent the mother from leaving the nest before all the eggs are hatched; they should be placed in a basket lined with flannel, or in a warm brooder. When all the young are hatched give the goslings back to the mother, and she will watch over them with great care. The gander may now be allowed to return to the goose and her little family, as he helps her to protect the young and watch over them very tenderly. Although goslings are very hardy they are very susceptible to cold or rain, and it is best not to let them wander far from the nest for the first few days, and not too far from suitable shelter before they are two weeks old, so that they may be placed under cover in case of rain. The gander becomes most fierce during the periods he is assisting with the care of the young, therefore young children should not be permitted to visit the young goslings until they are three to four weeks old.

*Care of the Young.*—During the first few days goslings may be given bread-crumbs, bran, cooked mealie meal, mashed potatoes mixed with milk, finely chopped vegetables, such as lettuce, young green barley, or young green grass. A good way of providing the latter is to procure a sod covered with short grass and place it near the nest or brooder. When the young are fairly strong, i.e. about two weeks old, they may be allowed to run at large with their mother, providing always that they are not exposed to rainstorms. A goose will mother as many as forty goslings. When they come in at night they should again be given food as mentioned above. It will be seen that by setting two or more geese simultaneously the broods of two may be given to one, and the other goose returned to the breeding-pen. She will come on to lay again shortly, and in that way produce two broods in a season. Artificial rearing of goslings is also successful.

*Fattening.*—This takes twenty-five to thirty days. Geese to be fattened should be given such grain as cracked mealies, rolled oats, rolled barley, with a little mealie meal mixed with water; raw chopped mangels are also very good; this diet should be given for about fourteen days, then the cracked mealies should be discontinued and the mealie meal increased. The mangel or other roots should be boiled, mixed with bran, mealie meal, finely ground oats and barley, and fed in troughs. It is an advantage if milk can be added to the above, as it is claimed that milk fat produces a flavour of its own. During the fattening period geese should be kept in crates or fattening pens, with little or no liberty, giving food as indicated, with clean water to drink.

*Killing.*—Geese are killed by sticking a knife in the roof of the mouth, a quick motion severing the arteries and penetrating the brain. The feathers are removed by dry plucking, care being taken to avoid tearing the skin, which in a fat bird is very tender and tears easily.

*Commercial or Marketable Geese.*—In South Africa there is very little demand for very heavy geese, such as Toulouse or Embden, the most popular weight being ganders 10 to 12 lb., and geese 8-10 lb. It will, therefore, be seen that, speaking commercially from a popular market view-point, the two best breeds to meet the requirements of the South African markets are the Chinese and Cape goose. Many breeders, however, cross the Cape goose with the Embden or Toulouse bird with the object, it is claimed, of producing faster maturing goslings. It is thought personally that very little is gained by this procedure, as both the Chinese and Cape goose are particularly hardy and quick maturing, and, as already mentioned, meet public requirements.

*By-products.*—The by-products from geese are the feathers and down, and also their manure. The most valuable by-product is undoubtedly down, which has given rise to a practice (greatly to be deprecated) of cutting the down from the geese every month or six weeks. This is a most cruel practice. Geese may, however, be plucked once annually with advantage, that is, when the feathers are ripe, usually in the month of December. It stands to reason that, just prior to moulting, unless the feathers are plucked they would fall out naturally and be lost, therefore there is no reason why all geese should not be plucked just before the moulting period. To do this

properly the operator should sit upon a low stool or box with the goose across his knees, the head being towards the back of the body, and the legs firmly held in the left hand. Two baskets are required, the coarser down being placed in one and the finer in the other; in this way the down is graded at the time of plucking. Only the down from the breast, thighs, and paunch, should be removed: all top feathers, such as wings and back, should be left. Geese are susceptible to colds, and the removal of these feathers may lead to the loss of geese from cold or pneumonia.

*Sexes.*—When just hatched goslings of the Embden breed are bright yellow on the back; the others are grey, and the latter are generally females and the former males. It is fairly easy to tell the sex in an adult bird: the male is larger than the female and his cry is shrill, while that of a female is harsh; the neck is a little longer and a little thinner in the male. The cheeks are less prominent, but the posterior part of the upper mandible, which is generally of orange colour up to the skull, is more prominent in the female. As two indications are better than one it is best to inspect the sexual organ, which furnishes absolute proof. In the female the sphincter, or muscular tissue closing the anus, is folded and sinuous when stretched with the fingers. In the male, on exerting a light pressure on the same place, the sphincter soon appears; it protrudes more quickly in warm weather and also in a mature male.

---

## The New Apple-box.

The attention of apple growers is called to Clause 5, Section (b), of the Regulations (Government Notice No. 260 of 6th February, 1920) under the Fruit Export Act, No. 17 of 1914, which reads:—

“The following fruits shall be packed in boxes the sizes of which shall be:—

### INSIDE MEASUREMENT.

(b) For apples, 18 in. by 11½ in. by 10 in.”

This box has been substituted for the one 20 in. by 10 in. by 11 in. previously in use for export. All growers catering for local trade should adopt this size of box. It is a convenient package, holding just under one bushel, and, if generally used, will be far more satisfactory both to seller and purchaser than the different sized boxes now found on the various local markets.

In order to allow growers to dispose of their stocks of the old size apple-box, the regulations respecting the new box will not be vigorously enforced this season, but its use will be compulsory next season.

## THE CROSSING OF NORTH AFRICAN AND SOUTH AFRICAN OSTRICHES.

### The Success of the Experiment.

IN 1912 some 130 ostriches from Nigeria were imported for the purpose of crossing them with South African ostriches, with the object of improving the feathers of the latter, and it is desired to give a short account of the history of these birds and the reasons for their importation.

Prior to 1911 it had been ascertained that the feathers of the domesticated South African ostriches were of two distinct types. The one, in many respects—though enormously improved—resembled the feathers of the wild ostriches which in former days were to be found in large numbers all over South Africa: the other was entirely different from it and quite unlike the feathers of any of the indigenous wild birds of South Africa, the chief points of difference being that the former type was a large "thin," open feather, considerably lacking in the two important qualities of *density* and *strength*, while the latter was a small compact feather and had most remarkable density and strength. The question arose, where did this dense type, which differed remarkably from the native bird, originate? Inquiries were accordingly made as to the birds imported into South Africa in the past, and it was found that in 1876 four ostriches had been introduced from North Africa. At the instance of Mr. R. W. Thornton, then Government Agriculturist for the Cape Province, the Department of Agriculture made a collection of feathers from the wild ostriches of every land in which they were to be found. When this collection came to hand it was found that certain feathers which had been sent by the British Consul at Tripoli, but which had come from the south-western Soudan, bore a striking resemblance to the dense-feather type found in domestication in South Africa, and it was deduced that the present South African type had evolved from the original importation of North African birds.

Some time after this it was found that America was endeavouring to secure ostriches with feathers of a dense type which, if successful, would seriously compete with the Union's ostrich feather industry. For this and other reasons the Government took into consideration the advisability of importing some of these birds, and a meeting of the South African Ostrich Breeders' Association was held. The question was thoroughly discussed. A resolution was passed urging the Government to send at once a Commission to the Soudan to further investigate the matter. This was carried into effect, and in August, 1911, the Commission, composed of Messrs. R. W. Thornton, J. M. P. Bowker, and F. C. Smith, left South Africa and proceeded first to England, where they secured the necessary passports and equipment, and from thence to the west coast of Africa, touching at various ports and making

inquiries regarding the ostriches. They finally landed at Forcados, on the Niger Delta, and after proceeding about 500 miles up the Niger left the river at Baro and struck due north. After journeying about 300 miles in this direction they arrived at Kano, the great central market for the Soudan. Here they were enabled to examine various parcels of feathers brought in from the surrounding districts, and a fair quantity of the type which they were seeking were found amongst them. The birds themselves, it was found, existed in their wild state a considerable distance inland, and that large numbers are killed each year by hunters for the sake of their feathers, while quite a number of the chicks are caught at the nests and reared in captivity. The methods of keeping these domesticated birds are very different to our South African methods. The birds are kept in small pens about six or eight feet square, and usually only one or two in a pen. Of course, under these conditions they never breed, whilst the methods of taking the feathers are not the humane ones employed in South Africa, the feathers being pulled from the birds often before they are ripe, the bird being plucked absolutely bare.

The chain of evidence in the history of the present South African ostrich was, fortunately, established, for the four ostriches imported in 1876, already referred to, were actually traced by the members of the expedition as having come from the exact locality where the birds of the dense-feather type had been located. The son of the Arab who had originally received the contract to supply these birds was interviewed, and he gave full details of their long journey across the Sahara and of the final shipping of the birds from a Tripolitan port. With this proof of the correctness of their deductions the expedition set about to procure what birds they could of the desired type and to return to South Africa with them.

All the birds in British Nigeria were examined, and every one of the right type was secured. Of these a total number of 150 were purchased, and, after considerable difficulties, 132 of them finally reached the Grootfontein School of Agriculture, Middelburg (Cape), in May, 1912.

The total amount expended on the importation of the ostriches was £7272. 19s. 6d., which included everything, such as money spent on purchase of the ostriches, chartering of the boat from Lagos to Capetown, salaries of officials, etc. The amount is small when compared with the money spent by the Government on the importation of cattle or sheep.

No internal parasites of any kind were found in the ostriches in Nigeria. Ostrich tapeworm and wireworm seem to be non-existent in that country, although the imported birds soon developed them after arrival in South Africa.

As soon as the birds were landed in South Africa and before they had recovered from the effects of the long journey they were condemned and pronounced to be quite useless by a number of individuals who were expecting to see something superior to the domesticated South African birds, forgetting that the latter had reached their present high standard of quality after generations of selective breeding.

In addition to the strain imposed on the birds by their long journey by land and sea most of them had been subjected to very severe treatment in the matter of plucking in their native land, and

the majority of their feather sockets had been permanently ruined. Furthermore, they were imported not for their feathers but for crossing with the South African birds, so that their marked qualities of density and strength would have a beneficial effect on the South African birds, the feathers of which were weak in these two respects. It is known that the feathers of the wild birds of the Soudan are of a much higher standard than those of South Africa. Therefore, if the present high standard plumes of the domesticated South African birds have been evolved by selective breeding from a relatively poorer stock, the introduction of the stronger strain of the Nigerian bird was calculated to give a much better product.

*Acclimatization.*—The birds reached South Africa just at the beginning of winter. This was unfortunate, as the sudden change from the heat of the tropics to the severe winter of the midlands of South Africa was a very great strain on their constitutions. Then, also, they suffered severely from wireworm and tapeworm, but by means of continued dosing the trouble was eventually overcome, enabling a start to be made in cross-breeding with South African birds.

*Experiments.*—The chief objects of the first experiments were (1) to find out whether the imported birds would breed with the South African birds, (2) whether the progeny would be fertile, and (3) whether the desirable characteristics of the northern bird could be blended with those of the southern.

The following are the results of these experiments up to the present:—

(1) The birds interbreed freely.

(2) The progeny are fertile both *inter se* and back to either of the original varieties.

(3) The blending of the desired characteristics has been remarkably successful. The feathers of some of the first crosses can be rated as really first class. This was hardly hoped for even by the most sanguine, as it was considered that it would be necessary to cross the birds several times before plumes of this nature could be obtained. The feathers from these cross-bred birds are quite equal in size to the first class South African primes, and the desired characters of density and strength have been introduced to a wonderful degree. The ostriches have been crossed both ways, that is, North African cock with South African hen, and vice versa, and in both cases the above-mentioned high standard of feather has been reached in the progeny. Various other crosses have also been obtained, namely, cross-bred bird mated with either of the original strains, and also two cross-breeds mated together. The cross which up to the present has proved most consistently successful has been where the cross-bred bird was mated back to a South African bird. The resulting progeny are three-quarters South African and one-quarter North African, and out of twenty-odd birds thus bred at Grootfontein last year every one is considered first class. A certain number of pure North African ostriches are also being bred at Grootfontein so that the strain may not be lost.

Certain other minor characteristics have been observed amongst these cross-bred chicks:—

1. The birds take a good deal longer to reach full feather maturity. With South African birds it is generally possible to form a fairly accurate idea from examination of the "spadonas," or chick feathers, as to what a bird will develop into at maturity. This has proved quite impossible with the cross-bred chicks, and it is only on the second or third crops of feathers that an accurate opinion of the bird can be formed.

2. The cross-bred birds are by nature very wild and untractable. This necessitates very careful rearing and management.

3. The cross-bred chicks are exceedingly healthy and comparatively easy to rear in comparison with South African chicks. In appearance they cannot be said to favour either of the parent strains more than the other. They vary in all degrees, from some exactly resembling the North African to others which could not be distinguished from the South African bird.

The undoubted success of these cross-breeding experiments justifies the Government's action in importing the Nigerian ostriches, for there can be no doubt that had these birds fallen into the hands of any other country it could in time, by means of selection and cross-breeding, have built up a strain of birds which would have proved serious rivals to our South African ostrich feather industry. As the position stands at present, however, South Africa holds the lead both for quantity and quality of feathers produced, and with this long start, and by means of a judicious infusion of Nigerian blood, the industry should be secure. Should another country obtain a number of these Nigerian ostriches it would take a number of years to reach the present South African standard of quality of feathers, and by that time, by means of the start mentioned above, it is hoped that our industry will have relatively advanced.

---

### **Citrus Export.**

Commenting on certain aspects of the export of citrus fruit this year, the Trade Commissioner in London refers to the large proportion of fruit shipped in ventilated hold and the excellent condition generally in which our fruit arrived; indeed, the opinion of the trade is that never have South African oranges been marketed in better condition. Mr. Cambam is of opinion that the cool weather experienced this year accounts in a measure for the satisfactory state in which the fruit was received, but, notwithstanding the good condition of the fruit sent over in ventilated hold, he is emphatic on the point that all our fruit should be shipped in cold storage, which, he states, is the opinion also of the trade.

---

### **Plant Nurseries in Quarantine as at 1st October, 1920.**

The nurseries listed in last month's *Journal* (page 670) were still in quarantine on the 1st October, 1920, with the exception of that of Mr. E. Krohn.



---

**MYLABRIS BEETLES.**

---

By W. F. SCHLEPP, B.Sc., Entomologist, School of Agriculture and Experiment Station, Potchefstroom, Transvaal.

---

THERE are a number of native Mylabris beetles that have been known as plant pests since early days. In 1889 Omerod listed (1) several species as injurious and quoted from a correspondent that "all our Mylabridae are scourges," a rather sweeping statement.

These beetles are included in the family Meloidae (Cantharidae, Mylabridae), a large group generally known by the cosmopolitan name of "Blister Beetles," because of a vesicating property due to the presence of cantharidin, which, according to some writers, occurs in the blood plasma. On account of a fluid that oozes from their joints they are sometimes also known as "Oil Beetles." Because of a fancied resemblance to the uniform of the Cape Mounted Rifles some of the native forms are called "C.M.R. Beetles."

Of the above family Dr. Peringuey, Director of the South African Museum, has listed thirty-four native species belonging to the genus Mylabris and twenty-one belonging to the genus Cantharis (2).

The Meloidae as a rule are not above medium in size, but large species are found among our South African Mylabrids. The species most common at Potchefstroom, *Mylabris oculata*, a species that is very common also in many other parts of the Union, is about one and one-fourth inch long, and with its black and yellow colouring is a conspicuous insect. As a rule it appears earlier than the fruit beetles (Cetonids), coming about the time the fruit trees bloom. The writer has taken it from bean plants in the low veld (Komati Ward) during the middle of August, and doubtless it appears even earlier there.

#### LIFE-HISTORY OF BLISTER BEETLES.

To studies made many years ago by C. V. Riley in America and M. Fabre in France we are indebted for much of our exact knowledge of the life-history of these beetles. The larvae feed upon the eggs of other insects, and may be divided into two groups, viz. (a) those that subsist upon the eggs of locusts, grasshoppers, and crickets, and consequently do a great deal of good; and (b) those that feed upon the eggs of wild bees. The larvae attach themselves to bees and are thus carried to the nests. They often attach themselves by mistake to other insects, and so get nothing except a free ride.

Among the American species that have been investigated many belong to the first group. T. B. Fletcher states (3) that in India also most of the larvae of the species for which the life-histories are known (several of which belong to the genus Mylabris), are parasitic upon the egg masses of grasshoppers. In the absence of close studies we may assume that the larvae of many of our South African Mylabrids are parasitic upon the eggs of locusts and grasshoppers, but this is by no means certain, as all attempts to rear the insects have failed.

Mr. Claude Fuller, Assistant Chief of the Division of Entomology, has on a number of occasions found beetle larvae in the egg masses of locusts in Natal, but the specific identity of the larvae is unknown.

Blister beetles have remarkable life-histories, in that they exhibit the phenomenon of hypermetamorphosis, i.e. they pass through more stages during their growth than do the ordinary beetles or other insects. Thus, instead of egg, larva, pupa, and adult, there are three different larval forms, a pseudopupa, and a pupa before the adult stage is reached.

#### FOOD HABITS AND STATUS OF THE BEETLES AS PESTS.

Our common Mylabrids injure the blossoms of plants, but since the larvae are perhaps beneficial the question arises: Just how much damage do the adults really do, and is it enough to make the destruction of the beetles advisable? Opinions will differ on this question.

Many years ago (1893) Dr. Peringuey remarked (4) that "It is so seldom that a beetle proves to be useful to the farmer that, were they plentiful in my garden, I would purposely sow a patch of beans for the delectation of Mylabris, knowing full well that such a small favour would be amply repaid."

On the other hand, the late Dr. J. B. Smith, an eminent economic entomologist, referring to some leaf-eating American blister beetles, stated that: "In the larval stage they are beneficial, in so far as they feed upon the eggs of grasshoppers, but it is questionable whether this benefit overbalances the damage they do as adults, and I never hesitate to advise prompt measures for their destruction" (5).

With regard to the Indian species Fletcher makes the following statement: "Blister beetles often do great damage to crops by devouring the flowers and tender shoots. Cereals and leguminous crops are especially subject to attack, and there seems to be some special attraction for these beetles in flowers of yellow colour. . . . Whether these beetles are to be ranked as pests or beneficial insects is at present, however, an open question. In the adult state they certainly do harm to crops. . . . If, therefore, the larva of a blister beetle destroys even one egg-mass containing (say) forty eggs of a grasshopper the good it accomplishes by so doing at this stage must be offset against any damage it may do later as an adult, and the question we have to answer is whether the damage that would have been done by the grasshoppers is greater than that done by the beetle that has destroyed them. And for the present, at least, this must remain an open question, and we can give the blister beetles the benefit of the doubt" (3).

Although the damage done by the Mylabrids in gardens is often rather small when compared with that done by the fruit beetles (Cetonids), they are undoubtedly a great nuisance at times, eating and defiling the blossoms of ornamental plants, especially roses. They injure the blossoms of fruit trees, but here it is a question of whether or not the setting of the fruit is interfered with, and not one of damage to the beauty of the trees. The blossoms of beans, peas, etc., are also attacked, the beetles being particularly fond of these.

It has been the experience of the writer that the damage to plants, as well as the number of beetles present, is often over-estimated. It is true that the blossoms are eaten, but are they entirely destroyed?

Some of them are, some are not. Dr. Peringuey stated (4) that he had examined beans and peas, and that of the flowers eaten 80 per cent. had been previously fertilized; so in that particular case at least the damage was much less than it appeared. In such cases control measures are hardly necessary.

*Damage to Foliage, etc.*.—However, considerable damage is sometimes done by the beetles, and apparently this damage is not always confined to the blossoms. Mr. Jacobus Faure has called the attention of the writer to two letters on file at the Office of the Division of Entomology, in which *M. aculata* appears in a different rôle. One letter, from the Waratah Citrus Farm, Brits, Transvaal, states that the beetles did considerable damage to tomatoes, beans, potato foliage, etc. The other letter states that five muids of potatoes were planted on farm Sweetput, Content Station, Cape Province, that the crop was entirely destroyed by beetles, and that it looked as though a hail-storm had gone through the lands.

When severe injury is done to crops, etc., one need not hesitate to destroy the beetles. The Division of Entomology recommends the destruction of the insects in all such cases. Even though the larvae of our Mylabris beetles do feed upon the eggs of grasshoppers (a point that has not been definitely established), the fact must be taken into consideration that most of our common grasshoppers feed principally upon grasses, particularly those of the veld; and that the value of this grass is relatively small when compared with the value of the cultivated plants destroyed by the adult beetles. Furthermore, the number of beetles coming to the fields and gardens is usually only a small percentage of the number present in any given locality; therefore, killing them will hardly upset the "balance of nature."

#### CANTHARIDIN.

*Properties and Uses.*.—Blister beetles are dried and reduced to a powder, which is used in medicine under the name of "*Cantharides*." From the powder a crystalline substance known as *Cantharidin* is extracted. This is occasionally used internally in minute doses as a stimulant and diuretic; but its principal use, which is true also of the powder, is in solutions, tinctures, plasters, etc., where a strong irritant is desired. It has powerful blistering properties.

Cantharides was formerly much in vogue as an aphrodisiac, but it is now recognized that its action in this respect is not great; and, furthermore, that this aphrodisiacal action appears as a rule only after the kidneys have been greatly irritated and often injured.

*As a Poison.*.—Cantharidin is a powerful poison, the fatal dose, according to Blyth (6), ranging from 1 grain upward, although recovery from very large doses has taken place. For purposes of comparison it may be mentioned that the fatal dose of white arsenic is stated by the same author to be about 2.5 grains.

Cantharides has been employed as a poison in at least one or two criminal cases; and there have been many cases of accidental death from its internal use, and also, it is said, even from its external use. Riley and Johannsen state (7) that cases are not rare in which cattle have been poisoned by feeding on herbage bearing a large number of blister beetles. They also quote from the work of Kobert that when

birds, frogs, etc., have fed on such beetles the flesh of these animals is poisonous.

Dr. C. F. Juritz mentions (8) two comparatively recent cases where kaffirs were killed by powdered *Mylabris* beetles administered by native medicine men.

*Commercial Sources.*—The cantharides of commerce is derived principally from a European blister beetle, the so-called "Spanish Fly," *Cantharis vesicatoria*. There are other beetles that could be utilized, but the one mentioned occurs in regions where labour has been fairly cheap, the beetles are gregarious, are present in large numbers, and are easily collected. There are other beetles that are higher in cantharidin content, in fact, some of our native beetles are considerably higher.

*Collection and Preparation of Beetles.*—The presence of the Cantharides is manifested by the strong penetrating odour which they diffuse to some distance. When by the aid of this smell they are discovered, generally settled on an ash, they are collected in the following manner: Very early in the morning a cloth of light tissue is stretched out at the foot of the tree and the branches are shaken, which causes the insects to fall. These, numbed by the cold of the night, do not try to escape. When there is a sufficient quantity the four corners are drawn up and the whole plunged into a tub of vinegar diluted with water. This immersion causes the death of the insects. They then carry them to a loft, or under a very airy shed. To dry them they spread them out on hurdles covered with linen or paper, and from time to time, to facilitate the operation, they are moved about, either with a stick or with the hand, which is more convenient; but it is then necessary to take the precaution of putting on gloves, for, if touched with the naked hand, they would cause more or less serious blisters. The same precaution must be observed in gathering them.

When the Cantharides are quite dry, they are put into wooden boxes or vessels of glass or earthenware hermetically sealed, and preserved in a place protected from damp. With these precautions they may be kept for a long while without losing any of their caustic properties. Dumeril made blisters of Cantharides which had been twenty-four years in store, and which had lost none of their energy. When dry, they are so light that a kilogramme contains nearly 13,000 insects (9).

*Cantharidin Content of Exotic Species.*—The yield from *Cantharis vesicatoria* ranges from 0.38 to 0.57 per cent. according to Blyth, and from 0.38 to 0.62 per cent. according to Squire. Greenwich, in the "Introduction to the Study of Materia Medica," states that occasionally 0.8 per cent., and sometimes even 1 per cent., is found. Analyses by Ferrer showed 0.082 per cent. in the wings and their cases; 0.088 per cent. in the head and antennae; 0.091 per cent. in the legs; and 0.24 per cent. in the thorax and abdomen.

In *Mylabris cichorei* Ferrer found 0.1 per cent. (?); in *M. punctata* 0.193 per cent.; and in *M. pustulata* 0.33 per cent. Wolff found .0815 per cent. in *Lytta aspersa*; and Self found 1.215 per cent. in two Chinese species, viz., *M. cichorei* and *M. sidac*. Kobert states (10) that the amount of cantharidin varies from 0.4 or 0.5 per cent. to 2.57 per cent., depending on the species of beetle.

## INVESTIGATIONS OF SOUTH AFRICAN MYLABRIDS.

During the latter part of 1918 Mr. C. P. Lounsbury, Chief of the Union Division of Entomology, suggested that as cantharidin had reached a high price it might be possible to utilize Mylabrids and so meet the cost of collecting them when it becomes necessary to adopt control measures. Accordingly, the question was taken up by the writer and some data secured. The problem of collecting will be discussed under control measures.

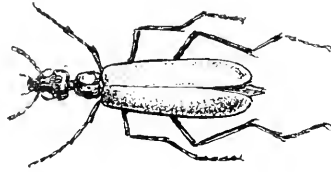

*Cyaneolytta subcoriacea.*



*Mylabris lunata.*

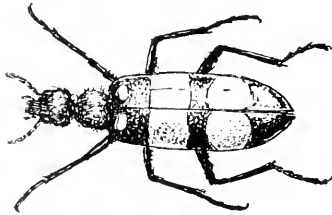

*Mylabris oculata.*

*Loss in Live Weight.*—When kept in cages the beetles lose a certain amount of weight, principally by the expulsion of excreta. When kept in captivity for twenty-four hours beetles lost in weight as follows:—

Lot 1 lost 12.4 per cent., Lot 2 lost 12.5 per cent., Lot 3 lost 17.8 per cent., Lot 4 lost 3.3 per cent.

*Methods of Killing.*—Three methods were employed:—

(a) The method described by Figuier was ineffective. A 15 per cent. solution of strong vinegar was used, but beetles were swimming on the surface of the liquid at the end of two hours, quite uninjured. Other beetles were immersed in the solution for one hour, so that they

could not obtain even a bubble of air, but upon removal they soon recovered. The vinegar had no effect at all.

(b) A sample was prepared by dropping the beetles into boiling water, which, of course, produced instant death.

(c) Inserting a little cotton-wool, saturated with carbon bisulphide, into the tin containing the beetles was the most convenient method, and, as will be seen later, proved to be the best one.

*Method of Drying.*—When spread in thin layers upon the floor of a dry room the beetles dried well enough without the use of artificial heat.

*Loss in Weight by Drying.*—Beetles collected in December, killed with carbon bisulphide, weighed about an hour after death and again on 15th January, 1919, showed the following losses in weight:—

Lot 1 lost 70.2 per cent. in 44 days; Lot 2 lost 60.5 per cent. in 43 days; Lot 3 lost 65.0 per cent. in 42 days; Lot 4 lost 60.6 per cent. in 41 days; Lot 5 lost 64.4 per cent. in 40 days; Lot 6 lost 65.0 per cent. in 40 days.

*Number of Beetles per Quart and per Pound.*—About one hour after being killed with carbon bisulphide the beetles (i.e. *M. oculata*) were measured and weighed. It required from 275 to 300 to fill a quart measure and from 300 to 400 to weigh a pound.

*Results of Analyses.*—Two lots of *Mylabris oculata* were prepared, one by killing the beetles with carbon bisulphide, the other by dropping them into boiling water. These beetles were analysed at the laboratory of Dr. C. F. Juritz, Agricultural Research Chemist, Capetown. Dr. Juritz reported (8) the results as follows:—

Lot 1, killed by carbon bisulphide: 1.19 to 1.20 per cent. of cantharidin.

Lot 2, killed by boiling water: 0.66 to 0.69 per cent. of cantharidin.

The boiling water evidently causes a great loss of cantharidin, as is seen by the difference between the two lots. Many of the beetles of Lot 1 had been kept alive for twenty hours, and had lost weight by excretion, but this will account for only a small part of the difference in cantharidin content, not more than one-tenth at most. If the beetles are to be used they should be killed with carbon bisulphide.

Dr. Juritz obtained also a supply of *Mylabris lunata* from another source. These contained 1.15 per cent. of cantharidin. A mixed lot of museum specimens of *Cyaneolytta subcoriacea* and *C. pectoralis* yielded only 0.9 per cent.

*Commercial Possibilities.*—The results of analyses show that our *Mylabris* beetles are much higher in cantharidin than is *Cantharis vesicatoria*, and should the necessity ever arise they can be employed for the production of the drug. However, the demand for cantharides is at present so limited, according to the statement of a leading wholesale chemist, that it would be difficult to find a ready sale for the beetles.

Moreover, the beetles, unlike the "Spanish Fly" of Europe, are not gregarious: they must be captured one, two, or three at a time instead of in masses; and, as already stated, the number present is nearly always greatly over-estimated. If five hundred beetles are

scattered over an acre of plants they appear to be fairly numerous. Small gardens, where the writer failed to find one hundred beetles, were described by the owners as "simply alive with them." When it is considered that it requires about one thousand dried beetles to weigh a pound it can be seen that unless the price is very high, collecting merely for the sake of the sale price of the beetles would not be a very remunerative business, with the exception, possibly, of a few localities where the beetles are exceptionally abundant, and that as a rule it is only when it is necessary to reduce damage that collecting can be profitable.

#### THE CONTROL OF MYLABRIS BEETLES.

When control measures become necessary, spraying suggests itself, but it is not a satisfactory remedy. In the first place, the beetles are often rather scattered, making it necessary to spray quite a large number of plants in order to kill a few beetles. Secondly, the spraying is not effective enough to be worth while. It might possibly be effective when the beetles attack foliage, but they generally eat flowers. The blossoms of plants are waxy, only a small amount of spray adheres to them, and it requires a comparatively large dose of poison to kill a large beetle. Collecting is cheaper and much more effective than spraying.

#### COLLECTING.

*Method.*—The writer found collecting with the hands to be more satisfactory than the use of a net, although the beetles have a disagreeable habit of expelling the excreta when handled, and also giving off large drops of a blistering fluid, especially from the femur-tibia joints. Some people find that this fluid blisters their hands, but it did not injure the hands of the writer nor those of three students who assisted for a few days in collecting. If necessary gloves could be worn.

The collector must work quietly, otherwise the beetles will fly away. When the beetles are on trees, it is necessary to knock them off with a sharp blow from a lath or stick.

*Time.*—The writer did most of the collecting in the afternoon, but when taking the beetles from fruit trees it became necessary to do the work in the morning, as the insects were less active then than later in the day. Collecting from trees was difficult even in the mornings.

*Killing.*—If the beetles are not intended for use the most convenient method of dealing with them is to drop them into water on which a little paraffin oil is floating. After passing through the film of oil they die within a couple of minutes, often in a few seconds. Boiling water or carbon bisulphide could be used if desired.

#### EFFECTIVENESS OF COLLECTING.

When one advises hand collecting as a control measure, one is generally met with the statement: "The beetles fly into the garden as fast as they can be collected." In order to determine just how effective collecting really is the writer counted the number of beetles taken each day in different gardens and kept records. To make the

comparison plain in the tables that follow, the number of beetles taken in each garden the first day is stated as 100 per cent. Thus if 200 beetles were taken the first day, 50 the second, and 20 the third, the figures would appear as 100 per cent., 25 per cent., and 10 per cent., and so on.

*Results in 1918.*—Collecting was done in three gardens, marked A, B, and C in the table. A and B were private gardens, C represents the vegetable garden of the Experimental Farm. In the first two gardens the beetles were taken principally from ornamental plants, in the third from broad beans, etc. The results were as follows:—

GARDEN A.			GARDEN B.			GARDEN C.		
Per Cent.			Per Cent.			Per Cent.		
Dec.	1 ...	100·0	Dec.	5 ...	100·0	Dec.	12 ...	100·0
"	2 ...	89·2	"	6 ...	92·4	"	13 ...	42·3
"	3 ...	33·0	"	7 ...	28·0	"	14 ...	10·5
"	4 ...	13·3	"	8 ...	19·6	"	15 ...	(no collection)
"	5 ...	5·3	"	9 ...	2·8	"	16 ...	16·2
"	6 ...	3·5	"	10 ...	0	"	17 ...	20·3
"	7 ...	1·7	"	11 ...	0	"	18 ...	14·6
"	8 ...	0	"	12 ...	2·8	"	19 ...	(no collection)
"	9 ...	0	"	13 ...	0	"	20 ...	1·6
"	10 ...	0	"	14 ...	0			

In gardens A and B only three or four beetles were found during the rest of the season; a few were found in C but not enough to be of any consequence.

*Results in 1919.*—During the early part of the season the beetles attacked the plum blossoms in the orchard (D) of the Experimental Farm, and later on the vegetable garden (E). Results of collection:—

ORCHARD D.			GARDEN E.		
Per Cent.			Per Cent.		
Oct.	28 ...	100·0	Dec.	17 ...	100·0
"	29 ...	22·4	"	18 ...	34·8
"	30 ...	(no collection)	"	19 ...	19·6
"	31 ...	32·7	"	20 ...	2·2
Nov.	1 ...	(no collection)	"	21 ...	(no collection)
"	2 ...	(Rain)	"	22 ...	0
"	3 ...	31·0	"	23 ...	0
"	4 ...	9·5	"	24 ...	0
"	5 ...	0·9			
"	6 ...	0			

No more beetles were found in either D or E during the rest of the season. In the case of the plum orchard (D) this was partly due to the fact that the weather suddenly became cool, and by the time it became warm again most of the petals had fallen, but the major factor in reducing the number of beetles was the collecting. The rapid elimination of the insects from the vegetable gardens was due entirely to collecting, the superiority of the results over those of 1918 being due, perhaps, to the fact that the beetles were less numerous in 1919 than during the previous year.



The foregoing tables show that collecting was a very effective measure in small gardens. The results from the vegetable garden in 1918 and from the orchard in 1919 were not quite so good, but, nevertheless, were fairly satisfactory. In large fields and orchards the results are not likely to be always so good as those obtained by the writer; yet, if properly carried out, collecting should prove an effective control measure.

From five to thirty minutes were required each day for about a week to clear the beetles from a small garden, so it can be seen that controlling the pests in such cases is not a difficult proposition as a rule. In orchards and fields it is a different matter, but our experience is that collecting is quite practicable. It requires a certain amount of labour, but so does every other operation on the farm, and the labour required for this work is less than it would appear on first thought. Half a dozen boys working for an hour or two can cover a pretty large area of ground.

---

#### REFERENCES CITED.

---

- (1) Omerod, E. A.—Notes and Descriptions of a Few Injurious Farm and Fruit Insects of South Africa, pp. 21-22.
  - (2) Peringuey, L.—Transactions of the Royal Society of South Africa, Vol. 1, pp. 165-302.
  - (3) Fletcher, T. B.—Some South Indian Insects, pp. 154-155, 302-306.
  - (4) Peringuey, L.—*Agricultural Journal of the Cape of Good Hope*, March, 1893 (Correspondence).
  - (5) Smith, J. B.—Economic Entomology, pp. 225-228.
  - (6) Wynter-Blyth, A. and M.—Poisons, their Effects and Detection, pp. 491-497.
  - (7) Riley, W. A., and Johannsen, O. A.—Handbook of Medical Entomology, pp. 54-55.
  - (8) Juritz, C. F.—*South African Journal of Industries*, Vol. II, No. 5, pp. 466-472.
  - (9) Figuiier.—Insect World (English Translation).
  - (10) Kobert, R.—Lehrbuch der Intoxikationen.
- 

#### Offer of Tractors.

The Department has received an offer of a number of heavy tractors of the caterpillar type, which were built for war purposes and are now available for disposal. These are of 110 h.p., are petrol-driven, and are capable of exerting a draw bar pull of six tons. The use of petrol as fuel is undoubtedly a great disadvantage under present circumstances. Any one interested in this type of tractor is recommended to apply to the Secretary for Agriculture, Pretoria, for further information.

## THE EFFECTS OF STORMS ON CERTAIN FORESTS IN THE TSOLO DISTRICT, CAPE PROVINCE.

By J. S. NIBLOCK STUART, Acting District Forest Officer, Umtata.

DURING the early days of the present year two storms of exceptional severity broke over the Ceka Group of Demarcated Forests in the Tsolo District of the Transkei, and the havoc wrought was so remarkable that it is thought a short description of the storms and their effects, illustrated by photographs, might prove of interest.

The Ceka Forests are in the form of a half-moon, and are situated on a range of hills about 25 miles to the north of Umtata and 15 miles to the south-west of the village of Tsolo.

It was on the 7th January, 1920, between midday and sunset, that the storms raged in all their fury. According to sawyers working in the forests on that day, the morning was bright and sunny, but at noon the sky became overcast and large drops of rain fell, followed by terrific thunder and lightning, with a short spell of hail. For two hours thereafter an exceptionally heavy downpour set in, and then slowly abated until the rain almost subsided late in the afternoon. But worse was to come, for a south-east wind heralded another storm. This time overhanging storm-clouds seemed to burst and to empty themselves with intense fury over the forests, continuing until sunset, when the storm finally spent itself. During the whole period of the storms there was a heavy, continuous roar, and it was necessary to shout to be heard even at a short distance.

The flood-water rushed over krantzes, dislodging huge boulders, uprooting trees, and washing away tons of soil in its wild race downwards and towards the partially dried-up forest streams, which in a short time were converted into raging torrents. The Ceka and Bambunyoko streams, normally about five yards wide, soon overflowed their banks, sweeping away all traces of native gardens, until they were roaring rivers about 80 yards wide.

The deluge caused extensive landslides, leaving open barren gaps, forty to eighty yards wide, previously wooded, and masses of trees, twisted and torn, boulders, soil, blue and bush buck, and all manner of débris, were engulfed and swept out of the forests into the Ceka and Bambunyoko Streams, and eventually into the Umtata River, where they silted up at Luchaba Drift, fifteen miles away, forming a huge barrier. This was fortunate, as the mass of timber and débris might easily have carried away the girder bridge over the Umtata River lower down.

The trees on the lower slopes of the forests resisted the mass of rocks, trees, and soil swept down, thereby forming barriers 15 to 20 feet high. The impact of the débris on these standing trees was tremendous, and they were severely bruised up to a height of 15 feet. In one instance a large stone was found imbedded in the trunk of a big yellowwood (*Podocarpus* sp.). It is curious to relate that nearly

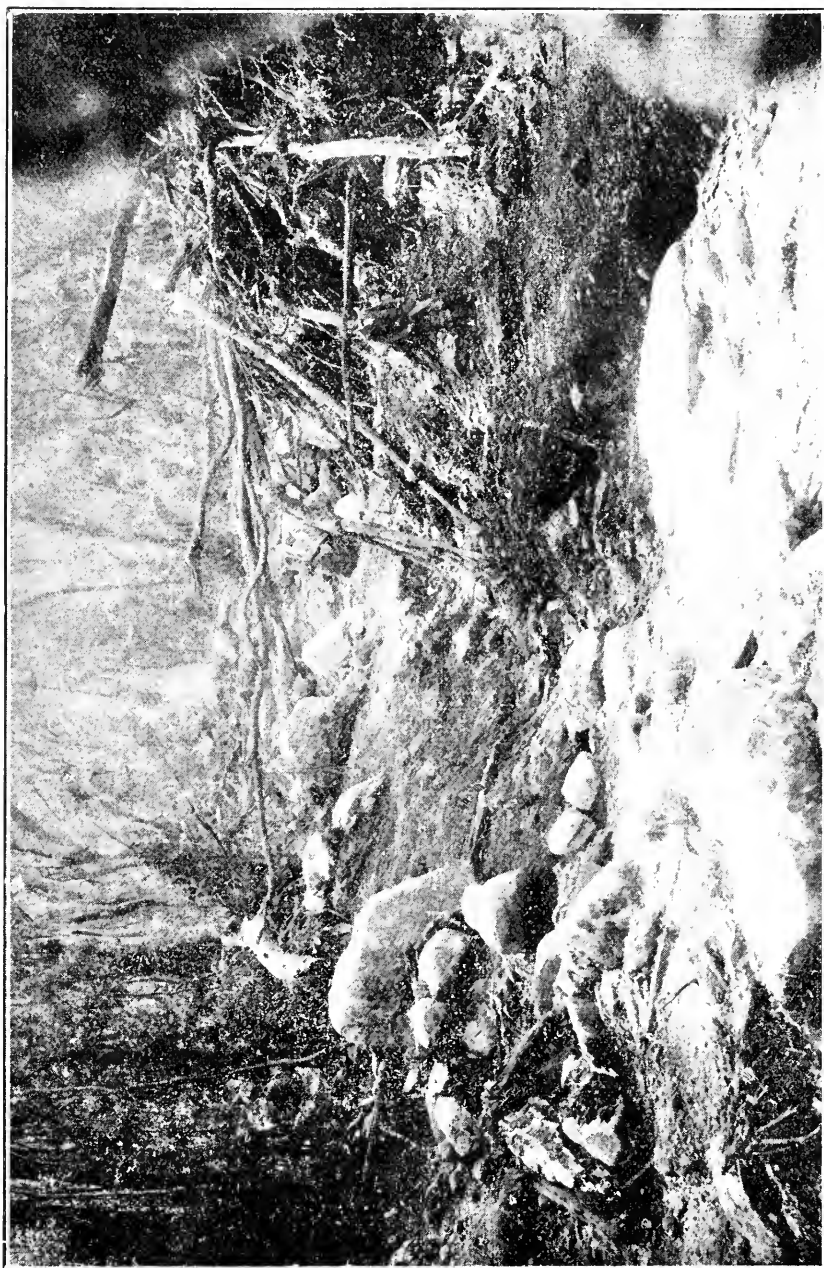

Ceka Forest, lower portion, about 100 yards in, looking in, showing barren area, previously wooded, and trees, rocks, etc., washed down by the floods. B 12222



Ceka Forest, centre portion, about 300 yards in, looking down at havoc wrought by the storms.

all these trees have since died from the damage they sustained, and in working them up it is being found that water oozes out whilst the logs are being sawn, that the timber is streaked with black, and that it gives out an offensive odour like that of stagnant water. Chips of yellowwood showing these characteristics were submitted to the Plant Pathologist for examination, and he reports that "the discoloration in the wood is due to moisture at the roots. It is similar to the trouble in oaks known as 'wet-foot,' due to the same cause. There is no fungus present—the walls of the cells are simply impregnated with some resinous substance."

About one hundred trees of different species (Yellowwood—*Podocarpus* sp., Stinkwood—*Ocotea bullata*, Assogai—*Curtisia faginata*, Lemon—*Xymalos monospora*, Chestnut—*Calodendron*

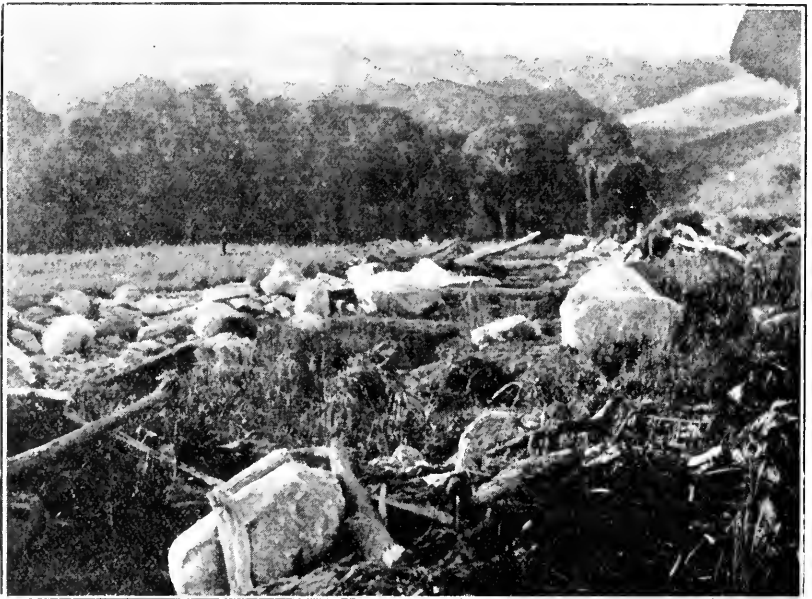

Showing track of the storms on the flats below the forests.

*capense*, and Pear—*Apodytes dimidiata*), however, were swept out of the forests and deposited on the flats below, a distance, in some instances, of from 3 to 4 miles. The majority of these trees were not very much damaged, although several were over 100 inches in girth and over 30 feet in length. They have all since been converted into timber by local sawyers.

Owing to the large amount of soil washed into the Umtata River thousands of eels were carried down with the current in a choked condition, and it was an interesting and unique sight to see them being hauled out from the banks in buckets, by rakes, and even by hand.

The small colony of woodcutters living below the forests in question and close to a small stream from the Ceka Forest, at which

they were wont to obtain their water supply, had a very anxious and terrifying time. The stream, ordinarily about 5 yards broad, soon overflowed its banks and widened out to about 100 yards, and the flood-water rose to about 4 feet round some of the huts, completely flooding them. In this emergency, escape being cut off, they fastened their wagons with chains to tree stumps to place their wives and families on should the flood increase. Fortunately the storm subsided before this was necessary.

The plight of two native families living below the Bambunyoko Forest might also be described. One, Mpipi by name, was working in the forest on the day of the storms, but about noon he made for his kraal, as he thought a storm was brewing. He and his family occupied two huts on a ridge, and his neighbour also had two huts on another ridge about 50 yards away. The water rushing from the hills soon completely surrounded and cut them off from help, and they had perforce to spend the night shaking with terror in their huts. The water rose steadily and swept past in such force that it carried off horses, fowls, goats, and pigs that happened to be standing near one of the huts. The horses managed to crawl out lower down, but four goats, a pig, and nearly all the fowls were lost. The fact that this particular hut was built on sloping ground saved it from being washed away, as the water rose to over 2 feet in height around it.

It is difficult, if not impossible, to convey an adequate idea of the extraordinary havoc wrought by these short but terrific storms. The accompanying photographs, showing the destruction, are accordingly reproduced, as it is felt that they more than anything else, except, perhaps an actual visit to the locality made immediately after the storms, will at a glance show that which no words can properly express.

---

### Export of Grain, etc.

During August, 1920, 7267 bags maize and 300 of maize meal were graded and exported through the various ports, while in September the exports were 8,111 bags maize, 650 bags maize meal, 6352 bags hominy chop, 125 bags oats, and 216 bags lucerne seed. The total quantity of bags exported from the 1st July last to 30th September was : Maize, 18,141; maize meal, 1370; hominy chop, 6352; oats, 125; beans, 138; and lucerne seed, 216. The stocks on hand at all ports on the latter date were, in bags: Maize, 2881; maize meal, 2541; hominy chop, 595; and lucerne seed, 60.

---

### The 1920 Vintage of South Australia.

The 1920 vintage of South Australia was 5,085,939 gallons (a decrease of 22.28 per cent. on the previous season), valued at £643,738. The last three vintages substantially exceed all previous records. Averaging the past five years 1916-1920, the following are the chief items of the industry annually, viz.: Grapes used, 29,682 tons; wine made, 4,726,431 gallons; average per ton, 159 gallons; estimated value, £504,804; stocks, 6,113,960 gallons.

## BUILDING UP THE FERTILITY OF THE SOIL.

By A. BAGULEY, B.Sc., F.I.C.

By fertility of the soil is meant useful productivity. We have to recognize many limitations in useful productivity due to various causes, such as latitude, altitude, proximity of the sea or other water, aspect, slope, position, sub-soil, etc. These affect productivity in the quantity and kinds of crops that can be grown with profit, and generally do not admit of modification in building up the fertility of the soil. This process, carried to completion, however, makes possible a very much wider and more profitable range of crops. Properly done it increases the certainty of the crop, and always it enables the agriculturist to succeed with a minimum rainfall.

These advantages, together with the general low level of inherent fertility in the soils of our country, make this matter one of importance and interest. It is not enough to maintain fertility. We must increase it to a notable degree. To do that safely and uniformly we have to follow faithfully a few physical and chemical principles which universal experience indicates.

Building up fertility is clearly associated with additions to the soil. Other considerations are no less important and must have attention if success is to be attained: such are, tillage, drainage, weeding, and harvesting. But in addition to these necessary operations, we have to provide for the full supply of food and stimulation. By increasing the amount and availability of plant food we build up the fertility of the soil.

Usually several, sometimes all, of five essential things are lacking. These are:—

1. Humus.—This term includes the remains of plant and animal life, decayed to a stage far beyond recognition. It is usually dark brown or black in colour, porous and absorbent of water and gases. In this property and in composition it resembles charcoal. The power which soils have of deodorizing and purifying dirty water may be attributed largely to the humus they contain. Humus is not soluble in water, but as oxidation proceeds it yields organic acids which are useful solvents of soil material. It imparts mellowness to soil and relieves the harshness belonging to grit and sand. It provides home and food for innumerable micro-organisms which use it as a source of energy, oxidizing atmospheric nitrogen, which thus becomes capable of nourishing crop-plants.

Humus suffers loss and diminution in several ways: (a) By oxidation in the soil; this is a legitimate loss, and the humus in undergoing it serves its purpose. The process is rather rapid owing to the high mean temperature; it is increased by tillage operations and by the use of quicklime. (b) By the activities of various creatures such as ants, worms, larvae, and others. (c) By natural agencies as fires, floods, and winds. Organic material is carried off and lost or destroyed. Sometimes a fertile soil is overlaid by gravel and sand or it may be washed away.

Humus in the soil is increased (*a*) by residues of crops and green manures added to the soil; (*b*) by dung and kraal manure; (*c*) by leaf mould and turfy material; (*d*) by additions of seaweed where it is available.

In the matter of building up the humus-content of the soil the agriculturist has often to fight a losing battle. Where stock have to be fed it is not good practice to plough in green crops. The residues of crops grown and taken away are not sufficient to maintain the humus of the soil. If such parts of the stalks of the mealie crop as are not eaten by stock were ploughed in, the soil might gain. Very often they are broken up and blown away or burned or otherwise lost to the soil. The farmer might, by a little thought and care, very much increase his stock of organic manure and secure corresponding benefit to many crops.

The conservation of organic matter is a process that helps itself a good deal. Better crops are grown and bigger residues are left. Some part of each successive application of organic matter resists decay more strongly and persists. These parts accumulate, and in time become a very valuable addition to the soil material, giving it that highly prized quality called "condition," and making it more stable and uniform in crop-production, becoming, in fact, a precious reserve of actual and potential fertility.

Organic manures which are the origin and sustainers of this highly desirable "condition" should be the subject of thought and study on the part of every farmer, and their augmentation and use should be the object of continual effort. Bedding ought to be used freely and all residues incorporated in the dung-heap. Applications of the fresh material are highly useful to the potato crop and to other gross-feeding crops, while succeeding grain crops benefit to a notable degree by the residual matters left by such applications.

Only in very exceptional circumstances ought quicklime to be used in farm practice: where lime is required agricultural lime (ground limestone) should always be chosen. Quicklime (caustic lime) very rapidly uses up the precious humus; the carbonate of lime is comparatively very mild and economical in this respect.

II. A second essential is lime; this is often wanting. Some crops, as potatoes, appear to flourish in its absence; some are indifferent, as mealies; while others, like lucerne, depend upon it to make profitable growth. Generally, for the usual purposes of agriculture, the lime in soils requires additions. It performs several functions.

(*a*) It is the one available corrective of acidity in soils. Acidity arises from two causes. (1) The oxidation of organic matter gives rise to numerous acid substances. These are neutralized by lime. As oxidation proceeds simpler acids are produced, until, finally, carbonic acid is arrived at, and the lime becomes available for further use. If this were the only purpose to be served a small quantity of lime would meet all requirements. The organic acids literally burn themselves out, and the lime is regenerated. (2) The addition of fertilizing substances usually leads to acidity in soil. Superphosphates are strongly acid substances, and when added to soil are dissolved in the soil water, and then precipitated on the soil material. Salts of iron oxide and alumina with phosphoric or sulphuric acid are formed. These are



strongly acid in reaction and hurtful to plants, and they must be decomposed with lime. Ammonium sulphate is broken up and oxidized and becomes a source of sulphuric acid and nitric acid. These acids must be neutralized by lime. Potash salts have their potash removed and fixed by the crop. The sulphuric or hydrochloric acid with which it was combined is set free in the soil and must be neutralized by lime. In neutralizing these sources of acidity the lime is not regenerated, except in so far as the crop may assimilate the acidic radicals of the salts formed. This is the case with the nitrate, and to a less extent with the sulphate.

(b) Lime provides a neutral medium in which bacteria favourable to farm crops can flourish. The productivity of the soil is dependent largely on the activity and multiplication of useful micro-organisms, which fix atmospheric nitrogen, produce nitric acid, and generally give powerful aid in the dissolution of soil material.

(c) Lime prevents the harmful effects of a high proportion of magnesia in the soil. Land in magnesian limestone districts is sometimes found that is more or less infertile and that does not respond properly to fertilizers. The magnesium carbonate is a very effective neutralizer of acids, but if lime is not abundant it proves dangerous where fertilizers are used. Magnesia is required as food by plants to a slight extent; they can find sufficient for their needs in all soils, and it is not, therefore, required in fertilizers.

Where the magnesia in the soil exceeds the lime in amount, crops sometimes make poor growth in spite of fertilizers. If lime is applied the soils recover. The reason is to be found in the greater solubility of magnesium compounds, especially magnesium sulphate (epsom salt). This salt is very soluble in water, and, where soils contain more magnesia than lime it is formed by double decomposition whenever fertilizers containing sulphates are used. Sulphates are the commonest and most useful of all salts in fertilizers. They occur plentifully in all dissolved phosphates. There is no other obtainable acid that can be used or that is more suitable for use for this purpose than sulphuric acid. The principal reason for this is that its use results in the formation of gypsum, which is an excellent drying agent only very sparingly soluble in water, and, therefore, harmless to plants. Now, where magnesia occurs too plentifully in soils, the application of most fertilizers results in the formation of sulphate of magnesia. This is a very effective plant poison, and its formation always leads to a reduced crop.

Soils, therefore, containing magnesia in notable amounts are particularly in need of lime, so that when fertilizers are applied the harmless gypsum may be formed and not the poisonous epsom salt. The farmer may generally best give a dressing of a ton or more of ground limestone per acre to the crop following potatoes in the rotation.

III. A third requirement is nitrogen. This is very costly and has often to be purchased. It is not easily retained by the soil and is liable to loss in several ways. Therefore, except in so far as humus may help, no attempt should be made to accumulate nitrogen in the soil, as loss and disappointment would follow any such course of action. In the matter of nitrogen farmers have to live from hand to mouth.

Care in the use of nitrogenous fertilizer is necessary, because sometimes their free use would defeat the object in view by making it hard or impossible to secure a seed crop. For these reasons mixed fertilizers do not contain high percentages of nitrogen.

Nitrogen may be bought in three forms:—

(a) As nitrate. This is always soluble and highly available.

(b) As an ammonium salt. This is also highly soluble and available and frequently undergoes conversion into nitrate.

(c) As organic nitrogen. This is of many kinds and varies greatly in value according to the ease with which it undergoes decay and oxidation. Some kinds like those occurring in blood and urine are of high value; other forms such as those found in leather and horn are of low value because they are so slow to become available. If a highly active concentrated nitrogenous fertilizer is ever used, it ought only to be applied sparingly, with full knowledge of its effects and limitations.

IV. A fourth necessary in building up fertility is potash. This is a requirement of all crops, but especially of potatoes and tobacco. Leguminous and root crops also benefit notably by its use, and in the absence of kraal manure it is needed by all crops on sandy soils.

Potash salts to be useful should be soluble in water. Potash occurs plentifully in some felspars, but it is highly insoluble and of very low fertilizing power. The nitrate is too costly for use as a fertilizer. The carbonate is not suitable owing to its caustic properties, which make it an active plant poison. The chloride is objectionable owing to the formation of calcium chloride in the soil by double decomposition. The only really useful and available salt of potash, then, is the sulphate. This is very soluble in water, and cannot be used freely because of that property. A reserve of potash cannot be built up, and the farmer must use it as and when it is required by crop and soil and lack of kraal manure.

It is this danger of too great concentration in a droughty time which limits the amount of potash which may be used with advantage in a mixed fertilizer. When concentrated salts of potash are used alone, they ought to be applied sparingly with full knowledge that the most profitable limit is soon reached and that an overdose will result always in a reduced crop. This has been proved over and over again in many countries, more especially with the potato crop.

V. Phosphoric oxide is a most important factor in building up fertility. Supplies are obtainable in many forms, and all are useful when applied to soil. It may be accumulated in the soil with advantage, because it is not subject to loss by fermentation or volatilization or drainage. Its compounds in the soil are only slightly soluble in water, and are, therefore, not dangerous to crops however plentiful they may be. They are not caustic nor usually acid. The typical form in fertilizers is that occurring in bone-dust. When this material is properly prepared and of sufficient fineness, and applied to a soil not wanting in humus or moisture, it is highly available, being readily dissolved by the soil water as required. For permanent crops, as lucerne, and fruit trees coarse bone-meal may be used with profit. For crops with a short season of growth, and particularly on soils deficient in organic matter recourse must be had sometimes to dissolved phosphates. Bone and mineral superphosphates are forms

very widely used. These soluble phosphates when applied to soil become insoluble in a very finely divided form which plants generally can make use of, and which, in the presence of lime, is quite safe.

A very superficial study of fertilizer price lists with their published analyses will show in the case of mixed fertilizers for specified crops that they uniformly contain a very high proportion of phosphoric oxide. There are several reasons for this. They are:—

- (a) Phosphoric oxide is not liable to loss from the soil even when freely applied; nitrogen is.
- (b) Phosphoric oxide is never dangerous owing to its numerous insoluble forms. Potash salts are dangerous when freely used, because they are all very soluble in water.
- (c) Phosphoric oxide is comparatively very widely deficient and there is more need, therefore, to afford a supply.
- (d) Phosphoric oxide is returned to the soil less freely in the various residues than are nitrogen and potash.
- (e) Phosphoric oxide occurs more plentifully in produce sold off the farm than does potash.
- (f) Phosphoric oxide is not replenished from the air as nitrogen is.
- (g) The smallest part of phosphoric oxide that can be used by the plant is about five times as heavy as the smallest part of nitrogen that can be so used.
- (h) Phosphoric oxide is built up into the seed to a greater extent than potash. Potash is used in the plant over and over again to bring about the changes in which it is active. Less of it is therefore required.

Special fertilizers containing a low proportion of phosphoric oxide are rarely needed, and when they are used, the reasons why should be well understood, as loss and harm may easily follow.

The order of importance of the five requirements in building up the fertility of the soil is:—

1. Humus, because (a) it is so commonly deficient in amount; (b) it serves so many useful purposes; (c) it is the longest step towards the desired goal.
2. Phosphoric oxide, because it is nearly always required and is sold in most of the produce sent off the farm and can only be replaced by purchased fertilizer or foodstuff.
3. Lime.
4. Nitrogen.
5. Potash.

When considering the building up of fertility, the beneficial effects of a change of crop ought not to be forgotten. In this connection, nearly any change adapted to the farmer's requirements can be made to yield the main advantages of a well-designed rotation of crops.

## *PAPPEA CAPENSIS* SEED.

---

### Report of the Imperial Institute, with Description and Illustrations of the Species.

---

By K. A. LANSDELL, Division of Botany, Pretoria.

---

THE plant *Pappea capensis*, Harv. & Sond., was first brought to the notice of this Division by Mr. G. H. Harvey, the Honorary Secretary of the Alicedale Farmers' Association, who wrote on 16th January, 1918, covering a sample of seeds: "I have been instructed by the members of the above association to send you a sample of a wild fruit tree seeds which contain oil. These trees are very plentiful among the various kind of bush about these parts. Will you please let us know if the oil when extracted is of any value, etc."

This sample was forwarded to Dr. J. Schlesinger, of the New Transvaal Chemical Co., Ltd., Delmore, who reported that "you will be interested to hear that our provisional test made with the sample of the berries has given sufficiently encouraging results for further investigating this matter."

Mr. Harvey, on being communicated with, forwarded to the Division a sample of 20 lb. of the above seeds, and this was sent to the Director of the Imperial Institute, London, who reports as follows:—

#### "PAPPEA CAPENSIS" SEED FROM SOUTH AFRICA.

*Description of Sample.*—The sample weighed 14 lb., and consisted of small reddish-brown seeds which were almost spherical, and measured from 0.2 to 0.3 inch diameter. A fair number of the seeds had been attacked by insects. The shells were brittle and could easily be separated from the soft kernels, which were yellow and very oily.

The seed consisted of shell 35 per cent. and kernel 65 per cent. The average weight of a single seed was 0.26 gramme, and of a kernel 0.17 gramme.

*Results of Examination.*—The entire seeds as received were found to contain 7.4 per cent. of moisture and to yield 47.8 per cent. of oil, equivalent to a yield of 73.5 per cent. from the kernels.

The oil was of golden yellow colour and fairly viscous. It deposited a small amount of stearin on standing. On chemical examination it gave the following results, which are shown in comparison with the figures recorded for ground-nut and olive oils:—

	<i>Pap­pea capensis</i> Oil.	Ground-Nut Oil.	Olive Oil.
Specific gravity at 15/15 C. ...	0.9150	0.916 to 0.918	0.915 to 0.918
Solidifying point of fatty acid	39.5 C.	28.1 to 29.2	6.91 to 26.4
Acid value ... ..	13.1	—	—
Saponification value ... ..	188.0	190 to 196	190 to 195
Iodine value, per cent. ...	69.8	87 to 98	80 to 87
Unsaponifiable matter, percent.	0.51	0.1 to 0.8	0.5 to 2.0
Volatile acids, soluble ... ..	0.12	—	—
Volatile acids, insoluble ...	0.32	—	—
Acetyl value ... ..	21.1	9.06	10.64
Optical rotation ... ..	Nil.	—	—

The above figures indicate that the *Pap­pea* oil is of the " non-drying " type, and could probably be used either for soap manufacture or as a lubricant.

The residual meal left after extracting the oil from the entire seeds was light brown, and had a mild, very faintly bitter flavour. The meal similarly obtained from the decorticated kernels had a similar flavour, but was of cream colour. Both these meals were analysed at the Imperial Institute, and the results are given below in comparison with the figures recorded for undecorticated and decorticated cotton-seed meal :—

	<i>Pap­pea capensis</i> Meal.				Figures Recorded for Cotton-Seed Meal.	
	Meal from Undecorticated Seeds.		Meal from Decorticated Kernels.		(1)	(2)
	(1)	(2) Calculated to correspond to 6.5 per cent. of Fat for comparison with the Cotton-Seed Meal.	(1)	(2) Calculated to correspond to 10 per cent. of Fat for comparison with the Cotton-Seed Meal.		
	per cent.	per cent.	per cent.	per cent.	per cent.	per cent.
Moisture ... ..	9.2	8.7	7.4	6.7	13.75	7.4
Crude proteins ... ..	16.3	15.4	38.3	34.5	24.62	42.37
Consisting of :						
True proteins ... ..	13.5	12.8	28.7	25.9	—	—
Other nitrogenous substances ... ..	2.8	2.6	9.6	8.6	—	—
Fat ... ..	1.0	6.5	0.4	10.0	6.56	10.16
Carbohydrates (by difference) ... ..	51.9	49.1	42.9	38.9	29.28	25.86
Fibre ... ..	18.6	17.5	5.1	4.6	21.19	7.06
Ash ... ..	3.0	2.8	5.9	5.3	4.60	7.15
Nutrient ratio ... ..	1 : 3.3	1 : 4.2	1 : 1.1	1 : 1.8	1 : 1.67	1 : 1.16
Food units ... ..	95	103	110	150	107	157

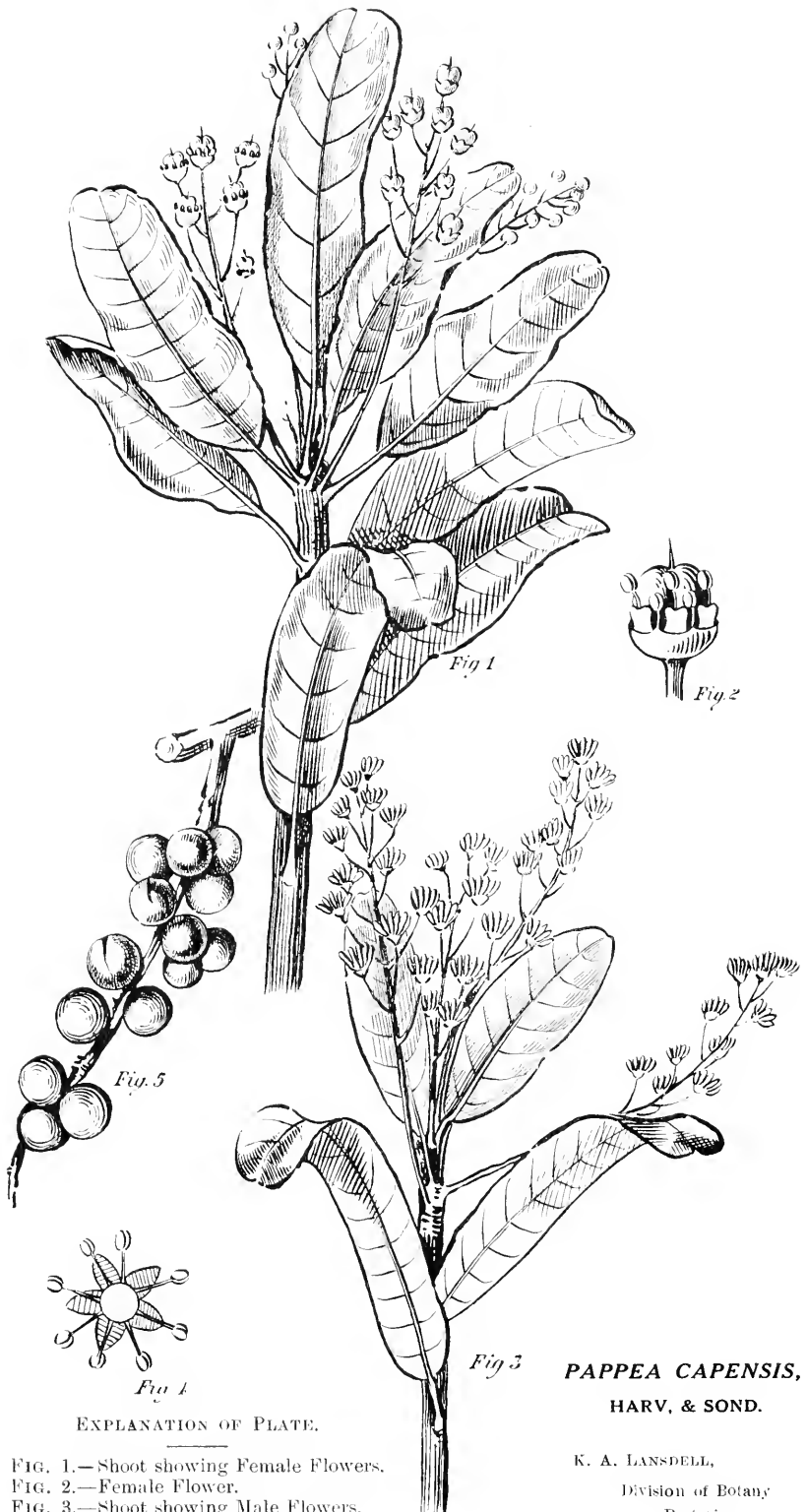

## EXPLANATION OF PLATE.

- FIG. 1.—Shoot showing Female Flowers.  
 FIG. 2.—Female Flower.  
 FIG. 3.—Shoot showing Male Flowers.  
 FIG. 4.—Male Flower.

*PAPPEA CAPENSIS*,  
 HARV. & SOND.

K. A. LANSDELL,  
 Division of Botany,  
 Pretoria.

The above figures indicate that the meals from the whole and decorticated seed of *Pappea capensis* have a fairly good nutritive value, though they are inferior to the corresponding products obtained from cotton seed.

The Pappea meal contained no alkaloid or cyanogenetic glucoside, but a saponin was present which gave the meal a slightly bitter flavour. Emulsification and frothing tests were made with the meal in comparison with tea-seed cake and *Bassia longifolia* meal, and the results indicated that the Pappea meal contained a much smaller amount of saponin than these materials. The meal could, however, not be recommended as a feeding-stuff until practical trials have been carried out to ascertain whether it is harmless.

If the meal should prove unsuitable for use as a feeding-stuff it might be employed as a manure, but as the meal from the undecorticated seed contains only about 2.6 per cent. of nitrogen and 0.7 per cent. of phosphates (calculated as  $P_2O_5$ ) it would realize only a low price in normal conditions. Rape-seed cake, which contains about 5 per cent. of nitrogen and 2.5 per cent. of phosphates, was sold in pre-war times at about £2 per ton in the United Kingdom.

*Commercial Value.*—Samples of the seed and oil were submitted for valuation to oil-seed crushers, who stated that the oil was not suitable for edible purposes, and could not be rendered suitable by any of the ordinary refining processes. The oil would, therefore, have to be regarded mainly as a soap-making material, for which purpose its value under normal conditions would be about equal to that of cotton-seed oil, which, in ordinary circumstances, is worth about £25 per ton in the United Kingdom, although it is at present quoted at £110 per ton.

The market value of the seed will depend to some extent on that of the residual meal, but the oil crushers stated that assuming the residual meal to be of no value they were of opinion that these *Pappea capensis* seeds would be saleable in the United Kingdom at a price rather higher than that of cotton seed if they could be offered in commercial quantities. In the present abnormal conditions the seeds might realize as much as £30 per ton in the United Kingdom. Cotton seed is at present quoted in the United Kingdom at £28.10s. to £29. 10s. per ton, but before the war the usual price was only £7 to £9 per ton.

*Remarks.*—These *Pappea capensis* seeds give a good yield of oil, which could be used for soap-making or as a lubricant, and they would be of interest to oil-seed crushers in the United States if large supplies are available. The residual meals from both the whole and decorticated seeds are not such rich feeding-stuffs as the corresponding products from cotton seed, and they have a slightly bitter flavour due to the presence of saponin. Feeding trials will, therefore, be required in order to determine whether the meals could safely be used as a cattle food.

Information should be furnished to the Imperial Institute as to the quantity of the seeds likely to be available annually in South Africa, together with an estimate of the price at which they could be offered in the United Kingdom. It will then be possible to decide whether it would be worth while to arrange for a large scale trial in order to determine the exact value of the oil and the possibility of using the meal or cake as a feeding-stuff.

## DESCRIPTION OF PLANT.

*Pappia capensis* is a dioecious shrub or a tree up to 10-30 feet high. *Stem* and branches usually ash-coloured, striate, and covered with scars of old branches or leaves. *Branches* spreading, forming an almost flat symmetrical crown. *Leaves* simple, alternate, thick, shortly petioled, crowded at the ends of the branches, 1-3 inches long, about  $\frac{1}{2}$  inch wide, oblong or obovate, rounded at the apex, tapering to the base, smooth, with a prominent midrib, lighter on the under surface, with entire revolute margins which are sometimes toothed in coppice shoots. *Male flowers* paniced, small. *Female flowers* in 5-20 flowered racemes. *Fruit* globose, about the size of a small cherry, covered with fine brown hairs. *Seeds* brown, spherical, shining.

*Pappia capensis* S. occurs abundantly in certain parts of the Eastern Province, and other species are found in the Transvaal, Rhodesia, and Namaqualand.

The species is commonly known as the Wilde Pruim, Wild Amandel, Berg Pruim, Kambessie, and Oliepetten. The native name is Hitzte (meaning a stone), and in Rhodesia is called The Indaba Tree.

The fruits of this tree were known to the early colonists as having a savoury flavour, and that a vinous beverage could be produced from them. The kernel was known to possess an oil which was somewhat purgative.

Mr. Harvey states that while large quantities of fruits are produced each year they are difficult to collect, as wild animals and birds (also stock) are very fond of them, and they are soon eaten after dropping from the trees.

The above report from the Imperial Institute is sufficiently encouraging to pay more attention to this source of oil, and any one interested in this may apply to the Chief, Division of Botany, Pretoria, for any further information received by the Division.

---

## The Poor White Problem.

Dr. Dunstan, the Commissioner of Mentally Disordered and Defective Persons, states in his report\* of November, 1919, that the primary cause of poverty is the inherent incapacity as a result of feeble-mindedness to compete on equal terms with normal individuals. "The psychological side of the poor white problem," he states, "requires quite as much attention and investigation as any other." He points out that no scheme for solving problems of poverty can succeed until the feeble-minded have been weeded out and treated separately from the normal unfortunate poor who can make good. "Settlement schemes, labour colonies, and similar undertakings will succeed if the feeble-minded are eliminated, but not otherwise, for these unfortunates so far reduce the value of the result as to make the scheme a failure, or at least seriously impair its chance of success."

\* Report of the Commissioner of Mentally Disordered and Defective Persons for the Union of South Africa. U.G. No. 31-'20. Price 4s.



## CALCIUM CYANAMIDE.

### Its Agricultural Use as a Fertilizer.

By CHAS. F. JURITZ, M.A., F.I.C., Agricultural Research Chemist.

OF all the varieties of fertilizers, good, indifferent, and bad, that are usually applied to the soil, there is no class more important, and, at the same time, more costly, than what has been termed the nitrogen group. The fertilizers belonging to this class have the property of stimulating the active growth of the plant and promote the formation of its leaf system. They increase the size and weight of the ears in cereal crops, but in the case of fruit-bearing plants they cause loss of fruit by producing abnormal development of leaf and woody stem if applied with too great liberality. While, therefore, it is essential to be discreet in the use of the fertilizers of this group, it will easily be realized that they are of great practical value to the crop. Unfortunately the advantages of a proper use of nitrogenous fertilizers are often as little understood as the caution necessary to prevent a misuse. This, however, applies not merely in the case of fertilizers of the nitrogen group, but wherever fertilizing of any kind has to be practised, and hence has arisen the oft-quoted precept regarding the need of "manuring with brains."

From the time that the value of nitrogen compounds as fertilizers of the soil began to be realized, up to recent years, agricultural chemists have been continuously keeping their thoughts on the vast quantities of

#### NITROGEN IN THE AIR,

and striving for some means of securing portion of that nitrogen and bringing it into the soil for the benefit of the crops. That this could be done for very many years without affecting the quantity of nitrogen remaining in the air was evident, because as much as seven tons of nitrogen rest on every square yard of the earth's surface, that is to say, in the air over the Union of South Africa alone, there is no less than  $10\frac{1}{4}$  million of million tons of nitrogen.

For a long time there seemed to be no way of utilizing this stupendous store of nitrogen, and then, almost unexpectedly, after much patient research, one method after another was announced and practically applied. Amongst these was the process based on the use of calcium carbide, the substance which had become prominent because of its power of producing acetylene gas by mere addition of water, and so affording an easy and portable illuminant for bicycles, motor cars, etc. When calcium carbide is heated to near  $1200^{\circ}$  C., and nitrogen is passed over it, chemical combination takes place, and cyanamide or, more properly speaking, calcium cyanamide, is produced. The article, as commonly purchased, contains about 50 to 55 per cent. of pure calcium cyanamide, and this is the article which has lately come

into use as a fertilizer. As a supplier of nitrogen it has the advantage over sulphate of ammonia that it does not render acid any soils deficient in carbonate of lime.

It may be said at once that calcium cyanamide, as such, is of

#### NO USE WHATSOEVER TO PLANTS.

but in the soil it slowly breaks up, and eventually compounds are formed from it which are of distinct value to the plant. The application of calcium cyanamide to the soil is not without risk to the crop, and in more than one way. As in many other cases, when a new idea is introduced people do not take to it at once, but when once its value begins to dawn on them they fly to the opposite extreme and misuse it or apply it in excess. After the first introduction of chemical manures they speedily fell into disfavour simply because they had been applied injudiciously or ignorantly and brought disaster. This is no argument against the use of calcium cyanamide, but means merely that it must be used with circumspection, and with brains.

Calcium cyanamide, as above remarked, breaks up in the soil. This is due to the action on it of the soil water, and dicyanamide, a substance poisonous to plants, is produced. The dicyanamide in turn also decomposes, and ammonia is formed, with subsequent nitrification. When first applied, therefore, calcium cyanamide is poisonous in its action, but this effect slowly passes away. It follows, naturally, from this that cyanamide must be applied some time before sowing, otherwise it would prevent germination of the seed. Hence, too, it cannot as a rule be used as a top-dressing when the young crop has appeared above ground. It has, nevertheless, been recommended for cereals in this form. It must, in consequence, be looked upon as a slow-acting fertilizer.

The poisonous effect of cyanamide shortly after its application to the soil is not without its advantages. It is well known that heating the soil may increase the ultimate crop. A similar result has followed the addition of such substances as carbon disulphide, naphthalene and other germicides, which destroy pests in the soil, not only such as wireworms and others of that class, but also microscopic organisms, which may either injure the plant itself directly or indirectly by destroying the bacteria which aid it in its growth. Calcium carbide has been used for such a purpose, and it is also easy to see how similar must be the action of the poisonous emissions from the cyanamide when once it begins decomposing in the soil.

As far as the

#### PRACTICAL APPLICATION.

the effects, and the efficacy of cyanamide as a fertilizer is concerned, there have been no investigations in South Africa, so that all our information must be based on experiments carried on in other countries. Of some of these experiments I propose to give an outline, and it will be seen in what respect their results are explained by the foregoing remarks.

In Austria it has been found (*Exp. Stn. Rec.*, vol. 33, p. 818) that cyanamide retards the germination of both wheat and barley, particularly the wheat, if supplied in proportions varying from one-tenth of a ton to half a ton per acre. That, however, should not be regarded

as condemnatory to the use of canamide, for other fertilizers may act similarly. Large applications of nitrate of soda, for example, retard the maturity of such crops as sugar beet. Cyanamide does the same, and its addition does not result in as large an increase of sugar per acre of beet as the addition of nitrate of lime or nitrate of soda. When added immediately *before* the sowing of the seed cyanamide was found to hasten the development of beets (*Exp. Stn. Rec.*, vol. 34, p. 431).

Of course cyanamide should not be added in too large quantities, but then over-manuring of *any* kind is apt to be harmful. It is considered advisable to limit the addition of cyanamide to 60 lb. per ton of a fertilizer containing half a ton of superphosphate.

The *ultimate* action of cyanamide on vegetation is virtually that of ammonia and nitrates, for in the soil the cyanamide, in process of time, becomes converted first into urea, then into ammonia, and finally into nitrates, and these changes proceed more rapidly in sterilized than in unsterilized soil.

In mixed fertilizers cyanamide causes reversion of the phosphoric oxide, but no loss of nitrogen is involved. If such a mixture however is left to stand, its fertilizing value has been found to become less. Again, it must be remarked, other materials cause similar reversion; lime, for example, but lime is not for that reason discarded as a fertilizer.

A decidedly *beneficial* effect of cyanamide is that it retards denitrification of other inorganic nitrogenous fertilizers, and so adds to their durability "while being itself also a nitrogenous fertilizer." (*Exp. Stn. Rec.*, vol 34, p. 220).

An *injurious* effect has been noticed on acid meadow soils which are excessively damp (*Exp. Stn. Rec.*, vol 34, p. 820), but this, too, cannot be counted to the discredit of cyanamide.

Cyanamide has repeatedly been declared to possess a lower

#### FERTILIZING VALUE

than ammonium sulphate or sodium nitrate as a constituent of a mixed fertilizer, but it has been proved to be of special value in increasing the yield of beets and potatoes, in which respect it has been pronounced (*Exp. Stn. Rec.*, vol. 34, p. 24), practically equal to sodium nitrate, a mixture of cyanamide and sodium nitrate being particularly recommended for all kinds of beet.

When used *alone* cyanamide has been recommended as a top-dressing for grains but not for potatoes. In the latter case it gives best results if harrowed in before planting. Hoffmann (*Deut. Landw. Presse*, 1915, pp. 489, 490) has compared the value of cyanamide as a top-dressing with that of sodium nitrate and ammonium sulphate as follows, as the result of experiments (*Exp. Stn. Rec.*, vol. 34, p. 622).

	Sodium Nitrate.	Ammonium Sulphate.	Cyanamide.
For rye ... ..	100	75.7	72.9
„ wheat... ..	100	75.7	79.1
„ barley ... ..	100	77.1	80.1
„ oats ... ..	100	132.5	82.0
„ potatoes... ..	100	85.0	62.2

In the monthly *Bulletin of Agricultural Intelligence and Plant Diseases* for February, 1915, issued by the International Institute of Agriculture, several series of experiments with cyanamide and other nitrogenous fertilizers are summarized, and the average results from five experiment stations show that, if the nitrogen assimilated by crops from nitrate of soda be reckoned as 100, that from sulphate of ammonia is 78, and from cyanamide 65. In the March, 1916, issue of the same Bulletin further experiments by Schneidewind are recorded. He concludes that "stickstoffkalk" (which is virtually cyanamide) may give much the same results as ammonium sulphate, *but is only effective if the weather is very dry during the chief growing period*. In general, he admits its productive value is a little lower than that of ammonium sulphate.

Even if its results are not quite as good as those of other nitrogen fertilizers, calcium cyanamide is probably quite as *profitable* in use as those others, on account of its cheapness.

It has been estimated that cyanamide loses from 0.1 to 0.4 per cent. of its nitrogen daily during storage, but experiments carried on at Wye have shown that neither the moisture nor the carbon dioxide of the air, nor both combined, could be responsible for this (*Exp. Stn. Rec.*, vol 34, p. 724) and *Monthly Bull. of Agric. Intell. and Plant Diseases*, May, 1915, p. 675).

In the foregoing remarks I have confined myself to cyanamide as such, and have not specially dealt with the question of its

#### TOXIC CHARACTER

or that of any dicyanodiamide contained therein. The toxic nature of dicyanodiamide should no more bar the use of cyanamide than the fact that sodium perchlorate is apt to occur in nitrate of soda bars the use of the latter as a fertilizer.

Dicyanodiamide is the prevailing form in which nitrogen is present in granulated Norwegian cyanamide (lime nitrogen), and this lime nitrogen has at least one advantage, namely, a less marked tendency to revert the phosphoric oxide in superphosphate than the more common (dusty) cyanamide (*Exp. Stn. Rec.*, vol 35, p. 22).

It would appear that the presence of excess of dicyanodiamide depends upon the process of manufacture, and as the expectation is expressed that the nitrogen problem in the United States has the best prospect of being met, as far as the agricultural requirements are concerned, by the manufacture of cyanamide in that country (C. G. Gilbert: *Smithson Inst. publication, vide Exp. Stn. Rec.*, vol. 36, p. 122), it is plain that *there* at least no fear exists of deleterious effects resulting from its use. Moreover, even if the article now produced were not quite as suitable as it might be "it is only a question of time" as Pranke remarks (*Chem. News*, vol. 100, pp. 20, 28; *Journ. Indus. and Eng. Chem.*, vol. 6, No. 5) until an ideal product is developed and sold at the lowest prices. In the meantime, however, the industry must have the support of the public.

If there were any well-grounded fear of harmful effects it does not seem likely that calcium cyanamide would have the output that it has already acquired. In 1904 the world's total production was 5000 tons: in 1909 it was 50,000; in 1914 it 275,000. In Canada, at the beginning of 1916 one factory alone was turning out crude cyanamide

at the rate of some tons per day, and "its principal use in this country (America) is (to quote Franke again) as a source of nitrogen in mixed fertilizers." It is true that much of the cyanamide is converted into ammonia, but that is effected at a cheaper rate than that at which it is possible to get ammonia from gas liquor (*Journal Indus. and Eng. Chem.*, vol. 8, p. 160) and that is rather a recommendation for the production of cyanamide than otherwise.

As far as the

### POISONOUS ACTION

of the dicyanodiamide is concerned, Liechti and Truninger performed a series of experiments from which it appeared that abnormal specimens of cyanamide, containing 7 per cent. of nitrogen in the form of dicyanodiamide, affected injuriously the yield of wheat grain and to a lesser extent wheat straw, as compared with the normal cyanamide. (*Journ. Soc. Chem. Ind.*, vol. 35, p. 647, and *Exp. Stn. Rec.*, vol. 36, p. 426). They found that three months' storage of calcium cyanamide, in an atmosphere saturated with moisture, converted the original cyanamide almost wholly into dicyanodiamide, whereas during *eight years* storage in a wooden box in a dry place no deterioration took place. Independent experiments by Hager and Kern (*Journ. Soc. Chem. Ind.*, vol. 35, p. 856) proved that cyanamide underwent no perceptible change during seven months if no water was added; there was very little immediate change when 25 per cent. water was added, but in seven months the dicyanodiamide had increased to 2.58 per cent. When 50 per cent. water was added profound changes took place, and the material set to a hard, stone-like mass, which in 2½ months contained 7.51, and in seven months 9.17 per cent. of dicyanodiamide nitrogen. From this it follows that calcium cyanamide which has got wet should be used immediately, as otherwise it becomes converted into dicyanodiamide.

I have above referred to the fact that Norwegian granulated cyanamide contains dicyanodiamide. This may be due to the fact that the granulated form is produced by the agency of water, a method which Hager and Kern predict is not likely to succeed. In 1913 a granulated cyanamide was placed on the market made by pressing damp cyanamide into briquettes, and this is no doubt the method that is now used in Norway.

If the cyanamide be not thus granulated its dustiness is apt to produce a caustic action on the skin and mucous membranes, hence the need of converting it into a non-powdery form.

### CONCLUSION.

From what has been ascertained thus far, I am of opinion that if proper care be taken in manufacture and storage no ill effects are to be feared from the agricultural use of cyanamide, and I do not see the slightest reason why, if manufactured in this country, it should not be made good use of by our farmers.

If mixed with other fertilizers its incompatibility with sulphate of ammonia and with superphosphate should be noted, but there is no reason why it should not be mixed with basic slag.

## THE POULTRY YARD MONTH BY MONTH.

By J. J. JORDAAN, Lecturer and Instructor in Poultry, Glen, Orange Free State.

### November.

*Breeding Pens.*—The breeding pens should now be broken up.

*Runs.*—All the breeding pens should, if possible, be irrigated, and dug over the following day at least 12 inches deep; irrigated again, and after three or four days redug and planted with a quick-growing plant: sunflower, mealies, pumpkins, rape, or barley. Keep irrigating and cultivating until April or May as conditions allow. Plant growth is the surest means of absorbing the fowl manure and sweetening up the soil.

*Male Birds.*—Confine all males it is intended to keep for next season's breeding in one run if large enough. To prevent them fighting, remove them at night and place them all into one house, fairly dark. Feed and water them in the house for four or five days, and then let them out one evening just before dark. Wherever necessary remove the spurs from such birds before putting them into the house. The operation is a simple one: cut a notch on top and below the spur close to the leg, and with a sharp pruning shears cut off the spur at the notches. Pour a little Friar's Balsam or sear with a hot iron to stop the bleeding.

*Table Poultry.*—Place all the male birds it is desirable to dispose of along with the culled cockerels, fatten, and get them ready for the South African Christmas "chicken" trade. The hens are usually in good condition and fit for killing at once; prices are usually high at this time, so dispose of them as soon as they stop laying.

*Egg Production.*—Some of the early hatched pullets will continue laying. Give them a liberal allowance of meat meal to keep them at it, or they are liable to go into a partial moult and stop laying until next spring. Continue preserving all surplus eggs. A scratching shed for the young pullets will also help to increase and keep up the egg output.

*Chickens.*—Endeavour to remove the chickens to fresh runs and ground, because there is nothing like it to promote growth.

*Incubation.*—Examine all parts of the incubators, thoroughly disinfect the machines, repair and replace any broken or missing parts, and store for next season.

*General.*—Inland heavy rains may be expected. See that the runs are well drained and that there are no stagnant pools of water about, or worms will easily be contracted, especially by the young stock.

---

## THE VEGETABLE GARDEN.

### November, 1920.

By H. B. TERRY, Cert. R.H.S., Lecturer in Horticulture, School of Agriculture, Potchefstroom.

ALL summer crops should be sown as soon as possible; temperature will rapidly increase, and no further fear of frosts need be entertained. Do not neglect to keep all crops well hoed or cultivated after rains. Transplanting, except when on commercial lines, should be done towards evening, and the plants well watered in.

**ASPARAGUS.**—Plenty of water is required to maintain the supply of young growths for cutting. It is not advisable to cut too severely from recently planted crowns. Seeds may now be sown to obtain new plants.

**ARTICHOKES.**—The soil should be ridged up along the rows in a similar manner to potatoes; this ensures heavy yields.

**BEANS (RUNNER).**—Growing crops should be well ahead now and in need of no special treatment. Seeds may still be sown this month; the best are St. Fiacre, Scarlet Champion, Mont d'Or, Dutch Case Knife.

**BEANS (DWARF).**—As these are ready in eight weeks' time and the plants stop producing unless constantly picked, further sowings should be made for succession; use Sugar, Canadian Wonder, Burpee's Stringless, Golden Wax Podded.

**LIMA BEANS.**—For a green vegetable these are delicious, and as a dry bean they are invaluable in winter. Allow three feet between the rows and one foot between each plant. There are two types, climbing and bush.

**BEETROOT.**—Continue to sow for succession Red Globe, Eclipse, and Egyptian Turnip. These are quick-maturing, shallow-rooting varieties.

**CARROTS.**—Sow quick developing sorts as Model, Horn, Oxheart. The rows should be 15 to 20 inches apart, dependent upon method of cultivation. The crop should be thinned early to allow for normal development; if sown on ridges large roots are obtained early.

**CAPSICUM.**—Young plants should be set out 2 feet 6 inches each way, not closer; provide a short peg for each plant to prevent them being broken off by the wind. These are also known as chillies.

**CUCUMBERS.**—A further sowing should be made towards the end of the month to follow up previous crops.

**CELERY.**—Make a good sowing to transplant in January.

**EGG FRUIT.**—Transplant seedlings from seed-tins; allow 3 feet apart each way; when carrying fruit the plants may require staking to support them.

**LETTUCE.**—All cabbage varieties may be sown now; growth is rapid if copious waterings are given. Let the rows be 12 to 15 inches apart. Neapolitan is the quickest. All the year round Iceberg and Webb's Wonderful are also good. Thin out at an early stage for salading.

**RADISH.**—It is customary to sow the turnip-rooted varieties of radish with the lettuce to save ground, and it is recommended, as the radishes are ready and off weeks before the lettuce.

**MELONS.**—Both Watermelons and Sweet Melons do best when sown in November on the high veld. The soil should be well prepared, and the holes or hills made at least 6 feet apart.

**ONIONS.**—Complete transplanting spring-sown onions; keep the soil clean and not too loose; set the rows 15 to 18 inches apart. For producing pickling onions choose a poor piece of land and sow thickly (not so thickly as to cause the bulbs to rise out of the soil) such varieties as Queen, Bermuda, Silver King, Bartletta. These should mature where sown.

**PARSLEY.**—Sow plentifully now and transplant into rows or borders for winter use. Moss Curled, Triple Curled are suitable.

**PUMPKINS.**—Sow largely of Boer Selected, Ironbark, Dundas, Large Cheese.

**SQUASHES OR VEGETABLE MARROW** may be sown for succession; use bush-type, as these conserve space and yield heavier crops.

**SWEET CORN.**—Fortnightly sowings should be made according to requirements; Golden Bantam, Early Cory, Boer Bread, Maizena should be drilled out 2 feet 6 inches apart and 1 foot apart in the rows. Keep down all suckers, as these delay the formation of cobs.

**TOMATO.**—Planting may now become general; for small gardens it is as well to purchase a few plants from seedmen.

**POTATOES.**—Plant potatoes where opportunities did not occur last month.

## NOTES FROM THE "GAZETTE."

Attention is drawn to the following matters of interest which appeared in the *Union Government Gazette*:—

(Abbreviations: "Proc."—Proclamation; "G.N."—Government Notice.)  
*Gazette.*

No.	Date.	ITEMS.
1003	10 9/20	Professor E. Anderson (Transvaal University College); G. A. Kolbe, Esq. (Orange Free State); and Colonel W. Arnott (Natal) are appointed (among others) as members of the Advisory Board of Industry and Science to advise on Agriculture. (G.N. No. 1651.)
1003	10 9 20	By Parliamentary resolution (Session 1920), and in terms of the provisions of Forest Act, No. 16 of 1913, the piece of land known as the Umnxsha Forest Reserve, Division of Kingwilliamston, has been withdrawn from the demarcated forests area. (G.N. No. 1618.)
1003	10 9 20	Mr. J. D. Borthwick, Assistant Principal Veterinary Surgeon, has been appointed Acting Principal Veterinary Surgeon, <i>vice</i> Mr. C. E. Gray, Principal Veterinary Surgeon, on leave, as from 30th August, 1920. (G.N. No. 1619.)
1003	10 9 20	The area of Harkerville Forest, as described in G.N. No. 343 of 20 2 20, has, in terms of the Forest Act, No. 16 of 1913, been declared a demarcated forest. (G.N. No. 1620.)
1003	10 9 20	Owing to partial prevalence of scab therein, the Minister has ordered that the District of Williston, as well as the area mentioned in G.N. No. 1594 of 1920, and portion of Kenhardt District be semi-protected areas, as provided for in G.N. No. 1793 of 1919. (G.N. No. 1617.)
1003	10 9 20	All cattle in the District of Queenstown have to be dipped every fourteen days (in the fourteen day dip), commencing three months after 8th September, 1920, in manner prescribed by G.N. No. 638 of 1915. Cattle in the Gwatjui Ward, however, shall continue to be dipped as provided for in G.N. No. 551 of 1916. (G.N. No. 1643.)
1003	10 9 20	In terms of paragraph (a), Section 16, of the Stock Diseases Act, the Minister has ordered that, after the expiry of three months from 8th September, 1920, no cattle other than pure-bred and grade cattle bearing the owner's distinctive mark, shall be allowed to be moved within the District of Rustenburg unless they bear the registered brand of the owner. (G.N. 1644.)
1003	10 9 20	The compulsory dipping of cattle (1) every five days (in the five-day dip) has been ordered for the Bizana District; portions of the Alfred, Entonjani and Umfolozi Districts; for the areas specified in paragraph (c) of G.N. 1698; and for portions of Umzimkulu (Transkei), Umvoti, Babanango [paragraphs (a) and (b) of G.N. No. 1799], and Willowmore [paragraph (c), G.N. No. 1799]; (2) every fourteen days (in the fourteen-day dip) for the Mount Fletcher District, and for portions of Maclear; (3) every seven days (in the seven-day dip) for the areas specified in paragraph (d), G.N. No. 1698, and Lydenburg [paragraph (d), G. N. No. 1799]; (4) every ten days (in the ten-day dip) for the areas specified in paragraph (e), G.N. No. 1698; (5) every three days (in the three-day dip) for portions of the Barberton District. [G.N. Nos. 1647, 1698 (amended), 1756, 1799.]
1004	17 9 20	
1005	24 9 20	
1006	1 10 20	



(Abbreviations: "Proc." Proclamation; "G.N."—Government Notice.)

*Gazette.*

No.	Date.	ITEMS.
1004	17 9 20	Owing to absence on leave of Sir Arnold Theiler, K.C.M.G., Director of Veterinary Education and Research, the Assistant Director, Dr. P. J. du Toit, has been appointed Acting Director at Onderstepoort as from 15th September, 1920. (G.N. No. 1664.)
1004	17 9 20	Compulsory dipping of sheep and goats, in terms of the Stock Diseases Act and the Scab Regulations, has been ordered (1) in the Districts of Fraserburg, Hopetown, Maraisburg, Molteno, Tarka, Queenstown, Cradock, Pearston, Uitenhage, Steytlerville, and Jansenville, within the period 1st October to 31st December, 1920 (G.N. No. 1094); (2) for the Districts of Ngqeleni and Libode (Transkei) within the respective periods 1st October-30th November and 15th November-31st December, 1920 (G.N. No. 1666); (3) for the Districts of Tsolo, Qumbu, Mount Frere, Mount Ayliff, Mount Fletcher, Matatiele, and Umzimkulu within the period 1st October-31st December, 1920. (G.N. No. 1809.)
1006	1 10 20	
1004	17 9 20	The Minister of Agriculture has ordered that three months after 15th September, 1920, no permits for the movement of cattle within the District of Pretoria will be issued other than for cattle kept within the boundaries of a municipality and subject to certain conditions, unless the owner has a cattle dipping tank of his own at which his cattle are being regularly dipped at specified intervals, or at other tanks under conditions further outlined in G. N. No. 1697.
1004	17 9 20	The disposal of Crown Lands by public auction is notified to take place at 10 a.m. on 27th November in front of the Court-house at Montagu; 10 a.m., 11th December, in front of the Court-house at Robertson; 10.30 a.m., 8th December, outside the Civil Commissioner's Office, Old Supreme Court Buildings, Capetown; 2 p.m., 18th December, at Van Wijksvlei; and 10 a.m., 18th December, in front of the Magistrate's Office at Victoria West. For further particulars see G.N. No. 1711.
1005	24 9 20	All stock brands registered under the Orange River Colony Registration Ordinance, 1913, in the Free State for the quarter ended 30th June, 1920, are published in G.N. No. 1717. Brands for horses, cattle, ostriches, sheep, and goats, registered under the Brands Registration Acts, Nos. 12 of 1890 and 4 of 1897 (Cape of Good Hope), for the quarter ended 30th June, 1920, appear in G.N. No. 1724.
1005	24 9 20	Crown land, in the Division of Albany, will be offered for sale by public auction in front of the Magistrate's Offices, Grahamstown, at 10 a.m., on 5th January, 1921. (G.N. No. 1763.)
1006	1 10 20	A Commission has been appointed to investigate and report on the following:—Measures to prevent losses owing to drought; change of farming methods; improvements in farming conditions; indigency among the farming community in consequence of losses, and the production of feeding by the cultivation of various grasses. The members of the Commission are:— H. S. Du Toit (Government Agronomist— <i>Chairman</i> ). S. M. Gadd (Cape). G. A. Kolbe (Orange Free State). A. Stead, B.Sc., F.C.S. (Grootfontein School of Agriculture). R. A. B. Mussman, Secretary. (G.N. Nos. 1805, 1871.)
1008	15 10 20	

(Abbreviations : "Proc."—Proclamation; "G.N."—Government Notice.)  
*Gazette.*

No.	Date.	ITEMS.
1006	1/10/20	Crown Lands in the Humansdorp and Paarl Divisions will be offered for sale by public auction respectively at Humansdorp in front of the Court-room at 10 a.m., 15th December, and at Wellington in front of the Magistrate's Office at 11 a.m., 15th December, 1920. (G.N. No. 1806.)
1006	1/10/20	Applications will be received by the Department of Lands, Pretoria, up to the 12th November, 1920, for the allotment of certain Barberton holdings to be disposed of on lease. Further particulars to be had on reference to G.N. No. 1811.
1006	1/10/20	The Department of Lands, Windhuk, will receive applications up to the 9th November, 1920, for the allotment of various farms in the Windhuk district to be disposed of on lease for a period of five years with option of purchase. For particulars of farms and other conditions see G.N. No. 1812.

## SOUTH AFRICAN PRODUCE ON THE OVERSEA MARKET.

### Extracts from Report of the Trade Commissioner.

**August, 1920.**

*Wool.*—At the auction sales held on the 28th August, 5955 bales of South African wool were offered. There was a large attendance of buyers, and competition was much better than for the last month or two. This was not reflected to any extent in increased prices, but a much better proportion of sales were effected, and it was a welcome change from recent stagnation. French buyers operated freely. Good, greasy wools of combing lengths were most in request, and on these an advance of fully 5 per cent. was frequently secured, but wasty wools of indifferent lengths showed no improvement. Snow whites sold irregularly.

The prices as compared with the July series were :—

	<i>Current prices per lb.</i>
Snow white extra super, 5 per cent. dearer ... ..	61d. to 80d.
Snow white super, par to 5 per cent. dearer ... ..	45d. to 60d.
Snow white medium, par to 5 per cent. dearer ... ..	36d. to 44d.
Snow white inferior, par to 5 per cent. dearer ... ..	26d. to 35d.
Grease combing, long, 5 per cent. dearer ... ..	21d. to 31½d.
Grease combing, medium, par to 5 per cent. dearer	15d. to 20d.
Grease clothing, light, par to 5 per cent. dearer ... ..	16d. to 22d.
Grease clothing, heavy, par to 5 per cent. dearer ...	11d. to 15d.

I gathered that the opinion held of the improvement is that the recent demand was more or less of a momentary character, and due to certain branches of the trade having of necessity to secure sufficient supplies to carry them on. It is, therefore, considered doubtful whether any further advance can be expected in the near future. It is hoped, however, that prices for fine class wools will remain at their present level. Supplies of this type of wool at present are small. On the other hand, there are good supplies of coarse wools, and prices for these are tending downwards. From opinions expressed it is evident that the better prices obtained at the last sale must not be counted upon too much as the tendency all round is for prices to decline. The continental demand, fortunately, shows some signs of improvement. It is

scarcely necessary to state that the present labour troubles are adversely affecting the market, and until a satisfactory settlement is reached buyers cannot operate freely.

*Mohair.*—There has been practically no alteration in the mohair market during the past month. The tone of the textile trade generally appears a little more animated, but all buying is simply to cover the day's requirements. Owing to the small outlet for mohair, transactions are still few and far between, and at prices favouring the buyers.

*Hides.*—Owing to the absence of demand the brokers decided to abandon the raw hide sales, which were fixed for the 10th August. Prices throughout the month remained unchanged.

*Sheep Skins.*—Auction sales were held on the 3rd September. 627,377 Cape sheep skins were offered, and 124,112 sold. The brokers report that the collection, much of which had been previously offered, was fairly representative of the usual origins, and on the whole in fair condition, but many of the combing wools were distinctly on the short side. There was a fair demand, chiefly for export, for skins of really "extra long" staple, but a falling off in bidding was always manifest, as the skins approached the "long wool" category.

Of 150,774 common Cape (glovers') sheep skins offered, 28,582 skins were sold. Of extra large skins of standard selection there was no adequate representation, but there is practically no change of value to record. For bye shorts there was after the auction some exchange at prices representing a reduction of about 20s. per dozen on previous nominal value.

*Maize.*—According to the Baltic Exchange, maize is ruling very firm owing to a good inquiry for near positions, helped by the strength of the freight position and better Argentine options. A cargo of Rhodesian maize, approximately 4000 tons, has been resold at 80s. For parcels of South African No. 2 White Flat, 77s. 6d. to 80s. is about the nominal price offered for United Kingdom and Continental ports. Parcels of La Plata shipping shipped made 60s. August-September and 67s. 6d. September-October.

*Maize Meal.*—There are buyers at £18. 10s., and possibly £18. 15s. could be obtained.

*Kaffir Corn.*—There is a good market for kaffir corn at about 90s. per quarter, but at the present moment no offers have been received from the Union.

*Beef.*—The market is very difficult at present owing to the large quantities of poor quality frozen meat in store. South African beef is worth approximately 5s. per stone (8 lb.) for hindquarters and 3s. for forequarters.

*Pork.*—The market is good for frozen pork, and the price to-day ranges from 10s. to 10s. 3d. per stone of 8 lb.

*Bacon.*—This article is still controlled and supplies are on the small side. Shipments to the Union would, therefore, be welcomed. The average price recently paid for South African bacon was about 20s. per cwt. for Green Wiltshire Sides in bales. Smoked bacon should on no account be shipped.

*Eggs.*—The old foreign egg connections are still missing, and the trade is dependent chiefly on home supplies and Danish for best qualities, with an occasional arrival of Chinese for lower grades. Later, Egyptian and Morocco eggs and a certain quantity of cold stored Americans and Canadians will be available. Trade has been bad during the past two months on account of high prices and limited supplies.

*Ostrich Feathers.*—Auction sales were held on the 6th and 7th September. It will be remembered that at the auctions held in May last a heavy decline was experienced, and it was decided to postpone further sales until September, when it was hoped that an improvement would have taken place. These expectations have only been partly realized, and the auctions just closed passed off with less activity than had been hoped for. The most interesting feature of the auction was the sale without reserve of 320 cases of western feathers, part of which were very fine, and which met a fair demand. There does not at present seem to be much demand from America, but Paris was fairly well represented, and this, it is thought, augurs well for the future fashions in feathers. As regards prices, whites and feminas of good quality showed

practically no change, but seconds and thirds declined about ten to fifteen per cent., whilst the common were much cheaper. Byocks were ten to fifteen per cent. lower. Light spandons were scarce, and sold well; coloured, however, were rather easier. Boos, blacks, drabs, and floss were much below the average quality, and declined about 15 to 20 per cent. all round.

The total quantity offered was 1700 cases, of which 1000 cases were sold, realizing £81,000. The next sale is fixed for 7th February, 1921.

---

## OVERSEA PRICES OF SOUTH AFRICAN PRODUCE.

---

### MARKET PRICES OF SOUTH AFRICAN PRODUCE IN THE UNITED KINGDOM, CABLED BY THE TRADE COMMISSIONER, LONDON, ON THE 9TH OCTOBER, 1920.

---

*Wool*.—Approximately 3000 bales free South African wool offered for sale on 22nd September. Competition uncertain, and large quantities withdrawn. No demand for best description Snow Whites, price 20 per cent. below last sale rate; medium and inferior declined 15 per cent. Good demand for long greasy combings at 10 per cent. reduction, but medium and short greasies declined 15 per cent. (Cabled 23rd September, 1920.) Prices show no change since last cable, but markets have still lower tendency. (Cabled 9th October, 1920.)

*Mohair*.—Market unchanged.

*Cape Hides*.—Wet Salted, 1s.; Dry Salted, 1s. 4½d. to 1s. 5d.; Best Heavy, 1s. 6d. per lb. nominal. Market dull.

*Cape Merino Sheepskins and Cape Goatskins*.—Market dull; prices unchanged.

*Natal Wattle Bark*.—Market dull; nominal value, £15 ground, £14 chopped. Considerable stocks in hand.

*Ostrich Feathers*.—Market continues steady, but no alteration in prices.

*Maize*.—South African No. 2, White Flat, offered at 80s. Argentine quoted at 62s. 6d. September-October shipments, 61s. 6d. October-November shipments.

*Maize Meal*, £18. 10s., but market very weak.

*South African Raisins*, in boxes, worth approximately £5 to £5. 5s. per cwt., duty paid, but bags difficult of sale. Valencias, £6. 10s. to £7. Market dull.

---

### MARKET PRICES FOR OTHER PRODUCE OF INTEREST TO SOUTH AFRICA.

---

*Cotton*.—October future, for week ended 1st October, highest 19.20; lowest, 16.30.

*Cotton Seed*.—Neglected. Bombay to Hull, September-October shipments, October-November shipments, £15 sellers. Egyptian, of fair average quality, new crops, to London, September-October shipments, £19. 10s.; to Hull, £19. 5s.

*Eggs*.—Argentine, 34s.; Canadian, 34s., 35s.; Irish, 38s., 40s.; Danish, 39s., 42s.; English, 45s., 46s., per 120.

*Bacon*.—Canadian £10. 3s.; American Wiltshire, £9. 5s. 6d. to £9. 12s.; Danish, £10. 8s.; Irish, £14.

*Crayfish*.—Small stock. Quotations for goods to arrive, £5. 7s. 6d. to £5. 10s., c.i.f. London, for 96 8-oz. flats.

## NOTES FROM THE DIVISIONS.

### AGRICULTURAL CO-OPERATION

THE month of September has again proved a very busy period for the co-operative maize societies in receiving and providing storage accommodation for the new crop, the bulk of which has now been delivered by the members.

Compared with the prices obtained by non-co-operators, who, as a rule, have to sell their maize immediately after reaping, when the market is generally flooded, the prices for the previous season's crop realized by the societies on behalf of their members were so satisfactory that they induced several hundreds of farmers to enrol themselves as members of the older maize societies. In addition to this, many newly-established societies have recently commenced active operations, so that, altogether, the turnover in maize this present season is likely to be a record one.

Apart from the efforts of the central organizations in the direction of closer co-operation in wool, wool-growers generally are displaying the keenest interest in this subject. A very successful meeting was held at Wepener during the month, consisting of representatives of several of the wool districts of the western Orange Free State, and several further meetings were convened for October in various wool centres of that Province for the purpose of forming co-operative societies. There are still many difficulties to be overcome, but, as the wool-growers are becoming alive to the necessity of introducing better methods for disposing of their wool, the time cannot be far off when they, also, will be properly and effectively organized.

As the members of the Rustenburg Tobacco Society have now delivered the bulk of their 1920 tobacco crop, it can safely be stated that the turnover of this society during the current financial year will at least equal that of the previous year, viz., 2,795,641 lb., or that even better results will probably be achieved than in the previous year, when the society paid exceptionally high prices to its members, and was in a position to add a sum of £8475 to its reserve fund, which now stands at £29,997. 4s. 9d.

### SHEEP.

Mr. J. J. McCall, Acting Principal Sheep and Wool Expert, travelled extensively during September in the Bedford, Cradock, and Somerset East districts, culling and mating stud sheep. He also attended the Bedford Ram Fair for the purpose of selecting rams and advising prospective farmers. Prices ruled high, and any animal showing exceptional quality was in demand. One breeder realized up to £20. 15s. for his flock rams, while another averaged £11 each for nearly 100 rams.

At the close of September rain had not yet fallen in the Albany district, and a continuance of the drought will spell disaster for many farmers. Butter was at famine prices, and milk unobtainable. The surrounding districts, however, though in need of more rain, are in a far better position, and all stock are in a good condition. The lambing so far has been excellent; in fact, on some farms it has been a record. In one flock of 400 ewes there were 40 per cent. of ewes with twins.

The wool question is the burning topic amongst sheep farmers, and the ultra-pessimistic reports from the coast add to the fears of a slump. The last reports from Australia are, however, more encouraging, and the papers there promise sheep farmers a better outlook.

## VETERINARY EDUCATION AND RESEARCH.

With the arrival of spring the work in this Division generally increases, and continues to do so as the summer proceeds. The number of smears sent in for diagnosis shows a steep rise. This increase in the number of deaths must be attributed—apart from the ordinary diseases which exact their toll all the year round—in the first place, to *poisonous plants* which spring up with the young vegetation. Farmers should be on the look-out for this, and keep their animals away from those camps where Giftblaar and other poisonous plants abound. The symptoms which these plant poisons produce are not very characteristic; death generally comes on quickly, and treatment will, as a rule, be too late. The post-mortem is practically negative. Death is usually vaguely ascribed to Gall-sickness. The blood-smears show no changes at all.

*Anthrax* and *Blackquarter* are still very frequent. There is no doubt that the former disease is gradually spreading over South Africa, and that it will continue to do so as long as there are farmers who refuse to co-operate with the Government authorities in their efforts to stamp out the disease. As long as farmers refuse to report all cases of Anthrax immediately and to comply with the regulations of the Veterinary Division, the disease will continue. Inoculation alone will not remove it, valuable though this measure may be in protecting individual animals. Experiments are being carried out in this Division to improve the present method of inoculation.

*Blackquarter* (Quarter Evil, Spontziekte) has been a cause of complaint for some time. It would appear that a particularly virulent form of the disease has been prevalent this year. The strain of Blackquarter bacteria that was used to produce our vaccine does not seem to have been strong enough in all cases to protect animals against the natural infection on the veld. More potent strains are now being collected from various parts of the country, and it is hoped that the vaccine to be issued in future will give general satisfaction. Experiments are also being carried out with a view to substituting a liquid vaccine for the powder now in use. One point in regard to Blackquarter is often lost sight of by farmers, and that is that when the disease breaks out the animals should at all costs be removed from the infected camp, otherwise the inoculation cannot be expected to yield good results.

*Blue-tongue* can be expected at any time now that the rains have set in. The Division has been very busy preparing vaccine, and there are more than a million doses on hand ready for issue.

*Horse-sickness* will also soon make its appearance. Farmers are continually asking us to do the inoculation for them at the laboratory. They are perfectly willing to face the risks attached to the inoculation, and say they would rather have two salted horses than three susceptible ones. It is hoped that it will be possible to do this on a small scale in the near future. The greatest difficulty to be overcome is stable accommodation. A stable is being erected for the purpose, and, when completed, a beginning will be made with the inoculation.

The issue of *Redwater* vaccine has been causing the Division some trouble. There are at present only six heifers providing practically the whole of South Africa with vaccine. An order for ten more imported heifers was placed over fifteen months ago, but so far it has been impossible to procure suitable animals. It is hoped, however, that the difficulty will soon be overcome. Most farmers are aware that the Redwater and Gall-sickness vaccine will not keep for more than a few days. It is absolutely imperative, therefore, to obtain the vaccine in the quickest way possible and to inoculate immediately on arrival. Hence it is very advisable to order the vaccine from the nearest Research Laboratory (Onderstepoort, Pietermaritzburg, or Grahamstown).

*The Wire-worm Remedy* issued by this Division seems to give general satisfaction. Most of the complaints about worms in sheep that reach us now refer to the *nodular worm disease*. A considerable amount of experimental work is being carried out on this parasite at the present time, but no very successful method of treatment has yet been found. In the meantime preventive measures have to be resorted to. An article on this subject by Sir Arnold Theiler will appear in the *Journal* in due course.



## RECENT AGRICULTURAL LITERATURE.

By PAUL RUBINK, Librarian, Department of Agriculture

### I.—UNION GOVERNMENT PUBLICATIONS.

#### A.—DEPARTMENT OF AGRICULTURE.

(Bulletins obtainable from the Department of Agriculture, Pretoria.)

<i>Price per copy.</i>	<i>Number of Publication.</i>
Gratis. The Composition of Natal Wattle Bark (Third Article), by C. O. Williams, B.Sc., A.R.C.S.	Bulletin No. 1/1920.
3d. Prickly Pear as a Fodder for Stock, by Chas. F. Juritz, M.A., D.Sc.	Science Bulletin No. 16/1920.

#### B.—MISCELLANEOUS REPORTS, ETC., OF INTEREST TO FARMERS.

(Obtainable from the Government Printer, Pretoria.)

- 5s. 0d. Official Year Book of the Union of South Africa, No. 3. S.P. 14.  
1919.

### II.—THE AGRICULTURAL PRESS OF SOUTHERN AND TROPICAL AFRICA.

#### SELECTED ARTICLES.

*De Boer* (Byvoegsel tot *De Volkstem*), Pretoria.

- 10/9/20 Hogeveldeklimaat vs. Zeeklimaat, deur Medicus.  
24/9/20 Arugtekwekerij in Suidafrika, lesing deur I. Tribolet. 't Zwarte  
Gevaar: III, deur P. J. Wannenburg.  
1/10/20 Setlaars in Australië, deur F. T. Nicholson.

*Die Boerenvrou* (Posbus 984, Pretoria).

- 9/20 Iets oor Bye en Heuning, deur G. R. von Wielligh. Die Voeding  
van Klein Kinders, deur Dr. A. F. Cleaver. Oor Dahlias.

*Farmers' Advocate, South African* (P.O. Box 247, Bloemfontein).

- 9/20 A Constructive Agriculturist, Mr. F. B. Smith. What the  
Agricultural Department has done. Dry-land Farming in  
Utah, by H. W. Turpin.

*The Farmers' Journal* (Nairobi, B.E.A.).

- 19/8/20 Cattle Dip Control, by A. C. Barnes. Coffee Die-back. Veterinary  
Report for June, 1920. System of Book-keeping for Farmers.  
26/8/20 Pigs and Prices, by Lt.-Col. W. K. Tucker. Flax Culture,  
Retting. Gall-sickness (*Inaplasmosis*). Flax-scutching Revolution-  
ized.  
2/9/20 Flax-growing and its Future. The Progress made by the East  
Africa Flax Association, by A. Vincent. Basket-making.  
9/9/20 Inquiry into the Life-history of the Coconut Beetles, by F. W.  
Dry. The Selection and Use of Agricultural Machinery, by  
Wm. D. MacDonald.  
16/9/20 The Rossi Process of Flax-retting.

*The Farmers' Weekly* (Bloemfontein).

- 8/9/20 Birds and Boys, by F. W. Fitzsimons. Showyards in South  
America, by Dr. E. A. Nobbs.  
15/9/20 The Great Scottish Show.  
22/9/20 Cattle Markets in South America, by Dr. E. A. Nobbs. Sugar  
Production, by Nevison.  
29/9/20 Internal Combustion Engines. Birds and Food, by F. W. Fitz-  
simons.



*The Independent* (Salisbury, Rhodesia).

- 3/9/20 Veld Pastures, by F. Eyles.  
 10/9/20 Wheat: Advice on Culture.  
 24/9/20 Soil Moisture, by F. Eyles.  
 1/10/20 Hints on Brickmaking, by G. T. Dyke.

*Die Landbouwer* (Posbus 1035, Pretoria).

- 15/9/20 Bolsjewisme en die Russiese Boer. Verboue van Tabak. Verboue van Lyusaad. Die Wol Industrie.  
 30/9/20 Grondbemesting, deur Dr. B. de C. Marchand. Gekondenseerde of Blikkies Melk.

*Die Landbou Weekblad* (Posbus 267, Bloemfontein).

- 8/9/20 Sement en Konkreet (*verreolj*). Landbouonderwys in die Skool (*verreolj*). Kaasmaak op die Plaas, deur Ed. O. Challis.  
 15/9/20 Wat is 'n Ko-operatiewe Vereniging? (*verreolj*).  
 22/9/20 Landbouonderwys in die Skool (*verreolj*). Koeiertverbouing, deur G. J. Bosman.  
 29/9/20 Boereorganisasie Kongres, gehou te Bloemfontein, 15 September 1920.

*Mitteilungen der Farmwirtschafts-Gesellschaft für Südwestafrika* (Post-sach 128, Windhuk, S.W.A.).

- 1/9/20 Der Urwald von Omaruru, von W. Volkmann. Schau Omaruru, von Rosenow.  
 15/9/20 Der Regenfall in Gross-Namaland, von Dr. P. Range. Muzbrand Warnung, von A. Goodall. Der Shorthorn, von C. A. Pope. Anaplasmose und Rinderzucht, von Dr. G. Schmid. Statistik, Buchführung und Farmerei, von Ph. Bender.

*The National Bank of South Africa, Ltd., Monthly Trade Report.*

- 30/9/20 South African Business and Prospects. Crops and Live Stock. South African Products.

*South African Dairyman* (P.O. Box 925, Durban).

- 10/20 Export of Butter and Cheese. The Work of Cow-testing Associations, by F. Joubert.

*South African Farm News* (P.O. Box 4860, Johannesburg).

- 9/20 Lessons of the Johannesburg Fat Stock Show.—Lessen van de Johannesburg Vet Vee Tentoonstelling. Experts: Their Use and Abuse.

*South African Fruit Grower and Smallholder* (P.O. Box 3958, Johannesburg).

- 9/20 Citrus Growing in California, by Sir P. Fitzpatrick. Agriculture in the ex-German Colonies, by F. H. Cooper. The Slug Caterpillar of Deciduous Fruit Trees.

*South African Gardening and Country Life* (P.O. Box 3958, Johannesburg).

- 9/20 Hedges as they should be Grown. Carnation Growing in South Africa, by A. G. Murray. Dahlias for Garden or Exhibition, by W. Skevington.

*South African Journal of Industries* (Government Printer, Pretoria).

- 9/20 Cultivated Timber Trees: I, by T. R. Sim. The Water-power of the Union of South Africa: II, by F. E. Kanthack, C.M.G. The Prickly Pear: II, by Dr. Chas. Juritz. Pottery in the Pretoria District. Destruction of Rodents: I, by W. F. Schlupp. Advertising South Africa.

*South African Poultry Magazine* (Bloemfontein).

- 9/20 Production and Handling of Eggs, by Utility. The Carnivorous Animals of South Africa, by F. W. Fitzsimons. Feeding of Poultry, by J. J. Jordaan.

*South African Poultry Review and Small Holder* (Johannesburg).

- 10/20 Wyandottes, by H. Moore. How Egg-laying Tests Benefit the Poultry Industry, by Wm. A. Bartlet. The National Utility Poultry Society of South Africa.

*South African Sugar Journal* (P.O. Box 925, Durban).

9/20 The Native Labour Shortage, by Mquieza. Premature Arrowing of Sugar-cane.

*The Sun and Agricultural Journal of South Africa* (P.O. Box 634, Johannesburg).

9/20 Transvaal to Tangier: IV. The Peanut. South African Grain Trade Association.

*Sunday Times* (Farmers' Supplement), Johannesburg.

12/9/20 Cultivation of Rhubarb, by H. B. Terry.

19/9/20 Judging Maize, by Boerseum.

26/9/20 Some South African Parasites, by R. Bigalke (*continued*). Sterility, by A. Hodder, M.R.C.V.S.

3/10/20 Some South African Parasites (*continued*). Houses Everlasting in Pisé, etc. Refrigeration on the Farm, by G. S. Cooper. Sterility (*continued*).

### III.—SELECTED LIST OF BOOKS ADDED TO LIBRARY.

[NOTE.—The first number is that of the class to which the book belongs, the last number is that of the book itself.]

*Class No.*

#### GENERAL.

- 017 Carnegie Institution. "Classified List of Publications of the Carnegie Institution, Washington, 1919." No. 7067.
- 017 Lloyd, A. C. G. "Cape Peninsula List of Serials," Capetown, 1917. No. 7070.
- 017 South African Railways and Harbours. "Catalogue of Books in the Official Libraries at Johannesburg and Capetown," Johannesburg, 1920. No. 7077.
- 050 Cory, G. E. "The Rise of South Africa," Vol. III, London, 1919. No. 7164.
- 110 Tauchnitz New Pocket Dictionaries: "Dictionary of Italian and English Languages," Leipzig, 1920. No. 7088.
- 110 Wesley, J. E., and Stevens, Hills "Italian-English Dictionary," London, 1914. No. 7086.
- 230 Hugo, I. J. "Karakter Tiepes van Kinders en Hulle Behandeling," Den Haag, 1918. No. 7076.
- 240 The Carnegie Institution, Washington. "Organization, Plan, and Scope, with Articles of Incorporation and By-laws," Washington, 1902. No. 7075.
- 240 Petavel, J. W. "The Problem of Healthy Towns and Healthy Industrial System," Calcutta, 1920. No. 7140.
- 290 Ministry of Munitions Raw Materials. Trading Accounts, with Reports thereon to 31st March, 1919, of Raw Materials administered during the War by the Surveyor-General of Supply at the War Office, and subsequently transferred to the Ministry of Munitions, London. No. 7105.
- 320 King, W. H. "Handbook of Hydraulics," New York. No. 7099.
- 350 Macara, Bart., Sir Charles. "The International Idea in Industry," Manchester, 1920. No. 7129.
- 361 Davidis, H. "Practical Cook Book," Milwaukee, Wisconsin, 1904. No. 7083.
- 380 "Derde Nederlandsche Jaarbeurs te Utrecht, Herinnerings Album, 1919," Den Haag, 1919. No. 7135.
- 380 "Tweede Nederlandsche Jaarbeurs, 1918, Herinnerings Album," Den Haag, 1918. No. 7136.
- 380 Graadt van Roggen. "De Eerste Nederlandsche Jaarbeurs (Het Bezoek)," Utrecht, 1917. No. 7137.
- 380 Graadt van Roggen. "De Eerste Nederlandsche Jaarbeurs (Algemene Indrukken)," Utrecht, 1917. No. 7138.
- 380 "Holland's Annual Industries Fair, Utrecht," Boekhoven Press, Utrecht, 1919. No. 7139.

## AGRICULTURE, LIVE STOCK, AND ALLIED SUBJECTS.

*Class No.*

- 400 International Harvester Co. "Miscellaneous Papers on Agriculture," Vol. I-V, Chicago, N.D. No. 7156.
- 400 Wickson, E. J. "Second Thousand Answered Questions in Californian Agriculture," San Francisco, 1916. No. 7062.
- 400 Various Authors. "Farm Economy and Supplement," Toronto, N.D. No. 7096.
- 411 Richardson, A. E. V. "Agricultural Education and Agricultural Development in America," Melbourne, 1918. No. 7066.
- 420 Donaldson, H. "The Rat," Philadelphia, 1915. No. 7079.
- 430 Vaughan, H. W. "Types and Market Classes of Live Stock," 430.7 "Poultry, Pigeons, Ostriches, etc.," Columbus, Ohio, 1919. No. 7095.
- 430.7 Lippincott, W. A. "Poultry Production," Philadelphia, 1916. No. 7081
- 430.7 Menegaux, H. "L'Elevage de L'Austruche," Paris, 1913. No. 7121.
- 431 Ernst, W. Mohler, and Others. "Text-book of Milk Hygiene," London, 1914. No. 7117.
- 432.1 Dadant, C. P. "First Lessons in Bee-keeping," Hamilton, Illinois, 1919. No. 7103.
- 432.1 Miller, Dr. C. A. "Thousand Answers to Bee-keeping Questions," Illinois, 1919. No. 7085.
- 450.8 Collins, Hoare. "Chemical Fertilizers and Parasiticides," London, 1920. No. 7087.
- 450.8 "The Chilean Nitrate of Soda Propaganda," Maitland Street, Bloemfontein. "What Nitrate of Soda is," 1920. No. 7072.
- 462 Maiden, J. H. "A Manual of the Grasses of New South Wales," Sydney, 1898. No. 7131.
- 465 Beaumont Roberts. "Union Textile Fabrication," London. N.D. No. 7125.
- 465 Mitchell and Prideaux. "Fibres used in Textile and Allied Industries," London, 1910. No. 7124.
- 465 Wilson, W. B. "Cotton Growing in South Africa," Durban, 1918. No. 7134.
- 466 Japan, Department of Agriculture. "The Statistical Tables of Formosan Sugar Industry," Tokio, N.D. No. 7078.
- 466 The Chilean Nitrate of Soda Propaganda. "The Cultivation of Uba Sugar-cane in South Africa," Bloemfontein. N.D. No. 7071.
- 467 The Chilean Nitrate of Soda Propaganda. "Die Bo-bemesting van Graansoorte, Kaapstad." No. 7074.
- 471 Boyle, J. G. "Vegetable Growing," Philadelphia. No. 7082.
- 472 Hedrick, U. P., and Others. "The Cherries of New York," Albany, 1915. No. 7106. "The Peaches of New York," Albany, 1915. No. 7108.
- 472 Hedrick, U. P., and Others. "The Plums of New York," Albany, 1911. No. 7109.
- 473 Hedrick, U. P., and Others. "The Grapes of New York," Albany, 1908. No. 7107.
- 474 Wickson, E. J. "Californian Garden Flowers," San Francisco, 1915. No. 7061.
- 477 Howard, A. "A Manual of the Timbers of the World," London, 1920. No. 9093.
- 480 Blackburn, Samuel. "Problems in Farm Woodwork," Peoria, Illinois. N.D. No. 7069.
- 480 Roehl, L. M. "Agricultural Woodworking," Milwaukee, Wisconsin, 1916. No. 7080.
- 483 Etchevery, B. A. "Irrigation Practice and Engineering," Vols. I, II, III, New York, 1915. No. 7060.
- 483 Schwartz. "The Kalahari," Capetown. No. 7126.

## SCIENCE GENERAL, PHYSICS, CHEMISTRY, GEOLOGY, ETC.

- 541 Millikan, A. R. "The Electron," Chicago, 1917. No. 7097.
- 544 Gardner, A. A. "Paint Technology and Tests," New York. No. 7101.
- 544 Hinchley, J. W. "Chemical Engineering," London, 1914. No. 7159.
- 544 Vosmaer, H. "Praktisch Werktuigkundig Hulpboek," Rotterdam, 1913. No. 7127.

*Class No.*

- 524.1 Andes, L. E. "Oil Colours and Printing Inks," London, 1903. No. 7091.  
 544 Furnell, John. "Students' Handbook of Paints, Colours, Oils, and Varnishes," London, 1903. No. 7122.  
 544.1 Martin, G. "Animal and Vegetable Oils, Fats, and Waxes," London, 1920. No. 7098.  
 545 Wiley, H. "Beverages and their Adulterations," London, 1919. No. 7089.  
 550 Chamberlin, C. T. "The Origin of the Earth," Chicago, 1916. No. 7100.  
 550 Johnston, J. P. "The Mineral Industry of Rhodesia," London, 1911. No. 7120.  
 514 Finch, J. H. "Topographical Maps and Sketch Mapping," New York, 1920. No. 7092.  
 514 MacCullough, Ernest. "Practical Surveying," New York, 1919. No. 7115.  
 514 Williamson, James. "Surveying and Field Work," London, 1915. No. 7116.  
 520 Jaeger, F. M. "Lectures on the Principles of Symmetry," Amsterdam, 1917. No. 7128.  
 540 Dreaper, W. P. "Notes on Chemical Research," 2nd Edition, London, 1920. No. 7160.

## BIOLOGY, ZOOLOGY, BOTANY, MEDICINE, ETC.

- 620.7 Wilks, Rev. W. "Report on Genetics," London, 1907. No. 7065.  
 630 Reese, A. M. "Outlines of Economic Zoology," Philadelphia, 1919. No. 7094.  
 630.1 Carrington, H. "Vitality, Fasting, and Nutrition," London, 1908. No. 7123.  
 630.1 Sherrington, C. S. "Mammalian Physiology: A Course of Practical Exercises," Oxford, 1919. No. 7146.  
 630 Howes, G. B. "Atlas of Practical Elementary Zoology," London, 1902. No. 7084.  
 630.6 Balfour, Andrew. "War against Tropical Disease," London, 1920. No. 7167.  
 630.6995 Bandelier, Dr., and Roepke, Dr. "Tuberculin in Diagnosis and Treatment," London, 1913. No. 7118.  
 630.6995 Riviere, Clive, and Morland. "Tuberculin Treatment," London, 1913. No. 7119.  
 631 Dobell, Clifford. "The Amoebae Living in Man," London, 1919. No. 7104.  
 640 Junod, H. A. "The Life of a South African Tribe," I and II, Neuchatel (Switzerland), 1912 and 1913. No. 7145.  
 650 Adami, J. G. "Medical Contributions to the Study of Evolution," London, 1918. No. 7132.  
 650 Van Noorden. "Metabolism and Practical Medicine," Vols. I, II, III, London, 1907. No. 7102.  
 651 American Medical Association. "Useful Drugs," Chicago, 1920. No. 7064.  
 651 Hatcher, R, and Wilbert, M. "The Pharmacology of Useful Drugs," Chicago, 1915. No. 7068.  
 651 MacGuigan, Hugh. "Experimental Pharmacology," Philadelphia, 1919. No. 7063.  
 651.3 Sayre, L. A. "Manual of Organic Materia Medica and Pharmacognosy," Philadelphia, 1917. No. 7147.  
 651.9 Vaughan, V. C. "Poisonous Proteins," London, 1917. No. 7161.  
 671 Drude, Dr. Oscar von. "Die Ökologie der Pflanzen. Braunschweig 1913." No. 7143.  
 671.6 Cockayne, L. "New Zealand Plants and their Story," N.Z. 1919. No. 7144.  
 674 Smith, B. A. "Poisonous Plants of all Countries," London, 1904. No. 7058.

## AT THE SCHOOLS OF AGRICULTURE AND EXPERIMENT STATIONS.

September, 1920.

CEDARA, NATAL.

*Climatic.*—The rainfall for the period 27th August to 26th September, inclusive, was .63 inches. The mean maximum shade temperature was 72.61° F., and the mean minimum 48.41° F. The highest maximum shade temperature 87.5° F. was registered on 26th August, and the lowest minimum 39.6° F., on 5th September. The weather has been fine during the greater part of the month. Northerly winds prevailed, with occasional south-east winds. Light rain fell on a few days.

*Crops.*—The oats are making fair growth; they are slightly affected by rust, and are retarded by the prolonged drought. For the latter reason the vetches are also backward. Paspalum and sheep's burnet are showing up well. The veld grasses are showing green over the burnt-off areas, but badly need rain.

*Field Experiments.*—The cocksfoot grass proved frost resistant during the winter, but is now showing the effects of the drought. *Rottbaelia compressa* is maintaining steady growth and resisting the drought very well. Sheep's burnet has proved frost and drought resistant. A course of co-operative experiments carried out over a period of five years has proved the value of cowpeas in a crop rotation. A series of experiments carried out to demonstrate the value of soluble phosphates with and without lime, has provided very useful data, of which details will be published later.

*Stock.*—Four calves were born during the month, one Ayrshire heifer from dam 19 years old, two Friesland heifers (twins from F. 13), and one Friesland bull calf. One case of gallsickness was treated successfully. Grazing is at present very poor; rain is badly needed. A young Friesland bull, "Dunovan John Bull," a grand-son of "Admiral Beatty," was purchased for this institution at the Bloemfontein Stud Stock Sales, and it is hoped will prove a valuable addition to the Friesland herd.

*Chemical Laboratory.*—The leaves and twigs of three species of bamboo were analysed at the instance of a farmer who found that they were eaten with great avidity by stock during the winter when little green food is available. The results of the analysis show that the twigs have no great feeding value, but the leaves show up very favourably in this respect. The number of food units present in the leaves and twigs combined is almost identical with the amount found in the same weight of dry matter in ordinary veld grasses growing on this farm. A wild chicory root examined was found to contain an abnormally high percentage of sugars, there being nearly 40 per cent. of sucrose in the dry matter and about 50 per cent. of total sugars.

*Apiculture.*—European foulbrood and sacbrood have recently reappeared in some of the weaker colonies. Dequeening a diseased colony for ten days, and then requeening with a vigorous young Italian queen is the remedy for European foulbrood now recommended by the American authorities. Italian queens, however, are not obtainable in South Africa. Hence, queen rearing from the best stocks in the apiary is being carried out, and the diseased hives will be requeened with young queens of the yellow-banded African race of bees. It will be interesting to note whether dequeening and requeening after an interval will effect a cure under these conditions.

*Students.*—There were fifty-seven probationers in residence at Cedara at the beginning of the month. Three were transferred from Winkle Spruit to Cedara. Nine have left, seven of whom secured positions on farms, one was allotted a Government holding, and one was discharged. Fifty-one probationers are in residence at present at Cedara and two at Winkle Spruit.

---

 ELSENBURG, MULDER'S VLEI, CAPE.
 

---

*Climatic.*—The rainfall during the month was exceptionally heavy, 5.34 inches being recorded, as against the normal average of 2.68 inches. Most of this rain fell between the 11th and 17th instant. The maximum temperature was 82° F. on the 22nd instant, and the minimum 43.5° F. on the 4th.

*Field Operations, Crops, etc.*—A further quantity of rape seed was sown for summer grazing, the total area under this crop at present being 80 acres. The main "braaking" operations are now completed, an area of 250 acres at Elsenburg and Mariendahl being ready for next season's cereal crops. The cereal crops are looking very well on both the farm lands and the experimental section, the "variety" plots making a particularly fine show. Approximately 7000 vines were planted at Mariendahl during the month. A number of apple trees of several varieties were planted in the orchard at Elsenburg, also a number of olives, and in the nursery a quantity of prune seed and olive cuttings.

*Live Stock.*—A further improvement in condition of all live stock is noticeable. All the cattle to be offered at the annual sale were submitted to the tuberculin test with negative results.

A great increase in egg production is observed in the poultry section since the installation of the intensive house. The average production is now 100 eggs per diem, and the fertility of the eggs of birds mated intensively appears to be excellent.

*Staff.*—Mr. E. Baker, Lecturer in Botany, resumed duty at Elsenburg during the month after six months' leave of absence.

It is with deepest regret that the death on the 24th instant of Mr. W. O. John, Lecturer in Poultry, is reported. The institution and the poultry industry in particular suffer a severe loss in his untimely decease.

---

 GLEN, ORANGE FREE STATE.
 

---

*Climatic.* The weather was comparatively warm and dry, and high winds have been prevalent. On the 4th and 5th .74 inch of rain was registered. Frosts occurred on the nights of the 3rd, 14th, 24th and 25th.

*School.*—The total number of students in residence during the month was 64, consisting of 14 seniors, 38 juniors, and 12 one-year students.

On the 18th, 26 students of the Normal College, Bloemfontein, visited the institution, and were given lectures and demonstrations in horticulture and animal husbandry.

*Farm.*—Some of the winter cereals are coming into ear already, and if any late frosts should occur considerable damage will ensue.

The fields intended for summer crops are being harrowed and put into a good tilth so that when the spring rains arrive the seed beds would require very little extra preparation. Some lucerne fields as well as some of the oat crops were irrigated during the last week, and ought now to survive without further application.

*Live Stock.*—The annual sale of pure-bred stock was held on the 14th instant when the whole of the Lincoln Red herd was disposed of, in addition to the following animals:—2 Percheron stallions, 3 Friesland cattle, 5 South Devon bulls, 3 Berkshire pigs, 12 Large Black pigs, 13 Wanganella sheep, 6 Tasmanian sheep.

The stock offered for sale were in good condition, and the prices as a whole were fairly satisfactory, and the amount of £3174. 10s. was realized. The demand for pigs was keen, and the prices obtained were good.

The following stud bulls were added to the herds during the month:—1 South Devon bull, "George III."; 1 Friesland bull, "Sheltered Vale Karel."

*Educational Tours of Students.*—On 1st and 2nd September the senior students attended the Beef Breed Stud Sales, and on the 15th the Friesland Stud Sales. On the 25th the senior students, accompanied Mr. Dormehl, Conservator of Forests, to the Arboretum and certain plantations in Bloemfontein.

*Experiments.*—The winter experiments with wheat, oats, and barley promise well. The ground is being prepared for extensive summer crop experiments. Variety tests with maize, beans, cowpeas, and other summer crops will be conducted.

*Horticulture.*—The officer in charge of this section reports that the late frosts during the month, unfortunately, killed the whole of a fine crop of plums.

Various kinds of vegetable seed have been sown during the month.

---

#### GROOTFONTEIN, MIDDELBURG, CAPE.

---

*Climatic.*—The maximum shade temperature was 88° F., with a mean maximum of 71.2° F. The absolute minimum temperature was 26.5° F., with a mean minimum of 38.5° F. Rain fell on two days with a total of 1.70 inches for the month.

*Sheep Section.*—175 Black Head Persians were purchased during the month as an addition to our slaughter flock from which the hostel is supplied with meat.

Mr. G. J. Schuurman examined the stud sheep at this institution, and passed one Wanganella ram and fifteen ewes and two Tasmanian ewes for the South African Merino Stud Book. He also examined the special sheep and wool students in their final sheep judging examination, and passed twelve out of the fourteen entered.

At the annual stock sale on 25th August sheep realized excellent prices, the top price being £105 for a Wanganella ram.

Shearing operations started on the 15th September, students only being employed on this work.

*Horticultural Section.*—Severe frosts on the 4th and 5th inst. killed the blossoms on the early flowering varieties of fruit trees, demonstrating that the planting of early flowering varieties is a somewhat risky procedure in this area.

The rainfall of 1.45 inches on the 5th September has to a great extent spoil the irrigation experiments mentioned in last month's notes. The late flowering trees promise a very fair crop of fruit.

*Farm Section.*—Owing to the good rains a very large amount of work has been pushed forward. All land for summer crops, including mangolds, is being prepared. Lucerne crops were irrigated, and the cereal crops are promising exceptionally well. Stocks are also improving in condition.

*Chemical Section.*—Investigational work was carried out in connection with the suitability of certain calcareous soils for use in making dam walls. Mr. Stead, the Research Chemist, has been appointed to serve on the Drought Commission.

*Coastal Co-operative Experiments.*—The manurial and variety experiments with cereals in the Uniondale and Humansdorp districts are very promising, the growth being exceptionally good in the first-mentioned district. Lucerne and numerous other varieties of seed were sown at Hankey and in the Sundays River Valley last month. The germination of seed sown on experimental plots at Hankey (Gamtoos River Valley) was good, and growth strong, whereas the germination in the Sundays River Valley was very disappointing.

In all there are 268 experimental plots covering 40 acres at seven different farms.

---

#### POTCHEFSTROOM, TRANSVAAL.

---

*Climatic.*—The evaporation for the month of September was very heavy. The weather was overcast on several occasions, followed by desiccating winds. No rain of any value fell until the night of the 27th, when .53 inch was registered. The minimum daily temperature varied from 50.0° to 30.0°. The absolute maximum shade temperature for the month was 87.5°, which was reached on the 12th and 25th.

*Farm Section.*—Sixty acres of oats and wheat were irrigated during the month. Winter cereal crops are very backward on account of the extreme shortage of irrigation water. Fifty-four acres of lucerne lands have been fertilized with superphosphate at the rate of 300 lb. to the acre. The shortage of bedding has necessitated the cutting of further quantities of field grass for this purpose. The mangold crop has been of great assistance in keeping stock in good condition. Single roots of the Mammoth Long Red variety scaled 23 lb., and the average of a number of weighings of the larger roots amounted to 17 lb.

*Live Stock.*—The annual sale of live stock realized £3614. 15s. 9d. The following are the average prices obtained for stock: Horse stallions, £63; Sussex bulls, £162. 11s. 10d.; Friesland bulls, £108. 16s. 1d.; Hereford bulls, £68. 15s. 6d.; Africander bulls, £93. 6s.; Ayrshire bulls, £32. 6s. 9d.; Wanganella rams, stud, £70. 5s. 6d.; Wanganella rams, flock, £10. 14s. 1d.; Romney Marsh rams, £18. 4s.; pigs, Berkshires, £7. 4s.; pigs, Large Blacks, £9. 12s.

The prices realized on the whole are considered satisfactory, except in the case of Wanganella selected flock and flock rams. On account of the large number offered for sale and the few buyers, some of these rams did not realize their full value.

Spring calving has commenced in the breeding herds. Fourteen calves were born during the month, one of which died from pneumonia. On account of the drought cows have not much milk, and are being fed heavily. Sheep are in excellent condition. They have run on lucerne and oats throughout the month. One hundred and forty cross-bred Suffolk Persian lambs were born during August and September, and are all doing well.

*Experimental Section.*—A large amount of maize, cowpea, and peanut seed was distributed to farmers. The demand for seed maize and peanuts was seven times greater than the available supply, and for cowpea seed twenty times. The main object of this distribution is to supply the farmer with sufficient approved varieties of cereals to enable him to produce for his own requirements, and requests for seed for the main crop cannot be entertained.

A certain amount of seed of promising varieties of crops such as soya beans, cowpeas, and millets were distributed free to farmers for the purpose of co-operative trials.

The maize ears submitted by the lads who took part in the maize competition were entered in the juvenile section at the Witwatersrand Maize and Fat Stock Show. A report on the past year's competition is now being prepared.

Varieties of potatoes, salt bushes, artichokes, and spineless cactus were planted, and the wheat varieties were strangled and cleaned and the breeding rows in the cage attended to.

*Horticultural Section.*—Light frosts were experienced during the 15th and 17th, and have, it is thought, done some damage to the fruit crop. Strong winds were prevalent during the month, and made spraying a difficult matter. Early blossoming pears were sprayed for codling moth. Thirteen rows of diseased trees were grubbed out; the land under them will be dynamited and prepared for replanting next year.

The apiary has been put in order for the coming season; stocks are good, and the colonies seem prosperous.

*Poultry Section.*—The breeding season has now closed, and the breeding pens are being broken up. The aim now is to stop laying and force an early moult in 1921. The young stock are continuing to grow satisfactorily. The demand for settings of eggs has been heavy. The birds in the egg-laying competition have done very well. The quantity of eggs obtained during the sixth period of the competition, 10th August to 15th September, exceeds that of the previous period by 300.

*In the Engineering Section* the suction gas engine was fitted with brake gear, and a test was run to determine the consumption of charcoal per brake horse-power hour. The gas was also analysed, but showed too much oxygen due to leakage of air into the producer.

*School.*—Four students for next year's Diploma Course were admitted for practical work only until the end of the current session. Five one-year students in the Soldier Probationers' Course left the institution to start farming operations of their own or with other farmers.



## STAFF : APPOINTMENTS, TRANSFERS, ETC.

### (1) AGRICULTURE.

- 1/9/20 *F. J. v. d. Kaay*: Transferred from the Department of Justice to this Department as Senior Clerk in the Sheep Division.
- 15/9/20 *P. J. du Toit*: Appointed Acting Director of Veterinary Education and Research during absence on leave and duty of Sir Arnold Theiler.
- 21/9/20 *G. W. Klerck*: Appointed Editor, *Journal of the Department of Agriculture*, as from 1st April, 1920.

### (2) AGRICULTURAL EDUCATION.

- 27/8/20 *Dawson, C. A.*: Appointed Lecturer in Field Husbandry and Experimentalist, Potchefstroom.
- 20/10/20 *Wolfe, H.*, Technical Assistant, Pretoria: Resigned to take up post of Assistant Director of Agriculture, Tanganyika Territory.
- 4/9/20 *Fuiter, Mrs. E.*: Appointed Matron of the School of Agriculture, Grootfontein.

## MOVEMENTS OF OFFICERS

*Mr. P. J. du Toit*, Under-Secretary for Agriculture, who has been on the Public Service Commission of Inquiry for 2½ years, returned to the Department on the 14th October.

*Mr. A. G. Michaelian*, Principal Sheep and Wool Expert, returned to duty in the Sheep Division on the 11th October after an absence of eight months spent principally in Australia in connection with the sheep and wool industry.

*Government Veterinary Surgeon J. Chalmers*, who, until recently, has been in charge of the meat inspection at Durban, left on the 15th October for the Argentine, where he has been sent by the Government to inquire into the system of meat inspection in that country.

*Domestic Science*.—*Miss M. van Dugu* will be stationed in Pretoria, and *Miss R. Oosthuisen* at the School of Agriculture, Glen, Orange Free State.

*The Botanist* at the Elsenburg School of Agriculture, *Mr. E. Baker*, returned to duty on the 22nd September after a holiday of six months in England.

*Drought Commission*.—*Mr. Arthur Stead*, Research Chemist at the Grootfontein School of Agriculture, has been appointed to this Commission. The Commission proposes to hold the following meetings in the Orange Free State during November: Bloemfontein (preliminary meeting of Commission), 12/11/20; Bloemfontein meeting, 15/11/20; Brandfort, 17/11/20; Edenburg, 18/11/20; Hoopstad, 20/11/20; Boshoff, 22/11/20; Jacobsdal, 24/11/20; Koffiefontein, 25/11/20; Fauresmith, 26/11/20; Jagersfontein, 26/11/20; Luckhoff, 29/11/20.

## MEAT STATISTICS.

### I.—RETURN OF BEEF INSPECTED AND PASSED FOR EXPORT, SEPTEMBER, 1920.

Place.	Cattle.			Carcasses.		
	Inspected.	Rejected.	Passed.	Inspected.	Rejected.	Passed.
Durban ... ..	397	—	397	397	10½	386¾
Pietermaritzburg ...	170	—	170	170	—	170
Pretoria ... ..	—	—	—	—	—	—
Johannesburg ... ..	54	—	54	54	—	54
Bloemfontein ... ..	360	—	360	360	7¼	352¼
Capetown ... ..	—	—	—	—	—	—
Port Elizabeth ... ..	—	—	—	—	—	—
Germiston ... ..	—	—	—	—	—	—
<b>TOTAL</b> ... ..	<b>981</b>	<b>—</b>	<b>981</b>	<b>981</b>	<b>18</b>	<b>963</b>

Beef actually exported during the month of September, 1920 : Total, 13,723 quarters (e.e. Durban, 13,323 quarters ; e.e. Capetown, 400 quarters).

Total shipments of Beef in quarters—

1916 ...	115,992	1918 ...	123,354	*1920 ...	55,867
1917 ...	309,214	1919 ...	285,367		

II.—OTHER MEAT EXPORTED\* : Pork, carcasses inspected and passed, 5812.

### III.—RETURN OF CATTLE IMPORTED INTO THE UNION FROM ADJOINING TERRITORIES.

Territory.	Imported September, 1920.		Total from 1st January, 1920, to 30th September, 1920.
	No.	No.	No.
For Slaughter—			
Rhodesia ... ..	912		20,933
Bechuanaland Protectorate	1,243		14,967
S.W. Africa	1,480		10,468
Swaziland ... ..	56		1,215
Basutoland ... ..	—		8
For Breeding—			
Rhodesia ... ..	—		8,568
Bechuanaland Protectorate	892		14,490
<b>TOTAL</b> ... ..	<b>4,583</b>		<b>70,649</b>

### SUMMARY OF IMPORTS.

Calendar Year.	For Slaughter.		For Breeding.	Total.
	No.	No.	No.	No.
†1916	26,580	—	—	26,580
1917	47,970	5,440	—	53,410
1918	36,767	13,286	—	50,053
1919	40,574	16,693	—	57,267

\* Total from 1st January to 30th September, 1920.

† 1st July to 31st December only.

## CROP AND LIVE STOCK REPORT.

September, 1920.

## CONDITION OF LIVE STOCK.

Compiled from Reports furnished by Sheep and Stock Inspectors.

Area.	Large Stock.	Small Stock.
CAPE—		
South-West ... ..	<i>Good to medium</i> ... ..	<i>Good to medium.</i>
North-West ... ..	<i>Good to medium.</i> Fat in parts	<i>Good to medium.</i> Fat in parts.
South Coast ... ..	<i>Good to medium.</i> Fat in parts	<i>Good to medium.</i> Fat in parts.
Southern Karroo ... ..	<i>Good.</i> Fat in parts ... ..	<i>Good.</i> Fat in parts.
Central Karroo... ..	<i>Good to medium</i> ... ..	<i>Good to medium.</i>
Northern Karroo ... ..	<i>Good to medium</i> ... ..	<i>Good to medium.</i>
Eastern Karroo ... ..	<i>Medium</i> ... ..	<i>Medium.</i>
Bechuanaland ... ..	<i>Good to medium.</i> Fat in parts	<i>Good to medium.</i> Fat in parts.
Griqualand West ... ..	<i>Good</i> ... ..	<i>Good.</i>
North-Eastern ... ..	<i>Medium</i> ... ..	<i>Medium.</i>
Border ... ..	<i>Medium</i> ... ..	<i>Medium.</i>
Transkeian Territories...	<i>Medium.</i> Poor in parts ... ..	<i>Medium.</i> Poor in parts.
TRANSVAAL—		
Eastern High Veld ... ..	<i>Medium to poor</i> ... ..	<i>Medium to poor.</i>
Central ... ..	<i>Medium to poor</i> ... ..	<i>Medium to poor.</i>
Western High Veld ... ..	<i>Medium.</i> Good in parts ... ..	<i>Medium.</i> Good in parts.
Low Veld ... ..	<i>Good to medium</i> ... ..	<i>Good to medium.</i>
ORANGE FREE STATE		
North-Eastern ... ..	<i>Medium.</i> Good in parts ... ..	<i>Medium.</i> Good in parts.
North-Western... ..	<i>Good</i> ... ..	<i>Good.</i>
South-Eastern ... ..	<i>Medium</i> ... ..	<i>Medium.</i>
South-Western... ..	<i>Medium.</i> Good in parts ... ..	<i>Medium.</i> Good in parts.
NATAL—		
High Veld or Highlands	<i>Medium</i> ... ..	<i>Medium.</i>
Middle Veld or Midlands	<i>Medium.</i> Good in parts ... ..	<i>Medium.</i> Good in parts.
Coast ... ..	<i>Good to medium</i> ... ..	<i>Good to medium.</i>

## WHEAT, OATS, AND BARLEY.

Correspondents estimated the condition of the crop as appearing on the 30th September, 1920, and from reports received it is estimated that the prospects of the Union's wheat crop are very much the same as appeared at the end of the previous month. The crop in the principal producing area of the country, the south-west districts of the Cape Province, is fortunately progressing very favourably, but this is counterbalanced by bad reports from other parts of the Union where, it will be observed from the statement published hereunder, the crop is suffering from the effects of drought principally and is below normal in condition, so that taking the Union as a whole the wheat crop is estimated to yield 5 per cent. less than what was originally anticipated.

Oats and barley generally are not up to normal and reference to the statement will show the extent to which these crops have been affected, mainly due to prevalence of dry conditions as at the date of reporting. For all cereals the Orange Free State shows the poorest returns and at present indications point to a shortfall on the original estimate of one quarter in the case of wheat and over one third in respect of oats and barley.





## THE LOCAL MARKET.

September, 1920.

(NOTE.—The local market prices of certain other agricultural produce and of stock are given on page 793.)

### WOOL.

The market continues quiet and very little business is being done. Only a few buyers are operating at present and in some cases the orders on hand have been cancelled. This may probably be due to the unsettled conditions in England and the threatened coal strike which would cause stagnation in all industries. Unless a satisfactory settlement is arrived at soon it is feared that very few orders will be forthcoming. The latest advices received from London report little competition amongst buyers and a further decline in prices.

The following nominal prices are quoted at the various ports :—

#### GREASE WOOL.

	Pence per lb.		Pence per lb.
Choice superfine Kaffrarian sound combing, well skirted, of good regular length ... ..	23 to 25	Average shorts ... ..	8 to 12
Extra super combing, deep stapled, sound, and well skirted ... ..	18 „ 21	Inferior shorts ... ..	6 „ 8
Super combing, skirted ... ..	15 „ 20	Native medium ... ..	10 „ 11
Average combing ... ..	11 „ 17	Native inferior ... ..	8 „ 10
Super medium, skirted ... ..	14 „ 16	Bellies and good pieces, combing ... ..	10 „ 11
Average medium, skirted ... ..	12 „ 14	Bellies, etc., mixed ... ..	9 „ 10
Inferior medium, skirted ... ..	10 „ 12	Locks and second pieces ... ..	6 „ 7
Superfine shorts, skirted ... ..	10 „ 15	Average white coarse ... ..	6 „ 7
		Average coarse and coloured ... ..	6 „ 7
		Cross-bred supers ... ..	8 „ 10
		Cross-bred average ... ..	4 „ 6

#### SNOW WHITES.

Extra super snow whites, good bulk, free ... ..	42 to 50	Ordinary, shorter and faulty ... ..	27 to 30
Super snow whites, fair bulk, free	33 „ 39	Inferior ... ..	16 „ 18

#### MOHAIR.

The market remains inactive and only a few bales of good summer firsts have changed hands at prices from 18d. to 23d. per lb. There have been no sales or inquiries for other classes of mohair.

#### HIDES AND SKINS.

There has been a good demand for hides and skins and large quantities have been offered for sale at the various markets at the coast. The following prices are quoted :—

#### SHEEP SKINS.

Sound long woolled sheep skins per lb. ... ..	10½d. to 11¼d.	Hair Capes, salted, each ... ..	7s. 3d. to 8s.
Damaged long woolled sheep skins, per lb. ... ..	7d. „ 7¾d.	Hair Capes, sundried, each ... ..	5s. 6d. „ 6s. 3d.
Pelts, sound, per lb. ... ..	6¾d. „ 8d.	Coarse and coloured skins, per lb. ... ..	9½d. „ 10d.
Pelts, damaged, per lb. ... ..	2½d. „ 3d.	Coarse and coloured skins, damaged, per lb. ... ..	4d. „ 4½d.

## GOAT SKINS.

Angoras, light, per lb. ... 9d. to 9½d.	Goatskins, sundried, per lb. ... 18d. to 19½d.
Angoras, heavy and sundried per lb. ... .. 7d. „ 7½d.	Goatskins, heavy, per lb. ... 17d. „ 18d.
Angoras, damaged ... .. 2d. „ 3d.	Goatskins, damaged, per lb. ... 9½d. „ 11d.
Goatskins, light, per lb. ... 21d. „ 22½d.	Bastards, sound ... .. 16d. „ 17d.
	Bastards, damaged ... .. 8d. „ 9½d.

## HIDES.

Sundried, sound, per lb. ... 12½d. to 13¾d.	Dry salted, sound, per lb. ... 13d. to 13½d.
Sundried, damaged, per lb. ... 11d. „ 11½d.	Dry salted, damaged, per lb. 9d. „ 10d.

## OSTRICH FEATHERS.

Since the last report there have been five public sales of ostrich feathers in Port Elizabeth, the prices and weights being as follows:—Total weight sold 16,128 lb., value £23,306. Withdrawn or “not sold” 4143 lb., value £3142. During these sales, especially the latter three, genuine shippers took a far larger proportion of the goods offered and thus the totals given represent more accurately the weight and value of goods actually handled than has been the case for some time previously. This is much to the benefit of the market since, when the feathers are taken by shippers, only a few of them find their way back to the market, whereas when they are bought by brokers, they may be and frequently are returned to the same market again for sale with but slight modifications.

The average price per lb. of the feathers sold on the three sales under review was £1. 8s. 10d., but as was pointed out previously, since the proportion of wings to short feathers varies, this average figure gives little indication of the prices obtained.

There was no great variation in prices during the period under review. On 6th September, the date of the London feather sale, there was a better demand and somewhat improved competition on the Port Elizabeth market, and at the sale held on 20th September the market showed a somewhat firmer tone.

Advices from overseas do not lead to anticipate any real improvement in prices in the near future, although encouragement is to be found in the heavy purchases by France on the London market.

Advices from Paris all state that at the present time ostrich feathers are very fashionable, and the present bad condition of the trade must therefore be due partly to the unfavourable exchange rates of the franc and mark.

Although the London feather sales showed a decided fall in most of the chief lines, they may on the whole be considered satisfactory, in view of the condition of trade generally.

As was pointed out in the last report it is impossible to give forecasts, but from the general trend of the market, and improved competition, it seems unlikely that prices will go lower than they are at present. Nevertheless there is little indication of any great improvement in the near future.

## CORRIGENDA.

August, 1920, issue of *Journal* (Vol. I, No. 5, page 495).

“Cape Fruit” should read “Grape Fruit.”

October, 1920, issue of *Journal* (Vol. I, No. 7, page 674).

“The Menace of Anthrax.” The prices quoted have been changed and are now as follows for double anthrax vaccine:—For cattle, 3s. for 10 doses and 7s. 6d. for 25 doses. For horses, mules, donkeys, sheep, and goats, 3s. for 20 doses, 7s. 6d. for 50 doses.

October, 1920, issue of *Journal* (Vol. I, No. 7, page 615).

Fourth line from bottom; the word “former” should read “latter.”

## DEPARTMENT OF AGRICULTURE.

## ANALYSIS OF SOILS.

## Methods of Taking Samples.

In taking soil for analysis it is of the utmost importance that a truly representative sample be secured, otherwise the analysis will be of little value.

If the type of soil varies from place to place in a field or farm, separate representative samples of each type should be forwarded for analysis.

The depth to which a sample is taken is important. In some cases a clear line of separation between the soil proper and the sub-soil is perceptible. This is often shown by difference in colour, the soil being richer in organic matter and therefore darker than the sub-soil. Under such circumstances the sample of soil should be taken down to the line, but in no case to a depth of more than a foot. In all cases a sample of the sub-soil down to the depth of 2 feet must also be sent, separately.

## METHOD OF TAKING SAMPLES.

Soil samples should be taken in one of the following ways:—

1. Having selected a representative spot, the vegetation upon it is removed and a hole is dug with a sharp spade to the necessary depth. One side of the hole is then trimmed with the spade so as to be smooth and vertical, the hole being cleaned out. A slice of uniform thickness, about 3 or 4 inches, is then removed by the spade down to the required depth. This slice is placed on a clean board or sack and mixed with similar slices, obtained in the same way from other parts of the field. Finally, all the samples are thoroughly mixed together with a trowel or the spade, the sticks, large stones, and roots removed, and a portion of about 9 lb. placed, with a label giving details, in a clean box or suitable bag of canvas, cloth, or other impervious material through which the fine soil will not sift out during conveyance to the laboratory, the sample of the sub-soil being kept separate from that of the soil proper.

2. Another method is to have wooden boxes 6 inches square and 12 inches deep to hold the samples. A large hole is dug with a spade at the selected spot and a square upright block of soil is left standing in the centre. This is carefully trimmed with the spade until a box will just fit over it. The box is inverted over the block and forced down, the spade slipped under, and the box with its contents removed. A label giving particulars of the soil is put in and the lid screwed on. A sample of the sub-soil beneath should be taken in a similar manner.

Method (1) will, under ordinary circumstances, be found the most convenient.

In all cases full details as to exact locality, etc., must be given on the form provided for the purpose. The average annual rainfall and the altitude should be stated as well.

## BRAK SOILS.

Should an analysis of a soil be required on account of "brak" being suspected, the method of taking the samples is similar to that described above, excepting that, provided the soil appears uniform, it should be sampled in six sections and down to a depth of 3 feet. Should the soil not appear uniform (for example, should hard and soft layers be encountered) the depths to which the various sections of soil are taken should be governed by the thickness of the varying layers.

(NOTE.—Regulations and tariff governing the analysis of agricultural materials were published in the September, 1920, issue of the *Journal*, cover pages ii, iii, and iv.)



PRICE 5/-  
PER ANNUM.



# Journal

of the

Department of

# Agriculture

ISSUED BY AUTHORITY OF THE  
MINISTER OF AGRICULTURE.

## PRINCIPAL CONTENTS.

- Hides and Skins.
- Coccidiosis of the Fowl.
- The Agriculture and Soils of the Cape Province.—V.
- Irrigation Enterprise in the United States of America.
- A South African Gum.
- Breeding Sheep for the Export Trade.
- A Cheap Serviceable Hive.
- Prickly Pear as a Stock Food.
- Parasitic Attack on "Eucalyptus Globulus."
- The Mally Fruit Fly Remedy.
- Plan of a Small Farm Dairy.

PRICE **6** PER COPY

STEWARTS AND LLOYDS (SOUTH AFRICA), LTD.

# TUBES AND FITTINGS.

P.O. Box 1195,  
JOHANNESBURG.

P.O. Box 74,  
PRETORIA.

P.O. Box 131,  
DURBAN.

P.O. Box 296,  
MARITZBURG.

AGENTS FOR :

National Gas Engine Co.,  
Gas, Oil, and Petrol  
Engines.

Eagle Engineering Co.,  
Ltd., Petrol Paraffin  
Engines.

Davey Paxman & Co.,  
Steam Engines and  
Boilers.

Gilbert Gilkes & Co.,  
Water Turbines and  
Centrifugal Pumps.

Mirrlees, Bickerton &  
Day, Diesel Oil Engines.

IRRIGATION  
AND WATER  
SUPPLY OUR  
SPECIALITY.

PUMPING PLANTS,  
PIPE LINES  
AND  
POWER UNITS  
OF EVERY  
DESCRIPTION.

ESTIMATES AND ADVICE  
FREE OF COST.

AGENTS FOR :

John Blake, Ltd.,  
Hydraulic Rams.

Thomas & Sons,  
Windmills and Pumps.

Bell Bros., Ltd., Filter  
and Water-Softening  
Plants.

Glenfield & Kennedy,  
Hydraulic Specialities.

Clydesdale Steel Plates.

# CONTENTS.

DECEMBER, 1920.

	PAGE
NOTES ... ..	797
Meetings of Officers of the Department—Locusts—The Danger lurking in Imported Cotton Seed—Tsetse Fly Investigations—Preventing Wastage in Citrus Fruit Shipments—Anthrax Vaccines—Cost of Maize Production—United States Maize Crop, 1920—Prickly Pear—Beetle Pest—Dipping Tanks, Pretoria District—Rinderpest—Poor Grade Australian Cheese—Cotton Growers' Competitions—Agricultural Literature—The Annual Report of the Department—Madumba (Dasheen) Root—The Union's Timber Supply—The Wheat Crop of the World—Inoculation and Dosing of Breeding Ewes—Plant Nurseries in Quarantine as at 1st November, 1920 (page 818)—Sterilization of Grain (page 828)—Export of Grain, etc. (page 833)—Lucerne Seed (page 841)—Pure Salt for Hides (page 851)—Preparation of Hides and Skins (page 858)—Fruit Export (page 861)—Seville Oranges (page 866).	
HIDES AND SKINS... ..	809
COCCIDIOSIS OF THE FOWL ... ..	815
THE AGRICULTURE AND SOILS OF THE CAPE PROVINCE ... ..	819
IRRIGATION ENTERPRISE IN THE UNITED STATES OF AMERICA ... ..	829
A SOUTH AFRICAN GUM ... ..	834
BREEDING SHEEP FOR THE EXPORT TRADE... ..	838
A CHEAP SERVICEABLE HIVE MADE FROM PARAFFIN BOXES... ..	842
PRICKLY PEAR AS A STOCK FOOD ... ..	848
PARASITIC ATTACK ON "EUCALYPTUS GLOBULUS" ... ..	852
THE MALLY FRUIT FLY REMEDY ... ..	859
PLAN OF A SMALL FARM DAIRY ... ..	862
THE POULTRY YARD MONTH BY MONTH ... ..	867
CORRIGENDUM ... ..	867
THE VEGETABLE GARDEN ... ..	868
NOTES FROM THE "GAZETTE" ... ..	869
SOUTH AFRICAN PRODUCE ON THE OVERSEA MARKET ... ..	871
OVERSEA PRICES OF SOUTH AFRICAN PRODUCE ... ..	873
NOTES FROM THE DIVISIONS ... ..	874
RECENT AGRICULTURAL LITERATURE... ..	876
OUTBREAKS OF ANIMAL DISEASES IN THE UNION ... ..	880
AT THE SCHOOLS OF AGRICULTURE AND EXPERIMENT STATIONS ... ..	881
MEAT STATISTICS ... ..	886
STAFF: APPOINTMENTS, TRANSFERS, ETC. ... ..	887
CROP AND LIVE STOCK REPORT ... ..	887
LOCAL MARKET PRICES ... ..	890
THE LOCAL MARKET ... ..	891

## DEPARTMENTAL NOTICES.

---

### AGRICULTURAL DEPARTMENT.

---

#### GOVERNMENT GUANO.

It is hereby notified that an allotment of guano will be made early in February next.

The total quantity of guano which will be available for distribution in this allotment cannot yet be determined, but all collections, ready in time for the forthcoming sowing season, will be disposed of and delivered with as little delay as possible.

The distribution of the guano will be limited to bona fide farmers and gardeners only, within the Union, who are requiring supplies for use during the period from February to June, 1921.

Applications must be made on the *prescribed form* obtainable from the Superintendent, Government Guano Islands, 69 Strand Street (P.O. Box 251), Capetown, and these will be received and booked up to and including noon on Saturday, the 18th December, 1920, after which date no further applications will, under any circumstances, be accepted or entertained in respect to this allotment.

Applicants are warned that, in making applications for guano, the purposes for which this fertilizer is required must be distinctly stated on the form of application and that *only the quantity actually needed for those purposes must be asked for, as all inflated orders will be liable to be disallowed.*

No application will be accepted, or considered, from any person who is not actually farming on his own account, and only one application will be accepted in respect to any one farm, portion of a farm, or group of farms under one ownership, or partnership, as the case may be.

All applications must be signed by the individuals requiring the guano and in no case will this fertilizer be supplied to or consigned to any persons other than those for whose use it is actually required.

The price of guano will be £10 per ton of 2000 lb., or 20s. per bag of 200 lb., including bags, and delivered on rail at Capetown, or on board ship in Table Bay Docks, but no remittances will be accepted until after allotments have been made.

Railage in all instances is payable by the consignee and must be prepaid where guano is to be consigned to railway sidings.

All inquiries and applications for guano must be sent direct to the Superintendent, Government Guano Islands, Capetown.

---

### FOREST DEPARTMENT.

---

Farmers and others interested in treeplanting are invited to apply to the Forest Department for advice as to the most suitable trees for growing in the various climates and soils of the Union, and on the best methods to adopt in the formation of plantations, wind-breaks and shelter-belts. Applications for such advice should be addressed to the Forest Officer nearest to the locality where it is intended planting should be done or to the Conservators of Forests, Capetown, Knysna, Kingwilliamstown, Umtata, Maritzburg, Pretoria, or Bloemfontein.

To encourage treeplanting, transplants of forest trees may be obtained from the Forest Department Nurseries of which there are 26 situated throughout the Country and forest tree seeds from the Conservator of Forests, Capetown, who has charge of the Department's Seed Store.

Copies of the latest price-list (No. 642 of 1920) for both transplants and seeds are obtainable from the Forest Officers mentioned in the foregoing or from the Chief Conservator of Forests at Pretoria. This publication contains a considerable amount of information useful to farmers and others desirous of planting trees and it also indicates that the average price for young trees ready for planting out is only 6s. per 100. These are sold firmly established in half paraffin tins, each tin containing about 25 transplants.



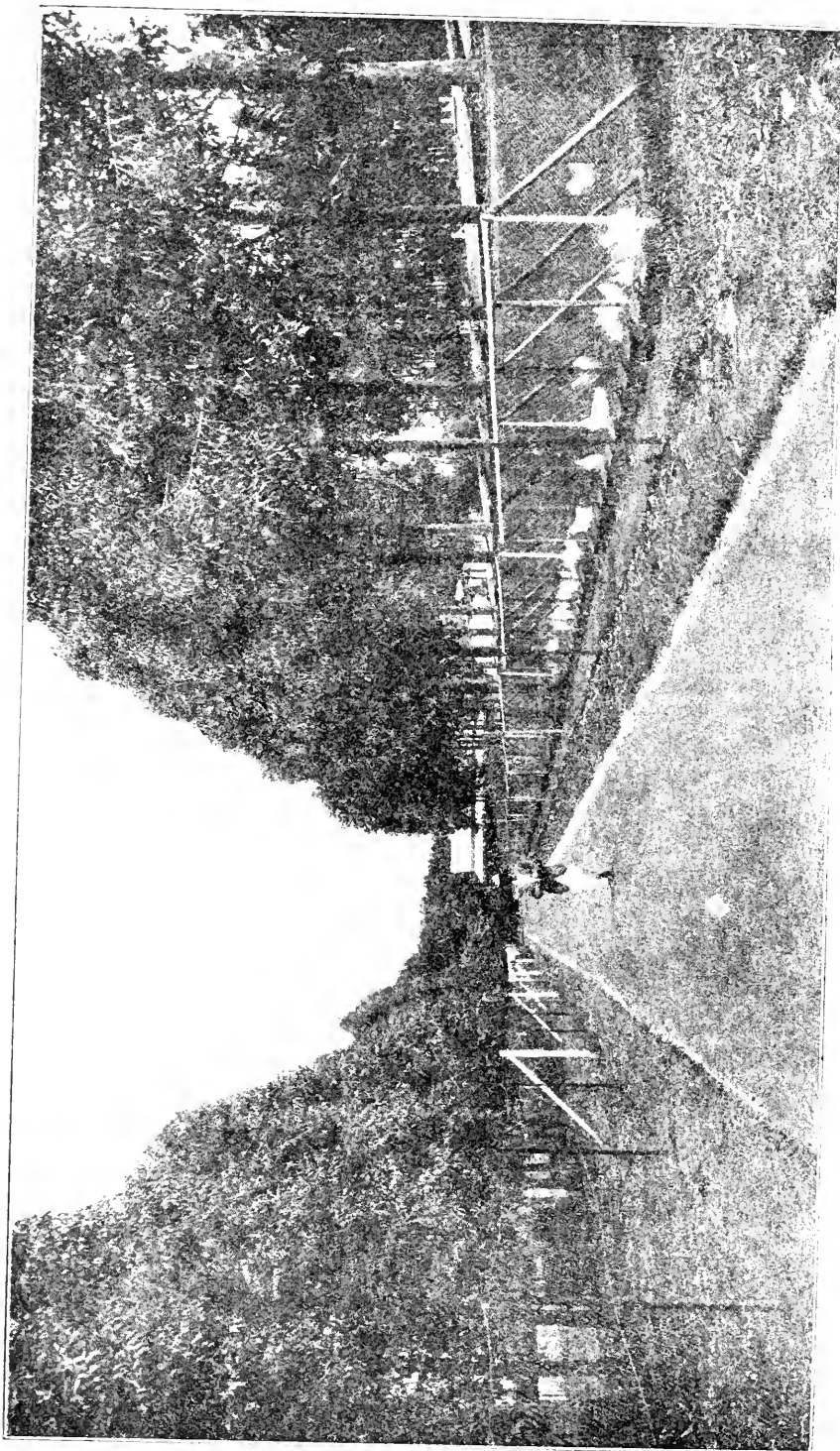

THE POULTRY DIVISION, CEDARA.



# JOURNAL OF THE DEPARTMENT OF AGRICULTURE.

---

VOL. I.

DECEMBER, 1920.

No. 9.

---

Published monthly in English and Afrikaans by the Department of Agriculture,  
Union of South Africa.

**Editor: G. W. Klerck.**

**SUBSCRIPTION:** Within the Union and South-West Protectorate, **5s.** (otherwise **6s.**)  
per annum, post free, payable in advance.

Applications, with subscriptions, to be sent to the Government  
Printer, Box 373, Pretoria.

---

## NOTES.

---

### Meetings of Officers of the Department.

The Right Honourable F. S. Malan, M.L.A., Minister of Agriculture, has inaugurated monthly meetings with the Secretary, the Under-Secretaries, the Heads and Sub-heads of Divisions, including the Principals and Vice-Principals of Agricultural Schools. The object of these monthly meetings is to enable the chief officers of the Department to become acquainted with the work performed in the different branches, and to engender a feeling of co-operation and unity. Officers will by this means be in a better position also to answer inquiries by the public with whom they may come in contact in the course of their official travels. These meetings will be utilized for discussing questions of policy and any new work projected. The first meeting was held on the 8th November and proved to be a great success.

Annual meetings of heads of divisions with officers who are situated at outlying stations will also be held in order to give such officers an opportunity of exchanging views and learning directly from the head of their division, matters of importance which he may have in view. Such meetings, it is believed, will facilitate work of officers in the country and afford an opportunity for discussing suggestions which they may desire to put forward. They cannot fail to stimulate interest in the work of officers. To a limited extent this was done in the past, but it is proposed to make it a regular practice in future.

---

### Locusts.

Up to 12th November voetgangers in small numbers had been reported this spring in the Districts of Kimberley, Jacobsdal, Cradock, Graaff-Reinet, and Willowmore. For the most part the insects occur

so scatteringly in the veld that effective operations against them are impracticable. Evidently the hatching in Kimberley and Jacobsdal was irregular and began very early, as by 1st November newly fledged locusts were present along with small and large voetgangers. Some early hatching must also have occurred somewhere near Conway, in the Middelburg District north of Cradock, numerous flyers being observed there on 4th November. The outbreak in the Willowmore District is in Baviaans Kloof, a section of the country considerably south of any place where locusts have been known to the Division of Entomology for many years. It is thought quite probable that voetgangers in small swarms, small clusters, and as solitary individuals are widespread in the Karroo, and that farmers are ignorant of their presence or else disregarding them. Small clusters and solitary voetgangers cannot be satisfactorily combated in the veld, but swarms can and should be, and farmers are earnestly urged to search diligently for such aggregations of the insect and to destroy every one located. Some farmers delude themselves into accepting that it is useless for them to worry about the first little swarms when they must leave myriads of scattered locusts. But the Division of Entomology believes that the destruction of those swarms is particularly important, and reasons that the more of them the farmers destroy the greater will be the proportion of solitary locusts that will fall victims to locust birds and other natural enemies. Great locust trouble in the past has followed big droughts. The 1919 drought in the Karroo was one of the worst on record. The extent to which locust swarms will now develop depends on the extent to which the initial little swarms are destroyed by man.

---

### The Danger lurking in Imported Cotton Seed.

We drew attention in last month's *Journal* to the great risk which faces our infant cotton industry in the introduction of cotton seed and how the danger must be guarded against. Another instance of the manner in which seed, bearing one of the most dreaded cotton scourges, may be introduced, has been brought to our notice by the Chief of the Division of Entomology.

A passenger for Portuguese East Africa who landed at Durban recently had with him a small bag of Egyptian cotton seed procured from the British Cotton Growing Association. The Customs Department took possession of the parcel and passed it to the local Entomologist, who, under instructions from Pretoria, forwarded it intact, as arranged, to the Entomologist of Portuguese East Africa for inspection and disinfection before delivery to the owner. The seed was obtained from an association devoted to the encouragement of cotton growing in British Dominions, while all cotton seed from Egypt is supposed to be machine-treated by heat as a precaution, but it was feared that notwithstanding the seed might possibly be carrying the terribly destructive pink boll worm. The fear proved to be well founded. On picking over the five pounds of seed contained in the little bag 1430 seeds, or about 6 per cent. of the total, had been eaten out by the pest, while five moths, six pupae, and fifty larvae were found. Thirty of the larvae and pupae were alive. The holding of cotton seed over for a year, it may be of interest to add, is not



a reliable precaution against this pest. The Chief Entomologist of Egypt has stated that worms have been found to survive in seed for at least two and a half years. These remarks may help the public to understand why the Department of Agriculture has become extremely particular about the introduction of cotton seed. Any one who brings cotton seed into the country in ignorance of the regulations on the subject, or who receives any uninspected foreign cotton seed by post or otherwise, is earnestly urged to keep such seed tightly enclosed and to communicate at once with the Department. Negligence may be the means of causing incalculable loss to South Africa.

---

### **Tsetse Fly Investigations.**

The Minister has instructed the Division of Entomology to station an Entomologist without delay in the Empangeni area of Zululand to conduct a special investigation of tsetse flies. Arrangements are being made accordingly. The immediate necessity for the projected investigation is the very serious loss of stock through Nagana that has been experienced by recent settlers under a Government scheme. It so chanced, however, that the Imperial Government a short time ago approached the Union Government to learn if the latter would be prepared to co-operate in a plan to have the bionomics of tsetse flies studied on common lines, by special Entomologists, to be stationed in suitable localities in six widely separated "fly belts," in as many of the British countries of Africa. It was suggested one station be in Nyasaland, one in Southern Rhodesia, and one in Zululand. The Union Government agreed to support the project, and undertook to conduct an investigation in accordance with the plan in Zululand at its sole expense and to contribute a substantial sum annually to a common fund for general purposes. If the Imperial scheme comes to fruition, the work now about to be started in Zululand will therefore be conducted under the great advantages to be derived from similar investigations, simultaneously carried on at other places under the same general direction. The work of the several stations would be co-ordinated through the Imperial Bureau of Entomology (London), which would probably have an experienced tsetse fly investigator visit each periodically. Each station, moreover, would be kept informed of the progress being made at the others. It is expected that the investigations will extend over five years, and it is hoped they will disclose facts, through the knowledge of which tsetse fly transmitted diseases of man and the lower animals may be successfully suppressed.

---

### **Preventing Wastage in Citrus Fruit Shipments.**

During the past few months investigations were conducted into the cause of wastage in our export citrus trade. These experiments were carried out by Miss Thomson, B.A. (Cape), M.Sc. (Lond.), F.L.S., at Pretoria, and Mr. Putterill, M.A. (Cape), Government

Mycologist, at Capetown, in close co-operation with the Trade Commissioner. The picking, grading, and packing had been under the supervision of Mr. Hobson, Chief Inspector on the Citrus Canker staff, who had also made a study of the handling of the fruit on the London market.

The results obtained over the whole season's shipment of the experimental consignments proved—

- (1) that with reasonable care it is possible to land fruit in London showing no waste;
- (2) that waste, when it does occur, is due to carelessness in packing injured fruit, in packing too lightly, and in stacking the packs insecurely in the ship.

Arrangements are further being made whereby a series of experiments will be conducted next season to determine as fully as possible the keeping qualities of citrus fruit, after subjection to conditions prevailing in ventilated hold and cold stores.

---

### **Anthrax Vaccines.**

In the last issue it was indicated that the Division of Veterinary Education and Research was busy preparing a new vaccine against *Anthrax*. This so-called *Spore-vaccine* has been tried at the Laboratory on a fairly large number of animals (horses, donkeys, cattle, sheep, and goats) with excellent results. The chief advantages are the following:—(1) The vaccine seems to be perfectly harmless, so that no evil results need be feared after inoculation if the instructions are carefully carried out. (2) The degree of immunity conferred by this new vaccine seems to be very much stronger than that which followed on the inoculation with the old vaccine. Animals were inoculated with the prescribed doses, and were then tested with varying amounts of virulent anthrax germs to see whether they could resist the infection. An example of such a test may be quoted. A sheep was inoculated with a single dose of the vaccine ( $\frac{1}{2}$  c.c.) and showed no symptoms at all. A month later it received an injection of 100,000 virulent anthrax spores without showing any reaction. It may be mentioned that in the case of susceptible sheep, fifty virulent anthrax spores generally form a fatal dose.

Before issuing this spore-vaccine to the public it will be tested on a fairly large scale on a few badly infected farms (probably in the Boshof District). As soon as this test is completed (towards the end of November), the vaccine will be ready for issue to the farmers.

A printed leaflet will accompany each batch issued, and farmers will be requested to fill in two forms and return them to the Laboratory four weeks and one year respectively after the inoculation. In this manner it will be possible to collect valuable information on the results obtained with the new vaccine. It is hoped that every farmer will co-operate and assist the division in its endeavour to check the spread of this dreadful disease.

## Cost of Maize Production.

With the co-operation of the Maize Breeders', Growers', and Judges' Association, and with the assistance of interested farmers, an attempt is being made by the Department to ascertain the cost of production of maize.

The method, briefly, is to ask some representative growers in the principal maize-growing areas to keep records of all labour and other costs in producing a crop of maize on a selected area, on prepared schedules supplied by the Department. It is recognized that this method will possibly not produce such completely reliable results as would a scheme whereby the full costs, over the whole farm, were kept, inasmuch as it entails estimates of the value of ox labour and other factors, but it is felt that to ask farmers to undertake the labour involved in a complete account of the cost of production would be unwarranted, since the partial or single crop method proposed will give returns sufficiently accurate for the purpose in view.

It is anticipated that the information furnished by the records as to the cost of growing and marketing maize in representative areas will benefit not only the maize industry in general, by indicating the minimum cost per bag at which maize can be grown—a question on which there is so much erroneous opinion among both producers and consumers—but also to a very great extent the individual farmers participating, by providing them with detailed information of the costs involved in producing their maize, and indicating means of avoiding some portion of this expenditure or of cheapening their methods or otherwise lowering the cost of production in succeeding seasons.

Mr. Parish, Technical Assistant to the Department, is in charge of the work, and he is now engaged in visiting those farmers participating in the scheme, in order to explain the methods of entering up the schedules and labour record-sheets and any difficulties that may arise, and further for the purpose of obtaining information on the economics of maize production by inquiry amongst farmers.

Up to the present about forty schedules have been distributed in the following areas:—*Transvaal*: Pretoria, Pietersburg, Mokeetsi, Malelane, Devon, Standerton, Balfour, Rustenburg, Marico, Ventersdorp, Lichtenburg, Potchefstroom, Klerksdorp, Wolmaransstad; *Orange Free State*: Vierfontein, Rendezvous, Heilbron, Frankfort, Senekal, Clocolan; *Natal*: Richmond, Ladysmith, Elandslaagte, Mid-Illovo, Ixopo.

Progress and information of interest obtained as the work proceeds will be reported month by month in the *Journal*.

---

## United States Maize Crop, 1920.

According to the International Crop Report for September, 1920, the maize crop of the United States, though 20 per cent. below normal in condition, is estimated to yield 7.3 per cent. more than that of last year and 13.4 per cent. more than the average of the previous five years.

## Prickly Pear.

We publish in this number an article by Dr. Juritz on "Prickly Pear as a Stock Food," which will be read with interest and profit by farmers situated in those parts of the Union where the prickly pear abounds and where the problem of utilizing or eradicating a plant cumbering thousands of acres of land is ever present. The phase of the problem discussed by Dr. Juritz is the one found thus far to afford the best means of making some use of the plant, but even then its benefits are limited and not of any wide economic value. The article sets out the feeding value of the prickly pear very clearly and may be taken as the latest pronouncement on the subject by one who has studied it carefully, not only in the aspect of the plant's value as a stock food but in respect of other likely means of putting its unwelcome presence to the best possible economic use.

Dr. Juritz discusses the matter very thoroughly in a scientific bulletin recently published, and those desirous of pursuing the subject should certainly obtain a copy of the bulletin.\* It may be had on application to this office.

The spread of prickly pear in the Union and methods for controlling the pest have exercised the authorities for many years, but serious as the matter is in South Africa, it is small when compared with the situation in Australia, where it is estimated that the worst species of prickly pear occupies over 22 million acres of land, and is spreading at the rate of a million acres a year. It is to be expected, therefore, that the subject has received much investigation in Australia, and one of the latest publications dealing with the problem is a bulletin (No. 12) entitled "The Prickly Pear in Australia," issued by the Commonwealth Institute of Science and Industry. The result of the Australian investigations, and they have been very thorough, shows that of the great number of ways suggested for utilizing the pear, the only one which has proved satisfactory is that of feeding it to stock, and that only by the addition of various feeding stuffs. "The manufacture from prickly pear," the report states, "of alcohol, paper or cardboard, potash, and various other materials has been suggested, but in all these cases the fact that prickly pear consists very largely of water makes its profitable utilization very unlikely." In the *South African Journal of Industries* (August and September, 1920) Dr. Juritz discusses this industrial aspect of the subject, dealing very fully with the various uses to which, it has been considered, prickly pear might be put. This publication gives the result of many years of investigation and experience of local conditions, and contributes a valuable addition to the existing literature on the subject.

But as an outcome of all these investigations it seems, as has been the experience in Australia, that the real problem is the best means of eradicating the pest, for its economic utilization offers no satisfactory solution to the effective control of the plant. While, therefore, we may derive a measure of utility from a pest occupying large areas of fertile land, by using it as a stock food, the way out of our difficulty appears to lie in the effectual extirpation of the plant at a cost commensurate with the value of the land cleared.

\* "Prickly Pear as a Fodder for Stock." Science Bulletin No. 16 [1920]. Price 3d. (prepaid).

## Beetle Pest.

More numerous complaints of cockchafer outbreaks than usual are being received this season by the Division of Entomology from various parts of the Transvaal. Several species are concerned in these attacks, the common one this year being *Adoretus tessulatus* Burm., a beetle about half an inch in length and brownish in colour, with interrupted lines down the back. The immature stages are passed in the ground, and the beetles emerge in the spring, when they do damage by feeding at night on the more tender parts of plants. This year grapevine, rose, plum, and almond appear to suffer most. Other plants being attacked are peach, apricot, nectarine, apple, pear, cherry, and oak; even cabbage, cauliflower, and turnip suffer on occasion. Complete defoliation may result, but usually only the tender parts are attacked. During the day the beetles hide in the soil beneath the infested plants, where they may be searched for and destroyed. Spraying with arsenate of lead (four ounces of paste or two ounces of powder) in four gallons of water is the usual remedy for cockchafers. A strong mixture is surer to kill, but it must be borne in mind that all stone fruits are liable to be injured. For these it is advisable to use half the usual amount of poison, and also to add a like amount of lime. In small gardens hand-collecting at night into a paraffin tin containing a little water with paraffin oil on top is another efficient, though somewhat laborious, remedy.

---

## Dipping Tanks, Pretoria District.

The prevalence of East Coast fever in the Pretoria District has made drastic measures imperative. This particularly applies to the provision of cattle dipping tanks by farmers who own stock. In the November *Journal*, attention was drawn, under "Notes from the *Gazette*," to Government Notice No. 1697 of 15th September, 1920, containing a Minister's Order to the effect that three months after that date, i.e. after 15th December, 1920, the provisions thereof restricting the movements of cattle will take effect. These provisions will be rigidly enforced. Stock owners in the Pretoria District will do well to bear this in mind so as to be prepared to comply with the order.

---

## Rinderpest.

It will be remembered that considerable apprehension was caused in the early part of 1917 by ominous reports of the spread of rinderpest in the territory then known as German East Africa, and prompt steps were taken to prevent the spread of the disease southward, a Commission being appointed, with Mr. C. E. Gray, Principal Veterinary Officer for the Union, at its head, for the purpose of dealing with the outbreak. This Commission was occupied for over a year in establishing a belt of immunized cattle over a large area, stretching from Lake Nyasa to Lake Tanganyika, and their object, happily, was achieved, for the southward trend of this fell disease was checked. Mr. Gray's report\* on the work of the Commission has now been

\* Report of the Rinderpest Commission. (U.G. No. 52—'20.) Price 1s. 6d.

published, and gives an interesting description of the hardships faced and the work accomplished. The magnitude of the task may be gauged from the fact that in the course of its operations the Commission inoculated close on one hundred thousand head of cattle, all the property of natives (if cattle levied by the military for commissariat purposes are left out of account) and all in the territory referred to above. Mr. Gray states that generally speaking the results from inoculation of the animals against rinderpest were successful and the mortality following inoculation was small, and all round was not more than 5 per cent. Most farmers carry a vivid picture of the ravages caused by the rinderpest invasion of this country many years ago, and the success attending the operations of the Commission in Central Africa brings the assurance that the means we now possess of fighting the disease are a guarantee against a similar invasion in the Union, another monument to the advance made in overcoming the cattle diseases which are found in southern and tropical Africa.

---

### **Poor Grade Australian Cheese.**

A considerable quantity of Australian cheese, a good deal of which was of inferior quality, was imported earlier in the year. As a consequence some of our last season's cheddar cheese stocks are still being held. It is expected, however, these will probably be exported before the new season's comes on the market. The position is now somewhat easier. Owing to its poor quality difficulty was experienced in getting rid of the cheese locally, and several lots were re-exported to Great Britain. It is feared that, at least in one instance, the inferior article was thought to be of South African manufacture, and is likely to have an undesirable effect on the export of our own cheese. The matter is being fully investigated with a view to the good name of the South African product being protected.

---

### **Cotton Growers' Competitions.**

Intending competitors are reminded that all entries for the cotton growers' competitions for the forthcoming season should reach the Chief, Tobacco and Cotton Division, not later than the 15th December, 1920. Full particulars have already appeared in the Press. Prizes amounting to £175 and £87. 10s. for 50 acres upwards and 10 acres up to 50 acres, respectively, of cotton, including the entire crop except ratooned cotton, have been provided by the British Cotton Growing Association, the conditions governing the competitions being as follows:—

1. A cotton grower may compete in only one class.
2. There must be at least eight competitors in the first and ten in the second competition, otherwise the prize money is to be held over for a similar competition the following year, etc,

3. The points for scoring will be: (1) method of preparation of land, cultivation, etc., 30 per cent.; (2) quantity, 30 per cent.; (3) quality, 40 per cent.
4. Officers of the Tobacco and Cotton Division will judge and score as to (1) cultural methods and handling the crop, and (2) quantity.
5. Samples of 10 lb. will be taken from each competitor's crop by officers of the Tobacco and Cotton Division.
6. Samples of 5 lb. each will be forwarded to the British Cotton Growing Association, who will judge and score as to the quality of the lint.

Cotton growing is rapidly increasing in the Union, and we trust that there will be many entrants for these competitions, which are designed to encourage the cultivation of the crop on the right lines. Whether the competitor be successful or not his efforts will be amply repaid in the practical experience he will gain by association and competition with other cotton growers.

---

### Agricultural Literature.

Readers are reminded that the Department holds a stock of bulletins dealing with various agricultural subjects of a South African nature. Sections of these bulletins were published in the *Journal* issues of May, June, July, and August last, and the complete list will be sent, post free to inquirers, on application to the Editor. Most of the bulletins are issued free of charge, but such as are priced, according to the list, should be prepaid when application is made for them. It may be explained that between August, 1914, and April, 1920, no *Journal* was issued by the Department, and, instead, bulletins on various subjects were published from time to time; these are the bulletins which, together with certain others, constitute the above list, and are available to the public. With the advent of the *Journal* the publication of articles in bulletin form disappears, excepting in the case of Science Bulletins and other special publications, so that all wishing to be equipped with the pronouncements of the Department on the many important matters affecting farming in this country should obtain the *Journal*, which is the Department's chief medium for placing its valuable information before the public.

Our subscribers are reminded that the present issue (No. 9) completes the first volume of the *Journal* for the year 1920, and if previous numbers have been kept these should, together with the index which will be published at the beginning of next year, form a valuable asset to the farmers' library and serve as a basis of a complete collection of *Agricultural Journals* for future years.

It is therefore essential that our readers carefully preserve their *Journals*. Should missing or back numbers be required these may be had from the Government Printer at 6d. per copy, payable in advance. The index will be supplied free of charge to all subscribers.

## The Annual Report of the Department.

Hitherto the annual report has been an elaborate document and has been regarded as the proper channel for recording in detail the activities of the Department. The report was issued for the financial year which ends on the 31st March. This date being about the middle of the Parliamentary Session, the preparation of the report had either to be undertaken when other work was heaviest or had to be delayed until the prorogation of Parliament. Usually delay occurred in its preparation. The time taken in printing the bulky report also delayed its issue. The result has been a belated report which, although retaining its value, had lost a great deal of its interest by the time it reached the public. The report of the Department is really its *Agricultural Journal*. The Department has come to the conclusion, therefore, that, while a general review of its work for the year is desirable, the report would serve all purposes if it were merely a brief compendium relating the work in hand and the results achieved. The report for 1918-19 is still in the press. That for 1919-20 will be issued in the form described in this note and will appear simultaneously with the earlier document.

It is proposed to remove the handicap of issuing the report for the financial year. In future the twelve months ended 30th June will be regarded as the report year. The report for 1919-20 will, therefore, cover fifteen months. By altering the report year, as stated, it will be possible to present to Parliament a more up-to-date report than has hitherto been practicable.

---

## Madumba (Dasheen) Root.

The Madumba is the tuberous rhizome of a plant largely cultivated in tropical countries, and by some of the natives and Indians in South Africa. The plant has a short stem, with arrow-shaped leaves attached to foot-stalks rising from the ground. The rhizomes are rich in carbohydrates, hence their value as a human food. An acid substance is also present, which, however, is rendered harmless after boiling. They are commonly known as "Kafir Potatoes" by the Europeans in Natal, who utilize them as a vegetable. Starch of excellent quality may be obtained from the Madumba, manufactured in the same way as in the case of arrowroot.

### CULTIVATION.

*Soil and Climate.*—A sandy loam, rich in organic matter, is best suited for the crop. It will not thrive on a clay soil or pure sands. A warm climate is essential for its successful growth, and it will stand excessive heat and moisture.

*Preparation of the Land.*—The land should be cross-ploughed and well broken up by means of the disk harrow and worked with the respective tillage implements until a very fine tilth is obtained. At time of planting, the soils should be free from weeds.



*Selection of Seed.*—In order that an even crop may result, the rhizomes should be divided into three grades before setting.

*Planting.*—This is performed at any time from September to December. The rhizomes are planted in drills, 3 inches in depth, 3 feet apart, and 2 feet between each plant. They are covered with soil, and later banked up.

*After-cultivation.*—The drills should be kept free from weeds and the soil in a loose condition. This can be accomplished by hand-hoeing and cultivating between the rows at frequent intervals.

It takes approximately eight months for the crop to mature. The rhizomes may be allowed to remain in the soil for some time after they have ripened.

The Madumba finds a ready sale on the markets, and is largely purchased by the natives. It also makes a good feed for pigs. The yield cannot be compared with sweet potatoes. It is a much more expensive crop to raise on account of the extra labour required in weeding, whereas the sweet potato chokes out all weed growth after a short period.

The following is the composition of Madumba tubers, analysed at Cedara in January, 1913: Moisture, 76.5; ash, 1.1; crude protein, 3.2; crude fat, 0.2; soluble carbohydrates, 17.8; crude fibre, 1.2.

---

## The Union's Timber Supply.

In a short summary outlining the steps which should be taken to protect and develop the forest resources of this country, the Forest Department states that such resources are insignificant in proportion to the Union's needs. The indigenous forests produce timbers which, for special purpose, are unsurpassed in the world, and for which there will always be a strong demand. In this connection the value of Stinkwood (*Ocotea bullata*) for furniture and other purposes may be mentioned. There is such a good market for it that it freely fetches 10s. per cube. It is, therefore, of the utmost importance that research and investigation should be instituted so that the most effective steps may be taken to render the forests as highly productive as possible. In their present uncultivated condition the forests yield a very poor increment, but there is no doubt that, with the application of proper silvicultural principles, they could give a greatly enhanced yield. As a preliminary to the introduction of improved methods, the urgency for the study of the silvicultural requirements of the numerous species composing the forests is undoubted. In the past, owing to the insufficiency of the numbers of the trained staff, and to the time of the few men qualified to undertake the subject being almost entirely devoted to administrative duties, there has been no opportunity of dealing with the matter. The opening up of the forests by roads, and the more complete utilization of the timber, are matters that call for attention; while a careful study of many of the timbers, the uses and value of which are at present little known, is a matter of great importance.

But the future of forestry in South Africa is dependent on the extension of plantations, for the indigenous forests, even under proper

management, can never be expected to produce more than a fraction of the country's requirements. Moreover, most of the indigenous timbers are hardwoods, and the woods the country uses most largely are softwoods. Fortunately, experience shows that these woods can be grown successfully in selected portions of the Union, and it is only by rapidly expanding the area under these plantations that the Union can hope to become to any extent independent of other countries for its needs.

---

### **The Wheat Crop of the World.**

In the September, 1920, International Crop Report, published in Rome, it is estimated that the approximate area sown to wheat in the Argentine, Australia, and the Union this season is 11,486,900 hectares (1 hectare = 2.47 acres), which is 28.4 per cent. greater than the acreage of the previous season and 2 per cent. greater than the average area under wheat during the five years 1914-15 to 1918-19. In the same report it is shown that in the Northern Hemisphere the 1920 wheat crop, covering an area representing about half of the world's total yield, and including the United States and India, is .1 per cent. more than in 1919, but 1.7 per cent. under the average for the five years 1914-18.

---

### **Inoculation and Dosing of Breeding Ewes.**

Mr. A. G. Michaelian, Principal Sheep and Wool Expert, furnishes the following note:—

Breeding or pregnant ewes should not be inoculated or dosed whilst the rams are with them or during pregnancy.

Inoculation should take place at least one month before shearing to enable the ewes to recover before they are shorn or put to the ram. When ewes are put to the ram immediately or shortly after shearing, the lambing percentage will not be good. This applies to both rams and ewes. The reason for this is that at no time during the twelve months does a sheep grow wool more rapidly than during the first three or four weeks after being shorn. Practically all the energy of both rams and ewes is concentrated on the production of a coat to keep them warm and not on reproduction. This fact should be obvious to an experienced sheep man. Both rams and ewes should be shorn one month before tupping time. Ram lambs, ewe lambs, dry sheep, and maiden ewes not put to the ram may be dosed whenever necessary. When necessary all sheep, whether dry or breeding, should be inoculated one month before shearing.

If sheep are shorn whilst undergoing the mild attack or otherwise of blue-tongue produced by the inoculation, it stands to reason that they will be more susceptible to chills which are liable to produce an aggravated form of the malady.

---

---

The *Journal* is the Department's medium of making known its activities. It contains information of value to every farmer in the Union. Keep it for reference.

## HIDES AND SKINS.

---

### Useful Hints on Flaying.

---

UNDER the title "Butchering and Flaying," a helpful article was published in the March, 1919, issue of the *Journal of Industries*, and as there is room for much improvement in our methods of treating hides and skins (we referred to this subject in our issue for April, 1920, under the heading "Curing of Hides"), we commend to the careful attention of our farmers and others concerned, the following advice taken from the article referred to. In studying the accompanying illustrations, which are all of cattle and their hides, it should be noted that they apply equally well—and often more so—to sheep, lambs, and calves.

Flaying in general can be summed up in a few words—see that the knives used are suitable and in good order, and keep them out of the hide or pelt when skinning.

Do not skin the legs down to the hoofs, but cut off at the rings shown in the sketches. This lower part of the hide is useless to the tanner.

Hides and skins are *perishable goods*, and great loss is often sustained through their being spoiled for want of attention. At the outset of their treatment they should be properly cooled. Do not lay them in heaps when warm. If possible, hang sheepskins on hooks, and spread hides out till their natural heat is gone. Keep them in a cool place out of the sun. Do not let them get wet. Hides and skins that have been cooled, if allowed to get wet and put in heaps, will rapidly generate heat and decompose; a few hours is sufficient to do much damage. These precautions are absolutely necessary in hot weather, but even in the colder months hides and skins will spoil if allowed to lie in heaps when warm or wet. When not sent off immediately during warm weather, *and after they have been cooled*, they should be sprinkled on the flesh side with salt, which should be spread evenly all over. It is essential that the edges and shanks should be opened out and salted as well as the middle of the hide or skin.

If once allowed to get tainted nothing can restore the damage done, which shows even when the hide or skin is converted into leather, while, on the other hand, if due attention is given to them immediately after skinning in the slaughterhouse, there is less risk of their going wrong at later stages.

Sometimes hides or skins are used to scald an occasional pig upon. Naturally the process scalds the hide or skin beneath as well as the pig, thereby completely spoiling the hide or pelt. It is actually much cheaper to buy a proper scalding trough.

Fat should be spread out and allowed to cool, the larger pieces being hung up. See that it is clean and free from guts and other refuse. It is easier to get the guts clean whilst hot than when cold.



This figure shows, approximately, the correct way of ripping, to take the horns out, so as to leave the face and cheeks as valuable as possible.

Tripes should be emptied of the dung, and, *whilst still warm*, should be washed and then hung up to drip; they must not be washed when cold.

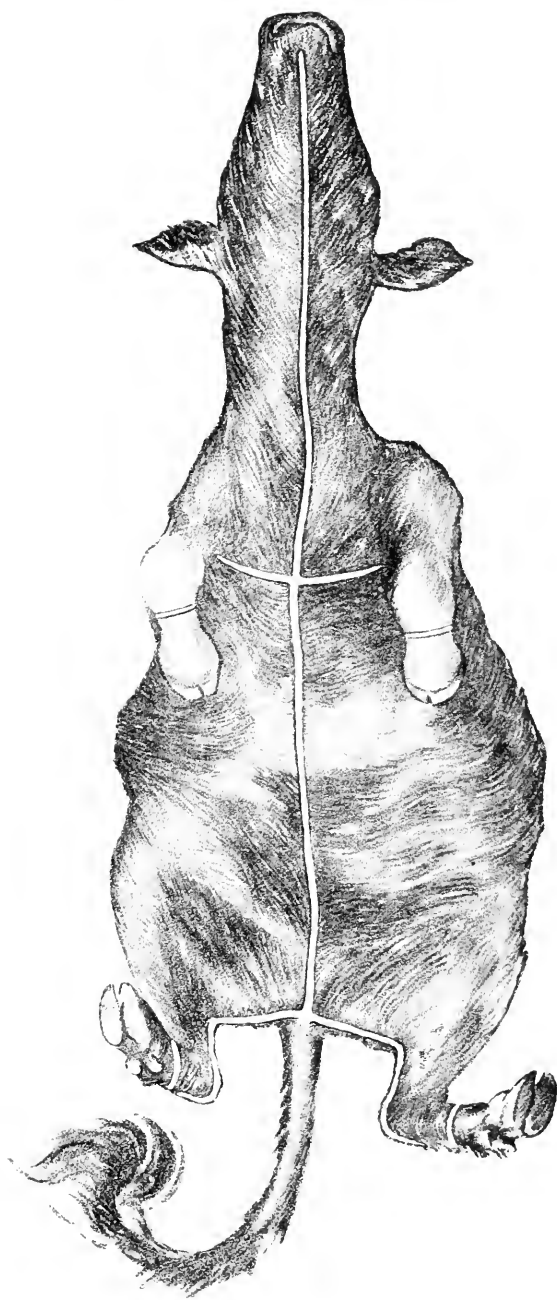

## RIPPING OF FORELEGS.

Ripping from top of breastbone to *inside* of forelegs, the ripping from chin to breast and thence onward being as straight as possible. The cross-ripping to hindlegs is just included in this sketch, whilst the continuation to the tail-root cannot of course, be shown.

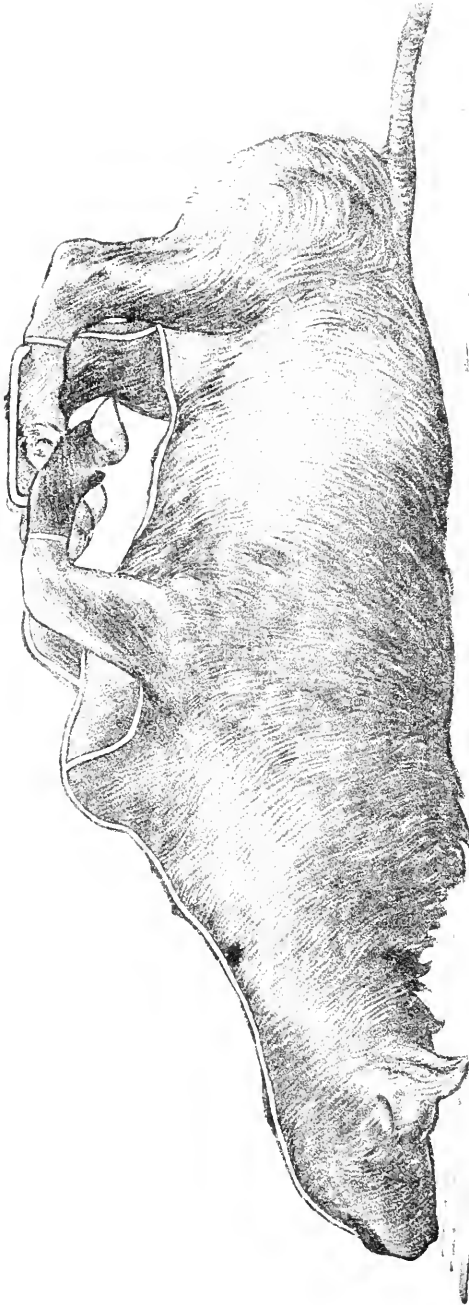

#### GENERAL IDEA OF RIPPING.

This gives a general idea of the lines of ripping, and also shows the method of hooking the hindlegs on to the forelegs: this is a great assistance in steadying the hindlegs for skinning, making the work easier and more readily visible. It will be noticed from this sketch that the ripping from breast to *inside* of foreleg shows a curving line. This is due to the forelegs being pulled back by the hooking, the ripping, of course, having been done as shown in the preceding illustration before hooking.



## RESULTS OF GOOD AND BAD WORKMANSHIP.

The figure on the left represents a hide properly rippled, thereby rendering it as square as possible, and avoiding ragged edges, so much of which is cut to waste in the tannery. The right-hand figure shows a hide faulty in this respect, and also how many hides are badly scored with the knife, particularly at the bellies, ribs, and hindlegs. It will also be noticed that in this case the tail is almost severed from the body of the hide: this is a serious fault, and should be avoided.

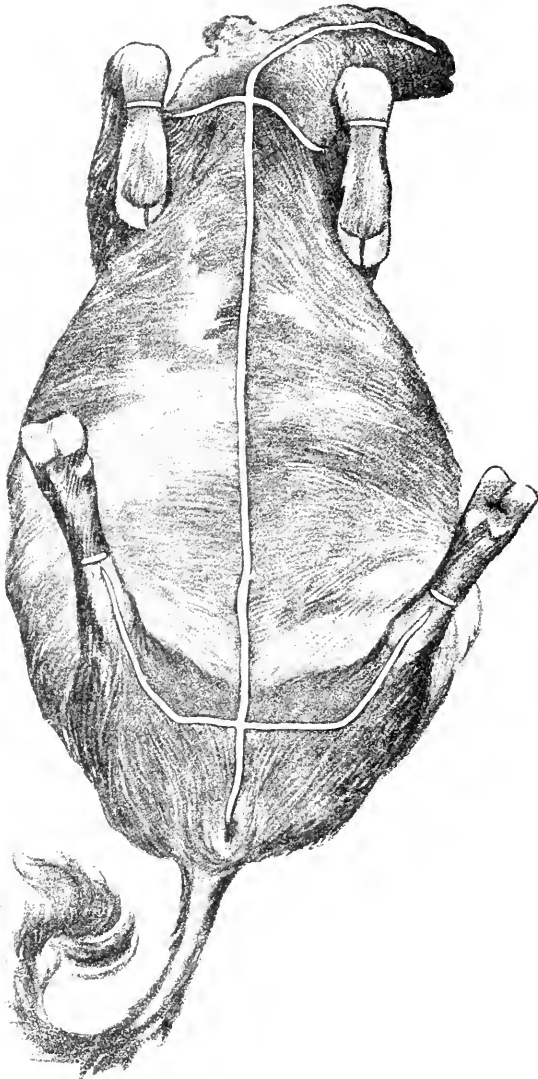

#### RIPPING OF HINDLEGS.

This sketch shows more particularly the correct way of ripping at hindlegs, the general idea being to get the thin part of the legs on to the belly-side and the stout part on to the tail-side. It also shows ripping from breastbone to *inside* of forelegs. The ripping in all cases from tail-root to breast and thence on to chin should be as straight as possible.



## COCCIDIOSIS OF THE FOWL.

By H. H. CURSON, M.R.C.V.S., Veterinary Research Officer,  
Grahamstown.

THIS disease is very prevalent in the Cape Peninsula and probably in other parts of the Union, and, as many poultry owners are not even aware of its existence, and others seem to regard it as a new disease and are therefore ignorant of the ravages it may cause among their birds, a brief description should prove useful, especially as the disease is so important from an economic point of view.

Among poultry breeders coccidiosis is often known as "white diarrhœa" from the most common and most evident symptom. The term "white diarrhœa" is, however, somewhat misleading, for there are other diseases which have as a common symptom the passage of fluid-like fæces, and in many cases of coccidiosis the discharge from the bowels is green or yellowish-green.

### DEFINITION AND COURSE OF DISEASE.

Coccidiosis is the name applied to a disease which is caused by a parasite (*Coccidium* or *Eimeria avium*) belonging to the class of organisms known as Protozoa. The main clinical symptom is an enteritis or inflammation of the lining membrane of the intestines. The course of the disease may be *acute*, as is generally the case in chicks, or *chronic* in the chicks that survive an acute attack and in older birds. In certain outbreaks many of the birds are found dead before the disease has been noticed; in other cases they are ill a few days and then die. In adult fowls, however, in the more chronic stages of the malady, they may linger for a few weeks and then succumb.

### CAUSE OF DISEASE.

The causal parasite (*Coccidium* or *Eimeria avium*) is found in the intestine. The cysts that are passed out with the fæces are of a regular ovoid or spherical shape, and can only be detected with the aid of a microscope.

The life-cycle of the parasite is somewhat complicated, involving as it does more than half a dozen intermediate stages. The length of the course, from the time the cysts become ingested with the food or drinking water until a new generation of cysts is excreted in the fæces, varies from eight to ten days. The cysts may then remain alive in the crevices, etc., of a poultry-run for at least twelve months and during that time again become ingested, thus re-infecting the birds.

### SYMPTOMS.

In the *acute* stage these, especially in birds that have unlimited running space, are often unobserved, but, if observed, they may be described as follows: The onset is sudden and the chicks lose their

appetite, but thirst is increased; they also appear dull, droop their heads, and stand about in a listless manner. Associated with these symptoms is diarrhœa, which, as mentioned above, is the most noteworthy feature of the disease.

In the *chronic* form a progressive anaemic condition is seen; the featherless parts are pale, the growth of the bird is slow, and there may even be a paralysis of both limbs. The bird stands in a dejected manner, the head droops, the eyes half close, the comb has a bluish tinge, the feathers are ruffled, and gait is difficult. There may be alternately constipation and diarrhœa, and, finally, death results from sheer weakness. The so-called "leg-weakness" is often due to coccidiosis.

#### POST-MORTEM APPEARANCES.

In *acute* cases there is often nothing abnormal to be seen except in the caeca (blind gut) which, one or both, are sometimes affected, and may become distended to about double the normal size. On opening, the contents are seen to consist of offensive smelling, yellow, pasty-looking material. The mucous membrane shows inflammation, which may be so severe that there has been shedding of the epithelial lining. The inflammation is usually in patchy areas, but it may also be diffused; the former, however, is the more usual. The remainder of the large intestine down to the cloaca may even be affected in this manner.

The duodenum is described by some authors as being the main seat of the pathological changes, but in outbreaks observed in the Cape Peninsula it is the caeca that show the most pronounced inflammatory changes.

When there has been diarrhœa the feathers in the region of the cloacal opening will naturally show adhering faecal matter, either white or yellowish-green in colour.

In *chronic* cases the carcass is generally emaciated and anaemic. The inflammatory changes are all present except that they are chronic: the mucous membrane is greatly thickened and may sometimes show white spots, which are heaped-up masses of coccidia and epithelial cells. In some cases the liver becomes infected, showing white spots, which are made up of coccidia and liver cells.

#### DIFFERENTIAL DIAGNOSIS.

*Fowl Cholera* is, perhaps, the chief disease which may be confounded with coccidiosis, as the onset and course of both maladies, in the *acute* form, are somewhat similar. Microscopic examination, however, differentiates the two, for cholera is due to an ovoid bacterium which can be demonstrated in the blood by staining. In the *chronic* form, which is seldom met with in fowl cholera, the joints of one or both legs may become swollen, and these cases are often confused with tuberculosis or gout of the joints.

#### TREATMENT.

Curative or medicinal is, in *acute* stages, unsatisfactory. In *chronic* cases the ideal treatment would be the administration of some of the coal-tar derivatives. Naphthalin or its derivatives alpha- and beta-naphthol, on account of their insolubility, are the most promising,

as these are parasiticides, antiseptics, and sedatives, and also check the diarrhœa which so exhausts and debilitates the bird. The dose varies from 1 grain to 3, according to the size of the bird and frequency of administration. The powder may be given as a pill, and along with either castor or olive oil ( $\frac{1}{2}$ -1 teaspoonful).

A tonic and an astringent, such as iron sulphate, can be given in the form of Douglas' mixture. This is prepared by dissolving one ounce of iron sulphate in a quart of water, then add one drachm of diluted sulphuric acid, and of this mixture put two teaspoonfuls in a quart of drinking water, which must be kept in a shady spot. The drinking vessel should be of earthenware or enamel.

Another remedy that has given considerable satisfaction is the addition of powdered catechu to the drinking water, in the proportion of 15 grains of catechu to a gallon of water; continue for fourteen days and at the end of that time very few or no parasites at all should be present in the fæces.

It must be remembered that the birds are extremely anaemic and in a weakened state, therefore diet must be liberal and nourishing; finely chopped or minced meat, boiled linseed, etc., should not be omitted.

Preventive Treatment.—In dealing with this disease it is important to remember that the excreta of diseased birds contains the parasites. To eradicate this complaint the following directions should be strictly adhered to:—

(1) All dead birds to be buried deeply or destroyed by burning.

(2) It is known that coccidia live for twelve months, possibly much longer, after having been evacuated by an extremely infected bird. It is therefore difficult to disinfect a poultry-run and a change to fresh ground is necessary. If, however, the infected stock is moved to fresh ground that ground will rapidly become infected. The old stock should, therefore, be left where it is, any birds which show symptoms of the disease being promptly killed. Only newly hatched chicks should be placed on the new ground, and all brooders, coops, feeding and watering utensils should be thoroughly disinfected before use. There must be no communication with the old infected yard. In this connection it must be remembered that a person may unknowingly convey infected material to the new "run" on his boots.

(3) If hens are used for hatching there is a danger that they may infect the chicks; incubators are preferable, but, if hens are used, then broody hens must be secured from a clean brood.

(4) If these suggestions cannot be carried out, or if fresh ground cannot be provided, the best procedure is

(a) to kill all birds exhibiting the first symptoms of the disease;

(b) to take off about three inches of the top soil of the most frequented parts of the runs and disinfect or burn it;

(c) to disinfect thoroughly all houses, roosts, laying houses, food and water utensils;

(d) to use only healthy hens for setting; and

(e) to place eggs in a solution of 90 per cent. alcohol or first wash in methylated spirits, allow to dry, and then dip in perchloride of mercury (1-2000) before setting them.

If the disease is *non-existent*, then all new arrivals should be viewed with suspicion and kept isolated until it is certain they are free from the disease; microscopical examination of the fæces is the only reliable method of ascertaining the infection.

Newly purchased eggs for setting purposes should be first washed in methylated spirits, allowed to dry, and then dipped in perchloride of mercury (1-2000).

The incubator trays, drying boxes, brooders, market baskets, crates, cages, and any articles likely to convey infection should be thoroughly cleaned and then disinfected.

On farms, and wherever possible, a fresh site for coops and hatching boxes, etc., should be selected every year, and the old ground treated as recommended above.

#### METHOD OF DISINFECTION.

It will be sufficient to wash the incubator trays and drying boxes with a 5 per cent. solution of Lysol, Hycol, or other carbolic preparation, and then allow to dry.

Coops, hatching boxes, brooders, perches, cages, and fowl-houses should be scrubbed with boiling water and caustic soda. When dry, the woodwork, etc., can be limewashed, and to the wash add some disinfectant, such as Hycol.

The floor should be scraped and the scrapings burnt. Then may follow either the sprinkling of freshly slaked lime or the spraying with disinfectant. A very serviceable spraying fluid is paraffin emulsion, which is easily prepared, thus:—

Hard soap ... ..	½ lb.
Boiling water ... ..	1 gallon.
Paraffin ... ..	2 gallons.

First dissolve soap in the water and then add the paraffin and stir vigorously; finally dilute with *four times* the amount of water. The advantage of spraying is that the liquid more easily penetrates the crevices and corners. A good plan is to paint the perches and uprights and crevices with boiling tar, as ordinary limewash is soon rubbed off.

As poultry farming is becoming more important every day and owners are realizing the value of wellbred stock, the first lesson that should be learnt is cleanliness. Any time spent on cleaning the fowl-run is well worth the labour, and at the same time disease and financial loss are reduced to a minimum.

---

#### Plant Nurseries in Quarantine as at 1st November, 1920.

The whole of Mr. Jas. Clark's nursery, Koch Street, Pretoria, has been placed under quarantine for *C. rossi* and *C. dictyospermi*, and is added to the list of quarantined nurseries as published in the September *Journal* (page 670), with the exception of Mr. Krohn's nursery.

## THE AGRICULTURE AND SOILS OF THE CAPE PROVINCE.

By ARTHUR STEAD, B.Sc., F.C.S., Research Chemist, Grootfontein School of Agriculture, Middelburg, Cape.

### I.

#### Witkop—Burghersdorp.

(Concluded from page 670, September Journal.)

The principal particulars relating to the foregoing described samples of soil will be found collected hereunder in Table VII, which has been

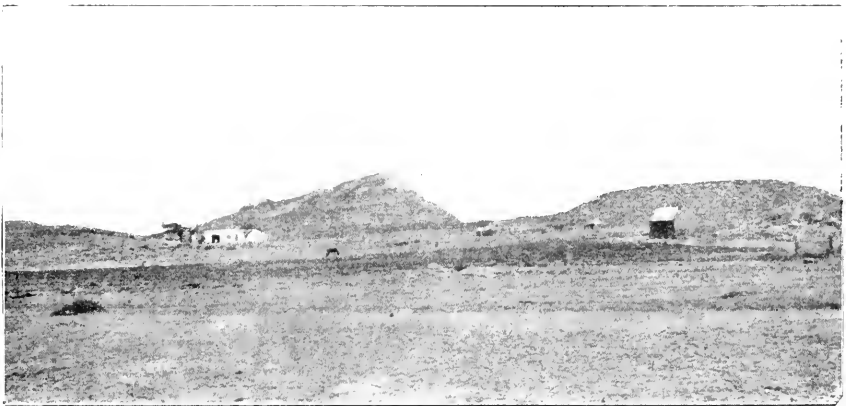

Plate No. VIII.

GRYSKOP.

This kop is quite close to Witkop Post Office. Up to the left of the picture the soils are of reputed high value. In their formation volcanic beds have played a considerable part.

compiled to facilitate comparisons. The basis of the order of arrangement in the table is that of the farmer's own classification, i.e. (1) sandbult soil, (2) mixed sand and turf soil, (3) black turf soil.

Under the sandbult type fall Nos. 611, 612, and 619; the mixed sand and turf type is represented by Nos. 608 and 615, while Nos. 607, 616, 609, and 617 make up the black turf group. This leaves Nos. 613, 614, 610, and 618 unclassified.

The average figures for the three types are set down in Table VIII; they indicate very clearly the chemical and mechanical differences between the three types.

TABLE VII.

*Classified Summary of the Principal Features of the Witkop Soils.*

Farm of origin ... ..	Lemckenkraal	Paardenverlies	Kraaifontein	Paardenverlies	Olivier's Rust
Sample number ... ..	611	612	619	613	608
Underlying strata... ..	Red Beds	Molteno Beds	Molteno Beds	Molteno Beds	Red Beds
Surrounding strata which probably also have influenced soil composition	—	—	Red Beds	Distant Red Beds and Dolerite	Cave Sandstone and Volcanic Beds
Local name for soil-type...	Sandbult	Sandbult	Sandbult	—	Mixed sand and turf
Colour ... ..	Reddish brown	Light reddish brown	Reddish brown	Dark reddish brown	Dark brown
Indigenous vegetation ...	Suur rooigras and blaw-saad gras	Same as No. 611	Suur rooigras	Same as No. 611	Suur rooi- and rooi platblaar grasses
Crops found most suitable	Rye and oats	Rye, oats, and maize	Rye and oats	Potatoes	Potatoes and wheat
Degree of fertility ...	Low	Low	Low	Fair	Very fair
Altitude above sea-level (approximate)	6200 ft.	5700 ft.	6000 ft.	5800 ft.	6400 ft.
Period under crops ...	Virgin	Virgin	10 years	Practically virgin	Practically virgin
Analytical:—	Per cent.	Per cent.	Per cent.	Per cent.	Per cent.
Fine earth ... ..	100	100	97·7	100	100
Coarse sand ... ..	24·5	21·2	13·3	15·3	2·1
Fine sand ... ..	51·1	54·6	55·4	46·4	54·60
Silt ... ..	4·3	3·7	7·1	11·0	10·8
Fine silt ... ..	3·9	3·9	6·4	9·4	11·3
Clay ... ..	8·9	11·8	12·9	11·8	12·8
Solubility in N/5 Hydrochloric acid	0·68	0·56	0·90	0·67	0·87
Reaction... ..	Acid	Acid	Acid	Acid	Acid
Carbonates ... ..	0·03	Nil	0·025	0·005	0·035
Humus ... ..	1·83	1·93	0·77	1·96	3·19
Loss on Ignition ...	2·90	3·20	2·70	3·50	5·7
Moisture... ..	0·41	0·83	0·90	0·82	1·41
Permeability ... ..	3·36	3·35	2·56	0·53	0·58
Retentiveness ... ..	24·00	—	28·00	35·00	35·0
Nitrogen... ..	0·08	0·08	0·08	0·11	0·16
Insoluble inorganic matter	91·13	88·60	90·20	88·20	85·9
Lime ... ..	0·26	0·35	0·21	0·28	0·58
Magnesia ... ..	0·20	0·24	0·23	0·20	0·44
Potash ... ..	0·28	0·40	0·46	0·57	0·40
“Available” Potash ...	0·015	0·006	0·022	0·032	0·028
Phosphoric oxide ... ..	0·05	0·053	0·042	0·048	0·055
“Available” Phosphoric oxide	0·003	0·003	0·003	0·013	0·019

TABLE VII—(continued).

*Classified Summary of the Principal Features of the Witkop Soils*  
—(continued).

Farm of origin ... ..	The Willows	Kalkfontein	The Willows	Olivier's Rust
Sample number ... ..	615	607	616	609
Underlying strata ... ..	Red Beds	Molteno Beds	Red Beds	Red Beds
Surrounding strata, which probably also have influenced soil composition	Red Beds with Dolerite dyke	Red Beds and Dolerite	Volcanic Beds, Cave Sandstone, and Dolerite dykes	Volcanic Beds, Cave Sandstone, and Dolerite
Local name for soil-type ...	Mixed sand and turf	Black turf (vlei)	Black turf (vlei)	Black turf
Colour ... ..	Dark brown	Black	Black	Black
Indigenous vegetation ...	Same as 608 with some clover as well	Rooi platblaar, rooi ruigte, blaw ruigte, and kweek grasses, together with a yellow-flowered trefoil	Rooi platblaar grass with some clover	Rooi platblaar grass, blawbloemetjes, and some suur rooigras
Crops found most suitable	Potatoes, wheat, and oats	Wheat	Wheat	Wheat and possibly lucerne
Degree of fertility ... ..	Very fair	High	High	High
Altitude above sea-level (approximate)	6500 ft.	6000 ft.	6150 ft.	6350 ft.
Period under crops ... ..	Virgin	Virgin	Virgin	Practically virgin
Analytical:—	Per cent.	Per cent.	Per cent.	Per cent.
Fine earth ... ..	100	100	100	100
Coarse sand ... ..	8·7	20·6	4·9	2·22
Fine sand ... ..	56·2	26·2	28·8	31·0
Silt ... ..	9·2	8·1	7·8	13·1
Fine silt ... ..	6·3	9·86	11·3	14·0
Clay ... ..	13·8	20·0	24·8	25·2
Solubility in N/5 Hydrochloric acid	0·76	2·20	7·59	2·59
Reaction ... ..	Acid	Alkaline	Alkaline	Acid
Carbonates ... ..	0·025	0·10	5·80	0·045
Humus ... ..	3·62	5·60	5·60	6·00
Loss on Ignition ... ..	4·2	8·4	9·5	9·3
Moisture ... ..	1·10	4·7	3·3	2·21
Permeability ... ..	1·31	—	0·116	—
Retentiveness ... ..	31·8	—	41·8	—
Nitrogen ... ..	0·13	0·23	0·26	0·20
Insoluble in organic matter	87·6	77·0	70·7	79·2
Lime ... ..	0·85	1·09	3·9	1·2
Magnesia ... ..	0·30	0·66	0·97	0·85
Potash ... ..	0·52	0·57	0·54	0·63
“Available” Potash ...	0·025	0·019	0·034	0·025
Phosphoric oxide ... ..	0·078	0·114	0·117	0·055
“Available” Phosphoric oxide	0·012	0·021	0·028	0·021

TABLE VII—(continued).

Classified Summary of the Principal Features of the Witkop Soils  
—(continued).

Farm of origin ... ..	Witkop	Paardenverlies	Kalkfontein	Kraaifontein
Sample number ... ..	617	614	610	618
Underlying strata ... ..	Molteno Beds	Molteno Beds	Molteno Beds	Molteno Beds
Surrounding strata, which probably also have influenced soil composition	Volcanic Beds, Red Beds, Cave Sandstone, and Dolerite dykes	Dolerite	Red Beds and Dolerite	Red Beds
Local name for soil-type ...	Black turf	—	Vlakte	—
Colour ... ..	Black	Black	Dark brown	Dark brown
Indigenous vegetation ...	Blauwsaad and kweek grasses, kamferbos, and some clover	Blauwsaad and rooi platblaar grasses with some clover and sour Karro bosjes	Rooi platblaar, rooi ruigte, and suur rooi grasses with a few suur Karro bosjes	Kweek and blauwsaad grasses and some clover
Crops found most suitable	Wheat and potatoes	Wheat	Excellent grazing	Wheat
Degree of fertility ... ..	Good	Good	—	Fair
Altitude above sea-level (approximate)	6100 ft.	5800 ft.	5950 ft.	6000 ft.
Period under crops... ..	Virgin	Virgin	Virgin	Virgin
Analytical:—	Per cent.	Per cent.	Per cent.	Per cent.
Fine earth ... ..	100	100	100	100
Coarse sand ... ..	13.7	8.4	9.2	6.6
Fine sand ... ..	30.0	33.1	31.5	32.2
Silt ... ..	13.5	14.1	2.5	18.3
Fine silt ... ..	9.9	16.1	26.4	19.3
Clay ... ..	20.7	20.0	23.8	15.0
Solubility in N/5 Hydrochloric acid	1.24	0.71	1.37	1.89
Reaction ... ..	Acid	Acid	Acid	Acid
Carbonates ... ..	0.042	0.005	0.025	0.025
Humus ... ..	5.50	5.60	3.20	2.96
Loss on Ignition ... ..	7.70	5.50	4.00	4.90
Moisture ... ..	3.10	1.96	1.18	1.58
Permeability ... ..	0.43	0.34	—	0.30
Retentiveness ... ..	39.3	33.9	—	35.5
Nitrogen ... ..	0.21	0.15	0.11	0.12
Insoluble inorganic matter	74.4	83.7	84.5	87.5
Lime ... ..	0.87	0.53	0.54	0.42
Magnesia... ..	0.52	0.50	0.45	0.35
Potash ... ..	0.55	0.47	0.58	0.51
“Available” Potash ...	0.613	0.033	0.022	0.027
Phosphoric oxide ... ..	0.082	0.100	0.053	0.047
“Available” Phosphoric oxide	0.013	0.018	0.019	0.003



TABLE VIII.

*Average Composition of the three Principal Types of Witkop Soils.*

	Sandbult.	Mixed Sand and Turf.	Black Turf.
	Per cent.	Per cent.	Per cent.
Fine earth ... ..	99·2	100	100
Coarse sand ... ..	19·7	5·1	10·4
Fine sand ... ..	54·7	55·4	29·0
Silt ... ..	5·0	10·0	10·6
Fine silt ... ..	4·7	9·0	11·3
Clay ... ..	11·2	13·0	22·7
Solubility in N/5 HCl ... ..	0·71	0·81	3·4
Reaction ... ..	Acid	Acid	—
Carbonates... ..	0·018	0·03	—
Humus ... ..	1·51	3·4	5·7
Loss on Ignition ... ..	2·93	4·45	8·7
Moisture ... ..	0·71	0·90	3·32
Permeability ... ..	3·1	0·9	0·27
Retentiveness ... ..	26·0	33·4	40·6
Nitrogen ... ..	0·08	0·15	0·25
Insoluble inorganic matter ... ..	90·0	86·8	75·0
Lime ... ..	0·27	0·16	1·76
Magnesia ... ..	0·22	0·37	0·75
Potash ... ..	0·38	0·46	0·57
“Available” potash ... ..	0·014	0·026	0·025
Phosphoric oxide ... ..	0·048	0·066	0·092
“Available” phosphoric oxide ... ..	0·003	0·015	0·021

Taking the “chemical” figures first, it will be observed—excepting the figure for “insoluble inorganic residue,” a figure which represents that portion of the soil which is insoluble in strong acids, and therefore of little or no use to the plant for food purposes—that the figures are lowest for the sandbult type, intermediate for the mixed type, and highest for the black turf group.

Coming to the “mechanical” differences, a study of the tables will show that there are clear differences between the three types. For example, as one proceeds from the sandbult to the mixed type, and thence to the black turf type, there is a marked increase in the humus content of each group; clay likewise increases, similarly also the silts and the retentiveness to water. On the other hand there are decreases in the sand content, the sandbult type containing most and the black turf least—decreases which are, as was to be expected, accompanied by a diminishing permeability to water.

In passing, it may be pointed out that 613 would fall under the mixed type did it contain more humus; so also would 614 come under the black turf type had it a higher humus content.

No attempt will be made at this juncture to trace the boundaries of soil types; to do so at all accurately would necessitate much more field work. Speaking approximately, the sandbult type occupies the bults, the mixed turf and sand soils occupy the lower slopes of the hills and mountains, while the black turf soils are found in the valley bottoms, in vleis, and in kloofs.

Since the general reader may find it somewhat difficult to follow figures, Table IX has been compiled in which, in place of figures, the terms "fair," "good," and so on have been used.

TABLE IX.

	Sandbult Type.	Mixed Sand and Turf Type.	Black Turf Type.
Fertility... ..	Very low	Very fair	High
Colour .. .. .	Reddish brown	Dark brown	Black
Situation ... ..	Bults	Lower slopes of mountains, etc.	Vleis, kloofs, and valley bottoms
Organic content ... ..	Low	Medium	High
Clay and silts ... ..	Rather low	Medium	High
Sands ... .. .	Very high	High	Medium
Permeability ... ..	High	Medium	Fair
Retentiveness ... ..	Fair	Good	Very good
Plant food ... ..	Low	Fair	Good
Crops found most suitable ...	Oats and rye	Potatoes and wheat	Wheat

The soils which are the most fertile are evidently those which, owing to their high proportion of humus, are black in colour and which contain a good amount of plant food and considerable quantities of clay and silts; all of which points to the utility of the laboratory investigation of the soil.

The reddish brown soils are without exception highly permeable to water and only fairly retentive; they lack humus and are poor all round in plant food. In the experience of the farmer they are very poor crop producers. Again the experience of the farmer and laboratory investigation are in agreement, as is also the case with the mixed dark brown type. In this connection the writer would like to express the opinion that laboratory investigation, based on careful work in the field, is of much assistance to farmers; that it is only where the field work (as, for instance, the sampling which, in the writer's experience, the average farmer is not good at, notwithstanding clear written instructions) has not been properly done that analytical methods are likely to fail.

So far we have only alluded, here and there, to the influence of geological origin on the fertility of the soil. Nothing very definite can be said on this point, but it is obvious from Table VII that the best soils are those in the formation of which there would appear to have been lava or doleritic influence. The nearer the volcanic beds or dolerite the better are the soils. In this connection the following is of interest with reference to the sale in portions of a Witkop farm. The portion of the farm on which there is a large mass of volcanic beds was sold for £13. 15s. per morgen; lower down, where the soils overlie Molteno beds, but are doubtless still subject to lava influence, the price fetched was £11 per morgen; lower down still the price dropped to £8 per morgen.

The record of the vegetation given in Table VII is perhaps not very complete but is the best the writer could do unaided by a botanist. From the data therein set down it would appear that the best soils are those which carry the greatest variety of plants; that

soils monopolized by suur rooigras en blauwsaad gras are poor; that the platblaar and ruigte grasses are indicative of good soils. A point worthy of note in connection with the indigenous vegetation is that clover grows very well in many localities if protected from stock: its roots were invariably found to be well infected with the nodule-forming bacteria.

#### REFLECTIONS.

There is not the slightest doubt that the development of the Witkop area is being held back owing to transport and haulage difficulties which is a pity, because, owing to its considerable acreage of excellent wheat lands, the valuable national asset we possess in this area is only partially developed. The climate is also particularly well suited to wheat culture. True, a large area of the district is taken up by the infertile sandbult soils, but even these could be made fertile by a proper system of farming which would involve the application of phosphatic manures and incidentally the transport of them.

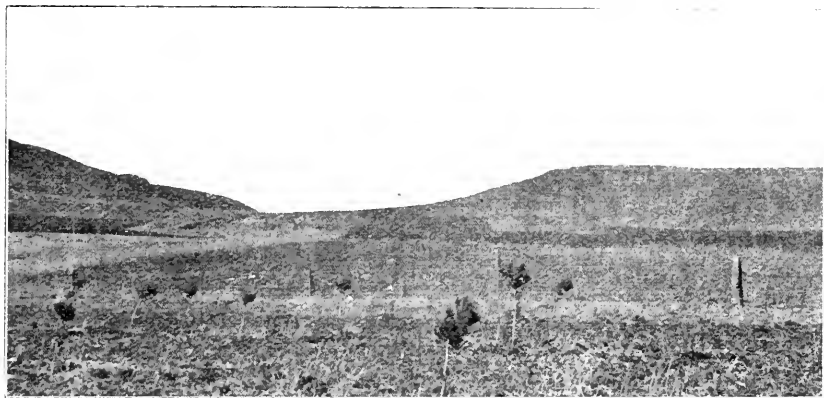

Plate No. IX.

#### DANKFONTEIN'S NEK.

Volcanic beds surmount the hills. Bo'land samples were taken here. The small pine trees in the foreground came through the very severe frosts of last winter well.

As in most other parts of the Union ploughing, harrowing, and transport are dependent on the ox. Transport to and from Witkop is a matter of considerable difficulty; the railway is far distant (Burghersdorp is the nearest station) and the road is very heavy, especially when there is most call for transport, i.e. from January to April, months during which most of the annual rainfall is precipitated. These are the months when the farmer sends his grain to market. To enable him to do so he has to reserve for grazing for his oxen large areas of what could be turned into some of the best wheat lands of the Union. Under present conditions a span of oxen cannot make more than three journeys per month to Burghersdorp without getting seriously knocked up. Thus it happens that not only is there a minimum of good wheat land under cultivation, but, also, the ploughing and harrowing that should be done during those months to

conserve the rainfall and prepare the seed-bed for April-May sowings, cannot be undertaken. Following on this, seeding time is delayed owing to the necessity of waiting for rain to enable ploughing to be done. Thus it comes about that there is much spring-sown wheat. Late sowing not only means reduced yields on account of the lateness of the sowing, but also the risk to the crop of being covered up with sand blown by the heavy winds of August-September. What applies to the wheat crop in respect of cultivation also applies in a considerable degree to other crops; one of the great needs of the Witkop area is more thorough cultivation and better preparation of the seed-bed.

It is difficult to see how the farmer is to cultivate better under present conditions; but since the development of wheat-producing areas would seem to be a matter of national importance, it is permissible to point out how the position would be improved. Good roads that would bear heavy wagon traffic in wet weather are not to be despised; so much the better if they would also bear heavy motor

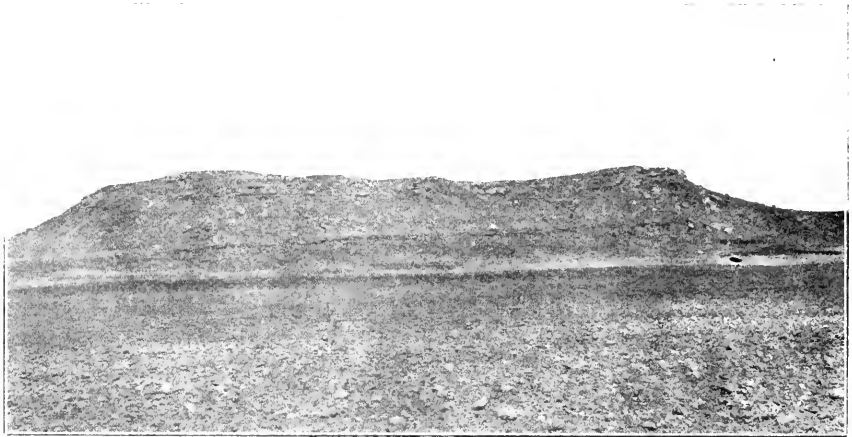

*Plate No. X.*

VAALKOP.

From the rock fragments of various sizes which cover its sides it is evident that this kop is weathering. The soil below the kop is a mixed sand and tuif type.

traffic, for this would free the oxen for other purposes and incidentally would lead to an increased acreage under the plough, part of which increased acreage could be devoted to the production of fodder crops. Tractor ploughs would also be very useful. Best of all, of course, would be a railway.

Shelter for stock is badly needed and would of itself make the grazing go further, because when animals are well sheltered they require less food for maintenance. Many kinds of trees grow well in this area; one wonders therefore why the farmer does not plant shelter belts, which would, besides protecting his cattle from the biting cold winds, enhance the value of his land. The writer gathers that the principal reason why tree-planting is not indulged in away from the homesteads is the necessity to fence in the young trees against the animals grazing on the farm.

A few words concerning crops that are not grown at Witkop, but which would probably do well, will not be out of place, especially if they are crops that will help the farmer to carry more stock and plough more acres. Of such crops mangel wurzel, swede turnips, and white turnips should do very well. Mustard should also succeed as a seed crop. Clovers, sainfoin, vetches, rye grass, and teff grass are likely to succeed as hay crops and soil improvers. Horse beans and field peas are crops that should do well and provide not only an increased store of fodder, but also a source of income from sales.

The climatic conditions would appear to be very suitable for the apple and the pear, for ordinary and for greengage plums. Of smaller cultures blackberries, raspberries, currants, gooseberries, and strawberries are among those that might be expected to thrive at Witkop.

In conclusion, I have to thank members of my staff (particularly Mr. W. Torrance, who made most of the analytical determinations) for the assistance they rendered in connection with the above work.

---

## APPENDIX.

---

### METHODS OF ANALYSIS, ETC.

1. *Sampling*.—This was done in accordance with the official instructions of the Department of Agriculture (*vide* Regulations and Tariff for Chemical Analyses of Agricultural Materials).

2. *Chemical Analysis*.—(a) Nitrogen by Kjeldahl's method; (b) lime, magnesia, phosphoric oxide, potash, and insoluble inorganic matter were determined, after extraction of the soil, for twenty-four hours in a boiling water bath, with hydrochloric acid, sp.g. 1.112; (c) "available" potash and phosphoric oxide were determined after extraction of the soil according to Dyer's method.

3. *Mechanical Analysis*.—A. D. Hall's beaker method was employed.

*N.B.*—(1) Humus in the analysis represents the loss on ignition of the clay fraction. (2) Carbonates were determined by the method of Hutchinson and Maclellan (*J. Agr. Sci.*, 1914, p. 323).

4. *Permeability to Water*.—100 grns. of air-dried fine earth are made slightly moist and then packed into a brass cylinder having a 60-mesh gauze bottom, and provided with a detachable snugly fitting funnel. The height of the cylinder is  $4\frac{1}{4}$  inches and its diameter  $1\frac{1}{2}$  inches. The soil having been packed into the cylinder, it is covered with a circular piece of filter paper. Distilled water is then added in definite quantity and the cylinder covered.

After the water has commenced to percolate well, water is added to restore the original head above the soil column and the time noted. Percolation is allowed to proceed until about 40 c.c. have been collected and the time again noted. A graduated cylinder is used to collect the percolate.

Finally the rate of percolation is calculated, i.e. c.c. water percolated per sq. em. soil surface per hour.

5. *Retentiveness.*—Any water remaining above the soil column at the conclusion of the above described percolation experiment is removed and the covered cylinder allowed to drain for twenty-four hours. By weighing before and after, and by taking into account the moisture contents of the air-dried soil, one calculates the percentage water retained by 100 grms. of oven-dry soil.

Neither the figures for permeability nor for retentiveness are to be regarded in any way as accurate. They have been found, however, to furnish very useful comparative data.

*(Succeeding articles of this series will deal with the Agriculture and Soils of the Elliot District.)*



### **Sterilization of Grain.**

An article in the August, 1919, issue of the "Monthly Bulletin" of the California Department of Agriculture tells of difficulties encountered by the American Government in guarding against the accidental introduction of new plant diseases in connection with emergency importations of cereals during the war. Maize from Asiatic countries, it is stated, was permitted to enter after sterilization by heat. A temperature of  $212^{\circ}$  F. was applied for a net period of three minutes and found to destroy disease spores and improve the quality of the maize. "This treatment," the article continues, "applied to barley, oats, or rye, does not interfere with the value of the cereal for stock feed. It does, however, kill the germ of the seed, making it useless for planting. Experiments completed and in progress show that the value of wheat for flour and bread making is also seriously impaired. Heating wheat with dry heat to  $140^{\circ}$  F. destroys all insects, but injury to the quality of the flour for baking begins at  $160^{\circ}$  F., and is completely ruinous to good bread-making at  $212^{\circ}$  F. The loaf decreases in volume as the heat is increased, while at the same time the colour becomes more yellow and the texture more brittle. The effect of live steam is even more pronounced. Live steam at  $212^{\circ}$  F. applied for three minutes reduces the loaf volume one-half, and otherwise renders it unfit. No application of heat which does not seriously injure the flour for bread-making will destroy the fungous spores, and, conversely, all applications of heat which destroy the spores completely ruin the flour for bread-making."

## IRRIGATION ENTERPRISE IN THE UNITED STATES OF AMERICA.

### Wonderful Engineering Achievements: Agricultural Disappointments.

IN any country like ours, with its wide stretches of arid land and uncertain rainfall, irrigation figures prominently as a question of great importance. It calls for skill and forethought, for an irrigation scheme requires the consideration of many factors, each of far-reaching importance. Irrigation is considered by many to be the concern of the engineer only. How mistaken this conception of irrigation is may be gauged from the fact that water supply is only one of the following factors, all of which are equally important in plant growth: (1) oxygen, (2) light, (3) temperature, (4) water supply, (5) food supply, and (6) absence of harmful factors. Then, also, a matter of first importance is the type of water available for use, whether it is saline (which is inadmissible) or whether it is suitable for the class of soil to be irrigated. Indeed, the agricultural and chemical side is of no less importance than the engineering aspect in the planning of any irrigation scheme. It is to be expected, therefore, that all schemes, many presenting new features in themselves, are not uniformly successful and that some are failures. The story of irrigation enterprise is one of varying fortunes. In fact, it is no exaggeration to say that by irrigation many thousands of acres of once fertile land have been made barren, owing to insufficient thought as to whether the land would *bear* irrigation and whether the water was suitable for the purpose. A valuable object-lesson is obtained from the history of irrigation undertakings in the United States, as outlined in an interesting article in the "Geographical Journal" for October, 1919, by R. H. Whitbeck, Professor of Geography at the University of Wisconsin, Madison. The article brings out most of the troubles besetting a country which is entering upon the more advanced stages of irrigation enterprise; in many respects we are having troubles of a similar nature in the Union. Professor Whitbeck's article refers to some extraordinarily bold engineering schemes most diverse in character, but such engineering feats, it may be added, are not confined to the United States of America. It must be admitted, for instance, that for courage and diversity of engineering problems the most recent irrigation enterprise undertaken in northern India, the great Punjab Triple Canal Scheme, is not surpassed in any other country.

In opening his article Professor Whitbeck states that 500,000,000 acres in the western half of the United States are very sparsely peopled, and normally produce no crops because of a lack of water. In the arid south-western parts of the country the Indians practised irrigation in a crude way centuries before the white man came. Then the Spanish settlers employed irrigation, and the practice gradually

spread with the influx of population. By 1889, 54,000 farms, having a total area of 3,600,000 acres were under irrigation; but the areas were not large, and the construction work was of a temporary character, the undertakings being carried out and managed by the settlers themselves, or groups of them working co-operatively. The first settlers had the choice of land, and selected, of course, that which could easily be irrigated. The method often took the form of a crude dam thrown across a stream from the mountains, flowing across an alluvial stretch whose soil wanted water only to make it productive. Some undertakings, however, required a large amount of capital and were managed by commercial enterprise; but it often happened that they were over capitalized and that the profits of the company were studied rather than the service to the farmers.

The following extract from the United States Census, 1910, shows the acreage irrigated by various classes of enterprise in 1909, and shows that nearly 90 per cent. was carried out under the conditions referred to above, viz.:—

Class of Enterprise.	Percentage of Total Acres Irrigated.
1. U.S. Reclamation Service ... ..	2.9
2. U.S. Indian Service ... ..	1.3
3. Carey Act enterprises ... ..	2.1
4. Irrigation districts ... ..	3.8
5. Co-operative enterprises ... ..	33.8
6. Individual and partnership enterprises... ..	45.5
7. Commercial enterprises ... ..	10.6
	100

Representing a total of 13,738,485 acres.\*

Of the other four methods of conducting irrigation enterprises (*vide* Nos. 1-4 in the foregoing table), only one—the U.S. Reclamation projects—has had any considerable development. The Reclamation Service (and from the term “reclamation” it must not be inferred that land which has been ruined is necessarily implicated: the word is more often used in the sense that good land lying idle through want of water is being reclaimed for the service of man) for carrying out irrigation works by the Government with money received from the sale of public lands, began its undertakings in 1902. Thirty great projects, scattered over a wide area, were undertaken, each with at least one major engineering problem for whose solution there was scarcely a precedent, and each with its own difficulties of labour, transport, and climate. Professor Whitbeck gives the following examples:—

“In North Dakota, in the Williston unit, the engineers found it impossible to secure water from the Missouri River by gravity methods, but lignite beds existed on Government land a few miles away. Here they installed a modern electric generating plant, using the lignite for fuel, and sent the current to a pumping plant installed

\* According to the 1918 Census, the irrigated area in the Union of South Africa was 958,823 acres, and the area irrigated and irrigable was 2,318,056 acres.



on a barge anchored in the river, whence the water is pumped into a reservoir and is distributed by gravity to the land. Government coal of a quality too poor to ship was to irrigate 30,000 acres of previously waste land. This project has not, however, proved very successful.

“ In Western Colorado is the Uncompahgre Valley, with a broad alluvial plain traversed by a small stream. Some miles away in a parallel valley is the larger Gunnison River flowing in a canyon. One valley had land without water, and the other water without land. The engineers drove a tunnel six miles long through a mountain range and brought the water of the Gunnison to the valley of the Uncompahgre, and it is irrigating 140,000 acres.

“ In the Yuma project in California-Arizona, the main canal has to be on the California side of the river, where there is less land to irrigate than on the Arizona side. An enormous inverted siphon passing under the river has been constructed, and the surplus water is carried to the east side, where it is distributed.

“ In the construction of dams for the reservoirs, a wide range of problems was presented. In several of the projects dams were built across deep and relatively narrow mountain gorges where the dam had to be very high but could be firmly anchored at the bottom and sides in solid rock. The famous Roosevelt dam in Arizona is solid masonry 280 feet high, 235 feet long on the bottom, and 1125 feet long on top. So great is the pressure of the impounded water that the dam is 180 feet thick at the base. A roadway on top is wide enough for three automobiles to travel abreast.

“ The Arrowrock dam in Idaho is 349 feet high, and the Sun River dam in Montana is 329 feet high: the Elephant Butte dam, in New Mexico, 318 feet; and the Shoshone dam, in Wyoming, 328 feet. Other dams have been built in broad, open valleys, where great length and thickness but small height were requisite. The Hondo dam, in New Mexico, is only 25 feet high, but has a crest length of over 3 miles. The Nelson Reservoir dam, in Montana, is 39 feet high and 4 miles long.

“ No two undertakings were alike. The ingenuity and resourcefulness of the engineers were tested anew with every project. No case illustrates this better than the Salt River project in Arizona. The topography of the region led to the adoption of a dam site 60-70 miles from the land which was to be irrigated. The nearest town of any size was 70 miles away, and the nearest railway 40 miles. The site selected for the dam was in almost inaccessible mountains. From the railroad to this site a road had to be constructed, miles of it cut into the precipitous face of the mountains. This road alone cost a half-million dollars. The expense of getting timber and cement to this remote region, involving a wagon haul of 40 miles, would have been prohibitive. Moreover, labourers could not be induced to go there to work. Yet the building of the dam required a vast quantity of materials, a great number of workmen, and a large amount of mechanical power. The engineers decided to develop hydro-electric power at the dam site, and they built a power canal 15 miles long, costing a million and a half dollars, installed a power plant, and produced their power on the spot. They erected a cement mill, quarried the rock for making the cement, and manufactured

their entire requirement, 300,000 barrels, at the dam site. They built a wagon road 20 miles through the mountains to Government forests, cut their timber, erected a saw-mill, and sawed the necessary lumber. About the only inhabitants of the region were half-civilized Apache Indians, who despise manual labour, yet the Government officials actually induced hundreds of them to don overalls and wield the pick and shovel for daily wages. In fact, the major part of the unskilled labour was performed by these red men. So difficult was it to secure food supplies that Government employees raised a considerable part of the food needed for the men. Thus it was that power, cement, timber, labour, and food were wrung from the mountains and the desert, and the great dam was finished. It stores enough water to irrigate the dependent lands (200,000 acres) for two years, even if no rain fell in its catchment basin in that time. This project has 800 miles of canals; it cost over \$12,000,000 to construct; the power plant now sells electric power to the value of a half-million dollars a year, and a large part of the cost of the project may be paid for from this income."

#### THE OTHER SIDE OF THE PICTURE.

While these bold engineering achievements fill one with admiration, it is a sad fact that although some have seen their ultimate object attained, others have not, and there are instances where the agricultural gain is in no way commensurate with the effort and expense involved. Indeed, it is not unlikely that in some parts brought under irrigation the evil of waterless land has merely given way to, perhaps, the greater evils arising from the improper application of water. Thus, in Utah, dry-farming methods are succeeding to-day on lands lying above the furrows that led to the ruin of the irrigable areas below them.

The problems of an irrigation scheme are not all solved when the reservoir and distributing system are completed and water can be led over the lands. The method of applying water and the quantity applied are of supreme importance. The desert soil is porous, water quickly percolates through it, and in a few years an excess of ground water accumulates and spreads to the lower land. This results in water-logging, possibly ruining the land for crops, so that drainage and pumping have to be resorted to at great additional cost. Nearly every project in the United States is presenting this problem in a greater or less degree, and large sums of money are needed to remedy it. Thus, uncertainty regarding the final costs to be paid by the water users is deterring many from taking up the lands under the U.S. Reclamation projects, nearly all of which have unoccupied land. Had these projects been other than Government enterprises, all, Professor Whitbeck states, would have gone into bankruptcy; the money they bring in from water users would pay a fraction only of the interest charge; the majority are not paying to the Government the operating and maintenance cost, and large numbers of irrigation farmers would be ruined if Government laws and contracts were rigidly enforced. Lucernehay, it may be mentioned, is the largest crop grown under these projects, occupying about 40 per cent. of the area taken up and yielding 36 per cent. of the value of all crops.

In regard to the value of the land, Professor Whitbeck states: "It is fully established that it costs more to produce crops on our irrigated land than it does on good land under rainfall. . . . It seems clear that general farming under irrigation offers the average farmer little more than a living for his labour." There are, however, conspicuous cases of success, especially among the fruit growers of California, where a large portion of the crop is grown under irrigation. Here most of the irrigation is under private control, and, having been in progress more than fifty years, is firmly established.

The construction of the irrigation works has been very expensive, and far greater than was predicted when the Reclamation Act was passed. "To many Americans," the author states, "it appears that the Government entered upon its extensive irrigation enterprises too soon and on too costly a scale. Millions of acres of farm lands in the humid part of the United States are unused; millions more are producing but a fraction of their possibilities. There was no lack of good land that required no irrigation and would produce nearly as much as the irrigated land after great sums had been expended merely to bring water to it."

This huge experiment in irrigation, says the writer, "may cost the United States Treasury from a hundred million to two hundred million dollars, but it will not all be lost: a good deal of benefit will come from the undertakings."

"If the question is asked, Has irrigation in the United States been a success? the answer is neither Yes nor No." It has been an unquestionable success in many enterprises, a reasonable success in others, while many cases also of financial failure have resulted.

Farmers are aware of the several irrigation schemes of the Union, and the brief outline given above of the story of irrigation enterprise in the United States will bring with it this lesson, that each irrigation scheme has its own problems and difficulties. Some schemes originally pregnant with brilliant possibilities may be found in the course of time to be adversely affected by forces, some beyond the power of man and others unforeseen, which may reduce them to failure or considerably modify the good originally anticipated. Therefore let it be borne in mind that an irrigation scheme cannot be entered into lightly. It calls for the most scrupulous care, skill, and foresight. The oversight of any of the problems involved in a scheme, or lack of due regard thereto, may lead to disaster. As indicating what may happen, readers are referred to an article appearing in the April, 1920, issue of the *Journal*, entitled "Brak in its relation to Irrigation," which discloses some of the dangers to be considered in irrigation enterprise.

---

### Export of Grain, etc.

The exports of grain, etc., for the month of October, were as follows: Maize, 40,526 bags; maize meal, 37,484 bags; hominy chop, 11,160 bags; oats, 830 bags; lucerne seed, 150 bags; and kaffir corn, 10 bags. For September the figures are: Maize, 8111; maize meal, 650; hominy chop, 6352; oats, 125; and lucerne seed, 216. The total number of bags exported from 1st July last to 31st October was: Maize, 58,667; maize meal, 38,854; hominy chop, 17,512; oats, 955; beans, 138; lucerne seed, 366; and kaffir corn, 10. Stocks on hand at all ports on 31st October, 1920, were, in bags: Maize, 88,630; maize meal, 61,685; hominy chop, 5409.

## A SOUTH AFRICAN GUM

(*COMBRETUM ERYTHROPHYLLUM*, BURCH.).

By K. A. LANSDELL, Division of Botany, Pretoria.

In recent years much difficulty has been experienced in obtaining supplies of "Gum Tragacanth," which to-day is selling in South Africa at 22s. per lb. Gum Tragacanth is used extensively in tanneries, and the prohibitive price and lack of material suggested that local sources of a substitute should be investigated.

Mr. Chas. Maggs, of Pretoria, approached the Division in October, 1919, for assistance in this matter, and the subsequent investigations of Dr. I. B. Pole Evans resulted in an excellent native substitute for Gum Tragacanth being brought to light in the shape of a half-insoluble gum produced by a local tree—*Combretum erythrophyllum*. A sample, 2 lb. in weight, was submitted to Mr. Maggs for trial, and he reported as follows: "I have carefully tested the sample and am very pleased with the result. The gum is soluble with difficulty, and when applied as a coating is elastic, quite unlike Gum Arabic, which powders and crumbles when dry. I consider that this gum is a good substitute for Gum Tragacanth, as it is tasteless, and so far as I am aware does not possess any injurious properties. I shall be very pleased if you could inform me where I may obtain trees or seeds of the tree for planting."

Mr. Maggs further states that the local gum has been used by him as an elastic non-cracking varnish for finishing uppers and other leather; previously he had used the imported Gum Tragacanth exclusively, but finds the local product every bit as effective, and, especially now that Gum Tragacanth is such a prohibitive price, infinitely cheaper. The gum is applied in a solution of water mixed with various dyes: the strength of the solution varies with the nature of the surface under treatment. As there is a large demand for gums of this nature a sample of the local gum was submitted to the Imperial Institute for valuation on the London market, and the following report has been received:—

"*Description of Sample.*—The sample weighed 2 lb., and consisted of small irregularly shaped tears, many of which were elongated and stalactitic in form. The tears were pale yellow to pale yellowish-brown, and had an average weight of about 2 grammes. The sample was in fairly clean condition, and contained only a small amount of adherent bark.

"*Results of Examination.*—The gum was analysed, with the following results:—

	<i>Per cent.</i>
Moisture... ..	11.2
Ash ... ..	2.6
Acid value ... ..	7.1



*Combretum Erythrophyllum*, Burch.  
(FLOWERING BRANCH.)

K. A. LANSDALL,  
Division of Botany,  
Pretoria.

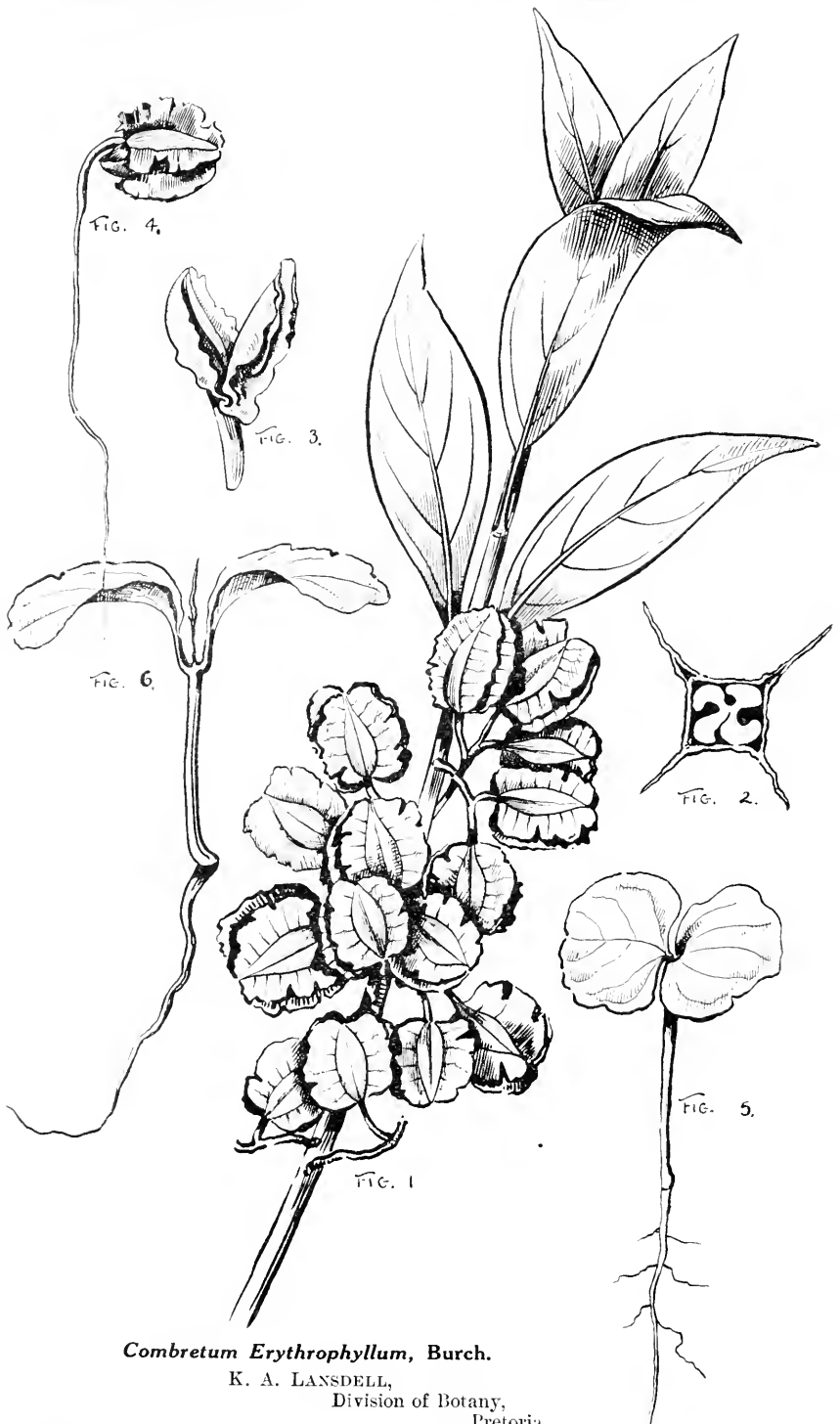

***Combretum Erythrophyllum*, Burch.**

K. A. LANSDELL,  
Division of Botany,  
Pretoria.

Plate II. FIG. 1.—Fruiting Branch. FIG. 2.—Cross-section of fruit showing the folded cotyledons. FIG. 3.—Embryo removed from the fruit showing the two folded cotyledons and the cylindrical radicle. FIG. 4.—A stage in germination. FIG. 5.—Seedling showing a surface view of the cotyledons. FIG. 6.—Seedling showing a side view of cotyledons and plumule.

“With ten parts of cold water the gum formed a pale-coloured jelly, which was fairly clean and transparent and practically without odour or taste. On heating with water, the gum readily dissolved and furnished a permanent homogeneous solution. A 10 per cent. solution obtained in this way was, after filtration from insoluble matter, a brownish, slightly cloudy liquid with a viscosity of 83.7, as compared with 1 for water and 7.0 for a 10 per cent. solution of Gum Acacia made under the same conditions. The solution possessed fair adhesive power.

“*Commercial Valuation.*—Samples of the material were forwarded for valuation to brokers and merchants in London, who did not consider it likely that the gum would be saleable under present conditions except at a very low price. Both firms, however, suggested that a trial shipment of the gum might be forwarded in order to test the market.

“*Remarks.*—This gum is superior in quality to previous samples of Combretum Gum received at the Imperial Institute from other sources, being pale in colour and easily rendered soluble by heating with water. The solution is also of fair adhesive power. As stated above, it is doubtful whether the gum would be saleable at the present time in the United Kingdom at a remunerative price, but in order to ascertain this definitely a small consignment of a few cwt. might be forwarded to the Imperial Institute so that further inquiries and technical trials can be made.”

#### DESCRIPTION.

*Combretum crythrophyllum*, Burch., a tree 15.20 feet high, or bush 8-10 feet high. *Branches* opposite, greyish, smooth; branchlets densely pubescent. *Leaves* opposite or sub-opposite, 4.5-7 cm. long, 1.5-2.5 cm. broad, elliptic or elliptic-lanceolate, shortly acuminate, acute, narrowed at the base, pubescent above and beneath. *Inflor-escence* axillary, more or less globose, on tomentose peduncles up to 2 cm. long. *Pedicels* and receptacle tomentose. *Petals* spatulate. *Fruit* 1.3 cm. long, 1.2 cm. broad, 4-winged.

This tree, locally known as “Rodeblad Vaderlands Wilg,” or Bosveld Wilg,” is found in the Transvaal, East Griqualand, and Natal. It grows plentifully in the valley of the Aapies River in the neighbourhood of Pretoria, and produces fruit freely. The smaller trees or bushes growing away from the river “gum” more copiously than the taller trees on the river bank. In the Fountains Valley, near Pretoria, three natives gathered 5½ lb. of gum in 3½ hours.

The fruits are often infected with a grub, but sound fruits germinate readily, and at present no difficulty can be foreseen in establishing a plantation of this Combretum in suitable localities.

Samples of the gum and specimens of the tree yielding it may be seen at the Division of Botany, Pretoria, and any further information which the Division may receive regarding this gum may be had on application to the Chief, Division of Botany, P.O. Box 994, Pretoria.

## BREEDING SHEEP FOR THE EXPORT TRADE.

By O. RIVERS, Officer in Charge of Sheep, Potchefstroom School of Agriculture.

DURING the past five years much has been done by cattle breeders to improve breeds with a view to meeting the requirements of the export trade, and they are certainly going the right way to work to breed beef suitable for the European markets, although, of course, it will take some years yet before any great number of the right class of cattle will be available after our wants are supplied. The war has retarded to a great extent the importation of the best beef sires, but there is every hope that as shipping becomes more plentiful in the near future large numbers of good beef bulls will be imported to carry on the work so well begun.

Why is it that our sheep farmers never seem to think of the possibilities of the great trade in mutton that can be worked up in considerably less time than it takes to grow the right kind of beef? Is it because they are so well satisfied with what they are doing already or because they are indifferent to the enormous outlet they have for the right class of sheep? At the present time, and for some years past, there has been the greatest opportunity for South Africa to participate in this trade, yet up to the present, if we take the number of carcasses of mutton exported as a guide, there has not been anything like the progress there ought to have been, nor is the number increasing.

South Africa has now some of the finest parent stock on the female side to work on that can be found anywhere in the world. I refer to the few million Persians and Bastards we have. These sheep will sell as they are in Europe, in fact almost anything will sell there at present, but it is not for the present we want to work, but for a sound export business in the future, so that in due course we shall be able to hold our share of this great trade against all comers.

For some years past experiments in crossing Blackhead Persian ewes with Suffolk rams have been carried out at Potchefstroom, and the results have been very satisfactory, and many farmers who have seen what has been done have been so struck with the results that they intend taking up this line of cross-breeding in future in preference to going on with the Persian, as they are fully alive to the advantages that the crosses have over the pure breeds, not only for the local markets of South Africa, but also for export.

The

### BENEFIT TO THE FARMER

of crossing Suffolk rams with Persian ewes has been conclusively proved; the first cross are of a very good shape and carry the fat evenly distributed all over the body, the lambs commanding a ready sale at first-class prices. They are very hardy and thrifty and grow out to good marketable weights at five months old, if given anything



like a fair chance to do so, and care is taken to keep them free from worms. This is absolutely necessary if the best results are looked for. This cross also gives a fleece of black wool which is of a good hosiery quality and has brought up to 19½d. per lb. The average weight of fleece for twelve months is about 2 lb.

The second cross, breeding from the first cross ewes with Suffolk rams, is even better; they mature earlier, and as lambs at five months, kept under exactly similar conditions, average from seven to eight pounds heavier, while their fleece is superior in quality, and a large percentage are white-woolled sheep. The weight of fleece is also nearly double, and the price obtained for the wool much better.

With winter-fed lambs on green feed (oats and green lucerne) some excellent results have been obtained at Potchefstroom, where 20 first-cross lambs at nine weeks old at the beginning of July, off veld, weighed an average of 44½ lb. each (890 lb. total weight), and 12 second-cross, of the same age, averaged 53 lb. each (636 lb. total weight), the average weight for the 32 lambs being 47.69 lb. each. These lambs were fed on crushed mealies, bran, and oats at a cost of 2s. 3d. per head for ten weeks, in the same paddock of green oats or lucerne. The first-cross gained 33.5 lb., or nearly half a pound a day, finishing at 78 lb. each (total weight of 20 lambs, 1560 lb.). The second-cross gained 39.75 lb. each in the same time and on the same feed, and finished at the remarkable weight of 92.75 lb. each, a gain of over half a pound a day (total weight of 12 lambs, 1115 lb.).

These lambs would have sold on the Johannesburg market at anything from 35s. to 40s. each, and at the present time would fetch considerably more.

Seventeen similar lambs—10 of which were first-cross and 7 second-cross—whose total weight was 743 lb., or an average of 43.75 lb. each, kept as controls, and fed entirely on green oats or lucerne with no artificial feed, did remarkably well. They started on the green feed at the same time as the fed lambs, and ten weeks later had gained 27.25 lb. each, the total weight of the 17 being 1206 lb., or an average of a fraction less than 71 lb. each, and were all fit for market.

#### IX COMPETITION.

During the past three years trial lots of these cross-bred lambs have been sent to London for sale, and have been very highly thought of by the leading salesmen there, who say they can do with any quantity of similar lambs. As these salesmen are not backward in criticizing anything that is considered unsuitable, it is sufficient proof that lambs of the above kind will always be welcome, and that the grown sheep are of the type wanted.

Picked lambs of the first cross of this type (actual age 4 months 20 days) won first prize in the under-six months class at Johannesburg Fat Stock Show in 1917; first and champion in 1918; while second-cross got first prize, with first-cross second, in September, 1919, and were beaten by lambs one year old for the championship, seemingly an unfair comparison in view of the differences in the ages of the competitors. In 1917 the first-cross lambs averaged 74 lb.; in 1918, 78 lb.; and in 1919, 83 lb. The second-cross, exhibited only in 1919, averaged at the same age (4 months 23 days) 93 lb. live weight. These weights speak for themselves, and comment is needless.

The

### THIRD CROSS

favours the Suffolk very much, is a hardy good doer, and carries a good fleece of wool weighing up to 6 lb., with very little grease in it, consequently bringing in a good price per lb. Hamels of this cross at 2½ years have averaged 85 lb. of beautiful mutton, the fat being very evenly distributed; a few hamels that were shown at Johannesburg Fat Stock Show, 1918, were killed during the winter of 1919, giving from 90 lb. to 115 lb. of dressed carcass.

These weights and the quality of mutton will command the attention of the best buyers on the London market, and if farmers will try, even on a small scale, this class of cross breeding, they will be so satisfied with the results that in a very short time there would be many thousands of sheep fit for export. One of the great advantages in breeding crossbreds from the Persian ewe is that the progeny appear to inherit all the good qualities of their dams, being resistant to most of the many diseases unfortunately found in this country, and their fattening qualities are in no way diminished nor their hardiness, while, in addition, they have a more symmetrical frame. They will thrive and do equally well as their mothers on the veld, and neither grass seed nor ticks worry them much, although it is much better, of course, if the latter can be kept down, especially as these sheep can be dipped in almost any kind of dip at fortnightly intervals without doing the wool any harm, thus assisting in cleansing the farm from ticks.

Another great advantage is that even the third cross do not grow any belly wool to speak of; their points are also, comparatively speaking, bare, and the head is quite free from wool, so that in a country where it would be quite impossible to keep Merino sheep successfully because of the grass seeds, the cross will thrive and pay much better.

Of the April, 1918, lambs which were fed all the winter on green feed until September, and ever since out on rough hill veld country, with very little grass and a little thorn bush, the majority at the beginning of 1920 were fit for market and have all grown out well. This shows what adverse conditions they are able to stand. Another point worth consideration is the Suffolk ram; he is just right for this cross, seems to nick very well, and is, in the opinion of the writer, about the best of the English breeds for the purpose, as he has the frame and covering of flesh, the good thick thigh, and is a hardy, active, thrifty sheep; taking him all round, he seems to adapt himself to adverse conditions in a way that shows he has come to South Africa to stay.

Suffolks are, at the present time, very scarce, the supply being far from equal to the demand, and there is an excellent opening for a few breeders of rams, who will not only be making money themselves but be assisting other farmers who wish to push this line of cross-breeding but find it impossible at present to get rams at any price.

Farmers must not be tempted to use half or three-quarter bred Suffolk-Persian rams for cross-breeding purposes, as they will not give the results obtained by the use of the pure Suffolk ram.

The above experiment has not yet been concluded, but has gone far enough to prove without a doubt that its application as a commercial proposition assures success.

Other experiments have still to be conducted with some of the English breeds of sheep on our native stock to ascertain which cross will give the best results. There are large areas where millions of more or less nondescript native sheep are being depastured, and the result of crossing them with a desirable mutton sheep will have a far-reaching effect on the lamb and mutton export trade of South Africa.

---

ELSENBURG SCHOOL OF AGRICULTURE.



WINNING FRIESLAND GROUP, ROSEBANK SHOW, 1919.

---

### Lucerne Seed.

There are no regulations in force providing for the examination of lucerne seed prior to shipment, but when requested to do so by shippers the Department undertakes the inspection of such seed to ascertain its freedom from dodder, and carries out a germination test, the charge for the service being 3d. per bag. Each bag is stamped with the Government's mark to show that it has been examined, and a certificate is issued to the effect that the seed is free from dodder and stating the percentage of its germinal power. Capetown is the only port at present where such tests are carried out.

It may be mentioned that the requirement of the Commonwealth Government that 5 per cent. of the total bulk of lucerne seed imported into Australia must be stained with saffarin has been withdrawn for the present.

## A CHEAP SERVICEABLE HIVE MADE FROM PARAFFIN BOXES.

By S. H. SKATFE, M.A., M.Sc., Entomologist, School of Agriculture, Cedara, Natal.

AT the recent agricultural shows held at Pietermaritzburg and Durban a double-sided hive for Hoffman frames was shown as part of the Cedara School of Agriculture exhibit. This hive, which was made entirely out of empty paraffin cases by the students at Cedara, attracted a good deal of attention, and many inquiries were received concerning the details of its construction. The following directions are, therefore, given more especially in the interests of those desirous of keeping a few colonies of bees, who are deterred from making a start by the initial outlay involved. These directions are not intended for the skilled carpenter, but only for the average man who has little time or skill to devote to the elaboration of dove-tailed joints and other refinements of the highly finished article.

A photograph of the complete hive, in use in the apiary at the above school, is shown in figure 4. Its construction is simplicity itself; the only tools required are hammer, saw, and plane, and the materials from which it is constructed consist of a few empty paraffin or petrol boxes. The component parts of the hive are shown in figure 5.

The paraffin box is just of the size required for the brood chamber, and this fact does away with much tiresome measuring and ensures a certain degree of accuracy otherwise difficult to attain. The brood chamber (figures 1-3) consists essentially of an empty paraffin box from which the sides have been removed, the lid replaced, and the whole turned on its side. The box, when taken this way, will just accommodate ten Hoffman brood frames, but the sides are too thin to afford the requisite amount of strength or of protection for the bees, hence they must be reinforced.

Narrow strips of wood are nailed along each side, as shown in figure 2, and on top of these a second side is nailed securely (figure 3). This not only greatly strengthens the box, but at the same time makes a double side to the chamber with an air-space in between, which keeps the bees cool in summer and warm in winter, a very important factor in successful beekeeping. But the exposed ends (figure 3E) are insufficiently protected from the weather and would soon warp, hence these have to be bound in strips of tin cut from empty paraffin tins (figure 5c). These strips are cut out with a pair of tin shears to the shape shown in figure 7 and nailed on with half-inch tacks. Binding the corners in this way renders them impervious to the weather and makes the joints as strong as any dove-tailed joint could be.

To complete the brood chamber, pieces of wood have to be nailed on the inner side of each end to form ledges for the support of the frames. A longitudinal cross-section of the brood chamber, with a

1.

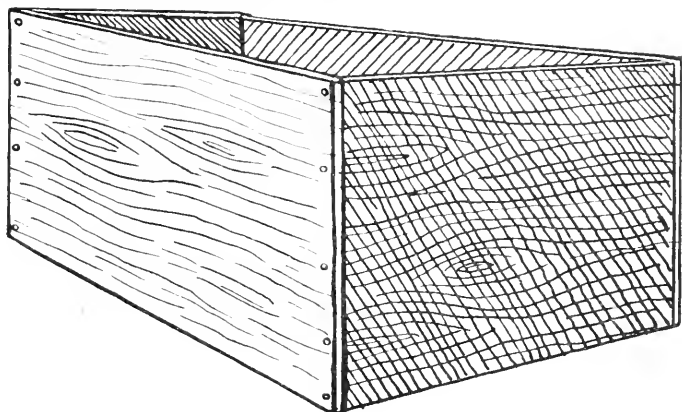

2.

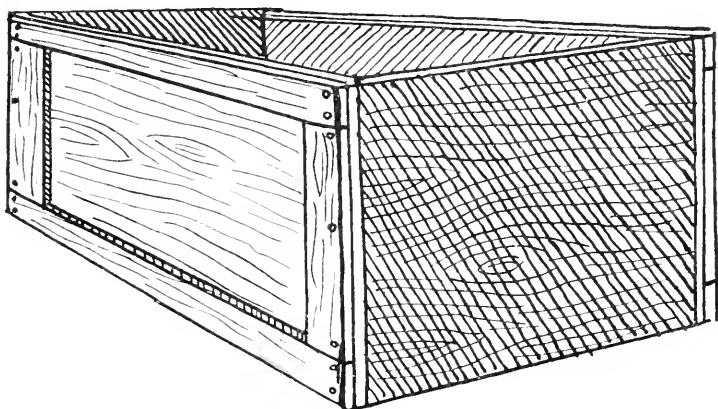

3.

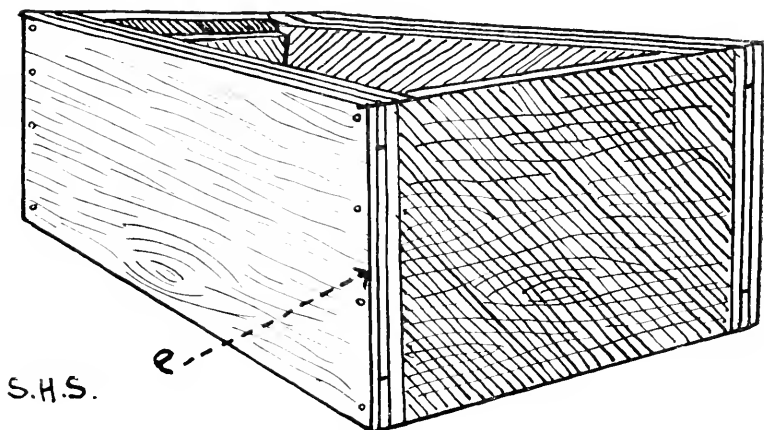

FIG. 1.—Brood Chamber, 1st Stage in Construction. FIG. 2.—Brood Chamber, 2nd Stage. FIG. 3.—Brood Chamber, 3rd Stage.

Hoffman frame in position, is shown in figure 6. The inner pieces (*a*) measure  $8\frac{3}{4}$  inches by 14 inches by  $\frac{3}{8}$  inch, and are cut from the sides of a paraffin box. They are nailed on the inside of each end, flush with the bottom, and seven-eighths of an inch from the top. A narrow strip of iron, such as is used in binding packing cases, is now nailed along the top edge of each of these end-pieces so that it projects above the edge for a quarter of an inch (figure 6*a*). The edge of this



FIG. 4.—Photograph of one of the Hives in use in the Apiary, Cedara School of Agriculture. Danzenbaker Hives in the background.

iron strip forms the only point of contact between the frames and the sides of the hive, hence the bees are unable to gum the frames fast with propolis, or bee-glue, a feature which greatly simplifies the manipulation of the frames. At the same time a passage-way is left for the bees beneath the ends of the frames, and this prevents their being crushed when the frames are moved.

The Hoffman frames are turned out so cheaply by machinery nowadays that it does not pay to make them at home. They can be bought of any dealer in beekeeper's appliances, and cost about 5s. 6d.

a dozen. Ten are required for each brood chamber, so five dozen would be sufficient for six hives. The copper staples shown at (c) in figure 6 are supplied with the frames, and serve to keep the frames

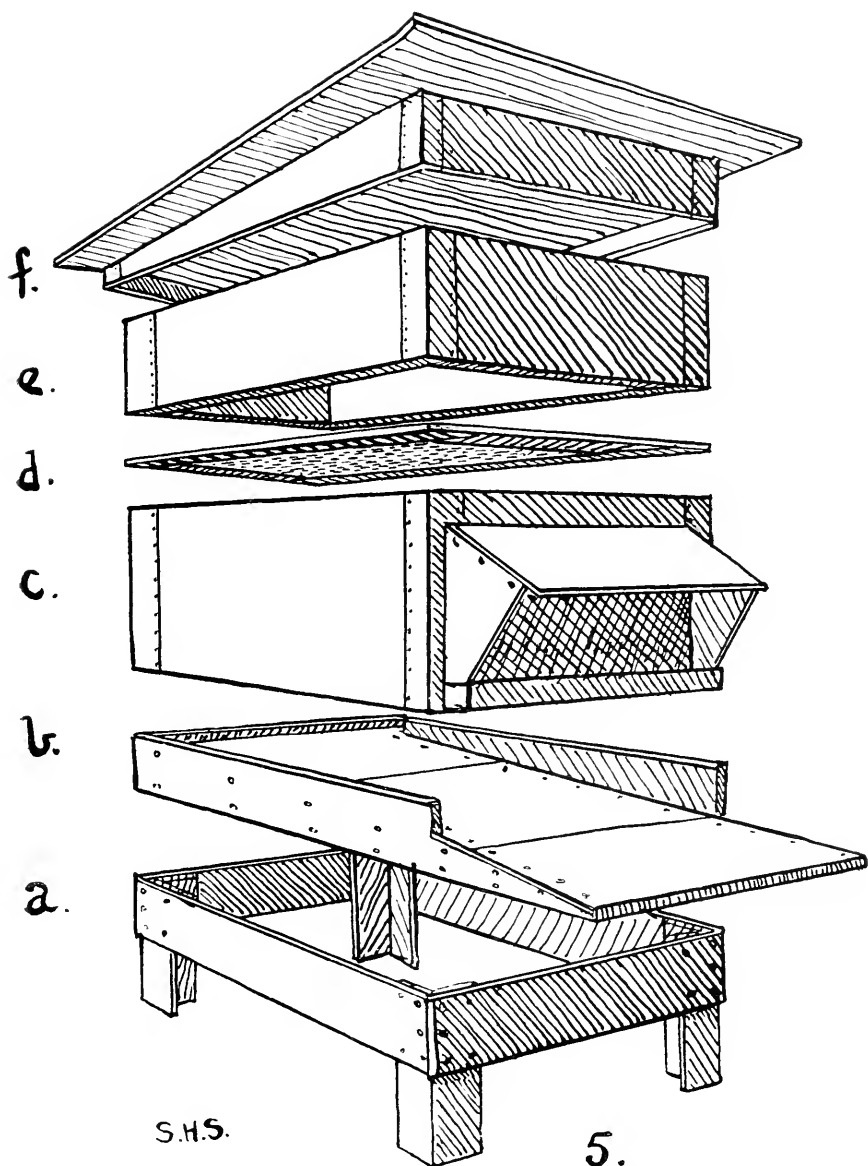

FIG. 5.—Complete Hive, showing component parts. *a.* Stand. *b.* Bottom Board. *c.* Brood Chamber. *d.* Queen Excluder. *e.* Super. *f.* Cover.

accurately spaced from the ends of the hive. They should project a quarter of an inch from the sides of the frame, and in nailing them

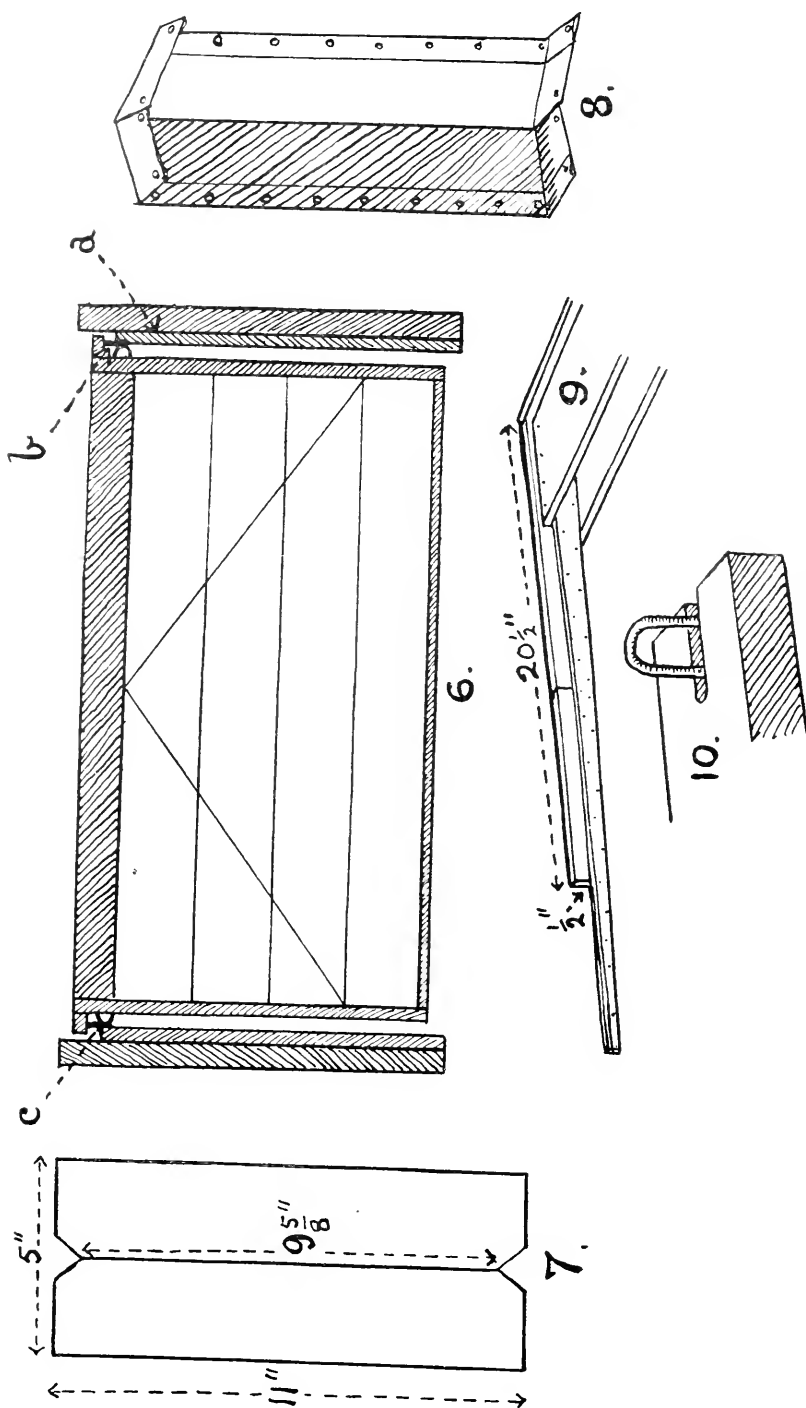

FIG. 6.—Section of Brood Chamber, showing brood frame in position. *a*, Inner piece forming ledge, *b*, Iron strip, *c*, Spacing staple. FIG. 7.—Tin for binding corners of brood chamber. FIG. 8.—Tin bent and pierced in readiness for nailing in position. FIG. 9.—Wooden guide for nailing staples in sides of frames. FIG. 10.—Wooden guide for nailing staples in sides of frames.



in position a notched piece of wood, a quarter of an inch in thickness, should be used as a guide (figure 10).

The porch over the entrance, shown in figure 5c, is not absolutely necessary, but it gives a finished appearance to the hive and also affords some protection from the weather, so it is worth the little trouble entailed in nailing it on. Two coats of white paint are now all that is required to complete this portion of the hive.

The "super" (figure 5e) is made in exactly the same way as the brood chamber, only in this case the box has to be cut down to the required width. The Hoffman extracting frame is only five and three-eighths inches in depth, so the super must be made five and five-eighths inches in depth, the extra quarter of an inch being allowed for the bee space at the top. The ledges inside must be so arranged that when the frames are in position the bottoms of the frames are flush with the bottom of the super, and the tops are a quarter of an inch down from the top edge of the super. It is necessary to pay careful attention to this spacing in the making of any hives, for if spaces less than three-sixteenths of an inch wide are left anywhere in the hive the bees are liable to fill them up with propolis, and if spaces wider than three-eighths of an inch are left bur-combs may be built in them and cause trouble. Thus, in providing for passages for the bees, it is usual to leave spaces of a quarter of an inch in depth. Shallow extracting frames for the super cost 2s. 6d., a dozen, and ten are required for each super.

The lid can be made to any desired pattern, but that shown in figure 5f is simple in construction and affords ample protection from the weather. It is double, slopes from front to back, and is covered with malthoid or similar material. The bottom board is also double, and so made that the floor of the hive slopes gently downward from back to front. The sides of the bottom board must be made of wood at least three-quarters of an inch thick in order to afford a firm base to support the body of the hive. They can be made from the ends of paraffin boxes cut and joined as shown in figure 9. The stand (figure 5a) is easily made and needs no detailed description. Finally a sheet of queen excluder zinc must be purchased, cut to fit the top of the brood chamber, and bound round the edges with wood three-eighths of an inch thick (figure 5d). In placing this queen excluder on the hive, the wooden frame is placed uppermost; thus there is a space three-eighths of an inch wide left at the bottom of the super when it is placed in position, and this forms the bee-way. If the beekeeper intends to go in for comb-honey production only, the queen excluder is unnecessary, as the queen rarely enters supers filled with section-boxes and separators.

---

The *Journal* aims at keeping farmers informed of what the Department of Agriculture is doing, also of such matters affecting their interests as come under its purview. The *Journal* contains original articles for the guidance of the farmer on the many and diverse problems which face him. Every farmer should read it and keep it.

## PRICKLY PEAR AS A STOCK FOOD.

By CHAS. F. JURITZ, M.A., D.Sc., F.I.C., Agricultural Research  
Chemist, Capetown.

THE prickly pear, like all plants which contain much water, is of great service to drought-stricken stock in arid countries, but it follows of necessity that because it contains so much water it cannot at the same time contain much solid nourishment. Those green stem-joints, which are also called sections or cladodes, but which we generally—but wrongly in the case of the prickly pear—call “leaves,” often contain as much as 90 per cent. of water, and, accordingly, form too one-sided a diet for stock unless more “solid” food is given at the same time, in order to keep up the balance. Animals may be kept alive for some time on prickly pear alone, but they lose in condition.

The value of prickly pear lies in its capability of being used as a roughage in normal times, and as a supplementary food for eking out a scanty supply of other food-stuffs under drought conditions.

Mr. Ingle, when Chief Chemist of the Transvaal in 1908, pointed out how refreshing and welcome a winter stock-food the prickly pear would prove in the Transvaal, and he recommended burning off the prickles from the leaves (as for convenience sake I shall continue in this paper to call the stem-joints) by means of a blow-lamp, and then slicing the leaves in a turnip cutter.

Many analyses of the *leaves* of various kinds of prickly pear have been published, showing that the amount of water which they contain when fresh is about 90 per cent. Of the remaining 10 per cent., which constitutes the dry matter, mineral substances like salt and phosphates make up nearly 2 per cent., about 3 to 4 parts per thousand consist of albuminoid or nitrogenous matter, and one part in a thousand is oil or fat. The fibrous material in the fresh prickly pear leaf does not make up much more than one per cent. The quantity of sugar in the leaf is generally under one per cent., and about 2 to 3 per cent. is made up of mucilage or gum-like substances.

If the prickly pear leaves are chopped up and allowed to dry out they become relatively more nutritious. The amount of moisture contained in them may drop to about 10 per cent. Of this dried leaf 14 or 15 per cent. may be mineral substances, 3 per cent. albuminoids, or proteins, as they are now more generally called; oil or fat would be nearly one per cent.; fibre about 10 per cent., sugar 5 or 6 per cent.; and mucilage approximately 18 per cent.

As regards the fresh *fruit* of the prickly pear, it is estimated that the husk constitutes 37 per cent. and the seeds 4 per cent. The husk contains about two-thirds of its weight of water, and the shelled fruit slightly less. The whole fruit contains between 6 and 7 per cent. of proteins and about 11 to 12 per cent. of sugar.

In the New Mexico Experiment Station, some 14 or 15 years ago, the possibility of using a certain variety of prickly pear, *Opuntia lindheimeri*, in making up a stock ration was investigated. The

nutritive ratio, that is to say, the ratio of muscle-forming to heat-giving constituents was found to be 1 to 18. This is too wide for milch cows, which need a ratio of about 1 to 6, and it was, therefore, suggested that the prickly pear should be balanced by other food, for example in such a ration as the following:—

Prickly pear, 40 lb.; wheat bran, 10 lb.; maize stover, 12 lb.

Another ration suggested was: Prickly pear, 60 lb.; brewers' grains, 14 lb.; cotton seed meal, 1 lb.

This would probably need a little more widening by the addition of coarse, dry fodder.

Yet another ration was suggested by Dr. R. F. Hare, namely:— Prickly pear, 50 lb.; wheat bran, 10 lb.; lucerne, 10 lb.

As an emergency farm crop for use in periods of drought, and of value in dairy farming, the planting of prickly pear has been recommended in the United States both on account of the hardness of the spiny plants and the small amount of handling which they need, as well as for the other advantages possessed by such a crop, namely, its practical immunity from injury by wild animals, and the absence of any need for fencing it.

As indicated above, *dried* prickly pear contains more nutriment than when fresh, and in some parts of India the dried plant is moistened with salt and fed to cattle. Proposals have been made in India for the importation of dried prickly pear leaves into other provinces; in South Africa for the manufacture, under patent, of dry fodder balls; in Australia for the preparation of a finely-ground, sun-dried material. In none of these cases is there any record of the actual adoption of the proposals: this may be due partly to the extra cost of preparation and partly to doubts regarding the feeding value of the materials.

Various attempts have been made in India to use unmixed prickly pear as an *ensilage*, but not with very much success. More satisfactory results were achieved by alternating layers of prickly pear and maize or sorgham. In South Africa the experience has been similar: the prickly pear ensilage could not be used alone, and grass or linseed meal had to be fed along with it. In Queensland it was found that alternate layers of prickly pear and maize made an excellent ensilage.

There are objections on the part of many to the use of prickly pear as fodder. When fed alone the fibre tends to form balls in the digestive canal. Many believe that the prickly pear causes general debility and parging, and, furthermore, the animals by passing the seed broadcast soon infest large tracts of country. Evidence was given before more than one Select Committee of the Cape House of Assembly to the effect that cattle are frequently so scoured out by prickly pear that death results, and that the small spines of the fruit cause inflammation of the mouth, gullet, and even stomach, until the whole internal lining of the digestive organs becomes a mass of thickened and inflamed mucous membrane.

The small spines, too, often get into the animals' eyes and blind them. Although cattle, sheep, and goats take to prickly pear leaves which have been deprived of their spines by singeing, scouring is apt to occur in such cases as well, but the tendency may be lessened by giving the stock coarse feed or dried grass.

The *spiny character of the leaves* naturally gives rise to a great deal of trouble, and in the United States the most common practice is

to remove the spines by singeing. Then the leaves are chopped up or the cattle turned loose into the prickly pear paddocks. For singeing, either a plumber's blast-lamp or a bush fire is employed, or else the leaves are boiled or steamed for some hours; conversion into silage is also said to soften the spines.

There is no question that, apart from its disadvantages, the prickly pear has often been of service in South Africa for *ostriches*, *oxen*, and *pigs*. The last named have been found to relish the plant, which, when mixed with dry grain, afforded them a fairly fattening food.

Some years ago the *Cape Agricultural Journal* described a successful experiment in pig-feeding carried on during a lengthy period on a New South Wales farm. Prickly pear leaves were boiled for some hours with meat and fed to nearly 200 pigs for several months without any of them developing the least internal trouble from the spines or bristles.

Although the aperient nature of the plant at times proves a drawback, it was the custom in South Africa, as long as thirty years ago, to feed ostriches on prickly pear leaves denuded of their spines, and so enable them to withstand severe droughts. The late Hon. A. Douglass, whose life was so closely associated with the rearing of ostriches, used to feed the chopped up leaves to his birds and milch cows during drought and general scarcity, with marked success, and, according to Mr. Burt-Davy, Mr. H. Abrahamson, of Longhope, Cape Province, lost none of his ostriches during a period of drought, because he fed them on prickly pear leaves and fruit, but his neighbours, who neglected to use the prickly pear, although they had it on their farms, lost heavily. In India, it was found that caution had to be exercised in feeding prickly pear to ostriches, because of the danger of intestinal trouble. Mr. R. W. Thornton, experimenting at the Robertson Station, Cape Province, found that ostriches did well on prickly pear in all cases, but best when lucerne hay was added. Draught cattle did fairly well when idle, but lost in condition when worked. Neither milch cattle nor pigs did at all well on unmixed prickly pear. In the Eastern Province Mr. J. Martin, of Perseverance, pulped the prickly pear so as to render the spines harmless, and then fed it, together with rakings from forage lands and mealie meal, to slaughter oxen which had become poor through drought. After two and a half months of this feeding the oxen were found in first-class condition.

In the Canary Islands cattle have been kept alive by feeding on prickly pear; in Cyprus, Spain, on the Barbary and Syrian coasts, and in fact in nearly all the Mediterranean countries, it is used as fodder for animals, the smooth-leaved varieties being preferred.

On several occasions during periods of *famine*, prickly pear has been used in different parts of India as an emergency food-stuff for cattle; for instance, cattle in the extensive Bellary district, in the Madras Presidency, were kept alive in the great famine of 1876-1877 by a mixture of one part of rice straw and 40 parts of pear leaves, which had been cut up after removal of the spines. Similar experiences were repeated at intervals until as late as 1912, when the plant was used as an emergency feed in the Poona district. As an example, it is recorded that on the latter occasion a herd of cattle was kept alive for eight months on a daily ration of 1000 lb. of prickly pear and 60 lb. of cotton seed. One of the latest recorded stock-feeding experiments

with prickly pear was carried out at the Government Civil Dairy, Poona, in 1914, when it was shown that singed and sliced prickly pear mixed with 6 per cent. of its weight of cotton seed enabled animals which had become very poor from semi-starvation to regain condition.

In its application to *milch cattle* in particular the effect of prickly pear feeding has been shown to increase the quantity while maintaining the quality of the milk. In Corsica and Sardinia a daily ration of about 50 or 60 lb. per cow, comprising prickly pear finely cut up, mixed with bran or dry grass, was fed to impoverished cows, which had almost ceased their supplies, with good results. Mr. Martin, whose experience in feeding prickly pear to oxen has been quoted above, found his milk supply greatly augmented by utilizing prickly pear as a feed for his milch cows. In Mexico, milch cows maintained their yields, in spite of the increasing coldness of the season, when fed on prickly pear, thus minimizing the need of purchasing expensive winter fodders.

The main points to be noted in connection with feeding prickly pear to stock are the following:—The leaves consist mostly of water, and hence are useful in times of drought. For the same reason they are not rich in nourishment unless dried. The spines on the leaves should be removed before feeding to stock, and the thorns on the fruit are likewise a source of danger. During drought the prickly pear forms a valuable emergency ration, but cannot be advantageously fed to stock unless mixed with more concentrated food. To such food, however, it is a valuable accessory.

---

### Pure Salt for Hides.

The following is extracted from "Hide and Leather" of 1st May, 1920:—

Hides should be salted only with clean, pure salt, free from alum, according to a recent statement of the Bureau of Chemistry, United States Department of Agriculture. This Bureau is making a study of the best methods for skinning farm animals and curing hides in order to produce a high-grade leather. Salt containing alum partly tans the hide and sets the hair so that it cannot be removed. Hides which cannot be unhaired properly bring a loss to the tanner and prejudice him in future purchases against hides from the same source.

Tanners recently submitted to the Bureau of Chemistry green salted hides which could not be unhaired after liming in the usual way, in order to find out the cause. An examination showed that on the basis of the dry hide unhaired spots contained 0.8 per cent. of alumina, and the portions where the hair was not loosened contained 1.25 per cent. of alumina. The portions of the hide which contained 0.8 per cent. alumina unhaired with difficulty, while the portions containing 1.25 per cent. could not be unhaired even on the beam. An inferior salt containing alum had been used in salting the hides and had set the hair.

This incident illustrates the importance of attention to details in the handling and curing of hides and skins. Farmers, country butchers, and dealers are advised by the Department to use only clean, pure salt in salting hides. The presence of alum in salt is especially objectionable, and as little as 5 per cent. in the salt can be detected usually by its astringent, bitter taste.

## PARASITIC ATTACK ON *EUCALYPTUS GLOBULUS*.

### A Note on *Stereum hirsutum* in Plantations in the Transvaal.

By A. M. BOTTOMLEY, B.A., Mycologist, Division of Botany, and  
K. A. CARLSON, Conservator of Forests, Transvaal Conservancy.

BEFORE proceeding with the actual account of the damage caused by *Stereum hirsutum* on *Eucalyptus globulus* trees in Transvaal plantations, a few preliminary remarks with regard to the organism



Plate 1.

(Photo by I. B. Pole Evans.)

*Stereum hirsutum* on living *Eucalyptus globulus* at "Cliffendale."

itself may not be out of place, and may be of some interest to those to whom the fungus may be unfamiliar and who are concerned with growing gum plantations as an industrial proposition, e.g. as timber for mine props.

*Stereum hirsutum* is very widely distributed and is one of our commonest saprophytic fungi. Its fruiting bodies or sporophores may usually be found growing in bracket-like fashion on dead trunks, stumps, etc., though occasionally and, in fact, usually in the early stages of growth it forms a yellow crust on the wood on which it develops. As a rule these sporophores are produced in large numbers forming successions of brackets one above the other, close together, but seldom overlapping (Plate I). Each individual fructification consists of a thin but firm leathery structure with a lobed margin. Its upper surface is dingy ochraceous to grey in colour, faintly zoned, and covered with fine grey hairs, while the under-surface, the region which produces the spores or reproductive bodies of the fungus, is smooth and bright ochraceous in colour. Under moist conditions the fungus is expanded at right angles to its point of attachment, but on drying it contracts and curls over.

The fungus under discussion is one of a very large number of fungi belonging to the genus *Stereum*. With the exception of a few which grow on humus, the members of this group occur on wood and are generally considered to be saprophytic, i.e. depend for their existence on dead organic matter. Some few, however, though usually saprophytic are known at times to be active parasites, and as such cause a considerable amount of damage, though even in these cases it is very probable that the fungus starts as a saprophyte on dead wood, such as is found in dead branches and wounds, and spreading from this to living wood eventually becomes parasitic on the latter. Amongst the best known of those parasitic *Stereums* which are of economic importance, are *S. purpurcum*—said to be the cause of "silver-leaf" disease in the plum, peach, apricot, etc.—*S. rugosum* which parasitises the cherry laurel to such an extent in some parts as to preclude its cultivation—*S. frustulosum* which attacks oaks in Germany, causing a rot known as "partridge wood"—and lastly the fungus under discussion, *S. hirsutum*, the well-known cause of "white-piped" and "yellow-piped" wood in oaks in Europe.

It has been suspected for some time that *S. hirsutum* was responsible in this country for damage to various trees other than oaks, e.g. peach trees, but no clear proof of its parasitism has been forthcoming. Recently, however, this fungus has been found growing on the living stem tissues of *Eucalyptus globulus*, the ordinary blue-gum, in plantations on the farm Cliffendale, near Roodepoort, Witwatersrand. So far, however, the fungus has not been found on living tissues except at Cliffendale, though careful examination has been made of it in gum plantations on the farms The Willows, District Pretoria, and Lions Glen, near Amsterdam, District Ermelo, where it is abundantly present as a saprophyte.

The following observations were made on the attack at the three places mentioned:—

#### CLIFFENDALE.

The plantation is situated in a sheltered valley, about five miles north of Roodepoort, on gently sloping ground with a north aspect, sheltered from the south wind, and at an elevation of between 4500 feet and 5000 feet. The soil is a red sandy loam of good depth, probably resting on shale or quartzite. The rainfall is estimated at between 30 and 33 inches, and the situation is hot in summer with cold

nights in winter. The species grown are *Enc. globulus*, *E. robusta*, *E. tereticornis*, *E. amygdalina*, *E. longifolia*, and *E. rostrata*. About two-thirds of the stand contains *E. globulus*, fairly pure with a sprinkling of the other species, while in the remaining third the other species predominate.

Originally planted in 1890, the whole area was clear felled in spring, 1911. In 1917 an unhealthy appearance was observed in the second growth of trees, some of which were dying back in the tops. This was at the time attributed to something unsuitable in the subsoil. In 1919 the larger of the unhealthy trees, 8 to 10 inches in diameter, were felled, but the wood of many of these was found to be useless, being rotten inside. It was then discovered that many dead old stumps of the trees cut in 1911 were covered with fruiting bodies of the fungus *Stereum hirsutum*, which had also spread on to the living stems of the second growth. Microscopic examination of the latter



Plate II.

(Photo by I. B. Pole Evans.)

Stump of *E. globulus* showing discoloration and soft dry rot in centre caused by *S. hirsutum*.

revealed the presence of fungal threads or mycelium, i.e. the vegetative part of the fungus, in the living tissues of the stem, causing a yellowish-brown discoloration and in advanced stages of infection a disorganization and destruction of the tissues resulting in a typical soft dry rot. (Plate II.) The fruiting bodies of the fungus were not, however, always present on infected trees, and it was only on felling that the rot inside was disclosed, showing the insidious nature of the disease.

As a result of careful observation it was concluded that the disease had originally started in the stumps, where it had gained ready entrance through the exposed cut ends. From these it had then



spread to living tissues, either by means of the mycelium invading new shoots directly from the infected stumps or by dissemination of the spores of the fungus which are produced in immense quantities by the sporophores, and which through the agency of wind and rain, on finding suitable lodgment in any wounds that may be present, germinate and set up new infections.

The above conditions were observed in the two blocks of nearly pure *E. globulus*. Immediate felling of these blocks was recommended, to be followed by piling and burning all debris of leaves and branches on top of the infected stumps to destroy the sporophores and thus prevent infection spreading by means of the spores to the adjoining block. Painting stumps with carbolineum or tar was also suggested as an alternative preventive measure.

The recommendations were carried out, and on inspecting the two blocks, in June, 1920, a crop of coppice growth had again sprung up, and of fairly normal appearance, except for a somewhat dingy colour, from 2 to 7 feet in height.

The stumps were again covered with an abundance of fruiting bodies, showing that the burning process had only a temporary effect and did not destroy the fungus inside the stumps. The young coppice shoots growing from diseased stumps showed light brown discoloured streaks on the bark directly adjoining the stump. Examination of these revealed the fact that the discoloration penetrated as far as the cambium and as traces of mycelium were found in this area it was concluded that this discoloration was probably due to the fungus spreading from the stump into the new shoot.

In a corner of one block some trees had apparently been cut after the felling and burning of the main portion, the inner wood of the stumps of which also disclosed a light brown discoloration and the soft dry rot characteristic of the action of the fungus. (Plate II.)

Although the fungus had attacked dead wood in the stumps of all species, a careful search failed to discover it on the living tissue of any other species than *E. globulus*, either on young shoots or live stumps.

In the third block the various species are more or less confined to pure groups with only a small percentage of *E. globulus*. Felling was here only recently begun and so far confined to *E. rostrata*.

Here again there was no sign of the fungus on living tissue except on *E. globulus*. Practically every tree of this species was, however, badly attacked, the lower part of the stems being generously covered with fruiting bodies to a height of several feet, while the cambium of young shoots was penetrated by the mycelium.

#### THE WILLOWS.

Local conditions in this situation differ very slightly from those at Cliffendale. It is ten miles east of Pretoria, in a wide open valley, at an elevation of about 4500 feet with a north aspect and very gentle slope. The soil is here also of a sandy nature, but the shale is more pronounced and nearer the surface. The rainfall which averages 28.36 inches is probably a couple of inches less than at Cliffendale. The principal species in the area, where the fungus was found, are *E. resinifera*, *E. rostrata*, *E. tereticornis*, and *E. sideroxyloa*. *E. globulus* is confined to an avenue and a few scattered specimens.

Felling of second growth was in progress here also. The fungus was present on dead stumps, though less abundantly than at Cliffendale, but in no instance could it be found on living wood, even in *E. globulus*, though diligent search was made among old and young coppice shoots growing directly from heavily infected old stumps.

Most of the wood felled at time of inspection was *E. resinifera* and *E. rostrata*; all of good quality. Growing trees were healthy and vigorous looking.

Stumps of felled trees were sprayed with "winter spray," but less than a year later, previously infected stumps were again producing fresh sporophores, proving that the spray is quite ineffective in destroying the fungus inside the wood.

#### LIONS GLEN.

Lions Glen is situated about five miles from the Swaziland border, north of Amsterdam, at an elevation of about 5600 feet, with an average rainfall of 35 inches, and frequent mists.

The plantation in which the fungus was here found is on a slight slope with an east aspect. The soil is granitic and open. The stand is composed of pure *E. globulus*, about 25 to 30 years old, and ranging up to about 24 inches diameter breast high. A number of these trees have at some time been killed by ring-barking, and the dead wood is now badly infected with the fungus. From this source the infection has spread, through the medium of sporophores, to the outer bark of a large number of the living trees in the stand, which is now covered with both fruiting bodies and the mycelium of the fungus in large quantities. Specimens of both dead and living bark were examined, and it was found that while the dead bark was heavily infected with the fungus, showing not only the discoloration and disorganization of the tissues characteristic of the organism in question, but the presence of its mycelium ramifying through the tissues, the living bark on the contrary could not be definitely stated to be infected owing to the absence of any mycelium. Owing to the fact, however, that discoloration was starting in the living tissues adjacent to the infected dead bark, and further that all discoloured cracks in the living tissues contained an abundance of mycelium, it was thought quite possible that the fungus might be encroaching into this part. However, no prediction as to what part the fungus would play in the future could be made as the virulence of the disease seems to be directly dependent on the general health of the trees and on climatic and soil conditions. Actual observation of the trees in question over an extended period is therefore the only means of discovering this point.

#### CONCLUSIONS.

The chief conclusion to be drawn from the above investigations is that attack by *Stereum hirsutum* on living tissues of eucalypts is probably confined to the species *E. globulus*.

So far the parasitic form of the fungus has only been discovered in the Cliffendale plantations, though infection of dead wood has been found in widely separated areas. It is not unlikely, however, that attack on living wood may exist in other blue gum plantations, and a thorough investigation of all such, especially those that have undergone felling operations at some time or other, should be made.

Pending a thorough investigation of other plantations, and correlation of all the evidence as to local conditions, etc., it is difficult to assign the cause of the attack at Cliffendale with confidence. The most obvious thing is to ascribe the outbreak to lack of vigour of the trees due to unsuitable local conditions of soil, or climate, or both these factors, and if so the reason for immunity of living tissue at The Willows where these conditions differ only slightly from Cliffendale is not clear. On the other hand, at Lions Glen, where the local conditions approach those of the natural habitat of the blue gum more than at either of the other two places there is at least a suspicion that living tissue may shortly be attacked. Possibly the explanation may be found in differences of strain of the fungus, a supposition that can only be verified by introducing the fungus from one place to another or by experiments in the laboratory.

#### RECOMMENDATIONS.

Meanwhile it is advisable to take such steps as suggest themselves at our present stage of knowledge to prevent loss of a serious character.

In its saprophytic form the fungus is, of course, harmless to living trees, even though the outer dead bark is attacked. As there is no way of detecting the difference between this and the parasitic form until living tissue is actually attacked, it is advisable to watch blue gum plantations carefully and take the earliest possible steps to destroy the fungus as soon as it first appears. If the trouble is allowed to attain extensive proportions destruction of the fungus becomes too costly to be practical.

As far as is known, the mycelium does not spread in the soil but in any form of woody debris including twigs and roots, all of which must be destroyed round the infected spot. Experience at Cliffendale shows that mere charring of the outside of the stumps is insufficient to destroy the fungus as the mycelium inside remains unaffected and soon develops fresh fructifications. The whole stump and root system must be consumed by fire, and the following method is recommended for this purpose:—

For large trees bore a hole 18 inches deep and 1 inch to 2 inches diameter vertically into the infected stump, put in 1 to 2 ounces of saltpetre, fill with water and plug up. After a month or two put a little kerosene oil in the hole and set it alight when the stump will smoulder away to every part of its roots. For smaller trees, holes  $\frac{1}{2}$ -inch to  $\frac{3}{4}$ -inch diameter will suffice, and  $\frac{1}{2}$  to 1 ounce of saltpetre.

The debris should at the same time be placed round the stump and burned. The above plan is, of course, only practical on a limited scale.

Spraying with "winter spray," as applied at The Willows, or painting the stumps with some disinfectant, such as carbolineum or tar, which was tried at Cliffendale, is no more effective than charring the outside of the stumps.

When infection has reached a stage beyond which the above method of destruction becomes impracticable, the only remedy is to convert an infected plantation of *E. globulus* to an immune species naturally adapted to local conditions. In the case of Cliffendale the best species would be *E. rostrata*.

To effect this conversion the best plan is to fell the blue gums and convert the wood into charcoal, leaving plenty of debris, in the form of branches, twigs, and leaves, on the ground, and to burn this shortly before replanting is undertaken. If the original stand was dense enough to eliminate quick grass, no further preparation of the soil should be necessary. The newly burned soil makes an excellent planting bed and promotes rapid growth of the young transplants. It may be necessary to slash away coppice growth from the blue gum stumps once or twice during the first year or two, but if the *E. rostrata* have been correctly spaced, no further treatment should be necessary until the time for first thinning arrives.

When laying down new plantations, it is advisable to exclude *E. globulus* in doubtful localities. In forestry it is always safer to select species which are known to be naturally suited to the local conditions. Others may appear to do well for a time, and quickness of early growth is an almost irresistible attraction in this respect, but if the local conditions are foreign to the nature of the species there is always a tendency to invite disease.

The attention of the reader is invited to Forest Department Bulletin No. 1 of 1920, relative to The Growing of Mine Props on the High Veld, which appeared in the June, 1920, number of the *Agricultural Journal*.

---

---

## Preparation of Hides and Skins.

The following is extracted from a list of instructions circulated by a well-known local tannery for the benefit of farmers and others, in the flaying and preservation of hides and skins. The advice is sound and worthy of careful attention:—

The hide or skin of any animal worth flaying is worth the trouble of doing it properly.

Do not delay flaying until the hide or skin is semi-putrid; avoid cutting it unnecessarily and immediately salt it thoroughly; don't spare the salt.

*Wet Hides.*—Fold hide carefully, flesh side inside, and let remain for twenty-four hours, then drain off the water, lightly sprinkle the hair side with salt, and again fold up *with hair side inside* into a small bundle. It will then keep without damage until it reaches the tannery.

*Dry Hides.*—If the hides are to be dried thoroughly, open them out after they are thoroughly salted and allow them to dry in the shade and *not* in the hot sun. When they are nearly dried fold them, with hair *inside*, double only, so that they lie flat and unwrinkled.

Skins should be thoroughly salted with fairly fine salt and dried in the shade, and, when dry, should be packed carefully one on top of the other.

Don't allow your natives to make sleeping mats of the skins or to walk on them. The smallest scratch or crack on the grain of the skin reduces its value very considerably. You won't notice it, but the buyer will, and you will suffer loss.

Don't spalk or peg out any hide or skin in the sun or even in the shade.

## THE MALLY FRUIT FLY REMEDY.

**For the Prevention of Maggots in Fruit by the Destruction of the Parent Flies before eggs are laid.**

THERE are two closely related flies in South Africa, one a native species, the other introduced from abroad. The native species predominates in Natal, the introduced in the Cape and Free State, and both abound in the Transvaal. Both flies are brightly coloured and in general appearance similar to one another; they are somewhat smaller than house flies with iridescent spotted wings, shining metallic eyes, and grey and yellow-brown bodies. Together they are spoken of as fruit flies, and constitute one of the principal fruit pests of South Africa. Almost all kinds of fruit are attacked, more especially apricots, peaches, nectarines, apples, pears, quinces, mangoes, guavas, and oranges. The damage begins when the female fly deposits its eggs in the fruit, from which come the well-known maggots that spoil the fruit for ordinary purposes.

Fruit flies are very prolific, and during the summer months a generation will mature about every four weeks. It is therefore easy to account for the great abundance of maggots during the summer, when stone fruits are abundant. During autumn and winter—the citrus season—they do not develop so rapidly. Under natural conditions they are no doubt able to wait for some time for fruit to ripen.

Experience in South Africa has shown that by persistently using the Mally Fruit Fly Remedy, fruit growers in town and country alike need not suffer the loss of their fruit on account of the fruit fly.

The remedy consists in sprinkling a very small quantity of poisoned bait—a dilute syrup rendered poisonous by the addition of arsenate of lead—at frequent intervals over the trees whose fruit it is designed to protect. The remedy acts by fatally poisoning the flies that would otherwise sting the fruit and deposit eggs that would develop into maggots and spoil the fruit. The bait should be prepared as follows:—

Sugar, 2½ lb. or 25 lb.

Arsenate of lead (paste), 3 oz. or 2 lb.

Water, 4 gallons or 40 gallons.

The lesser quantities are for a paraffin tin, the larger for a barrel. The arsenate of lead should be thoroughly mixed with a small quantity of water and then stirred into the bulk. The sugar may be poured into the full amount of water and stirred till it is all dissolved. The proportion of arsenate of lead is more than ample to ensure the death of flies that take the bait, and is about as much as can be used with safety to the foliage of peach trees. Rain-water (from an ordinary tank) is preferable to that from a stream.

Made as recommended the bait does not attract bees to an appreciable extent, but house flies and a number of other species feed on it to their destruction.

An ordinary garden syringe is the best means of distributing the bait. A small quantity of arsenate of lead, a packet of sugar, a barrel, tub, or drum of convenient size, an improvised pail to carry the poison by hand from tree to tree, and a syringe are the requirements. The bar across the top of a paraffin tin serves as a handle, and also prevents any animal from drinking the bait.

The finest "rose" on the syringe should be used, and only a very small quantity of bait should be applied to each tree—about a pint to a tree about 10 feet high and 10 feet wide. It is particularly important not to overspray stone fruits owing to their extreme liability to injury. The man should walk around the tree, keeping two or more yards away, and should distribute the spray in a series of short squirts directed so that the liquid will fall in innumerable small drops over and through the tree, and with no more in one part than another. A single fill of the syringe will often be enough for one tree, and thus the man will be back at the starting place by the time the syringe is empty. The mixture should be stirred before each filling of the syringe in order to ensure uniformity of strength.

The number of applications necessary to protect a crop will vary with local conditions and with the season. The aim should be to have poison present as long as there are fruit flies about to take it. Where citrus, mango, guava, or loquat trees are present they should be given one or two preliminary baitings during October so as to destroy any fruit flies that may have harboured there during the winter or that may arise from maggots in any late-maturing fruits. This will prevent the flies migrating to summer fruit later on. The first application should be made to the earliest susceptible kinds of fruit by the time they are half-grown and repeated every seven to fourteen days, depending on the prevalence of the pest in the vicinity. As rain will dissolve and wash off the sweet ingredient and leave the specks of poison in unattractive form, the baiting should be repeated after every rain or during bright spells in rainy weather throughout the fly season. Very likely a single application every three or four weeks will suffice after midsummer, especially if there has been a succession of early treatments and if neighbours close by have also adopted the treatment, and if, at the same time, reasonable care has been taken to collect and destroy fallen fruit. Hedges, vines, coffee plants, and ornamental shrubs, as well as wild fruit plants—prickly pear, passion plant, granadilla, blackberry or bramble, Kaffir plum, Kei apple, or Dingaon apricot, etc.—in or immediately bordering on the garden or orchard, should be treated so that they will serve as "carriers" to keep bait available for fruit flies that may be harbouring there or that may alight to rest on their journey from near-by untreated premises.

The later maturing kinds of fruit—late peaches, apples, pears, quinces—should be baited when half-grown and the baiting continued till the fruit is all off. Where citrus fruit is the main crop it is advisable to bait any late summer fruit trees for two or three weeks after their crop is off so as to destroy flies emerging from the soil beneath promptly, and thus prevent their migrating to the citrus orchard. This is an important matter, because fruit flies may bring about serious loss to shippers of citrus fruit by stinging the fruit in attempts to oviposit and thereby injure the surface sufficiently to serve as a point of entrance for organisms that cause the fruit to decay on

the way to market. Quite a number of different species of flies try to feed on the surface of citrus fruit, especially if there are specks of honey-dew from scale insects or aphides present. It is possible that they also cause injury sufficient to induce decay; these the bait will also destroy.

If grapes are attacked it is fairly certain that peaches or other summer fruit near by has been badly infested, and that the resulting flies have found their way to the vineyard. Baiting the fruit trees will do much towards preventing injury to grapes. If infestation in grapes is feared the vines should be sprinkled the same as in the case of fruit trees.

Experience only will enable one to decide on the necessary number of baitings under any given circumstances. Advice from those who have had local experience should be obtained whenever possible. The bait costs so little and is so easily applied that it is best to err on the right side and bait frequently. Much depends on convenience. All materials should be kept in a safe but handy place so that time will not be wasted in getting ready for work, but the bait should always be freshly made.

Where town gardens or other small holdings are concerned, interested parties should co-operate and arrange for some one to distribute the bait regularly for all of them.

*Caution.*—There is no necessity to sprinkle the fruit itself. Reasonable care should be taken not to put bait on to the fruit, but if a few drops do strike the fruit there is no cause for alarm, because the amount of poison is so small that it is impossible for any one to eat enough fruit at one time to get an injurious dose of arsenic.

Do not leave tins or other receptacles containing bait standing open in places where animals can get at them and drink the poison solution.

Keep the jar or tin containing the arsenate of lead tightly closed so as to prevent loss of moisture, and put it away in a safe place where children or irresponsible individuals cannot get access to it.

## Fruit Export.

The following is a return of fruit shipped overseas during the month of October, 1920 :

Variety.	<i>Er</i>		<i>Er Port</i>	<i>Er</i>	Total.	
	Durban.	Boxes.	Elizabeth.	Capetown.		
	...	...	Boxes.	Boxes.	Boxes.	
Oranges	...	...	201	4365	2050	6616
Grape Fruit	...	...	—	—	124	124
<b>TOTAL</b>	...	...	<b>201</b>	<b>4365</b>	<b>2174</b>	<b>6740</b>

Total shipments from all ports for July, August, and September, 1920, were 37,438, 29,365, and 24,816 boxes respectively.

## PLAN OF A SMALL FARM DAIRY.

By W. S. H. CLEGHORNE, B.Sc., A.M.I.Mech.E., Lecturer in Engineering, School of Agriculture, Potchefstroom.

THE accompanying plan is of a small farm dairy, suitable for the farmer who sells milk or cream or makes butter. Such a dairy should be situated conveniently near to the cow-byre; indeed it is often built against the byre as a lean-to or otherwise. In the drawings, a separate building has been shown.

If more room is desired than shown in the drawings, the milk-room and the washroom might each be made 10 feet wide, in place of 8 feet.

The building should preferably be placed so that the milkroom is at the cool side with regard to the sun, existing shade, etc., the position of the cow-byre also being taken into consideration.

Whenever possible the building should be on high ground with good natural drainage. In accordance with the Dairy Industry Act, 1918, the dairy should not be less than 150 feet from any piggery, manure heap, or offensive stagnant water.

The walls of the building are of stone, 18 inches thick, and the eaves overhang 2 feet (horizontally) beyond the walls, for the sake of coolness. Immediately under the eaves an air-brick ventilator is built into the outer wall of each apartment, i.e. eight ventilators in all. The rooms are ceiled and louvered openings are provided at each end of the corrugated iron roof. As an alternative to stone, brick walls might be adopted, hollow or cavity walls being erected in order to make the building as cool as possible. The following methods of heat insulation may also be mentioned:—

- (1) If the building is near the coast a thick layer of dry seaweed should be laid on sheets of paper on the top of the ceiling, i.e. between ceiling and roof.
- (2) If the building is distant from the coast the place of the seaweed may be taken by a layer of wood charcoal 6 inches thick.

The use of thatch for the roof, instead of corrugated iron, would also make for coolness. With the same end in view, the windows are set high up in the walls. Should it be necessary to shade any window this may be done by louvered shutters outside or blue blinds inside.

The floors are of granolithic and slope towards the gutter, which discharges through the wall in the corner of the boiler-room, either into the drainage system from the byre, into a french drain, or on to the veld outside. In the latter case the drainage should be led away in an open channel of concrete or hard bricks plastered with cement mortar. As shown in the elevations, the gutter is merely a shallow depression in the floor. In laying the floor, 6 inches of hard-core, i.e. stones about the size of a quarter brick, is put down and well rammed. On the top of this a 3-inch layer of 1: 2: 4 concrete is deposited, and this is covered by the granolithic, consisting of (1) a layer about  $\frac{3}{4}$  inch thick, consisting of one part cement to one part







sloping towards the sink) on which cans, etc., may be placed to drip after having been washed. In addition, a shelf of open spar-work is provided above the drain-board, while in the milkroom are two solid

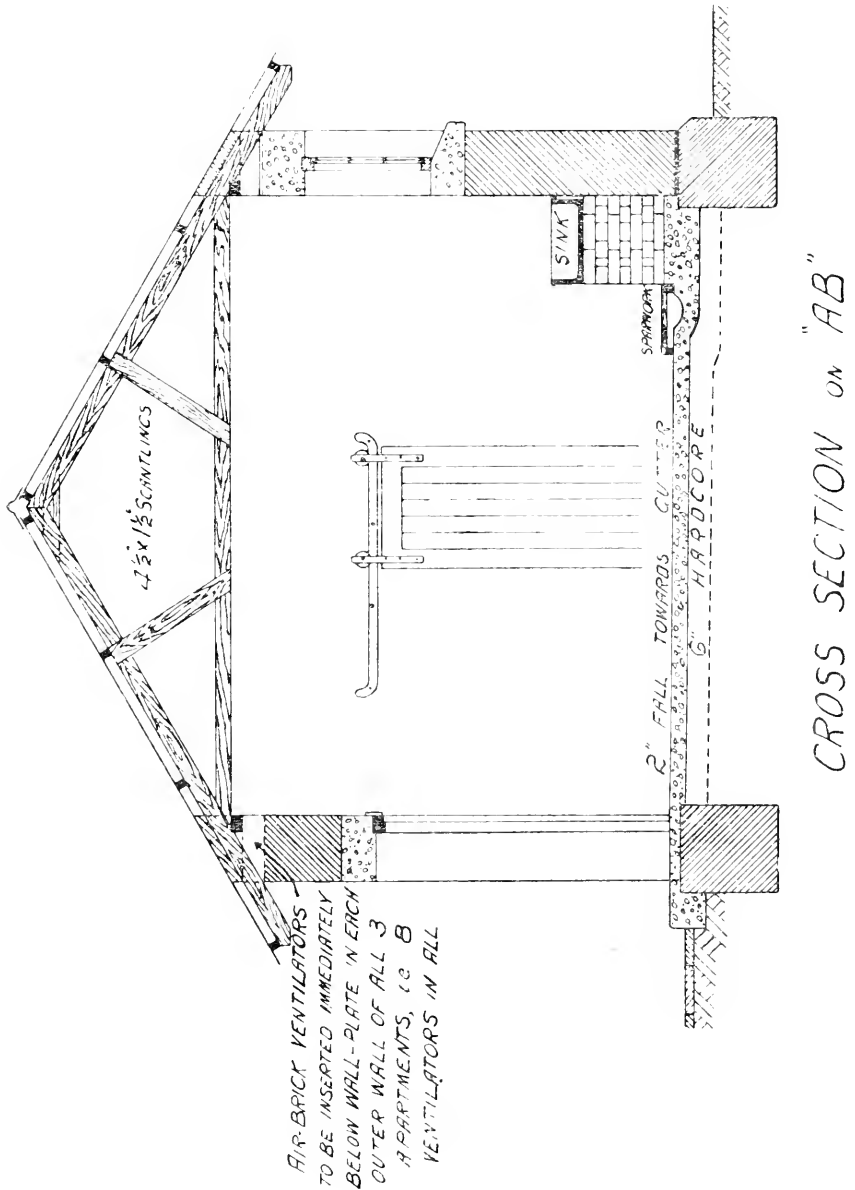

shelves for the reception of dry milk cans. An open spar-work platform is placed in front of the sink for standing on.

The hot-water system consists of a vertical boiler and hot-water cylinder connected by piping, as shown; the water circulation is

indicated by arrows (see elevation). The system is supplied from a supply tank on the roof, from the bottom of which tank a pipe leads to the bottom of the hot-water cylinder. The supply tank is replenished from the main, through a ball-cock. From the top of the hot-water cylinder an expansion pipe, for the escape of steam, takes off, and may be either bent over the supply tank so as to discharge into it or carried through the roof. As an additional precaution, in case of the expansion pipe becoming choked through deposit from highly mineralized water or otherwise, a small safety valve, set to open at a comparatively low pressure, should be attached to the boiler. The service pipe to the hot-water tap or taps branches off from the lower end of the expansion pipe.

A list of some of the quantities of materials more difficult to estimate is appended. It is only approximate, however, because the quantities used depend greatly on the particular workman, and on other circumstances, such as the size of stones used in building etc. :—

Bricks for party walls, 3000 bricks. Mortar for walls, 42 bags blue lime;  $15\frac{1}{2}$  cubic yards sand. Materials for floor,  $15\frac{1}{4}$  bags portland cement;  $1\frac{3}{4}$  cubic yard sand;  $2\frac{3}{4}$  cubic yards broken stone, to pass a  $2\frac{1}{2}$ -inch ring;  $\frac{3}{4}$  cubic yard broken granite to pass a  $\frac{3}{4}$ -inch ring;  $\frac{1}{4}$  cubic yard granite chips to pass a  $\frac{1}{4}$ -inch ring. Materials for lintels and sills (of 1:2:3 concrete),  $7\frac{3}{4}$  bags portland cement; 1.1 cubic yard sand; 1.6 cubic yard broken stone, to pass a 1-inch ring. Cement plaster for lower 4 feet of walls,  $5\frac{1}{2}$  bags portland cement;  $1\frac{1}{4}$  cubic yard sand. Lime plaster for upper 6 feet of walls,  $6\frac{1}{2}$  bags blue lime;  $2\frac{1}{2}$  cubic yards sand.

The quantities of timber, corrugated galvanized iron, piping, etc., can readily be measured from the drawing, which is sufficiently detailed for the purpose. It is better for the person who is responsible for the work to do so than to rely on a list of materials, because in the former case he gets a better understanding of what each piece of material is for.

### Seville Oranges.

Citrus growers will be interested to hear that a farmer in the Pietersburg District who states that his Seville trees are not affected by frost, enabling him to grow them in areas not generally accepted as being adapted for citrus culture, sent a sample box of Seville oranges, used for the manufacture of marmalade, to a well-known firm of jam manufacturers in England, who report that "they prove to be the true bitter orange, and have made an excellent product, being very similar to the marmalade made from Seville oranges at the commencement of the season. They are perhaps slightly more bitter, and not quite so aromatic, but the jellying property seems to be fully up to standard. Such good results from bitter oranges have not been met from any other part of the world, and . . . they must have been grown from the Seville seed."

## THE POULTRY YARD MONTH BY MONTH.

By J. J. JORDAAN, Lecturer and Instructor in Poultry, Glen, Orange Free State.

### December.

*Chickens.*—Watch for worms in the growing stock, and if found treat the birds at once. Birds eating greedily and yet remaining anaemic and in poor condition, although otherwise in good health, may be suspected. Examine the droppings under the perch, and if worms are found treat as follows:—

Fast the birds from both food and water for at least 24 hours, then dose individually with 1 teaspoonful of salad oil to which has been added four to six drops of extract of male fern. Three hours later give each bird a teaspoonful of epsom salts dissolved in a tablespoonful of water. After another lapse of three hours give them a good feed of warm bran mash. If possible, remove them the following day to a fresh run. Dig over the old run, irrigate, and plant something on it; keep the birds off it for two or three months. Growing chicks will want plenty of shade and liberal feeds of green food from now on to the end of April.

*Table Poultry.*—Get all old discarded and culled birds from the breeding pens into condition and away to market before the second week is ended. Do not wait until two or three days before Christmas; most people want their Christmas fowl a few days in advance in order to finish it off.

*Moulting.*—By the end of the second week, a start must be made to get next year's breeding birds through the moult as quickly as possible, so as to mate up in April and obtain early chicks, which make the best birds. The best ones to take are the 18-month old hens; as they are well grown and of sound constitution, they will respond best to the treatment, and also be excellent birds to breed from the following year. Their eggs being large, and the fertility good, they are likely to produce the strongest chickens if mated to 12-month-old cockerels. Select your birds individually according to record and breeding. Examine them closely as to condition and also for insects. If the latter are found dip the birds, or feather eating may break out during the moulting period. A fat bird takes longer under each treatment to get through the moult than one in good, hard condition. Give each one selected a good dose of epsom salts and then put them in a run by themselves; add just enough epsom salts to their drinking water daily to make it taste "brakish" for two or three weeks according to their condition.

*Feeding.*—Cut the mash food out altogether and reduce the grain rations heavily, allowing only about two ounces per bird per day. This feed should be dug into the ground late in the afternoon. Give liberal feeds of green food.

*General.*—All small chick brooders want to be looked over, broken parts repaired and missing parts replaced; thoroughly scrub with some disinfectant, paint with solignum and store for next breeding season. Continue waging war against insects. Early hatched turkeys will be "shooting the red," and this is a critical time; give them Douglas mixture in their drinking water, one tablespoonful to one quart of water. Their sleeping quarters must be dry. Remove birds and houses to new runs and fresh sites if run on the colony system.

### CORRIGENDUM.

The description of Fig. 5, omitted from the plate on page 762 (Article *Pappea capensis* November *Journal*, should read:—"Fig. 5. Fruit."

## THE VEGETABLE GARDEN.

December, 1920.

By H. B. TERRY, Cert. R.H.S., Lecturer in Horticulture, School of Agriculture, Potchefstroom.

THIS is a busy month in the vegetable garden, for not only must late sowings of summer crops be made, but first sowings of autumn and winter vegetables be thought of. Some discrimination is necessary as to what should be sown in different districts. In the colder districts the sowing of summer crops should cease and a start made to hurry along winter crops, such as Carrots, Cabbage, Cauliflower, and Swiss Chard.

**CABBAGE.**—Make a first sowing of Castle, Early Savoy, Mammoth, Surehead, Copenhagen Market, and Offenham. Keep the young plants growing vigorously right from the start and control Bagrada Bug.

**CAULIFLOWER.**—To obtain early heads make large sowings of Gilt Edge, Eclipse, and Snowball as the earliest, to be followed by Veitche's Autumn Giant and Italian Giant. Treat the seed-beds and transplant in a similar manner to Cabbage.

**BROCCOLI.**—This is a hardy type of cauliflower, succeeding in localities too severe for ordinary cauliflower. The heads are larger but take longer to mature. Sutton's Autumn Mammoth and April Queen are medium late; Metropole and Self Folding are late, requiring nine months to mature. Treat the same as Cabbage and Cauliflower.

**BEEF.**—A good sowing of an early sort and also a long-rooting variety should be made for succession. Do not choose recently manured soil or the roots will split owing to the heavy rainfall, etc.

**BEANS.**—Sow dwarf sorts fortnightly; they mature in eight weeks.

**CARROTS.**—A good sowing should be made for autumn; Chatenay, Altringham, Danver's Yellow, and James' Intermediate are suitable varieties.

**CELERY.**—Prepare for transplanting next month; if not already sown it will save time to purchase plants.

**CUCUMBER.**—Destroy any plants showing mildew and make another sowing for succession; do not allow any fruits to remain uncut, as they prevent others forming.

**SWEET CORN.**—Sow every two weeks to keep up supplies of tender cobs later on. The rows should be  $2\frac{1}{2}$  feet apart, and each plant 1 foot distant.

**LETTUCE.**—Continue to sow every three weeks; at this period there is always a tendency to bolt to seed during hot weather.

**MELONS.**—The last sowings of this season may be made; it is necessary to select a site with perfect drainage.

**ONIONS.**—Store any crop that may have ripened recently. Continue to sow for green salad onions; also sow thickly for producing small pickling bulbs; use the Queen.

**PARSNIPS.**—On ground which was manured for some previous crop, make a good sowing. If the soil is shallow or heavily manured the roots fork. If sown now they should provide a good supply throughout winter.

**RADISH.**—Try the half-long varieties now. Icicle, French Breakfast, Olive Shaped, Long Red, and Sparkler. These stand better in the heat than turnip-rooted sorts.

**SPINACH.**—The New Zealand variety sown in rows 2 feet apart and thinned out to 1 foot apart will thrive better and give more food than ordinary spinach.

**MARROWS AND SQUASH.**—Another sowing should be made of the bush types if a succession is required.

**TOMATOES.**—Keep all growing plants tied up to protect them from storms and disease. A spraying with bordeaux mixture will be a great help in checking disease. Seedlings transplanted now will fruit in the autumn and until the frosts kill them off. Too late to sow now and expect fruit, except in low veld.

**POTATOES.**—Plant a small crop, but prepare to plant the main crop at the end of the month or early January on the high veld. Secure the required quantity of seed while you may. Five Towers, Up-to-Date, Factor, King of the Blues and Carmen are reliable varieties to hold over winter.

## NOTES FROM THE "GAZETTE."

Attention is drawn to the following matters of interest which appeared in the *Union Government Gazette*:—

(Abbreviations: "Proc."—Proclamation; "G.N."—Government Notice.)

*Gazette.*

No.	Date.	
1097	8/10/20	The compulsory dipping of cattle has been ordered (a) every five days (in the five-day dip) for portions of Weenen, Idutywa, Alfred, Paulpietersburg, Vryheid, Tsolo, and Durban districts; (b) every seven days (in the seven-day dip) for portions of Lydenburg and Nqamakwe districts and the district of Eshowe; and (c) every three days (in the three-day dip) for portions of Pretoria, Zoutpansberg, Pietersburg, Piet Retief, and Barberton Districts. (G. N. Nos. 1829, 1870, 1909, 1954, 1996.)
1098	15/10/20	
1099	22/10/20	
1101	29/10/20	
1102	5/11/20	
1097	8/10/20	In terms of Section 21 (f) of Government Notice No. 638 of 1915, the Magistrate of Piet Retief District has, by Minister's Order, to take a Cattle Census for that district. (G. N. No. 1830.)
1098	15/10/20	After the 15th November, 1920, the Cattle Stealing Act, 1898 (No. 1 of 1899), of Natal, shall have force and effect in the District of Entonjaneni, Zululand. (Proc. No. 173.)
1098	15/10/20	The reappointment of members to Local Boards of the Land and Agricultural Bank of South Africa for the Cape of Good Hope, Eastern and Western areas; and the Orange Free State and Natal areas is notified in G. N. No. 1877.
1098	15/10/20	Compulsory dipping of sheep and goats under the Scab Regulations and the Stock Diseases Act within the period 20th October, 1920, to 20th December, 1920, has been ordered for portions of the Cape District and the Districts of Stellenbosch, Paarl, and Malmesbury (G. N. No. 1868), and for the whole of the Bredasdorp District (G. N. No. 1869); for the District of Barkly West for the period 1st November to 31st December, 1920. (G. N. No. 1906.)
1099	22/10/20	
1099	22/10/20	By Parliamentary resolution (Session, 1920) the Qukanca Forest Reserve, Block 1 (V) of Block 1, Mount Frere Western Reserve has been withdrawn from the demarcated forest area. (G. N. No. 1892.)
1099	22/10/20	It has been ordered, in terms of the Stock Diseases Act, No. 14 of 1911, that after 1st January, 1921, no permits for the movement of cattle within the Piet Retief District will be issued unless such cattle are tick free and certain other provisions are complied with. (G. N. No. 1922.)
1099	22/10/20	The British Cotton Growing Association have again offered £250, 10s. for prizes for two cotton growers' competitions to be held in the Union during the forthcoming season. Competitors must send in their names before 15th December, 1920. The conditions governing these competitions are published in G. N. No. 854.
1099	22/10/20	An allotment of Government guano will be made early in February next. Bona fide farmers and gardeners only within the Union will be considered, and they are to apply before the 18th December to the Superintendent, Government Guano Islands, Box 251, Capetown. (G. N. No. 870.)

*Gazette.*

- | No   | Date.    |  |
|------|----------|--|
| 1101 | 29/10/20 | Regulations relating to the reservation of portions of Commonages in surveyed Native Locations in the Transkeian Territories for purposes of winter grazing, are now published. (Proc. No. 183.)   |
| 1101 | 29/10/20 | All brands for horses, cattle, ostriches, sheep and goats, registered under the Brands Registrations Acts (C.G.H.) for the quarter ended 31st March, 1920, are published in G. N. No. 1932, and for the quarter ended 30th June, 1920, in G. N. No. 1933.  |
| 1101 | 29/10/20 | In terms of Section 16 (a) of the Stock Diseases Act, the removal of all cattle from various farms in the Lydenburg District has been ordered. (G. N. No. 1934.)   |
| 1101 | 29/10/20 | For purposes of the Stock Diseases Act, certain police posts on various farms in the Pretoria District have been declared temporary isolation pounds. (G. N. No. 1946.)  |
| 1101 | 29/10/20 | The appointment of Mr. P. J. du Toit as Acting Secretary for Agriculture, as from the 1st October, 1920, has been approved of, in terms of Public Service and Pensions Act, No. 29 of 1912. (G. N. No. 1969.)  |
| 1101 | 29/10/20 | Applications for holdings to be disposed of on lease and situated in the Districts of Barberton, Pietersburg, and Zoutpansberg will be received by the Department of Lands, Pretoria, up to the 11th December, 1920. (G. N. No. 1940.)   |
| 1101 | 29/10/20 | Up to 10th December, 1920, applications will be received (1) by the Secretary for Lands, c/o Surveyor-General, Pietermaritzburg, for various farms to be disposed of on conditional purchase lease, situated in Zululand, Nkandhla, Lower Umfolozi, Camperdown, Klip River, Alfred, Polela, Impendhle, and Weenen (G. N. No. 1972); (2) by the Department of Lands, Pretoria, for various farms in the Van Rhynsdorp Division (G. N. No. 1973); and (3) for certain farms in the Ermelo and Middelburg Districts (G. N. No. 1974.) |
| 1102 | 5/11/20  | Owing to the absence of scab therein, protection, in terms of the Scab Regulations, has been extended to certain portions of Molteno and Maraisburg Districts and added to the protected Steynsburg District; and to portions of the Hope-town District to be added to the protected District of Britstown for the purposes of the above regulations. (G. N. No. 234.)   |
| 1102 | 5/11/20  | The Department of Lands, Pretoria, will receive applications up to 17th December, 1920, for Crown farms in the Lydenburg, Pietersburg, Pretoria, Rustenburg, Zoutpansberg, Kuruman, Cape, Mafeking, Vryburg, and Hoopstad Districts to be disposed of on conditional purchase lease. (G. N. No. 1981.)   |
| 1102 | 5/11/20  | Up to 10th December applications will be received by the Department of Lands, Windhuk (S.W. Protectorate), for Crown farms to be disposed of on conditional purchase lease, situated in the Otjiwarongo, Karibib, Bethany, Gobabis, and Windhuk Districts. (G. N. No. 1994.)   |
| 1102 | 5/11/20  | The conditions and terms upon which advances may be made by the Minister of Lands to lessees under Crown Land Disposal Ordinance (No. 57 of 1903, Transvaal) have been amended. (G. N. No. 2009.)  |



## SOUTH AFRICAN PRODUCE ON THE OVERSEA MARKET.

Extracts from Report of the Trade Commissioner  
(dated 7th October, 1920).

September, 1920.

*Wool.*—The wool auctions during the month lasted from 22nd to 30th. The total quantity of South African wool offered at these series was approximately 10,000 bales, but only about 1500 bales were disposed of, the remainder having to be withdrawn. For the best descriptions of snow-whites there was practically no demand, and prices for these were quite 20 per cent. below those obtained in August. Medium and inferior snow-whites declined fully 15 per cent. There was a fair amount of competition for the better styles of long greasy combing wools at about 10 per cent. reduction, but medium and short greasies declined about 15 per cent. The feature of this sale was the absence of competition for scoured South African wools, and the bulk of the offerings has been withdrawn. As mentioned in the report for August, the wool market at that time showed a downward tendency, and the result of the recent auctions has more than confirmed the forecast. The tendency is for prices to go even lower. It has been realized for some considerable time past that a decline was bound to set in sooner or later owing to the unsettled state of the market. Buyers have limited their purchases to a minimum and secured only sufficient supplies to enable them to carry out the orders they have in hand. Sales of Australian wools were held in Antwerp on the 23rd, and here again prices ruled irregularly at from 5 to 10 per cent. below those obtained at the previous sales on the 9th. It is evident that the market conditions on the Continent closely resemble those in the United Kingdom, and buyers are only purchasing sufficient wool for their immediate requirements. The following are the current prices for South African wool as compared with those ruling during the previous sales:—

	Current Prices. per lb.	Prices current at Previous Series. per lb.
Snow-white, extra super, 20 per cent. cheaper ... ..	50d.-59d.	61d.-80d.
Snow-white, super, 20 per cent. cheaper ... ..	39d.-49d.	45d.-60d.
Snow-white, medium, 20 per cent. cheaper ... ..	30d.-38d.	36d.-44d.
Snow-white, inferior, 20 per cent. cheaper ... ..	21d.-29d.	26d.-35d.
Grease combing, long, 15 per cent. cheaper ... ..	17d.-27d.	21d.-31½d.
Grease combing, medium, 15-20 per cent. cheaper ...	12d.-19d.	15d.-20d.
Grease clothing, light, 15 per cent. cheaper ... ..	14d.-19d.	16d.-22d.
Grease clothing, heavy, 15 per cent. cheaper ... ..	9d.-12d.	11d.-15d.

*Mohair.*—The mohair market at the commencement of the month opened with a downward tendency and business very restricted. The Bradford spinners have only purchased sufficient to cover the orders they have in hand, which are few and on the small side. Stocks of mohair in this country are large, and, at the present rate of consumption, they will take some time to work off. The market of late has been considerably depressed owing to the threatened coal miners' strike, but, apart from this, prospects are none too bright. It is not anticipated that any material increase in the demand for mohair yarn will be experienced for some little time to come. At the close of the month the position of the market was practically unchanged.

*Hides.*—Auction sales were held on the 9th, and a representative catalogue of goods was placed before the trade. The result was again disappointing, as only a few lots were sold. A small number of dry Cape hides (thirds) were sold at 11d. to 12d. per lb., but dry-salted were neglected. Since

the sales there has been a slight improvement, and a small number of wet-salted Johannesburg hides have changed hands at 12d. Dry and dry-salted have been neglected. Prices are quite nominal, best heavy dry hides are worth 18d., dry-salted from 16½d. to 17d.

*Goat and Sheep Skins.*—329,000 Skins were offered by auction on the 15th, but nothing was disposed of, although about 10,000 skins have since been sold by private treaty. Brokers report that there was no general demand for any class of skin. Sales were confined to kidskins and dry damaged goat, also a small line of medium goatskins of mixed character. In addition, a few sea damaged were cleared.

Of 180,581 Angora skins offered, 233 only were sold, comprising a sample of extra light Capetown at 13d. and heavy Algoa Bay at 12d. per lb.

*Wattle Bark.*—The market for this article is very dull, and inquiries from the home trade are few and far between, whilst the Continent has also shown no interest. The present value of ground bark is approximately £15 *ex store*, whilst chopped is offered at £14. There are large stocks of chopped bark, but supplies of ground are somewhat short and are being firmly held.

*Ostrich Feathers.*—Since the sales the market has continued steady, and some lines of all descriptions have been disposed of. There is no improvement in prices, and buyers have not been anxious to purchase, except for actual requirements. The uncertainty regarding the foreign exchange, particularly the French, and the threatened coal strike, have had an adverse influence on feathers as on other articles. However, with more settled conditions we may experience a better demand, as there is certainly a feeling that in the coming fashionable ostrich feathers will take a prominent part.

*Maize and Maize Meal.*—During the month a fairly large business was done both in South African maize and meal. South African No. 2 White Flat and Rhodesian made 82s. 6d. and 82s. per quarter for September-October shipment. The demand for maize meal was quite good, and up to £19 per ton was secured for white. During the past week, however, the market was in a very weak state. South African No. 2 White Flat was offered at 80s. without result, and offers of £18. 10s. for meal failed to interest buyers. Generally speaking, the market has slumped owing to the weakness of the American market. Argentine maize has fallen in sympathy and is quoted at 62s. 6d. per quarter for September-October shipment, and 61s. 6d. October-November.

*Dried Fruit.*—Although a fairly good business was done in South African raisins at the beginning of the month at prices up to 127s. 6d. per cwt. duty paid, the market demand has slackened off considerably, and trade is rather dull. At the auction sales held on the 5th October South African raisins, in boxes, only secured 100s. per cwt., duty paid. Valencia (new crop) are quoted at 130s. to 140s. per cwt.

*Crayfish.*—Supplies are reported to be short, and brokers consider that well-known South African packs are worth about 107s. 6d. to 110s. c.i.f. for 96 ½-lb. tins.

*Eggs.*—The market is very weak, due to the arrival of large quantities from all sources of supply, consequently prices have declined. The following are the present prices ruling:—Argentine, 31s.; Canadian 34s. to 35s.; Irish, 38s. to 40s.; Danish, 39s. to 42s.; English, 45s. to 46s. per great hundred (120).

*Cotton.—American Spot.*—For the week ended 1st October brokers report a small amount of business on the spot; sales 19,000 bales. The basis for cotton fully middling and over is fairly steady, but for the lower grades cotton is pressed for sale, and low offers would be entertained. For new crop cotton, the basis is distinctly lower for forward deliveries ordinary 1½ in. Texas fully middling and good middling being offered on the 29th at 200 on and 450 on respectively. On the 23rd ult., September "futures" closed at 19.35d. and October at 19.05d. October "futures" closed at 17.02d. The highest for October was 19.20d., and the lowest 16.30d.

*Cotton Seed.*—The market for cotton seed has been somewhat neglected, and Bombay seed to Hull September-October and October-November shipments are quoted at £15 sellers. Egyptian f.a.q. new crop to London September-October shipment is quoted at £19. 10s., whilst the same shipments to Hull are offered at £19. 5s. Several parcels of South African cotton seed are at present in store, but so far no sale has been effected. The value of this seed on the basis of Egyptian is probably about £13 c.i.f.

---

**OVERSEA PRICES OF SOUTH AFRICAN PRODUCE.**

MARKET PRICES OF SOUTH AFRICAN PRODUCE IN THE UNITED KINGDOM,  
CABLED BY THE TRADE COMMISSIONER, LONDON, FOR THE MONTH  
OF OCTOBER.

---

*Wool*.—Extra super scoured, 45d. to 58d. per lb.; snow whites, 26d. to 44d. per lb.; super long deep grown, 26d. per lb.; super sorted, 12 months, 22d. per lb.; super long, 18½d. per lb.; long combings, 17d. per lb. The remainder, greasy combings, ranged down to: Heavy faulty, 6 to 9 months, 13d. per lb.; cross-breeds, 6d. to 14d. per lb., nominal; coarse and coloured, 4d. to 10d. per lb., nominal; kempy, 9d. to 15d. per lb., nominal; and greys, 18d. to 38d. per lb., nominal. Owing to the coal strike the next auctions, which were fixed for the 25th, have been postponed.

*Mohair*.—The ruling prices are: Summer firsts, 20d. per lb.; mixed firsts, 10d. to 16d. per lb.; Basutos, 18d. to 19d. per lb.; winter hairs, 10d. per lb. Prices are purely nominal. There is very little demand, with large stocks. For Turkey and Cape mohair a further decline in prices is considered likely.

*Cape Hides*.—Sun-dried, sound, 16½d. per lb.; salted, 15½d. per lb.

*Sheep Skins*.—Sound combings, 14d. to 16d. per lb.; pelts, sound, 6d. per lb.; Capes, salted, 100s. to 140s. per doz.; coarse and coloured skins, 9d. to 10d. per lb.

*Angora Goat Skins*.—Light and heavy sun-dried, 12d. per lb.; bastards, 30d. per lb.

*Goat Skins*.—Light sun-dried and heavy, 30d. per lb.

*Seal Skins*.—45s. to 60s. each.

*Wattle Bark*.—Chopped, £14. 10s. per ton; ground, £15 per ton; extract, £44 per ton, nominal. There are sellers at above prices, *ex store*, London, but there is no demand.

*Ostrich Feathers*.—In ostrich feathers there is very little business doing. Prices for most of the descriptions show a distinct decline since last sales.

*Maize*.—13th, La Plata October-December parcels, 63s.; 16th, La Plata October-November shipments, 61s. 3d.; 21st, La Plata October-November shipments weaken, but 58s. 9d. was paid; 30th, La Plata November-December quoted at 57s.; South African No. 2 white flat, November-December quoted at 66s. and yellow at 58s.

*Wheat*.—The Royal Commission on wheat has raised the selling price of wheat to figures ranging from 121s. for Australian to 103s. for inferior Canadian per 480 lb. c.i.f.

*Sugar*.—Prices have further declined since previous month, owing to excess supplies in America. New York refineries are working only half-time and the outlook is uncertain. Brokers consider the fall in prices is too precipitate, and some improvement in the near future is not unlikely.

*Citrus Fruits and Raisins*.—Oranges are quoted at 30s. to 40s. per case; grape fruits, 27s. 6d. to 30s. per case; naartjes, 5s. to 10s. per tray; raisins, 100s. per cwt. The market is weak.

## MARKET PRICES FOR OTHER PRODUCE OF INTEREST TO SOUTH AFRICA.

*Cotton*.—9th, American middlings, 17.75d.; East African, good, fair, 31d.; 23rd, American, 15.73d.; East African, 26.00d.; 30th, American, 16.33d.; East African, 26.00d.

*Mutton* (good).—75s. per cwt.

*Beef* (good).—73s. per cwt.

*Eggs*.—23rd, 2872 cases arrived from South Africa, quality satisfactory. Finest selected quoted at about 46s., fine quoted at from 40s. to 44s.; 22nd, South African eggs are 40s. per 120. The market is firm, the supply short, and there is an upward tendency. 30th, finest selected, 45s. to 46s.; fine, 42s. to 43s.

*Sunflower Seed*.—Sunflower seed is £28 per ton.

*Lucerne Seed*.—£120 per ton, nominal.

*Flax*.—There is no market for the time being.

*Kapok*.—Kapok is 9d. per lb. The market is slow.

*Sisal Hemp*.—£40 to £55 per ton. There is a strong demand for African, and there is a large business being done at advancing prices.

*Aloes*.—Cape aloes are 65s. to 82s. 6d. per cwt. The market is quiet with a lower tendency.

*Ground Nuts*.—£35 per ton. The market is steady at the lower level of prices

---



---

## NOTES FROM THE DIVISIONS.

---

### HORTICULTURE.

---

The Horticulturist, writing from Durban, says: The effects of hybridization which has taken place naturally between the various varieties of pawpaws at Winkelspruit Experiment Station, Natal, have in some cases produced weird results. A depth-planting experiment of citrus trees has been in hand for some seasons. It consists of very shallow (almost wholly above ground), ordinary, and very deep planting of various kinds. These experiments, to be of any use, however, still require to be continued for several years over a variety of areas, on differing soils and under varying climatic conditions.

Of value to banana growers are the banana varieties. There are about 20 variety plots at this station to select from.

Australian apples are very noticeable in Durban and other coastal towns; in fact, the local fruit seems to be entirely absent. Of the varieties imported the Dunns and Rokewoods are the best carriers, as they come through with little waste, packed in bushel boxes made of hardwood, but not very attractive in appearance.

## DAIRYING.

Most creameries and cheese factories are preparing for the season, and the services of officers of the Dairy Division have been in frequent demand. The prospects for the 1920-21 season are favourable in some districts where good rains have fallen, but other areas, notably the Eastern Province, are still very dry. A factor which is likely to retard production during the early months of the season is the calvings which appear to be very late in most of the dairy farming districts, due no doubt to the severe drought experienced last season when cows got into low condition. Nevertheless a good season is predicted, and it is anticipated that considerable quantities of butter and cheese will be available for export towards the end of the summer. This means that prices obtainable for these products overseas will largely determine those the factories will be able to pay for milk and cream. Consequently, farmers must be prepared for lower prices than those which prevailed last season, which did not allow of the surplus being exported at a profit, and considerable losses have been sustained by creameries and cheese factories who have had to export their surplus before the commencement of the new season.

The Superintendent of Dairying (Mr. E. O. Challis), together with Dairy Inspector Gow, have been engaged in grading and supervising the export of butter and cheese at Durban, while the Assistant Superintendent (Mr. E. G. Hardy) and Dairy Inspector Allison have been engaged on similar work at Capetown. It is not anticipated that any more butter will be exported for a couple of months at least. All the graded butter has been purchased by the Food Controller, London, at a contract price, as the sale of this commodity in Great Britain is still under control. A condition of the contract is that the butter must be covered by a Government Grader's certificate. Only first and second grades are accepted, and every case is stamped with the Union Government's grade stamp before being shipped. Creameries should mark every case of butter packed, whether intended for export or not, with a mark or number indicating the date of manufacture and churning it is from. Grading regulations are in course of preparation, and after they have been gazetted, no butter will be accepted for grading unless it is marked in accordance with such regulations. The quality of the butter examined was not altogether satisfactory; a good deal of it had to be de-graded to second grade, no doubt largely due to the fact that it had been in cold storage for several months. "Fishy" flavour was the cause of trouble in many cases. This objectionable flavour develops in the butter during cold storage, and has still baffled all efforts to ascertain its cause and means of prevention. It is probably due to an organism which is not affected by ordinary storage temperatures, but has only rarely been found to develop in butter stored below 5° F. As pasteurisation of the cream would appear to be the most successful means of prevention, creameries are strongly recommended to adopt this process more generally. The dearth of knowledge regarding the origin of this trouble is fully recognized, and it is hoped to carry out research work in this direction shortly.

Quantities of cheese have also been exported, chiefly from East Griqualand factories, and shipped to the open market as the control of this commodity has been removed. All this cheese has been carefully graded, and should realize good prices, particularly in view of the fine advertisement obtained by our cheese at the recent London Dairy Show. Notwithstanding this, it is, unfortunately, practically certain that the factories will sustain a loss owing to the high price paid for milk last season. There appears to be still a good deal of last season's cheddar cheese held, which will probably be exported before the new season's make comes on the market. The position, however, has been considerably relieved, as practically all the Australian cheese imported earlier in the year has now been disposed of.

New co-operative creameries will shortly be running at Ladysmith, Natal, and Empangeni, Zululand. New cheese factories will open at Estancia, Transvaal, and Clanville in the Dordrecht District, Cape Province.

The possession of motor cars by two itinerant officers of this Division has greatly facilitated the performance of their duties.

---

Keep your *Journals*! The contents will be indexed every six months and a copy of the index sent to each subscriber.

## RECENT AGRICULTURAL LITERATURE.

By PAUL RIBBINK, Librarian, Department of Agriculture.

### I.—UNION GOVERNMENT PUBLICATIONS.

MISCELLANEOUS REPORTS, ETC., OF INTEREST TO FARMERS.

(Obtainable from the Government Printer, Pretoria.)

<i>Price per copy.</i>	<i>Number of Publication.</i>
1s.	Excise for the Union for the year ended 31st December, 1919, Report of the Superintendent. U.G. 53/20.
5s.	Lands Department of the Union of South Africa, Report for the year ended 31st March, 1919. U.G. 45/20.

### II.—THE AGRICULTURAL PRESS OF SOUTHERN AND TROPICAL AFRICA.

#### SELECTED ARTICLES.

*Die Boer* (Geïllustreerde Landbou-byblad van de *Volkstem*), Pretoria.

- 15/10/20 Kalkoene, deur T. B. Cross.  
 22/10/20 Die Wolmark.  
 29/10/20 Boerebymekaar te Potchefstroom. Konferensie van Graanboere.

*Die Boerevrou* (Posbus 984, Pretoria).

- 10/20 Iets oor Bye en Heuning, deur G. R. von Wielligh. Plumvee, deur J. J. Jordaan. Skoon- en Mooimaak van Ons Huise, deur Mej. M. v. d. Byl. Vereenvoudiging van Ons Huiswerk, deur A. H. van Gent.

*Farmers' Advocate, South African* (P.O. Box 247, Bloemfontein).

- 10/20 Gall-sickness, by A. F. Harber. Fertilization with Carbonic Acid, by A. Karlson. Dry-land Farming in Utah, III, by H. W. Turpin.

*The Farmers' Journal* (Nairobi, B.E.A.).

- 23/9/20 Flax-scutching Machinery. Flax Seed. Plant Life in the Tropics (*continued*).  
 30/9/20 Introducing Kudzu. The Composition and Feeding Value of Silage.  
 7/10/20 Kerry Cattle, by A. Stephen.  
 14/10/20 The Flax Crop and Manure.

*The Farmers' Weekly* (Bloemfontein).

- 6/10/20 South American Cattle Industry, by Dr. E. A. Nobbs. Gum Trees for Timber, by C. S. Hayter.
- 13/10/20 The Agricultural Museum of Buenos Aires, by Dr. E. A. Nobbs. East Coast Fever, by Geo. D. Alexander. Birds and Rodents, by F. W. FitzSimons, F.Z.S. A Home-made Tip-cart, by "Settler." Cape Agricultural Congress, Special Report. A Visit to Pirbright, by S. Y. F.
- 20/10/20 The Railway Rates. East Coast Fever, II, by Geo. D. Alexander. Do Animals Think? by J. Sauer van Pletzen. Cape Agricultural Congress, Conclusion of Special Report.
- 27/10/20 Gum Trees for Timber, II, by C. S. Hayter. Holland's Bulb Industry, by S. Y. F. Birds Useful and Destructive, by F. W. FitzSimons, F.Z.S. Farming Conditions in Uruguay, by Dr. E. A. Nobbs. East Coast Fever, III, by Geo. D. Alexander. Principles of Poultry Breeding, by J. Fisher, B.Sc., N.D.A. Agricultural Organization. Transvaal Agricultural Union's Propaganda.

*The Independent* (Salisbury, Rhodesia).

- 8/10/20 The Colours of Animals, by Bemhex.
- 15/10/20 The Colours of Animals (*continued*). Plant Trees.
- 22/10/20 The Meat Industry. Annual Maize Muddle. Meat for Export. Smithfield Company's Visit. 'Ware Rand, Warning to Cattle Exporters. The Research Scheme.

*South African Journal of Industries* (Government Printer, Pretoria).

- 10/20 Manufacturing Iron and Steel in the Union, by Prof. G. H. Stanley. A New Motor Spirit, by Dr. C. F. Juritz. The Council of Commerce. Marking of Merchandise. The Permanent Labour Organization of the League of Nations, by G. E. Di Palma-Castiglione. Water-power in the Union of South Africa, III, by F. E. Kanthack. Dealing with the Rodent Pest, by W. F. Schlupp. A New Method of Sugar Manufacture in Natal, by W. A. Campbell. Timber Trees for Commercial Culture, by T. R. Siva.

*Die Landbouwer* (Posbus 1035, Pretoria).

- 30/9/20 Verboue van Tabak, III, deur P. Koch. Bolsjewisme en die Russiese Boer (Slot). Grondbemesting, III, deur Dr. B. de C. Marchand. Transvaalse Landbou Unie, Verslag van die Dage-likes Bestuur vir die termyn 1919-20 (*vervolg*).

*Die Landbou Weekblad* (Posbus 267, Bloemfontein).

- 6/10/20 Landbouonderwys in die Skool (*vervolg*). Die Goewernementsbosse, deur C. Truter. Sprinkhaanbevegting. Suidafrikaanse Rysmiere, III, deur C. Fuller.
- 13/10/20 Dorre Suidafrika (*vervolg*). deur J. D. Schonken. Die Goewernementsbosse (*vervolg*). Verskillende Soorte Ko-operasies (*vervolg*), deur Dr. J. E. Holloway.
- 20/10/20 'n Skaapplaas in die Colesbergse Distrik. Die Inkampsistees vir Jakhals (*vervolg*), deur P. Hamersma. Die Outomobiel (*vervolg*), deur J. L. v. d. Merwe.
- 27/10/20 Dorre Suidafrika (*vervolg*). Landbouonderwys in die Skool (*vervolg*). 'n Skaapplaas in die Colesbergse Distrik, II. Suidafrikaanse Rysmiere, III.

*Mitteilungen der Farmwirtschafts-Gesellschaft für Südwestafrika.*

- 1/10/20 Beziehungen des Ackerbaues zur Viehzucht in Südwestafrika, von G. Agster. Der Ackerbau, und seine Bedeutung für die Zukunft unserer Farmwirtschaft, von Hans Stier. Kunstliche Trocknung von Mais, von Otto Henning. Ackerbau im Bezirk Grootfontein, von F. Martinsen.

*South African Farm News* (P.O. Box 4860, Johannesburg).

- 10/20 An Industry that has fallen into Decay. Een Industrie wat Agteruitgegaan het. The Origin of British Breeds of Cattle (*continued*). General Farming in South Africa. Cotton Culture. Katoenbou. door Pieter Koch.

- South African Fruit Grower and Smallholder* (P.O. Box 3958, Johannesburg).  
 10/20 Citrus-growing in California, by Sir P. Fitzpatrick. The Fruit Shed in Relation to the Control of the Codling-moth, by F. W. Petty. The Spraying of Stone Fruit Orchards in the Cape Province, with special attention to "Red Spider," by F. W. Petty.
- South African Gardening and Country Life* (P.O. Box 3958, Johannesburg).  
 10/20 Carnation-growing in South Africa, by A. G. Murray. Native Plants at the National Botanic Gardens.
- South African Poultry Magazine* (Bloemfontein).  
 10/20 S.A.R. Club's "Practical Poultry Week." "Fergue," Melville. Egg Production Extraordinary—Advantages of Dry Mash Feeding. Buying of Foodstuffs and Stock Birds, by J. J. Jordaan. Wyandottes, by H. Moore. The Carnivorous Animals of South Africa, by F. W. FitzSimons.
- South African Poultry Review and Small Holder* (Johannesburg).  
 1/11/20 The Principles of Breeding as Applied to Poultry, by J. Fisher. South African Poultry Association: The Forthcoming Conference, Pretoria, 9th-13th November. Poultry Pests, by S. H. Skaife.
- South African Sugar Journal*.  
 10/20 The World's Sugar Outlook. Motor Alcohol from Molasses. The Future of the Sugar Industry, by A. Mortifee. Sugar-growing in Natal. The Native Labour Problem, by A. E. Parkin.
- The Sun and Agricultural Journal of South Africa* (P.O. Box 634, Johannesburg).  
 10/20 Transvaal to Tangier, V. The Story of the Marquis Wheat. The South African Maize Breeders', Growers', and Judges' Association. Report of the Proceedings of the Annual Maize Congress held on the 8th September, 1920.
- Sunday Times* (Farmers' Supplement).  
 10/10/20 Leguminous Crops, by J. B. Osborn. Cattle Ranching, Disease Prevention and Treatment. Houses Everlasting, Pisé de Terre, by E. T. Bains. South African Parasites, by R. Bigalke.  
 17/10/20 Tobacco Insects. Cattle Ranching (*continued*). Houses Everlasting, Pisé de Terre (*continued*). Some South African Parasites (*continued*).  
 24/10/20 The Tricks of Stock Dealing. The Millets, by J. P. Sellschop. Index to "Farmers' Supplement" for the preceding six months.  
 31/10/20 Some South African Parasites (*continued*). By-products of the Packing Industry, by E. K. Hall. Cattle Ranching (*continued*). Houses Everlasting, Pisé de Terre (*continued*). The Millets (*continued*).

### III.—SELECTED LIST OF BOOKS ADDED TO LIBRARY.

[NOTE.—The first number is that of the class to which the book belongs, the last number is that of the book itself.]

#### GENERAL.

- 018,73 Bostwick, A. E. The American Public Library. New York, 1917. No. 7213.
- 050 Peace Conference, Versailles. The Treaty of Peace between the Allied and Associated Powers and Germany. The Protocol, annexed thereto, the Agreement respecting the Military Occupation of the Territories of the Rhine, and the Treaty between France and Great Britain respecting Assistance to France in the event of Unprovoked Aggression by Germany. Signed at Versailles, 28th June, 1919. London, 1919. No. 7189.



- 240,51 Nederbracht, J. A. "Penetration Pasifique" in China. 's Gravenhage, 1918. No. 7222.
- 240,52 Bosch, P. A. R. Japan in den Oorlog. 's Gravenhage, 1920. No. 7223.
- 240,54 Curtis, L. Letters to the People of India on Responsible Government. 2nd Ed. London, 1918. No. 7170.
- 290 Adams, C. A. Textbook of Commercial Geography. New York, 1901. No. 7178.
- 290,49.2 Brackel, G. J. L. Dividend-Politiek en een Onderzoek naar de Toepassing ervan by eenige Nederlandsche Scheepvaart Maatschappijen. Rotterdam, 1919. No. 7225.
- 290,49.2 Smith, M. F. J. Tijd-Affaires in Effecten aan de Amsterdamse Beurs. 's Gravenhage, 1919. No. 7226.
- 320 Lamb, C. G. Notes on Magnetism. For the Use of Students of Electrical Engineering. Cambridge, 1919. No. 7220.
- 370 Verrill, H. A. Knots, Splices, and Rope-work. (A Practical Treatise.) 2nd Rev. Ed. New York, 1919. No. 7186.

## AGRICULTURE, LIVE STOCK, AND ALLIED SUBJECTS.

- 400 MacDonal'd, W. Makers of Modern Agriculture. London, 1913. No. 7174.
- 410 Smith, R. J. The World's Food Resources. London, 1919. No. 7180.
- 420 Beenhouwer, H. A. Het Onderzeesche Kabelnet. Rotterdam, 1920. No. 7224.
- 420 Boelter, W. R. The Rat Problem. London, 1909. No. 7177.
- 430.2 Barker, A. F. Wool and the Textile Industries. Raw Material to Finished Fabric, English, French, Italian, and Spanish, with a Technical Glossary. Leeds, 1919. No. 7187.
- 430.2 Victoria Department of Agriculture. Specification and Small Wool Shed for Shearers. Victoria, N.D. No. 7206.
- 430,4,74 Guilford, W. S., California Hog Book. San Francisco, Cal., 1915. No. 7210.
- 431 Makay, G. L., and Larsen, C. Principles and Practice of Butter-making. 2nd Ed., Rev. and Enl. New York, 1915. No. 7215.
- 431 Victoria Department of Agriculture. Daily and Weekly Milk Chart. Victoria, N.D. No. 7207.
- 440,42 Great Britain, Government of. Report of the Committee on the Staffing of the Veterinary Departments in the Colonies and Protectorates. London, 1920. No. 7204.
- 466 Von Knauer, F. Der Rûbenbau. 7th Ed., Berlin, 1894. No. 7184.
- 477,42 Great Britain, Government of. British Empire Forestry Conference. Resolutions passed at the meeting held in London on 22nd July, 1920. London, 1920. No. 7205.
- 450 Weir, W. Productive Soils. (Lippincott's Farm Manuals.) Philadelphia, 1920. No. 7176.
- 465 Bradbury, Fred. Flax Culture and Preparation. London, N.D. No. 7168.
- 468 Smith, H. H. Notes on Soil and Plant Sanitation on Cacao and Rubber Estates. London, 1911. No. 7212.
- 470 Baily, L. H. The Nursery-Manual. New York, 1920. No. 7181.
- 470 Trelease, W. Winter Botany. Urbana, 1918. No. 7175.
- 470,68 Roth, J. Manual of South African Gardening. Port Elizabeth, 1883. No. 7171.
- 475 Freeman-Mitford, H. B. The Bamboo Garden. London, 1896. No. 7182.
- 181 King, D. W. (Edited). Homes for Home-builders, or Practical Designs for Country, Farm, and Village. New York, 1914. No. 7188.
- 483 Jeffery, J. H. Textbook of Land Drainage. New York, 1919. No. 7197.
- 483 Lynde, C. J. Home Waterworks. New York, 1912. No. 7198.
- 483 Owensboro Ditcher and Grader Co., Land Drainage and Irrigation Department. Insured Profits with Drainage. Owensboro, N.D. No. 7169.



## AT THE SCHOOLS OF AGRICULTURE AND EXPERIMENT STATIONS.

October, 1920.

CEDARA, NATAL.

*Climatic.*—The rainfall for the month (27th September to 26th October inclusive) was 4.27 inches. The mean maximum temperature was 71.1° F., and the mean minimum 50.53° F. The highest maximum temperature, 96.2° F., was registered on 21st October, and the lowest minimum, 40.5° F., on 8th October. Occasional heavy mists, following close after hot winds, caused considerable and rapid variations in the temperature. The rains were light and well distributed.

*Crops.*—Potatoes (Flourball, Carman, and Up-to-Date) are showing up well and present a healthy appearance, having benefited by the steady rains. Some portions of the oats are well advanced and have formed grain, whilst others are not so well grown owing to the long drought. There should be an average crop. The pasture grasses, paspalum, fescue, cocksfoot, and sheep's burnet, have shown up well since the advent of the rains. The veld grasses have also responded well and are making good growth. The kikuyu has made a rapid and excellent recovery from the effects of the winter drought and frosts.

*Stock.*—Seven calves were born during the month. All of the beef cows and young stock have been turned out to grass and are doing very well. One Ayrshire bull was received from the Potchefstroom School of Agriculture for use in the Ayrshire herd here.

*Horticulture.*—Most varieties of plums, peaches, and citrus have set their fruit well. Thinning is now in progress. The citrus trees have been sprayed with lime-sulphur (immediately after the blossoms fell) as a preventive of fungous diseases.

*Poultry Section.*—The Fourth Poultry Breeders' Conference was held at Cedara on the 4th. Unfortunately the weather was most unfavourable, rain falling practically all day. Nevertheless about ninety people attended from all parts of the Province. The programme included inspection of the poultry plant, an exhibit of various poultry foods and appliances, a set of specimens showing the internal anatomy of the fowl, also the embryology of the chick from the first to the twenty-first day. Mr. J. J. Jordaan, of Glen School of Agriculture, gave a demonstration on the correct method of holding a post-mortem; Mr. T. B. Cross on the correct methods of administering medicines and the treatment of various diseases. After lunch the Principal lectured on Modern Principles of Breeding, the Entomologist on Poultry Pests, and Mr. A. Bartlett, of Johannesburg, on the Laying Hen.

*Chemical Laboratory.*—Filter-press cake is a by-product of the sugar-cane mills, and a sample of this was sent in by a coast firm to ascertain what it was worth as a manure. The sample, as received, had partly dried out, and the results of the analysis are as follows:—

Moisture, 32.6 per cent.; organic matter, 47.7 per cent.; inorganic matter (ash), 19.7 per cent.; (a) including nitrogen, .9 per cent.; (b) including potash, .7 per cent.; and phosphoric oxide, 1.2 per cent.

It will thus be seen that the fertilizing value is not high, but should prove valuable for local use on sandy soils to supply the deficient humus. In other countries it is largely used for manure to prevent, as far as possible, the exhaustion of the cane lands by returning the ingredients taken out of them by the growing crops. A sample of Uba cane tops was submitted by a large cane grower on the coast for analysis to determine their feeding value. The results are:—

Moisture, 77.2 per cent.; ash, 1.9 per cent.; pure protein, .6 per cent.; amides, .1 per cent.; crude fat, .3 per cent.; soluble carbohydrates, 12 per cent.; crude fibre, 7.8 per cent.

The soluble carbohydrates included 1.2 per cent. of sucrose and 1 per cent. of invert sugar. The number of food units is only 14.6 with a nutritive ratio of 1 to 29.2. For comparison it may be stated that ordinary veld grass in the green state, with the same amount of moisture, would have an approximate nutritive value (in food units) of 15.9, so that the cane tops do not compare very favourably with the veld grass as a feed for stock. If fed, however, with some concentrated food of a high protein ratio, it would make a very satisfactory item in the animal's ration.

*Students.*—Fifty-one probationers were in residence at the beginning of the month. Four men were transferred to Winkle Spruit, five were admitted, and eight men left, three obtaining positions on farms, and five left after completing their course of training. Forty-four probationers are in residence at present at Cedara and six at Winkle Spruit.

---

#### ELSENBURG, MULDER'S VLEI, CAPE.

---

*Climatic.*—Mild and comparatively dry weather prevailed during the month. The rainfall recorded up to the time of writing is 1.79 inch, the normal average for October being 2.1 inches. The maximum temperature was 81.5° F. on the 15th, and the minimum, 40.0° F., on the 4th.

*Field Operations, Crops, etc.*—Small areas were planted to kaffir water-melons, maize (for ensilage), thousand-head kale, potatoes, Sudan grass, and sorghums during the month. Cereal crops are showing up exceptionally well on the farm lands, especially oats and rye, and an excellent harvest is assured. Considerable time was devoted to budding and grafting in the orchards, and also to spraying in connection with the control of codling moth, red scale, and *fusicladium*. The vineyards received their final cultivation. The young vines planted at Mariendahl in September have taken well, and are making satisfactory growth.

*Live Stock.*—The condition of all live stock at present is highly satisfactory. The annual stock sale took place on the 6th. In spite of the showery weather there was a good attendance, and the prices realized for practically all classes of live stock were excellent. Young Jersey bulls in particular were in great demand and commanded exceptionally high prices. A considerable decrease in egg-production was noticed in connection with the intensive poultry-house. This is due apparently to the marked tendency of the heavy-breed hens to become broody. It is concluded that heavy breeds of poultry are not adapted to the intensive-house system.

*Extension Work.*—The annual Grain Farmers' Conference was held on the 22nd. Owing to the threatening weather conditions, the attendance was somewhat smaller than expected. Close upon a hundred visitors were present and were conducted around the rotation, manurial, and general fertility experiments and the cereal variety plots during the morning. In the afternoon, lectures were delivered upon various phases of grain farming, including soil fertility, crop varieties and diseases, and much interesting discussion took place.

*Investigational Work.*—Comparative experimental trials of various insecticides in the orchard are being continued by the Entomologist. An attempt is being made to establish in the Cape Province parasites of the codling moth—these parasites will be imported from Italy. Comparative tests are being made by the Botanist relative to the efficacy for the control of *fusicladium* of various fungicidal preparations. Numerous other investigations previously referred to are being continued relating to soil fertility, manurial, and other problems.

---

#### GLEN, ORANGE FREE STATE.

---

*Climatic.*—On the 2nd, 24th, and 25th, 2.93 inches of rain were registered. The maximum temperature was 95 degrees on the 22nd and 23rd, and the minimum temperature was 33 degrees on the 8th. Frost was experienced on the lower lands on that date. The weather has been otherwise normal for the time of the year and the grass is now growing rapidly.

*School*.—The total number of students in residence during the month was fifty-eight, three having left since last month. Miss R. Oosthuizen, Lecturer in Household Science, assumed duty here on the 15th, and Mr. G. W. Mogg-ridge, assistant stockman, on the 1st.

*Farm*.—With the rain on the 2nd the river came down, replenishing our water supply to such an extent that it was possible to give the winter cereals, as well as the lucerne fields, another irrigation. The oat crops are promising well, and those sown early in the winter which are in ear now, should mature without any further waterings. A fairly large acreage of Sudan grass was put in; this is now coming up after the recent rain we have had.

*Live Stock*.—The health of the animals on the farm has been satisfactory, except that the Percheron stallion Krampton is at present suffering from laminitis. He has been very bad, but it is hoped that he will recover. Owing to an inadequate supply of roughage, which is always very scarce at this time of the year, there has been a marked decrease in the milk flow of the dairy herd.

*Experiments*.—The variety tests of the winter cereals are promising well. The grounds for summer experiments have been properly laid out and prepared by the Assistant Experimentalist, and planting of such crops as kaffir corn, peanuts, and cowpeas has been commenced.

*Engineering*.—The Lecturer in charge of this division reports that the farm buildings have been painted, several small construction works have been carried out, and a considerable amount of pumping was done for irrigation purposes.

*Poultry*.—The Lecturer in Poultry assisted at the Poultry Day held at the School of Agriculture, Cedara, on the 4th October, and subsequently paid a visit to Durban to examine some eggs in connection with the export of eggs. Incubation is being closed down, the young stock are growing well, and, on the whole, the birds are in good condition and laying well.

*Entomology*.—The Entomologist reports that a considerable amount of his time was devoted to the destruction of flies. In connection with this work, poison-sprayed branches were hung in the cow-byres and pig-sties. Fairly satisfactory results were obtained, especially in the former, where no other food is available at certain periods of the day. Manure was also placed in tins to tempt the flies to lay therein, and the larvae were then fed to the chickens. This seems to be an effective method of controlling the breeding.

*Horticulture*.—The Horticulturist visited Grey College, Bloemfontein, and gave advice on grafting, budding, and other matters *re* fruit trees. The vegetable garden promises well, and it is expected soon to furnish sufficient vegetables for both hostels. Lawns were laid down in front of the educational buildings, trees were sprayed for codling moth, and fruit was thinned out.

*Dairying*.—This division has suffered under a great handicap owing to the lack of facilities for demonstration and practice in dairying. When the new dairy building is completed better work will be accomplished. There are still six Friesian cows under test for the advanced registry.

---

#### GROOFFONTEIN, MIDDELBURG, CAPE.

---

*Climatic*.—The highest temperature recorded was 94° F. on the 21st. The weather was very changeable and frost was experienced on the 9th. The rainfall was .13 inch.

*Farm*.—During the month, in spite of the extreme changes of weather, the crops have made fair growth. About 60 acres of oats are now in full ear, and the latest sown oats are doing well. An area of about 75 acres of lucerne is almost ready to cut; the students started cutting the most advanced portion on the 25th. The veranda fencing round the first four jackal-proof camps has been completed.

*Experimental Section*.—The crops in this section are fairly well advanced considering the unseasonable weather. A few of the earlier varieties of wheats were slightly frost-bitten. The Chinese lucerne, which was cut on the 15th September, is now well advanced, but the second crop will be utilized for seed

owing to the great value of this variety due to its early spring and late autumn growth. A new spineless cactus nursery has been established, and the best varieties are being planted extensively in it. About 12,000 leaves were dispatched to farmers during the month, and a number of orders for special varieties could not be filled, but with the new nursery these varieties should be available to a greater extent next year.

*Cattle Section.*—The young cattle have improved in condition. Several of the calves from "Craigie All," the Friesland stud bull, are showing up remarkably well.

*Sheep Section.*—The special sheep and wool students are nearing the completion of their course. Practically all sheep have been shorn, and, on the whole, the sheep, and particularly the lambs, are looking well.

The eight hundred guinea ram imported for this institution from Australia arrived here safely and in good condition. It is hoped that this sire will be of great benefit to the Wanganello flock. With a thirteen months' growth he cut 33 lb. of strong bulky wool.

The lambing of the pure-bred Karakul ewes was completed during the month, and the result of the lambing is given below. Total number of lambs obtained, 88, made up as follows.—

Specials, 10; Class 1, 16; Class 1-2, 12; Class 2, 15; Class 2-3, 12; Class 3, 22; Class 4, 1.

There are still a few pure-bred Karakul rams for sale at prices varying from £5 to £19 each.

*Entomological Section.*—Baiting for the destruction of house flies has been commenced round all the stables and byres, and all the manure from these is being carted away daily. As hatchings of brown locusts have been reported from the Midlands, all farmers are advised to keep a sharp look out for hatchings on their farms and to notify the police of any which may be observed.

*Horticultural Section.*—Another busy month has been spent in the vegetable garden and orchard. The planting of vegetables has been conducted throughout the month, all of which are doing well. The chief work in the orchards has been the spraying for codling moth and the grafting of unprofitable fruit trees. Frost was experienced on the 9th and a considerable amount of damage was done to the fruit crop, particularly the trees in the private gardens. A new piece of ground has been cleared for an additional vegetable garden, and this will make it possible to grow sufficient vegetables for the school's requirements.

*Poultry Section.*—The Poultry Lecturer was absent from the institution for some days during the month assisting in the inspection of eggs for export at Capetown. The Assistant Lecturer, Mr. Nash, judged the Poultry Section at Beaufort West Industrial Show, and states that there were some exhibits of very good quality. One hundred chicks were hatched during the month.

---

#### POTCHEFSTROOM, TRANSVAAL.

---

*Climatic.*—The rainfall for the period 28th September to 28th October amounted to 3.26 inches, most of which fell on the first four days of October. During the middle of the month rather dry and extremely hot weather was experienced. The highest temperature was recorded on the 20th, when the thermometer registered 96.5 degrees. Temperatures of 95 and 94 degrees were registered on three days, in each case during the period under review. On the other hand frost was observed on the mornings of the 7th and 8th, the minimum temperature in the screen for the previous nights being 37.0° F. and 35.0° F. respectively.

*Farm Section.*—Forty acres of lucerne and 28 acres of oats were irrigated during the month. The supply of irrigation water has been good since the rains. At this station 100 acres of land have been ploughed and 30 acres cross-ploughed. At Brakspruit 18 acres of virgin land were broken up and 40 acres of ploughed land cultivated and planted to Red Cob Congo maize. A dressing of fertilizer, amounting to 200 lb. per acre, was applied broadcast to this crop. A clipping of lucerne was made on a field planted last May in order to remove the weeds before the latter came into seed.

*Live Stock.*—The rains have come in time to provide much needed grazing. All young stock, as well as the cows of the beef breeds, have been turned out to paddocks, and all feeding has been stopped, except in the case of certain imported breeds with calves at foot. These are still receiving a small amount of mangels daily. Cows calving this month did not cleanse well.

Three merino rams arrived here from Australia, one from each of the following estates: "Haddon Rig," "Canowie," and "Bundemar." These rams are intended for the various Schools of Agriculture, including this institution. The Wanganelia stud sheep are in excellent condition. The percentage of lambs in this flock, as well as the cross-bred Suffolk-Persian flock, amounts to 72 per cent. and 116 per cent. respectively. The former figure is lower than that of previous years on account of the somewhat late date at which the merinos were mated. This year these sheep will be mated from the beginning of November onwards, fully six weeks earlier than last year. Shearing is well under way.

*Experimental Section.*—The Experimentalist made several crosses of Black Don wheat. Rust in plants in the wheat variety plots has not been observed this year. Some rust has been noticed on the wheat plants in the Cape, however. Grains from 600 ears of maize were subjected to germination tests. The ears are intended for variety trials and single-ear test plots. Investigating the relation between the weight of ears and the germinating power of the grain has yielded no data in support of the general belief that heavy ears show a greater percentage of germination in the grain than light ears. The matter needs further investigation.

*Engineering Section.*—A paper on "Concrete" was written for the Irrigation Association and is to be read at the next Congress. Three tests were carried out with the gas engine using charcoal from different species of eucalyptus. The test consisted of a six-hours run with engine and producer. The horse-power and fuel consumption were measured, and in each case a sample of the gas drawn off and analysed.

*Horticultural Section.*—Spraying for codling moth has been continued. Up to the 6th the prospect of a good fruit crop was very rosy; strong winds set in, however, after this date, followed by the two frosts referred to, and this resulted in scores of stone fruits dropping from the trees, as also certain varieties of pears. The section to be planted next year has been pegged off and dynamited.

*Poultry Section.*—Stock birds are now run in a large camp and fed reduced rations to force an early moult. A number of the early hatched pullets have commenced to lay, so that there will be a good number of stock, chiefly White Wyandottes and Leghorns, for early disposal. The Egg-Laying Competition is still progressing favourably. During the seventh period of the test, viz., 16th September to 13th October, the average daily yield was 183 eggs for a total of 276 birds. This compares very favourably with previous periods, although the production has dropped off due to an increase in broodiness amongst heavy breeds.

The Chemist's time has been occupied in assembling the data of his work of the last eighteen months on Nitrification of Soils. A paper will soon be published on this work. Twenty-four soils were tested for their "lime requirements"; in addition, nine foodstuffs and five peanut varieties were analysed.

*School.*—The number of Diploma students enrolled to commence Part I of the Diploma course in January now amounts to twenty. Of this number nine are in residence already as practical students. Final examinations in the following subjects for the year 1920 have been held:—

Agricultural Law, Seniors; Zoology, Juniors; Book-keeping, Juniors.

Two more students were admitted to the One-Year Returned Soldiers' Course. Three one-year Returned Soldier students left to take up farming on their own account.

*Staff.*—The Lecturer in Poultry was absent in Capetown in connection with egg export duties. He returned to the Institution on the 23rd. The Superintendent of the R.S. Hostel, the Assistant Matron, and a lady clerical assistant were on leave during the month. The Farm Manager, Mr. A. C. Pigott, has been absent on leave in Ireland since the 16th June. He is expected back by the 1st December. The Institution has several vacancies on the technical as well as on the clerical staff.

## MEAT STATISTICS.

### I.—RETURN OF BEEF INSPECTED AND PASSED FOR EXPORT, OCTOBER, 1920.

Place.	Cattle.			Carcasses.		
	Inspected.	Rejected.	Passed.	Inspected.	Rejected.	Passed.
Durban ... ..	392	—	392	392	5½	386½
Pietermaritzburg ...	—	—	—	—	—	—
Pretoria ... ..	—	—	—	—	—	—
Johannesburg ... ..	—	—	—	—	—	—
Bloemfontein ... ..	—	—	—	—	—	—
Capetown ... ..	—	—	—	—	—	—
Port Elizabeth ... ..	—	—	—	—	—	—
Germiston ... ..	—	—	—	—	—	—
<b>TOTAL ... ..</b>	<b>392</b>	<b>—</b>	<b>392</b>	<b>392</b>	<b>5½</b>	<b>386½</b>

Beef actually exported during the month of October, 1920: Total, 2388 quarters (see Durban, 2388 quarters).

Total shipments of Beef in quarters—

1916 ...	115,992	1918 ...	123,354	*1920 ...	58,255
1917 ...	309,214	1919 ...	285,367		

II.—OTHER MEAT EXPORTED\*: Pork, carcasses inspected and passed, 7872.

### III.—RETURN OF CATTLE IMPORTED INTO THE UNION FROM ADJOINING TERRITORIES.

Territory.	Imported October, 1920.	Total from 1st January, 1920, to 31st October, 1920.
		No.
<b>For Slaughter—</b>	<b>No.</b>	<b>No.</b>
Rhodesia ... ..	1,798	22,731
Bechuanaland Protectorate	2,137	17,104
S.W. Africa	2,265	12,733
Swaziland ... ..	782	1,997
Basutoland ... ..	—	8
<b>For Breeding—</b>		
Rhodesia ... ..	353	9,921
Bechuanaland Protectorate	138	14,628
<b>TOTAL ... ..</b>	<b>7,473</b>	<b>78,122</b>

#### SUMMARY OF IMPORTS.

Calendar Year.	For Slaughter.	For Breeding.	Total.
	No.	No.	No.
†1916	26,580	—	26,580
1917	47,970	5,440	53,410
1918	36,767	13,386	50,053
1919	40,574	16,693	57,267

\* Total from 1st January to 31st October, 1920. † 1st July to 31st December only.



**STAFF : APPOINTMENTS, TRANSFERS, ETC.****(1) AGRICULTURE.**

1/10/20 *P. J. du Toit*: Under-Secretary for Agriculture, appointed Acting Secretary for Agriculture.

**(2) AGRICULTURAL EDUCATION.**

- 7/10/20 *Miss M. M. van Duyn*: Assumed duty at Pretoria as Lecturer and Demonstrator in Domestic Science.
- 15/10/20 *Miss R. Oosthuizen*: Assumed duty as Lecturer and Demonstrator in Domestic Science at Glen School of Agriculture.
- 15/10/20 *Gill, G. A.*: Assumed duty as Lecturer in Botany at the Grootfontein School of Agriculture. Mr. Gill was awarded a Government Bursary for study at Cambridge in 1914, and has just returned to South Africa. His studies were interrupted by three years' active service.

**MOVEMENTS OF OFFICERS.**

*Mr. E. Parish*, who has been visiting those farmers participating in the scheme for the determination of the cost of production of maize in the Transvaal, Orange Free State, and Natal, returned to Pretoria for the Principals' Conference on the 30th November. The object of the scheme is to determine, for representative farmers in the chief maize-growing areas, the economics of maize production. The work is being undertaken with the co-operation of the Maize Breeders' Association.

*Hartebeestpoort Training Farm*.—This farm is now being prepared for the admission of returned soldiers with phthisical tendencies. The present staff consists of:—

Superintendent, Mr. G. W. Edmunds; Horticulturist, Mr. D. J. Dreyer; Field Foreman, Mr. L. C. Gott; Matron, Mrs. L. G. Dodd.

Instruction will be given in poultry, horticulture, and other branches of agriculture suited to the needs of the students. This Department will be responsible for the administration and management generally.

**CROP AND LIVE STOCK REPORT.****October, 1920.****WHEAT, OATS, AND BARLEY.**

From the reports received it is estimated that the prospect of the Union's wheat crop is about 3 per cent. less than September owing to drought conditions prevailing in parts of the districts of Bredasdorp and Caledon, to rust in parts of Malmesbury, and green fly in Calvinia, the four principal wheat growing districts in the Union.

There is a slight decline in the Transvaal and an increase in the Orange Free State, which makes the condition of the wheat crop for the whole of the Union 8 per cent. below normal as shown by the following statement. Oats have shown an improvement over September, but barley has decreased slightly.



## DECIDUOUS FRUIT.

Crop Report Cards were issued to correspondents in the main deciduous fruit producing districts with a view to ascertaining the prospects of the earlier fruits, and the table hereunder shows the condition of these at the end of October, 1920. For the purposes of comparison, the term "very good" is regarded as representing 100 per cent., or a full yield; "good," 90 per cent.; "fair," 80 per cent.; "poor," 70 per cent.; "bad," 60 per cent. or less.

## APRICOTS.

<i>Good.</i>	Oudtshoorn, Prince Albert, Robertson, Middelburg (Transvaal).
<i>Fair.</i>	Caledon, Ceres, Piquetberg, Swellendam, Clanwilliam, Gordonia, Ladismith, Pretoria, Krugersdorp, Potchefstroom.
<i>Poor.</i>	Cape, Worcester, Riversdale, Montagu, Marico.
<i>Bad.</i>	Malmesbury, Paarl, Stellenbosch, Tulbagh, Van Rhyndorp, Heidelberg, Rustenburg.

## PEACHES.

<i>Very good.</i>	Oudtshoorn.
<i>Good.</i>	Caledon, Cape, Malmesbury, Swellendam, Clanwilliam, Ladismith, Prince Albert, Robertson, Pretoria, Middelburg (Transvaal).
<i>Fair.</i>	Ceres, Paarl, Stellenbosch, Tulbagh, Worcester, Gordonia, Riversdale, Heidelberg, Marico, Krugersdorp, Potchefstroom.
<i>Poor.</i>	Piquetberg, Rustenburg.
<i>Bad.</i>	Van Rhyndorp.

## CONDITION OF LIVE STOCK.

Compiled from Reports furnished by Sheep and Stock Inspectors.

Area.	Large Stock.	Small Stock.
<b>CAPE—</b>		
South-West ... ..	<i>Good to medium</i> ... ..	<i>Good to medium.</i>
North-West ... ..	<i>Good to medium</i> ... ..	<i>Good to medium.</i>
South Coast ... ..	<i>Good to medium</i> ... ..	<i>Good to medium.</i>
Southern Karroo ... ..	<i>Good</i> ... ..	<i>Good.</i>
Central Karroo... ..	<i>Medium.</i> Good in parts ... ..	<i>Medium.</i> Good in parts.
Northern Karroo ... ..	<i>Good to medium</i> ... ..	<i>Good to medium.</i>
Eastern Karroo ... ..	<i>Medium.</i> Good in parts ... ..	<i>Medium.</i> Good in parts.
Bechuanaland ... ..	<i>Good to medium.</i> Fat in parts ... ..	<i>Good to medium.</i> Fat in parts.
Griqualand West ... ..	<i>Good</i> ... ..	<i>Good.</i>
North-Eastern ... ..	<i>Medium.</i> Good in parts ... ..	<i>Medium.</i> Good in parts.
Border ... ..	<i>Medium</i> ... ..	<i>Medium.</i>
Transkeian Territories... ..	<i>Medium.</i> Poor in parts ... ..	<i>Medium.</i> Poor in parts.
<b>TRANSVAAL—</b>		
Eastern High Veld ... ..	<i>Medium.</i> Good in parts ... ..	<i>Medium.</i> Good in parts.
Central ... ..	<i>Medium.</i> Good in parts ... ..	<i>Medium.</i> Good in parts.
Western High Veld ... ..	<i>Medium.</i> Good in parts ... ..	<i>Medium.</i> Good in parts.
Low Veld ... ..	<i>Good to medium</i> ... ..	<i>Good to medium.</i>
<b>ORANGE FREE STATE</b>		
North-Eastern ... ..	<i>Medium.</i> Good in parts ... ..	<i>Medium.</i> Good in parts.
North-Western... ..	<i>Good</i> ... ..	<i>Good.</i>
South-Eastern ... ..	<i>Good to medium</i> ... ..	<i>Good to medium.</i>
South-Western... ..	<i>Medium.</i> Good in parts ... ..	<i>Medium.</i> Good in parts.
<b>NATAL—</b>		
High Veld or Highlands	<i>Medium.</i> Good in parts ... ..	<i>Medium.</i> Good in parts.
Middle Veld or Midlands	<i>Medium.</i> Good in parts ... ..	<i>Medium.</i> Good in parts.
Coast ... ..	<i>Good to medium</i> ... ..	<i>Good to medium.</i>



## THE LOCAL MARKET.

October, 1920.

(NOTE.—The local market prices of certain other agricultural produce and stock are published elsewhere in this issue.)

### WOOL.

Since the issue of the previous report the market has remained inactive, and very little business has been done. In view of the threatened coal strike buyers were holding back awaiting developments, and until the industrial difficulties in England have been settled it is not expected that business of any importance will be done. To what extent the market will recover is impossible to predict. There is at present a great surplus of wool on hand, and until this surplus has been used up it is feared there will be no appreciable improvement in prices.

At the various Union ports there are at present approximately 122,000 bales unsold wool of last season's clip, consisting of about 10 per cent. super combing, 60 per cent. medium, and 30 per cent. short wools. As there does not seem to be any prospect of these being disposed of at present, farmers are advised to store their wool up country so as to avoid heavy storage charges at the ports. The forwarding of large quantities of wool to the ports at the present time may also tend to further reduce the prices.

Cable advices from England state that at the latest wool sales held at Hull there was a further decline of 5 per cent. for average combing wool as compared with the previous London sales.

In view of the very depressed and unsettled state of the market, and almost complete absence of orders from overseas markets, it is quite impossible to quote ruling prices for the various types of wool at the ports.

### MOHAIR.

The market in mohair is lifeless, and there has been no inquiry for this commodity of late. Reports from London state that the position in regard to all classes of mohair remains very unsatisfactory, and still lower prices are expected. The mohair markets of England and America are dead, and it is difficult to effect sales. There is no demand for yarn; in many instances orders have been cancelled, and as a consequence the mills in Yorkshire are working short hours. It is, therefore, impossible to give reliable quotations for mohair.

### HIDES AND SKINS.

The market for all descriptions remains very quiet, buyers displaying no interest whatsoever, and prices show a decline of about 25 per cent., with a downward tendency. The following prices have lately been obtained:—

#### SKINS.

Sound long-woolled sheepskins ... 7d.		Coarse and coloured, damaged ... 1½d.
Damaged long-woolled sheepskins ... 3½d.		Transkeis, excluding pelts ... 3½d.
Sound short-woolled sheepskins ... 3½d.		Goatskins ... .. 15d.
Damaged short-woolled sheepskins ... 1½d.		Bastards ... .. 11d.
Sound pelts ... .. 2½d.		Angora skins ... .. 7d.
Damaged pelts ... .. 1d.		Damaged goats and bastards, each ... 10d.
Coarse and coloured, sound ... 3½d.		Damaged angoras ... .. 6d.

#### HIDES.

Sun-dried, sound ... .. 11d.		Dry-salted, sound ... .. 11d.
Sun-dried, damaged ... .. 7d.		Dry-salted, damaged ... .. 7d.

## GOVERNMENT WOOL PURCHASE SCHEME.

The Central Wool Committee has issued a statement to the effect that an interim dividend of £250,706 has been received from the Imperial Government, being the Union of South Africa's share in the profit on wool sold under the Government Wool Purchase Scheme. As the final dividend will probably be declared in December, it has been decided to defer payment of profits to participants in the scheme until the final amount is received in order to avoid a double payment, provided the final dividend is received before the end of December. In the meantime the above amount bears interest at the rate of 5 per cent. per annum. Participants in the scheme will receive their pro rata share of profits, calculated on the appraised value of their wool delivered under the scheme. Cheques for the amount due will be made out in their favour by the Central Wool Committee and forwarded to them through the respective brokers who were appointed Government Agents under the scheme. The brokers should, therefore, be notified without delay of any change of address in order to avoid delay in payment.

## OSTRICH FEATHERS.

During the period under review, five public sales of ostrich feathers were held in Port Elizabeth, viz., 27th September, 5th, 11th, 18th, and 25th October. Weights sold and the prices obtained were as follows: 23,693 lb. sold, value £35,131; 6022 lb. withdrawn, value £9209. During the five sales mentioned above, one buyer took the major portion of the offerings. Speculators did not operate so freely as was the case the previous month.

With regard to the prices obtained during the above sales, there has been very little change to note. For the period covered by the first three sales prices remained more or less steady, although the fact that one buyer was the principal operator caused a certain amount of irregularity and lack of competition. At the last two sales, prices for superior quality feathers were more or less unchanged, whilst prices for medium and common grades were decidedly weaker.

The coal strike in England appeared to unsettle matters considerably, more especially as competition was not as general as it should have been.

The present unsatisfactory condition of foreign exchange rates, makes it very difficult to forecast even the near future, but advices from overseas state that there is a very great demand at present for ostrich feathers, and if the factors mentioned above could be remedied the trade would probably again flourish as it did in 1913.

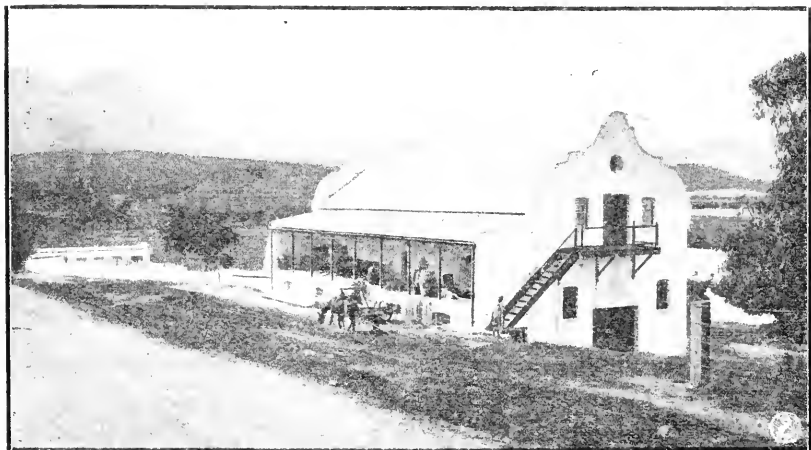

WINE CELLAR.

2332  
25







New York Botanical Garden Library



3 5185 00265 1923

28

